

ELECTRONICS

Australia

HiFi, Radio & Computers

MARCH 1980

AUST \$1.40* NZ \$1.50

◀ Digital Capacitance Meter To Build
CompuColor II Computer Review ▶



- Auto-Switch for Hifi Systems
- How to Build A Crystal Set
- Super Flywheel Stores Energy

**SPECIAL
OFFER**
TI Software
See p9

UNIQUE.

Philips Motional Feedback Speakers.

Every now and then a technical breakthrough is achieved and a unique product emerges to set a new standard in its field.

Such is the case with Philips Motional Feedback Speakers.

These electronic masterpieces have been developed after years of exacting research in our European Laboratories and, as a result, we've created a speaker system that comes very close to the ultimate in Hi-Fi reproduction.

Technically speaking, the system incorporates a piezo-electric crystal built into the woofer cone that monitors and converts the acceleration of the cone into an electric signal. The acceleration of the cone is linearly translated back to the original signal driving the loud-speaker. This signal is fed back to a comparator circuit in the amplifier incorporated in the enclosure and compared with the original signal. This enables the loud-speaker to be immediately corrected at the slightest deviation. And, in this way, the acoustic behaviour of the woofer can be completely controlled.

Each speaker contains 3 integrated power amplifiers — a 50W amplifier for bass output, 20W amplifier for mid-range and a 5W amplifier for treble — providing a total power output of 75W. And low-note filters are incorporated in each speaker enclosure for matching the bass response to the location of the box near walls and floor.

Practically speaking, the results are dramatically simple. A drastic reduction in distortion. Flawless clarity — from the fullest bass notes to the most detailed treble extremes. And a remarkable compactness in enclosure and speaker construction.

Listen to Philips Motional Feedback Speakers. They'll speak for themselves.

Technical specifications: Model AH 5875

Type of enclosure:	Motional Feed Back box with three amplifiers
Internal volume:	19 litres
Total power of amplifiers:	75W cont. sine wave power
Loudspeakers:	AD81671/MFB4, 8" woofer AD21160/ST 8.15 combi dome squawker/tweeter
Cross-over frequencies:	650 Hz and 3500 Hz
Frequency characteristic:	27-20,000 Hz
Input sensitivity:	variable; impedance up to 3V: 100 kohm above 3V: 1 kohm switchable

Low-note filters:

Amplifier for woofer

Output power: 50W cont. sine wave power

Amplifier for squawker

Output power: 20W cont. sine wave power

Amplifier for tweeter

Output power: 5W cont. sine wave power

Also available Model AH585

Output power: 35W cont. sine wave power

Subject to modification without notice

Philips Motional Feedback Speakers. A step closer to sound perfection.

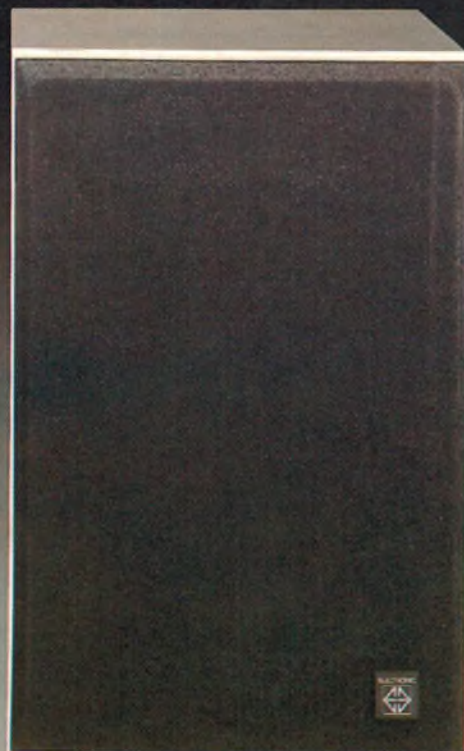

PHILIPS

367 2217

We want you
to have the best



ELECTRONICS

Australia

Volume 41 No. 12 March, 1980
Australia's largest selling electronics magazine

Hifi Auto-Switch

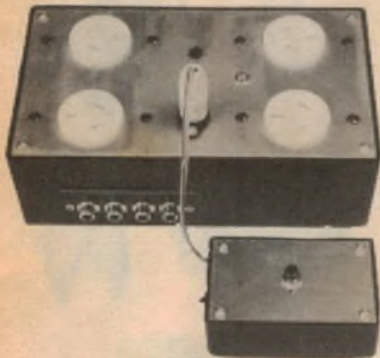

This easy-to-build electronic device cleans up messy power cords and automatically switches your hifi system off at the conclusion of a record or tape. Full details on p44.

Dick Smith catalog

NEXT MONTH's issue will be distributed through newsagents in a sealed plastic bag, containing a big 104-page "1980 New Decade" catalog from Dick Smith Electronics. Inside the catalog are all the latest products, kits, components and sound gear, plus a completely updated data section. And in the issue:

- * LCD digital clock/timer to build
- * An audio prescaler for improved DFM performance
- * A review of the Nakamichi 680 cassette deck and High Com II noise reduction system

On the cover

The colour graphics capability of the Compucolor II personal computer is dramatically illustrated by this photograph of its close relative, the Intecolor II. A full review of the Compucolor II starts on p74. At top, left is our new digital capacitance meter. It's easy to build, has a 4-digit LED readout, and measures from 1pF-99.99uF. Details on p50.

FEATURES

BASEMENT FLYWHEEL <i>Stores solar energy at 15,000rpm</i>	10
MAGNETIC BUBBLE MEMORY DEVICES <i>High density, non volatile data storage</i>	14
THE CENTENARY OF THE ELECTRIC LIGHT <i>Was Edison its true inventor?</i>	22
SECOND THOUGHTS ON ALIEN INTELLIGENCE <i>Or are they communicating?</i>	42
INDEX TO VOLUME 41 — APRIL 1979 TO MARCH 1980	104

HIFI TOPICS AND REVIEWS

3DA — WHAT THE TERM SIGNIFIES <i>Displaying amplifier parameters</i>	26
MEASURING HEAD WEAR IN CASSETTE DECKS <i>A novel method from B & O</i>	28
HIFI REVIEW <i>Philips AH587 motional feedback loudspeaker system</i>	35

PROJECTS AND CIRCUITS

HIFI AUTO-SWITCH <i>Turns your system off automatically</i>	44
DIGITAL CAPACITANCE METER <i>Easy to build, measures 1pF-99.99uF</i>	50
BUILD AN RF PREAMP FROM A KIT <i>For the HF and VHF/UHF bands</i>	57
LET'S TALK ABOUT CRYSTAL SETS <i>Special project for beginners</i>	68
A SIMPLE LIE DETECTOR <i>Use it to liven up a dull party</i>	72

MICROCOMPUTERS

THE COMPUCOLOR II PERSONAL COMPUTER <i>3-page in-depth review</i>	74
MICROCOMPUTER NEWS & PRODUCTS <i>Printers, modules, computers</i>	78
MOTOROLA 6802D3 EVALUATION KIT <i>Features hex keyboard, LED readout</i>	86
A/D CONVERTERS: WHAT YOU NEED TO KNOW <i>What they are, how they work</i>	91

AMATEUR RADIO, CB SCENE, DX

AMATEUR RADIO <i>WICEN active during bushfire emergencies</i>	109
CB SCENE <i>Government policy on 27MHz remains unchanged</i>	113
SHORTWAVE SCENE <i>Major increase in frequency allocations</i>	114

COLUMNS

FORUM <i>Further thoughts on current flow</i>	38
THE SERVICEMAN <i>As Aesop said: "a rash friend is worse than a foe"</i>	62
RECORD REVIEWS <i>Classical, popular and special interest</i>	98

DEPARTMENTS

EDITORIAL 3 — NEWS HIGHLIGHTS 4 — CIRCUIT & DESIGN IDEAS 66 —	
LETTERS TO THE EDITOR 106 — NEW PRODUCTS 116 — BOOKS & LITERATURE	
122 — INFORMATION CENTRE 124 — MARKETPLACE 126 — NOTES & ERRATA	
125	

SOANAR

NOW! YOUR MOST RELIABLE SOURCE FOR RESISTORS

Fixed

Carbon Film
Metal Film
Flame Proof
Power
Wire Wound

Potentiometers

Slide
Rotary
Trim
Cermet
Switched
Ganged

Rheostats

Wire Wound
Metal Glaze

Readily Available
Throughout Australia.



Technical Information available on request.

SOANAR

SOANAR ELECTRONICS PTY. LTD.

A MEMBER OF THE A+R-SOANAR ELECTRONICS GROUP
30 Lexton Road, Box Hill, Vic., 3128, Australia. Telex 32286.

VICTORIA: 89 0661
N.S.W.: 789 6733
Sth. AUSTR.: 51 6981
QUEENSLAND: 52 5421
WEST AUSTR.: 381 9522



Editorial Viewpoint

Technology isn't everything

EDITOR-IN-CHIEF

Neville Williams
M.I.R.E.E. (Aust.) (VK2XV)

TECHNICAL EDITOR

Leo Simpson

ASSISTANT EDITOR

Greg Swain, B.Sc. (Hons. Sydney)

TECHNICAL PROJECTS

Ron de Jong, B.E. (Hons. NSW), B.Sc.
Ian Pogson (VK2AZN/T)
John Clarke
Gerald Cohn

GRAPHICS

Robert Flynn

PRODUCTION

Danny Hooper

ADVERTISING MANAGER

Selwyn Sayers

CIRCULATION MANAGER

Alan Parker

At about this time, students at Universities and Colleges of Advanced Education around Australia will be enrolling or re-enrolling for the 1980 academic year. It is to these students I write, as they review their course requirements and decide upon their subjects for study. In particular, I have in mind students of engineering and other courses involving high technology, who have a limited opportunity to take Humanities' subjects as electives.

In the past, students in this situation have tended to spurn Humanities' subjects as electives in favour of specialised subjects in their field of endeavour. I feel this to be a mistake, for two reasons:

First, by their very nature, specialised subjects in most fields of endeavour are soon outdated by rapidly advancing technology. This is in contrast to the more broadly based fundamental subjects — basic principles do not change.

Second, and more importantly, a rejected opportunity to study Humanities' subjects is a lost chance to acquire a vital part of a technical education — a human-oriented overview of technology and its effects. The engineer who has studied politics, history and philosophy, even if only briefly, must ultimately be the better judge of how his work will impinge on society at large.

This theme has been taken further by the School of Humanities at the New South Wales Institute of Technology. There, the curriculum for the Business Studies degree course includes a subject called "Technology and Society". This subject is concerned with the social consequences of advancing technology and the challenge that it poses to social structures, institutions and value systems. Topics considered include computers and their impact on privacy of the individual, and some of the difficult moral dilemmas raised by modern medicine.

The purpose of a study such as this is not to present solutions but to acquaint the student with some of the problems of rapid technological change. The current troubles in Iran, for example, largely represent a violent rejection of rapid change; the Shah may have been a despot but much of the reaction was against his attempt to bring a medieval society into the 20th century within the space of a few decades.

Engineers and technologists of tomorrow should not only be aware of the technical aspects of their chosen field but also be alive to the social problems caused by advancing technology. The study of the Humanities can help promote this perspective.

— Leo Simpson

Registered for posting as a publication — Category B.

Printed by Magazine Printers Pty Ltd, of Regent Street, Sydney and Masterprint Pty Ltd of Dubbo, NSW, for Sungravure Pty Ltd, of Regent St, Sydney.

Editorial Office

57 Regent St, Sydney 2008.
Phone (02) 699 3622 Telex 25027
Postal Address: PO Box 163, Beaconsfield 2014

Advertising Offices

Sydney — 57 Regent St, Sydney 2008.
Phone (02) 699 3622 Telex 25027
Representative: Narciso Pimentel.

Melbourne — 392 Little Collins St, Melbourne 3000. Phone (03) 602 3033
Representative: Keith Watts

Adelaide — Charles F Brown & Associates Ltd, 254 Melbourne St, North Adelaide 5006
Representative: Sandy Shaw, (08) 267 4433.
Perth — 454 Murray Street, Perth 6000
Representative: Ashley Croft (09) 21 8217

Subscriptions

Subscription Dept, John Fairfax & Sons Ltd, GPO Box 506, Sydney 2001
Enquiries: Phone (02) 20944, ext 2589.

Circulation Office

21 Morley Ave, Rosebery, Sydney 2018
Phone (02) 663 3911.

Distribution

Distributed in NSW by Sungravure Pty Ltd, 57 Regent St, Sydney; in Victoria by Sungravure Pty Ltd, 392 Little Collins Street, Melbourne; in South Australia by Sungravure Pty Ltd, 101-105 Weymouth St, Adelaide; in Western Australia by

Sungravure Pty Ltd, 454 Murray Street, Perth; in Queensland by Gordon and Gotch (A'asia) Ltd; in Tasmania by Ingle Distributors, 93 Macquarie St, Hobart; in New Zealand by Gordon and Gotch (NZ) Ltd, Adelaide Rd, Wellington.

Copyright. All rights reserved

Devices or arrangements shown or described herein may embody patents. Information is furnished without responsibility for its use and without prejudice for patent rights. All manuscripts, photographs and other material submitted to Electronics Australia for publication must be accompanied by a stamped, addressed envelope. Contributions are submitted at the sender's risk, and responsibility for loss cannot be accepted by Electronics Australia

*Recommended and maximum price only.

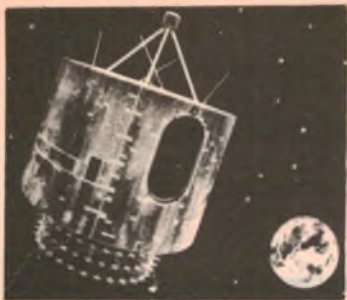

News Highlights

British & French agree on viewdata standards

A compromise international technical standard embracing both British and French viewdata systems has removed a major impediment to the introduction of viewdata to Australia.

by Ian Reinecke,
Australian Financial Review

Both systems use telephone lines to connect a central computer to modified television sets equipped with hand-held keypads, allowing users to call up stored information.

The British system, Prestel, has the front running for introduction to Australia, but any decision to introduce viewdata here had been postponed by Telecom until international standards were agreed upon.

A meeting of a viewdata technical standards group in the Netherlands, held last December, has provided a draft standard which includes both Prestel and the French Teletel system, also known under the name of Antiope.

The significant advantage given to Prestel by agreement of the standard is that it comes on the eve of an international market trial of the British system involving seven countries: Britain, Australia, the US, West Germany, Holland, Switzerland and Belgium.

A working party of the Consultative Committee of International Telecommunications, the CCITT, meeting in the Netherlands, also recognised the Canadian system Telidon as technically dissimilar to French and British systems. It will be covered by a separate standard.

If Australia opts for Prestel, it will be compatible with the French system, with the Swedish-developed viewdata which has been developed independently, and with the other six countries involved in the international market trial.

An interface with Telidon would be possible but technically difficult, which suggests that system has a better chance of acceptance as second-generation technology, while compatibility problems with the Japanese are massive and impractical.

TI releases speech synthesiser

A speech synthesiser module, designed to serve a wide range of industrial commercial applications, has been released by Texas Instruments. Designated the TM/990/306, it provides verbal instructions or signalling as a more effective means of communication than indicator lights or audible alarms.

The TM990/306 module uses the same basic speech technology as the "Speak and Spell" talking spelling aid and offers a basic industrial vocabulary of over 160 words.

Soviet technology surprises Americans

Soviet electronics technology is giving US defence planners a few surprises. A new tactical shoot-down radar system tested in the US was found to be superior to anything the Americans have in the air. A recent report also said that Soviet missile guidance systems are now on par with US systems and that Russia is spending a billion dollars a year on laser research.

Wristwatch security alarm for the elderly

A new fail-safe security system for elderly or partially handicapped people has been developed in Britain and incorporated into a wristwatch. This scarcely perceptible personal alarm will always tell the time — but in an emergency, when a wall-mounted alarm may be out of reach, it could save a life.

Using silicon chip technology, the watch has a battery powered transmitter built into the casing. In the event of a fall, health crisis or the suspicion of intruders, the retractable aerial can be extended and the alarm raised in a few seconds. A signal is sent from the watch to a receiver, prominently mounted in a window, a neighbour's house or a warden's flat. The receiver will emit a strident, intermittent klaxon-type warning. At the same time the red light on top of the receiver casing will flash on and off and both signals will

continue until cancelled at the receiver.

The wristwatch weighs only 60 grams and has a sweep second hand and an easily-readable face. The normal set and wind knob is at the side of the casing between the alarm button and a red indicator light which illuminates when the alarm button is depressed and goes out only when the signal has activated the alarm. Transmission range can be in excess of 100 metres, a special coding system eliminating interference on the 27.45MHz operating frequency.

The watch is mainly intended for elderly and infirm people, but can also be an effective safeguard for personnel working alone or in hazardous conditions.

For further information contact Emerald Electronics Ltd, Willowburn Industrial Estate, Alnwick, Northumberland, NE66 2PQ, England.



The miniature transmitter is activated at the touch of a button.

One-board Teletext decoder uses LSI chip set

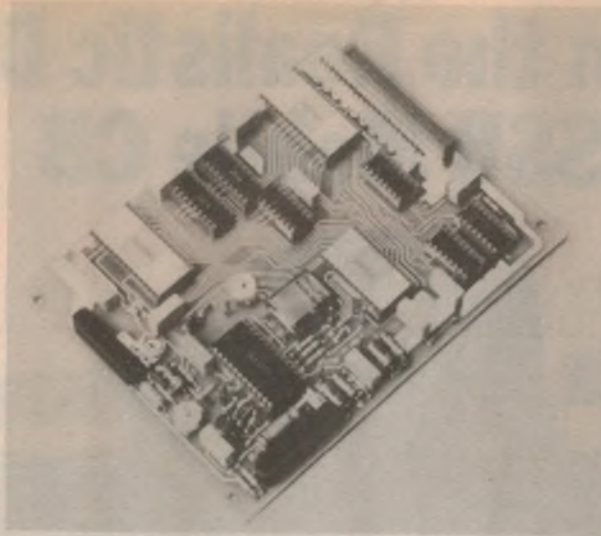

Developed by the Philips company, this one-board Teletext decoder is comprised of four dedicated LSI circuits, two 1k x 4 static RAMs and four low-power Schottky TTL ICs. The dedicated LSI circuits are: SAA5020 timing chain, SAA5030 video processor, one of the SAA5040 series of acquisition and control circuits (SAA5043 for Aust. TV), and one of the SAA5050 series of character generators. Further details from Philips Electronic Components and Materials, 67 Mars Rd, Lane Cove 2066.

Micro-controlled device will aid lip reading

A microprocessor-controlled device that can analyse and display spoken words symbolically for deaf people is under development in the US. The device, called an "Autocuer" will display only the tricky "look-alike" sounds that frustrate the lip-reader, says Robert L. Beadles, project director for the Research Triangle Institute, Research Triangle Park, North Carolina.

In operation, the device will project the sounds as nine simple visual symbols, or cues, in front of the deaf person's face so that they can be read. Prototypes based on Data General minicomputers and using symbols formed from two 7-segment LED readouts have improved syllable identification to an accuracy of 75%, compared with 25% for a trained lip-reader.

Research is now under way to miniaturise the device so that it could fit into a pair of glasses. Preliminary cost estimates for a mass-produced Autocuer are around the \$1000 mark.

New IBM circuits are world's smallest

Scientists at the IBM Thomas J. Watson Research Center in the US have fabricated and tested the smallest electronic circuit elements ever reported. The devices, called nanobridges, are thin-film stripes of superconducting niobium metal only 40nm wide and 30nm thick — almost 1/100th the size of circuit elements found in existing microcircuits!

The new devices developed by IBM are based on the Josephson switching effect, and can operate as switches in computer logic at speeds 10 times faster than anything previously tried. External magnetic fields can turn the devices on or off in less than 10 picoseconds!

Also, the amount of heat generated

in them is extremely small, making it possible to pack them to high density, further increasing operating speed. These factors point to the possibility of constructing very high speed, very compact, powerful semiconductor microcircuits.

A hypothetical large-scale Josephson computer based on existing technology would fit into a box half the size of a basketball, which itself would be placed in a larger cryostat, or refrigerator. It would execute 20 times more instructions per second than IBM's existing large mainframes, would have 3 times as much memory, and would dissipate only 7 watts of power. The helium refrigerator would require about 15 kilowatts of power. In contrast, today's big machines dissipate as much as 20 kilowatts.

Unique DC/AC inverter is 93% efficient

Household power from the Sun may be a step closer with the development of an exceptionally efficient DC to AC power inverter by LEP, a research laboratory in France which is part of the Philips group. The inverter achieves an efficiency of over 93% which is not all that unusual; what is unique about the system is that it is over 90% efficient at very low outputs.

The system uses no transformers. Instead, it switches a bank of batteries into the load in sequence, under electronic control, thus avoiding transformer losses which plague existing systems at lower loads.

Colour TV set displays four pictures

New from Toshiba is a 63cm colour TV set that can display four 30cm colour pictures on its screen simultaneously. The set, slated for US release later this year, also features a built-in "frame-grabber" to freeze any picture on command from a remote-control unit.

Another Toshiba TV set, also scheduled for US release this year, combines voice activation and speech synthesis. It can be programmed to accept verbal commands from two people and can be ordered to switch on, change channels, adjust volume etc. The set itself has a two-word vocabulary. When a command is accepted a female voice replies "OK"; when the command is not understood it says "repeat".

Go micro — go bust if you don't

The application of microprocessors in British industry should increase by about 60% during 1980 compared to 1979, according to American semiconductor manufacturer Motorola. This would make the UK Europe's biggest user of microprocessors and contradicts surveys from Britain's Department of Industry which paints a gloomy picture of microprocessor use among firms.

Motorola's research has indicated that there will be strong growth in the use of microprocessors in industrial equipment.

Meanwhile, a report released by

Britain's National Computing Centre says that Britain has "no choice but to go forward with microelectronics technology or go out of business." According to the report, microelectronics will ultimately affect the whole manufacturing process and not only the boring and repetitive work will be at risk — many skilled and semi-skilled industrial jobs will also be lost.

The report also saw an acute need for retraining in the near future and said that the move from the traditional manufacturing industries into the service industries would continue.

Save \$70 on the Realistic Deluxe AM/SSB Mobile CB



**SAVE
\$70**

REALISTIC®

199⁹⁵
Regular Retail Price 269.95

- 18 Am & 36 SSB Channels
- Noise Blanker
- LED Dimmer Control
- R.F. Gain Control
- 5 watt PA facility with CB monitor

Unbelievable savings on the Realistic TRC-450. In town or on the road, you'll find SSB's greater range and cleaner signals really make a difference! Goes way beyond AM-only rigs. Dual IF stages and crystal/ceramic filters provide superb freedom from adjacent channel interference. Switchable blanker and ANL cuts impulse noise. Reliable quartz PLL circuitry. LED AM/USB/LSB mode indicators. With adjustable mobile mounting bracket, dynamic mike and power cord. The saving on this rig is certainly a big 10-4. 21-9450

Specifications

Sensitivity: (For 10 dB S + N/N) AM, 0.5 microvolt;SSB, 0.25 microvolt. **Adjacent Channel Selectivity at 10 kHz:** -65 dB. **Image Rejection:** 80 dB. **RF Output:** 12W P.E.P. SSB max. , 4W AM max. **Power Requirement:** 12VDC pos. or neg. gnd. **Size:** 6.3x18.4x22.8cm

Sale Ends March 29th, 1980

**TANDY
ELECTRONICS**

An extensive range of products is available to you at Tandy Electronics. Over 200 stores across Australia

Independent Tandy Electronics dealers may no be participating in this advertisement

NEWS HIGHLIGHTS

Microwave ovens pose problems for British radio astronomers

According to a recent report in the British magazine "New Scientist", Britain's radio astronomers have complained that microwave ovens can interfere with their measurements, and possibly with radio services.

Most of the complaints have come from Jodrell Bank, home of the University of Manchester's radio astronomy laboratories. Researchers there have calculated that a microwave oven at a distance of 1km will raise background noise by a factor of 12 in a radio

telescope observing at 1.4GHz. And, says the Jodrell Bank team, a telescope tracking an object in deep space will be affected by any microwave oven within 25km!

Suggestions that the rules governing radiation from ovens should be made tighter have met stiff opposition from manufacturers, one industry spokesman even suggesting that "society must choose between microwave ovens and the requirements of radio astronomers."



Guidance system for blind athletes

For blind people the thought of taking part in a sprint race is probably remote, but with the aid of a new British electronic guidance system, Graham Salmon, the world champion sightless sprinter has shown that it can be done.

The inexpensive, completely portable system is based on a single channel transmitter similar to those used to guide model aircraft and boats. It emits a high or low pitched "bleep" which is picked up in the earpiece worn by the athlete. A low signal means "go left" and a high signal means "go right". The technique can be mastered by untrained people in only a few minutes.

Further information from Research Into Child Blindness, 9 Drysdale St, London N1, England.

Canada has plenty of oil, but . . .

The world's energy problem is not that we are running out of oil according to the National Research Council of Canada. Apparently, there is more untapped oil in the Canadian tar sands than in all the Middle East, but the cost of getting it out of the ground is soaring.

Ten years ago, it cost about \$200 to find and tap a unit flow of oil of one barrel per day in the Middle East. That figure jumped to about \$10,000 for the North Sea, while the pilot plant at the tar sands in Alberta (Canada) cost \$16,000 per barrel-a-day unit. Getting a flow of oil of one barrel per day from the ocean floor off Labrador is projected to cost at least \$20,000!

As for the future, the NRC says we will be forced to conserve oil for its one indispensable use — powering automobile engines.

Britain to go ahead with nuclear program

Following a decade of uncertainty, Britain has decided to cautiously go ahead with its nuclear power program. According to a statement in the House of Commons by the Secretary of State for Energy, Mr David Howell, there must be continuing nuclear power station orders if the country's long-term energy supplies are to be secured.

But, says Mr Howell, the British Government attaches an "overriding importance to the safety of nuclear

power and will want to ensure that the lessons at the Three Mile Island Station in the United States have been learnt." Initial plans call for the construction of two advanced gas-cooled reactors and one pressurised water reactor.

The precise level of future ordering will depend upon developments in electricity demand, the latest projections suggesting an order for at least one new nuclear station a year in the decade from 1982.

Business Briefs:

The **IREE Microprocessor Group** has advised that Support Product Managers from Intel will give a talk on the 8086 microprocessor family in Sydney on March 18. The venue is the School of Electrical Engineering, University of Sydney at 6.30pm. For further information, contact Steve Wolkowicz on (02) 648 1711.

Plessey Australia Pty Ltd has expanded the systems activity of its Telecommunications Division at Meadowbank and is now marketing a wide range of communication and control systems in Australia. The division can supply project design, engineering, management and co-ordination. The projects handled will range from complex computer-based remote control and monitoring systems to VHF/UHF radio links for multi-station control networks.

Warburton Frankl has advised that as from 1st January, 1980, their Chatswood factory adopted the new trading name "Warburton Frankl Energy Controls." The purpose of the name change is to allow easier identification of the type of business conducted by this manufacturing division of the Warburton Frankl Group. The company address and telephone and telex numbers remain unchanged.

National Panasonic (Australia) Pty. Limited are moving their Sydney Head Office to North Ryde in March, 1980. The new address is 95-99 Epping Road, North Ryde, 2113. Telephone (02) 888 1188.

Vicom International Pty Ltd has announced the appointment of Mr Laurie Wade as Branch Manager, New South Wales operations. Mr Wade, a chartered electronic engineer, is well known in the Australian electronics industry and brings with him many years of experience in the communications and test equipment fields. Vicom's NSW address is 339 Pacific Hwy, Crows Nest, telephone (02) 436 2766.



SOFTWARE

ACCOUNTING PACKAGES

DEBTORS	\$330.00	GENERAL	
CREDITORS	\$330.00	LEDGER	\$330.00
DIRECT		PAYROLL	\$500.00
MAIL	\$500.00	STOCK/ INVOICE	\$500.00

Packages are written in C BASIC II in Australia. Source is available (P.O.A.). Packages supplied on 8" or 5 1/4" disk and need 80 x 24 serial terminal, 48K RAM, 2 x 240K (MIN) capacity disk drives, 132 column printer.

CUSTOMISING AVAILABLE.

OPERATING SYSTEMS

CP/M VERSION 1.4	\$145.00
CP/M VERSION 2.0	\$175.00
(suitable for HARD DISK)	
MPM VERSION 1.0	\$305.00
(CP/M 2.0 extended for MULTI-USER)	
CPM374X (transfer between IBM 3741 data sets and CP/M files)	\$200.00

LANGUAGES

C-Basic II (Semi Compiler)	\$110.00
BASIC-80 (Microsoft Disk Extended Basic)	\$305.00
BASIC COMPILER (down to HEX!)	\$355.00
FORTRAN-80	\$405.00
COBOL-80	\$630.00
CIS-COBOL (includes full ISAM)	\$860.00
PASCAL/Z (includes VARIANTS)	\$400.00
APL/Z80	\$393.00
ALGOL-60	\$205.00
Full ISAM file utilities are available plus good CARTING PACKAGES.	

ASSEMBLERS

MAC (by DIGITAL RESEARCH)	\$ 95.00
SID (Symbolic Debugger 8080 code)	\$ 85.00
ZSID (as per SID but Z80)	\$105.00
MACRO-80 (by MICROSOFT)	\$155.00
XMACRO 86 (8086 cross compiler)	\$300.00
Z80 CROMEMCO relocatable assembler	\$130.00
Z80 Development Package	\$103.00
ZDT (Z80 debugger)	\$ 55.00
DISTEL, DISILOG (disassemblers)	\$ 70.00

EDITORS/WORD PROCESSORS

WORDSTAR (for SERIAL TERMINALS)	\$445.00
WORDMASTER	\$130.00
POLYVUE 80 (full screen editor)	\$140.00
POLYTEXT/80 (text formatter)	\$ 90.00
POSTMASTER	\$150.00
TEXTWRITER III	\$130.00

UTILITIES

SAVER (Reconstitutes files erased by the CP/M command ERA. Display/Alter information on disk sector by sector independantly of file structure!)

WE HAVE MUCH MORE SOFTWARE (INCLUDING COMPREHENSIVE 3D GRAPHICS) AND IT IS ALL DESCRIBED IN OUR COMPREHENSIVE CATALOGUE.

HARDWARE

POWER CONTROLLER MODEL A \$460.00

Controls 6 channels 240 volts x 1.5A, 2 channels 24 volts DC x 3 amps. Requires a computer with an 8 bit latched parallel port.

16K STATIC RAM BOARD \$400.00

Fully assembled and tested, 4MHz 2114 chips no wait states, phantom line capability, addressable 4K blocks anywhere in 64K, fully buffered, meets S-100 IEEE standards. Ideal for use with SORCERER.

64K DYNAMIC RAM BOARDS \$1400.00

These S-100 boards are completely compatible with CROMEMCO systems.

DELTA PRODUCTS S-100 CPU BOARD \$495.00

Features 4MHz Z80; 2 x RS232C serial programmable I/O ports; 1 x 8255, 24 bit parallel I/O port, M1 wait state for 450 NSec memory chips; conforms to IEEE proposed std with memory management on A16 and A17.

DISK CONTROLLER — supplied with CP/M

MICROPOLIS (5 1/4" DRIVES)	\$495.00
MICROMATION (8" double density)	\$570.00
DELTA PRODUCTS (8" double density)	\$570.00

CROMEMCO D + 7a \$280.00

Features 7 channels of 8 bit analog — digital and 7 channels digital — analog.

VECTOR GRAPHICS BITSTREAMER II \$310.00

3 RS232 C serial ports and 2 eight bit parallel port.

MATROX ALT 256 \$500.00

Produces 256 x 256 graphics display to Aust standards. Supplied with SUBLOGIC graphics Software. 512 x 256 display board and character generator board is available. Send for details.

NDK SERIAL/PARALLEL PRINTERS \$3500.00

Includes stand, 6 month warranty, 170cps, bi-directional.

WORD PROCESSING PRINTER \$4085.00

Dot Matrix printer that produces normal draft copy at up to 200cps and full WORDPROCESSING QUALITY at 40-50cps. Can have up to 16 software selectable fonts. At last a GENERAL PURPOSE PRINTER — 16 CPI, 12 CPI, 10 CPI etc. Choose from 18 fonts! Send for details.

SHUGART SA 801 R 8" drives \$650.00 (ex-stock)

Case with 2 x Shugart 8" disk drives, power supply, 8 slot S-100 motherboard, Delta Products Disk Controller, CP/M (available for Exidy Sorcerer) **\$2870.00**

We have systems from Cromemco, Altos, Vector Graphics and our own OMEGA. We build system to order.

SEE OUR CATALOGUE FOR FULL DETAILS.

TO RECEIVE OUR CATALOGUE ON HARDWARE, SOFTWARE, SYSTEMS AND COMPONENTS SEND 3 x 20c STAMPS AND BECOME A MEMBER OF OUR MAILING LIST CLUB THAT WILL KEEP YOU INFORMED ON THE LATEST DEVELOPMENTS IN THE COMPUTER FIELD AND ENTITLE YOU TO RECEIVE NOTICE OF OUR REGULAR SPECIALS.

JOHN F. ROSE COMPUTER SERVICES PTY LTD

33-35 ATCHISON STREET, ST LEONARDS, NSW 2065, AUSTRALIA

TELEPHONE: (02) 439 1220 TELEX: AA 27901

PRICES SUBJECT TO CHANGE WITHOUT NOTICE. ALL PRICES INCLUDE SALES TAX.

NEWS HIGHLIGHTS

Remarkable program wins software contest — turns TRS-80 into a scientific calculator!



Mr Spencer Broughton (right) receives his prize, a Tandy TRS-80 Level 1 personal computer, from store manager Bob Hamilton, Indooroopilly, Queensland.

A university lecturer, Mr Spencer Broughton of Toowong in Queensland, has won the Tandy Electronics Grand Software Contest, announced in "Electronics Australia" last October. The contest was a huge success and attracted some 228 entries.

Mr Broughton's winning program, titled "The TRS-80 Visible Calculator", was judged by Tandy computer staff to be outstanding. Supplied with complete documentation, it effectively turns a standard TRS-80 4K/Level 1 computer into a powerful, easy-to-use scientific calculator using reverse polish notation (RPN)!

Mr Broughton, a Lecturer in Surveying at the University of Queensland, took three months of weekends and many nights to write his successful entry. Because he did not own a TRS-80 machine, program verification was carried out on a demonstration machine at his local Tandy store — this thanks to the co-operation of store manager Bob Hamilton!

In standard form, Mr Broughton's program provides five work locations and nine registers, all visible; 16 control and arithmetic functions; 12 register operations, including arithmetic on transfer; and 19 common functions. A further 20 functions, ready for immediate implementation, allow the user to select options to suit his individual requirements, in addition to those provided as standard.

The standard functions include square root, trig and inverse trig functions, natural and base 10 logarithms, exponentials, factorial, reciprocal, random number, rectangular-polar coordinate conversion, and others. Some of the optional functions include error function, normal probability, hyper-

bolic amplitude, hyperbolic and inverse hyperbolic functions, summation, and standard deviation.

Actual usage is similar to an ordinary calculator, although a mnemonic scheme has been employed so that a keyboard overlay is not necessary. In operation, the computer prompts in the lower left-hand corner of the screen.

When interviewed, Mr Broughton said what he had always been interested in developing a calculator facility for the TRS-80 so that it could become an immediately useful tool for the first-time user. He plans to use his prize TRS-80 to write a random conversational maths teaching aid to help his daughter in her studies.

Congratulations to Mr Broughton from Tandy Electronics and Electronics Australia, and our thanks to all those other readers who took part in the contest.

Free offer from Tandy

Because Mr Broughton's calculator program is too long for publication, Tandy Electronics has decided to offer EA readers a cassette recording of the program together with a photostat copy of the documentation for free. That's right! ... you get the cassette and the documentation for free! You don't even have to be a TRS-80 owner!

All you have to do is to ask at your local Tandy store, and the material will be ordered for you from Tandy head office (it will not be carried by Tandy stores as a normal stock item). Offer closes on April 30, 1980.

We are sure that there are many readers who will want to take advantage of this very generous offer from Tandy.

Barra Sonobuoy for world market

One of the most significant projects ever undertaken by the Australian defence industry, the Barra Sonobuoy, is now entering the world export market. It is being manufactured by Amalgamated Wireless (Australasia) Ltd, and establishes for Australia a world lead in submarine detection.

The Barra Sonobuoy is a device dropped into the sea by anti-submarine aircraft to locate submarines. It is part of a joint Australian/British system, with the UK developing and building an airborne computer-based processor and receiver, which picks up radio signals transmitted from Sonobuoy and processes them into a "fix".

In operation, the Barra Sonobuoy is dropped by parachute from an anti-submarine aircraft into a designated search area, either singly or in a pattern. On striking the water the lower part of the Sonobuoy detaches and sinks to a preset depth, while the upper unit, which is connected to the lower unit by cable, returns to the surface.

The lower unit contains a compass and booms fitted with specially developed hydrophones; the arrays are switched in a sequence to give the required directional beaming. Multiplexed signals from the lower unit are fed to the upper unit, whence they are transmitted as a radio frequency signal to the patrolling aircraft.

Aboard the aircraft, the AQS-901 sonics processor decodes the data from each Sonobuoy to identify the source — submarine, surface vessel, and typical marine noises — and the bearing. This information is then interfaced with the aircraft display and weapons control system.

Texas Instruments software offer

An interesting Texas Instruments software offer, originally confined to professional and trade magazines, has been extended exclusively to EA readers.

Here are the details — by filling out the coupon on page 41, those readers who purchase (or purchased) a TI-58C programmable calculator between February 28 and April 30, 1980, will receive two free software "Pakettes" valued at \$20; those who purchase a TI-59 between the above dates will receive four free software "Pakettes" valued at \$40.

There are 16 "Pakettes" available in all, and cover the fields of engineering, mathematics, statistics and finance. Readers can specify which of the 16 they want.

Further details on this special offer are available on page 41. Please note that the offer is void in those states where the requirement to fill in a coupon is prohibited by law.

BASEMENT FLYWHEEL

stores solar energy at 15,000rpm

Better than batteries? Flywheels may well be — at least for storing random bursts of energy from the sun and wind. Research into practical flywheel energy storage systems is now under way in the United States.

by **SUSAN RENNER-SMITH**

"See, here's the air gap," said Dr Alan Millner, pointing at the spinning flywheel. I peered close and saw a tiny space no thicker than a business card between the flywheel's whirling shaft and the bearing above it.

I'd come to MIT's (Massachusetts Institute of Technology) Lincoln Laboratories especially to see this magnetically suspended flywheel. Millner pointed out other features. "Here are the touch-down ball bearings. If the electromagnets lose power, the shaft will rest on these."

To demonstrate, he flipped a switch, shutting off the magnets. As I watched, the spinning shaft moved down slightly, touching the ball bearing. Instantly the flywheel slowed down, then coasted to a stop.

"Why did you turn off the flywheel motor?" I asked.

"It was never on," Millner answered. "I just spun the wheel up this morning with my finger. It's been spinning ever since."

"A perpetual-motion machine?"

"Not quite," said Millner, grinning. "The longest it's spun without power has been about 36 hours. But the magnetic bearings really do reduce drag drastically. And without air drag, this thing would spin for much longer. That's why we'll put the full-size flywheel in a vacuum can."

The small flywheel is the first step in Millner's plan — to bury a 90cm diameter, two tonne, magnetically suspended flywheel underneath a house.

Why would anyone want a flywheel in the basement? To store energy. Spun

up by electricity from a solar photovoltaic array — or from a wind generator — a flywheel's momentum can power a residential-sized generator. The buried flywheel can also tap power lines during cheaper, off-peak hours.

As another oil shortage threatens our power plants, such alternate-energy schemes seem more and more attractive. And as oil prices soar beyond expectations, sun and wind power begin to look economical, despite initial equipment costs.

But these energy sources are intermittent, requiring a storage system to ensure a constant supply of electricity. Today's experimental solar arrays use deep-discharge, lead-acid batteries. They store energy chemically, using electrical energy to drive a reversible chemical reaction. But lead-acid batteries have a number of drawbacks — that's why researchers are trying so hard to develop better types. Most energy experts think that future energy-storage systems will be some kind of advanced battery pack.

But Alan Millner thinks the flywheel is a practical alternative to batteries for large-scale energy storage. Flywheels store energy mechanically. But, says Millner, they can do more than store energy. In Millner's system, the flywheel will also convert the direct current produced by the solar cells to the alternating current used by the house. To increase efficiency, Millner will mate the underground flywheel with components originally developed for spacecraft.

Within the year, Millner hopes to be testing a scale model of a giant flywheel energy-storage system. He also hopes to get manufacturers' cost estimates for the system. If both his model and his

cost estimates work out the way he thinks they will, you may have a flywheel in your future.

An ancient idea

The flywheel has been around for thousands of years, ever since the first smart potter plopped a lump of clay on a rotating wheel. But most of today's flywheels, like those used in cars and sewing machines, are small and can store little energy. A flywheel's energy-storage capacity is based on mass, diameter, and speed — but the larger the flywheel and the faster it spins, the greater the stresses trying to rip it apart. Overstressed, a metal flywheel explodes in a lethal charge of shrapnel-like fragments. This hazard and other problems have kept flywheels from being used for large-scale energy storage until recently.

Oddly enough, it was space research that gave the ancient flywheel its renewed prominence.

"Until we started putting spacecraft up, the conventional lead-acid battery was a perfectly acceptable way of storing energy needed for brief periods of time," Captain Leon Smith, a spokesman for the French firm Aerospatiale, told me. "But space is very demanding; things must be strong, but weigh little and take up little space. These demands gave rise to the use of the flywheel. Though it has so far been used only as a momentum wheel to control spacecraft attitude, the flywheel has potential as a substitute for spacecraft batteries."

The needs of space sparked a renaissance in flywheel research that led to great improvements in design and storage capacity. And as aerospace engineers continued to improve

flywheel design, their work was applied to earthbound projects. In recent years, flywheels have been used in subways, trolley cars, and automobiles to recycle energy wasted during braking. But only in the past couple of years have flywheels been considered for use in stationary energy-storage systems.

Battling batteries

One of Millner's earlier jobs at MIT involved flywheels: he designed a magnetic bearing for a satellite's momentum wheel. Then he was asked to design electronic controls for the giant 25kW solar array MIT has at an experimental farm in Nebraska.

"We've got a truckload full of electronics out there," he said "and another one full of massive, two-foot-tall (60cm) deep-discharge batteries."

MIT discovered that the big batteries needed coddling. The trailer had to be ventilated to avoid buildup of explosive gases, but then the batteries had to be protected from the cold air. Millner also had to keep the batteries from overcharging, while estimating exactly how much current they should be drawing from the solar array.

He began dreaming about the ideal energy-storage device. Besides avoiding the problems mentioned, the device should require minimal maintenance (batteries have to be watered regularly) and should come close to the 25-year life expectancy of the solar array (batteries last about five years).

Conventional flywheels meet these requirements, he realised, and have about the same energy density as batteries. This is measured by the number of watt-hours delivered per kilogram of material. Today's best lead-acid batteries are rated at about 8Wh/kg. But today's advanced flywheels get at least 9Wh/kg.

Millner's proposal, based on these facts, was accepted by the Department of Energy, which funds the project.

Flywheel-powered house

Millner is currently building a one-tenth-capacity working model of the proposed system. The 230kg flywheel will store up to 4kWh. (A house-sized system would store about 40kWh to meet the 25kWh daily demand of an average home. Mechanical losses siphon off an extra 5kWh. The rest remains in the wheel.) The flywheel will be suspended by six magnetic bearings (see diagram) when energy is being stored.

Current from the solar array will drive an advanced permanent-magnet motor/alternator mounted on the flywheel shaft to accelerate the flywheel. When energy is to be withdrawn, the motor/alternator, will convert mechanical energy stored in the spinning mass into a steady supply of AC for use in the house. Both of these functions can be going on

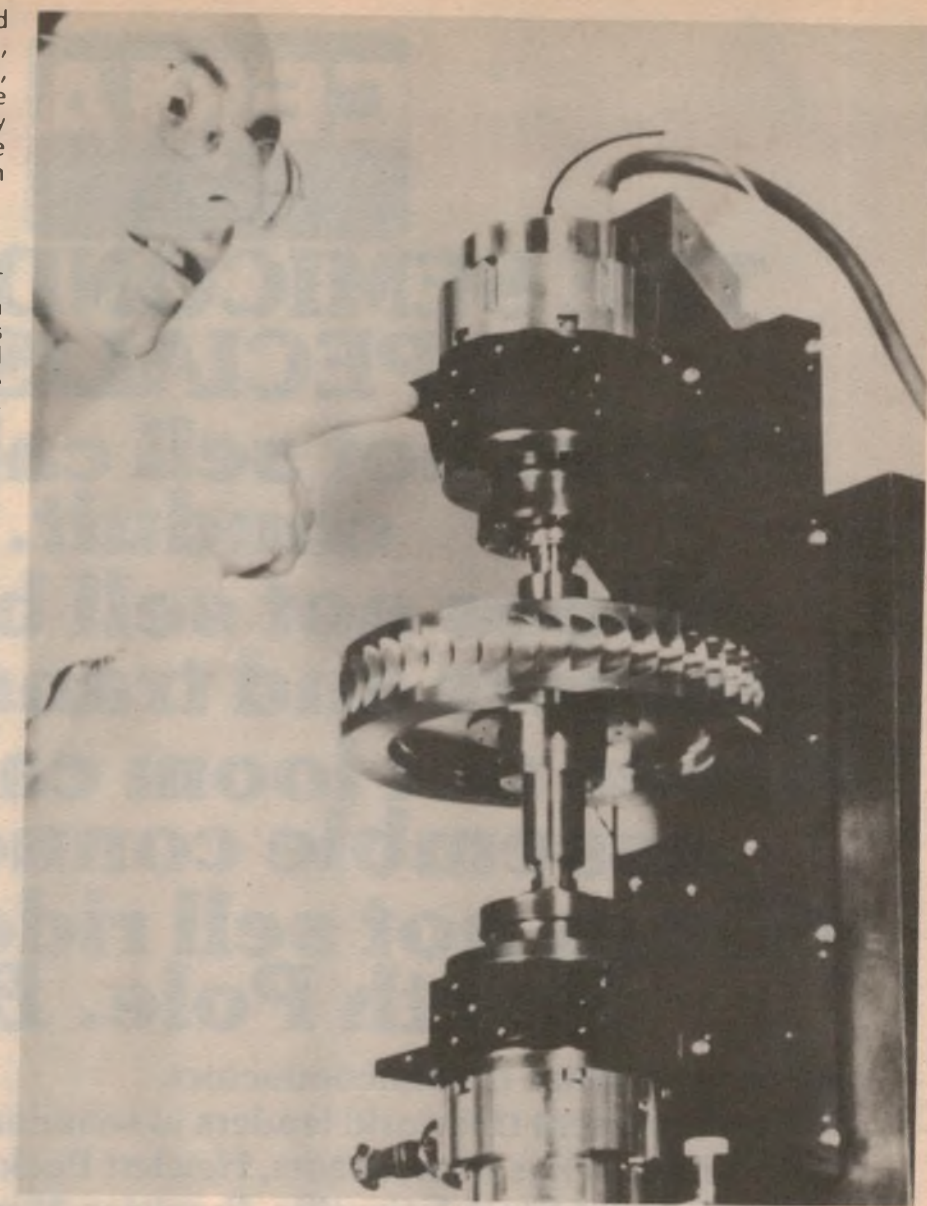

DR ALAN MILLNER points to one of two magnetic bearings that suspend a small flywheel between them. To cut system size, a larger model will have six sets of small bearings mounted above the flywheel. This setup also permits a fairly simple stator support system — making for easy exchange of experimental rotors.

simultaneously. In addition, if the solar array generates excess electricity, the circuitry can feed it into the power grid. If the flywheel slows down on cloudy days or at night, the power lines can be tapped for additional energy to accelerate the rotor to its optimum 15,000rpm.

The entire assembly — bearings, motor/alternator, and flywheel — will be enclosed in a sealed vacuum container that doubles as a safety enclosure. This can will be lowered into a concrete pit below the garage of a solar-powered test house MIT is building.

Why hasn't this practical-sounding idea been tried before?

"Friction has always limited flywheel potential, severely reducing the ef-

ficiency of even advanced flywheels," Millner told me. "That's why magnetic bearings are essential to this design. The importance of these bearings is that nothing touches the rotating unit. That means there's nothing to wear out and nothing to lubricate.

"Also, the gaps between the rotating and the stationary units are measured in ten-thousandths of an inch, as opposed to ball bearings where millionths of an inch are the norm. So the magnetic bearings are much less sensitive to the abrasion caused by tiny pieces of dirt and dust," he said.

Such bearings have been used for years to support delicate laboratory instruments. But within the past decade, NASA, Aerospatiale and other commercial firms have worked to improve



THE SEMICONDUCTOR SPECIALIST

- Does not sell cable and conduit.
- Does not sell battery chargers and transformers.
- Does not loom cables and assemble connectors.
- Does not sell rides to the South Pole. *But*

- Does specialize in semiconductors.
- Does represent the world leaders in semiconductors including Motorola, Texas Instruments, Hewlett Packard, Philips, Signetics, Harris, Solid State Scientific, Precision Monolithic and others.
- Does have over 3,000 semiconductor line items in stock worth over \$1 million.
- Does have computerized on-line inventory access and order processing in Sydney and Melbourne (soon in Brisbane).
- Does deliver stock items ex Sydney Warehouse within 8 working hours of order receipt.



CEMA ELECTRONICS PTY. LTD.

Sydney 21 Chandos Street, St. Leonards. 439-4655
 Melbourne 208 Whitehorse Road, Blackburn, Vic. 877-5311
 Brisbane 22 Ross Street, Newstead, Qld. 52-4261
 Adelaide 170 Sturt Street, Adelaide, S.A. 51-6483
 New Zealand 7-9 Kirk Street, Grey Lynn, Auckland. 76-1169

NEW CEMA BRANCH OFFICE
 Perth Unit 1, 25 Brisbane Street, East Perth. 328-8325

AGENTS
 Canberra Ortex (062) 82-4995
 Wollongong Macelec (042) 29-1455
 New Guinea Daltron Electronics, Boroko 25-6616
 and soon in Wellington, N.Z.

Where semiconductors are our business not our hobby.

Basement flywheel: stores energy at 15,000rpm

the bearings so they could support the weight of a spacecraft momentum wheel.

Millner's contribution? "We're breaking new ground by fitting the bearings into a lower-cost system."

The system's other key component — the brushless DC motor — was also developed especially for use in space. Brushes don't hold up well in a vacuum. Besides, brushes cause drag; eliminating them increases the motor's efficiency and reliability.

The motor has another uncommon feature — it has no iron in its armature (see diagram). This construction reduces a different type of drag caused by electromagnetic forces.

"The lower drag of an ironless armature is critical when you're talking about flywheels that may go many hours or even days between charges," explained Millner.

The MIT group is not alone in proposing to link these components designed for space into an earthbound energy-storage system. But they are the first to build a prototype that will be tested in a real house. And, according to Millner, they have added a key element to the concept of flywheel energy storage.

"The important contribution we've made," he said "is the idea that the flywheel can do the power conditioning as well as the energy storage. That way, we bring down the cost of the conversion equipment needed to go from DC to AC."

Broadly speaking, power conditioning means matching the input power to the demands of the load. A battery-storage system often requires two essential pieces of power-conditioning equipment. The first takes the varying voltage and current generated by the solar cells, converts this energy to the proper voltage, and delivers it to the charging circuits at the proper impedance. A separate inverter converts the batteries' DC output into 60Hz, 115-volt AC voltage.

But the flywheel needs only one piece of power-conditioning equipment — the motor/alternator. It is the simplicity of this self-contained flywheel energy-storage system that is the key to his whole scheme.

Will the flywheel be as advanced as the motor/alternator and bearings?

Surprisingly no. "What we're trying to demonstrate in this model is everything but the rotor," said Millner. "Others are working on advanced flywheel designs. I'm just going to put a steel wheel in there to test the system. My goal is to show that the system can compete economically with a battery-storage system."

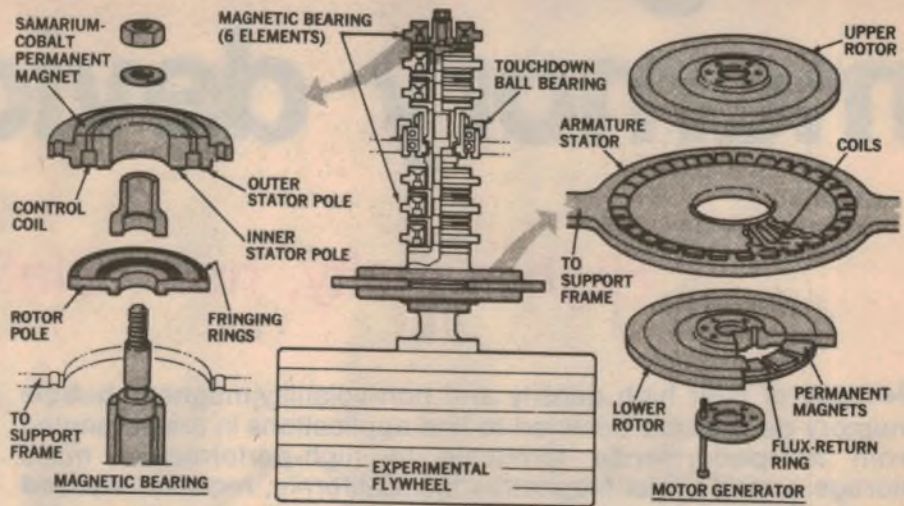

EXPERIMENTAL FLYWHEEL CONCEPT:

Magnetic forces alone suspend the flywheel. Each magnetic bearing has two parts: a rigid stator bolted to a support frame and a shaft-mounted rotor. Powerful samarium-cobalt permanent magnets in the stator attract the iron rotor. Stator electromagnets modify the attractive force to keep the rotor in place. If it falls away slightly, the electromagnetic force increases to restore it to its proper position. If it gets too close, the attractive force diminishes. Scored "fringing rings" on the stator's underside match a set on the rotor's face. By effectively creating many small concentric magnets, the rings control sideways slipping or tipping. The ar-

mature of the motor/alternator is made of fibreglass (rather than the usual iron) with copper windings. This ironless armature design reduces eddy currents ordinarily generated when magnetic fields cut the iron armature. The motor's two rotors have alternately polarized, permanent field magnets embedded in iron rings that provide a return path for the magnetic flux. But whether the unit is operating as motor or alternator, current flows only in the stationary armature, so neither brushes nor commutator are needed. A stator-mounted sensor monitors pole position, and signals semiconductor circuits to switch coil polarities as needed.

Low-cost flywheels to come?

It's hard to project accurate costs for the system, since nobody yet mass-produces these magnetic bearings or brushless DC motors — or giant flywheels either. But, based on costs of materials and labour estimates, Millner has developed some cost projections. He figures that by 1985, a battery-storage system with a usable storage capacity of 25kWh might cost around \$3900, though it could go as high as \$8700. A comparable-capacity flywheel system would cost, at the least, about \$4000, though it might be as much as \$7400.

Not everybody agrees that a flywheel system will compare that favourably with batteries by 1985. Henry Dodd, of Sandia Labs, for one, thinks Millner is underestimating costs. He told me: "While it's true that the flywheel will allow you to replace three pieces of hardware with one, batteries still look better than flywheels. The basic cost of

the flywheel mass is much in excess of what is estimated."

Millner replies that his cost estimates are based on a new breed of advanced, low-cost flywheels that should be available by the mid-80s. The low end of his estimate is based on reports from Johns Hopkins of a rotor costing about \$50/kWh. The higher estimate assumes that a flywheel GE is developing for autos would cost about \$100/kWh when sized up for a house.

"But the whole point of this exercise," Millner said, "is that flywheels can probably be at least as good as the advanced batteries now under development. So it's worth investigating this technology."

And Millner's hope is that, when a practical, low-cost flywheel is developed, his model system will be ready to test it.

Copyright 1979 Time Mirror Magazines, Inc. New York. Reprinted from 'Popular Science' by arrangement.

Magnetic bubble memory devices

High density, non-volatile data storage

Because of their high density and non-volatility, magnetic bubble memory devices are destined to find applications in areas ranging from low-performance terminals to high-performance mass storage systems. Intel Magnetics Inc., California, recently released the world first commercially available 1-megabit magnetic bubble device.

Intel calls its new magnetic bubble memory (MBM) device the 7110, and has released it along with a family of peripheral LSI devices as part of a prototyping kit. The peripheral devices overcome MBM device interfacing problems, which are somewhat more challenging than those posed by semiconductor memories.

The designer for example, must not only provide addressing and control logic for the memory device but must also provide precise current pulse generation, low-level analog voltage sensing and relatively high current waveforms in a set of coil drivers. Intel sees its approach as a "total system solution for product design".

What is a bubble memory?

Bubble memories are compact, non-volatile mass storage elements processed in a manner similar to silicon wafer

fabrication.

Data is stored as magnetic "bubbles" in a very thin film of synthetic garnet. The bubbles are micrometre in size and move in a plane of the film when a magnetic gradient is present. Viewed under a microscope with linear polarized light, the bubbles appear to be fluid circular areas that step from space to space following fixed loops and tracks. The IM 7110 is organized as a serial-in parallel loop serial-out shift register as shown in Fig. 1.

The bubbles can be controlled to perform memory functions. Corresponding to the on/off concept for semiconductor memories, the presence of a bubble represents a binary "1" and the absence of a bubble represents a binary "0". The bubbles shift synchronously around storage loops and along input-output tracks in step with the rotating magnetic field which is in the plane of the wafer. (The

film is magnetically polarized in one direction and the bubbles are of reverse magnetic polarity).

Data is read in a unique manner. A bubble from each loop is replicated (duplicated). One of the two bubbles continues around the loop to retain memory while the other proceeds along the output track to the detector.

Standard photolithography is used to make conductor and magnetic permalloy patterns on the chip. A pair of AC-driven crossed wire wound coils are slipped over the chip to provide the rotating magnetic field. The system is stabilised with a pair of permanent magnets and is protected from external magnetic influences by a sleeve of shielding material. This allows the device to be used around CRT coils, transformers and other equipment that produces magnetic fields.

Memory devices compared

It is easy to compare bubble memories to existing semiconductor memories and magnetic storage devices. But while the bubble memory may compete with specific performance characteristics of existing memories, it will not replace RAMs, ROMs, PROMs, floppy disks or other magnetic auxiliary storage devices. The primary applications of MBMs will be to augment other memories and to develop new products based on its inherent unique characteristics.

Bubble memories have several inherent advantages when compared to other memory systems. They can store comparatively large amounts of information, are non-volatile, compact, highly reliable and can be used in harsh environments. A non-volatile memory is one which retains data even when the power is turned off.

The 7110 has a normal data capacity of 1,048,576 bits (128K bytes). In comparison, the largest RAM recently announced has 64K bits (8K bytes), the largest announced ROM has 128K bits (16K bytes), and a single-sided minifloppy disk can only store approximately 720,000 bits (90K bytes). 1M bits of information is over 30 pages of single spaced typewritten pages of data!



Intel Magnetics 7110 1-megabit magnetic bubble memory device.

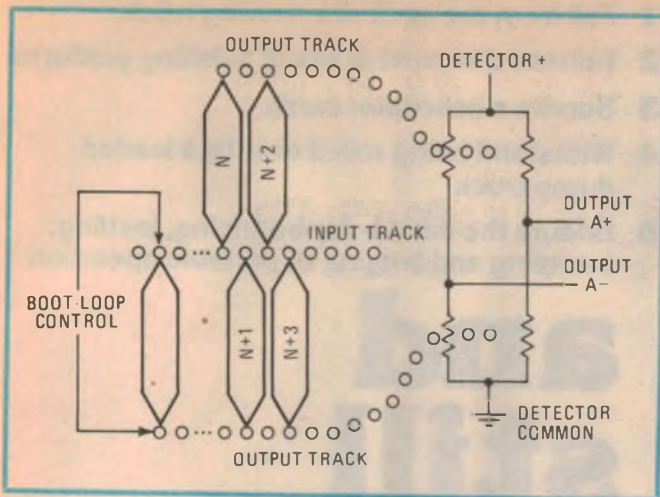
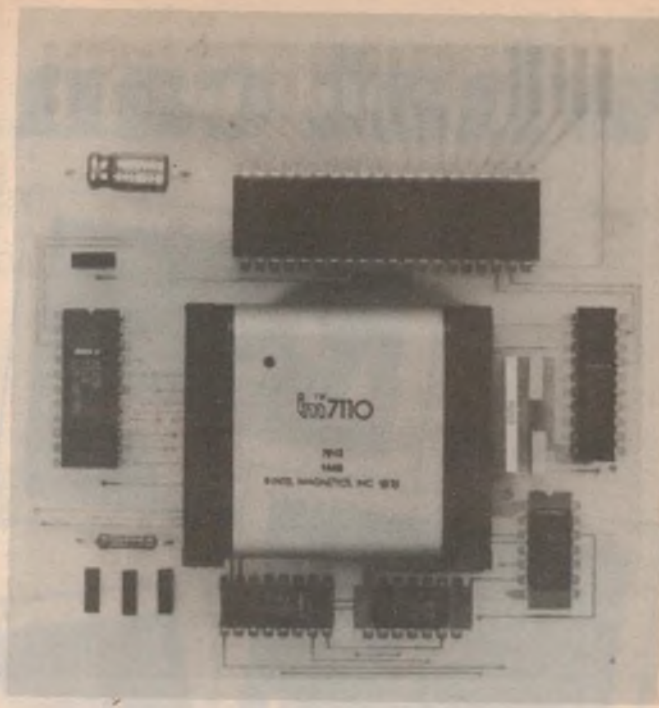

Fig. 1: The 7110 magnetic bubble memory has a serial-parallel-serial organisation. Shown here in block form is one of two channels of the 1-megabit MBM. There are 128 loops in each channel, plus a so-called "boot" loop which identifies and keeps track of the guaranteed-good loops.



Intel's new 7110 MBM device is supported by a complete family of LSI circuits which provide drive and interfacing.

Non-volatility is one of the most important characteristics of the MBM. Data is retained if power is removed as the bubbles stay in position indefinitely. While ROMs and PROMs are also non-volatile, the MBM data can be changed or modified at the same rate as it is read.

Physical size is another significant feature of the MBM approach. In fact, one of the early applications for bubble memories will be to reduce the physical size of equipment. The MBM takes up a lot less physical space than either a tape or a disk. Even when grouped together to form a 1 or 2-megabyte system, bubble memories save considerable board space over semiconductor memories of similar system capacity. The minimum 7110 system (128K bytes) resides on a board size of less than 100 square cm.

In some systems, it will also be possible to use MBMs in place of tape or disc peripherals. This will enable the designer to eliminate large power supplies, motors and other costly electromechanical devices from such systems. As for reliability, bubble memories have a high resistance to shock, vibration, humidity and radiation, making them ideal for use in harsh environments. Extra storage loops are built in for error correction.

One drawback of the bubble memory is that it has a slower access speed than the semiconductor memory. It's faster than other magnetic storage techniques, however.

System concept

Fig. 2 is a block diagram of the system concept developed by Intel. The system interfaces directly with the Intel microprocessor bus system, so that the memory can be treated as a slave to 8080, 8085, 8086, or 8088 host systems.

Other features include binary data organisation, standard +12V and +5V power supply operation, transparent handling of spare loops, built-in automatic error correction, single page (512 bits or 64 bytes) or multiple page data transfers, and power failure reset.

The peripheral devices accompanying the 7110 include the 7220 bubble memory controller, 7242 formatter/sense amplifier, 7250 coil predriver, and the 7230 current-pulse generator. Together they can be used to build a system with a minimum capacity of 128K bytes, without the designer having to worry about interfacing and drive details. For larger systems, up to eight MBMs can be interfaced with one controller for a megabyte of storage.

As mentioned, the 7110 is a serial-in parallel serial-out shift register device. The 2cm² chip stores 2048 pages of 512

bits each, formed by combining two 256-bit registers with serial output channels. There are 128 data storage loops per channel divided into two sections of 64 data loops each. A page address is selected and the page shifted to the starting location for a read or write operation.

The first part of the read operation replicates the bits of the page in parallel on an output track to feed a detector bridge. The bits are shifted serially through the bridge so that the maximum data rate is twice the shift rate. In the write operation, the bits for a new page are first written serially on an input track. The bits shift until they coincide with the bits of the page in storage to be replaced. A swap operation then exchanges the new page for the old at the address location selected.

In operation, either a page or a group of pages can be read or written for a

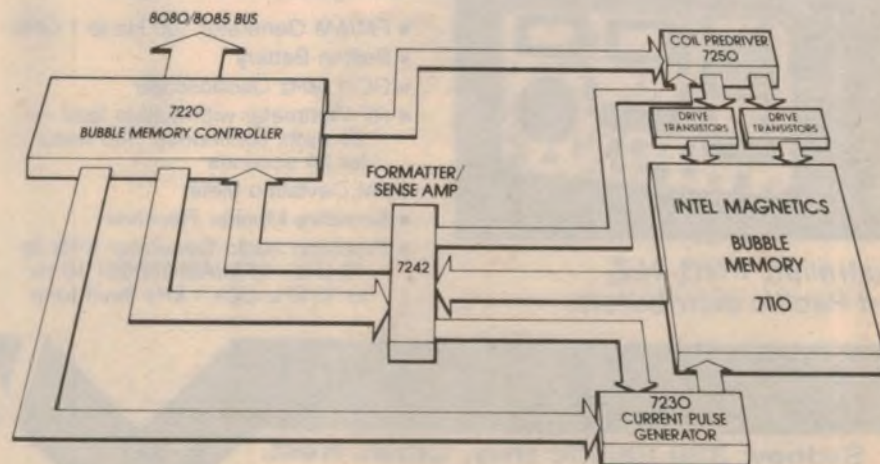
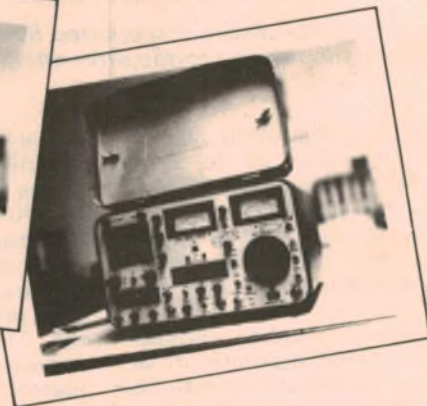
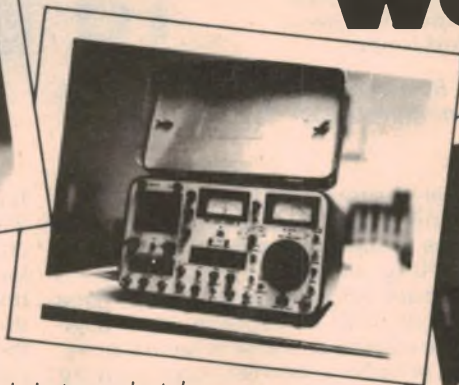

Fig. 2: A complete 128K byte bubble memory system can be implemented using one 7110 bubble memory package, four LSI devices and two quad transistor packs.

what can

- 1 Fall from the back of a moving truck
- 2 Bounce down the stairs of a drilling platform
- 3 Survive a helicopter crash
- 4 Withstand being rolled over by a loaded dump truck
- 5 Endure the day-to-day bouncing, jostling, bumping and lugging of portable operation

(Here's a Hint)



and still work? *

Unretouched copies of Polaroid photographs taken immediately upon arrival of case #3 at the Customer Service Department. All we did was connect power and turn it on.

* **answer:**  **Service Monitors...**

FM/AM-1000A and FM/AM-1000S

All of These Features Are Standard...at a Price Far Below Competitive Monitors

- FM/AM Generator 100 Hz to 1 GHz
- Built-in Battery
- DC-1 MHz Oscilloscope
- RF Wattmeter with built-in load — 20 watts continuous, 100 watts for 30 seconds
- FM Deviation Meter
- Sensitive Monitor Receiver
- Precision Audio Generator 5 Hz to 10 kHz... (FM/AM-1000S) 10 Hz to 10 kHz plus 1 kHz fixed tone
- RF Output 0.05 μ V to 5000 μ V (FM/AM-1000A) 0.05 μ V to 224 mV (FM/AM-1000S)
- Accurate Master Oscillator FM/AM-1000A — Oven-stabilized Crystal 0.00005% FM/AM-1000S — TCXO 0.00005% (typically 0.00002%)
- Spectrum Analyzer (FM/AM-1000S)
- RUGGED CONSTRUCTION



Australian, PNG, N.Z. and Pacific distributors:

**Sydney: 339 Pacific Hwy, Crows Nest.
Ph. 436 2766**

Melbourne: 68 Eastern Rd., Ph. 699 6700

YCOM

Magnetic bubble memories

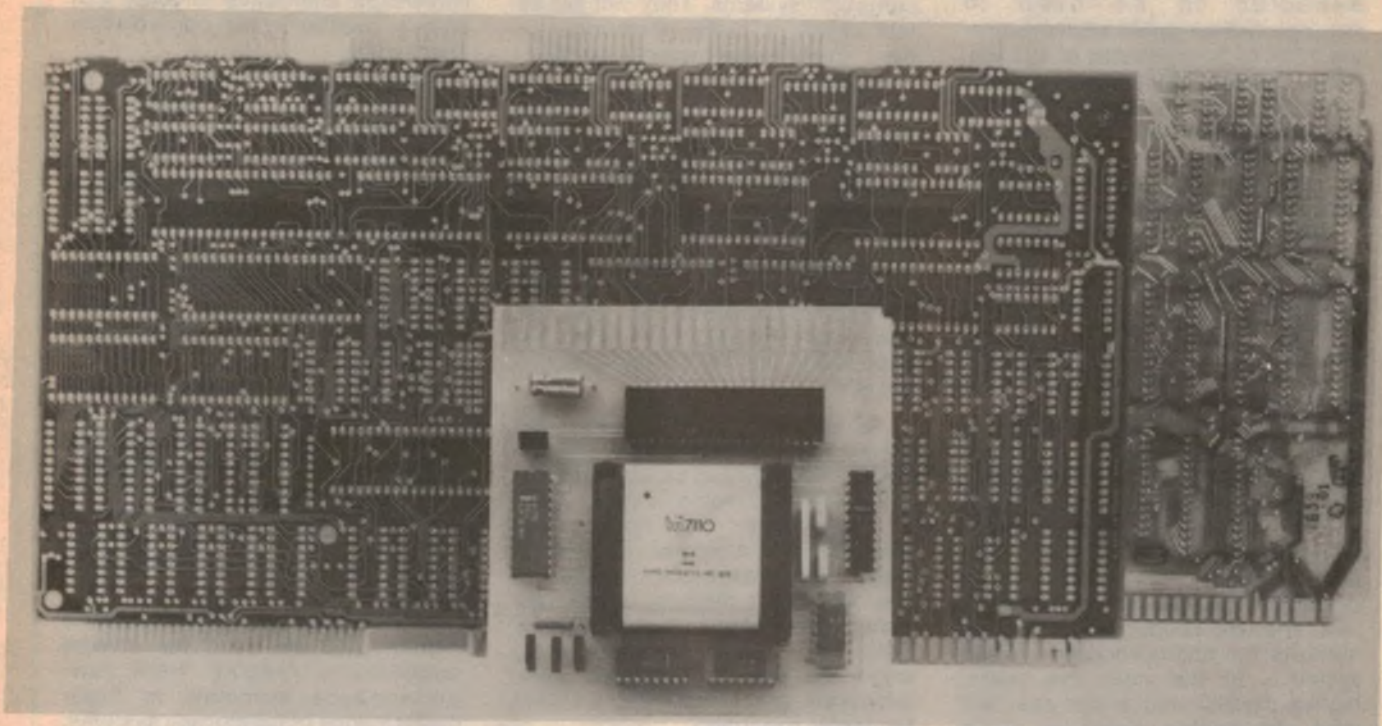

Space saver — new Intel 7110 MBM device and supporting LSI family reduce space and component count for a 1-megabit bubble system by an order of magnitude, replacing two PC boards, four 256K modules, and about 85 ICs.

given system request. Upon completion, the bubble device itself can be stopped until the next request. This start/stop feature can reduce the average page access time in systems where successive page accesses are not random. Least recently used (LRU) and look-ahead algorithms can be used to put expected future pages at the locations corresponding to the start of the page read or write cycles.

With a standard shift rate of 50kHz, the average random access time of the 7110 is 40ms, or 80ms in the worst case. The maximum data rate is twice the shift rate, or 100kHz. Page read and

write time for the 7110 each require a minimum of 327 shift cycles, or 6.5ms.

At the systems level, the data rate can be increased by operating bubble devices in parallel. By using eight 7110 devices, the nominal bit rate becomes 544kHz compared with 64kHz for a single device. Using 16 devices connected to two controllers, the bit rate is 1.088MHz. Table 1 shows the expected performance characteristics of the 7110.

Additional loops

Along with the 256 guaranteed storage loops to hold the megabit of useful data, there are 64 additional

loops. Sixteen of these loops are guaranteed good for an error correction code. Up to 48 of the remaining loops can be defective, so that in fabrication a few defects will not cause the chip to be rejected. This increases chip yield and holds down costs.

The defective loops are identified during testing and provisions made in the support electronics to compensate for them. Basically, the MBM has an addition loop (called the Boot Loop) which identifies the good and spare loops and controls a loop map. This map is read out of the 7110 and stored in the 7242 dual formatter/sense amplifier each time the system is initialised prior to reading or writing.

Interface circuits

User interface is provided by the 7220 Bubble Memory Controller (BMC), a 40-pin device built with NMOS technology. It provides bus interface, generates all memory system timing and control, maintains memory address information, and interprets and executes user requests for data transfers. From a practical standpoint, the 7220 interface makes the MBM system look like a peripheral to the microprocessor system bus.

The 7242 formatter/sense amplifier is actually a dual channel unit which interfaces with both channels of the bubble memory. A 20-pin device, it too uses NMOS technology, and senses the low-level bubble signals, handles

TABLE 1. BUBBLE MEMORY SYSTEM PERFORMANCE

	One MBM	Four MBMs	Eight MBMs operated in parallel	Eight MBMs multiplexed one at a time
Capacity	128K Bytes	512K Bytes	1 Megabyte	1 Megabyte
Nominal Data Rate	68KHz to 136KHz	272KHz to 544KHz	544KHz to 1088KHz	68KHz to 136KHz
Avg. Access Time	40 to 20ms	40 to 20ms	40 to 20ms	40 to 20ms
Power Dissipation (100% duty factor)	6W	20W	40W	11W
Standby Power	1.3W	3.7W	7.0W	7.0W
Board Area	100sq.cm	290sq.cm	580sq.cm	580sq.cm

Applications for magnetic bubble memories

Initially, bubble memories are expected to be used in microprocessor applications requiring 128K to 2-megabytes of storage. Such current applications include terminals, word processing systems, telecommunications and process control applications. Basically, they will be used wherever non-volatile program or data storage is required.

Currently, bubble memories will provide very large amounts of non-volatile memory that can be modified. They will not replace any existing forms of memory but will augment other memory devices and may be used to develop new products.

One of the first applications for the bubble memory is to reduce equipment size. As the MBM can store a tremendous amount of data in a very small area, the possibilities to make equipment more compact are increased. This leads to more portability of existing products, to new end-use products and to new markets for microprocessor based systems. In the next five years, higher density and lower cost will allow the bubble memories to be

used in minicomputers and large computer systems. They will act as fast cache or buffer memories for even larger mass memory units.

The MBM can be treated as a "sometimes changed" ROM or PROM. As an example, if an MBM is resident in a terminal connected to a larger system, either permanently or through a modem, the system can, from time to time, modify the program such as updating a price or tax table stored in the bubble memory. The MBM can also be treated as a PROM with the program changed in the field or by a device change.

As a more "frequently changed device" the MBM can be treated as a RAM. The MBM can be used in a terminal to keep track of inventory and sales figures. The figures are transmitted to a central computer at night when transmission costs are low. As bubble memory speeds are compatible in applications involving data with human interface, data might be read in and out while programs are transferred to RAM for faster execution.

Bubble memories offer a low cost, lightweight alternative to RAM with battery backup where non-volatility is essential.

MBMs can augment disk products to reduce many electromechanical service and maintenance headaches. Compared to tape or disk where dirt, dust and handling are frequent problems, the bubble's magnetic film is free from contamination. Therefore, MBMs can be produced for applications in garages, machine shops and grocery stores as well as offices and computer rooms.

The MBM can be used as a second disk for a system. The first disk loads the programs which are then transferred to the MBM. The bubble memory provides more reliable operation with faster access times. A similar system would be implemented with programs entered via tape.

In the future, the magnetic bubble memory will be used for diverse applications ranging from low-performance terminals to high-performance mass storage systems.

redundant loops and buffers data. It also contains the burst error detection and correction circuits for each channel.

The 22-pin Schottky bipolar 7230 current pulse generator supplies the peak currents required by the MBM. It also contains a power down circuit to shut off the current sources whenever the device is deselected and has power failure detect circuitry to shut off pulses to the bubble memory.

Relatively high peak currents are required to drive the coils, necessitating the use of driver transistors. The 7250 coil predriver interfaces the 7220 controller to these driver transistors, which can be quad bipolar transistor packs or Intel's 7524 quad VMOS FET transistor packs. The 7240 is a CMOS device supplied in a 16-pin DIP package.

The significance of these support circuits is that they provide all the complex control and interfacing necessary between the system bus and the MBM. They replace what would otherwise be a board full of control electronics and make it practical for the original equipment manufacturer (OEM) to use the 7110 MBM in production products.

Prototype kit

A "Bubble Memory Prototype Kit" — the BPK-71 — has been released by Intel Magnetics, and allows users to construct the 1-megabit system pictured in this article. Application information on system interconnections and

The new 1-megabit magnetic bubble memory system is easily held in one hand.

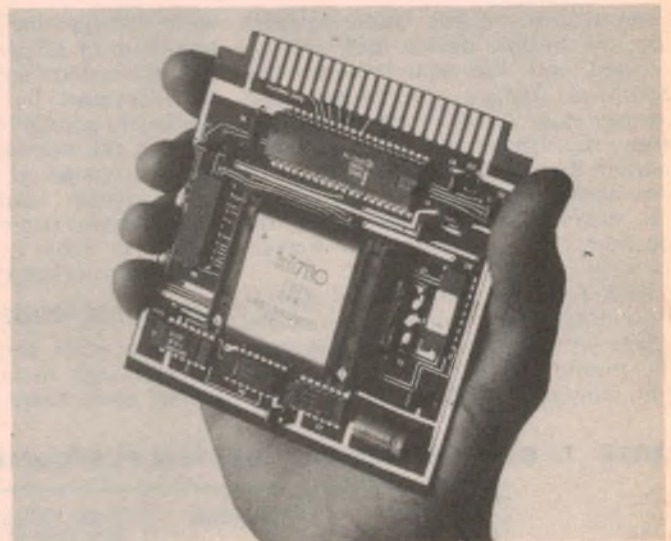

a complete description of an 8085-based controller are included in the kit. Price is around the \$2,500 mark, plus sales tax.

Also available is a "1-megabit Bubble Memory Development Board", the IMB-100. Included on the board is an 8085 microprocessor with associated memory (1k RAM, 4k EPROM), and a 7110 bubble memory and its support chips. All the required drive, control and sense signals are provided, and the board can be plugged into an Intel Microcomputer Development System.

The IMB-100 sells for \$4,000 (approx.)

plus sales tax.

The new 7110 memory is expected to be used initially in microprocessor applications requiring 128K bytes to 2M bytes of memory storage. These include terminals, word processing systems, telecommunications systems, process control, and a host of other applications where non-volatile storage is required.

Further information on the Intel 1-megabit bubble memory system is available from Warburton O'Donnell Ltd, 372 Eastern Valley Way (PO Box 182), Chatswood, NSW 2067.

HEATH DATA SYSTEMS



Now better value than ever.

The recently introduced range of 8 bit and 16 bit computer systems from Heath have now been expanded and represent particularly good value for the hobbyist and professional alike. Key features are expandability, reliability and performance which have made the Heath Schlumberger name famous around the world.

1. **The WH14 Line Printer—Performance, Reliability and Value**

The WH14 line printer is designed for a broad variety of uses in the personal computer field. The microprocessor based WH14 combines speed, flexibility and ease of use with any computer providing standard RS/232 interface connections. It prints the standard 96 character ASCII set (upper and lower case) on a 5 x 7 dot matrix print head. The printer comes complete and ready to operate with cable, paper tray and ribbon and features tractor feed for positive forms handling.

2. **The WH19 Video Terminal—One Of The Smartest Buys You Can Make In An I/O**

The WH19 features a powerful Z80 microprocessor and a heavy duty professional keyboard designed for daily use. The 12", high resolution CRT gives you a clear, easy to read screen image. The smart Z80 microprocessor makes the WH19 capable of a multitude of high speed functions, controllable by keyboard or software and an addressable blinking cursor lets you edit or make corrections anywhere on the screen.

3. **The WH27 Floppy Disk Drive—Adds Power and Versatility to WH11's**

The dual drive WH27 floppy disk unit gives you enormous storage capacity for data and programmes. The 8" disks have 512K bytes of storage area, more than enough to hold entire files. Disks are IBM compatible. The WH27 features a Z80 microprocessor-based controller for high speed access and programmes can be loaded in seconds. The operating system for the WH27 was developed in conjunction with DEC and supports BASIC, FORTRAN and ASSEMBLER LANGUAGES—all available from Heath Schlumberger Data Systems.

4. **The WH89 All-In-One Computer**

The all-in-one computer brings you all the power and built in peripherals needed for any business computer task. Easy to programme, easy to operate, it can save you money in many ways.

The smart video terminal has its own Z80 microprocessor so it never shares processor power with the computer, making the terminal capable of a multitude of high speed functions. Floppy disk storage makes this a true all-in-one computer with enormous storage capacity for programmes and data. Each 5¼" diskette has more than 102K bytes of storage area, enough to hold entire files. All terminal functions can be controlled by keyboard or software and programmes can be loaded in seconds from the keyboard. The system comes with 16K RAM expandable to 48K and memory diagnostics are built in for fast, easy memory checks.

5. **The WH11A 16 Bit Computer—Professional Performance At Hobby Prices**

The WH11A gives you the 16 bit capacity to run complex programmes. It uses the same powerful microprocessor and runs all software designed for the DEC PDP 11/03. You can choose from scores of practical programmes that can reduce your clerical costs and increase efficiency of data management. The WH11A gives you the flexibility to configure exactly the system you require. 7 plug-in slots let you add any combination of I/O's and a maximum of 60K bytes of memory. To date the computer has found wide use in education, industry and small business areas.

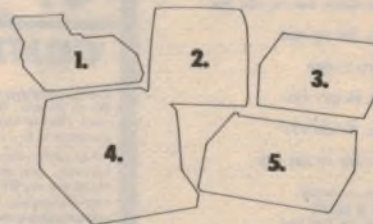

For further information contact:

- ADELAIDE 356-7333 • BRISBANE 52-7255 • HOBART 23-1841
- MELBOURNE 699-4999 • PERTH 277-7000 • SYDNEY 648-1711
- AUCKLAND N.Z. 77-0924 • WELLINGTON N.Z. 698-272

WF 678/80



WARBURTON FRANKI

NEW KITS (and new kit components)

Remember: parts for most kits in most of the electronics magazines are normal stock lines. So even if a kit isn't listed, we may be able to help you anyway. Call in and ask us!

ETI 300 WATT AMPLIFIER MODULE (See ETI February)

Short Form Kit (F glass PCB, components, heatsink brackets & instructions)	Cat K-3444	\$89.00
Transformer	Cat M-0150	\$29.50
100 volt fan	Cat D-2885	\$2.00
MJ15003 Transistor	Cat Z-1809	\$6.00
MJ15004 transistors	Cat Z-1810	\$6.00
2500uF/50V RB electro.	Cat R-4572	\$3.95
Heatsink (two rec. per module)	Cat H-3460	\$4.75

PLAYMASTER ANALYSER/LEVEL METER (See EA February)

Complete kit, including instructions	Cat K-3510	\$89.50
Printed circuit boards (set of two)	Cat H-8313	\$8.50
MM5837 IC	Cat Z-6130	\$3.90
UA-4138 IC (10 required)	Cat Z-6105	\$1.88

SUPERBASS FILTER (See EA February)

Printed Circuit Board	Cat H-8370	\$2.40
-----------------------	------------	--------

FLASH EXPOSURE METER (See EA January)

Printed Circuit Board	Cat H-8371	\$2.10
Solar Cell	Cat Z-4820	\$2.50
100uA panel meter	Cat O-2070	\$12.50
50B2-2800 diode	Cat Z-3230	\$2.88
CA-3140 IC	Cat Z-5417	\$1.48

GUITAR PRACTICE AMPLIFIER (See ETI January)

Printed Circuit Board	Cat H-8625	\$4.60
-----------------------	------------	--------

PLAYMATE AMPLIFIER (See EA January)

Printed Circuit Board	Cat H-8369	\$4.80
-----------------------	------------	--------

TRANSISTOR ASSISTED IGNITION (See EA December)

Complete kit including instructions	Cat K-3300	\$32.50
Printed circuit board	Cat H-8367	\$2.20
BUX80 power transistor	Cat Z-2150	\$10.95

FAN SPEED CONTROL (See EA December)

Short form kit (PCB, components, no hardware)	Cat K-3090	\$11.50
Printed Circuit Board	Cat H-8368	\$2.50
SC141D Triac	Cat Z-4510	\$1.28

(zippy box, etc. normal stock lines - or build it in to appliance.)

NEW METAL LOCATOR (See EA November)

Complete kit (excluding dowel & former)	Cat K-3504	\$19.50
Printed Circuit Board	Cat H-8366	\$2.40

INFRA-RED REMOTE CONTROLLER (See EA October)

COY89A infra red diodes	Cat Z-3235	\$1.50
BPW34 photo transistors	Cat Z-1954	\$3.50
Printed circuit boards (pair)	Cat H-8365	\$8.95

JUST RELEASED!
Our brand new, up-dated colour kit catalogue is now available. Send for your copy NOW - it is

FREE!

MAJOR DICK SMITH RESELLERS

Listed below are re-sellers who stock a large range of our products. However, we cannot guarantee that they will have all items in stock or at the prices we advertise.

- AAM Electronics**
78 High Street, Wodonga, Vic. Ph 244 588
- Advanced Electronics**
5a The Quadrant, Launceston Tas. Ph 317 075
- Aero Electronics**
123a Bathurst Street, Hobart Tas. Ph 348 232
- Peter Brown Electronics**
9 Doveton Street North, Ballarat Vic. Ph 323 035
- Crystal TV Rentals Pty Ltd**
66 Crystal Street, Broken Hill NSW. Ph 6897.
- Decro Electric**
Cnr Magellan St & Brunner Hwy, Lismore, NSW. Ph 214 137
- Electrofix**
133 Malop Street, Geelong, Vic. Ph 97 827
- Elektron 2000**
181 Wharf Road, Newcastle NSW. Ph 262 644
- Hitel Hi Fi**
Shop 12, Vanuere Arcade, High Street, Penrith (Also at St Marys)
- Hutchesson's Communications**
5 Elizabeth Street, Mt Gambier SA. Ph 256 404
- Keller Electronics**
218 Adelaide Street, Maryborough, Qld. Ph 214 559
- M&W Electronics**
48 McNamara Street, Orange NSW. Ph 626 491
- Mellor Enterprises**
Shop 2/15 Forsythe St, Whyalla Norma, SA. Ph 454 784
- Power & Sound**
147 Argyle Street, Traralgon, Vic. Ph 743 638
- Purely Electronics**
15 East St, Rockhampton Qld. Ph 21 058
- Stevens Electrical**
42 Victoria Street, Mackay, Qld. Ph 511 723
- Summer Electronics**
95 Mitchell Street, Bendigo, Vic. Ph 431 977
- Sound Components**
78 Brisbane Street, Tamworth NSW. Ph 681 363
- The Silicon Chip**
Suite 3, 98 Bridge St Muswellbrook, NSW
- Tomorrow's Electronics & Hi Fi**
68 William Street, Gosford NSW. Ph 247 248
- Trilogy Wholesale Electronics**
40 Princes Hwy, Fairy Meadow, Wollongong, NSW. Ph 831 219
- Tropical TV Services**
249 Futham Rd, Vincent, Townsville Qld. Ph 791 421
- Variety Discounts**
113 Horton Street, Port Macquarie NSW. Ph 835 486
- Viking Electronics**
3108 Gold Coast Hwy, Surfers Paradise, Qld. Ph 388 280
- Wagga Wholesale Electronics Sales**
82 Forsyth Street, Wagga NSW
- Wellington Electrical Services**
110 Lee Street, Wellington NSW. Ph 325

COMING NEXT MONTH...

The all-new 1980 Dick Smith catalogue is almost here. With loads of new products, a huge new computer section and an up-dated data section, the Dick Smith catalogue is a hobbyist's dream. Don't miss out on your 'New Decade Dick Smith Catalogue'; you might regret it for the next ten years! **IT'S FREE - WITH THE APRIL ISSUE OF BOTH ELECTRONICS AUSTRALIA & ELECTRONICS TODAY!**

STILL TIME FOR THAT PARTY...

Turn it into a DISCO!

Not a kit: ready to plug in and go!

\$79.00

This is our incredible disco colour organ. It looks like a speaker box with a perspex panel. Connect it to your favourite music source and watch it light up your life. It won't harm your amplifier, etc. and makes any party come alive. 3 channels and 6 colours for a sparkling effect. Comes complete with audio lead and mat.



Cat A-4950

INCREDIBLE VALUE

Compare this superb LCD digital alarm/stop watch with others having similar features - some of the big brand names, for instance. They contain EXACTLY the same large scale integrated circuit and liquid crystal display as ours - yet you would pay up to twice, even three times the price of ours!

This outstanding example of integrated circuit technology offers five different modes of operation:

- Normal hours/minutes/seconds display
- Hours/minutes display plus date
- Split time zones (ag daylight saving & standard time)
- Alarm mode fully settable
- Lap timing

Each watch comes complete with a comprehensive instruction sheet use it once and it's child's play!



Cat X-1044

- Complete with attractive bracelet strap.
- Comes in smart gift box for protection!
- Compare our price!

\$49.50

NEW! FM WIRELESS TIE-CLASP MIC

Here's a brilliant idea: a tiny tie-clasp condenser microphone complete with miniature FM transmitter: receive it on any standard 88 to 108MHz; FM receiver. Transmitter section is small enough to slip into shirt pocket; mic comes complete with tie bar. A great idea for entertainers, demonstrators, public address, etc etc etc.



DUCE IN SHORTLY!
\$29.95
Cat T-1030

DEAR CUSTOMERS
Quite often, products we advertise are completely sold out within a few days. Or problems may hold up delivery of promised goods so they are not in the stores when the advert appears. Please don't blame the store manager or staff: they are powerless to do anything about it! What we are trying to say is that, if you are about to drive across town to pick up a particular line, give the store a ring first - just in case!

Dick Smith and Staff

SUPA SAVING!

This liquid crystal display calculator with memory uses no batteries. It operates from either solar power or normal room lights. It was selling for \$29.95 - now you save an incredible \$14.00! Yes, be quick for this one - stocks won't last long at this price.



\$25.95
Cat O-3050

NEW! 5 WATT, 8 CHAN. HAND-HELD.

For the weekend boating set: take along a bit of security - this handy marine transceiver. Huge 5 watts output (maximum legal power), with 6 channel capacity (comes with one channel fitted on the 27 MHz boating safety channel). Comes with illustrated case - attractive and durable. Easy to use - and it's handy to find out where the fish are biting! Approved by the P&I Dept for operation on the 27MHz marine band.



Cat D-1120

STOP PRESS! NEW REGULATIONS ALLOW 8 CHANNELS ON 27MHz. THIS SET IS READY FOR ALL 6!

Incredible audio accessories sellout!

Save around 10% and more on these value packed 'BIB' audio accessories. And save even more by keeping your audio gear in tip-top condition!

Groove clean:
It's the modern automatic record cleaner which keeps your records clean while they are being played (the time they collect the most dust!) No liquids, silent operation, has self-adhesive base and counterweight to ensure proper light tracking. Was \$8.95. Now only **\$6.25**. Cat C-7060

Deluxe cassette care kit.
Everything you need to keep your cassettes in top condition. Splicing block, tape, extraction tool/winder, head cleaning tape, labels, etc. A must for the serious recorder. Was \$16.25. Now only **\$14.60**. Cat C-7074

Stylus balance
Make sure your stylus is correctly balanced with this easy-to-use balance. You'll get longer record and stylus life. Pays for itself times over. Was \$5.80. Now only **\$5.20**. Cat C-7075

Static reducer
The latest in static reduction. Simply point the 'groove stat' at the record, turntable, etc. and squeeze the trigger. A stream of ions neutralises the static charge, incredibly effective. Was \$23.55. Now only **\$21.20**. Cat C-7079

Stylus brush
Keep your stylus clean and ready for use with a brush designed to do the job properly. Was \$2.80. Now only **\$2.30**. Cat C-7081

SPEAKER FADER

High power (25W) control for fading between front and rear speakers. Easy to fit, a delight to use! Cat A-7834



\$9.95

CODEMASTER:

Play against the computer: can you beat it? This remarkable thinking game gives you the clues; you have to try to work out the answers. Great for all ages; size approximately that of an 8-track cartridge. Cat X-1150



\$29.50

DISCOLITE

- It's a strobe!
- It's a music colour!
- It's a light dimmer!

This is the most incredible device going. It is three in one: a strobe circuit which flashes incandescent globes in a green-strobe effect; plus it's a colour organ which has its own built-in music to modulate lights in accordance with music or sound received; plus it is a conventional light dimmer. All you do is plug it into the power point, and plug your lights into it. It really is incredible!



\$47.50
Cat X-1105

PLUG-IN TIME SWITCH

Incredible! Up to 3 on/off actions per 24 hours fully adjustable, auto and manual control. Contacts rated at 2400 watts (same rating as your power point) appliances simply plug in! Pool lights, security lights, battery chargers, electric blankets, etc etc etc. Auto or manual control. Cat X-1120



24.50

COMPUTER CORNER:

Calling computer experimenters: if you like to 'dabble', Dick has the IC's you need. Here are just a few specialised computer ICs - just for experimenters.

ISP 8A/5000 - Minisync IC. Now less than half price... way under cost! Cat Z-9307. Was \$19.95; now only **\$9.95!** (limited quantity)

2-80 Microprocessor IC - one of the most popular (as used in Sarcos). Cat Z-9100 \$19.95

MM5740AIF Encoder - a keyboard to ASCII encoder chip. Cat Z-9207. \$15.99

MM5303N/MS6011/51803 UART IC - the universal data communicator. Cat Z-9204. \$5.25

RAMS

2102 1K Static RAM. Cat Z-9302. \$1.30

2112 256 x 4 bit static RAM. Cat Z-9304. \$2.25

2114 4k static RAM. Cat Z-9306. \$7.30

4118 18k Dynamic RAM - as used in just about everything! Cat Z-9310. \$17.00

BUDGET KEYBOARD KIT

Here's value! 80 key computer keyboard, with hayslabbed ready for connection. Each key is separately switched, allowing for virtually any usage. Compare other keyboard prices!



\$39.95

TRS-80 OWNERS:

Save with Dick's TRS-80 18k upgrade kit! Brand new prime spec components, was half the price of Teady's equivalent; NOW REDUCED EVEN FURTHER! That's right - save \$40.00 on our old price, and a massive \$18.00 on Teady's equivalent! Cat X-1188

\$149.50 NOW ONLY \$109.50

BUYING BY MAIL?

It's so easy! Simply list the items you want, with their catalogue numbers and post it off with your cheque to our mail order centre (address at right). Don't forget to include postage and packing charges apply to total order value as per table at right). Then watch your letterbox!

ORDER VALUE:	P&P
\$5 (min) to \$9.99	\$1.00
\$10.00 to \$24.99	\$2.00
\$25.00 to \$49.99	\$3.00
\$50.00 to \$99.99	\$4.00
\$100 or more	\$5.00

NOTE: These charges apply to goods sent by post in Australia only. Large and bulky items cannot be sent by post. If you prefer, we will dispatch your order by Comet Road Freight to anywhere in Australia for only \$6.00 - that's below what it costs us! Large and bulky items are normally sent by Comet unless you specify differently (eg by rail or air - you pay freight on delivery).

extra special SCOOP PURCHASE

We've bought the entire stock from a major manufacturer of these superb hi-fi system cabinets and stands. Finished in a deluxe wood-grain look material, some even have smoked doors on record cabinets, etc. - really smart. They're selling fast, so some models may already be sold out. Hurry in before they all go! Five models, all one price.

(Sorry no mail orders available on this item as there are few different models. Personal shoppers only, while stocks last.)

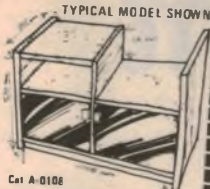

Cat A-0108

5 models to choose from (while stocks last!!!)

\$49⁵⁰

NEW! INCREDIBLY LOUD AUDIO ALARM

You've got to hear this to believe it! It's our shattering Remonally rated at 5 watts, operates from around 5 to 25 volts.

Cat L-7024



BUILDING IC PROJECTS? Use this IC insertion tool. Saves ruined MOS ICs, suits all DIP packages. Plunger action.

\$4⁹⁵

Cat T-4640

AMATEURS Don't forget: Dick Smith will better any genuine Australian advertised price on Yaesu!

RUNNING A BIT HOT? Cool things down with a quality Yaesu fan.



\$29⁵⁰

And you save nearly \$10.00! We've dropped the price - you reap the benefit! 100 watt fan (see top on transistor transformer, or series C direct on 240 volt), approx. 100mm mounting clearance. Keep your gear running cool - and happy! (This fan is also used in the new ET1482 200/300 watt amplifier modules). Cat D-2085

NEED BIGGER FEET?



YAESU FL2100B LINEAR AMP.

\$599⁰⁰

This superb Yaesu linear covers all HF bands, and is rated at a massive 1.2kW (at maximum legal power) it's just cooling - no stress, no problems! Beautifully made for years of reliable service. Final is rugged 5Z7's in a grounded grid. Features front panel adjustable SWR meter, too. Every ham should have one! Cat D-2548.

YAESU OPTIONS:

- MEMORY UNIT** Suits 901/101 allows split frequency operation remembers DSX or other popular frequencies, etc. Very easy to fit. Cat D-2858 **\$149.50**
- DC-DC Converter** Suits 101/901, allows operation from 12 volts DC in the field. Very handy for DXing, etc. Cat D-2856 **\$75.00**
- YD148 DESK MIC** Dual impedance suits just about any transmitter 600 ohms and 50k. Has push-to-talk with lock-down bar for long range chatters. "Professionalist's your shack" Cat C-1118 **\$44.50**

WHAT'S THE TIME?

You can tell at a glance what the time is in any area in the world with this highly accurate time clock by Yaesu. Rugged 24 hour movement, designed to withstand shock, and will keep correct time mounted at various angles. Uses one UM 2.1 V battery with a life of approx. one year. **\$29⁵⁰** Cat X-1054

How many times have you been working on a circuit and needed a specific resistor? Our new resistance wheel dials up the value you want! The handiest thing in your workshop or toolbox!

IDEAL FOR THE EXPERIMENTER 5 ohms to 1 megohm in 38 steps. Cat Q-1410 **\$5.95**

BUYING A COMMUNICATIONS RECEIVER?

Then consider this:

The 'state-of-the-art' in communications receiver design is the famous 'Wadley Loop' principle. This simply is a special circuit which causes errors and drifting in the receiver to be self-cancelling. The result: a better signal. Most of the really expensive (\$1000-\$2000 plus) monitor receivers used by broadcasting authorities throughout the world use the 'Wadley Loop' principle for its inherent reliability. Now Yaesu has brought the Wadley loop into communications receivers in the under-\$1000 price range. Don't be fooled by claims of other receiver manufacturers that their circuits are 'as good as Wadley Loop'. If a receiver hasn't got the real thing - Wadley Loop circuitry - it just isn't in the race. Insist on Wadley Loop!

FAMOUS FRG-7: WADLEY LOOP COMMUNICATIONS RECEIVER



\$319⁰⁰ Cat D-2850

Without doubt, the world's most popular receiver. 0.5 to 30MHz continuous coverage. 10kHz. The Wadley Loop circuit with a mode conversion superheterodyne system guarantees extremely high sensitivity with excellent stability. Has 3 position RT attenuator, auto noise suppression circuit, 3 position tone selector, and can be operated from 240V AC or 12 volts DC. Sensitivity: 0.25uV for 10dB S-N-N (SSB) CW or 0.7uV AM. Selectivity: 3dB at 10kHz bandwidth at 800 and 7MHz at 80dB down.

DELUXE FRG-7000

All the features of the FRG-7 plus! This remarkable receiver has a digital display for highly accurate frequency reading, plus a digital clock displaying either GMT or local time at the flick of a switch. The clock also allows you to turn the receiver on at a later time so you can record a program you might otherwise miss! In addition, this receiver covers all of the MF & HF bands - down to 0.25MHz and up to 27.5MHz. Note: because of the digital display this receiver needs to be operated from 240V AC - but can be operated from 12V if you wish.



\$599⁰⁰ Cat D-2848

BONUS!

Every purchaser of the FRG-7 or FRG-7000 will receive, as a bonus, a copy of Dick's exclusive booklet, written by world-famous short-wave and broadcasting authority Art Cohen, MBE. This explains the controls of the receiver in detail, and how to get the most out of your short wave listening. It is available only from Dick Smith.

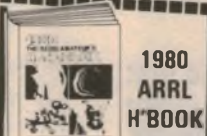

1980 ARRL H'BOOK

The all new 1980 ARRL Handbook, The Radio Amateur's Handbook, is now available. With new sections, new data and new features, this is one volume that every amateur and aspiring amateur should have. Cat B-2218

\$15⁹⁵

ARRL ANTENNA ANTHOLOGY Cat B-2205

\$6²⁵

A collection of the best antenna articles from the ARRL's monthly journal 'QST'. 151 pages of the latest antenna design theory, practices, etc. Also for the serious amateur operator.

HERE IT IS! At long last, Dick has his own laboratory oscilloscope. Check it out - feature for feature it compares favourably with others being offered. Dollar for dollar there is simply no comparison! Save with Dick Smith quality products for the hobbyist and professional!

Vertical Sensitivity: 10mV/division
Horizontal Sensitivity: 500mV/division
Timebase: 10MHz - 100MHz in 4 ranges
Sync: External or Internal
Bandwidth: DC to 5MHz

\$199⁰⁰

Why spend \$300 or more and do you know? Compare the features - and the price! It's been worth the wait!

HOW ARE YOUR MAGS? Magazines are getting pretty expensive - and you'll probably want to refer to them in the future. Protect them with a binder. Easy to insert, stiff covers so your magazines won't warp. Holds up to 12 magazines (size of EA/ETI amateur & motoring mags, etc.).

\$4⁹⁹ Cat B-4045

CAR \$\$\$\$ SAVERS

Both our CD or trans. assisted ignition kits! Keep saving money on your car by keeping it running properly. (Left) this compression gauge tells you if your engine is sick - before damage occurs! Easy to use, way under normal price. Cat A-8508 **\$7.50** (was \$13.50)

(Right) Mean timing light lets you keep ignition timing spot on so you use less fuel and get more power. Connects to No. 1 spark plug, pistol grip for easy use. Cat A-8507 **\$9.95** (was \$13.50)

90¢!!!

NEW! LCD CLOCK/TIMER/ALARM/STOP WATCH MODULE WITH HUGE 8mm LCD DIGITS!

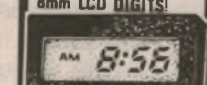

\$17⁵⁰

Incredible sophistication! This component 7 channel digital clock and timer module operates from a single 1.5 volt penlite cell, can be used for a huge range of time and timer projects. Complete on one PCB. Data supplied with unit. Cat X-1050

COMPUTER PHONE DIALLER with 32 number memory!

\$179⁰⁰

It offers all the features of a conventional desk-top calculator - and then some! It's also a push button phone dialler which remembers up to 32 most-used numbers. Very simple installation; operates from a plug-pack adaptor (Cat M 9514 @ \$5.90). Has battery standby (Note: although this unit works perfectly with Australian phones, present regulations do not allow them to be used for this purpose).

PRINTED CIRCUIT CLEAROUT SALE

Our stocktake is over - and we're wildly overstocked on printed circuit boards. So to cut our losses, we've slashed the price of many of them. You reap the benefit of our errors; be quick - some of these boards might run out quickly at these prices!

Cat. No.	Board project description	Was:	Now:
M-8310	650MHz Prescaler (EA)	\$2.50	\$1.00
M-8320	Microamp Memory board (EA)	\$3.75	\$2.00
M-8331	Cassette Interface (EA)	\$3.75	\$2.00
M-8332	Stereo Cassette Deck (EA)	\$3.75	\$2.00
M-8361	Playmaster Twin 10 amplifier (EA)	\$7.75	\$4.50
M-8813	Crankshaft/dot generator (ETI)	\$3.00	\$1.75
M-8802	Tractor PCB Intro in Electronics	\$8.95	\$3.85
M-8894	10 motor/30 watt linear amp	\$8.00	\$3.00
M-8888	80m exciter	\$8.00	\$3.00
M-8888	27MHz/80m Converter	\$8.00	\$3.00

NEW! METAL FILM RESISTORS

For accuracy, dependability and life it's hard to go past metal film resistors. Trouble has been the price! Now back again. Top grade 1/4 watt metal film resistors in values from 10 ohms to one megohm. Outstanding value at only **6¢ ea**. WE EXPECT STOCKS OF THESE RESISTORS IN APPROX 4 TO 6 WEEKS

A FULL RANGE OF QUALITY CAR SOUND

All long last, we have good stocks of all quality car sound components from radios through cassette amplifiers and graphic equalizers. Buy in confidence from Dick Smith, you get top quality gear at the right price. Fully backed with service & spares.

REAL AUDIO COMPM: Ten car amplifier gives 60 watts peak power, simple to install in speaker leads. Beat the road noise. Cat A-8660 **\$49⁹⁵**

AM P/B CAR RADIO A superb Japanese made quality radio with great fringe-area reception. Easy to install. Cat A-5980 **\$45⁰⁰**

AM/FM CASSETTE The best of both worlds. AM or FM radio for when you're close enough stereo cassettes when stereo is not. Cat A-6A90 **\$149⁰⁰**

AUTO REV CASSETTE Brilliant stereo reproduction plus auto reverse facility. No more taking your eyes off the road. Cat A-8486 **\$79⁰⁰**

QUALITY CAR SPEAKERS Not the usual rubbish manufacturers give you. Superior in-car speakers for real hi-fi sound. Cat A-7000 **\$39⁵⁰**

ELECTRIC CAR ANTENNA Not just a pass prevents vandalism and keeps your antenna out of the elements. A very worthwhile investment for any car. Cat A-1360 **\$23⁰⁰**

SURE IT'S SHURE

For stereo reproduction at its best experts choose 'Shure' phone cartridges. You can get the most out of your stereo system with a quality Shure cartridge from Dick Smith.

- Shure M708 cartridge Spherical stylus. For great audio on a limited budget. Cat C-5611 **\$12.80**
- Shure M708J cartridge. For the enthusiast, has elliptical stylus for great performance. Cat C-5612 **\$17.85**
- Shure M91ED cartridge. The best for the genuine audiophile. Also with elliptical stylus. Cat C-5618 **\$35.95**
- Replacement stylus: M708 spherical. Cat C-5032 **\$7.50**
- M708J elliptical. Cat C-5034
- M91ED-elliptical. Cat C-5038 **\$17.50**

DICK SMITH ELECTRONICS

NSW 125 York Street, SYDNEY Ph 290 3377
147 Hume Hwy, CHULLORA Ph 642 8922
162 Pacific Hwy, GORE HILL Ph 439 5311
30 Grosse Street, PARRAMATTA Ph 683 1133
263 Keira Street, WOLLONGONG Ph 28 3800
ACT 96 Gladstone St, FYSHWICK Ph 80 4944

VIC 399 Lonsdale St, MELBOURNE Ph 67 9834
656 Bridge Road, RICHMOND Ph 428 1614
QLD 166 Logan Road, BRISBANE Ph 391 6233
SA 203 Wright St, ADELAIDE Ph 212 1962
WA 414 William St, PERTH Ph 328 6944

MAIL ORDER CENTRE: PO Box 321, NORTH RYDE NSW 2113. Ph 888 3200. PACK & POST EXTRA.

bankcard welcome here

SHOPS OPEN 9AM to 5:30PM (Saturday: 9am till 12 noon) BRISBANE: Half hour earlier

ALL TERMS OFFERED ARE TO APPROVED APPLICANTS ONLY

RE-SELLERS OF DICK SMITH PRODUCTS IN MOST AREAS OF AUSTRALIA.

The centenary of the electric light

Was Thomas Edison its true inventor?

October 1979 marked the centenary of the development of the first commercial electric light globe by Thomas Edison. But the event has sparked off controversy in the technical press as to whether Edison should receive all the credit. This article sheds new light on the subject. It was originally published in a bound volume entitled "Science For All", and was written around 1885.

by T. C. HEPWORTH

The circumstances under which we live are much altered since the time when the curfew bell warned all loyal people to extinguish their fires and lights at eight o'clock pm. The simple lives and habits of our forefathers called for no more labour at their hands than could be accomplished between sunrise and sunset; so that artificial light was to them a matter of secondary importance. But now all is changed. We no longer consider that our day's work is over when darkness comes upon us; indeed, a large proportion of the population are more busy during the night hours than at any other time. Hence, the possession of some reliable and effective means of procuring artificial

light becomes almost as much a necessity to us as our daily bread.

Oil-lamps and candles were the only sources of light available until the beginning of the present century, when gas was first introduced. Its adoption met with great opposition, and lecturers in all parts of the country proclaimed the direful effects that would follow its employment. The antagonistic feeling thus aroused may be compared to the strong prejudice previously evinced against the use of its parent, coal, as a fuel. Only two hundred years ago the citizens of London petitioned Parliament to forbid the burning of coal in the city, "on account of its stench". But the threatened

failure of the wood supply helped them to forget their objections, and coal soon became the principal source of artificial heat, as it, has since become our chief means of obtaining light.

Now, although gas represents a vast improvement on all previous modes of illumination, we are far from being altogether satisfied with it. It often contains impurities, which are not only prejudicial to health, but are most destructive to property. In fact, we want something purer and more wholesome. How common it is to hear the remark, "I must examine this or that by daylight before I can judge of it." Is not this an acknowledgment that our present resources are not equal to our requirements? That gas will be immediately supplanted is very improbable, but we hope that the day is not distant when some better means of illumination will be vouchsafed to us. Many circumstances have taught us to look for this boon to the magic power called "electricity."

Candles and lamps have become such common things of our every-day life that there is no sort of mystery about them, or, at least, about their composition. We all know that a candle is made of wax or animal fat, and that it has a cotton wick. These are things which we can see and touch, and which we can readily trace to their sources of production. In electricity we have a very different thing to deal with, for in character it partakes of nothing with which we are familiar. Invisible, neither solid, liquid, nor gaseous, we regard it as an intangible something in which we must believe in spite of ourselves, for we have constant evidence of its marvellous powers. Our present object

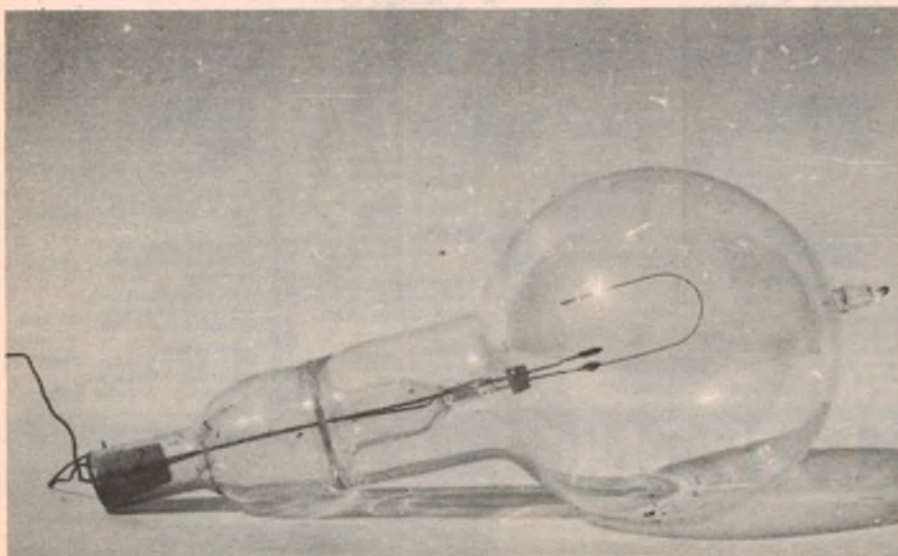

A replica of Edison's original successful lamp of October, 1879. This particular lamp was made in the USA for the 50th anniversary of Edison's invention in 1929.

is to explain how this wonderful natural agent can be made to afford light.

Without detailing the many theories which have been advanced to explain electrical phenomena, and avoiding such elementary points as can be obtained from all the excellent text-books on the subject now published, we shall prefer to plunge headlong into the matter, with the statement that there are two methods by which we can produce an electric light. (1) By the current afforded by a battery, and (2) by that obtained from a magnetic machine. For experimental purposes, or where a light is required for some special service for a short time, a battery can be employed.

The form of battery suitable is that known as a Grove battery, or in its modified form known as Bunsen's. The first form of cell consists of an earthenware or ebonite vessel, holding a bent zinc plate immersed in water, rendered acid by the admixture of about one-eighth part of sulphuric acid. Held within the embrace of the U-shaped zinc plate is a porous pot full of nitric acid, within which is a piece of platinum foil. The Bunsen battery exhibits the same arrangement of parts and the same fluids, but the platinum is represented by a plate of carbon. To obtain a powerful light, at least fifty of such cells must be employed, joined up in such a manner that the zinc of one cell is in contact with the platinum or carbon of the next. From the last carbon of the series, as well as from the last zinc at the other end of the row of cells, a wire is led off for use.

Upon bringing the free ends of these two wires together, a brilliant spark is seen, and the copper of which they are composed becomes sensibly heated. By furnishing each end with a pointed piece of carbon, by means of the simple piece of apparatus shown at Fig. 1, we can obtain the electric light. A few particulars regarding the use of this little contrivance will be necessary, if we wish to understand the conditions which have to be met in the construction of electric lamps or regulators.

In the first place, there is no light until the carbon points actually touch one another. Then, and only then, they begin to glow with intense heat. They can now be separated for a short distance, and although separate, a most brilliant light is maintained between them. This "arc," as it is called, will remain until the carbons waste away to such an extent that they are too far apart to be longer bridged over by it. It now becomes necessary to bring the points once more together before the arc can be re-established. One more circumstance is noticeable, and that is, that one carbon wastes away twice as quickly as the other.

The article then goes on to describe how a dynamo works and, in particular, describes machines developed by Gramme and Siemens. We resume the

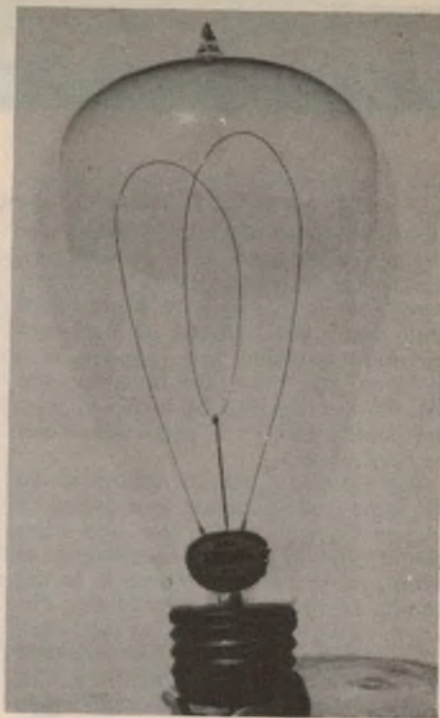
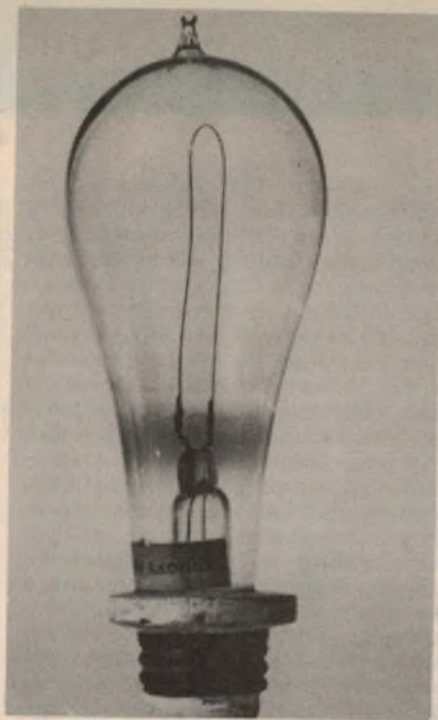

1881 Edison lamp (left) and Edison lamp of 1910 (right).

story where the author takes up the development of incandescent lamps — Ed.

The arc form of electric light is so extremely brilliant that its use is almost confined to the illumination of large open spaces, and we may feel quite certain that if there were no other method available, we should hear very little of the fear that gas would cease to be used for domestic lighting. By means of what is known as the incandescent system, electric lamps, giving a beautifully soft but brilliant light, can be made of from five to twenty-five candle-power. To understand this system we must once more glance back at a simple battery experiment, which can easily be performed with half-a-dozen Grove or Bunsen cells.

If the terminal wires from such a battery are bridged over with a piece of thin iron binding wire about eight inches in length, it will get redhot, owing to the resistance which it offers to the passage of the current, and will eventually fall to pieces in a shower of brilliant sparks. A platinum wire will behave in much the same way, but it

will hold together far longer than the iron, being a much more refractory metal; indeed, if the length of the wire be carefully adjusted to the strength of current available, platinum can be kept at a white heat for some time. During this period of incandescence the little wire will give out a wonderful light, but sooner or later if falls to pieces, owing to the action of the atmosphere upon it. We may substitute for the iron or platinum wire in this experiment an extremely thin pencil of carbon, but with the same result. Although it will afford a brilliant light for a certain time, it will soon fall to pieces.

It will be readily seen that to any one in search of an improvement upon the usual means of obtaining an electric light, the experiment just detailed must have been a most suggestive one. That it was so is proved by the numerous patents which were taken out about thirty years ago, which detailed methods of obtaining light by the incandescence of metals or carbon in the way described. These early inventors saw that the enemy they had to guard against was the air. So in these pioneer

Basic scheme for the arc lamp

Fig. 1: the basic idea behind the arc lamp. The two carbon rods must first be brought together and then separated by a short distance so that an arc is maintained between them.

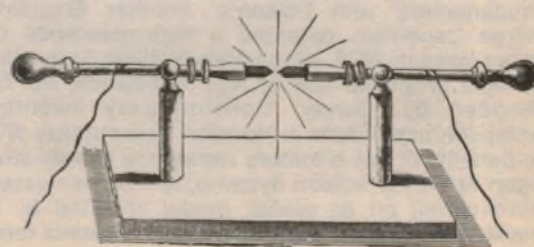

Thomas Edison: inventor of the electric light?

lamps we find that the platinum or carbon employed is enclosed in a glass globe exhausted of air, or in some cases charged with a gas such as nitrogen, which is quite inert. The first of these inventions is that of E. A. King, dated 1845, who used a ribbon of platinum-foil held between two supports in a globe of glass. In a later invention the platinum is replaced by a stick of carbon contained in a glass vessel exhausted of air.

The following year lamps on much the same principle were introduced by Messrs Greener and Staite, and their patent specification is noteworthy as being the first to call attention to the quality of the carbon employed. The rough carbon from the gas retorts had been exclusively used for electric lighting purposes up to this time. The material is full of impurities, which give rise to irregularities and other difficulties. Messrs Greener and Staite recommend the employment of specially manufactured carbon, made of lamp-black purified with acid, and moulded under pressure. The importance of this innovation may be estimated when we state that in the present day the manufacture of carbon pencils for electric lighting purposes constitutes a distinct branch of trade, for only manufactured carbon is now employed.

By the year 1871 lighting by incandescence had reached such a forward place in the estimation of many, that a company was formed at St Petersburg for its installation on a large scale in that city. In the result no fewer than 200 lamps were exhibited on one electrical circuit. The machine used was of the "Alliance" pattern. The excitement which this installation caused may be likened to that which we have more than once seen within recent years as improved lamps or machines have been brought forward. But the scheme altogether collapsed, and we may say that lighting by the incandescent system was altogether forgotten until a few years back, when Edison commenced experiments in the same direction. He began by using platinum wires enclosed in a vacuum, and he was more fortunate than his predecessors in having an air-pump at his disposal — such as that of Sprengel — which gives far more perfect results than those of older pattern.

Edison was the first to study the curious and important phenomenal changes which occur in platinum wire when subjected to heat. The metal contains gases which, if the heat at first applied be above a certain temperature, is expelled with such violence as to split up its surface; so that in preparing the platinum wire

used in his first form of incandescent lamp, the following procedure became necessary. The platinum wire, enclosed with a glass bulb in connection with the air-pump, was subjected for about ten minutes to a current tending to raise its temperature to 150°F. This moderate heat expelled the gases, which were drawn off by the air-pump kept in action the whole time. After a quarter of an hour's rest the heat would be raised to 300° for another short period. With like intervals of rest the heat was gradually raised to incandescence, with the result that a wire which before such treatment would give a light of only 3-candle power before it melted away, would now afford one of 25-candle power without risk of destruction.

Edison next turned his attention to "carbon wire," and he found that it needed the same treatment before it was fit for permanent use — becoming very homogeneous and hard. After trying cotton-thread, and various carbon compounds rendered plastic and rolled out into wire, he came to the conclusion (at least, so says one of his patent specifications) that the carbon used should preserve its structural character, either cellular or otherwise. After experimenting with fibres of jute, bast, manilla, hemp, &c, he chose bamboo, as being, on the whole, the best for his purpose, and of that material the car-

Edison — "a skilled practitioner of systems"

In an article in the February 1979 issue of IEEE "Spectrum", Christopher S. Derganc, a Ph.D student at the University of Pennsylvania, describes Edison as "a skilled practitioner of systems engineering, not the tinkerer of legend."

According to Derganc, "Edison's single, immense contribution to the field of electric lighting was his ability to locate, assimilate, and then synthesise state-of-the-art science and technology into an economically feasible system. This was the key to his success". He goes on:

"Edison made no revolutionary breakthroughs in electric-lighting technology. Joseph Swan, an English inventor, produced a high-resistance carbon lamp almost simultaneously with Edison's. Another Englishman, St. George Lane-Fox, patented a high-resistance platinum-iridium lamp in 1878. Albon Man (William Sawyer's partner) had also proposed use of high resistance, but had been overridden by Sawyer. Contemporary inventors Elihu Thompson and Edwin J. Houston had publicly announced the benefits of low armature resistance shortly after Edison began work; the Edison dynamo, in fact, was essentially an improvement on an earlier model invented by Siemens. Finally, Sawyer and Man anticipated Edison's feeder-main design by almost two years."

Derganc describes how Edison with assistance from Grosvenor P. Lowrey (general counsel for Western Union and Edison's longtime friend and advisor) set up a well-equipped laboratory at Menlo Park, Calif. using funds supplied by such people as William H. Vanderbilt and J.P. Morgan, the controlling interests in Western Union. The result, says Derganc, "was one of the best and most versatile electrical laboratories in the world, a facility not unlike the modern industrial research laboratory in its reliance upon machine tools and scientific instruments."

The laboratory was also well staffed . . . "In the early phases of the project, he (Edison) maintained an intimate working and personal relationship with his relatively small group of some 30 assistants, of whom perhaps half were actively involved in the work on lighting. After the essential system components had been invented and work had progressed to the development stage, the staff were enlarged to perhaps as many as 100 and a hierarchal management structure was established".

One concludes, from reading Derganc's article, that Edison's genius lay in directing his research staff to make the electric light a viable commercial proposition. His laboratory not only produced successful lamp and dynamo designs, but ensured their commercial success by inventing or improving various auxiliary devices such as meters, lamp

bon loop in the modern Edison incandescent lamps is made. Let us briefly describe its preparation.

A bamboo rod is cut to the length required, divested of its hard siliceous coat, and split into six pieces, each one of which is reduced in thickness until its diameter is not much greater than a horsehair. Each thread of bamboo is then placed in a mould formed by cutting a U-shaped depression in a plate of nickel, another plate of the same metal covering it over. The mould is then placed in a muffle, and subjected to such a heat that the horse-shoe-shaped fibre is carbonised. It is then placed in a glass bulb in connection with an air-pump, and is gradually coaxed into order in the way already explained.

The two ends of the horse-shoe carbon thread are fastened to platinum wires which are sealed into the glass, and the ends of these wires form conductors for the electric current. One is in connection with a kind of outer collar surrounding the foot of the lamp, and the other is fastened to a screw socket. The mere act of screwing a lamp to its fittings places it at once in electrical communication with the supply.

Swan, in England, claims to have made incandescent lamps upon this same principle many years ago. He does not hold to Edison's opinion that the carbon employed should possess

structure, for his lamps contain cotton-thread loops which, previous to carbonisation, have been "parchmentised" by immersion in sulphuric acid. That they answer their purpose most efficiently is proved by the fact that they have been in use for many months without requiring renewal — all this time giving the most satisfactory results in every way. Maxim, and many others, have introduced lamps on the same principle, with slight variations of treatment, which have been sufficient to give them the protection of the Patent Office.

The principal public "installations" of the incandescent system in this country have been at the Savoy Theatre, London, which is entirely lighted by Swan lamps; at the International Fisheries Exhibition, 1883, where more than one thousand were seen on one circuit; at Holborn Viaduct, which thoroughfare, with the houses adjoining, has been lighted by Edison's lamps; and at the Electrical Exhibition at the Crystal Palace, where the suitability of the system both for public and private use was most successfully demonstrated.

To Edison must always attach the credit of having been the first to serve entire streets with a supply of electricity for lighting purposes in lieu of gas. The details which he has worked out with regard to fittings, conducting cable,

switches for turning the current on and off, much in the same way as people have been accustomed to in turning gas on and off, besides meters for measuring the amount of current utilised by each consumer, exhibit the greatest ingenuity and constructive ability. To the meter especially we may devote a few words.

The amount of electricity used by each house-holder is measured by the amount of metal deposited upon zinc plates in a special form of cell attached to the fittings. The collector exchanges these plates for new ones, and takes them to the chief office, where they are carefully weighed. The difference between their original weight and that now indicated gives the exact amount of metal which has been deposited by the action of the current, and from this sum the total amount of electricity supplied to the consumer can be accurately gauged. Another slightly more complex method of arriving at the same result is exhibited in Edison's continuous "current counter," where dials, after the manner of a gas-meter, show the amount of current which has been used. The Edison Company fix their unit at the quantity of electricity which will give a light equal to that produced by the combustion of one cubic foot of gas, so that the three familiar dials can be still employed.

engineering"

sockets and bases, switches and fuses. Says Derganc:

"Edison timed his entry into electric-lighting research almost perfectly. Most of the ideas and concepts necessary for a commercial system were either already available or about to emerge from the expanding research front. It was Edison's wide-ranging approach to invention — his inventive style, if you will — that allowed him to bring them into focus."

Conceptual difficulties

Derganc's article also highlights one of the major conceptual difficulties that confronted early researchers of electricity. The problem of the "subdivision of light" — or, more accurately, the subdivision of current — was a topic of heated debate among scientists and engineers in the late 1870s. The prevailing opinion was summarised by Sir William Preece, a noted English engineer, during a speech to the Royal United Service Institution in February 1879:

"Theory shows unmistakably that to produce the greatest effect we must have only one machine (dynamo) to produce one light . . . But the moment we attempt to multiply the number of lights in circuit this power diminishes . . . It is . . . easily shown (and that is by the application of perfectly definite and well-known scientific laws) that in a circuit

where the electromotive force is constant . . . a subdivision of the electric light is an absolute *ignis fatuus*."

The fallacy of this argument obviously lies in the assumption that only a fixed amount of current is available. Early dynamos employed a high-resistance armature and so behaved as constant current generators with very poor voltage regulation. This meant that, as additional lamps were added in a parallel circuit, each lamp was progressively dimmed.

It was this characteristic of early generators that misled the researchers. They thought that all dynamos would produce a constant current, regardless of their construction and the electrical circuit connected to them.

Edison was among the first to realise that this was not the case. The problem of the subdivision of light could be overcome simply by employing a constant voltage generator having a low internal impedance and by using relatively high impedance lamps. The amount of current drawn from the generator would vary, depending on the number of lamps connected across the circuit (i.e. the electrical load). The generator would not "squeeze out" a fixed amount of current for all load conditions, as Preece and others had thought.

With acknowledgement to IEEE "Spectrum", February, 1979.

3DA

What the term signifies

If you've been thumbing through Technics literature of late, you may well have come across the term "3DA". If you've been wondering what it's all about, the following explanation may help.

While hifi manufacturers are relying as much as ever on cosmetics and gimmicks to sell their latest products over recent years they have had to back their marketing ploys with an intense engineering effort covering initial design, quality control and performance testing.

In the process, they have had to go far beyond traditional audio instrumentation and techniques in an effort to convince would-be customers that their latest amplifier (or other device) will perform as impeccably on actual music as it appears to do on instrument-generated signals.

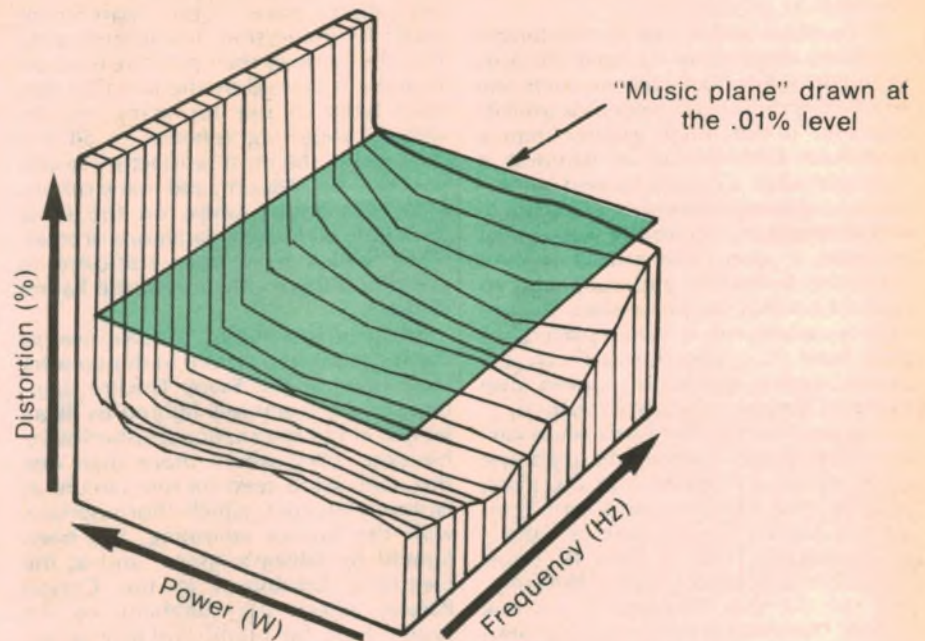

by
**NEVILLE
WILLIAMS**

When amplifier parameters are plotted separately (bottom curves) it is difficult to see exactly how they interrelate over the whole dynamic area. The problem is overcome by bringing them together in a pseudo 3D plot.

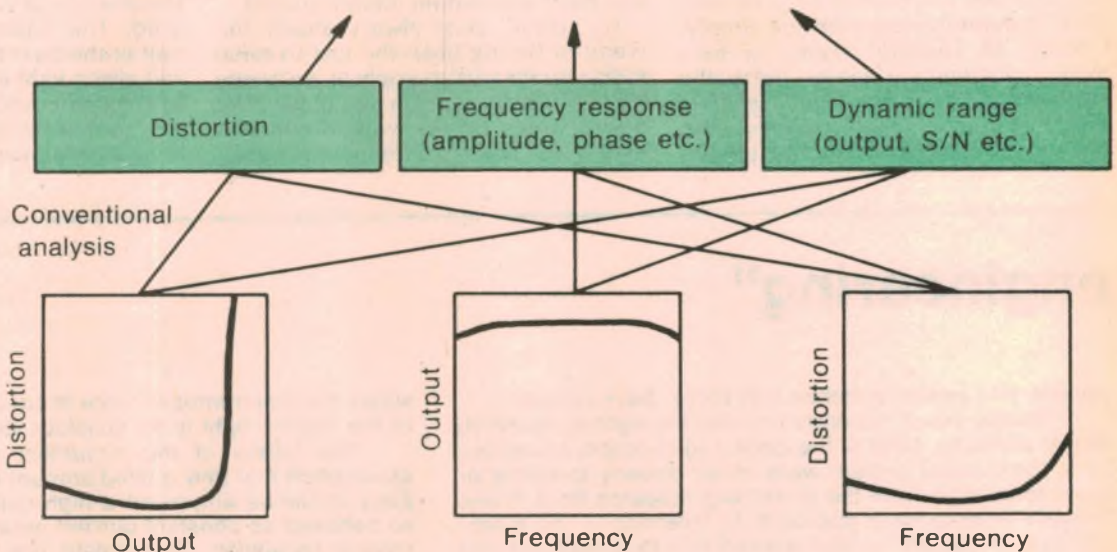

Facing heavy competition, most major manufacturers have up-graded their designs and procedures along parallel lines. The relative importance of the various refinements is open to some debate but, certainly, little is being left to chance in amplifier design at least.

It is one thing, of course, to perform a lot of tests; it is quite another to present the information in a way which will be comprehensible and convincing to hifi dealers and the buying public. Tables of data can too readily dissolve into a blur of figures, while multiple graphs are quite daunting to those not accustomed to them.

That's where Technics' concept may well score.

Looking at multiple graphs, intended to correlate power output, frequency response and distortion, Technics engineers realised that they could be combined into a single simulated three-dimensional presentation, with the aid of modern computer graphics techniques. As such, they would be seen by the viewer as a shape or a contour, and interpreted as being generally good, bad or indifferent.

So, in collaboration with the Hewlett-Packard Corporation, Technics engineers devised a system which would accept data from an amplifier

test set-up (including a spectrum analyser) and plot a "3D" diagram correlating vital parameters:

- Power output from 200 milliwatts to above the rated figure;
- Frequency response from 10Hz to 100kHz;
- Distortion above 0.0001%, involving components to 1MHz.

A rack full of equipment is involved plus a graphics display unit and a hard printer. During the course of one run, some 4000 reference points are taken, each representing a particular combination of frequency, power level and distortion.

A typical "3DA" plot is shown in the accompanying diagram. With it, engineers had a graph which they could read in as much detail as they might require; sales-technical staff had a diagram which they could explain readily enough to would-be customers; and copywriters had a term which offered just about the right amount of mystique!

In explaining the diagram, Technics engineers point to zone A, which shows low distortion at the lowest frequencies over the whole power range — a tribute to power supply design and to the use of DC coupling wherever possible.

Zone B, with low THD (total harmonic distortion) over the frequency range, with very low output, is only possible because of good signal/noise ratio.

The smooth characteristics in zone C indicate freedom from spurious coupling at high frequency and high power levels, while sustained power and low distortion at extreme frequencies mean that there are negligible slew rate limitations.

But, in general, if it is possible to draw a plane at 0.01% THD, or some other very low level, above which distortion never rises under any condition, the amplifier should indeed behave impeccably with any likely program input.

In discussing the wealth of information in such a 3DA graph, Technics stress the potential limitations of any amplifier for which power vs distortion plots are available at only spot frequencies within the normal audio passband.

With modern signal sources, they say, or with those in the immediate off-frequency, very high amplitude and very high

ISOLATING SUBTLE DISTORTION

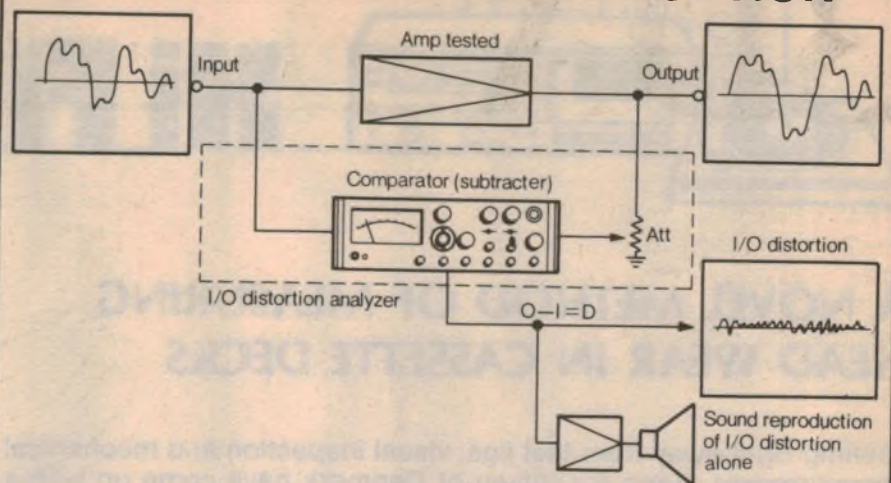

While Technics engineers are satisfied that the 3DA will reveal the strength and weaknesses of an amplifier, they have anticipated the criticism that it uses instrument-generated signals rather than live program material. As a back-up, therefore, they have done parallel work on what they call "I/O Distortion Analysis" or input/output transfer distortion. As illustrated above, actual program signals are fed to the amplifier under test and a sample of its output is used to cancel the original signal in a comparator-subtractor. The difference signal can be viewed on an oscilloscope, or reproduced on a loudspeaker to evaluate its audibility and subjective effect. The frequency response of the comparator input is tailored to match exactly that of the amplifier, all other differences being regarded as distortion. The method can expose THD levels above .001%.

frequency transients can be presented to the amplifier input. It is vitally important that they do not overload the amplifier. Even though the transient itself may be inaudible to an ageing listener, or completely outside the

audio spectrum, the disturbance caused by an overload may be evidenced in other ways. A uniform power capability over an extended frequency range must therefore be considered as highly desirable.

Another distinct possibility is that the rise time of a transient may be shorter than the response time of the negative feedback network(s) present in most amplifiers. In such a case, the overload can be gross, because the amplifier responds with its full intrinsic gain, undiminished by feedback. However, if it can be shown to handle signals easily up to 100kHz, the chances of its being upset by transients from within the audio spectrum are remote.

These desired characteristics are indicated when a "3D" plot reveals a wide plateau where the distortion remains low at all power levels up to clipping point and for all input frequencies up to 100kHz. Technics engineers claim that research has shown that, in such cases, the amplifier can be relied upon to have very low transient intermodulation distortion (TIM) and excellent slew rate characteristics — both a measure of its ability to cope with difficult program material.

And, true to the traditions of the hifi industry, Technics have coined a term for this plateau.

If their term catches on, future hifi buyers will not be concerned just about a flat frequency response.

They'll be insisting on a flat "music plane"!

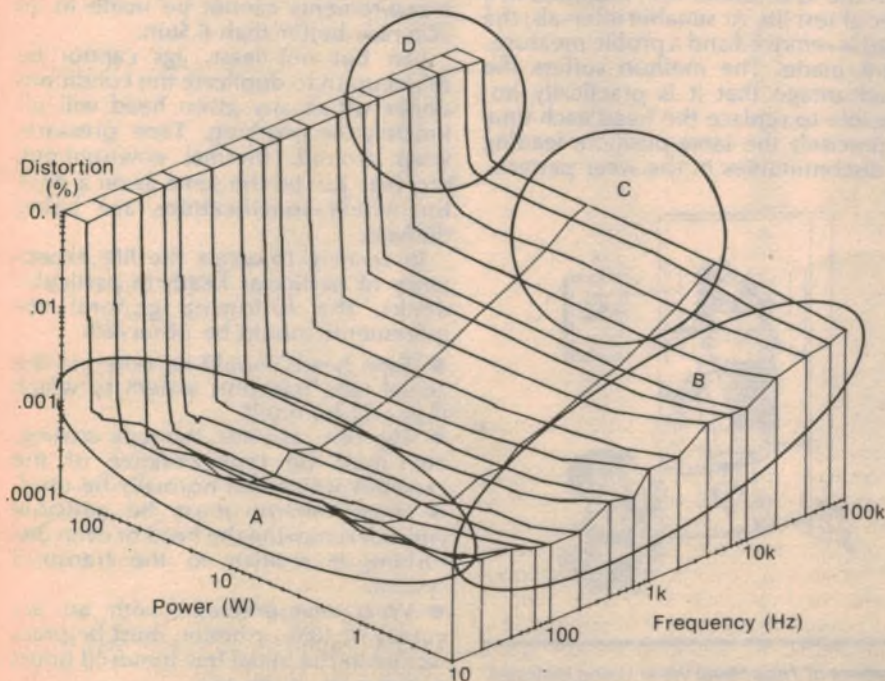

A 3DA plot of the Technics SU-8099 amplifier. A plane drawn at the 0.01% THD level, as in the lead illustration, would show that the THD would never rise above this plane under any likely signal condition, up to actual overload.



Hi Fi Topics

A NOVEL METHOD OF MEASURING HEAD WEAR IN CASSETTE DECKS

Getting right away from test jigs, visual inspection and mechanical measurement, Bang & Olufsen of Denmark have come up with a new and precise method of measuring tape head wear, involving radioactive isotopes. The following article has been adapted from an engineering* paper prepared by Jorgen Selmer Jensen.

It is a well known fact that mechanical wear sets a limit on the length of time a tape head may be used, before its performance begins to deteriorate markedly.

Many factors influence head wear, including the configuration of the deck (pads, pressures, etc), geometry of the head itself, the kind of tape used, tape speed, relative humidity, etc. However, the most important single factor is usually considered to be the material of which the head itself is made; the greater the "hardness" of the gap face, the less rapid will be the wear.

With the development of heads made from "ferrite" based materials, it was commonly assumed that head wear had been reduced to an acceptable level. However, attempts to translate this assumption into firm product specifications have served only to emphasise how broad it is, with manufacturers' estimates of head life varying widely from very conservative to the very optimistic. Or so it would seem!

As a general observation, hardness cannot be considered in isolation from other characteristics. In fact, cassette recorders can present special problems with ferrite heads, particularly when the same head is used for recording and replay. Ferrite tends to saturate rather easily and, if a sufficiently narrow gap is used for good replay characteristics, the ferrite material may saturate, during recording, before the particles on the tape. Chromium dioxide tape makes greater demands on the

head than the ferric variety, with the new metal tape posing an even greater problem.

New head materials are being introduced to alleviate these problems, along with new tape coatings and new transport systems — all having a potential effect on head life. This being the case, there is a clear and continuing need for an accurate method of measuring wear, not just to indicate actual life, but also the pattern of wear during the useable period.

The usual method of measuring head wear is to allow tape to run in contact with the head under test, mounted in a special test jib. At suitable intervals, the head is removed and a profile measurement made. The method suffers the disadvantage that it is practically impossible to replace the head each time in precisely the same position, leading to discontinuities in the wear pattern.



SUMMARY

A method is described for measuring wear on tape heads, based on implanting a radioactive isotope in the gap region. By measuring radiation, rather than a mechanical parameter, an analysis of the wear pattern as a function of time is obtained, with an order of accuracy of 10% on a 300-hour scale. The method allows indication of the transition from an initial wear period to the stable wear pattern. From such figures, it is possible to predict the necessary period of usage, before stable tape head specification measurements may be made.

Again, inaccuracies in measurement arise due to physical handling or thermal change. In any case, profile measurements cannot be made to an accuracy better than 0.5um.

Last but not least, jigs cannot be relied upon to duplicate the conditions under which any given head will ultimately be working. Tape pressure, wrap around, thermal environment, etc, may not be the same as on a deck for which specifications are being derived.

In seeking to assess the life expectancy of particular heads in particular decks, the following general requirements should be observed:

- Tape heads should be tested in the actual tape transport system to which they will be fitted.
- The test cassettes, the tape coating, etc, must be representative of the cassettes which will normally be used.
- Measurement must be possible without removing the head or even disturbing it relative to the transport system.
- Wear measurement, with an accuracy of 10% or better, must be practicable in the initial few hundred hours of the start of the test.

In an effort to satisfy the above requirements, the B&O research team decided to "label" the immediate gap

The original paper was entitled "Accurate Measurement of Tape Head Wear Using Isotopes" by Jorgen Selmer Jensen. It was made available to "Electronics Australia" by B&O distributors in Australia: GRD Group Pty Ltd, 698 Burke Road, Camberwell, Vic 3124. Phone (03) 82 1256. A parallel paper appeared in the Journal of the Audio Engineering Society for May 1979, Vol 27, No 5.

We've got news for you!



How many times have you seen build-it-yourself electronic and hi-fi kits and thought: 'No way could I build anything like that!'

NOW YOU CAN!

All of our Playmaster hi fi kits come with a highly detailed, step-by-step instruction manual - with far more constructional details than you'll find in the magazines. If you can hold a soldering iron and read simple English you can build one of these kits (yes, we even show you how to solder!)

And just in case you run into difficulties, there's our exclusive 'Sorry Dick, it doesn't work' repair coupon which allows you to have your kit repaired in our service centre for a token fee.

Plus our 7 day satisfaction guarantee: examine the kit, read the instructions - then if you feel the kit is beyond you, return it within 7 days for a full refund!

What have you got to lose?

And you'll save hundreds of dollars by doing it yourself.

Compare commercial equivalents: they're hundreds of dollars dearer. And each Playmaster audio component is perfectly matched - electrically and aesthetically - to the others in the series.

As we've said before: 'They look so good and work so well your friends won't believe you built them!'

Superb Playmaster Speakers

Just a couple of hours of your labour - and you'll have a set of speakers to be proud of. The hard parts are done for you: all woodwork is ready to fold together and glue. Rebates for the speakers are cut. The wiring is supplied in a no-soldering colour coded loom: just push the lugs onto their terminals!

Your choice of three superb systems to cater for any size system; any size room. Each box is finished in an attractive imitation walnut veneer, they look so good you don't even have to fit the beautiful sculptured acoustic foam grilles supplied.

Designed by Neville Williams, Editor in Chief of 'Electronics Australia'.

3-75L 12" 3-WAY SYSTEM

75 litre cabinet, with 12" bass driver. Has tone controls, too!

\$284.00 pr

3-53L 10" 3-WAY SYSTEM

53 litre 'mid sized' cabinet, 10" bass driver. 3 speakers

\$224.00pr

3-26L 8" 3-WAY SYSTEM

Smaller 26 litre enclosure suits flats, etc. Ideal for budget systems, too.

\$149.50 pr



Playmaster hi fi components

The perfect partners for your Playmaster speakers: a Playmaster amplifier, or a Playmaster tuner. Or tailor your sound to suit your environment with a Playmaster graphic analyser and equaliser. All with the quality of design you'd expect from Australia's largest selling electronics magazine.

Each of the Playmasters was designed by Leo Simpson, Technical Editor of Electronics Australia. And with the exclusive features added by Dick Smith Electronics - like bronze anodised front panels, matching imported knobs, plated chassis, etc etc, your Playmaster will be a winner!

Playmaster Forty Forty Stereo Amplifier:

Very simple to build, performance equal to amplifiers two and three times the price!

Cat K-3411 **\$129.50**

Twin Twenty Five:

Don't need so much power: try the twin 25. 25W rms per channel; ideal for compact speaker systems.

Cat K-3410 **\$105.00**

Digital Tuner/Clock

Superb AM and FM tuner with digital readout; plus clock. The tuner module is pre-built!

Cat K-3494 **\$129.50**

Graphic Equaliser

Have your sound the way YOU want it. Easy to build kit gives you 'tailor made' response!

Cat K-3500 **\$99.50**



NOTE: All units shown with optional walnut vinyl veneer sleeve: Cat H-3113 **\$8.50**

NOW: A PLAYMASTER GRAPHIC ANALYSER

Two projects in one. Analyser lets you set up the system to best possible standard (use with graphic equaliser); also doubles as power output meter. Leds flash in sympathy with music according to level (up to 400 watts!) Get the most from your system: and impress your friends!



Cat K-3510

\$99.50

GO ON - HAVE A GO: YOU CAN DO IT!





DICK SMITH ELECTRONICS



SEE OUR OTHER ADVERTS IN THIS MAGAZINE FOR OUR STORE ADDRESSES AND RESELLERS

fact: a Genuine Shure upgrade stylus is unquestionably the biggest bargain in hi-fi

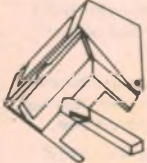
We strongly urge you to check your stylus for wear at least once a year to protect your records and maintain the highest standards of listening pleasure. Regardless of when (or where) you purchased your Shure cartridge, there is a Genuine Shure replacement stylus available which will bring your cartridge right back to its original specifications. Even better, *you may actually be able to improve its performance significantly over the original* with a Genuine Shure upgrade stylus... at surprisingly low cost! For example:

IF YOU OWN:	UPGRADE WITH:	THIS IS THE RESULT:
 <p>V15 Type III SERIES</p>	<p>VN35HE Hyperelliptical stylus</p> 	<p>A dramatic reduction of harmonic and intermodulation distortion (formerly available only to owners of the incomparable V15 Type IV) is now possible with the V15 Type III and the M95 Series of cartridges simply by replacing the stylus. The Hyperelliptical stylus configuration contacts the record groove in a "footprint" that is longer and narrower than the popular Biradial tip design, making it pre-eminent for reproduction of the stereo-cut groove.</p>
 <p>M95 SERIES</p>	<p>N95HE* Hyperelliptical stylus</p> 	
 <p>M70 SERIES</p>	<p>N72EJ Biradial (Elliptical) stylus N72B Spherical stylus</p> 	<p>Improved trackability, especially at high frequencies, due to a new, redesigned low-mass N72 stylus assembly.</p>
<p>ANY M91, M92, M93</p>	<p>N91ED* stylus</p>	<p>Much improved trackability due to the lower effective tip mass of the nude Biradial (Elliptical) stylus tip. Less tracing distortion compared with a Spherical stylus tip.</p>
<p>ANY M71, M73, M75</p>	<p>N75 TYPE 2* Series styli</p>	<p>Improved trackability at higher frequencies due to a stylus assembly with a lower effective tip mass.</p>
<p>ANY M44 Series</p>	<p>N55E* stylus</p>	<p>Lower tracking force with a Biradial (Elliptical) stylus, lower distortion, lower effective tip mass.</p>
<p>M3D, M7D</p>	<p>N21D* stylus</p>	<p>Improved performance at lower tracking forces.</p>

* Before purchasing any replacement stylus be certain your turntable is compatible with the tracking force of the stylus you select.

**Always insist on a Genuine Shure replacement stylus.
Look for the name "Shure" on the stylus grip.**

Genuine Shure upgrade styli by

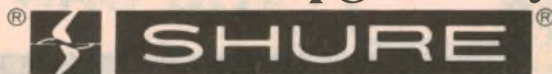

AUDIO ENGINEERS P/L
342 Kent Street,
SYDNEY 2000 N.S.W.

AUDIO ENGINEERS (Vic.)
2A Hill Street,
THORNBURY 3071 Vic.

AUDIO ENGINEERS (Qld.)
51A Castlemaine Street,
MILTON 4064 Qld.

ATHOL M. HILL P/L
33 Wittenoom Street,
EAST PERTH 6000 W.A.

area by implanting a radio-isotope and relying on radiation detection equipment to indicate the progressive reduction in radiation with progressive wear.

Radioactivity provides a particularly useful measurement tool in cases where the amount of material removed by wear amounts to only fractions of a micron.

In the present study where several materials of varying composition were tested, neither neutron activation, nor the production of radioactivity by nuclear reaction were appropriate. Since the object was to measure the wear properties of the magnetic material on only a small area of the tape head, it was decided to label this area by ion implantation of radioactive atoms and, by measuring the loss of radioactivity from the surface, to evaluate the amount of material removed during operation of the tape recorder.

Krypton-85 was chosen as the radioactive tracer because it is an inert gas and escapes when the material in which it is embedded is lost through wear. The half-life (10.6 years) is sufficiently long, requiring no correction due to radioactive decay, and the 670-keV gamma ray is easily detected by a 7.5mm sodium-iodide crystal without removal of the head from the recorder mechanism.

A mixture of stable krypton isotopes and the tracer was introduced into the ion source of the 60-kV isotope separator at the University of Aarhus. Ion beams of the tracer isotope and the stable isotopes with an energy of 60-keV were allowed to impinge on the samples to be "labelled".

Due to the small target area, it was necessary to devise a system of "mapping" and masking to ensure that the radioactive area, for each head tested, lay within the tape contact area. (The technique is described in the original paper).

EIGHT TYPICAL HEADS

Altogether, eight types of head (two of each type) were implanted, making 16 in all. They were tested in decks of the dual-capstan closed-loop type, operated in an ambient of 22C and a relative humidity of 29%. Temperature rise at the surface of the head was 15C. Standard commercial cassettes were used (BASF C-90 Cr02) operating at 4.76cm/sec. Cassettes were turned over each 10 hours and changed each 20 hours. At regular intervals, the decks were moved into a lead-shielded cabinet and radiation from the head measured by means of a gamma counter at a distance of 19cm.

Allowance had to be made for the density law of the implant, ambient radiation, etc, in order for the raw radiation readings to be converted into rate-of-wear graphs for the various head materials (Details in the original paper). In all, however, the general approach was vindicated as entirely valid.

New Ferrograph models for open reel and cassette



Pictured above is the handsome new Ferrograph "Logic 7" open-reel tape recorder. Produced in England by Neal-Ferrograph, the Logic-7 can broadly be described as a 3-head, 3-motor, 3-speed recorder, with line and microphone mixing, master control, bass and treble controls, full monitoring facilities and variable bias. The "High" speed version provides for 38, 19 and 9.5cm/sec; the "Medium" version provides 19, 9.5 and 4.76cm/sec; "Low" goes down a further step to 2.38cm/sec. Half-track and quarter-track stereo versions are available, with or without in-built power amplifiers and loudspeakers. Dolby-B noise reduction is a further option. The touch buttons give smooth and foolproof control over tape traverse and spooling, with appropriate interlocks. Dimensions, with lid, are 515mm(w) x 445mm(h) x 255mm(d) and weight is 26kg.

Pictured below is the new Neal stereo cassette deck model 302. Designed for either studio or domestic use, it employs a heavy duty 3-motor drive system, with IC control and operated by solenoids. Meters are peak reading and include the effect of pre-emphasis on record mode. They can be switched to indicate the level at which the bias is set; also for signal level calibration in connection with an internal oscillator. Dimensions are 446 x 226 x 155mm.

For further details of these recorders and other Ferrograph equipment: British Merchandising Pty Ltd, Shaw House, 49-51 York St, Sydney 2000. Phone (02) 29 1571.



HIFI TOPICS — continued

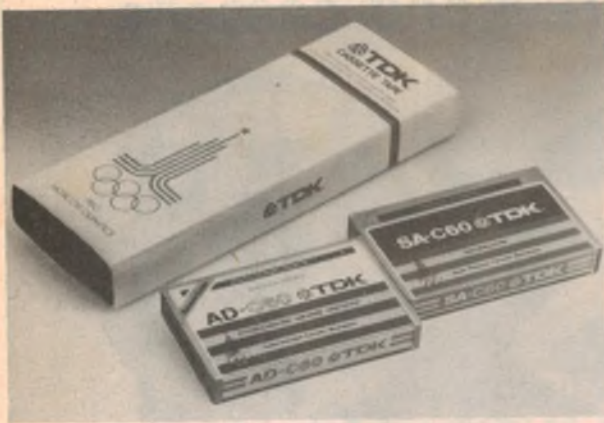

Late last year, TDK Electronics Co Ltd of Japan signed an agreement with the Organising Committee of the 1980 Olympiad, whereby TDK became the official supplier of cassettes for the Games, with the right to use the Olympic emblem on the packaging. The agreement has now turned into a political "hot potato"!

A fact that emerged clearly from the work was that all the heads tested showed a comparatively high rate of wear during the first 100 hours of use. After that, the curve flattened out so that, for all practical purposes, the rate of wear thereafter remained constant (broadly in the range 10 to 100µm per hour).

The curves for heads using Supermalloy, Alfesil-tipped Sendust and Ferrite produced similar looking curves but with wear rates diminishing in the order listed.

By comparison, sendust heads tipped with nitrite hardened Alfesil started off

with the same initial rate of wear, but then fell rapidly to one-fourth or one-fifth the wear rate of the other materials.

In presenting these findings, however, Jensen stresses that they do not represent absolute hardness values for the various materials, because they were derived from heads having a different geometry. This and other factors would have to be taken into consideration before conclusions could be drawn about the ultimate life of any given head, in terms of electrical performance.

What does emerge from the work is a viable method of assessing wear rate.

Furthermore, it is one that, within a few hundred hours, can reveal both the pattern of early wear, and the wear rate to which the head will settle down for the rest of its life on a given deck and with given tape. Knowing this, a manufacturer would be in a much better position to quote more meaningful specifications and guarantees.

IN BRIEF:

PIONEER ELECTRONICS Aust Pty Ltd have formed an OEM Division under Mr Macey Kawabata to supply basic loudspeakers to original equipment manufacturers. The company feels that there is only a limited range of drivers available in this country to meet specific needs — house brand hifi systems, TV sets, disco systems, musical instruments, PA, background music, educational, car sound, home hobbyists, etc. The parent company, Pioneer Electronic Corporation produces in excess of three million loudspeaker units per month. Pioneer Australia is at 178-184 Boundary Rd, Braeside, Vic 3195. Phone (03) 90 9011.

BASF have just released a new cassette under the designation "Ferrichrom". As the name suggests, it is a two-layer tape with a "microscopically thin" layer of chromium dioxide on top of the main coating of "the finest ferric oxide". BASF's Ferrichrom is intended to be used with normal bias and normal

The video cassette you buy today...
can only be as good
as the service you get tomorrow.

It's not like purchasing a simple television set, which requires little or no intricate adjustments on installation. When you buy a video cassette recorder, the expert service that comes immediately with it is absolutely essential for good performance. And it is equally self-assuring to know the service will always be there when you need it. That's why people come to VIDEO TECHNICS. Because we're more than just a store for video cassette recorders and a range of electronic equipment. We're service experts, too.

SPECIAL

Universal TV Video Monitor. Ideal as display unit for dream 6800 Sorcerer TRS 80 Apple CCTV, or any composite video signal. Features 240v AC or 12v DC. Video input via quality BNC socket. Can be switched over as TV receiver. Priced at \$149. See our complete range of video equipment and other special items such as clock timers, full length features and many more.



BUY FROM THE
SERVICE EXPERT



VIDEO TECHNICS

The Carousel Centre, Shop 17-18, 530 Oxford Street, Bondi Junction, P.O. Box 50, Bondi Road, Bondi 2026 NSW 2022 Telephone 387 2555. Third floor, Equitable Life Building, 301 Coronation Drive, Brisbane 4064 Telephone 36 1257.



70µs compensation, under which conditions it is likely to give a gradually rising response in the 1kHz to 8kHz region. While this may seem to be a rather surprising provision, BASF say that the new tape should be an excellent choice for use in automotive tape players, which frequently suffer from a falling response over this region. Ferrochrom cassettes are currently available as C-60 and C-90. For further information: Mr N. Price, BASF Australia Pty Ltd, 55 Flemington Rd, North Melbourne 3051. Tel (03) 329 9555.

GARRARD ENGINEERING, taken over by Plessey in 1960 has been sold to the Brazilian company Gradiente Electronic, which operates from Sao Paulo and makes a range of audio amplifiers, speakers, receivers, tuners and cassette decks. Garrard, long known for its phono turntables, looked in good shape in 1974, turning in a profit

3-head system. Metal tape.

Yet only \$599 r.r.p.

The new Sony Stereo Cassette Deck TC-K75 offers an astonishing number of new techniques and features:

- Three-head system.
- Two motor, closed-loop dual-capstan drive system.
- Metal tape compatibility.
- Microcomputer control and feather-touch switches.
- LED Peak Programme Meter.
- Bias and record level calibration systems.

Dolby* NR.

Many more new features make the TC-K75 one of the best stereo cassette decks that Sony has ever produced. Convenience is exceptionally high. Performance is at the limits of today's technology.

TC-K75 specifications:

Frequency response: 30 Hz to 18000 HZ ± 3 dB (NAB, Fe-Cr, METAL), Signal to noise ratio: 60 dB (NAB Fe-Cr, Dolby* off peak level), Wow and flutter: 0.04% weighted rms, Harmonic distortion: 0.8% (Fe-Cr).



*Dolby is a registered trademark of Dolby Laboratories.

SONY
AUDIO

Color your thinking with CompuColor 11

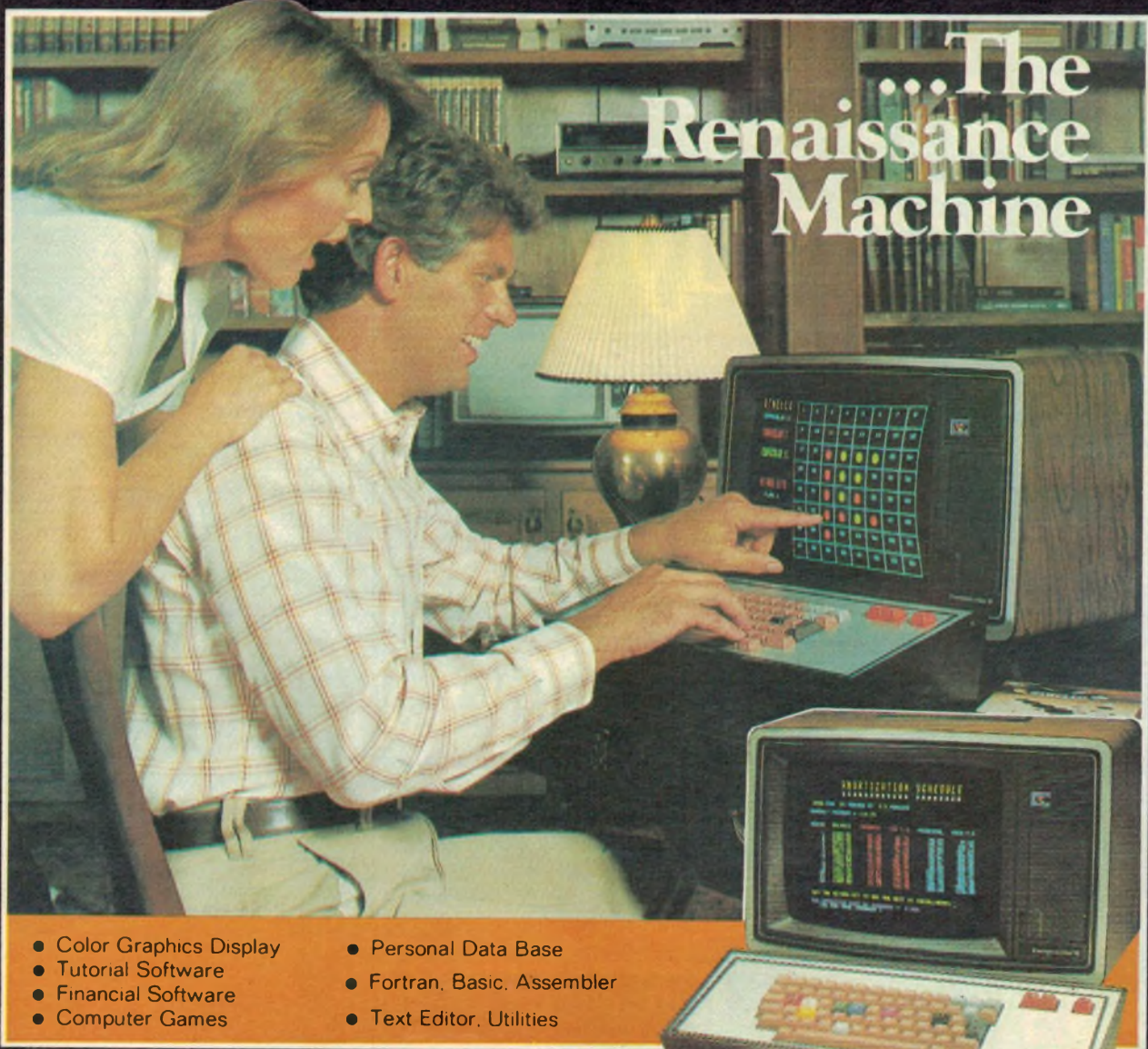

- Color Graphics Display
- Tutorial Software
- Financial Software
- Computer Games
- Personal Data Base
- Fortran, Basic, Assembler
- Text Editor, Utilities

The Renaissance Machine is a "one-of-a-kind" system for the "one-of-a-kind" person who demands, and will not settle for anything less than, the best.

The color machine with the black and white price

Available from

ANDERSON DIGITAL EQUIPMENT PTY. LTD.

MELBOURNE: 1 Expo Court, Mt. Waverley, (03) 543 2077. SYDNEY: (02) 808 1444.

Your local dealer:

Sydney: Logic Shop (02) 699 4910 ● Melbourne: Logic Shop (03) 51 1950

Newcastle: D.G.E. Systems Pty. Ltd. (049) 69 1625 ● Canberra: A.D.E. (062) 58 1811

Brisbane: A.D.E. (07) 59 6436 ● Adelaide: Applied Data Control Pty. Ltd. (08) 79 9211

Perth: W. J. Moncrieff Pty. Ltd. (09) 325 5722 ● Hobart: Management Technology. (002) 34 4522

Darwin: Direct T.V. and Electronic Services (089) 81 9313

NEW ZEALAND:

Wellington: A.D.E. 64 4585 ● Auckland: A.D.E. 87 6570 ● Christchurch: A.D.E. 79 0210 — 89 7598

NEW GUINEA: Komputel Systems. 42 3924

ADE

DEALER ENQUIRIES
WELCOME



Now also available in King Size

Dunhill Superior Mild

The new standard of excellence in mild smoking



For those who appreciate the finer things

WHY CUT? WHY STRIP? WHY SLIT?
WHY NOT...

NEW

JUST WRAP™

WIRE WRAPPING TOOL

- AWG 30 Wire
- .025" Square Posts
- Daisy Chain or Point To Point
- No Stripping or Slitting Required
- ...JUST WRAP™...
- Built In Cut Off
- Easy Loading of Wire
- Available Wire Colors: Blue, White, Red & Yellow

traditional Wire-Wrapping

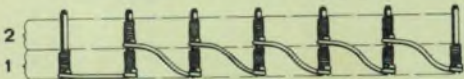

JUST WRAP Wire-Wrapping



U.S.A. FOREIGN PATENTS PENDING

JUST WRAP TOOL WITH ONE 50 FT. ROLL OF WIRE		
COLOR	PART NO.	LIST PRICE
BLUE	JW-1-B	\$19.30
WHITE	JW-1-W	19.30
YELLOW	JW-1-Y	19.30
RED	JW-1-R	19.30
REPLACEMENT ROLL OF WIRE 50 FT.		
BLUE	R-JW-B	\$3.84
WHITE	R-JW-W	3.84
YELLOW	R-JW-Y	3.84
RED	R-JW-R	3.84
JUST WRAP-UNWRAPPING TOOL		
	JUW-1	\$4.50



AMPEC ENGINEERING CO PTY LTD
1 WELLINGTON ST, ROZELLE

Available from:

NSW: RADIO DESPATCH; G. BROWN; M. DE LAUNAY; DAVID REID. ELECTRONIC DISTRIBUTORS
VIC: ELLISTRONICS; ARLIN; TECH SCIENTIFIC.

SA: PROTRONICS
WA: RESERVE
QID: WILBER.

input polarity).

This tells the SAR that it has "overshot", so its next move is to reset bit 7, and try setting bit 6 instead. This drops the DAC voltage to below the analog input, so the comparator output switches to logic 0. The SAR accordingly leaves bit 6 set, and next tries setting bit 5 as well. This increases the DAC output, but it is still below the analog input. So the SAR leaves bit 5 set also, and tries bit 4. And so on.

As you can see, this simple trial-and-error strategy allows the SAR to match the analog input in only N steps, where N is again the number of bits. And as each step can correspond to a single clock period, this means that the conversion time for this type of ADC is only NP, where P is again the clock period. So if we have an 8-bit SAR and 1MHz clock pulses, the conversion time will be only 8 μ s — 1/32nd of the time required for a counter-type ADC of similar capacity.

For ADCs of larger bit capacity, the speedup ratio is even more dramatic. For example a 16-bit successive approximation ADC will tend to be 4,096 times faster than an equivalent counter type. This is because the measurement time of a successive approximation type is a linear function of the bit capacity (NP), instead of an exponential function ($2^N \cdot P$).

How does the SAR itself work? There are a number of different types, but one of the more common arrangements is shown in Fig. 9. Here the SAR actually consists of two separate registers: a shift register and a set of latches, together with a control flipflop FF1, a gate G9, and eight further gates G1-8.

The SAR shown is one of eight bits, and as you can see that is the number of bits in the latch register. The shift register has two additional bits, whose purpose should become evident shortly.

Before the start of a conversion sequence, control flipflop FF1 is in the reset state with its Q-bar output at logic 1. This output is connected to the set input of stage 0 of the shift register, and to the reset inputs of all of the remaining stages. As a result the first stage of the register is loaded with a 1, and the remaining stages with zeroes.

When a start pulse arrives, it does two things. One is to reset all of the latches, via the master reset (MR) input of the latch register. The other function is to set FF1, so that its Q-bar output now goes to logic 0 and its Q output to logic 1. The parallel loading inputs of the shift register are thus disabled, while G9 is enabled to admit clock pulses.

On the arrival of the first clock pulse the "1" in the first (0) stage of the shift register is moved into the second (1) stage, while a 0 is moved into the first stage from the D input. Because of the direct connection between the 1 output of the shift register and the S7 input of the latch register, this causes the B7

(MSB) latch to be set also. So after the first clock pulse, the MSB has been set for the SAR's "first try".

This bit will be fed to the DAC (see Fig. 8), and the corresponding voltage compared with the analog input by the comparator. So the comparator output fed back to the SAR will have a value indicating whether or not the MSB is "too big": a 1 will indicate too big, while a 0 will indicate the converse.

On the arrival of the second clock pulse, the "1" in the shift register will be moved along to the third (2) stage, with another "0" moved into the first (0) stage. The logic 1 at the 2 output of the

most significant bit position of the latch register and resetting the previous bit position if the comparator output indicates that it produced a "too big" output from the DAC.

The final clock pulse shifts the "1" into the last (9) stage of the shift register, allowing the B0 stage of the latch register to be reset if required. At the same time a pulse is fed back to the reset input of FF1, to reset it and provide the "conversion completed" signal.

Not all SARs operate in the same way, but this should give you the basic idea.

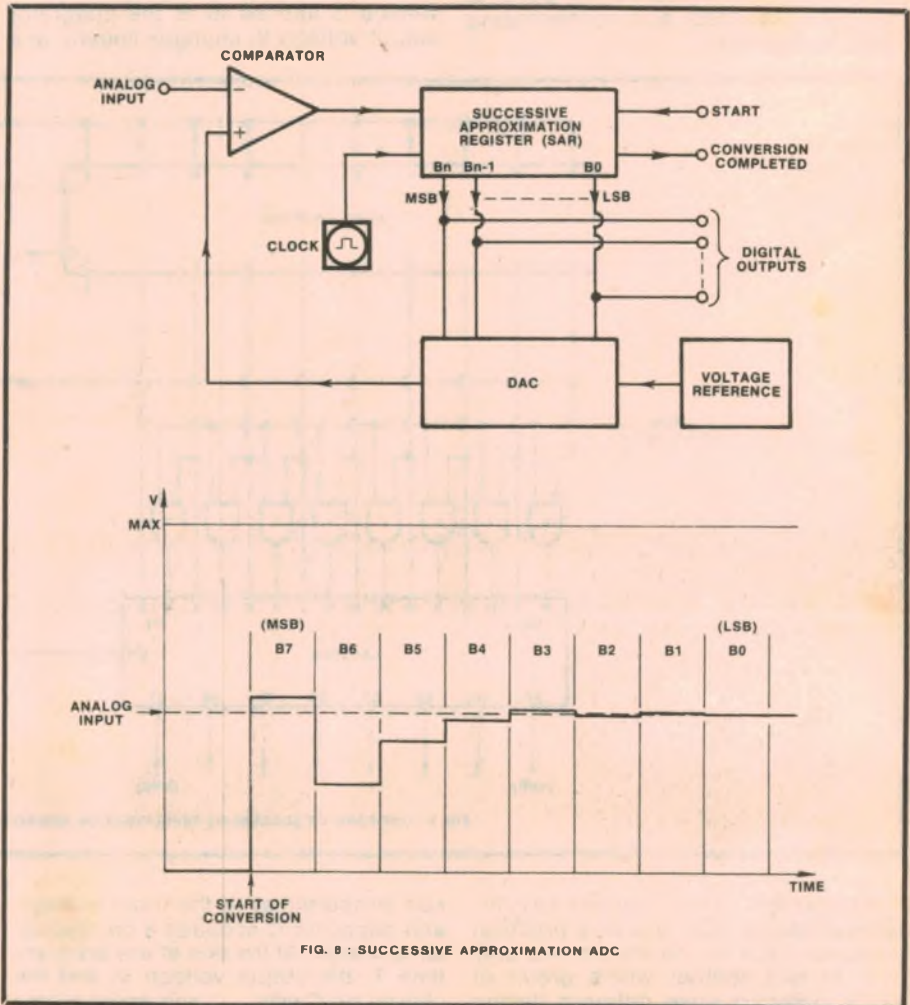

FIG. 8 : SUCCESSIVE APPROXIMATION ADC

shift register will have two effects: it will set B6 of the latch register, and it will enable gate G1. As a result, B7 of the latch register will be reset if the comparator output was 1, or left set if it was 0.

So B6 will be left set after the second clock pulse, while B7 will be left either set or reset depending upon the feedback from the comparator.

This sequence of events continues with succeeding SAR clock pulses, to give the required SAR operation. Each clock pulse moves the "1" in the shift register along another stage, setting the next

It should have become apparent from the foregoing that the successive-approximation ADC is basically an improved version of the counter type. It is still based on the use of a DAC, to produce a second analog voltage which is compared with the input.

This is the type of ADC most commonly used as an input interface with modern microprocessor systems. It is fast in operation, and can be made with almost any desired resolution. Typical modern monolithic-IC successive approximation ADCs are made with a resolution of eight bits, while hybrid-IC

THE SELECTRIC* APPROACH TO HIGH QUALITY PRINTING

Any model IBM SELECTRIC typewriter can be interfaced as a computer output printer operating at 13.5 cps. The interface comprises a precision solenoid assembly which fits to the underside of the typewriter without drilling, tapping or permanent modification. Installation takes approximately 4 hours and is extensively documented. If you prefer, ASP or interstate agents will install the solenoids for \$75.00 (subject to inspection of your typewriter). Use as a typewriter is unaffected, the keyboard does not feel heavy, or in any way altered.

The electronics provided convert ASCII code into the proper bail select code for the typewriter, control the operation of the typewriter and allow the host computer to communicate on a variety of different interface standards. Available are S100, TRS80 (without Expansion Interface) and Universal Interfaces.

Prices: (including Sales Tax)	S100	\$599.00
(10% off for multiple orders)	TRS80	\$699.00
	RS232/Parallel	\$729.00
	IEEE	\$759.00

Dear Ali, I'm convinced I should be more Selectric.* Please reserve the conversion noted below and send me your Order Form.

Type of Interface	Quantity	My computer is a

NAME: _____

ADDRESS: _____

PHONE: _____

* SELECTRIC is a Trade Mark of IBM

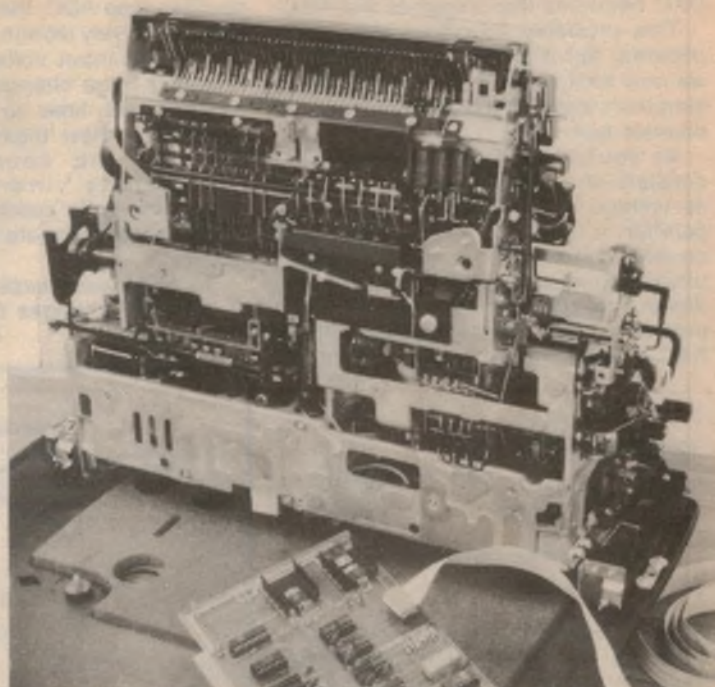

ASP MICROCOMPUTERS
 799 DANDENONG ROAD,
 EAST MALVERN 3145.
 Telephone 211 8855 211 8344

"THE S100 BUS STOP"™

S100 16K STATIC RAM KIT



ETI 642

16K 2114. Low Power 12 Amps Typ for 16K 300 or 450nS 4K addressing 4K write protect switches. Cromemco bank select, wait states, plated thru holes, solder mask. See FEB ETI project for details Assembled and tested \$380.00. \$5.00 P&P Reg mail Kit price \$315.00.

UV EPROM ERASERS



New product range LEE/T 15W tube — 120 min. timer — up to 40 eproms — will erase in 10/15 min. Model MEE/T — 8W tube — 120 min. timer up to 10 eproms — will erase in 20/30 min. Model MEE is the same as MEE/T but with no timer. All erasers have safety cut out switch.
 PRICE: LEE/T \$105.00. MEE/T \$93.50. MEE \$74.00
 P&P \$3.00

S100/6800 CHASSIS



11 Slot back plane, 15 amp power supply, fan, key switch, bench mount, rack mount, fully card guided, anodised alum. 5 sockets in basic unit

S100 Rack Kit	\$306.00	Assembled	\$406.00
S100 Bench Kit	\$345.00	Assembled	\$445.00
6800 Rack Kit	\$331.00	Assembled	\$431.00
6800 Bench Kit	\$370.00	Assembled	\$470.00
6800 Power Supply	5V at 10 amps. + 12V at 2 amps		
S100 Power Supply	8V at 15 amps. + 16V at 2 amps		

S100 16K Eprom Board Kit	\$98.00
S100 280 4 MHz CPU Board Kit	\$156.00
S100 Floppy Disc Controller Kit	\$195.00
S100 Double Density Disc Controller Kit	\$285.00
S100 2708/2716 Programmer Kit	\$175.00
S100 2708/2716 Eprom Board kit	\$115.00
S100 11 Slot Back Plane	\$36.00
Extender Termination Board	\$70.00
S100 Sockets	\$8.00
S100 Wire Wrap Board	\$28.50
S100 Extender Board Kit	\$33.00
Number Cruncher Kit (MM57109)	\$49.50
SBC 200 Single Board Computer	\$295.00
S100 80 x 24 Video	\$290.00

DUAL SERIAL PORT BOARD



9 Parallel Ports (programmable) 2 Serial Ports TTY RS232 or TTL. Baud rate generator 9600 to 75, full address decoded, low power buffers, plated thru holes, solder mask.

KIT PRICE \$189.00 P&P \$3.00 ASS PRICE \$225

Dual serial port version

DISC DRIVES

Shugart SA400Mini	\$410.00
Shugart SA801	\$710.00
Remex 4001 Double Sided	\$795.00

6800 PRODUCTS

6800 11 Slot Back Plane	\$36.00
6800 11 Slot Chassis (Basic Rack)	\$175.00
6800 Extender Board Kit	\$33.00
2708 EPROMS (ceramic)	
450nS guaranteed quality	\$12.00
2716 Eproms (single supply)	\$47.50
2114 RAMS Low Power Hitachi, Super Rams	
450 NS	\$7.50
300 NS	\$8.50

Send 60c in stamps for computer printout catalogue for full production information and price list. All products Aust. made and ex-stock (almost).

S.M. ELECTRONICS
 MELBOURNE

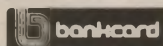

Give name, number, expiry date and signature. For mail order sales.

BUILT AND TESTED P.O.A.
 ALL PRICES ADD 15% S.T. IF APPLICABLE

S.M. ELECTRONICS

1096 Doncaster Road, Doncaster East, Vic 3109.

Phone (03) 842 3666

Telex AA37213 10am 6pm Mon/Fri

Dealer A.C.T. 81 5011

Dealer SYD 661 9237

two voltages are equal, so that the current binary number applied to the DAC becomes the output of the ADC.

This probably sounds a little complicated, but it should become clear if we now look at the basic circuit for the simplest variant of this kind of ADC, the counter type (Fig. 7).

As you can see, this type of ADC consists of a comparator, a DAC with its voltage reference supply, a binary counter, a source of clock pulses and an AND gate (G1). The outputs of the binary counter are fed to both the digital outputs of the ADC and to the inputs of the DAC, while the output of the DAC is fed to the "+" input of the com-



FIG. 6 : ANALOG COMPARATOR

parator. The analog input to the ADC is fed to the "-" input of the comparator, while the output of the comparator is fed to G1 and used to control the admission of clock pulses to the counter.

Operation begins when a reset pulse is applied to the binary counter. All counter outputs switch to logic 0, forcing the DAC analog output to fall to zero also. This causes the comparator output to switch to logic 1, enabling G1 and admitting clock pulses to the counter.

As the pulses reach the counter, its outputs cycle upward through the usual binary counting sequence. As a result, the analog output of the DAC produces a rising "staircase" waveform, which steadily approaches the analog input voltage.

At the instant that the DAC output voltage matches the analog input voltage, the comparator output will switch to logic 0 level. This will disable G1, preventing any further clock pulses from entering the counter. So the counter will stop, with its count "frozen" at the binary equivalent of the analog input voltage.

If the analog input voltage increases, the circuit will continue counting to match it. However if the input voltage decreases, the only way to make the basic counter-type ADC of Fig. 7 follow it is to reset the counter again, and have it produce a new conversion "sample". In fact this type of counter is generally reset regularly, so it performs a continuous series of conversions.

An alternative approach is to use an up-down or "bidirectional" counter, which is capable of counting downward as well as upward. The circuit is then modified so that the comparator output is used to control the direction of counting. This produces a **continuous ADC**, capable of producing a digital output which can continuously follow a changing analog input.

Although this produces a circuit which is less clumsy than the basic counter-type ADC, the continuous ADC is still relatively slow in operation. When the analog input voltage undergoes a relatively large change, the ADC takes a significant time to reach the corresponding new digital value. This is because the counter must be laboriously incremented or decremented to reach the new value, using the appropriate number of clock pulses.

So in the worst case, where the input to the ADC changes from one end of

shown in Fig. 8.

The main difference between this type and the counter-type ADC shown in Fig. 7 is that instead of the binary counter, there is a "successive approximation register" (SAR). This feeds the digital outputs and the DAC inputs as before, with the DAC output again fed to the comparator along with the analog input voltage.

Instead of laboriously counting its way up to match the analog input, the SAR adopts a "short-cut" approach: it tries each of the binary outputs in turn, starting with the most significant bit

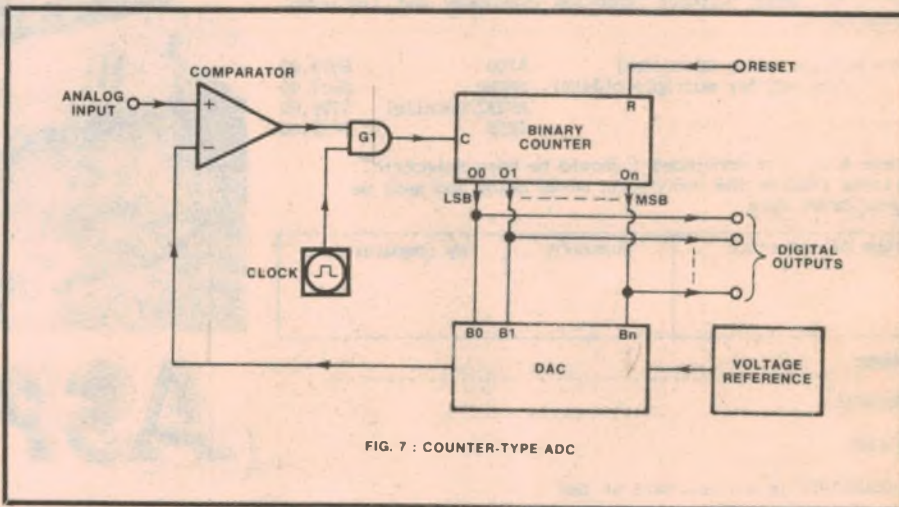
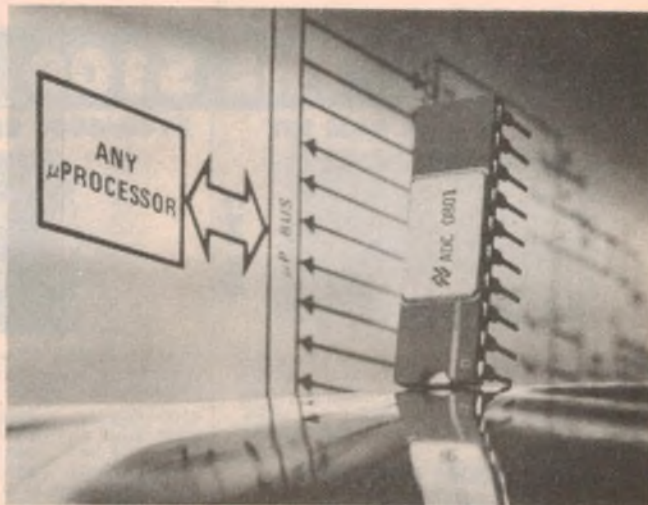

FIG. 7 : COUNTER-TYPE ADC

National Semiconductor's ADC0801 series are 8-bit analog-to-digital converters and are directly compatible with microprocessors. They use the successive-approximation method.



the allowable voltage range to the other, the time required to reach the new value will be $2^N \cdot P$, where N is the number of bits in the counter and P is the clock pulse period. If we use an 8-bit counter and 1MHz clock pulses (ie, a clock period of 1us), the ADC could take up to $(2^8 \cdot 1)$ or 256us to reach its new value.

This order of conversion time is far too long for most practical ADC applications. For this reason neither the basic counter-type ADC nor the continuous ADC is used very often. Much more commonly used nowadays is the **successive-approximation ADC**,

(MSB). As each bit is tried, it is guided by the comparator signal in deciding whether that bit should remain set, or be reset. This allows it to "zero in" on the correct value, very rapidly.

A typical conversion sequence for an 8-bit successive approximation ADC is shown in Fig. 8, below the logic circuit. As you can see, when the SAR is directed to begin conversion (by the microprocessor, for example) it first tries setting the MSB, bit 7. In this case, the corresponding DAC output voltage is greater than the analog input, so the comparator output will go to the logic 1 level immediately (note the comparator

WE HAVE A 6809 FOR YOU

POWER SUPPLY

Modular plug-in construction with computer grade filters and a 25 AMP rectifier bridge. Blower fan is standard equipment. All connections to the power line are beneath the safety shield.

INTERFACE

Convenient serial or parallel I/O cards have DB-25 connectors mounted directly on the circuit board. Up to 16 interface devices may be installed on the address decoded I/O bus. Programming strips are provided for input and output baud rate selection on each port. All outputs are fully buffered.

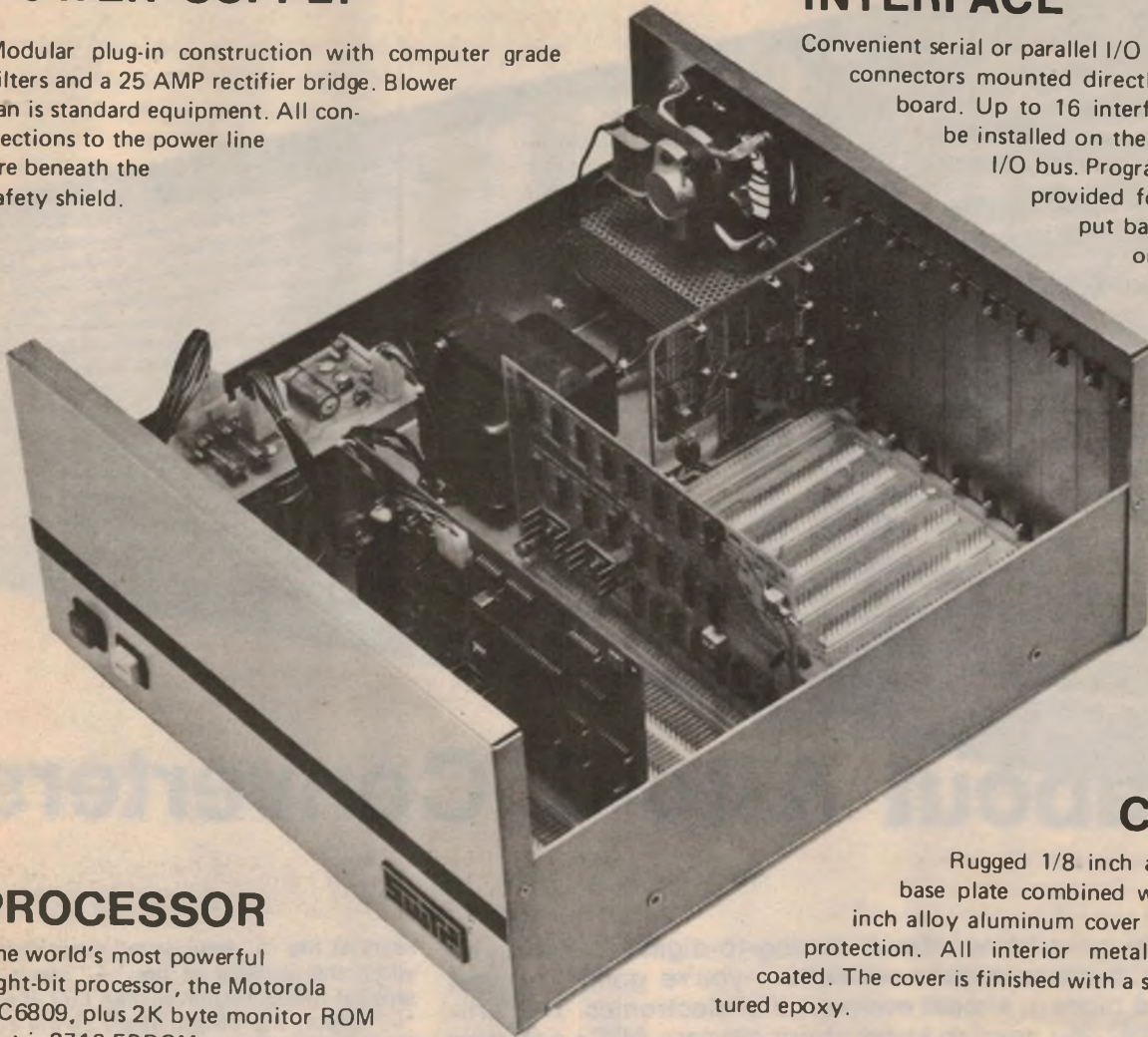

CABINET

Rugged 1/8 inch alloy aluminum base plate combined with a solid 1/8 inch alloy aluminum cover for unsurpassed protection. All interior metal is conversion coated. The cover is finished with a super tough textured epoxy.

PROCESSOR

The world's most powerful eight-bit processor, the Motorola MC6809, plus 2K byte monitor ROM that is 2716 EPROM compatible and full buffering on all output lines. Built-in multiuser capability, just add I/O cards to operate a multi-terminal system.

MEMORY— You can purchase the computer with either 8K bytes of RAM memory (expandable to 56K), or with the full 56K. The efficient, cool running dynamic memory used in this system is designed and manufactured for us by "Motorola Memory Systems Inc."

PERIPHERALS— The wide range of peripheral hardware that is supported by the 6809 includes: dot matrix printers (both 80 and 132 column), IBM Electronic 50 typewriter, daisy wheel printers, 5-inch floppy disk system, 8-inch floppy disk systems and a 16 megabyte hard disk.

SOFTWARE— The amount of software support available for the 6809 is incredible when you consider that it was first introduced in June, 1979. In addition to the FLEX9 operating system, we have a Text Editor, Mnemonic Assembler, Debug, Sort-Merge, BASIC, Extended BASIC, MultiUser BASIC, PASCAL and PILOT.

69/K Computer Kit with 8K bytes of memory — 69/A Assembled Computer with 8K bytes of memory
69/56 Assembled Computer with 56K bytes of memory

SOUTH WEST TECHNICAL PRODUCT CORPORATION
(COVERING AUSTRALASIA)

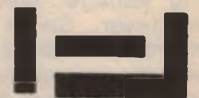

7A BURTON STREET, DARLINGHURST, N.S.W. 2010
P. O. BOX 380 DARLINGHURST N.S.W. 2010

CABLE: "PARADIO" TELEX: AA 22579 PHONE: 02-313273.

What you need to know . . .

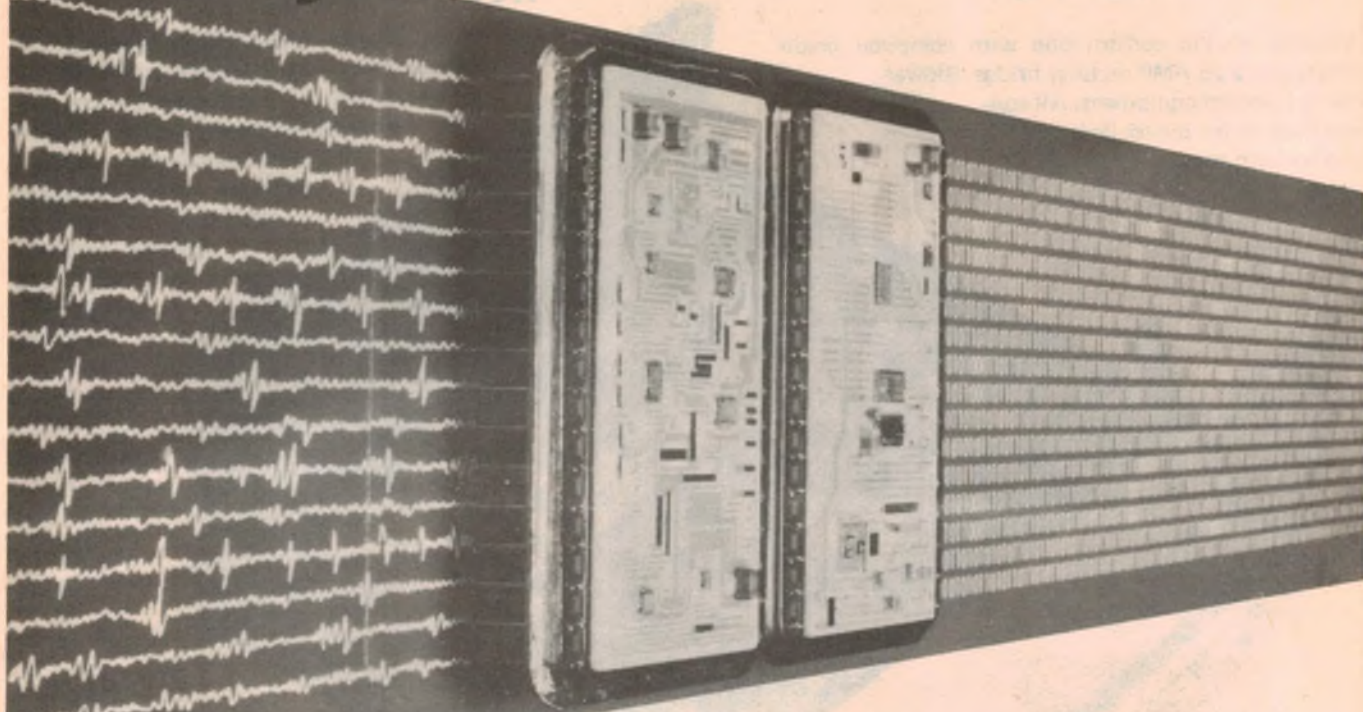

. . . about A-to-D Converters

How much do you know about analog-to-digital converters? Thanks to the microprocessor revolution, you're going to meet them more and more in almost every area of electronics. This article tells you what you need to know about modern ADCs and how they work.

by JAMIESON ROWE

If you hadn't already noticed, the microcomputer revolution is well under way. Microprocessors and microcomputers are appearing in all sorts of electronic equipment, simplifying the construction and often increasing the number of functions that can be performed.

Of course the microprocessor is a digital device, which is basically designed to handle information in the form of numbers. But information usually occurs in the "outside world" in analog form — as a continuously varying voltage, current, frequency or whatever. So in order to use the microprocessor, it is necessary to convert the information from analog form into digital form, and back again. This means that the microprocessor revolution is also causing a tremendous upsurge in the use of digital-to-analog and analog-to-digital converters.

In the first part of this two-part series

we looked at digital-to-analog converters or "DACs", which are used at the output end of digital systems. Now let us look at the complementary process of analog-to-digital conversion, and the "ADC" circuits used to perform it.

There are a number of different types of ADC, as we will see shortly. They all depend for their operation on a circuit element which you may not have met before: **the analog comparator.**

An analog comparator is basically a high-gain operational amplifier or "op amp", whose output is designed not for linear amplification, but for switching between two voltage levels which are compatible with logic circuitry. It switches between the two levels in response to the relative size of two analog voltages applied to its inputs (Fig. 6).

When the voltage at the "+" input is greater (more positive) than the voltage at the "-" input, the comparator output

rests at the "1" logic level. Conversely when the voltage at the "+" input is smaller (more negative) than that at the "-" input, the output rests at the "0" logic level.

Needless to say, the only way to get from one of these two situations to the other is to pass through the point where the two input voltages are equal. At the instant that this occurs, the comparator output switches from its existing logic level to the other.

Hence the reason for calling this circuit element an analog comparator: by connecting its inputs to two analog voltages, we can tell whenever the two are equal. This will be whenever the comparator output switches logic levels — from 1 to 0 or 0 to 1, depending upon which one was previously the greater.

Of the various types of ADC, probably the simplest types are those which combine an analog comparator with a digital-to-analog converter or DAC. The general principle of operation used in these types of ADC is quite straightforward: a counter or other digital circuit is used to produce a series of binary numbers. These are converted by the DAC into an equivalent varying analog voltage, which is then compared with the analog input voltage by feeding them both to the comparator. The comparator output is then used to indicate when the

THINKING OF BUYING A MICRO-COMPUTER?

The proliferation of Micro-Computers over the last few years has made the task of selecting one very difficult. Here are some of the reasons why we believe that you could buy a Commodore CBM™ or PET™ Computer from Microcomp.

- (1) Commodore is the world's fastest growing Micro-Computer manufacturer. This means that Commodore products will be around long after a lot of other Micros have cashed in their chips.
- (2) The popularity of Commodore products ensures that software and hardware support is readily available.
- (3) Commodore products are designed to be functional, portable and attractive. Each Computer consists of a video monitor, keyboard and a main memory board with 2 cassette interfaces, memory expansion interface, IEEE 488 interface, 8 BIT I/O user port and a built in clock. Unlike other Micros, there are no hidden extras to be purchased before you can make it work for you.
- (4) MICROCOMP has the expertise required to help you with both hardware and software problems. We specialise in sales and support of all the Commodore product range and would be happy to hear from anybody who is having any problems with Commodore hardware or software.

AVAILABLE NOW!

WORD PROCESSOR ROM	PROGRAMMERS TOOL-KIT ROM	MEMOREX MINI-FLOPPY DISKS
Now your CBM™ or PET™ computer can be a powerful Work-Processor. Prepare letters, reports, circulars, etc. Complete with full instructions:	Enhance the operating system of your PET™ or CBM™. This ROM allows extra commands such as auto line numbering, trace, renumbering, deletion of multiple lines and more.	Top quality guaranteed Disks: 1-9 = \$6.00 each 10+ = \$5.50 each
FOR 8K Pet: \$100.00 FOR 16K-32K CBM: \$150.00	FOR 8K PET: \$130.00 FOR 16K-32K: \$119.00	CONTINUOUS STATIONERY 9½" x 11" Tractor Feed Paper suitable for most printers \$28.00 per box (2000 sheets)

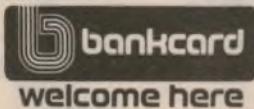

MICROCOMPUTER SYSTEMS DESIGNERS

B.S. MICROCOMP
47 Huntingdale Road,
BURWOOD, Victoria, 3125.
Ph: 288 9129/288 9512.

PRICE BREAKTHROUGH

A COMPLETE S100 BUS Dual Disk Computer for — **\$4950** plus tax



DEALER AND OEM ENQUIRIES WELCOME

THIS IS IT!

The amazing NEW dual processor Versatile 4 with an 8085 and Z80.

The system with 630K of disk storage and 32K of RAM.

Expandable to 96 Megabytes!

Also available:—

Full business software,
Word Processing, CP/M, CBASIC,
Mainframe polling capability and more.

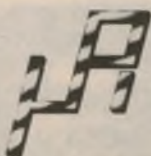

**MICROPROCESSOR
APPLICATIONS PTY. LTD.**
(03) 754 5108

MASKELL'S HILL RD, SELBY, 3159

Small computers solving large problems

- * Built in Diagnostics
- * New Keyboard
- * Scientific Symbols
- * 10 SLOT S100 BUS
- * Dual Serial I/O Ports
- * EX STOCK

system for your dollar on quality!

Exidy S-100 Expansion Unit

The Exidy S-100 expansion unit opens the way to almost unlimited expansion of your Sorcerer system, because more than 100 manufacturers world wide produce plug-in PCB card modules designed for the S-100 bus system. There are S-100 plug-ins available for almost every conceivable avenue of system expansion. Memory cards, floppy disc and hard disc controllers, EPROM programmers, special I/O interfaces and power control cards, colour video graphics controllers, D-to-A and A-to-D converters, music and speech synthesis cards, even speech recognition cards plus more being announced all the time. Supplied complete with inbuilt power supply, ribbon cable and connector.

**Use other manufacturers
peripherals with your
SORCERER**

\$499⁰⁰

Cat. X-3010

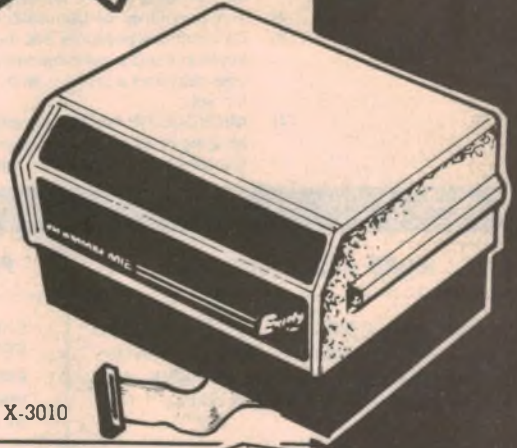

ECONOMICAL PRINTER

The C.I.TOH model 8300 dot matrix printer is a high performance unit that incorporates the latest micro processor technology. This unit is priced below many printers offered by other companies but if you want a non-sense printer that can chum out the full 96-character ASCII at a brisk 125 characters per second on standard fan-fold paper, then you can't do better. Character spacing of 80 and 40 columns - software selectable with inbuilt 80 byte character buffer and self testing string generation. Interface 7-bit parallel Centronics type, this is available as Cat. X-3112 @ \$49.50.

\$970

Cat. X-3255

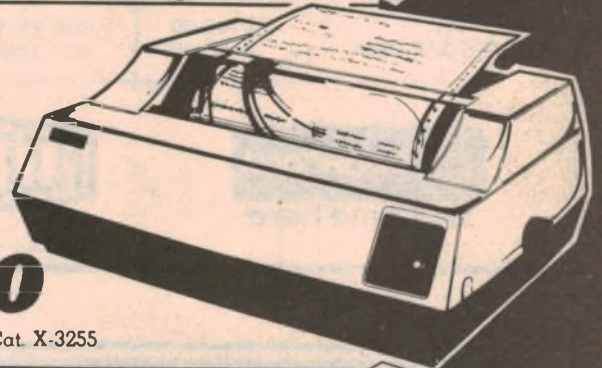

Universal Monitor WHY PAY MORE?

Suits virtually all systems including The Sorcerer, Tandy TRS-80, Apple, System 80 etc. Compare our prices to theirs! Large screen (30cm) with jitter free, distortion free characters. Simple connection plus dual power - 240V AC or 12V DC.



\$149⁵⁰

Cat. X-1196

TANDY OWNERS - DON'T MISS OUT

This superb Dick Smith Mini Disc Drive provides 228% the storage capacity of the Tandy drives yet costs far less! Check these features - ● 133.4mm minifloppy diskette ● 40 tracks instead of 35 - 14% more storage per side ● soft sectored ● dual sensors for reading on both sides - doubles the storage capacity ● recording density (inside track) 2768bpi ● 100K bytes per side ● drive number is switch selectable ● use as first drive or add-on drives for TRS-80. (SAVE \$1000 plus on the latest Tandy price - Jan 1980)

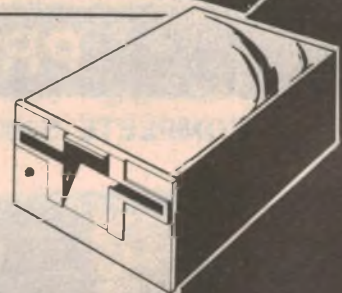

\$379

Cat. X-3230

Power Supply

Cat. X-3234

\$60⁰⁰

Especially suited to the Dick Smith mini disc drive. The unit has dual voltage and will power TWO drives.

Connecting Cable

Cat. X-3232

\$49⁵⁰

34 way daisy-chain cable for controlling 4 disc drives to your TRS-80.

DICK SMITH ELECTRONICS



SHOPS OPEN 9AM to 5.30PM
(Saturday 9am till 12 noon)
BRISBANE Half hour earlier
ANY TERMS OFFERED ARE TO
APPROVED APPLICANTS ONLY
RE-SELLERS OF DICK SMITH
PRODUCTS IN MOST AREAS OF AUSTRALIA

NSW 126 York Street.
147 Home Highway.
182 Pacific Highway.
30 Grace Street.

283 Keira Street.

SYDNEY Phone 280 3377
CHULLORA Phone 842 8822
GORE HILL Phone 438 5311
PARRAMATTA Phone 883 1133

WOLLONGONG Phone 28 3800

ACT 86-88 Gladstone Street.
VIC 388 Lansdale Street.
858 Bridge Road.
QLD 188 Logan Road.
SA 203 Wright Street.
WA 414 William Street.

FYSHWICK Phone 88 4844
MELBOURNE Phone 87 8834
RICHMOND Phone 428 1814
BURANDA Phone 381 8233
ADELAIDE Phone 212 1862
PERTH Phone 328 8844

MAIL ORDER CENTRE: PO Box 321, NORTH RYDE NSW 2113 Ph 888 3200 PACK & POST EXTRA

DICK gives you more
 — without compromising

**NOW EVEN
 BETTER!
 Sorcerer Mk II**



As part of their on-going research and development, Exidy have made some changes giving the Sorcerer on-board capability of up to 48K RAM — plus greater-reliability. You still get the interchangeable ROM PAC™ feature, high resolution graphics of 122,880 pixels (nearly twice that of any rival computer), both upper and lower case characters, graphics, I/O ports as standard, S-100 expansion capability, 2 cassette player interface plus many more outstanding features.

Mk II

Cat. X-3000

8K
 ONLY

Cat. X-3001

16K
 ONLY

\$1095 \$1250

**FANTASTIC
 VALUE**

Micropolis™

METAFLOPPY™
 goes beyond!

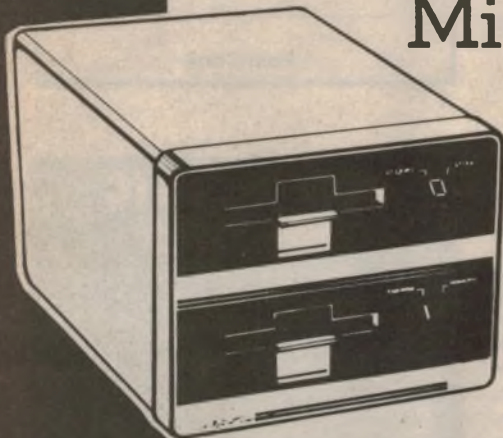

The Micropolis Metafloppy™ gives you more than four times the capacity of anyone else's 133mm floppy. Because it uses 77 tracks instead of the usual 35. The Metafloppy™ model 1053 comes with 630,000 bytes on-line and is designed for use with S-100/8080/Z80 bus. Comes complete with controller board, inbuilt power supply, cables, a new BASIC software package, DOS with assembler and editor, even an inbuilt ROM to eliminate tiresome button pushing.

For a superb disc system see Dick Smith — the Micropolis has more bytes in store for you!

Cat. X-3210 **\$1950**

Cassette Recorder

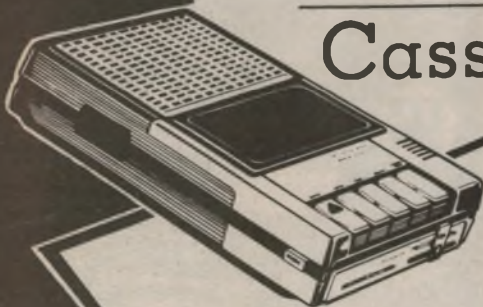

\$39⁹⁵

Cat. A-4092

A good quality cassette recorder for use with your computer. If using the Sorcerer you simply interface with serial cable (Cat. X-3110 @ \$34.50), which can handle two cassette recorders, and the computer will stop and start your program tape. This unit works on 240V AC or 6V DC and measures 260x140x65mm. Ideal for use with the Tandy TRS-80.

ROM PACs

**Word Processor
 PAC™**

Add to your Sorcerer for a system that is more powerful than other available systems. It includes instruction manual and features auto text wrap, auto checking drastic commands, powerful search functions auto commands and macro programming, single key commands plus much more.

Cat. X-3085 **\$199⁰⁰**

**Development
 PAC™**

Turns your Sorcerer into a dedicated development tool. Includes instructions and features designer's debugging tool, text editor, Z80 assembler, linking loader, I/O driver routines.

Cat. X-3090 **\$139⁵⁰**

EPROM PAC™

Write your own program. This PAC comes complete with special PCB, ancillary components and case and is ready for insertion of your EPROM IC.

Cat. X-3095 **\$75⁰⁰**



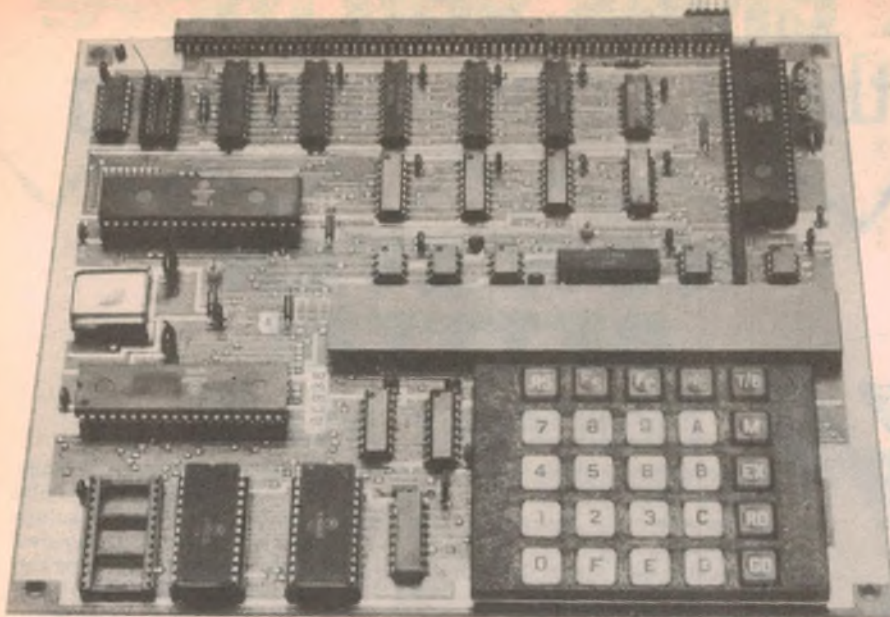

The Motorola 6802D3 evaluation kit is supplied fully assembled and tested.

MOTOROLA PROGRAM

0000 8E 00 7F	LDS STACK	DEFINE STACK IN USER AREA
0003 86 FF	LDAA \$FF	
0005 B7 80 82	STAA DDR	SET DATA LINES AS OUTPUTS
0008 86 01	LDAA \$01	SET DATA LINE PO HIGH
000A B7 80 83	AGAIN STAA PDR	ONE LINE HIGH
000D BD 00 14	JSR DELAY	KEEP PDR LINE HIGH WITH DELAY
0010 49	ROLA	SET NEXT LINE HIGH
0011 7E 00 0A	JMP AGAIN	
0014 CE FF 00	DELAY LDX \$FF00	SET DELAY TIME
0017 09 DELI	DEX	DECREASE INX REGISTER
0018 26 FD	BNE DELI	RETURN IF NOT EQU ZERO
001A 39	RTS	DELAY ENDED

The author's sample program. It sequentially sets each line of the user I/O port (the SK1 socket) to a high state, and keeps it there for a brief period.

demonstrates that the I/O port is working.

What the program does it to set the PIA of the MC6846 to a "write" operation. Each data line P0 to P7 is in turn set to a high state. A delay subroutine keeps each data line high for a short time. If a meter is connected from the negative supply to one of the outputs on the SK1 socket, while the program is running, the operation can be watched.

To summarise, the MEK6802D3 is a

small, well thought out microprocessor development system, adequate for learning 6800 programming. It has plenty of provision for expansion so that it can be made into a more elaborate system if desired. In short, it is good value for money.

The MEK6802D3 computer is distributed by Total Electronics and our computer for review came from Radio Despatch Service, 869 George Street, Sydney. Price of the computer is \$175 plus 15% sales tax where applicable.

IF YOU PROGRAM MICROPROCESSORS, THESE SHEETS ARE FOR YOU

Writing microprocessor programs on blank or plain ruled paper is messy and time consuming. To make the job easier, Electronics Australia has produced custom-designed programming sheets for use with virtually any microprocessor system. The sheets feature columns for a 4-digit address, up to six digits of instruction code or data, labels, mnemonics, and comments. There is space for 46 lines per sheet, and the sheets are provided with space for program title, date and sheet number. All for less than 5 cents per sheet, posted!

PRICED AT \$2.00 FOR 50 SHEETS
(plus 40c for postage anywhere in Australia)

Available only from Electronics Australia.
57 Regent St, Sydney (P.O. Box 163, Beaconsfield, NSW 2014)

MICRO-80

MONTHLY MAGAZINE

for **TRS-80** users

Each issue has:

- At least 6 Programs
- Programming Tips
- Hardware Articles.

ORDER NOW

TO:

MICRO-80: PO Box 213, Goodwood, SA 5034

PLEASE SEND ME:

- 12-MONTH SUBSCRIPTION FOR \$24.00 STARTING FROM (Dec. 79's issue 1)
- CURRENT ISSUE FOR \$2.50 (MAKE CHEQUE PAYABLE TO MICRO-80)

Name:

Address:

Post Code:

ELECTRONIC ORGANS

Quality Wersi Organ Kits from Germany
Technical knowledge not required
Comprehensive instruction books to last detail (also available in German)

7 full organ models

Extensive voicing 16ft to beyond 1ft
24 rhythm unit using 16 instruments

Auto features:- reverb, sustain, percussion, wah-wah, transposer, piano, string orchestra, plus others.
Electronic tremolo 70 watts RMS output per channel.

Approx. half cost of equal shop models

Catalogue \$2.00, 104 pages in colour (Refundable on \$50 order).

Klaus Wunderlich demo record. Music only with jacket notes \$6.50 incl. postage

Arriving shortly —

Mini organ, "The Entertainer", low cost, 240V or 12V DC, suit caravan.



WERSI electronics



All inquiries direct to:—

DEFI AGENCY

9 Florence Street, Burwood, Vic. 3126.
Phone (03) 288 7899

Motorola 6802D3 evaluation kit

Features a hexadecimal keyboard and LED readout

As recently announced, Motorola has just released a new microprocessor evaluation kit based on the MC6802. Called the MEK6802D3, the new system is supplied fully assembled and supersedes the well known MEK6800D2 two-board evaluation kit. The MEK6802D3 is accommodated on a single PCB which has a hexadecimal keyboard and an eight-digit LED readout.

by JOHN CLARKE

Many of our readers will probably be sorry to see the end of the Motorola MEK6800D2 but they may rest assured that most of its features are carried on in the newly released MEK6802D3 system.

The single board D3 system employs the MC6802 microprocessor chip which has all the registers and accumulators of the MC6800 plus an internal clock oscillator and driver. In addition, the 6802 has 128 bytes of RAM and a "Vcc standby" feature which allows the first 32 bytes of RAM memory to be retained in a low power mode.

In addition to the MC6802 chip there are two MC6810 static RAMs, one MC6821 Peripheral Interface Adaptor (PIA) and MC6846 ROM-I/O-Timer. A 3.579545MHz crystal reference is provided for the clock. This frequency is divided by four within the MC6802 chip itself which consequently operates on 894.88kHz.

The MC6821 PIA is provided for interfacing the keyboard and LED displays to the processor. The only user input/output device is the relatively new chip, the MC6846. The MC6846 provides 2048 8-bit bytes of ROM, an 8-bit bidirectional data port for parallel interface plus two control lines and programmable interval timer-counter functions. The ROM accommodates the D3BUG monitor program. The data port differs from a standard PIA in that all the control registers can be accessed so that, for example, the choice of positive or negative edge triggering and/or latching can be easily implemented.

The timer within the MC6846 can be operated in various modes such as pulse width comparison, frequency comparison, normal single-shot con-

tinuous and cascaded single-shot operations. Comprehensive information is given on all these modes in the data sheets.

The total volatile memory (RAM) available on the D3 computer board is 256 bytes.

The D3 evaluation kit is supplied fully assembled and tested. All that is needed to have it running is a 5V power supply capable of delivering 900 milliamps. Dimensions of the double-sided PCB are 210 x 180mm.

Comprehensive literature is provided in loose-leaf form, suitable for insertion into a standard 3-ring binder. The literature includes a manual on the D3 system itself, with chapters on general description and operation, hardware, software and expansion. Data sheets on all the major chips in the D3 system are provided plus schematics and an appendix on number systems and 6800 addressing modes. Also supplied is a programming reference manual on the M6800.

The D3BUG monitor is quite an advance on the JBUG monitor program of the D2 kit. With the D2, memory could only be advanced when in JBUG, however, with the D3BUG memory can be also stepped backwards. Breakpoints with the D3 computer can be removed separately, whereas the D2 monitor only removed breakpoints all at once. Up to eight breakpoints can be inserted compared to the D2's five.

Using breakpoints is easy with the D3BUG since the registers and their contents are displayed. The D3BUG will also calculate offsets for branch instructions. Just enter the start address, type the "FS" key and enter the final address. Type "GO" and the hexadecimal offset is displayed. The D2 kit had a

separate program to calculate offsets.

The D3 computer as it stands is not capable of transferring RAM contents onto an audio tape, although there is routine in the D3BUG monitor program. An extra board is required to be connected to the D3 system bus to enable use of the dump and load routine.

A chapter in the manual is devoted to expansion of the D3 computer. This chapter is well written and describes the necessary modifications required for the expansion boards. Extra memory boards and a colour TV monitor interface board are examples of the variety of expansion boards available.

Working through the introductory program load-run-debug example which Motorola have thoughtfully provided in the kit manual, I quickly learned to operate the system in D3BUG. The example is well done and should be equally effective in introducing a newcomer to microprocessing systems.

Programming the system was more difficult until I was able to sort out the addressing modes. Once this was done, another problem arose; how to access the I/O peripheral port? The manual refers to the PIA timer address being located at 8080 to 8087 but the order in which the registers are located is not clear. Reference to the data sheets showed a truth table for the register selection.

After conversion of the addresses 8080 to 8087, it became clear that the registers are located in memory in the order in which they occur in the above truth table. With that sorted out I was able to write a short program which

Microcomputer News & Products

over the map and can restrict access to I/O or another device (memory included) to itself. The monitor provides dual commands: one for each context.

Each 4K page can be independently write protected under software control. Any attempt to write into a protected area or access an absent page generates an interrupt to the System.

Each type of interrupt (SWI, IRQ, etc), when it occurs in the User context, can be independently set to either return to the System via its interrupt vectors, or stay in the User context via the User interrupt vectors.

The User context can have a whole 64K of logical address space to itself without having to leave gaps for I/O, interrupt vectors, monitors etc.

The card is Motorola 6800 Exorciser compatible. Any signals not produced by the 6809 but required by Exorciser compatible cards are synthesised and provided at the edge connector.

The Monitor provides commands to allocate resources and configure the system to the user's requirements. This feature is ideal for a development system. No longer do cards have to be swapped, with resultant wear on the edge connectors, or switches switched. Cards can remain plugged in all the time and software can select a subset for each application and set address ranges of individual cards.

The hardware provided is ideal for supporting a sophisticated operating system, multiprogrammed if desired. Only the System context has access to the Map and all interrupts can be directed to the System. The User (or users) can be forced to do all I/O via the operating system using driver routines.

Pennywise Peripherals,
19 Suemar Street, Mulgrave, 3170.

Tektronix catalog

Tektronix have published a 36 page catalog on their complete range of computer graphics hardware and software.

Included are graphics terminals from \$3500 and several new products including Dynamic Graphics (combined storage display and vector refresh capability) and 3-D graphics support software.

Product information provided covers:

- Graphics computing systems
- High resolution and raster scan graphics display terminals
- Colour graphics display terminals
- Plotters and hard copy printers
- Digitizers
- User graphics software

For a copy phone Sydney 888 7066 or write to Tektronix Australia Pty Limited, 80 Waterloo Road, North Ryde, NSW 2113.

New peripherals from Warburton Franki

Warburton Franki have just announced a new range of micro/mini computer peripherals including an improved version of their low cost video terminal, the WF 40z.

Other peripherals from Warburton Franki are a range of Shugart disk drives, both hard and soft, and the Epson daisy wheel printer.

The Epson printer is low-cost and features 80 columns, 125 character/sec, 96 ASCII character set, both tractor and friction feed, and is compatible with PET-2001, TRS-80 and Apple II systems via serial and Centronics plug-compatible interfaces.

Further information on these products can be obtained from Warburton Franki, 199 Parramatta Road, Auburn, NSW 2114. Phone (02) 648 1711.

OHIO VIDEO

OHIO COMPUTERS (OSI) SOFTWARE

GAMES: Machine Language 4K	
G 1 Chess	\$19 95
Games: Basic Language 8K	
G 2 Backgammon	\$15 95
G 3 Super Doodler	\$7 95
G 4 Blackjack	\$9 95
Games: Basic Language 4K	
G 5 Ten Tank Blitz	\$9 95
G 6 Star Fighter	\$7 95
G 7 Seawolf	\$7 95
G 8 Tank for Two	\$7 95
G 9 Fighter Pilot	\$7 95
G 10 Killerbot	\$7 95
G 11 Battle Ball	\$7 95
G 12 Battle Fleet	\$7 95
G 13 Slash Ball	\$7 95
G 14 Break Thru	\$7 95
G 15 Bomber	\$7 95
G 16 Awar	\$7 95
G 17 Robotank	\$7 95
G 18 Lunar Lander	\$6 95
G 19 Tankkanna	\$6 95
G 20 Gobbler	\$8 95
G 21 Bowling	\$5 95
G 22 Teen Age Driver	\$6 95
G 23 Battle Ground	\$6 95
Education: Basic Language 4K	
E 1 Math Practice	\$6 95
E 2 Master Mind/Gleep	\$6 95
E 3 Master Mind II	\$6 95
E 4 Concentration	\$6 95
E 5 Biohythm	\$5 95
Utility: Basic Language 4K	
U 1 Line Renumberer	\$6 95
U 2 Variable Table Maker	\$6 95
U 3 Search	\$6 95
U 4 Branch Finder	\$5 00
U 5 Super Utilities Pack (U1-4)	\$19 95
U 7 Poker Routine Maker	\$5 95
U 8 Cursor Control	\$9 95
U 9 Flashboard — Merry Xmas	\$5 95
Utility: Machine Language 4K	
U 6 Autoloader	\$7 95
Utility: Basic Language 6K	
U 10 Disassembler	\$7 95
Instructions:	
I 1 Graphics Instructions	\$4 95
I 2 How to read a line of microsoft	\$1 95
I 3 600 Baud Interface	\$1 95
I 4 Joy Stick Instructions	\$3 95
I 5 RS-232 Conversion	\$4 95
I 6 OSI ROM Basic	\$9 95
I 7 How to Write Professional Programs	\$1 95
I 8 Disassembled ROM Listing	\$9 95
I 9 Tokens & Basic Storage	\$2 95
WP 6502 Word Processor	\$249 NOW \$99 00

Mail Order: P&P \$1.00 for 1 or 2; \$1.60 for 3-5; \$2.00 for 6-9; \$2.50 for 10 or more

LOOKY VIDEO

PO Box 347 Richmond Vic. 3121
Shop: 418 Bridge Rd, Richmond Vic.
Ph. (03) 429 5674



THE BASE 2 MODEL 800 IMPACT PRINTER

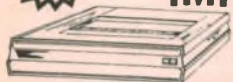

... fresh off the drawing board".
At a price you won't believe!!!

SPECIAL
\$695

Inc options "S" & "T"
Usually
\$895

UNIT PRICING
Model 800, 800C
Option "S"
Option "T"
Option "S" & "T"
Option "S" & "T" & "C"
Option "S" & "T" & "C" & "D"
Option "S" & "T" & "C" & "D" & "E"
Option "S" & "T" & "C" & "D" & "E" & "F"
Option "S" & "T" & "C" & "D" & "E" & "F" & "G"
Option "S" & "T" & "C" & "D" & "E" & "F" & "G" & "H"
Option "S" & "T" & "C" & "D" & "E" & "F" & "G" & "H" & "I"
Option "S" & "T" & "C" & "D" & "E" & "F" & "G" & "H" & "I" & "J"
Option "S" & "T" & "C" & "D" & "E" & "F" & "G" & "H" & "I" & "J" & "K"
Option "S" & "T" & "C" & "D" & "E" & "F" & "G" & "H" & "I" & "J" & "K" & "L"
Option "S" & "T" & "C" & "D" & "E" & "F" & "G" & "H" & "I" & "J" & "K" & "L" & "M"
Option "S" & "T" & "C" & "D" & "E" & "F" & "G" & "H" & "I" & "J" & "K" & "L" & "M" & "N"
Option "S" & "T" & "C" & "D" & "E" & "F" & "G" & "H" & "I" & "J" & "K" & "L" & "M" & "N" & "O"
Option "S" & "T" & "C" & "D" & "E" & "F" & "G" & "H" & "I" & "J" & "K" & "L" & "M" & "N" & "O" & "P"
Option "S" & "T" & "C" & "D" & "E" & "F" & "G" & "H" & "I" & "J" & "K" & "L" & "M" & "N" & "O" & "P" & "Q"
Option "S" & "T" & "C" & "D" & "E" & "F" & "G" & "H" & "I" & "J" & "K" & "L" & "M" & "N" & "O" & "P" & "Q" & "R"
Option "S" & "T" & "C" & "D" & "E" & "F" & "G" & "H" & "I" & "J" & "K" & "L" & "M" & "N" & "O" & "P" & "Q" & "R" & "S"
Option "S" & "T" & "C" & "D" & "E" & "F" & "G" & "H" & "I" & "J" & "K" & "L" & "M" & "N" & "O" & "P" & "Q" & "R" & "S" & "T"
Option "S" & "T" & "C" & "D" & "E" & "F" & "G" & "H" & "I" & "J" & "K" & "L" & "M" & "N" & "O" & "P" & "Q" & "R" & "S" & "T" & "U"
Option "S" & "T" & "C" & "D" & "E" & "F" & "G" & "H" & "I" & "J" & "K" & "L" & "M" & "N" & "O" & "P" & "Q" & "R" & "S" & "T" & "U" & "V"
Option "S" & "T" & "C" & "D" & "E" & "F" & "G" & "H" & "I" & "J" & "K" & "L" & "M" & "N" & "O" & "P" & "Q" & "R" & "S" & "T" & "U" & "V" & "W"
Option "S" & "T" & "C" & "D" & "E" & "F" & "G" & "H" & "I" & "J" & "K" & "L" & "M" & "N" & "O" & "P" & "Q" & "R" & "S" & "T" & "U" & "V" & "W" & "X"
Option "S" & "T" & "C" & "D" & "E" & "F" & "G" & "H" & "I" & "J" & "K" & "L" & "M" & "N" & "O" & "P" & "Q" & "R" & "S" & "T" & "U" & "V" & "W" & "X" & "Y"
Option "S" & "T" & "C" & "D" & "E" & "F" & "G" & "H" & "I" & "J" & "K" & "L" & "M" & "N" & "O" & "P" & "Q" & "R" & "S" & "T" & "U" & "V" & "W" & "X" & "Y" & "Z"
Option "S" & "T" & "C" & "D" & "E" & "F" & "G" & "H" & "I" & "J" & "K" & "L" & "M" & "N" & "O" & "P" & "Q" & "R" & "S" & "T" & "U" & "V" & "W" & "X" & "Y" & "Z" & "A"
Option "S" & "T" & "C" & "D" & "E" & "F" & "G" & "H" & "I" & "J" & "K" & "L" & "M" & "N" & "O" & "P" & "Q" & "R" & "S" & "T" & "U" & "V" & "W" & "X" & "Y" & "Z" & "A" & "B"
Option "S" & "T" & "C" & "D" & "E" & "F" & "G" & "H" & "I" & "J" & "K" & "L" & "M" & "N" & "O" & "P" & "Q" & "R" & "S" & "T" & "U" & "V" & "W" & "X" & "Y" & "Z" & "A" & "B" & "C"
Option "S" & "T" & "C" & "D" & "E" & "F" & "G" & "H" & "I" & "J" & "K" & "L" & "M" & "N" & "O" & "P" & "Q" & "R" & "S" & "T" & "U" & "V" & "W" & "X" & "Y" & "Z" & "A" & "B" & "C" & "D"
Option "S" & "T" & "C" & "D" & "E" & "F" & "G" & "H" & "I" & "J" & "K" & "L" & "M" & "N" & "O" & "P" & "Q" & "R" & "S" & "T" & "U" & "V" & "W" & "X" & "Y" & "Z" & "A" & "B" & "C" & "D" & "E"
Option "S" & "T" & "C" & "D" & "E" & "F" & "G" & "H" & "I" & "J" & "K" & "L" & "M" & "N" & "O" & "P" & "Q" & "R" & "S" & "T" & "U" & "V" & "W" & "X" & "Y" & "Z" & "A" & "B" & "C" & "D" & "E" & "F"
Option "S" & "T" & "C" & "D" & "E" & "F" & "G" & "H" & "I" & "J" & "K" & "L" & "M" & "N" & "O" & "P" & "Q" & "R" & "S" & "T" & "U" & "V" & "W" & "X" & "Y" & "Z" & "A" & "B" & "C" & "D" & "E" & "F" & "G"
Option "S" & "T" & "C" & "D" & "E" & "F" & "G" & "H" & "I" & "J" & "K" & "L" & "M" & "N" & "O" & "P" & "Q" & "R" & "S" & "T" & "U" & "V" & "W" & "X" & "Y" & "Z" & "A" & "B" & "C" & "D" & "E" & "F" & "G" & "H"
Option "S" & "T" & "C" & "D" & "E" & "F" & "G" & "H" & "I" & "J" & "K" & "L" & "M" & "N" & "O" & "P" & "Q" & "R" & "S" & "T" & "U" & "V" & "W" & "X" & "Y" & "Z" & "A" & "B" & "C" & "D" & "E" & "F" & "G" & "H" & "I"
Option "S" & "T" & "C" & "D" & "E" & "F" & "G" & "H" & "I" & "J" & "K" & "L" & "M" & "N" & "O" & "P" & "Q" & "R" & "S" & "T" & "U" & "V" & "W" & "X" & "Y" & "Z" & "A" & "B" & "C" & "D" & "E" & "F" & "G" & "H" & "I" & "J"
Option "S" & "T" & "C" & "D" & "E" & "F" & "G" & "H" & "I" & "J" & "K" & "L" & "M" & "N" & "O" & "P" & "Q" & "R" & "S" & "T" & "U" & "V" & "W" & "X" & "Y" & "Z" & "A" & "B" & "C" & "D" & "E" & "F" & "G" & "H" & "I" & "J" & "K"
Option "S" & "T" & "C" & "D" & "E" & "F" & "G" & "H" & "I" & "J" & "K" & "L" & "M" & "N" & "O" & "P" & "Q" & "R" & "S" & "T" & "U" & "V" & "W" & "X" & "Y" & "Z" & "A" & "B" & "C" & "D" & "E" & "F" & "G" & "H" & "I" & "J" & "K" & "L"
Option "S" & "T" & "C" & "D" & "E" & "F" & "G" & "H" & "I" & "J" & "K" & "L" & "M" & "N" & "O" & "P" & "Q" & "R" & "S" & "T" & "U" & "V" & "W" & "X" & "Y" & "Z" & "A" & "B" & "C" & "D" & "E" & "F" & "G" & "H" & "I" & "J" & "K" & "L" & "M"
Option "S" & "T" & "C" & "D" & "E" & "F" & "G" & "H" & "I" & "J" & "K" & "L" & "M" & "N" & "O" & "P" & "Q" & "R" & "S" & "T" & "U" & "V" & "W" & "X" & "Y" & "Z" & "A" & "B" & "C" & "D" & "E" & "F" & "G" & "H" & "I" & "J" & "K" & "L" & "M" & "N"
Option "S" & "T" & "C" & "D" & "E" & "F" & "G" & "H" & "I" & "J" & "K" & "L" & "M" & "N" & "O" & "P" & "Q" & "R" & "S" & "T" & "U" & "V" & "W" & "X" & "Y" & "Z" & "A" & "B" & "C" & "D" & "E" & "F" & "G" & "H" & "I" & "J" & "K" & "L" & "M" & "N" & "O"
Option "S" & "T" & "C" & "D" & "E" & "F" & "G" & "H" & "I" & "J" & "K" & "L" & "M" & "N" & "O" & "P" & "Q" & "R" & "S" & "T" & "U" & "V" & "W" & "X" & "Y" & "Z" & "A" & "B" & "C" & "D" & "E" & "F" & "G" & "H" & "I" & "J" & "K" & "L" & "M" & "N" & "O" & "P"
Option "S" & "T" & "C" & "D" & "E" & "F" & "G" & "H" & "I" & "J" & "K" & "L" & "M" & "N" & "O" & "P" & "Q" & "R" & "S" & "T" & "U" & "V" & "W" & "X" & "Y" & "Z" & "A" & "B" & "C" & "D" & "E" & "F" & "G" & "H" & "I" & "J" & "K" & "L" & "M" & "N" & "O" & "P" & "Q"
Option "S" & "T" & "C" & "D" & "E" & "F" & "G" & "H" & "I" & "J" & "K" & "L" & "M" & "N" & "O" & "P" & "Q" & "R" & "S" & "T" & "U" & "V" & "W" & "X" & "Y" & "Z" & "A" & "B" & "C" & "D" & "E" & "F" & "G" & "H" & "I" & "J" & "K" & "L" & "M" & "N" & "O" & "P" & "Q" & "R"
Option "S" & "T" & "C" & "D" & "E" & "F" & "G" & "H" & "I" & "J" & "K" & "L" & "M" & "N" & "O" & "P" & "Q" & "R" & "S" & "T" & "U" & "V" & "W" & "X" & "Y" & "Z" & "A" & "B" & "C" & "D" & "E" & "F" & "G" & "H" & "I" & "J" & "K" & "L" & "M" & "N" & "O" & "P" & "Q" & "R" & "S"
Option "S" & "T" & "C" & "D" & "E" & "F" & "G" & "H" & "I" & "J" & "K" & "L" & "M" & "N" & "O" & "P" & "Q" & "R" & "S" & "T" & "U" & "V" & "W" & "X" & "Y" & "Z" & "A" & "B" & "C" & "D" & "E" & "F" & "G" & "H" & "I" & "J" & "K" & "L" & "M" & "N" & "O" & "P" & "Q" & "R" & "S" & "T"
Option "S" & "T" & "C" & "D" & "E" & "F" & "G" & "H" & "I" & "J" & "K" & "L" & "M" & "N" & "O" & "P" & "Q" & "R" & "S" & "T" & "U" & "V" & "W" & "X" & "Y" & "Z" & "A" & "B" & "C" & "D" & "E" & "F" & "G" & "H" & "I" & "J" & "K" & "L" & "M" & "N" & "O" & "P" & "Q" & "R" & "S" & "T" & "U"
Option "S" & "T" & "C" & "D" & "E" & "F" & "G" & "H" & "I" & "J" & "K" & "L" & "M" & "N" & "O" & "P" & "Q" & "R" & "S" & "T" & "U" & "V" & "W" & "X" & "Y" & "Z" & "A" & "B" & "C" & "D" & "E" & "F" & "G" & "H" & "I" & "J" & "K" & "L" & "M" & "N" & "O" & "P" & "Q" & "R" & "S" & "T" & "U" & "V"
Option "S" & "T" & "C" & "D" & "E" & "F" & "G" & "H" & "I" & "J" & "K" & "L" & "M" & "N" & "O" & "P" & "Q" & "R" & "S" & "T" & "U" & "V" & "W" & "X" & "Y" & "Z" & "A" & "B" & "C" & "D" & "E" & "F" & "G" & "H" & "I" & "J" & "K" & "L" & "M" & "N" & "O" & "P" & "Q" & "R" & "S" & "T" & "U" & "V" & "W"
Option "S" & "T" & "C" & "D" & "E" & "F" & "G" & "H" & "I" & "J" & "K" & "L" & "M" & "N" & "O" & "P" & "Q" & "R" & "S" & "T" & "U" & "V" & "W" & "X" & "Y" & "Z" & "A" & "B" & "C" & "D" & "E" & "F" & "G" & "H" & "I" & "J" & "K" & "L" & "M" & "N" & "O" & "P" & "Q" & "R" & "S" & "T" & "U" & "V" & "W" & "X"
Option "S" & "T" & "C" & "D" & "E" & "F" & "G" & "H" & "I" & "J" & "K" & "L" & "M" & "N" & "O" & "P" & "Q" & "R" & "S" & "T" & "U" & "V" & "W" & "X" & "Y" & "Z" & "A" & "B" & "C" & "D" & "E" & "F" & "G" & "H" & "I" & "J" & "K" & "L" & "M" & "N" & "O" & "P" & "Q" & "R" & "S" & "T" & "U" & "V" & "W" & "X" & "Y"
Option "S" & "T" & "C" & "D" & "E" & "F" & "G" & "H" & "I" & "J" & "K" & "L" & "M" & "N" & "O" & "P" & "Q" & "R" & "S" & "T" & "U" & "V" & "W" & "X" & "Y" & "Z" & "A" & "B" & "C" & "D" & "E" & "F" & "G" & "H" & "I" & "J" & "K" & "L" & "M" & "N" & "O" & "P" & "Q" & "R" & "S" & "T" & "U" & "V" & "W" & "X" & "Y" & "Z" & "A" & "B" & "C" & "D" & "E" & "F" & "G" & "H" & "I" & "J" & "K" & "L" & "M" & "N" & "O" & "P" & "Q" & "R" & "S" & "T" & "U" & "V" & "W" & "X" & "Y" & "Z" & "A" & "B" & "C" & "D" & "E" & "F" & "G" & "H" & "I" & "J" & "K" & "L" & "M" & "N" & "O" & "P" & "Q" & "R" & "S" & "T" & "U" & "V" & "W" & "X" & "Y" & "Z" & "A" & "B" & "C" & "D" & "E" & "F" & "G" & "H" & "I" & "J" &

D3, THE NEW LOW COST POWER BASE TO BUILD YOUR SYSTEM ON!

Motorola's Microcomputer Expansion Systems are built around the completely new D3 module, and that means you now get all the versatility you want on one printed circuit board. This new module is the power base on which you can build your own powerful micro system, and its big capacity allows you to construct simple or complex systems — as you want them.

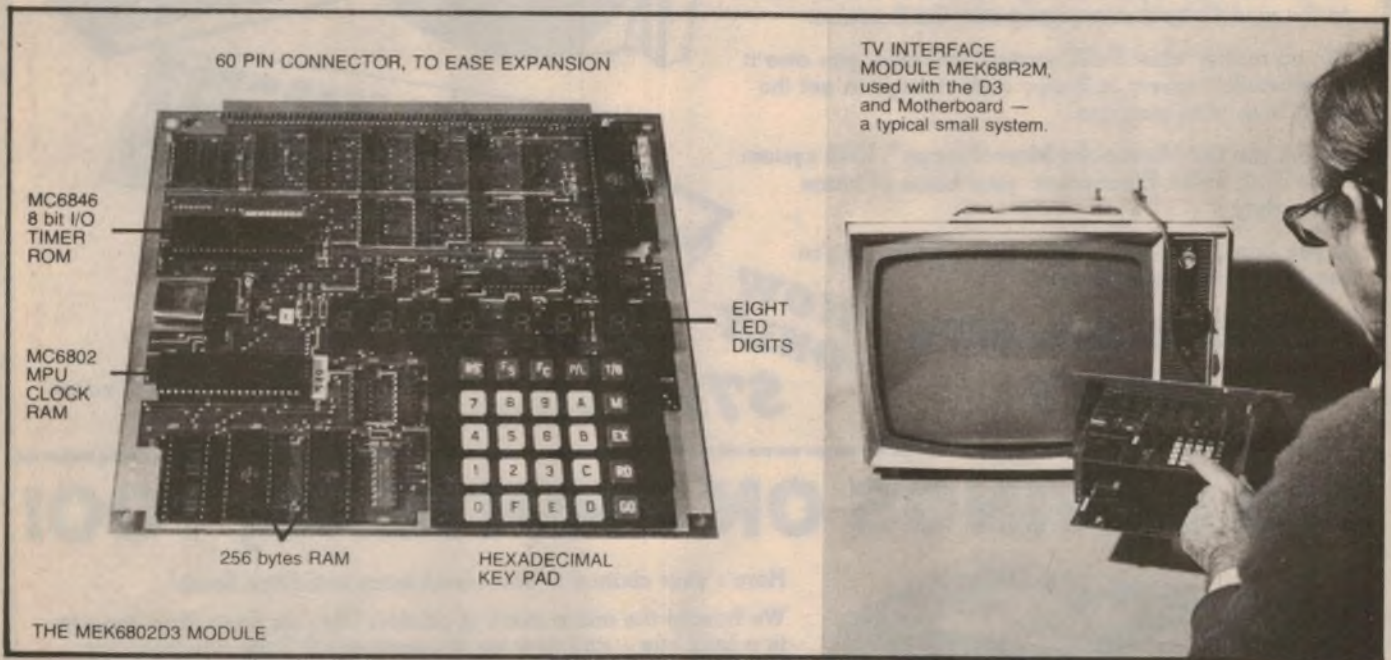

D3 features a multilevel memory paging technique, memory expandable to 256 K bytes RAM, and 160 K bytes ROM, a 2 K byte monitor — D3 BUG, for control of the systems microprocessor through the D3 hexadecimal keypad and LED display.

And there's the 16 K byte dynamic memory module, a television interface board, the combination card cage

and motherboard, wirewrap board, and a RAM/ROM board.

No assembly or soldering because Motorola have designed each module to simply plug into the motherboard and the D3 module does the rest! If you have one of the ever popular D2 kits — don't panic. There is a new range of expansion products to suit these kits too!

D3 IS NOW AVAILABLE FROM:

Stewart Electronic Components Pty. Ltd.
44 Stafford Street
Huntingdale, Vic 3166. Ph (03) 543 3733

Ellistronics
289 Latrobe Street
Melbourne, Vic 3000 Ph (03) 602 3836

Electronic Distributors
Shop 2-4, 7-10 Joyce Street
Post Office Arcade
Pendle Hill, N.S.W. 2145. Ph (02) 636 6052

Martin De Laveay Pty. Ltd.
Chr. King & Darby Streets
Newcastle, N.S.W. 2300. Ph (049) 2 4741

Radio Dispatch Pty. Ltd.
869 George Street
Sydney N.S.W. 2000. Ph (02) 211 0191

Electronic Components (Qld)
16/205 Moggill Road
Taringa Qld 4068 Ph (07) 371 5677

George Harvey Electric Pty. Ltd.
162 Argyle Street
Hobart Tas 7000 Ph (002) 34 2233
76 York Street
Launceston, Tas 7250 Ph (002) 31 6533

Our floppy disk storage system goes twice the distance — for about half the price!

That's right. The superb Micropolis MacroFloppy™ Disk Drive sub-system for S-100/Z-80/8080 bus packs a whopping 100% more capacity into a 5¼ inch floppy disk than anyone else.

143K bytes, to be exact. For as little as \$750!!!

- Here's what you get:
- One disk drive — complete with inbuilt power supply
 - S-100/Z-80/8080 compatible controller on a PCB (capable of controlling up to 4 drives)
 - Interface cable
 - Huge comprehensive user manual
 - Two diskettes (master and backup copy) with powerful MDOS version 4.0 disc operating system and Microsoft Extended Disc BASIC

And remember, it is made by Micropolis — pioneers and acknowledged world leaders in high density floppy disk technology.

Of course, this superb storage system is ideally suited to the world's best microcomputer: the Sorcerer.

But no matter what S-100 system you own, you owe it to yourself to invest in floppy disk storage to get the most from your machine.

Check out the Micropolis MacroFloppy™ 1042 system from Dick Smith Electronics: your home of home computers.

If you buy some other floppy disk system, you're throwing good money away!

**SAVE A MASSIVE
\$125!!!**

**NOW
ONLY**

\$750 WAS \$875

Cat X-3200

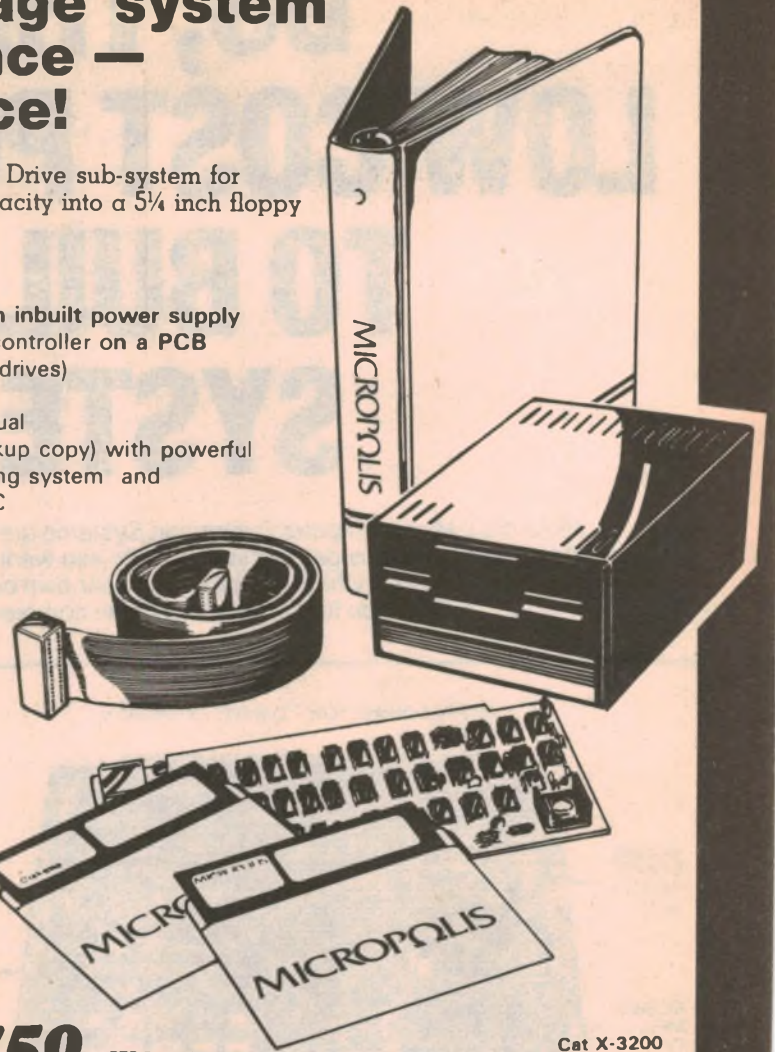

BIG SAVINGS ON PRINTERS, TOO!



Cat X-3250

~~\$495.00~~

Here's your chance to save even more with Dick Smith!

We bought the entire stock of printers from an Australian importer in a bulk buy — and now we're overstocked. Take advantage of our error: we were selling these for around \$200 less than you could buy them elsewhere; now we're forced to slash the price by a further \$50.00 — just to give us some breathing space!

These printers are brand new, prime spec, and suit virtually any of the microcomputers around: Sorcerer, Apple, TRS-80, etc etc. They feature 3 sizes of print, with a speed of 150 lines per minute. You won't need a ribbon — they use heat sensitive paper. And they're quiet — unlike many printers!

Be quick for this outstanding bargain — we cannot repeat this offer once our excess stocks are cleared!

now only \$445 — around \$250 saving!

DICK SMITH ELECTRONICS



SEE OUR OTHER ADVERTS IN THIS MAGAZINE FOR OUR STORE ADDRESSES AND RESELLERS

TRS-80 SOLUTION

HARDWARE	
3 Speed Mod — a simple Kit — easy reversible	\$29.95
Light Pen with software cassette Kit	\$14.00
CASSETTE SOFTWARE	
SARGON	\$25.00
SARGON II — New The best yet	\$37.50
Business Package 8 cassettes level 1 — 4k	\$29.00
Golf — Crosout 2 Programs TRS80	\$9.00
10 Pin Bowling TRS80 — TRS80 L1 & L2	\$9.00
SANTA PARAVIA TRS80 L1 & L2	\$9.00
SPACE TREK IV K216K	\$9.00
Oil Tycoon L1 & L2 4K	\$9.00
Electric Pencil word processor — L2 16k	\$99.00
Game Playing with basic Tapes 1 2, or 3 TRS 80	\$12.50
Clone 2 — copy any program — System or basic	\$18.00
Complex Matrix Mathematics	\$12.50
General Mathematics	\$12.50
Microchips "Still the best seller"	\$22.00
Trak 80 — System tape with sound	\$18.50
Electric Paintbrush — Great Graphics	\$18.50
Checker King-System "Fantastic Draughts"	\$24.00
Whip it it gives beam leading for 240	
D X CC Countries with distance plus ross diste cassette	\$14.00
Light Pen Demo cassette	\$12.50
Right "Fly" plane at home"	\$9.00
Teache: "A great educational program"	\$12.00

DISK SOFTWARE	
New Dos + 35 Track	\$99.00
New Dos + 40 Track	\$109.00
New Dos + 35 Track	\$49.00
New Dos + 40 Track	\$59.00
Games — 2 starttraks 3D Luna Lander	
Tribotrap etc	\$20.00
Invysori "Marvelous"	\$20.00
Inventory "Very comprehensive" — 2000	\$50.00
Accounts payable Taranto Osborne	\$99.00
General Ledger Taranto Osborne	\$99.00
Invoicing Taranto Osborne	\$99.00
Accounts Receivable Taranto Osborne	\$99.00
UTILITIES	
Utility 1 — Duplik copy tapes & Renumber	\$9.00
Utility 2 — Merge basic programs & Merge System	\$9.00
Clone — Copy any program	18.00

PROGRAMMING AIDS	
Coding/crt Forms "Marvelous"	2 pads \$8.50
	10 pads \$30.00
Flow Charts 780mm x 408mm	2 pads \$10.00
	10 pads \$45.00
Giant Print cut sheets: 380mm x 558mm	1 pad \$10.50
	5 pads \$37.50

SUNDRIES	
Scotch Diskettes 10 for	\$70.00
Memoes Diskettes 10 for	\$53.00
Anti Static Mat 24" x 20" (A must)	\$70.00
Binders for CB Action or Amateur Radio Action	\$6.50
Combination OSL Album/Log Book	\$9.95
Non profit newsletter 8 issues for	\$10.00

BOOKS	
Basic Bash	\$11.00
Basic from the ground up	\$11.00
Basic Workbook	\$7.50
Discovering Basic	\$8.50
Game Playing with Basic	\$10.00
76 Basic Programs	\$12.50
Sargon	\$19.00
Build a computer Controlled Robot	\$15.00
Introduction to Microcomputers "Osborne"	\$11.75
Introduction to Microcomputers book 1	\$12.50
280 Programming Porcogic Design	\$12.50
280 Assembly Language Programming	\$13.50
6502 Assembly Language Programming	\$13.80
Cost Accounting "Osborne"	\$20.00
Accounts payable/receivable "Osborne"	\$20.00
General Ledger "Osborne"	\$20.00
Basic from the ground up	\$11.00

DEFOREST SOFTWARE

QUALITY OSL PTY. LTD
26 STATION STREET, NUNAWADING, VICTORIA 3131
TELEPHONE: (03) 878 9276 (03) 877 6946

Postage is included at no charge except for binders \$2.00 however we suggest certification or registration. Schools less 10% — Trade Enquiries Welcome

Microcomputer News & Products

New keyboard & display for PRO-LOG's STD BUS

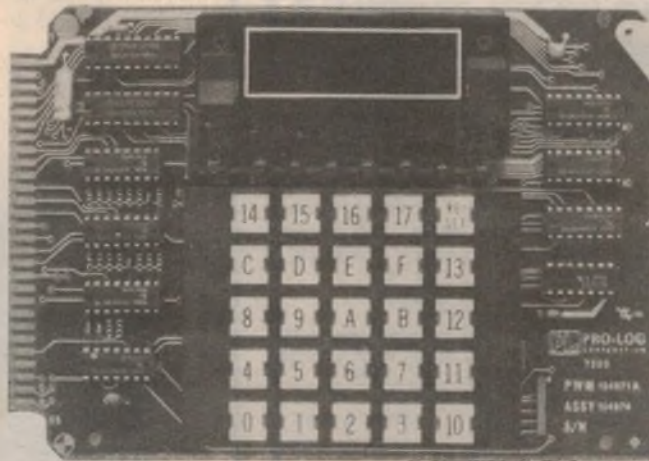

PRO-LOG's 7303 keyboard and display card is ideal for control system and system development purposes.

MONTEREY, California. — A general purpose control panel card with data input and display capabilities has been added to Pro-Log Corporation's line of STD BUS-compatible microprocessor support cards.

Pro-Log's 7303 Keyboard/Display card is designed for applications in which a low-cost operator interface is required for system control, data entry, status display and operator prompting. It is also suitable for system development, testing and training applications.

The 7303 card features two status displays. The alphanumeric display consists of eight 16-segment digit positions, each of which accepts one of 64 ASCII coded characters. An LED display tracks data in eight-bit binary form.

The card's keyboard contains a system-reset key and 24 programmable keys. The card operates from a single +5 volt supply.

For further information contact Pro-Log at 2411 Garden Road, Monterey,

CA 93940, (408) 372 4593; or Janis Ulevich at TFB Public Relations, 505 Hamilton Ave, Palo Alto, CA 94301, (415) 328 4745.

New 6809 computer card from Pennywise

The Pennywise Peripherals' 6809 card contains many features only expected on larger computers. In addition it is backed up by a powerful monitor.

The central feature of the card is special memory mapping hardware. The page size is 4K and physical addresses can lie within 4 64K address spaces.

There are two "contexts": System and User. The System has sole control

MICRONEWS CONTINUED →

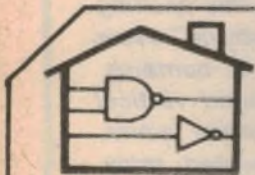

Cottage Computers

a division of Embryonic Systems Pty Ltd

386 QUEENS Pde., CLIFTON HILL Vic., 3068 Tel:(03)481 1975

ACORN Systems ARE HERE!!!

From µcontrollers to Disc based systems, the ACORN is built around the 6502 MPU and Eurocard technology...SEE the ACORN at COTTAGE COMPUTERS Now !!!!



CQ electronics

and get your components

SHOP 9, TOWN CENTRE 95 REGENT STREET
30 CAMPBELL STREET CENTRAL RAILWAY
blacktown. sydney.
621 5809 698 8079

\$1.00 packs

10% discount for 20 pack

SINGLE GANG 45mm SLIDE POTS

50 K. LOG. 2 FOR \$1.00
100 K. LIN. W. TAP 2 FOR \$1.00
10 K. LINEAR 2 FOR \$1.00
2 K. LINEAR 2 FOR \$1.00



CERAMIC CAPACITORS 500v.

PACK OF 30 OF ONE VALUE \$1.00
12, 15, 18, 22, 33, 68, 82, 100,
180, 220, 270, 330, 470, 560,
680 pF



PACK OF 2 EACH VALUE \$1.00

ELECTROLYTICS PCB TYPE

0.47 uF 50v. 25 FOR \$1.00
2.2 uF 25v. 25 FOR \$1.00
3.3 uF 16v. 25 FOR \$1.00
3.3 uF 25v. 20 FOR \$1.00
4.7 uF 10v. 25 FOR \$1.00
4.7 uF 16v. 20 FOR \$1.00
2.2 uF 10v. 25 FOR \$1.00
22 uF 50v. 15 FOR \$1.00
100 uF 50v. 10 FOR \$1.00
220 uF 16v. 10 FOR \$1.00
470 uF 6.3v 10 FOR \$1.00
470 uF 16v. 8 FOR \$1.00
470 uF 25v. 6 FOR \$1.00
1000 uF 25v. 4 FOR \$1.00
1000 uF 35v. 3 FOR \$1.00
1000 uF 50v. 2 FOR \$1.00

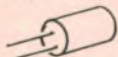

DIODES

EM 4005 1A. 50v. 20 FOR \$1.00
IN 4007 1A. 1000x9 FOR \$1.00
AA 119 H.F. 6 FOR \$1.00
BA 100 SILICON 8 FOR \$1.00
OA 90 GERMANIUM B FOR \$1.00
PA 202 GERMANIUM B FOR \$1.00
IN 914 PRECUT 15 FOR \$1.00

HARDWARE

12 ALLIGATOR CLIPS \$1.00
10 4mm BANANA PLUGS \$1.00
5 4mm BAN. PLUGS & SOCK. \$1.00
1 DP DT MIN. TOGGLE \$1.00
2 CHR. GREEN LEDS \$1.00
20 PCB STAND OFFS \$1.00
25 75mm CABLE TIES \$1.00
20 6.3v. FLY LEAD LAMPS \$1.00
3 9 PIN VALVE SOCK. \$1.00
10 1/2 mm RUBBER FEET \$1.00
2 5 WAY RCA SOCKETS \$1.00
2 6 WAY RCA SOCKETS \$1.00
1 SP. DT. C-OFF MIN. TOGGLE \$1.00

40673 DUAL GATE MOSFET \$2.95
BF 180 VHF TRANSISTOR -85c

MICRO PROCESSOR

LIMITED STOCKS !!!
Z 80 CPU \$11.00
8085 CPU \$10.00
8080 CPU 2 FOR \$10.00
825A UART 2 FOR \$8.00
5303 UART 2 FOR \$8.00
4116 16 K. DRAM \$8.00
2708 8 K. EPROM \$8.00



CERAMIC TUNING CAPACITORS

AIR SPACED 1/4" SHAFT
10 pF, 15 pF, 20 pF, 30 pF \$3.95
100 pF \$4.95
150 pF \$5.95



REDUCTION DIALS

50 mm. 0-100 \$3.95
50 mm B-CAST \$3.95
70 mm 0-100 \$4.95



EA AND ETI PC BOARDS

ALL SINGLE SIDED BOARDS
AVAILABLE, DRILLED AND
TINNED ON FIBREGLASS.
COST 50¢ PER BOARD
PLUS 2¢ PER HOLE.
BOARDS TO YOUR ART
WORK AT \$2.50 PER
BOARD PLUS 2¢ PER HOLE.

LINEAR IC'S

AN 210 A \$1.95
CA 3013 .95¢
CA 3014 .95¢
CA 302B \$1.95
LN 2126 \$1.95
LM 1303 \$1.95
MC 1314 \$7.50
MC 1315 \$9.50
SN 76005 \$2.95
TL 083 \$1.95
8038 \$6.95
DATA AVAILABLE 40¢

PANEL METERS

20 v. DC. 75mm \$10.50
10 A. DC. 75mm \$10.50
VU METERS 40mm \$1.50

CASTORS

CASTORS FOR LARGE
SPEAKER BOXES, ETC.
SET OF 4 \$4.00

Capacitors and resistors, integrated circuits,
Wires and cables, semiconductors, fuses, knobs
Radio and TV valves, plugs and sockets, pots
Manufacturers of PC boards and disco lighting.

Prices subject to change without notice
Pack and postage within Australia: \$1.00

02-
621 5809

CQ ELECTRONICS
30 CAMPBELL ST
BLACKTOWN 2148

WRITE



Don't miss this

PROJECTS and CIRCUITS No. 2

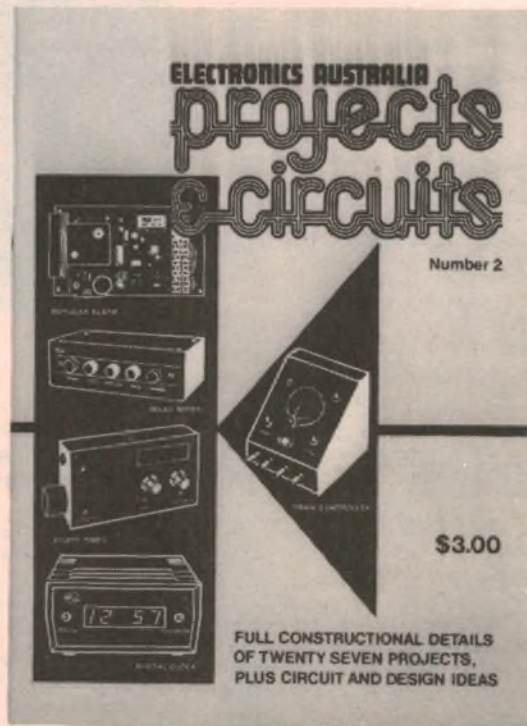

27 DO-IT-YOURSELF PROJECTS FROM "ELECTRONICS AUSTRALIA"

You can't afford to miss out on this exciting new book from "Electronics Australia". Here are just a few of the projects it contains: remote TV headphones, multi-band vertical aerial, roulette wheel, radar burglar alarm, model train control, voice-operated relay, transistor tester, water level alarm ... plus many more. Get your copy now!

Available from:
"Electronics Australia", 57 Regent St, Sydney.
PRICE \$3.00 OR by mail order from "Electronics Australia", PO Box 163, Beaconsfield 2014. PRICE \$3.60.



THE LOGIC

SHOP PTY. LTD.

Discount shopping for your professional Microcomputer and terminal requirements

COMPUCOLOR II

from \$2065



features:

Up to 32K User RAM
Eight-colour display
32 lines of 64 char.
5" Mini Disk Drive
40 Tracks, 48 TPI

Low Cost LOGIC TLS 900

from \$1415



features:

24 lines
80 char. per line
Transmission rates 75-19,200 Bd.
96 char. ASCII Upper & Lower Case
12" Monitor

MICROLINE 80 PRINTER

from \$960



features:

80 char. per sec.
80 and 132 char. per line
9x7 DOT MATRIX character or graphics printing.

PLUG COMPATIBLE TO TRS-80

"retail saving on professional products"



THE LOGIC

SHOP PTY. LTD.

212 HIGH ST, PRAHRAN Vic
3181. Tel 51 1950

91 REGENT ST, CHIPPENDALE,
NSW 2008. Tel 699 4910

Microcomputer News & Products

also available. On-board programming permits the system designer to blow PROMs on line using the computer in lieu of an off-line device. Results can be tested, compared and executed immediately.

The MDB-MR-004 module can accommodate commercially available 2716 and 2732 UV erasable PROMs.

The on-board programmer is switch or program selectable. It has a status register for programming write, interrupt enable and done. The PROM, status register and vector addresses are switch selectable.

The MLSI-MRV-004 PROM programmer module for use with LSI-11 systems accommodates commercially available 2716 and 2758 UV erasable PROMs. The on-board programmer is switch selectable, as are memory area allocations. It is a dual module requiring one-half quad slot in the chassis.

For further information: Gene Sylvester, Director of Marketing, MDB Systems, Inc, 1995 North Batavia Street, Orange, California 92665. Tel: 714/998-6900. TWX: 910-593-1339.

SORD Computers sold to Swedish hospitals

Sord Computer Systems of Japan have announced receipt of an order from the Swedish Government for 165 SORD M200 MKIII Series Computers for use in Swedish National Hospitals. This is the first large order for any

Japanese Microcomputers from Sweden. The 165 computers are part of a proposed 2000 units expected to be ordered within the next year.

The SORD computers will be used at 16 hospitals for stock control of blood, medicine, medical equipment and also food control. All the hospitals have main frame computers to which the SORD computers will be attached as intelligent terminals. SORD won the order despite intense competition from the US and European manufacturers.

SORD M200 series computer are imported into Australia by Mitsui & Co (Australia) Ltd, and are sold by the Small Business Computer Company.

Hard copy for DEC MINC systems

Tektronix has announced a new version of the desktop 4632 Video Hard Copy Unit. Called the 4632 Option 8 Video Hard Copy Unit; it is specially designed for providing high resolution graphics and copies from DEC MINC systems: MiniMINC, and the VT105-based DECLAB-11/MNC.

The 4632 Option 8 copies both alphanumeric and graphics simultaneously. Copies can be handled like conventional paper and may be erased or written on with pen or pencil. The first copy takes 18 seconds to produce and 8 seconds for subsequent copies of the same display. Copy cost is around 8c. The 4632's dry-process development system uses dry silver paper for the high image quality required by complex graphics and alphanumerics.

Further information from Tektronix Australia Pty Limited, 80 Waterloo Road, North Ryde, NSW 2113. Phone (02) 888 7066.

TRS-80® PET® S-100

APPLE® NORTH STAR® MEDICAL & PROFESSIONAL SYSTEMS-BUSINESS SYSTEMS

*INSTANT SOFTWARE®

OVER 300 PROGRAMS

BUSINESS-HOME-EDUCATION

SCIENCE-GAMES-HEALTH

EASY INSTRUCTIONS

PROFESSIONAL DISKS & CASSETTES

GUARANTEED QUALITY

*TESTED HARDWARE-VIDEO MONITOR \$ 120

Z80-S100-DISK SYSTEMS-CP/M or new TPM

VERBATIM mini DISKS 1-9\$4-25; 10up \$4

*S-100 BOARDS ASSEMBLED

16K STATIC RAM (2114) \$ 370

VIDEO 64x16 ETI 640 \$ 165

EPROM (2708) \$ 149

*SEND FOR FREE CATALOGUE OF SOFTWARE AND HARDWARE-SPECIFY COMPUTER

*NEWSLETTERS-SPECIFY YOUR SYSTEM AND APPLICATIONS \$12 pa.

ALL PRICES TAX EXEMPT-ADD 15% WHERE APPLICABLE-F.O.B. HAWTHORN VIC.

SUBJECT TO CHANGE WITHOUT NOTICE

BANKCARD-GIVE NAME NUMBER EXPIRY DATE AND SIGNATURE

MICRODOT P.O. BOX 420 HAWTHORN 3122 AUSTRALIA 03-819 2411



Microcomputer News & Products



NEW 132 COLUMN PRINTER FROM ANADEX



Bell and Howell have just announced the release of the new Anadex DP-9500 line printer. They claim that it is the most feature-packed and cost-effective printer of its type on the Australian

market today.

A spokesman from Bell and Howell said that the release of the DP-9500 would coincide with the US product launch and that it earned its title as

"super printer" by virtue of its many standard features not previously available in a line printer for under \$2000. He stressed that the only options that the user need consider are: heavy duty head (from 150M to 650M characters), increased buffer storage (from 500 characters to 2K) and high density graphics.

A significant feature of the DP-9500 series is dual character fonts of either 9 x 9 and 7 x 9 allowing column widths of 132 or 175 with print speeds of 150 or 200 cps (for model DP-9500) or fonts of either 11 x 9 and 7 x 9 with column widths of 132 or 220 characters and print speeds of 120 or 200cps (model DP-9501). Thus the industry standard 132 columns are printed with true lower case descenders.

An on-board microprocessor ensures high throughput with shortest distance sensing logic and built in self-test diagnostics to ensure trouble free operation.

Complete communications control is another standard feature which allows the printer to act as an intelligent device. As with the smaller DP-8000 all three interfaces (RS-232C, current loop and Centronics parallel) are inbuilt and switch selectable as is full-width adjustable tractor feed.

DON'T BUY A 6809 CARD YET FIRST CHECK OUT OURS OTHERWISE YOU'LL BE SORRY!

The 6809 is the most advanced 8 bit microprocessor with many 16 bit operations. It deserves more than just being plonked on a PCB with the usual RAM, PROM, I/O and standard Monitor.

PP's 6809 Card has advanced memory mapping and protection hardware with a powerful Monitor to match.

- Increased addressing capability — up to 256K.
- Memory protection hardware — 4K pages can be individually write-protected or marked absent by software. Any violation causes an immediate interrupt to the monitor which prints diagnostics.
- No more worn out edge connectors — reconfiguration of hardware is done by software, not by switching switches or swapping cards.
- Cassette or Disk-based software available including — operating system, macroassembler and linking loader, higher level languages, and application programs.
- Software controlled baud rates — the monitor determines the speed of any terminal connected and configures the UART for the observed baud rate (up to 9600) and parity.
- Supports proper operating system — system has privileged control of memory map and I/O.
- Motorola Exorciser compatible.

Call us or send a stamped SAE
for further details.

PP Pennywise Peripherals
Pennywise Peripherals

19 Suemar Street, Mulgrave, Vic, 3170.
Phone (03) 546 0308.

COMPUCOLOR II

decimal number is followed with an exponent, eg 3.4567E-29. The exponent must be in the range +/-38.

The file control commands are quite comprehensive. Programs can be loaded and saved quickly and reliably on the floppy disk, eg LOAD "DEMO", SAVE "DEMO", and it is also possible to create data files and save arrays or variables. Updates to accounts or lists are easily made on the floppies — if you are used to pushing the piano key controls on a cassette deck this is a welcome relief.

To further facilitate disk operations the Compucolor has an AUTO key. When this is pressed the file control system searches for a BASIC program called "MENU" on the disk and then loads and runs it. This "MENU" program is usually provided on most disks for the purposes of outlining what is on the disk or any information about it. It's used, for example, on the "Sampler" disk which comes with the Compucolor and all the other software disks but it can also be used when creating your own disks.

From within the file control system itself the "DIRECTORY" command will list all the files on one side of the floppy disk. The directory includes file name, version, size and address. Files can be deleted or copied from one floppy disk to another using the screen-refresh RAM as a temporary buffer.

If necessary an additional disk drive can be purchased.

Blank mini floppy disks with the proper formatting are quite cheap at a quoted price of \$9.95 for two. If you're after software for the Compucolor there is certainly a lot of it available on Compucolor "Sofdisk" floppies. The supplied "Sampler" disk is just an appetiser — there are also "Sofdisks" with Hangman, Startrek, Chess, Othello, Text Editor, 8080 assembler and each disk has at least 3 or 4 other games or programs on it.

More software will shortly become available such as games, a screen editor, monitor, finance, engineering and statistical packages — making the Compucolor an even more useful computer.

To keep users aware of the latest developments Compucolor also publishes a monthly newsletter called "Colorcue". It includes information on software and hardware developments, user groups and a fair bit of user input. It may be available from some Compucolor retailers but a subscription is also available for US\$24 a year.

There are a few features we have not discussed in detail, like the on-board "real-time" clock, or the sockets provided for an additional 8k of ROM but clearly the Compucolor II is a winner and it has to be ranked as one of

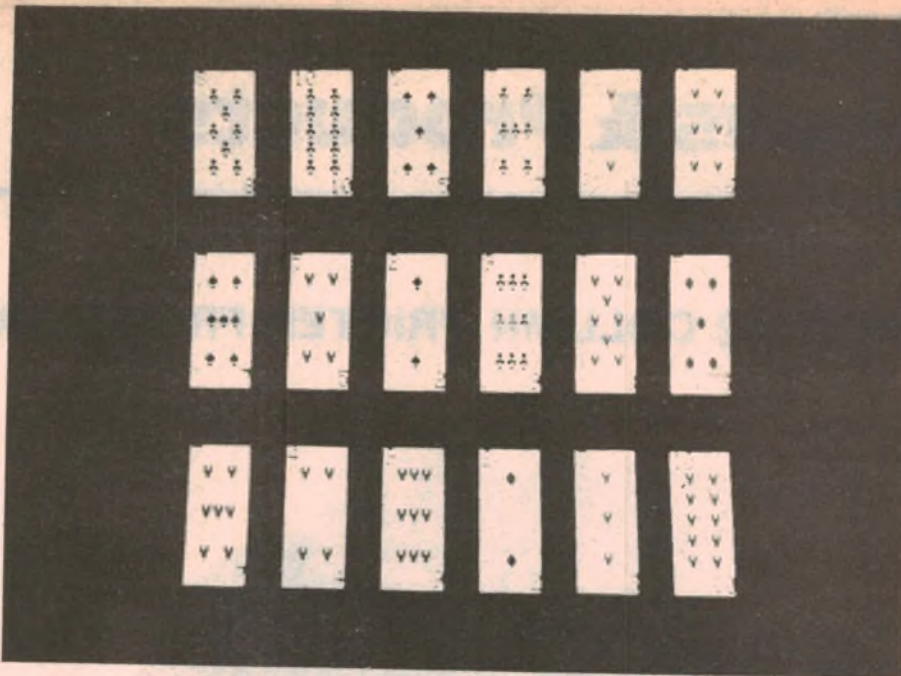

Full card suites are included in the graphics repertoire of the Compucolor II.

the big four personal computers.

Quoted price for the Model 3 is \$2065, the Model 4 is \$2410 and the Model 5 is \$2755 retail. The Expanded keyboard costs an extra \$202, the Deluxe keyboard \$322 and the 16k

RAM module \$539. Further enquiries should be made to the distributors, Anderson Digital Equipment, PO Box 322, Mt Waverley, Victoria 3149 or their dealers. In NSW, The Logic Shop, 91 Regent St, Sydney. (Ph 699 4910).

The "spirograph" pattern shown in our photograph on page 75 is just one of the numerous patterns which can be generated using the program listed below. What it basically does is to trace out the path of a point rotating about a centre which itself is also rotating or in other words one circle rolling around the circumference of another. Three parameters are required: the ratio of the diameters of the two circles; the ratio of their angular velocities and the number of steps to be taken.

The number of patterns which can be created is almost endless, but just to get you started some interesting patterns can be generated with the following parameters — (1,25,150), (1,100,150), (1,200,132), (1,200,134), (.2,10,100), (.5,2,100).

```

1 REM THIS "SPIROGRAPH" PROGRAM PLOTS
2 REM THE LOCUS OF A ROTATING POINT
3 REM CENTRED ON THE CIRCUMFERENCE OF
4 REM ANOTHER ROTATING POINT
5 REM AUTHOR RON DE JONG 11/1/80
6 REM WRITTEN FOR THE COMPUCOLOR II
7 PLOT 12
10 INPUT "R-"; RRATIO: REM RATIO OF OUTER TO INNER RADIUS
11 INPUT "W-"; WRATIO: REM RATIO OF ANGULAR VELOCITIES
12 INPUT "S-"; ST: REM NUMBER OF STEPS TAKEN IN LOCUS
20 R1=62/(RRATIO+1)
30 R2=R1*RRATIO
40 K1=2*3.141593/ST
50 K2=K1*WRATIO
60 PLOT 12,2,127,63,242
70 FOR N=1 TO ST
80 P1=K1*N
90 P2=K2*N
100 X=R1*COS(P1)+R2*COS(P2)
110 Y=R1*SIN(P1)+R2*SIN(P2)
120 PLOT INT(X+63),INT(Y+63)
130 NEXT N
140 PLOT 255,8
150 GOTO 10

```

Meet two new Printers from Anadex:

Revolutionary!

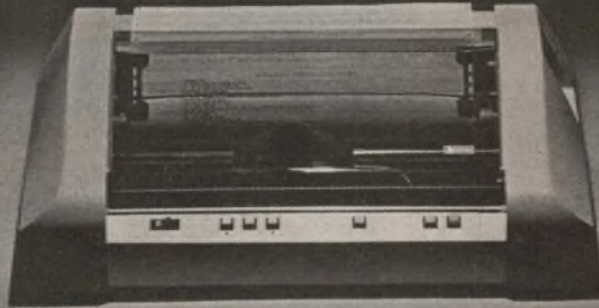

Introducing two totally new alphanumeric line printers from Anadex - Models DP-9500 and DP-9501 - featuring 132/175 or 132/220 columns, respectively.

Both models employ a new, Anadex-manufactured 9-wire print head with 150 million character life (optionally, 650 million) that makes them ideal for high-resolution printing requirements including high-density graphics where print quality and reliability must go hand in hand.

The full standard 96 character ASCII character set, including descenders and underlining of all upper and lower case letters, can be printed bidirectionally on up to 5 crisp copies at speeds up to 200 CPS. Adjustable-width tractors, accommodating paper from 1.75 to 15.6 inches wide, allow the printers to adapt to your application.

The three ASCII compatible interfaces (Parallel, RS-232-C, and Current Loop) are standard in every printer; so interfacing is usually a matter of "plug it in and print." With simplified interfacing, the printers also feature sophisticated communications capability including control of Vertical Spacing (6 or 8 lines/inch), Form Length and Width, Skip-Over Perforation, Auto Line Feed, and full point-to-point communications capability.

Other standard features are a 500 character FIFO buffer (optional, an additional 2048 character buffer), shortest distance sensing logic, self test, and replaceable ribbon cartridge with 6 million character life.

For complete details, attractive OEM pricing, and a demonstration, contact Anadex today.



Represented by:



BELL & HOWELL AUSTRALIA PTY. LTD.

55 MURRAY ST, PYRMONT, NSW 2009 ELECTRONICS & INSTRUMENTATION DIVISION

the vertical and horizontal bar graph functions. These can be used for histograms and since these internal routines are much faster than BASIC alone, it is possible to create real-time colour displays such as, for example, a 16 channel audio spectrum analyser.

Colour selection for text or graphics is via the colour keys on the left side of the keyboard. Both the foreground and background colours can be set individually for each character or "plot block" on the screen and characters can be made to blink against their background. Debits and credits, for example, can be colour coded and special comments made to flash. Character size can also be large or small.

The 64 special graphics characters which are also available have a resolution of 384 x 256. The whole set can be seen in an accompanying photograph and they include chess figures and card suits. These character are accessed according to a flag bit and by pressing the shift key and one of the alphabetic keys on the keyboard.

Each of the 128 x 128 graphics locations can be also individually accessed if you wish to create a kaleidoscopic pattern from scratch. The locations are arranged in a 4 x 2 matrix inside blocks which are the size of large characters. Each point within the matrix corresponds to one of the eight colour keys plus the cursor control.

The central feature of the Compucolor is of course the BASIC operating system. In most respects it's similar to the standard Microsoft BASIC found on other personal computers. It has 29 statement types (IF, FOR, GOTO etc), three command types (LIST, RUN, CONT), 19 mathematical functions



Shown above is the Compucolor II with an extended keyboard. The "spirograph" pattern on the screen shows the graphics capability of the Compucolor.

(ABS, COS, PEEK etc) and 9 string functions (LEN, MID, CHR\$ etc). In addition 11 disk-file commands are provided (GET, LOAD, FILE "N", SAVE etc).

An interesting feature of this BASIC is that many of the keywords such as PRINT and GOTO can be entered simply by pressing the "COMMAND" key

and one of the eight colour keys labelled with the appropriate command. This single keystroke action causes the Compucolor to print the keyword on the screen, which is a real time saver when you're programming. If you are keen the remaining BASIC keywords can also be accessed by pressing the "COMMAND" key and one of the regular keys, but since these keys are not labelled with their corresponding command, it is not as convenient.

Interestingly, each of these keywords is actually stored in the computer as a single "funny" character to conserve memory space and while the Compucolor isn't the only computer to do this, it is the only one we know of that will print the command out as you're typing a line in — impressive!

Some differences in this BASIC include the absence of a LET statement preceding an assignment, for example, LET X=A + B, but since few programmers would even include the LET statement anyway, this is a minor point. It also has a few extensions like the acceptance of variable names longer than two characters. It still only looks at the first two characters but the advantage is that longer variable names are more meaningful, such as CREDIT rather than CR.

Calculations are performed in single precision, that is, 6-digit mantissa with one hidden digit for accuracy. Numbers can be expressed in floating point or scientific notation in which the

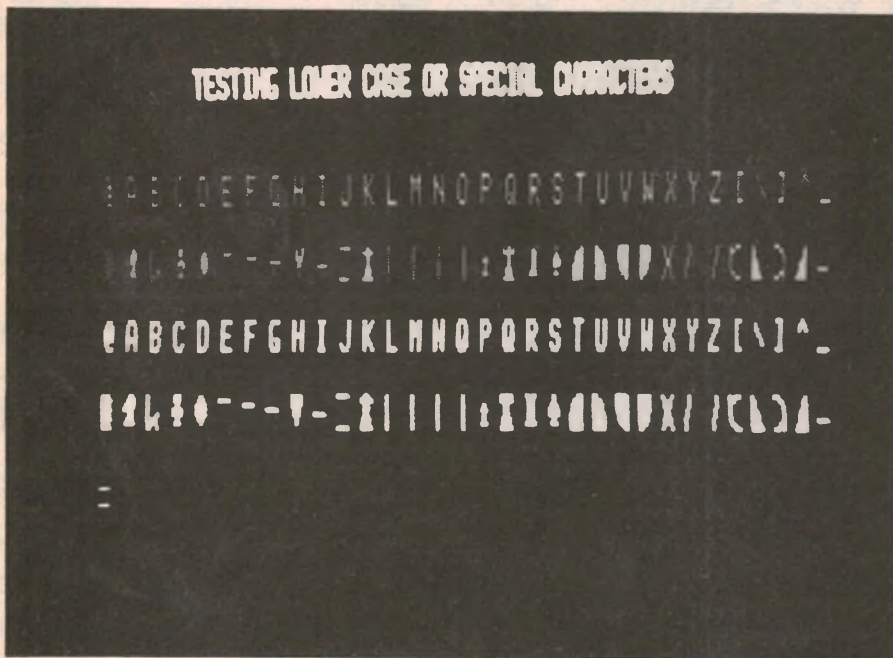

Stylised chess figures are included in the character set of the Compucolor II.

Has colour graphics, floppy disc and up to 32K of RAM

The Compucolor II

The Compucolor II "complete personal computer" is a new release on the computer scene that's sure to interest serious enthusiasts and beginners alike. It features colour graphics, in-built mini floppy disk drive and a powerful BASIC disk operating system plus loads of software.

by **RON DE JONG**

Few personal computers today include a colour monitor and a floppy disk drive as standard equipment. The Compucolor II does, and they've put it all together into a "complete" and highly affordable system.

First off, there are only two components, a monitor, and a keyboard which is connected to it via a flat ribbon cable. The sample floppy disk provided contains games and other programs which can be called up with a single keystroke. From there on it is a quick step to writing your own games, programs and graphic displays and saving them on blank floppy disks.

The Compucolor is based on an 8080A microprocessor and has a BASIC operating system in 17K of ROM. Maximum user memory available is 32K and there are three models available — the Model 3 supplied with 8K of RAM, the Model 4 with 16K of RAM and the

Model 5 with 32K. If further memory is required, 16K RAM modules are available for the Model 3 and 4. In addition "Extended" and "Deluxe" keyboards can be purchased in place of the standard keyboard.

The monitor houses the microprocessor, floppy disk drive and the colour CRT. Eight bright colours are available on the 30cm CRT screen which can display text in 32 lines of 64 characters, and has a resolution of 128 x 128 in the graphics mode. In addition to the 64 standard ASCII characters there are also 64 special graphics characters and a plethora of colour control, cursor control and special function characters.

The floppy disk drive can be seen to the right of the CRT and is the most convenient feature of the Compucolor II. It uses the standard 125mm disks with Compucolor format and provides 51.2 kilobytes of storage per side, a 7680

characters/sec transfer rate and an access time of 200ms. Compare this to the performance of a cassette which only has a transfer rate of typically 120 characters per second and an access time of around five minutes or more and you'll realise why floppies are so popular!

An RS-232C serial interface at the back of the unit is suitable for connection to a printer or modem. It can be accessed from a program and the baud rate can be set from 110 to 9600 baud. A 50-pin bus is also provided for future expansion of peripherals and we understand that an expansion unit is being developed as well as some interesting peripherals like a music synthesiser.

The photograph above shows the complete unit with an Extended keyboard. The standard keyboard has 71 gold cross-bar commercial key switches including CPU reset and AUTO disk loading key. If you're going to do a lot of graphics though I would seriously suggest getting the Extended keyboard. It has 101 keys with a colour cluster and a numeric cluster plus four edit keys. The Deluxe keyboard provides a further 16 keys for simplifying graphic functions.

Some of the graphics capability of the Compucolor is shown in the accompanying photographs. The photograph of the complete unit for instance, has a "spirograph" pattern on the screen which gives some idea of the resolution of the graphics. The program we've written to generate this pattern appears in a separate box. It is a surprisingly simple program because of the powerful PLOT functions available — it is only necessary, for example, to specify the end points of a line and the vector PLOT function draws it.

There are 16 PLOT functions available plus colour selection to help you create almost any pattern you desire. Each function is represented by a single character or sequence of characters and is directly accessible from the keyboard. In BASIC, each function is invoked simply by sending the corresponding character to the screen using the PLOT command — which makes it easy to use and enables patterns to be prototyped directly.

The vector PLOT function just mentioned is particularly useful for point-to-point plotting like graphs and curves (see Biorhythm curves). Two other PLOT functions which are notable are

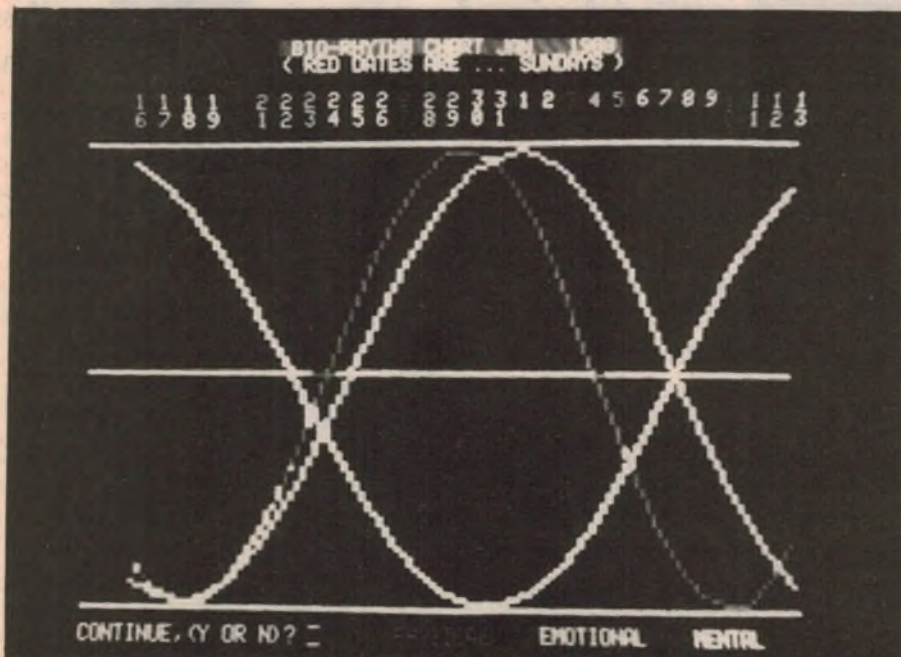

Display of the Biorhythm program which is available on the sampler floppy disk.

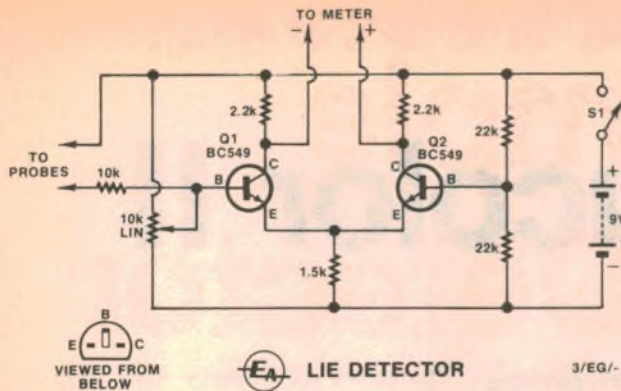

This simple differential amplifier circuit registers changes in skin resistance.

battery sets a reference voltage for Q2. The potentiometer at the base of Q1 is used to "null" the circuit so that the voltages at the two collectors are equal.

A meter is connected between the collectors of the two transistors and this is used to indicate a change in the skin resistance of the person being tested. We opted to use a multimeter here as it is the cheapest option whereas the cost of purchasing a separate meter movement may not be justified.

The skin probes are connected to the positive supply rail and the base of Q1. These when connected to the "victim" will raise the voltage at the base of Q1 and unbalance the circuit. This is where the significance of the potentiometer becomes evident. Before any readings can be taken we first have to null the meter so that even the smallest change in skin resistance will show up as a deflection from zero on the meter.

In general, you will find that changes in skin resistance will cause the meter to deflect in the positive direction.

CONSTRUCTION

Construction of the unit is a simple process and should only take about one and a half hours or so. We used Veroboard for the prototype since this is a very convenient medium for the construction of these simpler projects. The piece of Veroboard is mounted onto a piece of offcut timber together with a small piece of aluminium sheet onto which are mounted the power switch and the potentiometer.

The first part of the construction entails cutting the Veroboard to the appropriate size and then cutting the tracks as shown in the overlay diagram. Having done this you can proceed to mount the components, starting with the wire links resistors, leaving the transistors until last. The positions of all the components are clearly shown on the component overlay diagram.

Connect all the wires to the board and put it aside. The next thing now is to prepare the front panel for the unit. This is made from a small piece of aluminium (or whatever is handy) and has the power switch and potentiometer mounted on it. This is screwed to the edge of the base as is shown in the photograph. The battery is held in

place by a small bracket cut from an empty food can.

The piece Veroboard is held in place with a single screw as shown in the photograph. The output leads are terminated with crocodile clips which then connect to the probes of your multimeter. The best range to set the multimeter on is either 5 or 6mA depending on the type of meter you happen to have. The probes that connect to the skin can be made from aluminium foil held in place with a rubber band.

All that now remains to be done is a final check on all the wiring to ensure that it is free of errors, after which you can turn the unit on and start to ferret out the liars from the honest people. Have fun!

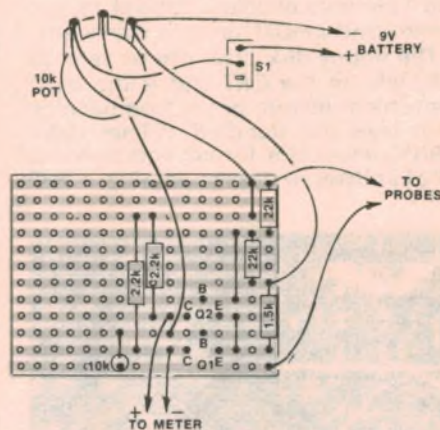

PARTS LIST

- 1 piece Veroboard 40 x 35mm
- 2 BC549 transistors

RESISTORS

- 1 x 1.5k, 2 x 2.2k, 1 x 10k, 2 x 22k
- 1 10k linear potentiometer
- 1 single pole miniature toggle switch
- 1 No. 216 9V battery and clip to suit
- Knob to suit potentiometer

MISCELLANEOUS

- Timber offcut, aluminium sheet (see text), tin plate, aluminium foil, screws, hookup wire and solder.

SWITCHCRAFT[®]

CONNECTORS & ELECTRONIC COMPONENTS

Superb quality and reliability from one of the oldest and most experienced manufacturers in the U.S.A.

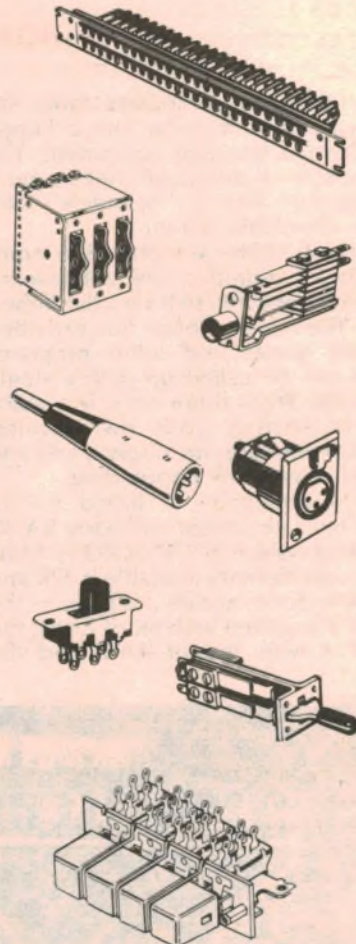

AUSTRALIAN DISTRIBUTORS

AUDIO TELEX COMMUNICATIONS PTY. LTD.

SYDNEY
1 Little Street,
Parramatta, 2150
Tel: 633 4344

MELBOURNE
7 Essex Road,
Mt. Waverley, 3149
Tel: 277 5311

BRISBANE
394 Montague Road,
West End, 4101
Tel: 44 6328



by GERALD COHN

A simple Lie Detector

Do you have lying friends or honest enemies? One way to find out may be to use our simple lie detector. Whether you will ever find out the truth is another matter. What we can guarantee is that you will learn something about the elements of a differential amplifier if you build this lie detector. And you will have some fun into the bargain.

Over the years, many methods have been developed which have been claimed to be capable of lie detection. Of these, two methods have been subject to particular controversy, and these are the "polygraph" and voice analysis. Both methods have been widely used in the United States particularly for employee selection procedures. Fairly clearly, these methods have proved to be often unreliable and subject to abuse.

We have no intention of contributing to or continuing this controversy in presenting this article. Our lie detector is simple and we make no ambitious claims for it. It works by indicating changes in skin resistance and in so doing, can point to changes in emotional stress on the person being tested.

The reason for this change in skin resistance in situations of duress is, quite simply, because the person concerned begins to perspire involuntarily. We have all experienced

capable of revealing a degree of emotional stress, we shall proceed. Make it up for a few hours of fun with your friends and family. It could be just the thing to liven up a dull party.

The circuit presented here is actually a differential amplifier of the simplest kind. As the name implies, it is an amplifier that detects and amplifies the difference between two signals. To understand how it does this, let's take a look at the circuit of the basic differential amplifier.

The circuit of the basic differential amplifier is shown in Fig. 1. It consists of two NPN transistors each with collector load resistors but both sharing the same emitter resistor. The bases of the two transistors are the two inputs to the circuit and the output is taken from the two collectors.

Now, let's say that we have a voltage applied to each of the two inputs, A and B. These voltages are represented by v_{iA} and v_{iB} . As a result of these input voltages we can expect respective

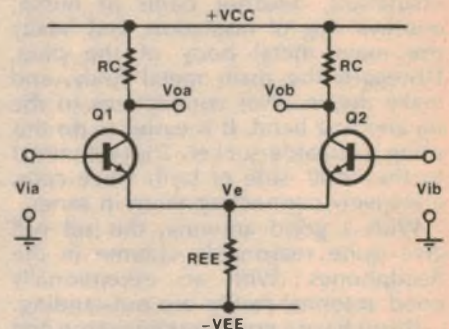

FIG. 1 : BASIC DIFFERENTIAL AMPLIFIER

that the voltages at the collectors of the transistors will be equal. With equal voltages at the two outputs there is no voltage to be measured between them, ie, there is no differential output voltage. But what happens if we leave one of the inputs at a set level and start to vary the voltage at the other?

If we raise the voltage level at input B to a value that is above v_{iA} , we find that the voltage at the collector of Q2 falls as the transistor passes more current. This in turn causes a rise in the voltage at point V_e in the circuit therefore applying less forward bias to the base emitter junction of Q1. This reduction in forward bias applied to Q1 has the effect of raising the voltage at the collector of Q1. We therefore now have the situation where the collector of Q1 is at a higher voltage level than the collector of Q2, resulting in a voltage difference that is directly proportional to the difference in the input voltages.

The same principle applies if the level at input B is below input A except that the polarity of the output will now be reversed.

We can do the same thing if we decide to fix the level at B and to vary the level at A. Assuming that any measuring instrument is left connected as in the previous example, then we will note similar results, with polarity reversal, for the same input conditions.

Now let's take a look at how this applies to the circuit of the lie detector. One of the first things that becomes apparent is that we have used a single supply instead of a dual one by splitting the voltage from a single 9V battery into ± 4.5 volts. This splitting is done by the two 22k resistors at the base of Q2.

This voltage divider across the 9V

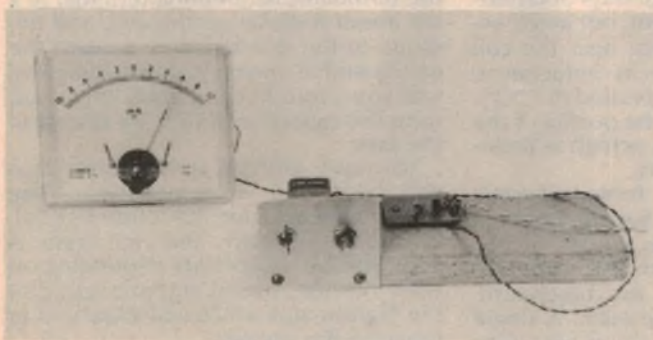

This photograph of our prototype shows it connected to a centre-reading meter, but it would be cheaper to employ a multimeter (see text).

this situation but it does not necessarily indicate that we are telling lies.

So with the understanding that the circuit presented here is not really intended as a serious attempt to produce a lie detector but is a unit

voltages to appear at the outputs and these are represented by v_{oA} and v_{oB} .

If the voltages at the inputs are assumed to be equal initially, and knowing that the gains of the two transistors are identical, then it follows

again with the matching transformer.

The transformer we used in the prototype has a primary impedance of 5000 ohms and secondary impedances of 4, 8 and 16 ohms. The transformer was supplied to us by Dick Smith Electronics who assure us that they have adequate stocks. Another possible source for a transformer would be from an old valve radio or television set.

The headphones are arranged with the voice coils in series. Take note of the headphone plug (usually a 6.5mm jack plug). You should see three distinct sections — the tip, then a ring of insulation, another band of metal, another ring of insulation, and finally the main metal body of the plug. Disregard the main metal body, and make the receiver connections to the tip and first band. It is easier to do this using a suitable socket. These connect to the "hot" side of both voice coils, effectively connecting them in series.

With a good antenna, this set will give quite reasonable volume in the headphones. With an exceptionally good antenna, results are outstanding.

If you have a good antenna setup and you are close to a radio transmitter you may find that the output of the set is high enough to drive a loudspeaker at modest volume levels. If you wish to try this, use the largest speaker you can find. Contrary to popular belief, a large speaker is not harder to drive than a small one. Rather, the larger one may be more efficient.

Now that we have explained how it works, we can get down to building the actual device. The best place to start is the coil.

You will need approximately 15-20 metres of 22-24 B&S enamelled copper wire and a stiff cardboard former. The one we used was a cardboard mailing tube, approx 5.5cm diameter. If thin wall cardboard tube has to be used, it would be wise to give it one or two coats of clear enamel to stiffen it.

The tube should be long enough to allow easy working — say 15cm or so. It can be trimmed after the coil is completed. Incidentally other non-metallic materials can be used for the former, such as a plastic bottle.

Start by drilling two 2mm holes, close together, near one end of the tube. Pass about 15cm of wire through one hole then the other, several times, to provide a secure anchorage. Then wind on five turns (either direction, it doesn't matter) and make a tap. This is to be repeated every five turns.

The easiest way to do this is to wind the tap turn over a match. The match can be pushed up the coil as the turns progress. While we used ten taps on the prototype, we recommend seven. We found that only seven of the taps are useful — and it is easier to wind without taps.

After the seventh tap (35 turns) wind on another 35 turns, making 70 in all. This number will be adequate for coil

formers close to or the same as ours, but may have to be changed slightly for readers who (a) use different size formers or (b) have a station close to either end of the band.

If the coil cannot pick up stations at the high frequency end of the band, take a few turns off. If it cannot pick up stations at the low end, add a few turns.

As can be seen from the photo, the start, taps and finish are all in one straight line.

To finish the coil, drill another pair of 2mm holes, and pass at least 15cm of wire through them, as before. This wire goes vertically through the coil centre, and emerges through another hole

baseboard using number 4 self-tapping screws.

Because the capacitor and transformer are connected together, the connections from the earth terminal need be connected only to the transformer case, simplifying the wiring. The components on the tagboard are connected by a short length of wire to the capacitor frame.

We fitted an extra three lug tagstrip on the baseboard. One lug connects to the antenna terminal, and another to a tap on the coil. This was for an experiment which we will discuss later. For the present, the two lugs are simply joined together.

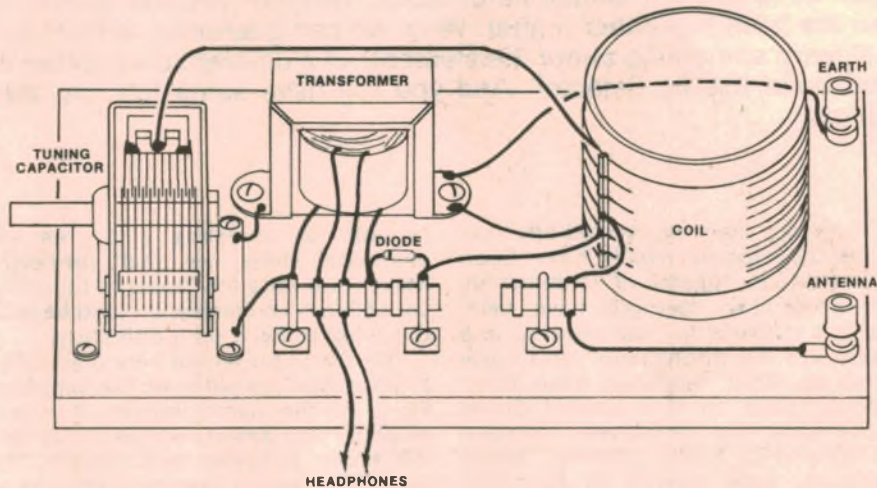

Together with a typical set of low impedance stereo headphones, this easy-to-build crystal set can give surprisingly good results.

near the bottom. This makes a neat coil and keeps the windings tight.

We used a small tagstrip to mount the diode and provide tags for the headphones connection. A flying lead makes connection from the detector to the tap required. The same system is used for the aerial connection.

On the same tagstrip, connections to the impedance transformer are made.

There are a number of ways of fastening the coil to baseboard, but avoid using metallic parts. Metal near the coil may not only change its inductance, but could effect what is called the "Q". The Q is a measure of the quality of the coil — and it should be as high as possible for optimum results.

We glued our coil former directly onto the baseboard. Aquadhere or a similar wood glue does the job nicely. The antenna and earth terminals are screwed directly into the baseboard, with a solder lug under each. A single length of stiff tinned copper wire runs from each terminal to its respective connection.

The tuning capacitor and impedance transformer, can be mounted so that they share a common mounting hole — a convenient arrangement, as we will explain. All parts are screwed into the

Use of the crystal set is simple. It does, however, depend on a good antenna and an equally good earth. Remember that there are no power connections, so the set is not earthed through the power cord. You must provide an external earth, preferably a water pipe or a metal stake driven well into moist ground.

Connect the antenna and earth to the terminals the antenna terminal to a tap about midway up the coil, and the diode to the one below — toward the earthy end. Connect your headphones, and you should hear signals when you tune the capacitor. If not; try changing the taps.

The best antenna and detector taps will be found by experiment. The higher taps will give the loudest signal, but poor selectivity, and vice versa. A compromise is necessary depending on your location, size of antenna, etc. Use the highest taps which will allow you to separate the stations.

This, then, is our basic crystal set. Our next article on this topic will describe a number of variations on the crystal set theme, each one designed to exploit one or other of the novel characteristics of the "simplest radio set".



ALL TEXAS INSTRUMENTS

Scientific & Programmable CALCULATORS

Readily available from



EMAIL LIMITED
A totally Australian enterprise



When you judge the value of a high-technology product, it pays to look closely at the company behind the product.

**Australia's largest distributor of
T.I. Calculators.**

METERING DIVISION OFFICES:

Sydney 699 0033, Melbourne 557 2944,
Adelaide 51 0411, Brisbane 44 0281,
Perth 446 9392



AIM 65



Rockwell Aim-65

TAX PAID

AIM-65 with 1K RAM	\$525
AIM-65 with 4K RAM	\$570
4K Assembler in ROM	\$105
8K Microsoft Basic in ROM		\$125
5V, 24V Power supply	\$ 72
Case to suit AIM-65	\$ 75
22 way edge connection	...	\$ 7

DWELL

ELECTRONICS

JADE

COMPUTER PRODUCTS

5100

Z80 Board A & T	\$262.90
Video Board A & T	224.00
Expandoram 32K with 16K fitted A & T	355.00
Versafloppy A & T	315.50
6 Slot Motherboards incl. sockets	65.70
12 Slot Motherboards incl. sockets	118.30
Apple Hi-speed serial interface	225.00

All prices include sales tax

Integral Data Systems

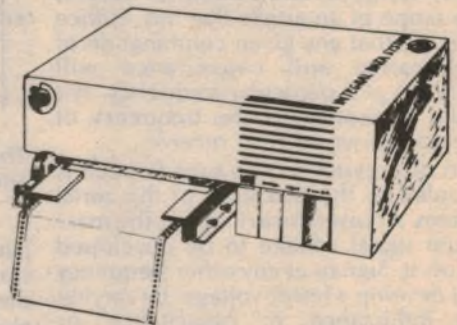

The Brighter Writer Printers



The printer that's brighter
than your computer!

IP 125 friction feed	\$ 999
IP 225 tractor feed	\$1199

including sales tax

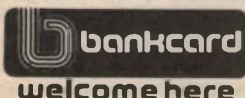

77 EDGEWORTH-DAVID AVENUE, HORNSBY, NSW 2077
TELEPHONE: (02) 487 3111



radio receiver processes a transmitted signal, at least at an elementary level. A first requirement is to understand the nature of the signal. This consists of a radio frequency "carrier" which is "modulated" by the speech or music we wish to transmit. The modulation is achieved by varying the amplitude of the carrier at the frequency of the signal. (Hence, amplitude modulation). Thus, if we wish to transmit a 1000Hz note we cause the carrier amplitude to vary 1000 times a second.

Reception of such a radio signal requires that we provide four basic facilities, (1) means to intercept a portion of the radiated signal, (2) a means to separate the wanted signals from unwanted ones, (3) a means to extract the audible ("audio") information from the radio frequency carrier and (4) a means to convert the audio signals into sound.

For (1) we use an aerial or antenna system. Considered at its most basic this is simply two plates of a capacitor. Traditionally, one plate is the aerial wire and the other plate the earth. However, the second plate can take a number of forms. It may be a second aerial wire underneath the first (a counterpoise), the metal frame of a vehicle (car or aircraft) or the metal body of a ship and the surrounding water. Generally, the larger the plates and the greater the distance between them, the more signal will be intercepted.

For (2) we use a tuned circuit or, in more elaborate sets, a number of tuned circuits.

A tuned circuit consists of two components; a capacitor and an inductor. The exact manner in which it works is quite complex, and somewhat beyond the scope of an article like this. Suffice it to say that any given combination of inductance and capacitance will resonate at a particular frequency. We make it resonate at the frequency of the station we wish to receive.

In our crystal set the tuned circuit is coupled to the two sides of the aerial system. At resonance, it allows the maximum signal voltage to be developed across it. Signals at any other frequency will develop a lesser voltage. By varying the inductance, or capacitance, or both, we can adjust the resonant frequency and select the signal we want.

For (3) we use our much discussed "crystal" or the diode which has replaced it. It can be considered simply as a half wave rectifier. The diode clips off one half of the cycle, leaving either a positive or negative going waveform.

Remember how we described an amplitude modulated signal? How the carrier strength (amplitude) varies up and down at the frequency of the modulating signal? Well, it is these variations in strength we wish to recover.

Since the carrier frequency is much too high for us to hear, neither can we hear any changes in its strength. As far

as the ear is concerned each half cycle of the carrier occurs so rapidly after the previous one that it might just as well have occurred at the same time. As a result the two halves effectively cancel one another.

But if we remove one set of half cycles (with a rectifier) the remaining ones will all be effective in the one direction. While we still cannot hear

Our circuit employs a germanium diode and a transformer coupled set of low impedance headphones.

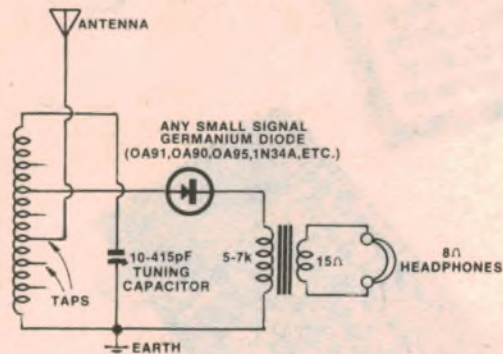

the carrier frequency, we can create a new signal which is an exact copy of the changes in the carrier amplitude. This is our audio signal.

This brings us to requirement (4); a means to convert the audio signal into sound. For this we use a pair of headphones. In their most common form these are like miniature loudspeakers. When a varying current flows through the voice coil it causes the loudspeaker cone to vibrate in sym-

metry of the tuned circuit. There are three ways of doing this — adjusting the capacitor and leaving the inductor fixed, adjusting the inductor and leaving the capacitor fixed, or, in some cases, adjusting both the inductor and capacitor.

Most readers will be familiar with tuning capacitors — a device with two sets of plates, which can be adjusted so

that the area they have in common changes. When the plates are fully closed ("in mesh") they provide the maximum capacitance obtainable (usually about 400 picofarads). Conversely, when they are wide open they are at minimum capacitance (usually about 10 picofarads).

But now let us look at our most popular crystal set. This one has become our "standard" model, because it is about the simplest and easiest to make.

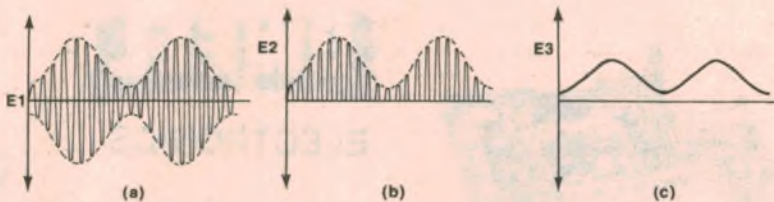

The waveform at (a) represents a modulated RF carrier. (b) shows the waveform after rectification by a diode while (c) is the audio modulation.

pathy with it. This vibration we hear as sound. This is necessarily a much simplified explanation of headphones; also other types operate on quite different principles.

But it is not hard to see how a series of RF pulses, all operating in the same direction, will behave when applied to such a device. Each pulse will try to move the diaphragm, and will succeed to some extent. Each following pulse will have the same effect and, because they occur so rapidly one after the other, each will reinforce the previous one. The inertia of the diaphragm is too great to allow it to respond to the gaps between pulses but not so great that it cannot respond to the relatively slow variations in the strength of succeeding pulses.

As already explained, tuning the set involves adjusting the resonant fre-

quency of the tuned circuit. The parts involved are readily obtainable from either the junk box or your normal parts supplier. You should be able to "scrounge" some of the parts, at least.

For example, you should be able to find a suitable tuning capacitor in almost any discarded receiver. Do not worry if it has more than one section as it is still quite useable, as only one section is needed.

Crystal sets generally were connected to a set of high impedance headphones but these are now generally unavailable, so we have opted to use ordinary HiFi headphones and these are matched to the set using an impedance matching transformer. If you don't happen to have a set of these headphones, you will find that the small earpiece usually supplied with portable radios will do almost as well,



Let's talk about Crystal Sets

If you are just becoming involved with electronics as a hobby but have not yet decided what you would like to build as your first project, then we have just the thing for you. Generally the first thing that the budding electronics hobbyist constructs is a crystal set and despite the easy availability and the low cost of a transistorised radio receiver today, there is still that special satisfaction gained from building your own. We know you'll enjoy building it.

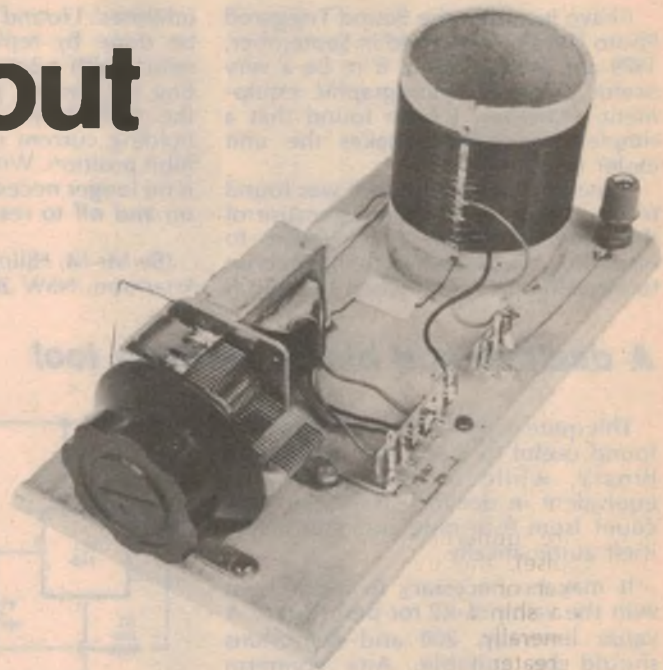

The crystal set was the first radio used by the public for broadcast reception. Its inherent simplicity was its main advantage, since it suffered from limited sensitivity, selectivity and signal output. When better sets became readily available it was soon discarded. Yet enthusiasts continually revive it from time to time, and marvel that such a simple device works as well as it does.

Rather ironically, the crystal set built as a novelty today is likely to perform a whole lot better than the serious version of 1923. Technological advances aimed at more elaborate circuits can also help the crystal set. Today we can produce more efficient coils, we have more efficient detectors and more efficient headphones. On top of that, broadcast stations use many times the power they did in the old days. It all adds up to a quite surprising order of performance for the "simplest radio set".

When I built my first crystal set nearly 15 years ago, one thing really puzzled me. That was the name "crystal set".

I knew what a crystal was — it was a device used as a frequency standard. But there certainly wasn't one of those in my set.

I wondered whether I had left something out, but no — "Radio & Hobbies" (predecessor to "Electronics Australia") assured me I hadn't. Besides

which, the darn thing worked!

The trouble was, I was born about 50 years too late. Had I made a crystal set early this century — or even later — I would have used what was then one of the first types of detectors — a crystal.

The crystal detector of 50 years ago bears absolutely no resemblance to the frequency standard crystal we know today. Whereas the latter is a crystal of quartz, very accurately cut and mounted, the crystal detector resembled,

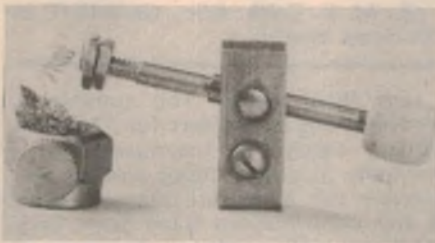

Crystal detectors used to look like this.

ed, to some extent, a small lump of shiny coke.

This material was actually galena, or lead sulphide. It was not just one crystal, but a crystalline structure. To make contact with the crystal, a fine wire was used to press against the surface. This could be moved around the surface of the crystal to find the best position. The wire assembly was known

as a "cat's whisker".

Even though the cat's whisker and crystal were not forgotten, the invention of the thermionic valve led to their eventual demise. From the late 1920's radio receivers began to move away from the novelty stage, and crystal sets were left to the experimenters.

The invention of the germanium diode was the last straw as far as the crystal and cat's whisker were concerned but, rather strangely, created a mild revival for the "crystal set" itself. In one small package came all the features of the crystal detector, but with improved sensitivity and none of the disadvantages. Perhaps some readers remember how the fiddling cat's whisker would move at the slightest heavy footstep — just as England won the test match!

So it was that germanium diodes became the "crystal" in a crystal set. And they are used in sets other than crystal sets. Many transistor radios use diode detection in exactly the same way as in the crystal sets to be described.

A crystal set is interesting because it performs, at an elementary level, all the functions needed to receive a radio signal, and most of those performed by larger sets. Granted, it does not do all of them particularly well, but an understanding of what it does and where it fails provides excellent grounding for understanding more elaborate circuits.

It is not difficult to understand how a

Modification to Sound Triggered Photo Flash

I have just built the Sound Triggered Photo Flash as described in September, 1979 and I have found it to be a very useful piece of photographic equipment. However, I have found that a simple modification makes the unit easier to operate.

Repetitive use of the unit was found to be a little inconvenient because of the need to operate two switches to reset the unit. It seemed to make sense to have the unit reset when the unit is

inhibited. I found that this could readily be done by replacing the inhibit/on switch with a 2-pole switch and by putting the second pole of the switch in the SCR bleed circuit, so that the holding current is removed in the inhibit position. With this modification, it is no longer necessary to switch the unit on and off to reset it.

(By Mr M. Hillman, 4/8 Buller Street, Artarmon, NSW 2064.)

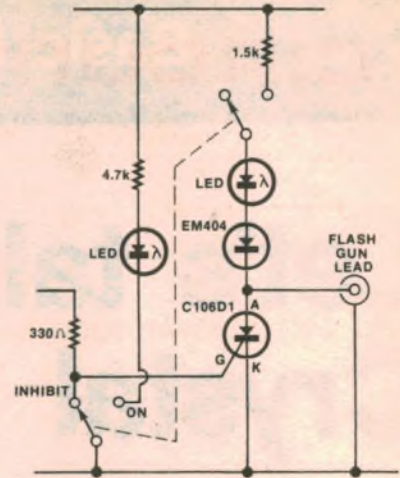

A decimal and binary learning tool

This quite easy to build circuit may be found useful to teach you to count in binary, while it also shows the equivalent in decimal. The circuit will count from 0 to nine and then resets itself automatically.

It may be necessary to experiment with the value of R2 for best results. A value between 200 and 600 ohms should be suitable. Any common cathode seven-segment display may be used. IC3 can be either a 7447 or a 7448. The appropriate LEDs should be arranged in a DCBA sequence.

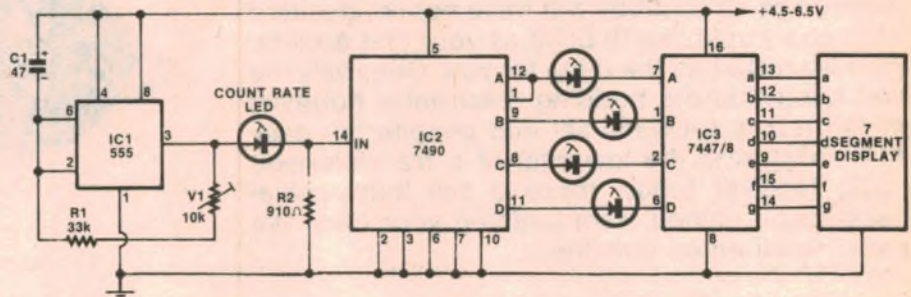

(By Mr Nino Benci, 24 Briggs Street, E. Oakleigh, Victoria 3166.)

A simple joystick control

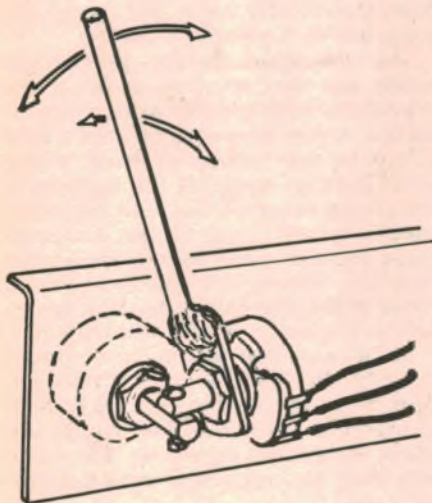

A simple and economical method of "joystick" control is shown in the diagram. This involves bolting two potentiometer shafts together at right angles. The body on one potentiometer is attached to a base via a mounting bracket, and the body of the other is attached to the joystick control.

The potentiometers are then wired so that the direction of movement on

the joystick corresponds to the direction of movement required. Under this arrangement, only about half of the total resistance of each unit is usable. Therefore, if 25k and 50k are required, the potentiometers would have to be 50k and 100k, respectively.

(By M. K. Cook, B.Sc., G6AMB/T, in "Wireless World".)

EDITORIAL NOTE: The number of contributions by readers for Circuit & Design Ideas has increased quite markedly in recent times and we appreciate this increased interest. Some of the contributions have been very good and well presented and most of these have found their way into these columns.

On the other hand, there have been a number of contributions which, though they may have had considerable merit, were badly presented with insufficient information, illegible writing and unintelligible drawings. To those contributors we say "Don't sell your ideas poorly. A little care in presentation can make all the difference".

BILL EDGE'S ELECTRONIC AGENCIES

115-117 Parramatta Road,
Concord 2137 Ph: 747 6472

(corner Lloyd George Ave and Parramatta Rd. Concord)

Bill Edge introduces some fantastic new kits. (Some exclusive to Electronic Agencies):

- **FAMOUS EA GRAPHIC ANALYSER**
Complete down to last nut & bolt
only **\$99.50**
- **ETI 300 WATT AMP MODULE**
only **\$69.00**
- **EA TRANSISTOR ASSISTED IGNITION**
only **\$32.50**
- **PHILIPS/ETI 4000 SPEAKER SYSTEM**
(details ETI Feb 80) (less woodwork)
only **\$439.00**
- **FAMOUS ETI 4000 AMPLIFIER KIT**
with wooden case **\$179.00**
with rack mt. case **\$189.00**

A FULL SELECTION OF ALL DICK SMITH ELECTRONICS KITS IS ALWAYS AVAILABLE.

TRADING HOURS:
9 am-5.00 pm Mon-Fri.
9 am-Noon Sat
10 am-2 pm SUNDAY

MAIL ORDER \$1.00 plus 5% of order value up to \$80 thence a flat \$4. Heavy items sent "freight on" thru carrier.

THE SERVICEMAN — continued

microvolts, suggesting that this stage was working.

Unfortunately, this was where the circuit became very hard to follow. It was reasonable to expect that it would go to the antenna coil, but the path was far from obvious, while a signal injected at the antenna coil suffered severe attenuation.

Finally, I suggested that he set up the good unit on the bench and try tracing the circuit in that, with the generator. It was only a long shot, but he agreed it might work and set about trying it.

As I learned later, the idea did work. He traced out the circuit in the good set and, having identified the relevant copper track, went through the same procedure with the faulty set. The first I knew of his progress was when he called out excitedly, "Hey, look at this."

I went over and he filled me in on the path he had traced out. "Now look at this", he said, running a fine wire from the generator lead along the copper track. For the first few centimetres the signal came through loud and clear, then suddenly dropped as it passed over what looked like a dirty mark on the track.

He repeated the exercise several times and it was plainly obvious that there must be a break in the track. But how? As you might remember, the copper pattern had been covered with solder.

I fetched the jeweller's loupe again and studied it carefully. What had looked like a dirty mark turned out to be a tiny valley in the solder, but it was too narrow and too deep for us to see what was at the bottom of it. All we knew was that there had to be a break in the copper pattern.

A HIDDEN CRACK?

The most obvious explanation would seem to be that it had been a genuine hairline crack which, in some mysterious way, had been "copied" by the solder coating. If so, then it must surely be one of the strangest faults ever; the kind of set-up which, had one tried to create it, would have proved virtually impossible.

Not that my friend was in the mood for much speculation. All he wanted to do was fix it — which he promptly did with a hot iron and solder. That done, it is no exaggeration to say that the set jumped into life.

That wasn't quite the end of the job. There was still the faulty antenna and "on-off" switch to be fixed, plus a fair amount of mechanical work on the aluminium case.

The case problems were out of my sphere, but I was able to contribute something to the antenna and switch problems. An old car aerial yielded a length of stainless steel rod, with which my friend was able to restore the aerial to its full length, even though it would no longer fully retract.

Soldering the stainless steel presented a minor problem. The proper flux for stainless steel is, I understand, phosphoric acid, but this is not the kind of thing I keep in the pantry. After trying several other fluxes, we found that borax, as used for brazing, did a reasonable job.

The problem with the "on-off" switch was that the small punched bakelite lever, which actuates the contacts, was missing. The pot element and the switch mechanism were similar to most modern pots of this type, but the mounting was quite different.

From the junk box I unearthed a couple of discarded pots and suggested he might be able to salvage the bakelite lever. It was a tricky job but, with the aid of my jeweller's loupe and a lot of patience, he finally managed it.

And that was more or less the end of the exercise as far as I was concerned. I

did see him again a few weeks later and he proudly displayed the set in full working order.

I think the story prompts a couple of comments. I won't belabour the point about the havoc one dry joint created in the factory, can cause in later years; I've made that point several times recently. But it would seem appropriate to add that the same can apply to hairline cracks.

Which brings us to the major point of the story; how the best intentions can cause more problems than they solve if they are not properly carried out. It sounds so easy to cover a printed board with solder, as a blanket cure, but think very carefully before you tackle it. The idea might just backfire.

Another point worth noting is that both faults, tricky though they were, eventually yielded to the use of suitable equipment — plus a lot of time and patience. This later is really the crux of the matter, for there is no way that the hours my friend spent on the job could have been justified on a commercial basis. Had I spent that time, and charged normal rates, it would have been cheaper to buy a new unit — which is precisely what you do, these days.

Not that this worried my friend. I am sure that the satisfaction of finding the faults was more than ample reward, plus the fact that he scored another unit.

But it is a luxury I can seldom afford if I'm to earn a living!

BRIGHT STAR CRYSTALS PTY LTD

35 EILEEN ROAD, CLAYTON, VICTORIA, 546 5076
(ALL MAIL TO:— P.O. BOX 42, SPRINGVALE, VIC. 3171)

INTERSTATE AGENTS

• ROGERS ELECTRONICS
ADELAIDE Phone 42 6666
J. E. WATERS PTY. LTD.
SYDNEY 666 8144

B.S.C. TELEX AA36004

• DILMOND INSTRUMENTS
HOBART 47 9077

• WESTEST ELECTRONICS
PERTH 337 6393
• FRED HOE & SONS PTY. LTD.
BRISBANE 277 4311

NEW MODELS

C-MOS CLOCK FREQUENCY GENERATORS

Supply Requirements:
5 - 12 V Dc at 6 MA No load.

Output Drive:
5 MA

Stability:
Better than 1-PP/M

Operating Temperature Range:
0-60°C
Supply voltage to be nominated by user

Output frequency:
Nominated by user

Maximum Crystal Frequency:
5 Volt Supply - 5MHz max 12 Volt - 9MHz max

Crystal Frequency:
Required frequency X number
counters
Frequency X 2x

NUMBER OF COUNTERS

BSC 6 BR 12 or 14
BSC 6 GP 24 or 28
BSC DC 12 BIN 4 Decade

BSC 6 BR also Supplied with outputs
of 16x Baud rates of 300 to 9600
Baud

FORMULAR for crystals frequency:-
(Required output frequency X 2x to
give a crystal frequency of 2 to 8MHz
ie 100Hz X 2¹⁴ = 65536)

Output: Square wave 0 - 99 supply
volts 1 - 5 MA Max
Supply voltage 5 - 12 Volts Dc

Stability: ± 003% / 0-60°C

PCB Dimensions

	length	width	height
BSC 6 BR	53mm	36mm	20mm
BSC 6 GP	70mm	36mm	26mm
BSC DC	75mm	38mm	26mm

Have BSC6 BR, BSC6 GP edge connectors

**Crystal RF Modules also
available 1MHz TO 200MHz**



Model BSC 6 GP



Model BSC DC



Model BSC 6 BR

Another innovation from **Hioki**

MEET A TOUGH BABY

HIOKI 3012
Thin
Drop-Proof
Multimeter



**Only 22mm thick and can drop from a height of 1 metre without any harm.*

Specifications:

DC VOLTAGE: 0.3, 3, 10, 30, 100, 300, 1000V, 20kΩ/V, ±3% of FS
DC CURRENT: (50μA) 1, 3, 30, 300mA 300mV drop, ±3% of FS
AC VOLTAGE: 10, 30, 100, 300, 1000V 10kΩ/V, ±4% of FS
RESISTANCE: 10k, 100k, 1MΩ (Rc100Ω) ±3% of Scale Length
POWER SOURCE: 1.5V (Size AA)
ACCESSORY CIRCUIT: Meter protecting circuit, Circuit protecting 0.5A fuse DC-AC1000V measuring terminal OUTPUT terminal
METER: TAUT BAND type (with mirror scale)
DIMENSIONS: Approx 140Hx84Wx22Dmm (Max 26D) Apprx 250g
ACCESSORIES: Test leads, 0.5A Spare fuse Soft case Strap



Our little pocket tester is so slim, small and light you might overlook the fact that it is a rugged, hard-working precision instrument — tougher than most multimeters twice the size. It can fall from a

work bench (1 metre high) and still work perfectly well.

The "DROP-PROOF" pocket multi-meter demonstrates our claim that "HIOKI puts you years ahead". It gives you the advantage of HIOKI Core Magnetic TAUT

BAND for precise readings.

It is friction-free and is remarkably resistant to shock.

The pencil type leads fitted with guards are a pleasure to handle, especially when testing complex electronic circuits, etc. HIOKI innovation is apparent in every detail.

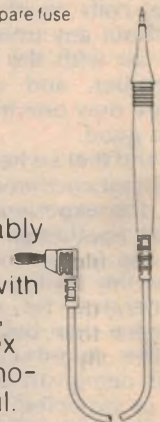

HIOKI PUTS YOU YEARS AHEAD!

• SYDNEY 6016600 • MELBOURNE 3296511 •
• BRISBANE 525231 • ADELAIDE 466411 • PERTH 4466622 •

H. ROWE

& CO. PTY. LTD.

SOLE
AUSTRALIAN
AGENTS

any case, he decided that the job would be a lot easier if he had access to a suitable signal generator. This was where I came into the picture. Not having a generator of his own, he asked whether he could use mine, in my workshop, when it was mutually convenient. I readily agreed.

In fact, the job turned out to be fairly routine. With a generator to help, he soon identified the appropriate coils, followed by the three IF transformers.

There was a slight problem concerning the antenna coil, which did not seem to want to peak, either at the new frequency or with the original crystal in circuit. When he told me what was happening I suggested that it might only tune correctly when the antenna was fully extended and without the generator across it.

We checked this by using a short length of rod connected to the generator to serve as a transmitting aerial, with the receiving antenna a few feet away. This solved the problem completely.

Another problem concerned the cores in the coils. They had obviously been twiddled before, by our technician friend, though for what reason is not clear. What was obvious was that he was apparently just as heavy handed with an alignment tool as he was with the soldering iron, because the screw-driver slots were badly butchered.

My friend had no cores which would fit and, initially, I could find none either. Then I remembered an old monochrome TV set in the store room from which I had already salvaged a good many hard-to-get spare parts. It used similar looking cores in the IF transformers and they turned out to be an exact fit.

That was more or less the end of the story concerning that unit, at least as far as I was concerned. My friend trimmed the coils in the transmitter section without any trouble, checked the unit on air with the aid of another group member, and announced that they were now one more-hand held unit to the good.

And that's where it might have ended had not my friend, his appetite whetted by the experience so far, decided to have another go at the other unit. One of the factors influencing his decision was the feeling that, with access to a generator, he might have a better chance than before.

The soundness of this assumption was demonstrated sooner than either of us expected. No sooner had he set up the unit and fed a signal into it than a marked change in its behaviour became apparent. The indiscriminate crackle had now changed to a quite definite change in signal level as the board was flexed and various components pushed or prodded.

Even more encouraging was the fact that a particular area around the RF stage exhibited far more sensitivity to

such prodding than anywhere else.

Some time later he called out, "Hey, come and have a look at this." I went over and found him with his finger on the RF coil and, as he pushed gently one way and the other, the signal level jumped.

I put my finger on the coil and pushed it first one way, then the other. The level changed as before but what intrigued me was a quite definite movement on the part of the coil.

"That coil is moving", I said.

I fetched my jeweller's loupe and took a close look at the base while I rocked the coil. Not only was a slight movement evident, but I could identify which corner was moving. However, due to the presence of other components close to the coil, I could not be sure whether the pin was moving with the base, or was loose in the base.

"Take the solder away from that pin on the underside of the board", I suggested. My friend did so, and we both noted how easily the solder came away; much more readily than it should have done. The pin looked bright and shiny under the glass and it was impossible to say whether it had actually been soldered or not, so all we could do was clean it carefully with a pointed knife blade and re-make the joint.

As soon as the solder was set I felt the coil again. I sensed the difference immediately; it was now quite rigid, a clear indication that the pin was now secured where it had not been before. I wasn't really surprised when the generator test showed no sign whatever of the fault.

Naturally, my friend was jubilant. At long last he had cracked a problem which had defied both himself and others for so long.

YET ANOTHER FAULT

Unfortunately, his jubilation was short lived. With that fault cleared it became possible to measure the overall sensitivity, using the other unit as a reference, and this proved to be extremely poor. Whereas the good unit could be overloaded at 1uV, this one was worse than 100uV.

In theory, such a problem should not be hard to solve. Using the generator to check the gain, stage by stage it should be possible to nominate the faulty stage without much effort. The problem here was that, without a circuit, it was almost impossible to trace the signal path.

Some time later he called me over. He had identified what appeared to be the mixer stage (there was a separate crystal oscillator stage) between the RF coil and the first IF transformer and had fed 455kHz into this base. This showed a sensitivity of around 30uV, which we both felt was reasonable.

From this he had identified the RF amplifier transistor and fed a 28MHz signal into its base. The sensitivity had jumped here, down to a couple of



TRIMMER
POTENTIOMETERS

SERIES PT

PT 10



PT 10 h (2'5)



PT 10 v

PT 15



PT 15Lv (15)



PT 15Lh (2.5)

**THE FULLY ENCLOSED
DESIGN OF PIHER PT
SERIES POTS PROTECTS
THE POTENTIOMETER
FROM DUST AND
INGRESS OF
COLOPHONY.**

Piher Trimpots are available
Interstate from:—

- A.C.T. (062) 82 4995
- ADELAIDE (08) 42 6655
- BRISBANE (07) 277 4311
- MELBOURNE (03) 277 0600
- PERTH (09) 275 2377
- NEWCASTLE (049) 69 1625
- WOLLONGONG (042) 29 1455



**ELECTRONIC
DEVELOPMENT
SALES PTY LTD**

92 CHANDOS STREET,
ST LEONARDS,
NSW 2065
TELEPHONE: 438 2500
TELEX: AA25963

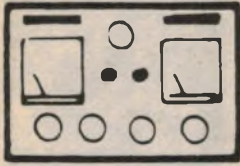

The Serviceman

As Aesop said: "A rash friend is worse than a foe"

Aesop's fable told the story of a man who employed his pet monkey to brush away the flies while he slept. The monkey, enraged by one particularly persistent fly, tried to hit it with a stone, breaking the man's jaw. Such reactions are not confined to monkeys trying to kill flies, they can happen to humans trying to cure persistent electronic faults!

The modern version of this saying might well be the popular cynicism; "With a friend like that, who needs enemies!" Either way, the implication is the same: good intentions are not enough; they have to be carried out with due care.

As well as making this point, this month's story is unusual in other ways; it involved a piece of rather specialised equipment, and it really happened to someone else; I was only a spectator. But it could just as easily have happened in a TV set or radiogram that belonged to you — or me!

The equipment was a 27MHz hand-held transceiver — or rather a pair of such devices — which had been acquired by a friend, who is a licensed amateur.

The sets were quite old — probably 15 years or more — and it is necessary to trace their history in order to fully appreciate the story. They had been purchased originally by the firm for which my friend worked, for use by the maintenance staff.

The transceivers performed very well in this role for several years but they took quite a few hard knocks in the process. Thus it was that they eventually needed to be serviced. This was undertaken by an electronics technician attached to the electricians' department and, for a while, he had no trouble coping with various minor problems.

Then one of the units developed a more serious fault, and this was the beginning of the end. The fault was a mechanically sensitive crackle which, apparently, defied all efforts to track it down.

The technician apparently decided that the most likely cause was a hairline crack in the printed board pattern; a not unreasonable assumption. His ap-

"Henry had the trouble almost licked when he had to leave for work!" (Radio-Electronics)



proach to the problem was also quite reasonable, at least in theory. This was to cover the entire copper pattern with solder, thus bridging the suspected intermittent, without actually finding it.

This was where things went wrong. Perhaps because of inexperience, or because the surface of the copper had deteriorated, he finished up applying far more heat to the copper than its bond to the board could tolerate. As a result, several sections of copper lifted clean away from the board.

As my amateur friend commented, in what I can only regard as a considerable understatement, it was in pretty much of a mess!

This may not have mattered so much if he had cured the fault. But he hadn't, and the situation was rapidly becoming uneconomic. To make matters worse there were other faults to be considered. The telescopic antenna had been damaged and was now several inches shorter than its mate, and the "on-off" switch on the volume control had failed. In neither case was a suitable replacement readily available.

The upshot was that the technician was told "Chuck 'em away, they're not worth fixing." And, as my amateur friend rather quaintly put it, he made sure he was standing where they were chucked.

He was not quite sure what he was going to do with them, but reasoned that it should be possible to shift them

onto the 28MHz amateur band — assuming he could get them working.

His first efforts were only partially successful. The second unit had some minor faults which he managed to fix but the crackle in the other unit defied all his efforts. After many hours of bashing and prodding, he was still no closer to even nominating which section was involved. To make the job even harder, the circuit diagram had long since been misplaced.

At that point he became somewhat discouraged and put the sets aside.

That was several years ago, and he had not had much incentive to do anything more about them until recently. Then he became involved in a local WICEN group. (Wireless Institute Civil Emergency Net.) Although most of their activities involved the popular two-metre band, they had also established a couple of channels in the 28MHz band, and were busy collecting as many 27MHz units as they could and converting them.

So my friend fished his two units out and started all over again. At this stage his main aim was simply to convert the good unit to the new channels. The group had acquired a stock of crystals, so his main job was to trim, or modify, the antenna and RF stages for the higher frequency.

This wasn't quite as easy as it sounds, it only because the identity of the coils was not immediately obvious. But, in

claimed in the literature. No measurements were made at higher frequencies.

Connecting the amplifier ahead of a communications receiver in our city location confirmed that it had what appeared to be a very useful amount of gain up to at least 30MHz. However, it was very difficult to assess the value of the amplifier because of the excessively high external noise level. There was just more of everything, noise and signal. Subsequently, a staff member took the device home for a weekend and tried it with an all-band receiver he happened to have on hand.

It is a rather old "poor man's" communications receiver, somewhat wanting in front-end performance. With the HF395 amplifier connected it became much more lively and the overall performance was markedly improved. However, results depended very much on the type of antenna used. The location is fairly close to one of the local broadcast stations and this tended to overload the amplifier, unless precautions were taken.

With a vertical whip antenna resonant at about 28MHz and fed with a length of coaxial cable, the amplifier behaved very well and gave a worthwhile improvement from the broadcast band to 30MHz. However, when a random length of wire replaced the whip, the local station overloaded the amplifier and the results were poor.

From these tests it would seem that the amplifier is a worthwhile addition to receivers lacking front-end gain, or with high internal noise, but care would have to be taken if used near a powerful transmitter.

ANTENNA LENGTH

In fact, there would seem to scope for experiment in any particular situation, to determine the optimum length of antenna and how best to couple it to the amplifier. In the case of the 28MHz whip, the coaxial cable would have introduced considerable capacitive loss at other frequencies, thus avoiding the overload problem.

In spite of these losses the amplifier still provided an overall improvement in sensitivity, while the fact the antenna was outdoors, clear of house wiring etc, would have been beneficial.

The next step was to assemble the HF385 VHF/UHF amplifier. This job is much the same as the other one, but it takes a little longer as it is larger. A couple of small inductors have to be wound on ferrite beads but they have only two turns each and they are easy to wind. No precise measurements were made on this amplifier but we can see no reason why it should not meet its specifications. Instructions are given for fixing the amplifier into the plastic waterproof box for mounting at the mast head.

We also made up the mains power

THE FINISHED UNITS

At top left is the mains power supply, intended mainly for use with the HF385 preamp but usable also with the HF395.

At top right is the HF395 preamplifier, well suited for use with ageing communications receivers but with useful gain to around 200MHz.

At right is the HF385 preamplifier. Note the pattern of conductors, giving the required inductive and capacitive effects.

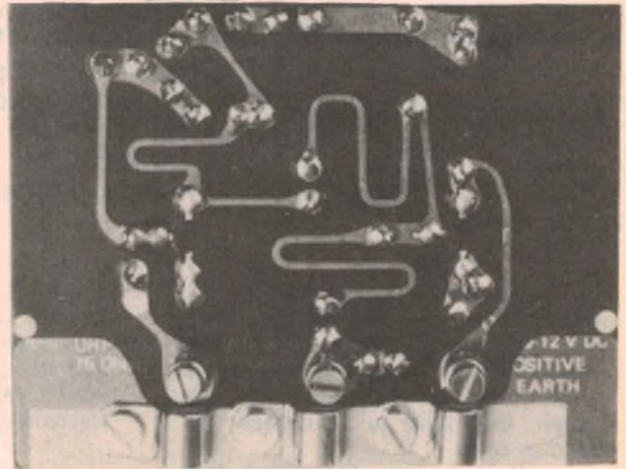
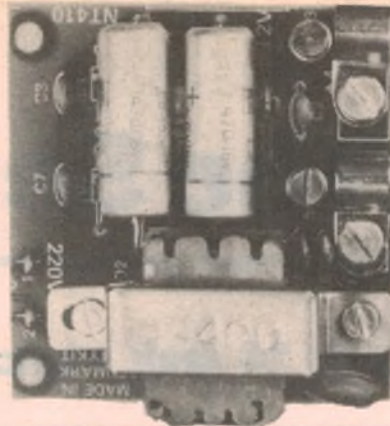

supply, NT410. The complete supply, including miniature power transformer, rectifiers, and filter, is built on a small printed board. For safety, this supply should be mounted in a suitable box, but this left to the builder to supply.

The power supply polarity is positive to earth, which is compatible with the HF385 VHF/UHF amplifier. However, the HF395 HF amplifier uses a negative earth and care must be taken if used with this power supply. The correct connections are shown in the power supply instruction book but, in many cases, a small battery may be preferred for HF395.

The power supply circuit is simple and straightforward. The transformer provides 9V RMS to a bridge rectifier. A capacitor is connected across each of the four diodes to inhibit modulation hum. Filtering is by two 470uF electrolytic capacitors and a 10 ohm resistor. The DC output voltage depends upon the current drain and is about 12V at 25mA.

Assembling the power supply does not present any particular problems, but it is important that the components be assembled in the order given in the instructions. Once the power transformer and electrolytic capacitors have been mounted, it would be difficult, or impossible, to add some of the smaller components.

It has already been pointed out that the VHF/UHF amplifier must be install-

ed at the mast head, implying that power must be fed to it in some way. Fortunately, there is a neat trick which can be used to feed the DC supply up the coaxial cable, which in turn, feeds the RF from the amplifier down to the receiver. This is done by using capacitors to pass the RF signal but block the DC from unwanted parts of the circuit, and inductors to pass the DC component but block the RF.

All the circuitry and connections for this function are provided on the amplifier and power supply boards, and it is only a matter of connecting everything together as shown in the instruction booklet.

To sum up: These JOSTYKITS are well designed and presented and should be readily built by anyone who can follow instructions and use a soldering iron. The result is a useful piece of equipment.

Kits for review were supplied by Vicom, with the exception of the HF395 Aerial Amplifier, which was supplied by Radio Despatch Service. Suggested prices are; HF395 Aerial Amplifier — \$6.00, HF385 VHF/UHF Aerial Amplifier — \$30.00, B850 plastic box for the HF385 — \$6.00, and NT410 Power Supply — \$20.00. These prices include sales tax.

Further details on all of the above kits are available from Vicom, 68 Eastern Road, South Melbourne, Victoria 3205, or from their agencies, including Radio Despatch Service, 869 George Street, Sydney, NSW 2000.

TANDY ELECTRONICS

FRANCHISE OPPORTUNITY

For established retailer COUNTRY AREAS

Now you can add extra profit, volume, traffic to your store by adding a range of the famous Tandy/Radio Shack Electronic products to your line.

If you have a successful store. (Hardware, Furniture, Appliance, Sporting Goods, Toys/Hobbies, Chemist, Radio, TV, etc.) contact us now!

A minimum investment covering inventory and start-up costs can begin a new and exciting association with Tandy — a leader in home entertainment and electronics!

Write or phone:

Mr. E. Epps, Franchise Manager.

Tandy Corporation.

P.O. Box 229, Rydalmere, N.S.W. 2116.

Phone: (02) 638 4333

BUILD AN RF PREAMP. — Continued

Power supply requirements are 9-15V DC at 35-50mA.

Applications include VHF and UHF TV, FM, and other services within the frequency coverage. For masthead operation a waterproof plastic box, type B850, is available, along with a power supply, type NT410, for installation at the receiver.

This amplifier consists of two stages, each using a special UHF transistor. From the VHF antenna input, only one stage is used, whereas from the UHF antenna input the two stages are cascaded.

The amplifier is built on a double sided printed board, 90mm x 70mm. It uses conventional resistors, capacitors, and inductors for most functions, but not all. Due to the need for good UHF performance, the tuned circuit inductors and capacitors are built into the board. The inductors are shown on the circuit as black rectangles, with capacitors to ground.

PCB INDUCTORS

Some of the "inductors" may be identified on the board. The more obvious ones are in the form of an "S", while the others are loops or straight lines. The other side of the board forms the earthy part of the circuit. The copper tracks, against the earthy side and with the dielectric material of the board, provide the required capacitance. In some cases, a pattern is etched on the earthy side to give the right characteristics. This type of construction is called "strip line".

Clearly, the design of a board along these lines involves a great deal of care, precision, and know-how. It would be an almost impossible task for readers to duplicate this kind of board and the only option is to buy the ready-made article as part of the kit.

We were supplied with two amplifier kits, a power supply, and a plastic box. Full assembly and application information is provided with each kit. The small components are packed in plastic bags, complete down to solder and the last nut and bolt.

Following the instructions carefully, I set about assembling the smaller amplifier. With the position of each component marked on the board and the components clearly identified as to type and value, the job is an easy one. Each component is placed on the board in turn, soldered, and the excess leads cut off. With only 13 components to fit, the job was completed in a matter of minutes.

As a preliminary check, I connected the amplifier to a 12V source and, with a generator and a CRO, established that the gain at about 10MHz was 30dB as

NEW BOOK!

TV & FM AERIAL INSTALLATIONS

FOR AUSTRALIAN CONDITIONS

CHOOSING THE RIGHT AERIAL FOR YOUR RECEPTION

- Local
- Fringe
- Outback
- Caravans
- Satellite

78 Informative pages for Beginners & Tradesmen. Step-by-step guide. Fully-illustrated.

SEND TODAY!

Send \$5 (Includes postage in Aust.) to:
HI-Q AERIALS 69 Maitland Rd,
Islington N.S.W. 2296

Name _____
Address _____
P.C. _____

NEW EDITION

FUNDAMENTALS OF SOLID STATE

Fundamentals of
SOLID STATE



ONLY
\$3.50
+ 60c
p&p

Fundamentals of Solid State has been reprinted, revised and updated showing how popular it has been. It provides a wealth of information on semiconductor theory and operation, delving much deeper than very elementary works but without the maths and abstract theory which make many of the more specialised texts very heavy going. It begins with atomic theory, diode types, uni-junction, field effect and bipolar transistors, thyristor devices, device fabrication and microcircuits. A glossary of terms and an index complete the book. Fundamentals of Solid State has also been widely adopted in colleges as recommended reading — but it's not just for the student, it's for anyone who wants to know just a little bit more about the operation of semiconductor devices.

Available from:
"Electronics Australia", 57 Regent St.
Sydney. PRICE \$3.50 OR by mail order
from "Electronics Australia", PO Box
163, Beaconsfield 2014. PRICE \$4.10

THE CIRCUIT DIAGRAMS:

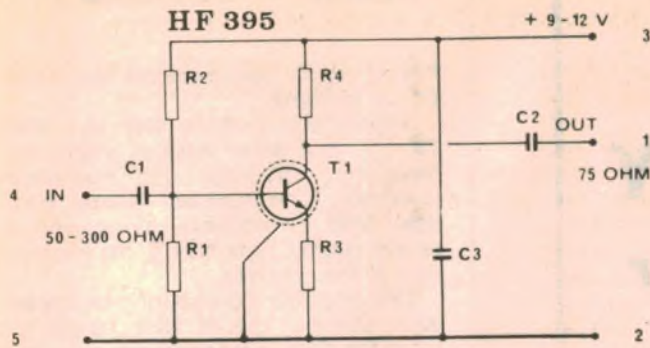

The HF395 amplifier (above) uses a conventional grounded emitter configuration, but gives useful gain up to 225MHz. Current consumption is only a few milliamps and can be supplied from a battery. T1 is a BF125 or BF199; R1 22kOhms; R2 100kOhms; R3 18 Ohms; R4 1.2kOhms; C1 470pF; C2 470pF; C3 1nF. D1 to D4 are 1N4148 silicon rectifiers.

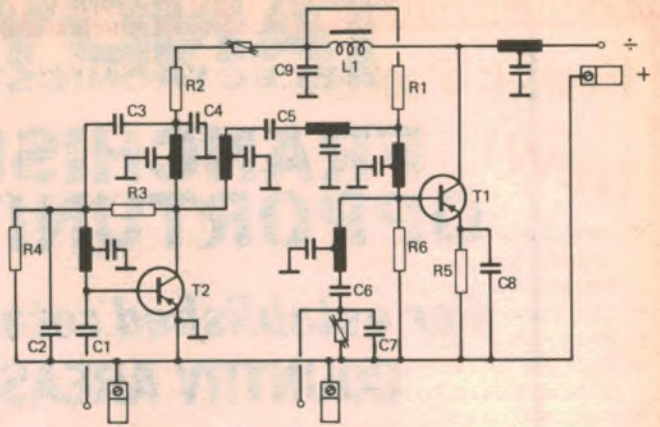

TF385 amplifier circuit above is of mainly academic interest. The black rectangles and their associated capacitor symbols represent inductors and capacitors incorporated into the double-sided P.C. board pattern.

Basically, the power supply (right) employs a conventional circuit, but has additional components to permit feeding DC power to the masthead amplifier, via the coax. TR1 is rated at 9V 50mA; R1 10 ohms; C1, C2 470uF; C4 to C8 1nF; L1 0.68uH.

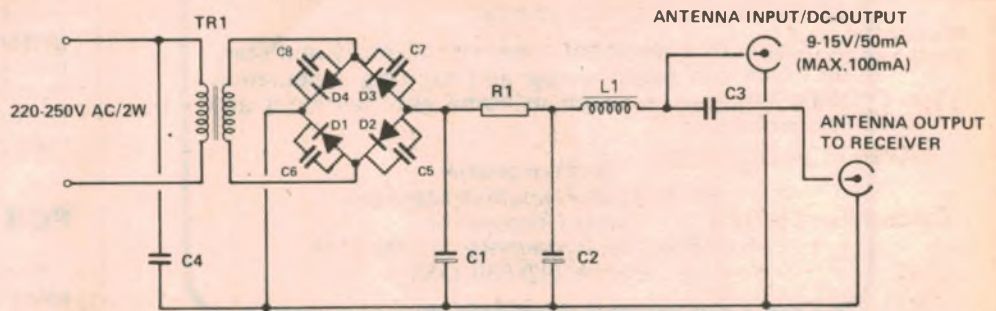

hill if necessary — and use the amplifier to overcome the cable losses.

Another limitation is their behaviour in the presence of strong signals. Of necessity, these preamplifiers have to be broadband devices. When located on a mast head, there is no convenient way to provide channel selection, as in the set's RF stage, and they must cover the entire TV VHF band and, in many cases, the UHF band as well.

This means that they have no protection against a strong local TV (or other) signal even though this may be well removed in frequency from the wanted signal. The fact is that RF preamplifiers are not intended for use in typical city or suburban areas (in the presence of strong local signals), as an aid to receiving weak distant signals from country stations.

They may work in this role, but only if the geographical location favours an antenna which is back-on to the local stations, is at least outside the shock area, and the antenna itself favours the wanted station.

But don't bank on it!

The general remarks about VHF/UHF aerial amplifiers apply also to the HF bands, but the emphasis changes somewhat. At VHF and UHF, atmospheric noise is relatively low, so that internal noise is a major factor well worth tackling. In the HF bands, particularly the lower frequencies, atmospheric noise is usually the major factor, putting less emphasis on the design of the RF stage(s) in the receiver.

This situation changes somewhat at the high frequency end (around 30MHz) where some of the VHF characteristics begin to become apparent. In addition, many old style communication receivers, particularly valve sets, exhibit a marked falling off in sensitivity at this end, while their internally generated noise is often significant.

An RF preamplifier will almost certainly benefit such sets, at least at the higher frequencies, by increasing sensitivity, countering internal noise, or both. By how much depends on how much help the set needs in the first place.

On the other hand, many simple HF amplifiers are broadband devices, similar to the VHF/UHF devices, and so are similarly prone to overload by strong local signals, such as from broadcast stations in the same general area. They are likely to be most useful, therefore, in remote situations.

This does not rule them out, in urban areas, but it does necessitate experimenting to establish a length of antenna which will give enough of the wanted signal, without producing an overload condition due to powerful local signals.

So much for the general picture; let us now look at the practical hardware. Included in the JOSTYKIT range are two amplifiers, between them designed to cover a wide frequency range. The smaller one (HF395) is a single stage,

broadband unit covering from about 150kHz to 225MHz. The gain at the lower frequencies is quoted as 30dB, falling to 5dB minimum for 225MHz. Maximum noise level is quoted at 2dB. Input and output impedances are 50-300 ohms and 50-75 ohms, respectively. A power supply of 9-15V at 1-3mA is required, which may be a battery or mains derived.

The HF395 amplifier can be used with long-wave, medium-wave and short-wave receivers, FM receivers, TV receivers, etc. It may be installed as a masthead amplifier for VHF applications but can be installed at the receiver for HF or MF operation.

The circuit uses a conventional grounded emitter amplifier with a low value of emitter resistor, unbypassed, giving some negative feedback. Base biasing is also conventional, and a fairly low value of collector resistor, together with a high frequency silicon epitaxial transistor, ensures good performance well into the VHF range.

The other amplifier (HF385) is a much more elaborate device, designed to cover from 40-250MHz and from 400-820MHz. Provision is made for two separate aerials, one VHF, one UHF, without the need for a diplexer, as this facility is built into the amplifier. Only one coaxial cable is needed from the amplifier to the receiver. The gain of the 40-250MHz range is given as 12-18dB and for the 400-820MHz range as 21-9dB. Input noise at 800MHz is 5.6dB.

THE GREATEST RANGE OF CALCULATORS AND COMPUTERS IN AUSTRALIA

Hewlett-Packard

You will never know how good H.P.'s are till you own one.

NEW!

FANTASTIC SYSTEM
L.C.D. ALPHA-NUMERIC

- HP410-over 400 steps, up to 65 Data registers (continuous) \$359.90 (\$323) the 41C has 4 interface ports for:
 - Card reader \$237 (\$213)
 - Printer/plotter \$425 (\$382)
 - Extra memory modules each with the capacity of basic 41C \$56.40 (\$49.10)
 - Plus 16 application pacs (plug-in modules) \$56.40 (\$49.10) ea.
 - And 24 solution books \$15.70 (\$13.60) ea
- also HP67/97 software compatible



NEW!

- HP 33C scientific programmable 49 steps continuous memory \$148 (\$133)
- HP 34C scientific programmable 210 steps continuous memory \$184.50 (\$165.50)
- HP 38C financial programmable 99 steps continuous memory \$184.50 (\$165.50)
- HP 31E scientific \$63 (\$56.60)
- HP 32E advanced scientific statistical \$87 (\$78)
- HP 33E advance scientific/programmable 49 step \$111 (\$99.95)
- HP 29C scientific programmable 98 steps, continuous memory \$202.50 (\$182)
- H19C same as 29C but with printer \$251.50 (\$225)
- HP 97A card programmable printing 224 steps \$913 (\$820)
- HP 38E finance \$148 (\$133)
- HP 37E business \$93.50 (\$84)

HP'S ONLY POST FREE! FOR FEBRUARY/MARCH

ASK OUR PRICES LAST — WE ARE NEVER KNOWINGLY UNDERSOLD

COMPUTERS — HARDWARE — SOFTWARE — ACCESSORIES

The CBM™ Computer Business System

2023 Friction feed 2001-16/32

Tractor Feed Printer



2040



AUTHORISED DEALER

commodore

Dual Drive Floppy Disk

Commodore sales top \$71 million — fantastic additions coming in 1980 — watch our ads for details

- C ITOH 8300 impact printer \$970 (Free delivery in Australia)
- Trend com thermal printers 100 Model (40 charact wide) P.O.A. 200 Model (80 charact wide) P.O.A. (Free delivery in Australia) (We have interfaces too!)

SOFTWARE FOR CBM & PET

16/32K CBM word processor	\$150	Accounts	\$25
8K pet word processor	\$90	Address book	\$15
Creditors/general ledger	P.O.A.	Frame pack	\$100
Debtors ledger	P.O.A.	Taxi management	\$500
Stock Control	\$100	Roof master	\$48
Super stock control	\$400	Sales analysis	\$22
Percentage costing	\$110	Real estate agent	\$65
Payroll — basic	\$55	House finder	\$55
Payroll — up to 400 (Disk)	\$110	Job evaluation	\$50
Mailing list	\$30	Profit & loss	\$25
Invoicing	\$40	Debtors letters	\$25
Service station/garage	P.O.A.		

PLUS DOZENS OF PROGRAMMES ON GAMES. EDUCATIONAL. MATHS. PROGRAMMING AIDS

CANON AX1 and BX1

Self-contained desk computers with fantastic programs for business, farming, etc.



Expandable to IMPACT printers, extra disks, etc Very powerful symbolic algebraic language

TEXAS PROGRAMMABLE SYSTEMS

- STILL ON! The greatest package offer ever!! A TI59 and PC100C printer ~~\$625~~ \$530 (\$470)



ONLY WHILE STOCKS LAST

HURRY!!

PRICES HAVE INCREASED

- Modules 58c/59 \$34.50 (\$30.50)
- Pakettes 58c/59 \$9 (\$8)
- 3 Rolls Therm Paper \$12 (\$10.50)
- 40 Mag Cards \$15 (\$13.50)
- TI58C \$127 (\$112)
- TI59 \$229.90 (\$265)
- PC100C \$237 (\$210)
- TI \$61.50 (\$54)

NEW! CASIO

● fx502P/FA1 PROGRAMMABLE LCD



256 Steps
22 Memories
Manual plus huge book of programs
FA1 adaptor plugs into ordinary cassette

fx 502p \$149 (\$135) ~~\$172.95~~
FA-1 \$43.50 (\$39) ~~\$48.95~~

P&P NSW \$3.50 ELSEWHERE \$4.50

SCHOOL AND COLLEGE SPECIALS

Wholesale Prices For Bulk Orders

Price List Avail

- TEXAS TI25 \$34 (\$31)
- TEXAS TI50 \$39 (\$35)
- NS108 \$41 (\$36)
- CASIO fx510 \$41 (\$36)
- CASIO fx310 \$31.50 (\$28)
- CASIO fx80 \$28.50 (\$25)
- G.E. LCS500 \$36 (\$31.90)

PRICES IN BRACKETS EXCLUDE SALES TAX

Pack and Post — All LCD models \$1.50 anywhere in Australia. Otherwise \$2.50 for NSW elsewhere \$3.50 per order. (Extra \$1.50 for registered Sales Tax Forms must be duly signed and stamped. (Forms available))

bankcard
welcome here

Leasing arranged

copy and complete
Please debit my Bankcard \$

No Expiry Date

Signature

Name & Address

ELECTRONIC CALCULATOR DISCOUNTS

Phone (02) 624-8849 (8am till 3pm), PO Box 106, Baulkham Hills, NSW 2153

BUILD AN RF PREAMP FROM A KIT



◀ *JOSTYKITS come complete with all hardware, solder, and instruction booklets. Shown is the power supply kit, the VHF/UHF amplifier kit, and the waterproof masthead box for the latter.*

Radio and TV systems often give poor performance because of insufficient signal reaching the receiver. Under certain conditions reception may be improved by adding a suitable RF preamplifier, as often available ready-made or in kit form. This article describes two JOSTYKIT "aerial amplifier" kits from Denmark.

by IAN POGSON

Before we deal with these specific amplifiers, it may be helpful to consider RF preamplifiers in general terms; how and why they work, what they will do and, just as importantly, what they will NOT do. Also, since the benefits and limitations are not always the same for the HF band as they are for the VHF/UHF bands, they need to be considered separately.

Consider first the VHF/UHF bands. In a typical situation where, say, a TV signal appears to be inadequate, it might be assumed that it is a simple case of insufficient receiver sensitivity and that, therefore, a preamplifier will solve the problem.

Such a situation can exist, but it is seldom as clear cut as this. Coupled with the sensitivity problem is that of "noise"; random electrical impulses, from many sources, which compete with the signal. Noise appears on a TV screen as white flecks, called "snow". In sound channels it is evident as a frying background noise.

Whether a preamplifier can reduce such noise depends on the noise source, ie, whether it occurs before the signal reaches the aerial (external) or whether it is being generated after the aerial, within the receiving system itself.

Some of the noise will be present in the atmosphere and will present itself to the antenna along with the signal. Fairly obviously, a preamplifier cannot reduce this noise. It will simply amplify

the noise along with the signal and the ratio between the two — the signal-to-noise ratio — will remain the same.

The other main noise source is within the set itself. All electronic components, particularly valves and transistors, generate noise, and the first stage (the RF stage) contributes most because the signal is weakest at this point. It is this noise which an additional amplifier may help to reduce.

If there appears to be a contradiction here, in that we intend to use one amplifier, which in itself must generate noise, to overcome the noise generated in another amplifier, then be patient. There are rational explanations.

One concerns the location of the extra amplifier. Cable between the antenna and the receiver, either ribbon or coax, introduces significant signal loss; sufficient in many cases to make the difference between a satisfactory picture or a bad one. And, to make things worse, any attempt to find a better signal, by increasing the aerial height, may be more than offset by additional loss in a longer cable.

But if we put the additional amplifier at the top of the mast — ie, a "masthead amplifier" — we can overcome these losses. Here (hopefully) the signal is adequate; above the atmospheric noise and strong enough to overcome the amplifier's own noise. Thus the amplifier delivers a high level, noise-free signal to the line, more than offset-

ting the line losses, and strong enough to override the set's internally generated noise.

And so we score simply by putting the amplifier in the right place, even if its noise performance is no better than that of the receiver's RF stage. But the chances are that the noise performance will be a good deal better, and this is another reason why an add-on amplifier can be beneficial.

There are many factors governing the noise generated in an amplifier, including the choice of amplifying device and the circuit configuration. In general, transistors generate less noise than valves and modern transistors less than older types.

Because of the job they are intended to do, RF preamplifiers are normally designed to make best use of current devices and circuit techniques. On the other hand, most TV sets, for economic reasons, are designed for average signal conditions rather than ultimate fringe area performance.

Thus, apart from the advantage of having the preamplifier at the mast head, most sets will also benefit from the better performance designed into it. Old sets, particularly valve sets, will benefit most, but even a modern set is likely to show some improvement.

Therefore, while the logical position for an RF preamplifier is between antenna and feedline, some limited benefit may accrue from using it, more simply, between the feedline and the receiver antenna terminals.

So much for the likely benefits from a typical mast head amplifier, but what about its limitations? One we have already touched on; its inability to do anything about atmospheric noise. If the signal at the antenna is unusable for this reason, then no amplifier can help. The only solution is to find a better antenna position — on a nearby

Check out these sophisticated kits from Denmark

JostyKits... Denmark's finest, offer the kind of innovative design inside and outside that you'd expect from Scandinavia. Created by qualified electronic engineers, they feature solid-state space age technology advanced enough for the most

demanding kit builder. Each comes with a comprehensive instruction booklet. Whether you're a novice or experienced builder — JostyKits will give you hours of satisfaction in construction and performance!

Audio

AF300 AUDIO AMPLIFIER

A real work-horse, this universal power amp has a wide range of applications such as car radio, record players and small receivers.

Due to its well designed electronic circuit, the AF300 can be used over wide voltage ranges without deterioration of the specification parameters.

Kit AF300 — \$25.00

AF340 40 WATT AUDIO AMPLIFIER MODULE

High quality 20-20,000 Hz, 37w RMS with low distortion.

Kit AG340 — \$35.00

FM Tuners

HF325-2 QUALITY FM TUNER MODULE

The HF325 is a complete high quality FM tuner of professional standing. The tuner unit is ready-made and pretrimmed, making it child's play to assemble. Tuning range 88-108 MHz, operating voltage 12-55 ac. Kit HF325 — \$79.00

Stereo decoder HF 310

HF310 FM RECEIVER

The HF310 is a very reasonable priced HF FM tuner. Fully trimmed, the sensitivity according to IHF standards is better than 10uV. Features 60 dB S/N ratio and low harmonic distortion.

Kit HF310 — \$49.00

HF330 STEREO DECODER

Gives 40-45 dB channel separation, just add to a good quality FM receiver. Kit HF330 — \$24.00

Pre-amps (RF)

HF395 RF PREAMPLIFIER

Gain 30dB to 20 MHz, 10 dB to 100 MHz and 5 dB to 226 MHz. Ideal to boost reception on short-wave receivers. Kit HF 395 — \$6.00

HF385 VHF/UHF ANTENNA PREAMP

Superb quality with two aerial inputs and one down lead which simultaneously supplies current from the power supply. Frequency range 40-250 MHz and 400-820 MHz. Gain 9-18 dB, depending on frequency. Kit 385 — \$30.00. Box B850 — \$6.00.

VHF (FM) TRANSMITTER
60-148 MHz. Cat HF65.
Only \$9.00!

SHORT WAVE RECEIVER PREAMP
Cat HF 395. Only \$6.00!

VHF/UHF RECEIVER PREAMP
Cat HF 385. Only \$6.00!

Light Shows

AT465 LIGHT SHOW

Turn your music into light.

Simply connect this 3

channel light show to the audio terminals of your amplifier and this quality kit does the rest for you!

Kit AT465 — \$64.00

Attractive box and knobs B6065 — \$25.00

AT468 4 CHANNEL LIGHT SHOW

This superb kit drives 4 lights (400w per channel) from the audio amplifier output. Kit AT468 — \$75.00. Attractive box and knobs B3265 — \$48.00

AT365 LIGHT SHOW

This quality kit uses microphone input instead of connection to the audio output. 1599w max.

Kit AT365 — \$69.00

Box and knobs B3265 — \$48.00

FM Transmitter

HF65 FM TRANSMITTER 60-148 MHz

Will run 5w output with heat sink. Ideal for signal testing of for a miniature transmitter which could be received on a standard FM receiver. Kit HF65 — \$9.00.

Receiver Converter

HF305 VHF CONVERTER

Converts FM 105-148 MHz to

105 MHz

Kit HF305 — \$28.00

Box B3405 attractive chassis kit — \$24.00

AM Receiver

HF61 MEDIUM WAVE

RECEIVER 540-1600 KHz receiver complete with ferrite coil antenna. Kit HF61 — \$19.00

Power Supplies

NT415 LAB POWER SUPPLY

0-30V 1 amp well-regulated supply for professional use.

Complete with box and transformer.

Kit NT415 — \$128.00

NT300 LABORATORY POWER SUPPLY

2-30V High quality supply, regulated 2-30V dc at 2 amps with overload protection. Complete with box and transformer. Kit NT300 — \$110.00

Quick assembly kits

JK01	GENERAL PURPOSE AMP 0.5w	\$18.00
JK02	MICROPHONE AMPLIFIER	\$18.00
JK03	SINE WAVE GENERATOR	
	20-20,000 Hz	\$30.00
JK04	FM TUNER 88-108 MHz	\$30.00
JK05	27 MHz RECEIVER	\$33.00
JK06	27 MHz TRANSMITTER	\$29.00
JK07	DUAL TONE DECODER FOR R/C MODELS	\$43.00
JK08	330vac LIGHT OPERATED RELAY	\$19.00
JK09	SIREN KIT inc. SPEAKER	\$19.00
JK10	PHOTOGRAPHIC TIMER 240 Vac	\$23.00
JK101	CAR BURGLAR ALARM KIT	\$55.00

New Kits

AT347	Electronic Roulette	\$54.00
AT350	2 amp triac light controller	\$12.00
AT357	Touch-control light dimmer	\$33.00
AT356	6 amp AC regulator	\$27.00
MI-360	Multivibrator, sq wave to 10MHz	\$6.00
SY-310	15w stereo amplifier kit	\$230.00
SY-340	37w stereo amplifier kit	\$289.00

JostyKits are now available from:

Sydney: Vicom,

339 Pacific Hwy, Crows Nest
Ph 436 2766
Radio Despatch Service,
869 George St, Sydney.
Ph 211 0816

Customs Communications,
Parramatta, Ph 635 6399

Adelaide: Hamtronics,
Goodwood Rd, Kingspark
Ph 272 8417

Melbourne: Eastern

Communications,
898 Riversdale Rd,
Camberwell. Ph 836 8635
Tasman Electronics,
12 Victoria St, Coburg.
Ph 354 5062

Magraths, 208 Lt Lonsdale St,
Melbourne. Ph 663 3736.

Brisbane: Delsound,

1 Wickham Tce,
Ph 229 6155
CW Electronics,
Marshall Rd, Tarrindi
Ph 48 6601

Perth: Willis Electronics,
993 Hay St,
Ph 321 7609

Adelaide 43 7981
Gold Coast 32 2644
Geelong 78 9660
Rockhampton 28 2843
Wagga 21 2125

Hobart 43 6337
Cairns 54 1035
Launceston 44 3882

Launceston 31 7075

Launceston 31 5815

Brisbane 38 4480

Wellington (N.Z.) 28 7946

VICOM

Mail Orders: Direct to VICOM, 68 Eastern Rd.

Stn. Melbourne, Vic. 3205. Enclose \$1 extra for handling and postage costs

Digital capacitance meter

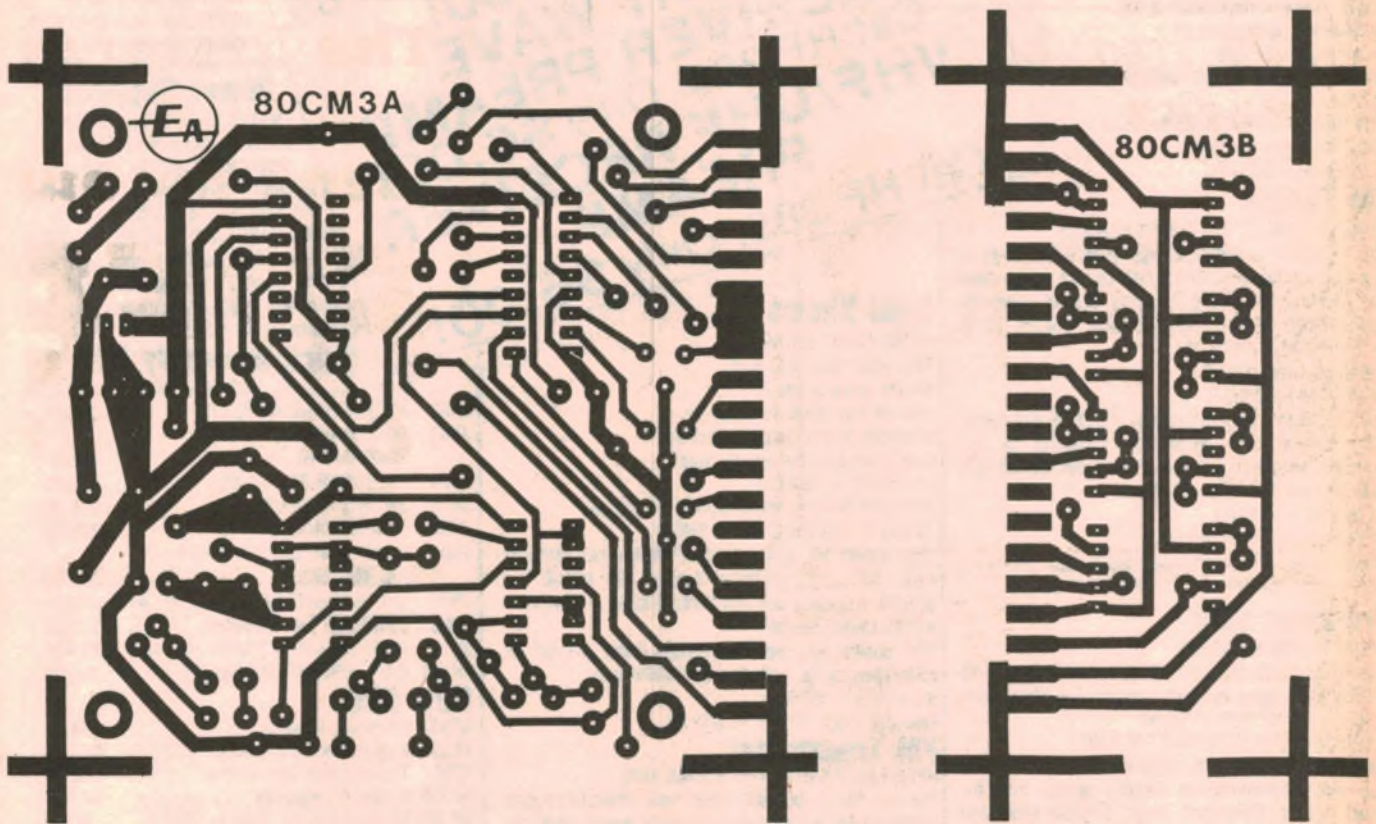
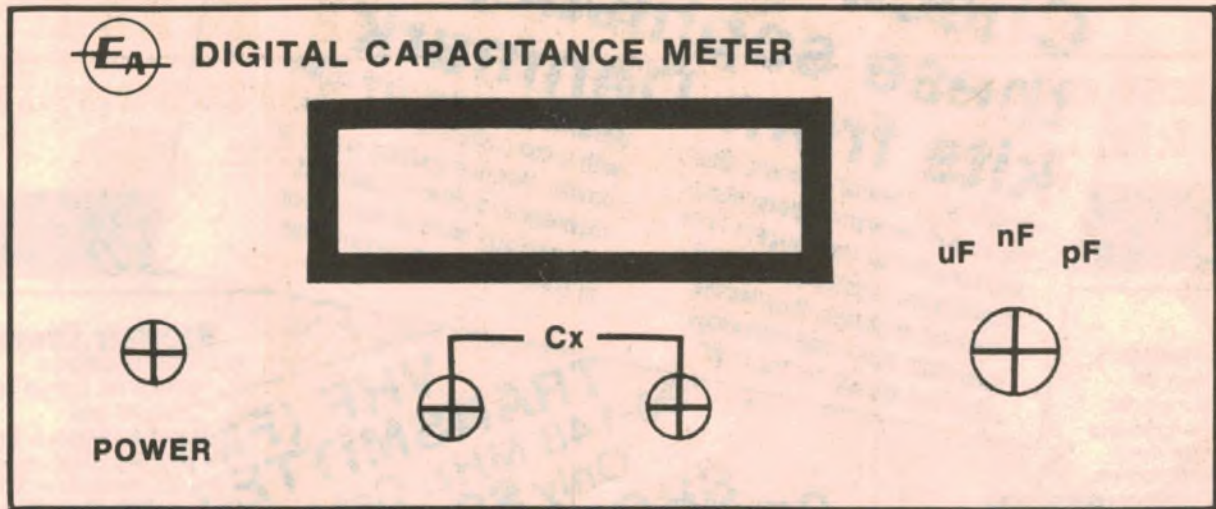

Above are actual size artworks for the front panel and the two PC boards.

panel or you can purchase a finished panel from Radio Despatch Service, 869 George Street, Sydney.

Now you can "fire up" the meter and proceed with the calibration. Ideally a capacitor standard for each range would be desirable. Lacking these or access to an accurate capacitance bridge you can purchase 2% capacitors for the purpose.

Calibrate the "nF" range first using a capacitor of about 0.47uF and adjusting

We estimate that the current cost of parts for this project is approximately

\$50.00

This includes sales tax.

VR1 for the appropriate reading (eg, 470.0nF). Next, switch over to the "pF" range and without any capacitor connected to test terminals or leads, adjust the NULL control VR4 until the display shows "0001" and then just touch it so the display reads "0000". Using, say, a 4700pF capacitor, calibrate the "pF" range using trimpot VR3. Finally, switch over the "uF" scale and calibrate it using trimpot VR2 and an appropriate capacitor.

What's so hard about a DICK SMITH Kit?

Just choose a kit.



Everything from audio amplifiers to car ignitions with degree of difficulty for your guidance.

Full instructions PLUS guide to kit construction included



all parts supplied

Just follow the simple, step-by-step instructions. You'll find all the parts are supplied - even nuts, bolts and even solder!



It's finished & it works

And it looks so good your friends will never believe that you actually built it yourself! Settle back and wonder why you never built anything before!



GUARANTEE

All Dick Smith kits are made from brand new and guaranteed components. Each kit is made up in consultation with the major electronics magazines, and includes latest amendments.

If by chance you cannot get your kit to work, many of the major kits include a 'sorry Dick, it doesn't work' coupon which allows you to have the kit serviced in our laboratories for a token fee.



The first step?

send for our

FREE

Colour Kit Catalogue

Our colour kit catalogue contains detailed illustrations of most of our kits - and it's yours free for the asking.

16 pages of kits for all tastes and budgets. Send for your free copy today!

(also available to personal callers at any of our stores and many re-sellers).



MAIL ORDER CENTRE

P.O. Box 321, North Ryde, NSW 2113, Australia.

Dick, send me my FREE Colour Kit Catalogue.

Name

Address

Postcode

DICK SMITH ELECTRONICS



SEE OUR OTHER ADVERTS IN THIS MAGAZINE FOR OUR STORE ADDRESSES AND RESELLERS

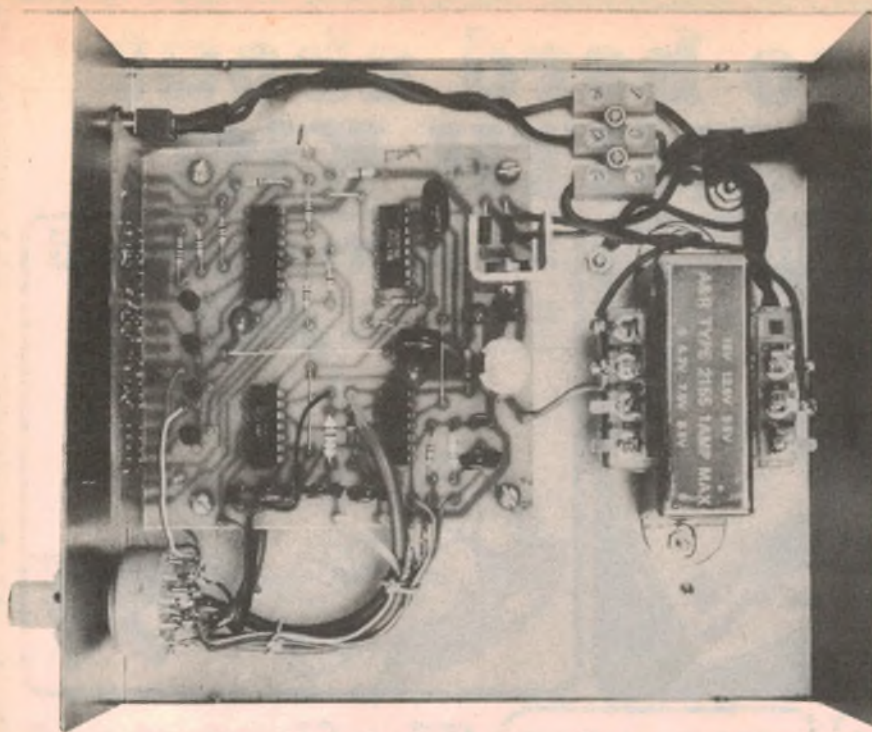

This view of the prototype shows the simplicity of construction. The PCB assembly is mounted using 25mm brass spacers.

ulator. An additional 150uF capacitor on the output of the regulator is mounted close to the 74C926 so as to decouple the display multiplex "hash".

The oscillator circuits (IC1) are separately decoupled from the regulator via a 22 ohm resistor and 0.1uF and 150uF capacitors. This is necessary to prevent the oscillators locking onto any "hash" signals superimposed on the supply.

The seven-segment readouts used for the display are Fairchild FND500s which have 15mm high digits and integral red plastic filters, eliminating the need for a separate red filter in front of the display.

Construction of the digital capacitance meter is fairly straightforward. Most of the components are mounted on the main PC board while the seven-segment displays are mounted on a display PC board which is soldered at right angles to the main board. The two connector strips on the edge of each PCB make all the necessary connections, keeping wiring to a minimum.

Dimensions of the main PCB, coded 80cm3a, are 92mm x 89mm. The display PCB is coded 80cm3b and measures 89mm x 37mm. The actual size artwork for both PCBs appears elsewhere in this article.

The FND500 displays are mounted on the display PCB after the links have been installed. Some links pass underneath the displays so care should be taken to ensure the displays are flush and in line with each other. This can be done by soldering only two of each of the display leads, checking alignment

and adjusting where necessary and then finally soldering the remaining leads.

Mount the components on the main PCB next, leaving the CMOS ICs till last. The LM340 regulator requires a heat-sink which can be made from a small piece of aluminium bent in a U-shape. Take the usual precautions when soldering the CMOS ICs: avoid handling the pins; use an earthed soldering iron and solder the supply pins first. Make sure the orientation of the electrolytic and tantalum capacitors is correct as well as for the ICs or damage may result.

With the main PCB and display PCB complete, the two can be soldered together. Let the lower edge of the display PCB overlap the lower surface of the main PCB board by about 2mm and make sure the two are exactly at right angles to each other. First, solder "tack" one strip at either end of the boards together and manipulate them until the orientation is correct; then solder the remaining connectors.

The circuitry is housed in a metal case measuring 184mm x 70mm x 160mm (D x H x W). Drill the mounting holes for the transformer, cable clamps and terminating block as shown in the photographs of the internal layout. The mains earth lead should be slightly longer than the other mains leads and should be terminated to a solder lug screwed down to the chassis.

Use the front panel artwork, shown actual size elsewhere in this article, to obtain drill centres for the on/off switch, range selector and banana plug test sockets as well as the dimensions of

PARTS LIST

- 1 PC board, 92mm x 89mm, coded 80CM3A
- 1 PC board, 89mm x 37mm, coded 80CM3B
- 1 metal case
- 1 transformer, A&R2155 or similar
- 1 4-pole 3-position rotary switch
- 1 SPST miniature toggle switch
- 1 red banana plug socket
- 1 black banana plug socket
- 1 mains cord and plug
- ½ metre of shielded audio cable
- 1 2M mini vertical trimpot
- 1 100k mini vertical trimpot
- 1 22k mini vertical trimpot
- 1 4.7k mini vertical trimpot

MISCELLANEOUS

- 3-way terminal block, cord clamp, grommet, knob, rainbow cable, 4 x 25mm brass standoffs, nuts & screws

SEMICONDUCTORS

- 1 74C926 CMOS IC
- 1 74C14, CD40106 or MC14584 CMOS IC
- 1 4017 CMOS IC
- 1 4011 CMOS IC
- 4 BC338 transistors
- 2 1N4002 diodes
- 1 LM340T-5 regulator
- 1 1N4148 signal diode
- 4 FND500 seven-segment LED displays

CAPACITORS:

- 1 1000uF/16VW PC electrolytic
- 2 150uF/6.3VW tantalum electrolytic
- 2 10uF 35VW tantalum electrolytics
- 1 0.22uF greencap (metallised polyester)
- 1 0.1uF greencap
- 1 .0022uF greencap
- 1 .001uF greencap

RESISTORS: (all ¼ watt 5%)

- 1 x 2.2M, 2 x 680k, 1 x 6.8k, 1 x 2.2k, 1 x 47 ohm, 7 x 27 ohm, 1 x 22 ohm

NOTE: Ratings are those used on the prototype. Components with higher ratings may generally be used providing they are physically compatible.

the cutout for the display. With the cutout complete mount the main board using 25mm washers. Then mount the switches and complete the wiring.

Keep all the leads as short as possible and use shielded cable for all the connections to the gating oscillator. The connection to the input of IC1a continues on from the wiper of S1a and to the test sockets. Make sure the cable is shielded every bit of the way, otherwise multiplex hash may influence readings, causing a slight "sticking" or bouncing of the display.

An attractive finish to the meter can be provided by using a "Scotchcal" photosensitive aluminium front panel. Use the artwork provided to make the

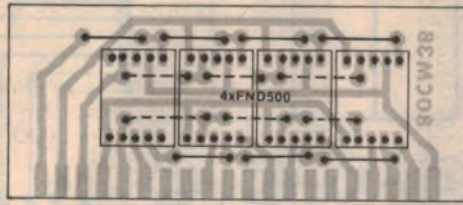

The display board is easy to assemble. Note the wire links underneath the 7-segment LED displays.

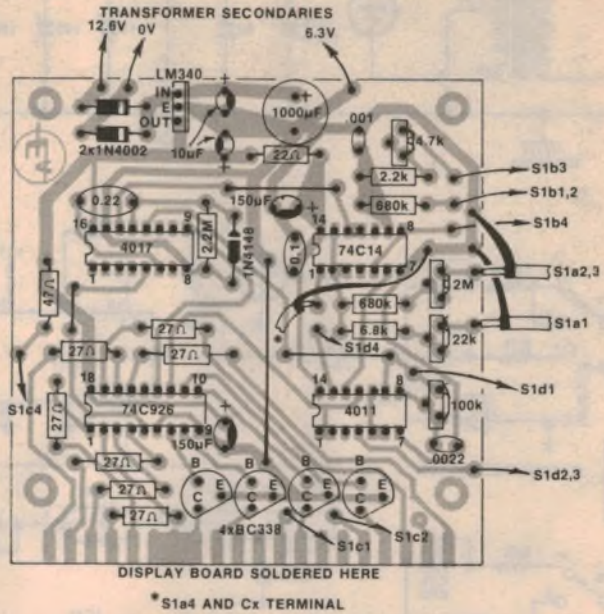
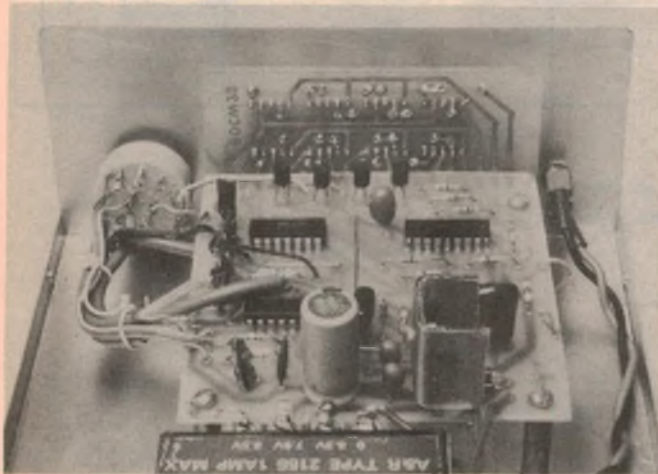

Above: follow this wiring diagram in conjunction with the circuit when wiring up the capacitance meter. Note that the connection to switch wiper S1a should be run in shielded cable.

Left: view inside the completed prototype. The display board is soldered at right angles to the main PC board.

reference oscillator, IC1d, clocks up the 74C926 counter; as soon as the gating signal is finished the latch enable goes high and the contents of the counter are displayed (ie, the reading is updated); finally, the reset goes high, clearing the counter for the next cycle.

In practice, we have used the "carry" signal from the 4017 as the gating signal instead of using the output of the gating oscillator direct. However, this does not alter the principle of operation. The "carry" signal from the 4017 is high during the time the decoded outputs 0 to 4 are high, so the 74C926 is clocked during this period. The latch enable signal is the decoded "6" output from the 4017 (pin 5) while the reset

signal is the decoded "8" output (pin 9).

Note that with this system there is a discrete clock period (ie, period of the gating oscillator IC1a) between each housekeeping signal, so that the circuit operates reliably and without "glitches".

One point that emerges from the foregoing description is that the display will be updated at a rate given by the "gating" oscillator which can be quite rapid when small capacitors are being measured. To prevent the display from flickering as a result of this rapid updating, a half second delay is introduced by connecting the decoded output "7" to the clock enable (pin 13) via a 0.22µF capacitor. When in the normal course of events the "7" output goes high, the "clock enable" will be forced high, disabling the 4017 and effectively freezing the display. The 0.22µF capacitor is discharged via the 2.2M resistor. So about half a second later clocking commences again.

Finally, we can describe the feature we are quite proud of: the stray capacitance nulling circuit. It is comprised of two NAND gates, IC3c and IC3b and the basic operation of the circuit is shown in Fig. 2. Stray capacitance in the internal wiring or the test leads acts in parallel with the capacitance being measured and is added to it. Thus,

stray capacitance has the effect of lengthening the pulses from the gating oscillator by a fixed amount.

The function of the nulling circuit is simply to shorten the gating pulses, effectively removing the additional time due to the stray capacitance. Fig. 2 shows the timing diagram of the nulling circuit. The gating pulse is fed to one input of NAND gate IC3c and to the other input via a delay network with time-constant "T", consisting of a variable resistor VR4 and a .0022µF capacitor. When the delayed version of the gating pulse is "ANDed" with the original, the resultant output pulse is shortened by the corresponding amount.

Range selection is provided by a four-pole three-position switch S1: switch poles S1a and S1b select appropriate resistors for the two oscillators as already discussed while switch S1d switches the nulling circuit out for the high range; S1c turns on the appropriate display decimal point for the range selected.

The power supply consists of a 12.6 volt centre-tapped transformer feeding a full-wave rectifier and 1000µF filter circuit. An LM340 three-terminal regulator at the output of the filter provides the regulated 5-volt supply for the CMOS circuitry. The 10µF tantalum capacitors ensure stability of the reg-

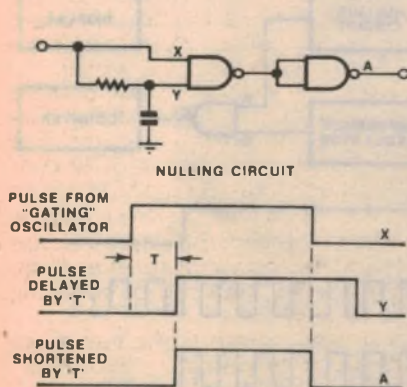
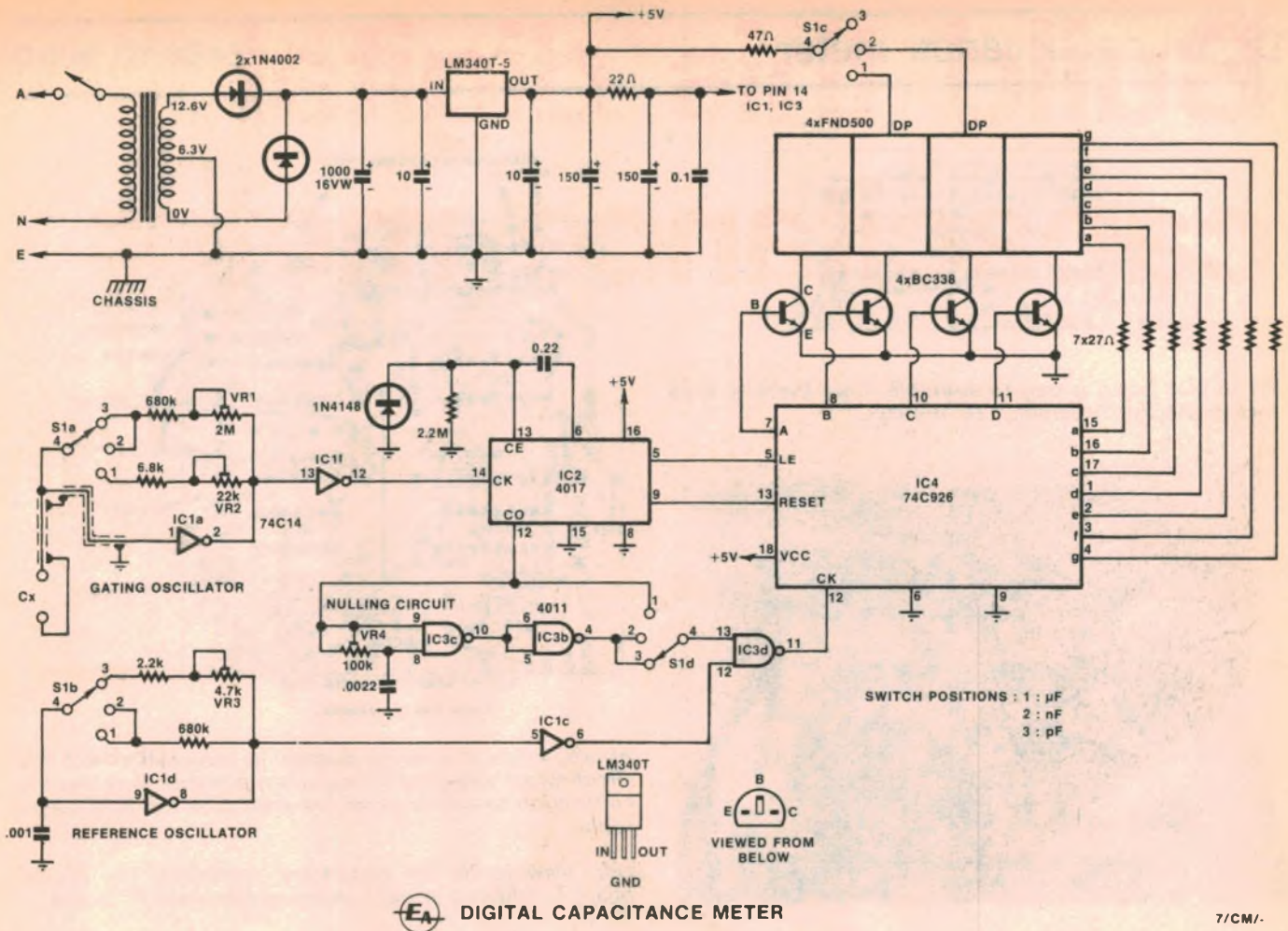

FIG. 2



EA DIGITAL CAPACITANCE METER

7/CM/-

Just 5 ICs and 4 LED displays make up this accurate digital capacitance meter. Note that, for the sake of clarity, the components associated with S1a and S1b are not shown in the order that they appear on the PCB.

If the reference oscillator is set to an appropriate frequency then, the counter will actually display the capacitance value directly.

There is a little more to it than that, as reference to the circuit diagram will indicate. The two oscillators we've mentioned are IC1a, which is the "gating" oscillator and IC1d, which is the reference oscillator. Both are Schmitt oscillators in which switches S1a and S1b provide for appropriate range selection. The "gate" referred to in Fig. 1 is actually IC3d which is a 4011 NAND gate while the counter is IC4, a 74C926 CMOS IC.

The 74C926 is a four-decade counter which we have used before in other projects such as our digital frequency meter. As well as a four-decade counter, the 74C926 has latches, decoder drivers and internal multiplexing circuitry which drives a four digit LED display directly using four transistors. If conventional ICs were used in place of the 74C926, as many as 12 extra ICs would be required.

To make the 74C926 counter function properly, certain "housekeeping" signals are necessary, namely the "reset" and "latch enable" signals. The contents of the latches are used to drive

the display so that the decade counters remain free to count up without affecting the display. When the count has to be displayed the "latch enable" signal goes high, transferring the contents of the counter to the latches. The purpose of the "reset" signal is to clear the counters, so that a new count cycle can begin.

These "housekeeping" signals must be generated in a particular sequence, together with the signal from the "gating" oscillator, IC1a. To do this, we

have used a 4017 decade counter IC which has 10 decoded outputs as well as a "carry" output. Only one of the decoded outputs is on (high) at any given time. The "clock" signal for the 4017 is obtained from the "gating" oscillator, IC1a, so that the length of the pulses from each of the 10 decoded outputs is equal to the period of the clock signal.

The sequence of the housekeeping signals is as follows: First the gating signal arrives and the output from the

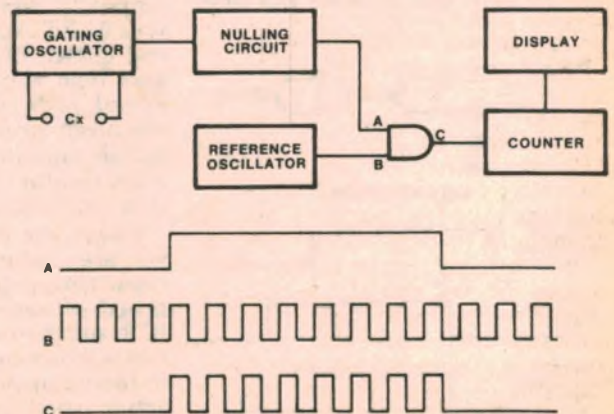
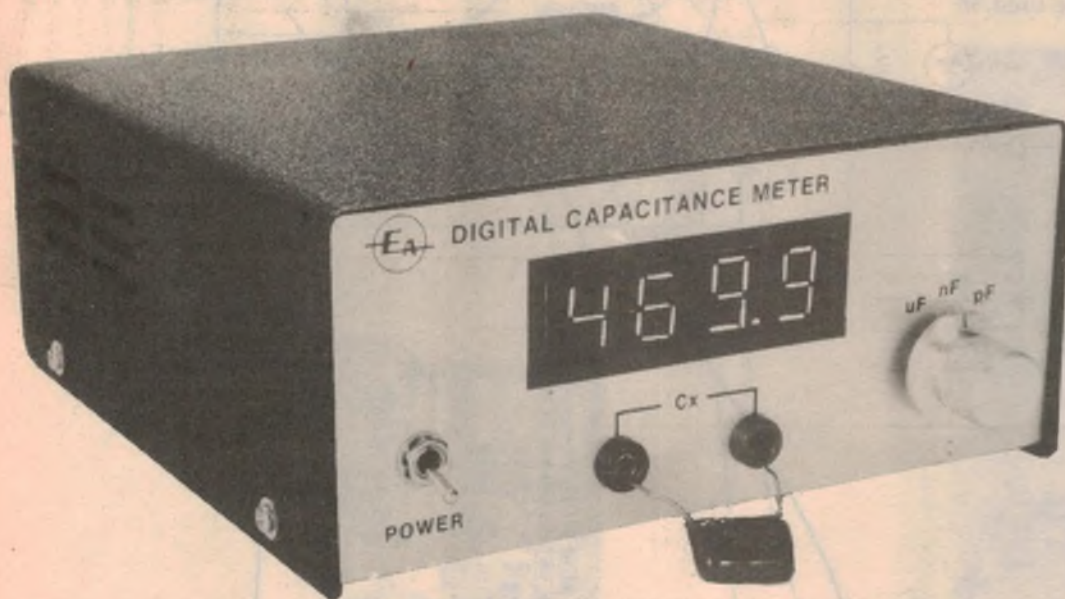

Fig. 1 (right): how the circuit works. Pulses from the reference oscillator are gated by the gating oscillator and fed to the counter circuit.

FIG. 1

Build this digital capacitance meter



- ☆ Easy to build
- ☆ 4 digits
- ☆ LED display
- ☆ Measures 1pF-99.99uF

Here is an inexpensive digital capacitance meter which measures from 1pF to 99.99uF in just three ranges. It's simple to use and features a big bright four-digit display with automatic updating and decimal points.

by **RON DE JONG**

We have described quite a few capacitance meters in the past, the last one published in January 1979 proving to be quite popular. It was a simple analog meter and gave good performance at low cost. Considering the success of that project, we have taken the next "logical" step and developed an up-to-the-minute digital capacitance meter.

Our new capacitance meter uses only five ICs and has a large four-digit LED display. There are three ranges with full scale readings of 9999pF, 999.9nF and 99.99uF with over-range available on each. This means that capacitance measurements can be made over the range from one picofarad to beyond 100 microfarads. No adjustments are necessary to make a reading: just connect the capacitor, select the range and there is the reading — bright and clear.

It is certainly simpler to operate than a conventional impedance bridge but also has the advantage over both bridges and conventional analog meters in that it will accurately measure capacitance down to one picofarad directly. This is possible because of the internal "nulling" circuitry which

cancels the effect of any stray capacitance between the test terminals or test leads, so when you measure a 5pF capacitor it will display 5pF! In this respect it also has the advantages of the more complex "probe" type capacitance meters used for in-circuit capacitance measurements.

With features like these our digital capacitance meter should be invaluable to experimenters and even professionals. It is a simple matter to sort capacitors even if they have no markings or the markings are difficult to decipher. This can be the case with capacitors which use colour codes, etc, or tuning and trimmer capacitors which usually have no markings at all.

The capacitance of wiring and cables can also be readily measured. For example, it is often desirable to know the capacitance of shielded audio cable when connecting cartridges, since most cartridges usually have an optimum capacitive load.

Unlike conventional meters a digital meter offers high resolution; in this case, four digits. This means it is possible to select close-tolerance capacitors from a batch of low-tolerance units or

to match capacitors for use in filters.

Last but not least our "DCM" also measures electrolytic and tantalum capacitors. The test terminals are actually polarised with a potential difference of about 3 volts between them, so electrolytics with voltage ratings of more than 3 volts can be readily measured.

To see how it all works, refer to Fig. 1. The heart of the whole meter is the "gating" oscillator which is actually a simple RC oscillator. The capacitor to be measured forms the "C" part of the oscillator so the period of oscillation will be proportional to the value of the capacitor. For example, a small capacitor will result in a relatively short period of oscillation while a larger capacitor will cause a correspondingly longer period.

The output pulses from the "gating" oscillator gate through a series of pulses from a reference oscillator which operates at a fixed frequency. With this arrangement, the number of pulses gated through to the following counter is proportional to the pulse length of the "gating" oscillator and hence the value of the capacitor being measured.

HIFI AUTOSWITCH

10mm from the board. A final adjustment can be made with the lid in place before the leads are cut.

The recessed mains sockets we used had metal strips attached to them to give a wider mounting distance. Either these strips can be used for mounting the sockets or the mounting holes in the sockets themselves can be used. In

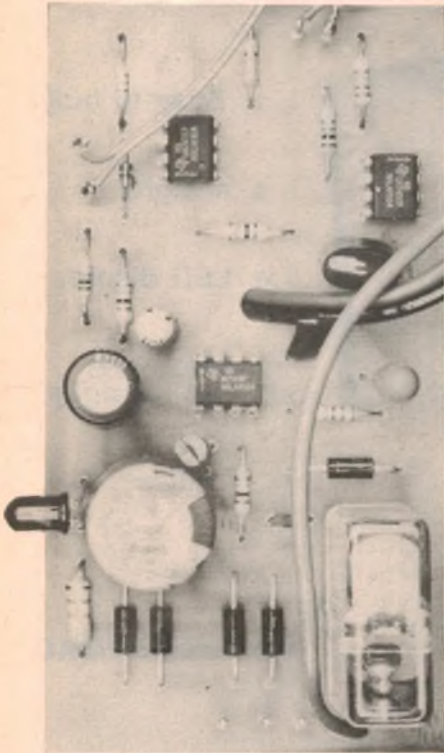

The LED is positioned and bent to fit through the front panel bezel when the PCB is assembled into the box. This assumes that you use the Dick Smith box with PCB mounting slots.

the latter case spacers are required to prevent the panel from buckling when the screws are tightened. As can be seen in the photo the sockets do not all lie in the same direction. This was done because the terminal connections on the sockets are easier to manipulate when they face outwards from the panel.

The socket for the remote control start switch needs to have its pins isolated from the metal lid. We used a DIN plug and socket which provides insulation with its plastic construction.

The transformer is mounted on its side to allow enough room for the panel mount sockets. Plastic sleeving is used on the resistor and capacitor leads which are located on the insulated terminal strip. Follow the details of the mains wiring closely, for safety's sake.

With assembly complete, check all your wiring and apply power. Check the voltages and then press the remote switch. You have to keep it depressed for about one second for the relay to

close. With no signal applied, the relay should open again after one minute. With those checks complete, you are ready to connect the unit to your high fidelity system. ②

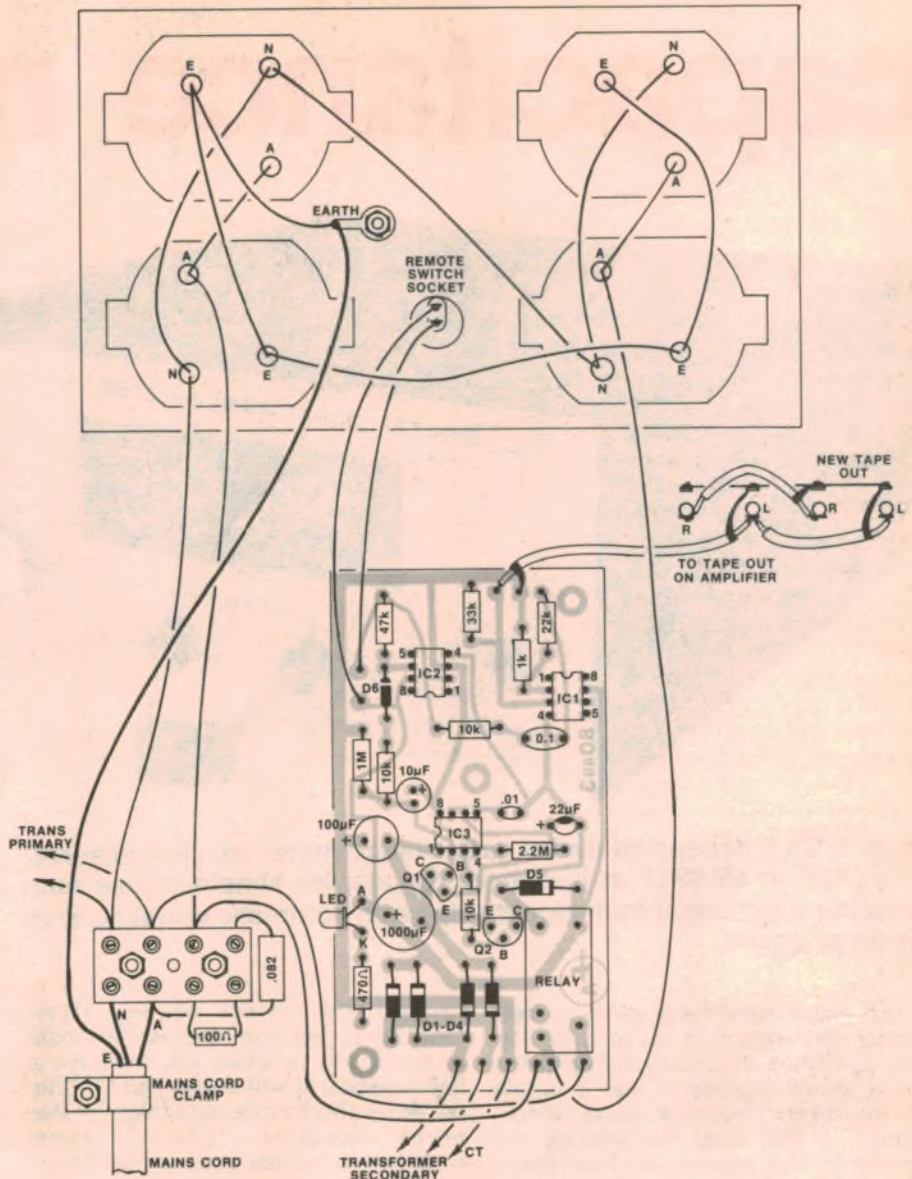

Do not forget to sleeve the leads of the resistor and capacitor on the insulated terminal block. Follow the details of the mains wiring closely, for safety's sake.

One-Second Desoldering

with **SODER-WICK**



1. Hold Soder-Wick on termination with hot soldering tip. Wicking action soaks up solder.
2. Remove tip and braid. Termination is left clean and free of solder.



Soder-Wick is a specially treated copper braid which soaks up molten solder like a sponge. Desolders a P.C. pad in a second or so: acts as a heat sink to protect circuits and components.

From your Components supplier or ring:

Royston Electronics

(02) 709 5293	(07) 44 0131
(03) 543 5122	(08) 42 6655
(002) 34 2233	(09) 381 5500



sanwa

... the long term reliable multimeter.

N501 Multimeter The executive choice!

- Measurements similar to a VTVM can be taken as the N501 has a constant $1M\Omega$ input impedance on the ACV ranges.
- Widespread coverage of the principal measurements is available as the N501 has AC + DC Volts to 1.2kV, AC and DC Amps to 12 Amps and 6 resistance ranges to 200 $M\Omega$.
- Attractive, 9mm thick walnut sideboards help protect the multimeter from accidental damage.



T-55 THD Multimeter (T-55D c/w optional temperature probe)

The latest lightweight with heavyweight features!

- Adds a temperature capability (-50°C to 200°C) to the newest thin-dimension multimeter. Lets you measure the temperature of industrial and commercial appliances or individual component heat.
- Offers a multi-role multimeter to cover normal requirements plus AC Amps, battery test, LED test and temperature selections.

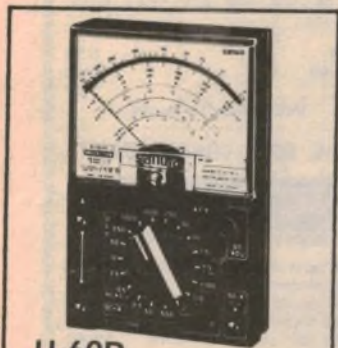

U-60D UNIVERSAL MULTITESTER

- 44 μ A movement—quality performance, diode protected
- Stable ACV measurement—solid-state rectifier & enlarged frequency coverage.
- Linear scale characteristic—common scale reading for DCV and ACV
- Semiconductor test—simultaneous reading of load current & voltage with Ω
- Temperature measurement of -30°C to +150°C with extra probe

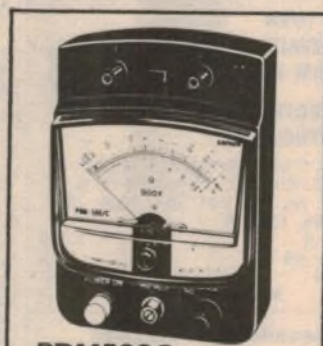

PDM500C INSULATION TESTER

- Easy push button operation.
- Large easily read scale.
- No wearing parts (transistorized for long trouble-free life).
- One-man operation—no handle to crank.

Specifications
Rated Voltage 500V.
Resistance 100 Megohm.
Effective scale reading: 0.1—100—200 Megohm.
Continuity Scale: 0—100 ohms
Including vinyl-leather case with lead pouch, shoulder strap and insulated test leads.



460-ED MULTITESTER THE BEST BUY IN MULTIMETERS

100,000 ohms per volt with $\pm 2\%$ accuracy for DC ranges with only 10 microamperes loss at full scale. H.F. current blocking when making DC measurements.

- 10 μ A movement—100k Ω /V, varistor protected
- Polarity reversal switch—negative measurements
- Equalising transformer—common shunts & jacks for 1.2A & 12A DC/AC



BX-505 MULTITESTER

- Fast-response, 24 μ A movement—fuse & diode protected with high resolution factor (0.4 μ A/scale division)
 - Revised scale marking—intermediate readings readily determined
 - Polarity reversal switching—negative measurements
 - Series capacitor terminal (OUTPUT+)-AF output level check
- RANGES: AC & DCV to 1.2kV [30kVDC with optional probe]. AC & DCA to 12 amps



WARBURTON FRANKI

- ADELAIDE 356-7333 • BRISBANE 52-7255 • HOBART 23-1841
- MELBOURNE 699-4999 • PERTH 277-7000 • SYDNEY 648-1711
- AUCKLAND N.Z. 77-0924 • WELLINGTON N.Z. 698-272

ROD IRVING ELECTRONICS

499 HIGH STREET, NORTHCOTE 3070, MELBOURNE VICTORIA. Ph. (03) 489 8131.

NEW PRODUCTS

RIE are now distributors for 3M products including Scotchcal range.

8016 blue on white plastic	\$4 10
8018 green on white plastic	\$4 10
8011 red on white plastic	\$4 60
8012 black on transparent plastic	\$4 10
8013 black on yellow plastic	\$4 10
8015 black on white plastic	\$4 10
8009 light blue on aluminium	\$4 10
8001 red on aluminium	\$4 10
8005 black on aluminium	\$4 60
8007 reversing film	\$3 75

*Note — all above sheets 10in x 12in	
8500 Photosensitive developer	\$4 40
3900 clear coating (glossy finish)	\$9 30
3930 clear coating (matte finish)	\$9 30
ML-3 Applicator block	\$3 90
ML-4 developer pads 10 for --- 8002KA evaluation kit	\$8 90

SOAR corporation



Digital hand multimeter \$77

EA METAL DETECTOR

EA 79md 9	\$2 60
As A Kit (without H/phones)	19 90
ET576	4 90
Dream 6800	9 90
ETI 472	2 90
ETI 471	9 90
ETI 470	2 75
ETI Series 4000 Kit	179 00
ETI 585 Rx ultrasonic Rx	15 95
ETI 585 Tx ultrasonic Tx	8 95

INTERSIL ICL7106 LCD EVALUATION KIT \$32.50

INTERSIL LCD 3 1/2 DIGIT PANEL METER KITS

Build a working DPM in 1/2-hour with these complete evaluation kits.

Test these new parts for yourself with Intersil's low cost prototyping kits complete with A/D converter and LCD display (for the 7106) or LED display (for the 7107). Kits provide all materials including PC board, for a functioning panel meter ICL7106EV (LCD).

COMPONENTS

2114 RAMS	\$5 50
2708 EPROM	8 50
741 s 10 up	2 50
555 s 10 up	2 90
BD139 10 up	4 00
BD140 10 up	4 00
SC141D 10 up	11 00
SC151D 10 up	21 10
RED LEDS 10 up	1 40
RED LEDS 100 up	11 00
YELLOW LEDS 10 up	2 90
8 PIN I/C SKTS 10 up	2 00
BC547 10 up	1 00
BC548	0 15 ea.
BC549	0 19 ea.
MJ802	3 60
6.800/50V CAPS (LUG)	4 50
5.600/40V CAPS (PCB)	1 90

KITS & CIRCUIT BOARDS

ETI SERIES 4000 AMP

● Complete Kit	\$179 00
● Quality front panel to suit above	8 99
● ETI 470 kit of parts	19 90
● ETI 480 kit of parts 100w (incl bracket)	19 75
● ETI 470 PS kit of parts (includes relay, not transformer)	19 50
● Transformer to suit	22 90
● ETI 471 pre-amp	45 50
● ETI 585R ultra sonic RX	15 95
● ETI 585T ultra sonic TX	8 95
● EA 79 SF9 sound flash trigger	15 00
● All parts available for DREAM computer project	
● P.C.B.'s (all quality fibreglass boards)	
ETI 574 disco strobe	2 80
ETI 549A metal detector	2 75
DREAM circuit board	9 90

PROJECT BOARDS (FIBREGLASS)

ETI 043	1 40	ETI 481M	2 00
ETI 044	1 30	ETI 481PS	3 50
ETI 047	1 50	ETI 483	2 20
ETI 061	1 40	ETI 484	3 90
ETI 062	1 80	ETI 485	2 90
ETI 063	1 70	ETI 486	2 90
ETI 064	1 70	ETI 489A	2 50
ETI 065	1 70	ETI 499	1 99
ETI 067	1 80	ETI 528	2 20
ETI 068	1 40	ETI 541	2 20
ETI 071	1 40	ETI 547	2 20
ETI 072	1 80	ETI 581	2 20
ETI 081	1 50	ETI 583	2 20
ETI 083	1 80	ETI 585R	1 60
ETI 084	1 70	ETI 585T	1 40
ETI 085	1 30	ETI 586	2 30
ETI 130	1 90	ETI 603	2 50
ETI 134	1 90	ETI 604	1 60
ETI 135	1 90	ETI 635	2 90
ETI 136	1 80	ETI 638A	3 90
ETI 137A	2 90	ETI 708	1 90
ETI 137B	2 90	ETI 713	3 90
ETI 139	1 90	ETI 714	1 90
ETI 245	1 60	ETI 717	2 90
ETI 417	1 80	EA 78A08	2 90
ETI 445	1 50	EA 78TM8	2 00
ETI 446	1 90	EA 78N6	3 20
ETI 449	1 50	EA 78NG4	2 50
ETI 450A	1 90	EA 78UT4	3 90
ETI 450B	1 90	EA 78T3	4 20
ETI 480	2 40	EA 78C5	3 90
ETI 480PS	2 40		

COMPUTER COMPONENTS

Attention Sorcerer & TRS 80 owners. Memory expansion kits available. We also offer full service on the popular computer projects and systems.

SPECIAL 4116 RAM OFFER
8 OFF PRIME SPEC 4116 I/Cs \$88.00
16 4116s for \$160.00
STATIC RAM KIT 16K S-100

KIT FORM \$269.00
ASS & TESTED \$299.00

All front panels available for ETI & EA projects in scotchcal from July '79. Phone for details.

DIP PLUGS

Ideal for use with flat ribbon cable or to mount components on

14 pin	\$0 56	24 pin	\$0 94
16 pin	\$0 58	40 pin	\$2 00

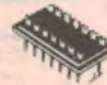

COMPUTER COOLING FANS

Muffin fan 4 1/2" square

110V	\$26 50
240V	\$24 50

Sprite fan 3 1/2" square

110V	\$26 50
240V	\$24 50

Range of larger fans available. Send for details

POWER TRANSFORMERS

SPECIALLY DESIGNED FOR MICROCOMPUTERS

- See Feb 1979 EA for full details
- Good regulation electrostatic shield
- RI 805
| 8V @ 5A 2x15V @ 1A | \$18 50 |
- RI 810:
| 8V @ 10A 2x15V @ 1A | \$20 50 |
- RI 820
| 8V @ 20A 15V @ 1A | \$30 50 |
| 15V @ 3A | |

20 TURN CERMET TRIM POT



SPECTROL 43P ACTUAL SIZE

STOCK RESISTANCE VALUES

10R 20R 50R 100R 200R 500R 1K 2K 5K 10K 20K 50K 100K 200K 500K 1M 2M	
1-9	\$1 20
10-99	0 95
100	0 90

Values may be mixed

cermet single TURN TRIM POT

Spectral model 63P ACTUAL SIZE

STOCK VALUES

10R 20R 50R 100R 200R 500R 1K 2K 5K 10K 20K 50K 200K 500K 1M 2M	
1-9	0 95
10-99	0 85
100	0 75

Values may be mixed.

P.C. EDGE CONNECTORS

STOCK RESISTANCE VALUES

10R 20R 50R 100R 200R 500R 1K 2K 5K 10K 20K 50K 100K 200K 500K 1M 2M	
1-9	\$1 20
10-99	0 95
100	0 90

Values may be mixed

DREAM

ELECTRONIC AUSTRALIA MICROCOMPUTER PROJECT

Kit for main board (including programme 2708)

\$109 00	
PCB (fibre glass) only	\$9 90
2708 programmed	\$16 50
Key Pad 19 keys	\$19 50
Kit (less key pad)	\$90 00
PCB for power supply	\$3 50

Hexadecimal Keypad

\$19.50/each

19-key pad includes 1-10 keys ABCDEF and 2 optional keys and a shift key

Ideal for dream project

MULTIDIALS

Dials to suit 10 T Pots

Model 21 1 8" dia	\$9 90
Model 16 9" dia	\$9 50
Model 18 1 1" x 1 75" dia	\$17 50

10 TURN POTENTIOMETERS

Stock resistance values

50R 100R 200R 500R 1K 2K 5K 10K 20K 50K 100K	
Spectral model 534 1/4" shaft	
Price 1-9	\$6 25
10 + values may be mixed	\$5 75

HEAVIER ITEMS ADD ADDITIONAL POSTAGE. EXTRA HEAVY ITEMS SENT COMET FREIGHT ON. PRICES SUBJECT TO CHANGE WITHOUT NOTICE. SEND 40c & S.A.E. FOR FREE CATALOGUE.

MAIL ORDERS: PO BOX 135, NORTHCOTE, VIC 3070.
MIN PACK & POST \$1.00

HIFI AUTO-SWITCH

106mm. The lid of the utility box must be replaced with one of a more substantial gauge to mount the mains sockets.

A much smaller plastic utility box, measuring 83 x 54 x 28mm, is used as the remote switch box.

Before assembling the PCB, its size should be trimmed so that it fits neatly in the box without fouling the metal lid. When filing the edge of the PCB leave a ½mm margin between the edge of the board and the copper track. Drill the 5mm hole located at the centre of the PCB, for the neutral and earth wires to pass through. Chamfer the copper away from the edge of the hole to prevent chafing of the wire insulation.

Start assembly of the PCB by mounting the small components such as the diodes and resistors. Next, the capacitors and transistors can be soldered in place. Lastly the relay can be mounted. The use of PC stakes is recommended. Please note that five of the six connections on the relay end of the board have wires leaving from the copper side of the board.

The LED is mounted directly on the PCB and has to line up with the hole on the metal lid. Bend the LED leads virtually flush with the plastic moulding and solder the LED in place at about

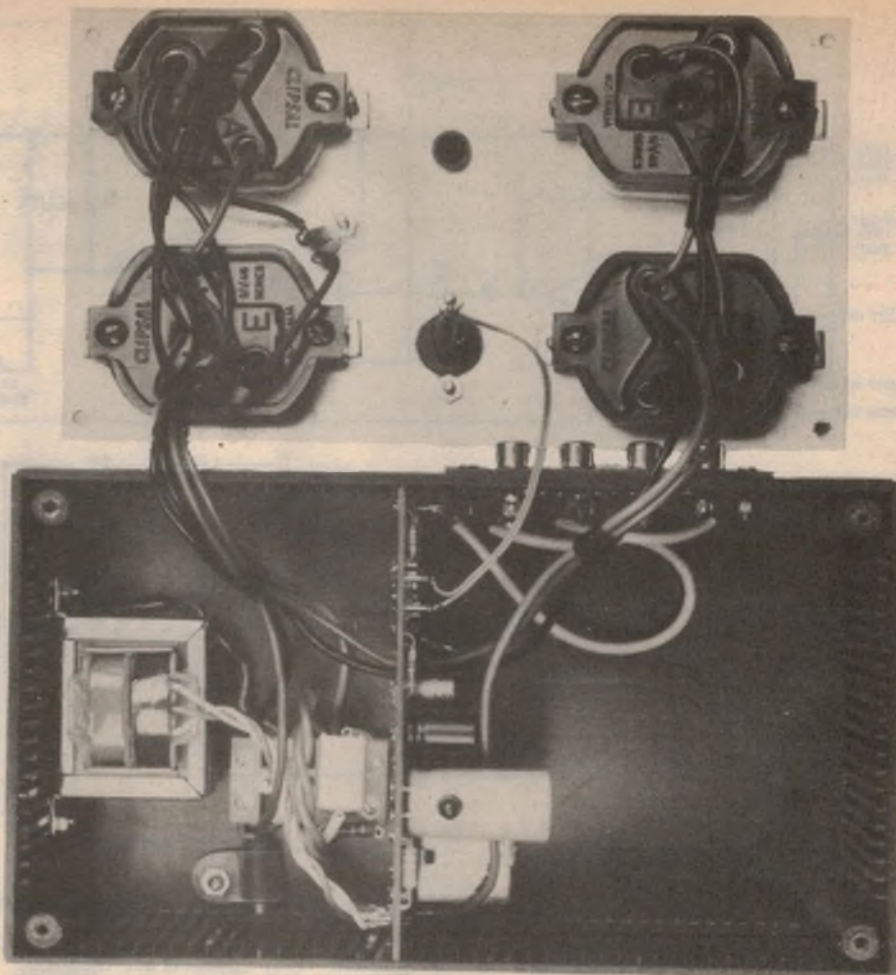

Below is the actual size artwork for the PCB while above right is the internal view of the Auto-Switch wiring.

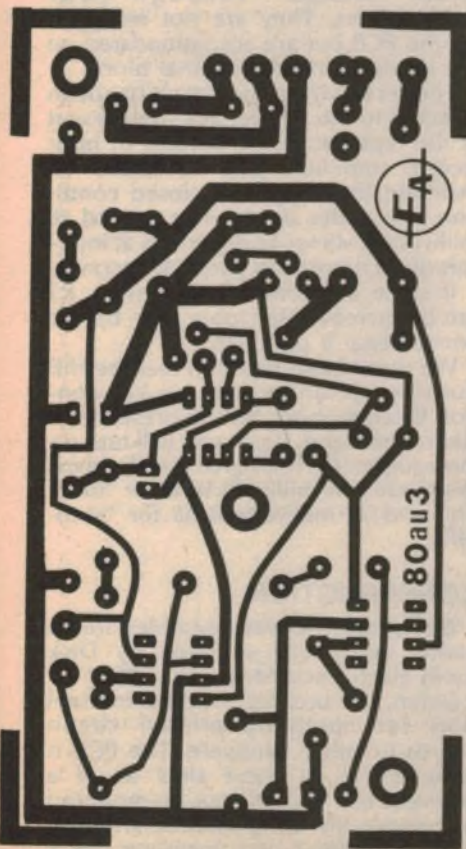

PARTS LIST

- 1 sheet of 1.5mm aluminium, 190 x 107mm
- 1 plastic utility box 83 x 54 x 28mm
- 1 plastic utility box 196 x 113 x 60mm
- 4 3-pin flush-mount mains sockets (Clipsal S/1/415 series)
- 1 transformer, 12.6V CT 150mA, Ferguson 2851, DSE2851 or similar.
- 1 PC mounting 12V relay, SPDT 5A 240V contacts, 265-12-C2 or similar
- 1 PCB 80au3 56 x 106mm
- 1 4-way RCA socket panel
- 1 2-pin DIN panel socket
- 1 2-pin DIN line plug
- 1 4-way mains terminal strip
- 1 miniature pushbutton switch
- 1 mains cord and three-pin plug
- 2 solder lugs
- 2 grommets, 2 small, 2 large
- 1 cord clamp
- 1 short length of shielded cable
- 1 length of two-core flex (low voltage)
- ½ metre of each: red, black and green 23 x 0.19mm 250V hook-up wire.

SEMICONDUCTORS

- 5 EM404, 1N4004 1A 400V PIV silicon diodes
- 1 0.5mm red LED and bezel

- 1 1N4148 small signal diode
- 1 BC548 NPN transistor
- 1 BC558 PNP transistor
- 2 741 operational amplifiers (8 pin)
- 1 555 DIL package timer (8 pin)

CAPACITORS

- 1 1000uF/25VW PC mount electrolytic capacitor
- 1 100uF/16VW PC mount electrolytic capacitor
- 1 10uF/16VW PC mount electrolytic capacitor
- 1 22uF/35VW tantalum capacitor
- 1 0.1uF metallised polyester (greencap) capacitor
- 1 0.01uF metallised polyester (greencap) capacitor
- 1 0.082uF/630VW or 250VAC polycarbonate capacitor

RESISTORS

- (¼W unless otherwise noted)
- 1 x 2.2M, 1 x 1M, 1 x 47k, 1 x 33k, 1 x 22k, 3 x 10k, 1 x 1k, 1 x 470 ohm, 1 x 100 ohm 1W.

MISCELLANEOUS

Screws, nuts, 10 PC stakes, solder.

NOTE: Components with higher ratings may be used provided they are physically compatible.

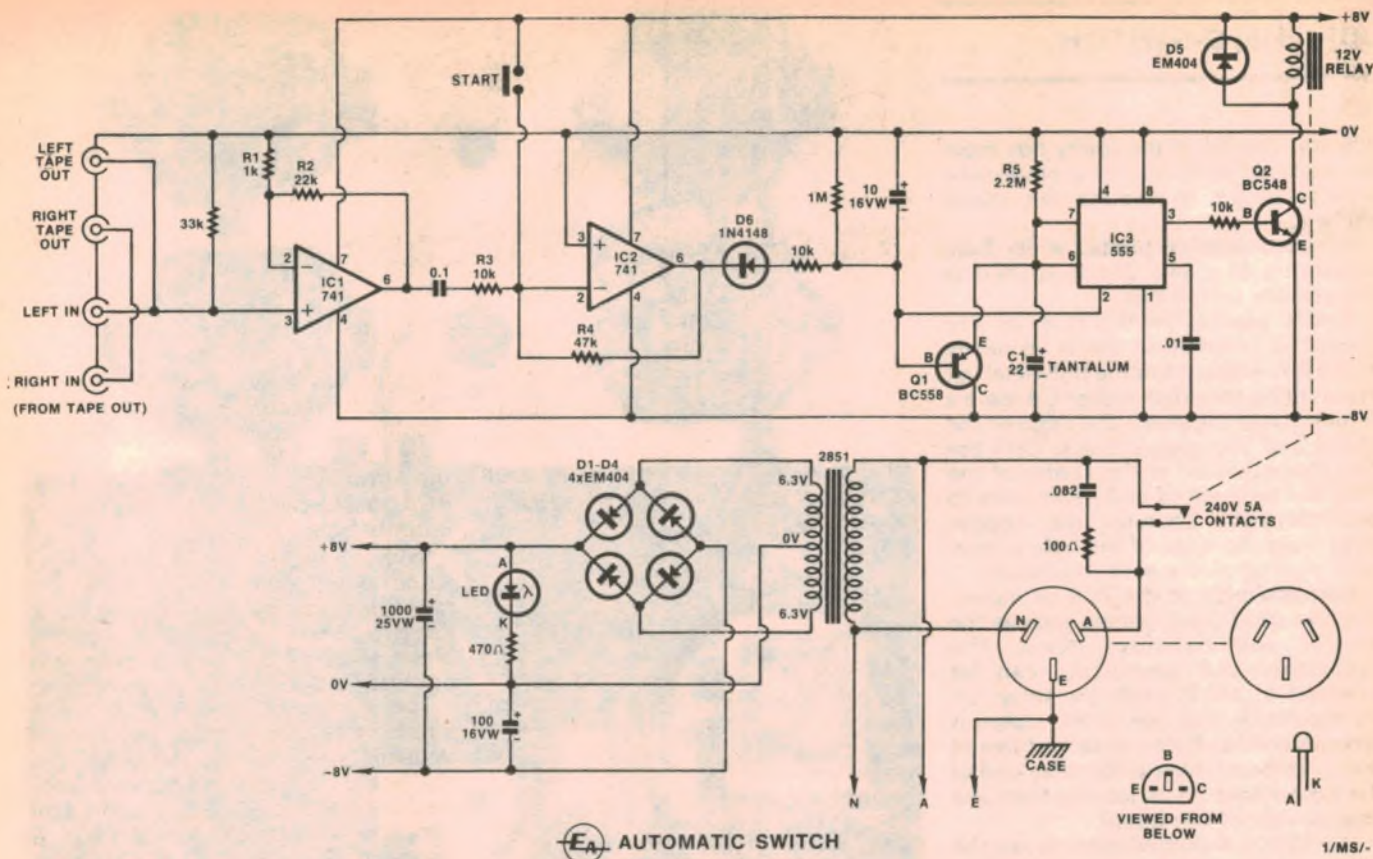

E_A AUTOMATIC SWITCH

1/MS/-

The Auto-Switch circuit monitors the amplifier tape outlets and switches off the power 30 seconds after the signal ceases.

This unusual filter arrangement is used because the relay, which accounts for most of the current drain, and the sensitive low-power signal circuitry both run from the full 16V supply. Only the 555 timer IC runs from the -8V supply.

The audio signal present at the amplifier tape outputs is amplified and detected by two 741 operational amplifier ICs which provide a total gain of over 100. IC1 is a non-inverting amplifier with an input impedance of 33k. This relatively low value of input impedance is provided to ensure stability. The output of IC1 is capacitively coupled to inverting amplifier IC2. The output of IC2 is rectified by diode D6.

Now consider IC3, the 555 timer IC and transistor Q1. As long as D6 is maintaining the voltage at the base of Q1 negative with respect to its emitter, Q1 will be conducting and C1 will be discharged. This will mean that the output of the 555 (pin 3) will be high with respect to the -8V supply rail and so Q2 will conduct and maintain the relay in an energised condition. This means that power is supplied to the external hifi equipment.

If the input signal to IC1 is removed, D6 will no longer be able to hold Q1 off and so, after a minimum delay of about 30 seconds, (depending on the charge on the 10uF capacitor) C1 will charge to the point where the 555 triggers and its output at pin 3 goes low. This turns off

Q2 and the relay contacts are opened, turning off the hifi equipment. Diode D5 protects Q2 from damage caused by inductive kickback when the relay is turned off.

We estimate that the current cost of parts for this project is approximately

\$29

including sales tax.

To turn on the hifi equipment, the remote switch is closed which pulls the inverting input of IC2 high. The output IC2 goes fully negative (almost to -8V) as a result which causes Q1 to discharge high once again. This causes Q2 to conduct and energise the relay so that power is applied to the hifi equipment.

60 SECOND INITIAL DELAY

Because the starting sequence charges the 10uF capacitor to almost -8V, (which turns Q1 fully on) there is an extra time delay involved before the relay can turn off, if no audio signal appears. So, whereas, the minimum time delay for switch-off after cessation of the audio signal is about 30 seconds, a full minute after initial switch-on will pass before the relay opens if no audio signal appears at the input.

The RC network across the relay contacts is there to prevent mains transients at switch-off from producing loud "bangs" through your loudspeakers. They are not mounted on the PCB but are accommodated on the insulated mains terminal block.

The sensitivity of the circuit has been selected to suit the signal levels present at the tape recording outputs of most stereo amplifiers and receivers. To maintain the relay in a closed condition, the audio signal must exceed 20 millivolts RMS for brief periods at intervals of no more than about 30 seconds.

If some adjustment is necessary, R2 can be increased for more gain, but do not increase it past 100k.

We should also mention that the Hifi Auto-Switch can be used as a Vox control. It can monitor for the presence of audio signal and, if present, will turn on the equipment. The signal threshold for this mode is 40 millivolts RMS for "turn-on" and 20 millivolts RMS for "turn-off".

CONSTRUCTION

Our prototype was assembled into a plastic utility box supplied by Dick Smith Electronics. Measuring 196 x 113 x 60mm, the box has multiple internal slots for mounting printed circuit boards or other hardware. The PCB is designed to fit these slots or, if a different box is used, can be mounted conventionally using spacers. The PCB is coded 80au3 and measures 56 x

Hifi Auto-Switch

Turns your system off automatically

Do you often inadvertently leave your hifi system running for days on end? Do you have a problem with a messy array of power plugs "piggy-backed" into a wall socket? Would you like your entire system to switch off automatically at the conclusion of a record or tape? If the answer to any of these questions is "Yes" then our Hifi Auto-Switch presents a neat solution to your problem.

by JOHN CLARKE

Anyone who owns a hifi system must have often had the experience of inadvertently leaving the system on for long periods of time, even for days on end. Perhaps the phone rings or someone knocks at the door; or one of your children falls out of a tree. Some event like that causes you to stop the tape or record, just for a the time being. Thus distracted, you forget to restart the system or turn it off. Or maybe the cassette or record has come to an end, leaving the gear still on.

Our Hifi Auto-Switch solves that problem neatly: it senses that the system is no longer handling a signal and, after a 30-second delay, turns all the equipment off. When power is first applied, there is a full one minute delay, for a record or tape to be started, before the unit will turn off.

Of course, if your equipment is well designed and reliable it should make no difference if it is left on indefinitely. But there are many people who do not like the thought of having their equipment left on inadvertently, and needlessly consuming power. In these days, when we are more conscious of energy waste, that is a good attitude to have.

Maybe you are not worried about energy wastage (shame) but are one of those people who find it irksome to have to switch on or turn off three, four or more pieces of equipment in your system. Our Hifi Auto-Switch solves that problem as well as neatly solving the untidy tangle of power cords from the various pieces of equipment.

Maybe you are one of those few remaining purists who persists in using a manual turntable. Isn't it annoying to be greeted by a constant "cher-wuffle-squeak . . . cher-wuffle-squeak . . ." at the end of the record? Our Hifi Auto-Switch can solve that problem too.

The unit has been tested on many records and works well on all except the old shellac 78's. The surface noise

from these was so high that it is impossible to distinguish the program from the surface noise! Records with a pronounced click at the end of the record did not affect the operation of the turn off mechanism.

The Hifi Auto-Switch is split into two parts. One, a box with four flush-mounting AC outlets is hidden away behind your system. The idea is to connect the power cords of your equip-

the signal present, in one channel, at the tape recording outputs of the amplifier or receiver. So that you still have full use of the recording facilities, the Auto-Switch has parallel connected RCA sockets which duplicate the tape outputs from the amplifier.

With the tape out facility in use, there is no degradation in signal-to-noise ratio compared to using the "tape-out" directly from the amplifier. The loading effect of the circuit upon the tape output was -0.25dB — a negligible effect.

The circuit of the Auto-Switch is simple and uses cheap and readily available components. Three low-cost ICs, one relay, two transistors and a few diodes comprise the major part of the circuitry. Refer now to the circuit diagram. The Auto-Switch is permanently connected to the mains. Its power consumption, about two watts, is negligible.

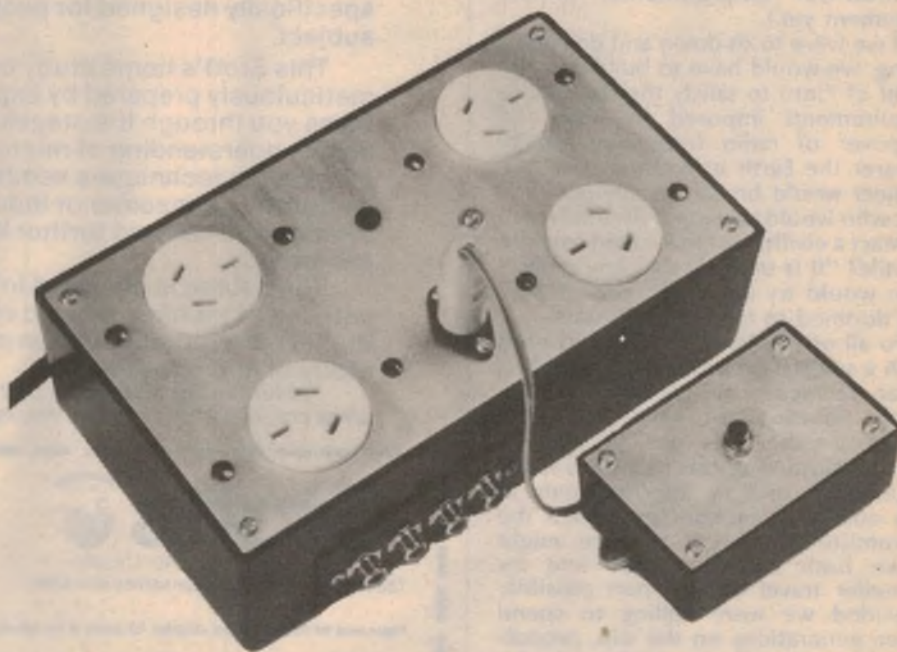

The larger box can be placed out of sight behind your hifi system.

ment to this box so that they can be all turned off automatically. You then turn the system on by pushing a button on a small remote control box which can take its place unobtrusively on a shelf next to your amplifier or receiver.

There is no need to modify any of your existing equipment to use the Hifi Auto-Switch. It works by monitoring

A small transformer with centre-tapped 12.6V secondary winding feeds a bridge rectifier to provide supply rails of $\pm 8\text{V}$ (nominal) with an unusual connection of the electrolytic filter capacitors. Note that the 1000 μF filter capacitor is connected across the full 16V supply while the 100 μF is connected between 0V and -8V.

expand to fill available space like a gas. Man is now achieving conquest of alien environments by intellect: air, water, underwater, space." Papagiannis's thesis is that a colonising civilisation would not land on planets but would build artificial colonies using alien planets only for obtaining material resources.

As to the cost effectiveness arguments, which are based on population pressure, he says he thinks we would do it not only for lebensraum (living space), but for reasons of glory or curiosity. If there are such colonising civilisations, they may even have colonised our solar system and be sitting behind a screen of rocks in the asteroid belt watching us, not yet decided what to do.

If Papagiannis's hypothetical nearby aliens are not communicating for whatever reasons of their own, the others may have good technological reasons. V. L. Troitsky of the Soviet Union points out that the technical requirements for such a telescope are formidable. He calculates that an antenna capable of broadcasting a beam signal to a distance of 10,000 light years would have to be 15,000km in radius and need a power of 2×10^{18} watts. The size is based on the temperature of the antenna not exceeding 300°K so as to preserve the integrity of the interplanetary and interstellar medium. (This represents the farthest-out environmental impact statement yet.)

If we were to sit down and do such a thing, we would have to build it at the orbit of Pluto to satisfy the size, waste requirements imposed by heat and slopover of radio frequency energy (nearer the Earth it might fry us). The project would be technically possible, but who would so extend themselves to contact a civilisation that might even be hostile? "It is unlikely that any civilisation would try any such construction. It's doomed to fail," Troitsky says.

To all of this Von Hoerner responds with a suggestion of his own regarding what he meant by intelligent life on Earth. Pointing out what the world spends on the arms race, he suggests that application of this money to space exploration and to improvements in the quality of technology, which the pessimists discount in advance, might make both communication and interstellar travel on our part possible. Provided we were willing to spend three generations on the trip, propulsion by nuclear fusion might make it.

And then we might discover we need not sophisticated radio searches but a loyal wookie, two handsome young men and a beautiful princess with a sharp tongue, not to mention a certain android with a curious resemblance to an old-fashioned jukebox. ☺

Copyright 1980, Science Syndication Services, International Features Division, UPI.

IF YOU WANT TO UNDERSTAND MORE ABOUT MICROPROCESSORS

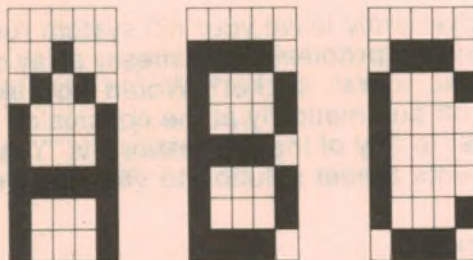

APPLY HERE...

One of the fastest growing sections of the electronics industry is microprocessing and its associated technology. A sound basic knowledge and a constant up-dating of that knowledge is necessary to stay informed of the developments within this exciting new technology.

Stott's Technical Correspondence College has produced an up-to-the-minute home study course specifically designed for people interested in this subject.

This Stott's home study course has been meticulously prepared by experts in this field and takes you through the stages necessary to reach a basic understanding of micro-computers and the processing techniques needed for their application, whether for consumer or industrial use. To this basic training you can add further knowledge and gain more experience.

The course is prepared in three stages. It begins with initial training in basic electronics, goes on to digital electronics and then proceeds to an in-depth study of microprocessors.

For further information on Stott's Microprocessors Course or other courses which interest you, mail the coupon below.

Stotts

TECHNICAL CORRESPONDENCE COLLEGE

The name to trust in correspondence education.

Melbourne, 159 Flinders Lane 3000. Tel: 63 6212
 Sydney, 383 George Street 2000. Tel: 29 2445
 Brisbane, 290 Adelaide Street 4000. Tel: 31 1627
 Adelaide, 85 Pirie Street 5000. Tel: 223 3700
 Perth, 140 St. Georges Terrace 6000. Tel: 322 5481
 Hobart, 1st Fl 29 Argyle Street 7000. Tel: 34 2399
 Singapore, P.O. Box 3396, Singapore 1.

Please send me free and without obligation full details of the following courses:

(PLEASE PRINT) _____

MR MRS MISS _____ AGE _____

ADDRESS _____

_____ POSTCODE _____

Stott's undertake that no sales counsellor will visit you

The Stott's range of courses in Electronics is:

Radio for Amateurs
 Introduction to Electronics
 Digital Electronics
 AM Radio Receivers
 Radio/TV Servicing
 Colour Television
 Amateur Radio Operators' Certificate
 A full range of Hobby and Business courses also available

ALA/ST/1483/EA380

Second thoughts on alien intelligence

. . . or are they really out there and are they communicating?

Many of the world's leading radio astronomers have devoted a great deal of time and effort in the search for extraterrestrial intelligence. Now some scientists are beginning to have second thoughts. Is communication with alien civilisations technically feasible? Would they be friendly or hostile? And would they want to communicate with us anyway?

The search for intelligent life elsewhere in the universe began as a topic of science fiction. It proceeded from there to tentative searches apologetically undertaken by a few radio astronomers in what amounted to their spare time and to some rather grandiose plans for the future put forward from certain locations inside NASA. Now the search is finally achieving a certain scientific respectability. That seems to be the meaning behind the choice of the topic for an all-day symposium at the meeting of the International Astronomical Union held recently in Montreal.

But SETI (Search for Extraterrestrial Intelligence) achieves the regard of the conservative and establishmentarian IAU at a certain cost. That cost is some

serious second thoughts on the part of some scientists who have been thinking about the enterprise as to whether it is possible at all. This articulates itself into three questions: Are any of them out there? Are they communicating? And finally, to quote symposium participant Sebastian Von Hoerner, "We always speak of intelligent life in space, and the question is how much of it do we have on Earth?"

SETI enthusiasts have usually assumed that once a civilisation achieved a certain level of technology, it would just naturally spread out and colonise space, either by setting up on such habitable planets as it might find or by building artificial habitats, or both. Eventually such waves of colonisation would spread across the galaxy from

their original centres. The galaxy would be full of stations we might hear with our radio telescopes.

That is, if the aliens were interested in colonisation and interested in communicating with us or with other civilisations unrelated to them. Colonisation is seen as a response to population pressure in analogy to similar movements on Earth: the Polynesians, the Turkic tribes of central Asia, the nations of western Europe. The suggestion is now strongly made that zero population growth rather than colonisation will be the answer for more if not all civilisations.

Michael Hart of Systems and Applied Sciences Corp., in Maryland defended the positive point of view by referring to the unwarranted assumption that extraterrestrials will not be interested in colonising and exploring. "Why should the human race be an exception?" A comment from the audience pointed out that this "exceptional" human race went only to the Moon. "People may wish the money had been spent on something else," says this interlocutor. "We have talked about a mission to Mars, but so far no clearance. People who are aggressive are also stingy."

These remarks set the tone for an extended discussion. Frank Drake of the National Astronomy and Ionosphere Center at Cornell University, one of the pioneers of SETI activities, remarked "We do not do everything that's possible. The Moon landings were not cost effective. Colonies may not be cost effective. How do you create the best quality of life for individuals?"

Figuring the cost of a good life from the energy consumption per head of the United States in 1974 (because it was the highest in the world), Drake concluded that it would take a good life for a million people to send one person to a star (and it would take 1500 years). "Biology and physics conspire to make colonisation impossible."

Michael Papagiannis of Boston University gave a somewhat more optimistic view. "Life has a tendency to



You're jamming the interplanetary football match!

Choose up to 4 of these software packages ... **FREE!**

- Electronic Engineering
- Civil Engineering
- Mathematics
- Lab Chemistry (1)
- Marketing/Sales
- Fluid Dynamics
- Statistical Testing
- Securities
- Oil/Gas/Energy

- Astrology
- 59 Fun (1)
- 3D Graphics
- Blackbody

- Printer Utility (2)
- Programming Aids (2)
- Production Planning

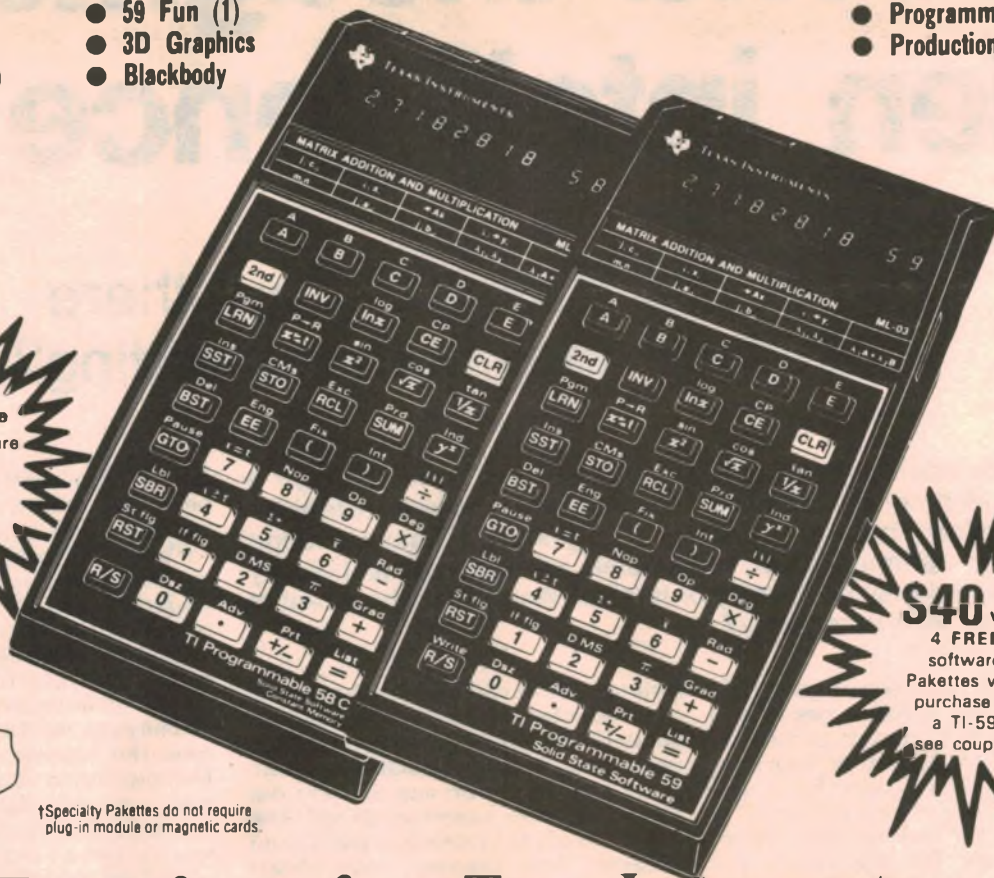

\$20 value
2 FREE software
Pakettes with
purchase of
a TI-58C
see coupon

\$40 value
4 FREE
software
Pakettes with
purchase of
a TI-59
see coupon



†Specialty Pakettes do not require
plug-in module or magnetic cards.

Free software from Texas Instruments can help make this year a little easier

A special offer if you act now! From February 28, 1980, to April 30, 1980... that's your special opportunity to purchase one of the world's most advanced programmable calculators... and get up to \$40* worth of free software Specialty Pakettes in your choice of 16 different application areas.

TI's Specialty Pakettes are a new way to expand the usefulness of your TI Programmable 58C or 59. The convenient notebook format includes complete step-by-step program listings, application notes, and sample programs. Just enter the program you need and you can put it to work right away.

Four FREE SPECIALTY PAKETTES with the purchase of a TI Programmable 59. A \$40* value. Two FREE SPECIALTY PAKETTES with the purchase of a TI Programmable 58C. A \$20* value.

Both the TI Programmable 58C and 59 feature TI's exclusive Solid State Software plug-in library modules. Each 5,000-step module contains a wide selection of pre-recorded programs. Optional library modules are available in a variety of fields, including engineering, science, statistics, and business.

The TI Programmable 59 has up to 960 program steps or up to 100 memories. Magnetic card read/write capability lets you record your own custom programs or programs from your Specialty Pakettes. \$349.95.*

The TI Programmable 58C features up to 480 program steps or up to 60 memories.

And it has TI's Constant Memory feature that retains data and program information even when the calculator is turned off. \$164.95.*

ACT NOW!

Visit your college bookstore or other TI retailer for more information, and let him help you select the programmable that's right for you.

Use this coupon to obtain your **FREE** Specialty Pakettes

- I've bought my TI-58C, send me these 2 free Pakettes
- I've bought my TI-59 send me these 4 free Pakettes

1.
2.

3.
4.

Send to: **Texas Instruments Australia Limited,**
PO Box 108,
North Ryde, NSW 2113

Name
Address
City State
Calculator Serial Number (from back of calculator)

Texas Instruments will fulfil the offer you have selected above when you return this completed coupon, including serial number, and a dated copy of proof of your purchase verifying purchase of a TI Programmable 58C or 59 (whichever is applicable) between February 28 and April 30, 1980. Items must be postmarked on or before May 1, 1980, to qualify for this special offer.

Please allow 30 days for delivery. Offer void where prohibited by law.

Texas Instruments technology — bringing affordable electronics to your fingertips.

*suggested retail price, incl sales tax
© 1980 Texas Instruments Incorporated

TEXAS INSTRUMENTS
AUSTRALIA LIMITED

(1) TI Programmable 59 required.
(2) TI Programmable 59 with PC-100C or PC-100A printer/plotter required.

FORUM: Current flow — continued

recognised as an inadequate concept, in need of clarification. But, in the meantime, the word has entered the language of technology, where it will probably remain for a long time to come, in the manner of other words like "valve", "tube", "condenser" and "earth".

More about that later.

But from that point M.D. launches into the philosophical:

"The encouragement of argument or debate provides the invitation to points of view, which, even though they are totally contradictable by definition are still allowed to play the game of rejecting fact, at most, or establishing confusion at the least."

The letter continues in a philosophical thru-religious vein and puts itself way outside the scope of these columns by so doing. But, in seemingly deploring debate and points of view, M.D. has himself provided a marvellous paragraph for group discussion!

Creed for a dictator?

Getting back to the subject of holes, we are indebted to Dr R.C. Cross for the accompanying discussion. Dr Cross is attached to the Wills Plasma Physics Department, at the School of Physics, University of Sydney.

In fact, Dr Cross' letter also discussed the movement of charge carriers inside batteries but we have omitted it, partly to conserve space and partly because (as mentioned earlier) it falls outside the subject originally discussed.

But the material on conductors, semiconductors, the Hall effect and holes is an extension of the December



"So I said: Fred fixes TVs. He'll know all about holes!" (Electronics World)

article and is clearly relevant. If you haven't already done so, I suggest you read Dr Cross' remarks at this point.

As it happened, while in the process of preparing this material, I came across an article in "New Scientist" for November 15, 1979 entitled "A Century of Bent Electrons". Written by Dr Sean McAlister and Dr Colin Hurd of the National Research Council of Canada, it commemorates the centenary of the important breakthrough by Dr Edwin Hall.

In talking about Hall effect, the Authors follow the same broad approach as does Dr Cross. We quote:

"In some metals and semiconductors the (Hall) voltage has a positive sign. Does this mean that the current is carried by positively charged particles? Effectively, yes, because the interactions of the moving electrons with the fixed ions in the metal make the electrons behave like positively charged particles, although microscopically they are negatively charged. In this case, the current is said to be carried by "holes"; a doped semiconductor with this

behaviour is known as P-type; otherwise it is N-type."

The Authors go on to suggest that the electrons behave, not so much as free particles, but more like "quasi-particles", which can be thought of as electrons modified by the effects of their interactions with all the other constituents of the conductor. They continue:

"The most profound variation is in the particle's effective mass, which can be positive or negative! The variation comes from the electron's interaction with the regular electric potential that the lattice of positive ions produces."

"We can consider the electron as a wave and think of its reflection by the lattice planes of ions — just as X-rays can be reflected in conventional crystallography. If an electron close to the Bragg reflection condition is accelerated it can be reflected and its velocity perpendicular to the planes will become opposite to that expected for a negatively charged particle."

"It is a matter of choice whether we regard this electron's effective mass as negative or its effective charge as positive, for both lead to a working interpretation of the Hall effect. However, we must not confuse this so-called positive hole with a genuinely positively charged particle like the positron."

Looking back to the article in the December issue, the two paragraphs beginning with the last line on page 21 simply establish the idea that conduction through semiconductors is not easy to visualise. It mentions a number of jargon terms, including holes, and concludes: "so while the concepts of electron flow remain as valid as ever, the urge to make an issue out of them has greatly diminished."

If we want to elaborate on this, we can do so with the aid of the accompanying material from Drs Cross, McAlister and Hurd and this could be summarised as follows:

- The term "hole conduction" should not be interpreted to mean that missing valence bonds, or nuclei, or whole atoms migrate through the lattice structure. They don't. What it signifies is electron movement of a special kind, dependent on the presence of "holes" or missing valence bonds. The end effect is as if there were positive charge carriers migrating from positive to negative.

- If you object to the term "hole conduction" as inappropriate or unprecise, it is no more appropriate to simply equate it with electron flow in the reverse direction, for the reasons stated. You have to get across the idea that the electrons are behaving as if they were characterised by a positive charge or a negative mass. Take your pick which!

My guess is that the term "hole conduction" will be around for a long time, albeit with a refined interpretation.

For precision soldering. Light weight. High power.

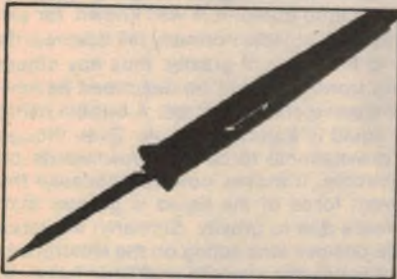

ADCOLA STANDARD

No frills.
Just high performance.
3mm S 30
5mm S 50

Fitted with non-seize tips

Fully automatic 'THERMATIC' also available.

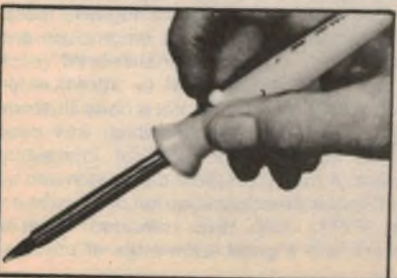

ADCOLA DUOTEMP

Temperature control at your fingertips.
3mm D 30
5mm D 50

FROM YOUR RADIO PARTS SUPPLIER OR:

(02) 709 5293
(03) 543 5122
(002) 34 2233
(07) 44 0131
(08) 42 6655
(09) 381 5500

SD2A

ADCOLA

identified only as "Stirrer", professes not to be convinced by radio "nuts" who are "in a kind of trance-like state of almost seeing electrons flying from . . . heater . . . to the positive plate . . ."

Is it not true, he argues, that in leaving the cathode, they make it more positive; and that in arriving at the plate, they make it more negative? Thus we have electrons flying from a cathode which is going positive to a plate which is going negative!

Surely the man has missed his calling! With the ability to so manipulate words, he could be writing scripts for: The Return of Perry Mason!

Voltage drops around the usual valve circuit do tend to make the cathode more positive than it would otherwise be, and the anode less positive. However, this does not alter the basic fact that electron flow depends on the anode potential being still positive with respect to cathode, voltage drops notwithstanding.

The diagram in the December issue remains entirely valid.

"Stirrer" also maintains that we told only half the story — that to do with the "external" circuit. Even if electrons do flow from negative to positive in a valve or other circuit, they must complete the journey through the battery: from positive to negative!

We were quite aware of this but we

omitted any reference to it for one simple reason: the arguments with which we were concerned all had to do with the external circuit — source potentials, current flow, related magnetic fields, Fleming's right-hand and left-hand rules, etc. We resisted the temptation to introduce what seemed to be a "red herring".

Things do happen inside voltage sources, of course, but they don't affect what we were really talking about.

Another NSW reader (M.D., Manly) is obviously unhappy about the compromise adopted by magazines like EA in referring, as necessary, to "conventional" current flow and "electron" flow.

He says:

"Your December article suggesting that the two different current flows is a situation to which we might best conform makes me suspicious that it may have been the world's magazines, trying to accommodate both issues, that has helped preserve them.

"We have had all this century to accept that electron current flow is a scientific fact, and that conventional current flow is a fiction."

Magazines would undoubtedly have had some influence in the matter. At least, magazine writers (and others) have taken some heat out of the situa-

tion and provided a basis on which the two disciplines can communicate with reasonable facility. And they have done it openly, as further evidenced by the December article.

We shall never know what the situation would have been had electronics magazines, textbooks, teachers and academics all adopted the hard-line approach. Poor Mr Fleming might not have been the only one unable to tell his right hand from his left!

M.D. is also upset about our mention of "holes" in the context of conduction:

"Yet further fiction has been allowed to support initial fiction. For example, the holes created by missing valence electrons in the crystal lattice of semiconductor material are said to move in the direction of conventional current flow, thus seeming to support the original story."

There may be a hint here that the holes concept was promoted because of its fortuitous and seeming support of "conventional" current flow. If that is implied, I don't buy it.

The holes concept was the product of a struggle to verbalise a conduction mechanism that was, at the time, very obscure to a great many people — including students, lecturers, technicians and engineers. It is now widely

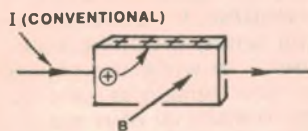

FIG. 2

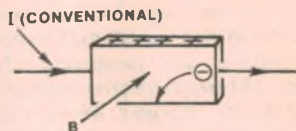

FIG. 3

current in the same direction as an electron moving to the left. But this leads us to an obvious question — if a hole moving to the right is equivalent to an electron moving to the left, why do we bother introducing the hole as a new type of charge carrier?

The answer is simply this: a hole moving to the left is NOT the simple equivalent to an electron moving to the right! The directions of (conventional) current are the same but, as we have already shown in Fig. 1 and 2, the sign of the Hall voltage is different. Consequently a hole must be regarded as a completely different type of charge carrier to an electron. Our analogy with seats in a picture theatre has its limitations and it is time to look a little more deeply into the nature of a hole.

Unfortunately, most textbooks stop at this point or they become so mathematical that it is beyond the comprehension not only of the layman but also of more advanced students. The reason for this is that electrons in an N-type semiconductor behave almost as they would as free particles: they move more slowly due to collisions in the semiconductor, but otherwise they are quite normal.

In a P-type semiconductor, however, the behaviour of electrons is quite remarkable. The electrons responsible for conduction of current in P-type material interact more strongly with the positive ions than they do in N-type material, due to differences in the type of impurities added to the material. The result is that electrons in P-type material behave as if they had negative mass! As a consequence, these electrons accelerate the "wrong" way when they are subject to electric or magnetic forces.

The behaviour of "negative mass" electrons is shown in Fig. 3. Looking again at Fig. 1, we see that positive mass electrons are deflected upwards when they travel from right to left. Negative mass electrons are therefore deflected downwards by the magnetic force, even though the force is acting upwards. Consequently, the upper side of a P-type semiconductor is positively charged.

Since we get the same result, in Fig. 2, when we talk in terms of holes, it is tempting to say that a hole is really just an electron with negative mass. Unfortunately, life is not so simple, since a hole moving from right to

left does **not** produce a current in the same direction as a negative mass electron moving from right to left. The correct conclusion to be drawn from Figs. 2 and 3 is that a hole (with positive mass!) moving from left to right is equivalent to an electron with negative mass moving from right to left.

Because of the difficulties we can get into by talking in terms of negative mass, most people prefer to think in terms of holes with positive mass. Indeed, Fig. 3 has never appeared in a textbook as far as the author is aware.

The concept of negative mass is really not so difficult to grasp. It is well known, for example, that objects normally fall downwards due to the force of gravity; thus any object falling upwards could be described as having negative effective mass. A bubble rising in a liquid is a good example. Even though the gravitational force acts downwards on the bubble, it moves upwards because the buoyant force of the liquid is greater than the force due to gravity. Similarly, the force of the positive ions acting on the electrons in Fig. 3 is greater than the magnetic force, so the electrons appear to have negative mass.

The above discussion is incomplete and leaves many questions unanswered (such as, do like charges repel or attract when their mass is negative?), but it does illustrate that the simple question "which way does current flow?" hides a lot of interesting physics. A more complete discussion can be found in the American Journal of Physics article, P771, July 1978, directed towards readers with a good knowledge of physics.



FORUM

Conducted by Neville Williams

FURTHER THOUGHTS ON CURRENT FLOW

In the December 1979 issue we presented an article "Current — which way does it flow?". Nor surprisingly, it provoked a certain amount of comment, but it was the range of comment which surprised us — all the way from philosophy and metaphysics to the heavy stuff!

On the actual contents of the article, there was little debate. It had set out to explain how electrical conventions had become rooted and established before physicists were even aware of electrons and the consequent association between electron movement and current flow.

But, despite the logic of this association and subsequent campaigning by

valve-orientated "wireless" engineers, the original (and suspect) convention had survived. Textbooks and magazines like ourselves had since had no choice but to compromise and to draw distinctions, where necessary, between "conventional" current flow from positive to negative, and "electron" flow in the reverse direction.

The article made the further point

that the apparent contradiction had become somewhat less urgent and emotive in the present solid-state era, if only because the physics of conduction through semiconductor materials is more complex and less easy to visualise.

As if to set the seal on the situation, the symbols adopted for modern semiconductors by the electronics industry had inherited the positive-to-negative arrowhead from long-forgotten, pre-thermionic rectifiers.

That's what had happened; that's where we now stood; and that's where we sought to break off the discussion in the December article.

Commenting on all this, a reader from Katoomba, NSW, who wants to be

Dr Cross: Holes don't really move

It is common knowledge that current in a copper wire is due to the motion of negatively charged electrons, but not everyone would know how to prove that statement experimentally.

In fact, it can be demonstrated by placing a rectangular copper sheet in a strong magnetic field, with the field perpendicular to the direction of current in the copper. The magnetic field exerts a force on the electrons in the copper in a direction perpendicular both to the magnetic field and the right-to-left direction of motion of the electrons. The same type of magnetic force is used to deflect the beam of electrons in a TV picture tube.

The action of a magnetic force on the electrons in a sheet of copper is shown in Fig. 1, electrons being deflected towards the upper side of the sheet. The upper side of the sheet becomes negatively charged, and the charge builds up until the electrostatic force of repulsion acting downwards on electrons exactly balances the magnetic force acting upwards. All subsequent electrons move from right to left through the sheet without being deflected.

In this condition, a measurable voltage exists between the upper and lower sides of the copper sheet. The voltage is measured in microvolts, but the sign of the voltage indicates that the charge carriers are negative, and are therefore electrons. The effect

described above is known as the "Hall" effect and the voltage generated between the upper and lower sides of the copper sheet is known as a "Hall" voltage — as identified by Professor Edwin Hall in 1879.

To dispel any possible doubt about the sign of charge carriers in copper, consider Fig. 2. The directions of (conventional) current flow (I) and magnetic field (B) are the same as in Fig. 1 but the carriers are assumed to be of opposite sign and moving from left to right. As such, they would be diverted upwards, to impart a positive charge to the upper surface of the sheet. But this is at variance with observed fact, indicating that Fig. 1 is valid; Fig. 2 is not.

We can repeat the Hall effect experiment with materials other than copper to test for the sign of the charge carriers. Most, but not all, metals have a negative Hall voltage, indicating that the charge carriers are negative.

N-type semiconductors also have a negative Hall voltage, indicating that most of the charge carriers are negative. In fact, charge carriers of both signs are always present in semiconducting materials, but the controlled addition of impurities ensures that there are more negative carriers in an N-type semiconductor.

P-type semiconductors have a positive Hall voltage, indicating that most of the charge carriers are positive. The situation is,

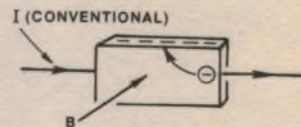

FIG. 1

in fact, as illustrated in Fig. 2. But the point must be made that positive charge carriers are not a new type of particle, as distinct from protons, neutrons and electrons. Protons and neutrons together make up the nucleus of all atoms and the nucleus is much too heavy to move freely as a charge carrier.

The truth is that the so-called "holes" in a P-type semiconductor represent the collective behaviour of all the electrons in the semiconductor.

As Neville Williams pointed out, the behaviour of a hole can be described most simply by the analogy of a nearly full row of seats in a theatre; by moving the patrons (electrons) in one direction, the empty seats (holes) effectively move in the opposite direction. Another analogy is the motion of a bubble rising upwards in a liquid — the motion of the bubble (hole) is really due to the liquid (electrons) falling into the hole.

Both of these analogies are useful in helping us visualise the motion of a hole and they preserve the idea that a hole moving one way is, in one respect, equivalent to an electron moving the other way. At least, it is true that a hole moving to the right produces a

Professional Sound Systems Start With The Stanton 881S

Stanton Magnetics presents the new 881S Professional Calibration Standard Cartridge. It's the cartridge preferred by recording engineers worldwide and it assures a new standard for home audiophiles desiring the very best in recorded sound. Its patented, low mass Stereohedron™ stylus

tip makes possible the flawless reproduction of high velocity modulations present on today's finest recordings.

The Stanton 881S... where great sound begins.



STANTON

THE CHOICE OF THE PROFESSIONALS™

Sole Australian Distributors:
LEROYA INDUSTRIES PTY LTD

Head Office: 156 Railway Pde, Leederville, Western Australia, 6007. Phone 81 2930

NSW Office: 100 Walker St, North Sydney 2060. Phone 922 4037

Available at quality conscious Hi-Fi dealers throughout Australia!



millimetres thick, which functions as the chassis and heatsink for the three power amplifiers within the enclosure.

At the top of the rear panel is a mains 2-pin output socket of European design, and a mains on-off push-button switch. We were not enthused about the European mains plugs which were supplied on our samples and which we assume are supplied on all stock. Our lack of enthusiasm has nothing to do with safety — the AH 587 uses a double-insulated mains circuit and the two-pin European plugs are probably safer than our local design, especially when the former are used with their shrouded and shuttered sockets. No, our reasons for doubt are simply that the plugs and sockets are not compatible with the Australian sockets. We noted, too, that the mains output socket on the AH 587 is not shuttered.

Lower down the rear panel is a sensitivity control knob, a set of RCA phono sockets for left and right signals and a slide switch to select left or right channel operation. The AH 587 can be driven to full power, a total of 75 watts RMS, by any preamplifier, amplifier or control unit delivering 1V RMS or more, up to 25V RMS. In the latter condition, it may be driven from the output of a conventional stereo amplifier.

The three amplifiers are powered by a large double-bobbin C-core transformer with open windings. The amplifier circuitry is relatively conventional using fully complementary output

stages (Darlington) which are direct-coupled to their respective drivers. Each amplifier is protected against overdrive and overheating.

Power output of the three amplifiers is 50 watts RMS for the woofer, 20 watts RMS for the midrange and a mere 5 watts RMS for the tweeter. Because of the nature of the overload protection system, the actual peak power before clipping could be considerably higher than these figures indicate.

Our listening tests produced some interesting results. Perhaps I should admit that we half-expected to be impressed, having in mind the obvious amount of design effort and technology packed into the two relatively compact boxes.

Certainly the AH 587 was able to deliver a large volume of sound which indicates that, not only does it have generous amplifier power, but also that the drivers are reasonably efficient. But at first hearing, the Philips was quite unimpressive, particularly as far as the treble and midrange was concerned. But let me hasten to add that this is a guide to just how good the Philips AH 587 system really is. Just as a loudspeaker system with extended and level bass response should not sound loud and boomy, then so too a loudspeaker with smooth midrange and treble should not sound obtrusive. And this is definitely the case with the Philips. On some musical passages it is difficult to believe that the tweeter is

working at all. This is because tape hiss and disc surface crackles and pops are not emphasised to anything like the same extent as with other typical good quality systems.

The same can be said of the bass quality. The bass response is clean, well defined and very smooth and extends to at least 30Hz. But for most of the time it just simply does not obtrude. With the correction filters switched in to compensate for room position, the same thing occurs—the system becomes less obtrusive and easier on the ear.

Judged on this basis, the Philips AH 587 system must be one of the best available. This is possibly the highest praise we can give. Buy a pair of the AH 587's and, for most of the time, you will be quite unaware of the fact that you are listening to a system with three separate drivers!

So when you add up the cost of equivalent high quality loudspeakers, and equivalent stereo power amplifier the cost of a pair of Philips AH 587 loudspeaker systems is really quite reasonable, even though it is still a large sum. But for anyone aspiring to the highest quality listening, the Philips AH 587 must be a most attractive package at the recommended retail price of \$1300 per pair.

Further information is available from high fidelity retailers or from Philips Consumer Products, 443 Concord Road, Rhodes, NSW 2138 or interstate branches. (L.D.S.)

STUDIO DISCO MIXER

\$199.00

- Low Noise
- 4 Stereo Program Inputs
- 2 Microphone Inputs
- 5 Channel Stereo Equaliser
- Full Cueing Facility

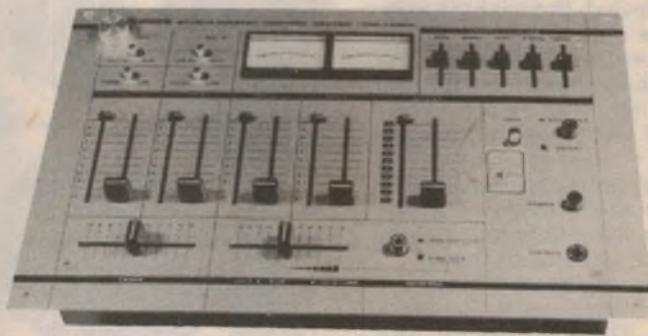

SPECIFICATIONS

Input Sensitivity	MIC	0.5mV	Hum And Noise	MIC	52dB
	PHONO	3mV		PHONO	62dB
	LINE	150mV		LINE	65dB
Input Impedance	MIC	10K ohms	Frequency Response	MIC	30 to 16000Hz (-1dB)
	PHONO	50K ohms		PHONO	30 to 20000Hz (RIAA±2dB)
	LINE	50K ohms		LINE	20 to 30000Hz (-1dB)
Maximum Input Level	MIC	45mV	Equaliser Section		
	PHONO	140mV	Control Frequencies		60Hz 250Hz 1kHz 3.5kHz 12kHz
	LINE	35V	Control Range		±12dB Boost or Cut
Rated Output	AMP	1V	Control Type		Slide Centre Detent for "Flat" setting
	REC	1V	Headphone Output (CUE)		50mW at 75 ohms at 0.5% THD
Output Impedance		100 ohms	Talk Switch		-14dB at Phono or Line at TALK Position
Harmonic Distortion		At Rated Output 0.2%	Power Consumption		AC 220V 50/60Hz 8 Watts
		At 6V Output 0.3%	Dimensions		15.3" (W) x 3.7" (H) x 10.2" (D)
			Shipping Weight		9.3lb

Distributed by

Freeman Electronics PTY. LTD.
89-91A LIVERPOOL ROAD, SUMMER HILL, NSW 2130

* Trade Enquiries Welcome

MANUFACTURERS ● IMPORTERS ● WHOLESALERS
SALES AND SERVICE TO ALL SOUND EQUIPMENT
TELEPHONE (02) 797 9941, 797 0988

Philips AH587 motional feedback loudspeaker system

Considering the theoretical advantages of the motional feedback principle, it is surprising that more loudspeaker manufacturers have not embraced the idea. Philips have produced very successful loudspeaker systems using the motional feedback principle and here we review their latest release, the model AH587. It is a three-way system with three inbuilt power amplifiers and motional feedback applied to the woofer.

When you think about all the advantages of a powered loudspeaker with motional feedback, there really are quite a few. There is no need to have a large separate stereo power amplifier — the AH587 has power to burn and it can be positioned well away from the control unit. Using conventional loudspeakers this requires heavy and expensive cables to avoid power losses and degradation of damping factor. By contrast, each of the drivers in the AH 587 has the optimum order of damping — it is designed into each amplifier.

When the power is off and mains cords are concealed, there is little to indicate that the Philips AH 587 has inbuilt amplifiers and employs the motional feedback principle. However anybody lifting the system soon receives a clue that these loudspeakers are different — they are surprisingly heavy. And with power applied, there is another clue in the form of two LED indicators which shine discreetly behind the removeable grille cloth frame.

Finish on the enclosure is black ash veneer which blends with the black grille cloth. Dimensions of the enclosure are 300 x 487 x 237mm (W x H x D).

The heart of the Philips AH 587 system is the motional feedback woofer. It looks little different from any other woofer from the front but it has a piezo-electric accelerometer transducer mounted on the back of the cone apex to generate the "motional feedback" voltages. These voltages are compared with the input voltage driving the woofer amplifier and correction is applied for any distortion which would otherwise be caused by the woofer.

With this system, it is possible to use a much smaller enclosure than would otherwise be required to achieve high radiated power and extended bass

response. In fact, with an internal enclosure volume of only 19 litres, Philips claims that the low frequency response extends down to 27Hz.

More unusual in appearance than



the woofer is the tweeter and midrange combination in the AH 587 which has a common baffle plate. Both tweeter and midrange drivers employ soft domes although at first glance, the dome surrounds give the appearance of conventional cones, albeit with rather dressy chrome rings. These rings are visible behind the grille cloth, as our photograph shows. All three drivers employ large ceramic magnets.

While the sides and part of the back of the enclosure are made of compressed particleboard, the baffle is unconventional in that it is a single large

injection moulding which has a pattern of large reinforcing ribs at its rear. Besides the drivers and LED indicators, the baffle accommodates three correction filter switches and frequency response curves.

These correction filters are just one of the advantages of a powered loudspeaker system such as the Philips AH 587. The correction filters compensate for deviations in the low frequency response caused by sitting the enclosure close to walls (side or rear) or by standing the enclosure on the floor, as opposed to mouting on a stand

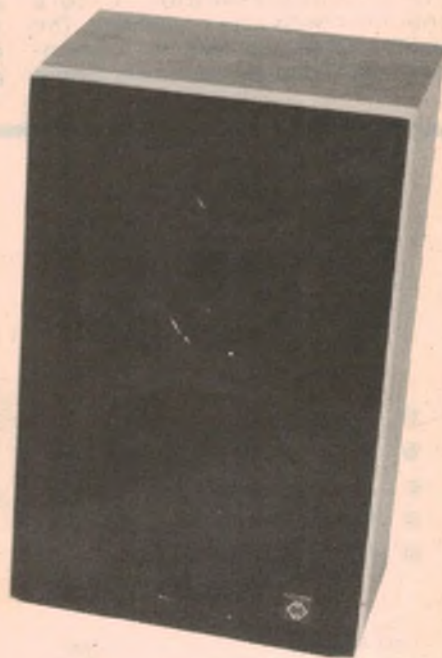

above floor level. These filters would be relatively difficult to provide in a conventional passive loudspeaker system, as well as being very wasteful of amplifier power. However, in a powered system such as this, the filters are provided at relatively low cost by the addition of a few components and inserted in series with the signal to the power amplifiers.

While the front of the AH 587 enclosure may look relatively conventional, at least at first glance, the rear panel is decidedly different. It is made of aluminium, approximately three

LOOK AT THESE TWO EXCITING NEW AUDIO KITS!

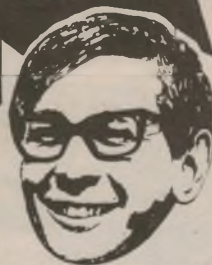

300

200Wrms
into 8 ohms

WATTS rms INTO 4 OHMS

This fantastic new amplifier kit gives you tremendous scope for boosting the output of your existing sound system - use one module to produce 300 WATTS rms into 4 ohms or two units to give you a truly massive 600 WATTS rms continuous power.

Price for unit is only \$69 - that's an incredibly low 23 cents/WATT.

KIT INCLUDES:

★ Fibreglass PCB ★ Special pre-punched heatsink brackets ★ All components ★ Instructions for module assembly ★ and details of complete amplifier layout and assembly

Simple and straight forward to build, these kits are ideally suited for mounting in the standard rack mounting case either singly or in pairs.

You will require an M-0150 transformer (\$39.95) and one or two H-3426 heatsinks depending on light or heavy use. For really heavy duty we recommend the D-2865 YAESU fan to aid cooling.

(Now reduced from \$39.00 to \$29.50)

SEE ET: FEBRUARY 1980



**YES! 300W RMS
FOR AN
INCREDIBLY
LOW 23 CENTS
/WATT**

\$69⁰⁰

P&P \$4.00

NOW A GRAPHIC ANALYSER FOR LESS THAN \$100*

SEE EA FEBRUARY 1980



Shown with optional timber dress sleeve Cat. H-3113 \$8.50

Ever since graphic equalizers have been widely available audiophiles have been saying "Great! - but how do I use it?" The Playmaster Analyser now takes the guesswork out of frequency response checks. A few simple connections and you can see the frequency response of your equipment and room. The Analyser lets you see in a glance the acoustic effects of changing speaker location, shifting furniture - so you can tune your system to your room.

***BUILD IT
YOURSELF FOR**

ONLY \$99⁵⁰

Cat. K-3510

P&P \$4.00

THE NEW Playmaster Analyser/Peak Level Meter

Now you can get a graphic display of your sound system's total frequency response and keep an eye on levels - at the preamp output and at the speaker terminals. Lets you see how your gear's performing.

- GRAPHIC DISPLAY OF FREQUENCY RESPONSE OVER 10 OCTAVE-SPACED BANDS.
- 3,6 and 9dB APERTURES FOR MAXIMUM FLEXIBILITY AND ACCURACY.
- IN-BUILT PSEUDO-RANDOM DIGITAL NOISE SOURCE.
- MICROPHONE AND LINE LEVEL INPUTS
- PEAK READING DISPLAY OF PREAMP OUTPUT LEVELS.
- PEAK READING DISPLAY OF POWER AMP OUTPUT - UP TO 400W!
- DELUXE PRE-PUNCHED STEEL CHASSIS BEAUTIFUL SCREEN-PRINTED ANODIZED ALUMINIUM FRONT PANEL - MATCHES THE REST OF THE PLAYMASTER RANGE.

Whilst we expect these products to be in stock at time of publication, to avoid disappointment, please phone your nearest store to check availability

DICK SMITH ELECTRONICS



SEE OUR OTHER ADVERTS IN THIS MAGAZINE FOR OUR STORE ADDRESSES AND RESELLERS



Aware that deluxe portable cassette radios had been getting progressively more complex, larger and heavier, Toshiba decided to reverse the trend with their RT-8000S. It measures 340mm(w) x 160mm(h) by 69mm(d) and, as such, can be carried more conveniently. Short-wave coverage has been eliminated but it retains full broadcast AM and FM-stereo coverage, with twin loudspeakers, the "stereo wide" enhancement system, 4 watts per channel power output and provision to operate from internal batteries, external 12V DC or an AC adaptor. For recording details: Toshiba (Australia) Pty Ltd, 16 Mars Rd, Lane Cove 2066.

equivalent to \$A3.2 million. But while business remained brisk for a couple more years, profitability reversed to produce a cumulative operating loss of well over \$20 million. Sale price to the Brazilian Company is reported to be \$A2 million.

SURROUND SOUND: IBA engineers are continuing their investigations into surround sound using the IBA's 3-channel matrix transmission system. The first test transmissions in the London area took place in mid-November and mid-December using, respectively, concert hall and studio orchestral music. The public did not have the opportunity to evaluate the broadcasts as surround sound, since suitable equipment is not available. However, they were invited to listen to the broadcasts on normal mono and stereo equipment. According to IBA engineers, laboratory tests have indicated that their new 3-channel system is more compatible with existing mono and stereo receivers than either the original 2/4 matrix formats or IBA's own 2 1/2-channel system. Object of the tests was to observe 3-channel surround in a typical broadcast situation. Reportedly, other British "surround" groups have yet to be convinced by IBA's claims.

SHURE are delighted to note that station WFMT-Chicago is using Shure /SME 3009 Series III tonearms, fitted with Shure V15 type IV cartridges. The point is that WFMT is not any old station, but a highly quality-conscious FM/stereo broadcaster, the holder of several industry awards, and the source point for many quality, syndicated programs. By way of further en-

dorsements the V15 type IV cartridge has joined its predecessors in receiving the highest acclaim in the renowned Japan Stereo Component Grand Prix competition. Add a "Superb" rating — the highest available — by "Radio-Electronics" newly established test lab, and Shure's proverbial cup for 1979 was just about full. Shure products are distributed in Australia by Audio Engineers Pty Ltd, 342-4 Kent Street, Sydney 2000.

PIONEER ELECTRONICS AUST PTY LTD claim to have led the movement to hifi systems, as distinct from a grouping of multi branded components. They say that systems now absorb well over 20% of the hifi dollar in Australia. Pioneer's move into systems dates most obviously back to 1974, with their release of the "Prelude" series, to which they have since added "Rondo", "Avante" and, most recently "Formula". Included in the current range are systems which offer convenient cost options:

Formula 4000, a 4-piece receiver system for \$499.

Formula 6000, a 6-piece tuner/amp system for \$699.

Avante 33, a 6-piece tuner/amp system for \$759.

Avante 55, a 6-piece tuner/amp system for \$999.

Avante 77, a 6-piece tuner/amp system for \$1199.

Except for the Formula 4000, the price includes a matching cabinet, fitted with glass doors in the case of the Avante series. Further information from Pioneer distributors or direct from Pioneer Electronics Aust Pty Ltd, 178-184 Boundary Rd, Braeside, Vic 3195. Tel (03) 99 9011.

Rapar

PUBLIC ADDRESS AMPLIFIERS YOU CAN DEPEND ON



TPA 50

Specs.

RMS power, 25 watts. Frequency response: 50Hz to 15kHz (+3dB at 8 ohms). Multiple outputs: 4, 8 and 16 ohms. 70 and 100 volt lines. Inputs: Mic. 1, 47k ohms. Mic. 2, 600 ohms. Aux. 300mV, Phono 2.5mV. Size: 310mm (width), 230mm (depth), 80mm (height). Weight 3.8 kilos. Finish: Durable two-tone baked enamel.

***\$146.97**



MODEL TPA 70

Specs.

RMS power, 50 watts. Frequency response: 50Hz to 15kHz (+3dB at 8 ohms). Multiple outputs: 4, 8, 16 ohms, 70 and 100 volt lines. Inputs: Mic. 1, 47k ohms. Mic. 2, 600 ohms. Aux. 300mV, Phono 2.5mV. Size: 310mm (width), 230mm (depth), 80mm (height). Weight: 4.3 kilos. Finish: Durable two-tone baked enamel.

\$183.60

**TRADE AND DISTRIBUTOR
ENQUIRIES WELCOME**

MANUFACTURED BY:



RADIO PARTS GROUP

562 SPENCER STREET,
WEST MELBOURNE, VIC. 3003.
TEL. (03) 329-7888.

1103 DANDENONG ROAD,
EAST MALVERN, VIC. 3145.
TEL. (03) 211-8122.

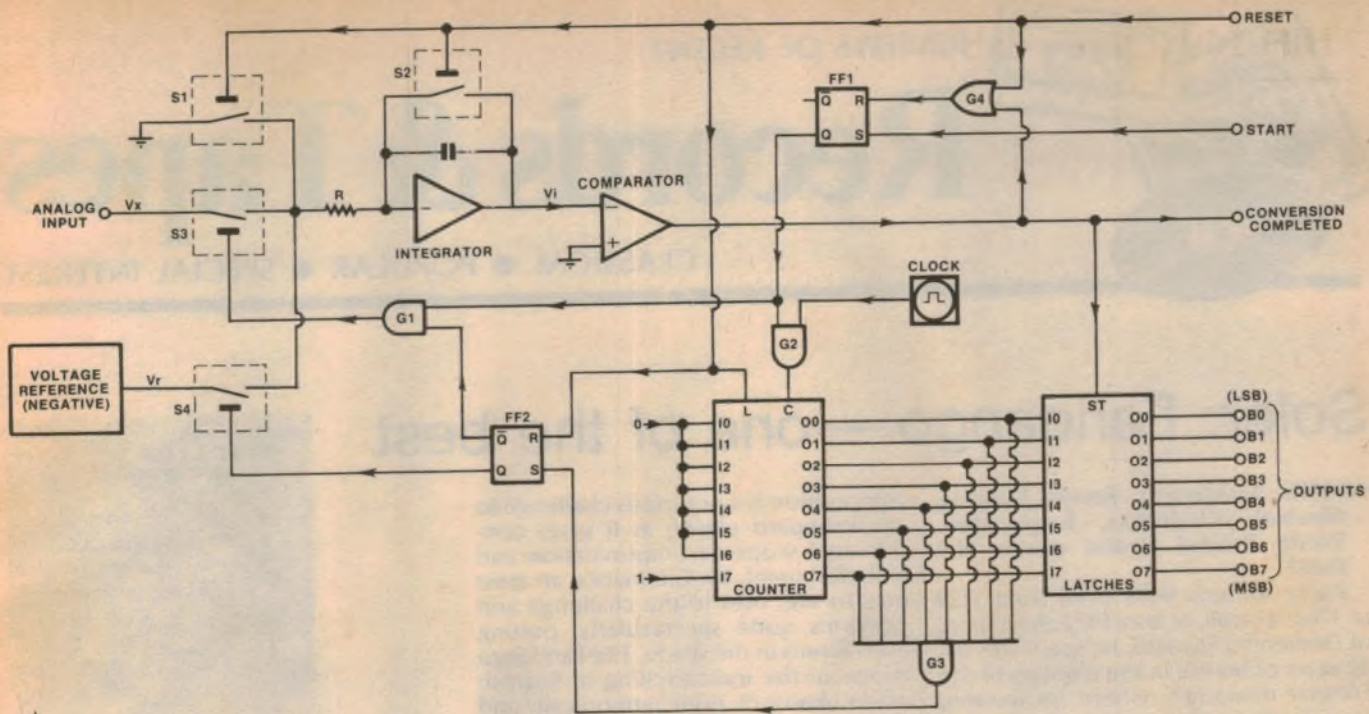
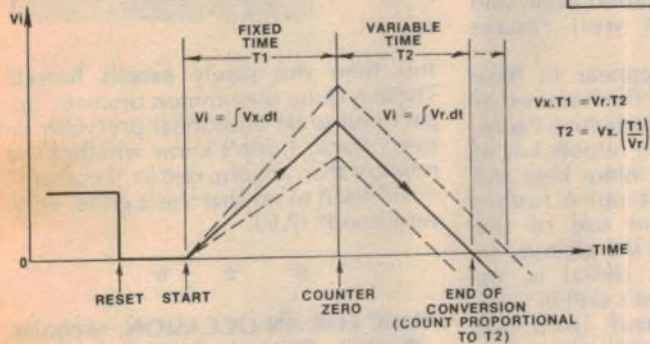

FIG. 10 : BASIC DUAL-SLOPE INTEGRATION ADC



As the reference voltage is arranged to be opposite in polarity to the analog input, the integrator immediately reverses its direction of integration and begins moving back towards zero. This time it does so at a rate proportional to the voltage reference, V_r . In the meantime the counter continues counting upwards from the zero count.

This second main phase continues until the output voltage of the integrator (V_i) reaches zero. The output of the comparator then switches to logic 1, enabling the strobe (ST) input of the latch register and causing the current count to be stored in the latches. At the same time FF1 is reset via OR gate G4, which disables G2 and stops clock pulses from reaching the counter. So operation ceases, with the latches containing a number representing the time it took for the integrator to return to zero.

You should be able to see from all this that there are two main phases of operation. In the first phase, the analog input voltage V_x is integrated, for a fixed period of time — the time (T_1) required by the counter to reach zero from its present count. Then in the second phase, the reference voltage is integrated in the reverse direction, until the integrator output has returned to

zero. This phase takes a variable time (T_2), as it depends on how far V_i had risen during the first phase.

In fact it turns out that time T_2 , and hence the count transferred into the latches, is directly proportional to the input analog voltage V_x . This is simply because we integrate V_x for a fixed time and then "de-integrate" it at a fixed rate. So T_2 is simply given by V_x times a constant equal to T_1 over V_r .

There are various ways of elaborating on this basic dual-slope integrating ADC. Some converters use an

additional up-down integration, to automatically cancel out zero drift in the comparator and other sources of potential error. These may be called "four-slope integrating" ADCs, but they still operate in the same basic way.

One of the most common uses for dual-slope integrating ADCs is in digital voltmeters and multimeters. Here the counter may be a multi-decade BCD type instead of a straight binary counter, with the latches feeding suitable decoder/drivers for a row of LED or liquid-crystal displays.

BAD TV RECEPTION — Improve your pictures by fitting a Mast-Head Amplifier plus a good quality cable such as Coaxial or Open-Wire cable. Your present signal can be increased by a minimum of three times if you use one of the following amplifiers:

HILLS	Input	Output	Gain	Ratio	Cost
MH1	300	300 ohms	10dB	3:1	\$47.62
MH2	300-75	75 ohms	20dB	10:1	\$63.31
MH4	300-75	300-75 ohms	25dB	17:1	\$71.52
MH4F	10 or 20dB down on Ch's 3-4-5A				\$74.97

LABGEAR	Input	Output	Gain	Ratio	Cost
6060	75	75 ohms	28dB	25:1	\$59.98
6059	75	75 ohms	Approx 15dB		\$57.30

KINGRAY	Input	Output	Gain	Ratio	Cost
MH20	300/75	300/75	20dB	10:1	\$74.97

Ecraft Line Amplifiers VHF-UHF						
Outlets	In	Out	Gain	Ratio	Cost	
1	75D16	75	75	16dB	6:1	\$45.00
2	75D12	75	75	12dB	4:1	\$52.79
3	75D10	75	75	10dB	3:1	\$53.70
4	75D10	75	75	10dB	3:1	\$54.29
1	75D25	75	75	25dB	18:1	\$53.65
2	75D21	75	75	21dB	11:1	\$60.45
3	75D19	75	75	19dB	9:1	\$61.45
4	75D19	75	75	19dB	9:1	\$61.95

CROWN Remote control Antennae rotator \$99.00

Ecraft Double screen coaxial cable
 2045 3.59 loss at 216Mhz per 30 metres .049c per m
 2063 2.05 loss at 216Mhz per 30 metres .108c per m
 Open Wire feeder 1.5dB loss at
 200Mhz per 30m .070c per m

Masting — Telo-masts — Guy fittings — Outlet plates —
 Splitters — Balun Ry leads etc. Belling Lee type plugs in
 lots of 10 — 55c each

Gold detectors — Bounty Hunter range
 84 VLF/TR Discrimination \$337.00 only TR1000D VLF/TR
 were \$445 now \$339
 Red Baron RB7 VLF/TR/SPD Ground reject discriminator
 \$595 ETI Kits May 77
 Build your own Gold Detector. To clear \$49

PL259 50 ohm plug 60c Jumper leads 6" fitted 2-PL259
 plugs \$2.00

ELECTROCRAFT PTY LTD
 68 Whiting Street, Artarmon 2064
 Telephone 438-4308, 438-3266



REVIEWS OF RECENT

Records & Tapes

CLASSICAL • POPULAR • SPECIAL INTEREST

Soler: Fandango — one of the best

SOLER: Fandango; Seven Sonatas. Elisabeth Chojnacka, harpsichord. World Record (Erato) stereo disc 06057

Padre Antonia Soler lived from 1729 to 1783; a pupil, at least for a short time, of Domenico Scarlatti, he spent the last 30 years of his life in the cloisters of the Escorial monastery where he became famous as organist and functioned as keyboard teacher to the royal princes in nearby Madrid. His cloistered existence, while providing him with the opportunity to write both music and treatises undisturbed, did not remove him from normal musical contacts with Spanish traditions and this is quite splendidly demonstrated on this disc which I regard as one of the year's best.

Usually, I tend to be wary of modern, elaborate harpsichords; the one recorded here is such a one, built by Sperrhake (German?) with five stops and pedals, but its use appears well justified when one listens to the fireworks and delicacies of shading it makes possible in the Fandango. This

composition is a notorious challenge to any keyboard player, as it gives considerable scope for improvisation and embellishment. Ms Chojnacka, an artist new to me, rises to the challenge and performs quite spectacularly, putting even Kipnis in the shade. The Fandango is one of the most exciting of Spanish works I know of, both harmonically and rhythmically and it well repays repeated attention.

The seven sonatas appear to have been well chosen from the hundred or so composed by the productive Padre. With one exception, the remote key of F sharp, they are all in minor keys and the typically Spanish flavour is further enhanced by frequent use of the Dorian mode. Much of the pleasure to be derived from this recital is, no doubt, due to the player's skill in varying registrations and involved fingerings — in any event, there is a great deal here to be enjoyed including, not least, the quality of recorded sound and successful processing. (P.F.)



this time she surely excels herself. There is quite uncommon dramatic impact and great emotional precision on every track; I don't know whether she is better than anyone else in "Exsultate" — suffice it to say that she is good; very, very good! (P.F.)

☆ ☆ ☆

MUSIC FOR AN OCCASION: Nicholas Danby; Organ of Eton College Chapel. CBS Masterworks stereo disc 76790.

Here are 11 tracks of festive and circumstantial music (these adjectives supplant "occasion" in the French and German texts; and with justice) by Weitz, Walford Davies, Elgar, Parry, Whitlock, Handel, Vaughan-Williams, W. H. Harris and Patrick Gowers. Musically — were it not for the unifying instrument itself — there is little enough to link the works; however, they are all reasonably weighty and are lent further gravity and solemnity (where required!) by Danby. We have had occasion to hear him in Australia — I'd also heard him in England on several occasions — and there is, of course, not the least doubt about his outstanding powers as an organist.

No doubt some organ lovers would be satisfied to buy the disc just for Danby's sake, but there really is much more to it. In the first place there's the Eton organ itself: a truly outstanding example of all that was good in 19th century design, it was installed in 1886 and has undergone only minor alterations since then. Its full specifications are given on the sleeve and organ enthusiasts will, I know, have a feast just reading them! The very well-made disc is, also, recommended as a useful test of your play-back equipment, especially for

Mozart: "a quite wonderful selection"

MOZART: Exsultate, Jubilate. Edith Mathis, soprano; Staatskapelle Dresden; conductor Bernhard Klee; with Hans Otto, organ and harpsichord. DG stereo disc 2530 978.

It would be short measure indeed if this disc contained nothing beyond the quarter-hour long Motet of K.165; apart from anything else, "Exsultate" has certainly suffered an excess of recorded exposure — it seems every soprano of note feels obliged to do it. Luckily, there is more to this disc: it includes six other items, best described as "arias" from various religious and semi-religious compositions of Mozart's. The one I appreciate most is the gorgeous "Laudate Dominum" from the "Vesperae solennes de Confesore",

K 339; this is surely one of the most moving of Mozart's ideas, strangely enough not dissimilar from some of his profound Masonic music.

Musically, this is quite a wonderful selection of Mozart's music; I am happy to add that the presentation (except for some reservations about peculiar packaging) is worthy of the occasion. Not for the first time in recent months, we have startlingly fine performances recorded in East Germany; the boys of the Dresden Kapelle are in fine voice and well disciplined, the orchestra is very good indeed and the anonymous organ produces some quite delicious sounds, all cleanly and well recorded. Over and above all this, Edith Mathis; I have yet to hear anything second-rate from her, in concert hall or opera, but

Reviews in this section are by Paul Frolich (P.F.), Neville Williams (W.N.W.), Jamieson Rowe (I.R.), Leo Simpson (L.D.S.), Norman Marks (N.J.M.), Greg Swain (G.S.), and Danny Hooper (D.H.).

bass response. Extremes in the treble are hard to find (though the high-pressure Trumpet stop used in Whitlock's "Paeon" is quite startling), but the first bars of the "Dead March" from Handel's oratorio "Saul" will tax any system of woofers! (P.F.)

☆ ☆ ☆

STERN & ZAKIN. BEETHOVEN: Sonata No. 7 in C minor, op 30 No. 2; MOZART-KREISLER: Rondo in G major; MOZART: Sonata No. 26 in B flat major, K.378. Isaac Stern, violin; Alexander Zakin, piano. CBS Odyssey mono disc ODA 5136.

Here is another of the Stern re-issues — as I will show, a particularly welcome one — without any clue to its original date; since the disc is monophonic, it was probably recorded in the late 50s. The sound is perhaps a trifle boxy, but not offensively dated. The Rondo turns out to be a Kreisler arrangement of a movement from Mozart's "Haffner" Serenade, K.250 and serves as a good sample of Stern's indebtedness to Kreisler, purely as a virtuoso.

As it happens, both the sonatas are often elusive items on disc and their coupling seems a brilliant idea. There have been some fine recorded versions of op 30 No 2: I recall Oistrakh/Oborin, Ricci/Gulda and Morini/Firkusny, all of them deleted; there is a version played by Yehudi Menuhin with Kempff which might still be around, but I did not think highly of it. Isaac Stern was at the very peak of his powers when he played this and his long-time partner Zakin (not gladly heard by quite a few, for some reason or other) is also excellent. Mozart's K.378 has not fared well on LP; a lovely reading by Haskil and Grumiaux is long deleted, a not as good one by Szeryng & Haebler has become scarce and a reputedly fine one by Goldberg with Radu Lupu on Decca has not come my way. In any case, anyone loving the music (surely everyone?) ought to settle for this one quite happily. (P.F.)

☆ ☆ ☆

SIBELIUS: Violin Concerto D minor, op 47; Four Historic Scenes, op 25 & op 66. Isaac Stern, violin; Royal Philharmonic Orchestra; Sir Thomas Beecham, conductor. CBS Odyssey mono disc ODA 5135.

Although this is, clearly, a historic recording, CBS have not seen fit to mention the date of its first release nor anything at all about its background; rather a pity, I think, the more so since there is a lot of white space left on the sleeve. . . .

From my experience, covering about 35 years of classical recording, I'd guess that the concerto was originally recorded about 1957, the remaining items perhaps two or three years later. At any



BILGRAM PLAYS BACH. Hedwig Bilgram at the organ of the Dominikanerkirche of Landshut. World Record Club, stereo R 04457.

I must confess that I've never before heard of either Hedwig Bilgram or the organ on which he plays on this disc. I imagine that most potential buyers of the record will be in the same position, even those who are organ music lovers like myself. But in this case it doesn't matter; both organ and organist give a very good account of themselves.

The Bach works played are all fairly familiar. There is the moving Passacaglia & Fugue in C minor, the Preludes and Fugues in E minor and B minor, and two chorales and a trio on the Lutheran hymn "Herr Jesu Christ, dich zu uns wend". Bilgram manages to make them all sound fresh and new — which to my mind is the ultimate test of a performance of familiar music. At the same time his playing is unaffected and authentic, with carefully balanced registrations.

The organ sounds a very musical instrument, too; its speech is clean and responsive. And the recording is very good.

In short, then, a disc which should interest all lovers of Bach organ music. (JR.)

☆ ☆ ☆

BACH. Michael Murray playing the Von Beckereth Organ at the First Congregational Church, Columbus, Ohio. Stereo, Telarc 5010. (From P. C. Stereo, PO Box 272, Mt Gravatt, Qld 4122.)

A mixed bag indeed is this conventional analog/analog release by Telarc, selling at \$9.50, plus postage.

The first item "Tocatta and Fugue in D Minor" has a harsh quality in the loud chords which one tends to blame initially on the organ. But, considering the age of the recording (1973) and on further hearing, I think it more likely to have been peak overload on the master

rate, though the sound is not the best (poorest in the concerto), there is quite enough here to tell latter-day listeners how lively a view Sir Thomas took of Sibelius' scores. This is even more noticeable in the Historic Scenes. Since Beecham's days, these pieces have become more widely known and have

ORGAN MISCELLANIA

. . . a very mixed bag

tape.

Suspicion about the original master is heightened at about 1½ minutes into track two, "Concerto No. 2 in A Minor", when there is a distinct change in pitch, and suggestions elsewhere that it is not as firm as it might be.

By contrast, side two gives no cause for query with "Sinfonia, Cantata No. 29" (actually recorded at St Meinrad Archabbey, Indiana), "Prelude and Fugue in B Minor" and "Prelude and Fugue in D Major". On all three tracks, the sound is clean and Michael Murray gives an impressive performance totalling a generous 28 minutes of playing time.

If the contents of side two appeal, maybe you won't be too upset about my reservations on side one. (W.N.W.)

☆ ☆ ☆

RULE BRITANNIA. The Organ of Glasgow Art Galleries. Played by Alexander A. Macpherson, with trumpet solos by Trevor Green. Stereo, Neptune NA-114. (Astor release).

Glaswegians may well have a nostalgic spot for the Art Galleries and for the impressive pipe organ which was installed therein early in the century. It has 48 speaking stops and 2914 pipes in all, and an excellent reputation for tone and dynamics.

The building itself would appear to have a reverberation time of about three seconds and, unfortunately, most of its shows up on this recording. Listening to it, one can follow the melodies through the mass reverberant sound but, after a few tracks, you begin to wonder why you are bothering.

It's a pity, because, it sounds like a competent performance of old chestnuts, which could add to the nostalgic appeal of the venue: Rule Britannia — Largo (Handel) — Jesu, Joy of Man's Desiring — Hallelujah Chorus — Londonderry Air — Crimond — Will Ye No Come Back Again? — Auld Lang Syne — Onward Christian Soldiers — All In An April Evening — Land Of Hope And Glory — The Holy City — Trumpet Voluntary — Ave Maria (Bach-Gounod) — National Anthem.

A pity that they didn't give more thought to miking. Strictly for nostalgia. (W.N.W.)

been recorded by others, particularly another Knight, Alexander Gibson; though his Scottish version fares much better acoustically, the Beecham version remains the more interesting one.

In the violin concerto, however interesting Beecham's views of Sibelius, interest really focuses on the soloist. It

**HARD TO GET
JAPANESE
INTEGRATED CIRCUITS
FOR CAR STEREO'S TV'S
AND AMPLIFIERS**



	Normal price (when available)	RADIO PARTS special price
UPC 23C	\$2.29	\$1.80
UPC 29C	4.38	4.27
UPC 575	3.45	1.46
UPC 1380	11.34	4.95
BA 511A	4.42	1.80
HA 1306	3.95	1.80
HA 1322	6.59	2.25
HA 1339A	—	1.80
TBA 810 AS	3.86	1.70
AN 214 Q	5.20	1.58
AN 228	8.87	3.40
AN 234	8.40	4.05
AN 241	7.60	1.95
AN 247 P	8.40	3.60
AN 245	8.40	3.85
AN 331	—	3.38

**THICK FILM AF.
POWER AMPLIFIERS**

	Normal price (when available)	RADIO PARTS special price
STK 011 (6.5 watt)	\$7.92	\$4.35
STK 015 (10 watt)	7.00	5.06
STK 016 (15 watt)	10.15	5.40
STK 031 (25 watt)	12.75	9.10
STK 084 (50 watt)	18.07	7.55
STK 086 (70 watt)	21.15	13.45

**ALL PRICES SUBJECT TO
27 1/2% SALES TAX IF
APPLICABLE.**

MANUFACTURED BY:

**RADIO
PARTS
GROUP**

562 SPENCER STREET,
WEST MELBOURNE, VIC. 3003.
TEL. (03) 329-7888.

1103 DANDENONG ROAD,
EAST MALVERN, VIC. 3145.
TEL. (03) 211-8122.

**DEVOTIONAL: Massed
voices at their best**

A THOUSAND TONGUES TO SING.
The Third All-Britain Festival of Male
Voice Choir from the Royal Albert
Hall, London. (From World Records
Aust, 18-26 Canterbury Road, Heath-
mont, Vic 3135.)

The title of this album indicates what is to be expected and it certainly lives up to those expectations. With 1000 choristers drawn from all parts of the British Isles, the singing is full-bodied and fervent, although highly disciplined under the guidance of the Festival's four conductors. Accompaniment is minimal, with piano and organ used mainly to set the mood and the key. The titles:

O Joy Of The Justified — O Love That Will Not Let Me Go — At The Cross — Am I A Soldier Of The Cross — Guide Me O Thou Great Jehovah — The Prince Of Peace — Onward, Christian Soldiers — He Hideth My Soul — Christ Liveth In Me — Like Men That Wait — What A Friend We Have In Jesus — Jesus, Lover Of My Soul — Praise, My Soul.

The titles are familiar, for the most part, but the tunes are not those which you will expect. However, don't let this deter you. They are refreshing arrangements, appropriate to a male choir and you'll enjoy them. And, just to make sure that you can follow them to advantage the words are printed in full on the sleeve.

Quality and sound balance is excellent and I have no hesitation in recommending this album. (W.N.W.)

☆ ☆ ☆

JUBILATION. The Proclaimers. Stereo, Move, MS-3022. (From Move Records, Box 266 Carlton South, Vic 3053. Phone (03) 497 3105.)

The Proclaimers are a group of young people, connected with the Rosanna Baptist Church, who specialise in singing American style Gospel. They have four earlier albums to prove their acceptance, following interstate tours and appearances on TV.

On this occasion, their sound is boosted by five brass players from the



Solid Rock Big Band and, for the most part, the sound is convincing as they present a variety of numbers including some from Osibisa, Paul Anka and Andre Crouch: Soon and Very Soon — Hey, Whatcha' Say — Tell Them — Woyaya — Great Jubilation — To God Be The Glory — Jesus Is The Answer — Just Like He Said He Would — Easter Song — I Don't Wanna Go Home — Late In The Evening — Take Me Back.

Having said all that, I must also warn that reactions to the album will be strongly divided. If you are turned on by the mod. Gospel sound, titles as above and snatches of the lyrics, you'll want to hear it. But, if you're one of those old-fashioned souls that would like to know what the Proclaimers are proclaiming, then you'll be disappointed: diction is so-so and there are no lyrics on the jacket. To buy or not to buy is up to you. (W.N.W.)

☆ ☆ ☆

ALL THINGS ARE POSSIBLE. Dan Peek Lamb & Lion Records LL1040. (From World Records Australia, 18-26 Canterbury Rd, Heathmont, Vic 3135)

Dan Peek breaks away from the prevalent rock format of a lot of Gospel music these days and presents his eleven tracks in a more or less up-tempo ballad style, which suits his light tenor voice.

The tracks are: All Things Are Possible — Divine Lady — Love Was Just Another Word — He's All That's Right — One Way — Ready For Love — Lighthouse — Hometown — You're My Saviour — I Have To Say Goodbye.

The backing musicians give excellent support, making for an enjoyable record with lots to think about in the lyrics. (NJM)

Sibelius violin concerto — continued

is good to have this proof that Stern, in his young days when we knew him, was truly a consummate artist, capable of tackling anything and everything. His status as a musician has, of course, never been seriously challenged, but it is a sad fact that he cannot, today, play the fiddle as nonchalantly as was then the case. There have been many fine recordings of this concerto, from Neveu and Oistrakh to such recent players as Perlman and Fontanarosa, and the work has never wanted for

passionate advocates; all the same, I do recommend this disc to all true music-lovers as yet another fine memento of Sir Thomas' specialisation and a timely reminder that Stern really was one of the greatest violinists of our times. (P.F.)

For information on World Record Club albums, contact the club at 605 Camberwell Road, Hartwell, Victoria, 3124. Tel. 29 3636.

BACH, Johann Sebastian: "Italin" Concerto in F, BWV 971; Chorale Prelude, "Ich ruf'zu dir, Herr Jesu Christ", BWV 639; Prelude (Fantasy) in A minor, BWV 922; Chromatic Fantasy and Fugue in D minor, BWV 903; Chorale Prelude, "Nun komm' der Heiden Heiland", BWV 659; Fantasy and Fugue in A minor, BWV 904. Alfred Brendel, piano, World Record Club stereo, WRC R 05535.

Alfred Brendel is a world renowned pianist who has recorded a really extensive program for Philips (this recording is by Philips) and lovers of Bach can rest assured that he has done full justice to the works on this disc. At times there is a trace of surface noise and tape hiss but this should not mar your enjoyment of a fine performance. (L.D.S.)

☆ ☆ ☆

NEGRO SPIRITUALS Jessye Norma, soprano; Dalton Baldwin, piano; Ambrosian Singers; directed by Willis Patterson. Philips stereo disc 9500 580.

My affection for Negro spirituals goes back to the singing of Paul Robeson and Marian Anderson, 40 and more years ago. Jessye Norma, who earned our admiration in lieder, operatic work and art songs when she visited Australia (including the odd spiritual usually as an encore) is every bit as good; she is as musicianly as Anderson, as moving as Robeson ever were. In addition, she has that superb voice, immense dignity and, on this occasion, far from negligible collaborators.

Two of the 15 tracks — "There's a man going round" and "Were you there" — are, traditionally, unaccompanied; on four of them, including

"Gospel train", Dalton Baldwin figures as co-arranger and accompanist. The remaining nine tracks feature the fine Ambrosian Singers; Willis Patterson, who conducts and made the arrangements, proudly points to the suitability of an English group for a project such as this. Indeed, they do sing beautifully and, in spots, quite idiomatically; all the same, their voices are recognisably un-American and they perform with such utter accuracy and discipline that I sometimes longed for the relaxed sound and blurry edges of a less tutored Negro ensemble. Never mind: what really matters is the gorgeous sound of Miss Norman and I can assert that the disc is full of rich, cleanly recorded and devout sounds. (P.F.)

☆ ☆ ☆

TED HEATH SALUTE THE DUKE. World Record Club stereo WRC R 05217.

There is no denying that Duke Ellington was a great composer and arranger of the big band era but I was not too keen on his band in his latter years. I much preferred bands like the Ted Heath Orchestra. And so I found this "salute" by Ted Heath very enjoyable. The recording quality of this disc is outstanding which is a bonus feature.

Ten great Ellington standards are featured here, although the knowledgeable will note that the first track was not composed by Ellington but was adopted by him as the theme tune for the band: Take the "A" Train — Do Nothin' Till You Hear From Me — Solitude — I Got It Bad — Caravan — Perfido — Mood Indigo — Sophisticated Lady — Don't Get Around Much Anymore — Cotton Tail. (L.D.S.)



Get The Professional Disco Sound!

Three great reasons why a recent survey published by Billboard Magazine reveals that for the third year in a row Stanton has increased its share of the Disco phonograph cartridge market. The Stanton share has grown to an impressive 55.8%... a full 24 percentage points more than its nearest competitor.



The 500AL... great sound without sacrificing performance quality.



The 680EL... for professional disco operators.



© 1979 STANTON MAGNETICS

The 680SL... especially designed for home Disco.

Sole Australian Distributors:
LEROYA INDUSTRIES PTY LTD

Head Office: 156 Railway Pde,
Leederville, Western Australia, 6007
Phone 81 2930
NSW Office: 100 Walker St, North
Sydney 2060. Phone 922-0437



STANTON
#1 in DISCO
THE CHOICE OF THE PROFESSIONALS™

RADCOM QUALITY COMPONENT

105 ELDRIDGE ST., BANKSTOWN
PHONE: 709-4706

Air spaced variable capacitors

10pF-25pF-50pF-100pF
250pF ALL AT \$2.50
500pF at \$5.00

All preferred values of capacitors

All preferred values of resistors

PLUGS CONNECTORS AND ACCESSORIES IN STOCK

High voltage fixed capacitors, all types of toggle and wafer switches.

Multi-tapped transformers

0-15v 1 AMP \$5.00
0-15v 2 AMP \$9.30

TRY US FOR THE HARD TO GET COMPONENTS

STOCKIST FOR

silicon valley

Correct us if these are not
**AUSTRALIA'S
 LOWEST PRICES**

(nobody has — nobody will)
 Add 27½% sales tax (LEDS 15%)
 unless exempt.

**RESISTORS
 PRICE BREAKTHROUGH!**

No misprint

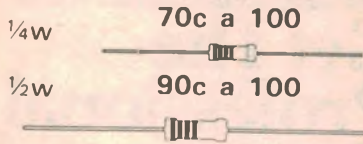

\$6/K ¼w. 1¼c ea

\$8/K ½w. 1¾c ea

Carb. film 5% E12 2.20 Ω to 4M7

DON'T MISS OUT!

If you are sceptical about quality — the
 joke's on you.

Trade samples against L/H



LEDS \$10½ a 100. \$95/K
 (red) 13c ea, \$1.20/10

Australia's best LED value. No brag — just
 fact Wide angle view well diffused Quality
 clips 3c ea all quantities



**\$30 a 100
 POTS**
 35c ea. \$3.20/10

Linear single only. 500 Ω, 1k, 5k, 50k,
 100k, 250k, 500k, 1m, 2m



POLYFILM CAPS
 from 3c, \$2.70/100

10% 100V (per 100 prices in brackets)

\$			s			s		
001	—	3c (2.8)	01	—	6c (4)	1	—	10c (7.5)
0012	—	4c (3)	012	—	6c (4)	12	—	11c (8)
0015	—	4c (3)	015	—	6c (4.2)	15	—	12c (8.8)
0018	—	4c (3.1)	018	—	6c (4.2)	18	—	13c (10)
0022	—	4c (3.2)	022	—	6c (4.5)	22	—	14c (11.3)
0027	—	4c (3.3)	027	—	6c (4.7)	27	—	16c (12.5)
0033	—	5c (3.4)	033	—	7c (5)	33	—	18c (13.7)
0039	—	5c (3.5)	039	—	7c (5.2)	39	—	19c (15.3)
0047	—	5c (3.6)	047	—	8c (5.3)	47	—	20c (17)
0056	—	5c (3.7)	056	—	8c (5.5)			
0068	—	5c (3.8)	068	—	8c (6)			
0082	—	5c (3.9)	082	—	8c (6.5)			

All values
in uF



ELECTROCAPS
 from 3c \$2.70/100

(Per 100 prices in brackets)

Cap	16V	25V	50V
0.47uF	\$ (2.7)	4c (2.8)	5c (2.9)
1 2.2 3.3 4.7 10uF	4c (2.7)	5c (2.8)	6c (3)
22uF	4c (3)	5c (3.2)	
33uF	4c (3.2)		
47uF	5c (3.5)	6c (4.2)	9c (6.9)
100uF	6c (4.4)	8c (5.7)	13c (10.1)
220uF	8c (6)	11c (8.2)	19c (15)
330uF	10c (7.3)		
470uF	12c (9.3)	18c (14.1)	32c (25.7)
1000uF	19c (15.2)	29c (22.5)	59c (46.9)

SALES TAX NOT INCLUDED

Paid orders over \$5 post free.
 Under — add 80c. Return mail service on
 paid orders. Credit by application.

**DIGGERMAN ELECTRONICS
 WHOLESALE**

Box 33, Coramba NSW 2466
 Ph (066) 544251

RECORDS & TAPES — continued

WE'VE COME A LONG WAY, BABY.
 Loretta Lynn. MCA stereo 3073.
 Cassette 4MCA 3073.

As far as music in the Nashville Opry
 style, is concerned Loretta Lynn is
 highly successful. Provided the phony
 "country" style and songs with no
 country theme don't turn you off, the
 record is enjoyable — just don't take it
 seriously, that's all! Recording quality
 is okay.

There are 10 "country" songs: We've
 Come A Long Way Baby — Easy Street
 — The Lady That Lived Here Before —
 Lullabies To A Memory — I Can't Feel
 You Anymore — True Love Needs To
 Keep In Touch — My Conscience Goes
 To Sleep — No Love Left Inside Of Me
 — Between The Preacher And The
 Lawyer — Standing At Our Bedroom
 Door. (L.D.S.)

☆ ☆ ☆

THE CURRIE BROTHERS, TAKE TWO.
 Lismor LILP 5094. Astor release.

This record should bring pleasure to
 those of you who enjoy Scottish
 dancing music. It carries eleven medley
 tracks of different styles plus one of
 Irish reels. The tracks are: Accordions
 On Parade — March, Stathspey and
 Reel — The Cuckoo Waltz — Scottish
 Reels — The Scotch Polka — Jigs
 Selection — Irish Reels — Scottish
 Waltzes — Pipe March and Reel —
 Scottish Reels — Musette Pour Tous —
 Slow Air, Jig and Reel.

Judging by the sleeve photo, the
 Currie Brothers would be in their early
 teens and, on the basis of this record,
 they have a bright musical career ahead
 of them. (NJM)

☆ ☆ ☆

THE NIGHT MUSIC AND YOU. Sacha
 Distel. Astor Records stereo SPLP
 1574.

Listening to this album, I could not
 help but compare Sacha Distel with Al
 Martino. Both have style, polish, and an
 easy delivery that one could listen to

for hours. The only real difference is
 that Sacha Distel has a French accent!

The album contains 16 tracks in all,
 most of them connected with love
 themes. Included are: This Guy's in
 Love With You — Close To You — It's
 Impossible — What I Did for Love —
 What Now My Love — Beyond the Sea
 — Feelings. One curiosity is that the
 order of track titles listed on the album
 jacket is incorrect. Track two on side
 one and track seven on side two are
 transposed!

The last point is only a minor quibble
 however, and in no way detracts from
 what is a very enjoyable disc. Recording
 quality is well up to standard. (G.S.)

☆ ☆ ☆

RAY THORNLEY PLAYS GULBRANSEN.
 Stereo disc, Audio Arts Enterprises,
 IMA-7914.

REEL MUSIC played by Ray Thornley
 and featuring the Lowrey orchestral
 keyboard. Stereo, cassette only,
 IMAC-774.

(Both recordings available direct
 from Soundbank Pty Ltd, PO Box 248,
 Gladesville, NSW 2111. \$5.99 each
 plus 80c P&P.)

These two recordings provide quite a
 contrast with "Christmas with Ray
 Thornley" performed on a Yamaha E-70
 and reviewed recently in these
 columns. The sound there was
 predominantly orchestral inspired, no
 doubt, by the wealth of orchestral
 resources on the new Yamaha.

Gulbransen organs, on the other
 hand, have had something of a reputa-
 tion for their tibias and theatre-like
 sound and that just about characterises
 the Gulbransen performance. Ray
 Thornley does it all himself, with the aid
 of multi-recording but, imagine a
 theatre organ and on-stage piano duo
 and you just about have it. The tracks:
 South — A Child Is Born — Cheek To
 Cheek — Root Beer Rag — You Light
 Up My Life — Music Box Dancer — I

TASMAN ELECTRONICS

12 Victoria St. Coburg, Vic. 3058. Phone (03) 354 5062

**ELECTRONIC
 COMPONENTS
 TRANSISTORS
 IC's
 RESISTORS
 CAPACITORS**

**PLUGS & SOCKETS
 TRANSFORMERS
 SANKEN MODULES
 ILP MODULES
 POTENTIOMETERS
 DIODES. ETC.**

**WIRE & CABLE
 AUDIO LEADS
 MULTIMETERS
 CALCULATORS
 INSTRUMENT CASES
 POWER SUPPLIES**

**MUSICAL INSTRUMENTS
 RECORDS, CASSETTES
 SPEAKERS AND
 SPEAKER KITS
 STYLII, BATTERIES
 VALVES**

**T.V. AERIALS
 AND ACCESSORIES
 HI-FI PRODUCTS
 JOSTY KITS
 PROJECT PC BOARDS
 BOOKS, PLUG PACKS**

**MAIL ORDERS
 WELCOME—
 COME AND SEE
 US — our
 prices are the
 "BEST IN TOWN"**

Can't Smile Without You — When I Grow Too Old To Dream — The Hustle — As Time Goes By — Anchors Aweigh. The sound quality is okay and there's some pretty fancy finger work, particularly in the last track.

"Reel Music" is built around piano and piano-like sounds, with rhythm bass, and ornamented by characteristically electronic contributions from the Lowrey. One might sum it up as a one-man piano, bass and electronic organ combo presenting film themes:

We May Never Love Like This Again — Borsalino — The Way We Were — Brian's Song — The Good, The Bad And The Ugly — Do You Know Where You're Going To? — Let's Do It Again — Speak Softly Love — The Morning After — Theme From Romeo And Juliet — The Entertainer — Lara's Theme.

If the contents appeal, you'll find the quality excellent. (W.N.W.)

☆ ☆ ☆

22 GREAT GUITAR FAVORITES. The Exotic Guitars. Festival Records L 45835/6.

"22 Great Guitar Favorites" is one of a number of similar albums currently on the market, and contains some very fine guitar renditions of a collection of old-time favourites. We'll list just a few of the titles: Indian Love Call — Harbour Lights — Ebb Tide — Somewhere My Love (Lara's Theme from "Dr Zhivago") — The Shadow of Your Smile — Moon River — Melody of Love — Love Story — Blueberry Hill.

My only real criticism is that the lack of variation in musical style may dissuade you from wanting to listen right through. Recording quality is about average. (G.S.)

REALITY . . . WHAT A CONCEPT. Robin Williams. Casablanca Records NPLP 7162. Astor release.

All the material for this album was written by Robin Williams, (Mork from his TV show as he is better known). However, he does not portray this character on the album, and his audience can discover the other sides of Robin Williams.

The album was recorded live at the Copacabana, New York City and the Boarding House, San Francisco. It is also "R-Rated — certain words in this album might be considered objectionable by parents of children under 16".

Whether or not you're a fan of Robin Williams you should have a listen to this album to experience his varying characters and moods. (D.H.)

☆ ☆ ☆

THE BEGINNING OF THE ENZ. Split Enz. Mushroom Records L 37132. Festival release.

Split Enz recently achieved outstanding success in the New Zealand Rock Awards by winning best group, best album ("Frenzy"), best singer (Tim Finn), best keyboards (Eddie Rayner), and a variety of other accolades.

The band is seeking worldwide commercial success in the 80s and assisting them is a new manager, imported from England. This album could be the first major step.

The tracks on the album are: Split Enz — For You — 129 — Home Sweet Home — Sweet Talking Spoon Song — No Bother To Me — Malmsbury Villa — Lovey Dovey — Spellbound. (D.H.)

GRAPHIC ARTS CATALOGUE

Listing the following: 3-M BRAND Label Material with added colours, step by step instruction how to make your own professional self-adhesive Labels, Signs and Nameplates in minutes without a darkroom. 3-M I.N.T. (Image'n Transfer) Material, a new graphic "Tool" for engineers, layout artists, draftsmen and many others. Now, you can make your own dry transfer sheets of P/C board symbols, line art, sentences, words and letters in any style and size. Step by step instruction how to make them yourself in minutes. Also artwork patterns for P/C boards, 0.100" precision grids on high stability polyester, plain and pre-sensitised printed circuit boards, black phenolic boards for Copper etchings, etching chemicals, etching tanks, heaters for etching tanks, UV lamps, automatic exposure timers with photocell, etc. etc. See full page colour Advertisement in E/T, March 80. We also design & manufacture Labels, Dry Transfer sheets, and P/C boards to your requirements, computerised typesetting, special effect screen and line conversion for deep etching and screen printing, colour separation of combined red & blue artwork for P/C boards etc.

Order your copy "GRAPHIC ARTS CATALOGUE" today.

DELTA SCIENTIFIC PRODUCT DISTRIBUTION
Red Bank Court, St. Albans Vic. 3021

Please forward your catalogue to: \$1.50 handling cost included.

Name: (please print)

Address:

Postcode:

Please tick if you wish to become a Dealer

PLESSEY COMPONENTS

Australian distributors
for



- IC MEMORIES
- SHOTTKY TTL HD74S SERIES
- LOW POWER SHOTTKY TTL HD74LS
- 6800 MICROPROCESSOR

GENERAL COMPONENTS
Stocks held of . . .

Connectors
Rotary Switches
Lever Keys
Reed Relays
Neon Lamps
Panel Lamps
Switches
Potentiometers
Integrated Circuits
Sonalert Devices
Indicator Tubes
Photodiodes
Photo Voltaic Cells
Nickel Cadmium Batteries
Loudspeakers

Try us for hard-to-get
components such as:-

SILVER MICA
TRANSMISSION MICA
TRANSMISSION CERAMICS
COMPUTER GRADE ELECTROLYTICS



PO Box 2 Villawood, NSW. 2163
Telephone 72-0133

Adelaide 269-2544 ● Melbourne 329-0044
Brisbane 36-1277 ● Perth 458-7111

INDEX TO VOLUME 41 — April 1979 to

General Features

Shadows of the Past (National Film Archive)	Apr p8
Automated manipulator looks, learns, assembles	Apr p14
Sound reveals a hidden world	Apr p16
Japan fights back — innovation is the key	May p10
Albert Einstein: A centenary tribute	May p16
Satellite station from surplus gear	May p18
Skylab: A rescue effort that failed	Jun p10
Charles David Tandy	Jun p17
Interference-Free Data transmission	Jun p18
The Philips compact disc	Jul p10
Training our film & TV professionals	Jul p12
Satellite terminal comes on a truck	Jul p18
Sydney's outstanding new pipe organ	Aug p10
MHD Power: Making better use of coal	Aug p16
The lady with the (arc) lamp	Aug p18
Experiment with Peltier devices	Aug p40
The personal computer revolution	Sep p12
Space Shuttle: Countdown to a 1980 launch	Sep p32
Ultrasonic ear finds power line faults	Sep p86
Wiegand's wonderful wires	Oct p10
Video Discs set for take-off	Oct p14
Tandy Electronics Grand Software Contest	Oct p65
Exotic new lithium-air batteries	Nov p10
Home Movies '79 — A whole new breed	Nov p12

Constructional Articles

CMOS die has LED display	Apr p36 3/EG/11
RF Preselector for the broadcast band	Apr p40 2/SW/76
Simple, effective Car Burglar Alarm	Apr p46 3/AU/21
Making use of Audio Indicators	Apr p50 1/MS/18
A simple Intruder Alarm	Apr p64 3/MS/77
FM Signals & Antennas	Apr p67 2/AE/34
Solid state RF test oscillator	May p42 7/RO/59
A Playmaster Amplifier for flats & home units	May p50 1/SA/62
Playmaster Stereo Graphic Equaliser	May p56 1/SC/9
An electronic Combination Lock	Jun p44 2/MS/56
A Playmaster Amplifier for Flats & Home Units, Pt 2	Jun p56 1/SA/63
Inductance ranges for the Direct-C Meter	Jun p75 7/CM/12
Easy-to-build Zener Tester	Jul p39 7/VT/15
A fully protected Dual Power Supply	Jul p42 2/PS/46
Antenna Tuning Unit covers all bands	Jul p49 2/AE/35
Video Ball Game Crystal Oscillator	Jul p55 3/EG/10
Quartz Multiple Frequency Reference	Jul p56 7/RO/60
The Infuriator	Jul p70 3/EG/12
A Frame Aerial & Tuner	Jul p72 2/AE/36
Masthead Amplifier for TV & FM	Aug p36 6/MS/5
Solid State Relay controls 700 Watts	Aug p42 2/PC/24
DIN/CCR Weighting Filters	Aug p47 1/F/12
RF Impedance Bridge	Aug p52 7/SW/11
Build a simple AM Radio Receiver	Aug p66 4/MC/3
A square wave Oscillator	Aug p72 7/AO/30
Sound triggered Photo Flash	Sep p52 3/EF/14
Autochime Musical Doorbell	Sep p60 2/MS/57
Control Unit for Car Windscreen Wipers	Sep p68 3/AU/22
Simple Tester for SCRs & PUTs	Sep p78 7/VT/16

Microprocessors

Miniscamp Printer Interface	Apr p72 2/CC/37
Faster dumping & loading — 2650	Apr p70 8/M/36
2650 Mini Assembler	Apr p76 8/M/37
Lunar landing game	Apr p82 8/M/38
DREAM 6800 Video Computer	May p82 2/CC/38
DREAM 6800, Part 2	Jun p82 2/CC/39
DREAM 6800 Power Supply	Jun p83 2/CC/40
4-Digit LED Display — 2650	Jun p94 2/CC/41
DREAM 6800, Part 3	Jul p84 2/CC/42
Software driven keyboard for K2 kits	Jul p92 8/M/39
DREAM 6800 — Chip-8 programming	Aug p83 2/CC/43

Microwaves in the classroom	Nov p24
Giant screen colour television	Dec p10
Home Movies '79, Pt 2	Dec p25
Power Line Interference	Dec p32
Star Trek: The motion picture	Jan p8
Choosing a cassette deck	Jan p14
Car computers	Feb p10
Electronics & the car of the 80s	Feb p14
Voice chess challenger	Feb p18
Broadband RF power amplifiers	Feb p74
Basement Flywheel	Mar p10
Magnetic bubble memory devices	Mar p14
The centenary of the electric light	Mar p22
Second thoughts on alien intelligence	Mar p42

Hifi Reviews

Audio-Technica AT12XE/H magnetic cartridge	Apr p34
Nakamichi 580 stereo cassette deck	May p37
Marantz 3650 stereo control centre	May p40
Teac A-300 3-head stereo cassette deck	Jun p39
Sennheiser HD420 & HD430 dynamic headphones	Jun p42
Audiosound 8033 Minuet loudspeaker	Jul p35
Nakamich T-100 audio analyser	Aug p33
Philips N6330 & N6325 stereo headphones	Sep p51
Audiosound 8022 Motet loudspeaker system	Oct p36
Kenwood KA-801 stereo amplifier	Nov p43
Audio Reflex EQ-1 10 band graphic equaliser	Dec p47

Peerless PAS-50 Loudspeaker system	Dec p49
JVC KD-A8 microprocessor-controlled cassette deck	Jan p36
Teac A-430 stereo cassette deck with auto bias	Jan p39
Phillips GP-413 II pick-up cartridge	Feb p37
Cassette converter for your car radio	Feb p38
Philips AH587 motional feedback Loudspeaker system	Mar p35

Forum

Are modern phono discs really as bad as they're made out to be?	Apr p18
A never-ending argument: who invented what, where and when?	May p24
They're working on 3D films and TV — but don't hold your breath	Jun p24
The height of human indignity: being bossed by a computer	Jul p22
Wind power isn't as easy as all that!	Aug p22
3D: It's a question of what you mean	Sep p36
I challenge you to make that point!	Oct p24
An incredible coincidence — or something else?	Nov p32
Repair, update or throw it away?	Dec p34
New Zealand has lots going for it ... but no FM stereo	Jan p24
Further to our December editorial	Feb p24
Further thoughts on current flow	Mar p38

A low-cost Audio Amplifier	Sep p89 1/MA/52
Simulating High-Impedance Headphones	Sep p96 1/XA/12
Versatile Moisture & Light Detector	Sep p98 3/MS/78
Modifications for CMOS die	Sep p116 3/EG/11
Stereo Infra-Red Remote Control	Oct p38 1/MS/19
Light Trigger for Slave Flashguns	Oct p50 3/EF/15
A Power Supply for the Movie Mixer	Oct p58 2/PS/47
Build the Quizmaster	Oct p84 3/EG/13
Intersil ICM 7226 Frequency Meter	Nov p50 7/F/26
The 'Prospector' Metal Locator	Nov p54 3/MS/79
A High Quality Pulse Generator	Nov p62 7/AO/31
Experimenter's Power Supply	Nov p95 2/PS/48
Playmaster 3-13L Compact Loudspeakers	Dec p54 1/SE/52
Transistor-assisted Ignition System	Dec p60 3/TI/15
Fan speed Control Unit	Dec p68 2/PC/25
Precision Power Supply	Dec p72 2/PS/49
Electronic Bongos	Dec p103 1/EM/48
Delay system for car courtesy lights	Jan p42 3/AU/23
Exposure meter for electronic flash	Jan p46 3/EF/16
Playmate 3W +3W stereo amplifier	Jan p52 1/SA/64
Build our reaction timer	Jan p68 3/EG/14
Build a super bass filter	Feb p42 1/F/13
A modulated signal injector	Feb p46 7/RO/61
Playmaster stereo graphic analyser	Feb p50 1/SC/10
An unusual audio amplifier	Feb p70 1/MA/53
Hifi Auto-Switch	Mar p44 1/MS/20
Build a capacitance meter	Mar p50 7/CM/13
Build an RF preamplifier from a kit	Mar p57 6/MS/6
Let's talk about crystal sets	Mar p68 4/CR/12
A simple lie detector	Mar p72 3/EG/15

Improved 2650 Disassembler	Aug p78 8/M/40
Adapter PCB for 300-BAUD PIPBUG mode	Aug p89 2/CC/44
Understanding BASIC	Oct p70 8/M/41
PIPLA/PIPBUG2 ROM with the 2650 Mini Computer	Oct p74 2/CC/45
Understanding BASIC, Part 2	Nov p77 8/M/42
Serial Interface (Ultra-Low Cost VDU)	Nov p83 2/CC/46
RS-232C Interface	Dec p81 2/CC/47
Random Morse — 2650	Dec p86 8/M/43
Chip-8 Interface for Motorola 6800MEKD2 Kit	Dec p89 2/CC/48
Interfacing your 2650 mini computer to an S-100 bus	Jan p78 2/CC/49
Improving the 2650 mini line assembler	Feb p76 8/M/44
Trace routine helps debug 2650 programs	Feb p84 8/M/45
Two Micro Basic programs for 2650 systems	Feb p87 8/M/46

Hifi Topics

A wide-band AM tuner in 1935	Apr p23
Direct drive turntables	Apr p27
Ultra hifi audio is on the way	May p28
Seeing is believing — especially with styli	Jun p29
The problem of subjective reactions	Jul p26
What's right and wrong with tape heads	Aug p26
True hifi sound from a half-speed cassette	Sep p41
The ultimate weightwatcher?	Sep p43
Hifi technology is still racing ahead	Oct p29
High power amplifiers	Oct p66
Zapp, crackle and pop!	Nov p36
New generation dynamic speakers	Dec p39
World's smallest full size phono player	Dec p50
Dr Takeshi Takei: Pioneer in ferrite technology	Jan p30
Microphones, music, reverb & all that	Feb p30
Revolutionary new cobalt tape	Feb p33
3DA what the term signifies	Mar p26
A novel method of measuring head wear in cassette decks	Mar p28

Theory

Practical Electronics: Tagstrips	May p68
Voltage Reference Circuits	Jun p54
Practical Electronics: Solders, Fluxes, etc.	Jun p66
VFETS — Power device of the future	Jul p36
Protecting SS Power Supplies	Jul p66
Practical Electronics: Tools	Jul p76
Practical Electronics: Wire wrapping — Tools & Techniques	Aug p96
Practical Electronics: Mains wiring — what you need to know	Sep p92
Lithium cells	Oct p16
Know your components	Oct p92
Practical Electronics: The multimeter & how it's used	Oct p94
Practical Electronics: Boxes & Cases	Nov p102
Current — which way does it flow?	Dec p18
Digital Counters	Dec p110
Practical Electronics: Passive components	Jan p72
The Hall effect	Feb p24
Inductive Ignition cable	Feb p72
D/A Converters: What you need to know	Feb p79
A/D Converters: What you need to know	Mar p91

The Serviceman

Power line hash: what every serviceman should know	Apr p60
Batteries that go "bang": a new twist	May p77
The same symptoms, but quite different faults	Jun p78
How simple faults can create complex problems	Jul p98
Funny (peculiar) faults which defy explanation	Aug p60
What an intermittent can do to a guarantee	Sep p82
That Blaupunkt set — a point that was missed	Oct p62
When is an earth not an earth?	Nov p70
First aid (and last gasp) for an old TV set	Dec p74
An 18-month intermittent: some kind of record?	Jan p60
There's no such thing as a good intermittent	Feb p64
As Aesop said: "A rash friend is worse than a foe"	Mar p62

Audio Talk

Loudspeakers cables & their mythology	Apr p31
Damping factor & loudspeaker damping	May p34
Rumble — a problem of measurement	Jun p36
Loudness controls	Jul p32
Noise weighting filters	Aug p32
The illusion of power	Sep p48
Strewth it's loud — must be hifi!	Nov p47
Which kind of disc is best?	Dec p52
Transformers and solid state amplifiers	Feb p40

Circuit & Design Ideas

Caravan DC Power — a better way	Apr p57
Handy aid to fine soldering	Apr p57
Auto repeat for keyboard	Apr p59
Another hee haw siren for toys	Apr p59
Simple noise generator	Apr p59
Protection for DC coupled speakers	May p73
Transistor lead identification	May p73
Variable current limiter for power supplies	May p75
Simple bounce-free switch	May p75
An interesting two-wire intercom	May p75
A comprehensive cable tester	Jun p71
General-purpose fault-finding probe	Jun p71
Opto-coupled magnet driver for teleprinters	Jun p72
Recording DC power using a chart recorder	Jun p72
W1JR HF broadband balun	Aug p65
JFET preamplifier for tired receivers	Aug p65
Simple voltage reference uses op-amp	Sep p75
Novel method for desoldering IC devices	Sep p75
Music for your lawn!	Sep p77
Lock switch for desk mains digital clock	Sep p77
Tracking dual voltage regulator	Oct p54
Note on opto-coupled magnet driver for teleprinters	Oct p54
Audio & video monitor for EA Terminal Keyboard	Oct p57
A TTL compatible audio switch	Oct p57
Six digit facility for four digit clocks	Nov p75
Autodim for fluorescent clock displays	Nov p75
Accurate motor speed control	Dec p77
A simple frequency doubler	Dec p77
Adjustable power supply up to + or -12V and 800mA	Dec p77
A novel vice to make	Dec p79
Flash strobe addition to sound triggered photo flash	Jan p65
Novel alarm for digital clock uses two CMOS oscillators	Jan p65
On screen clock with 2650	Jan p65
Counter records number of camera shutter openings	Jan p67
Make before break meter switching	Jan p67
Auto-chime — which tune is next?	Feb p68
Novel way to play your old 78s	Feb p68
Direct derivation of baud rate clock signals from a 4MHz clock signal	Feb p69
Simple high current regulated power supply	Feb p69
Build this simple solid state scope using LEDs	Mar p66
Test your reaction time on the 2650	Mar p66
Modification to sound triggered photo flash	Mar p67
A decimal & binary learning tool	Mar p67
A simple joystick control	Mar p67

The Australian CB Scene

School of the Air — in Melbourne suburb	Apr p102
New regulations are now in force	May p115
CB: more than its share of awkward questions	Jun p115
Holland to introduce CB radio — on 27MHz FM!	Jul p116
UHF CB is making its mark in the country	Aug p123
South Africa 27MHz CB!	Sep p124
UHF CB helps Commodore to win 1-2-3	Nov p121
First US-style REACT team set up in Sydney	Dec p123
A very private use for CB radio	Jan p104
Fight now — or face a debacle in 1982	Feb p111
Government policy on 27MHz remains unchanged	Mar p113

Regular Features

Editorial
Hi Fi News
News Highlights
Microcomputer News & Products
The Amateur Bands
Shortwave Scene
New Products
Information Centre

Notes & Errata

NRZ Recording (April 1977, 8/M/11)	Apr p109
Bipolar Train Controller (February 1979, 2/MC/17)	Apr p109
2650 Software Record (April 1978)	May p125
2650 Expansion Board (November 1978, 2/CC/32)	May p125
5V/10A (Mini-Brute) Power Supply (November 1977, 2/PS/43)	Jun p125
Low Cost Printer for Mini Scamp (April 1979, 2/CC/37)	Jun p125
Faster Dumping & Loading for the 2650 (April 1979, 8/M/36)	Jun p125
High Performance Train Controller (October 1978, 2/MC/16)	Jul p125
CMOS Die (April 1979, 3/EG/11)	Jul p125
6 Digit Clock (March 1979, 7/CL/29)	Aug p133
Playmaster Digital FM/AM Tuner (November, December 1978, January 1979, 2/TU/46,7,8)	Aug p133
2708 EPROM Programmer (February 1979, 2/CC/36)	Aug p133
Solid State Relay (August 1979, 2/PC/24)	Sep p133
DREAM 6800 (June 1979, 2/CC/39)	Sep p133
2650 Expansion Board (November 1978, 2/CC/32)	Oct p125
Masthead Amplifier (August 1979, 6/MS/5)	Oct p125
2½ Digit DVOM (September 1977, 7/M/52)	Nov p133
Electronic Seashell (December 1978, 3/MS/76)	Nov p133
Understanding BASIC (October 1979, 8/M/41)	Nov p133
Inductance-Capacitance Meter (June 1979, 7/CM/12)	Dec p139
Fan Speed Controller (December 1979, 2/PC/25)	Jan p117
Remote Control (October 1979, 1/MS/19)	Jan p117
6800/D2 to Chip-8 Adaptor (December 1979, 2/CC/48)	Jan p117
Metal Locator (November 1979, 3/MS/79)	Jan p117
Transistor Ignition (December 1979, 3/TI/15)	Mar p125
Autochime (September 1979, 3/MS/57)	Mar p125
Courtesy Light Delay (January 1980, 3/AU/23)	Mar p125
Stereo Graphic Analyser (February 1980, 1/SC/10)	Mar p125



Letters to the editor

Star Trek & EA "whoppers"

I was in a newsagency recently and saw your latest issue of "Electronics Australia". I saw the 'Enterprise' on the cover and being interested in both electronics and Star Trek I turned to p8 to have a quick glance. It was then I saw the first of many errors to come.

Firstly, every Tom, Dick and Harry who even looks at the newspapers will know that the Star Trek movie did not cost \$20 million, for if it did it wouldn't be the most expensive sci-fi production in history. In fact, it cost over \$40 million.

The next whopper was in the bottom corner of page 9. Here is a picture of two hairy, human-like creatures, whom you labelled "the alien approaching at warp 9". These are indeed aliens, called Klingons, who are an equally advanced civilisation and rivals to the Earth empire. These Klingons, in their battle cruisers, are the first victims of the approaching alien.

There two errors I picked up while just glancing at the article, which I didn't have time to read. Who knows how many more there are in the text,



"Ignorant wretch; that'll teach you to label Klingons as aliens."

since it is obvious that your sources of information are not very correct. As Mr Spock would say "quite illogical, captain".

B. Cunningham,
Ryde, NSW.

COMMENT: The figure of \$20 million was supplied to us by Paramount Pictures and, as far as we know, is correct. We admit that the caption labelling the Klingon as the alien invader is incorrect. The offending staff member has been randomised after being teleported to a planet with a pre-Cambrian landscape.

More on cigarette adverts

I have read and enjoyed your magazine for several years now and I regard the advertisements in it as genuinely informative about electronic products that I am interested in.

But a full page ad for tar and lung cancer? (p105 Jan.). That's a bit much! EA to me is a magazine that offers a higher standard of articles and projects than others in the field, and to see it finally succumb to publishing addictive carcinogenic drugs is a real blow.

I hope that this is but one of many letters you receive on this issue and that you keep up your high standards without the inclusion of such advertising.

John Jacobs,
Engadine, NSW.

COMMENT: We can only repeat what we said in our February issue and that is that cigarette adverts are legal and the result of an overall space booking involving the parent companies. Still, we sympathise — there is only one smoker in the EA office and we're working on him!

No CW filter for Yaesu FT625R

With reference to the "Amateur Radio" review of the Yaesu FT625R supplied by Dick Smith Electronics in your January magazine, it appears that there has been some miscommunication of information.

The article states that "at the time of writing the CW optional filter is available ex-stock." This is not so. We do not stock the CW filter nor do we intend to do so. Could you please advise your readers of this fact?

G. Crapp, Service Manager,
Dick Smith Electronics,
North Ryde, NSW.

Criticism of CDI computer program

I was amazed to find in a magazine of such a high standard as "Electronics Australia" the section in Circuit & Design Ideas entitled "On screen clock with 2650" (p67 Jan.).

Firstly, there is a mistake in the listing: 0505 should be 0C and not 00.

Secondly, I was appalled at the amateurish-in-the-extreme nature of the programming. No indirect addressing was used which could have saved up to 10 bytes. There are several wasteful programming combinations such as:

BCTR, GT 03
BCTA, UN 500
instead of
BCFA, GT 500

Also the whole style of data manipulation (ie. in ASCII) is wasteful in terms of memory space. Thirdly, the

setting up conditions are badly explained. It is stated that numbers should be entered in hex, whereas they have to be entered in ASCII; and it is implied that the minutes and hours should be multiplied by 10 on 2nd entry, whereas it requires tens and units digits to be entered.

You state that no responsibility is accepted for the design, but do you have such low standards in accepting material for this column? After all, this column is an advertisement for EA just as much as other parts of the magazine. Perhaps you should start accepting some responsibility.

0500	04	0D	3B	87	03	C1	3B
0510	02	69	77	10	04	65	05
0520	75	10	86	67	96	E6	60
0530	98	4E	07	00	1B	4A	

To set the record straight, I have rewritten the clock program in less than half the space of your published one. It is completely relocatable and must have R2 = Minutes and R3 = Hours (both in BCD) before calling the program. Fine to coarse adjustments are made by altering 0515, 0517 and 0519 respectively.

D. Fulcher,
Strathfield, NSW.

COMMENT: We admit the errors you refer to. However, we publish programs on the understanding that they work, even though they may not be the most refined.

88	04	3A	3F	02	B4	02	C1	3F
65	06	65	F8	7E	F9	7C	FA	7A
98	57	06	00	87	67	97	E7	24

WE'LL GET YOU INTO ELECTRONICS. ONE WAY OR ANOTHER.

At International Correspondence Schools, we have at least 16 career courses you can take in electronics and other inter-related fields, like computers and television. These are the fields of the future that you

should progress in now. And they are all ideally suited to home study. And ICS, being the largest institution of its kind in the world, has access to the latest world-wide developments and its teachers are amongst the best in Aus-

tralia. So, if you're interested in one or more of the courses below, mail the coupon to ICS, and we'll send back everything you need to begin a more successful career.

1 Basic Electronics course for a sound knowledge of radio theory and the industrial applications of electronics.

2 Electronics Technician course, with specialist courses in Audio, Radio and Hi Fi; Communications/Broadcasting; Electronic Computer Servicing; Industrial Electronics. Approved by TETIA.

3 Electronic Instrumentation and Control Systems course for electronics technicians interested in industrial instrumentation and control.

4 Electronic Technology, a program that will fit the ambitious technician for a wide variety of jobs.

5 Electronics Maintenance for basic principles and electronic theory, followed by a practical section of maintenance procedures and techniques.

6 Radio-Electronic Telemetry covers electrical and electronic aspects of telemetering. Employment opportunities abound in this very modern field.

7 Amateur Radio Operator's Certificate of Proficiency prepares you for the examination leading to the Certificate of Proficiency issued by the Postal and Telecommunications Department.

8 Digital Electronics course, as new as today, gives you a thorough understand-



ing of the applications of integrated circuits in electronic equipment.

9 Data Processing. Various courses including Electronic Computer Servicing.

10 TV Servicing courses, in black and white, and PAL colour. Approved by TETIA.

11 TV Principles course for basic television technology. And TV engineering course for complete practical coverage of television engineering.

12 Electrical Engineering Technician course, is especially for those who want to make a start in the industry or want a broad technical knowledge.

13 Electrical and Electronic Drafting is designed for experienced draftsmen wishing to enter this specialised field.

14 Automobile Electrician gives you the basics of servicing the automobile's electrical system.

15 Industrial Electrician course gives comprehensive training on all aspects of the electrician's work.

16 Electrical Mechanic course prepares you for external examinations.

International Correspondence Schools (A'asia) Pty. Ltd., 400 Pacific Highway, Crows Nest, N. S. W. 2065. Tel: (02) 43 2121.

Please send me, without cost or obligation, information about the ICS courses in Electronics.

or, I am interested in a (Please specify) course.

Mr/Mrs/Miss (Please Print)

Address Postcode

Occupation Age Phone

Tick here if currently full time student.

Write to your nearest ICS city: **International Correspondence Schools.**

Sydney: 400 Pacific Highway, Crows Nest, NSW, 2065. Tel: (02) 43 2121.
 Melbourne: 18-20 Collins Street, Melbourne, VIC, 3000. Tel: (03) 63 7327.
 Brisbane: 131 Elizabeth Street, Brisbane, Q.L.D. 4000. Tel: (07) 221 0178.
 Adelaide: 28 Grenfell Street, Adelaide, S.A. 5000. Tel: (08) 51 2834.
 Perth: P.O. Box D157, Perth, W.A. 6001. Tel: (09) 321 8530.
 New Zealand: 182 Wakefield Street, Wellington, C.I. N.Z.

ICS



224 138

THE FAMOUS 2M FM MOBILE IC22S

ICOM



**1000'S
SOLD IN
AUSTRALIA**



STILL ONLY \$299

SYNTHESISED

- * **IDEAL FOR MOBILE**
No digital display, easy to use on the move without looking.
- * **STACKS OF CHANNELS**
22 programmable channels — 11 popular ones already done and 11 for you to program to your own choice.
- * **REPEATER REVERSE**
Full reverse at a flick of a switch.
- * **SUPERB QUALITY AND PERFORMANCE**
The ICOM name is synonymous with reliable communications, as thousands of happy owners will confirm.
- * **COMPLETE**
Comes complete with mic, mobile mounting brackets, dc lead and comprehensive instruction manual. Backed by Vicom 90 day warranty.
- * **LOW RECEIVER NOISE**
The IC22S uses a FET front end and high-Q helicalised cavity resonators. Signal gain of 90dB or more up to second mixer.
- * **PROGRAMMABLE DIODE MATRIX**
It's easy to add extra channels. Just solder in the diodes!

SIMPLY THE BEST!

Typical Technical Characteristics

General: (Australian Model). Number of semiconductors: Transistors 41, FET 7, IC 13, Diode 33 (Except Matrix Board). Frequency Coverage: 146-148 MHz. Antenna Impedance: 50 Ohms unbalanced. Power Supply Requirements: DC 13.8V \pm 15% Negative Ground 2.5 A Max. Current Drain. Transmitting: Approx. 2.0A. Receiving: At Max. Audio: Approx. 0.7 A. Squelch: Approx. 0.4 A. Dimensions: 58mm(H) x 156mm(W) x 218mm(D). Net Weight: 1.9 Kg. Channels Installed: R1-8, 40, 50, 51. **Transmissions:** Transmitting Frequency: 22 Channels in the 2m Band. Programmable by a diode matrix for any channels on 25KHz spacing. Emission Mode: 16F3. Output Power: 10W. Max. Frequency Deviation: 5KHz. Modulation System: Variable

reactance phase modulation. Spurious Emission: More than 60dB below carrier. Microphone Impedance: 600 Ohms. Input level: 10mV typical. Dynamic or optional Electret condenser microphone. **Reception:** Receiving Frequency: 22 Channels in 2m Band. Modulation Acceptance: 16F3. Receiving System: Double super heterodyne. Intermediate Frequency: First IF 10.7MHz. Second IF 455KHz. Sensitivity: Less than 0.5uV for 20dB Noise quieting. More than 30dB S+N+D/N+D at 1uV. Squelch Sensitivity: Less than 0.3uV. Spurious Response Rejection Ratio: More than 60dB. Selectivity: \pm 7.5KHz at the -6dB point. \pm 15KHz at the -60dB point. Audio Output Power: More than 1 Watt. Audio Output Impedance: 8 Ohms.

Available from authorised dealers
throughout Australia



Check it out at your VICOM dealer.

Melb: 68 Eastern Rd. Syd: 339 Pacific Hwy. Bris: 48 6601
Sth. Melb. Perth: 321 3407
Ph. 699 6700 Adelaide: 43 7981

AMATEUR RADIO



by Pierce Healy, VK2APQ

WICEN active during bushfire emergencies

The Wireless Institute Civil Emergency Network provided valuable radio communication facilities during the disastrous bushfires around Sydney in December 1979. The large number of members who gave their services was particularly gratifying in view of the holiday period.

Backup communication links provided by WICEN members greatly assisted firefighting crews when the northern areas of Sydney, NSW, were subjected to the worst bushfires in living memory. Fifteen houses and hundreds of hectares of bushland were destroyed, and many homes and buildings damaged but, fortunately, no lives were lost.

The WICEN organisation was very heavily involved in the Warringah, Hornsby, and Ku-ring-gai emergencies for three days. Base and mobile communication units were provided for fireline tankers, called in from outlying areas, whose radios were incompatible with the local frequencies. Communication was also provided for the mobile canteens feeding the fire crews.

In addition, operators were provided for the bushfire council's emergency channel. This links all fire control headquarters in the Sydney area with the bushfire council operations room in Sydney, and the operations room of the NSW Fire Brigade.

At Warringah fire control centre, WICEN staffed the bushfire emergency channel continuously throughout the three days December 17, 18, 19, and a WICEN operator manned the bushfire council's operational terminal throughout the 18th December.

On December 23, WICEN was again activated and established VHF and HF links between Baulkham Hills fire control centre and two WICEN mobile units at Bilpin in the lower Blue Mountains. These links served the Baulkham Hills, Hornsby, and Warringah fire tankers and crews, deployed between Bilpin and Mt Tomah, providing communication with their home bases.

They handled traffic concerning relief crews, spares and materials, and catering requirements.

Around 9.00pm on December 23, the Blue Mountains emergency fire control appointee requested a teletype link between Katoomba fire control centre and the Colo fire control centre at Wilberforce. Members of WICEN and the Australian National Amateur Radio Teleprinter Society responded and, despite the lateness of the hour, coupled with it being a holiday period and involving a drive of over 60km, voice and RTTY links were established before midnight.

Operation continued until 6.00pm on December 24 when cooler conditions and light rain relieved the fire situation.

On the same afternoon the Central Coast WICEN group was put on standby due to a fire in very rugged country some 45km west of Gosford.

Actual operations commenced at 6.00am on December 27 and continued until 10.00pm on December 28. WICEN members provided fire line communication with the fire brigades and liaison communication with army units assisting the brigades, as well as maintaining direct links with the Gosford fire control centre.

During the period WICEN was activated, the channel 8 repeater VK2RWI at Dural, and channel 3 repeater VK2RAG at Somersby, were used for emergency traffic.

About 75 amateurs participated in various capacities such as area controllers, base station and field station operators, roster control officers, liaison duties and a multitude of activities associated with communications

during such emergencies. Many more amateurs were on standby had their services been required, and there were also a number of non-amateur WICEN members who assisted in various ways.

To record all call signs or names of those involved is not practicable here. However, collectively, their efforts and work as members of WICEN, in providing such an essential community service, has been recognised by the statutory bodies they assisted. These bodies have expressed their appreciation of the voluntary help given to the community.

It may be of interest to community organisations to know that WICEN already assists in a variety of community activities such as search and rescue exercises, memorial service marches, and sporting events. The latter include Sydney's famous City to Surf footrace, endurance equestrian events, motor trials, etc. It is willing and able to assist wherever it can, and operates in all states and the ACT. Further information from: NSW WICEN Co-ordinator, Wireless Institute Centre, 14 Atchison St, Crows Nest, 2065, or from other WIA state Divisions.

ITU WARC NEWS

Last month's notes made reference to discussion at WARC of the role which amateurs, and the amateur bands, can play in the case of natural disasters. This month's lead story, describing WICEN's role in the Sydney bushfires, adds emphasis to this aspect of amateur radio.

While there is nothing new about WICEN and similar organisations, or the provision of emergency communications by individual amateurs, or hastily organised groups, there has been little or no obligation in the past for administrators of radio regulations to recognise the role amateurs play, or to grant official status to emergency organisations, such as WICEN.

It is very gratifying, therefore, to learn of a WARC resolution aimed at providing official recognition of the

AMATEUR RADIO

role amateurs have played in the past and which they can play in the future, and at giving emergency organisations, such as WICEN, official status.

The resolution itself is quite lengthy and, as is customary, is couched in formal terminology. But, in its essentials, it puts on record the fact that amateurs have played a vital role in the past, and that they are often in a unique position to swing into operation more speedily than other organisations, who may have to apply for permission to use certain frequencies.

Having acknowledged these, and other, points in favour of amateur participation in emergency communications, it goes on to recommend that individual administrations give official recognition to the part the amateur can play, and to any organisation which amateurs may form to prepare themselves for such emergencies.

It also recommends that, where such an organisation exists, it be given the prior right to allocate the use of frequencies in the case of emergencies. Also, where amateur frequencies are taken over by other authorities, that their right to these frequencies be

restricted to the period and area of the emergency.

Another very important recommendation is that in emergencies, amateurs be allowed to communicate directly with other organisations, using other than amateur frequencies, where this would speed up communications.

All in all, it represents a major step forward in amateur status on a world-wide basis; one which, if taken full advantage of now, will enable us to present an even stronger case for retention of our rights at the next World Administrative Conference.

MAASARC

The bi-monthly meeting of the Museum of Applied Arts and Sciences Amateur Radio Club (MAASARC) will be held at the Museum, Harris Street, Ultimo, Sydney (off Broadway near Railway Square), on Wednesday evening 26th March, 1980.

The meeting will take the form of a demonstration and talk on one of the many interesting collection of historical and fine artifact held by the Museum.

Amateurs, either as visitors or prospective club members, and their families are invited to attend another of these interesting evenings.

The Museum's amateur radio station, VK2BQK, is part of an educational and historical display depicting various aspects of radio communication over the years and includes a tableau of an early 1920 amateur radio station and a

fully operational modern station with world-wide communication capabilities.

VK2BQK is operated on a voluntary basis by MAASARC members during weekends and for demonstration purposes to school groups.

Membership of the club is open to all amateurs who are interested in demonstrating amateur radio to the general public. Application forms are available from Mr Jeff Sergel, Curator of Electronics at the Museum on telephone (02) 211 3911 during business hours.

34th URUNGA CONVENTION

The 34th annual Urunga Convention and Field Day will be held over the Easter holiday weekend April 4, 5, 6, 1980.

Activities commence at 8.00pm at the Ocean View Hotel, Urunga, on Friday evening for registration and social get together. Registration fees — Men \$7.00; Ladies \$5.00; Family \$15.00. Includes — morning and afternoon tea Saturday and Sunday, supper Saturday and Sunday, maps and tourist information of the area, and entry fee for all events.

Field events commence at 10.00am Saturday opposite the Ocean View Hotel Urunga. These will consist of transmitter hunts on 7MHz, 28MHz and 146MHz. Bring your own lunch. A social evening commencing at 8.00pm will be held in the School of Arts Urunga with films and supper.

Sunday events will commence at 10.00am at the Bellingen Show Ground (turn at Bellingen Post Office and follow signs). Barbecue lunch will be available at the ground at \$3.00 per head. The Urunga scramble will be held 2.30pm-3.00pm any band, any power, any location. In addition there will be hidden transmitter hunts and events for ladies.

Car trips have been arranged to local cottage industries. There will be trade displays, bring and sell disposals, quizzes and lucky numbers.

The frequencies 7100kHz; 28.5MHz and 146MHz will be monitored for talk-in assistance.

Further information from the Urunga Convention Secretary, VK2BMK, Dowie Street, Bellingen NSW 2454, or the Coffs Harbour Radio Club net each Monday evening at 8.00pm (summer time) on 3610kHz.

STORM DESTROYS REPEATER

On Queensland's Gold Coast, local and visiting amateurs have been well served by the Gold Coast Amateur Radio Club VHF/UHF repeater, VK4RGC, at least until just prior to the Christmas holidays. Then came disaster.

The extent of the damage and action taken to rejuvenate the installation is given in the following note received from Glen Wallace, VK4NUX, secretary

Lafayette)) TWO-WAY RADIO

FOR INDUSTRY, FARMS BOATS, SPORTS, ETC.



1 WATT 3 CHANNEL LAFAYETTE HA-310



1000's of Lafayette HA-310 Walkie-Talkies in use in Australia. 100,000's throughout the world, attest to their superior qualities. A professionally designed, sturdily constructed, commercial quality unit for top performance and long term reliability. Rechargeable Nicad battery packs and large range of accessories available.



Pinnacle PE-920. 6 channels, 5 watts, transceiver for 27MHz marine, within premises and limited area services. Ideal mobile or base station unit. Design eliminates unwanted image interference from CB stations. Up-to-the-minute design with all wanted features.



P & T Dept Approved (Licence Required)

Lafayette are 2-way specialists. Large range of crystals, antennas, auxiliary equipment available!

Dealer enquiries invited.

Lafayette)) the Communicators

LAFAYETTE ELECTRONICS Div. of ETD Electronics Pty Ltd
94 ST KILDA ROAD, ST KILDA, VIC 3182. Tel 534 6036.

IONOSPHERIC PREDICTIONS FOR MARCH

Reproduced below are radio propagation graphs based on information supplied by the Ionospheric Prediction Service Division of the Department of Science. The graphs are based on the limits set by the MUF (Maximum Usable Frequency) and the ALF (Absorption Limiting Frequency). Black bands indicate periods when circuit is open. 3.80

14MHz EAST		01	02	03	04	05	06	07	08	09	10	11	12	13	14	15	16	17	18	19	20	21	22	23
EAST AUST TO BARBADOS (SR)																								
JOHANNESBURG																								
McMURDO SOUND																								
NEW DELHI																								
NEW YORK																								
RIO DE JANEIRO																								
TOKYO																								
VANCOUVER																								
WELLINGTON																								
WEST AFRICA																								
WEST EUROPE (SR)																								
WEST EUROPE (LR)																								
ADELAIDE TO SYDNEY																								
BRISBANE TO MELBOURNE																								
PERTH																								
SYDNEY																								
DARWIN TO SYDNEY																								
MELBOURNE TO PERTH																								
SYDNEY																								
21MHz GMT		15	16	17	18	19	20	21	22	23	24	01	02	03	04	05	06	07	08	09	10	11	12	13
EAST AUST TO BARBADOS (SR)																								
JOHANNESBURG																								
McMURDO SOUND																								
NEW DELHI																								
NEW YORK																								
RIO DE JANEIRO																								
TOKYO																								
VANCOUVER																								
WELLINGTON																								
WEST AFRICA																								
WEST EUROPE (SR)																								
WEST EUROPE (LR)																								
ADELAIDE TO SYDNEY																								
BRISBANE TO MELBOURNE																								
PERTH																								
SYDNEY																								
DARWIN TO SYDNEY																								
MELBOURNE TO PERTH																								
SYDNEY																								
28MHz EAST		01	02	03	04	05	06	07	08	09	10	11	12	13	14	15	16	17	18	19	20	21	22	23
EAST AUST TO BARBADOS (SR)																								
JOHANNESBURG																								
McMURDO SOUND																								
NEW DELHI																								
NEW YORK																								
RIO DE JANEIRO																								
TOKYO																								
VANCOUVER																								
WELLINGTON																								
WEST AFRICA																								
WEST EUROPE (SR)																								
WEST EUROPE (LR)																								
ADELAIDE TO SYDNEY																								
BRISBANE TO MELBOURNE																								
PERTH																								
SYDNEY																								
DARWIN TO SYDNEY																								
MELBOURNE TO PERTH																								
SYDNEY																								

of the Gold Coast Club.

"Unfortunately, in the early hours of 14th December, 1979, the Gold Coast Amateur Radio Society's VHF/UHF repeater, VK4RGC, was struck by lightning during a violent electrical storm. The repeater is almost beyond repair. The society plans to build and maintain a new repeater, expected to be in operation around February/March. Any donations towards the expense of the new repeater would be gratefully accepted.

"Donations should be sent to:— GCARS Secretary, PO Box 588, Southport, Qld 4215. Cheques should be made payable to:— Gold Coast Amateur Radio Society."

MORSE CODE

There have been many opinions expressed regarding the correct approach to learning Morse code and the way characters should be sent, particularly in relation to the give word per minute text for the novice licence examination conducted by the P&T Department.

Here is an extract from an article by Bill Welsh, W6DDB from "CQ August 1979".

"The dah is generally said to be three times as long as the dit. This relationship only holds true at about 15 words per minute. The length of the dit is constant; it is the time required to lift the wrist after depressing it to send the dit. Since it takes about the same length of time to depress or raise the wrist, the spaces between the dits and dahs in symbol are about a dit length.

"At a code speed of about 2wpm, the dah is commonly about six times the dit length and it shortens to about five times the dit length at 5wpm. The dah length is reduced to about four times the dit length at 9wpm and about three times the dit length at 15wpm. The dah is about twice as long as the dit at 35wpm and is reduced to about 1.5 times the dit length at 55wpm.

"The dit length does not vary in good code, nor does the space between dits and dahs in a code symbol. The dah length does vary with code speed, as does the space between words. The space between words is basically twice the length of the dah being sent, plus one dit length. If you are sending code

at 5wpm, the space between two words should be about 11 dits long and it is most easily obtained at this slow speed by taking your hand off the key between words."

Not wishing to start another rash of controversial opinions, it was noted, however that the foregoing statement, by inference, refers to a straight key (village pump variety). The question is — how do the multitude of other key types, including electronic and keyboard types, with character forming and speed control devices, fit that dit-dah relationship?

On the other hand; how many operators would agree with the view expressed in the following ditty heard on two metres FM?

"If you can fill the unforgiving minute
With twenty words of Morse well sent,
Yours are the bands and everything within;
And what is more — you will be a 'HAM' my friend."

Radio clubs and other organisations, as well as individual amateur operators, are cordially invited to submit news and notes of their activities for inclusion in these columns. Photographs will be published when of sufficient general interest, and where space permits. All material should be sent to Pierce Healy at 69 Taylor Street, Bankstown 2200.

LATEST EDITION OF BASIC ELECTRONICS

Order your copy now!

Available from "Electronics Australia," 57 Regent St, Sydney. **PRICE \$3.50.** OR by mail order from "Electronics Australia", PO Box 163, Beaconsfield 2014. **PRICE \$4.10.**

SO YOU WANT TO BE A RADIO AMATEUR?

To achieve this aim, why not undertake one of the Courses conducted by the Wireless Institute of Australia? Established in 1910 to further the interests of Amateur Radio, the Institute is well qualified to assist you to your goal. Correspondence Courses are available at any time. Personal classes commence in February each year.

For further information write to
**THE COURSE SUPERVISOR,
W.I.A.**

P.O. BOX 123,
ST. LEONARDS, NSW 2065

SPECIAL PURCHASES

NEW B.S.R. RECORD CHANGERS-PLAYERS



MODEL C197
\$47.50

This is a new model just released and is fitted with a ceramic cartridge & diamond stylus. Auto or manual operation. Three speed 33, 45 & 78rpm. Cueing control and bias compensation. Changer & player spindles supplied. 11" turntable. Post & packing extra. NSW \$2.75. Vic. Qld \$3.75. WA, NT & Tas \$4.75.

SPEAKER GRILLE FABRIC AT 1/2 PRICE

AVAILABLE IN BLACK, BLACK WITH GOLD FLECK, LIGHT & MID BROWNS. WIDTH 54"

\$4.80 Per YARD. Post & Pack \$1.75.

Send two 20c stamps for samples.

GARRARD CC10A RECORD CHANGER

\$15.75

Fitted with a Sonatone Garrard Ceramic Cartridge Sapphire Stylus supplied with template & instructions. Posts & Packing: NSW \$2.50 Inter. \$3.50

MODEL C142R

HI-FI UNIT WITH ADC MAGNETIC CART & DIAMOND STYLES

\$55.00



A precision automatic and manual record-playing unit fitted with 4 pole motor to provide constant speed conditions for the 11 1/2 inch turntable. The low resonance tubular pickup arm is counter-balanced with a resiliently mounted weight to permit light sensitive tracking, and the slide-in cartridge carrier enables styles inspection and the interchange of replacement of cartridges to be carried out simply and quickly. Fine stylus force adjustment and bias compensation are both calibrated for accurately setting the arm to given optimum playing conditions for the chosen cartridge.

The fluid-damped level-type cue and pause control ensures gentle lowering of the pickup to the surface of the record. A short spindle is supplied for single record play records. Precision engineering is reflected in the styling of the 142R, which is elegantly finished in black and silver.

POST AND PACKING EXTRA

NSW \$3.75
Tas. WA & NT \$7.00

Vic. SA & Qld \$5.75
(Reg. post \$2.00 extra)

NEW RANK-ARENA F.M.-A.M. TUNER AMPLIFIER

MODEL RA402. Output 24 watts RMS. (12+12). Response 50HZ to 50KHZ. Mag or ceramic inputs. High & low filters. Loudness control. Provision for 4 speakers.

Freight Extra.

\$147.00

NEW AWA HI-FI SPEAKER KITS 8" 2 WAY 3 SPEAKER SYSTEMS

AT LESS THAN 1/2 LIST PRICE

POWER RATING 20 WATTS R.M.S.
IMPEDANCE 8 OHMS
FREQUENCY RANGE 46 TO 18000 CYCLES

Supplied in kit form (less cabinet) each kit comprises: One AWA 8WAC 8in. bass unit, two AWA 4MBC 4in tweeters with ceramic magnets & curve-linear cones, crossover components, grille cloth, innabond lining and cabinet plans

CABINETS AVAILABLE
Post & packing extra. NSW
\$2.50. Interstate \$3.50.

\$18.50
Per Kit

NEW E.M.I. AND HITACHI RECORDING TAPE AT BARGAIN PRICES

HI-DYNAMIC EMITAPE — HIGH OUTPUT — LOW NOISE — HI-FIDELITY

HLP18 7" reel 1800ft. long play \$5.95 P & P \$1.00

HDP12 5" reel 1200ft. double play \$3.95

NEW E.M.I. SUPE C90 CASSETTES, 5 FOR \$10.00. P&P \$1.00

NEW E.M.I. HI-FI C90 CASSETTES 5 for \$12.50.

Hitachi LN 8-track 90 minute cartridge, 5 for \$10. P & pack \$1.50.



NEW GOODMAN-FOSTER 3-WAY 4-SPEAKER HI-FI SYSTEM

\$39.00 PER KIT

Frequency Range 45 to 22,000 cycles. Power rating 25 watts RMS Imp-8ohms. Supplied in kit form (less cabinet) each kit comprises two English Goodman 8" bass units. Foster 5" mid range. Foster 1" dome tweeter crossover components Ocodensers and inductance innabond, speaker fabric and plans of cabinet. Cabinet dimensions 23" x 13" x 10". CABINETS AVAILABLE.

Post & packing extra: NSW \$2.70; VIC. SA. QLD. \$4.70; WA \$5.70. (REGISTERED POST \$2.00 EXTRA IF REQUIRED) cabinets available

RANK-ARENA 2 WAY SPEAKER

\$42.00
PER PAIR

- 10 Watts RMS
- 8 ohm impedance
- 8" woofer with tweeter
- Supplied with lead and plug
- Teak finish

Dimensions 18"H, 11"W, 9 1/2"D

Freight extra per rail air or road transport



NEW HOKUTONE HI-FI SPEAKER KITS AT A FRACTION OF LIST PRICE

NEW THREE WAY HIGH FIDELITY SPEAKER SYSTEM WITH A FREQUENCY RANGE OF 35 TO 20,000 CYCLES. POWER RATING 50 WATTS.

Supplied in Kit form (less cabinet) Woofer HFW-302, 12" Mid range HM-24 dome Tweeter HT-60 dome. Three way crossover with separate controls for mid range & tweeter. Innabond lining, grill fabric & cabinet plans supplied Cabinet dimensions 668 high, 435 wide, 310 deep

\$69.00 per kit

Freight extra by rail, air or road transport

NEW HOKUTONE 12" HI-FI SPEAKERS

Model 300F W09YL 12" power rating 20 watts, 80HM IMP cone resence 30 cycles. Manufactured by Hokutone Onkyo Co Japan

\$14.50 POST & PACK \$2.50

NEW CAR CASSETTE CONVERTERS BICOH MODEL NA100/CC-007A AT APPROX. 1/2 LIST PRICE

By connecting this model with your existing AM car radio, you can enjoy the music of any cassette that has been pre-recorded.

Connection requires no alteration to the car radio. Plug your car aerial into the cassette recorder and using the patch cord supplied, connect the recorder to the aerial connection of your car radio. By following the instructions, installation is a simple procedure. All cords & brackets are supplied.

Can be used in any car with a 12-volt neg. earth system can also be used with any AM radio by using a 12V supply.

Dimensions: 150 x 110 x 53mm

(SEE REVIEW EA FEB 1980)



\$18.50
post & pack
\$1.50 extra

NEW GARRARD 6-200 CP RECORD PLAYERS

Fully automatic turntable automatically or manually as required. 11" turntable. Cue & pause control. Record speeds 33 1/3, 45 and 78 rev/min. Finished in black with silver trim. Fitted with ceramic cartridge. Post & packaging extra NSW \$2.70; Vic. Qld. SA \$3.70; WA \$4.70 (registered post \$2 extra if required).



\$34.00

CLASSIC RADIO

245 PARRAMATTA RD, HABERFIELD 2045. PHONES 798-7145, 798-6507.

The Australian CB SCENE

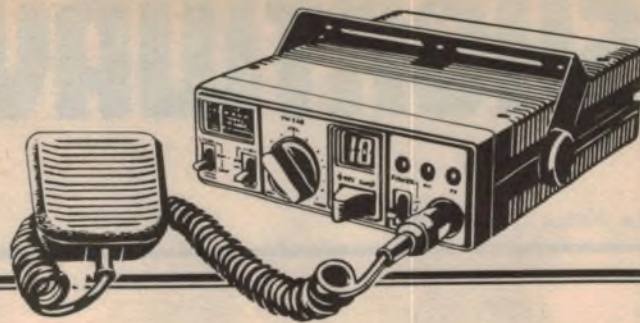

GOVERNMENT POLICY ON 27MHz REMAINS UNCHANGED

According to NCRA member Jan Christensen, the WARC Conference has come and gone with no sign of any feedback which would bear on the Australian Government's policy in regard to the 27MHz CB band. Reflecting the views of many other CB operators, she reports as follows:

Frankly I have grave doubts as to whether we ever will hear anything about that because I am cynical and pessimistic enough to believe that, Governmental statements to the contrary, the Australian 27MHz service didn't even rate worthwhile mention.

I do have a letter dated December 8th, 1979, from the Deputy Prime Minister, Doug Anthony. He states that his talks with the Minister for Post and Telecommunications on the subject of the retention of 27MHz after 1982 have confirmed the Government's stand that the HF part of the CBRS is still to be abolished (unless WARC makes a decision to the contrary).

I believe that the Queensland and Victorian Divisions of the NCRA, and possibly other Divisions as well, have rallies planned, and that petitions are (or soon will be) flooding the CB scene in an effort to show that we won't relinquish the band willingly, after spending many hundreds of dollars per member on equipment and licences.

The Government still refuses to face the fact that they will be killing the goose that laid the golden egg in regard to revenue derived from the HF service, if they persist in their stated intentions.

The administration and servicing of the HF (and the UHF) band cost the Department very little, simply because it has done very little administrating and/or policing since the introduction of the "Service" in 1977.

One can only hope that every operator in Australia will seriously consider how much he or she has gained out of CB radio and will add their voice to the fight to retain 27 megs. This is an election year, and with a little luck and a lot of effort, we could well make this an election issue. I am sure that we can achieve our aims in the fields of the retention, expansion and proper policing of the band if we strive together and continuously.

Getting away from 27MHz, a rumour has been running wild in Queensland to the effect that "a certain manufacturer of UHF equipment" has donated a reported 700 UHF sets to truck drivers in the Sydney area, with no strings attached. Further, that truckies in Queensland have received a similar offer which might indicate that the exercise is Australia-wide.

More than that, the offer includes linear amps and scramblers!

Flowing from the rumour two widely different explanations are being offered:

1. It's an elaborate (and costly) promotional exercise to boost the popularity of UHF CB;

2. It's part of a master plan to crowd the private CBER off the band and to transform it into a General Business Band.

It would seem, however, that both explanations are wasted.

When the story was drawn to his attention, the Editor-in-Chief of EA personally contacted the management of Philips-TMC, presumably the "certain manufacturer of UHF".

As it happened, Philips had heard the rumour, too, via their Brisbane office and their retort was the rather wry remark, "That'll be the day, when we're in a position to give away 700 transceivers — for any reason at all!"

Yes, Philips had donated some FM320 transceivers to the trucking association — about 30 in all — which were used to set up the highway emergency net between Brisbane and Melbourne. The gift was announced in September 1978 and the completed network featured in this magazine in January 1979.

To validate the rumour, Philips would have to spring another 670 FM-320s, plus the alleged linears and scramblers!

Their summary of the rumour: pure fantasy; hogwash!

According to Philips-TMC, sales of the FM-320 are picking up, particularly in rural areas, where farmers and others need reliable but inexpensive 2-way communication.

As for the alleged crusade to subvert UHF CB for business purposes, that would be particularly wasteful and unnecessary. From the very outset, Australian regulations have specifically envisaged non-priority commercial use of the bands: "The CBRS . . . may also be used for business activities which are compatible with the operating conditions in the service."

One final point for this month. In order to make the news on this page as diversified and interesting as possible, I would like to hear from you, the readers. Send any interesting snippets to: Jan Christensen, CB Scene, GPO Box 2264, Brisbane 4001. Let's all support EA. They're supporting us!



Pictured above is a pair of National RJ-380 transceivers, which cover 6 channels on the 27MHz CB band. Rated RF power output is 500mW, or 3W from the RJ-380S. Power source is eight "AA" size cells. Details from National Panasonic Aust Pty Ltd, 57 Anzac Pde, Kensington NSW 2033.

SHORTWAVE SCENE

by Arthur Cushen, MBE



Major increase in frequency allocations

The outcome of the World Administrative Radio Conference held in Geneva last year has been a 60% increase in the frequencies allocated to international short-wave broadcasting. This expansion has taken place in the 11, 15, 17 and 21MHz bands, with an overall increase of 850kHz.

The major increase in frequencies of all short-wave bands, except the 6 and 7MHz bands, will enable short-wave listeners to enjoy better reception, with less interference. The changes announced at the Geneva Conference will, however, not take place until 1989, because the fixed services currently using the newly allocated frequencies will have to be moved.

A new band has also been established for international broadcasting between 13600 and 13800kHz, while the only band to suffer loss of frequency space is the 11-metre band which will now be 25670-26100kHz — a loss of 70kHz. The band which possibly interests listeners most, the 31-metre band, will be increased from 9500-9775kHz to 9500-9900kHz. Other bands will be increased to a similar degree.

According to George Jacobs of the Voice of America, there will have to be a conference in 1983 or 1984 to try to clear up the present unsatisfactory frequency sharing of the international short-wave bands. It is thought that many of the current problems could be overcome by a better co-operation between the various broadcasting countries.

The fact that the 6 and 7MHz bands were not increased in size was of concern to Western European countries and the vote here was lost by a slim margin. This may mean that countries not satisfied with their allocation in this band may start out-of-band broadcasting. Some countries have already

Notes from readers should be sent to Arthur Cushen, 212 Earn Street, Invercargill, NZ. All times are GMT. Add eight hours for WAST, 10 hours for EAST and 12 hours for NZT.

been noted between 5900-5950 and 6200-6300kHz.

WARC AT A GLANCE

MHz	Old Band	New Band
6	5950-6200	5950-6200
7	7100-7300	7100-7300
9	9500-9775	9500-9900
11	11700-11975	11650-12050
13	—	13600-13800
15	15100-15450	15100-15600
17	17700-17900	17550-17900
21	21450-21750	21450-21850
25	25600-26100	25670-26100

The total increase in bandwidth is 850kHz. The only band to lose frequencies was the 25MHz band which lost 70kHz at the lower end. This portion has been transferred for use by Radio Astronomy. There will also be a restriction of 50kW in the tropical bands covering: 2300-2495, 3200-3400, 4750-4995 and 5005-5060kHz.

REGULAR MEETINGS

Though the World Administrative Radio Conference meets only once every 20 years, there are frequent meetings by regional organisations such as the Asian Broadcasting Union and by other stations involved in frequency allocations. This "club" of Western European stations, as well as VOA and CBC, meet to plan the seasonal changes within their respective areas of influence so that when they submit their frequency plans to Geneva they will not conflict with one another.

The last meeting was held in December in Cologne, when plans were drawn up for frequencies to be used in the J period from May 4. Stations attending included BBC, Radio

Nederland, CBC, VOA, Deutsche Welle, Radio Free Europe-Radio Liberty and the Federal Communication Commission which looks after assignments of the private radio stations in USA. One interesting outcome of the meeting was that Radio Liberty agreed to drop the use of 15290kHz which is the reason for the jamming on VOA in the past. This interference has now been eliminated. VOA is using this frequency from the Philippines Relay Base to Australia from 2200GMT.

DARWIN TO REOPEN

The Australian Minister of Foreign Affairs has announced that the Darwin transmitting site will be back in operation by 1982, and would play a major role in broadcasting Radio Australia programs in Chinese.

He indicated that the success of the Indonesian service, which includes Indonesian-English lessons, had been such that in the past 20 years over one million had applied for text books. It is anticipated that a Chinese-English Educational program will be broadcast from Radio Australia to mainland China in the hope that the same interest will be shown by students in that country.

The Darwin transmitters were put out of action some years ago when the station was devastated by cyclone Tracy.

DX PROGRAM POPULAR

Radio Nederlands "DX Jukebox", broadcast each Thursday for listeners in Australia and New Zealand at 0750 and 0850GMT on 9715kHz and 9770kHz (second transmission 9715kHz only), is now the most popular session in the program schedule. The station recently conducted a world-wide audience survey on listener program preferences and found that the DX Jukebox session rated high.

It was also found that the "Pacific DX Report", recorded in Invercargill and broadcast on the first Thursday of each month, was greatly appreciated by listeners. As a result, the writer has been asked to increase the time from five to eight minutes for this segment, which broadcasts short-wave items of

SHORTWAVE SCENE

interest to listeners in the Pacific area.

The new eight minute report is now broadcast on the first Thursday of each month, as before. Incidentally, the report from Invercargill is now in its 15th year on Radio Nederland and is the longest running DX report on the station.

SUNSPOTS DECREASE

The high sunspot count in recent months has forced short-wave stations to use higher frequencies. Now, however, the sunspot count has moved into the downward trend of its 11-year cycle and is rapidly declining. The predicted sunspot count for coming months is as follows: March 138, April 135, May 133 — down from a maximum of 182 last November. As the sunspot count decreases, short-wave stations will revert to lower frequencies and the 11 and 13-metre bands will become less active.

HCJB on 26020kHz

Radio HCJB in Quito, Ecuador, after several weeks of testing with 100W on 26000kHz, has moved to 26020kHz for the transmission which is broadcast 24 hours a day. The frequency of 26000kHz is used by the Voice of America in the Philippines from 2200 to 0300GMT. The change of frequency gives continuous interference free reception of HCJB which, in the South Pacific area, gives best reception around 0800GMT.

Sydney Listener Wins Trip

Probably the biggest prize ever won by a radio listener in Australia has been awarded to Chris Martin of Sydney. Chris was the most distant listener to CJVB, Vancouver, Canada for their broadcast on December 1.

On that occasion CJVB increased power to 50kW on 1470kHz and had a special program from a local ballroom. The station invited collect telephone calls from distant listeners. The program could not be heard in New Zealand because the broadcast ended at 0800GMT and daylight extended up to 0930GMT. Chris Martin, realising that it would be only in the Queensland area that it would be dark, listened at Coolool on the Queensland Coast and was successful in hearing the broadcast and telephoning the station. This month, Chris Martin is to marry Lynne Sprong and they plan to make the trip to Vancouver for their honeymoon.

There were many calls received by CJVB during the broadcast, including

one from Sweden and another from Neville Clarkson of Mt Hagen in Papua New Guinea, who lived for some years in Invercargill.



Chris Martin at his listening post.

LISTENING BRIEFS AFRICA

ALGERIA: Radio Algiers has been heard on the new frequency of 15155kHz at 0900GMT in French. This was followed at 0905 by a program in English — a language lesson for Algerian people learning the English language.

LIBYA: According to the BBC Monitoring Service, Libya has been heard on 7120kHz with English from 1500 to 1530GMT. Announcements state that the program is on the air daily and addresses in Libya and Malta are given for listeners' letters.

SWAZILAND: Trans World Radio, using a new 100kW transmitter, is now using 11740kHz in place of 11840kHz. An English broadcast at 1530GMT was received at fair strength and at 1600GMT a request for reception reports to Trans World Radio, Box 64, Manzini, Swaziland was given. The transmission continued in English but side-band from Radio Nederland, Madagascar, spoilt an otherwise good signal.

ASIA

TAIWAN: Taipeh is broadcasting in English 2140-2240GMT on several frequencies according to Bill Richards, Adelaide in "DX Post". The frequencies in use are 9685, 11825, 15270, 17890kHz.

Signals from a medium-wave station using the slogan "International Community Radio" have been noted on 1550kHz at 1500GMT. News is broadcast by Mike Mann and then follows light music. This station was formerly the American Forces Taiwan Network and has now been taken over by civilian staff. The address for reports is Taipeh Hilton Hotel, 38 Chungshao Road, Section 1, Taipeh.

SYN-1 Single Board Computer \$210.00
KTM-2 CRT TV Keyboard terminal module \$349.00
BAS-1 8K BASIC ROM for SYN-1 \$149.00
BUFFERED MOTHERboard for SYN-1, KIM-1 or AIM-65 systems \$179.00



16K-8 fully tested memory board WRITE PROTECT and BANK switching for SYN-1, KIM-1 or AIM-65 systems \$360.00

EPROM Programmer and EPROM ROM Board MEMORY mapped EPROM programming will program up to 16K per command firmware in PROM included. For SYN-1, KIM-1 or AIM-65 systems \$345.00



AUTOMATIC TELEPHONE DIALER PROM dialling 32 numbers plus other options \$180.00



PRESETABLE COUNTER 5 digits suitable for counting, batching and numerical control \$150.00



DIGITAL TACHOMETER \$120.00



STEPPING MOTORS wide range for N.C. Control, Plotters, Variable speed, Servo Control etc. From \$49.50



HAND HELD TACHOMETER \$180

STEPPING MOTOR DRIVING CIRCUITS for 3 or 4 phase in Mode 1 phase 2 phase 1-2 phase excitation. From \$12.00

THUMB WHEEL SWITCHES — \$2.20ea.

TROXINITY TRANSDUCERS — \$15.00ea.

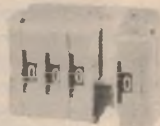

Mail orders add \$3.50 for postage and packaging

G.C.S. 67 Blackshaw Avenue, MORTDALE 2223. Telephone: 570 1225

(Trade enquiries invited)

New Products

New 35W PA Amplifier from Tandy

Designated in their catalog "New for 80", Tandy's solid-state public address amplifier model MPA-35 has been expressly designed to meet the needs of churches and other bodies requiring medium-power sound reinforcement. It is neat and compact but provides all the facilities normally required for such situations.

In terms of presentation, the MPA-35 has a matte finished metal panel, with five function knobs, each one skirted and with a 0-10 scale to facilitate setting up. An imitation wood-grain cover is fitted, which would merge easily with the average decor. Overall measurements are 290mm(w) x 98mm(h) x 235mm(d).

Mixing facilities are provided for three input channels, including two microphone channels, each with a rated sensitivity (for full output) of 1.5mV, and each with an input impedance of 50,000 ohms. This would make them suitable for use with a wide range of present-day dynamic or electret microphones.

The third channel operates in conjunction with a slide switch on the rear panel and can accept either an "auxiliary" input (150mV and 50kohms) or the output from a magnetic phono cartridge. For the latter purpose, L & R input connectors are provided but they are merged into a mono signal within the amplifier. Input impedance is 50k and sensitivity 3.5mV, with compensation approximating RIAA (+12dB at 100Hz, -13.5dB at 10kHz).

As an interesting provision, mic. 1 operates in conjunction with a "Priority" lever on the front panel and an associated switch on the back. In one position of the latter switch, Mic. 1 operates, as normal, into the 3-channel mixer. In the other position, it is functional only when the spring loaded "Priority" lever is depressed, an action which interrupts the other channels. This provision permits the amplifier to be used directly for pageing, using a local microphone to channel 1.

Other controls on the front panel include a master volume knob and a top-cut tone control (18dB at 10kHz). To the extreme right is an on/off switch and an indicator bezel.

The rear panel accommodates all the necessary connections and is generously labelled to minimise the risk of error. There are two 6.5mm sockets for the microphones, plus other input

facilities, as mentioned earlier, and a "GND" terminal for earthing to auxiliary input devices.

At the other end of the panel is the power cord and fuse while, in between, is a row of connectors for the loudspeaker(s). These provide for direct voice-coil connections (4, 8 and 16 ohms) and for constant-voltage lines of 25V and 70V.

Tandy have foreseen the need for a manual to explain all this to non-technical purchasers and a 14-page booklet which comes with the amplifier is quite commendable in this respect. We noted only one error, in that the "watts" markings on the primary of the constant-voltage matching transformers are back-to-front; (page 9).

To provide for multiple load

Signal/noise ratios, however, are quoted as 60dB or better.

Internally, the construction is about what one would expect from the kind of circuitry involved. A metal tray supports the three transformers, which are suitably orientated with respect to each other. It also supports the front and rear panels and provides heat sinking for the power transistors. Low-level circuitry is accommodated on an L-shaped PC board, with a fair amount of conventional wiring to the controls on the front panel and to the connectors and switches at the rear.

On test, the Tandy amplifier comfortably met or exceeded all its specifications. Harmonic distortion, for example, was 1.2% at 1kHz for 35W RMS into an 8 ohm load. At 2W, using the reference point we quoted above, the distortion measured 0.65% instead of the rated 1.2% for the auxiliary input.

Frequency response checked out at 70Hz to 17kHz at the minus 3dB points which is considerably better than the conservative specification. Signal-to-



noise ratios were also comfortably met or exceeded.

Our reaction to the Tandy amplifier is very favourable. While the hifi fanatics may not be impressed, Tandy have produced a well-designed and conservatively rated amplifier with a specification ideally suited to public address applications. It is priced at \$159.95 and is available from all Tandy stores. (WNW and JC).

Tektronix 492 Spectrum Analyser works to above 60GHz



The Tektronix 492 Spectrum Analyser is said to be capable of operating up to 220GHz with commercially available waveguide mixers.

Tektronix has announced the release of the 492 Spectrum Analyser which, it says, allows spectrum analyser users to go beyond 60GHz for the first time. Stated frequency coverage is 50kHz-21GHz using internal mixers, 21GHz-60GHz with external Tektronix waveguide mixers, and to 220GHz with commercially available waveguide mixers.

The 492 is designed for ease of operation. The instrument uses a three-knob sequence for frequency, frequency span and reference level settings. At switch-on, an automatic sequence provides maximum input attenuation plus vertical and horizontal control settings, thereby assuring a repeatable start-up reference sequence. Optional digital storage and signal processing

further enhance the instrument's ease of operation.

Performance levels of particular interest are: -123dBm average noise level at 100Hz resolution; on-screen dynamic range of 80dB, with 100dB measurement capability in the preselected ranges; and 70dB low phase noise at 3kHz offset.

Options for the 492 include phaselock stabilisation, digital storage and signal processing, front-end preselection and removal of the external waveguide mixer connection. The 492P, which is the IEEE-488 programmable version, can also be ordered when GPIB interface is desired.

Enquiries to Tektronix Australia Pty Ltd, 80 Waterloo Rd, North Ryde, NSW 2113.

Alco TL Series Tough/Light Momentary Key Switch

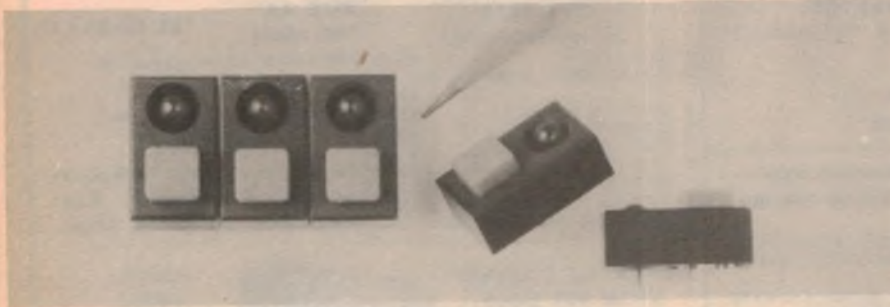

Designed for printed circuit board mounting, the Alco TL Series Touch/Light Momentary Key Switch features an integral red or green LED indicator. Alternatively, the user can specify a flashing red LED version incorporating an IC to provide three flashes per second. The square pushbutton is red. Enquiries to Total Electronics, PO Box 103, North Brighton, Victoria 3186.

printed circuits

- Accurately machine printed etched
- Phenolic & fibreglass-gold tin plated
- EA R & H ET Philips Mullard available
- Specials to your drawing
- POSTAGE small 80c large \$1.10.

80S1	2.50	80GA3B	3.20	80GA3A	5.00
ET560	2.80	79SB10	2.80	ET474	2.80
ET151	2.50	ET452	4.50	ET321	3.50
79D10	2.80	80SA3	4.50	79FE11	2.80
79T111	2.80	79EB12	2.80	79PC12	2.50
ET262	2.50	ET270	2.80	ET263	2.50
ET150	2.80	ET261	2.50	ET260	2.50
79PG9	3.00	ET146	2.50	79PS11	2.00
ET573	2.80	79MD9	2.80	ET606	3.00
79OM9	3.00	ET577	2.80	ET473	3.50
79RR8	4.20	79PS10	2.80	79R18	2.80
79BT9	2.60	79SF10	2.50	79AL9abc	4.20
79AC9	3.50	79T77	2.60	79W9	2.80
ET576	4.20	79SF9	2.60	ET731	3.00
ET730	3.50	ET574	2.80	ET575	2.20
ET252	3.00	ET814	2.80	ET725	3.50
79WF8	3.20	79SR8	2.80	79TRF5	2.50
79PS6	2.80	79UT8	3.00	79M8	2.80
ET451	2.50	79FR6	3.50	ET148	2.50
6.800	8.50	ET472	3.00	ET724	2.20
79UPS6	2.50	79CL7	4.80	79KB7	2.80
ET144	3.50	79SA5	8.00	ET651	4.50
79R05	3.00	ET254	2.50	ET471	5.50
77EQ2A	3.50	ET249	—	79EQ2B	4.00
		—	—	—	2.50
ET320	2.20	ET253	—	ET594	2.50
ET595	2.80	7905	—	ET470	3.20
49%	4.50	559	3.80	79A3	3.00
79PS3	2.60	78SE3	4.00	721	3.00
79P1B	2.80	79P1A	2.80	79PB2	3.20
79C1A	3.00	558	2.50	78C1B	2.80
142B	4.00	142A	8.00	557	3.00
79S1	4.50	79W3	2.60	79UP1	5.00
791T2	5.00	78SB12	3.00	79CL1	2.60
78S12A	5.50	781M12	3.00	78S12B	2.20
78N10	2.60	78C11	3.10	78UP10	7.00
78DT10C	2.50	78DT10B	2.80	78DT10D	2.00
ET813	3.50	ET143	2.80	78DT10A	6.50
ET812	2.80	ET593	3.20	ET141	4.20
ET556	6.00	78DB11	2.80	ET490	2.80
78BB49	3.50	555	4.00	78UP9	6.00
650B	2.60	650A	4.00	650C	2.60
718	2.60	553	3.00	138	3.80
590B	8.00	590A	8.00	811	3.30
78E09	2.50	ET605	7.00	78MC10	4.00
ET391A	2.50	ET551	3.00	ET391B	2.50
ET591C	2.20	ET550	2.80	ET641	ON/AP
78UT9	16.00	78MX9	3.30	ET592	4.50
78UM8	2.60	78CL8	3.00	78T9	2.30
ET638A	4.00	ET248	2.30	ET638B	3.00
ET581	4.00	ET810	2.80	ET318	7.00
78TSC7	2.50	78PT7	2.50	78TM8	2.80
ET137B	2.80	ET137A	3.50	78VBG7	3.50
ET717	3.50	ET507	7.00	ET139	2.50
78F6B	3.50	78N	2.80	ET640	16.50
246	4.00	489B	2.50	78A06	2.80
78CD4	2.60	78PS5	2.50	489A	2.80
78UP5	5.00	ET140D	4.00	78C5	3.20
ET1140P	5.50	ET136	2.50	ET140A	14.00
ET487A	7.50	ET588 20	10.00	ET487B	7.50
78UT4	4.00	78EK3	3.30	78NG4	3.00
78B2	3.00	781A2	2.60	78T3	3.60
ET450A	2.80	ET716	4.00	ET450B	2.60
ET486	3.20	ET245	2.50	ET715	3.00
78AF2	3.00	78S3	2.60	78C2	3.00
77CB12	2.60	77PH12	2.60	78CF1	2.80
ET135	3.00	ET586	2.80	77PM12	3.50
77SC11	3.80	77PS11	2.50	77MX11	2.50
77MX11	2.50	ET585T R	3.00	77UP6A	3.00
ET604	2.50	ASC11	2.80	77PS11	2.50
ET713	3.00	ET603	3.00	ET635	2.80
77TS9	3.00	77AL8	2.50	77UP11	6.50
ET134	2.60	ET065	2.50	ET583	2.50
77DVM9	2.80	ET063	2.50	77T10	2.50
ET067	2.20	ET085	3.00	—	3.20
ET072	2.50	ET484	2.00	ET083	2.20
ET485	2.80	—	—	ET084	2.50
				ET581	2.50

ALL SILICON 30/60w PA PORT AMP
 6 1/2"W x 8 1/2"D x 3 1/4"H 12 — 16V two inputs 5 &
 100mV 125, 250 500 ohm output only No. 763A
 \$70 ea 240V operation \$33 extra Freight collect.
 COILS and IF's All \$2.60 ea plus post 60c
 3/4"W x 3/4"D x 2"H

MAIL cheque or money order
 (add postage) direct to —

RCS radio pty ltd
 651 FOREST RD BEXLEY
 NSW 2207 587 3491

ELECTRONICS CENTRE

BARGAIN PRICES • PERSONAL ATTENTION • SLICK MAIL ORDER SERVICE • SATISFACTION •

NEW BSR STEREO CHANGER/PLAYERS MODELS

C198 (ILLUSTRATED)
S SHAPE TONE ARM
4 POLE MOTOR
WITH CERAMIC CART.

\$55.00

WITH MAGNETIC CART

\$65.00



C197
STRAIGHT TONE ARM
2 POLE MOTOR
CERAMIC CART.

\$47.50

PACK & POST. NSW \$2.75, V./SA./Q \$3.75, TAS/WA/NT \$4.75

With all the wanted facilities • Auto or manual operation • Cueing lever • Bias compensator • Adjustable stylus pressure • 33, 45, 78rpm • Plays 7", 10", 12" records • Separate changer and player spindles • Operating instructions • Template for cut-out • Big 28cm turntable • Diamond stylus • 240V AC 50Hz.

• BSR BELT DRIVE RECORD PLAYER •

ABSOLUTE
LATEST MODEL P-200

\$95.00

P&P NSW \$3.50
INTERSTATE \$4.50



STYLISH S SHAPE
PICK-UP ARM •
ADC MAGNETIC
CARTRIDGE
DIAMOND STYLUS
INCLUDED •

ALSO AVAILABLE WITH WALNUT BASE AND
PERSPEX COVER WITH HINGES

\$119

P&P NSW \$5.00
INTERSTATE \$7.50

Specs. 240VAC 50Hz. auto or manual operation • Plays 17, 25, 30cm (7, 10, 12in) records • 33 and 45 rpm, adjustable counter weight and stylus pressure • cueing lever • Bias compensator and anti skate control • Die-cast platter with mat • RCA audio plugs and cable, 3-core power cable and plug •

C-CORE TRANSFORMERS

LOW NOISE • HIGH EFFICIENCY • PRIMARY 240V 50Hz. CONT RATING

PACK AND POST

V. Q.

MODEL	SEC. V.	AMPS	PRICE	NSW	SA.	T.	WA.	NT.
JT 266	0-18V	8A	\$26.95	\$2.95	\$3.75	\$5.50		
JT 235	260-26V	2A	\$24.95	\$2.95	\$3.75	\$5.50		
JT 248	0-10V	10A	\$26.95	\$2.95	\$3.75	\$5.50		
JT 249	8.5-0.8 5V	4A	\$26.50	\$2.95	\$3.75	\$5.50		
	15VCT	1A						
JT 274	0-10V	10A						
	2x0.12V	1A	\$26.50	\$2.95	\$3.75	\$5.50		
JT 253A	0-18V	12.5A						
		30A						
		PEAK	\$46.95	\$3.50	\$5.50	\$7.00		

SUPER SCOOP



PASSIVE RADIATOR HI FI SPEAKER SYSTEM

Excellent frequency response from the 8 ohm 15 watt 200 mm (8") woofer and 200 mm tweeter with cross-over • modern styling sturdy walnut cabinet • 445H 280 W, 178 DMM

Pack and Post NSW \$2.75
V. Q. SA. T \$3.75
WA NT \$5.50

\$65

PAIR

SALE

STOCK CLEARANCE. COMPONENTS • BULK BUY MONEY SAVERS

- Guaranteed brand new A1 quality. Min order \$10. No. 1 electros. Chassis mount. 3300uF/75V 2200/63 1000/63 100/200V 10 for \$5.50 P&P NSW \$1.20. Interstate \$1.80 Axial leads 220uF/63V 220/40 150/25 200/100 2500/2.5 10 for \$2.00 P&P NSW 75c. Interstate \$1.50 64uF/40V 160/64 160/25 160/16 6.4/64 100/40 100/16 40/16 32/40 32/10 10/64 2/500 22/10 25 for \$2.50. P&P NSW \$1.00. Interstate \$1.50 PCB mount. 2500uF/16V 1000/25 470/50 47/35 10 for \$2.50 P&P NSW 75c. Interstate \$1.50 200uF/10V 220/6.3 100/10 100/12 47/16 50/12 50/10 22/10 5/10 25 for \$1.50 P&P NSW 75c. Interstate \$1.50
- Selenium bridge rectifiers 20V 4A. 4 for \$3.00 P&P \$1.00
 - DPST Momentary push switch. 240VAC 10A 10 for \$2.75 P&P \$1.50
 - Polyester capacitors 0.47uF/100V 2uF/50V 25 for \$4 P&P 80c
 - Wick-it desoldering braid. 5 x 1.5mtr spools \$4.00 P&P 80c
 - IRH 25 ohm 2W w/w tandem pots. Ideal speaker vol control. 10 for \$3.50 P&P NSW \$1.00. Interstate \$1.50
 - IRC PW10 ww resistors 39 56 82 120 150 510 560 820 910 1800 ohm 20 mixed \$4.50 P&P NSW \$1.00. Interstate \$1.50
 - Modern, attractive panel mount DPDT lever switch. 10 for \$2.75 P&P NSW 80c. Interstate \$1.20
 - Spark plug suppressors Straight and right angle. 10 for \$2.75 P&P 80c
 - Suppressors for car gen. etc. 10 for \$3.75 P&P NSW 80c. Interstate \$1.20
 - Red, green bezels. 15mm mt hole. Edison screw. 10 for \$2.80 P&P 80c

FAMOUS IMPORTED EMI CASSETTES

SUPER FERRIC • COMPARABLE TO CHROME • TOP QUALITY PERFORMANCE

• LOW NOISE • HIGH OUTPUT

C60 — 5 for \$7.50 P&P \$1.50

C90 — 5 for \$10.00 P&P \$1.50

TRANSISTOR-DIODE-IC PACKS

Guaranteed top quality — no rejects
Last offer order early.

Minimum order —
\$10.00 P&P 80c

TRANSISTORS at 418 BC546 BC548 BC549 BC550 BC556 BC558 BC327 BC337 BC177 BC178 BC639 2N3642 = 2N3053 2N4248 2N4250 AY1110 2S8367 TT1002 = BF115 10 for \$1.20
BD136 10 for \$1.75 BD139 BD140 10 for \$3.35 2SD200 = BU205 4 for \$3.00 2N3772 NPN 100V 30A 4 for \$11.90. MJ2955 2N3055 4 for \$3.50
DIODES OA200 1N9148 10 for 80c. A14A 100V 1A 1N4004 10 for \$1.20
ICs 7450 7451 7490 UA301 10 for \$2.00 555 10 for \$2.75 LM382N 4 for \$6.00 309K 5V 1A. 7812C. 12V 1.5A 4 for \$3.50
ZENNER DIODES BZX79 400mw series. 4V7 5V1 5V6 6V2 6V8 7V5 9V1 12V 15V 18V 62V 10 for \$2.00



PLESSEY
ROLA
SPEAKER
SPECIAL

GUARANTEED TOP QUALITY
BRAND NEW BARGAIN

Model C12PX. 15 ohms, 31cm (12in).
twin cone Specs. 30W rms Reson
Freq 40Hz. Freq respon 35-13,000Hz

\$19.95 ea. P&P NSW \$2.00
INTERSTATE \$2.75
2 for
\$37.00 P&P NSW \$2.75
INTERSTATE \$3.75

• POWER TRANSFORMERS •

Ex-PMG. excellent quality. guaranteed
Size 115 x 95 x 90mm
Primary 0.200, 210, 220, 230, 240,
250V 50Hz

No 1 0-110V. 2A. secondary
No 2 55-0-55V. 2A. secondary
No 3 85-0-85V. 2A. secondary
No 4 48-30-20-0-20-30 48V. 2A. second-
ary

\$13.95 ea P&P NSW \$2.75
INTERSTATE \$3.75

TRANSFORMER SPECIALS

Primary 240V 50Hz

1 12-0-12V 15A \$2.95
2 0-175V 20MA. 0-18V 1A. 0-5. 6V
1A \$2.95
3 0-18V 1A. 0-5. 6V 1A \$2.95
4 0-240V 60MA Isolation \$6.50
5 0-40V 250MA \$1.95
6 12-0-12V 1A. 6-0-6V 1A \$3.50
7 0-17V 200MA \$1.95
8 0-13V 1A. 0-9-1V 1A \$3.50
P&P NSW 90c. Interstate \$1.60

GEARED
MOTOR
240VAC 50Hz 3W
\$2.50

P&P 50c

5 RPM Plenty of torque With Cam and
N/O N/C microswitch 15 switch contacts
per min. OA size 65 x 60 x 35mm.

Refer Dec 79 EA. New Products Review

HEAVY DUTY NI-CAD RECHARGEABLE BATTERIES

1.2v



Top quality guaranteed
Used by many Govt Depts

SIZE D 4AH \$6.25 ea P&P 75c
4 for \$23 P&P NSW \$1.50
INTERSTATE \$2.50
SIZE C 1.8AH \$3.75 ea P&P 75c
4 for \$14 P&P NSW \$1.50
INTERSTATE \$2.50

SIZE AA
500 MAH 10 for \$14.75

P&P NSW \$1.25. Interstate \$1.75

OR 4 FOR \$6.40

P&P NSW 75c. Interstate \$1.25

SERVICE

Moderate charges — Repairs
guaranteed. Radios, Tape
Recorders, Cassettes, Amps.

VERSATILE CABINET WITH 101 USES



POWER
SUPPLY

AMP ETC. ETC. ETC.

Ex-PMG metal cabinet. 485W x 155D x 120mm Very rugged Fully ventilated Can
be 19in rack mounted.

\$6.50 P&P NSW \$2.50 INTERSTATE \$3.50

New Products

Digilog Universal Trainer

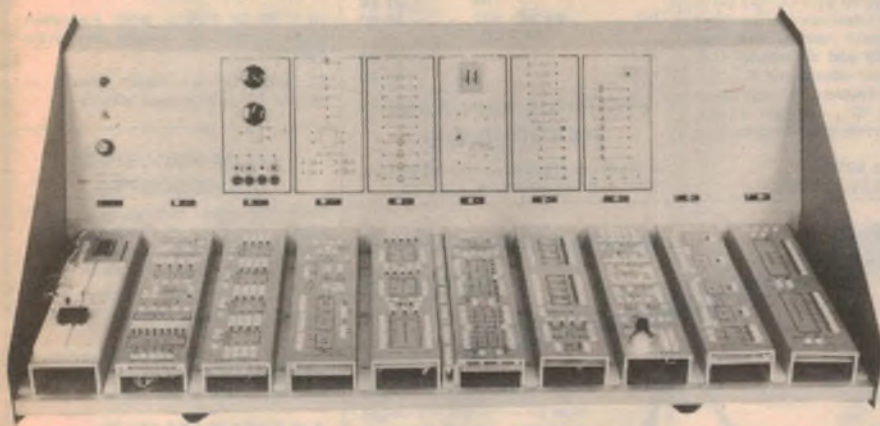

Developed by Digilog Electronics, the Digilog Universal Trainer is designed to fill the gap between simple digital logic trainers and microprocessor development systems.

The trainer has adopted a functional block approach. It places at the advanced student's disposal a variety of modules including counters, shift

registers, serial & parallel arithmetic units, RAMs, data converters etc. The result is that a student faced with constructing, say, a DVM in a two-hour experiment does not have to assemble and debug counters, display drivers and the like, out of individual gates and flip-flops.

The trainer consists of a mainframe

and a large assortment of plug-in modules. The mainframe provides the modules with the required power supplies and a comprehensive range of facilities. The power supplies distributed to all module stations (no supply patching) are +15V, +5V and -15V.

Among other mainframe facilities are two gateable clocks with complementary outputs 0.1Hz to 100kHz, a burst counter, an eight-bit word generator, six translators (15V CMOS to TTL), four debounced pushbuttons with complementary outputs, buffers and indicators. The mainframe can be supplied either as a six-module version or a 10-module version.

Currently available modules include a 16-bit up/down binary/BCD presettable counter, a triple shift register, a quad four-channel multiplexer/demultiplexer, an LED/LCD display module, a quad 16 word x four-bit RAM, an op amp module and many others. Also available are three "elementary" modules containing a variety of gates and flip-flops, including some tri-state gates.

Enquiries on the Digilog Universal Trainer should be directed to Digilog Electronics, 4 Bayview Rd, East Brighton, Victoria 3187.

RADIO DESPATCH SERVICE

THE SPECIALIST STORE

869 GEORGE STREET, SYDNEY, NSW 2000. (NEAR HARRIS STREET)
PHONES: 211 0816 211 0191

Texas Instruments	Excl	Incl
Calculators	ST	ST
TI.59	247.00	275.50
TI58C	109.00	120.70
TI PC100C printer	213.57	236.00
TI.30 Student Pack	20.00	22.10
TI.50	35.31	39.00
TI.55	53.00	59.00
TI Programmer.	53.60	59.00
Little Professor	15.00	16.57
Speak & Spell	64.83	70.00

SPECIAL COMPUTER COOLING FANS



Muffin fan 4 1/2" square.
240V \$24

NOTE: We keep all PC Boards for EA & ETI projects.
Write or call

Distributors For

XCELITE Tools

MAIL ORDER CUSTOMERS

\$1 packing plus 5% of order value up to \$80 and thence a flat \$4 for postal items
Carrier — freight on

We keep Texas Program Libraries pakettes, adaptors, battery packs, thermal paper black magnetic caras, etc.

Leader Test Instruments
Soar DVM's Fluke DVM's
University meters and multimeters

Weller soldering stations
Scope soldering irons
Adcola soldering irons
Josty Kits

Boxes and cases, Horwood,
Jiffy and die cast.

OPEN: MON-FRI 8.00 am-5.30 pm
Thursday late night shopping until 8.30 pm, Saturday 8.00 am-11.45 am.

**BRASS SHIPS CLOCKS
SMITHS 8 DAY 7 INCH
DIAMETER \$110**

Post A \$1.75; B \$3.00; C \$3.60.

**GENUINE EX ARMY WRIST
WATCHES**
Complete with nylon band \$19.50
Post \$1.10

P.M.G. TYPE TELEPHONES

Standard desk type with magneto bell calling device. Range 30 miles. Uses standard batteries at each phone. Any number can be connected together on single line **\$39.50**

(2 TELEPHONE SETS)

\$2 Cartage to Rail Freight payable at nearest attended Railway Station

RECEIVER No. 210

2-16 M/cs \$75
Transmitter No. 11 suits 210 \$35
24 volt Power supply to suit above \$15
Or complete station with Headphones. Mic \$110

**EX ABC
MAGNETIC RECORDING
TAPES 1/4"**

PROFESSIONAL QUALITY

5" x 600" \$1.50
7" x 1200" \$2.75
P + P \$1.30
10 1/2" x 2400" \$7.95
P + P A \$1.65 B \$2.75 C \$3.10

**COLLINS INDEPENDENT
SIDEBAND TRANSCEIVER
TRC/75**

Fully synthesised transceiver with am. upper, lower and independent sideband operation. 1KHz steps from 2MHz to 29.999MHz. 1 microvolt sensitivity. 2.5KHz bandwidth ssb. 6KHz bandwidth AM. 1 RW PEP max output. Fully automatic tuning of both transmitter and receiver from remote control unit. Complete with automatic aerial coupling unit, mic, headset, etc. 400Hz supply. *Ideal for amateur use*
PRICE \$750

**COLLINS SYNTHESISED 1
SB RECEIVER**

TRC/75 receiver section of transceiver specification as above
PRICE \$400

TELEPHONE WIRE

1 mile twin (2 miles) genuine ex-Army Don. 8 perfect condition \$45.00 per drum. \$6.00 cartage to rail freight payable at destination.

**20X to 60X
ZOOM TELESCOPE**

With Tripod. \$115.50
Post A \$2.25. B \$4.10. C \$6.10

RCA 44BX MICROPHONES

PROFESSIONAL QUALITY \$75
P&P A \$1.80. B \$3.50. C \$4.55.
D \$4.55

AERIAL CAMERAS
WITH 8" FL 3" DIAM LENS F24 MARK IV 2.9 LENS STOPS 11, 8, 5.6, 4, 2.9 — \$75
\$2 cartage to rail freight Payable to nearest attended railway station

PENTAC LENSES

3" DIAM 8" FL WITH DIAPHRAGM STOPS 11, 8, 5.6, 4, 2.9 MOUNTED IN METAL HOUSING — \$65
POST A \$1.85 B \$3.25. C \$4.10

PRISMS

4" SQUARE FACED RIGHT ANGLE PRISMS TOP QUALITY EX AIR FORCE — \$65. OR LENS & PRISM FOR \$120
POST A \$1.75 B \$3.00 C \$3.60

SOLENOIDS

200 MA 24 volt 1/4in push movement \$2.50 P+P 80c

NIFE CELLS

1.2 volt, fully charged. 4in x 3in x 1in 4 AH
\$1.50 each P&P 80c

CENTRE DRILLS

15/64 x 15/64
Carbon steel \$4.00 doz. Post 60c

ARTILLERY DIAL SIGHTS MK2

Can also be adapted as a Dumpy Level or as base for a telescope has full 360° 5 1/2" diam gunmetal rotating circle. Adjustable elevation and depression. Has top grade 3/4" diam object lens F.L. 10" with cross hairs, eyepiece, 3/8" right angle prism — height 10" — weight 3 1/2 kgs. With leather carrying case. Original cost \$300
Our Special only \$27.50
P&P A \$2.25 B \$4.00 C \$6.00

POSTAGE KEY:

A NSW
B Vic Qld SA
C NT Tas
D WA

VALVES

BRAND NEW
6SN7 \$1.95 6BM8 \$1.95
5U4 \$1.95 6GV8 \$1.95
EF50 \$1.50 6AK5 \$1.95
1H6 \$1.50
2x2 \$1.50 832 \$5.00
P+P 80c
6x4 \$1.95
VR65 \$1.50

**STC HIGH IMPEDANCE
HEADPHONES**

3400 ohms, brand new, only \$5.95 pair.
P&P A \$1.65. B \$2.75. C \$3.10

**WRIST WATCHES
SWISS JAEGER**

Le Coultre ex RAAF rated one of the world's best in smart chrome case with black dial. Original cost \$250

SPECIAL \$49.50
Post \$1.30

**PRISMATIC
TELESCOPES**

15 x 50 Ex RAN — black enamelled brass. Length 16", weight 5kg Price \$39.50.

\$2 cartage to rail, freight payable at nearest attended railway station

**ZOOM FOCUSING
MICROSCOPES**

Zoom focusing microscopes. 750X battery and mirror illuminated \$31.75
Zoom 1200X similar to above \$47.95
P&P A \$1.65 B \$2.75. C \$3.10

DIRECTOR LEVELS

Ex Army No 9 with azimuth horizontal circle and vertical adjustment suits all types of levelling. In leather case \$90.

P + P A \$1.75 B \$3 C \$3.60.

**MARCONI SIGNAL
GENERATOR**

Brand new type TF801A-1 Range 10 to 310MHz Continuous. Complete in original case — with instruction book, power leads, spare valves, etc.

\$600 value!
only \$195

\$2.00 cartage to rail. Freight payable at nearest attended railway station.

**16MM SOUND PROJECTORS
IN GOOD WORKING ORDER**

240 volts operated complete with Speaker and Amplifier.

SIEMENS \$375

BELL & HOWELL \$195

\$1 Cartage to Rail Freight payable at nearest attended Railway Station

**SELSYN MOTORS
MAGSLIP**

**TRANSMITTER 3" MK2
\$20.00**

Post Packing A \$1.75. B \$3.00. C \$3.10

MAGNIFYING GLASSES

4" Magnifier suspends from neck and rests on chest. leaves hands free ideal for mum or gran. sewing, etc.
\$6.30

4" Hand held \$5.95
3" Hand held \$3.80
2 1/2" Hand held \$2.65
3 1/4" Rectangular \$4.25

4" Magnifier on stand leaves hands free \$10.75
Illuminated 10 x power magnifier \$6.60

Postages \$1.30 extra



**ZOOM SPOTTING
SCOPES**

30 x 30
LENGTH 12 1/2" HEIGHT
10"
WEIGHT 1 3/4 lb
\$32.50

High grade coated lenses. Ideal for pistol and rifle ranges or general viewing. Zooms in from very low to high powers. Complete with tripods.
POST A \$1.75 B \$3.00.
C \$3.60

45 x 40
Length 16in
Height 10in
Weight 2lb
\$49.50

TELESCOPES

25 x 30 \$13.50
P&P A \$1.30

SPY TELESCOPES

8 x 17 mag size of a rifle cartridge extends to 8" Only \$8.95 each, post 60c.

BINOCULARS

PRISMATIC Coated Lenses Brand new Complete with case
8 x 30 \$42.00
7 x 50 \$48.95 P&P
10 x 50 \$51.00 A \$1.75
12 x 50 \$53.00 B \$3.00
20 x 50 \$65.00 C \$3.10
20 x 65 \$125.00

**SMALL CLIP-ON
POCKET TELESCOPE**

15X \$7.00. P+P 80c

THEODOLITES

Made by Wilds Microptic with tripod Model T2 reads down to one second of ARC \$1000 (Usual Price \$3200)

Freight payable at nearest attended R way Stn

C42 set 36 to 60M/Hz with 24 volt power supply headphone mic leads etc. \$95.
Or 42 set separate \$65.

AIRCRAFT INSTRUMENTS

Directional Gyros
AN5735-1 Air Operated. \$35
Sperry Artificial Horizon
AN5736-1 Air Operated. \$45
Slip and Turn Indicators \$17.50
P&P
A \$1.65. B \$2.75 C \$3.10

**MAGNESIUM DRY CELL
BATTERIES** Suits PRC25 and dozens of other uses. 15 volts long life. Only \$1.50 each P & P A \$1.35 B \$2.75 C \$3.60

ANEROID BAROMETERS

In brass case, made in London, \$39.50
P&P A \$1.65
B \$2.75
C \$3.10

CONDENSER LENS

2 1/2" diam 2" FL \$1.50 each or \$2.50 per pair P&P 80c

IMPELLER PUMPS

New gunmetal body. Stainless Steel Shaft. Neoprene Impeller. Up to 15ft Lift, suitable for almost any type of liquid. Self priming. Ideal boat bilge pump, siltage drains, etc. Approx. size 8" x 5".
3/8" \$35.75, 1/2" \$51.00, 3/4" \$56.50
P+P A \$1.95 B \$3.50. C \$4.60

**Liquid filled
compass**



With magnified lens sight and degree reader.
Only \$7.95 each Post \$1.30

**POLARITY & CURRENT
CHECKER**

3 volt to 400 volt Simple leads and prods quickly determines positive or negative with illuminated indicators, also checks AC current and intensity, fully insulated only \$4.95, pp \$1.30

**COLLINS COMMUNICATIONS
RECEIVER**

Type SJ-4
500kHz to 30MHz
\$350.00

Deitch Bros.
70 OXFORD STREET, SYDNEY 2010

SORRY NO C O D

New Products

Bar Code Wand from H-P

A new digital wand designed to scan black-and-white bar codes and output TTL and CMOS-compatible signals has been introduced by Hewlett-Packard.

Designated the HEDS-3000, it offers fast, easy data entry when used to collect information in self-contained blocks. Advantages over conventional keyboard input include speed, accuracy, low cost and ease of use.

At the heart of the HED-S3000 is a precision optical sensor that can read all common bar code formats printed with a minimum bar width of 0.3mm. An advanced, high-resolution, high-speed, emitter/detector sensor is sealed in a module near the tip of the wand. In the module, one half of a bifurcated precision plastic lens focuses visible light from a 0.17mm diameter LED onto the sensing plane, while the other lens half focuses the reflected light onto an integrated silicon photodetector. An on-board transistor in the detector provides additional gain.

Signal-conditioning circuitry in the wand includes an analog amplifier, a digitising circuit, and an output transistor. These elements, which are energised by a power-saving, push-to-read switch, provide TTL and CMOS-compatible logic level output. Non-reflecting black bars are interpreted as logic high levels, while reflecting white spaces are read as logic lows; ie, a black bar is read as a "one", and a white space is read as a "zero".

As part of a portable data entry system in retail sales, the HEDS-3000 could be used to read product identification and price tags for inventory



control and order entry. A system such as this would be faster and more accurate than a manual system.

The HEDS-3000 is also a viable data entry alternative to the keyboard as a computer terminal accessory or smart instrument accessory. For example, on a production line a bar-coded serial number on parts could be rapidly and accurately scanned with the HEDS-3000 as sub-assemblies are produced. This data could be used to set automatic test systems or be used for management information or warranty analysis.

For further information contact Hewlett-Packard Australia Pty Ltd, 31-41 Joseph Street, Blackburn, Vic. 3130. Telephone 89 6351.

LCD Time Zone Watch

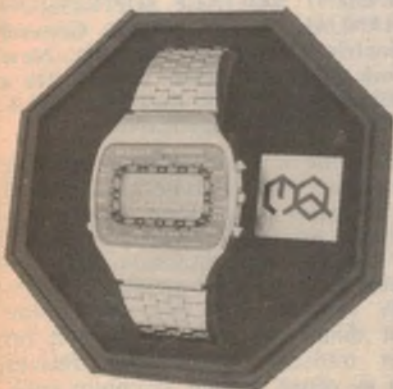

Featuring a built-in solar cell for automatic battery recharging, this LCD digital watch allows the wearer to tell

the time at various locations around the world. Other features of the Model 1700S include alarm, day, date and stopwatch functions, seconds readout, a stainless steel case, and a user-adjustable stainless steel band.

Price is \$89.00 plus \$2.50 postage from GFS Electronic Imports, 15 McKeon Rd, Mitcham, Victoria 3132.

12VA PC transformers from Ferguson

Ferguson Transformers Pty Ltd have released a range of three PC-mounting 12VA transformers which are available ex stock. Designated PL18/12VA, PL24/12VA and PL30/12VA, the transformers have output voltages of 18, 24 and 30 volts, respectively. Retail price is \$5.80 plus sales tax.

free gold pan

WITH EVERY



metal detector

LIMITED OFFER

10 Money saving reasons TO BUY NOW

- LIFETIME GUARANTEE A WORLD FIRST!
- PROVEN GOLD FINDING RESULTS
- GROUND CANCELLATION & DISCRIMINATION (You find gold even in heavy Australian mineralization conditions)
- WIDE RANGE...UP TO \$40 CHEAPER than nearest competitive makes.
- VLF for that HARD-TO-FIND deep treasure
- TRUE FACTORY SERVICE FACILITIES...HERE IN AUSTRALIA!
- WORLD-WIDE NAME YOU CAN TRUST
- EASY TO GET BATTERIES
- LARGE METER and hardwearing metal case
- FREE CONSULTATION... ON-THE-SPOT & ADVICE ON TREASURE HUNTING!

CLIP AND MAIL THIS AD.

for free booklet!

OR CALL AT OUR SHOWROOMS

ELECTRON 2000

NOTE NEW ADDRESS
181 WHARF RD. NEWCASTLE
PHONE 049 26 2644 2300

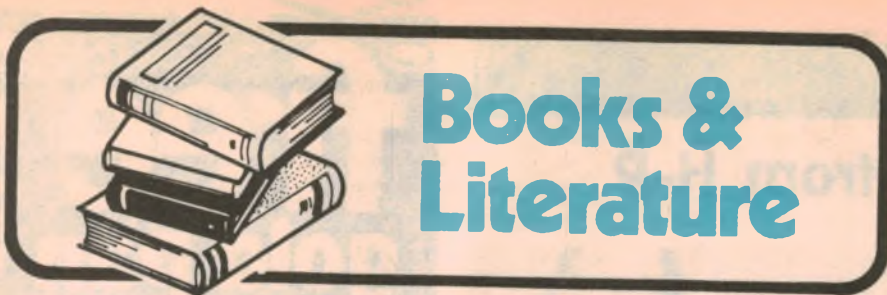

Books & Literature

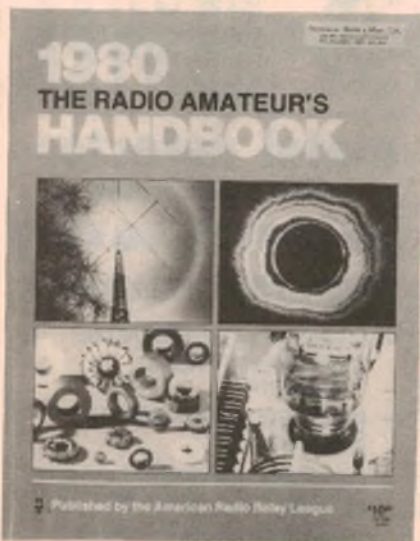

THE RADIO AMATEUR'S HANDBOOK, FIFTY-SEVENTH EDITION, 1980. Published by the American Radio Relay League, Newington, CT, USA 06111. Stiff paper covers, 560 pages plus index, 275mm x 209mm. Many diagrams, pictures and tables. Suggested price in Australia \$14.95.

As you will recall, the last edition of The Radio Amateur's Handbook was a completely new presentation of this well known publication. Much of the text was rewritten and a new format was adopted. In addition to the usual changes in the chapter material, it would seem that the publishers have taken the opportunity to make amendments and improvements which may have escaped the former edition.

One notable addition is the chapter "Vacuum Tubes and Semiconductors", which was omitted from the last edition. In its present form, the publishers have recognised that vacuum tubes are being used much less but that they will continue to be used for many years hence. The information has accordingly been somewhat abbreviated but it is still very useful.

Many chapters have had changes in their content in order to keep the Handbook up to date. Chapter 14 in particular has been renamed from "Narrow Band Voice Modulation" to "Specialised Communications

Systems". It has been considerably expanded and now includes such subjects as Satellite Communications, Radio Teletype, Amateur Television, Slow-Scan Television, as well as Narrow Band Voice Modulation.

If you bought a copy of the Fifty-Sixth Edition, which was the first of the new format, then it may be wise to check the differences between it and the newest edition before making another purchase. On the other hand, if you did not get a copy of the last edition, then this one is a must. Our review copy came from Technical Book and Magazine Company Pty Ltd, 289-299 Swanston Street, Melbourne, Victoria 3000. (I.L.P.)

Microprocessor Cookbook

MICROPROCESSOR COOKBOOK, by Michael F. Hordeski. Published by Tab Books, Blue Ridge Summit, Pennsylvania 1979. Soft covers, 130 x 210mm, 264pp, many diagrams. Price \$7.50.

According to the summary on the back cover, this book is intended as a one-stop guide to microprocessor technology. In his preface the author explains that his aim has been to help the reader to understand the performance and software requirements of modern microprocessors, together with the information necessary to match a device to an application. These comments suggest that it is intended for the experienced designer, rather than the beginner seeking an introduction to microprocessor concepts.

Unfortunately when judged as a reference work for beginners, it just doesn't seem to me to deliver the goods. For a start the author has still provided quite a bit of introductory material, which is not only out of place in this context, but is patched into the other material in what seems to me to be quite inappropriate places.

Apart from this he has tried to cover such a wide range of topics — architecture, specialised interfacing, particular devices and their programming — that no one topic can be treated properly.

All are presented in a half-baked and unsatisfying fashion, so that I can't imagine anyone who would find it of more than superficial interest and value.

In short, it's not a book I could recommend.

The review copy came from Technical Book and Magazine Company, of 289-299 Swanston Street, Melbourne, Victoria 3000. (J.R.)

Australian Gold Finder

THE AUSTRALIAN GOLD FINDER by Gerry Nolan. Stiff paper covers, 70pp, 180mm x 110mm, illustrated by diagrams and photographs. Published 1979 by Horwitz, Cammeray, NSW. Price in Australia \$1.95.

If you've spent any significant amount of money on a metal locator, (with aspirations to find gold) then a couple of extra dollars for this handbook would seem to be a logical further investment. It deals with gold itself, and with minerals that can be mistaken for gold; areas where it may be found, in what form and where to concentrate attention. There is brief reference to access, mining rights, "expeditions", &c, and to traditional ways of gold panning.

And, of course, there is the expected coverage of metal locators — basic principles, where to buy, how much to pay or not to pay, how to use and so on.

It's simple, basic material, as you would expect of 70 small pages and \$1.95 but it can point the novice prospector in the right direction. Our copy came direct from the author but we understand that the book will be sold through newsagents and through Dick Smith outlets. (W.N.W.)

Suppression Manual

TRANSIENT VOLTAGE SUPPRESSION MANUAL, second edition, General Electric Company, Auburn, New York 1978. Stiff paper covers, 215 x 280 x 129pp. Price in Australia \$3.00 + 15% sales tax if applicable.

If the title of this manual was taken at face value, then it would be expected that all types of transient suppression methods would be treated in detail. This is not the case, however, since the manual is concerned mainly with GE-MOV varistors and their use. Some short detail has been presented on other transient suppression devices such as zener diodes, selenium cells, gas tubes and R-C networks. The main theme though is the varistor which is shown to be generally superior to other methods of transient suppression, par-

ticularly when the source of the transient is unknown.

The manual begins with a description of voltage transients and of the two types, repeatable and random. The effects of transients are discussed with some examples such as contact pitting and semiconductor breakdown. Some methods of random transient detection are given. The devices to block transients or divert them are then discussed in chapter two.

From chapter three to the final chapter, chapter eight, varistors are discussed. The information in these chapters include the structure, V-I characteristics, design, telecommunication system suppression, automotive suppression, testing and reliability of varistors.

Some excellent worked examples are given which cover the most common situations where transient suppression is required. Specifications are provided at the rear of the manual for a large range of GE-MOV varistors.

Our copy came direct from Australian General Electric Company Pty Ltd, 86-90 Bay Street, Ultimo, NSW, 2007.



MASTER TRANSISTOR/IC SUBSTITUTION HANDBOOK. Paperback, 518 pages, 210 x 131mm. Suggested retail price \$11.25

MASTER TUBE SUBSTITUTION HANDBOOK. Paperback, 210 x 131mm, 321 pages. Suggested retail price \$6.95. Both books published by TAB Books, Blue Ridge Summit, Pennsylvania 17214. USA.

The transistor substitution book will prove helpful to the serviceman who encounters Japanese consumer equipment since it incorporates cross references to the Japanese part numbers and offers alternatives for direct substitution. The book also covers the most common types used in the industry today.

The tube substitution book provides a comprehensive list of tubes and suggested/preferred substitutions. Also included is a comprehensive section showing the base pinout details for all types mentioned in the book.

Both books were received for review from the Technical Book and Magazine Company, 289-299 Swanston Street, Melbourne, 3000. (G.C.)

BOOKS

NEW — NEW — NEW

Latest editions of some of the most popular books on the subject

ARRL Handbook 1980 Edition	\$14.95
World Radio TV Handbook 1980 (Now available)	\$16.95
RSGB Handbook — Volume 1	\$21.95
RSGB Handbook — Volume 2	\$18.90
Reference Data for Radio Engineers (New Edition) ITT	\$39.95
Radio Handbook (William Orr) 21st Edition	\$26.50
The World in my Ears (A. Cushen)	\$13.35

New Books:

Towers International Transistor Selector (T. D. Tower) 2nd Edition	\$9.80
Security Electronics (John E. Cunningham)	\$7.95
IC OP-AMP Cookbook (Walter C Jung)	\$17.50
TTL Cookbook (Lancaster)	\$12.95
IC Converter Cookbook (Jung)	\$18.95
TV Typewriter Cookbook (Lancaster)	\$13.50
The Cheap Video Cookbook (Lancaster)	\$7.95
CMOS Cookbook (Lancaster) 1st Edition 1977	\$14.25
Active Filter Cookbook (Lancaster)	\$19.95
IC Timer Cookbook (Jung)	\$13.50
Australian Electrical Wiring Theory & Practice (Pethebridge & Williams)	\$12.75

Microcomputers/ Microprocessors Books:

Stimulating Simulations — Second Edition (C. W. Engel)	\$6.00
Game Playing with Basic (Donald D. Spencer)	\$10.00
Scelbi "6800" Software Gourmet Guide and Cookbook	\$16.80
Scelbi "8080" Software Gourmet Guide and Cookbook	\$16.80
Programming the 6800 Microprocessor (Bob Southern)	\$9.45
The Future with Microelectronics (Iann Barron & Ray Curnow)	\$25.00
Z-80 and 8080 Assembly Language Programming (Kathe Spracklen)	\$10.00
Sargon: A Computer Chess Program (Dan & Kathe Spracklen)	\$19.00
Programming Microprocessors (M. W. McMurrin)	\$9.25
Microcomputer Primer (Waite & Pardee)	\$10.75
The Z-80 Microcomputer Handbook (William Barden Jr)	\$11.95
Getting Acquainted with Microcomputers (Lou Frenzel)	\$11.95
Microprocessors (R. Zaks) (Sybex)	\$17.60
Microprocessor Interfacing Techniques (Lesea & Zaks) (Sybex)	\$18.40
Understanding Microcomputers and Small Computer Systems (Scelbi)	\$15.40
Basic Primer (Waite & Pardee)	\$11.95
Basic Microprocessors and the 6800 (Ron Bishop)	\$16.00
Programming the 6502 (Zaks) (Sybex)	\$17.60
6502 Applications Books (Zaks) (Sybex)	\$17.80
More Basic Computer Games (Ed David H. Ahl)	\$11.75
Basic Computer Games (Ed David H. Ahl)	\$11.75
Introduction to Microprocessors: Software, Hardware Programming (Lance A. Leventhal) (Paper)	\$17.95

Just some of the books from the biggest range of radio and electronics books in Australia.

If the book you require is not listed below, it can be ordered from us.

Latest Adam Osborne Books:

An Introduction to Microcomputers — Volume 0 — The Beginner's Book	\$11.50
An Introduction to Microcomputers — Volume 1 — Basic Concepts	\$13.50
An Introduction to Microcomputers — Volume 2 — Some Real Microprocessors	\$29.00
An Introduction to Microcomputers — Volume 3 — Some Real Support Devices	\$19.00
Some Common Basic Programs	\$13.00
Accounts Payable and Accounts Receivable	\$20.80
Payroll with Cost Accounting in Basic	\$18.60
General Ledger	\$18.60
6800 Programming for Logic Design	\$13.50
8080 Programming for Logic Design	\$13.50
Z80 Programming for Logic Design	\$13.50
Z80 Assembly Language Programming	\$13.50
6800 Assembly Language Programming	\$13.50
8080A/8085 Assembly Language Programming	\$13.50
6502 Assembly Language Programming	\$13.50

American Radio Relay League Publications:

Hints and Kinks for the Radio Amateur	\$7.20
The Radio Amateur's VHF Manual	\$7.20
ARRL Antenna Handbook	\$8.80
Understanding amateur Radio	\$8.80
The Radio Amateur's License Manual	\$7.20
A Course in Radio Fundamentals	\$7.20
FM & Repeater for the Radio Amateur	\$8.80
Single Sideband for the Radio Amateur	\$7.20
Ham Radio Operating Guide	\$7.20
Electronic Data Book	\$7.20
Solid State Design for the Radio Amateur	\$12.80
Learning to Work with Integrated Circuits	\$4.00
The ARRL Antenna Anthology	\$7.20
Satellite Communications	\$8.80

Other Titles:

The Giant Book of Amateur Radio Antennas (Editors of 73 Magazine)	\$10.95
Motorola CMOS Data	\$7.50
Practical Solid-state Circuit Design (Jerome E. Eleksy)	\$8.75
Interfacing & Scientific Data Communications Experiments (Rony Larsen, Titus & Titus)	\$7.95
Design of Phase-locked Loop Circuits, with Experiments (Howard M. Berlin)	\$11.95
Modern Recording Techniques (Robert E. Runstein)	\$14.25
Linear IC: Principles, Experiments & Projects (Edward M. Noll)	\$14.20
World DX Guide — 1st Edition (Ed Jens M. Frost)	\$9.95
73 Dipole and Long-wire Antennas (Edward M. Noll)	\$7.50
73 Vertical, Beam and Triangle Antennas (Noll)	\$7.50
VHF Handbook for Radio Amateurs (Herbert S. Brier & William I. Orr)	\$9.40
Building Hi-Fi Speaker Systems (Philips)	\$3.95
Beam Antenna Handbook — New 5th Edition (William I. Orr & Stuart D. Cowan)	\$7.80
All About Cubical Quad Antennas — 2nd Edition (William I. Orr)	\$7.00
The Radio Amateur Antenna Handbook (William I. Orr & Stuart D. Cowan)	\$11.30

For Mail Orders please add: 80c Local, \$1.50 Interstate

McGILL'S AUTHORISED NEWSAGENCY PTY LTD

187 Elizabeth Street, Melbourne.

Phone: 60 1475-6-7

PRICES SUBJECT TO ALTERATION



INFORMATION CENTRE

TRANSISTOR-ASSISTED IGNITION: I find I cannot agree with two statements made in your December 1979 article on transistor-assisted ignition. Firstly, you claim that you have not published a circuit to enable a tachometer to be used with a CDI. Yet in the April 1978 issue, on page 68, just such a circuit is published.

Secondly, you say that with CDI, crossfiring can be a problem even with four-cylinder engines. Perhaps you can explain how this can be so; after all, when the intended cylinder is fired, the only other cylinder of concern has an uncompressed fuel-air mixture (the other two cylinders are, of course, completing power and exhaust strokes). (A.P., Oakleigh, Vic.)

● We must admit to overlooking the tachometer drive circuit you refer to. However, when we re-read the article we found that the contributor of the article merely included the preamp circuit as a suggestion. He stated that he had not tried it.

On the subject of crossfiring, it is true that the only cylinder of interest (in a four cylinder motor) has an uncompressed fuel-air mixture in it. This is the very mixture which can be ignited by a weak spark!

TRANSISTOR-ASSISTED IGNITION: Referring to the December 1979 issue, would the transistor-assisted ignition system be suitable for positive-earth chassis? I believe CDI's experienced problems on positive earth systems and wonder if the same applied. Myself and other members of my club (Hunter Car Club) would appreciate a reply on this one. (G.P., Williamtown, NSW).

● We are afraid there is no easy answer to your question, G.P. The circuit really needs to be turned "upside down" and the polarity of the transistors reversed. Unfortunately, though, there is no PNP equivalent to the BUX80.

CDI FOLLOW-UP: I refer to the letter from J.H., Tea Tree Gully, SA which you published in your January 1980 issue. This was concerning CDI problems and his effort to solve them, for which I think he deserves to be congratulated rather than receive the polite snub you gave him in your reply.

Your statement that increasing the switching time of the transistor increases the dissipation is obviously cor-

rect and his remedy is more of a palliative than a solution I admit, but his reasoning that the problems are caused by the make of transistor are quite clear to me.

Although I have never been involved with CDI, I have been plagued in the course of my job as a maintenance technician at a television station by the tendency of certain makes of 2N3055 to "take off" at high frequency for no apparent reason. This causes "runaway" and the only answer we have found is to fit a more stable version of the type.

I would suggest that the fault is not in the design of the unit or necessarily in the construction but rather in the unfortunate choice of the type of transistor which has become notorious at this station for its ability to set itself up as a 20 to 30kHz oscillator. Most 2N3055s are used as output stages for voltage regulated power supplies and in this configuration, should not oscillate. Nevertheless, some do. (F.P., Windsor Gardens, SA.)

● Thank you for your comments, F.P. None of our replies to readers are intended as polite snubs although we agree that in some cases the reply could be rephrased to appear less blunt. We do appreciate correspondence from our readers.

As particular comment on your letter, we are now of the opinion that CDI is entirely the wrong approach to automobile ignition. This opinion was outlined in our article on the transistor-assisted ignition system with dwell extension which was featured in December 1979.

The tendency of power transistors to oscillate when used as emitter-

followers in voltage regulator circuits is well known. In fact, this is a common fault of all emitter-follower circuits whether they use power transistors or not. But we would not regard this problem as being cured by selection of a particular transistor type. We would regard it as a design fault which can be cured by attention to PCB layout and the use of stopper resistors or ferrite beads in the base circuit and bypass capacitors where necessary.

Again, please do not regard this answer as a polite snub. It does not stem from a "superior" approach to circuit design on our part. If our approach to circuit design was perfect, we would not have a section called "Notes and Errata".

REMOTE CONTROL: After constructing the stereo infra-red remote control (October 1979) two faults were observed. (1) Unit stepped down when mains transients occurred. (2) When stepping down from level 8 (loudest level) the unit would step to level 6 and omit level 7.

Both faults were overcome by changing the 0.022uF capacitor in the rectifier following IC2d to 0.039uF. (D.M., Mor-dialloc, Vic.)

● Depending on how the unit is constructed some mains transients will get through. Apart from shielding the circuitry the only other course of action would be to increase the 0.022uF capacitor as you have done. This improves noise rejection but has the side effect that an "up" pulse may not be properly decoded if the capacitor value is too large.

Concerning your second problem,

240V REED SWITCH: I am interested in using a reed switch for a 240V application but I understand that this is not possible. I want a simple circuit whereby a light is switched on via a reed switch. Could you possibly refer me to a particular book which will give me the relevant information. (J.Z., Mt Waverley, Vic.)

● Well, we cannot refer you to a particular book, J.Z., although doubtless the information has been published, if only by the semiconductor manufacturers. We can help you directly, though, with a circuit adapted from

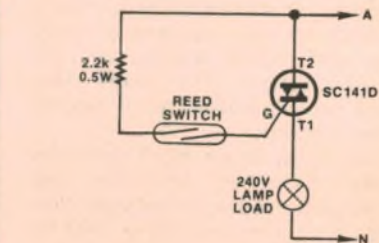

literature on Triacs published by RCA. The circuit uses a reed switch to control a Triac.

we have not heard of such a fault occurring and frankly we are at a loss to explain how it could happen.

6800 NIGHTMARE: I have recently completed your DREAM 6800 project. As suggested, I made a direct video connection to the TV set and I am quite pleased with the performance. I showed the unit to a friend, intending to connect it to his colour TV for a demonstration, (via an RF modulator) but he insisted that the use of a modulator on a colour set is dangerous. He claims that there is a possibility of overloading the RF section and also putting the guns out of focus and alignment.

I have been in contact with several TV manufacturers and they all agree with me that the only damage that can possibly occur is burning of the phosphor and this only happens over a long period of time. Still, my "friend" insists it may cause damage. Could you please put him straight on this or have I made a fool of myself? (A.B., Warrandyte, Vic).

● We agree with the TV manufacturers (How could we not?) A.B., although we think that you would be wise not to connect your DREAM 6800 to anyone's set but your own. This way, you avoid any chance of bitter recriminations in case of a coincidental failure.

PLAYMASTER TUNER: I have built your AM/FM tuner featured in the November 1978 issue from a Dick Smith Electronics kit and have since found it a worthwhile addition to my hi-fi equipment. During construction I found one fault concerning the AM-FM-FM Stereo switch. The switch performed its function but when in the FM mono position the stereo indicator lit and stereo was received, and the opposite was true when the switch was placed in the FM stereo position. A friend of mine also built the tuner and experienced the same problems but has since found a solution.

I have included the circuit diagram of the corrections that we made and hope that these can be of assistance to other readers that may have experienced the same problems. One other problem has to do with the FM tuning indicator. When tuned for maximum signal strength, I find that the tuning indicator is not in the exact centre of the scale. How is this offset adjustable? (P.S., Ipswich, Qld).

● We are pleased that you have constructed the tuner project and appreciate your kind remarks. The problem that you found with regard to the mode switch has since been corrected and errata to that effect was published in the August 1979 issue.

As far as the centre-tuning indicator is concerned, it may be possible to adjust the slugs of the coil associated with the HA1137 IF amplifier/detector IC to give a more accurate zero indication

Electronics Australia Reader Services

If you are unable to complete an "Electronics Australia" project because you missed out on your regular issue, we can usually provide emergency assistance on the following basis:

PHOTOSTAT COPIES: \$2 per project, or \$2 per part where a project spreads over multiple issues. Requests can be handled more speedily if projects are positively identified, and if not accompanied by technical queries.

METALWORK DYELINES: Available for most projects at \$2 each, showing dimensions, holes, cutouts, etc., but no wiring details.

PRINTED BOARD PATTERNS: Dyeline transparencies, actual size but of limited contrast: \$2. Specify positive or negative. We do not sell PC boards.

PROJECT QUERIES: Members of our technical staff are NOT available to discuss individual projects, either in person at our office or by telephone.

REPLIES BY POST: Limited to advice concerning projects published within the past two years. Charge \$2. We cannot provide lengthy

answers, undertake special research or discuss design changes.

BACK NUMBERS: Available only until our stocks are exhausted. Within three months of publication, face value. Four months and older, if available, \$2 (includes storage fee). Post and packing 60c per issue extra.

OTHER QUERIES: Technical queries outside the scope of "Replies by Post" may be submitted without fee, for reply in the magazine, at the discretion of the Editor.

COMMERCIAL SURPLUS EQUIPMENT: No information can be supplied.

COMPONENTS: We do not deal in electronic components. Prices, specifications, etc., should be sought from advertisers or agents.

REMITTANCES: Must be negotiable in Australia and made payable to "Electronics Australia". Where the exact charge may be in doubt, we recommend submitting an open cheque endorsed with a suitable limitation.

ADDRESS: All requests to the Assistant Editor, "Electronics Australia", Box 163, Beaconsfield, 2014.

when tuned for maximum signal strength. However, under normal circumstances this should not be necessary as this coil is supposed to be factory-adjusted for minimum distortion. In other words, unless the centre-tuning error indication is large, leave it alone.

CAPACITANCE METER: Several months ago I built the direct reading capacitance meter published in the January 1979 issue. It is one of the most useful projects ever presented. However, I do have a problem in that I want to be able to measure the capacitance of a varactor diode when a varying DC voltage is applied to it. I have tried to do this by several different methods but each time without success. Is there any way this can be done using the meter? (D.A., Findon, WA).

● The capacitance of a reverse biased diode can be measured by inserting

a capacitor in series with the diode and placing a variable power supply with a large series resistance across the diode. The capacitor should be large with respect to the capacitance of the diode; for the most part a 0.1uF capacitor will more than suffice.

The large resistor in series with the power supply is required to isolate the effects of the low internal impedance of the supply. Since the diode under test is reverse biased, the current drawn from the supply will be very small, hence a resistor of, say, 1M is suitable.

It is perhaps worth mentioning however, that the capacitance of the diode when reverse biased varies with both frequency and the amplitude of the applied signal. To have any significance at all, the measurements should be made at approximately the same frequency for which the diode is specified, and with signal amplitudes of around 100mV, not the 5V amplitude signals used in the capacitance meter.

Notes & Errata

AUTOCHIME (September, 1979, 2/MS/57): The MPU has been found to produce more than one pulse at pin 21 each time a tune is played and this upsets the CMOS counting circuit, causing tunes to be skipped. This is cured by removing the marked link to the 4016 and connecting pin 1 instead to the Vdd line. The two resistors connected to the 4016 should also be removed.

TRANSISTOR IGNITION: (December, 1978, File No. 3/TI/15): The connection diagram shown for the 2N6027 PUT is incorrect; the anode (A) and cathode (K) pins should be transposed. The circuit diagram and wiring diagrams are correct.

COURTESY LIGHT DELAY (January, 1980: File No. 3/AU/23): the 100 ohm resistor in series with D1 may overheat when the door switches are closed and the headlights are on. This can be remedied by substituting a 680 ohm 1/2W resistor.

STEREO GRAPHIC ANALYSER (February 1980, File No. 1/SC/10): The parts list contains a number of typesetting errors. It should read 4 x .047uF not 4 x 0.47uF polyester capacitors; 1 x .027uF not 1 x 0.27uF polyester capacitor; and 3 x 3.9k not 2 x 3.9k resistors. Note also that there are 5 only 3.3k resistors (not two lots of 5 x 3.3k as listed) and that all resistors are either 1/4W or 1/2W.

MARKETPLACE

FOR SALE

COMPUTER CASSETTES: QUALITY "PECOS" C-10 BLANKS \$4.50 for package of four or \$10.95 (leaderless) plus 90c postage & packaging. Quantity discounts available on request. Please make Cheque/Money Order payable to PECOS, PO Box 382 Royal Exchange, Sydney 2000.

ELECTRONIC ORGANS — Build your own! Send 45c stamp for full details of the SCHOBBER (USA) organ kits Schober Organs (Austl). PO Box 22, Guildford NSW, 2161. (Established 21 years.)

COMPUTER CASSETTES: Top quality C20 "leaderless", fully guaranteed 1 — \$180.5 — \$800. 10 — \$1600. 100 — \$10000

LIGHT PEN: to suit TRS80 with software cassette (9V battery required) only \$19.00 assembled \$14.00 kit both items plus postage 90c
Deforest Software 26 Station Street, Nunawading (03) 8789276.

R & H. RTV & H 1939-65. 175 issues in GC. Offers Tel (03) 376 2989.

ROLLS ROYCE OF RADIOS: National Panasonic RF 8000, 24 Band Communications Receiver as new cost. \$2300 sacrifice sell for \$980. 52 Harding St, Petrie, Qld 4502.

AMIDON CORES — REFER 79 ARRL HANDBOOK
Toroids T200-2, T106-2, T68-2/6/10, T50-2/6/10/12, T25-2/6/10/12, FT50-43/61. Beads and sleeves for wideband RF pwr amps: FB43-2401, S43-625-1. Large SASE with 35c for data/price list. R. J. & U. S. Imports, Box 157, Morildale, NSW 2223. Tel (02) 579 3848.

ASTATIC SSB Dynamic microphone type 10D, successor to D104. Never used with stand and lead. \$50 (03) 848 7945.

TRS-80 GENERAL LEDGER ACCOUNTING SYSTEM
Level 1, uses 2k memory. Cassette \$14.00 Micro-Basic 80, 9 Myers Crt, Doncaster, Vic. 3108 (03) 848 5549.

FREE ... List of bargain electronic components, ideal for hobbyists, servicemen. Radio Clubs, etc. Send 9" x 4" SAE Now!! MICRONICS, PO Box 175, Randwick NSW 2031.

TIME CLOCKS



SANGAMO \$17.50 DAY OMIT DEVICE	HORSTMANN \$13.50 TYPE 'K' NOTE PRICE INCREASE	SANGAMO \$15.00 LESS DAY OMIT DEVICE
--	---	---

240V 50 cs 15A Contacts

Used tested and guaranteed
PACK & POST N.S.W. \$2.00
Vic. & Qld. \$2.90. W.A. \$3.40

CLOCK DISPOSAL CO.
P.O. Box 147
LINDFIELD, N.S.W. 2070

DISCO EQUIPMENT for sale or hire. Chasers, Mirror Balls, Light boxes, Strobes, PAs for more info send stamped SAE to Madjenk Lighting and Electronics, PO Box 202, Dapto 2530.

BACK ISSUES — EA, ETI, EE various years. Phone (02) 949 3499.

TRANSISTORS & INTEGRATED CIRCUITS for equipment of Japanese origin. Range includes: 2SA777 \$1.10, 2SC900 \$0.33, 2SC1014 \$1.47, 2SC1307 \$4.80, 2SC1602 \$0.55, 2SC1969 \$5.48, 2SC2166 \$3.20, PLL-02AG \$8.60, LM386 \$2.80, UPD858C \$9.52, UPC1025 \$3.10, UPC577H \$1.26, LM1496 \$3.80, TA7310 \$5.18, REC86345 \$12.00, LM3860D \$6.00, HD38991A \$6.00, HD3890C \$6.00 and many others.

Special for March, ends March 28 (May 16 for NZ Orders) 2SC1306 \$1.10 (Normally \$1.80). Limit of 3 per order.

Wide range of other products including: Coil formers and Toroid formers, Power Supplies, Linear Amplifiers and accessories. Detailed lists supplied with orders only.

Minimum Order \$10.00. Minimum Post & Pack \$1.00 add extra for large orders. 24 hour mail-order service. ZL-VK Electronic Services, Box 221, Summer Hill, NSW 2130.

WANTED

VALVES — Five only 6J7G and Two only 6R7G. Phone (02) 969 5768 anytime.

VARIOUS CHARITIES require surplus B&W TV parts. Valves 6V Valve Tuners also Valve Tester. Phone Brenda or Miles (02) 699 4073, (02) 699 2260 or A.H. see Ernie at 2a Westmoreland Street, Glebe.

READER SERVICE

BOOMERANG TAPE RECORDING CLUB — full details. 9 x 4 SAE PO Box 118, Wellington, NSW 2820.

COMPUTERIZE your club, society or association's membership mailing list. Fast, efficient printout of adhesive labels. Moderate charges. Selective coding of members' data. Write: COMPUTERLIST, PO Box 9, Crows Nest NSW 2065 or phone (02) 437 6681.

RESISTOR SALE

Top quality 1/2W carbon film resistors. 10 ohm — 10 Megohm 3c ea; or \$2.50 per 100. No minimum quantity. Will mix any values. Get some of these now & avoid paying top dollar for these common components.

If you are a beginner, seasoned hobbyist or just want to stock up, we have available packs of 100 most commonly used resistors at \$2.50.

First 100 purchases of \$10 & above will receive a free veroboard pin insertion tool. One PP charge of \$1.00.

R & C Electronics,
PO Box 68, O'Halloran Hill,
South Australia 5158

DISPLAY ADVERTS IN MARKETPLACE are available in sizes from a minimum of 2cm x 1 col rated at \$11 per col cm.

Please state classification: For Sale, Wanted, Reader Service, Position Vacant, Position Wanted, etc.

CLASSIFIED RATES \$2 per line per insertion payable in advance. Minimum two lines.

CLOSING DATE is six weeks prior to the on-sale date. Issues are on sale the first Monday of each month.

ADDRESS all classified orders, copy, enquiries, etc. to: The Advertising Manager, **ELECTRONICS AUSTRALIA**, Box 162, Beaconsfield 2014.

SHORTWAVE LISTENERS & DXERS: Australia's National "Southern Cross DX Club inc" has the latest from the ever changing world of International Shortwave. Tropical & Medium Wave Bands, in our monthly publication "DX POST" featuring world famous Arthur Cushen's monthly column "Sample DX POST" and details of subscription for a 25c stamp to: George Kuznecovs, 87 Cashel St, Pasadena, (Adelaide) SA 5042.

FUNDAMENTALS OF SOLID STATE

Fundamentals of Solid State has been reprinted, revised and updated showing how popular it has been. It provides a wealth of information on semiconductor theory and operation, delving much deeper than very elementary works but without the maths and abstract theory which make many of the more specialised texts very heavy going. It begins with atomic theory, diode types, unijunction, field effect and bipolar transistors, thyristor devices, device fabrication and microcircuits. A glossary of terms and an index complete the book. Fundamentals of Solid State has also been widely adopted in colleges as recommended reading — but it's not just for the student, it's for anyone who wants to know just a little bit more about the operation of semiconductor devices.

Available from "Electronics Australia", 57 Regent St, Sydney. **PRICE \$3.50 OR** by mail order from "Electronics Australia", PO Box 163, Beaconsfield, 2014. **PRICE \$4.10.**

LATE NEWS: Dick Smith Explorer Series

Dick Smith wishes to advise that Channel 7, Sydney, will broadcast the pilot program of the "Dick Smith Explorer" series on Thursday, March 27. The program, to be shown in other capital cities on approximately the same date, will go to air on Channel 7's enormously popular "The World Around Us" series of documentaries.

Dick has been involved in making the "Explorer" series since acquiring his Bell Jet Ranger III helicopter some 12 months back. The series of programs traces the steps of Australia's early explorers, and promises prime TV viewing. Watch for it!

RESISTORS

150 ohm, 5W	20c
10 ohm, 5W	20c
47 ohm, 5W	20c
12 ohm, 3W	20c
2.5 ohm, 3W	20c
33 ohm, 3W	20c
8 ohm, 10W	25c
4000 ohm, 10W	25c
100 ohm, 5W	25c
330 ohm, 10W	20c
220 ohm, 5W	20c
5 ohm, 5W	20c
220 ohm, 10W	25c
950 ohm, 3W	20c
115 ohm, 5W	20c
10 ohm, 5W	20c
1k ohm, 5W	20c
5000 ohm, 5W	20c
6.8k ohm, 3W	20c
330 ohm, 10W	25c
6800 ohm, 10W	25c
1500 ohm DUAL, 21W	50c
50 ohm, 5W	20c
330 ohm, 5W	20c
1k ohm, 5W	20c
820 ohm, 5W	20c
12 ohm, 10W	25c
470 ohm, 7W	20c
4700 ohm, 4.5W	20c
5000 ohm, 10W	25c

ELECTROS

470uF, 25V	5 for \$1
400uF, 10V	5 for \$1
47uF, 63V	5 for \$1
350uF, 16V	2 for \$1
27uF, 160V	5 for \$1
25uF, 63V	10 for \$1
22uF, 160V	10 for \$1
47uF, 16V	5 for \$1
47uF, 200V	5 for \$1
2200uF, 10V	10 for \$1
68uF, 16V	10 for \$1
1000uF, 25V	5 for \$1

CAPACITORS

0.0039uF, 1500V	20c ea
6N8, 1500V	20c ea
0.0068uF, 1500V	20c ea
1200PF, 400V	10 for \$1
0.068uF, 400V	50c
2200PF, 630V	10 for \$1
0.47uF, 250V	10 for \$1
0.10uF, 400V	5 for \$1
0.082uF, 160V	10 for \$1
26k, 250V	10 for \$1
0.041uF, 400V	10 for \$1
0.033uF, 250V	5 for \$1
0.027uF, 100V	20 for \$1
220uF, 10V	10 for \$1

Power leads 240 volt, suit most tape recorders, radios, etc \$1 each.

TV Stick Rectifiers 20SC, \$1.00.

Phillips Colour TV Convergence Boards, \$3 each

455KC IF Transformers for valve radios, \$1 each. Also aerial and OSC coils, 75 cents each.

Slide Pots	
250K-50K	3 for \$1
Dual 500K	3 for \$1
1 Meg	3 for \$1
2 Meg	3 for \$1

Including Fancy Gold Knobs

SPECIAL
100 mixed resistors, all useful\$2
100 mixed capacitors, fresh stock.....\$2

AUDIO LEADS	
3.5m to 3.5m, 7ft	75c
3.5m to 6.5m, 7ft	75c
6.5, 7ft	50c

MICRO SWITCH
5A, 250V AC75c ea.

TUNING CAPS
2 and 3 gang\$1 ea
Min 2 gang50c

FUSES
0.5A, 2A, 3.2510 for \$1
In line fuse holders30c
RCA jack plugs and sockets40c pair

L. E. CHAPMAN

122 PITT ROAD, NTH CURL CURL.
MAIL ORDERS: BOX 156, DEE WHY, NSW. 2099.
TELEPHONE 93-1848.

SPECIAL TRANSISTORS

AD161-162	\$2.50 pair
2SC 901A	\$1.50 each
BC 548	10 for \$1
AC 187	50c
BD 262	50c
OC 955	50c
OC 957	50c
OC 2N1111	25c
OC 944	50c
OC 9304	25c
OC 9524	50c
C 106F1	50c
OC 967	50c
OC 968	50c
C 10480 SANYO	75c
2SA 246	50c
2SC 1548	75c
AT 350A	50c
AT 473	50c
2SB 77	50c
2SB 186	50c
2SB 303	50c
2SB 407 SANYO	\$1.50
OC 9554	50c
DELCO 2N174	\$3.00
DELCO DTS 105	\$2.00
2SB 405	50c
BD 139	50c
B 324	50c
A 436	50c
AT 324	25c
AT 341	25c
AT 322	25c
2SA 101	50c
2SB 186	50c
AT 473	50c
AD 149	\$3.00 pair
IS 309	75c

DIODES

OA 626	4 for \$1.00
OA 662	4 for \$1.00
EM 410C	4 for \$1.00
DS 150A	50c
DSY 130YO	50c
OA 636	50c
HR 15	50c

POTS ROTARY

½ Meg	30c
1 Meg	30c
100K	30c
100K Switch	50c
50K Double Pole Switch	50c
7.500	30c
10K Switch	50c
250K	30c
50K	30c
20K	30c
10K Min Pots	25c
50/Ohm	50c
½ or 1 Meg Switch	50c

SPEAKER SPECIALS

6 x 9	\$6.00
7 x 5	\$4.50
5 inch 3.5/ohm	\$3.50
5 x 3	\$1.50
2½ inch	\$1.50

6 x 9 27/ohm	\$6.00
6 x 9 47/ohm	\$6.00

PILOT LIGHTS
Screw in 6.3V10 for \$10.50
12V10 for \$1.00
24V10 for \$1.00

- Car radio suppressors, 3 for \$1
- 3 position slide switch, 50c
- Toggle switches, 25c
- 2 position push button switch, 50c
- 6 position push button switch, \$1
- 4 position push button switch, 75c
- Transistor ear plugs & leads, 3 for \$1
- In-line fuse holders, 4 for \$1
- 4 pole 2 position rotary switches, 50c

Special: 100 mixed capacitors, fresh stock, all useful.

\$2.00

- Telescopic aerials, \$1.50
- Top quality, low impedance microphones, \$3.50
- 6 inch ferrite rods, 75c
- Rainbow lead, 5 strand, 20c per metre
- Line output transformers, 600 ohm, to 15 ohm, 20 watts, \$5
- Line output transformers, 1200 to 3/ohm, 5 watt, \$1
- Power supply units, filtered, 240 to 20 volt \$12
- 240 to 15 volt transformers, \$3.50.

POWER TRANSFORMERS

240V pri: two x 25V, 117V & 6.3V sec windings, \$7 P&P NSW \$1.50, interstate \$2.50



RECORDING LEVEL METERS

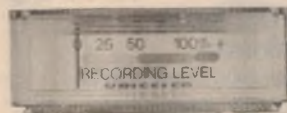

\$2.50

SUPER SPECIAL

GRAMOPHONE Motor and Pickup 3 Speed Stereo Balance

Arm 240 volt \$9.75
PP \$1.50 interstate



\$250 WA \$3.50

ICS TBA 760, TBA 540, 7400, TDA 1005, TCA 750, TCA 240K, TBA 720 \$2.50 each

24V MOTORS

Reversible



Only \$2.50 ea.

SPEAKER SYSTEMS



Inc. two 5 x 3 speakers, 5W RMS, \$7 ea P & P NSW \$1.50. Interstate \$2.50 (For singles or pairs)

TV TUNER VALVE TYPE

\$2.50 inc. valves

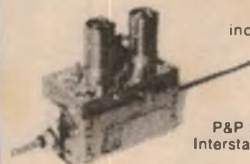

P&P \$1.00
Interstate \$2.50

SUPER SPECIALS

FM STEREO TUNER KITS



Sets of 3 modules include FM tuner, decoder and IF detector. Circuit diagram supplied. Can be used with amp modules.

ONLY \$18.00
P&P \$1.00

VU & BALANCE METERS



STEREO VU \$3.00



12Kn 100uA \$2.00

PHILIPS TV TUNERS

Transistor NT3024, NT3030, NT3032. Colour — P&P \$1



\$10 ea.

Don't let your valuable issues go astray

ELECTRONICS AUSTRALIA BINDERS

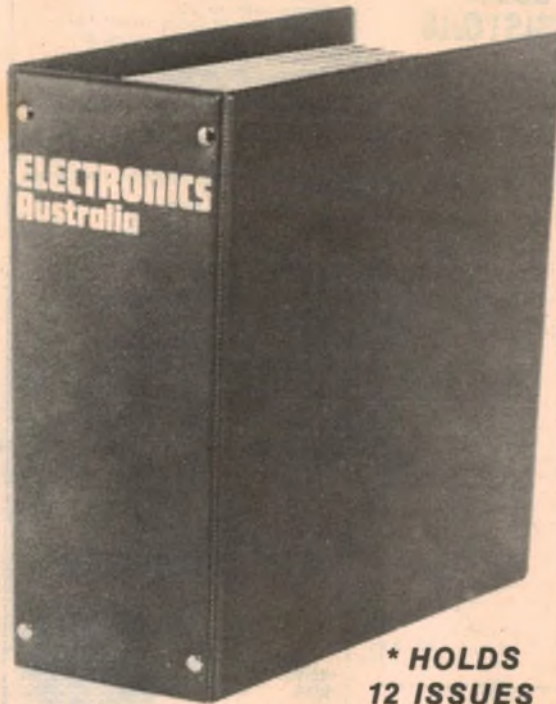

These attractive binders finished in brown plastic with gold lettering will keep your back issues of Electronics Australia neat and tidy.

*** HOLDS 12 ISSUES**

Available from
Electronics Australia,
 57 Regent St, Sydney. PRICE: **\$4.50**
 or by mail order from Electronics
 Australia, P.O. Box 163, Beaconsfield 2014.
 PRICE **\$5.50** NSW; **\$6.50** other states;
 or 6 for: **\$28.00** NSW; **\$30** other states.

*Magazines prior to April 1971 will need to be trimmed to fit binder

ADVERTISING INDEX

ADVERTISER	PAGE
A & R Soanar	2
ASP Microcomputers	94
Abacus Computer Store	85
Ace Radio	118
Adcola Products	40
Alfred Dunhill International Ltd	facing 97
Ampec Engineering Co Pty Ltd	facing 96
Anderson Digital Equipment Pty Ltd	facing 33
Audio Telex Communications Pty Ltd	30, 73
B S Microcomp	90
Bell & Howell Aust Pty Ltd	76
Bright Star Crystals	65
C Q Electronics	81
Cema (Distributors) Pty Ltd	12
Chapman L E	127
Classic Radio	112
Clock Disposal Co	126
Coates, H. F. & Co Pty Ltd	115
Defi Agency	87
Delta Design Scientific Products Dist	103
Deitch Bros	120
Dick Smith Electronic Group	20, 21, 29, 34, 54, 83, 88, 89, Insert
Diggerman Electronics	102
Dwell Pty Ltd	70
Electronic Development Sales Pty Ltd	63
Email Ltd	70
Embryonic Systems Pty Ltd	82
Electrocraft Pty Ltd	97
Electron 2000	121
Electronic Agencies	67
Electronic Calculator Discounts	58
Freedman Electronics Pty Ltd	36
Hagemeyer (Aust)	OBC
Instant Software	80
International Correspondence Schools	107
John F Rose Computer Service Pty Ltd	8
Lafayette Electronics	110
Logic Shop, The	80
Looky Video	85
McGills Newsagency Ltd	123
Micro-80	87
Microprocessor Applications	90
National Panasonic (Aust) Pty Ltd	IBC
Paris Radio Electronics	92
Pennywise Peripherals	78
Hi-Q Television Services Pty Ltd	60
Philips	IFC
Plessey Components	103
Quality QSL Pty Ltd	82
RCS Radio	117
R & C Electronics	126
Radcom Pty Ltd	101
Radio Despatch Service	119
Radio Parts Group	33, 100
Rod Irving Electronics	47
Rowe, H. & Co	64
Royston Electronics	49
S M. Electronics	94
Sony Australia Pty Ltd	facing 32
Stanton Magnetics, Inc	37, 101
Stotts Technical College	43
Tandy International Electronics	6, 60
Tasman Electronics	102
Texas Instruments Australia Ltd	41
Total Electronics	84
Vicom International	16, 56, 108
Video Technics	32
Warburton Franki	19, 48
Wireless Institute of Australia	111
Zero One Electronics	79

SUBSCRIPTION SERVICE



ELECTRONICS Australia

Subscription Rates
\$18.00 per year
within Australia.
\$A21.00 per year
elsewhere.

Make sure you receive every copy of the magazine by ordering it from your newsagent or the publisher. For publisher subscriptions post this coupon, with your remittance, to Electronics Australia Subscription Dept., John Fairfax & Sons Ltd, GPO Box 506, Sydney 2001. Subscription will start with first available issue.

Name

Address

Postcode Enclosed is for years

Technics Q Series. We can't say they're perfect. You will.

Nobody's perfect, but Technics quartz-locked direct-drive Q Series turntables come incredibly close.

With speed drift a miniscule $\pm 0.002\%$ - that's 99.998% accurate; wow and flutter of only 0.025% WRMS and rumble of -78 dB (DIN B) it's no wonder that Technics is the choice of top broadcasting stations and discos throughout the world.

The Q Series: the SL-Q3 automatic and SL-Q2 semi-auto both have soft-touch front panel controls for operational convenience. To help overcome any possibility of acoustic feedback they are mounted on a base made of Technics unique non-resonant compound.

The highly sensitive, low mass S-shaped tone arm features a genuine

gimbal suspension. The one-piece moulded aluminium headshell has gold plated contacts for maximum conductivity.

You might think you have to be rich to afford Technics Q Series. You don't. Your Technics dealer can advise how surprisingly reasonable they are.



Technics

When it comes to speaker design, JVC goes 2969 times further.

Traditionally, speaker systems have been designed by a tedious trial and error process, by which individual combinations of speaker, crossover and enclosure combinations are analyzed—one at a time—until the desired sonic results are achieved.

JVC has put an end to these time-consuming and archaic procedures, with a revolutionary new system called Phase Moire (Mor-ay) Propagation Technology, that uses a specially-constructed device to move a test microphone in a way that creates and preserves, via computers, video and high-speed filming, a field of nearly 3000 sound testing positions.

By viewing the film, our engineers can actually see what a speaker will sound like before they get too far into the design process.

The initial result of our unique Phase Moire Technology, combined with a great deal of human engineering, is the SK-1000. This unusually-efficient, extraordinary-sounding three-way speaker system delivers

truly magnificent, rock-solid bass from its 12" free-edge woofer and heavy magnet structure. Capable of handling up to 170-watt peaks (85 watts RMS), the SK-1000 reproduces vocals and midrange with unusual smoothness, thanks to our specially-designed 5" midrange driver. Clear, crisp, brilliant highs are dispersed evenly within the listening area from a 1" soft-dome tweeter.

We also give you complete control over midrange and tweeter response with a pair of front-panel level controls.

But all the technology in the world can't fool two of the most sophisticated testing devices known: your ears. And all the words in the world can't tell you what the SK-1000 (and its two smaller companions, the SK-700 and SK-500) really sound like.

So we suggest that you hear what we've been talking about at a JVC dealer.

For details on all JVC Hi-Fi Equipment, write to JVC Advisory Service, P.O. Box 307, North Ryde, New South Wales 2113.



For pure Hi-Fi entertainment!

JVC

the right choice