

ELECTRONICS

Australia

HiFi, Video & Computers

NOVEMBER, 1980

AUST \$1.60* NZ \$1.70

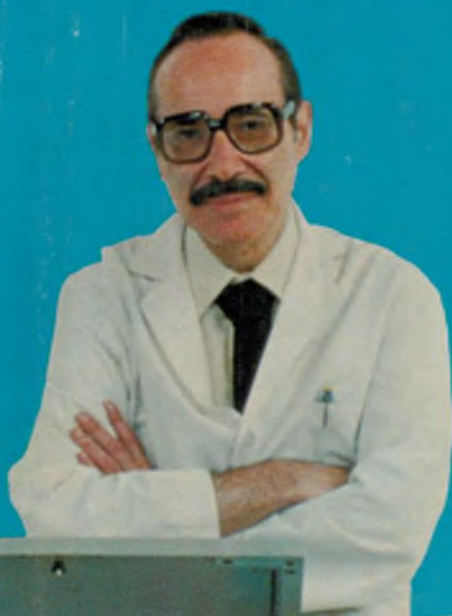

SHORTWAVE RECEIVER

SIMPLE LIGHT BEAM RELAY
MODEL TRAIN CONTROLLER
TECHNICS NEW CLASS-A
AMPLIFIER REVIEWED

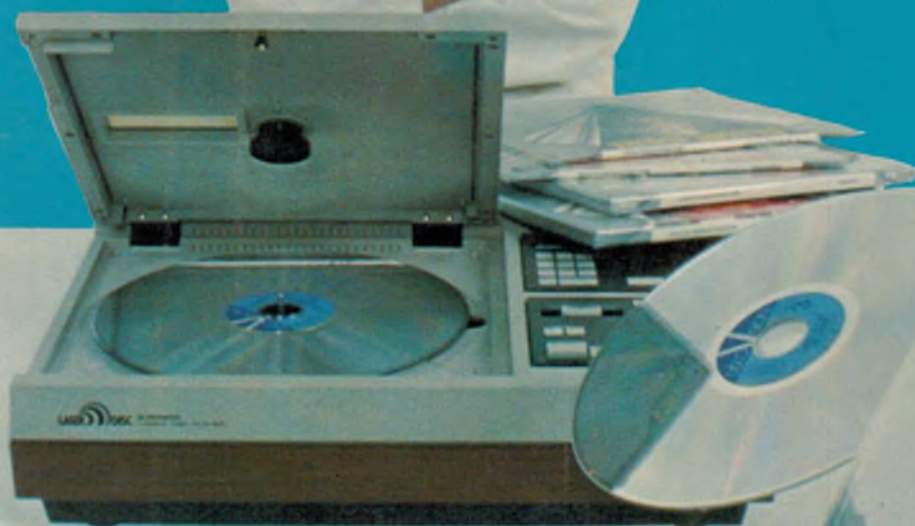

VIDEO DISCS!

— the three-way race

Sony's inseparable separates.

Sony's new ST-J55 tuner and TA-F55 amplifier come in elegant matching designs. Separately, they're

straight signal processing circuit construction, revolutionary Heat Pipe, and Pulse Power Supply, providing



outstanding. Together, they're out on their own, both in appearance and performance.

The J-55's tuner is frequency synthesized and quartz locked. A neat line of feather-touch switches gives a choice of Memory, Auto, or manual tuning.

The J55's incredible electronic MNOS memory tuning lets you preset your 8 favourite AM/FM stations - including reception adjustments like muting or mode pre-set.

The other half of the team, the 65W F55 Amplifier, features an electronic motor driven volume control,

extremely clean and noise-free sound quality.

The F55 operates with almost any type of MC and MM cartridge; has gold-plated phono jacks, oxygen-free copper wiring, metallized film resistors and polypropylene capacitors.

You won't find better engineering than these. Not even from Sony.

SONY®

ELECTRONICS

Australia

Volume 42 No. 8

November, 1980

Australia's largest selling electronics magazine

Build this model train controller

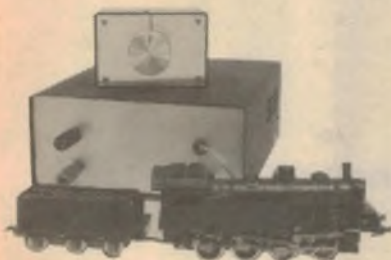

Featuring full overload protection, this model train controller is easy to build and provides bi-directional speed control using a single control potentiometer. Why not build it in time for Christmas? Details p40.



Here's a great project for those who cannot afford a conventional storage oscilloscope. It's a Digital Storage CRO Adapter that you can build for around \$80. The details are on p54.

On the cover

The video disc war in the US is hotting up, with three rival non-compatible systems slated for market by the end of 1981. The main cover theme shows Pioneer's version of the Philips DiscoVision system, while inset shows RCA's SelectaVision player. Our feature story on p14 has a rundown on the three-way video disc race. (Main photo courtesy "Video Review" - Steve Eisenberg photographer. Inset courtesy RCA.)

FEATURES

- OTC UPDATES CARNARVON** *A vital link in Australia's communications* 12
VIDEO DISCS: THE THREE-WAY RACE *Philips vs RCA vs JVC* 14
FIFTY YEARS OF TALKING PICTURES *An intriguing look back* 18

HIFI TOPICS AND REVIEWS

- HIFI REVIEW** *Technics SU-V4 "New Class-A" Amplifier* 29
AUDIO/VIDEO ELECTRONICS *Loudspeakers: what happens to the watts?* 32
EA/CONVOY INTERNATIONAL CARTOON CONTEST *The winning entry* 38

PROJECTS AND CIRCUITS

- BIPOLAR MODEL TRAIN CONTROLLER** *For model railroad enthusiasts* 40
A SUPERHET SHORTWAVE RECEIVER *Low in cost and easy to build* 44
DIGITAL STORAGE CRO ADAPTER *Add storage facilities to your CRO* 54
A COLUMN SPEAKER FOR SUPER BASS *Uses KEF B-139 woofer* 64
EASY-TO-BUILD LIGHT BEAM RELAY *An ideal shop minder* 76
RS-232C PRINTER INTERFACE FOR THE TRS-80
Has 20mA current loop as well 79

MICROCOMPUTERS

- COLUMN 80** *TRS-80 and System-80 cassette interfaces* 114
THE TEXAS TI-58/59 CALCULATORS *More features than you thought* 116
MICROCOMPUTER NEWS AND PRODUCTS
Colour graphics board from Raydata 119

AMATEUR RADIO, CB SCENE, DX

- AMATEUR RADIO** *Radio and aviation in the outback - a tribute* 89
CB SCENE *November 1980 convention; emergency services* 92
SHORTWAVE SCENE *New shortwave service from Namibia* 94
CB EQUIPMENT REVIEW *New CB units from Apollo* 99

COLUMNS

- FORUM** *It's legal to ruin one another's hearing* 24
THE SERVICEMAN *Servicing domestic television was never like this!* 68
RECORD REVIEWS *Classical, popular and special interest* 105

DEPARTMENTS

- EDITORIAL 3 - NEWS HIGHLIGHTS 4 - CIRCUIT AND DESIGN IDEAS 72 - LETTERS TO THE EDITOR 86 - NEW PRODUCTS 97 - BOOKS AND LITERATURE 112 - INFORMATION CENTRE 130 - MARKETPLACE 134 - NOTES AND ERRATA 133**

There's a whole lot more to us than apples.

We're ComputerLand, the number one retailer of small computers in the world.

For years people didn't realise we sold the widest selection of micro-computer products available from one shop. Well, we do.

ComputerLand does feature what is said to be the best small computer in the universe, Apple II. But since everyone's needs are different, we also carry more than 1000 other fine products that may better suit your needs. You'll find all of our components to be affordable, serviced locally, and in most cases available from stock.

At ComputerLand you can get real quality from recognised name brands like:

- Zenith Data Systems
- Texas Instruments
- Onyx Systems
- Northstar Computers
- Diablo
- Cromemco Systems and
- Apple Computers

Whether your interests lie in personal, business, or educational computing, we can make a system right for you. So don't limit your options with one brand shops, come to ComputerLand. We're expanding the way your world thinks.

Adelaide	—	131 PIRIE STREET	PHONE 2235083
Brisbane	—	127 CREEK STREET	PHONE 221 9777
Melbourne	—	555 COLLINS STREET	PHONE 62 5581
Perth	—	197 ST. GEORGES TERRACE	PHONE 321 4671
Sydney	—	55 CLARENCE STREET	PHONE 290 2422



Franchise opportunities available. Call (02) 27 8959



Editorial Viewpoint

Technology at the highest (?) level!

During recent weeks, the idea of invisible planes and missiles has attracted a great deal of publicity. At a casual level, it has been taken to mean aircraft which are invisible optically, but this is not what is meant. The time has long since past when anti-aircraft and anti-missile defence relied on visual contact and visual tracking.

What is necessary now, and what is being sought so diligently, is reduced visibility to radar and to infrared heat-seeking defensive weapons.

To date, a vital evasive measure has been to rely on low-flying terrain-following techniques, such that ground clutter will camouflage the radar image; this, plus back-up electronic counter-measures to further confuse any possible interception.

But now, it seems, high flying defensive missiles, with sophisticated look-down radar, are becoming increasingly able to neutralise such tactics. So the emphasis has swung back to rendering the attacking plane or missile less visible – to the watchful radar eyes.

The idea of absorbing incident RF energy in a lossy surface coating dates back to German research in World War II. Since then, work with RF absorbent coating has continued, not just in respect to aircraft, but also in relation to such prosaic things as RF anechoic chambers.

It now appears that what would otherwise have been fairly automatic technological progress has been accelerated by the injection of (reportedly) \$100m annually of Pentagon money, concentrated on the so-called "Stealth" program. A prime aim is to render the surface of new generation aircraft and missiles substantially less efficient as a reflector of incident radar energy. This has to be backed up by work on contours around intakes and other discontinuities, which can function as slot reflectors. And, somehow, infrared emissions have to be hidden or diffused, as well.

If the program succeeds, intruding aircraft and missiles will indeed become "invisible" – until the next generation of defensive weapons is evolved, with even more perceptive "vision".

There is, of course, a fascination about this intense technological rivalry and I can well imagine that no one is more fascinated or more motivated than the scientists and engineers who are facing the challenge to crack each new problem. At a personal level, their ego-satisfaction may be little different from yours or mine, when we manage to reach some new objective.

The staggering difference is that these human responses to challenge, initiative and accomplishment are being played out at a level where the prize for success or failure alike may be . . . oblivion!

Neville Williams

EDITOR-IN-CHIEF

Neville Williams
M.I.R.E.E. (Aust.) (VK2XV)

TECHNICAL EDITOR

Leo Simpson

ASSISTANT EDITOR

Greg Swain, B.Sc. (Hons, Sydney)

TECHNICAL PROJECTS

Ron de Jong, B.E. (Hons, NSW), B.Sc.
John Clarke, B.E. (Elect., NSWIT)
Ian Pogson (VK2AZN/T)
Gerald Cohn

GRAPHICS

Robert Flynn

PRODUCTION

Danny Hooper

SECRETARIAL

Pam Hilliar

ADVERTISING MANAGER

Selwyn Sayers

CIRCULATION MANAGER

Alan Parker

Registered for posting as a publication — Category B.

Printed by Magazine Printers Pty Ltd, of Regent Street, Sydney and Masterprint Pty Ltd of Dubbo, NSW, for Sungravure Pty Ltd, of Regent St, Sydney.

Editorial Office

57 Regent St, Sydney 2008
Phone (02) 699 3622 Telex 25027
Postal Address: PO Box 163, Beaconsfield 2014

Advertising Offices

Sydney — 57 Regent St, Sydney 2008
Phone (02) 699 3622 Telex 25027
Representative: Narciso (Chit) Pimentel.
Melbourne — 392 Little Collins St, Melbourne
3000 Phone (03) 602 3033.
Representative: Janis Wallace

Adelaide — Charles F. Brown & Associates Ltd, 254 Melbourne St, North Adelaide 5006.
Representative: Sandy Shaw (08) 267 4433.
Perth — 454 Murray Street, Perth 6000.
Representative: Ashley Croft (09) 21 8217

Subscriptions

Subscription Dept, John Fairfax & Sons Ltd, GPO Box 506, Sydney 2001
Enquiries: Phone (02) 20944, ext 2589.

Circulation Office

21 Morley Ave, Rosebery, Sydney 2018.
Phone (02) 663 3911

Distribution

Distributed in NSW by Sungravure Pty Ltd, 57 Regent St, Sydney; in Victoria by Sungravure Pty Ltd, 392 Little Collins Street, Melbourne; in South Australia by Sungravure Pty Ltd, 101-105 Weymouth St, Adelaide; in Western Australia by

Sungravure Pty Ltd, 454 Murray Street, Perth; in Queensland by Gordon and Gotch (A'asia) Ltd; in Tasmania by Ingle Distributors, 93 Macquarie St, Hobart; in New Zealand by Gordon and Gotch (NZ) Ltd, Adelaide Rd, Wellington.

Copyright. All rights reserved.

Devices or arrangements shown in this magazine may embody patents. Information is furnished without responsibility for its ultimate use, or for failure of equipment to operate as expected, or for any damage, loss or injury which may be sustained. Material intended for publication is submitted at the sender's risk and, while care will be taken, responsibility for any possible loss will not be accepted by "Electronics Australia".

* Recommended and maximum price only



News Highlights

Electric postal van aids hybrid vehicle research



The University's electric "postie" – a demonstration of how not to build an electric vehicle. (Photo courtesy University of Sydney, Department of Information Services).

An electric van is doing the postal rounds at the University of Sydney, but the move does not herald a breakthrough in electric vehicle design. The vehicle is on permanent loan to the University from the Sydney County Council, and does a twice-daily postal run around the University grounds.

The Sydney County Council purchased the vehicle from the United States Otis elevator company in the mid-seventies for evaluation. The Council found the vehicle so unsuited to Sydney's hilly terrain and heavy traffic that it was confined to flat enclosed areas such as depots. However, the van's low speed and quiet operation make it ideal for use within the University, and the Department of Electrical Engineering took over the vehicle for use in its research.

Senior Lecturer Dr Godfrey Lucas and Technical Officer Paul Hinds jokingly tell

visitors that the van is a demonstration of "how not to build an electric car". On hills the van is extremely inefficient, and even around the University the vehicle achieves a range of only 30 to 40 kilometres from its power source of 48 heavy duty 2V cells. The batteries when fully discharged take about 10 hours to fully recharge, but continual deep discharges of the batteries shorten their life. This can be expensive, as even with careful maintenance the batteries must be replaced each year, and a complete set costs about \$3000.

The Department of Electrical Engineering is using the vehicle to assist their research into a hybrid vehicle which would combine a petrol engine with an electric transmission, providing the range and speed of a petrol driven vehicle with some of the fuel savings of an electric vehicle.

Predicasts highlights new growth areas

Predicasts Inc, a US-based business information and market research firm, has predicted that home video cameras and solar collectors will be among the fastest growing new market opportunities of the '80s.

The home video camera market, with sales of 60,000 units in 1979, is expected to increase to 270,000 sales in 1982, while the number of solar collectors in use is forecast to increase at an average rate of 30% per year over the next 12 years.

Other products seen as a big sellers in the coming decade are word processors, desktop computers and industrial robots.

Solar power for the oilfields

The McDonnell Douglas Corporation has proposed a plan for using solar energy to help produce more oil. Under the scheme, steam generated by solar energy would be pumped into an oil field to thin heavy oil and increase the underground pressure to a point where pumps could extract otherwise unrecoverable crude oil.

The steam injection technique to enhance oil production is already in common use in the United States. In 1979 it was estimated that steam injection allowed the recovery of about 300,000 barrels of oil a day. The problem is that one out of every three barrels of oil recovered must be used to produce steam for injection.

McDonnell Douglas is one of the developers of the solar "power tower" concept now being studied by the US Department of Energy. An array of Sun-tracking mirrors is used to focus the Sun's heat on a central tower which contains equipment to utilise the energy. If the company's plan is accepted the central tower would be used to generate the steam pumped into the ground to extract the oil.

GE chooses VHD video disc system

The General Electric company has put its weight behind a third videodisc system, JVC's Video High Density (VHD) system. The VHD system uses a 25cm grooveless disc to store colour and stereo sound information in the form of capacitance variations in the disc. Each disc offers a playing time of one hour per side.

General Electric made its announcement during talks being held to establish three jointly owned companies to produce and market the system. Talks are being held with Matsushita and JVC to manufacture the players in the USA, with Thorn EMI of the UK covering the manufacture of discs. In addition, all three companies are negotiating for rights to programs for the discs.

JVC plans to have its systems on the American market by the end of next year. (See p14).



Action station for Nimrod AEW aircrew

The six-man tactical crew of an airborne early warning (AEW) Nimrod aircraft operates the most powerful airborne electronics system ever produced in Britain. The system, called MSA (Mission System Avionics) comprises a powerful radar with large scanning antennas which fit into radomes at the nose and tail of the aircraft. The radar gives the Nimrod a complete 360° coverage in all weather conditions over a range of 300km, enabling its operators to "see" over the horizon and detect, identify and track hostile aircraft.

The first AEW Nimrod to carry the system made a successful maiden flight some months ago. Eventually 11 aircraft fitted with the system will provide early warning coverage for the UK Air Defence Region, East Atlantic and Channel. (Photo courtesy of Marconi Avionics Ltd, Elstree Way, Borehamwood, Herts, England.)

TCN Channel 9 abandons Teletext "engineer's toy" says General Manager

TCN Channel 9 in Sydney has decided not to proceed with the development of a Teletext system. TCN's general manager, Mr Sam Chisolm, has described the system as "nothing more than an engineer's toy" and said that the channel had shelved development of the system until a commercial application could be demonstrated for it. It was quite clear that advertisers were not yet prepared to support it, he said.

TCN's major rival, ATN 7, has pressed ahead with plans for Teletext, including setting up closed user groups and running advertising as part of its Teletext service. Other stations to continue with the service are NBN 3 in Newcastle and BTQ 7 in Brisbane, both of which charge advertisers nominal rates to sponsor pages of information.

ATN 7 has a number of plans for its system. One proposal is to set up a closed group of subscribers who would pay a fee to receive a scrambled signal which only they are equipped to decode. Potential customers would be stock brokers requiring sensitive commercial information which could be provided by specialist sources and broadcast daily.

Regardless of their plans for the future all the parties involved in Teletext concede that there has not been strong market demand for the service in Australia. As reported in these pages in July, acceptance of the system in the United Kingdom has also been slow. So far, after two years of Ceefax service by the BBC, only 15,000 sets equipped to receive the transmissions have been sold

CSIRO to design integrated circuits

The CSIRO will set up a research group to design silicon chips using Very Large Scale Integration (VLSI) techniques under a plan announced recently by the Federal Minister for Science and the Environment.

The CSIRO's decision to enter the field of VLSI design was influenced by recent developments demonstrating that a small skilled group could make significant progress in the area. The research group will be based in Adelaide, and will be part of the CSIRO Division of Computing Research with the Institute of Physical Sciences.

The work of the CSIRO group will concentrate on design procedures only, and will not involve the establishment of production facilities.

Parameters moves to larger premises



Parameters Pty Ltd, agents for Trio, YEW and Analog Devices, has moved its Sydney office to larger premises at 41 Herbert St, Artarmon, 2064. Expanding business and diversification of activities are the main reasons for the move, according to Mr Bruce McCarthy, the Managing Director of the company.

Marine buoy generates own power

The Ryokuseisha Corporation of Japan has bought licences to a wave energy system developed by Queen's University in Belfast, Northern Ireland. Under a limited rights agreement the company will be able to apply the University's technology to marine buoys, which will generate their own power for lights and radio beacons from the waves.

The primary objective of the research at Queen's and other British Universities is to develop a system of generating electricity from ocean waves and transmitting it ashore.

Using Japanese patents, Ryokuseisha has sold around 1000 wave-energy buoys over the past 15 years. The Japanese buoy has two valves which feed air to the blades of a turbine. When air flows in one direction one valve opens and the other closes, and when the air flow changes direction the valves

reverse so that the turbine blades always move in the same direction.

In the Belfast system no valves are used, and the turbine blades move in the same direction regardless of the direction of air flow. The heart of the system is the Wells turbine, developed in 1970 by Professor Wells. The turbine rotates in a constant direction as air rushes in either way through a duct from a partially flooded chamber. The air is alternately driven out and sucked into the chamber by the rise and fall of the water level caused by wave action.

Research at Queen's University is aimed at achieving a wave-power system using a line of huge concrete and steel two-chamber buoys, each about 36 metres high and weighing 3500 tonnes. Each buoy would generate up to one megawatt, which will be transmitted ashore as DC by flexible cables.

**the most
compelling
story in
Australia's
aviation
history**



DICK SMITH'S SEARCH FOR THE KOOKABURRA
 Research by Dick Smith Story by Pedr Davis

EDUCATE YOUR FAMILY AND FRIENDS WITH THIS INCREDIBLE BOOK!

This book presents the first account of the 'Kookaburra' and the men who flew the plane. It describes the harsh conditions endured by the first aviators in their daring quests to break records over long distances, or to carry passengers and mail across the continent.

This compelling account of great courage, daring and determination, gives a fascinating glimpse at the spirit of excitement which was evident in those pioneering days of Australia's aviation history.

READ DETAILS OF THE KOOKABURRA

GOLD REEF
 IT HAS YET TO BE FOUND!

**ALL THIS
FOR ONLY
\$12.95**
 Cat. B-9500

130 PAGES HARDBACK

INCLUDES MAPS & NEWSPAPER REPRODUCTIONS OF THE TIME

OVER 100 PHOTOS B&W AND COLOUR
 SOME NEVER PUBLISHED BEFORE!

**MAKES A
MAGNIFICENT
CHRISTMAS GIFT!**

14 DAY TRIAL OFFER!!!

YES, please send me a copy of 'Kookaburra'. I understand I can return it in 14 days for a full refund

Name

Address

..... P/code

Payment by cheque bankcard

**DICK SMITH ELECTRONICS
MAIL ORDER CENTRE**

P.O. Box 321, North Ryde, NSW, 2113. Ph: (02) 888 3200.

Bankcard No Expiry date

Signature



FREE POST & PACKING!

ALSO AVAILABLE AT NEWSAGENTS AND DICK SMITH STORES

A printer for the Chess Challenger

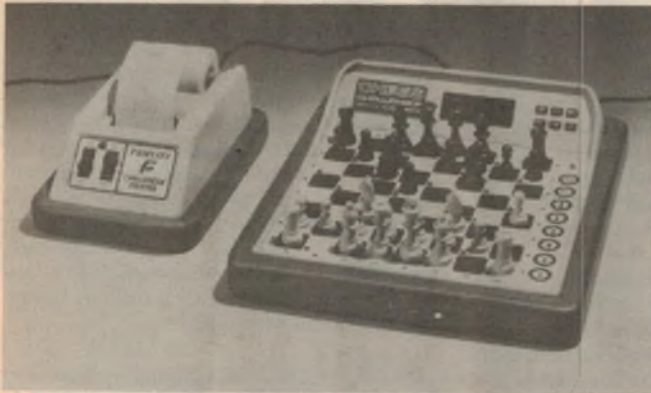

LEFT: Fidelity Electronics' Voice Sensory Chess Challenger and the new companion printer unit.

Fidelity Electronics Ltd of Miami, USA, has introduced a printer companion for their Voice Sensory Chess Challenger. The Fidelity Challenger Printer records and numbers both black and white moves on a single line in large type. The printer can also display current board positions by printing a graphic display of black and white pieces in their actual locations, using standard 40mm heat

sensitive paper.

The printer plugs into the back of the Voice Sensory Chess Challenger, and is designed with a plastic case and walnut base to match the styling of the Chess Challenger. A power transformer is also supplied.

Further information can be obtained from Fidelity Electronics, 8800 N.W. 36th Street, Miami, Florida 33178.

The latest in heart pacemakers

The latest in electronic pacemakers for cardiac patients is a programmable device which can be adapted to changes in the patient's condition without the need for surgical removal and re-implantation. The programmable pacemaker, called the Spectrax, was demonstrated at the recent 29th annual scientific session of the American College of Cardiology by Meditronic Inc.

The Spectrax is not only very small and light (10mm thick, with a weight of 45g), but includes a microprocessor chip which permits a doctor to change the instrument's functioning to suit changing medical conditions throughout the pa-

tient's lifetime. Previously, changed medical conditions required another operation and the installation of a different pacemaker.

The new pacemaker will be of particular benefit to children. A young child's heartbeat is faster than that of an adult, and slows down with age. In the past children have required repeated operations to install new pacemakers as they grow older. The Spectrax, programmed by radio pulses from an external instrument, can easily be adjusted to the decreasing heart-rate through childhood. In fact the pacemaker is sold with a lifetime guarantee.

Business Briefs:

- National Semiconductor Corporation recently announced plans for the construction of a new semiconductor Wafer Fabrication plant in Arlington, Texas. Company officials expect the plant to be operational in early 1982 and to employ about 1500 people by 1986.
- OTC Australia has expanded its bureau to bureau facsimile transmission service, Overseasfax, to New Zealand. Facsimile transmission of documents from OTC's bureaus in Sydney, Melbourne and Brisbane to the required overseas destination takes only a few minutes per page.
- Philips Telecommunications Manufacturing Company has been awarded an order worth \$200,000 for radio systems to be used by the Queensland Department of Harbour and Marine Boating and Fisheries Patrol. The order involves five UHF repeaters tied together by a full duplex link system, and the installation of transceivers in the vessels of the Fisheries Division.

New research effort into solar cells

Two of California's largest electricity suppliers, Pacific Gas and Electric Company and Southern California Edison, have agreed to a jointly funded project to develop an automated solar cell production process. The cells, solar panels and a pilot production line will be developed by Westinghouse Electric Corporation's advanced energy systems division in Large, Pennsylvania, with costs of the development shared by Westinghouse and the electricity suppliers.

The first phase of the plan calls for the construction of a pilot plant capable of producing each year solar cells with a total generating capacity of 50 kilowatts. After successful conclusion of this phase, Westinghouse plans a semi-automated facility and a fully automated production line able to produce a total generating capacity of 25,000kW per year.

Under a contract from the US Department of Energy, Westinghouse's Research and Development Centre has developed a technique for growing single-crystal silicon ribbon and processing the ribbon into solar cells. The silicon ribbon, known as a dendritic web, is produced directly from molten silicon in a process which yields a long, smooth ribbon of pure silicon ready for solar cell fabrication. Costly slicing of silicon ingots, polishing and cleaning are eliminated, resulting in significant cost savings.

A different "videophone" technique

A British company, Gresham Lion, will manufacture under licence a method of transmitting television pictures over telephone lines developed by the British Post Office. The technique was developed by the British Telecom Research Centre at Martlesham Heath, and involves reducing the vast amount of data in a television signal to a level which can be handled within the limited bandwidth of ordinary telephone lines.

The device captures a single monochrome TV image, digitises it and transmits the signal over the telephone line. Using a private leased line the technique is fast enough to allow a separate picture every 5.4 seconds, equivalent to a data transmission rate of 48,000 bits per second. Using the ordinary switched public network a picture can be transmitted every 54 seconds, a transmission rate of 4,800 bits per second.

The system will have applications in security monitoring, industrial control and traffic observation — anywhere in fact where continuous surveillance is required but second to second changes are unimportant.

The vodka is good but the meat is rotten!

Researchers in the United States are close to perfecting equipment which translates text from one language to another. The system will soon be available commercially, according to Dr Allan Melby, assistant professor of linguistics at Brigham Young University in Utah, where the equipment is being developed.

Techniques for translating languages by machine have been studied for at least 30 years with only limited success. The main problem is in trying to relate grammatical rules which define the syntax of a sentence to the meaning, or semantics, of the sentence. For example "He washed the floor with a mop" and "He washed the floor with Bill" have a similar grammatical structure but different semantic contexts.

Most previous research has concentrated on performing a syntactic analysis of a group of words followed by some automatic way of working out their meaning. The simplest technique is a direct word-by-word translation with a limited search for the syntactic context of each word, which may involve looking at associated articles and pronouns.

The problems of this method are highlighted by the old story of the machine which was used to translate "The spirit is willing but the flesh is weak" into Russian and back into English. The sentence emerged as "The vodka is good, but the meat is rotten".

Researchers at Brigham Young have adopted a new approach. Decisions

about the appropriate meaning of a particular sentence are not performed by the computer, but by a person who instructs the computer which of several meanings to adopt in a particular context. Originally the researchers hoped to develop techniques based on artificial intelligence research which would automatically carry out the task of assigning meaning to ambiguous sentences. This would mean that even the limited assistance of a human being would not be required.

Dr Melby believes, however, that for the foreseeable future the assistance of a human being combined with computer analysis of sentence structures offers the best chance for a commercially available text translation machine.

Talking switchboard for the blind



Shown above is SAM — the Switchboard Advisory Module — being used by a blind telephonist to give her a spoken prompt about the state of the calls she is handling. Linked to a standard switchboard the device provides the operator with important information about outgoing calls, engaged extensions, callers awaiting assistance and the correct keying of digits. The SAM equipment incorporates a microprocessor-controlled voice synthesiser which speaks to the operator through a built-in loudspeaker.

Now undergoing proving trials at the Royal National Institute for the Blind, London, SAM is expected to save the jobs of blind telephonists who are unable to see flashing lights on the illuminated display panels of modern telephone equipment. It was designed and developed at Britain's Imperial College of Science and Technology, and funded by the National Research Development Corporation.

The device is not yet commercially available.

Electronic device monitors sleep



Mrs Joan Hannan and Dr Peter Birrell demonstrate the sleep monitor. (Photo courtesy Univ. of NSW Public Affairs Unit).

Researchers at the University of NSW School of Psychology have developed an electronic sleep monitoring device based on a microprocessor to assist research into insomnia.

The small bedside machine emits an audible chime at programmed intervals during the night. The research subject presses a button if he or she hears the chime. The number of chimes, the number responded to, and the pattern of responses is analysed to tell the researchers when and for how long the subject slept.

The device is used every night for a week, and records the subject's responses on cassette tape. When the cassette is full it is posted back to the University for researchers to study.

Sleep monitoring devices have been used for some time but previous devices recorded the data as a series of dots on paper tape, requiring laborious manual examination. The cassette tape can be fed directly to a computer which scans, sorts and presents the information in a single operation.

The head of the School of Psychology, Professor Syd Lovibond, hopes that the monitor will tell the researchers whether insomniacs really do sleep less than most people, or if they just think so. The computer reading of the results of the monitoring experiment will tell the researchers exactly when the subject was awake. The University will offer treatment to insomniacs after the monitoring phase of the experiments.

“the only part of your Sound system, that by changing, would make an enormous listening difference. . . are the speakers”



MODEL FIFTEEN SERIES TWO

CENTRE CHANNEL 3 PIECE REFERENCE SYSTEM OPERATING RANGE

40 to 150 watts (RMS) per channel

The larger sub. woofer (dual wound) can be placed unobtrusively in any part of the room, and the small bookshelf pair for stereo image, placed on the wall, bookcase, or stands.

IN HAND CRAFTED VENEER, INDIVIDUALLY GRAPHED, TESTED, AND ASSEMBLED

THIS SYSTEM CREATES INCREDIBLE DYNAMIC RANGE USUALLY ONLY PRESENT WITH VERY LARGE ENCLOSURES, AND STABLE STEREO IMAGE, BECAUSE THE LOWER FREQUENCIES ARE REMOVED FROM THE REST OF THE MAIN FREQUENCY SPECTRUM.

they only look and sound like you cannot afford them.



Australian technology at it's finest. . .

**TRADE ENQUIRIES ONLY
7 ALEX AVENUE,
MOORABBIN VIC.
TELEPHONE: (03) 553 1055**

eterson **SPEAKER LABORATORIES Pty Ltd**

STOCKED BY MOST REPUTABLE OUTLETS

PARTS FOR NEW KITS

If a kit you want to build is not listed, the parts may be available anyway. Check the Dick Smith Catalogue or call in to your nearest Dick Smith store.

ELECTRONIC MUSIC GENERATOR (See EA December)
Complete kit, including instructions Cat K-3512 81.60
PCB only Cat H-8382 81.90

TRAIN CONTROLLER (See EA November)
PCB Cat H-8381 1.90
All other components for this kit (including case) are normal stock lines

'3000' STEREO AMPLIFIER (See ETI November)
PCB Cat H-3631 87.50
All other components for this project are normal stock lines.

MOISTURE INDICATOR (See ETI November)
PCB Cat H-8632 81.90
All other components for this project are normal stock lines.

ACOUSTIC COUPLER (See EA September)
Complete kit, including metalwork, etc. Cat K-3005 576.00
Printed Circuit Board only Cat H-8380 94.00

EXPANDED SCALE AUTOMOTIVE VOLTMETER (See ETI Sept.)
Printed Circuit Board Cat H-8630 81.60
LM3914 IC Cat Z-8295 84.28
Choose round or rectangular, large or small LEDs to suit your particular application.

CHASER (See EA August)
Complete kit, including front panel Cat K-3145 96.90
PCB only Cat H-8379 86.96

NASA POWER CHOPPER (See EA August)
Short form kit (All components & PCB) Cat K-3325 816.50
PCB only Cat H-8378 83.00

LEDS AND LADDERS GAME (See EA August)
Complete kit inc. printed panel Cat K-3390 816.78
PCB only Cat H-8378 83.00

LED TACHO (See ETI August)
Short Form Kit (includes PCB components etc, but no case - build it into your dash board) Cat K-3240 824.50

FAST NICAD CHARGER (See ETI August)
PCB only Cat H-8027 83.00
All other components in this kit are normal stock lines)

GITAR/PA PREAMP (See ETI August)
Short form kit PCB & components, no transformer or case) Cat K-3035 629.50

300 WATT AMPLIFIER (See EA June)
Printed Circuit Board only Cat H-8376 89.95
Most other components are normal stock lines.

TV CRO ADAPTOR (See EA May)
Complete Kit Cat K-3060 829.95
Printed Circuit board Cat H-8375 83.75

KA'S NEW MUSIC GENERATOR

This is a great little kit for the beginner or the experimenter - it uses a very special IC, which is pre-programmed with two popular tunes. A few more components and a printed circuit board make the kit complete. It plays a complete melody - including chords (not just a few notes as other IC's). It is intended for novelty or alarm applications; with a suitable amplifier it could be used as a singing doorbell.

ONLY \$12.50

Cat K-3512

OPENING SOON AT AUBURN (NSW)

Yes, another new store will soon be opening in Sydney's Western Suburbs. Right on Parramatta Rd, near the Auburn Motor Inn. Watch your local papers for the opening date!



145 PARRAMATTA RD AUBURN.

DON'T FORGET: ONLY 9 WEEKS TO CHRISTMAS!!!

Need a few ideas for someone into electronics? Go no further than your nearest Dick Smith store!



IT'S CUTE!

It's called a 'Cutie Phone'!

You've probably seen phones like this one in the movies. Here it is - in Australia! It gives push-button dialling, last number re-dial and folds down when not in use. Great for a bed-side phone, etc.

NOTE: Although this phone connects directly to standard Australian telephone lines, current regulations do not permit them to be used for this purpose.



\$69.50

THE DICK SMITH SOLDERER'S SPECIAL!

1: 30W, 240 VOLT IRON

A budget iron for the hobbyist; beginner or expert. Ideal for all electronic assembly work. Cat T-1300. Normally \$9.75

2: 250g ROLL SOLDER

Economy pack of popular 1.25mm solder; enough to last you for many, many projects. Cat N-1619. Normally \$4.95 roll

3: SOLDERING STATION

Our incredibly popular 3-in-1 stand which holds PCB or any other, iron and solder. Incredibly versatile; you'll wonder how you got along without it! Cat T-5700. Normally \$19.50



ALL ITEMS AVAILABLE SEPARATELY

ALL THREE FOR ONLY \$29.90

XMAS IDEAS FOR THE KIDS!

SPACE INVADERS !!

WHY SPEND HUNDREDS OF DOLLARS PLAYING ARCADE MACHINES. BUY YOUR OWN!

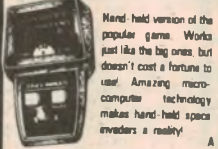

\$24.50

Cat X-1150

Hand-held version of the popular game. Works just like the big ones, but doesn't cost a fortune to use. Amazing micro-computer technology makes hand-held space invaders a reality!

SPACE INVADERS AND BLOCKBUSTER!

\$29.95

A more elaborate version - and this one also has a second game Blockbuster! Easy to play, great sound effects, with various options to make the game even more exciting. Battery operated, so they can take it anywhere. Cat X-1152

MORE THAN AN ORGAN



\$29.50

IT'S MICROCOMPUTER CONTROLLED!
With this remarkable organ you can not only play tunes, you can record them in the computer memory for later playback! And it also plays its own repertoire - just in case you're feeling lazy! Battery operated, a superb gift idea! Cat X-1158

TIME IT! STOP IT!

\$39.50

This superb new liquid crystal stop watch/clock is just the go for today's sportsman; whether you're taking part, or sitting on the sidelines! Huge, easy to read digits giving time to 1/100 second, also does lap times, etc. And when you're not using it as a stopwatch, it's a highly accurate clock! Incredible value; similar models sell for \$100 and more! Cat X-1041

Dear Customers,

Quite often, the products we advertise are so popular they run out within a few days. Or unfortunate circumstances might hold up goods so that advertised lines are not in the store by the time the advert appears. Please don't blame the store manager or staff; they cannot solve a dock strike on the other side of the world, or even locate a shipment that has gone astray.

What we are trying to say is that, if you're about to drive across town to pick up a particular line at a Dick Smith Store, why not give the store a ring first (addresses and phone numbers below) - just in case! Thanks,

Dick Smith and Staff

TOP VALUE MAINS IRON

Dick's own 240V fully approved mains soldering iron. Supplied with free solder sample, great value for hobbyist & technician alike. 25W rating. **COMPARE OTHERS AT \$14 AND MORE!!**



\$9.75

T-1300

NEW RANGE OF SOUND CARE EQUIPMENT JUST ARRIVED!

You asked for it, so here it is! Economy sound care equipment that will do a really professional job on your records and cassette. Something for everyone, at a bargain price!

- Cassette winders, labels and reel locks Cat C-7000 **\$2.95**
- Cassette head care kit Cat C-7000 **\$2.95**
- Cassette head demagnetizer and cleaning fluid Cat C-7000 **\$4.50**
- Deluxe record cleaner, Cat C-7002 **\$3.95**
- Deluxe record cleaning air and brush, Cat C-7004 **\$4.95**

WOTTA BARGAIN!

We've just brought a HUGE shipment of these incredibly popular push button telephone dialer - so our cart has dropped. You reap the benefit of Dick's huge bulk buying power!

Simply substitute for any rotary dial. Although these units fit perfectly into standard Aust. phones (no soldering required) current regulations do not allow you to use them for this purpose. Cat X-1176

Now: \$39.50



MAJOR DICK SMITH RE-SELLERS:

- Listed below are re-sellers who stock a large proportion of our range. However, we cannot guarantee that they will have any or all of the items or at the same prices, as those advertised on these pages.
- ATLANTON, QLD:** Tabiland Radio Service 2 Jack Street, Phone 912 817
 - BALBOONAH, VIC:** Advansy Electronics 181 Main Street, Phone 625 782
 - BERKHAMPTON, VIC:** Semmar Electronics 96 Mitchell Street, Phone 431 977
 - BLACKHEATH, NSW:** Goodwin Electronics 123 Station Street, Phone 578 378
 - BROKEN HILL, NSW:** Crystal TV Rentals 80 Crystal Street, Phone 487
 - COFFS HARBOUR, NSW:** Coffs Harbour Electronics 3 Coffs Harbour Plaza, Park Ave, Phone 525 684
 - DARWIN, NT:** Kent Electronics 42 Stuart Highway, Phone 814 746
 - FAIRY MEADOWS, NSW:** Trilogy Wholesale Elect. 40 Princess Hwy, Phone 831 218
 - GEELONG, VIC:** Electrolux 133 Malop Street, Phone 87 827
 - GERALDTON, WA:** KB Electronics & Marine 361 Main Terrace, Phone 212 178
 - GOSSFORD, NSW:** Tomorrow's Electronics & Hi Fi 80 Wilton Street, Phone 247 244
 - GOBBART, TAS:** Aero Electronics 123a Bathurst Street, Phone 348 232
 - KINGSTON, TAS:** Kingston Electronics & Records Channel Court, Phone 288 882
 - LANINGTON, TAS:** Advanced Electronics 6a The Bandstand, Phone 317 876
 - LEONORA, NSW:** Necca Electric Car Magellan St & Brazier Hwy Phone 214 137
 - MACKAY, QLD:** Stevens Electronics 42 Victoria Street, Phone 511 723
 - MARYBOROUGH, QLD:** Keller Electronics 214 Adelaide Street, Phone 214 658
 - MORUYA, NSW:** Coastal Electronics 43 Volcan Street, Phone 742 646
 - MY BARRIER, SA:** Hutchesson's Communications 5 Elizabeth Street, Phone 256 404
 - MUSWELLBROOK, NSW:** Silicon Chip Electronics Suite 3, 88 Bridge Street, Phone 43 1096
 - NAMBOUR, QLD:** Nambour Electronic Shop Shop 4, Lawson House, Ann St, Phone 411 604
 - NEWCASTLE, NSW:** Electron 2000 181 Wharf Road, Phone 282 844
 - NOWRA, NSW:** Lyrahird Electronics 50 Berry Street, Phone 26 626
 - ORANGE, NSW:** M&W Electronics 48 McNameer Street, Phone 828 481
 - ROCKHAMPTON, QLD:** Paraly Electronics 16 Esau Street, Phone 21 858
 - SOUTHPORT, QLD:** Amateur's Paradise 1211 Moring Street, Phone 322 644
 - SURFERS PARADISE, QLD:** Viking Electronics 3188 Gold Coast Hwy, Phone 322 644
 - TAMWORTH, NSW:** Sound Components 79 Brisbane Street, Phone 881 283
 - TOWNSHIRE, QLD:** Hants Electronics 18 Neil Street, Phone 328 844
 - TRARALGON, VIC:** Power'n'Sound 16 Franklin Street, Phone 743 838
 - VINCENT, QLD:** Tropical TV 248 Felham Road, Phone 781 421
 - WARRA, NSW:** Wagon Wholesale Electronics 82 Forayth Street
 - WALGETT, NSW:** P.J. O'Brien Electronics 82 Waa Waa Street, Phone 243
 - WINDSOR, NSW:** Newkashery Electronic Centre 111 George Street, Phone 773 411
 - WODONGA, VIC:** A & M Electronics 78a High Street, Phone 244 688
 - WHYLLA NORRIE, SA:** Walker Enterprises Shop 2, Farnytha Street, Phone 454 784

BUYING BY MAIL?

ORDER VALUE:	P&P
\$5.00 in. to \$9.99	\$1.00
\$10.00 in. to \$24.99	\$2.00
\$25.00 in. to \$49.99	\$3.00
\$50.00 in. to \$99.99	\$4.00
\$100 in. or more	\$5.50

NOTE: These charges apply to goods sent by post in Australia only. Large and bulky items cannot be sent by post. If you prefer, we will dispatch your order by Courier Road freight to anywhere in Australia for only \$6.00 - that's below what it costs us! Large and bulky items are normally sent by Courier unless you specify differently (eg by rail or air - you pay freight in delivery).

DICKSMITHELECTRONICS

MELBOURNE 399 Lansdale Street Ph (03) 87 9834	RICHMOND 656 Bridge Road Ph (03) 428 1614	BURANDA 186 Logan Road Ph (07) 391 8233	CHERRYSIDE 842 Gympie Road Ph (07) 58 6255	PERTH 414 Wilton Street Ph (09) 328 6944	ADELAIDE 80 Wright Street Ph (08) 212 1962	CANBERRA 96 Gladstone Street Ph (062) 80 4544	WOLLONGONG 263 Keira Street Ph (042) 28 3800
--	--	--	---	---	---	--	---

**AS SEEN
IN OCTOBER
ELECTRONICS AUSTR.**

Do-it-yourself ATOMIC BOMB (Short form kit)

Yes! You asked for this one! the fantastic do-it-yourself Atomic Bomb described in the October Electronics Australia. A great bit of parties; imagine the reaction you would get next cracker night! This kit comes complete with the two stray building as specified in the kit (unfortunately, it won't fit in the box, so we include a 'rain check' redeemable at any real estate agent. You specify the area you want to devastate).

The kit is complete to the last nut and bolt with the exception of the uranium. However, this should not be a problem, as the construction article gives full instructions on how to go about stealing your own.

No self-respecting terrorist should be without this kit. Come to think of it, if all self-respecting terrorists built themselves a bomb, there would be no self-respecting terrorists left!

NOTE: Life expectancy of bomb constructors is invariably reduced dramatically: like to a few hours or least!



**GREAT
GIFT IDEA
FOR BUDDING
NUCLEAR
PHYSICISTS!**

Cat X-3471

ONLY \$19280472⁰⁰ NOTE: NO U₂₃₅ SUPPLIED WITH THIS KIT
— YOU MUST OBTAIN YOUR OWN!

DON'T PAY 35¢ EACH FOR 1% RESISTORS . . .

Manufacturers . . . Laboratories . . . Government departments . . . Are you sick of paying 'through the nose' for high tolerance resistors? We've seen many people advertising them for as much as 35¢ each! If you need premium quality, 1% tolerance and unbeatable prices, you cannot go past our range of metal film resistors.

They're only 6¢ each ONE OFF; even cheaper in bulk quantities!

More of Dick's BONZA BULK BUY BARGAINS: BEWDY!



Here's this for a bargain: a superbly made 4PDT relay with 12 volt (185 ohm) coil at near half price! Yes, hundreds of uses for the professional, the hobbyist and the experimenter. And for 10 or more, the price drops to just \$2.50 — incredible! Cat S-7000

\$2.90

Unbelievable price! Famous quality Memorex real-to-real tape at pre-1974 price! Yes, 2400 ft Memorex tape on 7" reel, in box, for around 1/3 off current price while stocks last

Cat C-3408



MEMOREX

STILL AVAILABLE!

**Dick Smith's Fun
Fun Way into
Electronics, Vol 1.
VALUE PACK:**
The book and both
kits (worth over \$19)

for only **\$17.50!**

Just in case atomic bombs aren't your scene, Dick has the incredibly popular 'Fun Way into Electronics' (Vol 1), together with both kits of parts, in a special value pack. All the projects in Fun Way 1 are battery operated, with no soldering — so they're completely safe for even the youngest beginner. If you're looking for a different Christmas gift idea: this is it!

**FUN WAY TWO BOOK AND KITS
NOW AVAILABLE ALSO! SEE OUR
ADVERT ELSEWHERE IN THIS ISSUE.**

HARD OF HEARING?

This could be the answer: a telephone amplifier! Just connect the suction cup to your phone case (no electrical connection) and listen: it will amplify whatever you say into the handset as well as whatever is heard. So it's ideal for conference listening etc. Another quality Dick Smith exclusive import and just look at our low low price!



Cat X-1174

\$12.50

PRICES SLASHED ON DISKETTES

Look at these incredible new low prices for quality 5 1/4" diskettes! (Both styles (hard and soft sector!)) To suit most disk drives. And the savings are even greater if you buy in quantity! Hurry, stocks cannot last long at this ridiculous price!

1-10 \$4.95
10-100 \$3.95
100+ \$3.50!!

Hard Sector: Cat X-3505
(Sait Macropia drive)
Soft Sector: Cat X-3510
(Sait Partec drive)

HUGE SAVINGS ON FAST 4116 RAMS, TOO

Don't be conned into paying top dollar for RAMs by mis-leading ads: Ours are guaranteed prime spec, 250ns 4116 RAMs ideal for almost all applications. And they're available either singly, or in 10K packs with upgrade kits for popular computers.



Single 4116 RAMs, Cat Z-9310 \$7.90
10K kit, (8 x 4116) Cat X-1106 \$59.95

THE ATARI VCS* IS HERE!



INC. BONUS
COMBAT CARTRIDGE

This is it, the video computer everyone is talking about. The incredible Atari Video Computer System. It's a much, much more than a TV game computer: for this incredible device accepts a huge number of plug-in cartridges to give you years of family fun with thousands of game variations! And even more, with an optional program (which you can buy at many large department stores) the computer can ACTUALLY BE PROGRAMMED IN BASIC COMPUTER LANGUAGE!

As we said, it's much more than a video entertainment computer!
AND YES — IT HAS 'SPACE INVADERS'!

WHY WASTE MONEY ON 'PENNY ARCADES'?

CARTRIDGES CURRENTLY AVAILABLE:

Video Chess (X-1404)	\$59.95	Space Invaders (X-1408)	\$49.95
Night Driver (X-1413)	\$39.95	Bowling (X-1409)	\$39.95
Carson Azon (X-1405)	\$49.95	Street race (X-1414)	\$39.95
Sky Drive (X-1407)	\$39.95	Breakout (X-1411)	\$39.95
Air/sea battle (X-1408)	\$39.95	Irish 500 (X-1412)	\$59.95
Outlaw (X-1410)	\$39.95	P&P fees if bought with console	

NEW YAESU FRG-7700 COMING SOON!

In a word — WOW!
This incredible new receiver has absolutely everything the serious SWL could possibly want: all mode reception (yes, even FM — so you can use converters for 'amateurs'), tunes down to 150kHz for up to 30MHz; has a cont. variable RF attenuator; 3 positions of selectivity on AM — it must be far and away the best receiver available anywhere! And it has a digital memory unit for programming up to 12 frequencies for instant recall!



D-2840

**DUE IN STOCK
EARLY DECEMBER
WORTH WAITING FOR!**

**DON'T BUY AN R-1000
BEFORE YOU SEE THIS BEAUTY!**

WHY BUY BATTERIES? THEN THROW THEM AWAY!

NiCads are cheaper!
It's a fact. NiCad batteries work out far cheaper in the long run, they may be dearer at first, but if you work out the price vs. number of charges you'll agree. Partridge NiCads are ideal for replacing conventional 'AA' cells (1.2V is normally class enough).

Only **\$2.05** each
Or **\$1.80** ten or more.

**Can't charge Nicr's?
Problem solved!**

This great new NiCad charger from A&R plus our multi-voltage adaptor — you're in business. Simply slots 2 to 4 NiCads in the cartridge, plug in the adaptor, and you're away. Comes back in 15 hours and they're fully charged!

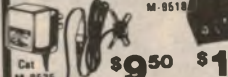

Cat M-9525 \$9.50
Cat S-3000 \$1.95

SNIP IT!

Incredible! These remarkable strips are ideal for the hobbyist, the housewife, the student, the lab — they cut just about anything! Even Templates and leather! Quality NZ made strips will last for years, too.

\$2.95

Cat T-4930

RADIO COMMUNICATIONS from the Radio Society of Great Britain

Stocks of both of the much sought after and very hard to get Radio Communication Handbooks are now arriving. Published by the RSGB, many people believe them to be BETTER than the ARRL handbook! Specs with the fundamentals goes through to the details. A perfect study reference for the AOC examinations.

Vol 1 (400pp) hard cover (Cat. R-2030) **\$24.50**
Vol 2 (334pp) hard cover (Cat. R-2032) **\$19.50**

**DON'T MISS OUT
STOCKS ARE
LIMITED!**

Reference books
LOGIC — TTL DATA MANUAL
Huge 785 pages crammed with data on popular TTL-type IC's. Worthwhile of a place in every experimenter's & hobbyist's reference library. Cat B-4021 **\$8.50**

Analog Applications Manual
Ever wondered where designers get their ideas from? Wonder no more! 416 pages of interesting and useful applications for Signetics linear integrated circuits. Cat B-4031 **\$8.00**

INCREDIBLE BARGAIN! Superseded Amateur Radio Handbooks

WOW! We've made an incredible scoop purchase of Amateur Radio Handbooks direct from the publisher. There are the 1978 issues: the last of the ones that contain useful valve data! Great for novices, beginners, etc: here's your chance to own the amateur's 'bible' at a tiny fraction of the current price!

\$15 VALUE! Cat B-2217
HURRY! LIMITED STOCK!



NEW EDUCATIONAL SOFTWARE TO SUIT THE DICK SMITH SYSTEM 86 (ALSO RUNS ON TRS-80)

Learning Fun 1: Scavie Invaders.
A unique program that combines basic maths drill with the ever-popular 'Spas Invaders' game. Practising maths has never been so much fun! Before being able to take each shot with the laser gun at one of the dreaded Scavies, the player has to feed the correct data into the spaceship's computer. Sound effects. Requires a 16K machine. This program was written by a NSW primary school teacher. Cat X-3694

Learning Fun 2: Hangman/Concentration.
Two programs which are not only great fun to play, but also help to increase familiarity with words. Hangman is the computer version of the well-known word guessing game — complete with graphics of the 'man' getting hanged. The words can be chosen by the computer or by a second player. Concentration is the computer version of the TV quiz game, trying to guess mystery word words. Requires 16K machine. Cat X-3698

Learning Fun 3: Alphabet Countdown/Rhyme Time
Two computer games which are a lot of fun, and give players of any age practice in selecting and manipulating words. Rhyme Time also helps to increase their skill in spelling and vocabulary. In Alphabet Countdown, random words from a list must be arranged alphabetically in the shortest possible time. Rhyme Time displays a list of unrhymed rhymes, and the player must type in the missing word from the clues given in the rhyme. The player's percentage correct is displayed. 16K, Cat X-3698

(ON CASSETTE) EACH ONLY \$9.95

WOULD YOU LIKE TO WORK WITH US?

Dick Smith Electronics is expanding — if you've been watching your local press you'll probably have noticed this already!

Opening new stores requires new staff. Good staff. Electronics enthusiasts who can be trained to become professional sales people and managers.

If you're talented and enthusiastic, we offer good wages and conditions. If you're above average, promotion can be very rapid. (One of our salesmen became general manager three years later!)

No matter what area you live in, if you'd like to work with us, drop us a line. When we open a store in your area, we'll be in touch . . .

Send your application to:
The Personnel Manager,
Dick Smith Electronics Pty Ltd
PO Box 321,
North Ryde, NSW 2113

COMPUTER HOTLINE . . . (02) 888 2002

Having computer problems? Or perhaps you'd like to buy a computer but don't quite know which one you want? Phone our computer hotline 9AM to 5PM Monday to Friday for friendly, helpful advice about computers. Note the special number

DICK SMITH ELECTRONICS

SYDNEY 125 York Street Ph (02) 290 3377	BROADWAY 818 George Street Ph (02) 211 377	BLAKEHURST 613 Princes Hwy Ph (02) 546 7744	BROOKVALE 531 Pinwater Road Ph (02) 93 0441	CHULLORA 147 Hume Hwy Ph (02) 642 8927	GORE HILL 162 Pacific Hwy Ph (02) 439 5311	PARRAMATTA 30 Grove Street Ph (02) 683 1133	MAIL ORDER AND SERVICE CENTRES: Cor Lane Cove & Waterloo Rds, North Ryde NSW 2113 (Monday to Friday, 9AM to 5PM only)
<p>SHOPS OPEN: 9AM TO 5:30PM MON. TO FRI. 12 NOON SATURDAY (Brisbane 1/2 hour earlier)</p>							

OTC updates

The majority of Australia's overseas communications are now routed through a network of communications satellites circling 36000km above the Earth, although no such system existed before 1965. Establishing the system demanded major advances in technology and in international co-operation, but the network operates so effectively that it is largely taken for granted.

by **PETER VERNON**

It is easy to forget that it is only 15 years since the world's first commercial communications satellite, Intelsat I, ("Earlybird") went into operation above the Atlantic Ocean. Only 12 years have passed since the opening of the Overseas Telecommunications Commission's earth station at Moree, NSW. Yet the ability to talk to friends overseas and to see events in other countries on television as they happen has become such a commonplace feature of our lives that it is now taken for granted.

The first earth station for satellite communications in this country was the 12.8 metre Cassegrain horn antenna at Carnarvon, WA, which went into service in 1966. Initially the station was used to provide direct communication between Australia and the USA via a Pacific Ocean satellite in support of the NASA space program.

It was through this station that Australia saw its first satellite television program – "Down Under comes Up Live" – late in 1966. The telecast was an exchange between Carnarvon and London via the Goonhilly Downs earth station in the UK. The transmission used an Intelsat II satellite which went out of control following a launch mishap, and temporarily drifted into a suitable position for the broadcast.

For some years the original Carnarvon station operated under contract with Intelsat as one of seven tracking, telemetry, command and monitoring (TTC&M) stations spread throughout the world. Carnarvon continuously tracks the satellites during launch and operation, ensuring that they are in the correct position and if necessary commanding on-board motors to adjust the positioning. Telemetry from the satellites is

monitored to check the functioning of the complex electronic and mechanical components of the satellites.

Last year OTC was awarded a five year contract by Intelsat to provide TTC&M services associated with the introduction of the new Series V communications satellites. The Intelsat V satellites, the first of which is due to be launched later this year, are designed to use a technique known as dual polarisation, which allows each satellite to provide 12,000 communications channels instead of the 6000 currently provided by the Intelsat IVa satellites.

Major modifications were required to the Cassegrain horn antenna at Carnarvon to enable it to meet the specifications demanded by Intelsat for monitoring Series V satellites. Total cost of the redevelopment was \$470,000, although this would have been much higher without the help of the CSIRO.

The upgrading of the Cassegrain horn antenna involved replacement of the antenna feed waveguide and low noise amplifiers, reconditioning of the hydraulic components of the antenna positioning system and major rearrangements of the control room.

The existing low noise amplifiers, cooled by liquid helium, have been replaced with amplifiers cooled by solid-state Peltier effect devices which provide the required performance without the compressors and associated refrigerator plumbing needed for cryogenic cooling.

The key element of the antenna is the feed unit – a metre long gold-plated tube which channels the microwave signals between the antenna and the control room. The precision made device incorporates some sections bought from Comsat, others manufactured by OTC's own workshops and a horn designed and built by the CSIRO's Radio Physics division – who are recognised as world leaders in this field.

The development and assembly costs of the new feed unit totalled almost \$100,000, about one sixth of the cost of a similar unit bought "off the shelf" and designed for installation in a new standard earth station with a parabolic dish. The feed was designed to accommodate dual polarisation – a technique of frequency re-use which substantially increases the effective bandwidth of the satellite transponders. Each frequency band simultaneously carries two sets of signals, with one set circularly polarised

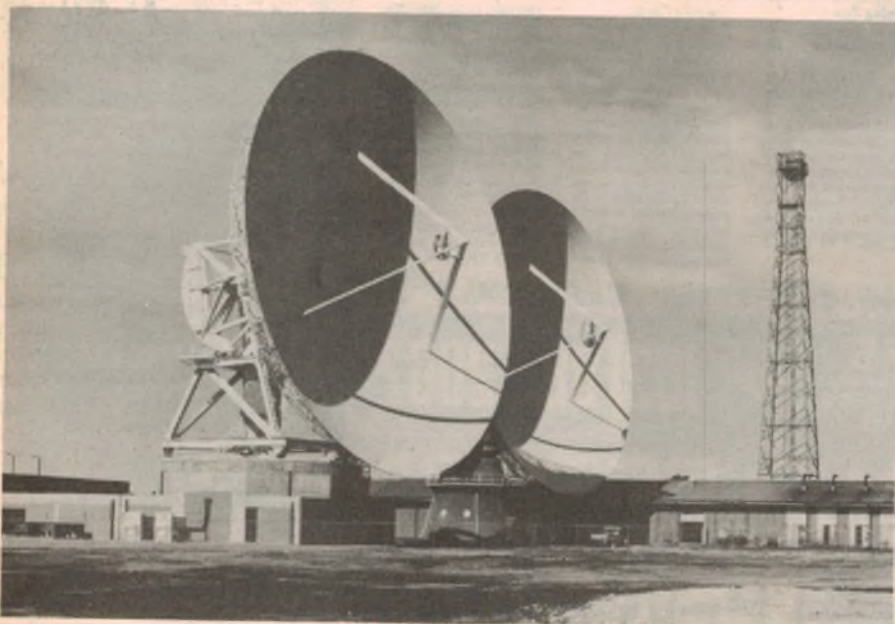

OTC's earth station at Ceduna, SA, links Australia to Europe via the Indian Ocean satellite. The Ceduna 2 antenna, opened last July, is in the foreground.

Carnarvon

to the left and the other set to the right.

Polarising vanes within the feed unit allow the waveguide to discriminate between the two sets of signals, so that the antenna can simultaneously transmit on 6GHz and receive on 4GHz.

The Cassegrain horn at Carnarvon is unique in that it is now the only facility of its type operating to the new standard in the Intelsat network.

Australia's first earth station to provide commercial communications links via satellite began operation in 1968. Situated 10km from Moree in NSW, the station uses a 27.5m parabolic dish antenna to communicate with the United States, Asia and other nations in the Pacific region through Intelsat's Pacific Ocean satellite. OTC now has five Intelsat standard earth stations in operation. Apart from Moree and the two stations at Carnarvon there are two stations at Ceduna in South Australia, providing communication channels between Australia and Europe, Africa and the Middle East.

Prior to December 1969, when the first station at Ceduna opened, telecommunications traffic from Australia to Europe was carried either by submarine cables or by satellite systems over the Pacific with a relay by satellite over the Atlantic.

The choice of Ceduna as the location of the earth station was determined by the limits of the zone covered by the satellite over the Indian Ocean and the need to position the station as close as possible to the south-eastern region of Australia where most of our international communications traffic originates. Ceduna, just east of the Western Australian border, is almost on the edge of the coverage zone of the Indian Ocean satellite, and the dish antennas point almost parallel to ground, looking just over the horizon.

To cope with the continuing high growth rate in communications between Australia and Europe OTC commissioned a second satellite earth station at Ceduna. Ceduna 2 was opened on July 24 this year, and also serves the fast growing communication paths to Africa, India and the Middle East.

Ceduna 2 has a slightly larger dish-shaped antenna than Ceduna 1 (32m compared to 29.6m) and weighs about 260 tonnes. The antenna is mounted on a track above the building containing the associated electronic equipment, unlike

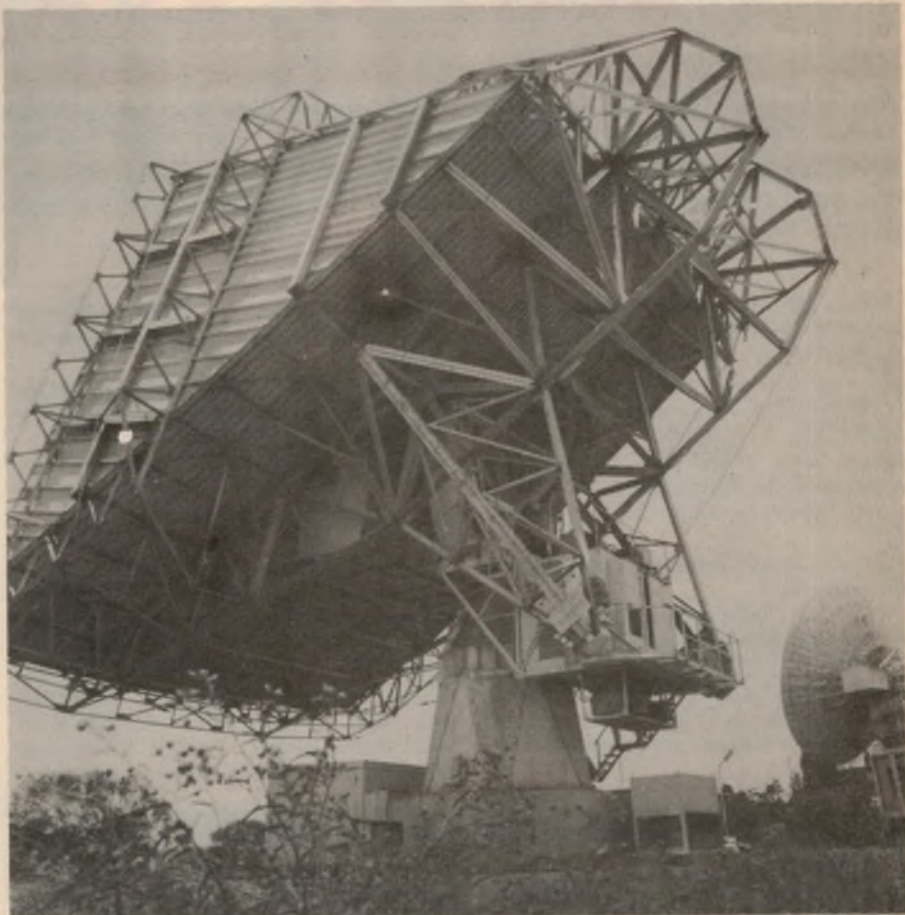

The Cassegrain horn antenna at Carnarvon, WA. Major modifications have been made to the antenna so that it can monitor the new Intelsat Series V satellites.

the Ceduna 1 antenna whose receiving equipment is housed in a control room mounted on the antenna structure. Another of the features of the new facility is a "beam waveguide", a tubular device which enables the signal to be reflected by a system of four highly-polished steel mirrors into the equipment room below the antenna.

Ceduna 2 will provide the additional capacity necessary to cope with the rapid increase in traffic and also provide a back-up system for increased security of the communication channels. It will operate to a second satellite over the Indian Ocean, thus providing two completely separate telecommunications paths between Australia and Europe.

Almost half of Australia's international communications are now routed through Ceduna, and there are good

reasons for having two separate earth stations operating in parallel. A temporary breakdown of equipment at one earth station or a failure of the satellite to which it operates could otherwise affect OTC's ability to handle the large amount of traffic that flows daily both ways through Ceduna. Additional security is provided by the duplication of terrestrial microwave links between Ceduna and eastern Australia, and by the duplicate power generating capability of Ceduna 2.

We have come a long way in 15 years, from Earlybird to a world-girdling network of communications satellites. The degree of international co-operation required to establish and operate the system stands as an example of what can be done when the nations of the world work together in a common purpose. ☺

Video Discs

— the 3-way race

The videodisc war is hotting up, with three rival non-compatible systems slated for the US market by the end of 1981. Each has its advantages and disadvantages, each has powerful industry tie-ups, and each represents a huge investment. The question now is which will win the three-way race?

by ROBERT ANGUS

When CBS introduced the long-playing record in 1948, RCA countered with the 45rpm. When Ford, RCA and Motorola came up with eight-track tape cartridges in 1964, Philips, Ampex and a number of others got behind the audiocassette. When Sony introduced the Betamax video recorder, Panasonic, RCA, JVC and a few others weren't far behind with VHS.

So why should it be any different with the videodisc?

If you thought your video options would lie strictly between the two videocassette systems and the videodisc system introduced at the end of 1978 by MCA, Magnavox, Philips and associated companies, you've got another think coming.

By this time next year, there will be at least three videodisc systems to choose from:

- Disco Vision, developed by MCA, Philips and Magnavox and presently available on a limited basis.

- Selecta Vision, developed by RCA with the cooperation of CBS, MGM and a number of others.

- VHD, brought to you by JVC, Panasonic, Quasar and General Electric.

Corporate egos, not to mention millions of dollars in potential profits, ride on which system wins out. CBS, back in the days of the LP-45rpm battle, discovered that no company, no matter how big, can win alone. At that time RCA dominated the record business in the US. But CBS, by offering a helping

hand to dozens of tiny, fledgling record companies, managed to triumph with its 33½-LP over RCA's 45rpm discs.

Accordingly, developers of each of the leading videodisc systems have been busy lining up support among other manufacturers and suppliers of program material. Here's how the three-way race lines up: In the Disco Vision camp are manufacturers such as Pioneer, Kenwood, Magnavox, Philips and Sony. The Selecta Vision counterparts are Zenith and RCA — which together account for 50% of the colour television business in the United States — plus Sanyo, Sharp, Hitachi, BSR and possibly Toshiba. VHD, developed by the giant Matsushita group, includes, so far, JVC, Panasonic, Quasar, General Electric and, in England, Thorn, one of that country's giants.

Programming is the key

Using the long-playing record as a case history, each team is fully aware that without interesting program material, the public won't care about the relative technical merits of the respective hardware systems. Accordingly, Philips-Magnavox formed a partnership early in the game with MCA, the colossal entertainment conglomerate that owns Universal Pictures and quite a chunk of the music business. Pioneer, another member of the Disco Vision team, has a close working relationship with Warner Brothers. And Pioneer-Philips-MCA recently formed OPA, a production company devoted entirely to producing program material for the videodisc.

RCA, the company that got so badly burned by trying to go it alone in 1948, has signed up the most formidable array of program suppliers, including the company's own record division, plus CBS (a major coup ending a feud lasting more than 30 years), Viacom, NBC, United Artists, MGM, Paramount, Walt Disney Studios and Beta-Taurus of Munich.

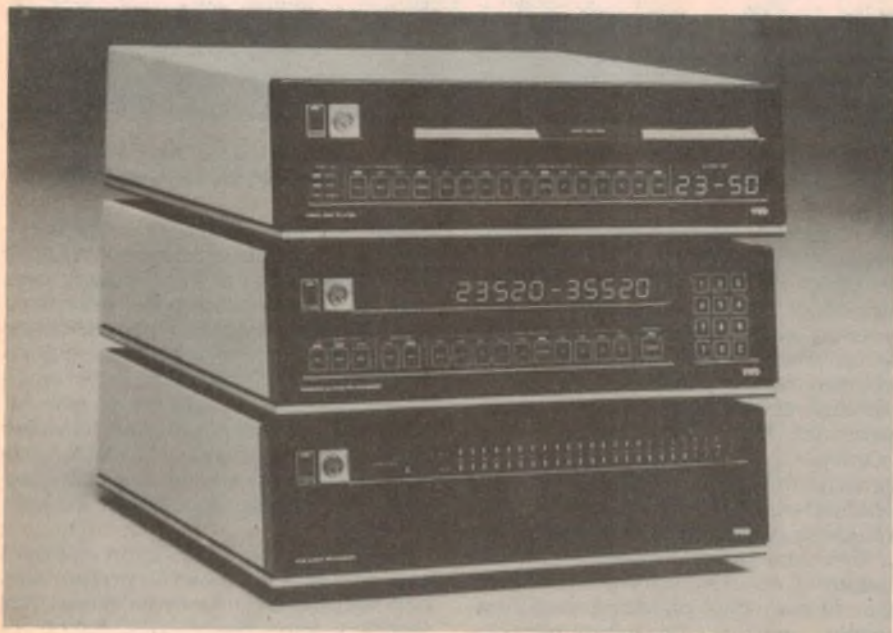

Above: General Electric Company's version of Matsushita's VHD videodisc system. At top is the VHD player itself, while a "Remote Access Programmer" and a "PCM Audio Processor" are shown at centre and bottom respectively.

By contrast, VHD, which got a late start, presently boasts only EMI, Teichiku and JVC Records, plus Matsushita's own production group. But that "only" may be a misleading term to apply to one of the world's largest entertainment companies — for EMI owns Capitol Records, several motion picture studios, distribution companies and TV productions, along with a huge worldwide record empire that could enable it to put together, virtually at the drop of a hat, a very impressive catalogue of video programs. Teichiku and JVC are important record companies in Japan with lots of know-how and production capability, but with a shortage of existing program material likely to interest non-Japanese audiences.

Matsushita, which owns record labels and originated the VHS videocassette format, has quietly been building a separate catalogue of videodisc and digital VHD audio material, and recently announced its own version of Disco Vision's OPA, a joint venture which would include GE, Matsushita, JVC and Thorn-EMI. The company would acquire videodisc rights to existing material, produce new titles, manufacture the records and distribute them to video dealers.

These starting lineups are, without doubt, impressive. But the important thing to remember is that each team contains a number of free agents — companies who either already have agreements with two or more systems (most commonly the equipment manufacturers) or companies which have granted *nonexclusive* distribution rights to their feature films and other programs to one system, leaving them the right to license the same material to others too. Sanyo, for example, believes that the RCA system will dominate North America while the Philips system will dominate Western Europe. So it intends to make both types of turntables, but only one for each market. Paramount, CBS and other program suppliers likewise have expressed confidence in Selecta Vision for the US market, but have said that if one of the others proves strong enough, they'll supply their programs for it. A tipoff to who's winning in the pennant race may well be to watch the movement of these "free agents".

The different systems

There are basically two ways of picking video images off the surface of a record. You can use a laser beam of light to pick out the coded signals embedded in the record surface, or you can use a stylus and cartridge similar to those used to track an audio record's groove to pick up the information mechanically. The former system is called *laser optical* because it relies on a laser beam and optical technique for analysing and translating the coded signals to electrical impulses. That system is being used by the Disco Vision. The VHD and RCA groups are using the other, lower-cost



The Philips VLP player as it appeared in the early 70s.

capacitance (referring to the type of mechanical pickup) system.

There are advantages and disadvantages to each. The chief advantage of the capacitance system is its low cost and high degree of reliability. Laser technology, still in its infancy, is more expensive and extremely delicate when applied to a device like a turntable pickup. However, the laser can do things a mechanical pickup can't — like repeating the same picture frame over and over, or not causing record wear because there's never any physical contact between the tracking element and the record surface.

All three systems use digital encoding in the form of tiny pits in the record surface to represent pictures and sound. It's possible to record pictures on a disc using analog technologies (the kind used to produce the grooves on a conventional long-playing audio record), and many of the early attempts at videodiscs used analog techniques. Digital pits, however, pack more information into a limited amount of space, and offer higher audio and visual fidelity.

RCA's digitally encoded pits are arranged along the sides of the groove, whereas Disco Vision's are pressed into a highly reflective surface below the actual surface of the record. VHD's pits are on the surface of a highly conductive polyvinyl chloride disc, arranged in a spiral similar to RCA's, but lacking the physical groove. The result of that is a Disco Vision record which is impervious to dust, dirt and scratches, but expensive and difficult to produce in quantity.

Both RCA's and VHD's records can be turned out on conventional audio disc pressing equipment, but the surfaces are subject to the same sort of physical risks of damage which afflicts audio records. To minimise that, and to keep it from affecting the quality of the pictures, both

manufactures use a "disc caddy", a device that looks like a long-playing record jacket. When you play one of these records, you insert both the record and its caddy (with the record still inside) into the player through a slot in the front. The turntable extracts the record and returns the caddy to you before beginning to play. When you want to remove the record, you must reinsert the caddy so that the turntable mechanism can return the disc to its jacket.

Until recently, there was no real way to compare the performance of the three systems. Disco Vision's vital statistics were clear enough, since its players have been on the market for nearly two years. But VHD and RCA's Selecta Vision remained laboratory toys until recently. The nation's video retailers and other "insiders" (including the press) got their first look at what may or may not be the finished product only within the past few months.

In terms of price, VHD and Selecta Vision, with target prices "under \$500", would appear to enjoy an edge over Disco Vision's approximately \$800 for a turntable. Likewise, one-hour VHD or Selecta Vision records priced at \$15 or less would be cheaper than Disco Vision's \$15.95 to \$24.95 records. Whether the VHD and Selecta Vision groups can meet those price targets remains one of the big unanswered questions at this time.

A factor of growing importance in figuring total cost of any video product these days is its power consumption. The figure for all three systems is surprisingly low compared to that of the colour television set on which you watch the program. Highest is Disco Vision, with 95 watts — almost three times that of Selecta Vision (35 watts) and VHD (39 watts).

Don't let technology pass you by!

Learn Microprocessor Programming and Application techniques

with the  **Microprocessor Self-Instruction Program.**



Microprocessor Trainer for EE-3401 Program



Functioning as a miniature digital computer, the ET-3400 Microprocessor Trainer is essential for the experiments in the EE-3401 self-instruction program. After completing the program, the ET-3400 is ideal for breadboarding, prototyping and system design.

If you're involved in scientific or electronic pursuits, microprocessors are becoming a way of life and a dominant factor in your success or failure. The EE-3401/ET-3400 self-learning program and accompanying computer trainer is the easy, effective way to learn about these powerful devices. The program uses Heath's proven self-instructional techniques including programmed instructions and audio-visual aids to teach computer programming, microprocessor operation, interfacing and related topics.

This self-instruction program covers microprocessor basics, computer arithmetic, programming, interfacing and much more.

The microprocessor course is organised into 10 learning units as follows: 1: Number Systems & Codes, 2: Microcomputer Basics, 3: Computer Arithmetic, 4: Introduction to Programming, 5: The 6800 Microprocessor—Part 1, 6: The 6800 Microprocessor—Part 2, 7: Interfacing—Part 1, 8: Interfacing—Part 2, 9: Programming Experiments, 10: Interfacing Experiments. Each unit is complete with introduction, unit objectives, activity guide, experiment, examination and examination answers.

The EE-3401 is complete with 62 electronic components required to complete the experiments. These components include two 2112 256 x 4-bit RAM's, 6820 PIA interface chip, 1406 d/a converter, 741 and 301 op amps and a variety of other microprocessor-oriented devices. The ET-3400 Computer Trainer is required for the experiments in the Microprocessor Course.

Course EE-3401

\$155.00

The ET-3400 features a built-in 1K ROM monitor program for controlling unit operation; 6-digit hexadecimal 7-segment LED display for address and data readout; 17-key hexadecimal keyboard for entering programs and data. Has 256 bytes of random access memory (RAM) built-in, expandable to 512 bytes with the RAM's supplied in the EE-3401 program. Also has 8 buffered binary LED's for display of breadboard logic states, 8 SPST DIP switches for binary input to breadboard circuits, a breadboarding socket for prototyping, interfacing and memory circuits.

All microprocessor address, control and data busses are buffered and terminated on the front panel for ease of connection to prototype circuits. There's also provision for a 40-pin external connector to extend memory and I/O capacity. Built-in +5, +12 and -12 volt power supplies.

Kit ET-3400

\$347.00

Microprocessor Trainer Accessory

The ETA-3400 gives you the additional I/O and memory you need to turn your ET-3400 Microprocessor Trainer into a complete, personal computer system. It provides an audio cassette interface so you can store programs on convenient cassettes. It also provides an additional 1K bytes of memory so you can run longer and more sophisticated programs through the ET3400. The memory can be expanded to 4K bytes with the optional 3K chip set (ETA-3400-1). A serial I/O with EIA 20mA loop format provided in the ETA-3400 accessory lets you hookup a video terminal.

A tiny BASIC interpreter is provided in ROM to let you do actual programming using the BASIC language.

Kit ETA-3400

\$270.00

ETA-3400-1, Optional 3K Chip Set

\$ 86.00

ORDER BY COUPON NOW OR COME TO OUR SHOWROOM

Please rush me the Heathkit of my choice. My cheque for \$..... is enclosed plus \$7.00 for package and post.

Name

Address P/Code

- Course EE-3401 Kit ET-3400 Kit ETA-3400
 ETA-3400-1

I'd like to know more about the full range of Heathkit Training Programmes and Prices. Please send to me, without obligation, my FREE catalogue and price list.

Send to: W. F. Heathkit Centre
 220 Park St., South Melb. 3205. Phone 699 4999.

EA11



Left: RCA's Selecta Vision player. As with the VHD system, the record is inserted with its caddy through a slot in the front of the player. The player then extracts the record and returns the caddy before beginning to play.

For purposes of comparison, a typical Beta video recorder draws 70 watts; a new solid-state 63cm colour console TV set about 170 watts.

What about availability? If you want a video turntable immediately, today, you're going to have to settle for Disco Vision. RCA's won't be available much before the end of the year — and early 1981 would seem more likely. By that time, Pioneer and Magnavox turntables, which have been available only in a limited number of cities, should be generally available, along with videodiscs. The VHD system won't be on the market until the end of 1981.

What you're really interested in, however, is how the three systems compare in picture and audio quality. Here I feel that Disco Vision and VHD clearly outpoint Selecta Vision. First, Selecta Vision has only one audio channel at present (RCA says it will add a second one "at some later date"), and its 50-15,000 Hz frequency response is less at both extremes than the 40-20,000 Hz claimed for Disco Vision and VHD. Matsushita, in fact, is busy stockpiling four-channel digitally-recorded masters in preparation for a library of true digital audio discs. Since that system can feature either a single quadraphonic hour-long program per side, or two conventional hour-long

stereo programs on the same disc side, VHD hopes to make the strongest appeal to audiophiles.

Philips, one of the Disco Vision partners, showed a 10.8cm digital audio disc last year which would require a player separate from the videodisc turntable. More recently, Pioneer has talked in terms of a compatible digital audio disc that would play properly on the Disco Vision turntable.

Meanwhile, Sony has been hard at work adapting a slowed-down version of the Disco Vision disc to archival work for storage of the Library of Congress' sound archives. The company says that this project is related more closely to its industrial and institutional efforts on behalf of the videodisc than to consumer products, but it clearly indicates the direction of Sony's thinking — and gives the Disco Vision system entree to the vast educational and archival field.

When it comes to picture quality, you'll have to be a test instrument to detect any difference in quality among the three systems. I found the picture quality of all three excellent, at least in company-presented demonstrations — in which, of course, it was impossible to compare the different systems side by side. Magnavox claims a video bandwidth of 4.2MHz, well in excess of RCA's 3MHz or the

3.1MHz claimed for VHD. However, Disco Vision and RCA don't talk about video signal-to-noise ratio, while VHD claims 42dB. Suffice it to say that in demonstrations all three appear distinctly better in chrominance and resolution than the best Beta or VHS videotapes.

All three videodisc systems offer a number of fast-forward, indexing and freeze-frame features not commonly found on videocassette equipment. All three offer fast-motion and slow-motion, visual search and the like. Disco Vision and VHD offer an additional feature: still-frame viewing, coupled with digital access to each frame.

In addition to the three major videodisc formats, there have been hints over the past year of as many as six more, some coming from Japanese manufacturers who have since decided to throw in their lot with one of the three established systems. There was a time, however, when it seemed that every major Japanese manufacturer had its own videodisc system. Virtually all have been abandoned in favour of Disco Vision, Selecta Vision or VHD.

There are still two other European systems active in specialised fields. One is the disc developed by Teldec in West Germany, which went on sale there briefly several years ago. Teldec's problems were short playing-time per side, problems with colour and a shortage of interesting programs. The system aroused virtually no interest among the general German public, and never made it to the United States.

Thomson-CSF, a French industrial giant, developed its own videodisc system several years ago using lightweight capacitance discs that could be rolled up and mailed. Playing-time is somewhat limited, and Thomson has made no effort to obtain popular program material. Instead, the company has been offering the system for industrial use — with great success. Because the records can be produced cheaply and in large quantity, and because they can be mailed easily and inexpensively, they're ideal for carrying corporate messages from headquarters to far-flung branches, or for sales pitches to retailers and their customers.

There have been, and undoubtedly there will be others. But with the intense competition going on now among the Big Three, it seems likely that the system you buy in the foreseeable future will be one of them.



A recent model Philips VLP player. VLP special playing modes include freeze frame, fast forward, reverse, slow motion and search. Double-sided discs play for either 30 or 60 minutes per side.

Reprinted with permission from "Video Review". Copyright 1980 CES Publishing Corporation.

It is now over 50 years since talking pictures first appeared on the Australian scene, and only the older generation can remember their introduction. These reminiscences, by a technician who was in the thick of it, should enlighten the younger generation and awaken memories for those old enough to recall the era.

Fifty years of talking pictures

by **G. M. NEALE**

34 Madeleine St, Glen Waverly,
Vic. 3150.

Technicians entering the field of electrical/electronic engineering today may find themselves concerned with the installation of complex electrical systems, the wiring of which entails little more than identifying a number of factory cut cables complete with plugs and sockets, and mating them with the appropriate cabinets and consoles.

It has occurred to me that the scene some 50 years back may make interesting reading for the young and not so young. I particularly refer to the early days of talking picture installations;

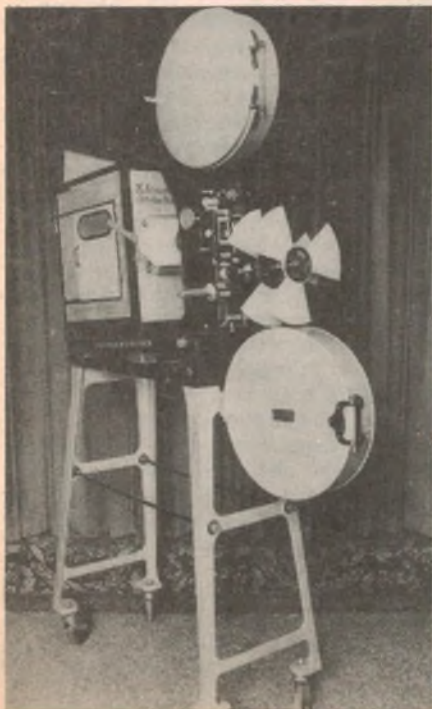

though the technology may now be "old hat", it was far from it then.

I entered an apprenticeship in the electrical engineering division of Hoyts Theatres, Melbourne, in 1931. Hoyts in those days operated 40 or more cinemas in Melbourne, along with country and interstate interests.

The greater part of the "talkie" installations had been completed when I started, but I well remember entering the projection room (better known as the box) of one, the Strand (Bourke St), which was to be wired for sound and reopened under the name of Mayfair.

It seemed nothing had been disturbed since the projectionist and his assistant had put out the house lights for the last time, many months or even years before.

The two machines were there under dust covers, the projection heads with 1500 metre upper and lower film magazines, large ornate lamp houses accommodating the arc lights, and fancy flue pipes with lobster-back bends winding their way out doors to dissipate the heat.

Standing prominently out from one wall was an open type marble switchboard with huge copper switches, porcelain fuses about the size of a beer stubby, three brass cased meters some eight inches in diameter and a generator field rheostat; all of which controlled and monitored the 110V, 90A, required by each of the two arcs. The bare copper and brass switchgear seemed to spell out "danger, keep clear".

A silent movie projector from A. G. Krupps, in use in Australian theatres around 1918. The unusual "fan" arrangement at the front is actually part of an optical shutter mechanism, and employed contra-rotating blades to blank the projection between film frames.

Having taken all of this in, the thing that arrested my attention more than anything was a sizeable teapot sitting in one of the projection wall ports. I learned that the old silent machines could be threaded with 1500 metres of film, amounting to some 45-50 minutes between machine change-overs, during which time the senior projectionist had little to do other than twiddle the arc feed from time to time. In order to break the monotony he had the assistant prepare a brew, and he sat there sipping tea until the next machine change-over.

Believe me, it was the assistant who did the work in those days. In many cases he collected the film from the distributors, re-wound it, threaded the machines, took part in the change-over, removed the previous reel, re-threaded and made tea; all for a fraction of the senior operator's pay.

What a change was about to take place in this peaceful routine, particularly for the senior. It was to be several years before procedures settled down, and even then there was little or no time for tea making.

Within a week or two there would appear on the wall of the box several heavy iron clad switches with large red bezels, six foot racks standing away from the wall (for access from both sides) with many small and not so small valves, and numerous green, red, and amber panel lamps, invariably grouped around a transfer switch designated Sync-Non Sync, or some equally unfamiliar term.

The operator now had to pay attention to the monitor speaker, listen for buzzer signals from the theatre (instructing an increase or decrease in sound level), attend the arc and arc generator voltage (the latter usually varied as the generator warmed up) and, as if to add fuel to fire, be on the alert to change from one machine to the other every eight to 10 minutes with such expertise

that there would be no noticeable break in sound or picture.

There were knobs and controls set against graduated escutcheons. The white faces of three inch panel meters were everywhere; on the six foot racks, others on the machine, the motor control consoles, and so forth. Some with red lined indexes or filled in sectors on the scale. What a contrast to the three old eight inch meters on the illuminated marble panel (still standing against one wall).

In 1928, when talkies were introduced to the world, the major equipment manufacturers were Western Electric and RCA. The ratio of installations in Australia during the mid 30s would be something in the order of 12 WE to one RCA, and perhaps there lies a lesson in marketing, for both systems were excellently engineered and backed by these giant organisations.

What the installation ratio was in the United States I have no idea. However, competition and what goes with it must have been fierce over there, for WE engineers were issued with passport type identity cards and a condition in the installation contract was that no one other than WE and theatre staff were permitted in a WE box unless expressly vouched for by the theatre manager. I have no doubt that installation sabotage took place in many quarters in the States, as indeed it did in Australia.

It is difficult for the younger generation to comprehend the importance of cinema entertainment 50 years ago. On Saturday nights each and every theatre was packed out. It was, in most cases, the one and only night's entertainment a family had outside their own home.

Many regular patrons had their favourite theatres and would walk past other shows to reach the one of their choice. Theatre management would avoid, at all costs, closing a theatre for renovation, alteration and so forth, for fear of losing their regular customers to the opposition.

So it is understandable that, once the decision was made to install talkies, every obstacle was swept aside to meet the re-opening date a week or so later. There would be intensive advertising; "Re-opening Saturday Night", "100% talkies", and so forth.

Quite often the installation team arrived after the last evening show of a Saturday, and commenced work in order to avoid loss of time. Penalty rates and overtime were no barrier. Such was the atmosphere. A team of electricians, carpenters, painters, carpet layers, riggers and labourers went to it, working as long as physically possible (sometimes snatching a few hour's sleep, on double time) and then at it again.

One case of sabotage I learnt of here in Melbourne occurred in a suburban theatre. The installation party had worked hard at it and by the end of the week the WE engineer completed his

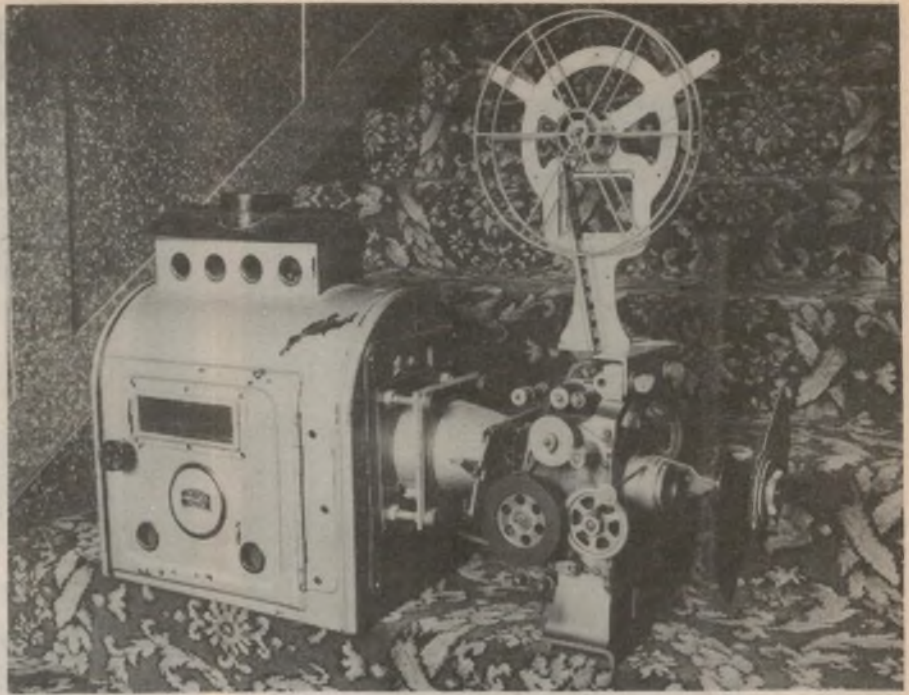

A 1912 Powers Bioscope projector. The extensive ventilation arrangements indicate that this projector was originally a "lime-burner", illuminating the film with an acetylene lamp, although this unit was subsequently converted to use a carbon arc lamp. Some later model Powers projectors were also converted for use with sound films by adding a sound head underneath the projector body.

testing. By late Saturday afternoon the projectionists had been given all the tutoring they could expect in the limited time, and all retired to their lodgings, for a wash-up, change of clothing, and refreshment prior to the big re-opening.

On returning at 7pm it was soon determined things were not right, and eventually discovered too late that someone had been in during their absence and cut through vital (sound) wiring. The show didn't re-open that night. In my opinion it may have been arranged by the nearest opposition theatre manager. However, the incident had little effect on the patronage, for the house was full the next Saturday night.

I mentioned earlier there may have been a lesson in marketing when one compared the number of WE installations against those of RCA. As an apprentice I soon became aware that the Western Electric system remained the property of that company, in other words, the equipment was hired while the RCA system became the outright property of the theatre. It is not surprising, then, that WE dictated rigid service arrangements as opposed to a more flexible "agreement" made with RCA.

The Western Electric contract called for the replacement of certain valves on a routine basis, even though there may have been many more month's of useful life left in them. The theatres paid dearly for this, though there is no denying the service was good.

To quote one example. Four large 211E

triode valves were used in the WE final stage amplifier. One pair, with their grids tied to their plates and wired as a full wave rectifier, supplied some 600 (plate) volts for the other pair wired in push-pull.

In the early thirties, these valves were invoiced to the theatre at about £8-10 (\$17.00) each, and they were either to be routinely replaced every three months or when a standing plate current dropped below a certain value. Once a valve was used as a rectifier, it was strictly forbidden to put it in the amplifier stage, though I have often wondered, had this been done, whether the audience would have detected any difference. Condemned valves were supposed to be destroyed by the engineer but odd ones were to be found carefully put away.

About 1934 our chief engineer (Trevor Hedberg MIEE) became aware there was a direct equivalent to the Western Electric 211E valve made by Slyvannia, USA, and available on the Australian market at about £2 (\$4.00). Bearing in mind we had some 30 theatres or more with WE equipment, with each of these changing four valves every three months or so, this was big money. He made an attempt to introduce the Slyvannia valve but the WE contract was not to be tampered with. Nevertheless, the invoice cost of the 211E was thereafter reduced somewhat.

Factors that contributed to Western Electric's successes in those early days were: (i) their readily available spares

50 years of "talkies"



LEFT: Film enthusiast Phil Doyle (Managing Director of the Mecca International Theatre, Kogarah, Sydney) displays a 1924 Kalee 30 projector – a model typical of those used to show the early silent epics. RIGHT: a 1935 C & W projector. C & W, an Australian company based in Sydney, subsequently went

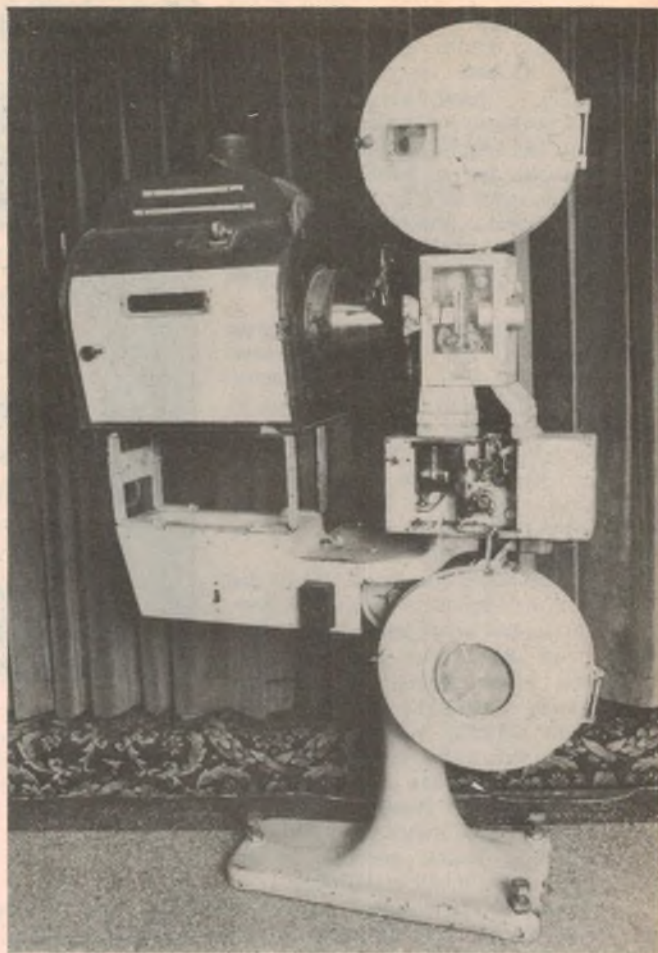

out of business as a result of fierce competition with overseas manufacturers. The projector shown was later fitted with RCA sound heads (note the way the camera body has been "jacked up on brackets") and continued in use until 1965.

and interchangeable units kept in all important centres, and (ii) their selection and training of service engineers; all of which was supported by the rigid installation contract signed at the time.

I came to know service engineers from both camps and, while both companies in Australia recruited electricians with suitable background, WE alone appeared to engage a proportion of university trained engineers or physicists. This academic expertise blended in very well when it came to team work.

It must be appreciated that the formal training available to electrical technicians, as we know it today, did not exist then, and to find an electrician with a basic knowledge of physics along with AC and DC technology was indeed rare. On the other hand there were a few fellows playing with amateur radio, even triode valves, but had little or no knowledge of installation procedures – transporting heavy fragile electrical apparatus into biograph boxes high up in a theatre, erecting, fixing, wiring with screwed conduits, and so forth.

The wiring in these systems was an electrician's dream and anyone who

ever worked through an installation would never forget how to handle screwed pipe. Each and every run of cable with but one exception, was protected in screwed conduit, which terminated in heavy sheet metal boxes, with lock nuts and screwed bushes.

On the wall behind the amplifier rack in a WE system, there was a main junction box pre-wired back to the amplifier. From this box emanated every size of screwed conduit from 18mm to 38mm: to the heavy iron clad switches on the wall; three runs to each machine with battery, 110V AC, and sound wiring separated; the projector motor control AC, and battery filament supplies; speech and signal lamp wiring to the fader on the front wall; the monitor speaker in the box; the non-sync dual turntable unit (AC and sound in separate runs) and, finally, two runs of 30mm and 38mm conduits to the back stage junction box.

In one of these conduits was a pair of heavy VIR insulated cables (7/064-60 amp.) supplying battery voltage for the speaker fields, and in the other several pairs of VIR cables (7/029-24 amp.)

providing sound to each speaker, depending on the number of speakers in the system. The heavy cabling was to guard against power or signal loss in these long cable runs of up to 90 metres, though the currents involved were only a fraction of the normal current carrying capacity of the cable:

The speakers were of the folded exponential horn type, the mean length of which was some five metres. The weight of the horn I would guess to be about 90kg, so that a group of speakers, plus the heavy timbering of the screen frame work and yards and yards of heavy felt acoustic draping became a weight to be reckoned with.

Where it was necessary, as in some theatres, to raise the entire screen and speaker system to allow stage presentations, it called for a substantial piece of rigging.

The only section of wiring unprotected by screwed conduit was that from the back stage junction box to each speaker unit, and this cable was first class industrial type twin-core flex, jute wrapped and braided, each pair having a finished diameter of about 15mm.



The old and the new – Phil Doyle with the 1924 Kalee projector and one of the two modern Eprad Universal projectors currently used at the Mecca Theatre, Kogarah, Sydney. (All photos in this article courtesy of Phil Doyle).

Consider then the work involved in getting sound wiring down to the stage. Not only the long screwed conduit runs with large inspection bends (elbows were not permitted), draw through boxes, running threads, etc, but the need for two or three strong men hauling the cable through the conduit while someone fed it in at the other end, guarding against twists or insulation damage (to say nothing of his fingers), and preferably still another hand making sure the cables did not tangle as they came off the drums. Communications between those pulling and those feeding followed no particular rules; however, it compared rather favourably with "bullocky jargon" of the old days.

The wire in those early days was plain copper as opposed to tinned copper. The VIR insulation had a nasty habit of both oxidising the copper and adhering to the wires during manufacture. Each and every strand had to be separated and scraped with a knife before any attempt was made to solder it. Tinned cable was introduced in the early thirties to overcome this problem.

Talking of soldering, just imagine having a kerosene blow lamp going hour upon hour in order to fit solder lugs, as compared to today's crimping methods. What a contrast to today's multicore cables arriving on the job, pre-cut and terminated.

(continued next month)



“HOW TO TURN ELECTRONIC THEORY INTO PRACTICE AND MAKE IT PAY...”

“If you understand and enjoy radio and electronics and want to extend your knowledge and experience, then we at Stott's can help you.

Stott's have home-study courses for complete beginners in Radio theory and basic Electronics through to the standards needed to maintain and service Colour Television.

Anyone who has these skills at their fingertips can make it pay by turning a fascinating hobby into a lucrative part or full time profession.”

Athol H. Kelly

Athol H. Kelly B Com (Hons.) AASA FCIS
Principal Stott's Technical Correspondence College

Stotts



The name to trust in
correspondence education

TECHNICAL CORRESPONDENCE COLLEGE

Melbourne, 159 Flinders Lane, 3000 Tel: 63 6212

Sydney, 383 George Street, 2000 Tel: 29 2445

Brisbane, 290 Adelaide Street, 4000 Tel: 31 1627

Adelaide, 85 Pine Street, 5000 Tel: 223 3700

W. Perth, 25 Richardson Street, 6005 Tel: 322 5481

Hobart, 1st Fl, 29 Argyle Street, 7000 Tel: 34 2399

Singapore, P.O. Box 3396 Singapore 1.

Please send me free, and without obligation,
full details of the following courses:

(PLEASE PRINT)

MR MRS MISS _____ AGE _____

ADDRESS _____

POSTCODE _____

Stott's undertake that no sales counsellor will visit you



The Stott's range of courses in
Electronics is:

- Intro. to Electronics
- Digital Electronics for Technicians/Servicemen
- Microprocessors
- AM Radio Receivers
- Radio/TV Servicing
- Colour Television
- Radio for Amateurs
- Amateur and Novice Radio Operators Certs
- Electrical Mechanics

A full range of Hobby and Business courses also available
ALA/ST1929/EA1 180

they're here!



LINSAC

Sinclair ZX80

SOFTWARE

(and more to come)

C-12 CASSETTES, \$12 per pack

Including postage & packing

PROGRAMS ON CASSETTE WITH FULL DOCUMENTATION.
ALL PROGRAMS RUN ON BASIC ZX80 SYSTEM UNLESS OTHERWISE STATED.

ZX80 COMPANION
87 PAGE BOOK

\$16

Book is arranged so that the intending user of the ZX80 entering computing may start using the system and gradually gain a better appreciation of the machine and facilities. The informed computer user will find the later sections useful in applying his knowledge to the ZX80 which has brought a breath of fresh air to the personal computer scene.

Linsac Software comes on C12 Cassettes with **Full Documentation** including

- Program Listing • User Instructions • List of Variables with Meanings
- Program Description • Sample Program Run

GAMES PACK ONE CONTAINS

- G001 Three Towers**
Rearrange the rings to build a new tower.
- G002 Number Guessing**
Find the hidden number with hints from the ZX80.
- G003 Mastermind**
Break the four digit code.
- G004 Sketcher**
Draw patterns of your choice with memory mapping.
- G005 Hurdle**
Hunt the horrible hurdle in the 15x15 grid.
- G006 Nim**
The familiar game of skill.
- G007 Symbol Simon**
Try and match the complex increasing pattern.

GAMES PACK TWO CONTAINS

- G008 Nine Lives**
A word game for two players — possibly fatal.
- G009 The Maze Game**
Find the treasure as the maze grows around you.
- G010 Plain Sailing**
Steer a yacht against dangerous currents.
- G012 Noughts & Crosses**
The ZX80 plays an excellent strategic game.
- G013 Chinese Puzzle**
Can you rearrange the blocks in the right way?
- G014 Tower of Hanoi**
The game of antiquity.
- G015 Battleship**
Realistic naval artillery action.

GAMES PACK THREE CONTAINS

- G011 Fruit Machine (2-4K)**
The ZX80 as a one-armed bandit.
- G016 Four in a Line (4K)**
A 2 player game arranging patterns of counters.
- G017 Zombies**
You are surrounded by zombies on a desert island.

EDUCATION PACK ONE CONTAINS

- E001 Maths Drill**
Two levels of difficulty included.
- E002 Dot recognition**
Recognise the number of a random dot pattern.
- E011 Musical Notes**
Teaches children notes on the scale.
- E004 Spelling Quiz**
The teacher sets five words to be tested.
- E007 Day Finder**
Gives the day of the week for a date.

EDUCATION PACK TWO CONTAINS

- E005 Graph Plotter**
Plots quadratic equations.
- E006 Prime Factors**
Calculates prime factors of given numbers.
- E008 Number Bases**
Conversions and calculations in different bases.
- E009 Bar Charts**
Plots bar charts from supplied data.
- E010 Statistics**
A collection of statistical routines.

UTILITY PACK ONE CONTAINS

- U001 Memory Display**
Displays 80-byte blocks of memory (char/hex).
- U002 Hex Code Monitor**
Handles machine code routines.
- U003 Renumber**
A full renumber routine.
- U004 Memory Search**
Finds and displays byte patterns.

C-12 CASSETTE ORDER FORM

SINCLAIR EQUIPMENT (AUSTRALASIA) PTY. LTD.
 308 High St., Kew 3101, Vic. Tel. 861 6224

Item	Quantity	Total
Games Pack One		
Games Pack Two		
Games Pack Three		
Education Pack One		
Education Pack Two		
Utility Pack One		
ZX80 Book		
Total		

I enclose cheque/Bankcard/Diners Club/Amex

Name

Address Postcode

ET12



FORUM

Conducted by Neville Williams

It's legal to ruin one another's hearing ... provided we do it with music!

Under-cover groups, currently operating in Australia, see it as their social duty to deface hoardings which, in particular, advertise alcoholic and tobacco products. Perhaps they should be turning their attention to the more extreme pop groups which, in the name of entertainment, are contributing to a generation of Australians who (you'll have to speak up) can't hear very well!

In typing the above introduction, I am aware that it may raise the ire of some readers but, on the other hand, it may well earn me honorary membership of BUGAUP — Billboarders Using Graffiti Against Unhealthy Promotions; at least, I think that's what it stands for.

In fact, I do not support the idea of defacing other people's property with (of all things) spray-paint, and especially if it amounts to vandalism for its own sake. But I can understand feelings of genuine frustration and the urge to protest against social liabilities that continue to be tolerated by the community and governments alike — seemingly in the face of all commonsense.

What does or does not constitute a social liability is, of course, open to debate and I am not about to start talking here about the merits or otherwise of alcohol and tobacco. But I am concerned about hearing loss and I think it may be hard to find any real justification for non-essential actions and attitudes which can seriously and permanently impair the hearing of thousands of young people.

I had a long, loud whinge about excessive sound amplification in the November 1977 issue, triggered by an experience at an ethnic style concert on the outskirts of Rome. In the mail which followed, correspondents gave literally complete support to my sentiments but there the matter seemed to end.

My protests, and others like it, seemed simply to fall on deaf ears! The position appears to be getting worse, not better.

These present remarks are prompted by a paper presented to the Tenth International Congress on Acoustics (Sydney) by Mr Steven Cooper, of James A. Mad-

den Associates Pty Ltd, consulting acoustical engineers. I was not present personally but am relying on reports published in the "Sydney Morning Herald" on September 9 and 10, 1980, and on a subsequent conversation with the lecturer.

Mr Cooper's report carries considerable weight because it is based on actual sound pressure level readings, as distinct from the ocker table: "loud — flamin' loud-deaf'nin — b... ridiculous — b... stupid!"

Readings were taken at 37 different entertainment venues in and around Sydney, including hotels, clubs and discotheques; this over a period of two years.

To serve as a reference for his observations, Mr Cooper used the occupational noise dose limit figure which now applies to employment situations

throughout Australia.

It nominates a figure of 90dB (A) as the maximum sound pressure level to which an employee should be subjected per eight-hour working day. It so happens that a table published in our August 1978 issue nominated 90dB as the start of the "Danger" zone in terms of hearing. As a broad guide, the same table suggested that this would approximate the noise level in the immediate vicinity of a heavy transport truck.

Exposure to a 90dB SPL (sound pressure level) for a period of eight hours represents a legal noise dose limit of 1.0. To stay within the legal limit, exposure time should be halved for each 3dB increase in noise level: 93dB — four hours; 96dB — two hours; 99dB — one hour; 102dB — 30 mins; 105dB — 15 mins; 108dB — 7.5 mins; and so on.

ABOVE LEGAL LIMIT

Mr Cooper said that a detailed analysis of levels and of exposure times experienced by patrons and staff suggested that the noise dose in entertainment centres playing recorded music ranged up to four or five times the legal limit, as permitted in factories and work situations.

But, in certain live concerts, the noise dose exceeded the limit by up to 30 times!

While this latter figure would have to be interpreted in relation to exposure times, it would have to point to sound pressure levels in the region 120-130dB which is in the "Injurious" range (our table, Aug 1978) and in the pain threshold area. This is confirmed by what Mr Cooper mentioned to me in conversation, that he had personally witnessed ruptured eardrums in the wake of a pop concert with signs of blood — not quite "with blood coming out of their ears" as quoted in the press.

As if that is not enough, after two years of taking measurements and assembling data, Mr Cooper is convinced that the problem is still building.

And here we run into this frustrating inconsistency which defies logic and seem-



*"The doctor says that all those pop concerts have sent you stone deaf... you silly old cow!"
(Adapted from BASF Newsletter)*

ingly motivates the graffiti artists:

● The community, unions and (even) governments get up-tight if people have to breathe polluted air; but they shrug off the situation of the same people filling their lungs with their own tobacco smoke!

● The Government can jump on anyone who initiates an illegal radio transmission but it dithers while the spectrum is con-

taminated by millions of hash-producing light and speed controllers. ("Forum", last month).

And so with the noise situation:

If an employee is required to work in an industrial situation where the noise level is above the legal limit, the union and/or the Government can intervene and require immediate palliative action.

If an entertainment centre produces an

PLEASE — more information about TV

Dear Sir,

I very much enjoyed the article "Pioneers of Television" in the September, 1980 issue. It answered several questions which have puzzled me for quite some time. However, there are still quite a few points that interest me.

For example, you have explained why 405 lines was chosen as the standard in Britain but can you explain why the USA selected 525 lines and Europe 625. And how did France come to choose 819 lines?

I surmise that the European standard was arrived at by Walter Bruch on the basis that 625 lines at 25 frames per second needs roughly the same bandwidth as 525 lines at 30 frames. And the frame frequency, of course, was decided by the frequency of the AC electricity supply. Am I right?

Thank you for the appreciative remarks but we take no credit for the article, except for the way it was presented and illustrated in EA. The original material was written and researched by English writer Pat Hawker for "Television" magazine, from which we bought the Australian rights.

Without getting involved in further lengthy research, we did come across a book written in 1945 by Capt. William C. Eddy: "Television — the eyes of tomorrow". The author outlines the confusion and rivalry which marked the US TV scene in the '30s. He quotes the provisional line standard as 343 in 1935, raised shortly afterwards to 441 — a figure which posed a challenge to the then current technology. The 525-line standard was adopted in 1940, presumably with the intention of achieving the highest possible definition commensurate with (then) manageable video bandwidth requirements.

Your assumption is correct about the relationship of field frequency and the local power mains. In the early days, common supply mains served as a reference for synchronisation between transmitter and receivers but the principle was later discarded. The convention has remained, however, partly as a carry-over, and partly because it helps minimise risk of strobing effects which might arise from spurious mains hum in TV equipment.

As we recall it, France had a limited service on 441 lines. After the war, unlike Britain, the French decided to re-establish television on a new super-high definition standard — 819 lines. The 441-line service operated for a while, standards converted from 819, but was abandoned when fire destroyed the Eiffel tower installation. With the arrival of colour, France adopted the 625-line 50-frame standard for their SECAM system; 819 lines remains as an obsolescent monochrome service. If you ask around the TV industry "why 819?" and "why SECAM?", you will get only facetious answers!

When and where was the European 625-line standard first used on a regular basis?

We'll pass on that one. Some other reader may happen to know.

The adoption of the European standard in Australia appears extremely logical now but there was much debate on the standards when the introduction of television was first being considered.

Incidentally, I recall seeing television as a young boy for the first time in 1948 at the Royal Easter Show. It had to be closed circuit and it was showing the ring events. I would be interested to know more about it.

Short of making a special search of newspaper or other files, we can't be sure about that particular occasion. But EMI, Philips and RCA would all have been looking to the Australian market. There may have been others.

I would also be interested to know more detail on the various decisions made in the USA before the NTSC colour system was adopted.

It's a long, involved and fascinating story. Our best suggestion, off the cuff, is that you read the article in our July 1977 issue: "The Shadow Mask Colour Picture Tube". That'll be a start.

Thank you for providing me with a good read and lots of information each month, I really enjoy your magazine. D. H. (Kum Kum, NSW).

HEATSINK EXTRUSION

TYPE XA

CHASSIS & MOUNTING FEET INTEGRATED IN HEATSINK DESIGN.

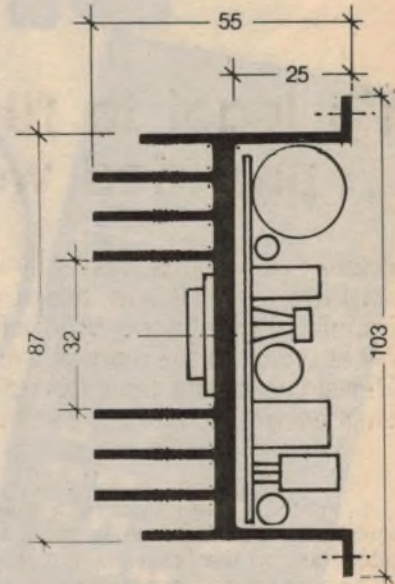

YOU DON'T HAVE TO DESIGN OR BUY ANY OTHER METAL WORK OR CHASSIS TO HOUSE ASSOCIATED CIRCUITRY & COMPONENTS.

YOU SAVE —

- ★ MONEY
- ★ TIME
- ★ SPACE
- ★ STOCK HANDLING

Designed & Manufactured in Australia

DISTRIBUTORS:

- W.A. ATKINS CARLYLE
(09) 321 0101
- S.A. PROTRONICS
(08) 212 3111
- N.S.W. ELECTRONIC DISTRIB.
(02) 636 6052
- QLD CW ELECTRONICS
(07) 48 6601
- VIC STEWART ELECTRONICS
(03) 543 3733
- ELLISTRONICS
(03) 602 3282
- ALL ELECTRONIC COMP.
(03) 662 3506

AUTOTRON AUSTRALIA
P.O. Box 202, Glen Waverley
3150 Victoria



CHRISTMAS SPECIALS

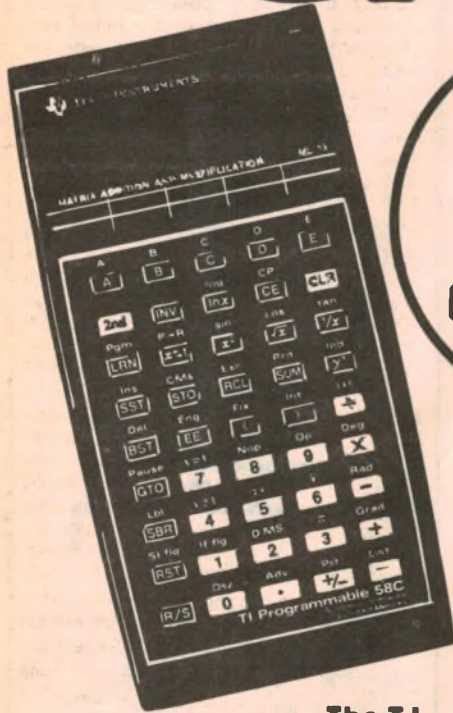

Save near
\$24

TI Programmable 58C

Here's a programmable calculator that offers more power, flexibility and capability and features TI's exclusive Solid State Software. With Master Library module with 25 programmes in math, statistics, and finance you can choose from 12 optional libraries. You can also programme the TI programmable 58C right from the keyboard. TI's Constant Memory feature retains data or programme information even when the calculator is turned off.

It has up to 480 programme steps or 60 memories with 4 types of display testing with independent test or "Y" register and 10 additional test registers.

Over 170 functions and operations in scientific, engineering, and statistical fields. Complete editing and error correction capabilities with single-step and back-step keys.

The TI Programmable 58C gives hard copy when used with the PC-100C thermal printer/plotter.

\$122.99 + TAX = \$141.44

The T.I. Programmable 59

A revolutionary new personal programmable calculator. 960 programme steps or 100 memories. Master library module plug in feature. 25 different programmes in key areas. Four types of display up to 10 additional test registers. 72 useful labels. Up to 6 levels of sub routines. Complete programme editing. Operates with PC-100C printer. Optional solid state software libraries.

\$276.99 + TAX = \$318.54



Saving
\$32.66



Save Over
\$23

\$198.99 + TAX = \$228.84

PC-110C

The PC-110C printer plotter turns your programmable T.I. 58C or T.I. 59 into a high speed quiet printer calculator that prints, lists and traces your programme.

TEXAS INSTRUMENTS
INCORPORATED

silicon valley



ADELAIDE: 170 Sturt St, Adelaide.
Telephone (08) 51 4080

BRISBANE: 22 Ross St, Newstead.
Telephone (07) 52 1339

MELBOURNE: 208 Whitehorse Rd, Blackburn.
Telephone (03) 877 5311

PERTH: Unit 1, 25 Brisbane St, East Perth.
Telephone (09) 328 8091

SYDNEY: 23 Chandos St, St. Leonards.
Telephone (02) 439 2965

NOTE: Offer closes 24th December, 1980

FORUM: Do It with music

external noise level which is unduly objectionable in the neighbourhood, action to limit the noise may be taken by the State Pollution Control Commission.

But, if people choose to enter such premises and become subject to sound pressure levels which may damage their hearing, that is supposed to be their own concern.

In conversation, Mr Cooper stressed that he was qualified in the field which his paper covered: making acoustical measurements, tabulating data and interpreting it in terms of noise dosage related to venues, locations within those venues, to staff, patrons, age groups and so on.

When it came to relating noise dosage to actual physiological damage, he had his own opinions but, under challenge, he had to defer to those with medical training. Here there was a mass of circumstantial evidence but some disagreement on the real magnitude of hearing damage in practical situations.

Some had suggested, for example, that certain types of industrial noise were disproportionately damaging. For example, cyclic hammer-like blows of metal on metal may produce transients so intense and so abrupt that they could stress the aural system out of all proportion to their apparent loudness. On this basis, they could conceivably be more damaging than subjectively louder music.

(I am reminded of the remark in "Forum" for August 1978, concerning the number of old-time boilermakers I had met who had suffered hearing loss.)

According to "The Sydney Morning Herald", opinions expressed from within the NSW State Pollution Control Commission and the Audiological society of Australia supported Mr Cooper's statements but a spokesperson for the NSW State Health Commission suggested that he had over-stated the danger.

Even so, Dr Allan Crawford, Head of the Commission's Divisional of Occupational Health said that people susceptible to hearing damage would suffer hearing loss if they frequented such places four or five times per week, for two or four hours each time, over a period of five to 10 years.

That sounds like a fairly casual way to achieve impaired hearing but it is no

more casual, and perhaps no less inevitable in terms of the end result, than a lot of other things people do which lead to physical impairment.

Again, it reminds of what was said earlier — in the November 1977 issue. It quoted a statement by a personnel officer from an Australian company concerned, at the time, with the welfare of 80 apprentices in the area of fitting and machining.

He stated that annual auditory checks had shown that 35 of the apprentices had registered discernible and progressive hearing loss and that the same 35 regularly attended discos and pop concerts. The remaining 45, subjected only to normal workshop noise, showed no such loss.

What should be done about the problem?

Mr Cooper pointed out that a number of entertainment centres around the World imposed their own limits on sound pressure level. For example, the Hollywood Bowl limited the SPL to about 94dB, which kept the noise dose down to 1.0 for a typical two to three hour performance.

But, perhaps surprisingly, Mr Cooper is not optimistic about the chances of noise dose being limited to 1.0 by legislation. Perhaps he remembers too vividly some of the resentment he encountered when it was noticed that he was taking noise level readings. It was quite obviously a sensitive area, with proprietors, bands and patrons all being rather defensive for their own reasons.

He is hopeful that a campaign of education will turn around the present trend towards larger and still larger sound systems.

In the meantime, as reported in the SMH, Mr Cooper's investigations did turn up an industrial "can of worms" that promoters and proprietors would prefer to keep out of sight:

Employees in certain venues may be able to prove that they were rostered to work under conditions where the noise dose regularly exceeded 1.0 and that, as a result, they have suffered irreversible hearing damage.

In the hands of resourceful counsel, a selected case could conceivably become a very expensive precedent in terms of workers' compensation! ☹

WHY DECIBELS? A number of readers have queried the practice of quoting noise levels in decibels, whether related to entertainment activities, factories or traffic. Loudspeaker manufacturers also rate sensitivity in decibels/watt. Is not the decibel a ratio, rather than a unit?

Accepted practice is now to measure and quote sound pressure levels in dB(A) (decibels, A-scale weighting) relative to a reference of 2×10^{-5} Pa (Pascall) or 20uPa. This approximates the threshold of human hearing and of practical measurement. Thus, the maximum factory noise reference should be quoted as 90dB(A) referred to 20uPa. It is commonly abbreviated to dBA dB(A) or, more loosely to 90dB.

SORCERER SOFTWARE

SUPER-X is the most versatile screen editor/renumberer utility available for use with the BASIC Rom Pac. This superb program features full screen editing facility including insert, delete, overwrite, truncate, and cursor control with TAB functions. Further features are selective listing, automatic screen numbering, and powerful search facilities. A sophisticated renumberer utility allows user to renumber program partly or wholly, compact program with options, and safely append programs, all performed with full protection and control. SUPER-X will fully recover programs after typing "NEW", "CLOAD", or pressing RESET. Versions exist for 16K, 32K, and 48K.

SUPER-X is available in cassette form (\$25.95) or have your ROM PAC upgraded (\$95). The ROM PAC version also gives reliable CSAVE* and CLOAD* facility, plus CSAVEG and CLOADG for auto execution of BASIC programs — post us your ROM PAC for upgrading and return by registered post.

MUZIK — two programs. MUSIC and MUZIK, plus six demonstration tunes. MUSIC loads tunes from cassette into RAM, then select any or all tunes; MUZIK allows you to compose and play your own tunes — also save them to replay later. Interface instructions to play your own music included. Runs on all machines. \$13.50.

PUNT — A horse racing game, with superb graphics and musical sound effects, for the avid better to have fun watching the all-time greats run over one to three laps. \$13.50

BTEXT — aids fast and efficient editing of BASIC text. Fully relocateable, taking only 0.5K of RAM. Functions include: fast re-entry of BASIC or BTEXT; delete or replace characters; cursor return and tab features; delete or truncate a line; suspend and restart listings; cause BASIC or Monitor to process the current line; insert spaces; "clear" without destroying graphics RAM. Relocation and op instructions provided. \$9.50

TREES — two players select the number of trees in a forest and race to cut down the most. For joysticks and sound effects. \$13.50

GRAPHICS PACKAGE — machine language graphics utility routines and a BASIC demo program to show off Sorcerer's graphics capabilities. Four minutes of superb figures, graphs and motion. \$32.95

ARTILLERY — for use with "Graphics Package". Across randomly generated windy hills two players fire cannon balls at each other's castle. \$12.95

BLANK TAPES: C-10 5 for \$6.50; C-20 5 for \$7.00; C-30 5 for \$7.50

All prices include packing and domestic postage. **TAPE COPYING** facilities also available — prices on request. Send a SAE for our catalogue.

ENQUIRIES/ORDERS TO:

Frank Schuffelen	Don weir
Creative Software	Customised Technology
GPO Box 5313 BB or	PO Box 461
Melbourne 3001.	Ashfield NSW 2131
(03) 846 2424	(02) 799 6373

A pro doesn't wrestle on stage.



We've all seen the artist who seems to spend half his time on stage wrestling with the mike stand adjustment. It doesn't look good. And it doesn't make for a good performance, either.

The problem is that a lot of stands are only fit for growing peas. A really good stand—one of Cunningham's—is precision built with fast, sure-grip adjustment clamps. It's solidly based, sturdily built to take the punishment of roadwork or hasty studio changes.

The boom arms stay where they're put, and the whole stand collapses down to the minimum possible space.

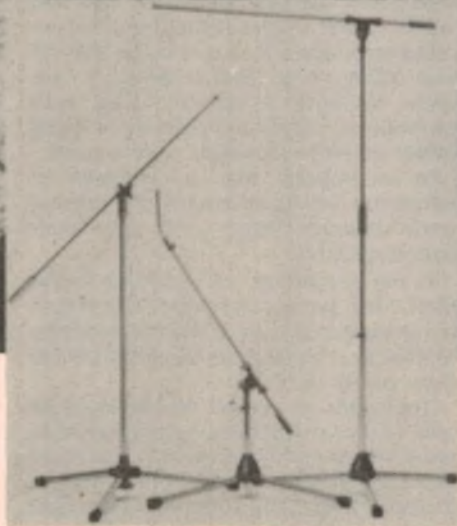

CUNNINGHAM MICROPHONE STANDS

R. H. Cunningham import some of the world's finest audio products—like Sennheiser microphones and headphones; radio mikes; voice synthesiser; loudspeakers—and more. Post this coupon for our Professional Audio Products Catalogue—free.

Name

Address

Are you a Musician/Engineer/ Educator/
Broadcaster/ Hi Fi Enthusiast/Other:

B&B/RH135/EA

From Germany, Cunningham bring you stands for every kind of use. And they have every conceivable accessory—all the way to a clip-on ashtray.

If you take your music seriously, you've got to look into the Cunningham stands. Sure they cost more than the amateur-hour stands. But then your public has paid to see a performance—not a wrestling match.

R.H. Cunningham
PTY.LTD.

Audio equipment for professionals
4-8 Waters Road, Neutral Bay, N.S.W., 2089.
146 Roden Street, West Melbourne, 3003.



HIFI REVIEW

TECHNICS SU-V4: performs very well

Recently released, the Technics SU-V4 stereo integrated DC amplifier is typical of — and centrally placed in — their “New Class-A” range. As such, it will have obvious appeal to the average hifi enthusiast. Featuring IC technology, it offers 55W + 55W (at least) into 8 ohms at a rated distortion level of 0.02% from 20Hz to 20kHz.

Hifi amplifier manufacturers, in striving for ever more impressive specifications, frequently come up with variations from traditional amplifier design concepts. The Technics “New Class-A” circuit is an example of this.

Despite the terminology, the new Technics circuitry has little in common with traditional class-A, where the output stage device(s) are biased near the centre of their working loadline. As a result, quiescent current is high, efficiency is low and dissipation becomes an almost horrendous problem.

As explained in our June issue (“HiFi Topics” page 30) the New Class-A system emulates the low standing current and high efficiency of class-B. However, it invokes an array of new circuitry, including what they refer to as “synchro-bias”, to sidestep that bugbear of traditional class-B: output stage “switching”.

In broad terms, it is probably more appropriate to regard Technics New Class-A as a development from class-AB operation, where the output devices are initially biased slightly on. The major departure in New Class-A is that the output devices are never driven into cut-off, drawing some current at all points during the signal output cycle.

As we indicated in the earlier article, one could spend hours debating definitions but the important thing is simply — how well does the amplifier actually perform? On this score, there is no need for double-talk; it performs extremely well. But, first, a general description:

The Technics SU-V4 amplifier has overall dimensions of 430 x 142 x 292mm (W x H x D) including knobs, feet and rear projections. The mass is 9kg.

Rotary knobs are provided for the input selector, record mode selector, bass, treble and balance controls and, of course, volume control. Both bass and treble controls are detented in the off position as well as at the 10 calibrated positions.

As well, there are five toggle switches for power, tone defeat, loudness and for the subsonic and high filters. Three push-button switches serve for main and remote speakers and for moving magnet/moving coil cartridge selection.

On the upper left-hand side of the panel are twin fluorescent bar-graph meters, calibrated over the range 0.1 to 100 watts into assumed 8 ohm loads. With the .01X switch activated, the range changes from 1mW to 1W. The displays indicate peak as well as average signal

levels, decay time on peaks being prolonged sufficiently to read.

The displays are horizontal, with the left channel graph being the upper one. While the graphs are interesting in the way they indicate the magnitude of transient peaks on modern discs, the power indications are only approximate.

On the rear panel, there is the usual array of RCA input sockets together with a DIN socket for tape deck connection. Gold plating is used on the phono input, giving a long-term reliable connection for the low signal level from moving coil cartridges.

Loudspeaker connections are made via shrouded rotate-to-make connectors, which are a good safety feature. They minimise the risk of shorted connections and isolate the user from the relatively high audio voltages.

Removing the cover of the amplifier reveals a neat interior with quite a few engineering innovations — all of which appear to be aimed at reducing the wiring and hence labour content in the unit. Four printed circuit boards are used, with one large one for the main amplifier, power supply and protection circuitry. One smaller PCB holds the equalisation and preamplifier circuitry and on another PCB, the power meter components. The fuses and supply capacitors are on a fourth board.

Two large (8200uF/56VW) filter capacitors are used for the power supply and are located to the rear of the amplifier on the main PCB. Also on this PCB, the protection circuitry monitors off-set voltages and excessive current

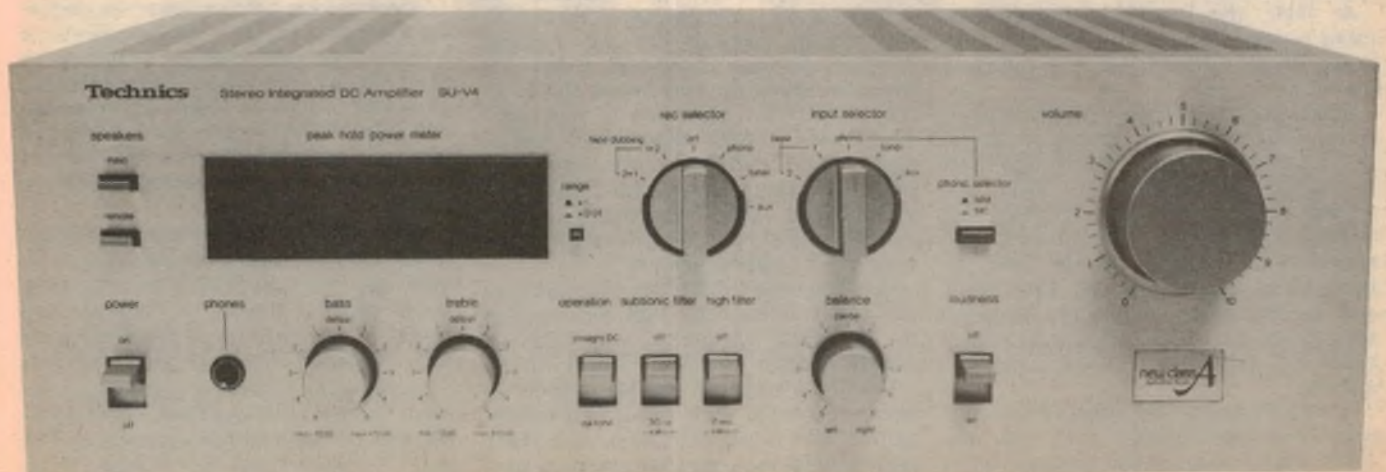

through the driver transistors. A relay connects the load to the driver transistors and will protect the loudspeakers from damage should excessive DC voltages appear at the output.

The power amplifiers are also located on the main PCB and large, vertically mounted heatsinks extend from the PCB to the top of the amplifier chassis. These sink the heat for the multiple pin IC which contains the Darlington complementary symmetry output stage.

The tone control potentiometers and filter switches are soldered directly to the main PCB.

As mentioned earlier, all the circuitry for the phono and other inputs is on a separate PCB, with the input sockets attaching directly to it. The input selector and record selector switches are also part of this assembly, being operated from the front panel by cables.

In all, nine ICs are used in the amplifier circuitry. Two are used in the power meter circuit, one for the protection circuit, two for the main amplifier, one for the filters and another for the phono RIAA equalisation. The input stage of the power amplifier comprises a Bi-FET IC — one for each channel.

We began our performance tests of the SU-V4 with the standard one-hour preconditioning, with both channels delivering 40% of rated power. This resulted in the heatsinks rising to and stabilising at about 60°C with the ambient temperature at around 20°. Although the air above the heatsink felt warm, this was indicative of an efficient heat transfer to the atmosphere. The heatsinks are more than adequate for the amplifier under even the most severe conditions.

Technics rate the SU-V4 power output at 55W RMS per channel with both channels driven into 8 ohm loads; this, for a total harmonic distortion of less than 0.02% over the range 20Hz to 20kHz.

As a matter of interest, we were able to measure 72 watts RMS per channel at the onset of clipping, with both channels operating into 8 ohm loads. With 4 ohm loads, the power at clipping point was no less than 92 watts per channel, both channels driven.

At 1kHz, the harmonic distortion at rated power was .005%, which is a four times improvement on the claimed figure.

However, at 5kHz and rated power, while THD in the left channel was on specification, the right channel had risen to 0.025%. Beyond 5kHz, the THD continued to rise, reaching 0.035% and 0.06% respectively in the left and right channels at 10kHz. While out of specs, these figures are still very small and all the more insignificant because they occur at frequencies from which harmonics would be mostly inaudible, anyway.

Intermodulation distortion, measured with 50Hz/7kHz signals in a 4:1 ratio was .018% into 8 ohms at full power. This is within specification, and a good result.

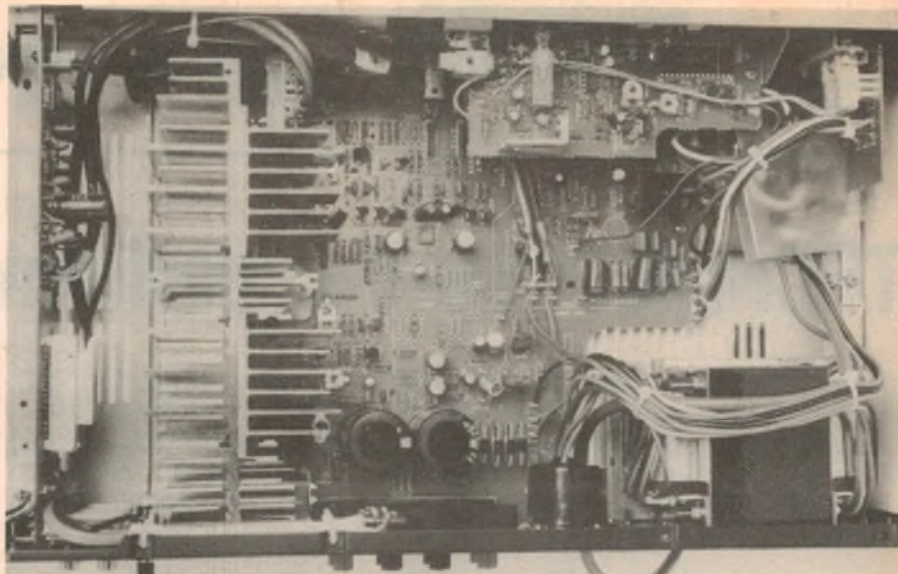

Above: An inside view of the Technics SU-V4 amplifier, looking down from the rear. Note the very large internal heat sink. Below is a plot of the THD at full rated power; but note that the distortion scale is from 0 to 0.1%. The rated figure is 0.02%.

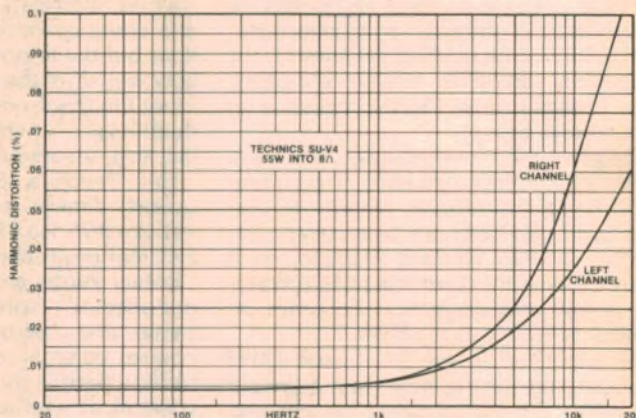

Technics claim that their SU-V4 amplifier has DC response from the auxiliary inputs to the outputs, provided the tone controls are switched out of circuit by the "Straight DC" switch. However, the claimed low frequency response is 3dB down point at 5Hz, as distinct from completely flat down to DC.

The measured frequency response at one watt into 8 ohms is -1dB down at 10Hz with the "Straight DC" switch on. The upper -1dB point is at 60kHz.

Phono sensitivity was measured at 2.5mV for 55 watts output at 1kHz with the phono selector on the moving magnet cartridge input and 160uV for the moving coil cartridge input. Signal-to-noise ratio with respect to 10 watts and 10mV was 78.5dB unweighted, with a typical MM cartridge connected and 64dB with the MC selected. Separation was 62dB at 1kHz. These figures are excellent. In fact, the S/N ratio figures are very much "state-of-the-art".

Signal-to-noise ratio for the auxiliary and tuner inputs was 79dB with respect to 10 watts. Separation was 59dB at 100Hz, 58dB at 1kHz and 44dB at 10kHz.

The tone controls provide ±10dB of boost and cut at 50Hz and 20kHz, which agrees with the specification. The 30Hz and 7kHz filters, when in operation, provide a -5dB cut at 20Hz and 10kHz. The

roll-off is at 6dB/octave with the -3dB points at 30Hz and 7kHz.

The Loudness control provides a 9dB of boost at 50Hz with a -30dB setting on the volume control. This boost tapers off at higher volume control settings until, at full volume, the boost is insignificant.

RIAA equalisation is rated at within ±0.8dB from 30Hz to 15kHz. We measured the limits as ±0.25dB from 20Hz to 20kHz, which is a very tight figure.

Listening tests confirm what the performance tests indicate — that the SU-V4 is a really high performance amplifier. In fact many of the performance parameters, such as frequency response and signal-to-noise ratio, are far beyond what is required for excellent audio reproduction. Recommended retail price is \$409.

At the time of writing, demand for the "New Class-A" series amplifiers is very high, with the SU-V4 being in particularly short supply. However, Technics are hopeful that, by the time this issue is on sale, further shipments will have arrived.

Further information on Technics equipment can be obtained from high fidelity retailers or National Panasonic (Aust) Pty Ltd, 95 Epping Road, North Ryde, NSW 2113. (J.C.).

"I have always wanted a really good loudspeaker system."



Today the cost of excellent turntables, cartridges, tape decks and amplifiers has fallen to the point where the average family man can afford equipment of a quality and performance-level that was impossible ten years ago.

But good loudspeakers have remained extremely expensive and, in most domestic hi-fi systems, the rest of the equipment can dramatically outperform the speaker.

Electronics Today International magazine, in co-operation with Philips Elcoma Division, set out to correct this imbalance and designed the ETI 4000/1 speaker system.

The Series 4000/1 is available in kit form which means you save money by assembling it yourself.

A total kit, including:

- 8 loudspeaker drivers (4 per box)

- 22 element crossover networks
 - pre-assembled boxes.
- For around \$798.00 per pair. (\$300.00 less, if you build your own boxes)!

The Series 4000/1 is comparable to systems selling for twice the price.

See your Philips dealer today or send for complete details including a free reprint of the original construction article. Further information on Philips loudspeakers; a list of Philips dealers and a free 4-speed stroboscope card for checking the speed accuracy of your turntable.

Philips Electronic Components and Materials

P.O. Box 50
LANE COVE, N.S.W. 2066

Please send me complete information on the Series 4000/1 loudspeaker system plus my free 4-speed stroboscope card and further information on loudspeakers.

NAME _____
Please Print

ADDRESS _____

STATE _____ P'CODE _____

EA



**Electronic
Components
and Materials**

PHILIPS

AHEARN EL37

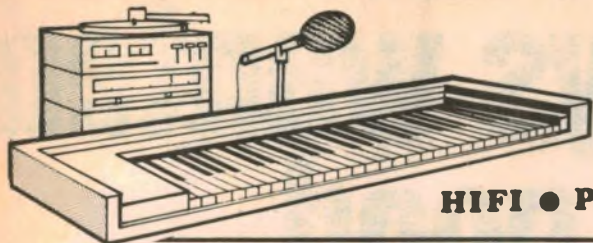

AUDIO ~ VIDEO ELECTRONICS

HIFI • PROFESSIONAL AUDIO • ENTERTAINMENT

LOUDSPEAKERS: what happens to the watts?

Readers are undoubtedly aware that some loudspeakers are more efficient (or more sensitive) than others. But not everyone realises just how great the differences are and what implications they hold in terms of amplifier power output requirements. In fact, high power output can largely be offset by low loudspeaker efficiency — and vice versa.

by NEVILLE WILLIAMS

When related to a loudspeaker, the term "efficiency" normally refers to its basic role as a transducer — transforming electric power input to acoustic power output. The more efficient a loudspeaker, the louder will the output sound be for a given amount of drive from the amplifier.

An efficient loudspeaker may alternatively be described as a "sensitive" loudspeaker.

Subjectively, a rough idea of the efficiency or sensitivity of an unknown loudspeaker can be gained by comparing it with one for which figures are

available. Simply connect them alternately to the output of a receiver or amplifier reproducing ordinary program material without, of course, changing any control settings. A just perceptible change in subjective loudness would probably represent a difference of about 3dB — plus or minus as the case may be.

An obvious change in level would probably represent a difference of at least 6dB.

To actually measure loudness, it is usual to substitute a "pink" (or white) noise signal for the program material and to monitor the acoustic output with a

calibrated microphone. Common practice is to use a standard drive power of 1 watt and to place the microphone on axis 1 metre from the loudspeaker. The measured result is expressed as:

Sensitivity = . . . dB/W.

Increasing use of this standard enables most loudspeakers to be compared directly. However, it is still necessary to be alert for exceptions as, for example, different placement of the microphone. Yet another practice is to quote power input required for a certain output level, e.g. 96dB.

An ideal loudspeaker would be 100% efficient, producing one watt of acoustic power for every watt of amplifier drive. Unfortunately, the efficiency of practical loudspeakers is much lower than this and, for the ubiquitous moving coil dynamic, a figure of around 5% would be nearer the mark. That means only 50 milliwatts or so of acoustic output for one watt of drive from the associated amplifier.

A fascinating comparison . . .

Developed as a no-compromise design, the B&W 801 has been acclaimed by reviewers, with Geoffrey Horn of "Gramophone" describing it as "one of the World's great loudspeakers". With a sensitivity of 85dB/W, it is typically used with amplifiers rated up to about 250W for the highest sound pressure levels ever likely to be required in a large home. But Technics' top-of-the-line SB-10000, with a sensitivity of 95dB/W, will produce the same acoustic output with 25W of drive. Yet it is rated to handle 300W!

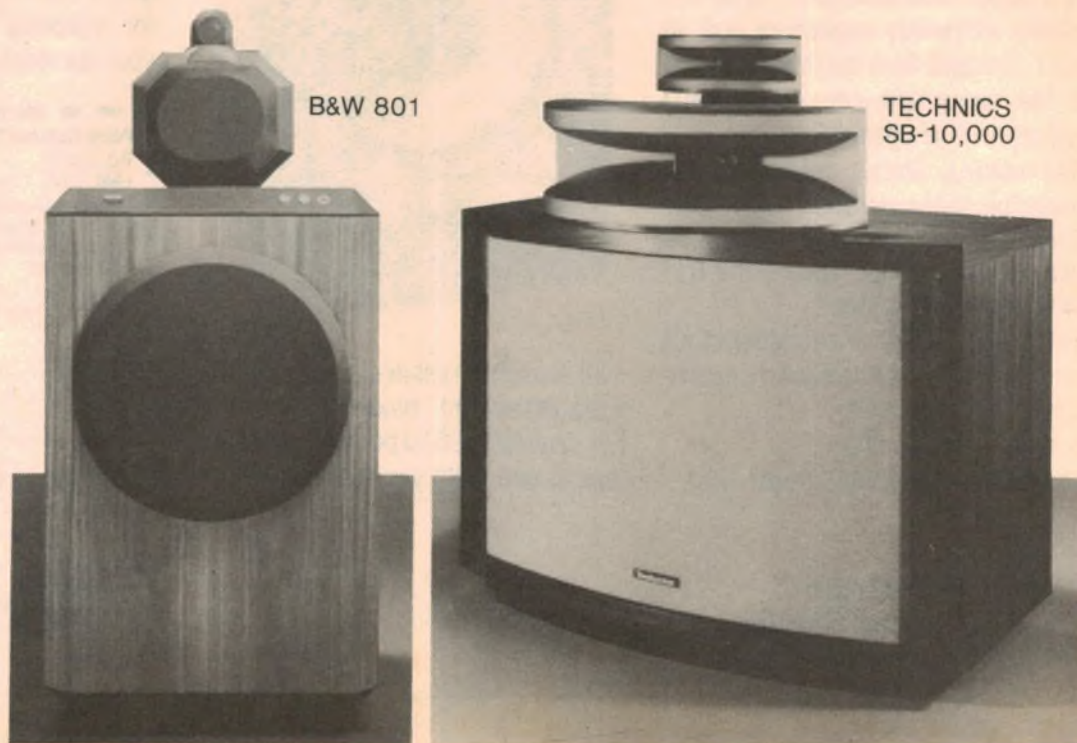

It's a better system, at a better price, and it's Sony. In Sony's new TC-K81 three head cassette tape deck, each head

The new TC-K81 also has microcomputer control and feature-touch operation, and LED Peak Programme Meter,

Sony's 3 head system. It's 3 ways better.

has its own individual casing and suspension system.

You get precise azimuth alignment,* equal record and playback head-to-tape pressure, and reduced magnetic leakage flux.

It's a unique three-head system, with two-motor, closed-loop dual capstan drive with metal tape compatibility.

bias and record level calibration system, and Dolby** NR.

It's an exceptional new system, at an excellent price. And it's Sony.

So in three-head technology, we're three-ways better.

SONY®

*Factory aligned.

**Dolby is a registered trademark of Dolby Laboratories.

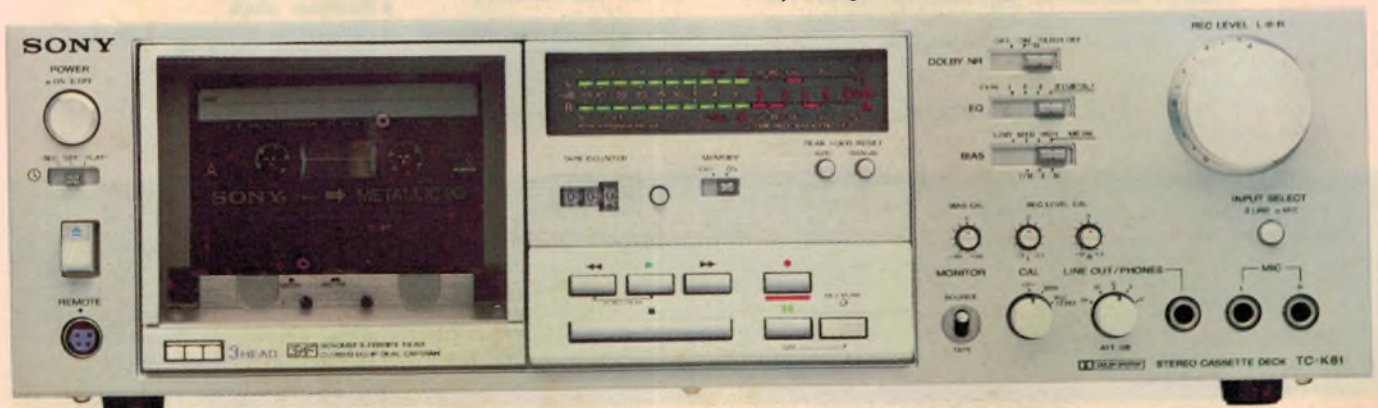

It's a winning combination

ADE

NorthStar



**The famous North Star Micro Computer is now sold, serviced and supported by
ANDERSON DIGITAL EQUIPMENT PTY LTD.**

In excess of 15,000 North Star Horizon Micro Computers are in operation throughout the world in business offices, schools and universities, research laboratories, and industrial plants. The Horizon's uses range from word processing to highly complex industrial monitoring.

SPECIAL FEATURES INCLUDE:

- Z80 processor
- 64KB RAM memory
- Two quad density minidisks (360KB each)
- The motherboard has 12 S-100 circuit board slots
- Realtime clock
- Two serial, one parallel input/output interfaces

Join the winners — RING NOW! Dealer enquiries welcome

ADE

Anderson Digital Equipment Pty Ltd

— THE VIABLE ALTERNATIVE —

P.O. Box 322, MT WAVERLEY, VIC AUST 3149 Phone (03) 543 2077. P.O. Box 341, PENNANT HILLS, N.S.W. AUST 2120 Phone (02) 848 8533. Adelaide: 79 9211. Perth: 325 5722. Hobart: 34 4522. Brisbane: 350 2611. Darwin: 81 5760. Canberra: 58 1811. Newcastle: 89 1825. Albury/Wodonga: (060) 2671. Barnawartha 129. N.Z. Wellington: 69 3008. Auckland: 86 3833. Christchurch: 79 8210. New Guinea Lae: 42 3924.

In the early days of radio, when electrical drive power was hard to come by, the "loudness" (therefore efficiency or sensitivity) of a loudspeaker was just about its most important single quality. Manufacturers vied with one another to gain the advantage, but there was often a price to pay, of one kind or another.

For example, with the old pre-war electro-dynamics, acoustic efficiency could sometimes be nudged up by increasing the dissipation ratings of the field coil, thereby achieving higher magnetic flux. But if, as a result, the structure became hot enough to buckle the voice coil, that would be that!

Again, flux density (therefore efficiency) could be raised by narrowing the gap in which the voice coil operated. But it then needed only slight misalignment or a few tiny foreign particles in the gap for the voice coil to scrape against the pole faces.

IMPROVED DESIGNS

The postwar period saw the almost universal adoption of permanent magnets (Alnico, etc) and a much better understanding of materials and of quality control. This was reflected in more reliable voice coil and suspension systems, narrower gaps, higher flux density in the gaps and an upward trend, at any given quality level, of acoustic efficiency.

In the hifi area, this trend was climaxed by the elite loudspeakers of the era — top-of-the-range models from Jensen and Magnavox in the USA, from Goodmans and Wharfedale in Britain and from Rola in Australia. There were others, of course, but those were the most familiar brands in this country.

Their sensitivity and power handling capability was due, in large degree, to a generous — and relatively expensive — magnetic system. But enthusiasts saved up for them, mounted them in the large enclosures that were normally specified, and settled back to enjoy the music — sometimes at very loud volume.

In retrospect, it is difficult to set a figure on their actual sensitivity but it seems likely that it would have been at least 90dB/W, measured under present-day practice, as mentioned earlier. It would have been 3 to 6dB above the sensitivity of less expensive models and, importantly, was combined with a generous power handling capability.

If such loudspeakers were notable for their comparative efficiency, why would the actual figure still be down around the 5% mark — abysmal by any other standards?

The first and most obvious loss in a practical loudspeaker has to do with the DC resistance of the voice coil.

By definition and function, it has to be a coil possessing inductance and the ability to interact with the fixed magnetic field. It is, in fact, one winding in a special kind of motor.

Unfortunately, with practical materials,

Another wall-mounting hifi unit from Toshiba

Following the recent release of their SK-01 "L Mini" hifi system (see our last issue) Toshiba have unveiled its smaller brother, the SK-02. Better still, they lent us one for a couple of weeks so that we could react to it at first hand.

Dimensions of the SK-02 are quoted as 350 x 308 x 160mm (WxHxD) and weight as 6.5kg. It can rest easily on a shelf or cupboard top but comes complete with a bracket which allows it to be hung directly on the wall, if that is preferred.

The SK-02 includes an AM/FM-stereo tuner with easy-to-read dial and a row of LED indicators which indicate signal strength, accurate tuning and stereo mode. The tuner has switchable muting on FM which makes tuning simplicity indeed.

Controls include Bass, Treble, Balance and Volume, with illuminated Function select tabs, and switches for Loudness, Mono/Stereo and Off/on.

The tape deck works very smoothly. It has bias and compensation for ferric, chrome and metal tape, and includes Dolby noise reduction. A twin LED bargraph indicates recording level but operates at other times as a power output meter for the system. A very effective MTSS (Music Track Skipping System) allows the user to skip forward

it is not possible for a coil to exhibit inductance, without it also exhibiting resistance. Having in mind that the voice coil has to operate within a very narrow gap to maintain concentration of magnetic flux, it has to be wound with relatively fine gauge wire or strip, therefore exhibiting significant resistance.

The end result is that something like half the total impedance (measured at around 400Hz) of a typical voice coil is represented by DC resistance. Therefore a significant proportion of the audio drive power is absorbed in simply heating the coil. This slashes the overall efficiency and also accounts for the not-infrequent phenomenon of burned-out coils.

A further problem is that only a portion of the voice coil can be within the full



by up to four tracks, or to review earlier tracks by simply pushing buttons. The deck senses silent spaces between tracks to provide the necessary cues.

RCA sockets on the rear panel allow the SK-02 to be used with a normal magnetic phono pickup.

With a power output of 15W RMS per channel, and commendable characteristics in other respects, the SK-02 can be used with any reasonably sensitive wide-range loudspeakers. We used a pair of Playmaster 3-13Ls but Toshiba suggest their own type SSB2W units, incorporating a 15cm main driver and a tweeter.

Everything about the SK-02 worked very smoothly, commending itself for situations where space is important.

Recommended retail price for the SK-02 is \$469 and, for the SSB2W loudspeakers, \$120 per pair. It is likely, however, that the complete system will be discounted to something over \$500 in some shops. (Details from Toshiba Australia Pty Ltd, 16 Mars Road, Lane Cove 2066. Phone (02) 328 2055.)

magnetic field at any time. The winding must be long enough so that there will always be a given number of turns in the gap as the cone vibrates to and fro. That part of the coil which is outside the gap will absorb power but it cannot contribute to the mechanical drive.

Further power losses accumulate from flexing in the cone itself, from the stiffness of the suspension system, and even from energy loss in moving air molecules and interacting with damping materials within the enclosure. The cone/air coupling efficiency also comes into it, while absorbent materials in the listening room take their further toll of the acoustic energy actually propagated into the room.

One segment of the audio industry which has been very conscious of

Sony unveils its range for the "Golden 80's"

In symposia held recently in Sydney and Melbourne, Sony (Australia) Pty Ltd previewed to the press and to dealers the huge range of products with which they have entered what they are calling the "Sony Golden 80s".

As if to remove any lingering doubt that Sony meant business in the new decade, we ended up with three massive loose-leaf folders, substantially filled with glossy full-colour brochures. The first one, appropriately gold, and entitled "The Sony Audio Catalog", covers quality cassette-radios, car radio systems, home music centres, a full range of audiophile equipment, of all descriptions and pages of accessories: headphones, microphones, power packs, battery chargers, cables galore, phono accessories and so on.

A second (blue) folder "Sony Total Audio World" amplifies the contents of the first and emphasises the totality of the new range. The third folder "Sony Total Video World" carries the sub-headings: Betamax, Trinitron Colour TV, Trinitron Video Camera, Video Projection and Beta Tape. It's job enough just to look through the folders, let alone to read them all or, worse still, to summarise the contents in print. The illustration on the right, lifted from the brochure "Total Video", includes everything from a domestic colour camera, through Beta format video cassette recorders to large-screen projection TV.

Said a spokesman for Sony: "What you have in those folders is mainly our consumer products for the start of the 80s. We have a whole lot of professional level products as well!"



AUDIO-VIDEO ELECTRONICS – continued

loudspeaker efficiency – or rather inefficiency – is that involved in large scale sound reinforcement.

At one time, talkie theatres set the standard with their need for high level sound, at a time when powerful valve amplifiers posed a major problem. For sure, the theatres still had to use large amplifiers but they made the best of the available power with drivers that were as efficient as they could be – plus horn type radiating systems which secured a much better cone/air match.

More recently, the emphasis has been on the needs of pop instrumentalists and pop groups, with their requirement (?) for very high acoustic output levels. Since mobility is also part of their scene, they don't want to be encumbered by amplifiers which are any larger than necessary.

Let's suppose that a group started out (modestly) with a number of 300W amplifiers, each driving a high-powered loudspeaker having a sensitivity rating of 90dB – a figure which is good by domestic standards. Then let's say that they decided (again modestly) to double their acoustic power. Their options would be to:

- Double the number of amplifiers and loudspeakers;

- Substitute 600W amplifiers and drive the existing loudspeakers harder;

- Retain their existing amplifiers but invest in loudspeakers with a sensitivity rating of 93dB.

That last point is the important one in this context: An extra 3dB of sensitivity in a loudspeaker system gives the same increase in loudness as doubling the power of the associated amplifier.

In fact, the manufacturers of high-power public address loudspeakers achieve figures a lot better than 93dB/W – at a price! As I write, we have a huge Celestion P1 system in our laboratory, with a rated sensitivity of 101dB/W. Some high power loudspeakers do better than that again, but the P1 will serve to illustrate the point.

Compared with 90dB, the difference ratio is 11dB or a power ratio of just over 12 times. This means that, compared with a 90dB system driven by 300 watts – as mentioned earlier – a Celestion P1 would produce the same level of sound driven by an amplifier rated at a mere 25 watts!

Again, if driven to its full rated power of 500 watts, it would match a hypothetical 90dB sensitivity loudspeaker system driven by an audio power of 6 kilowatts!

Celestion P1s and other high-power public address loudspeaker system are costly but they are far more affordable and far more practical than multi-kilowatts of amplifier power.

So much for the high-power public address scene. In terms of domestic hifi, the story turns completely upside-down.

A few of the larger and more expensive domestic systems just about match the 90dB/W figure which we "guesstimated" for the "sensitive" Wharfedales, Goodmans, Jensens and Rolas of a past decade. As such, they would sound about as loud for a given drive power. In addition, some of the modern units may carry higher maximum power ratings.

However, not everyone is able to afford or to accommodate the larger, top-of-the-line domestic systems, and there are strong market pressures which would dictate reductions in size, or price, or both. In general, these pressures also conspire to reduce the sensitivity to something less than 90dB/W for most such systems which can make any serious claim to full bandwidth and reasonable power handling.

Factors which tend to force efficiency down include the following:

- The use of smaller and cheaper

You're only as old as the games you play



- A. Astrological Computer/Calculator (65-801) 49.95
- B. Electronic Sports Arena — 3 games in 1 (60-2158) 39.95
- C. Pocket Repeat (60-2152) 19.95
- D. Memory Match for 1 or 2 players (60-2122) 24.95
- E. Electronic Pinball for 1 or 2 Players (60-2140) 39.95

- F. Computerized Chess Game (60-2160) 129.95
- G. Electronic Golf for 1 or 2 players (60-2148) 26.95
- H. Electronic Zingo (60-2123) 24.95
- I. 2-Player Electronic Baseball (60-2157) 39.95
- J. Biorhythm Computer/Calculator (65-802) 39.95

TANDY
ELECTRONICS

Available at all Tandy Stores and
Participating Dealers around Australia
or Mail Order Department, P.O.
Box 229, Rydalmere, N.S.W. 2116

Bang & Olufsen
Bang & Olufsen
Bang & Olufsen

**Danish precision
 at an unbeatable
 Australian price!**

**The SN series,
 current and
 voltage supply
 units**



Bang and Olufsen's SN14, 15 & 16 are versatile D.C. power supply units for use in laboratory, production, workshop and training centres.

Thanks to effective overload protection circuits and meticulous construction all three units are sturdy and hard-wearing.

They have high stability against temperature and mains voltage variations. Typically better than 0.02%.

Clear graphics and sensible operating buttons facilitate easy, accurate adjustments.

The units offer particularly good value for money and meet the most frequently encountered needs.

Models

SN 14 Output Voltage 0-20V

Output Current 0-2A

SN 15 Output Voltage 0-50V

Output Current 0-1A

SN 16 Fixed Output 5V/3A supply

Variable Outputs 2x0-30V/0-1A

For further information on these and complete range of Bang and Olufsen electronic instruments contact

G.R.D. GROUP Pty. Ltd.

Sole Australian Agent

698 Burke Road, Camberwell 3124

Phone (03) 821 256, Telex 31712 G 1434

AUDIO VIDEO ELECTRONICS — continued

magnets and less expensive magnetic systems;

- The use of ordinary wire for voice coils rather than edge-wound ribbon;

- The use of a smaller bass driver, requiring longer cone travel for a given output, a longer voice coil and lowered drive efficiency. (See earlier reference)

- Enclosure design considerations (see last month's article) which force a trade-off between efficiency and extended bass response, as enclosure size is progressively reduced.

In making these remarks, it is important to stress that acoustic efficiency is not a measure of ultimate fidelity — that depends on a variety of other factors. But it is interesting to note the relationship between efficiency (or sensitivity) and audio drive power, this time in the context of domestic hi-fi.

The simple fact is that, each time the sensitivity is lowered by 3dB, for any reason at all, the associated power amplifier has to provide double the power output to produce the same sound pressure level in the room.

What is more, we didn't have to try very hard to jot down a list of sensitivity ratings for recent or current model consumer loudspeakers spread across the range from 90dB/W down to 80dB/W.

This much reduced order of sensitivity is practical, nowadays, only because extra power output is available fairly readily from solid-state domestic amplifiers — up to 100+100W anyway.

Twenty years ago, our most popular Playmaster stereo amplifier was one using EL37 valves in ultralinear push-pull, rated to deliver 17W power channel. A larger unit using EL34s offered more power but we'll stick with the 17+17W circuit, for purposes of illustration, feeding (usually) into a pair of Wharfedales, or Goodmans or Rolas at a sensitivity level of, say, 91dB.

To equal the acoustic output using modern loudspeakers rated at around 88dB/W, a drive power of 34+34W would be necessary.

Drop another 3dB to 84dB/W and the drive power required for the same sound pressure level would be 68+68W.

Drop below that again, towards 81dB/W, and the audio power required to maintain the original loudness would climb towards and beyond 100+100W! It then, of course, become a question of whether the loudspeaker can handle that much power, anyway: if it is a compact type, it probably won't.

Having said all this, a few hopefully commonsense conclusions can be drawn:

BY COMPARISON: If you are using a quality amplifier or receiver with an output of around 50+50W and your loudspeakers have a sensitivity of around 86dB/W, the maximum sound pressure levels available to you will be about the same as from older style good quality systems, as nominated. But the modern system will be more compact, more reliable, and have an all-round advantage in ultimate performance.

PEAK OUTPUT CAPABILITY: If your aim is to own a system which will never be in danger of overload on peaks, you will naturally prefer a generously rated amplifier. But mate it with efficient loudspeakers (up around 90dB/W, if possible) so as not to sacrifice most of the watts you have paid for!

LOUDSPEAKER POWER RATINGS have to be considered along with efficiency. A loudspeaker rated at 100W and 84dB/W will offer the same maximum acoustic output as one rated at 50W and 87dB/W, or one rated at 25W and 90dB/W. There may be ample reason to prefer the 100W loudspeaker — as long as you realise that it needs a lot more drive to make it talk out loud!

Maruni microphones

Well known for their high quality stereo headphones, the Maruni Corporation also offer an excellent range of microphones, including those pictured. The two to the left are cardioid pattern electret condenser types and, while different physically, have similar specifications. The claimed frequency response is from 30Hz to 16kHz, output level —66dB at 1000Hz, impedance 600 ohms and signal to noise ratio better than 44dB. The UM-7425 (left) retails for \$42.45 and the UMC 7441 (centre) for \$51.25. The DM-902 (right) is a 600-ohm dynamic microphone intended for more exacting requirements and retails for \$73.50. Maruni microphones are available in NSW through Archer Sound Systems, 109 Bungaree Rd, Wentworthville 2145. Phone (02) 631 4538.



Meanwhile, at National Panasonic . . .



Mr Harry Yokoi ▶

◀ Mr Shozo Iimura



During September, Mr Shozo Iimura, president of Matsushita Electric Trading Co Ltd, visited Sydney to implement changes in the structure of National Panasonic Australia Pty Ltd. Mr John-Ukita is to return to the Matsushita Head Office in Osaka. His place as Managing Director will be taken by Mr Harry Yokoi, who has been in Australia for four years and who previously held the position of Director of marketing and sales.

Mr Yokoi, 41, and a family man with three children will be deeply involved in guiding the Australian company into the video era during the next couple of years, as National moves to capitalise on its already established position in the domestic and institutional field.

At a subsequent video conference, press representatives met another visiting Japanese executive Kazunori Tsumagari, export manager of the audio/video division, Matsushita Communication Industrial Co Ltd, of Yokohama.

On display was the new National Home video recorder NV-7000, which boasts a wide range of facilities, packed into overall dimensions which make it about one third smaller than other comparable units. It was coupled to a large self-contained TV console, using rear projection to fill a 110cm diagonal screen. Also on display was a portable version of the NV-7000 and a range of colour sound cameras intended for use with the recorders for home and institutional purposes. The theme which will emerge from advertising during next year will clearly be: 3 hours of colour and sound home movies for \$30!

Figures revealed by Mr Tsumagari indicated a steep upward demand curve for domestic/institutional colour cameras from Japan. Matsushita have found it necessary to open a second factory which will double their present output to a figure of 40,000 colour/sound TV cameras per month. For further information: National Panasonic (Australia) Pty Ltd, 95-99 Epping Rd, North Ryde, 2113.

ON THE VIDEO SCENE:

SOUND QUALITY has always tended to be something of the poor relation in domestic video cassettes. The sound source can often be mediocre and, by the time it is dubbed on to a video master and then copied on to a slow moving video cassette, the end result can be quite poor. The sourest reports relate to the new six-hour cassettes, where the traverse speed is 1.1cm/sec, about one-quarter that of a normal audio cassette and half that of even the microcassette used for dictation. By contrast, the video resolution and colour is said, generally, to be surprisingly good. The standardisation of Dolby-B or other noise reduction systems might help but, certainly, some kind of a breakthrough seems necessary.

VIDEO HOME MOVIES look like taking another big step forward with the unveiling by Sony of a prototype, self-contained portable video camera. It weighs around two kilos and measures about 19 x 17 x 6cm. The tape cassette is about the size of an audio microcassette but here's the punch line: it can store about 20 minutes of picture, compared to about 3.5 minutes for a film cassette. What's more, no processing is required; the cassette can be plugged straight into a home editor and viewed through the

domestic TV set. A charge-coupled device is used in place of a Vidicon style tube to sense the image and yields a sensitivity comparable with that of 400 ASA film. Sony says that they are looking at a price of about \$1000 and a release date of around 1985. However, their motivation at the moment is to try to provide a basis for some kind of industry standard for self-contained home-movie video cameras.

FOUR-COLOUR PICTURES in magazines originally involved optical and chemical technology to produce the colour-separation transparencies and the subsequent screened printing plates. To get a still from a scene being televised, a photographer had to snap a picture off the screen — hopefully when there wasn't too much movement. The film had to be developed and processed as above, before the scene could be printed. Even when electronic plate making became standard, the same tedious two-step procedure had to be followed. Now Dai-nippon Screen Mfg, in cooperation with Toppan Printing Co, have developed a system whereby video signals, diverted from the TV receiver, can be stored and processed, and then fed directly into an electronic plate making machine.

Piv·telli[®]

MULTI-DIRECTIONAL AUDIO/VISUAL BRACKETS

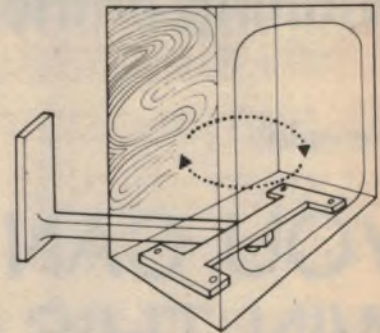

- Saves valuable floor space
- Complete with all necessary fixings
- Engineered in solid high-grade steel
- Beautifully finished in matt black or gloss white

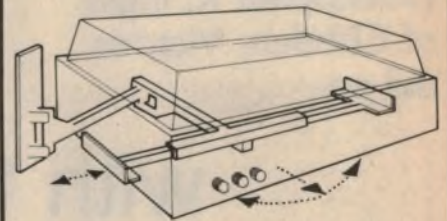

- 5 different models available
- Holds anything from 7" to 4" in width
- Holds up to 110 kilograms in weight
- Available with horizontal pivot and vertical tilt.

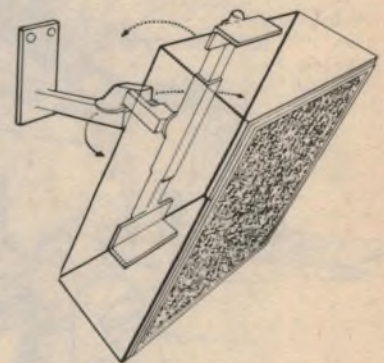

NOW AVAILABLE IN AUSTRALIA

Please send me free brochure/price list

Name _____

Address _____

Postcode _____

ASSOCIATED STEEL EQUIPMENT P/L
 11 Horscroft Place,
 Moorabbin, Victoria, 3189.
 Phone (03) 555 9921, 555 9355

NAKAMICHI CONTEST

Winning entries

We said:

YOU CAN WIN THIS ►

and
Christopher R. Inglis
of Cobden, Victoria
did so . . .

In our August issue, readers were invited to submit original humorous cartoons to do with audio/hifi; the prize for the best would be a Nakamichi 482 cassette deck, supplied by Convoy International Pty Ltd. The competition has now closed and we are in a position to announce the results, as determined by our editorial panel.



with this cartoon



*"Some idiot
pressed the
fast forward
button!"*

Arrangements will be made by Convoy International for Christopher Inglis to receive the Nakamichi 482 cassette deck and remote control as pictured, complete with documentation and the usual manufacturer's warranty. Congratulations, Chris Inglis!

In addition, a carton of 10 Nakamichi SXC-60 high quality cassettes will be forwarded to each of the entrants who drew the cartoons on the facing page. They were all on the short list to take the major prize and it needed a vote amongst our editorial executives to reach the final decision.

That leaves 60 cassettes of the original 100 to be distributed and Convoy International will be posting these out, in due course, to other entrants, selected on the merit of their respective submissions. Not every one will receive a cassette, of course, but that's the way it is with competitions.

Convoy International and Electronics Australia thank you for your interest and support.

But there's one other thing. Some of the cartoons other than the five shown here are suitable for publication. We plan to use some of them in forthcoming issues, as appropriate, and will pay a publication fee for each one so selected.

The Nakamichi 482 is a relatively new model three-head deck with in-built Dolby noise reduction and full metal compatibility. It was reviewed in our August 1980 issue and earned the commendation: "Subjectively, the Nakamichi 482 is one of the best cassette decks we have heard . . . Direct comparisons between source and tape, with Dolby noise reduction in use,

show just how far cassette tape reproduction has come."

With metal tape it measured virtually flat to 21kHz at -20dB, to 15kHz at -10dB and to 10kHz at 0dB. All other characteristics were excellent. The retail price is \$599 inc. tax, plus \$35 for the remote control. Details: Convoy International Pty Ltd, 4 Dowling St, Woolloomooloo 2001.



"Stretch higher, son!" (From Shane Wilson, North Steyne, NSW - 10 SXC-60 cassettes)

(From Neil Wight, Peakhurst, NSW - 10 SXC-60 cassettes)

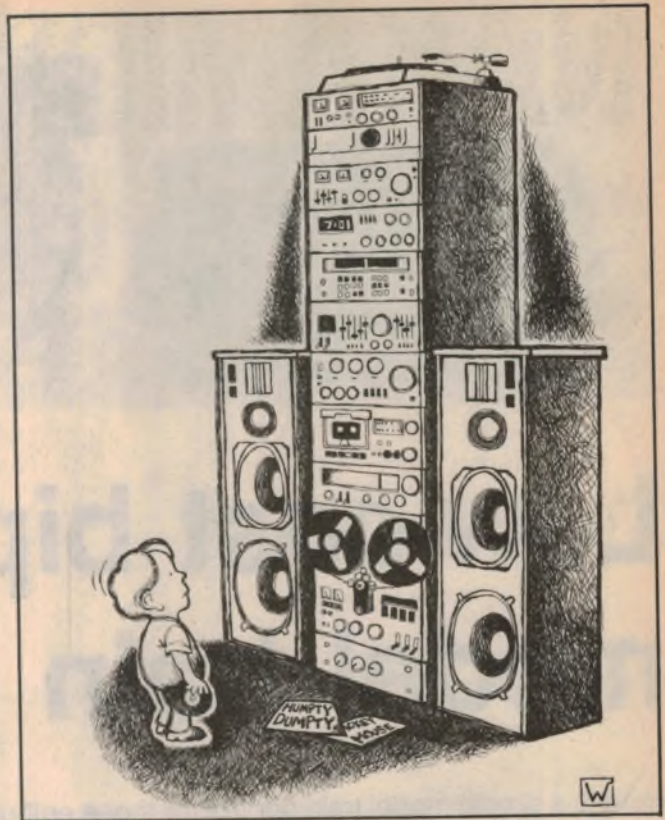

"Of course, it's direct drive!" (From J. A. Stokes, Smithfield, NSW - 10 SXC-60 cassettes).

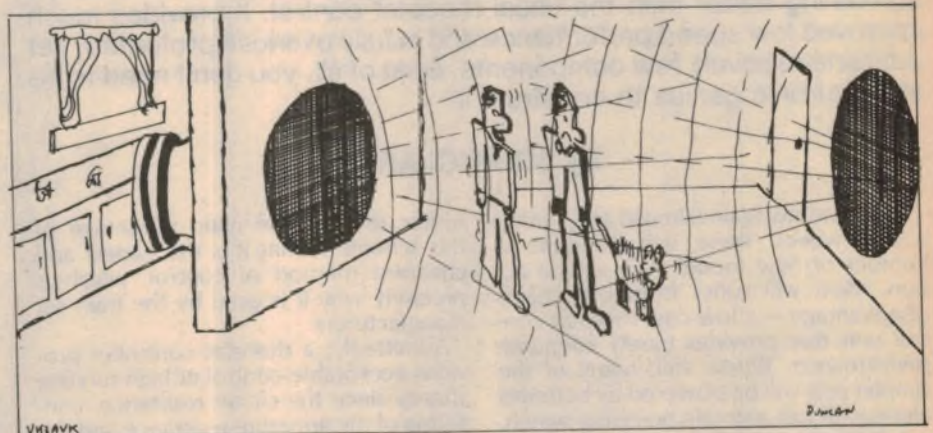

"Can you feel the pressure zone between them?" (From Neil Duncan, Heathmont, Vic. - 10 SXC-60 cassettes).



Our next big hifi competition

Next month, you will have the chance to win a pair of superb Sennheiser Unipolar HD-430 stereo headphones (RRP \$349) or one of two pairs of Sennheiser dynamics, offered by R. H. Cunningham Pty Ltd.*

* Subject to final confirmation and receipt of Government permit

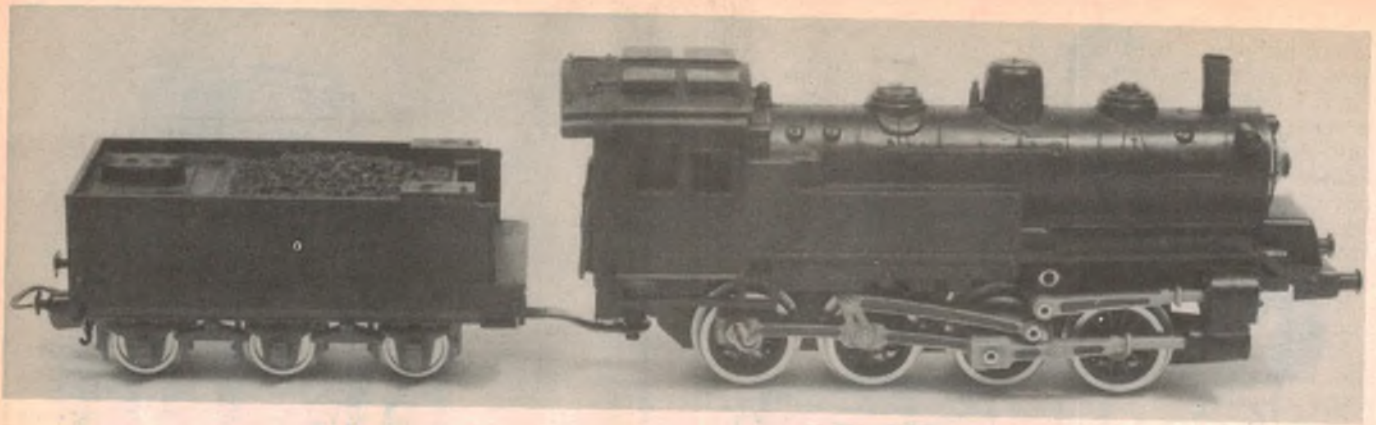

Low-cost bipolar model train controller

Here is a simple model train control for those enthusiasts who desire something better than the usual rheostat control. It provides much improved low speed performance and is fully overload protected, yet contains relatively few components. Best of all, you don't need to be an electronic genius to construct it.

by JOHN CLARKE

It's Christmas again (almost) and, within a few weeks, there will be quite a number of new model train sets in action. Most will suffer from one major disadvantage — a low-cost rheostat control unit that provides barely adequate performance. Worse still, many of the simpler sets will be powered by batteries alone with just a simple reversing switch.

A rheostat controller simply consists of a variable resistor in series with the supply voltage. This provides continuous control of the armature current and hence of

motor torque. The main advantage of this scheme is that it is the easiest and cheapest method of control, which is precisely why it is used by the train set manufacturers.

Admittedly, a rheostat controller provides acceptable control at high running speeds since the circuit resistance, consisting of the armature resistance and the control resistance, is quite small. In this situation, the back EMF of the motor is the major factor determining armature current and the speed of the train will be

substantially independent of load variations.

Problems occur at low speed settings, however. Here the large amount of series resistance in the supply circuit makes the rheostat controller behave as a "constant current" source, negating the beneficial effect of reduced back EMF. Normally, when a motor slows down, the back EMF generated by the motor falls and armature current rises, increasing the torque; conversely, when a motor speeds up, the back EMF rises and armature current falls, reducing the torque.

With the rheostat controller, however, the armature current (and hence the torque) is limited at low speed settings by the large amount of resistance in circuit. What's more, because the supply has a constant current characteristic, the ability of the motor to vary its torque according to back EMF is quite limited and the model becomes quite sensitive to load variations. The loco will slow noticeably on gradients and curves, and in some instances may even stall.

In addition, the supply voltage to the train is poorly regulated with a rheostat controller. Whenever additional current is drawn to cope with an increased load, the voltage drop across the resistance increases and the track voltage falls. Again, this has as an adverse affect on low-speed performance and the loco's ability to cope with load variations.

Another objectionable feature of the simple rheostat controller is its poor starting characteristics. It's almost impossible to start a train without having it take off like a rocket, no matter how skillfully the control knob is handled. The reason for this is that a very much larger armature

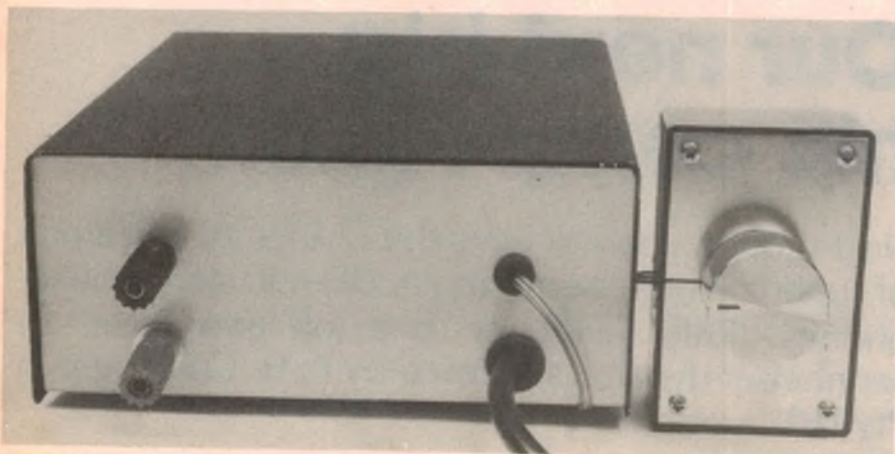

Here is the completed control unit, built into a standard metal case. A separate hand-held plastic case is used to house the speed control potentiometer.

current (torque) is needed to start the motor than to keep it running.

So in order to provide enough current to start the motor, the control knob must be advanced well up the scale. The result is inevitable: once the motor does start it quickly gathers speed and the train "blasts off".

This is where the controller described here scores. Basically, it is a variable power supply with a low output impedance. At any given setting it behaves as a constant voltage source, allowing the current to vary according to the motor's requirements and as dictated by the back EMF. As a result, low speed torque is considerably improved, leading in turn to much improved starting and low-speed running characteristics.

Other features of our new "Bipolar Train Controller" include overload protection and bi-directional control using a single control potentiometer. The unit can supply positive and negative output voltages variable from 0V to 20V peak (or around 13.5V average) and is easy to operate, with the control pot mounted in a small hand-held plastic case.

THE CIRCUIT

Let's take a look at the circuit and find out how it works.

The circuit is based on complementary Darlington transistor pair output stages, to which we have added protection circuitry. Transistors Q3 and Q5 make up one Darlington transistor pair, while Q4 and Q6 form the other pair.

The output voltage is determined by the setting of the 1k potentiometer, which forms the loco speed and direction control. When the control is centred, there is no output voltage, and the loco remains stationary. When it is rotated clockwise, the output voltage increases, driving the train in one direction, while anti-clockwise rotation produces movement in the opposite direction.

Operation of the circuit is as follows: the voltage at the wiper of the potentiometer is passed to the bases of the Darlington transistor pairs via the 470 ohm resistor. Depending upon the setting of the potentiometer, this will forward bias one Darlington pair, and reverse bias the other.

The forward biased stage operates as an emitter follower and supplies current to the load (in this case the loco) via two parallel 1 ohm emitter resistors. The emitter-follower action applies local negative feedback, and tends to keep the voltage applied to the train constant, irrespective of the load current. So the loco tends to have improved "pulling power", even at low speeds.

Overload protection is provided by transistors Q1 and Q2 which reduce the drive to the output stages under conditions of excessive loading (ie when there is a short across the tracks). In normal operation, the voltage drop across the two parallel 1 ohm resistors in the rele-

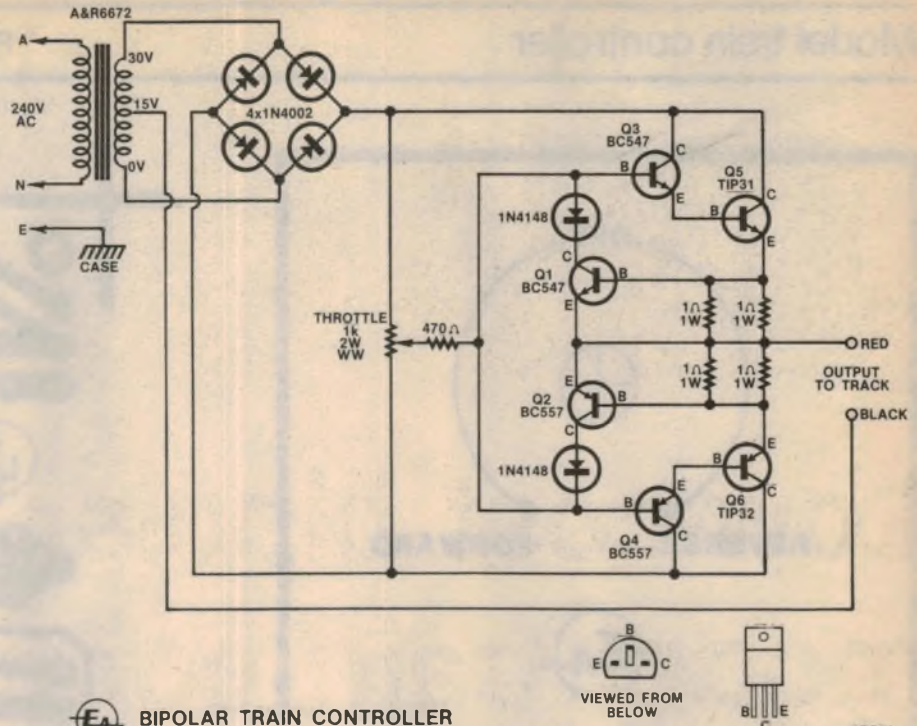

BIPOLAR TRAIN CONTROLLER

The circuit is based on complementary Darlington transistor pair output stages. Transistors Q1 and Q2 form the overload protection circuitry.

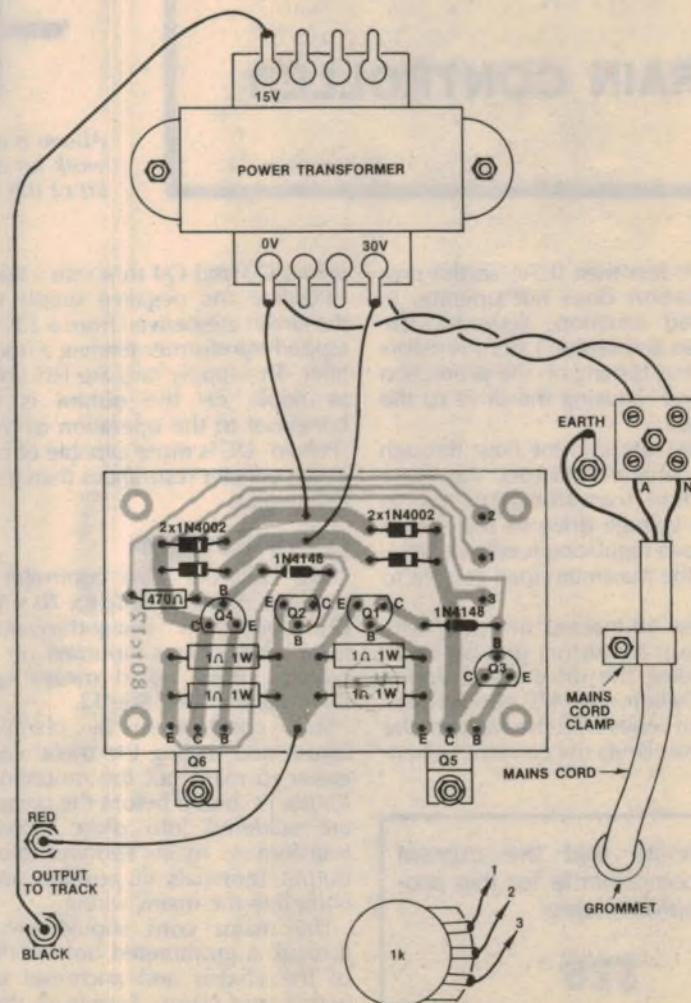

Make sure that you orient the transistors and diodes correctly, and keep mains wiring neat and tidy. Note that Q5 and Q6 must be isolated from chassis.

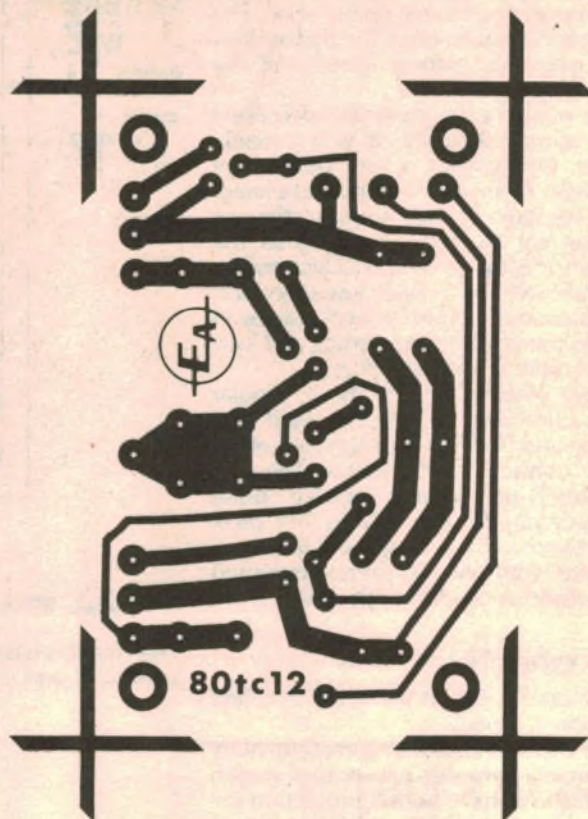
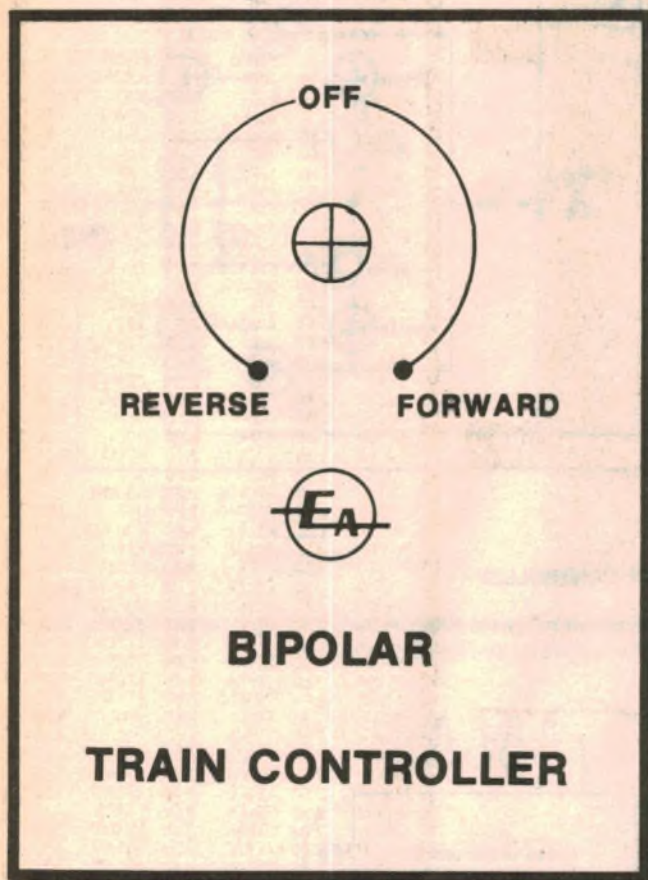

Above is an actual size PC artwork while at left is a panel artwork for those who choose to mount the control pot on the lid of the standard metal case.

vant stage is less than 0.5V, so the protection transistor does not operate. In the overload situation, however, the voltage drop across the 1 ohm resistors increases, thus turning on the protection transistor and reducing the drive to the output stage.

The greater the current flow through the 1 ohm emitter resistors, the more the protection transistor turns on to reduce the voltage drive to the output stage. This self-regulating feedback situation keeps the maximum load current to about 1A.

The diodes connected in series with the protection transistors prevent them from bypassing the drive signal during normal operation. The 470 ohm resistor connected in series with the wiper of the potentiometer, limits the current to tran-

sistors Q3 and Q4 to a safe value.

Positive and negative supply rails for the circuit are derived from a 30V centre-tapped transformer feeding a bridge rectifier. The supply rails are left unfiltered, as ripple on the output is actually beneficial to the operation of the loco. "Pulsed" DC is more capable of breaking down contact resistances than a smooth DC supply.

CONSTRUCTION

We built our train controller into a standard metal case 184 x 70 x 160mm. Construction is straightforward, with most components mounted on a small printed circuit board measuring 84 x 54mm and coded 80tc12.

Start construction by planning the layout and drilling the metal case. It is easier to mark out the mounting holes for the PC board before the components are soldered into place. Mount the transformer, mains terminal block and output terminals in position and then complete the mains wiring.

The mains cord should be passed through a grommeted hole in the front of the chassis and anchored securely with a cord clamp. Terminate the mains active and neutral to the terminal block and run the earth wire to an adjacent

solder lug. It is a good idea to leave sufficient slack in the earth lead so that it will be the last to break in the event of undue strain on the mains cord.

Assembly of the PC board can be tackled next. Make sure that the transistors and diodes are correctly oriented, and use PC stakes to facilitate external wiring to the board. This done, the PC board can be mounted in the case using 9mm Richco plastic supports, and the wiring completed.

Note that heavy duty hook-up wire should be used for all connections to the transformer and to the output terminals. A 3-wire length of rainbow cable will suffice for linking the hand-held control unit to the PC board.

The TIP31 and TIP32 power transistors are bolted to the base of the chassis and their leads soldered to the underside of the PC board. It is necessary to insulate the metal heatsink tab on each transistor from the chassis using a mica washer and an insulating bush. A smear of heatsink compound on each mating surface is recommended to aid heat transfer.

Check the electrical insulation with an ohmmeter after the securing bolt for each transistor has been tightened.

Some constructors may prefer to dispense with the separate hand-held

We estimate that the current cost of components for this project is approximately

\$26

This includes sales tax.

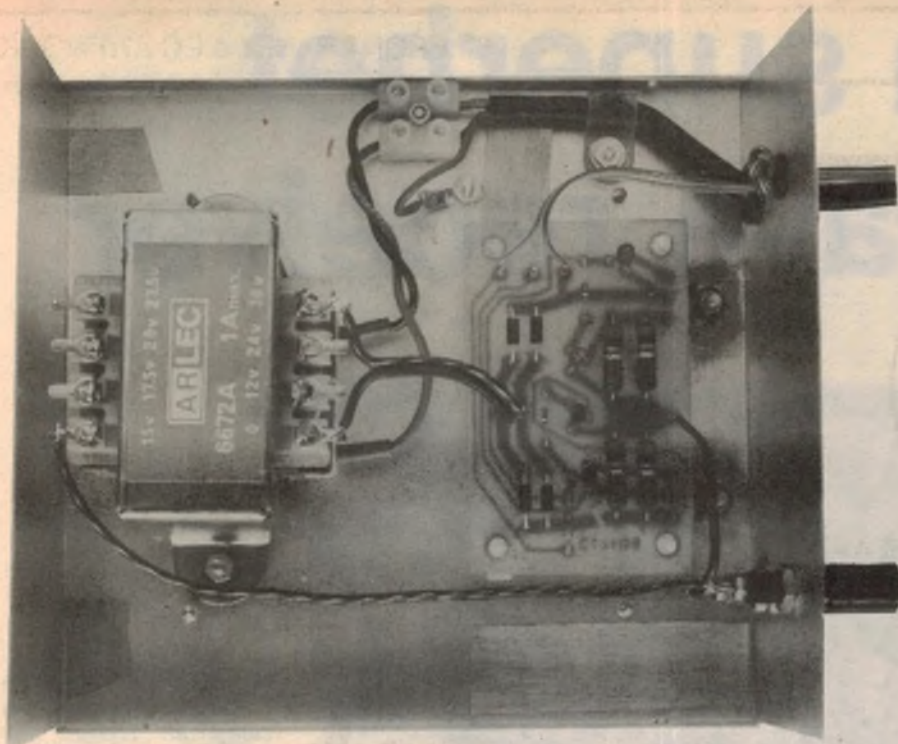

Use heavy duty hook-up for all connections to the transformer and to the output terminals. The PC board is mounted using plastic standoffs.

PARTS LIST

- | | |
|--|--|
| 1 PC board, 84 x 54mm, coded 80tc12 | 1 knob |
| 1 metal case, 184 x 70 x 160mm | 4 Richco CBS-6N plastic board supports |
| 1 plastic utility box, 83 x 54 x 28mm | 6 PC stakes |
| 1 1k 2W wire wound potentiometer | 1 10A mains cord and plug |
| 1 30V CT 1A mains transformer, A & R 6672, DSE M-6672, R6678 | 2 grommets; 1 large, 1 small |
| 1 TIP31 NPN power transistor with mounting hardware | 1 cord clamp and 2-way insulated terminal block |
| 1 TIP32 PNP power transistor with mounting hardware | 6 PC stakes |
| 2 BC557 PNP transistors | MISCELLANEOUS |
| 2 BC547 NPN transistors | Solder, hookup wire, solder lug, screws and nuts. |
| 4 1N4002 1A rectifier diodes | NOTE: Resistor wattage ratings are those used for our prototype. Components with higher ratings may generally be used provided they are physically compatible. Components with lower ratings must not be used. |
| 2 1N4148 diodes | |
| 1 470 ohm 1/2W resistor | |
| 4 1 ohm 1W resistors | |
| 2 binding post terminals: 1 red, 1 black | |

controller and mount the potentiometer on the lid of the power supply case. If you do choose this option, we suggest that you also purchase a Scotchcal adhesive label to dress up the project. Scotchcal panels should be available from Radio Despatch Service (869 George St, Sydney) and from other suppliers by the time this article appears.

Once you have completed the unit, double check all wiring, and then switch on. Use a voltmeter to check that the output voltage can be controlled by the knob, and that both positive and negative output voltages can be obtained. Note that the meter will give the

average value of the output voltage.

If all is OK, connect up to a train, and give the unit a practical test. If you have a suitable ammeter, connect it directly across the output, and check that the maximum output current is about 1A, in both directions.

Finally, it is quite normal for the control potentiometer to become warm during operation. This is because the pot is connected directly across the supply rails and continuously dissipates around 0.9W. Do not substitute a carbon potentiometer for the 2W wire wound type specified, as its rating (0.25W) will be inadequate.

printed circuits

- Accurately machine printed etched
- Phenolic & fibreglass gold tin plated
- EA R & H ET Philips Mullard available
- Specials to your drawing
- POSTAGE small 80c large \$1.10

ET1475 \$4.00	ET1457 \$3.00	ETI326 \$2.80
80LPG9 3.50	80B7 2.50	80DM9 4.50
80TR9 3.50	80LL7 2.80	80M07 3.00
ET1324 3.50	80LL7 2.80	80M07 3.00
80PC7 3.00	80CH7 4.80	565 3.50
563 2.80	467 4.00	149 2.80
80PP7B 2.50	80PP7A 5.00	80RF5 2.80
80G6 4.80	578 2.50	636 16.00
8006 3.00	78AF2 3.00	ET58820 10.00
80PA6 12.00	77CB12 2.60	78EK3 3.30
80BB3 2.80	ET135 3.00	781A2 2.60
454 3.00	BOHHS6 2.80	ET716 4.00
80AW4 4.00	325 2.50	ET245 2.50
80C14 2.80	80PC4 3.00	78S3 2.60
466 6.00	582 3.30	77PH12 2.60
80AU3 3.00	453 2.80	80PG6 5.00
264 2.50	566A 2.50	80HLA5 2.50
322 2.80	80GPS3 2.80	80TV8 3.30
80S1 2.50	496 5.00	566B 3.00
ET560 2.80	496G 6.50	80F3 2.80
ET151 2.50	80CM3A 3.20	ET152 2.80
79D10 2.80	561 2.80	726 8.00
79T11 2.80	80GA3B 3.20	80CM3B 2.80
ET262 2.50	79SB10 2.80	455 3.00
ET150 2.80	ET452 4.50	80GA3A 5.00
79PG9 3.00	80SA3 4.50	ET474 2.80
ET573 2.80	79EB12 2.80	ET321 3.50
79QM9 3.00	ET270 2.80	79FE11 2.80
79RR8 4.20	ET261 2.50	79PC12 2.50
79BT9 2.60	ETi46 2.50	ET263 2.50
79AC9 3.50	79MD9 2.80	ET260 2.50
ET576 4.20	ET577 2.80	79PS11 2.50
ET730 3.50	79PS10 2.80	ET606 3.00
ET252 3.00	79SF10 2.50	ET473 3.50
79WF8 3.20	79TT7 2.60	79R18 2.80
79PS6 2.80	79SF9 2.60	79A19abc 4.20
ET451 2.50	ET574 2.80	79W9 2.80
6800 8.50	ET814 2.80	ET731 3.00
79UPS6 2.50	79SR8 2.80	ET575 2.50
ET144 3.50	79UT8 3.00	ET725 3.50
79R05 3.00	79FR6 3.50	79TRF5 2.50
77EQ2A 3.50	ET472 3.00	79M8 2.80
ET320 2.50	79C17 4.80	ET148 2.50
ET595 2.80	79SA5 8.00	ET724 2.50
491 4.50	ET254 2.50	79KB7 2.80
79PS3 2.60	79EQ2C 2.50	ET651 4.50
79P1B 2.80	ET249 2.80	ET471 5.50
79C1A 3.00	ET253 4.20	79EQ2B 4.00
142B 4.00	559 3.80	ET594 2.50
79S1 4.50	78Se3 4.00	ET470 3.20
79IT2 5.00	79P1A 2.80	79A3 3.00
78S12A 5.50	558 2.50	721 3.00
78N10 2.60	142A 8.00	79PB2 3.20
78DT10C 2.50	79W3 2.60	78C1B 2.80
ET813 3.50	78SB12 3.00	557 3.00
ET812 2.80	781M12 3.00	79UP1 5.00
ET556 6.00	78C11 3.10	79C11 2.60
78BBD9 3.50	78DT10B 2.80	78S12B 2.50
650B 2.60	ET143 2.80	78UP10 7.00
718 2.60	ET593 3.20	78DT10D 2.50
590B 8.00	780B11 2.80	78DT10A 6.50
78E09 2.50	555 4.00	ET141 4.20
ET391A 2.50	650A 4.00	ET490 2.80
ET591C 2.50	553 3.00	78UP9 6.00
78UT9 16.00	590A 8.00	650C 2.60
78UMB 2.60	ET605 7.00	138 3.80
ET638A 4.00	ET551 3.00	811 3.30
ET591 4.00	ET550 2.80	78MC10 4.00
78TSC7 2.50	78MX9 3.30	ET391B 2.50
ET137B 2.80	78CL8 3.00	ET641 ON/AP
ET717 3.50	ET248 2.50	ET592 4.50
78FB6 3.50	ET810 2.80	78T9 2.30

ALL SILICON 30/60w PA PORT AMP
6 1/2"W x 8 1/2"D x 3 1/4"H 12 - 16V, two inputs 5 & 100mV. 125, 250, 500 ohm output only. No. 763A
\$70 ea. 240V operation \$33 extra. Freight collect.

COILS and IF's All \$2.50 ea plus post 60c
3/4"W x 3/4"D x 2"H

MAIL cheque or money order
(add postage) direct to -

RCS radio pty Ltd

651 FOREST RD BEXLEY
NSW 2207 587 3491

Build a superhet shortwave receiver

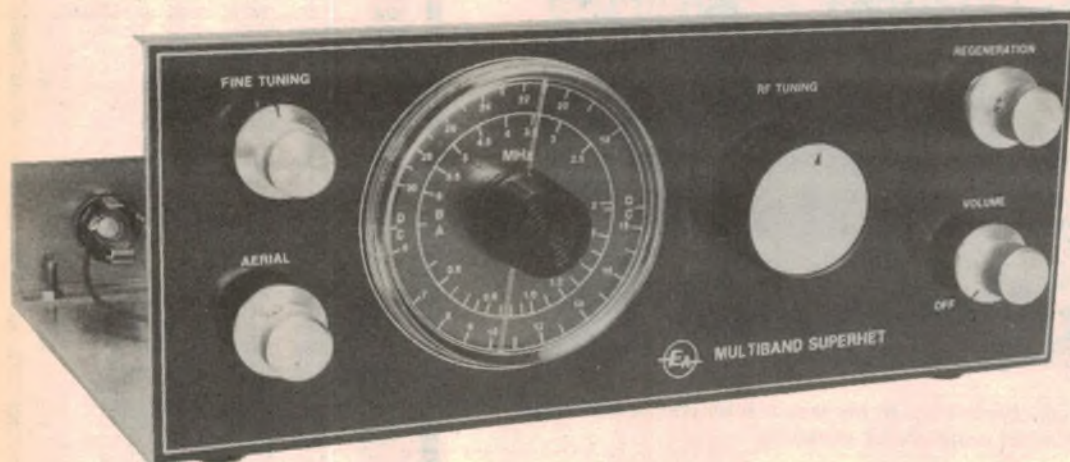

Our new superhet shortwave receiver is built on a simple folded aluminium chassis and finished with a "Scotchcal" front panel. The unit covers the broadcast band and from 2-30MHz.

This "Multiband Superhet" receiver is a step or so beyond the All-Wave Three described last April. It offers high performance with surprisingly good sensitivity and selectivity and covers the broadcast band and from 2MHz to 30MHz. If you liked the All-Wave Three, you will like the "Multiband Superhet" even better.

by IAN POGSON

The "All-Wave Three" receiver which we described in May, 1980 was a very popular and successful project, having been built up in large numbers. This made us think about the possibility of describing a unit with more performance but still retaining the basic simplicity of the All-Wave Three. With this idea in mind, we came across an interesting simple design for a superhet in "Radio and Electronics Constructor", for February, 1980. Using this design as our basis, we have added some refinements to come up with the unit to be described.

While we would hesitate to claim that this new receiver would match more expensive commercial receivers, given a good antenna and some skill in operation, you may virtually have the world at your doorstep! One thing is certain, for the modest outlay in money, the return in satisfactory performance should be well worth while.

To get an idea as to how this has been made possible, let us have a look at the circuit. The first stage employs a dual-gate field-effect transistor as a mixer. The incoming signal from the antenna is fed via a 5k potentiometer working as an antenna attenuator and then to the tuned circuit consisting of a plug-in coil and

a standard variable capacitor. The signal then passes on to gate one of the BFR84 FET. Bias for the FET is obtained with a 390 ohm resistor in the source circuit. Injection from the local oscillator is via a .001uF capacitor into gate two of the FET.

Because of the mixer action of the FET, the incoming signal is converted to an intermediate frequency (IF) of 1.8MHz. This is fed from the drain of the FET to the primary winding of a 1.8MHz IF transformer. The secondary of this transformer feeds the gate of a 2N5485 junction FET, operating as a source-follower. A potentiometer in the source circuit of the FET provides positive feedback to the secondary of the IF transformer. Although the gain of the source follower is less than unity, oscillation is possible by virtue of the step-up available from the tapped secondary of the IF transformer.

Very smooth and stable regeneration is available with this arrangement, resulting in markedly increased gain and selectivity, compared with what would be obtained without it. Also, when the stage is made to oscillate, reception of CW and SSB signals is possible.

Output from the source of the 2N5485

is coupled into the following stage, a BC548 operating as a class-B detector. Unlike diode detectors, the class-B detector gives a substantial amount of gain. The 47k trimpot in the base circuit of the detector allows optimum operating conditions to be set.

Audio from the detector is passed through the 100k volume control to the audio amplifier which is the popular LM380. Because the fixed gain of 50 of the LM380 is insufficient in this application, we added a transistor preamplifier. The LM380 is capable of driving a speaker of eight or 16 ohms.

As well as providing for loudspeaker use, it is also possible to use a set of low impedance headphones. When listening to those really distant weak stations, headphones can make all the difference in being able to pick them out from the noise.

The local oscillator uses a BF494 bipolar transistor which is intended for high frequency applications. This oscillator circuit has been used many times in the past and it has proved to be very stable. In order to keep costs down, we have used a simple handspan dial to drive the tuning capacitor directly. This is all right for tuning the stronger broadcast

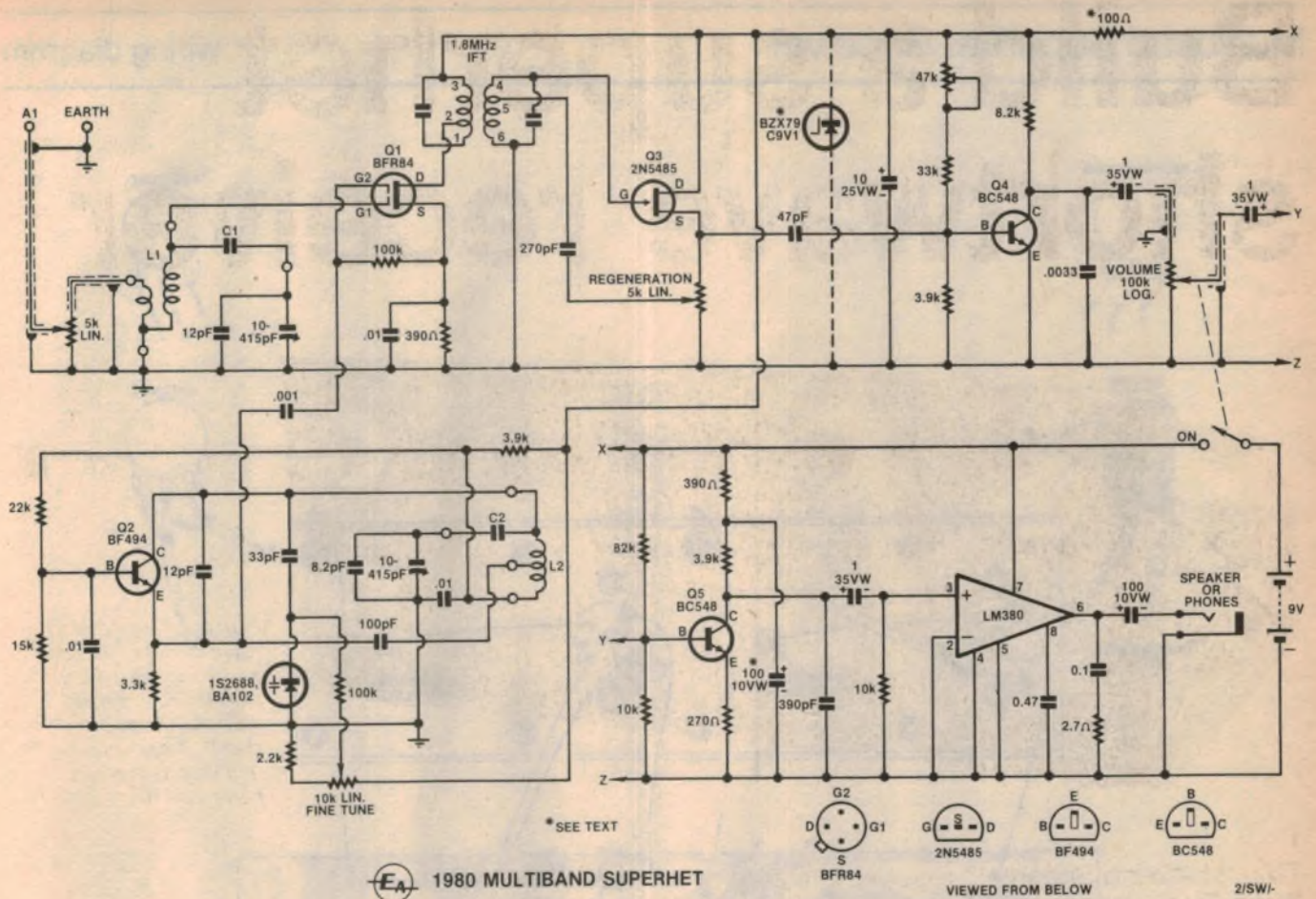

1980 MULTIBAND SUPERHET

VIEWED FROM BELOW

2/SW-

The circuit provides good performance for relatively modest outlay and can resolve AM, CW and SSB signals.

stations but when it comes to tuning the weaker shortwave stations, the extra "band-spread" afforded by the fine tuning knob makes tuning very much easier. The varicap diode is connected across the main tuning circuit and a 10k potentiometer controls its capacitance.

We have provided for battery operation but this little receiver can be run from the mains, using any plug-pack power supply which will deliver more than nine volts but no more than about 12V DC, at up to about 100mA. For this situation, provision has been made on the board for a 9V zener diode to be fitted. The 100 ohm series resistor may need to be increased if the supply voltage exceeds about 12V. This arrangement supplies the RF stages with regulated 9V, while the rest of the receiver is fed directly from the plug-pack. For battery operation omit the zener diode.

COMPONENT AVAILABILITY

At the time of writing, all the components used on the Multiband Superhet are available but comments on some of the items may be helpful.

In order to reduce the cost of building this project, many readers may be able to salvage some components from old radio and possibly television receivers.

While we used new components in the prototype, there is no reason why you should not save a few dollars here and there.

It is important to use the same coil formers as used on the prototype, to ensure that the dial calibrations track and to obtain similar performance generally. We obtained our coil formers from Watkin Wynne Pty Ltd, 32 Falcon Street, Crows Nest, NSW 2065. From the same source, we also obtained the Roblan 10-415pF variable capacitors, the Denco IF transformer type IFT18-1.6MHz and the handspan dial. These items should

normally be available from your local supplier.

Regarding the handspan dial just mentioned, we understand that stocks of the present version are running low and when they run out, they will be replaced with a modified version which will be a direct replacement.

The Scotchcal front panel overlay gives a professional finish to the unit and provides the extra facilities of dial calibrations and functions. Ready made panels may be obtained from Radio Despatch Service, 869 George Street, Sydney, or Rod Irving Electronics, 499 High Street,

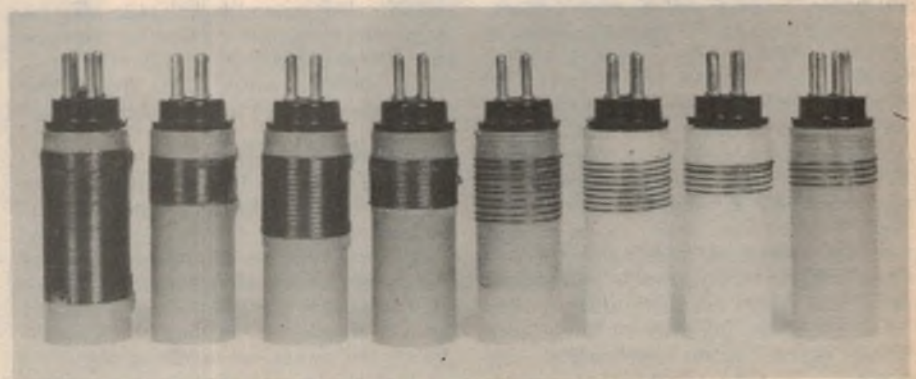

Eight plug-in coils are used to cover the frequency range from 0.5 to 30MHz. Full winding details for the coils are given in the text.

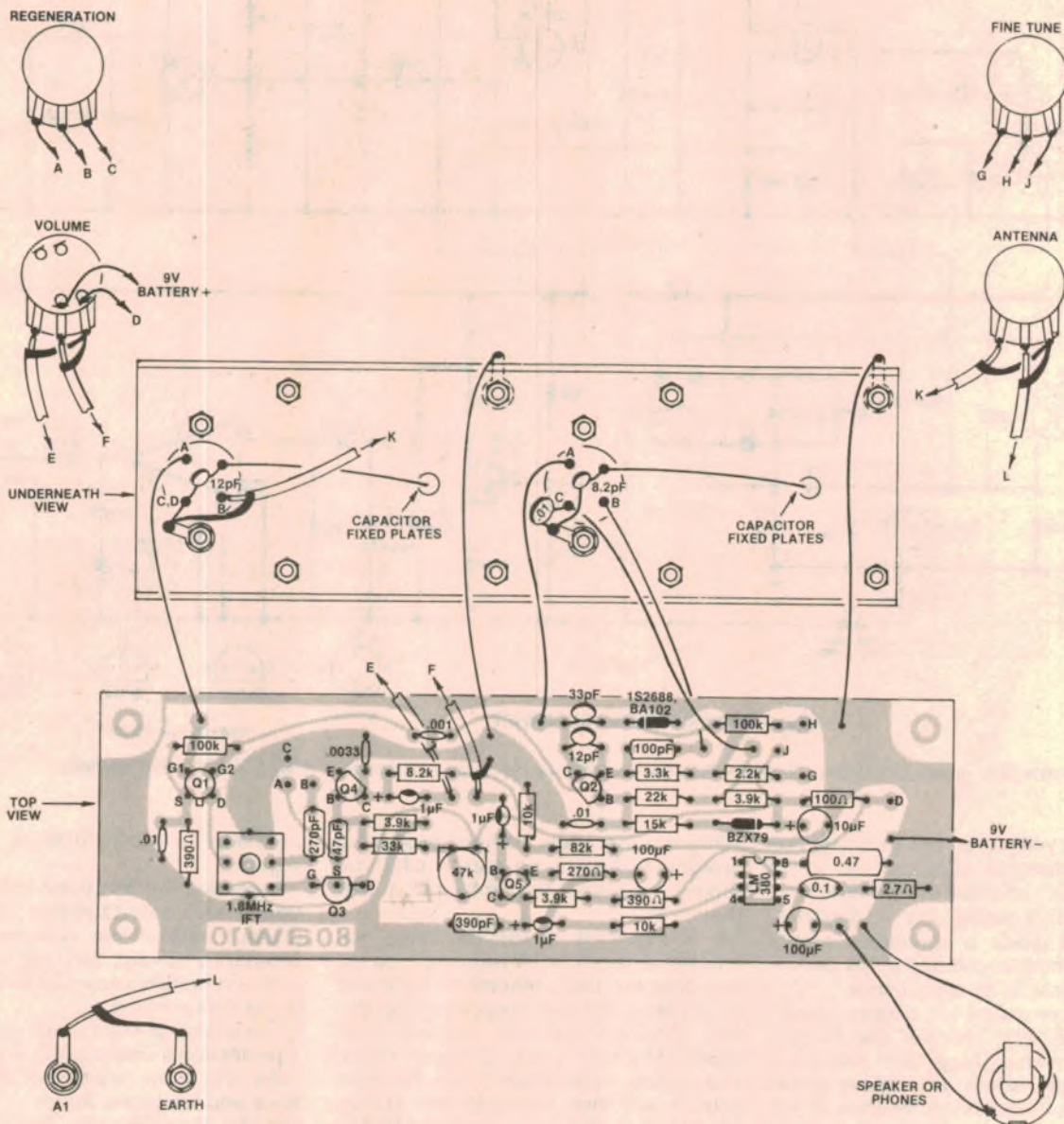

This wiring diagram shows the sub-chassis as viewed from below, while the PC board is shown from the component side.

Northcote, Victoria, and possibly others.

We used a metal "L" shaped chassis to accommodate the components, together with the sub-chassis and PCB assembly. Although it may be possible to use a wooden base, it is not recommended for this project. A metal front panel is a "must", in order to minimise hand capacitance effects when tuning. Also, if you live near to any high powered broadcast transmitters, it will also be necessary to provide an earthed metal top plate, corresponding to the top of a cabinet, to prevent these very strong signals from overloading the receiver.

It is very important to make the finished assembly quite rigid, for frequency

stability. The assembled chassis may be fitted into a suitable cabinet to improve the overall appearance. Of course, a metal cabinet would also avoid the overloading problem mentioned above.

ASSEMBLY DETAILS

Although the Multiband Superhet is a modest receiver, there is quite a lot of work in assembling it. However, by using a PCB the job is simplified and the chance of making wiring errors is reduced. There is no particular order in which the job should be tackled but all sub-assemblies should be made up first.

A logical place to start is to wind the coils. The relevant information is given in the coil table and must be followed

closely. To ensure that the coils perform similarly to those of the prototype, it is important to use the gauges of wire called for in the table, otherwise there will be deviations from the original windings and it is possible that the calibrations on the dial will be inaccurate.

McMurdo 4-pin plugs are fitted to the coil formers by means of a screw. We tapped the centre hole to 1/8in Whitworth and dropped a screw down through the former. This makes a very neat assembly. However, if you are unable to tap the holes, then it may be an idea to open up the hole if necessary and use a countersunk screw up through the plug and into the former and screwing on a nut. Whatever method is used, the plug

ROD IRVING ELECTRONICS

425 HIGH STREET, NORTHCOTE 3070, MELBOURNE, VICTORIA.

\$100 COMPUTER PRODUCTS

16K EPROM CARD-S 100 BUSS

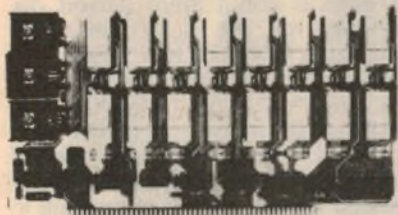

**\$89.50
KIT**

**FIRST TIME OFFERED!
BLANK PC BOARD - \$39**

USES 2708's!

Thousands of personal and business systems around the world use this board with complete satisfaction. Puts 16K of software on line at **ALL TIMES!** Kit features a top quality soldermasked and silk-screened PC board and first run parts and sockets. Any number of EPROM locations may be disabled to avoid any memory conflicts. Fully buffered and has WAIT STATE capabilities.

**OUR 450 NS 2708'S
ARE \$8.95 EA. WITH
PURCHASE OF KIT**

**ASSEMBLED
AND FULLY TESTED
ADD \$36**

8K LOW POWER RAM KIT-S 100 BUSS SALE

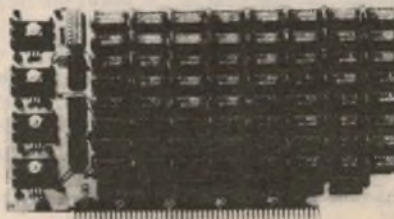

**PRICE
CUT!**

\$159.50

**21L02
(450 NS RAMS!)**

Thousands of computer systems rely on this rugged work horse. RAM board. Designed for error-free. NO HASSLE. systems use

Blank PC Board w/ Documentation

\$44

Low-Profile Socket Set **13.50**

Support IC's (TTL & Regulators)

\$13

Bypass CAP's (Disc & Tantalums)

\$7

**ASSEMBLED AND FULLY
BURNED IN ADD \$45**

**ALL ASSEMBLED BOARDS
ARE TESTED AT 4MHZ.**

16K STATIC RAM KIT-S 100 BUSS

**KIT \$249
A&T \$279**



KIT FEATURES

1. Addressable as four separate 4K Blocks
2. ON BOARD BANK SELECT circuitry (Cromemco Standard). Allows up to 512K on line!
3. Uses 2114 (450NS) 4K Static Rams
4. ON BOARD SELECTABLE WAIT STATES
5. Double sided PC Board, with solder mask and silk screened layout. Gold plated contact fingers
6. All address and data lines fully buffered
7. Kit includes ALL parts and sockets
8. PHANTOM is jumpered to PIN 67
9. LOW POWER under 1.5 amps TYPICAL from the +8 Volt Buss
10. Blank PC Board can be populated as any multiple of 4K

BLANK PC BOARD W/DATA **\$49**

LOW PROFILE SOCKET SET **\$19**

SUPPORT IC'S & CAPS **\$27**

ASSEMBLED & TESTED-ADD **\$30**

**OUR #1 SELLING
RAM BOARD!**

16K STATIC RAM SS-50 BUSS

PRICE CUT!

\$279

**FULLY STATIC
AT DYNAMIC
PRICES**

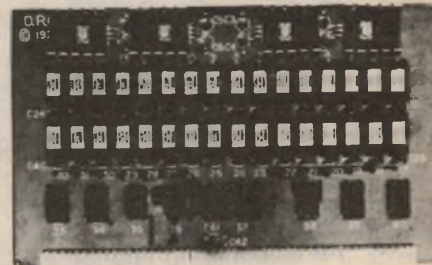

**FOR SWTPC
6800 BUSS!**

**ASSEMBLED AND
TESTED - \$30**

KIT FEATURES

1. Addressable on 16K Boundaries
2. Uses 2114 Static Ram
3. Runs at Full Speed
4. Double sided PC Board. Solder mask and silk screened layout. Gold fingers
5. All Parts and Sockets included
6. Low Power: Under 1.5 Amps Typical

BLANK PC BOARD— **\$39** COMPLETE SOCKET SET— **\$19**
SUPPORT IC'S AND CAPS— **\$45**

ITOH Model 8300 PRINTER. \$770 plus 15% sales tax.

This 80-column printer provides quiet operation, making it suitable for use in offices, classrooms and homes. Specifications include 125 cps, 60 lines per minute, paper loading from bottom or rear and Centronics-compatible, parallel interface.

A bidirectional, dot matrix impact printer with a print head designed for 100 percent duty operation, assuring a print life that exceeds 100 million characters. The precision sprocket-feed mechanism permits printing forms from 4½ to 9½ inches wide. A 96 ASCII character set prints in upper and lowercase with the added capability of producing double-width fonts in boldface. The vertical format unit provides preprogrammed/programmable tab positions, top of form and bottom of form for complete formatting capabilities.

ET1636 7 SLOT MOTHERBOARD WITH ACTIVE TERMINATION

Kit of Parts \$79.00. Assembled and tested \$105.00. inc. tax.

RITRON COMPUTER GRADE POWER SUPPLY: +5V Reg, 10A,
+ 16V Unreg. Kit of parts \$79.95 inc. tax. A&T \$99.95 inc. tax.

Write for list of other power supplies. Tax free prices also available.

JUST WRAP KIT - JWK-6 \$39.50

● 50ft ea. blue, white, red, yellow wire ● Just Wrap Tool ● Unwrap Tool

*** AVAILABLE AGAIN ***



- 16K Dynamic Ram Board
- Fully Expandable to 64K
- Assembled, tested and guaranteed
- \$100 Compatible

16K Dynamic RAM Board assembled and tested:
Special \$269 plus tax (2MHz), \$299 plus tax (4MHz)
This must be the best offer available on quality tested dynamic RAM boards.

32K Assembled and tested **\$339 plus tax (2MHz)**
48K Assembled and tested **\$369 plus tax (4MHz)**
64K Assembled and tested **\$409 plus tax (2MHz)**
\$439 plus tax (4MHz)
\$479 plus tax (2MHz)
\$509 plus tax (4MHz)

Bankcard
Mail Orders
Welcome

Please debit my Bankcard.
Bankcard No.
Expiry Date
Name
Signature

General enquiries (03) 489-8131. Mail order enquiries (03) 481-1436. Ritronics Wholesale (03) 489-7099.

Prices current till Dec. 7, 1980. Heavier items add additional postage. Extra heavy items sent Comet freight on. Prices subject to change without notice. Send 60c and SAE for free catalogues. MAIL ORDERS PO Box 135, Northcote, Vic 3070. Minimum pack

should be set with the cursor horizontal when the capacitor moving plates are fully closed. The RF tuning knob should be set with its pointer horizontal with its capacitor moving plates fully meshed. These two knobs will then point in approximately the same direction when tuning across the various bands. The fine tuning knob will be set after the receiver has been put into operation.

At this stage, the unit is almost ready for testing. Before proceeding however, all work should be thoroughly checked. Make sure that all components are in the right place and that polarities are correct. All wiring should also be checked for accuracy. Satisfied that all is well, the battery or other supply may be connected, also with due regard to polarity.

Assuming that all is well, we are now ready to put the Multiband Superhet into operation. Plug in the coils for the broadcast band, 520kHz-1600kHz, making sure that the coils are in their correct positions. Set the two variable capacitors to about mid-position, with the antenna potentiometer fully advanced and the regeneration potentiometer fully anti-clockwise. Inject 1.8MHz from a signal generator into the antenna and earth terminals. Keep the generator to the lowest level consistent with sufficient signal. Switch on and with the volume control suitably set, adjust the two slugs in the IF transformer for maximum audio level.

The fine tuning knob can best be set by making the adjustment at a high frequency. Plug in the coils covering the 18MHz-30MHz range and make the adjustment at around 28MHz. Again using the signal generator, set the fine tuning knob so that with the rotor and the pointer vertical, somewhere between the extremes of travel, rotating the control in each direction will give equal amounts of frequency tuning.

HINTS ON USING THE MULTIBAND SUPERHET

Here are some pointers which should be useful as a guide to the tuning and operation of this kind of receiver.

For the reception of morse code or "CW" signals, the IF stage is brought to the point of oscillation and then the signal is tuned slightly to one side or the other, thus producing a signal or beat note. The note is selected to suit the convenience of the listener. The side selected does not matter but if interference is present it can often be avoided by selecting a particular side.

When the reaction or regeneration in the IF stage is increased, the sensitivity is also increased and selectivity is sharpened as well. Sensitivity and selectivity reach a maximum just at the point of oscillation. For the reception of AM signals, the regeneration should normally be set just below the point of oscillation. However, when attempting to receive very weak signals which are not satisfactory under these conditions, it is often possible to copy them if the IF

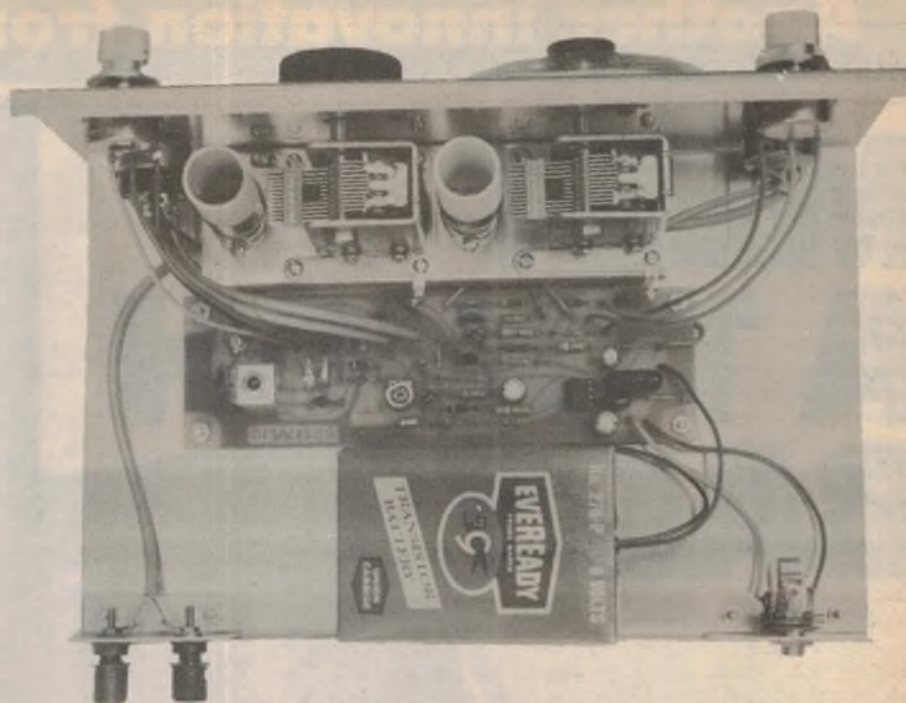

This photograph clearly shows the general layout of the receiver. The sub-chassis (top) is mounted on the main chassis using four 19mm brass spacers.

Coil winding details

Range 1: 520kHz-1600kHz

L1 Secondary, 155 turns 32B&S enamel close wound. Primary, 15 turns 32B&S enamel close wound over cold end of secondary. C1, link.

L2 46 turns centre tapped 32B&S enamel close wound. C2, 110pF (two 220pF in series).

Range 2: 2MHz-6MHz

L1 Secondary, 34 turns 24B&S enamel close wound. Primary, 4 turns 32B&S enamel interwound at cold end of secondary. C1, link.

L2 20 turns centre tapped 24B&S enamel close wound. C2, 423pF (390uF and 33pF in parallel).

Range 3: 6MHz-18MHz

L1 Secondary, 10 turns 24B&S enamel wound 6 turns per cm. Primary, 2 turns 32B&S enamel interwound at cold end of secondary. C1, link.

L2 8 turns centre tapped 24B&S enamel wound 6 turns per cm. C2, 1380pF (1200pF and 180pF in parallel).

Range 4: 18MHz-30MHz

L1 Secondary, 4½ turns 24B&S enamel wound 6 turns per cm. Primary, 1 turn

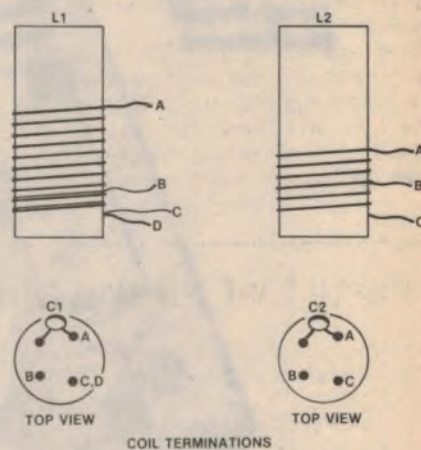

32B&S enamel interwound at cold end of secondary. C1, 180pF.

L2 4 turns centre tapped 24B&S enamel wound 6 turns per cm C2, 150pF.

All coils wound on label plastic formers, 20mm diameter x 50mm long and mounted on McMurdo 4-pin plugs. Smooth formers used for close wound coils and pre-grooved formers used for coils wound 6 turns per cm (16 turns per inch).

stage is made to oscillate and the signal carefully tuned so that there is no whistle.

For SSB reception, the IF stage is also made to oscillate and the signal is resolved by carefully tuning for the best speech quality. It is important to note that when the IF stage is made to

oscillate for all the conditions just mentioned, there is no point in advancing the regeneration control beyond the position where reliable oscillation is achieved.

Another point concerns adjustments for volume with strong AM signals. It is better not to back off the regeneration

Another innovation from **Hioki**

MEET A TOUGH BABY

HIOKI 3012
Thin
Drop-Proof
Multimeter

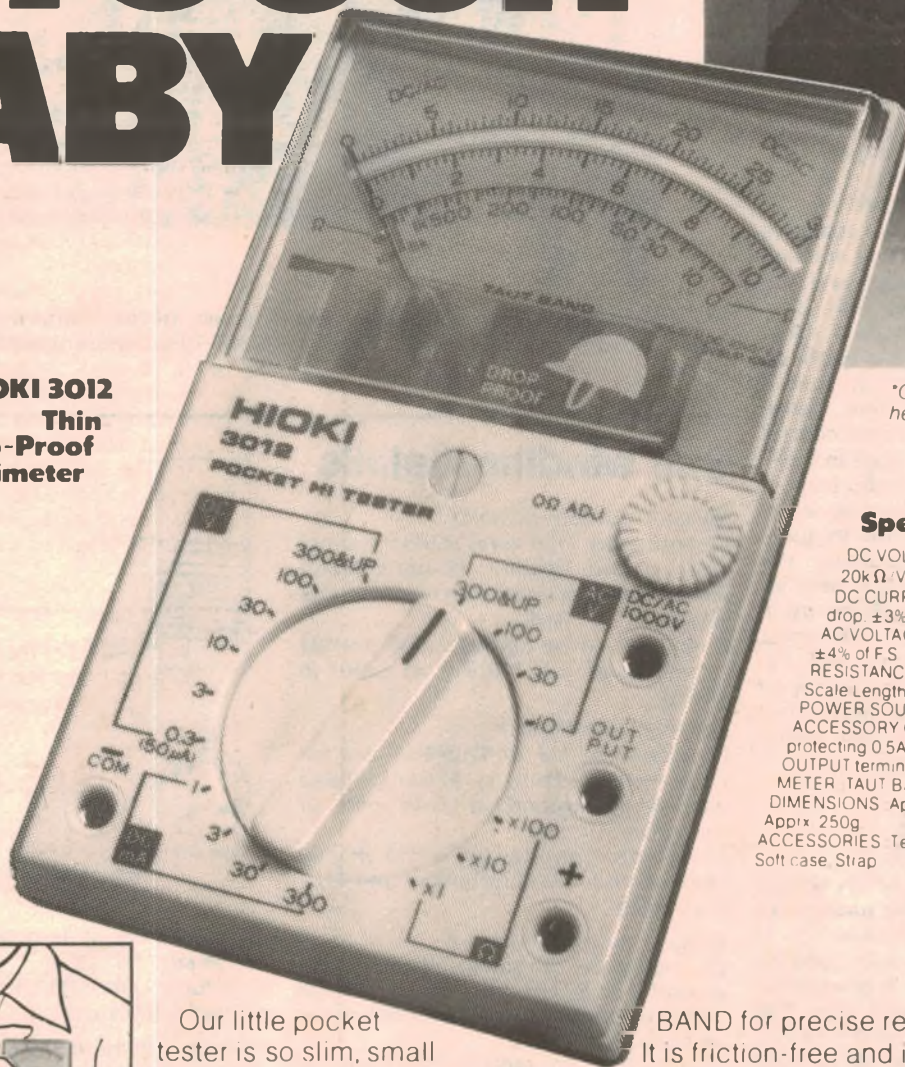

**Only 22mm thick and can drop from a height of 1 metre without any harm.*

Specifications:

DC VOLTAGE 0.3, 3, 10, 30, 100, 300, 1000V
20kΩ/V, ±3% of F.S.
DC CURRENT (50μA), 1, 3, 30, 300mA, 300mV
drop, ±3% of F.S.
AC VOLTAGE 10, 30, 100, 300, 1000V, 10kΩ/V,
±4% of F.S.
RESISTANCE 10k, 100k, 1MΩ (Rc100Ω) ±3% of
Scale Length
POWER SOURCE 1.5V (Size AA)
ACCESSORY CIRCUIT Meter protecting circuit, Circuit
protecting 0.5A fuse DC-AC1000V measuring terminal
OUTPUT terminal
METER TAUT BAND type (with mirror scale)
DIMENSIONS Approx. 140Hx84Wx22Dmm (Max. 26D)
Approx. 250g
ACCESSORIES Test leads, 0.5A Spare fuse
Soft case, Strap



Our little pocket tester is so slim, small and light you might overlook the fact that it is a rugged, hard-working precision instrument — tougher than most multimeters twice the size. It can fall from a

work bench (1 metre high) and still work perfectly well.

The "DROP-PROOF" pocket multi-meter demonstrates our claim that "HIOKI puts you years ahead." It gives you the advantage of HIOKI Core Magnetic TAUT

BAND for precise readings.

It is friction-free and is remarkably resistant to shock.

The pencil type leads fitted with guards are a pleasure to handle, especially when testing complex electronic circuits, etc. HIOKI innovation is apparent in every detail.



HIOKI PUTS YOU YEARS AHEAD!

• SYDNEY 6016600 • MELBOURNE 3296511 •
• BRISBANE 525231 • ADELAIDE 466411 • PERTH 4466622 •

H. ROWE

& CO. PTY. LTD.

SOLE
AUSTRALIAN
AGENTS

Multiband Receiver

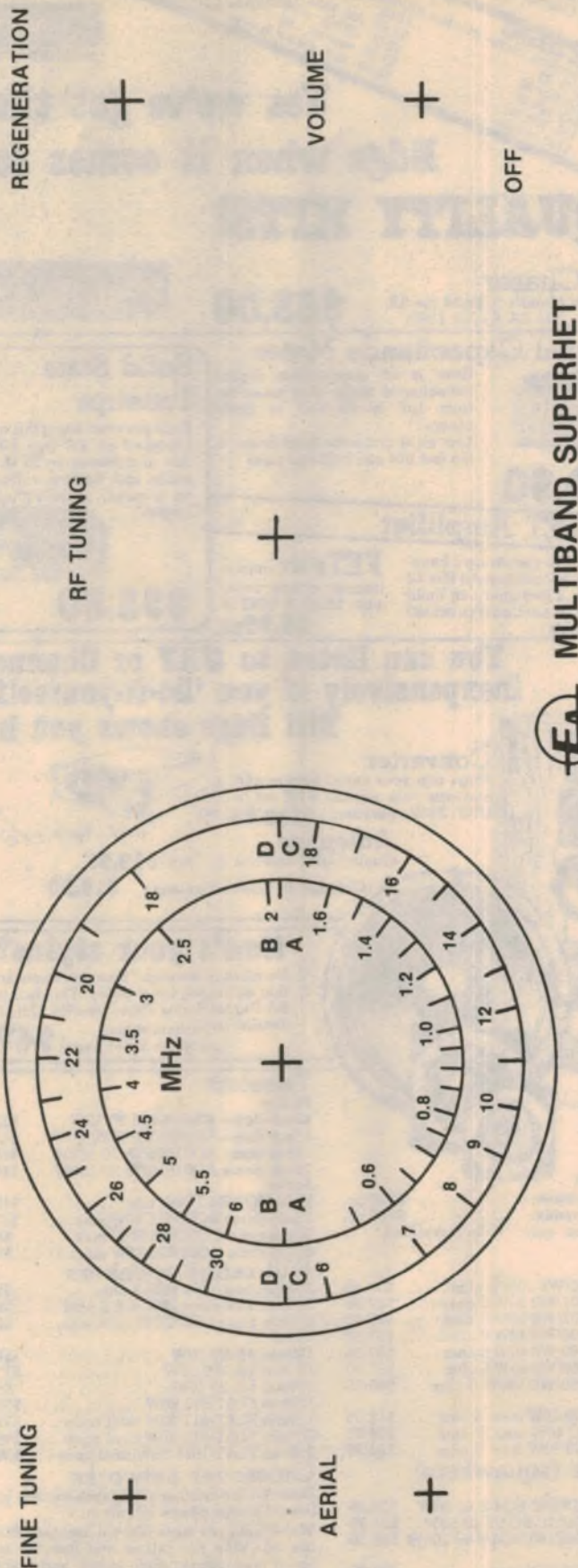

Here is an actual size reproduction of the front panel artwork.

control if the volume is too high. This practice will reduce the volume but the selectivity will be degraded as well. Whether this method is used to some extent will depend upon prevailing conditions.

With this particular receiver, in addition to the above, it is possible for very strong signals to overload the detector. This comes about because there is no automatic gain control, which normally would prevent this from occurring. To cope with this situation, we have provided an attenuator in the form of a potentiometer in the antenna circuit. The attenuator is adjusted to stop overloading where this is experienced. This situation is most likely to occur on strong local broadcast stations but it can also happen with some very strong overseas short-wave stations.

As mentioned earlier, we have used a direct drive dial for the main tuning and this has been supplemented with a "fine tuning" control. In practice, particularly on the higher frequencies, the main tuning control should be set about the middle of an immediate tuning range of interest. This setting is then maintained and tuning for each individual signal is carried out by the fine tuning control. When the range of the fine tuning con-

We estimate that the current cost of parts for this project is approximately

\$65.00

This includes sales tax.

trol is insufficient to proceed further, then the main tuning control should be readjusted.

Suitable antennas for the Multiband Superhet could be quite a topic in itself. For best results over the full coverage of the receiver, a number of different types of antenna would be desirable. The needs will vary according to the location and the frequencies on which most interest rests. In addition, a good earth connection is required. A fairly heavy gauge of wire should be run to the nearest water pipe and clamped to it.

As a guide, for the broadcast band and frequencies up to about 3MHz, a random length of wire would be suitable. This may be inside or outside and of such a length as suits local conditions, proximity of wanted stations, etc. For general shortwave reception, the "Twin Doublet Aerial" as described in the issue

Bill Edge's

ELECTRONIC AGENCIES

115-117 Parramatta Road Concord 2137
(Corner Parramatta Rd & Lloyd George Ave)
Tel. 745 3077 (two lines)

MAIL CHARGES
\$1 packing charge plus the following:
FREE
\$1.00 All heavy or bulky items (over 20 kg)
\$2.00 carrier
\$3.00 Bankcard welcome—by mail, phone or over the counter.
\$4.50

bankcard
welcome here

TRADING HOURS
Mon-Fri . . . 9am—5.30pm
Saturday . . . 9am—noon
Sunday . . . 10am—2pm

what else do we carry?
HARDWARE * TOOLS * SEMIS
VALVES * HI-FI * KITS * WIRE * PA EQUIPMENT
MIKES * SPEAKERS * CAR RADIOS
CAR CASSETTES * INTERCOMS * BOOKS

**Yes we've got the
Edge when it comes to
QUALITY KITS!**

300W of power! Playmaster quality

Playmaster 300 watt Amplifier (EA June 1980). The 300 watt module kit includes heatsink, thermal cutout, nuts, bolts PCB and components. All you need is a soldering iron, drill, cutters etc. You'll also need a multimeter (we have them from \$9.50).

MODULE KIT **\$78.00**
POWER SUPPLY TO SUIT 300 WATT AMPLIFIER
Includes transformer and all parts to construct the complete power supply. **\$82.95**

SPRITE FAN (100mm 240VAC) Recommended by EA for the project. **\$29.50**

CHASSIS & HARDWARE PACK FOR THE 300 WATT AMP

This pack includes all you'll need to finish off the amplifier kit (except the case & fan). **\$9.95**

CASE: The ideal case for this project is the rack mounting ETI4000 case for **\$88.00** or the wooden sided ETI4000 case for **\$48.00**

MATT BLACK SPRAY . . . 125 g can . . . **\$2.50**

300 WATT LOUDSPEAKER PROTECTOR KIT
Cheap insurance at only **\$12.95**
(includes PCB and all components)

NEW! 30MHz Receiver kit

What a bargain—everything you need to build your own multi-band receiver for only **\$65.00**. Four ranges from broadcast band to 30MHz—think of what you can pick up: amateurs, overseas broadcasts, marine etc. Complete kit (as per EA Nov. 1980) only **\$65.00**

build your own speakers & SAVE!

One of the easiest and best ways to get good sound on a tight budget is to build your own speakers. We've got probably the best range of speakers for home constructors in the country. Famous name Philips, Coral and Foster; 10 different woofers, 6 midrange, 8 tweeters and 10 full range units means you get a system that's just right for your needs and budget.

Complete kits (cabinets extra)
ETI 4000/1 Four-way system **\$459** pair

ETI 4000/2 Three-way system **\$360** pair

Coral kits

Complete kit for 300mm 3-way 4 speaker system (including cabinets!) only **\$218**

250mm 3-way 3 speaker system (no box) **\$95** pair

200mm 3-way 3 speaker system (no box) **\$58** pair

Playmaster 300mm 3-way kit **\$298** pair

Philips 300mm 3-way kit **\$320** pair

For mail order on all speaker kits include \$1.00 packing. We will ship your order 'Freight-on'.

Light Chaser

Complete kit of parts to build the EA Light Chaser (see EA August 1980) **\$65.00**

Digital Capacitance Meter



Here is an inexpensive digital capacitance meter that measures from 1pF to 99.00uF in three ranges. This kit is complete right down to the last nut and bolt and costs

\$59.90

New FET Amplifier

Bill Edge is now preparing a beautiful manual to complement this kit so that even a beginner can build it. Watch our next advertisement for full details.

FETs FET output transistors now available 2SJ49 & 2SK134 **\$8.95ea.**

Solid State Tuneups

Tune your car using this new kit. Designed by EA (see EA Oct), this unit measures RPM, dwell angle and battery voltage—all on a clear, unambiguous LED display.



\$55.50

You can listen to UHF or Channel 0 inexpensively if you 'Do-it-yourself' & Bill Edge shows you how!



Converter

Plugs into your aerial lead-in and converts your normal VHF set to UHF. 240V operation. **\$108.73**

Antennas

Quality UHF antenna . . . just **\$19.95**

Channel 0 'add-on' antenna **\$19.90**

How's your stylus?

No more guesswork! Now you know how long that stylus has been going. This is a fantastic EA Digital Stylus Timer (see EA Oct. 1980 for details) A bargain at just **\$47.95** (complete kit of parts)

Tweeters

Philips
25mm dome AD0140/T8 20-50W . . . **\$12.95**
25mm dome AD0162/T8/16 20-80W . . . **\$13.95**
25mm dome AD0160S/T8 20-100W . . . **\$16.95**
25mm dome AD01610/T8 20-100W . . . **\$16.95**

Foster
Horn HO16N17 50W max. . . **\$17.00**
25mm dome DO25N15 30W max. . . **\$11.95**
50mm cone CO50N08 60W max. . . **\$6.95**
66mm cone CO65N05 25W max. . . **\$6.50**

Full range speakers

200mm dual cone 10W 8 ohm . . . **\$7.50**
200mm dual cone 10W 4 & 8 ohm . . . **\$9.95**
100mm Foster C100K03 10W max. . . **\$8.95**
Coral
100mm 4A-60 16W . . . **\$18.90**
160mm 6A-100 15W . . . **\$17.50**
160mm 6A-25 10W . . . **\$9.95**
125mm FLAT-511 20W . . . **\$28.90**
170mm FLAT-611 30W dual cone . . . **\$37.90**
200mm FLAT-811 35W dual cone . . . **\$45.90**
250mm FLAT-1011 55W dual cone . . . **\$59.90**

Crossover networks

Essential for multi-speaker systems. For more details please phone or call in.

We've got even more that we just can't fit into this ad. Why not call us and find out more about our range. Full specs and cabinet details are available for the asking on all speakers and systems.

Cabinets

4000/1 4-way system . . . **\$300** pr.
4000/2 3-way system . . . **\$200** pr.
note 'Freight-on' only. Fully assembled

Woofers

Philips
130mm AD5060/W8 10W 8 ohm . . . **\$18.50**
180mm AD70601/W8 30W 8 ohm . . . **\$22.95**
200mm AD80652/W8 50W 8 ohm . . . **\$29.50**
250mm AD10100/W8 40W 8 ohm . . . **\$57.50**
300mm AD12100/W8 40W 8 ohm . . . **\$57.50**
300mm AD12650/W8 60W 8 ohm . . . **\$57.50**
300mm AD12250/W8 100W 8 ohm . . . **\$86.95**
Foster
200mm C200L09 15W max. 8 ohm . . . **\$12.00**
250mm C250.07 40W max. 8 ohm . . . **\$24.95**
300mm C300L05 50W max. 8 ohm . . . **\$29.95**

Midrange (squawkers)

Philips
125mm cone AD5060/SQ4/8 40-60W . . . **\$23.50**
50mm dome AD0210/SQ4/8 40-60W . . . **\$34.75**
50mm dome AD02160/SQ4/8 40-100W . . . **\$35.50**
Foster
100mm C100M02 30W max. . . **\$9.95**
130mm C130M08 60W max. . . **\$16.00**
130mm C130M06 30W max. . . **\$11.50**

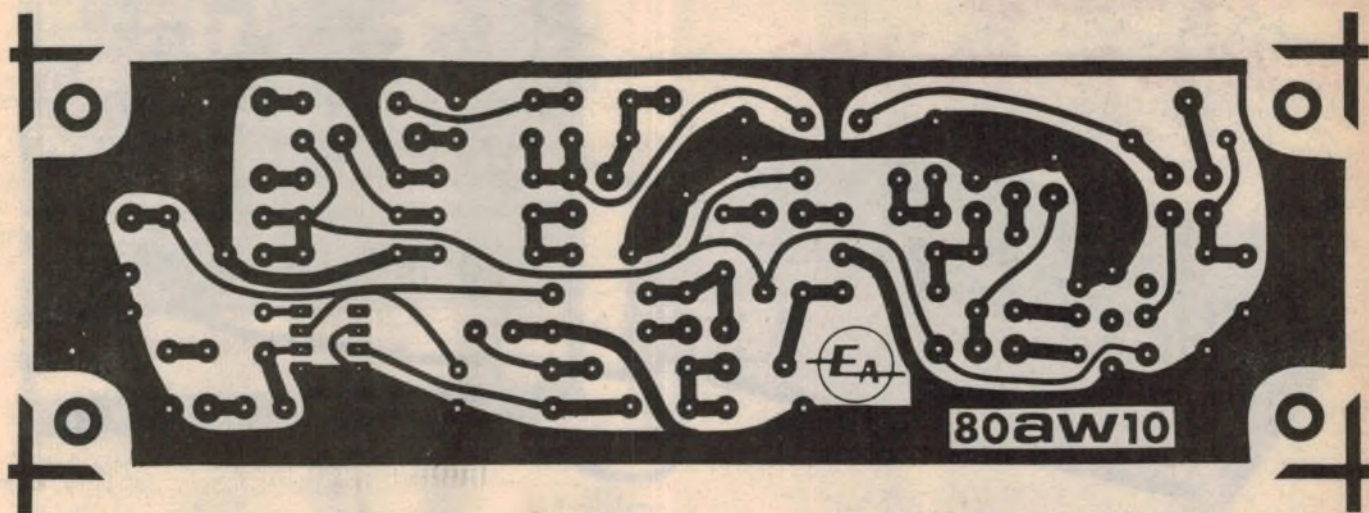

Above is an actual size reproduction of the PC artwork, while below is a metalwork diagram for the sub-chassis.

for November, 1963 would be very suitable. If, on the other hand, the amateur bands are of prime importance, then an antenna designed especially for these bands would be the logical choice.

We tested the prototype in our City laboratory under very adverse conditions. However, in spite of this, it gave a very good account of itself. Of course, all of the local broadcast stations were there. In fact, for most of them, we turned the antenna attenuator almost right down. Other out of town broadcast stations were also logged – the antenna attenuator was brought up as necessary. It is also worth noting that two of these more distant stations were only 9kHz apart and they could be reasonably well separated.

By plugging in each of the sets of short-wave coils, we were able to tune in stations on various bands, particularly on the 31 and 25 metre bands. Deutsche Welle, Madrid, London, Voice of America, etc, were all there, together with signals on the Citizen's Band, time signals and more. Unfortunately, due to our location, some of the signals were badly affected by electrical noise. The alternative was to take the receiver home and try it out under more typical conditions.

At home, I connected a multi-band antenna designed for amateur frequencies and tuned the three shortwave ranges provided by the appropriate coils. From early evening and for the next two hours or so, I tuned in literally hundreds of overseas and local short-wave signals. Most of the signals were on AM but some signals in the amateur bands on CW and SSB were also tuned.

Plugging in the broadcast band coils, I was able to tune in all of the local stations and many distant and interstate stations. However, the overloading pro-

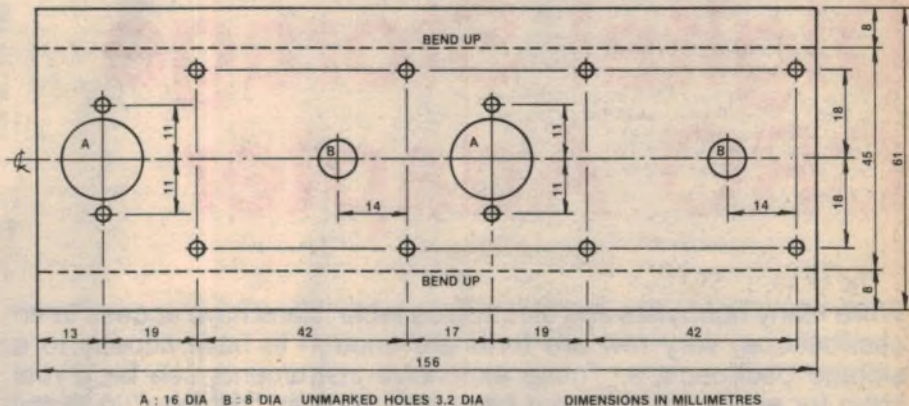

blem was evident on the local stations, even without any antenna at all but by introducing a top shielding panel, this problem was overcome.

After handling the "Multiband Superhet" under typical conditions, may I offer some suggestions which could help in getting the best out of the receiver. All of the control knobs are important and experimentation and observation as to the use of each one will pay good dividends. Experiment with antennas, from large outdoor ones to short pieces of wire indoors. Different antennas may give better results than others, for different frequency bands. A small

variable trimmer capacitor, up to about 100pF may be tried in series with the antenna right at the antenna terminal.

While the LM380 audio amplifier, with a 9V supply will drive a loudspeaker, it is not capable of giving much volume. A better way is to use a pair of headphones and so get more satisfactory volume and better copy of weak signals.

Finally, I would recommend that the receiver be fitted into a metal cabinet, preferably with a hinged lid to facilitate coil changing. The metal cabinet will reduce to a minimum the overload problem from local high powered transmissions. I wish you good listening.

MICROPROCESSOR PROGRAM SHEETS

Writing microprocessor programs on blank or plain ruled paper is messy and time consuming. To make the job easier, Electronics Australia has produced custom-designed programming sheets for use with virtually any microprocessor system. The sheets feature columns for a 4-digit address, up to six digits of instruction code or data, labels, mnemonics, and comments. There is space for 46 lines per sheet, and the sheets are provided with space for program title, date and sheet number. All for less than 5 cents per sheet, posted!

PRICED AT \$2.00 FOR 50 SHEETS
(plus 40c for postage anywhere in Australia)

Available only from Electronics Australia,
57 Regent St, Sydney (P.O. Box 163, Beaconsfield, NSW 2014)

Use this Adapter
to add storage
facilities to your CRO

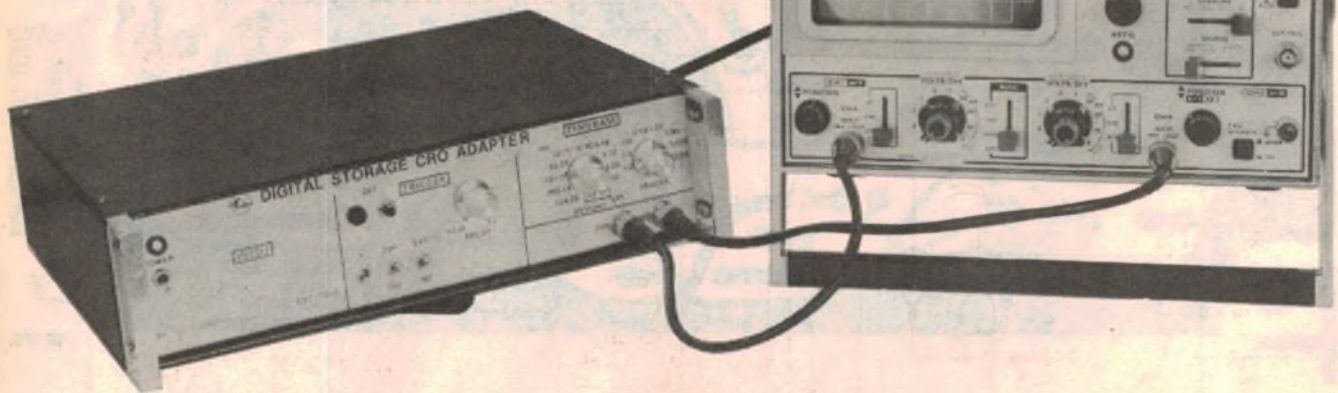

Digital Storage CRO Adapter

While many hobbyists and electronics technicians have access to an oscilloscope, very few are fortunate enough to have access to a storage oscilloscope. These expensive instruments can be a real boon for examining transient behaviour such as "glitches" in digital circuitry. Our Digital Storage CRO Adapter provides this facility at a fraction of the price of a conventional storage oscilloscope using low cost components.

by JOHN CLARKE

Unwanted transients in digital waveforms often go unnoticed when using conventional oscilloscopes but they can cause serious disruptions in the operation of circuitry and make fault finding difficult.

Storage of the waveform is a necessity in these cases and a relatively inexpensive method of achieving the store is preferable to the costly storage oscilloscope. Conventional storage oscilloscopes consist of either a special screen phosphor or charged mesh, which keeps the trace visible for long periods of time.

An alternative method of storing a waveform is to use a digital memory. Here the waveform is stored by sampling the waveform and placing in each memory location the discrete voltage level existing at that point in time. After the waveform is stored, the memory can be continuously cycled through its ad-

resses to display the stored waveform.

Several advantages are to be had from digital storage over conventional storage methods. Firstly, the stored waveform can be displayed indefinitely, giving the observer unlimited time to observe the waveform. Secondly, the trace can be expanded with either the oscilloscope or Digital Storage CRO Adapter timebase to observe critical areas in the waveform, without having to store the waveform again.

Since we can adjust the timebase after recording the waveform, some form of recorded timebase marker would be helpful for us to measure the frequency of the recorded waveform. This is done in the form of a tracer or marker pulse which is recorded during the recording of the waveform. This tracer is mixed with the stored waveform on playback to give a visible and unambiguous timebase marker. So however we set the

timebases after recording, the tracer will remain in a time relationship with the recorded waveform.

Turning now to the circuit diagram: Heart of the circuit is the 2112 memory (IC8) which features four input/output (I/O) lines and eight address lines. The eight address lines allow for 256 bytes of the four bit memory. In other words we can store and retrieve four channels each of up to 256 level changes.

Driving the memory address lines is the 12-stage binary counter IC7. This is normally operating in a continuous count mode such that the address lines are incrementing from 0 (eight zeros) to 256 (eight ones). When 256 is reached, the address count begins again at zero. In effect, we are continuously and sequentially addressing each memory location. If data is in memory then this will be retrieved as a repeating waveform.

To be able to store a digital waveform, the memory must be placed into the "write" mode, the address lines must be reset to zero and some means of preventing "overwriting" after the memory is full (256 addresses) is required. Ancillary to these requirements is that the storage of the waveform takes place only when a trigger signal is initiated.

To see how each of these functions are performed let us examine what happens when a waveform is stored. Initially the memory is in the output mode, supplying data and the counter is cycling through the addresses. Upon depression of the "set" switch, (S1) pin 3, the clock input of IC1a, a D-type flip-flop, is brought low. Releasing the switch allows the 10uF capacitor also connected to pin 3, to charge. This positive edge clocks IC1a. The Q-output now goes low ac-

FACING PAGE: the circuit diagram for the Digital Storage CRO Adapter.

S3 : MEMORY TIMEBASE

- 1 : 256us
- 2 : 512us
- 3 : 1.02ms
- 4 : 2.05ms
- 5 : 4.1ms
- 6 : 8.19ms
- 7 : 16.38ms
- 8 : 32.77ms
- 9 : 55.54ms
- 10 : 131.07ms
- 11 : 262.14ms
- 12 : 524.29ms

S4 : TRACER TIMEBASE

- 1 : 1/2 MEMORY TIMEBASE
- 2 : 1/4 MEMORY TIMEBASE
- 3 : 1/8 MEMORY TIMEBASE
- 4 : 1/16 MEMORY TIMEBASE
- 5 : 1/32 MEMORY TIMEBASE
- 6 : 1/64 MEMORY TIMEBASE
- 7 : 1/128 MEMORY TIMEBASE
- 8 : 1/256 MEMORY TIMEBASE

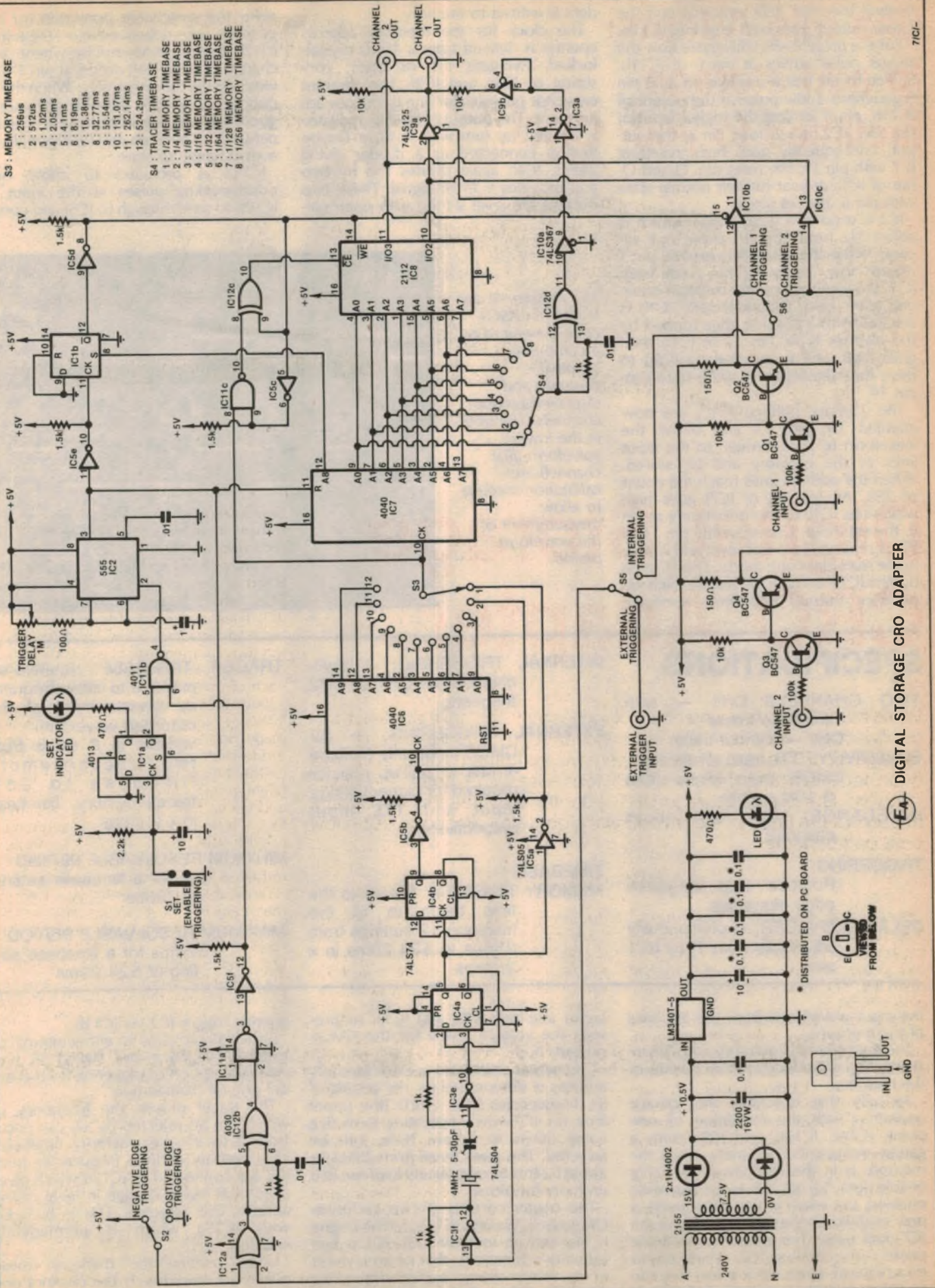

DIGITAL STORAGE CRO ADAPTER

tivating the "set" LED indicator and the Q-bar output goes high enabling IC11b.

For the present, we will ignore how the trigger pulse arrives at pin 6 of IC11b. Suffice to say that a positive pulse at pin 6 generates a low pulse at the output of IC11b, pin 4, driving the trigger input of the 555, IC2, pin 2, low. Pin 3, the output, consequently goes high, resetting IC7 with pin 11, the reset pin. Q and Q-bar of IC1a are set to their normal state with pin 6, the set input.

IC2 is used as a delay trigger which is adjustable from 10us to about one second. When the time delay expires, pin 3 returns low, removing the reset from IC7, allowing the counter to begin counting from zero. Simultaneously IC1b is clocked with a positive edge formed by the inverter IC5e. Pin 12 of IC1b then goes high, and is inverted by IC5d to drive the memory to its write state with pin 14.

The Tri-state buffers, IC10, are now enabled by pin 15 and allow the waveform to pass through to the input lines of the memory and be stored. When the address lines reach the count of 256, A8 (pin 12 of IC7) goes high which sets IC1b to its normal state at pin 8, the set input. Consequently pin 14 of IC8 is returned to a low level and is now in the read (data out) mode. The Tri-state buffers IC10 are now in Tri-state (high impedance output) effectively removing

data is written to memory.

The clock for the memory address counter is derived from a 4MHz crystal-locked, two-gate TTL oscillator, consisting of IC3e and IC3f. The trimmer capacitor provides for fine frequency adjustment. The output from this oscillator is divided by two with IC4a, a D-type flipflop connected as a divider giving 2MHz. IC4b again divides this by two and provides a 1MHz signal. These two outputs are level shifted with open col-

vides the switchable operation for this positive or negative-edge triggering. IC12b gives a positive pulse whenever a change in waveform occurs at pin 5. This works in the following way. When the inputs on IC12b are different the output goes high and is low otherwise. The RC network on pin 6 enables a 10us pulse at every change of state.

IC11a is provided to allow only positive-going pulses at the input of IC12b to pass through to IC5f and conse-

The Adapter in use — here an ASCII code generated by a computer terminal is captured and displayed by both channels. The dots in the lower waveform (first channel) are calibration markers to allow measurement of the waveform period.

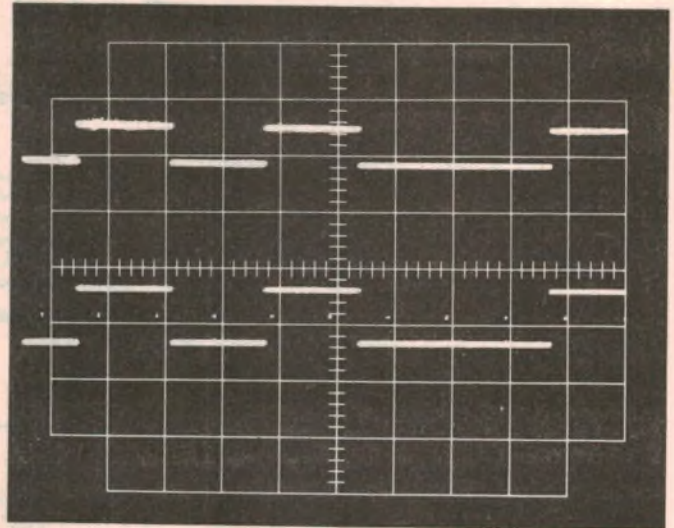

SPECIFICATIONS

TWO CHANNELS: CH1 — with timebase tracer

CH2 — without tracer

SENSITIVITY: TTL logic levels and CMOS logic levels from 3-15V supply

IMPEDANCE: 100k ohm (both channels)

TRIGGERING:

Positive and negative edge triggering:

DELAYED TRIGGER: — continuously adjustable from 10us to 1 sec

INTERNAL TRIGGERING: — switchable from CH1 or CH2 triggering

EXTERNAL TRIGGERING: — 5V CMOS input only (voltage divider or pull-up resistor required for higher voltage input and TTL input respectively)

TIMEBASE:

MEMORY TIMEBASE: (refers to the time taken to fill the memory) 12 settings from 256us to 524.29ms in x 2 steps

TRACER TIMEBASE: (calibrated markers to allow frequency measurement of the recorded waveform)

variable in 8 steps from two traces/memory timebase to 256 traces/memory timebase in x 2 steps

MINIMUM RESOLVABLE PERIOD:

1us for a timebase setting of 256us

MAXIMUM RESOLVABLE PERIOD:

524ms for a timebase setting of 524.29ms

the input waveforms from the I/O lines of the memory.

The data stored in memory is now constantly being produced at the I/O pins of the memory.

Basically that describes the storage operation with the exception of one point. IC11c, IC12c, and IC5c form a gating arrangement whereby when the memory is in the read mode the chip enable (pin 13) of IC8 is permanently enabled, but when in the write mode is only enabled on the positive cycle of the IC7 clock pulse. This is done to allow the ripple carry counter, IC7, which clocks on a negative going clock pulse, to settle its memory address outputs before any

lector inverters IC5a and IC5b, to provide the voltage levels for the CMOS counter IC6.

The actual clock rate for the memory address is determined by the setting of S3. Frequencies from 2MHz (the upper limit for IC7 when operating from five volts) down to below 1kHz, can be selected. This gives times from 256us to about 524ms to completely load the 256 memory locations.

The trigger consists of two exclusive-OR gates IC12a and IC12b, a NAND-gate IC11a and an inverter IC5f. IC12a performs two functions, that of an inverter or a non-inverting buffer depending upon the voltage level at pin 1. S2 pro-

quently trigger IC2 via IC11b.

Switch S5 provides for either internal or external triggering and switch S6 provides the option of triggering from channel one or channel two.

The tracer pulses, the frequency of which can be selected by S4, can occur from 2 to 256 per memory timebase. The memory address frequencies from IC7 are connected to IC12d which gives a pulse at every change in level of the address line selected. This is buffered with IC10a which is permanently enabled.

Upon reading the memory, these pulses are mixed with the channel one trace to display the combined tracer and

You spent thousands of dollars getting hi-fi. Keep it that way for a few dollars more.

To maintain the best performance from your cassette, reel to reel recorders and decks, video tape recorders and record playing equipment use Philips Maintenance Products.

Philips manufacture a very large range of maintenance aids to assist you to keep your valuable equipment in good order.

All these and many more products are available from your Philips Service Centre or dealer outlets.



Drop In Cleaning Cassette
Philips Drop In Cleaning Cassette is a complete kit for cleaning, tape head guides and capstan. **\$4.20***
Code 38920015

Philips RC3000
Hi Fi Record and Stylus Cleaner. Length pivot to pad 200 mm, arm overhang 35 mm. Complete with 2 pads, stylus brush, cleaning fluid. **\$25.46***
Code 39590159

Other popular Philips Service Products.



Philips Disco Combi Set
Gets down deep into the recorded grooves with a long lasting velvet pile, complete with special cleaning fluid. **\$3.89**
Code 39590157



Philips V.C.R. Cleaning Cassette
Maintains highest quality of picture and sound, removes deposits from video, audio heads and tape guides. Use every 30 hours for maximum results. **\$19.20*** Code 39590102



Philips Hi Fi Stereo Headphones
Hi Fi Stereo Headphones with twelve extra membranes for spatial sound. **\$96.00***
Technical Data (Subject to modification without notice)
Frequency response 16-20000 HZ (± 3.5 DB); Impedance (nominal) 2 x 600 ohm; Sensitivity 94 DB S.P.L. at 1 MW; Nominal power input 2 x 1 MW; Maximal power input 2 x 200 MW; Distortion < 1%; Weight 390 g approx.
Code 242 47017



Head Renovator Cassette
All recorders eventually lose performance through their heads becoming gradually magnetized. Thanks to the new SBC 137 you can effectively clean and demagnetize recorder heads all in one easy operation. **\$4.85***
Code 39590165
*Recommended retail price

All Philips audio and video service products are available through your nearest Philips Service Centre or selected dealers.
Sydney: 443 Concord Road, Rhodes, N.S.W. 2138. Telephone: (02) 73 0231. Philips Building, 2 Blue Street, North Sydney, 2060. Telephone: (02) 922 0181.
Newcastle: 190 Parry Street, Newcastle West, 2302. Telephone: (049) 61 1631. **Canberra:** 86 Wentworth Avenue, Kingston, A.C.T. Telephone: (062) 95 0321.
Melbourne: Cnr Miles & Dadds Street, South Melbourne, 3205. Telephone: (03) 699 2711. **Hobart:** 2A Pierce Street, Moonah, Tasmania, 7009. Telephone: (002) 28 0121. **Brisbane:** 55 Forbes Street, West End, Brisbane, 4101. Telephone: (07) 44 8121. **Townsville:** 38 Punari Street, Currajong, 4812. Telephone: (077) 79 7422. **Adelaide:** 81-97 Flinders Street, Adelaide, 5000. Telephone: (08) 223 2999. **Perth:** 875 Wellington Street, West Perth, 6005. Telephone: (09) 321 5131.

PHILIPS

ServiceServiceService



AHEARN PSI

AT LAST A FULLY
BUILT POWERFUL
COMPUTER FOR THE
SERIOUS PROGRAMMER

Australia's first under \$300 COMPUTER...

\$295
INCL. ZX80 BASIC
MANUAL



sinclair ZX80

FEATURES:

- Included leads etc
- Basic on board in PROM
- unique basic interpreter
- affords single key functions
- up to 26 string handling
- Powerful editor
- High resolution graphics
- All documentation included
- Single ROM contains basic interpreter
- char gen, operating system and monitor
- less RAM required due to large PROM
- expandable to 16K
- Small compact size
- connect your TV direct and cassette
- recorder and your away.

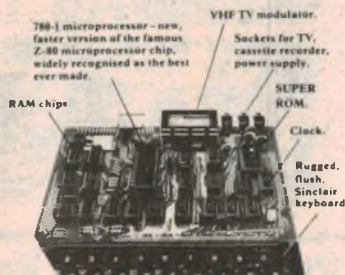

KITS KITS KITS KITS KITS KITS KITS

ETI Digital Clock ETI 564

At last a clock display that can be read at a distance;
Kit of parts
\$79.50



ETI 262 House Alarm

Kit of parts only
\$15.90

EA Power Saver

August EA, an interesting approach to power savings. Kit of parts
\$32.50

New EA Light Chaser

Kit **\$64.95**
Includes Case plus Kit of parts.



KITS KITS KITS KITS KITS KITS KITS

LEDS and Ladders

EA August 80
Great game for winter nights
Kit of parts **\$18.00**
Scotchcal Front Panel
to suit 3-25.



ETI Digital Car Tacho

ETI 324 Kit of parts
\$29.95

Kit for Exidy Sorcerer EPROM Programmer to be released in August EA Kit price including Scotchcal Front Panel **\$75.00**

TV PATTERN GENERATOR

Kit of parts as featured in EA JUNE 1980, Dot, Greyscale, Crosshatch, Raster, Check
COMPLETE KIT (including Scotchcal front panel) **\$48.49**
KIT WITHOUT BOX **\$36.90**

EPROM PROGRAMMER KIT

Kit of parts as featured in EA JULY 1980 Programs 2708, 2716 & 2532. Use with TRS 80, Soecerer & Compucolour Kit does not include connector from the programmer to computer
COMPLETE KIT (inc. Scotchcal Front Panel) **\$72.49**
KIT WITHOUT CASE **\$59.99**

DIGITAL PANEL CAPACITANCE METER

Kit of parts as featured in EA MARCH 1980
Four Digits. Extremely popular
COMPLETE KIT (inc. Scotchcal Front Panel) **\$52.49**
KIT WITHOUT CASE **\$39.99**

TV CRO ADAPTOR KIT (EA MAY 1980)

COMPLETE KIT (inc. Scotchcal Front Panel)
(Without power adaptor)
POWER ADAPTORS TO SUIT
1 240V to 6/7 5/9V **\$ 9.50**
2 240V to 9V **\$ 5.95**

300W BRUTE POWER AMP (EA JUNE 1980)

(Single Module including our NEW (and at least 20% better), Heatsink, Nuts, Bolts, etc **\$63.50**

POWER SUPPLY FOR EA 300 WATT AMP

(Inc Transformer and all necessary components) **\$52.90**

CASE for 300 WATT EA AMP

We have three cases available for this amplifier, all unpunched; ETI 4000 amp case (rack mounting) **\$54.99**
Wooden Sided ETI 4000 amp case **\$45.00**
DICK SMITH Rack mounting case **\$49.00**



Please debit my Bankcard.
Bankcard No.
Expiry Date
Name ..
Signature ..

Heavier items add additional postage. Extra heavy items sent Comet freight.
Prices subject to change without notice. Send 60c and SAE for free catalogues.
MAIL ORDERS: PO Box 135, Northcote, Vic 3070. Minimum pack and post \$1.00.
Phone (03) 489 8131.

ROD IRVING ELECTRONICS

425 HIGH STREET, NORTHCOTE 3070, MELBOURNE, VICTORIA. Ph (03) 489 8131.

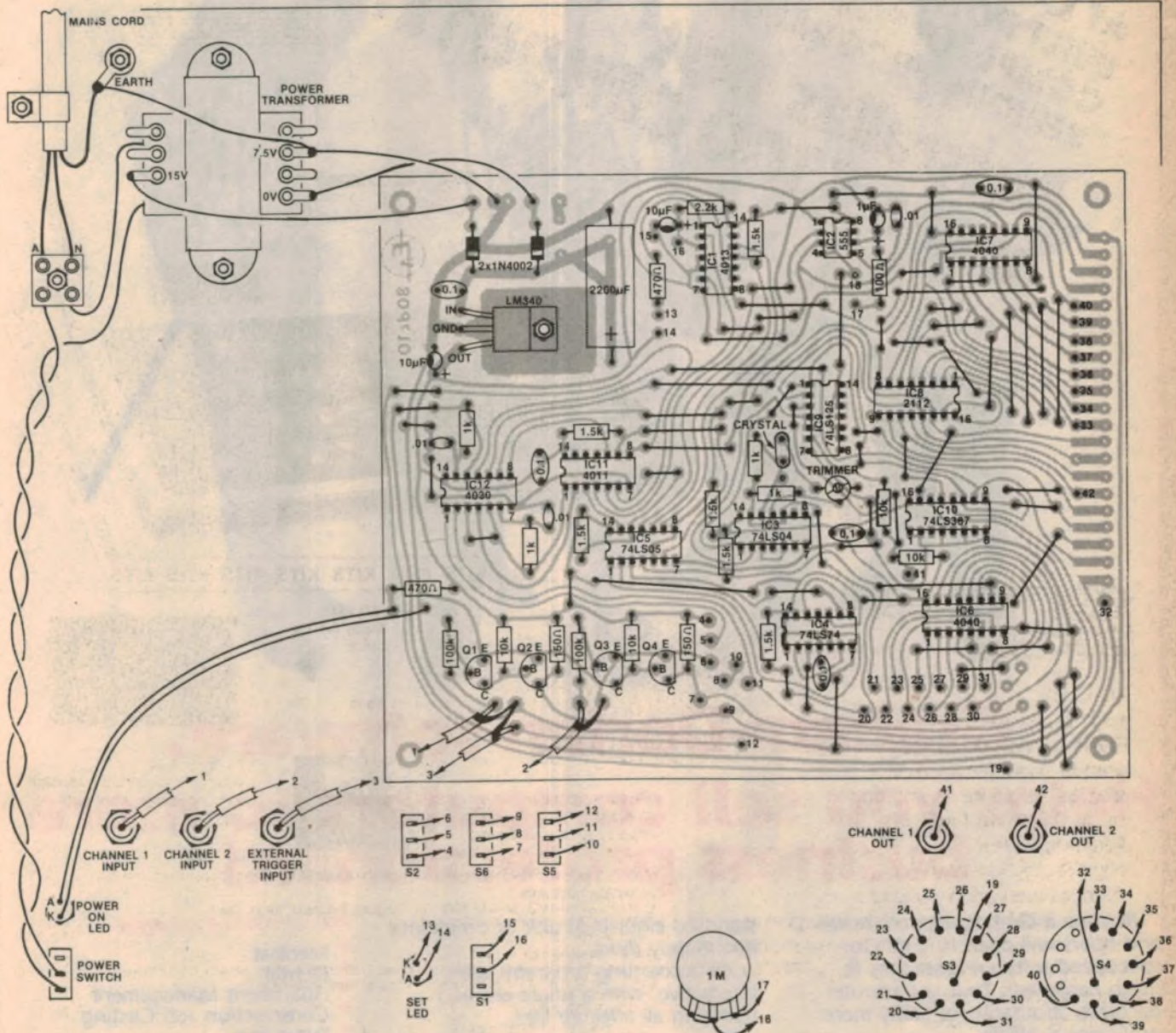

Follow this wiring diagram in conjunction with the circuit on p55. The PC board is shown from the component side.

stored waveform. This is done with two Tri-state buffers IC9a and IC9b, and inverter IC3a. IC9a and IC9b have their Tri-state controls complementary to one another, such that one is in Tri-state while the other is not. At the event of a tracer pulse, IC9a goes into Tri-state and IC9b pin 6 gives a negative pulse. This is voltage divided to give a 2.5 volt trace. At the completion of the tracer pulse, IC9b goes to Tri-state and IC9a gives the stored signal output.

Both input channels have transistor buffers to allow for various input voltage levels, such as 15V CMOS or TTL levels.

The power supply consists of a centre tapped transformer connected in a full-wave configuration. The rectified output

is filtered with a 2200µF capacitor and regulated with a 5V three-terminal regulator. Power on is indicated by a LED. Four 0.1µF capacitors are spread throughout the printed circuit board power supply rails to aid decoupling.

We built our Digital Storage CRO Adapter on a PC board measuring 141 x 174mm, coded 80dc10, and housed it in a Horwood instrument case measuring 305 x 76 x 228mm (W x H x D).

Start construction by placing the links on the PC board and soldering them in place. Use the overlay diagram to help you in the construction. There are over 50 links on the PC board.

Next the diodes and resistors can be

soldered into place, followed by the ICs. The CMOS ICs, the 4040, 4011, 4030 and 4013 should have their power supply pins soldered first with the barrel of the soldering iron connected to the negative rail. Note that the 2112 is oriented differently to the other ICs on the PC board.

Finally the capacitors, transistors and crystal can be soldered in place. The three terminal regulator is intended to be bolted flat to the board with a brass nut and bolt so that the small amount of heat generated by the regulator is dissipated by the copper beneath the board. The leads will need to be splayed and bent to fit into the holes reserved for the regulator.



Graham-Dorian software. Helps you sell computers to more business professionals!

Become a Graham-Dorian dealer and doors will open to you! Our specialized software packages fit micro hardware. Thus, a computer becomes affordable for many more professional offices.

Each package is highly detailed and well documented. Each is so comprehensive it takes little time to learn to run a program — even for someone who's never operated a computer before. Saves you hours of followup servicing on every sale.

And you have more to sell with Graham-Dorian. We offer new software packages every few months — each one thoroughly tested and ready to go to work for your customers.

Graham-Dorian programs are compatible with many computers using CP/M disk operating systems. Each package contains the software program in INT and BAS file form plus a user's manual and hard copy source listing. All packages offered on

standard eight-inch disk or on various mini-floppy disks.

All accounting programs are interactive, with a single entry updating all affected files.

Dealer discounts larger than on hardware!

You'll profit three ways with Graham-Dorian: good commission on each software sale... plenty of sales... and a continual supply of new customers for hardware purchases as we keep introducing new vertical application packages. And we'll help you keep those customers satisfied with program updates as they are developed.

Call us soon if you're the kind of dealer who wants to open doors to new markets. We'll send you our dealer packet on programs, promotions, policy, and profits. You'll be sold on joining the business software leader!

Professional Packages

- Medical
- Dental
- Apartment Management
- Construction Job Costing
- Surveying

General Accounting Packages

- Accounts Receivable
- Accounts Payable
- General Ledger
- Inventory
- Payroll
- Cash Register

* ORDER ENTRY



Postal Address: P.O. Box 420,
Hawthorn, 3122
Cable: RODCAM Australia.
Phone 819 2411

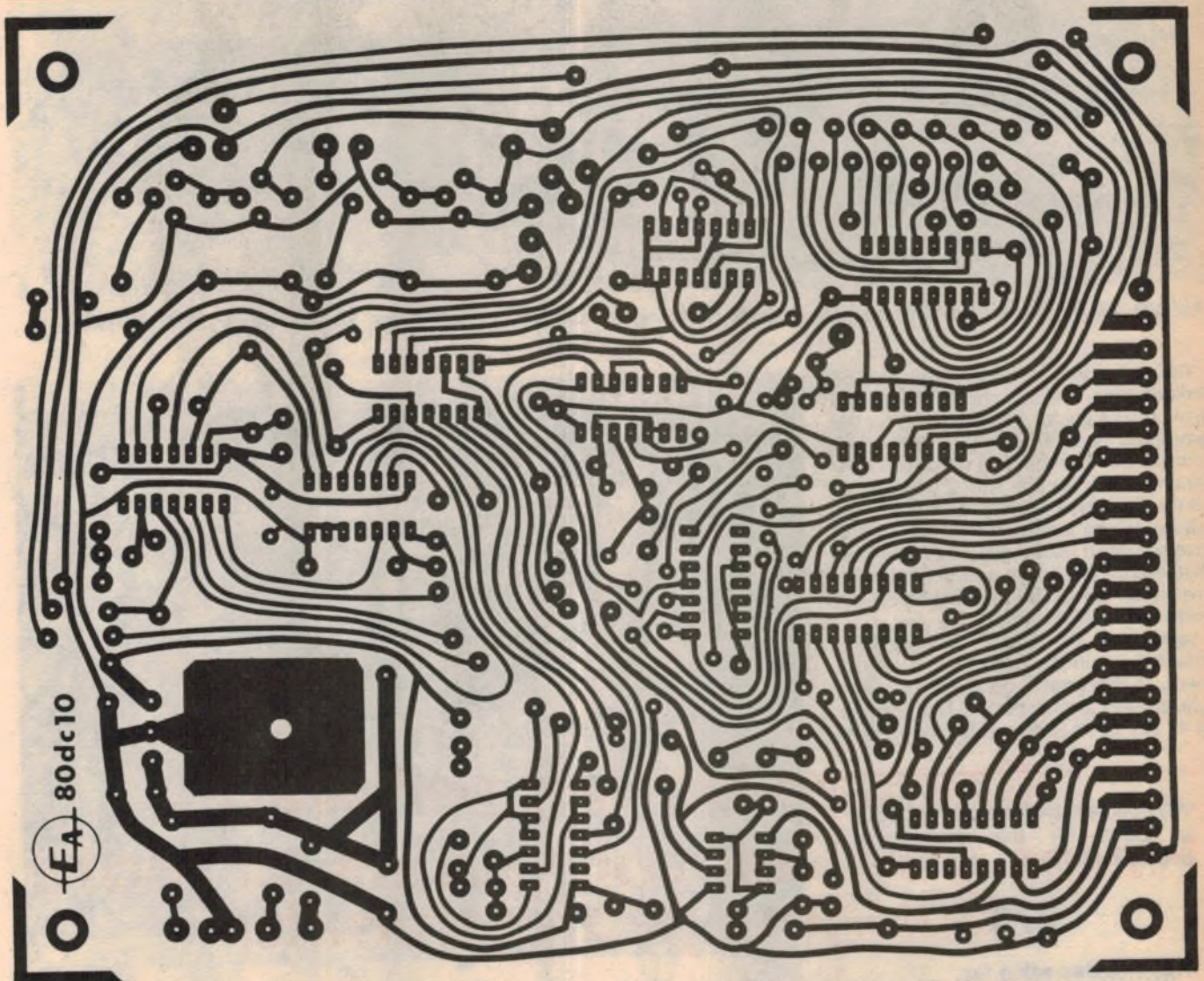

Here is an actual size reproduction of the PC artwork.

PARTS LIST

- 1 Scotchcal panel
- 1 Instrument case measuring 305 x 76 x 228mm (W x H x D)
- 1 printed circuit board measuring 141 x 174mm, coded 80dc10
- 5 panel mount BNC sockets
- 3 knobs
- 1 15 volt 1A centre tapped-transformer, A&R 2155 or equivalent
- 1 single pole, 12-way rotary switch
- 1 single pole, 8-way rotary switch
- 1 single pole normally open pushbutton switch
- 4 SPDT switches
- 1 4MHz crystal (miniature type)
- 1 mains cord and plug
- 1 grommet to suit mains cord
- 1 cable clamp
- 4 rubber feet

SEMICONDUCTORS

- 1 555 timer
- 1 LM340T-5, A7805, 5V 1A, 3-terminal regulator
- 2 LEDs with bezels
- 2 1N4002 100PIV rectifier diodes
- 4 BC547 NPN transistors

RAM

- 1 2112 256 x 4 static RAM, 450ns access time

CMOS

- 1 4011 quad two-input NAND gate
- 1 4013 dual D flipflop
- 1 4030, 4070 quad EXCLUSIVE-OR gate
- 2 4040 12-stage ripple carry binary counters

Low Power Schottky TTL

- 1 74LS04 hex inverter
- 1 74LS05 hex inverter with open-collector outputs

- 1 74LS74 dual-D flipflop
- 1 74LS125 Tri-state quad buffer
- 1 74LS367 Tri-state hex buffer

CAPACITORS

- 1 2200uF/16VW pigtail electrolytic
- 2 10uF/6VW electrolytic
- 1 1uF/6VW electrolytic
- 5 0.1uF metallised polyester
- 3 0.01uF metallised polyester
- 1 5-30pF ceramic trimmer

RESISTORS (1/4W, 5%)

- 2 x 100k, 4 x 10k, 1 x 2.2k, 6 x 1.5k, 4 x 1k, 2 x 470 ohms, 2 x 150 ohms, 1 x 100 ohms, 1 x 1M (linear) potentiometer.

NOTE: Ratings are those used on the prototype. Components with higher ratings may generally be used providing they are physically compatible.

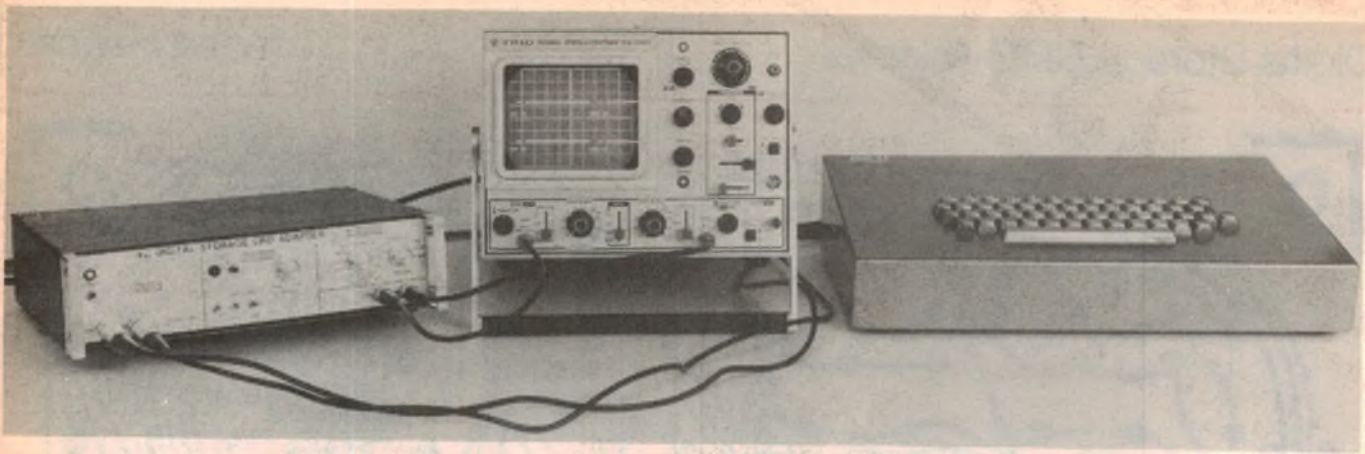

ABOVE: the Digital Storage CRO Adapter at work, capturing and displaying ASCII codes. BELOW: inside the prototype.

The holes in the front panel can be drilled using the Scotchcal front panel artwork as a guide. Also the holes for the grommet, cable clamp, earth lug, transformer and terminal block can now be drilled. Follow the wiring diagram for all the PC board to external component wiring. When wiring in the mains cord, give the earth lead a generous length so that even if the active and neutral wires are pulled out of the terminal block, the earth wire remains intact.

Setting up the Digital Storage CRO Adapter is simple. Apart from adjustment of the crystal oscillator no other adjustments are necessary. The frequency at pin 10 of IC3e can be trimmed to

We estimate that the current cost of parts for this project is approximately

\$78

This includes sales tax.

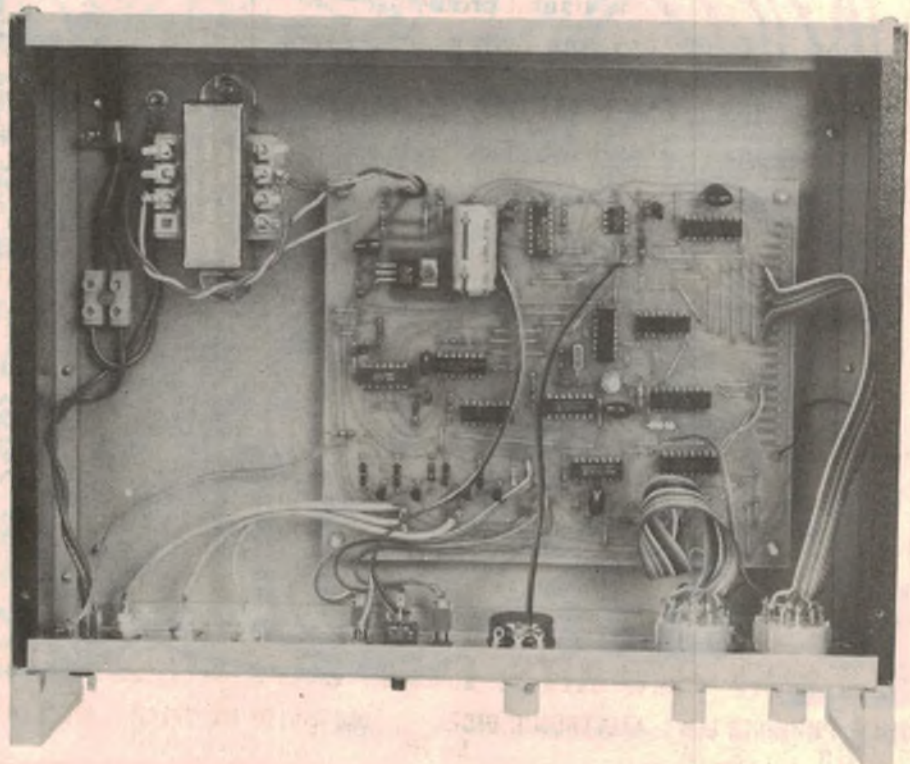

4MHz with the use of a frequency meter. This adjustment is not critical, however, and even without adjustment, will give a more accurate timebase than that on an average oscilloscope.

Although there are many controls, operation of the Digital Storage CRO Adapter is not difficult. Most of the controls are self explanatory. Firstly any signals to be stored are fed to the channel one and channel two inputs. The inputs to the CRO then come from the channel one and channel two outputs of the Adapter.

Triggering can be selected to be either from channel one, channel two or from an external source, in which case the external trigger input will need to be connected as well. Note that this input can be a 0-5V signal only. A voltage divider will be necessary if other logic levels are used. Positive and negative edge triggering can be selected. The time delay between the triggering and beginning of

storage can be set with the Delay control, for delays from 10us to about one second.

There are two timebase controls, the tracer and memory timebase. The graduations on the memory timebase refer to the time taken to completely load the 256 memory locations. For example on the maximum timebase of 256us, the memory will take 256us to load the data. Consequently we can load data which has level changes not exceeding $256\text{us}/256 = 1\text{us}$. Alternatively on the slowest timebase of 524.29ms, we can load data at the rate not exceeding $524.29\text{ms}/256 = 2.05\text{ms}$.

From the above discussion it is evident that we can record level changes from 1us (or 500kHz) down to the lowest resolvable frequency of $1/524.29\text{ms}$, that is 2Hz for a full cycle of storage or 1Hz for a half cycle of storage.

The tracer timebase is adjustable from two traces per memory timebase to 256

per memory timebase. For example with a 256us memory timebase and tracer timebase setting of 1/2, the time between each tracer is $256 \times 1/2 = 128\text{us}$. Alternatively on the same memory setting but on the 1/256 tracer timebase, the time between each tracer is $256\text{us} \times 1/256 = 1\text{us}$.

The Set switch enables the circuitry to be ready for storage of the waveform immediately there is a trigger signal. This can be immediately or if a rarely occurring pulse is to be stored, can be minutes or even hours away before the storage takes place.

Some readers may be wondering why the PC board has facilities for more external connections than are actually used. In a future issue we hope to produce an extra PC board incorporating an analog-to-digital converter and digital-to-analog converter plus extra memory and triggering circuitry so that an analog signal can be stored.

AT LAST!

STOP PRESS! FIRST PRINTING SOLD OUT! NEW PRINTING NOW UNDERWAY!

DICK SMITH'S FUN WAY INTO ELECTRONICS VOL 2

- Twenty exciting and useful projects to build
- Learn how to make your own printed circuit boards
- How to use a multimeter. ● How to solder
- AND MUCH, MUCH MORE!

Cat B-2605

Yes! The first printing of Dick Smith's Fun Way into Electronics Volume 2 **sold out** in just a few weeks! A new print run is currently underway, so if you've been unable to obtain a copy of 'Fun Way II', try again soon: it should be back in stock.

'Fun Way II' makes an ideal Christmas gift for anyone interested in electronics: all the projects are easy to build, and none of them costs more than \$8.50! (most are under \$5.00).

And with our 7-day money back guarantee, you cannot lose: if you're not completely happy with the book, you may return in in original condition within 7 days for a full refund of purchase price. What could be fairer?



ONLY \$6.95

'FUN WAY ONE' STILL AVAILABLE!

Don't forget that 'Dick Smith's Fun Way into Electronics Volume One' is still available from your nearest Dick Smith store, or most good booksellers and newsagents. 'Fun Way One' is intended for the complete beginner - no soldering is required! And it's only \$4.95. B-2600

Schools, re-sellers, etc. Ask about our incredible discounts for bulk quantities: books or kits!

FUN WAY TWO KITS: EASY, SAFE & ECONOMICAL!

MULTI-PURPOSE LED FLASHER \$2.75

A really simple kit that can be used as a warning device, electronic jewellery, etc. Cat K-2621

DING DONG DOORBELL \$4.00

Welcome visitors to your home with this integrated circuit doorbell! Cat K-2622

MORSE CODE TRAINER \$4.00

This simple oscillator circuit lets you learn Morse code the easy way! Cat K-2623

UNIVERSAL TIMER \$5.00

Use it as an egg timer, a dark-room timer, etc: in fact, it's got a lot of applications! Cat K-2624

ELECTRONIC DICE \$4.75

Throwing a dice is old hat: do it electronically! Simple circuit has other uses too. Cat K-2625

MONOPHONIC ORGAN \$7.50

Easy to build, and easy to play! And it even has 'vibrato' - just like the big ones! Cat K-2626

POCKET TRANSISTOR RADIO \$7.50

Simple to build, and it's nice and small. Listening is so much more fun! Cat K-2627

TOUCH SWITCH \$4.90

One touch on, next touch off - or 'on while touched'. Dozens of uses in the home. Cat K-2628

MOSQUITO REPELLER \$4.50

Don't get eaten by mozzies: scare them away electronically. Take it anywhere. Cat K-2629

SIMPLE AMPLIFIER \$6.00

A useful little amplifier for all those projects needing audio amplification. Cat K-2630

WIRELESS MIC. . . . \$6.50

A tiny transmitter that can be received on any FM receiver. A great little kit! Cat K-2631

LIGHT ACTIVATED SWITCH \$4.90

Highly useful for alarms, night light switches, etc etc. Sensitive and reliable. Cat K-2632

METAL/PIPE LOCATOR \$6.00

A simple BFO circuit you can use to find metals, pipes, wiring, etc - maybe gold! Cat K-2633

SOUND ACTIVATED SWITCH \$6.50

Picks up sound waves and mps a relay. Use as a telephone bell extender, too. Cat K-2634

HOME/CAR BURGLAR ALARM \$6.00

Learn how burglar alarms work when you install your own! For home or car. Cat K-2635

ELECTRONIC SIREN \$4.50

Great for alarm use - or where any warning is required. Good for kids toys, too! Cat K-2636

LED LEVEL DISPLAY \$8.50

This fascinating project shows you the audio level of any amplifier. Cat K-2637

INTERCOM UNIT \$8.50

Communicate! Build this intercom and talk between rooms, etc. Cat K-2638

LED COUNTER MODULE \$7.50

Learn how digital circuits work by building a counter. Count slot car laps, etc. Cat K-2639

SHORTWAVE RECEIVER \$6.50

Listen in to the exciting world of shortwave radio: amateurs, foreign countries! Cat K-2640

DICK SMITH ELECTRONICS



SEE OUR OTHER ADVERTS IN THIS MAGAZINE FOR OUR STORE ADDRESSES AND RESELLERS

15-YEAR-OLD IDEA REVISITED . . .



A Column Speaker for super bass

From the heading to Nate Garfinkle's original article in "Hi-fi News".

Recent talk of super-bass filters and amplifiers has prompted quite a few readers to ask about appropriate loudspeaker systems. Answers to that one don't come easily but an idea that may appeal to some was suggested, some years ago, by Bernard Simpson, Editor of the erstwhile AWA publication "Radiotronics". Here is a summary of that article, which he prepared for "Electronics Australia".

As Bernard Simpson explained in the original article (May 1975, page 40) he had owned and operated various stereo systems through the years and was as satisfied as an enthusiast ever is with what he currently possesses.

However, being an enthusiast of classical pipe organ music, he had gradually become intrigued by the idea of reproducing, at adequate level, the octave between 30 and 60Hz that might be lurking on some of his favourite records. For sure, his existing system appeared to exhibit a good conventional bass response but, perhaps, it was composed as much of the partials of the big pipes, as of their real, gut-throbbing fundamentals.

What he was after was added weight, plus the kind of sensation that you tend to feel rather than hear. Big pipes and big drums are the main source of such sound.

The seed thought had been sown by Nate Garfinkle in "HiFi News" for July 1969, but apart from verifying that his listening room was large enough to cope with extended bass, Bernard Simpson had done nothing more about it.

Nate Garfinkle's idea was to pick signal off each of the stereo channels through isolating resistors large enough so as not to affect their normal operation. The combined signal would then be fed to a small amplifier/filter ("active" filter) which would pass only those frequencies below about 70Hz. This low frequency mono signal would be fed to an auxiliary power amplifier and thence to a loudspeaker system which would have a meaningful response in the 30-70Hz region.

But, for Bernard Simpson, there were certain deterrents, which will not be un-

familiar to other enthusiasts:

- While his listening room was fairly spacious, the rather large and chunky enclosure suggested by Garfinkle, as suitable for super-bass, could not easily be accommodated.
- By the standards of the day a KEF B-139 woofer, as recommended, would strain the family budget.
- As a stereo purist, he doubted whether he could be happy with anything but sub-bass in stereo; that meant two speakers and two enclosures. Impossible!

The idea accordingly languished until

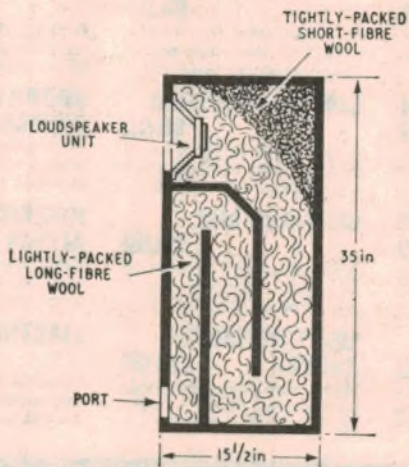

A side elevation of the transmission line enclosure suggested by Dr Bailey in "Wireless World". Width was given as 1 1/2 inches and the port was shown as a wide, narrow slit approximating the area of the cone. Material used was 1/4-inch.

suddenly revived by a "For sale" notice offering two unused B-139s at a most attractive figure. He bought them and then took another, much longer look at Garfinkle's article and at the design of the loudspeaker enclosure suggested. It had originally been described by Dr A. R. Bailey in "Wireless World" for October 1965, and was the subject of further correspondence, notably in the December 1965 issue of that journal.

The original Bailey enclosure incorporated both woofer and tweeter, being intended for full-range reproduction. Its main claim to fame (arguments aside) was a response substantially flat to 30Hz and only 5dB down at 20Hz. Hence its apparent suitability for super-bass.

In his "Wireless World" article, Dr Bailey stressed that the structure behind the cone should not be regarded as an enclosure, or a labyrinth or a resonant column; rather as an acoustic transmission line which, ideally, should be of infinite length and therefore incapable either of radiation or of supporting reflected or standing waves.

Since an infinite length was not possible, he had sought to make the line long enough and just lossy enough to approach the ideal at the lowest required frequency. To make the line lossy, he had filled the space with a selected amount of carefully chosen natural fibres.

Looking at the Bailey design, Bernard Simpson noted that the good doctor had rather reluctantly folded the transmission line in order to produce an enclosure of conventional shape. In so doing, he had admitted that discontinuities can, themselves, produce reflections.

Then why not unfold the line again with the idea of mounting it flat against something, and hopefully out of the way?

Following this thought, various possible options suggest themselves for a thin column-like system:

- Rest it on the floor, on its side, behind a settee;
- Rest it on the floor, on its side,

beneath a window, partly disguised by the drapes;

- Bury it in a wall;
- Mount it in the ceiling space, venting into the room through two sealed cutouts.

All these suggestions rest on one fortuitous fact: provided the super bass speaker is handling very low frequencies only, it can be located virtually anywhere in the listening area, without calling attention to itself as a source of sound.

One other point should be made, however: a driver should never be mounted in such a situation (eg in a dividing wall, in the ceiling, under the floor) in such a way that there is a pressure differential on the respective sides of the driver. If there is, there is a risk that a gust of wind or a slammed door will pop the cone!

Bernard Simpson's answer was to mount the line (column?), narrow end down against the wall in the least-used, least visible corner of the listening room, so that it became little more than a discontinuity in the wall.

Its size was determined by scaling up Dr Bailey's drawing, taking a mean through its convolutions and coming up with a regular tapered column, large enough to accept the B-139 at the top and diminishing to five inches thick at the bottom. Having two woofers available, a



double column was constructed; but a single woofer and tube would normally be adequate, driven with a summed signal and a mono amplifier.

Having the speaker(s) facing upwards might suggest the possibility of the cone sagging in the course of time, but the B-139 doesn't seem to mind! If you have strong convictions on this score, it could alternatively be mounted on the face or on the least visible side.

Dimensions of the double column are shown in Fig. 1. A single enclosure would be only about 14 inches wide. Construction was with 3/4in (now 18mm) particle board with 25mm dressed softwood as cleats. Cut accurately, then glue and screw for airtight, rattle-free joints. For preference, complete all the fitting and filling and, as a final operation, screw on the sloping panel, which will form the front of the unit. It can later be painted or papered to match the wall.

To retain the filling and also to inhibit the entry of "crawlies", the open end

You won't want to miss this...



27 DO-IT-YOURSELF PROJECTS FROM ELECTRONICS AUSTRALIA

You can't afford to miss out on this exciting new book from "Electronics Australia". Here are just a few of the projects it contains: loudspeaker protector, digital metronome, active filter, drill speed control, variable power supply, wiper control unit, tach and dwell meters, CDI, digital clock ... plus many more. Get your copy now!

Use this handy order form

To: Electronics Australia, PO Box 183, Beaconsfield 2014.

Please send me _____ copies of "PROJECTS & CIRCUITS NO. 2" at \$3.70 each. (Price includes packing and postage.)

NAME

ADDRESS

STATE POSTCODE

I enclose a cheque/postal order to the value of \$

SAE

Manufacturers of the world's finest Hi-Fi equipment

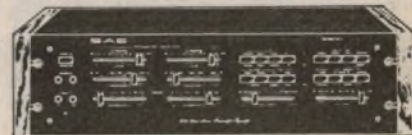

SAE 2900. High performance pre-amp with parametric equalizer offers full tape dubbing and tape EQ facility.



SAE 2200. High definition power amplifier. 100 watts per channel with L.E.D. output display.



SAE 1800. Two band parametric equalizer features cut and boost plus bandwidth and centre frequency control. This ensures precise control over room or programme problems.

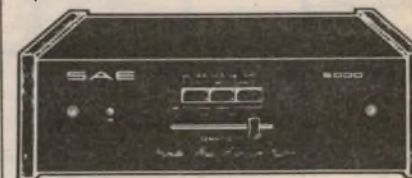

SAE 5000. Impulse noise reduction system. This is a specifically designed unit to reduce the "click" and "pop" (impulse noise) which are present in phonograph records and other programme sources.

AUDIO ENGINEERS PTY. LTD.

342 Kent Street,
Sydney 2000 NSW

HAWKAE146/TP

Super bass speaker — continued

should be covered with metal gauze (fly wire), secured internally before final assembly. You will also need to plan how the column is going to be fastened to the wall, with the opening clear of the floor. It is not easy to make a slender tube free standing.

The role of the filling material is complex but it can be thought of as a huge number of independant fibres, all free to vibrate with the air trapped behind the loudspeaker cone. The air behaves as if it is heavier than it really is, artificially lengthening the tube. But at the same time, the material is lossy, tending to attenuate standing wave patterns and propagation through the tube.

For it to behave this way, it must maintain its distribution and springiness, and not sag into a lump at the bottom of the tube. If that were to happen, the lower end of the tube would virtually be plugged. The woofer would then be working into a smallish sealed enclosure, raising its cone resonance and producing a most obvious roll-off in the mid-bass region.

Following Dr Bailey's suggestion, Bernard Simpson used about 1kg of raw long-fibred wool (fibres about 10cm long) obtained from a specialist spinning/weaver supply shop. To transform it into suitable filling turned out to be quite a job: vegetable matter had to be removed and soiled areas cut out, and then the whole had to be teased into what finally ended up as an enormous fluffy mass.

Ever an enthusiast, Author Bernard Simpson built up a twin column with two loudspeakers, one for each stereo channel. For the ordinary domestic scene, a single channel would be adequate, fed with signals taken from both channels. The enclosure needs to be very solidly constructed but the method of assembly can be varied to suit facilities. Dimensions are not highly critical and other high performance, low resonance woofers could be utilised.

The low-pass filter/amplifier suggested in Bernard Simpson's 1975 article, with the parts list set out below. If fed from two stereo amplifiers, isolating resistors of typically 100k or more would be necessary between each source and the input terminal.

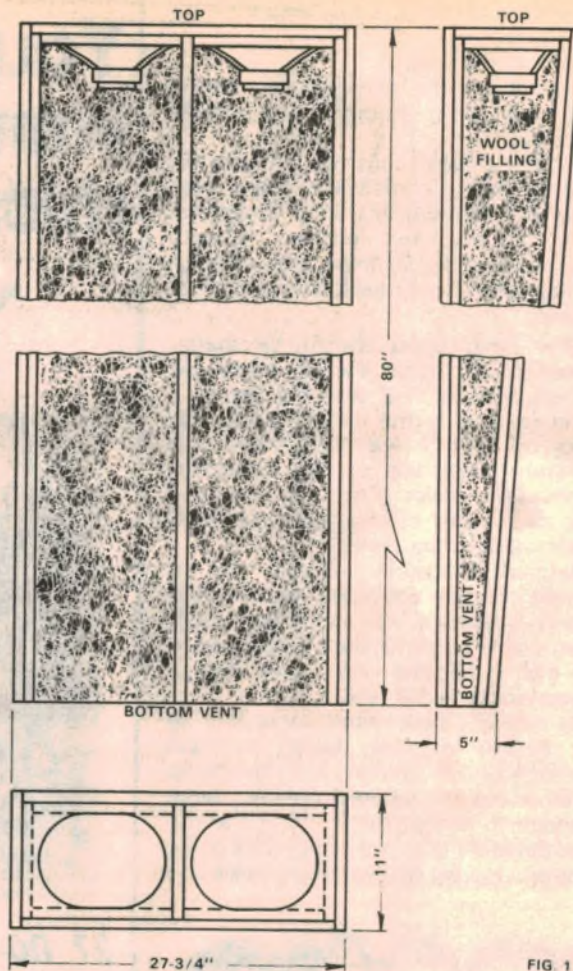

FIG. 1

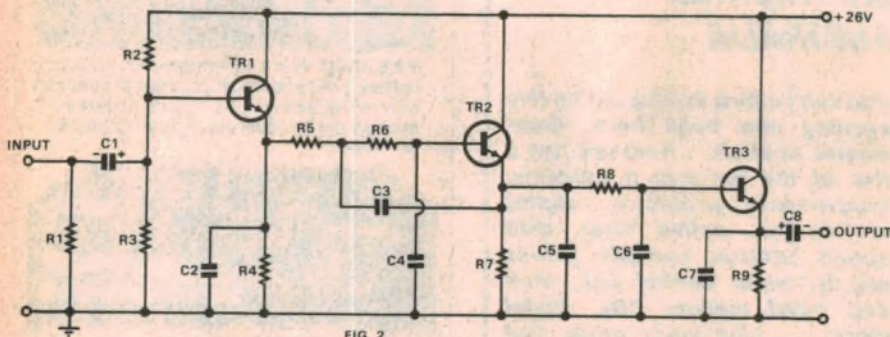

FIG. 2

But its springiness in this state proved little short of amazing.

Long-fibred scoured wool would require less handling but it was not actually tried.

Another option, available now in a greater variety than in '65, would be one or other of the synthetic fibres used widely for loudspeaker enclosures. It would probably be wise to avoid the more tightly compacted versions and go for open, springy filling that can be teased and pressed lightly to fill the total space.

Circuit details of a suitable filter/amplifier are shown in Fig. 2. Only one will be needed, followed by a mono amplifier if the lowest octave is to be handled by a single driver.

(For one channel, duplicate for full stereo)

CAPACITORS

C1, C8 10uF elec, 25 VW
C2, C5, C7 0.001uF poly
C3 0.27uF poly
C4 0.068uF poly
C6 0.15uF poly

RESISTORS

(All 1/2W, 10%)
R1 470k, R2 68k, R3 82k, R4 5.6k, R5, R6, R8 15k, R7, R9 10k

SEMICONDUCTORS

TR1, TR2, TR3 BC184L or equiv.

The left and right channel signals to feed the filter/amplifier can be picked up from the tape outlet sockets; if they are

in use, the signals could be tapped off the live loudspeaker outlets.

Wherever derived, be sure to insert isolating resistors between each pickup point and the input terminal to R1 and C1. We have suggested 0.1 megohm, as being normally adequate to preserve the isolation of the two source channels. Hopefully a supply of something like +25V will be accessible within the main amplifier.

Alternatively, a more up-to-date active filter was described in our February 1980 issue. It has the option of alternative pass bands but the lower curves, rolling off through 70Hz and 50Hz respectively, would normally be preferred.

A mono super bass amplifier would need to be generously rated in terms of power output, at least matching the total power of the two stereo channels. For stereo super bass, the supplementary amplifier should at least match the existing unit.

When setting up a super bass system, be cautious rather than otherwise. The role of a super bass system is to enrich ultra bass where it exists. On a great deal of program material, it will not be making a significant contribution.

Footnote: KEF B-139 woofers are available through Audioson International Pty Ltd, 64 Winbourne Rd, Brookvale, 2100. Phone (02) 938 1186.



79⁹⁵

THE RADIO CONTROLLED WINNERS!

Another winning line-up from Tandy, the pace-setters in radio controlled toys!

- Digital Proportional Dune Buggy.** You decide how fast it drives and how tight it turns by the amount you move the speed and steering controls! Goes forward, reverses, turns left/right, stops. Requires 6 "AA" batteries and 5 "C" batteries. 41cm long. LED power indicator. 27 MHz. Ideal gift for any age! 60-3038
- Radio Controlled Racing Team.** Each fully-detailed speedster operates on its own frequency and "steering wheel" remote control. 2-speed racing action! Requires 2 "AA", 2 9V batteries for each car and control unit. Length: 18 cm each. 27/40 MHz. 60-3018
- High Power Sherman Tank.** Your superb scale model of the W.W. II juggernaut manoeuvres left/right, climbs 45° inclines, stops where the action is. Requires 3 "C", 2 9V batteries. Length: 33cm. Hours of indoor/outdoor combat! 60-3037
- Porsche-928 Racer.** A 1/16th-scale replica of the real machine that starts, stops, corners left/right going forward or reverse! On/off switch, full hi-speed racing action at your fingertips. Requires 4 "C", 2 9V batteries. Car length: 29 cm. On your mark, get set, GO! 27 MHz. 60-3017



59⁹⁵ Pair

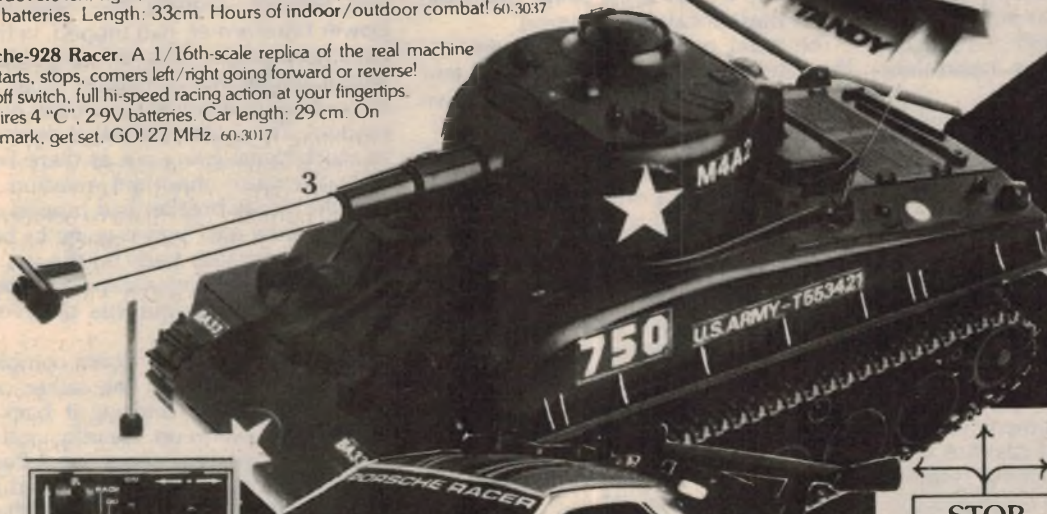

49⁹⁵



49⁹⁵

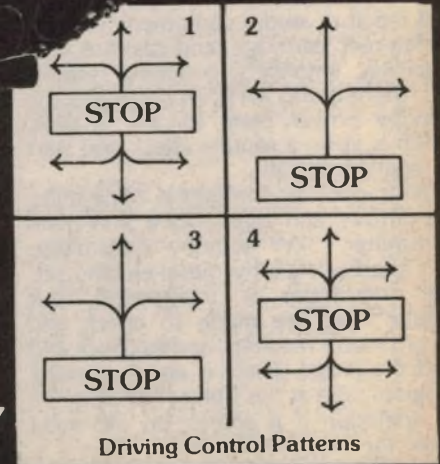

Driving Control Patterns

Available at all Tandy Stores and Participating Dealers Around Australia, or Mail Order Department, P.O. Box 229, Rydalmere, N.S.W. 2116

TANDY ELECTRONICS

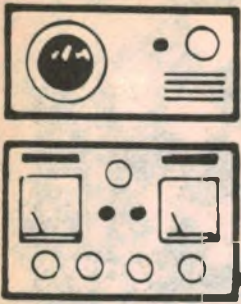

The Serviceman

Servicing domestic television was never like this!

For a change, this month's story comes from the other end of the entertainment chain; the broadcast station. We tend to imagine that these establishments are immune to the mundane faults we encounter, and it is true that their reliability is high. But when things do go wrong, it's all hands and the cook to the rescue!

The story comes from a colleague, who has his own TV and radio service business in a NSW coastal town. The area is not exactly a seething metropolis, but he is happy to stay away from the hassles of the "big smoke", even if business does have its slack periods.

In fact, it was these slack periods which were responsible for his becoming involved in a rather different electronic activity – the local broadcast station. It so happened that a staff reshuffle had left them short of a technician and they approached my colleague with the suggestion that he fill this role on a part-time basis.

The main requirement was for routine maintenance; the kind of thing which could be juggled to fit in with his own business commitments.

In fact, it has worked out very well. He averages a couple of days a week with the station, and while it sometimes means burning the midnight oil to keep faith with his customers, he is very happy with the arrangement.

Most of the work is at the studio complex in the town, and includes overhaul and repair of studio equipment, such as reel-to-reel, cartridge, and cassette tape machines, amplifiers, switching systems etc. There is also a 15kVA diesel-electric standby power plant for the studios, which is given a routine check and start at regular intervals.

The transmitter complex is a few miles out of town and consists of a 5kW main transmitter, 3kW standby transmitter, and another standby diesel-electric set. The transmitter is unattended, but regular visits are made to check and record meter readings, and to check and start the diesel. There is also a standby program tape at this site, set to come into operation if it senses no incoming audio for a specified time.

In addition to all this there is a satellite

transmitter some 60km inland to serve a small pocket of poor reception. It is a 300W unit, unattended, with no standby power plant or standby program.

Because of the distance, this transmitter is checked less frequently. In fact, a tentative agreement had already been made with another technician, who has a mobile radio service business in the vicinity, to take over the routine checking and be on call for emergencies. However, it was only being discussed when these incidents occurred.

The main part of the story concerns this satellite transmitter, and is best told more or less in my colleague's own words.

It all started late one afternoon, after a routine day at the studios, when I received a phone call from a listener in the satellite area, who suggested that there might be a fault in the transmitter; the signal seemed to be weak and distorted.

The only means of checking the transmitter at that time was with a receiver at the studios; an arrangement which wasn't really good enough. To make matters worse it was mid-summer, and static was quite bad. Nevertheless, it

was obvious that something was wrong.

After a brief discussion with the chief engineer, it was decided that I should visit the transmitter and check it out. At the same time the engineer contacted the other technician and suggested that he also visit the site. Not only might his assistance be valuable, but it would provide a practical introduction to the transmitter and the suggested job.

It is about an hour's drive to the site, and I arrived there a little after five o'clock. My colleague had not yet arrived, but he turned up a little later.

FINAL STAGE OUT

One glance was sufficient to indicate the broad nature of the problem; a circuit breaker, feeding the final stage power transformer, had tripped. In these circumstances the only RF being radiated would be that from the driver stage, and any modulation would have been purely random. The wonder was that there was as much signal going out as there was.

But the more important question was why the circuit breaker had tripped and, equally, how easy was it going to be to get the transmitter back on the air. The station runs 24 hours a day and time off the air means possible loss of revenue and prestige.

I shut the transmitter down completely, then went through the rather complex procedure of bringing it back on steam again; warm-up, standby, and the prescribed switching sequence. I hoped that the circuit breaker had tripped due to some minor fault only, and that it would hold.

But it was not to be. The breaker snapped out instantly when I tried to energise the final, and it was obvious that I had a major fault. My colleague arrived at about this time, and I filled him in on the situation.

The power supply for the final consisted of a power transformer delivering about 2300V at 300mA, feeding a full-wave bridge rectifier, a filter capacitor, a filter choke, and another filter capacitor. It was conventional electrically, but bigger all round than its counterpart in a TV set. The DC output was applied to the



"That bleary-eyed serviceman is here again!" (Adapted from "Radio-Electronics")

anode of the final via a modulation transformer, in the usual way.

From the symptoms, there seemed little doubt that we had a short somewhere in the HT system, the vital question being where. The filter capacitors, particularly the first one, were an obvious possibility, followed by a breakdown to frame of the bridge rectifier.

But none of these seemed to be at fault. In fact, there was no indication of a short anywhere, when checking with a multimeter; wherever the fault was, it was happening only at high voltage.

Having established this, we decided to disconnect everything from the transformer secondary and then, assuming the transformer behaved itself, we could re-connect each section of the filter and the plate circuit until we identified the culprit.

In fact, we found it sooner than we expected. Applying power to the unloaded transformer brought the circuit breaker out with a bang; it was either a shorted turn (or turns) or a breakdown to frame.

So where did we go from here? Was there some way to get the transmitter back on the air while we arranged to get a replacement transformer? There did seem to be one possibility, and I decided that we had little to lose by trying it. The idea was to unbolt the transformer from the bottom of the rack and float it clear of the frame. If it was only a breakdown to frame we might just get away with it.

So we got stuck into it. It was a big transformer, and I was glad I had an extra pair of hands to help manhandle it. In fact, it was not the transformer intended for this transmitter, but one pressed into service to meet the transmitter on-air deadline. Both physically, and in kVA rating, it was a lot bigger than necessary.

Anyway, we moved it clear of the frame, then lifted it onto a couple of large dry wooden blocks which were lying around. Leaving it unloaded, we applied power again and the circuit breaker held. We left it for a few minutes, watching for signs of distress, but there was none.

Thus encouraged we re-connected the rectifier and filter system and went through the routine to put the transmitter on the air. And it worked; everything held and we had a functional transmitter again.

But our jubilation was short lived. After about 20 minutes the transformer rebelled. Whatever the nature of the fault, it must have involved more than a simple breakdown; with an almighty bang and a puff of smoke it tripped the circuit breaker – for the last time.

By now it was about 7.30 in the evening and the possibility of obtaining a replacement transformer before the morning seemed remote. However, I rang the engineer and filled him in on the situation, indicating that we were prepared to make a trip to Sydney if he could line up a transformer.

He, in turn rang the chief engineer of the firm who supplied the transmitter, at his home, and explained the problem. Was a replacement transformer available and how soon could someone collect it? The engineer didn't hesitate; yes, there was a transformer available – the right one for the unit – and he would open the factory at whatever time we could get there to collect it.

And so, in short order, we were on our way with a two hours-plus drive between us and the factory. The engineer was as good as his word and was waiting for us with the new transformer.

He helped us manhandle it into the vehicle – it was smaller, but still weighed over 50kg – and then we were on our way again. Another two and half hours drive brought us back to the transmitter site, by which time it was about 1.30am. All we had to do now was fit it.

This wasn't as easy it might have been, mainly because of the physical differences between the old and the new transformer. New mounting holes had to be drilled for the transformer itself, and also for the new terminal strips for the primary and secondary taps.

So it was about 3am by the time we had everything mounted and wiring completed. Then we crossed our fingers and, step by step, brought the transmitter up to power. And, to our immense relief, everything held. We kept our eye on things while we tidied up but all appeared to be well. By 4am we were locking up and going our respective ways.

By 5am I was back at the studios, and surprised to find our chief engineer was also there. We had called him from the Sydney factory to let him know that we were on our way with the transformer, and suggested that there was nothing more he could do and that he might as well go to bed. So what was he doing here?

PROBLEM IN STUDIO

And then he told his story. He had gone to bed, as we suggested, but had been woken at about 3am by his phone. It was the night shift announcer at the studios with the plaintive cry, "I'm sitting here in the dark – we've got no power."

The engineer's immediate reaction was to ask, "Hasn't the diesel started up?"

"I don't think so, I can't hear it."

"All right, I'll be there as soon as I can."

While pulling on some clothes he turned on his own radio and was relieved to hear music. At least one backup system, the tape at the transmitter, had done its job.

Some 10 minutes later, as he drove up the street to the studios, he realised why there was a power failure. One leg of the overhead 11kV line was lying on the ground and creating a fireworks display that would have put cracker night to shame. But with one question answered another one was raised. As he drove into the studio parking lot the first thing he heard was the steady throb of

WANTED

RIPPED OFF TAPE BUYERS

Are you tired of paying too much for your cassettes and accessories? Your problems are over ... for one dollar!



You receive:

- One sample Dindy Super C46 cassette with a 5 year guarantee.
- One copy of Dindy News, the cassette user's journal, packed with info, accessories and bargain-priced cassettes (all brands, of course) at prices up to 50% off retail.
- A special introductory offer too good to refuse.



To: DINDY MARKETING
15 BOUNDARY STREET
P.O. BOX 55, RUSHCUTTERS
BAY, SYDNEY 2011

20,000 people have bought over 1,000,000 cassettes from us. They all can't be wrong. \$1 spent could save you hundreds.

Mr/Mrs/Miss

Address

 P/code

PP6004/EA03



HEWLETT-PACKARD
Count on quality — use HP's

HP41C Calculator	\$374 (\$336)
HP41C Accessories:	
Card Reader	\$273 (\$245)
Printer/Plotter	\$489 (\$439)
Memory Modules	\$56.40 (\$49.10)
Application Packs	\$56.40 (\$49.10)
Solution Books	\$15.70 (\$13.60)
Thermal Paper	\$7.50 (\$6.50)
40 Mag Cards	\$25.10 (\$21.80)
HP34C, 210 steps	\$192.50 (\$173)
HP33C, 49 steps	\$155 (\$139)
HP33E, 49 steps	\$117 (\$105)
HP32E Sci/Stats	\$91.50 (\$82)
HP31E Scientific	\$66 (\$59)

Also HP97 HP29C, HP38C, HP38E, HP37E

HP ONLY — POST FREE
(PRICE IN BRACKETS EXCLUDE TAX)

HP41C

COMPUTERS — \$990 to \$90,000

- Home/hobby computers. APF Colour System \$990. 8K PET (\$153 free prog) \$999
 - Business with standard software Commodore CBM \$5500 plus INTERTEC — language options, expandable, superb software.
 - Diablo fully tailored and supported systems.
- FREE BROCHURES AVAIL —



XEROX
DIABLO 3000

SCHOOL SPECIAL
A.P.F.5602 40 lence \$21.50 (\$19)
POST FREE

Pack and Post — all LCD models \$1.50 anywhere in Australia (except Casio fx502p)
Otherwise \$4 for registered post in NSW. \$5 elsewhere

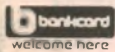

Copy and complete
Please debit my Bankcard \$
No _____ Expiry Date _____

Signature _____
Name _____
Address _____

TEXAS PROGRAMMABLE SYSTEMS

GREATEST PACKAGE DEAL EVER!!



LAST WEEKS
Ti59 and PC100C
PRINTER

\$510 (\$450)

(PRICES IN BRACKETS
EXCLUDE SALES TAX)

- Ti58C \$149 (\$132)
- Ti59 \$299.90 (\$265)
- PC 100C \$237 (\$210)
- Ti55 \$61.00 (\$54.50)
- Modules 58C/59 \$39 (\$34.50)
- Pakettes 58C/59 \$9 (\$8)
- 3 Rolls Therm Paper \$12 (\$10.50)
- 40 Mag Cards \$15 (\$13.50)

END OF YEAR SPECIALS!!

IDEAL GIFTS

CASIO fx8100
~~\$79~~
\$45 (\$39.90)

★
FEATURES

- 46 Scientific functions
- Clock
- Alarm
- 2 count down alarm
- Full-auto calendar
- 1/100 sec stopwatch
- Hourly time signal

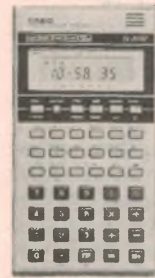

IT'S GOT THE LOT!

APF 5100 ~~\$29~~
clock/alarm, stop watch calculator with 3 key memory and % key.
\$23.70 (\$21)



Certified post on specials! \$1 anywhere in Aust.

CALCULATOR AND COMPUTER DISTRIBUTORS

INCORPORATING ELECTRONIC CALCULATOR DISCOUNTS AND EXCLUSIVE CALCULATORS AND COMPUTERS

PHONE (02) 624-8849
PO BOX 106, BAULKHAM HILLS
2153

TRANSFORMERS for MICROPROCESSORS



PF4405
9 Volts @ 10 Amps
Two Windings each
15 Volts @ 1 Amp

PF4354
9 Volts @ 10 Amps
9 Volts @ 1 Amp
Two Windings each
15 Volts @ 1 Amp

PL158/15VA
8 Volts @ 500mA
Two Windings each
14 Volts @ 400mA

PL30-9/40VA
9 Volts @ 3 Amps
Two Windings each
15 Volts @ 500mA

PL30-9/60VA
9 Volts @ 5 Amps
Two Windings each
15 Volts @ 550mA



PL161/5VA
8 Volts @ 200mA
12V-0-12V @ 150mA
Designed to suit standard PCB grid
— pins centred at 0.1 inch.

SEND FOR A DATA SHEET



FERGUSON TRANSFORMERS PTY LTD
331 High Street
CHATSWOOD, NSW, 2067
Tel: (02) 407-0261
Melbourne: (03) 329-6415



the diesel; it had started, but why hadn't it taken up the load?

(Also, why hadn't the announcer heard the diesel running? Answer: because he was sitting in his sound proof studio and hadn't bothered to go outside to check!)

Some idea of the standby setup is necessary to follow the story from this point. The incoming three-phase supply is fed to the building via a heavy duty three-pole circuit breaker, normally held in by the mains power. This, in turn, is controlled by a relay system which is constantly monitoring all three phases. Reduced voltage on any one phase will trip the breaker and disconnect the mains.

At the same time, another relay energises the diesel starter circuit and, in a few seconds, the diesel is up to speed and ready to take the load. At that point a three-pole circuit breaker between the alternator and the load pulls in and completes the operation. There is also a conventional overload type circuit breaker immediately following the alternator, to protect it in the event of a fault.

When the engineer reached the diesel room it took him only a few seconds to realise that it was this overload circuit breaker that had prevented the alternator taking up the load. Apparently it had sensed some kind of fault and had tripped. Tentatively, he pushed it in again and was relieved to find that it held as lights, air conditioning, and studio equipment came back into operation.

So why had it tripped in the first place? The answer wasn't immediately apparent and, in fact, it was only after a lengthy consultation with the council engineers that an explanation was forthcoming. Apparently the 11kV line lying on the ground had set up substantial earth currents and the alternator's overload breaker had interpreted this as a fault and promptly tripped.

EARTH RETURN!

And, somewhat ironically, the situation had been aggravated by one of the council's own regulations which had been insisted upon when the standby plant was installed. This was that earth points for both the standby plant and the council's supply should be at a common point. Following this incident, they agreed that the standby plant could have its own earth point and, hopefully, this problem will not occur again.

So what was next on the list? Well, we didn't have long to wait. The station takes a news service from a Sydney station every hour and while the 4am news came through OK, it became apparent as 5am approached that there was no signal from Sydney. But it wasn't our fault this time, it was a line failure and it was the Telecom boys' turn to be hauled out of bed.

I went home and had some breakfast and a general clean-up, while debating whether to front up for another day's work or take the day off. For a number of reasons I decided to keep going and at least finish the routine jobs I had been doing when the emergency began. So, by 9am I was back at the studios.

The day proved uneventful but I was still going at 7pm, helping with an OB from a Carols by Candlelight gathering at the local showground. Then came a phone call from my colleague of the previous night. By arrangement, he had visited the transmitter again and was shocked to find that the new transformer appeared to be running excessively hot.

So, after another discussion with the engineer, I grabbed a spare fan from the studios and set out on another hour's drive to the transmitter. My colleague was waiting, and together we checked the transformer. It certainly was hot, but whether it was abnormal was another matter.

TOO HOT, OR NOT?

Modern transformers are often designed to run quite hot, but we had no information as to the exact temperature in this case or, for that matter, a means to measure it anyway. We put in a phone call to the engineer who had organised the transformer the previous night and, while he couldn't quote exact figures, he confirmed that the transformer would run quite hot and it probably was behaving normally.

So we rigged up the fan inside the cabinet and waited around for a couple of hours to see what happened. As far as we could tell, the fan did seem to help and, as the transformer continued to run without any other signs of distress, we finally decided there was nothing more that we could do. So, just on midnight, we went our respective ways.

And so it was that, about 1am the next morning, I finally crawled into bed, something like 41 hours since the last time I'd been there.

Which gives some idea of the pressure which can occur in the broadcasting industry when things decide to go wrong. Fortunately, crises of this magnitude do not occur very often.

And what of the transformer heating problem? Well, it didn't blow up and we subsequently obtained specific temperature figures. Armed with these, and a temperature probe we had purchased to go with our existing digital voltmeter, we were able to check it out in greater detail.

In fact, it proved to be operating well within specs, even without the aid of the fan. To be truthful, the fan turned out to be a bit of a joke; the best it could do was lower the temperature by a mere one degree celsius. So much for subjective assessment and wishful thinking!

NEW
RPG HI-FI & MUSICAL INSTRUMENT SPEAKERS
 Manufactured to Radio Parts Group specifications by the world's largest speaker manufacturer



HIGH EFFICIENCY TWEETERS

2 1/2" H66AP45-01F 6W	\$5.14
2 1/2" E66CP45-01F 8W	\$5.14
1 3/4" B45DP70-01F 10W	\$8.95



HI-FI MID RANGE

B11EC80-02F 30W	\$15.79
(CAN BACK) 4 1/2 inch A11 DP60-02F 15W	\$7.37
(SEALED BACK) 4 1/2 inch	



WIDE RANGE

4 1/2" B11EC80-01F 15W	\$13.49
6" A16DC61-01FW 12W	\$8.44
6" C16EC70-01FW 15W	\$13.23
8" A20EP80-03FW 20W	\$15.04
8" A20 EC70-03FW 30W	\$14.35



WOOFERS

8" A20EU75-01F 30W	\$15.29
10" A25EP65-02F 20W	\$15.41
10" C25FU90-03F 50W	\$31.47
12" A30EU80-01F 35W	\$29.44
12" A30FU20-01F 65W	\$42.09



MUSICAL INSTRUMENT

8" B20HP14-01F 50W	\$23.54
12" A30GC40-01F 100W	\$57.92



"RPG" Speakers are only available from:



RADIO PARTS GROUP

562 SPENCER ST MELBOURNE
 1103 & 1097 DANDENONG RD,
 EAST MALVERN VIC.

CIRCUIT & DESIGN IDEAS

We invite readers to submit circuit ideas and solutions to design problems. Explain briefly but thoroughly the circuit's operating principle and purpose. Sources of material must be acknowledged and will be paid for if used. As these items have not necessarily been tested in our laboratory, responsibility cannot be accepted.

Conducted by Ian Pogson

Low voltage light chaser provides four separate outputs

The low voltage light chaser circuit shown provides four separate outputs suitable for driving 12V light globes. Lights in the chaser display can be connected in parallel and hence if any light in a particular channel fails, the other lights in that channel will still function. One advantage of the low operating voltage is that the circuit is quite safe to work on and there are no problems if the light display is accidentally broken.

As with most mains voltage light chasers we have used Triacs as the main switching elements, with gate triggering provided by transistors. The heart of the circuit is the 4017 which is a decade counter with decoded outputs. When the counter is clocked, each of the decoded outputs numbered from "0" to "9" turns on in sequence, with the other outputs all remaining off. We have connected the first four outputs to the trigger transistors Q1 to Q4 while the fifth output of the counter, "4", is connected back to the reset of the counter so outputs "0" to "3" turn on in sequence and thus turn on the triacs T1 to T4.

A simple 555 oscillator circuit provides the clock pulses to the counter. The frequency of the oscillator and hence the "speed" of the chaser is set by a 50k

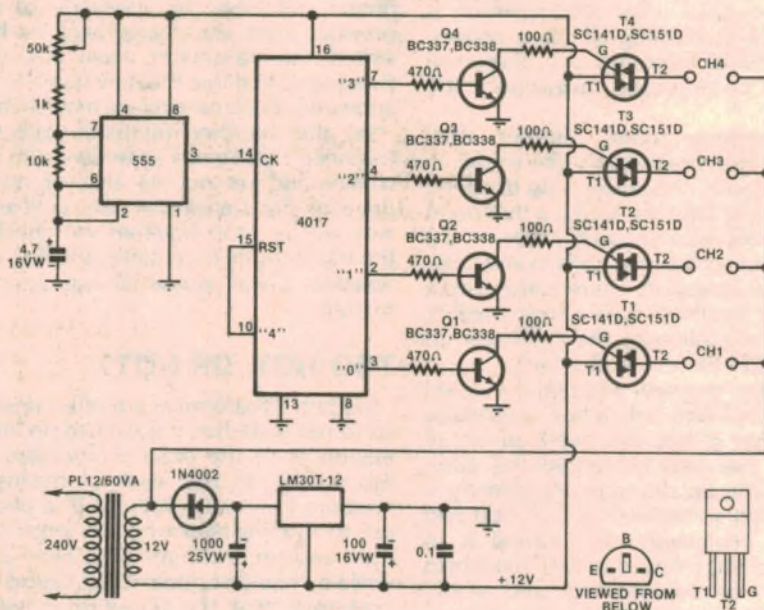

potentiometer and 1k resistor in series, from pin 7 of the 555 to the +12V supply.

We used a Ferguson low profile transformer PL12/60VA in the circuit but any 12V transformer with sufficient VA rating for the load could be used. For ex-

ample, the 60VA transformer which we used should drive a load of around 60W per channel, (for example, 60 1W lights or 12 5W lights) or a total load of 240W for the four channels.

(By Ron de Jong, "Electronics Australia".)

15V/0.5A power supply with good regulation & temp. stability

Although cheap and general purpose components are used throughout, this circuit offers good load regulation and temperature stability. Output resistance is typically 20 Ω at low frequencies and unlike conventional regulators where the power transistor is connected to the op-amp output, only a few hundred mV are required across the series pass transistor to maintain regulation.

The circuit can be built for negative regulation by using NPN transistors in the negative supply lead of the 741. Fold-back current limiting is included to limit the maximum dissipation to 4W. The 3.3k resistor allows the output stage of the 741 to turn off when no current is being drawn and the 220-ohm resistor prevents the 741 quiescent current from turning the power transistor on. The diode and the 470k resistor allow start-up and the 0.1 μ F capacitor improves the

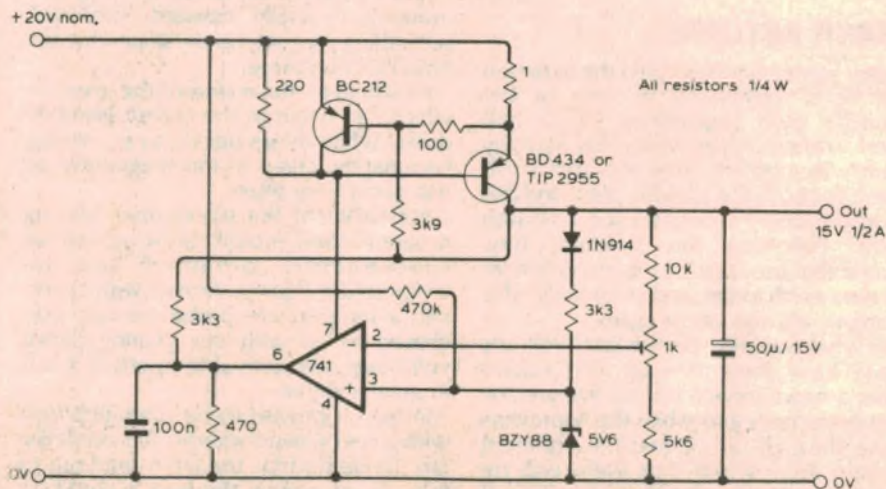

response to sudden changes in output current.

(By J. W. Rowe, in "Wireless World", May, 1980.)

ROD IRVING ELECTRONICS

425 HIGH STREET, NORTHCOTE 3070, MELBOURNE VICTORIA. Ph. (03) 489 8131.

NEW PRODUCTS



JUST WRAP™

- 30 AWG wire
- 025" square ports
- Daisy chain or point-to-point
- Built in cut off
- No stripping or soldering required
- Includes 50 ft wire
- Just wrap

Part No.	Wire Color	Price
JW-1-B	Blue	\$24.99
JW-1-W	White	24.99
JW-1-Y	Yellow	24.99
JW-1-R	Red	24.99

JUST WRAP™ Replacement Wire

Part No.	Color	50 ft roll	Price
R JW B	Blue	50 ft roll	\$4.99
R JW W	White	50 ft roll	4.99
R JW Y	Yellow	50 ft roll	4.99
R JW R	Red	50 ft roll	4.99

SCOTCHCAL FRONT PANELS FOR ETI & EA PROJECTS:

ETI 452 Guitar Practice Amp	\$4.80
Series 4000 Any colour	\$12.50
MOVING Coil Pre Amp	\$2.00
577 Power Supply	\$2.00
455 Loud speaker protector	\$2.70
Variable power supply	\$2.70
Linear ohmmeter	\$2.50
Muscle activity meter scale	\$1.40
ETI 576 Electromyogram	\$2.80
561 Metal Detector	\$2.50
EA Capacitance meter	\$3.50
EA Flash exposure meter	\$4.25
EA Sound triggered flash	\$3.50
EA Slave flash	\$1.20
EA Playmaster graphic analyser	\$8.50
EA Metal Detector 79md9	\$3.90
EA Pulse generator	\$4.80
EA Square wave oscillator	\$2.50
EA RF Z Bridge	\$3.25
EA Thyristor tester	\$2.40
EA Quartz frequency ref.	\$2.70
EA Multi monitor	\$1.90
EA Experimenters Supply	\$2.80
EA Quiz master	\$3.70
EA Variable wiper delay	\$1.10
EA Playmate stereo Amp	\$4.50

ALL FRONT PANELS AVAILABLE FROM DAY OF RELEASE OF MAGAZINES WHEN ORDERING FRONT PANELS. SPECIFY COLOUR OF LETTERING FIRST, THEN COLOUR OF BACKGROUND

KITS

TV PATTERN GENERATOR

Kit of parts as featured in Electronics Australia June, 1980. Dot, Greyscale, Crosshatch, Raster Check

Complete Kit	\$48.49
Kit without case	\$36.90
Pack and post	\$2.50

EPROM PROGRAMMER KIT

Kit of parts as featured in Electronics Australia July, 1980. Programs 2708, 2716 and 2532. Use with TRS80, Sorcerer, and CompuColor. Kit does not include connector from the programmer to computer

Complete Kit	\$72.49
Kit without case	\$59.99
Pack and post	\$2.50

DIG CAPACITANCE METER

Kit of parts featured in Electronics Australia March, 1980. Four digits

Complete Kit	\$52.49
Kit without case	\$39.99
Pack and post	\$2.50

COMPONENTS

4116 RAMS	\$8.00
2114 RAMS	4.30
2708 EPROM	8.50
741's 10 up	2.50
555's 10 up	2.90
BD139 10 up	5.50
BD140 10 up	5.50
SC141D 10 up	11.00
SC151D 10 up	21.10
RED LEDS 10 up	1.40
RED LEDS 100 up	11.00
YELLOW LEDS 10 up	2.30
8 PIN I/C SKTS 10 up	2.00
BC548	0.15 ea
BC549	0.19 ea
MJ802	3.60
6.800/50V CAPS (LUG)	4.50
5.600/40V CAPS (PCB)	1.90

KITS & CIRCUIT BOARDS

ETI SERIES 4000 AMP

● Complete Kit	\$179.00
● Quality front panel to suit above	10.90
● ETI 470 kit of parts	19.90
● ETI 480 kit of parts 100w (incl. bracket)	19.75
● ETI 470 PS kit of parts (includes relay, not transformer)	19.50
● Transformer to suit	22.90
● ETI 471 pre amp	45.50
● ETI 585R ultra sonic RX	15.95
● ETI 585T ultra sonic TX	8.95
● EA 79 SF9 sound flash trigger	15.00
● All parts available for DREAM computer project	
● PCB's (all quality fibreglass boards)	
ETI 574 disco strobe	2.80
ETI 549A metal detector	2.75
DREAM circuit board	10.90



SCHUGART SA 400

5in Minifloppy Drive	
Kit	\$399.00 Tax Inc
	\$347.00 ex

RITRON COMPUTER GRADE P/S

+5V reg 10a	16V unreg (r 1A)
Kit	\$79.95 inc
Built and tested	\$99.50

ETI636 MOTHERBOARD

7 Slot Motherboard	\$77.00
Built and Tested	\$95.00
ACTIVELY TERMINATED	

INTERSIL LCD \$32.50

3 1/2 DIGIT PANEL METER KITS

Build a working DPM in 1/2-hour with these complete evaluation kits. Test these new parts for yourself with intersil's low cost prototyping kits complete with A/D converter and LCD display (for the 7106) or LED display (for the 7107). Kits provide all materials including PC board, for a functioning panel meter ICL7106EV (LCD).

COMPUTER COMPONENTS

Attention Sorcerer & TRS 80 owners. Memory expansion kits available. We also offer full service on the popular computer projects and systems.

SPECIAL 4116 RAM OFFER
8 OFF PRIME SPEC 4116 I/Cs \$64.00
16 4116s for \$120.00
STATIC RAM KIT 16K S-100

KIT FORM	\$239.00
ASS & TESTED	\$269.00

All front panels available for ETI & EA projects in scotchcal from July '79. Phone for details.

DIP PLUGS

Ideal for use with flat ribbon cable or to mount components on

14 pin \$0.80	24 pin \$1.20
16 pin \$0.90	40 pin \$4.00



COMPUTER COOLING FANS

Muffin fan 4 1/2" square	
110V	\$39.50
240V	\$26.50

Range of larger fans available. Send for details.

POWER TRANSFORMERS

SPECIALLY DESIGNED FOR MICROCOMPUTERS

- Good regulation electrostatic shield
- RI 810
8V @ 10A 2x15V @ 1A \$22.50
- RI 820 8V @ 20A 15V @ 1A 15V @ 3A \$35.50

20 TURN CERMET TRIM POT

SPECTROL 43P ACTUAL SIZE

STOCK RESISTANCE VALUES

10R, 20R, 50R, 100R, 200R, 500R, 1K, 2K, 5K, 10K, 20K, 50K, 100K, 200K, 500K, 1M, 2M	
1-9	\$1.40
10-99	\$1.30
100	\$1.20

Values may be mixed.

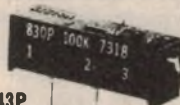

Hexadecimal Keypad

\$24.50/each



19-key pad includes 1-10 keys ABCDEF and 2 optional keys and a shift key

Ideal for dream project

MULTIDIALS



Dials to suit 10 T Pots	
Model 21 1.8" dia	\$16.50
Model 16 9" dia	\$12.50
Model 18 1" x 1.75" dia	\$20.60

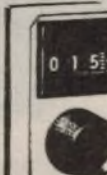

cermet angle TURN TRIM POT

Spectral model 83P ACTUAL SIZE

STOCK VALUES

10R, 20R, 50R, 100R, 200R, 500R, 1K, 2K, 5K, 10K, 20K, 50K, 200K, 500K, 1M, 2M	
1-9	\$1.00
10-99	0.90
100	0.80

Values may be mixed.



P.C. EDGE CONNECTORS

S100 gold plated wire wrap	\$6.90
S100 solder tail	\$6.50
D2 Motorola bus	
43/86 solder tail	\$6.34
43/86 gold plated wire wrap	\$7.40

DREAM

ELECTRONIC AUSTRALIA MICROCOMPUTER PROJECT

Kit for main board (including programme 2708) \$115.00

Also available re-designed 6802 PCB \$11.90

PCB (fibre glass) only	\$10.90
2708 programmed	\$15.50
Key Pad 19 keys	\$24.50
Kit (less key pad)	\$94.00
PCB for power supply	\$3.50

10 TURN POTENTIOMETERS

Stock resistance values

50R, 100R, 200R, 500R, 1K, 2K, 5K, 10K, 20K, 50K, 100K	
Spectral model 534 1/4" shaft	
Price 1-9	\$8.50
10 + values may be mixed	\$7.90

HEAVIER ITEMS ADD ADDITIONAL POSTAGE EXTRA HEAVY ITEMS SENT COMET FREIGHT ON PRICES SUBJECT TO CHANGE WITHOUT NOTICE. SEND 60c & SAE FOR FREE CATALOGUE MAIL ORDERS: PO BOX 135, NORTHCOTE, VIC 3070. MIN PACK & POST \$1.00 PRICES CURRENT UNTIL DEC 7 1980

Total Mass Termination System

Let Utilux terminate your wiring nightmares

If you haven't kept up with the expanding range of Utilux connectors you're in for a big surprise. Your wiring nightmares can be eliminated if you choose the **Utilux/Molex Mass Termination System** and associated products. **Whatever your connection**, whether it be board to board, harness to board or board take-offs, you can rely on Utilux. If we can't meet your requirements, we'll be very surprised. After all, we are one of the largest connector companies in the southern hemisphere.

We have connectors to DIN specifications and other standards and they all carry the Utilux guarantee to meet your rigid standards.

Take our Mass Termination System for instance, which has the following features:

- Memory U-shaped element cuts through insulation only, leaving the wire intact
- Visual inspection confirms proper connection
- Testing without disconnection for your convenience (probe fits through top of connector)
- Floating element assures a better contact every time

So your production costs are contained.

Here is a list of items we can supply ex stock:

- Discreet wiring connectors
- Ribbon cable wiring and connectors
- I.C. sockets
- Wire wrap jumper blocks
- Wire wrap pins
- Plugs and sockets
- Edge connectors
- Binary option selection switches
- Transistor sockets
- KK Interconnect systems
- Flat flexible cable connector
- Cable ties

If you want something that's not here, just discuss it with us.

We can supply a complete design to delivery service.

That's why you should be coming to Utilux. **So contact us and we'll "contact" you.**

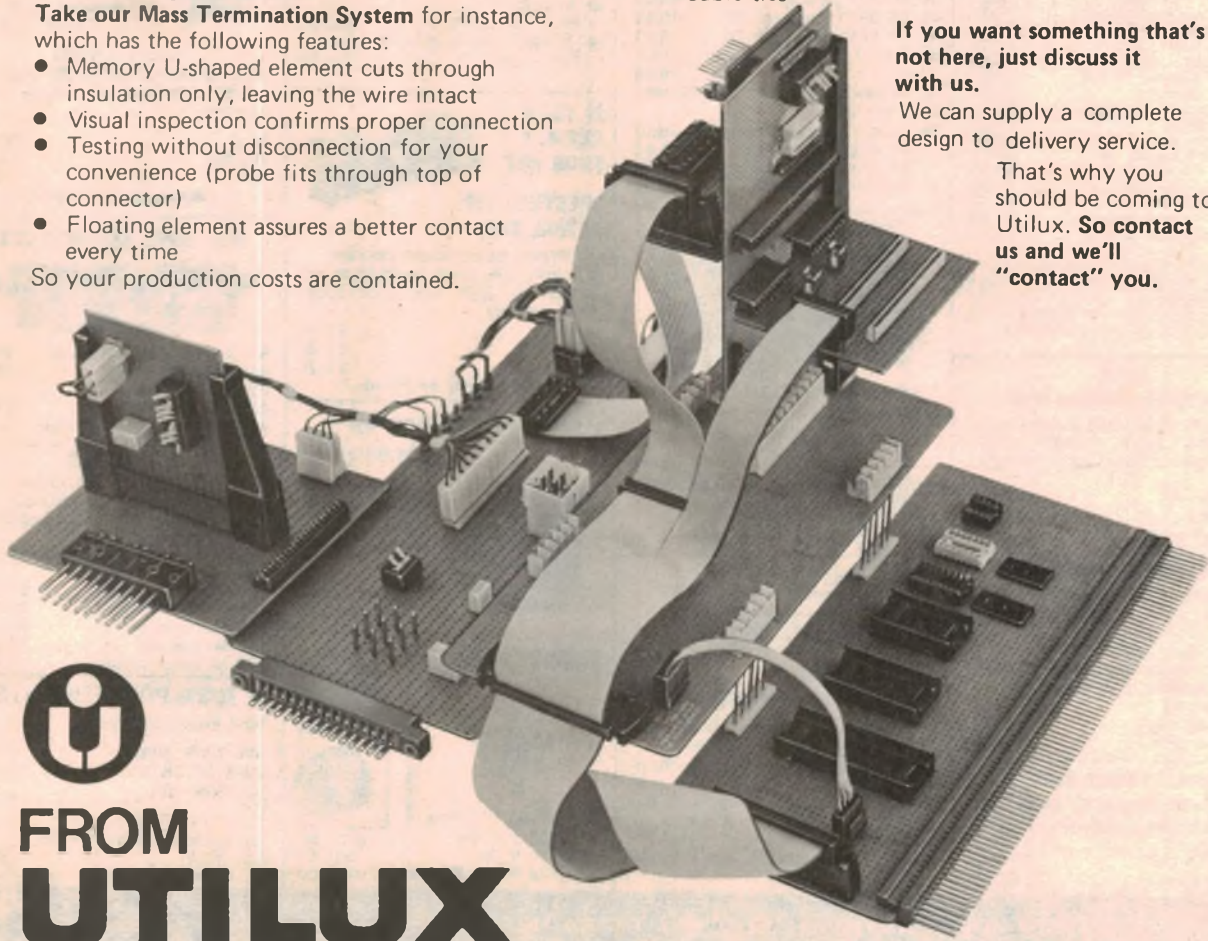

FROM
UTILUX

Utilux Pty. Limited, 14 Commercial Rd., Kingsgrove, NSW, 2208. Ph: 50-0155. Telex: 21516

Victorian Branch 1a Cromwell Street, Caulfield, Vic., 3162. Ph: 528-2533. Telex: 33971

Agents in all states

Simple wave shaper uses one 4017 IC

This simple circuit uses only a CMOS 4017 IC, 10 1N914 (or similar) diodes and 10 47k trimpots. A square wave is fed into the "IN" terminal and a waveform one tenth of the input frequency appears at the output. The shape of the output waveform depends upon the settings of the trimpots. To make a stepped sawtooth wave appear at the output, each of the trimpots must be set in a step-like manner with respect to each other. A little experimenting along these lines will soon indicate how the trimpots should be set.

If say only six trimpots are required, disconnect pin 15 from ground and connect it to pin 5 ("6" output). In this way you may choose how many trimpots you want. However, the output frequency will vary accordingly. (In this case, for example, the output waveform will be one sixth of the input frequency). In either case, once the values of each of the trimpots has been determined, they may be replaced with fixed resistors if this is desired.

The input resistance of the following stage should be high, about 100k, to prevent too much loading of the output.

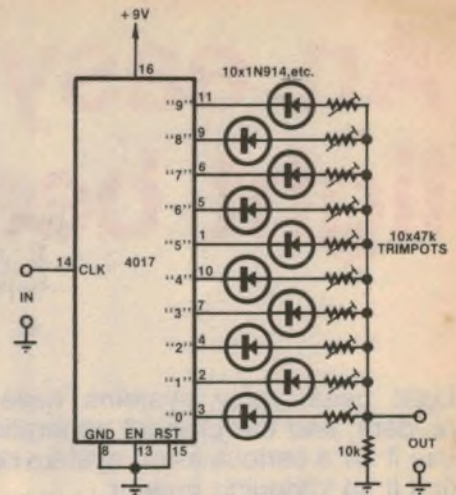

(By Mr D. M. Snodgrass, PO Box 133, Loxton, SA 5333.)

PLL lock indicator detects latching simply

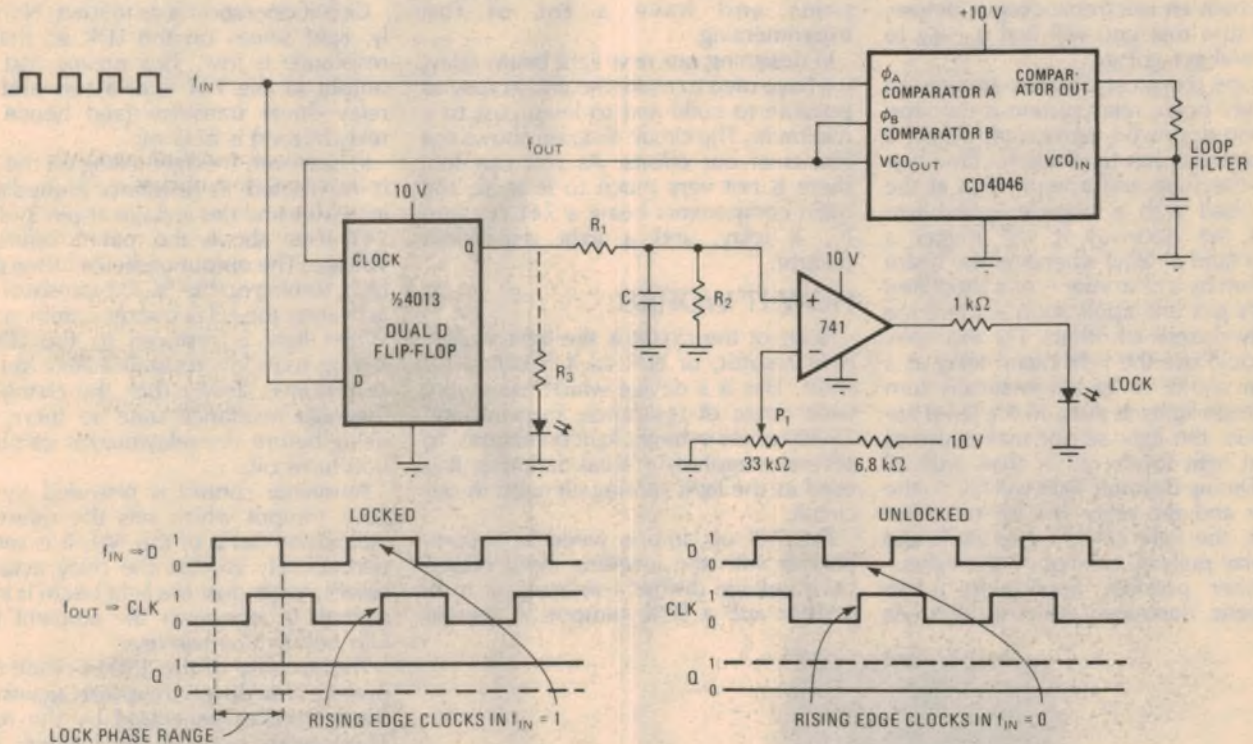

Much less complex than some of the previously described lock indicators for phase locked loops, with no need to derive and utilise a multiple of the input frequency for phase comparison purposes, this circuit is easier to set up and use. It sacrifices nothing in the way of accuracy and offers other advantages, such as the ability to lock onto harmonics of the input signal.

The locking technique is illustrated for the CMOS CD4046 PLL, whose output leads the input by 90° when the lock state is achieved. The loop's capture ratio is such that lock can be maintained for a square wave input signal no greater than +90° and no less than -90° out of

phase with respect to f_{IN} . The 4013 D flip-flop detects phase differences by clocking the state of f_{OUT} at f_{IN} 's rising edge. Assuming the PLL and its associated loop filter are working properly, a steady $Q = 1$ at the output of the flip-flop indicates the PLL is in or will shortly be in the lock state. The non-inverting input of the 741 comparator will then rise to 10V through the integrator R1R2C, and its resulting high going output will light the light-emitting diode.

If the PLL no longer locks on frequency, the phase of f_{OUT} with respect to f_{IN} will be random. The output of the flip-flop will thus be a train of variable width pulses. The comparator input thus drops to ap-

proximately 5V and because potentiometer P1 sets the inverting input at approximately 7V, A1 moves low, extinguishing the LED.

The lock detector will lock onto higher harmonics of f_{IN} . With a 50/50 mark-to-space square wave signal, locking has been observed to the fifth harmonic.

If a less precise indication is tolerable, lock detection can be achieved with even fewer parts by placing a LED at the output of the flip-flop and eliminating the comparator circuitry. Resistor R3 should be selected to hold the LED dim for the out-of-lock condition.

(By Steve Kirby, in "Electronics", April 10, 1980.)



An easy-to-build light beam relay

circuit by GERALD COHN
article by GREG SWAIN

Light beam relay systems have always intrigued our younger readers, and the present generation is no exception. Whether you use it for a serious alarm system or just for fun and novelty, you will find it an intriguing project.

We've had many recent requests for a light beam relay system, so this project should really prove popular. It uses only a handful of parts and is built on a small printed circuit board. Even if you have never built an electronic project before, we're sure that you will find it easy to build and get going.

Perhaps the most obvious application of a light beam relay system is monitoring shop doorways, particularly where a lone operator has to divide his time between the shop and a workroom at the rear. Used with a suitable light beam across the doorway it will trigger a buzzer (and a relay) whenever the beam is broken by a customer — or a shoplifter!

That's just one application — there are literally dozens of others. For example, you could use the light beam relay as a burglar alarm, or to automatically turn on outside lights at dusk. In the latter application, the light sensor makes use of natural light levels rather than artificial light. During daytime, light will fall on the sensor and the relay will be off. After sunset, the light sensor goes dark and the relay pulls in, turning on the lights.

Another possible application is an automatic darkroom warning light. As

soon as the darkroom lights were turned off, this project could not only light a "darkroom in use" light, but also turn on a darkroom safelight. We're sure that readers will discover many other applications and have a lot of fun experimenting.

In designing our new light beam relay, we have tried to make the unit as easy as possible to build and to keep cost to a minimum. The circuit diagram shows the results of our efforts. As you can see, there is not very much to it at all, the main components being a 741 op amp IC, a relay, and a light dependent resistor.

HOW IT WORKS

Heart of the circuit is the light dependent resistor, or LDR as it is called for short. This is a device which has a very wide range of resistance, from around 75-300 ohms in bright light conditions, to several megohms in total darkness. It is used as the light sensing element in our circuit.

The 741 op amp is wired as a comparator with the inverting input biased by a voltage divider consisting of a 1k resistor and a 500k trimpot. A second

voltage divider, consisting of a 100k resistor and the LDR, drives the non-inverting input. Output from the 741 IC is coupled to a BC337 transistor which acts as the relay driver circuit.

Circuit operation is as follows: Normally, light shines on the LDR so that its resistance is low. This means that the output of the 741 is also low and the relay driver transistor (and hence the relay/buzzer) is held off.

If, however, the light falling on the LDR is interrupted, its resistance immediately increases and the voltage at pin 3 of the 741 rises above the pin 2 reference voltage. The output of the 741 then goes high, turning on the BC337 transistor and activating the relay/buzzer combination. When light is restored to the LDR it returns to its low resistance state but this reversion is slower than the change to the high resistance state so there is a delay before the relay/buzzer combination turns off.

Sensitivity control is provided by the 500k trimpot which sets the reference voltage on pin 2 of the 741. It is set experimentally so that the relay actuates reliably whenever the light beam is interrupted, or whenever the ambient light falls below a certain level.

The purpose of the 1N914 diode is to protect the driver transistor against inductive spikes generated by the relay. These spikes occur as the magnetic field surrounding the coil collapses, and could damage the transistor if not suppressed. Base current for the transistor is limited



Larger than life size photo of the assembled PC board.

We estimate that the current cost of parts for this project is approximately

\$13

This includes sales tax, but does not include the plugpack power supply.

to a safe value by a 2.2k resistor, while the 560 ohm resistor ensures that the transistor turns off completely when the output of the 741 IC goes low.

If the circuit is used to monitor a doorway there will need to be a suitable light source which provides a useable beam. We found that the simplest and cheapest approach was to use a "pre-focused" torch globe (as used in a "penlite" torch). The type we used was rated at 2.3V and drew about 250 milliamps at this voltage.

Clearly battery power is not a practical proposition for this application. We suggest that both the circuit and the globe be powered from a "plugpack" rated 6V at 300 milliamps. The globe should be connected via a 15 ohm, one-watt resistor.

PARTS LIST

- 1 slotted plastic Zippy box, 150 x 90 x 50mm
- 1 6V SPDT relay, type 265/6/C2 or similar
- 1 PC board, code 80lbr12, 90 x 47mm
- 1 6V DC plugpack power supply
- 1 2.3V pre-focussed torch bulb
- 1 2.1mm DC power socket
- 1 miniature buzzer (optional)
- 1 ORP12 (or similar) light dependent resistor
- 1 741 op amp IC
- 1 BC337 NPN transistor
- 1 1N914 silicon diode (or similar)
- 1 500k vertical mounting miniature trimpot
- 1 100k ¼W resistor
- 1 2.2k ¼W resistor
- 1 1k ¼W resistor
- 1 560 ohm ¼W resistor
- 1 15 ohm 1W resistor

MISCELLANEOUS

PC stakes, hook-up wire, machine screws and nuts, solder etc.

CONSTRUCTION

Construction of the light beam relay is easy. All components, with the exception of the power socket, are mounted on a small PC board coded 80lbr12 and measuring 90 x 47mm. The board is designed to fit into a slotted Zippy box.

Follow the wiring diagram closely when wiring up the PC board. Fit the low profile components first, making sure that the semiconductor components (diode, transistor and IC) are soldered into circuit the correct way round. The buzzer is also a polarised device, so make sure that its positive lead (red) goes to the positive supply rail.

The LDR is not polarised, so it does not matter which way round you connect it.

(Continued on p104)

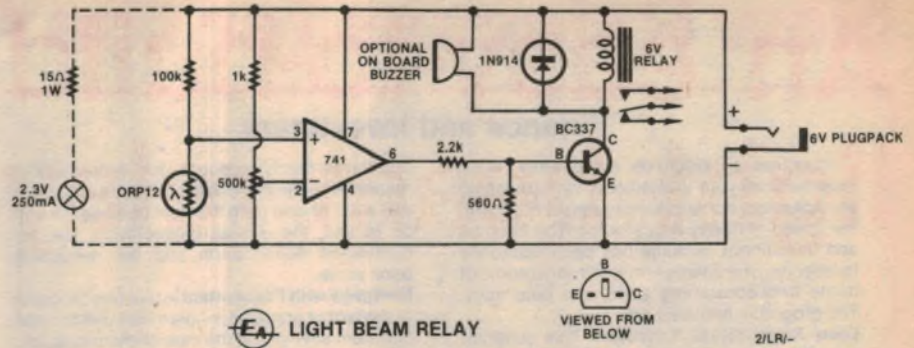

ABOVE: A 741 op amp IC, a relay and an LDR form the basis of the circuit. When the light falling on the LDR is interrupted, the output of the 741 goes high, turning on the transistor to activate the relay.

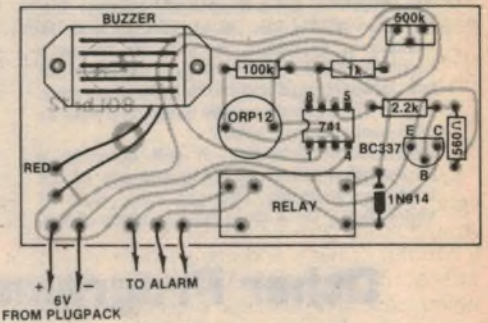

RIGHT: the component overlay diagram. Make sure that you fit polarised components the right way round.

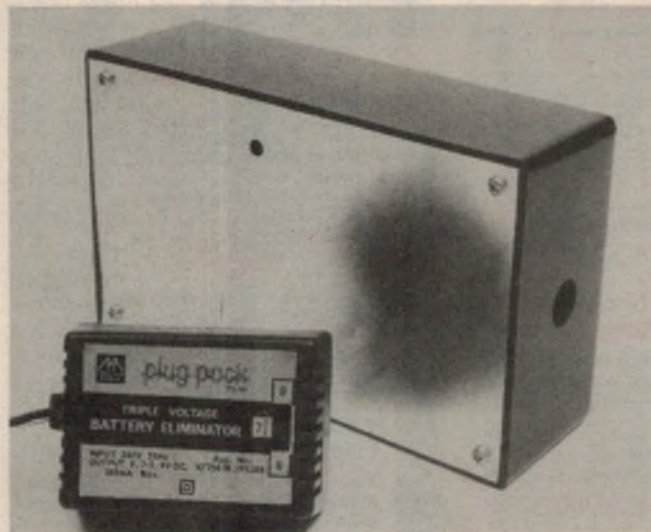

At left is the completed prototype, together with its plugpack power supply.

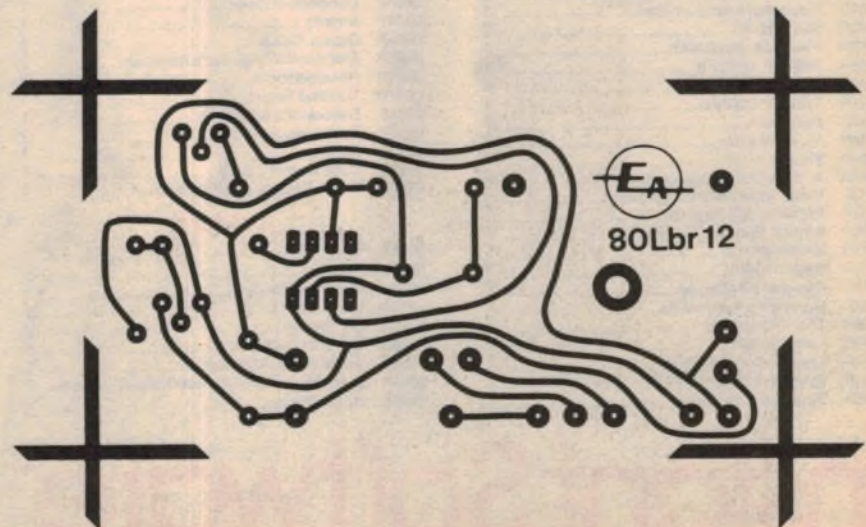

Here is an actual size reproduction of the PC artwork.

New Releases for the Apple...



Finance and Investment

Attention all would-be millionaires. Now, keep track of your investments by harnessing the power of your Apple II (or Apple II Plus) with the speed of floppy disk storage. The Finance and Investment package has been fashioned to help you, the businessman, to solve some of those time-consuming tasks you face daily. The programs included are:

Loan Amortization Schedule - This program will calculate a complete monthly breakdown of any loan or investment. All you do is enter the amount of the principal, the interest rate, the term of the loan or investment and the number of payments per year. You'll see a month-by-month list of the principal, interest, total amount paid and the remaining balance. Any of the amounts can be listed on a paid-to-date basis, at your option.

Depreciation Schedule - It will compute a depreciation schedule using any one of the following methods: Straight Line, Sum of Years-Digits, Declining Balance, Units of Pro-

duction or Machine Hours. Just enter data in response to the computer's prompts and you'll see a list of how long the item has been or will be in use, the annual depreciation, the accumulated depreciation and the remaining book value.

Mortgage with Prepayment - Use this program to develop a prepayment plan that will provide optimum savings on the cost of the mortgage, reduce the terms of the mortgage and help avoid overtaxing your income in the process. It will calculate the cost of the original mortgage, as well as the cost and savings on a mortgage with annual prepayments. If you must borrow money to make the prepayments, the computer takes the added interest into consideration.

Financier - This program is designed to take the extensive paperwork out of your daily financial planning. It performs ten common financial calculations that can help you: (1) design optimum investment schedules; (2) check



on depreciation rates, amounts and resale values; and (3) let you know exactly what a given loan is going to cost in terms of time and money.

Minimum system requirements are an Apple II or Apple II Plus with 32K of memory, one mini-disk drive and Applesoft BASIC. Order No. 0162AD - 3

Other Programs Available from Instant Software

TRS-80* LEVEL I & II

0001R	Basic and Intermediate Lunar Lander.....	1
0002R	Space Trek II.....	1
0004R	Beginner's Backgammon/Keno.....	1
0007R	Ham Package I.....	1
0008R	Electronics I.....	1
0009R	Golf/Cross-Out.....	1
0017R	Air Flight Simulation.....	1
0019R	Business Package IV.....	2
0023R	Oil Tycoon.....	2
0033R	Bowling.....	1
0043R	Santa Paravia and Fiumaccio.....	1
0046R	Othello.....	2
0050R	Grade Book.....	2
0057R	Chessmate-80.....	3
0099R	Typing Teacher.....	2

TRS-80* LEVEL II

0028R	Ramrom Patrol/Tie Fighter/Klionic Capture	1
0034R	Space Trek IV.....	1
0047R	Who-Dun-It?.....	1
0049R	Demo II.....	1
0051R	Ball Turret Gunner.....	2
0055R	Demo III.....	1
0056R	Bowling League Statistics System.....	4
0058R	Programmer's Converter.....	2
0063R	Cards.....	1
0065R	Teacher.....	2
0066R	Mimic.....	1
0068R	Your Cribbage and Checkers Partner.....	2
0069R	Household Accountant.....	1
0070R	Skirmish-80.....	2
0072R	Financial Assistant.....	1
0076R	TRS-80* Utility II.....	1
0077R	Enhanced BASIC.....	4
0081R	TRS-80* Utility I.....	1
0082R	Daredevil.....	2
0084R	Music Master.....	1
0089R	Energy Audit.....	6
0092R	Archimede's Apprentice.....	2
0100R	Video Speed-Reading Trainer.....	2
0103R	Personal Bill Paying.....	1
0106R	Airmail Pilot.....	1
0111R	Wordwatch.....	1
0117R	Night Flight.....	2
0125R	Investor's Paradise.....	2
0127R	Surveyor's Apprentice.....	2
0129R	The Wordslinger.....	5
0130R	Terminal-80.....	5
0132R	Energy Consumption.....	2
0135R	Executive Expense Report Generator.....	2
0136R	Beginner's Russian.....	2

0137R	Everyday Russian.....	2
0156R	Money Madness.....	2
0171R	Flight Path.....	2
0250R	IRV.....	4

TRS-80* DISKS

0052RD	Energy Audit.....	7
0075RD	Accounts Payable/Receivable.....	8
0095RD	Bowling League Secretary.....	6
0123RD	The One-D Mailing List.....	4
0139RD	Disk-Scope.....	3
0147RD	Check Management System.....	5
0180RD	Disk Editor.....	5
0212RD	The Russian Disk.....	4

PET**

0005P	Personal Weight Control/Biorhythms.....	1
0006P	Mortgage w/Prepayment Option/Financier.....	1
0014P	Casino I.....	1
0015P	Casino II.....	1
0026P	Dow Jones.....	1
0029P	Tangle/Supertrap.....	1
0032P	Trek-X.....	1
0035P	PET Demo I.....	1
0038P	Cubic-4/Go-Moku.....	1
0039P	Mimic.....	1
0044P	Penny Arcade.....	1
0045P	Arcade II.....	1
0048P	Accounting Assistant.....	1
0054P	Ham Package I.....	1
0062P	Baseball Manager.....	3
0064P	Dungeon of Death.....	1
0074P	Arcade I.....	1
0083P	Digital Clock.....	1
0085P	Electronics Engineer's Assistant.....	2
0091P	Hootedoodle.....	2
0097P	Turf and Target.....	1
0104P	Decorator's Assistant.....	1
0105P	PET Utility I.....	2
0110P	Chimera.....	1
0112P	Code Name: Cipher.....	1
0175P	Santa Paravia and Fiumaccio.....	2

APPLE***

0018A	Golf.....	1
0025A	Mimic.....	1
0040A	Bowling/Trilogy.....	1
0073A	Math Tutor I.....	1
0079A	Oil Tycoon.....	2
0080A	Sahara Warriors.....	1
0088A	Accounting Assistant.....	1
0094A	Mortgage w/Prepayment Option/Financier.....	1
0096A	Space Wars.....	1

0098A	Math Tutor II.....	1
0148A	Air Flight Simulation.....	2
0174A	Santa Paravia and Fiumaccio.....	2

PROGRAM PRICES:

Code	
1	\$ 11.95
2	\$ 14.95
3	\$ 24.95
4	\$ 31.95
5	\$ 49.95
6	\$ 62.95
7	\$112.95
8	\$199.95

APPLE DISKS

APPLE FUN - 3

PADDLE FUN - 3

MATH FUN - 3

CP/M SOFTWARE

DIAGNOSTICS 1 - \$75/15 (manual)

WORD PROCESSING - \$98/25

MERGE MAIL LIST - \$86/15

UTILITIES - \$57

ENCODE / DECODE 1 - \$58 11 - \$116

COMMUNICATIONS - \$127/20

FORTH - \$173/30

TINY PASCAL - \$98/15

ORDER ENTRY - \$399/25

GL A/P A/P INVENTORY PAY

\$140/25 EACH FOR MOST SYSTEMS

bankcard DEALER ENQUIRIES WELCOME

MICRODOT
Postal Address: P.O. Box 420,
Hawthorn, 3122
Cable: RODCAM Australia.
Phone 819 2411
Computer Growth Centre
PO BOX 281 Wodonga Vic 3690
Telephone 060 24 2433

Instant Software™

CATALOGUE \$ 1

RS-232C printer interface for TRS-80 & System-80 computers

There are quite a number of people out there who own a TRS-80 or System-80 computer and would like to be able to obtain hard copy without spending a small fortune for the expansion interface. The interface presented here uses the well established RS-232C standard and will interface to any of the commonly available printers having an RS-232C interface input. As an added bonus there is also a 20mA current loop interface for those people who may have one of the older Model ASR33 Teletypes.

by GERALD COHN

The implementation of the interface requires a minimum of hardware, and a short machine-language driver program. The driver routine, once loaded into the memory of the computer, is called up by the LPRINT and LLIST line printer commands of the TRS-80 or System-80.

A look at the circuit will convince even the most dubious person of the simplicity of the unit. The lead from the TRS-80 power supply unit is plugged into one end of the unit and a second lead from the interface then plugs into the power socket of the computer. The same thing applies to the output lead from the cassette interface (the grey lead).

Power for the interface is picked up from the computer power supply unit which is actually nothing more than a transformer. This is rectified by a full wave bridge to provide a nominal ± 9 volt split supply.

Smoothing is provided by two 100 μ F electrolytic capacitors.

The supply is used to power a 741 operational amplifier. The op amp is used in the non-inverting mode as a comparator. The inverting input has its reference set by diode D5 and the associated 4.7k resistor. This is required because of the nature of the output waveform, as we will see later. The non-inverting input is connected to the output of the TRS-80 cassette interface and has a 47k pull-down resistor.

The output of the op amp, pin 6, swings between ± 9 volts, and is the Transmit Data line for the RS-232 interface (pin 3 of the DB-25 connector). The signal ground line (pin 7) is zero volts, this being derived from the shield of the cassette interface output cable, and is used as the common reference throughout the circuit.

The BC558 transistor is used to provide the current loop for interfacing to a teletype via pin 10 of the DB-25 connector. A 0.1 μ F capacitor is provided between the collector and ground to offer some transient suppression. The other

half of the current loop is provided by the negative supply, on pin 9 of the DB-25 connector. Both of the lines for the 20mA loop have 470 ohm series resistors to provide an actual current in the loop of 18mA, which is close enough for most purposes.

The three 1k resistors connected between the positive supply and pins 5, 6 and 8 of the DB-25 connector are pullups for the signal lines which are not used here.

the cassette interface goes high, we find that the level is just above the 0.6V set by the drop across the diode, and the op amp now switches giving an output of +9V. When the signal is low, the output of the op amp is -9V.

The software driver is used to generate the serial data stream which as already mentioned is fed out through the cassette port on the TRS-80. Software timing loops are used to generate the baud rate. The software supplied in this article supports the following baud rates: 110, 150, 300, 450, 600, 1200, 2400, 4800, 9600.

When you first type the BASIC program into your computer, use the screen to check it, and do not attempt to run it at this stage since it could end up crashing. If you are happy that it is correct, save it on tape. Having done this, you are ready to use the program. The following few paragraphs explain in detail the procedure for using the software provided.

When the computer is first switched on, or when it is reset, it responds with:

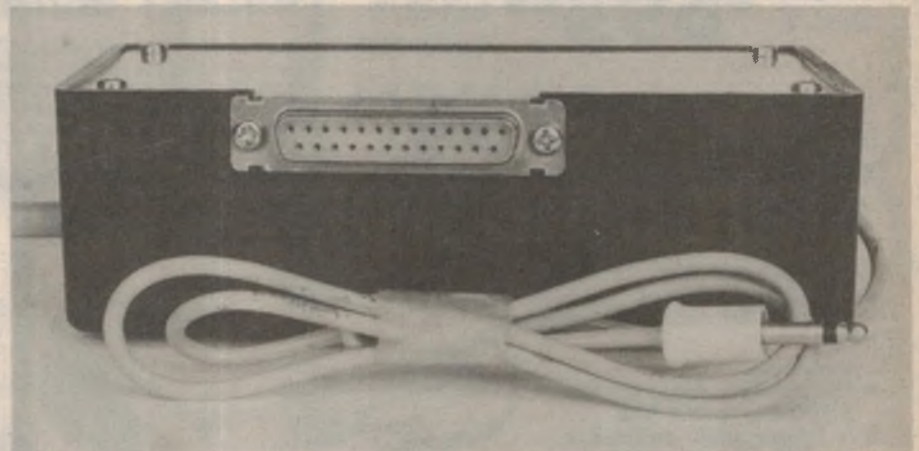

The unit is designed to plug straight into a standard printer with an RS232 interface input. A 20mA current loop interface is also provided.

As with the power supply, the audio lead to the cassette player is run through the interface, with a tap off to the interface circuitry.

Although the interface circuit uses the levels at the output of the cassette interface, the software driver program extends the width of the output pulses so that they are more like square waves. When this signal is applied to the input of the interface circuit the lower level of the waveform is just below the inverting input reference of the op amp. This means that the output of the op amp will be low. When the output of

MEMORY SIZE? Depending on the amount of available RAM in your particular system, you will have to enter a number at this stage. The number that is entered here is the top of RAM address (in decimal) less 110 bytes. This means that 110 bytes of RAM are being saved for the machine language driver, and are protected from the BASIC stack and program area. The table of Fig. 1 lists several common machine sizes and the corresponding number to be entered when "MEMORY SIZE?" appears.

After initialising the BASIC, load the program from cassette using the CLOAD

AT LAST...

THE SYSTEM 80 IS REALLY A SYSTEM!

NOW YOU CAN BUILD YOUR SYSTEM 80 INTO A SUPERB COMPUTER SYSTEM . . .

This is Australia's fastest selling microcomputer: the superb System 80 available only through Dick Smith Electronics (& authorised re-sellers).

However, until now, there has been a problem. The System 80 hasn't really been a system at all. Like a car without a tow-bar: useful, but limited in what you could do with it.

Now all that has changed: we're proud to announce the release of the System 80 S-100 Expansion Interface. The System 80, through its S-100 expansion interface, can now be used with hardware and software devices from over 200 different manufacturers. Just in case you didn't know, 'S-100' is the industry standard, which means you aren't tied to any one supplier for add-ons. A single supply source means that prices can be - and usually are - sky-high because there is no competition!

So now we expect the System 80 to really boom - not just to hobbyists, who've had it all their own way until now - but to businesses, to students, to housewives, to industry . . . There are virtually no limits to the System 80 system. All it takes is imagination.

And don't forget: software requirements for the System 80 are virtually the same as for the TRS-80: so most of the thousands of programs written for it will also run on your System 80 system!



**SAVE
HUNDREDS OF
DOLLARS OVER EQUIVALENT
COMPUTERS AND HARDWARE!**

FROM ONLY \$695⁰⁰ (4K RAM, LEVEL II Cat X-4003)

16K RAM, LEVEL II \$750⁰⁰
MODEL (Cat X-4005)

BUDGET MONITOR

The System 80 will run with any TV set: but in case you need a monitor, check this one out! P.S. This monitor will also work with most other micro-computers. Compare our prices and **SAVE!**

USE WITH ANY COMPUTER!

\$149⁵⁰

Cat X-1196



NOW: FULL S-100 EXPANSION

Yes! It's here! Add the S-100 Expansion Interface to your System 80 for incredible versatility.

It gives you:

- All interface logic for the S-100 expansion bus.
- A floppy disk controller capable of controlling up to four single-density drives (such as our Pertec drives at right) for up to 400K bytes of storage capacity.
- A full Centronics-type parallel printer port.
- An RS-232C serial communications port, capable of communicating with modems and acoustic couplers. May also be used to drive a teleprinter or other serial printer instead of a parallel printer.
- Two vacant S-100 card sockets, to plug in further expansion items.

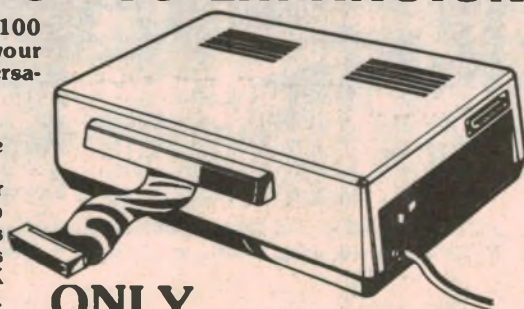

ONLY \$499⁰⁰

INCLUDING RS-232C PORT!

Cat X-4010

16K (or 32K) CARD Just plugs into the expansion box . . .

Expand your System 80 Memory - up to 48K via the expansion interface. The plug-in card comes with 16K RAM, with room for another 16K. So with one card and our 16K expansion kit, you can have a full 48K! Much lower cost than TRS-80 expansion (currently \$220/16K!) Cat X-4016

\$199

INCLUDING 16K RAM

HUGE SAVING ON TANDY'S PRICE!

BARGAIN PRICED MINI DISK DRIVE

\$200 less than Tandy's equivalent! You'd pay over \$1000 more from Tandy for a 4-drive system!

This incredible drive is world-famous Pertec brand; offers higher capacity than Tandy drive and will work with System 80 or TRS-80. Ask for more info. at your nearest Dick Smith store!

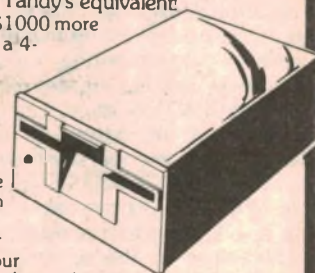

X-3230

\$379

DISK PRICES TUMBLE!

Unbelievable prices for either hard or soft sector mini diskettes. Suit virtually all disk drives available. Buy from Dick and save a fortune!

Hard Sector (X-3505)
Soft Sector (X-3510)

Trade enquiries welcome

WERE \$5.95 EA! NOW:
1 - 10: \$4.95
10 - 100: \$3.95
100 UP: \$3.50

ITOH 8300 BUDGET PRINTER

For budget printing, you can't go past this one! Uses standard tractor-feed paper, gives high quality print from its 7x5 dot matrix. Up to 240mm paper, prints 125 chars/sec. For either System 80 or TRS-80. Cat X-3255.

Uses Printer interface
and cable below

\$970

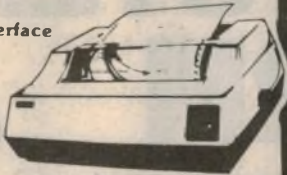

FAN-FORM COMPUTER PAPER
TO SUIT ABOVE PRINTER. 2000 SHEETS.

Cat X-1189

\$35.00

LETTER QUALITY DAISY WHEEL PRINTER

For top quality print, try this: it's over \$300 cheaper than Tandy's daisy-wheel, and is capable of proportional printing! Limited stocks when they arrive

Takes standard stationery!

DUE IN
STOCK
SHORTLY

Cat X-3265



\$1995⁰⁰

PROGRAM CASSETTES

Popular C-10 computer cassettes (just the right size for programs!) with computer-quality tape. Suitable for all 'compact cassette' type units (which everyone uses!) Cat X-3500

\$1.95



SAVE A FORTUNE ON MEMORY IC'S

Were almost \$100 more twelve months ago! Fast 250nS 4116 RAMs, for upgrading your 4K or 8K to 16K, 16K to 32K or 32K to 48K. 8 IC's in pack. With full instr. Cat X-1186



\$59⁹⁵

Also available individually.
Cat Z-9310 \$7.90 ea.

DON'T NEED FULL S-100 EXPANSION?

Use this parallel printer interface if you don't need full S-100 expansion. Save a bundle! Uses similar connecting cable to S-100 interface



\$49⁵⁰

PRINTER CABLE

Cat X-4013

Fitted with edge connector at one end, 57N-36 plug at other: suits virtually all Centronics-type printers. Use with either S-100 interface or parallel printer interface



\$39⁵⁰

Cat X-4014

SOUND OFF

Add sound to your System 80 programs! Includes am. programs and full instructions. You can add sound to existing programs too! Also suits TRS-80



\$19⁵⁰

Cat X-3648

MICROSOFT™ EDITOR/ASSEMBLER PLUS!

Editing, assembling & debugging power you've never had before! Equivalent of Tandy's Editor/assembler and T-bug products but in one package and at less than half the price! And it's far more powerful! Suits System 80 & TRS-80



\$39⁹⁵

Cat X-3680

LIGHT PEN BARGAIN!

The best value around Gives your System 80 or TRS-80 an eye. Easy to use, has simple programs

\$9⁹⁵

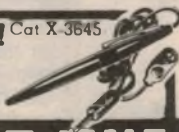

SOFTWARE for System 80 or TRS-80

GAMES AND EDUCATIONAL SOFTWARE
CURRENTLY AVAILABLE

TIME TREK **\$17.95**
You're boldly going where no man has gone before. Mind you those pesky Klingons attack you from time to time, so you'll need fast reflexes as well as sharp wits. Nine levels of difficulty. Cat X-3650

STIMULATING SIMULATIONS **\$17.95**
No less than 10 different games: all fascinating and original. Ari Auction, Forest Fire, Monster Chase, Nautical Navigation, Lost Treasure, Business Management, Gone Fishing, Rare Birds, Space Flight and Diamond Thief. Cat X-3652

ELECTRIC PAINTBRUSH **\$17.95**
This is a special machine language graphics interpreter program which lets you program dazzling graphics displays using simple high-level commands. Easy—and fun! Cat X-3654

BRIDGE CHALLENGER **\$17.50**
Keen on Bridge? This game never gets tired of playing with you. Ideal for practising and improving your level of play—whether you're an expert or just a beginner. Needs a 16K machine. Cat X-3656

MICROCHESS **\$22.50**
Think you're a wizz at chess? This program will put you to the test! But think out your moves carefully, the computer is out to beat you! One of the top selling chess programs in the USA. Cat X-3658

BLOCKADE **\$17.95**
You'll need fast reflexes and good co-ordination for this one. It's written in machine language so it can give really high speed graphics. Try to force your opponent into a collision with a moving wall, without running into a wall yourself! Cat X-3659

PUNTER'S DREAM **\$12.50**
Place your bets, please the race is about to start! Study the form of the various horses before placing your bets. Then the race is on! The program looks after the betting accounts, of up to nine punters, and can even cream off a percentage for the house! You get a realistic simulation of racetrack probabilities. Use it for fun or to improve your strategies! Needs a 16K machine. Cat X-3660

BANDITO **\$14.95**
Like playing the one-arm bandits down at the club? Here's one you can play seated at your friendly System 80! Tell the machine how much you want to spend, and it will feed it through. Watch the handle go down, the reels spin, and your money go! Then experience that familiar thrill when you hit a jackpot. Needs a 16K machine. Cat X-3661

MATHS/SPELLING **\$9.95**
Here's a great way to coach spelling and maths: imagine how much more interesting the lessons are if the computer is giving the problems! Help stamp out illiteracy and poor spelling—this great program can help you do it! Cat X-3662

AIRMAIL PILOT **\$12.95**
You're back in the early days of aviation. You must get the mail through in the shortest possible time. Your cloth-covered bi-plane must take you through unpredictable winds and electrical storms—can you make it? Cat X-3663

INTERLUDE **\$22.50**
This is the adults-only game for your computer. After the kids have gone to sleep, let the computer give you ideas for the rest of the night! It comes with a comprehensive instruction manual! (Note: this program is NOT available to any person under 18 years of age). Do not purchase this program if you are easily offended. Needs a 16K machine. Cat X-3675

SIMUTEK 1 **\$17.95**
Not just one, but FIVE superb space fantasy games. Includes Graphic Trek 2000 (try to dock the Enterprise with the space station without being shot down), Invasion Worg (protect the Earth), Star Wars (get in to the Death Star, plant a Bomb and get out again!), Space Target (a battle game) and Saucers (an action graphics game). Complete with instruction book. Needs 16K. Cat X-3658

POKER PETE **\$15.95**
Like a game of poker? He's a pretty shrewd player—hard to beat, although it can be done. Has really intriguing graphics; needs 16K machine. Cat X-3664

DEATH TRAP **\$9.95**
How's your co-ordination? Escape from the minefield without getting caught, ready to try again. Only it gets tougher! This one has sound effects, too. Requires a 16K machine. Cat X-3688

SPEED READING COURSE **\$19.95**
A set of programs on two cassettes designed to help readers of all ages improve their reading skills. Written by a primary school teacher. Requires a 16K machine. Cat X-3692

SCURVE INVADERS (Learning fun I) **\$9.95**
A unique program combining basic maths drill with the ever-popular Space Invaders game. Sound effects plus three levels of difficulty. Learning has never been so much fun. Needs 16K. Cat X-3694

HANGMAN/CONCENTRATION (Learning fun II) **\$9.95**
Great fun to play, but also increase familiarity with words. Two programs can be played with two players or two teams. Requires 16K. Cat X-3696

ALPHABET COUNTDOWN/RHYME TIME (Learning fun III) **\$9.95**
Another two games which give players of any age practice in selecting and manipulating words. Gives percentage correct. Requires 16K. Cat X-3698

COMPUTER HOT LINE . . .

Want to know more about our computers? Or are you having troubles? We've set up a special computer 'hot line' just to help you out. Call between 9AM & 5PM on Sydney (area code 02)

888 2002

DICK SMITH ELECTRONICS



SEE OUR OTHER ADVERTS IN THIS MAGAZINE FOR OUR STORE ADDRESSES AND RESSELLERS

AT LAST! A REAL COMPUTER IN KIT FORM

Real Computing Power available at kit prices

The Compukit 101 is a real computer — start with 4K RAM memory and full 8K Microsoft Basic in ROM. The Compukit 101 connects directly to your TV — just assemble, hit 'RETURN' and GO! A cassette interface allows you to use a normal cassette recorder to save and load programs.

Because the Compukit is available only as a kit, the savings are enormous.

Look at these features

- * The Compukit 101 is based around the ultra-powerful 6502 microprocessor — best value and most powerful microprocessor.
- * Steady clear picture using 50MHz refresh
- * Display of 48 characters x 16 lines — 1K memory mapped video system providing high speed access to screen display for games and graphics.
- * Extensive 256 character set which includes full upper and lower case, mathematical symbols, and graphics characters.
- * Full 8K Microsoft Basic in ROM compatible with APPLE, PET, SORCERER programs — much faster than currently available personal computers.
- * Video output and VHF high grade modulator which connects directly to the aerial socket of your TV set.
- * Fully stabilised 5V power supply, including transformer.



Rugged construction

A full and detailed assembly instruction manual is included with the Compukit 101. Only the best materials have been used for this kit:

- * High quality thru plated Printed Circuit Board with all I.C.s mounted on sockets.
- * Clear, easy-to-follow layout. Simple soldering due to clear and concise instructions compiled by Dr. T. Berk.
- * Professional 52 key QWERTY keyboard in 3 colours — software polled, meaning that all debouncing and key decoding is done in software.
- * Absolutely no extras required.

Tested and Tried

The Compukit 101 is Europe's best selling computer kit, with good reason. And now it's available in Australia, fully modified for VHF television.

- * Up to 8K RAM can be mounted on board. (4K RAM addition only \$85).
- * 40-line expansion interface socket on board for attachment of extender card containing 24K RAM and disk controller (Ohio Scientific compatible).
- * RS232 interface on board for printer connection.
- * Standard KANSAS CITY tape interface providing high reliability program storage — use on any standard domestic tape or cassette recorder.

If You Want to Learn about Computers, But Didn't Know which Machine to Buy, then this is the Machine for You

The Compukit 101 allows you to develop programs in either BASIC or machine language.

- * The BASIC is the best BASIC developed: Microsoft are internationally recognised as the industry leader.
- * Number range from 10^{-32} to 10^{+32} .
- * Scientific functions (such as EXP(X), SIN(X), LOG(X), etc), string variables, string functions, subscripted variables.
- * 6502 machine code accessible through powerful 2K machine code monitor on board.

No Extras Needed — Just Hit RETURN and Go

The Compukit 101 is available complete for \$595. No hidden extras. Includes RF modulator, Power Supply, Manual, Sales Tax, Post and Packing.



FREE Sampler tape including powerful DISASSEMBLER and MONITOR with each kit.



FREE Space Invaders (8K) program with 4K RAM add-on if ordered with Compukit 101 kit.

To: MELBOURNE HOUSE (Australia) PTY LTD 24 Peel Street, Collingwood 3066, Victoria

Please send me

- | | |
|---|-----------|
| <input type="checkbox"/> Compukit 101 kit, including all parts, manual, RF modulator and power supply | \$ 595.00 |
| <input type="checkbox"/> Additional 4K RAM Memory (fits on board) | 85.00 |
| <input type="checkbox"/> Case for Compukit | 80.00 |
| <input type="checkbox"/> Assembler / Editor tape | 25.00 |
| <input type="checkbox"/> Screen Editor tape | 6.95 |
| <input type="checkbox"/> Space Invaders (8K) | 14.95 |

I enclose cheque for \$ _____

Name: _____

Address: _____

Postcode: _____

TRS-80 Serial Printer Interface

command, and then RUN. The screen will respond with: ENTER MEMORY SIZE?

MEMORY SIZE	LAST LOCATION	ENTER
4K	20479	20360
16K	32767	32650
32K	49151	49030
48K	65535	65420

Fig. 1

Type in the same value that was used to initialise the BASIC. The second entry is required to make sure that the required area of RAM has been reserved. Having entered the top of RAM address, the program then pokes the machine language driver into the top 105 bytes and at the same time pokes the starting address of the driver into the printer device control block, (locations 16422 and 16423).

When either the LPRINT or LLIST commands are now used, the vector in the device control block will point to the new driver residing at the top of RAM.

After a short delay while the machine language program is loading, the computer will respond with:

BAUD RATE?

Answer this question with one of the values listed below. Check your printer manual for the correct baud rate to be used.

110	450	2400
150	600	4800
300	1200	9600

After the baud rate has been entered the computer will respond with:

ADD LF AFTER CR (Y&N)?

BASIC transmits carriage returns after each line of text, but does not transmit the line feed character. If your printer requires a line feed character to advance the paper, answer Y. If you are using a Centronics or a Selectric, answer N, since these printers automatically advance the paper when a carriage return is executed. If you are not sure, consult the printer's manual.

Having answered the last question the computer will respond with:

NUMBER OF NULLS (0-127)?

Some printers require null characters after each carriage return to allow time for carriage travel. If your printer requires these nulls, answer with the desired number, otherwise type 0.

After this question is answered, control returns back to BASIC and the READY message will appear. You are now ready to load and run any of your BASIC software.

CONSTRUCTION:

Construction of the hardware requires a little patience and about three hours of your time. All components with the ex-

ception of the DIN plugs and sockets for the power, and the audio plugs and sockets for the data signal are accommodated on a printed circuit board (PCB) which measures 74 x 51mm and is coded 80TRS11.

Start assembling the PCB by inserting the resistors and the capacitors and soldering these into place. Follow these up with the diodes and then the IC and the transistor. Then mount on the DB-25 connector. As can be seen from the photograph, it is soldered directly to the board. This is done by sliding the board in between the two rows of connector pins and lining the tracks up to meet the pins. When all the pins are aligned, solder them to the tracks.

Now that the assembly of the PCB is complete we turn our attention to the preparation of the case for the unit. We used one of the plastic utility boxes, measuring 131 x 69 x 42mm.

The preparation involves drilling of the holes for the 5 pin DIN socket, the hole for the 3.5mm audio jack and another two holes for the wires, ie, one for the four-core cable to the computer and the other for the audio shield to the cassette recorder. You will also need to file a slot to accept the DB-25 connector.

The slot for the 25-way connector should be just deep enough to allow the connector to be flush with the top edge of the box. This allows the lid to be screwed into place. It may be necessary to file two small slots into the PCB to allow for the length of the two screws that hold the assembly in place. The

```

1 REM BASIC PROGRAM FOR INITIALISING TRS232 PRINTER INTERFACE
2 REM
3 REM
4 REM SET MEMORY SIZE (LEAVE AT LEAST 110 BYTES FREE)
5 POKE 16553,255:INPUT"ENTER MEMORY SIZE",MS:MS=MS+1
6 HB=INT(MS/256):LB=MS-256*HB
7 POKE 16422,LB:POKE 16423,HB
8 IF MS>32767 THEN MS=MS-65536
9 REM
10 REM POKE PROGRAM INTO MEMORY
11 FOR I=0 TO 105:READ D
12 POKE MS+I,D:NEXT I
13 REM
14 REM SET BAUD RATE
15 INPUT"BAUD RATE",B:BR=1
16 IF B=110 THEN 24
17 IF B=150 OR B=300 OR B=450 OR B=600 THEN 20
18 IF B=1200 OR B=2400 OR B=4800 OR B=9600 THEN 22
19 PRINT"INVALID SELECTION":PRINT:GOTO 15
20 BR=BR+1:B=B/2:IF B<>0 THEN 20
21 GOTO 24
22 BR=BR+1:B=B/2:IF B<>600 THEN 22
23 BR=BR+4
24 FOR I=1 TO BR:READ D:NEXT I
25 DH=INT(D/256):DL=D-256*DH
26 REM
27 REM POKE BAUD RATE CODE
28 POKE MS+24,DL:POKE MS+25,DH
29 POKE MS+66,DL:POKE MS+67,DH
30 POKE MS+76,DL:POKE MS+77,DH
31 REM
32 INPUT"ADD LF AFTER CR (Y/N)",Q#
33 IF Q#="Y" THEN 37
34 IF Q#<>"N" THEN 32
35 FOR I=1 TO 4:POKE MS+48+I,0:NEXT I
36 REM
37 INPUT"NUMBER OF NULLS (0-127)",N
38 IF N<0 OR N>127 THEN 37
39 POKE MS+42,INT(N+1):END
40 REM
41 REM MACHINE LANGUAGE PROGRAM
42 DATA 243,121,254,13,40,3,254,32,216,245,229,197,6,9,55
43 DATA 245,245,33,1,252,205,33,2,33,222,0,43,124,181,32
44 DATA 251,241,31,245,48,19,33,0,252,24,19,14,2,175,13,40
45 DATA 2,24,219,62,19,24,215,24,47,198,0,33,1,252,205,33
46 DATA 2,0,0,33,222,0,43,124,181,32,251,16,212,17,222,0
47 DATA 203,74,40,11,33,0,252,205,33,2,27,122,179,32,251
48 DATA 241,241,254,13,40,198,183,40,197,193,225,241,201
49 REM
50 REM BAUD RATE TABLE
51 DATA 615,450,222,146,108,51,23,8,1
52 REM END OF PROGRAM

```

SORCERER OWNERS

Upgrade your existing 8K basic with the new software source mod 1.01. Makes your basic into a superbasic with capabilities that outstrip even some disk basics.

- Full input checking to eliminate unseen syntax errors and line overflows
- Redo from start if type mismatch in input statements
- Save numeric arrays with confidence
- Full line editing on input — change part of a line without retyping it all!
- Full selective renumbering — move your subroutines around; make a hole to insert more text
- Delete any block of lines
- Full recovery of program after accidental reset

Fully compatible with all existing Basic programs

AVAILABLE ONLY FOR EXIDY STANDARD BASIC VERSION 1.0
Basic mod 1.01 (include rompac with order) \$125.00

We are sorcerer specialists.

We carry an exciting range of software for the sorcerer, from powerful disc resident word-processors through business applications and accounting programs to fun-with-the-family games.

Talk to us about hardware and peripherals too! Write for free catalogue.

Need some specialised software? Call us. We can help.

Send cheque/money order to:

Software Source

PO Box 364 Edgecliff,
NSW 2027.
PHONE (02) 33 4536

LOOK VIDEO

SHOP: 418 Bridge Road (03) 429 5674
MAIL: PO Box 347, Richmond 3121 Vic.

Second hand video recorders and tapes, cheap. Also new

OSI HARDWARE FOR OHIO COMPUTERS

Superboard II	\$367.00
SII Covers/VDU Stands Plastic	\$ 18.95
RF Modulators 5/9V	\$ 19.95
4K RAM Kits	cheap
EPROM with Single Key Basic & Cursor Control	\$ 54.95

OSI SOFTWARE FOR OHIO COMPUTERS

Almost 100 varieties for C1P/SII.
Many available for C2/4P; enquire
Categories are: Games, Education, Business, Text, Instructions (Modifications), and Utilities.

K.2. Catalogue. Brief description of all programs, free hints. New enlarged version. \$3.50 PLUS \$1.00 P & P.

Example of titles:

G33. Grand Prix	\$ 9.95
G28. Death Ship (2 tapes)	\$18.95
U16. Filename (tape)	\$ 8.95
U19. Cursor/Editor C2/4	\$11.95
U20. Mini-Assembler	\$ 9.95
U21. Single Key Basic	\$ 9.95

Now available blank digital tapes C10 \$1.85 each less for lots of 10 or 100.

Mail orders allow postage, eg: OSI Software

1 or 2 \$1.00; 3-5 \$1.50; 6-9 \$2.00;
10 or more items \$2.50.

All prices INCLUDE sales tax.
Prices subject to change without notice.

TRS-80 Serial Printer Interface

photograph shows how we did this for the prototype unit.

When the box is suitably prepared, mount the DIN socket and the 3.5mm audio socket and wire the unit according to the circuit diagram.

When wiring the power supply leads make absolutely sure that the wires do not become mixed up since this could result in damage to the computer. If you are in doubt as to the numbering of the DIN plugs and sockets then we suggest that you remove the cover from the one on the end of the power supply lead and refer to this.

The wiring for the signal line is also quite important since this is where the unit derives its ground or zero volts reference. We have labelled one of the leads on the overlay diagram with GND

and this corresponds to the shield of the audio cable.

Having completed the construction we suggest that you go back and check the wiring again, very carefully. Particular attention must be paid to the power supply wiring since a mistake here could result in damage to the computer, and hence costly repairs. If you are satisfied that there are no errors then you are ready to test the unit. The best way of doing this is to use it with the computer and your RS-232 printer.

Connect the power supply transformer to the interface unit and then plug the power lead from the interface unit into the computer. Switch the computer on and make sure that it powers up properly. Next plug the output lead from the cassette interface in the computer into

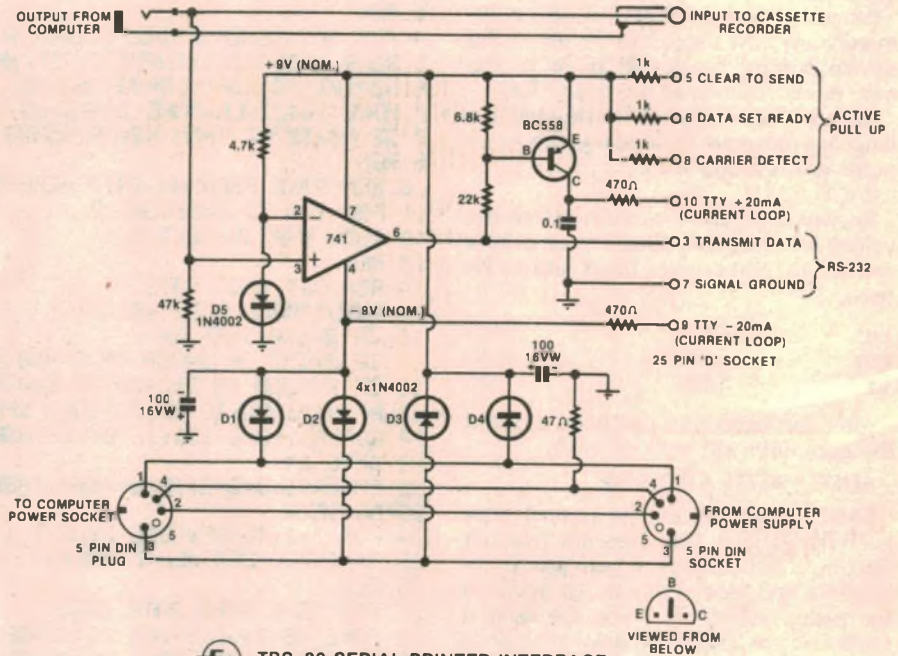

EA TRS-80 SERIAL PRINTER INTERFACE

2/CCI-

The 741 op amp provides the RS-232 interface while the transistor provides the 20mA current loop for interfacing to a teletype.

PARTS LIST

- 1 printed circuit board 74 x 51mm (80TRS11)
- 1 25-pin "D" type female connector
- 1 5-pin DIN socket (180°)
- 1 5-pin DIN plug (180°)
- 1 3.5mm audio socket
- 1 3.5mm audio plug
- 1 plastic utility box 131 x 69 x 42mm
- 4 6.5mm x No. 6 self tapping screws
- ½-metre 4-core cable
- ½-metre shielded audio cable

SEMICONDUCTORS

- 1 x 741 operational amplifier
- 1 x BC558 PNP transistor
- 5 x 1N4002 diodes

CAPACITORS

- 1 x 0.1µF metallized polyester
- 2 x 100µF/16VW aluminium electrolytic.

RESISTORS

- 1 x 47k, 1 x 22k, 1 x 6.8k, 1 x 4.7k, 3 x 1k, 2 x 470 ohms, 1 x 47 ohms.

FOR TRS-80 & SYSTEM-80 COMPUTERS

the audio socket in the interface unit. This is the lead with the grey plastic covering. This completes the wiring with the exception of the cassette recorder. The audio lead coming out of the interface unit is used to save programs on tape, obviating the need to remove the audio lead from the input. This means that the interface unit can remain in-line permanently, if this is desired.

The next step is to load the software driver routine. If you have already typed the BASIC program listing into the computer and saved it on tape, then all you need do is reset the computer and enter the memory size in accordance to the table of Fig. 1. Now load the program into the computer and then run it. If you have done your homework you will be able to answer the four questions immediately. When this is done, the computer will respond with READY. Now type LLIST into the computer and the program listing will be printed out on the printer.

We estimate that the current cost of parts for this project is approximately

\$15.00

This includes sales tax

If the response you get from the printer is a lot of unintelligible garbage then chances are that you have not answered the questions correctly. Check your answers and make sure that they agree with the data from the manufacturer of the particular printer you have.

If your listing appears as it should, then you have successfully completed the low cost RS-232 interface unit.

Apart from using the interface with a printer, it is also possible to hook it up with a modem for data transmission to a remote terminal or printer. The modem described in our September 1980 issue would be ideal for this. Imagine this situation: A friend rings you up from across the city and tells you that he wants to exchange some programs with you. What do you do? Jump into the car and drive across the city or just tell him to hook his printer to his modem while you hook your RS-232 interface to yours. You can now transmit the program listing to him, all for the cost of a single phone call.

Well there you have it: a low cost RS-232 interface for your TRS-80. It is a snack to build, and even simpler to use.

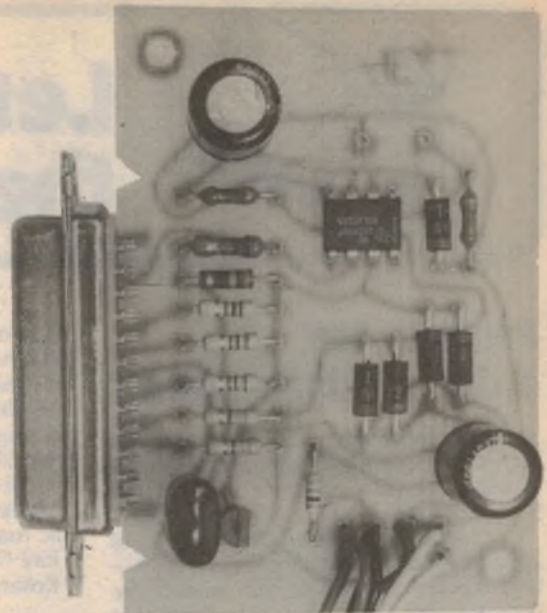
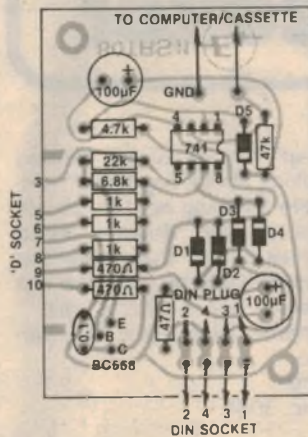

Construction is easy – just follow the component overlay diagram and the accompanying photograph. The DB-25 connector is soldered directly to the board.

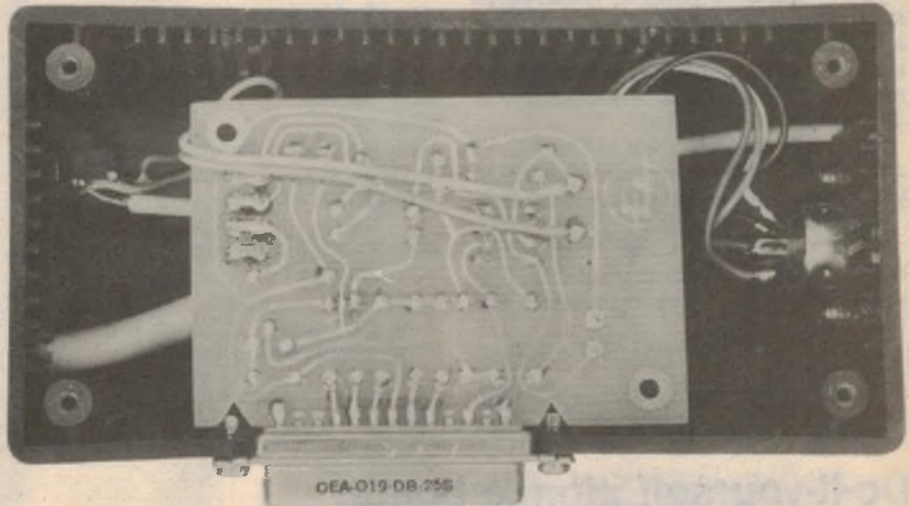

The view inside the unit is about as exciting as a politician.

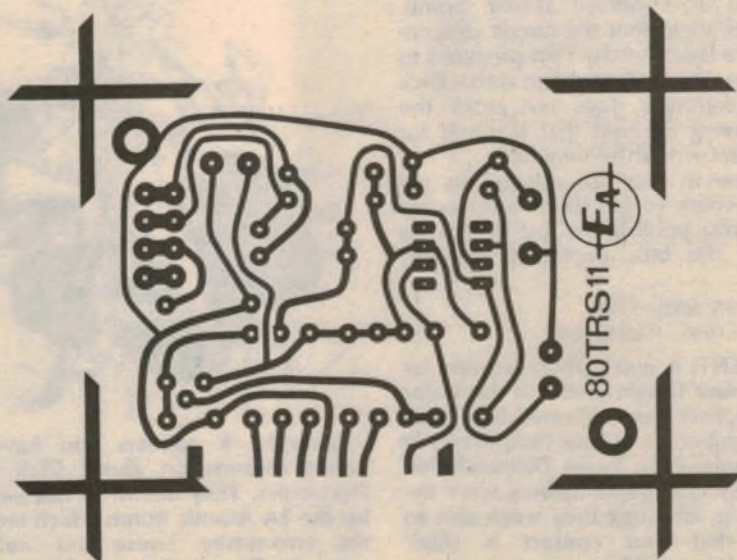

The PC artwork is reproduced here actual size.



Letters to the editor

Prefers the older loudspeakers

I have just read your articles on the subject of bass in speakers, including the article to do with the work of Thiele and Small.

It staggers me how the quality of speakers has gone down since 1959 – and the number of people who agree with this opinion. I can only hope that the work of Thiele and Small will effect a dramatic improvement.

The modern idea of tight bass is like listening to a lump of wood. I have yet to hear anything as good as a valve amplifier (push-pull ultra-linear) driving a pair of old-fashioned Wharfedales (or equivalent) in vented enclosures; i.e. 25/30 years ago.

I walked into a hifi shop in Melbourne and asked a young, bearded chap: "Do you have a really good pair of speakers?" "Of course", he replied.

When I mentioned that "they don't make speakers like they used to," a young customer standing beside me said:

"How old can you get? You're out of date, mate!"

"Don't laugh," the attendant replied,

"This old chap" (I'm all of 45) "knows what he is talking about. My father's set-up would leave anything here for dead!"

Modern bass just doesn't exist, although I must admit that there has been some improvement over the last couple of years – but at what a cost!

In the meantime, all the best for a terrific magazine.

Ray Goddard

Rosanna, Vic. 3084.

FM radio and the senate

I refer to the editorial in your August issue headed "FM has a fight on its hands". I have no quibble with the general tenor of the article but I wish to correct a glaring omission relating to the introduction of an FM service at all.

In the early seventies the then Australian Broadcasting Control Board recommended that an FM service be introduced in the 520MHz region to avoid shifting certain TV channels from the international band 88-108MHz.

The Senate, being disturbed by this suggestion, referred the matter to The

Senate Standing Committee on Science and the Arts (all party) and conducted an enquiry into the proposal. The Committee (chaired by Senator James McClelland – now Mr Justice McClelland) cross-examined the responsible authority's witnesses at considerable length and exposed the absurdity of the proposal. It finally recommended to the Government that the Board's proposal be rejected; that any television channels be removed from the international FM band; and that an FM service be introduced between 88-108MHz.

As a result of the Senate Committee's recommendation the Government requested Sir Francis McLean (formerly of the BBC) and Professor Rennick to conduct a further enquiry into the matter. This new committee agreed in essence with the Senate recommendations and our present service was born in the logical band.

When one thinks of what might have happened to FM (how hopeless it would have been in the 520MHz region), I think it only reasonable that credit be given where it is due – to the often maligned and abused Chamber, the Senate.

George Hannan,

Ex-Senate Committee Member,
Glen Iris, Vic. 3146.

More wanted on the DREAM 6800

I would like to support D. Willaton's letter published in EA's September issue. Although I do not own a DREAM machine as yet I have assisted a friend in getting his on line and was immediately "hooked". I have followed the rise of the microprocessor through your magazine since its inception some years back, taking care to read all the articles concerning them but I am still baffled as to how one works or how to program one.

Even with the short experience I have had with the DREAM and its supporting articles I find I can do no more than run the programs supplied, as all articles concerning any micro assume a certain basic knowledge.

Changing the subject slightly, would it be possible to add a circuit to the DREAM to convert the black and white video to colour? Also, could two joystick type controls be added for computer games?

J. C. Donnell,
Kambah, ACT.

COMMENT: Unfortunately it is not possible to convert the DREAM to colour video, if only because colour displays typically require about 4K of memory simply to control the video display. Other problems would also arise, such as conversion of the software to drive a colour display. The complexity of the circuit required would also be daunting. Joysticks could be added, but would require a full 8-bit input port.

Do-it-yourself atomic bomb!

I have just read with interest your article on a do-it-yourself atomic bomb. While I thought that the circuit description was a little sketchy I am prepared to have a go. The only problem is that Dick Smith Electronics does not stock the parts, having decided that demand for this project would be minimal.

As I see it, you are obliged to tell readers where to get the bits for every project you publish. So just where do you get the bits, particularly the PC board?

Ying Tong Iddle-I-Po,
Upper Creek, Paddleless.

COMMENT: A quick phone-around by staff member Tungin Cheke to the major parts suppliers has confirmed that parts for this project are at least temporarily in short supply. Even Radio Despatch Service of 869 George St, Sydney were unable to help, although they were able to suggest that you contact a ships' chandler for a paddle.



However, it appears you have the wrong information about Dick Smith Electronics. They intend to release a kit for the EA Atomic Bomb which includes the two-storey house but not the uranium. The price? Around \$19 million!

“Improving yourself is never easy, but ICS make it as easy as possible.”

—Greg Marr, ICS Student.

23-year-old Greg Marr wanted a change of career, so he applied for over 30 jobs in the computer industry. “There were plenty of jobs about,” said Greg, “it was just that there were always people with more qualifications than me.”

Greg decided to sign-up for an ICS course. “The program quickly gave me an understanding of the job I wanted. I studied at my own pace, passed a few exams and after a few months applied for another job.”

Yes, Greg got the job. But behind every success story like this there’s a bit you normally never hear about. And that’s what this page is all about.

What you put in. What you get out.

You’ll have to put aside a couple of hours a day. But with ICS you can pick and choose just when and where you study.

You have to take assignments and tests. But your ICS tutor will guide you and give you advice every step of the way.

It may take time. But in the end you’ll emerge with extra skills that may help you pick and choose jobs, ask for more money or set your own conditions.

“It was as if I was the only ICS student.”

ICS offers Guided Personal Study, a system that has proven successful for over nine million people around the world.

Unlike a classroom where the tutor deals with 40 people at a



time, your ICS tutor gets to know you personally. If you work at a slower or faster rate, you won’t be penalised because the class is ahead or behind you.

ICS doesn’t just send you text books, you receive a complete learning system. Each program is accompanied by notes and questions that allow you to

understand and remember every point.

“I was six months ahead of the rest.”

You can start an ICS course any time of the year. Which means if you clip the coupon now you can be months into your course before the new tech. year commences.



Choose the ICS course which interests you most

and mail this coupon to ICS for an immediate answer.

- Automotive
- Building Sciences
- Drafting
- Electronics
- Mechanical Engineering
- Electrical Engineering
- Civil Engineering
- Refrigeration and Air Conditioning
- TV Servicing
- Accountancy
- Business Management
- Sales and Marketing
- Computer Programming
- Hotel Motel Management
- Secretarial/English
- Art
- Writing
- Dressmaking
- Interior Decorating
- Guitar
- Photography

The course I am most interested in is _____
 (If the subject you want is not listed above, please write it in)
 Please send me without cost or obligation the ICS Careers Information Guide which tells me everything I need to know about the course I wish to receive information on.

Mr/Mrs/Miss _____ (Please Print) _____ postcode _____

Address _____ Occupation _____ Age _____ Phone _____

International Correspondence Schools Tick here if currently full time student
 Sydney: 400 Pacific Highway, Crows Nest, NSW 2065. Tel: (02) 43 2121
 Melbourne: 18-20 Collins Street, Melbourne, VIC, 3000. Tel: (03) 656 1950
 Brisbane: 131 Elizabeth Street, Brisbane, QLD, 4000. Tel: (07) 221 0178
 Adelaide: 28 Grenfell Street, Adelaide, S. A. 5000. Tel: (08) 219 4154
 Perth: P.O. Box D157, Perth, W.A. 6001. Tel: (09) 321 8530
 New Zealand: 182 Wakefield Street, Wellington C.I. N. Z. 224208



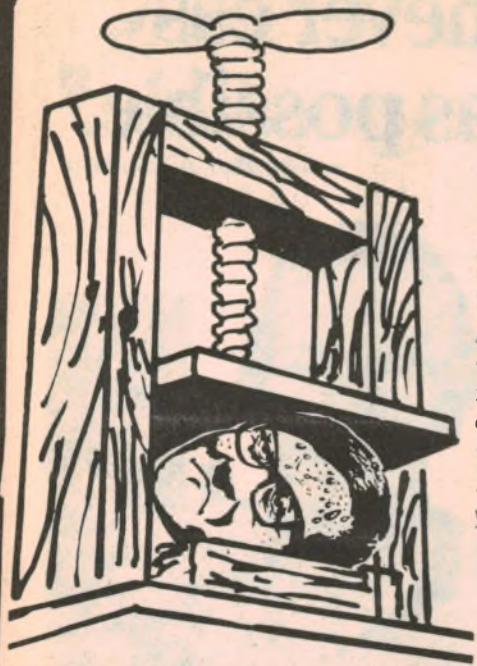

EXTENDED BY PUBLIC DEMAND!

Whoops! We're sorry! We give up! We will extend the deadline!

When we announced our Dick Smith-Yaesu 'Win a Fantastic Trip to Hong Kong' competition, we completely forgot about all the new Yaesu models.

Little did we realise that the new models would be so popular that they would sell out immediately: and anyone who waited for the next shipment would be too late to enter!

And then there were the customers who wanted the brand new models: the ones that hadn't even arrived yet!

Scores of customers have asked: 'Hey! What about us. Why should we miss out on winning the trip just because you guys ran out of stock?'

You're right, of course! So to give everyone a fair chance, we've decided to extend the deadline until the end of February 1981. So now you can have your new Yaesu - and still be in the running for the fabulous contest prize!

SO NOW YOU CAN BUY YOUR NEW YAESU: AND STILL BE ELIGIBLE!



\$543⁰⁰

OR FROM \$63 DEPOSIT
AND \$26.28/MONTH
(24 MONTHS)

NEW FT480

- All mode 2 metre SSB/CW/FM!
- Microprocessor controlled!
- Digital display!
- 30 watts PEP

This is the one they're all talking about: the fabulous new 2 metre all-mode transceiver from Yaesu. Offering outstanding performance and ease of controls, it must be the transceiver of the eighties! Cat D-2887



SAVE ON FT625!

WAS \$795.00 ..
NOW ONLY

\$695⁰⁰

OR FROM \$75 DEPOSIT AND
\$20.48/MONTH (48 MONTHS)

We've knocked an incredible \$100 off the price of these popular all-mode 6 metre rigs. There's still plenty of good DX out there on 6 - and the FT-625 is just the transceiver to get it! Cat D-2886



\$735⁰⁰

OR FROM \$75 DEPOSIT AND
\$22.48/MONTH (48 MONTHS)

NEW FT707

- All HF bands!
- AM/SSB/CW!
- Tiny Size!
- True digital display
- New WARC bands!

They've been pretty hard to get, and small wonder! The superb FT-707 packs a huge punch from its tiny size: 240W DC! It's the ideal rig for mobile, base or portable work. Cat D-2869

SUPERB FT-207

- Microprocessor controlled hand held giving full 144-148 band!
- Digital display.

For today's active ham, this is the set to take with you. Takes up virtually no room, but really gets out! Make contacts wherever you go with the FT-207R.

\$358⁰⁰

Cat D-2888

OR FROM \$38 DEPOSIT AND
\$17.52/MONTH (24 MONTHS)



\$1278⁰⁰

OR FROM \$138 DEPOSIT AND
\$38.32/MONTH (48 MONTHS)

NEW FT107M

- The ultimate!
- WARC bands
- All solid state
- Variable IF bandwidth!
- Speech proc.

It must be every amateur's dream to own one of these! You can: and take full control of the bands. Whatever you want from your transceiver, the FT-107 offers it! Cat D-2871

BUDGET FT-101Z

We throw in a digital display kit worth over \$100! This turns the FT-101Z into an FT-101ZD!

More hams have 'cut their teeth' on one of the famous '101' series than any other rig! Rugged and reliable, with all the features you really need. Cat D-2862

OR FROM \$85 DEPOSIT AND
\$23.19/MONTH (48 MONTHS)



\$775⁰⁰

WITH BONUS DIGITAL
DISPLAY WORTH \$139!!

ANY TERMS OFFERED ARE TO APPROVED, PERSONAL APPLICANTS ONLY. ORDER BY MAIL: USE YOUR BANKCARD!

DICK SMITH ELECTRONICS

SEE OUR OTHER ADVERTS IN THIS MAGAZINE FOR OUR STORE ADDRESSES AND RESELLERS



AMATEUR RADIO



by Pierce Healy, VK2APQ

Radio and aviation in the outback — a tribute

The Australian Inland Mission, the Royal Flying Doctor Service, and the School of the Air are all part of the Australian outback. Here is a tribute to two amateurs who made a major contribution to the establishment and continuation of these vital community services.

The sadness associated with death is often the emotion which recalls achievements of persons during their lifetime. Such was the case when two pioneers in the field of radio communication, with outstanding records of community service, died recently. Both shared a common interest — amateur radio — and contributed much towards communication in the vast Australian outback.

One was Leonard Schultz, MBE, aged 73, who died on June 21, 1980. Len obtained his amateur licence in 1922 with the call VK2ANM, and was accredited as being the first amateur to communicate by radio from the east to west coast of Australia.

As a pioneer in broadcasting he joined broadcasting station 2GB Sydney in 1927. He was chief engineer from 1928 to 1961, when he was appointed Director of Technical Services, Broadcasting Associates Pty Ltd, which has a controlling interest in 2GB and other Macquarie stations.

Len was responsible for introducing many engineering innovations to Australian broadcasting and from 1928 to 1939 designed several broadcast stations, including 2GB, 2CA, 2MW, 4BH and 5DN. He was a foundation member of the Institution of Radio and Electronic Engineers of Australia, and was president in 1955.

He was also a foundation member of the Royal Flying Doctor Service of NSW and served as a member of the executive committee, vice-president, and president of that service. He was also honorary technical advisor for 32 years and honorary aviation advisor for 29 years. The RFDS is the most complete communication and aviation medical service in the world.

His association with aviation as a pilot dates from 1928 and he held his licence until 1961. In 1935 he was club champion of the Royal Aero Club of NSW, and was later an honorary life member of the club. As a pioneer of gliding in Australia Len had a distinguished career, at one time holding a record for the longest nominated goal flight.

During World War II he was employed, part time, flight testing the only military gliders to be manufactured in Australia. The MBE for community services was awarded in June 1972.

The other pioneer was Alfred Traeger, OBE, who died July 31, 1980, on the eve of his eighty-fifth birthday. He was the inventor and designer of one of the best known Australian developments — the pedal wireless. Alf was a keen amateur operator and held the call VK5AX. Born at Glenlee, Victoria in 1895 and educated at the Adelaide School of Mines, his great contribution to outback communities began in 1926 when he was introduced to Reverend John Flynn, of the Australian Inland Mission, by Harry Kauper, chief engineer of broadcast station 5CL Adelaide.

The need for better communication in the outback was realised by John Flynn — "Flynn of the Inland" — during his mission work in the 1912-1919 era. With visions of aircraft and "wireless" to provide rapid communication and transport, for medical assistance when and where needed, he set about making the vision a reality.

Prior to Alf Traeger being introduced to Flynn, experiments with radio communication had been undertaken by George Towns, also an amateur, assisted by Harry Kauper during Flynn's trips through the country around Beltana, Innaminka, Birdsville, Marree, Oodnadat-

ta, and Alice Springs. The battery sets they used were very temperamental and unreliable, and the need for electric generators obvious, but the walkabout formed the basis for future experiments and the background to Alf Traeger's work.

Alf Traeger, the young electrical engineer, had been experimenting with electric generators since 1918 and, together with a knowledge of wireless, accepted the challenge presented by Flynn's vision of an outback communication service.

An experimental base station was established by Traeger and Flynn at Alice Springs in October, 1926. Contacts were made with outpost stations at Hermannsburg, 128km (80 miles) to the west and at Arltunga 112km (70 miles) to the east, using Morse code. The experiments proved that wireless contact could be made and regularly maintained in the outback.

Returning to Adelaide, Alf decided to devote his time and energy to developing a wireless transceiver that would



Traeger as a young man with an early model pedal generator & Morse code transceiver. (Photo courtesy Museum of Applied Services, Sydney).

AMATEUR RADIO

meet the needs of the outback. He was not satisfied with batteries as a source of power and set about solving the problem by means of a generator.

He started by coupling a small generator to a hand operated emery wheel, and tried turning the generator with one hand and operating the Morse key with the other. While the idea worked, several difficulties became obvious, and something better was needed.

He next used bicycle pedals and screwed the device to the floor. The result — anybody able to work the pedals could generate 20 watts; 300-400 volts at 50-60mA, or enough to drive a small transmitter.

The primitive pedal generator was taken to Alice Springs for further tests. These revealed that the most serious fault was variation in voltage output from the generator, due to operators' inability to maintain a steady pedalling speed. This, in turn caused serious changes in the transmitter frequency.

During this period experiments were being conducted in the medium frequency band (0.3MHz-3MHz) and reception over distances 320-480km (200-300 miles) was not possible during daylight,

the range for the most powerful station being 80km (50 miles). While improving the pedal generator, which developed into a sealed oil filled case enclosing the gear train, Alf found the answer to the problem of daylight distance coverage by changing to the shortwave (HF) bands.

Another turning point, and probably the final answer to his problem, was reading in a technical journal of the crystal controlled oscillator, available only in the USA at that time. Alf imported some crystals and was then able to stabilise the output of the transmitter — in spite of voltage variations from the pedal generator — and also provide a simple and reliable method of selecting a range of frequencies to suit day or night operation.

For consistent results under poor reception conditions, due to static and low power transmissions, Morse code was used by outpost stations when transmitting to the base station, where a trained operator could read the Morse code and, with a higher power transmitter, reply by voice.

However, this posed the problem that the outstation operators needed to learn to send correctly. Alf developed a keyboard, made from an ordinary typewriter, with a spring loaded drum and perforated strip which, when the keys were depressed, automatically sent the corresponding letters in Morse code. Even a child could tap out simple

messages to be interpreted and answered by voice from the base station.

Coinciding with Alf Traeger's improvements to his pedal set was the launching, in May 1928, of the AIM Aerial Medical Service, the other part of John Flynn's work for the inland. This service made the present day Royal Flying Doctor Service possible.

In November 1928, Alf took an improved pedal radio to Cloncurry, Queensland, where the AMS headquarters had been established, and proved beyond doubt the scope and service radio communication could provide for the isolated inland areas. The arrival in Cloncurry coincided with the running of the Melbourne Cup. It is recorded that a Cloncurry horse was racing and the whole town turned out to listen to the description of the event transmitted from Melbourne. Full reception was marred however, by a dog becoming entangled with the aerial lead to the pedal radio.

Other stories are recorded of the misinterpretation of Morse code signals by excited or inexperienced operators.

Following the success of the Cloncurry experiments, Alf returned to Adelaide and built a further eight sets. These were placed at outposts ranging from 480 to 650km (300 - 400 miles) from the Cloncurry base.

The sets cost from \$140 to \$200 but, in line with the philosophy of the Australian Inland Mission, they were supplied free of charge initially. Need rather than status controlled the distribution, until they were scattered far and wide in remote areas of the inland.

As further improvements were developed, voice replaced Morse code, but the Morse key board was retained for use in emergencies.

Alf Traeger's work in establishing an outback communication system brought another benefit to these isolated areas; the School of the Air which uses otherwise idle time on the channels to bring the advantages of education and companionship to children who would otherwise be denied those privileges.

Over the years there have been many

BRIGHT STAR CRYSTALS PTY LTD

35 EILEEN ROAD, CLAYTON, VICTORIA, 546 5076
(ALL MAIL TO:— P.O. BOX 42, SPRINGVALE, VIC. 3171)

INTERSTATE AGENTS
ROGERS ELECTRONICS
ADELAIDE PHONE 42 6666
J. E. WATERS PTY LTD
SYDNEY PHONE 666 8144



BSC TELEX AA36004.

DILMOND INSTRUMENTS
HOBART PHONE 47 9077
FRED HOE & SONS PTY LTD
BRISBANE PHONE 277 4311
WEST TEST ELECTRONICS
PERTH. PHONE 337 6393

With more than 36 years experience Bright Star can supply most of your crystal needs.

(WE ARE ALSO SUPPLIERS TO STATE AND COMMONWEALTH DEPARTMENTS AND CONTRACTORS TO DEFENCE FORCES)

NEW PRODUCT

CRYSTAL MARKER UNIT

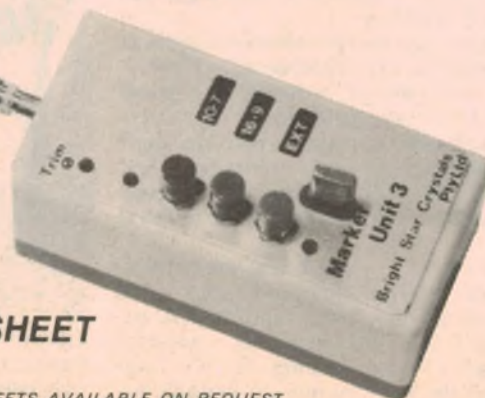

SEND FOR DATA SHEET

DATA SHEETS AVAILABLE ON REQUEST

SO YOU WANT TO BE A RADIO AMATEUR?

To achieve this aim, why not undertake one of the Courses conducted by the Wireless Institute of Australia? Established in 1910 to further the interests of Amateur Radio, the Institute is well qualified to assist you to your goal. Correspondence Courses are available at any time. Personal classes commence in February each year.

For further information write to
**THE COURSE SUPERVISOR,
W.I.A.**

P.O. BOX 123,
ST. LEONARDS, NSW 2065

AMATEUR RADIO

technical advances. With the advent of self-contained power, power plants in most missions and homesteads, the pedal generator has long been extinct, but such was the impact of this invention that the terms "pedal wireless" or, simply, "the pedal" are still common in the outback.

Alf Traeger kept abreast of all the technical advances and many thousands of transceivers were built in the Traeger Transceivers Pty Ltd factory in Adelaide and used in Australia and overseas.

In addition to his pedal wireless Alf Traeger invented a method of producing fresh water from salt water using solar power. At the age of 77 he designed a turbine driven car, with an electric transmission system, which would run on kerosene or diesoline, and promised a substantial saving in fuel.

A very shy person, Alf Traeger avoided publicity and, as far as is known, featured in only two short interviews about his work, both for the Australian Broadcasting Commission in 1972.

(Acknowledgement for information on Alfred Traeger's work is given to the Museum of Applied Arts and Sciences Sydney and ABC radio archives. Acknowledgement for information on Len Schultz to IREE "Monitor", August 1980).

Amateur Band Classified News

A well known and popular Sydney early morning radio personality has publicly confessed to being a long time reader of this magazine. Recently on air he expressed interest in the review of a book, "How to Build a Robot Dog" (September 1980 page 112), commenting on the possibility of it leaving little ICs on the lounge room carpet.

Aided and abetted by an equally well known news reader (VK2BL), he has already demonstrated his ability with radio teletype. Maybe, we will eventually be introduced to a unique canine personality on his program.

The above duo have been guest news readers for the WIA, NSW Division, Sunday morning broadcasts from VK2WI.

These WIA sessions have been coordinated by a third member who has an important backroom responsibilities in the same broadcast station and is a doggedly regular news presenter on VK2WI.

Where do these three spend their work-a-day hours? Who are they? No prize for spotting the clues. Just an exam-

ple of the cross section of careers found among amateur radio operators and enthusiasts.

AMSAT NEWS

In the June/July 1980 issue of "ORBIT", published by AMSAT - The Radio Amateur Satellite Corporation, it was recorded that AMSAT's president and general manager, Dr Perry Klein, W3PK, had notified the AMSAT board of directors that he desired to make an orderly withdrawal from his duties as president and general manager. The resignation is to be effective on June 1, 1980.

Perry served AMSAT in a leadership capacity since its inception eleven years ago and saw the organisation grow from just a few enthusiasts to an organisation with nearly 5000 members world-wide. His many articles are well known among amateurs, and amateur radio owes a deep gratitude to him for his work.

The decision to reduce his direct, active, involvement was made in order to pursue a new course of research, but he will remain a vital consultant as President Emeritus of AMSAT.

It was also announced that the "hard core" design team would stay intact in order to construct a Phase IIIB spacecraft. Prior to the unsuccessful launch of the ARIANE L02 rocket vehicle on May 23, 1980, which resulted in the destruction of the Phase IIIA AMSAT-OSCAR satellite, both Jan King, W3GEY and Karl Meinzer, DJ4ZC had indicated that they would reduce the scope of their participation in the construction of flight hardware for the OSCAR satellite series.

The launch malfunction resulted in a change of heart for both of them. Other members of the hard-core team are also of the same mind and the prospects for a Phase IIIB amateur satellite are thus looking better.

The loss of the Phase IIIA satellite was outside the control of AMSAT and the spacecraft in no way contributed to the failure of the European Space Agency ARIANE launch vehicle.

The satellite represented the culmination of five years work. More than 30 man-years had gone into the program. Referring to its loss, Jan King, W3GEY, stated, "the community will never know what they lost today". However, a duplicate set of sheet metal that constitutes the spaceframe, a second set of solar panels and sensors, together with documentation and artwork to replicate all the printed boards, are on hand. The knowledge and experience gained, and the fact that a network of ground telecommand stations is ready to go, makes a Phase IIIB satellite a very viable project.

CQ electronics
and get your components
SHOP 9, TOWN CENTRE 185 DEWENT STREET
30 CAMPBELL STREET CENTRAL RAILWAY
blacktown. | sydney.
621 5809 | 698 8079

REDUCTION DIALS \$2.95
50 MM
0-100
50 MM
B/CAST
70 MM
0-100

200 \$17.50
THREE DIGIT EVENT COUNTER!
0.5" LED DIGITS - 12V SUPPLY
10MHz MAX INPUT FREQUENCY
ADD POWER SUPPLY AND TIME BASE FOR FREE QUOTE

TO 3 TRANSISTOR COVERS 5 FOR \$1.00

TO 3 TRANSISTOR INSULATING KITS 5 FOR \$1.00

SE 7055 (BF 336) 225V VIDEO TRANSISTOR INCREDIBLE VALUE 4 FOR \$1.00 2 SD 200 SPECIAL \$1.95 EA.

LOOK
416 - 200MS.
16K DYNAMIC MEM.
8 FOR \$40.00
WHILE STOCKS LAST

AIR SPACED CERAMIC CAPS 10, 15, 20 & 30 pF \$2.50 EACH

8888 \$27.50
FOUR DIGIT EVENT COUNTER
0.5" LED DIGITS - 5V SUPPLY
4MHz MAX INPUT FREQUENCY
ADD POWER SUPPLY AND TIME BASE FOR FREE QUOTE

VALUE DP. DT 240V AT 2AMP ROCKER SWITCH
4 FOR \$1.00

COMBINATION SOCKETS
3.5+3.5+2.5 10 FOR \$1.00
3.5+2.1 DC 10 FOR \$1.00

SPECIAL!!
Z 80 4MHz \$11.00
Z 80 CTC \$7.00
Z 80 PIO \$8.00
8251 JART \$5.00
WHILE STOCKS LAST

NEW 11 TUBE ROD (NO SCHEM) GRAPHIC EQUALISER KIT \$19.50 (MOND)

LIGHT CHASER KIT \$62.50
AUGUST 1980 ELECT AUT
COMPLETE KIT SUPPLIED IN OUR OWN INSTRUMENT CASE
PACK AND POST \$3.00

EPROM \$72.50 PROGRAMMER KIT
SUPPLIED IN OUR OWN STANDING INSTRUMENT CASE 1.00 TO 500MHz \$3.00
NEW OUTRIG SUITS T8180. SELECTED THE COMPATIBLE II.

SPECIAL!! DUAL GATE MOSFET CA 3028A \$1.00 \$2.25

THERMISTORS
G 55 B GLASS BEADS
180 Ohm to 500 Ohm
300c - 20c
3 FOR \$1.00

VALUE! PLASTIC PC BOARD STAND OFFS 20 FOR \$1.00 100 FOR \$4.00
PLASTIC 4 CABLE TIES 20 FOR \$1.00 100 FOR \$4.00

Capacitors and resistors, integrated circuits, wires and cables, semiconductors, fuses, knobs, Radio and TV valves, plugs and sockets, pots, Manufacturers of PC boards and disco lighting

Price subject to change without notice
Pack and postage within Australia \$1.00
02-621 5809 CQ ELECTRONICS 30 CAMPBELL ST BLACKTOWN 2148
WRITE

Radio clubs and other organisations, as well as individual amateur operators, are invited to submit news and notes of their activities for inclusion in these columns. Photographs will be published when of sufficient general interest, and where space permits. All material should be sent to Pierce Healy at 69 Taylor Street, Bankstown

The Australian CB SCENE



NOVEMBER — 1980 CONVENTION, A NEW P&T MINISTER

Hello once again. The month of November should prove to be an interesting one for the CB operators of Australia. The Federal Elections should be over by the time you read this, and we will have a new Minister for Post and Telecommunications. We can only hope that he will take the same interest in CB as did Mr Tony Staley.

This month also sees the NCRA 1980 Convention here in Brisbane. Mr Ross Ramsay, the Acting First Assistant Secretary of P&T has promised that he will attend both the National Assembly and National Council meetings (provided of course that he has been given the post of FAS as a permanent position). He has also promised to answer questions from the floor at both the meetings. It is to be hoped that he may be able to indicate at least some of the findings of the current inquiry into the CBRS. Literally thousands of submissions were received by the Department and it will have a mammoth task in sorting them all out. But they must surely come up with some improvements to the Service.

I know that Ross Ramsay is a very dedicated man, who will be fair in his dealings, and we are hopeful of hearing good news at the Convention.

Our second guest speaker at the Assembly meeting will be Mr Bernie Bischa, the owner of OLBIS INDUSTRIES, Ipswich Road, Oxley, Brisbane. Bernie has been a CB retailer since way back, and is one of the few in Queensland to still be around. Bernie's subject will be "The State of the Industry".

Don't forget the date and Venue of the meeting. It is being held at the Astor Motel, Wickham Terrace, Brisbane, on November 22 and 23.

MAIL BAG

I received a letter from Mr Albert Davey who tells me that he reads my column in the library at Cottesloe (WA). Albert belongs to the so-called "Cherrokee Group", mainly avid DXers. He assures me that the folk in West Australia are just as concerned about the retention of 27MHz after 1982 as are the rest of us.

Because of the size of Australia, people in WA sometimes think that we on the

East Coast have forgotten about them or, even worse, that we don't care what they think about things! I would like to assure Albert and other WA readers that such is not the case: that their opinions are just as important as anyone else's.

Cottesloe is about 5km from the Port of Fremantle so, if any readers hear the Cherrokee Group calling on air, they will know where the call originates from. In response to your question, Albert, my address is a suburb of Brisbane. Thanks for your letter and I look forward to hearing from you again.

Also in the mailbag this month was a copy of the submission made by the Amateur & CB Club of NSW. The author is Mr Sam Voron. I read the submission carefully and commend Sam and his club for their enthusiasm. Some of the points made I agreed with, others I didn't — but this is only to be expected.

Really, it is quite incredible to see the range of opinions on the same subjects but I guess that this just proves that CB is different to all of us. Top marks to Sam, his club, and all the others who took the time and trouble to send in submissions.

From the ACRM (Qld) comes a letter which reads as follows:

"ACRM is a club formed to provide a

NEW UHF TRANSCEIVER

CBers interested in the UHF band will be pleased to know that a new transceiver is due for release this month. Marketed under the Apollo brand, it covers the normal 40 channels between 476.425 and 477.400MHz and meets other Australian P&T specs. in RB250. Rated RF power output is 5 watts, sensitivity 0.3uV and selectivity $\pm 25\text{kHz}$ for -60dB . For details contact the Mathews Haritos Group, Cnr Punchbowl & Yerrida Rds, Lakemba, 2195. Phone (02) 750 6666.

CB service to the CBer and through the CBer the general public. We monitor the Emergency Frequency on both 27MHz and also UHF.

"If you need assistance of any type, in any situation, we will do everything we can to assist you: whether it be a fire, traffic accident, your car broken down, or you wish to report some suspicious behaviour. Call us if you require the number of an after-hours chemist or the address of a rostered service station on weekends, and we will have the answer for you.

"We want you to help us to help others. If there is a traffic hazard or if traffic lights are not working, tell us and we can tell others.

"Who are we? No one special. We don't wear uniforms, halos nor do we have wings on our backs and we are not on an ego trip. We are from all types of trades, professions and walks of life. Some of us are retired, some are housewives and some are senior high school students. We are together because we saw the need for this type of service.

"We are working together with other organisations to provide a worthwhile service to all CBers and public alike. If you have a sick relative at night and the doctor gives you a prescription to alleviate the patient's distress, that to us is an emergency, so we have the addresses for you of chemists who are open seven days a week, 24 hours a day to have that prescription filled.

"We don't get paid, not even our phone bills. We like to think that if we called you for help you would not send a bill. That is how simple it is.

"Next time you are driving home and something catches your eye that you think we should know about, pick up the mike and ask, 'Is there an ACRM monitor on frequency?'"

I would like to thank the Queensland Division of the Australian Citizens Radio Monitors (ACRM) for their letter informing us all about their work. People interested in finding out more about ACRM (Qld) can write to PO Box 213 Everton Park, Qld 4053, or phone (07) 59 4682.

While it is gratifying to receive such a helpful letter as the one above, the fact is that I am far from happy about CB emergency services in general.

Surely it is high time that the Emergency Monitoring Groups stopped their in-fighting. I hear them fighting over skip calls, and bitching at one another. Even executive members of groups are not above throwing smart comments over channel 5 about other groups.

Worse still, this kind of behaviour is tending to become the norm rather than the exception. There is even trouble between members of the same group in the same State! Is this what they believe they are there for?

I firmly believe that it is high time for the members, and especially the executive members of the emergency monitoring groups, to take a long hard look at themselves and what they stand for.

Because of my involvement with the NCRA I have come into close contact with a number of these groups and have been able to get a more or less "inside view" of events. My proposals, for what they are worth, on the solution to this problem follow. I would appreciate hearing comments from the Emergency Groups. I would also like to hear comments from my readers who are not members of these groups.

1. There are too many chiefs and not enough Indians! This can lead to a situation where executives are pre-occupied with their position on the ladder, rather than how with effectively they can serve CB and the community.

2. Streamline the administrative structure to reduce the dominance of Federal and even State executives. When dealing with purely local matters, there is surely no need for "big brother".

3. Give monitors a bigger say in policy making. No changes in policy should be made without the majority consent of those who have to adhere to them.

I guess that what I am saying is that monitors and CBers generally are being overlooked in the squabbling at executive level. By all means gather the respective areas under the one banner and use the same basic operating procedures, but leave it at that. Get the personal politics out of saving people's lives!

I feel for the monitors. Their job is being made harder by all this in-fighting. Surely they have enough to contend with under normal circumstances, without having to worry about politics as well. They deserve double the praise for the fine work they are doing under very trying circumstances. I wish them well.

If you would like to write and let me know what is happening on the air around your area, or would just like to express an opinion, please write to me at PO Box 406, Fortitude Valley 4006.

... Jan Christensen

If you have a good all-round understanding of electronic technology ...

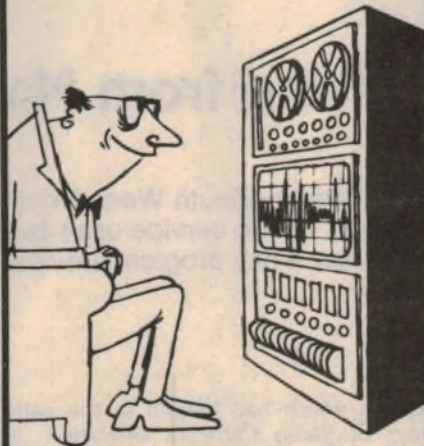

... and the ability to write clear prose

YOU COULD QUALIFY FOR A POSITION ON THE STAFF OF "ELECTRONICS AUSTRALIA"

You will need to be resident in Sydney and be able to commence work without undue delay.

A permanent position is envisaged, with opportunity for advancement, plus full leave, sickness and superannuation provisions. As for salary, that will depend on your present background and experience, but let's start talking around \$13,000 per annum.

Apply by letter, stating experience and enclosing copies of references and any sample essay or article that you may have written to:

The Editor in Chief,

ELECTRONICS AUSTRALIA,

57 Regent Street, Chippendale 2008.

SWITCHCRAFT
CONNECTORS & ELECTRONIC COMPONENTS

Superb quality and reliability from one of the oldest and most experienced manufacturers in the U.S.A.

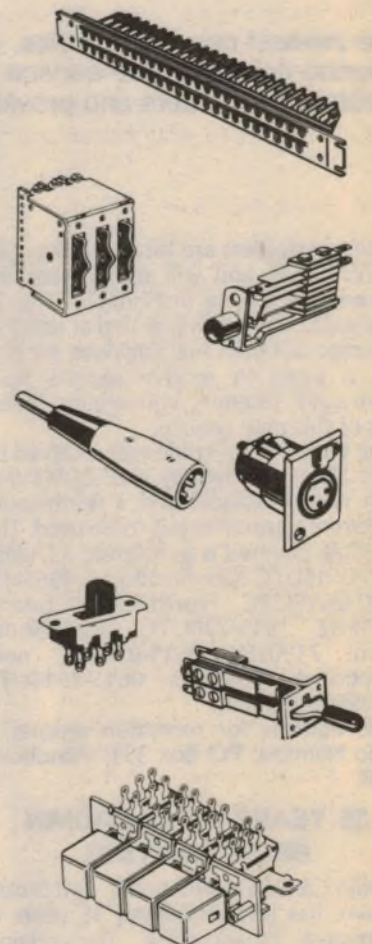

**AUSTRALIAN DISTRIBUTORS
AUDIO TELEX COMMUNICATIONS
PTY. LTD.**

SYDNEY
1 Little Street,
Parramatta, 2150
Tel: 633 4344

MELBOURNE
7 Essex Road,
Mt. Waverley, 3149
Tel: 277 5311

BRISBANE
394 Montague Road,
West End, 4101
Tel: 44 6328

SHORTWAVE SCENE



by Arthur Cushen, MBE

New Shortwave Service from Namibia

The newest country in Africa, Namibia, formerly South West Africa, opened its shortwave service on October 1. The service uses two 100kW transmitters and provides a 24 hour a day program service.

The transmitters are located 15km east of Windhoek and will supplement the present FM service in Namibia. The 24 hour a day operation is aimed at national coverage but the Chief Engineer, Mr Hippie, is keen to receive reports from short-wave listeners concerning reception of this new service.

The tentative schedule was received by Chris Martin of Sydney and shows that both non-directional and a north-south pattern of transmission is to be used. The schedule planned is as follows: 3270kHz 1615-0515UTC non-directional; 4965kHz 0300-0615UTC North/South beam; 4965kHz 1515-220UTC North/South beam; 7190kHz 0515-615UTC non-directional; 9650kHz 0615-1515UTC North/South beam.

The address for reception reports is Radio Namibia, PO Box 321, Windhoek 9100.

35 YEARS OF CANADIAN BROADCASTING

Radio Canada International, as it is now known, has just celebrated 35 years of shortwave broadcasting. The original 50kW transmitters were installed in Sackville, New Brunswick, and the station went into operation in 1945, staffed mainly by BBC personnel. Prior to this a 7½kW transmitter located near Montreal was in service.

Our records show that the early broadcasts were beamed to Europe. A 1946 letter from J. A. Acton, Senior Engineer of the International Service appointed the writer their Technical Observer and expressed appreciation for previous

Notes from readers should be sent to Arthur Cushen, 212 Earn Street, Invercargill NZ. All times are UTC (GMT). Add eight hours for WAST, 10 hours for EAST and 12 hours for NZT.

reports which had helped in the early days of Radio Canada's operation. In June 1947 a cablegram received from Radio Canada announced the beginning of test transmissions to the South Pacific which eventually became the South Pacific Service, operating for nearly 30 years.

In more recent years the 50kW transmitters were replaced by 250kW units and Radio Canada extended its schedule to operate almost 24 hours a day, concentrating on transmissions to Europe, Africa, South America and the United States. At the same time a separate transmission is carried on the Northern Service for listeners in Northern Canada who are beyond the reach of medium-wave transmissions.

Although Radio Canada does not broadcast to the South Pacific the transmissions to Europe and Africa in our afternoons provide good reception. Broadcasts are in English at 0200-0227UTC, 0300-0327UTC and 0400-0427UTC with the best reception on 9535, 9560 and 11845kHz during the last transmission.

On Mondays 25 minutes of the 0400 broadcast is devoted to DX digest and information for the shortwave listener.

TOKYO CALLING

Tokyo Calling is a program of music, DX news and information on Radio Japan heard on Sundays at 0950UTC on 11875 and 15235kHz. Those working on the program are Yoshitaka Yoshioka, a 20 years veteran announcer-producer, and Jiro Hara. These two announcers take turns in sharing the weekly production work, doing research, writing the script and selecting music.

The third member of the team is Miss Toshi Morikawa who runs tapes, spins

discs and gives cues. Miss Morikawa, who reads the DX news in the program, is the only female regular member of the staff of the English Service.

The DX news is contributed by Mr Yoshio Kabayashi, a mainstay member of Japan Shortwave Club who has been the regular contributor to Radio Japan for the past twenty years. Tokyo Calling is beamed to all parts of the world and the staff are interested in comments on the program, which can be sent to Tokyo Calling, NHK Tokyo, Japan.

RADIO SUPER

Radio Super broadcasts from Colombia have been heard on four frequencies during the evening listening period. The Bogota transmission, heard around 0800UTC on 6065kHz, is the most reliable and broadcasts from Radio Super at Medellin on 4875kHz have been also observed around the same time. Broadcasts on Radio Super at Cali have been noted on two frequencies: 6085kHz and 6125kHz. The fourth station is La Voz del Llano, Villavicencio, operating on 6115kHz which is also carrying Radio Super programs and broadcasting 24 hours a day.

The Radio Super network in Colombia is quite extensive and these four transmissions on shortwave carry independent programs, but generally link for news and other major events on a national network basis.

VOA COLOMBO EXPANDING

Plans are underway for an expansion of the Voice of America facilities in Sri Lanka according to Victor Goonatileke, reporting in UADX. The new relay station will be located at Seeduwa, the present site of the VOA receiving station. The plan is for four 250kW and two 100kW shortwave transmitters to be built with supporting antennas beamed at South Asia, the Middle East and Africa.

At present the Voice of America uses one 10kW and two 35kW transmitters. The Sri Lanka Broadcasting Corporation uses a third 35kW transmitter built by VOA, and when the other transmitters are not in use by the Voice of America

SHORTWAVE SCENE

they carry SLBC programs from 1030-1130UTC and 1845-1945UTC. When the new installations are completed the SLBC will have the use of one 100kW transmitter and the others will be put into service when not required by VOA.

ANTENNA BOOKLET

Radio Nederland DX Jukebox has promoted various aspects of shortwave listening for many years and has several correspondence courses available, including the All Round DXers course and a course on antenna design. Production of a booklet on antenna design has now passed the 60,000 mark. The booklet is currently being reprinted and is available free of charge to listeners who write to DX Juke Box, Radio Nederland, PO Box 222, Hilversum, Holland JG 1200.

The antenna booklet is a comprehensive coverage of various types of antennas, and over the years has proved very helpful to those who wish to improve reception with an outdoor or indoor antenna.

CHINESE ARMY RADIO

The Chinese Army Radio, which broadcasts two programs a day to Taiwan, has recently reorganised its transmission schedule. According to the BBC Monitoring Service, the People's Liberation Army Fujian Front station no longer relays programs from Radio Peking's Taiwan service and overall broadcasting output has been reduced. The schedule is 2100-0500UTC and 1000-1800UTC. At 1000UTC, the frequencies in use are 4045, 5240, 5265, 5900, 6765 and 7850kHz. There is continuous coverage on medium-wave on 666, 846, 1016 and 1266kHz.

NEW DEUTSCHE WELLE RELAY

The Government of Sri Lanka has signed an agreement with Deutsche Welle for the establishment of a new relay base in that country, according to the BBC Monitoring Service. The agreement, which is to run for 20 years, provides in the first stage for the installation of a 600kW medium-wave transmitter and three 250kW shortwave transmitters. In the second stage, Deutsche Welle will construct three more shortwave transmitters if it becomes necessary.

The Sri Lanka relay station, which will ensure the reception of Deutsche Welle's broadcasts in Asia, will complete a world-wide network of overseas relay stations. Deutsche Welle currently broadcasts from transmitters in West Germany and from relay stations in Sackville, Canada; Kigali, Rwanda; Sines, Portugal; Malta; and Antigua.

NEW MOROCCAN VOICE

Last year a French organisation set up a huge transmitting complex in Gabon, known as Africa No. 1, with the idea of leasing time to international broadcasters. Now comes news of a new station with a similar role in Morocco. A French Company has been entrusted with the building of the radio transmitter station in Nador in North Eastern Morocco to which the Moroccans and the French will contribute 51 and 49% of the cost respectively. The Nador radio station, which should be completed this month, will have two long wave transmitters to cover the whole of Morocco and a shortwave transmitter to cover the Middle East and Africa.

The foundation stone for the station was laid by the Moroccan Minister of Information in July and the Minister will be the chairman of the operating body, the Radio Mediterranee Internationale, which will have its headquarters in Tangiers. According to the BBC Monitoring Service, an agreement on the use of the radio station had been signed between the Moroccan government and Radio Mediterranee Internationale.

SOUTH AMERICAN NEWS

BRAZIL: Radio Nacional at Rio continues to be heard on 9705kHz closing at 0300UTC, and afterwards Radio Mexico has been observed on the same channel. According to information given by "Sweden Calling DXers" the power of the transmitter is 10kW and it is located at Itacoa, near the city of Sao Goncalo in the state of Rio de Janeiro.

ECUADOR: HCJB in Quito has recently commenced a two program English Service to the South Pacific. The full transmission is 0700-1000UTC on 6130, 9745 and 11900kHz; between 0800-0930UTC a new program is heard on 6130 and 11900kHz while 9745kHz continues to broadcast the previously scheduled programs. This means that the DX Party Line broadcast on Monday, Thursday and Saturday 0900-0930UTC is now heard only on 9745kHz.

PERU: A new station with the slogan "Radio San Martin, Tarapoto" has been heard on 4810kHz. Reception in New Zealand was up to sign-off at 0455UTC when full station details were given. Ray Crawford of Invercargill NZ reports that this station gave a complete close-down announcement including information on medium and shortwave frequencies. It is thought that the station opens for the day at 1100UTC, at which time reception should be possible in Australia.

GUATEMALA: Adventist World Radio is now broadcasting from Guatemala City with the slogan "Union Radio". The station operates on medium-wave, FM and shortwave on 5978kHz. The shortwave transmitter operates 0100-0500UTC with gospel programs, some of which are in English. The address is Adventist World Radio, Box 350, Guatemala City.

RAY CROSS ELECTRONICS SUPERMARKET

HOBBYIST
ELECTRONIC COMPONENTS



A
**DICK SMITH
DEALER**

KIT SETS - GADGETS - BOOKS

Dimensional Fidelity

RF

Ray Cross Electronics
Stereo Hi-Fi Centre

SOUND SPECIALS

Bulk deal on cassettes.

TDK SA 90	\$4.00
HITACHI UDC 90	\$2.90
OPUS UDC 90	\$2.00

151 BORONIA ROAD,
BORONIA 3155 VIC.
Phone (03) 762 2422

PLUGS - SOCKETS - CIRCUIT BOARDS - SEMI-CONDUCTORS - STYLUS - VALVES

RESISTORS - CAPACITORS - TRANSISTORS - SPEAKERS - TRANSFORMERS

SENSITIZED COPPER BOARD RISTON 3000 COATED

(Fibreglass Base)

	Single Sided	Double Sided
24"x36"	\$42.50	\$56.50
24"x18"	\$22.00	\$30.00
24"x12"	\$15.00	\$20.00
18"x18"	\$17.00	\$22.60
18"x12"	\$12.00	\$16.00
12"x12"	\$ 8.00	\$10.75

PRICES EX STORE

Developer 1 Litre	\$ 4.25
4 Litres	\$12.50

3M Photosensitive Metal
& Film: Image N Transfer

101 Burgundy Street,
Heidelberg, 3084.
(03) 458 2976
(03) 459 2892
Telex: AA37678
Regional Centre,
Western Highway,
Melton, 3337.
(03) 743 1011

KALEX

Electronic Components & Accessories

what can

- 1 Fall from the back of a moving truck
- 2 Bounce down the stairs of a drilling platform
- 3 Survive a helicopter crash
- 4 Withstand being rolled over by a loaded dump truck
- 5 Endure the day-to-day bouncing, jostling, bumping and lugging of portable operation

and still work? *

(Here's a Hint)

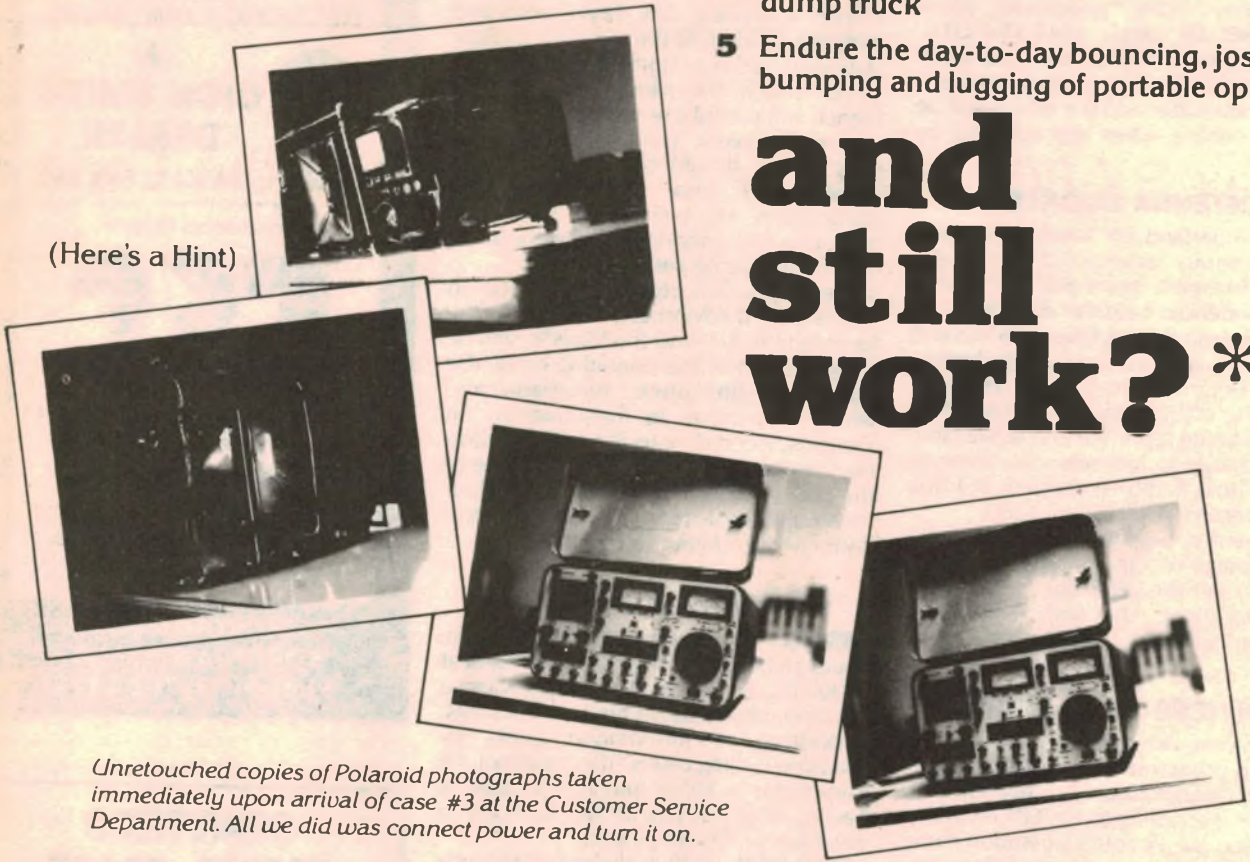

Unretouched copies of Polaroid photographs taken immediately upon arrival of case #3 at the Customer Service Department. All we did was connect power and turn it on.

* **answer:**  **Service Monitors...**

FM/AM-1000A and FM/AM-1000S

All of These Features Are Standard...at a Price Far Below Competitive Monitors

- FM/AM Generator 100 Hz to 1 GHz
- Built-in Battery
- DC-1 MHz Oscilloscope
- RF Wattmeter with built-in load — 20 watts continuous, 100 watts for 30 seconds
- FM Deviation Meter
- Sensitive Monitor Receiver
- Precision Audio Generator 5 Hz to 10 kHz... (FM/AM-1000S) 10 Hz to 10 kHz plus 1 kHz fixed tone
- RF Output 0.05 μ V to 5000 μ V (FM/AM-1000A) 0.05 μ V to 224 mV (FM/AM-1000S)
- Accurate Master Oscillator FM/AM-1000A — Oven-stabilized Crystal 0.00005% FM/AM-1000S — TCXO 0.00005% (typically 0.00002%)
- Spectrum Analyzer (FM/AM-1000S)
- RUGGED CONSTRUCTION

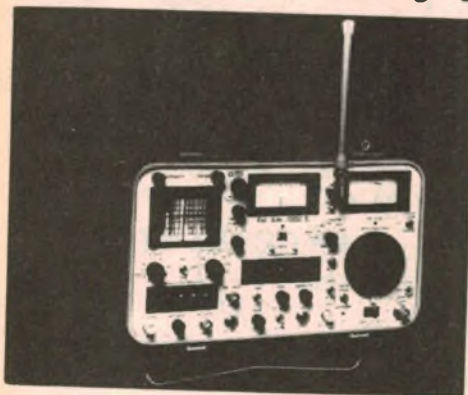

Australian, PNG, N.Z. and Pacific distributors:

**Sydney: 339 Pacific Hwy, Crows Nest.
Ph. 436 2766**

Melbourne: 68 Eastern Rd., Ph. 699 6700

YCOM



NEW PRODUCTS

Elbex EX-803 B&W TV Camera has Zoom Lens

With the ever increasing popularity of video recorders these days, there is also an increasing demand for low cost cameras. The Elbex EX-803 television camera has been designed to fill this need with features such as remote control of the video recorder, built-in electret microphone and styling that is typical of modern movie cameras.

Made in Japan and marketed in Australia by Vicom International, the EX-803 actually comprises two pieces of equipment: the camera and power supply unit. The power supply unit, apart from supplying the power to the camera, is also the terminating point for the video and audio signals. The camera is connected to the power supply unit via a 2.5m cable terminated with a 6-pin DIN connector.

The camera itself is no larger than a typical movie camera, measuring 74 x 212 x 240mm and weighing at 1.2kg. The power supply unit measures 105 x 76 x 110mm and weighs 0.53kg.

The camera uses the industry standard 17mm (2/3 inch) separate mesh vidicon tube which has the advantage of higher sensitivity and lower lag than previous types.

The camera also features automatic light control (ALC) operative over a range of 30 to 10,000 lux. The lens (not interchangeable) has a fixed aperture setting of f1.8 and features a 4:1 zoom capability which varies the focal length from 10 through to 40mm. The focusing range of the camera is from 1.2m to infinity.

Focusing is achieved with a reflex viewing system employing a split-image micropism system.

The specifications of the EX-803 are entirely compatible with Australian TV standards. The scan is 625 lines with 2:1 interlacing, unlike other low cost CCTV cameras which use random interlacing. Signal to noise ratio is better than 40dB while the ALC range is 333:1. The composite video output is 1V p-p (into 75 ohms) and the audio output is 100mV RMS. Total power consumption of the EX-803 is 7 watts, making it quite feasible for use with portable VCRs where the camera can be plugged in without the power supply.

The video output circuit of the camera requires a 75-ohm load (DC) for its open

emitter transistor stage to work correctly. This can be assumed to be present if the camera is used with a video recorder but if it is used with a TV monitor an external 75-ohm resistor load may have to be provided.

As mentioned previously, the video and audio outputs are located on the power supply unit, the video output being available through an RCA connector, while the audio output is a 3.5mm jacket socket. A remote control feature is also made available on the power supply unit, using a 2.6mm jack socket.

The Elbex EX-803 features a zoom lens, ALC, through-the-lens viewing, remote control of VCR and removable pistol grip.

A variety of leads are available for the EX-803 allowing the camera to be used with almost all popular video recorders to be found on the market. There is also a 6m extension lead available for use between the camera and the power supply.

The case for the camera is moulded in black impact-resistant plastic with a matte finish. The cover is a two piece assembly, held in place with four small

self-tapping screws on the base, and by moulded clips at the top. Removal of the covers reveals a neat and compact assembly, with all the electronics contained to two small PCBs. The camera appears to be quite well made and if the service manual is any indication, it should be easy to service and maintain.

The pistol grip has a tripod mounting hole at the base, but can be removed if this is desired. When the handgrip is removed the camera mounts directly onto any standard tripod.

We really appreciated the reflex viewing system on the Elbex. While a through-the-lens viewing system is not necessary for cameras which are mainly intended for CCTV applications, VCR applications do require a focusing system other than via a monitor. The zoom lens is also a very good feature which can make for a polished result.

We also found the automatic light con-



trol (ALC) to be quite effective although the room lighting must still be fairly high to produce reasonable results. At the other extreme, bright outdoor sunshine may overload the Vidicon. So, even though the camera has ALC, an adjustable aperture on the lens would be desirable. However, provided the lighting is within the range of the ALC, picture quality is fine, with good resolution and contrast.

NEW!

"THE BIG BOARD"
OEM - INDUSTRIAL - BUSINESS - SCIENTIFIC
SINGLE BOARD COMPUTER KIT!
Z-80 CPU! 64K RAM!

NEW!

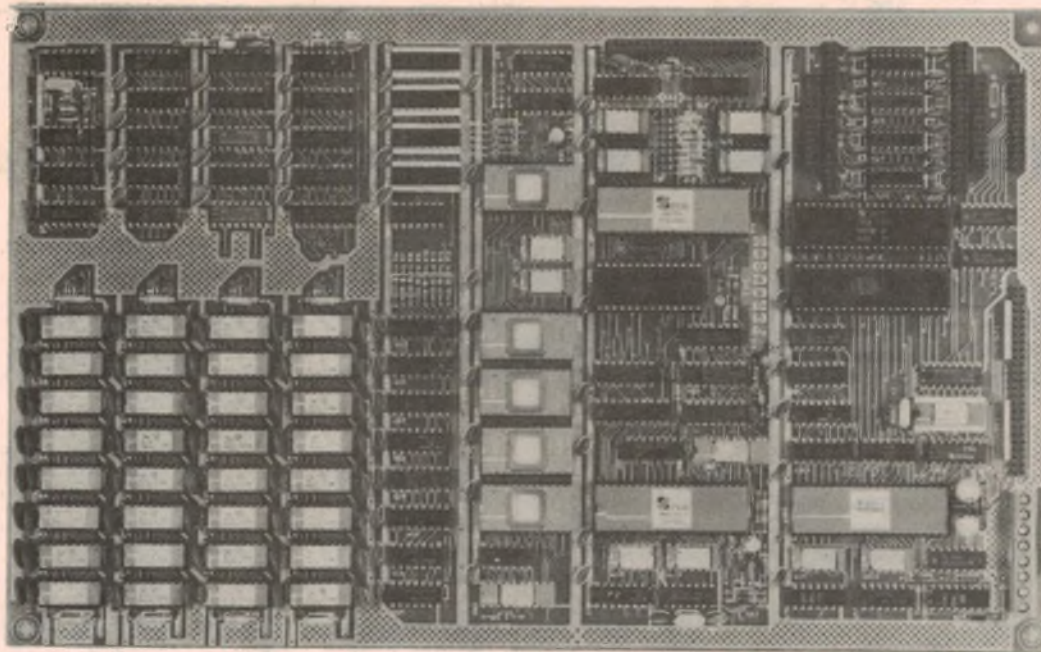

THE FERGUSON PROJECT: Three years in the works, and maybe too good to be true. A tribute to hard headed, no compromise, high performance. American engineering! The Big Board gives you all the most needed computing features on one board at a very reasonable cost. The Big Board was designed from scratch to run the latest version of CP/M*. Just imagine all the off-the-shelf software that can be run on the Big Board without any modifications needed! Take a Big Board, add a couple of 8 inch disc drives, power supply, and an enclosure, and you have a total Business System for about 1/3 the cost you might expect to pay.

\$695.00 (64K KIT BASIC I/O)

SIZE: 8 1/2 x 13 3/4 IN.
SAME AS AN 8 IN. DRIVE.
REQUIRES: 5V @ 3 AMPS
12V @ 5 AMPS.

FEATURES: (Remember, all this on one board!)

64K RAM

Uses industry standard 4116 RAM'S. All 64K is available to the user, our VIDEO and EPROM sections do not make holes in system RAM. Also, very special care was taken in the RAM array PC layout to eliminate potential noise and glitches.

Z-80 CPU

Running at 2.5 MHZ. Handles all 4116 RAM refresh and supports Mode 2 INTERRUPTS. Fully buffered and runs 8080 software.

SERIAL I/O (OPTIONAL)

Full 2 channels using the Z80 SIO and the SMC 8116 Baud Rate Generator. FULL RS232! For synchronous or asynchronous communication. In synchronous mode, the clocks can be transmitted or received by a modem. Both channels can be set up for either data-communication or data-terminals. Supports mode 2 Int. Price for all parts and connectors: **\$95**

BASIC I/O

Consists of a separate parallel port (Z80 PIO) for use with an ASCII encoded keyboard for input. Output would be on the 80 x 24 Video Display.

24 x 80 CHARACTER VIDEO

With a crisp, flicker-free display that looks extremely sharp even on small monitors. Hardware scroll and full cursor control. Composite video or split video and sync. Character set is supplied on a 2716 style ROM, making customized fonts easy. Sync pulses can be any desired length or polarity. Video may be inverted or true.

FLOPPY DISC CONTROLLER

Uses WD1771 controller chip with a TTL Data Separator for enhanced reliability. IBM 3740 compatible. Supports up to four 8 inch disc drives. Directly compatible with standard Shugart drives such as the SA800 or SA801. Drives can be configured for remote AC off-on. Runs CP/M* 2.2

FOUR PORT PARALLEL I/O (OPTIONAL)

Uses Z-80 PIO. Full 16 bits, fully buffered, bi-directional. User selectable hand shake polarity. Set of all parts and connectors for parallel I/O: **\$45**

REAL TIME CLOCK (OPTIONAL)

Uses Z-80 CTC. Can be configured as a Counter on Real Time Clock. Set of all parts: **\$25**

PFM 3.0 2K SYSTEM MONITOR

The real power of the Big Board lies in its PFM 3.0 on board monitor. PFM commands include: Dump Memory, Boot CP/M*, Copy, Examine, Fill Memory, Test Memory, Go To, Read and Write I/O Ports, Disc Read (Drive, Track, Sector), and Search. PFM occupies one of the four 2716 EPROM locations provided. It does not occupy any of the 64K of system RAM!

CP/M* 2.2 FOR BIG BOARD

The popular CP/M* D.O.S. modified by MICRONIX SYSTEMS to run on Big Board is available for \$150.00.

REGISTERED PACK & POST \$5.00

TERMS CASH CHEQUE OR BANKCARD (MIN \$100 DEP)

ALL PRICES PLUS TAX IF APP
DELIVERY 3-8 WEEKS ON ORDER



RITRONICS WHOLESALE

425 HIGH ST., NORTHCOTE VIC

481 1923 489 7099 PO BOX 235

Bankcard Mail Orders Welcome

Please debit my Bankcard

Bankcard No

Expiry Date

Name

Signature

New CB units from Apollo

Recent and interesting additions to the range of CB equipment currently available in Australia include a base unit and a mobile unit carrying the Apollo brand. They are being released through the Mathews Haritos Group, along with a new hand-held marine transceiver, with provision for up to six channels.

As noted elsewhere, the Mathews Haritos group are also about to introduce to the market a new, imported 40-channel UHF CB transceiver. We understand that the price will be slightly above that quoted for the existing Philips FM-320 but the claim is that it compares more than favourably in terms of overall performance.

While the UHF transceiver was not available at the time of writing, we had the opportunity of using the two 27MHz CB transceivers under typical conditions over a period of two or three weeks. Our reactions to them are therefore on the basis of a purchaser/user, rather than on bench testing in a laboratory.

On receiving the units, one of our first actions was to remove the lids to take a peek at the "innards". More or less as we expected, both were built up around recognisable modules, seen in other brands. In this case, they were from the well-proven Cybernet stable, using a PLL-02 phase locked loop to synthesise the various essential frequencies.

In fact, the AP-701 "Super de Luxe AM/SSB" mobile unit appears to be housed on the same chassis as the popular Super Panther and American Electronics transceivers. The external appearance is neat, with all controls being readily identifiable and accessible in a vehicle situation. The channel selector features a two digit readout displaying channels 1 to 18.

Other features to be found on the unit are an SWR scale on the built-in meter, together with the appropriate Set and Read pot. The accuracy of the internal SWR bridge is reasonable, but it is still probably best to use one with a larger scale during setting up, treating the in-built meter as an "all is well" indicator.

There are three toggle switches on the front panel: an SWR/S meter selector, a noise blanker and an RF gain switch; the last named functions in the same way as the DX/Local switch on the Super Panther.

Other rotary controls include a mode switch for AM/USB/LSB, volume/off, squelch/PA, and a dimmer which permits a reduction in the brightness of the chan-



▲ Above: the AP-701 mobile unit

◀ Left: the 6-channel hand-held marine transceiver

▼ Below: the AP-708 CB base station.

nel read-out, in situations where it might cause visual distraction. A small indicator in the top right-hand corner glows with amplitude modulation.

We mounted the set in a car for about two weeks and tried it out under all the normal operating conditions. Performance proved to be eminently satisfactory.

Points worthy of note include the noise blanker, which appears to perform better than in other units using ostensibly the same chassis. We were impressed with the way in which it coped with ignition noise — a definite plus.

And we were also very happy with the effect of the RF gain switch. When set to the off (local) position, it retained



enough sensitivity to receive stations over reasonable distances, while rejecting the in-between babble of Sunspot DX — an intrusion, if you are not specifically interested in DX working.

In all, we found the Apollo AP-701 mobile a pleasure to use and, with the foregoing evidence of minor refinements, it should prove to be a very popular unit. Recommended retail price is \$273.00.

The second of the two units, the Apollo AP-708 base station, has extras which distinguish it from earlier models from the same source manufacturer.

The first thing that you notice is the size. It is housed in quite a large case, and examination of the front panel reveals the reason: there are enough knobs and buttons to keep even the most demanding enthusiast occupied for quite some time!

Among the features are a built-in SWR bridge, variable modulation depth in the AM mode, a high and low tone switch, and a tape output socket which allows "off air" recordings to be made with a minimum of hassle.

It should be noted, however, that the use of the recording output (an RCA socket at the rear) is restricted to received signals only, since stray RF is likely to interfere with the recording when in the transmit mode.

The unit was hooked up to a half-wave ring-fed antenna (Ringo) situated about eight metres above ground level, and proved to be entirely satisfactory in operation.

One thing we did notice, when the set was first switched on, was the excellent



New Products

sensitivity of the receiver. The test was conducted in the northern beaches area of Sydney, and the number of DX signals received was quite staggering. Just to make sure there were no freak conditions, we set up an older base station next to it and switched the antenna between the two. The result showed that the receiver in the Apollo unit was much the more sensitive. Under high gain conditions, we noted some background hash but the noise blanker and ANL dealt with this very effectively.

We also checked on the accuracy of the in-built SWR unit by comparing it with a known external unit. In a practical situation we obtained readings of 1.35:1 and 1.3:1 respectively, which we felt to be highly reassuring.

Another useful feature is an antenna warning indicator light, mounted on the front panel. It is off under normal operating conditions, but comes on if the SWR of the antenna system exceeds 4:1 — presumably due to something having come adrift.

The adjacent channel rejection of this unit appeared to be on par with other similar units, still allowing break-through under "seige" conditions from the operator in the next block.

Inside the case we found that a heavier transformer has been used in place of the rather over-worked types found in the earlier models. Noticeable is the lack of flickering of the meter lighting during modulation — a welcome improvement.

One minor annoyance is the use of a DIN plug for the microphone — a change which compromises its compatibility with a lot of other CB gear. On the other

hand, this will be of no consequence to the CBER who wants simply to buy, install and use.

In summary, the Apollo AP-708 CB base station must be rated as an excellent performer, which will undoubtedly attract the attention of enthusiastic (and well heeled) CBERs. The recommended retail price is quoted as \$399.

More information on all these units is available from the Mathews Haritos Group, Cnr Punchbowl and Yerrick Roads, Lakemba, NSW 2195. Telephone (02) 750-6666. (G.C.)

Elbex TV camera ... ctd from p97

A small problem experienced with the camera we tried concerned the fade-in/fade-out button. This appeared to work intermittently at first and then stopped working altogether. Inspection of the PCBs revealed an unsoldered resistor leg on the video processing board, and a small spot of solder soon rectified the problem, after which the fade control worked perfectly.

In conclusion, we feel that the Elbex EX-803 black and white video camera should find ready acceptance amongst video enthusiasts. It is easy to handle and use and has the attractive feature of a zoom lens. Recommended retail price of the camera is \$399 including sales tax. It is distributed by Vicom International Pty Ltd, 68 Eastern Road, South Melbourne, Victoria or 339 Pacific Highway, Crows Nest, NSW. (G.C.)

New range of bicolour LEDs

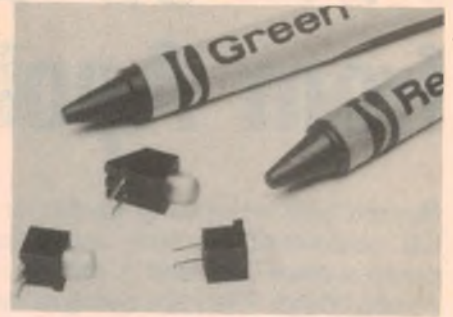

A new series of bicolour LED indicators for printed circuit board mounting has been introduced by Dialight, a North American Philips company. The indicators incorporate a red and a green chip in one package for enhanced display capability and are available in three mounting styles. Designated the Dialight 550-3000 series, they feature wide-angle viewing and provide a luminous intensity of 1.8mcd at 10mA. Power dissipation is 115mW.

Also available from Philips are four new shapes in LEDs. Plus and minus signs, triangular and square shapes can be obtained in three colours: super-red, green and yellow. The new types are designated CQX55-58 for super-red, CQX65-68 for green and CQX75-78 for yellow.

For further details contact Philips Electronic Components and Materials, 67 Mars Road, Lane Cove, NSW 2066.

Cordless 60W soldering tool



Scope Laboratories of Melbourne recently released a new version of their 60W rechargeable portable soldering iron. The new version of the iron features a green LED indicator which warns when the cells need recharging, and circuit polarity has been reversed for greater safety when recharging from a vehicle battery. The standard leather holster supplied with the iron has been re-designed to provide greater protection from residual heat and the sharp profile of some tips.

Further information is available from Scope Laboratories, PO Box 63, Niddrie, Vic 3042.

For precision soldering.
Light weight.
High power.

Fitted with
non-seize tips

From your radio parts supplier or:

Royston Electronics

N.S.W. (02) 709 5293 Q.L.D. (07) 391 8011
VIC. (03) 543 5122 S.A. (08) 42 6655
TAS. (002) 34 2233 W.A. (09) 381 5500

SD2C

ADCOLA STANDARD

No frills.
Just high
performance.
3mm S 30
5mm S 50

ADCOLA DUOTEMP

Temperature
control at your
fingertips.
3mm D 30
5mm D 50

Fully automatic
'THERMATIC'
also available.

ADCOLA

Coming! PERSONAL D.M.M.-AGE

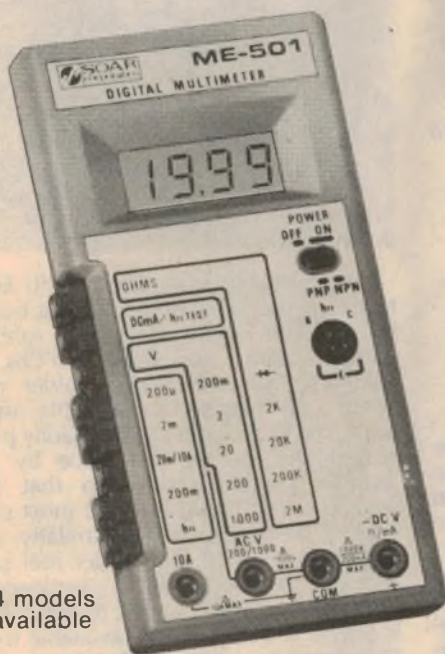

4 models available

ME-501A SPECIFICATIONS

DC Voltage

Ranges: 200 mV, 2V, 20V, 200V, 1000V
 Input R: 10 M Ohm
 Accuracy: 1 (0.8 percent of rdg plus 1 dgt)
 Overload protection: 100V dc/peak

AC Voltage

Range: 1000V
 Input R: 10 M Ohm
 Accuracy: 1 (1 percent of rdg plus 5 dgt)
 Overload protection: 1200 Vrms

DCmA:

Ranges: 200 uA, 2mA, 200 mA, 10A
 Voltage Burden: 250mV maximum at F.S.
 except 10A range, 5.00 mV
 Accuracy: 1 (1.2 percent of rdg plus 2 dgt)
 Overload protection: 0.5A/25DV Fuse

Resistance:

Ranges: 2k, 20k, 200k, 2M, Diode test
 Accuracy: 1 (1 percent of rdg plus 2 dgt)
 Overload protection: 250 Vdc/rms

Transistor Hfe Checker:

Range: 0 — 100 (IB 10 ma)
 Accuracy: 1 (10 percent of rdg plus 2 dgt)

RELIABLE DIGITAL MULTIMETERS

PROFESSIONAL RANGE

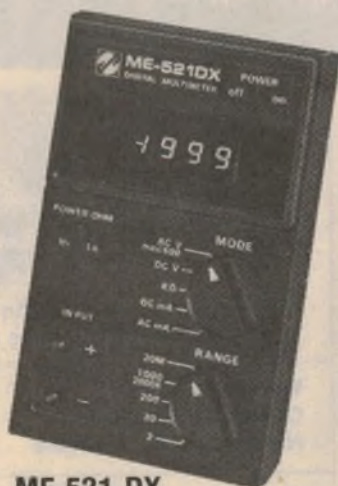

ME-521 DX
 3½ DIGIT LED DISPLAY



ME-522
 3½ DIGIT LCD DISPLAY



ME-523
 3½ DIGIT ¾" HIGH LCD
 WITH MODE DISPLAY

Digital Multimeter at an Analog price! Send for detailed specifications and compare before buying.

AMPEC ELECTRONICS PTY. LTD.

1 Wellington Street, Rozelle, 2039. Tel: (02) 818 1166.

Available from: **NSW** David Reid Electronics, 29 6601. Radio Despatch Service, 211 0191. Martin De Launay, 29 5834. Applied Technology, 487 2711. **VIC.** Stewart Electronics, 534 3733. Ellistronics, 602 3282. **S. Aust.** Protronics, 212 3111. **W. Aust.** Reserve Electronics, 328 3116. Taimac Electronics, 328 1988. **QLD.** N. S. Electronics, 36 5061.

New Products

New range of hand-held multimeters

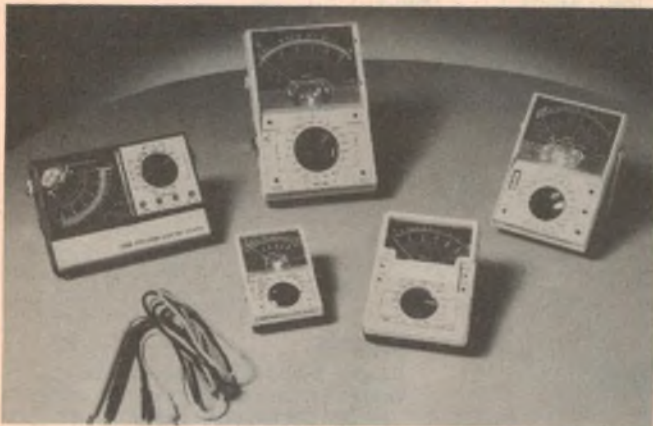

Parameters Pty Ltd has released a new range of hand-held multimeters, the YEW 2410 series, intended for professional use in maintenance, test and service applications. All five instruments in the range feature taut-band suspension and a common AC and DC scale with white lettering on a black background for readability.

The meter movements are diode protected with additional fuse

protection against overloading. Meter scales are colour-coded, as is the selection switch to simplify readings, and a single switch is used for all range and function changes.

A detailed colour brochure on the YEW 2410 series is available from Parameters Pty Ltd, PO Box 122, Mor-dialloc, Vic 3195, or 41 Herbert St, Artar-mon, NSW 2064. Telephone (02) 439 3288.

The YEW 2410 series of hand-held multimeters feature overload protection and colour coded scales for easy reading.

PC board holder from Dick Smith

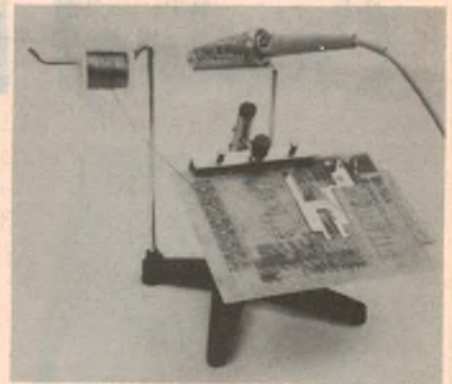

Now available from Dick Smith Electronics is the ST-10 printed circuit board holder. The holder features a rubber-padded clamp for holding PCBs, a soldering iron rest and a solder reel keeper, all mounted on a stable metal base. The PCB clamp can be readily positioned and locked into place by adjustable knurled screws so that the printed circuit board is in the most convenient working position. Similarly, the soldering iron rest and solder reel support can be adjusted for convenience.

The ST-10 Printed Circuit Board holder is priced at \$19.00 and is available from Dick Smith branches in all states.

PRODUCTS CTD ►

RADIO DESPATCH SERVICE

869 George St, Sydney 2000 (near Harris St)

Phone 211 0816, 211 0191

Rotary switch 1 pole — 6 positions special **50c**

Dome Tweeter. Model 4001 15 ohm S.T.C. special **\$9.00**

Record player perspex dust cover special **\$2.00**

Cable ties in various sizes
Plastic cable clamps 1/4", 5/16", 3/8", 1/2", 5/8"

P.C. Board stand offs 9 sizes to choose from

Technical Data Books. Fairchild, Texas Instruments, National Semiconductors, wire wrap tools. Wire & accessories

Digital Quartz Car Clock Thin Line Model 12V DC **\$18.99**

"Textool" Zero Force Insertion Socket 14 pin **\$6.22**, 24 pin **\$9.99**, 40 pin **\$10.81**

"Labgear" TV Games Combiner **\$6.31**

"Lake" CB Converter. Model 210 special **\$3.00**

"Interceptor" microwave Leakage detector **\$13.99**

CB Crystals Channels 1 — 18 special **\$3.50**

Ferguson Power Transformer PL 12/20VA/2 Prim. 240V Sec 12V 1.67A special **\$5.50**

"TDK" Gold Pak Cassette Tapes 3 X 660 5D special **\$5.90**

Cassette Storage Module Racks Model CSR4 special **\$3.40 per set**

Junior Groove Master Record & Cleaner by Metrosound special **\$2.75**

SC146D GE

1 off **\$1.20** + 15% **\$1.38**

10 off **\$1.00** + 15% **\$1.15**

SC151D GE

1 off **\$1.74** X 15% **\$2.00**

10 off **\$1.40** X 15% **\$1.61**



Hirose and Ansley Ribbon Cable Connectors fitted same day.

Watch batteries
Calculator batteries
Nicad battery charges

We specialise in P.C. Boards for ETI and E.A. projects. Scotchcal front panels for recent ETI and E.A. projects.

MAIL ORDER CUSTOMERS

\$1.00 packing plus 5 per cent of order value up to \$80.00, thence a flat \$4.00 for postal items. Carrier — freight on.

OPEN: Mon-Fri 8am to 5.30pm. Thursday night late shopping till 8.30pm. Saturday 8am to 11.45 am.

BUY TEXAS CALCULATORS

	Excl. S.T.	Incl. S.T.
TI 30 SP	20.00	22.10
TI 1750	16.40	18.15
TI BAII	40.97	45.35
TI 50	36.40	40.30
TI 55	53.35	59.00
TI Programmable 58C	132.00	149.00
TI Programmable 59	265.00	299.90
PC 100C Printer	210.00	237.00
Library Modules	33.32	36.90

Wanted:

**Foremen and Leading Hands
to become Officers in the Engineer Branch of
Today's Air Force.**



Few organisations can offer their Foremen and Leading Hands a career opportunity of this calibre. It's a unique opportunity to:

- join a professional team that's doing rewarding and vital work daily.
- be responsible for RAAF maintenance supervision and the manager of maintenance resources.
- work in the forefront of modern technology on some of the most advanced aeronautical and communications systems in the world.
- have a varied and stimulating life style.

Not everyone is capable of accepting such a challenge. You have to be able to lead, motivate and solve problems. And really make use of your skills. Your starting salary is \$13,000 plus p.a. And that's just the beginning. What are the necessary qualifications?

Firstly, you'll have to have completed Year 12 (or its equivalent). Hold a Certificate of Technology, or have completed an apprenticeship in an aircraft mechanical, instrument, electrical, electronic or radio engineering trade. Or have partially completed a tertiary engineering course.

You must be an Australian citizen or be able to meet our nationality requirements. Aged between 21 and 35 years. Prepared to live and work at our various bases. And meet our selection requirements.

Hurry! You may not get a better offer than this!
Return the coupon and we'll send you the facts. Alternatively, contact an Air Force Careers Adviser.
Phone.

Adelaide:	212 1455	Perth:	325 6222
Brisbane:	226 2626	Sydney:	212 1011
Canberra:	82 2333	Townsville:	71 3191
Hobart:	34 7077	Wagga:	21 1100
Melbourne:	61 3731	Wollongong:	28 6492
Newcastle:	2 5476		

To:
AIR FORCE CAREERS
ADVISER, G.P.O. BOX XYZ
in the capital city nearest you.
Yes! I am interested in an Air Force
career. Please send me full details.

Name: _____
Mr./Miss _____
Address: _____
State _____ Postcode: _____
Date of Birth: ____/____/____

AFDN 323 ENGINEERING

You're somebody in Today's Air Force

New Products

Tektronix Automatic Distortion Analyser



RIGHT: The new Tektronix AA501 Automatic Distortion Analyser. Features include a 3½-digit LED readout and automatic nulling.

Tektronix Australia Pty Ltd recently introduced the new AA501 Automatic Distortion Analyser and SG505 Oscillator System. The AA501 is a completely automatic total harmonic distortion (THD) analyser which, when used with its companion signal source the SG505 oscillator, permits automatic THD measurements to be made quickly and easily.

The AA501/SG505 system reduces measurement time and eliminates the

need for continual manipulation of manual controls. Level setting, tuning and nulling are done automatically by the AA501's internal circuitry. An option allows measurement of intermodulation distortion on signals conforming to SMPTE, DIN or CCIF standards.

The AA501 features a 3½-digit display which reads out distortion in % or dB. Signal input to the AA501 is displayed in dB, dBm, or volts. Fundamental frequency range is from 10Hz to 100kHz, and

residual distortion and noise are less than .0025% (-92dB).

The SG505 oscillator features low distortion - 0.0003% from 20Hz to 20kHz. Continuous dial tuning and vernier frequency control provide accurate frequency adjustment across the full range of 10Hz to 100kHz, and a precise step attenuator provides calibrated output from +10dBm to -60dBm plus variable attenuation between steps.

Further information can be obtained from Tektronix Australia Pty Ltd, 80 Waterloo Rd, North Ryde, NSW, 2113. Telephone (02) 888 7066.

IC sockets feature two-port contacts

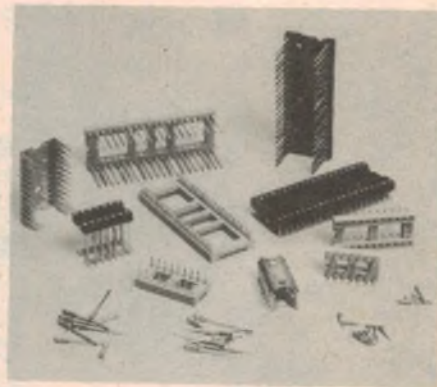

Utilux Pty Ltd has announced a new range of IC sockets, known as Series H7600, which feature a two part contact assembly consisting of an outer brass sleeve and an inner beryllium copper spring for reliable connections. The sockets are available in all standard pin configurations from 8 to 40, with low profile mountings. Two terminal styles are available; PC tail and Mini Wrap with 0.64mm square wire-wrap pins.

Both terminal styles are also available in loose quantities for individual insertion into a PC board. The PC tail variety can also be supplied on carriers for easy multiple insertion into PC boards.

More information can be obtained from Utilux Pty Ltd, 14 Commercial Rd, Kingsgrove, NSW, 2208.

Light beam relay

With the board assembly complete, drill a hole in one end of the Zippy box and mount the power input socket. Take particular care when wiring up this socket. It might be a good idea to check power supply polarity with a multimeter before making final connections to the board.

It is now a simple matter to drill a hole in the other end of the box to allow light entry to the LDR. Naturally, this hole should align with the LDR when the board is slid into position. For a light beam system, the board should be set

well back from the hole to eliminate possible false alarms due to varying ambient light conditions.

The opposite applies if you wish to use the unit as a dusk monitor. In this situation, the LDR should be mounted for maximum exposure to ambient light.

The final step of assembly is to drill a small hole (about 4mm) in the case lid, to allow access to the trimpot. You then simply adjust the trimpot until the relay triggers reliably under actual operating conditions.

... ctd from p77

ALKAY TRANSFORMER KIT

Designed for the R & D Engineer and the HOBBYIST.

15VA to 500VA. You get: 240V Primary already wound and finished. detailed, illustrated assembly information. charts to show windings needed for your secondary voltage. Four gauges of wire supplied - will cover most current needs. Polyglass bobbins with easily attached solder tags. All components to complete the transformer supplied.

• **Other Voltage primaries available.**

You get your own special order transformer at standard price. Just consult the table and wind your own secondary. A "MUST" for the electronic enthusiast.

Prices from: **\$8.00**

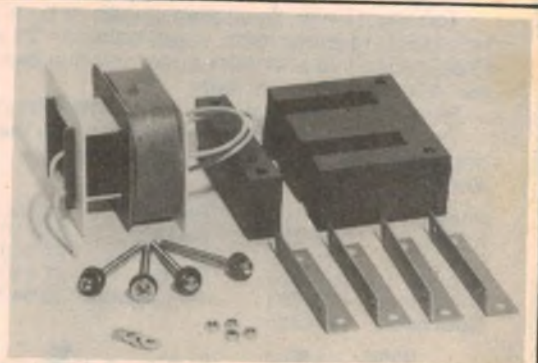

ALKAY TRANSFORMERS,

39a Barry Ave Morrdale 2223, Ph: 5331944



Remember how great she looked last summer.

National Colour Video Camera and Portable VHS lets you keep those moments and relive them over and over.

It's so simple. Point the camera, shoot... instant result. No processing is required with automatic viewing on TV, through your National Portable VHS recorder. Light to carry and will operate under low light conditions.

Other features include:

- Power zoom control
- Brilliant colour reproduction
- Pause control
- Electronic viewfinder
- Built-in microphone
- Low power consumption.

Because time doesn't stand still...

VHS



National
Instant Home Video

Net 100



RARE ADDITIONS FROM MARANTZ. SUPERIOR FM TUNERS.



Rare: very valuable.

Additions: the things added.

Marantz: a range of ultra-high performance FM Tuners which blend state-of-the-art engineering with operational versatility.

The name Marantz guarantees your choice from a superior range of AM/FM Stereo Tuners, guarantees exceptional quality and, with the advent of more FM stations, Marantz guarantees your total listening pleasure.

MARANTZ ST500 AM/FM STEREO COMPUTUNER

Sleek, slimline and microprocessor controlled — tune and recall stations with amazing speed and precision. The Computuner features state-of-the-art, quartz-locked, drift free frequency synthesised tuning with 7AM and 7FM memory presets. The LED signal strength display doubles as a multipath indicator and the Wide and Narrow IF Selector enables the switching of a tuning bandwidth best suited to reception area conditions.

MARANTZ ST600 AM/FM STEREO TUNER

This model incorporates a built-in oscilloscope that affords the most precise means possible to determine optimum reception, even from weak or distant stations. The functions of the oscilloscope extend well beyond those of conventional tuner meters.

MARANTZ ST400 AM/FM STEREO TUNER

A large, fuss-free Vacuum Fluorescent readout clearly displays the selected frequency and Electronic Gyro-Touch with Servo-Lock guarantees drift-free, razor-sharp tuning every time. Uncompromising quality through and through.

MARANTZ ST300 AM/FM STEREO TUNER

Consistent with all quality Marantz tuners, the ST300 features MOSFET FM front end and Phase Lock Loop demodulator for superlative performance — low distortion, extremely linear operation and wide dynamic range. Illuminated dial cursor, LED function indicators and Gyro-Touch tuning make the ST300 an exceptionally sophisticated buy at a modest price.

Your Marantz stockist will be pleased to demonstrate the complete range of Marantz tuners. If you see your hi-fi as an investment and, if you demand critical performance standards as well as the best value for money, listen to the future.

Listen to Marantz.

marantz
Now you're listening.

Distributed by MARANTZ (AUST.) PTY. LTD.
32 Cross Street, Brookvale, N.S.W. 2100
Telephone: (02) 939 1900 Telex AA 24121
Melbourne (03) 329 7655 Brisbane (07) 48 8882
Adelaide (08) 223 2699 Perth (09) 328 3874



REVIEWS OF RECENT

Records & Tapes

CLASSICAL ● POPULAR ● SPECIAL INTEREST

Handel/Boulez: "Royal Fireworks Music"

HANDEL — Royal Fireworks Music. Concerto Grosso in F and Overture to Berenice. New York Philharmonic Orchestra conducted by Pierre Boulez. CBS Masterworks Stereo Disc SBR 236006.

Boulez is no stranger to Handel: indeed, there is no reason why he should be. Many years ago he recorded for Concert Hall a rattling good account of the Royal Water Music that was in every way commendable — alternately frisky, solemn and pompous with sound quality — bearing in mind the period — excellent. Indeed I still often play it to musical friends to see if they can guess the conductor. They nearly all name Beecham. Yet the linking of the names of Boulez and Handel still remains, at least to British ears, as odd as combining Bizet with Bruckner.

About the time Boulez was recording his Water Music, Charles (now Sir Charles) Mackerras was recording the Royal Fireworks Music for Pye.

Mackerras' recording sessions started at 11 o'clock at night. The reason? Mackerras used, as closely as possible, Handel's original scoring and, in this piece, Handel used no strings. Instead, he substituted oboes. So Mackerras used 26 oboes, 14 bassoons, 4 contrabassoons, 2 serpents, 9 trumpets, 9 horns, 3 timpanists and 6 side drums. The sessions continued to the early hours of the morning. Why? Because, even in London, Mackerras had to wait until the 26 best oboe players had finished engagements elsewhere before they could play for him!

At any rate the sound, especially at first hearing, was overwhelming. If you didn't hear it then, you will be able to shortly, because Mackerras recently told me that World Record Club will be reissuing it soon. By the way, Mackerras has some very "squashy" sounding fireworks at the end. Not that that matters much because, at the original performance some 200 years ago, the fireworks made a real foul-up of everything anyway!

Boulez, in his recently issued Fireworks Music, does an excellent job but uses a later edition with strings instead of



oboes. There is plenty of vigor and double-dotting, which might well be

described in his native tongue as "C'est magnifique, but c'est ne pas la guerre." The sound is a bit on the coarse side but that might be due to Boulez trying to make his orchestra with his limited choice of instruments sound a little more like the original.

He uses the New York Philharmonic for the Fireworks and the Concerto Grosso in F on the reverse side, but the Philharmonia Chamber Orchestra for the Overture to Berenice, also on the reverse side. The playing is everywhere fine. (J.R.)

RAVEL TRIO: "Complete understanding"

RAVEL — Piano Trio. The Beaux Arts Trio. Violin for Violin and Piano. Tzigane. Arthur Grumiaux (violin) and Istvan Hajdu (piano). Philips Festivo Stereo Disc. 6570 177.

Although many of the greatest composers have written piano trios, and trios are perhaps the favourite form of chamber music among friends, the form has never been regarded as altogether satisfactory. The main objection is that the percussive timbre of the piano does not blend satisfactorily with the smoother legatos of the strings. Despite this, many very successful piano trio groups tour the world today.

Of these, one of the best is the Beaux Arts and they are at their own very best in the Ravel they offer here. Their balance throughout is so good that any piano-string anomaly passes quite unnoticed. The sound is completely homogeneous except, of course, in these sequences where the composer intended one or more of the instruments to stand out.

The dynamic range is perfectly adjusted — and engineered — to chamber music proportions, and they play as if they were revelling (I nearly wrote Ravelling) in it. Here is true music of friends, as chamber music was originally meant to be. There is complete understanding among the players and

complete consciousness of what were the composer's intentions.

The second movement is the more typical Ravel, with its characteristically piquant syncopations. The third movement is a passacaglia, built on with all Ravel's inventiveness in unhackneyed use of the variation form. Perhaps the most unusual is the Third where he surprisingly augments the bass. What a pleasure it is to listen to such gem-like elegance after a few years silence. I hope you get as much pleasure from it as I did.

On the reverse side that great Belgian violinist Arthur Grumiaux plays Ravel's only Violin Sonata. I attended the first performance of this in the Wigmore Hall, London, somewhere about 1928. My companion there was the eminent English composer Philip Heseltine (Peter Warlock).

I forget who the performers were but when they got about half way through the Finale, which is a moto perpetuum, Heseltine said in a very loud voice; "Come on, Julian. The thing's revving like a bloody little two-stroke motor bike." Thereupon he strode out of the hall and I, to my lifelong shame followed him.

Grumiaux — remember his seraphic recordings of the Beethoven Violin Sonatas some years ago — gets all that is possible out of this not very impressive late work. Istvan Hajdu deals handsomely with the not very graceful piano part. But the first impression one gets — and it lasts — is that there is usually very little

Reviews in this section are by Julian Russell (J.R.), Paul Frolich (P.F.), Neville Williams (W.N.W.), Leo Simpson (L.D.S.), Norman Marks (N.J.M.), Greg Swain (G.S.), and Danny Hooper (D.H.).

relation between the fiddle and piano parts. They seem often to go their very different ways and I must stress that this is not due to any fault of the performers. I still find this very off-putting, except in the second movement "Blues" with its sardonic but fascinating aural comments on that once popular form. Though here again the piano and fiddle parts are often irreconcilable with each other.

I am afraid I still agree with Heseltine's summing up of the Finale but not for anything would I nowadays express my disapproval in the same way.

Grumiaux overcomes with out the slightest evidence of effort the formidable technical problems of Tzigane. His is a glittering achievement of unabashed virtuosity. The piece is not surprisingly at times reminiscent of the Liszt Hungarian Rhapsodies and later works of the same kind. But it is not without gentle air of mockery here and there, a fact well noted by Grumiaux. In this, after the long violin unaccompanied violin solo, he is again well served by Hajdu at the piano (J.R.)

☆ ☆ ☆

DVORAK — Symphony No. 8 in G Major. Chicago Symphony orchestra conducted by Carlo Maria Giulini. DGG Stereo Disc 2531 046.

You can recognise instantly Giulini's rapport with Dvorak by his romantic treatment of the first few bars that lead into a vigorous first movement. Everything is comfortably unbuttoned, a mood interrupted only by cherished lyrical passages. This is a movement in which I enjoyed immensely Giulini's strongly rhythmic treatment. There is an attractive al fresco atmosphere about the whole movement, even in the little fugato bit. And special mention must be made of the many mellifluous wood-



wind sequences. The sound, by the way, leaves nothing wanting.

The second movement has a dignity that completely destroys any accusation of sentimentality. It is all obviously deeply felt and all the more effective after the brio of the first. It was originally intended as a funeral march and although it achieves no great merit in that form, its unquestionable success as a superb slow movement is never in question.

The third movement is graceful to the point of voluptuousness. The tempo is restrained and the control of dynamics firm yet sensitive.

ANITA KERR ON DIGITAL STEREO

ANITA KERR PERFORMS WONDERS. Stereo, Digital Master. Century Records, CRD-1160. [From MR Acoustics, PO Box 165, Annerley, Qld 4103. Phone (07) 48 7598.]



Creepin — If It's Magic — Knocks Me Off My Feet.

As you might imagine, the presentation is impeccable and, all told, it's one of those melody-rich albums which you can relax to and enjoy over and over.

And the quality? Exactly what you would expect. This master was recorded on the Sony 1600 digital tape recorder and, according to the jacket, subsequently transferred to the master disc without interference or editing en-route. Certainly, it has that relaxed, unstressed sound that is a pleasure to listen to. Recommended. (W.N.W.)

Be they classical, jazz or pop, most digitally mastered records to date have been instrumental or orchestral. I found it a welcome change, therefore to review this album by the Anita Kerr Singers. Anita Kerr does the soprano lead herself (and she sings as pleasantly as she looks) supported by alto Jackie Ward, tenor Stan Beard, and bass Mitch Gordon. Joe Reisman conducts the backing orchestra.

With one exception, the songs are by Stevie Wonder, hence the album title: Superwoman — Don't You Worry 'Bout A Thing — Seems So Long — Lookin' For Another Pure Love — Too Shy To Say —

Giulini takes the first theme of the Finale very steadily. He increases tempo and dynamics as he goes along until the long beautifully played flute solo urges him on to be still more persuasive. Other variations, for this is what the Finale really is — a set of variations — are treated to maximum but never exaggerated contrast. A spirited coda brings the works to an exciting end. The playing throughout is beyond praise. (J.R.)

☆ ☆ ☆

MESSIAEN — Turangalila Symphony. London Symphony Orchestra conducted by Andre Previn. World Record Club Stereo/Quadraphonic compatible Discs OR 05549/50. (Two Discs.)

That the average music lover will simply not patronise avant garde music is explained by their neglect of it, no matter how fine some of its quality may be. This great symphony is regarded by many of those who accept the genre as one of its key works. Yet, when I heard it in Paris in 1965, only about a quarter of the seats in the Theatre des Champs Elysees were occupied. Moreover I don't know how many of those occupied had been paid for! Mine certainly hadn't — I suppose I better add for professional reasons.

The symphony has been spectacularly well recorded many times but enjoyed only a short life before deletion. It is an enormous work, massive in conception and realisation. It has 10 movements which can be roughly divided into three parts. The sheer weight of its impact in the concert hall is well nigh overwhelming. It is scored for only a large symphony orchestra, with a vast percussion group added which, however, I hasten to add is used with the greatest discretion by the composer.

There is a prominent piano part of huge concerto proportions, superbly played by Michel Beroff. And an Ondes Martinot — one of the first electronic musical instruments to be invented — swoops and whistles, always significantly. The whole production is superbly handled by Andre Previn who conducts the London Symphony Orchestra.

The three dominating influences in Messiaen's work have been his deeply devout Roman Catholicism, his love of birds and their songs which he has reproduced in various musical media, and the mediaeval legend of Tristram and Iseult. The last of these is the most powerful influence in the thought behind the Turangalila Symphony. But the use of the legend bears no resemblance to Wagner's except in a very oblique nightmare sort of way. Messiaen has explained that the title of his symphony is a combination of two sanscrit words that, all too briefly, translated — I quote from R. S. Johnson's cover notes — is a "song of love" or a "hymn to joy". The work, however, is without any narrative element, although many of its 10 movements have titles — Song of Love, Joy of the Love of the Stars, Garden of Love's Sleep, and so on.

It is hardly necessary for me to add that Messiaen is a mystic, although there is nothing to demonstrate this in the magnificent music of this symphony. The feature to strike one instantly is the beauty of the love theme and its truly wonderful development through the work that runs just short of an hour and a half. Whenever I hear it, its loveliness haunts me for days and readers of this column might have noticed that I am no great lover of the avant garde school. Messiaen's music moves between

whispered conversation and the most ornate type of ornamentation imaginable, all peerlessly exploited by Previn and the London Symphony Orchestra.

I must however issue a warning in view of the enthusiasm I show in this review. If your appreciation of this century music goes no later than Debussy and Ravel, Tarangalila is not for you. You would probably hate it as much as you would me for having recommended it so enthusiastically. On the other hand, nobody even mildly interested in contemporary music should miss this glorious disc. (J.R.)

☆ ☆ ☆

GRAND CANYON SUITE – Grofe. EL SALON MEXICO (Copland). Utah Symphony Orchestra conducted by Maurice Abravanel. Stereo, World Record Club WRC R-06663.

Composed between 1921 and 1931 "Grand Canyon Suite" is Ferde Grofe's best known work and is a transparent example of scenery and events translated into music. The five movements are: "Sunrise", "Painted Desert", "On The Trail", "Sunset" and "Cloudburst". Rory Guy elaborates on each in his jacket notes.

Copland's "El Salon Mexico", which serves as a fill on side two, is also descriptive music, but music in which Copland seeks to capture the spirit of Mexico, simply as seen through the eyes of a tourist. Again, background information appears in the notes.

The notes are dated 1978 but there is no information about the actual time and place of recording. In fact, the sound quality is no more than average, clean enough but a bit "dry" (lacking in reverberation), and not notable either for ponderous bass or treble "shimmer". Maybe I was guilty of imagining how the music would have sounded, given the benefit of optimum acoustics and digital

mastering.

But, as an illustration of pictures in sound, this WRC release is still worthy of note. (W.N.W.)

☆ ☆ ☆

THE BEST OF THE MAGIC ORGAN. Stereo, Interfusion (Festival) L-27034.

For those who took an early fancy to "The Magic Organ" in the simulated style of a street fair organ, this new album may well be voted as a genuine "Best Of" release. The numbers are all in the strict tempo, toe tapping style of the early albums, and fit comfortably into the format:

Penny Arcade – Top Of The World –

Paper Roses – Tavern In The Town – Blueberry Hill – Tiny Bubbles – Over The Waves – The Lily Of The Valley – Drivin' Home – Sail Along Silvery Moon – Wheels – When The Roll Is Called Up Yonder.

Technically, the quality is fine and, if you want a happy sound to background a mature-age party, this one would certainly fill the role. (W.N.W.)

☆ ☆ ☆

HERB ALBERT – BEYOND. Stereo, A&M Records (Festival) L-37312.

Maybe it was me, maybe the time of day, or maybe it was the album itself, but there was a sense of wake about it

CHAUSSON CONCERTO ... an impressive recording

CHAUSSON. Concerto, Op 21 for piano, violin and string quartet. Israella Margalit, piano; Lorin Maazel, violin, with the Cleveland Orchestra String Quartet. Telarc Digital stereo DG-10046.

In the immediate past, digital recording techniques have more often than not been devoted to material which is naturally "showy" and ear-catching. And so, while there have been more than a few very good digital recordings, this is the first that I have come across which has not been made with the idea of deliberate sonic impact – the material just does not lend itself to this approach.

Nevertheless, it is an impressive recording with outstanding clarity on both the piano and strings and with very good signal to noise ratio. There is not a trace of hiss, even at high gain settings.

As far as the composition is concerned, this will take many listeners some time to know and appreciate. Chausson, a nineteenth century French Romantic, is

one of the less-well known composers, who published fewer than 50 works. The best known of these is his "Poeme".

Chausson's Concerto is a compelling work in four movements: Anime, Sicilienne, Grave and Tres Anime. And the most compelling of these movements is the third, Grave. It depicts some of the most abject melancholy I have ever heard expressed in music – definitely not suitable for listening to when you need cheering up!

The work is impeccably played by pianist Israella Margalit, violinist Lorin Maazel and the Cleveland Orchestra String Quartet. Top marks for performance and recording of a difficult work to Telarc. (L.D.S.)



The Imagination Machine



APF APF APF APF

IM-1 Your Life Will Never Be The Same – Two great achievements – a powerful state-of-the-art personal computer and a thrilling home entertainment centre in one single package

- User-programmable in BASIC ● With loads of pre-programmed software for educational entertainment and home and personal management ● Features – 9K RAM, 14K ROM ● 53 key typewriter-style keyboard ● 32 characters x 16 line screen format ● Alpha numerics in three colour modes with up to eight colours ● Built-in sound synthesizer with a range of three octaves including flats and sharps ● Six function built-in cassette tape deck ● Two game-style hand-held controllers ● Unique shift key for "BASIC keywords" ● Expandable for floppy disk, printers memory and more.

\$995 inc colour monitor. Tax paid.

Distributed by

APF ELECTRONICS (AUSTRALIA) PTY LTD
TRADE ENQUIRIES WELCOME.

435 Bourke Street, Melbourne. (03) 67 6412.

BARGAIN PRICES • PERSONAL ATTENTION • SLICK MAIL ORDER SERVICE • SATISFACTION

BSR

WORLD'S LARGEST MANUFACTURER
RECORD CHANGERS/PLAYERS

MODEL
P-208

BELT DRIVE STEREO PLAYER



Mechanism, cartridge only.
Pack and post NSW \$4.50 V. SA.
\$87.50 T. Q. \$5.50.
W. A. NT. \$6.50.

Mounted in walnut cabinet, with
perspex dust cover, hinges.
P-P NSW \$6.50 INTERSTATE
\$8.50. **\$117.50**

Specs. 240VAC 50Hz, auto or manual operation • Plays 17, 25, 30cm (7, 10, 12in) records • 33 and 45 rpm, adjustable counter weight and stylus pressure • cueing lever • Bias compensator and anti skate control • Big platter with mat • RCA audio plugs and cable, 3-core power cable and plug • High quality ADC magnetic cartridge • Diamond Stylus • Cut-out Template, instruction book •

Pro Model P-200. (specs. as above) **\$105.00**

or mounted in walnut cabinet with perspex cover **\$137.50**

P-P NSW \$4.50
INTERSTATE \$6.00

P-P NSW \$6.50
INTERSTATE \$8.50

FM WIRELESS MICROPHONES



NO CABLE TO TRIP OVER
OPERATE WITH FM RECEIVER,
88-106MHz

MINI MODEL WMI
100H x 35W x 25D mm
\$11.95 P&P \$1.00

UNIDIRECTIONAL MODEL
(ILLUSTRATED) **\$34.75 P&P \$2.50**

OMNIDIRECTIONAL MODEL
\$26.75 P&P \$2.50

TIE TACK MODEL WITH SEPARATE
POCKET SIZE TRANSMITTER
\$39.95 P&P \$2.50

SEND SAE FOR TECH DATA

FERGUSON POWER TRANSFORMER • SPECIALS •

BRAND NEW GUARANTEED STOCK

Type PVD 109. Prim. 230, 240.
250VAC 50Hz. SEC HT 126, 136,
146VAC. For voltage doubling to —
330, 355, 380V DC 180MA SEC
LT. 6.3VCT 3A. 6.3V 4A.
P-P NSW \$3.50. V.Q. SA. T.
\$4.75. WA. NT. \$7.50.

\$19.50

TYPE PF 2050, 220, 240VAC
50Hz. SEC HT 285VAC. For voltage
doubling, 250 MA SEC. LT.
2 x 34V 1A 25V 1A. 6.3V 1A.
6.3V 4.5A.

P-P NSW \$3.50. V. Q. SA. T.
\$4.75. WA. NT \$7.50.

\$22.50.

Type. PL 30/60VA Low Profile. 30V
2A. (15-0-15). 15V 4A.

P-P NSW \$2.00
INTERSTATE \$3.50.

ATTENTION!! STEREO FM TUNER BUILDERS

Fully constructed front end tuner
complete with coils • Variable tuning
condensator, 3:1 gear ratio, 2 gang
AM, 3 gang FM • High freq amp with
2 RF stages • 3 transistors FET input
varactor diode (AFC) • Reception
band 87.5-108.5MHz • IF freq
10.7MHz • Input imp 300 ohms •
Supply 12V at 10MA • In fully shield-
ed metal box 74W x 70D x 42H mm •
Circuit included • Top quality unit
guaranteed •

\$19.95 P&P NSW \$1.50
INTERSTATE \$2.00

GEARED MOTOR 240VAC 50Hz 3W \$2.50



P&P 50c
5 RPM Plenty of torque With Cam and
N/O N/C microswitch 15 switch contacts
per min. OA size 65 x 60 x 35mm
Refer Dec 79 EA New Products Review

PUSHBUTTON KEYBOARD



8 TOUCH BUTTON SWITCHES AND
8 RED LEDS MOUNTED ON
PRINTED CIRCUIT BOARD. REF.
PAGE 78 AUG 1980 EA REVIEW.

\$1.50 PACK & POST 75c

MAGNAVOX

Premium quality low freq driver
MODEL 10W MK6 10" WOOFER

1/2 PRICE
SPECIAL 8 OHMS
25W



Rolled foam surround • Polished
aluminium dust dome • Freq
response 40-5500Hz • Resonance
35Hz •

P&P NSW \$2.00
\$17.95 INTERSTATE \$2.75



NEW BSR STEREO RECORD PLAYER • MANUAL OPERATION •

Model P-207 • 240V AC, 50Hz • Auto-Stop
• S-Shape tone arm • Ceramic cartridge, dia-
mond stylus • 33-45rpm • Plays 17, 25,
30cm (7, 10, 12in) records • Cue lever •
Template for cut-out • operating instructions

\$49.95 NSW 4.50. V. SA. T. Q. \$5.50. WA.
NT. \$6.50.

FACTORY SCOOP • 1/2 PRICE BARGAIN BRAND NEW A1 QUALITY • 8"(20cm) 2-WAY SPEAKER SYSTEM • 8 OHMS • 10 WATTS •



\$42 PAIR

ATTRACTIVE WALNUT CABINET:
52H x 30W x 14 1/2 D cm

P&P NSW \$3.00. SA, V, Q \$4.00
TAS. NT. WA \$5.50

SLIM LINE LOW PROFILE AM-FM STEREO TUNER •



400W x 76H x 280D mm

P&P NSW \$3.50

\$149.95 INTERSTATE \$5.50

20 + 20W RMS STEREO AMPLIFIER TO MATCH

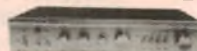

P&P NSW \$3.50

\$149.95 INTERSTATE \$5.50

Top quality and performance guaranteed. 12 month parts and labour
warranty. Send SAE for full technical data.

C-CORE TRANSFORMERS

PRIMARY 240V 50Hz CONT RATING.
LOW NOISE • HIGH EFFICIENCY •

MODEL	SEC.V.	AMPS	PACK AND POST V. Q.		
			NSW	SA. T.	WA. NT
JT 266	0-18V	8A	\$25.95	\$2.95	\$3.75 \$5.50
JT 235	26-0-26V	2A	\$24.95	\$2.95	\$3.75 \$5.50
JT 248	0-10V	10A	\$25.95	\$2.95	\$3.75 \$5.50
JT 249	8.5-0-8.5V	4A			
	& 15VCT	1A	\$26.50	\$2.95	\$3.75 \$5.50
JT 274	0-9.5V	10A			
	& 2x0-12V	1A	\$26.50	\$2.95	\$3.75 \$5.50

CMA POWER CABLE

2 CORE, FIG 8, 24/0.20, 250V,
CLEAR PVC
P&P NSW \$2.50
\$17.95 100m INTERSTATE \$4.00
3 CORE 32/0.20 250/440V
Ordinary duty. Bright orange PVC.
P&P NSW \$3, V.Q, SA, T \$5
\$35 100M WA, NT \$7

HEAVY DUTY NI-CAD RECHARGEABLE BATTERIES STANDARD TORCH SIZES



1.2v

FAMOUS BRANDS
Top quality guaranteed.
Used by many Govt Depts.

SIZE	AH	PRICE	PP
D	4	\$6.25	75c
C	2	\$5.00	75c
C	1.8	\$4.50	75c

BULK BUY AND SAVE •

SIZE D 4 for.....\$25
SIZE C 1.8AH 4 for.....\$16
SIZE C 2.AH 4 for.....\$18.50
SIZE AA .5AH 10 for.....\$17.75
P-P NSW \$1.75 INTERSTATE
\$3.60.

SERVICE

Moderate charges — Repairs
guaranteed. Radios, Tape
Recorders, Cassettes, Amps.

ETONE 12" SPEAKER SPECIAL



GUARANTEED TOP QUALITY BRAND NEW BARGAIN

* Rugged diecast frame
8 and 15 ohms available
12" Woofer, 30 Watts RMS.
Resonance 65Hz.
Freq response 50-8000Hz
\$21.00 each or 2 for \$37.95

12" Twin Cone, 30 Watts RMS.
Resonance 65Hz
Freq respon 50-15kHz.

\$22.00 each or 2 for \$39.95

Speaker	NSW	Interstate
Pack 1	\$2.00	\$2.75
Post 2	\$2.75	\$3.75

RECORDS & TAPES — continued

all. The title: "Beyond"; the line-up of instrumentalists who variously provide the backing in the nine tracks, and to who Herb Albert addressed the remark in the notes: "Thanks to all of you who helped to open the door for me — one more time"; and that last track, "The Factory", with its endlessly repetitive theme.

Be that as it may, fronting a strong line-up of acoustic and electric rhythm, keyboards and guitars, Herb Albert presents: Kamaili — The Continental — Reach For The Stars — Interlude For Erica — Red Hot — Beyond — That's The Way Of The World — Keep It Goin' — The Factory.

Soundwise, the album is well up to standard but my impression is that its appeal will be mainly to those interested in the career and the music of Herb Albert. (W.N.W.)

☆ ☆ ☆

THE HAGOOD HARDY COLLECTION.
Attic Lat 1073 Astor release.

It would be hard to categorise the music on this disc, from Canadian born Hagood Hardy. There is a jazz theme in there somewhere but it would be easiest to describe it as very pleasant big band music to eat by.

The 12 tracks are all Hardy compositions, including: The Homecoming — Love Of Life — Jennifer's Song — Love Song — Sonny's Ragtime — Les Arrivants — Tell Me My Name.

If you have heard the other recent release from this man and his orchestra "Reflections", you will recognise the style. There is no listing of musical personnel on the sleeve but I imagine it is similar to this other record, with about 50 names. The quality is good. (N.J.M.)

☆ ☆ ☆

SKYLARKIN' Grover Washington Jr
Motown M7933 Astor release.

Six long jazz tracks with a distinct disco influence make up this disc from Grover Washington Jr, with 11 other musicians.

DEVOTIONAL

LOOKIN' BACK. Ken Medema's Finest. Stereo. Word WSB-8834. (From Word Records Aust, 18-26 Canterbury Rd, Heathmont, Vic 3135.)

This album would have the most immediate appeal for those who are familiar with Ken Medema's compositions or, at least, have access to his songbook "I Saw You". Otherwise, the newcomer will have to concentrate in order to capture his themes and his style. Something in the way of meaningful jacket notes and a sheet of lyrics would make any such introduction much easier. Please, Word!

One thing would become evident, however, in the variety of material which he can create and use: traditional, lyrical, dramatic, jazz and, of course, rock. His voice is basically a pleasant baritone, with brief ventures into near-falsetto — with which I personally could happily dispense!

The compositions: Mister Simon — Lead The Way — Flyin' Like An Eagle — Jesus, Lover Of My Soul — Fork In The Road — Symphony Of Praise — Moses — Don't Play The Game — Sonshiny Day.

The technical quality is good and, if you're interested in a wide variety of recent devotional compositions, you will listen with interest as Ken Medema goes "Lookin' Back" over his song book. (W.N.W.)

☆ ☆ ☆

GINY GRANT. Stereo, Myrrh MSB-6625. (From Word Records Aust, 18-26 Canterbury Rd, Heathmont, Vic 3135.)

From the jacket photo and the jacket notes, one would judge Giny Grant to be a very pleasant lass, with strong family ties and a strong family-based christian faith.

The 13 tracks on the album are new to me and, for the most part, express Giny's devotion in human terms — sentimental, perhaps, but undoubtedly sincere:



Father's Eyes — Faith Walkin' People — Always The Winner — Never Give You Up — Bridegroom — Lay Down — You Were There — O Sacred Head — All That

I Need Is You — Fairytale — Giggle — There Will Never Be Another — Keep It Going.

The sound throughout side one is predominantly that of very soft rock but, fortunately, in the interest of variety, side two is refreshingly different — a touch of ballad, Bach, swing and fantasy.

Giny has a smooth, relaxed style and she is very capably backed by a small combo, with strings, trumpets and voices on call — the latter supplied by her sisters.

The lyrics appear in full on the inner sleeve and, while I wouldn't rate the album as wildly exciting, it's certainly makes for pleasant listening. (W.N.W.)



VIDEO TECHNICS

THE CAROUSEL CENTER, SHOP 17 & 18, 530 OXFORD ST. BONDI JUNCTION
P.O. BOX 50 BONDI ROAD, BONDI 2026, NSW 2022 TEL. 387 2555.
3RD FLOOR, EQUITABLE LIFE BUILDING, 301 CORONATION DRIVE,
BRISBANE 4064 PH 36 1257

SPECIAL COLOUR MONITOR

For your microcomputer. Same features as our B/W Universal TV Video Monitor. Specially priced at \$399.

3 HOURS VCR VIEWING

3 hours continuous recording/playback. 1-2-3 operation simplicity. Video head and azimuth recording system: key to perfect picture reproduction. The ingenious yet simple "M" loading system. low 35 watts power consumption.
Units available — Sony, Philips, National etc

VIDEO MOVIES

VHS & Betamax available in: PAL (Australian & European Systems) and NTSC (American & Japanese Systems)

VIDEO EQUIPMENT

VHS & Betamax Recorders/Players available.

Finally available Players with PAL and NTSC capabilities. This means, with these machines you can now play tapes from the US and Japan!

NOTE: In US System (NTSC) there are over 3000 titles available, many of current movies. These titles also include many professional subjects.

SPECIAL CLOCK TIMERS

Can be set to switch equipment up to 4 days ahead.

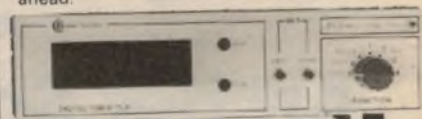

Starting time accurate to a second

\$195 + P.P.

FRANCHISEES REQUIRED FOR S.A., W.A., VICTORIA AND TASMANIA

RECORDS & TAPES — continued

Washington plays soprano, tenor and baritone saxophones. He is backed by Eric Gale, guitar; Marcus Miller, bass; Richard Tee, acoustic and electric piano; Idris Muhammed and Ralph McDonald, percussion; Ed Walsh, Oberheim 8 voice; Jorge Dalto, acoustic piano; Paul Griffin, Clavinet; Jon Faddis, Flu'elhorn; Alexander Otey, trumpet.

The tracks are: Easy Loving You — Bright Moments — Snakes Eyes — I Can't Help It — Love — Open Up Your Mind. With excellent quality and good musicianship, it makes an enjoyable record. (N.J.M.)

☆ ☆ ☆

BLUEBYRD. Charlie Byrd, guitar. Joe Byrd, bass and vocals. Wayne Phillips, drums. *Interfusion (Festival) stereo L 37257.*

It has been said before but Joe Byrd is one of the foremost jazz guitarists in the world. He certainly demonstrates this on this album which is one of the most enjoyable records to come my way this year. The whole collection of tunes presented just sings with happiness — they must have enjoyed making it.

And who says analog recording techniques are dead? This is a particularly fine recording and Festival can be proud of the pressing quality — it's a beauty. Playing time is just under 40 minutes.

Eleven tunes are performed: It Don't



Mean A Thing (If It Ain't Got That Swing) — You Vivendo — Nice Work If You Can Get It — Jitterbug Waltz — Soft Lights And Sweet Music — I Ain't Got Nothin' But The Blues — This Can't Be Love — Carinhoso — Mama, I'll Be Home Someday — Isn't It A Lovely Day — Saturday Night Fish Fry. (L.D.S.)

☆ ☆ ☆

DIANA. Diana Ross. *Motown M 8936. Astor Records.*

Diana Ross began her career in 1962 as the lead vocalist for a trio called The Supremes. She left The Supremes in 1969

For information on World Record Club albums, contact the club at 605 Camberwell Road, Hartwell, Victoria, 3124. Tel. 29 3636.

and released her first solo album. She now has over 15 albums to her name and 19 No. 1 records.

Diana Ross is truly one of the most important entertainers of the last decade and Billboard Magazine has even named her "Female Entertainer Of The Century".

Her new album is destined to be a hit in the discos but the more mellow tracks will also appeal to listeners who prefer a more relaxed sound.

The tracks on this album are: Upside Down — Tenderness — Friend To Friend — I'm Coming Out — Have Fun — My Old Piano — Now That You're Gone — Give Up.

A brilliant album, adding to her already outstanding track record! (D.H.)

☆ ☆ ☆

TERRAFORM. Randy Vanwarmer. *Bearsville Records L 37332. Festival release.*

This is Randy Vanwarmer's second album. His first album yielded the gold single "Just When I Needed You Most".

Randy's new album is predominantly soft rock and the eight original tunes add up to a refreshing musical offering by a major new talent. Instruments and vocals are mixed superbly.

The tracks on Terraform are: Whatever You Decide — I Discovered Love — All We Have Is Tonight — I'm Gonna Prove It — Doesn't Matter Anymore — Down Like A Rock — Terraform — Farther Along. (D.H.)

MARUNI

Microphones for best results!



Unique pre-sale service

Complete range available for self evaluation on 100 watt P.A. system, call us now!

P.A. hiring available 24 hours a day — 7 days a week

Agents for Auditec modules.

Archer Sound Systems,

109 Bungaree Rd, Wentworthville, NSW, 2145.
Phone (02) 631 4538





THE ALLEN ORGAN AT CHICHESTER CATHEDRAL

"... totally non-electronic"

THE ALLEN COMPUTER ORGAN AT CHICHESTER CATHEDRAL. Organist, George Thalben Ball. Stereo, Chalfont C77.007. [From Allen Organs Australia, 32 Woodhouse Rd, Doncaster East, Vic 3109. Phone (02) 842 3465. \$8.00 plus \$1.60 p&p.]

When commenting on this disc for "Audio" magazine (Feb 1980) reviewer E. T. Canby seemed quite unconvinced that the instrument he was listening to was, in fact, a full electronic; he made a point of the fact that the only reference to the matter was in the title. The jacket notes give an impressive list of classical stops but, for the rest, are confined to the organist and to the music.

One can understand the reviewer's dilemma if his knowledge of electronic organs was limited, because the sound is simply and utterly that of a classical organ. I attribute this partly to the instrument itself, partly to the cathedral acoustics and not in the least to the fact that George Thalben Ball treats it like any of the other traditional pipe instruments to which he has been accustomed.

With a long classical and music/academic background dating back to 1923, George Thalben Ball is a man of considerable age, but also of considerable capability and understanding as he plays 11 items, which exploit the many voices of the big organ:

Trumpet Tune (Stanley) - Minuet in D (Stanley) - Gavotte (Camidge) - Holsworthy Church Bells (Wesley) - Largo, Allergro, Aria and two Variations (Festing) - Fantasia and Fugue in C Minor (CPE Bach) - Grand Choeur Dialogue (Gigout) - Rondeau "La Musette" (Dandrieu) - Chorale "Praise To The Lord" (Reger) - Prelude on "Picardy" (Joubert) - Fiat Lux (Dubois).

The sound is clean, the balance and definition is excellent. An enjoyable album, and especially intriguing because of its totally non-electronic sound. (W.N.W.)

SPECIAL PURCHASES

NEW HOKUTONE HI-FI SPEAKER KITS AT A FRACTION OF LIST PRICE

NEW THREE WAY HIGH FIDELITY SPEAKER SYSTEM WITH A FREQUENCY RANGE OF 35 TO 20,000 CYCLES. POWER RATING 50 WATTS.

Supplied in Kit form (less cabinet) Woofer HFW-302, 12". Mid range HM-24 dome. Tweeter HT-60 dome. Three way crossover with separate controls for mid range & tweeter. Innabond lining, grill fabric & cabinet plans supplied. Cabinet dimensions 668mm high, 435mm wide, 310mm deep.

\$69.00 per kit Freight extra by rail, air or road transport.

RANK-ARENA 2 WAY SPEAKER



\$42.00 PER PAIR

- 10 Watts RMS
- 8 ohm impedance
- 8" woofer with tweeter
- Supplied with lead and plug
- Teak finish

A similar system available in walnut finish. Dimensions 18"H, 11"W, 9 1/2"D. Freight extra per rail air or road transport

NEW RANK-ARENA FM-AM TUNER AMPLIFIER

MODEL RA402. Output 24 watts RMS. (12+12). Response 50hz to 50Khz. Mag or ceramic inputs. High & low filters. Loudness control. Provision for 4 speakers.

\$147.00 Freight Extra

SPEAKER GRILLE FABRIC AT 1/2 PRICE AVAILABLE IN LIGHT & MID BROWNS. WIDTH 54"

\$4.80 Per YARD. Post & Pack \$1.75. Send two 20c stamps for samples.

NEW EMI RECORDING TAPE HI-FI LOW NOISE

At less than 1/2 less price HDP12 5" reel 1,200ft double play **\$2.95** 4 for **\$10.00**. P+P \$2.00



EMI SUPER C90 CASSETTES 6 for \$10 P & P \$2

NEW GOODMAN-FOSTER 3-WAY 4-SPEAKER HI-FI SYSTEM

\$42.00 PER KIT

Frequency Range 45 to 22,000 cycles. Power rating 25 watts. RMS Imp-8 ohms. Supplied in kit form (less cabinet) each kit comprises two English Goodman 8" bass units. Forster 5" mid range. Foster 1" dome tweeter crossover components Ocodensers and inductance innabond, speaker fabric and plans of cabinet. Cabinet dimensions 23" x 13" x 10" CABINETS AVAILABLE.

Post & packing extra: NSW \$2.70; VIC, SA, QLD, \$4.70; WA \$5.70. (REGISTERED POST \$2.00 EXTRA IF REQUIRED) cabinets available.



NEW STANDARD BSR RECORD CHANGERS MODEL C129R

\$36.00

Fully automatic turntable plays up to six records automatically and single records automatically or manually as required. 11" turntable. Cue & pause control. Record speeds 33 1/3, 45 and 78 rev/min. Finished in black with silver trim. Player and changer spindles supplied. Fitted with ceramic cartridge. Post & packing extra. NSW \$2.70; Vic, Qld, SA \$3.70; WA \$4.70 (registered post \$2 extra if required).

Spare cartridge and stylus for above \$4.50 (list price \$10.00).

NEW PLESSEY-FOSTER & AWA HI-FI SPEAKER SYSTEMS POWER RATING 50 WATTS RMS FREQUENCY RANGE 30 TO 18000 CYCLES.

This HIFI speaker system uses the top of the range Foster C00F05 8" woofer which is a free edge cone speaker with a resonant frequency of 27 cycles & a 2" voice coil, weight 3577G (magnet weight 607G). Two AWA 4" tweeters with ceramic magnet & curve-linear cones are supplied also crossover components, grille cloth, innabond lining & cabinet plans. (Cabinet not supplied)



\$59.00

(List price was over \$100)

Post & packing NT & NSW \$3.50

Qld, Vic, SA WA \$5.50 \$8.00

Per kit

Foster C00F05 8" woofer max power 80w available as separate unit at \$47.50 + post & pack as kit.

NEW HOKUTONE 12" HI-FI SPEAKERS

Model 300F W09YL 12" power rating 20 watts, 80HM IMP cone resence 30 cycles. Manufactured by Hokutone Onkyo Co Japan.

\$12.50 POST & PACK \$2.50

NEW AWA HI-FI SPEAKER KITS 8" 2 WAY 3 SPEAKER SYSTEMS

AT LESS THAN 1/2 LIST PRICE POWER RATING, 20 WATTS RMS. IMPEDANCE 8 OHMS frequency range 46 TO 18,000 CYCLES

Supplied in kit form (less cabinet) each kit comprises: One AWA 8WAC 8in bass unit, two AWA 4MBC 4in tweeters with ceramic magnets & curve-linear cones, crossover components, grille cloth, innabond lining and cabinet plans.

CABINETS AVAILABLE Post & packing extra: NSW \$2.50; Interstate \$3.50.

\$20

PER KIT

CLASSIC RADIO

245 PARRAMATTA RD., HABERFIELD 2045

PHONES 798-7145, 798-6507



Books & Literature

Computer Programming for Idiots

COMPUTER PROGRAMMING FOR THE COMPLETE IDIOT by Donald McCunn. Soft covers, 126 pages, 277mm x 212mm. Published by Design Enterprises of San Francisco. Price \$9.95.

As the author says in the introduction to this new book, the advent of personal computers has taken programming out of the exclusive domain of computer specialists and in so doing, has created a need for easily understandable guides to computer programming. This book is one attempt at creating such a guide.

"Computer Programming for the Complete Idiot" is an elementary presentation of some of the principles of programming, using as an example the Level-I Basic of the TRS-80. The choice of Level-I Basic is perhaps questionable, as fewer people are now using this language to begin with. Certainly, any serious application of the TRS-80 requires the use of Level-II Basic.

The book is divided into three sections, covering basic operating procedures, simple programming, and guide-lines to creating original programs. The major feature of the book is that programming is presented in terms of a real application, a pay-roll program, written in Level-I Basic and designed to occupy 9K of memory. Details are also given of how to convert the program to Level-II Basic, although the program would undoubtedly be improved if it was written in Level-II Basic from the start, rather than converted from Level-I.

The pay-roll program used as an example throughout the book is designed for American users, and many routines are provided for calculating tax exemptions and the like based on the tax legislation of California. Appendix A is a further guide to the taxes of California, and will be found less than useful. Appendix B is a chart of the variables used in the example program, while Appendix C is a copy of the Video Display Worksheet for the TRS-80, which can also be found in the Level-II Reference Manual.

The author claims that "It is not necessary to know all the technical details of how a computer works in order to create programs anymore than it is essential to know how an internal combustion engine works in order to drive a car." This is perhaps true, but to

drive a car well, and to obtain pleasure from driving it, some knowledge of the workings of the engine is required, beyond how to turn the ignition key.

Some may feel that the author's approach limits the usefulness of the book. Knowledge of the internal workings of the computer, while not strictly essential to writing programs, does contribute considerably to efficient programming, and to my mind at least, adds significantly to the enjoyment of programming.

More seriously, much of the material covered by this book is already available in the manuals accompanying the TRS-80 and in the book "Learning Level II" by David Lien. With this factor in mind, we found the book a little disappointing.

Our review copy came from McGills' Authorised Newsagency Pty Ltd, 187 Elizabeth St, Melbourne, 3000. (PV)

Satellites

COMMUNICATIONS SATELLITES, by Jos Heyman and Geoff Davies. Paper covers, 61pp 297 x 211mm, typewriter copy. Published 1980 by the Astronautical Society of Western Australia Inc. Price \$4.00 (Australia) \$4.50 (overseas) including postage in both cases.

Like most people with a technical background, I know there are satellites up there – quite a lot of them, in fact – and I even recognise a few of the names. But exactly how many, who by, when and what for is an area of utter confusion.

But it needn't be. The first few pages of this publication gives a simple and readable run-down on the technology behind satellites, written at ordinary magazine article level.

This is followed by notes on the early experimental launches in the '50s and '60s, and also on the various Amateur Radio satellites.

From page 17 to the end of the book is an alphabetical list of more than 20 countries, or groupings, which either have satellites in orbit, or are moving towards that objective. In this section appear all those names one remembers, and many others that one had forgotten, their launch date, period of service and possible demise.

If you happen to be interested in satellites, this book will save you from having to perform feats of memory or research. Our copy came direct from the Astronautical Society of Western Australia, Box E254, GPO Perth, 6001. Phone (09) 341 1449. (WNW)

Electronics Principles

ELECTRONICS Principles and Applications by Charles A. Schuler. Hard covers, 289 pages, 286mm x 224mm. Illustrated with schematics and diagrams. **Activities Manual for ELECTRONICS Principles and Applications** by Charles A. Schuler. Soft covers, 151 pages 280mm x 215mm. Illustrated. Published 1979 by McGraw-Hill Inc USA. Price in Australia \$22.35 and \$10.50 for the Activities Manual.

Specifically an educational book, the text covers introductory material on principles and applications of electronics and is designed for students who have a basic understanding of Ohm's law, Kirchoff's laws, power formulas, schematic diagrams and electrical components. A basic knowledge of algebra would also be an advantage in the understanding of this book.

The initial chapters deal with semiconductor physics and should provide sufficient knowledge for a good understanding of their operation. Semiconductors covered are diodes, zener diodes, LEDs, varicap diodes, transistors and in a much later chapter, SCRs and Triacs. In all cases the V-I characteristic is given as well as the physics of their operation.

Other chapters include discussions of small-signal amplifiers, power amplifiers, differential amplifiers, operational amplifiers, oscillators, receivers and linear ICs. Important points are discussed such as operating points of amplifiers, configurations and feedback.

Some of the good features of this book are the practical approach to the topics, the review questions and answers associated with each chapter and the summary of each chapter.

One point which needs to be mentioned is the fact that the current flow in all the diagrams of this book is shown to be flowing from negative to positive potentials. Although this is the true direction of electron flow, confusion can result if the reader is used to thinking in terms of conventional current flow (positive to negative).

Additional to the book described above is an activities manual. This comprises test questions related to the chapters in the book and has laboratory experiments which appear to be well thought out and illustrated.

Overall, this book in conjunction with the activities manual would form an excellent text for students in the early years of a Technical College electronics course or for hobbyists wishing to obtain a bet-

ter understanding of electronics.

Our review copy came direct from the publisher. (JC)

Microwave Devices

MICROWAVE SOLID STATE DEVICES AND APPLICATIONS, Edited by D. V. Morgan and M. J. Howes. Soft covers, 256 pages, 297mm x 210mm, illustrated with diagrams. Published by Peter Peregrinus Ltd. Price from the UK £15.50.

The contents of this book are an extended version of the lectures which formed the basis of the sixth IEE Summer School on "Microwave Solid-State Devices and Applications" held in July of this year at the University of Leeds. It provides a concise introduction to the state of current research in microwave physics and applications.

The theme of the book is the design and evaluation of microwave amplifiers, oscillators and mixers using solid state devices. This area has been marked by increased activity since the emergence of the Gunn diode and the IMPATT (Impact Avalanche and Transit Time) diode in the early sixties and the later development of FETs capable of operation up to 40GHz.

At microwave frequencies the behaviour of active devices is critically dependent on the configuration of the circuit they are used in, and the solution of the design problems posed by this state of affairs requires a detailed understanding of device operation and device-circuit interaction. Both aspects are covered in this text by engineers and physicists who are acknowledged leaders in their fields.

The text is divided into 14 chapters, and each chapter includes up to four lectures. Four basic topics are covered; the physics and technology of solid state microwave devices (Chaps 1-4), circuit and device characterisation (Chaps 5-7), the design of microwave oscillators and amplifiers (Chaps 8-13), and the design of mixers and detectors (Chap 14). There is some overlap between these categories, as is to be expected given the known facts of device and circuit interaction.

The problems of the design and analysis of microwave circuits are comprehensively discussed, with rigorous mathematical treatment.

This book will be of interest to engineers and research workers in the microwave field, containing up to date information on the state of current research in the area. It may also have something to offer the advanced hobbyist, particularly if they have been following the various articles published in "Electronics Australia" on microwave techniques. In any event it is a useful insight into a fascinating field.

Our review copy came direct from the publishers, but copies should be available in technical book-shops. (PV)

BOOKS

NEW NEW NEW

Latest editions of some of the most popular books on the subject:

The Silicon Civilisation (A. Burkitt & E. Williams)	\$19.50
Telecommunications System Engineering — Analog and Digital Network Design (Roger L. Freeman)	\$49.40
Amateur Operator's Handbook — Revised (Dec 78) (Postal & Telecommunications Department)	\$3.60
WIA Australian Radio Amateur Call Book 1980	\$2.95
RPG and RPII Programming: Applied Fundamentals — A Job Approach to Learning (W. Bux & E. Cunningham)	\$22.95
ARRL Handbook 1980 Edition	\$14.95
World Radio TV Handbook 1980 Edition	\$16.95

HOWARD SAMS BOOKS

Introduction to Biomedical Electronics (E. Bukstein)	\$8.75
Solid-state Power Electronics (Irving M. Gottlieb)	\$13.50
Practical Low-cost IC Projects (Herbert Friedman)	\$6.25
Regulated Power Supplies (Irving M. Gottlieb)	\$13.50
Audio IC Op-Amp Applications (Walter G. Jung)	\$10.75
TV Antennas and Signal Distribution Systems (M. J. Salvati)	\$13.50
Video Tape Recorders (Jarry Kybett)	\$13.50
Modern Recording Techniques (Robert E. Runstein)	\$14.25
Understanding CMOS Integrated Circuits (Roger Melen & Harry Garland)	\$7.50
Getting Acquainted with the IC (Rufus P. Turner)	\$6.75
FM From Antenna to Audio (Leonard Feldman)	\$7.00
Stereo High-fidelity Speaker Systems (Art Zuckerman)	\$8.50
IC Op-Amp Cookbook (Walter G. Jung)	\$17.50
TTL Cookbook (Lancaster)	\$12.95
TV Typewriter Cookbook (Lancaster)	\$13.50
The Cheap Video Cookbook (Lancaster)	\$7.95
CMOS Cookbook (Lancaster) 1st Edition 1977	\$14.25
Active Filter Cookbook (Lancaster)	\$19.95
IC Timer Cookbook (Jung)	\$13.50

MICROCOMPUTERS/ MICROPROCESSORS BOOKS

Principles of Compiler Design (A. Aho & J. Ullman)	\$23.50
Microprocessors and Microcomputers: Their Use and Programming (Eric Huggins)	\$12.50
Introductory Experiments in Digital Electronics and 8080A Microcomputer Programming and Interfacing Book 1 — (Rony/Larsen/Titus)	\$17.50
Introductory Experiments in Digital Electronics and 8080A Microcomputer Programming and Interfacing Book 2 — (Larsen/Rony/Titus)	\$14.75
Logic and Memory Experiments Using TTL IC's Book 1 — (Larsen & Rony)	\$13.50
Logic and Memory Experiments Using TTL IC's Book 2 — (Rony & Larsen)	\$13.50
TEA: An 8080/8085 Co-resident Editor/Assembler (Titus)	\$11.95
TRS 80 Interfacing — Book 1 (Titus)	\$11.95
Using the 6800 Microprocessor (Elmer Poe)	\$8.95
Interfacing and Scientific Data Communications Experiments (Rony/Larsen/Titus/Titus)	\$7.95
Basic Programming Primer (M. Waite & M. Pardee)	\$11.95
Programming in Pascal — Revised Edition (P. Grogono)	\$11.50
Learning Level II — CompuSoft Learning Series (David A. Lien)	\$20.00
Computer Programming for the Complete Idiot (Donald McCunn)	\$9.95
Microprocessor Cookbook (Michael F. Hordeski)	\$7.50
Scelbi: "8080" Software Gourmet Guide and Cook Book — Reduced to:	\$4.99

Just some of the books from the biggest range of radio and electronics books in Australia. If the book you require is not listed below, it can be ordered from us.

Programming the 6502 (Zaks) (Sybex)	\$17.80
Programming the Z80 (Zaks) (Sybex)	\$19.00
6502 Applications Book (Zaks) (Sybex)	\$17.80

LATEST ADAM OSORNE BOOKS

An Introduction to Microcomputers — Volume 0 — The Beginner's Book	\$10.40
An Introduction to Microcomputers — Volume 1 — Basic Concepts	\$16.20
An Introduction to Microcomputers — Volume 2 — some Real Microprocessors	\$29.00
An Introduction to Microcomputers — Volume 3 — some Real Support Devices	\$19.00
Some Common Basic Programs	\$16.20
Accounts Payable and Accounts Receivable	\$23.00
Payroll with Cost Accounting in Basic	\$23.00
6800 Programming for Logic Design	\$13.50
8080 Programming for Logic Design	\$13.50
Z80 Programming for Logic Design	\$13.50
Z80 Assembly Language Programming	\$13.50
8080A/8085 Assembly Language Programming	\$16.20
6502 Assembly Language Programming	\$16.20

AMERICAN RADIO RELAY PUBLICATIONS

The Radio Amateur's VHF Manual	\$7.20
Understanding Amateur Radio	\$8.80
The Radio Amateur's License Manual	\$6.20
A Course in Radio Fundamentals	\$7.20
FM & Repeater for the Radio Amateur	\$8.80
Single Sideband for the Radio Amateur	\$7.20
Ham Radio Operating Guide	\$7.20
Electronic Data Book	\$7.20
Solid State Design for the Radio Amateur	\$12.80
Learning to Work with Integrated Circuits	\$4.00
Weekend Projects for the Radio Amateur	\$6.20
The ARRL Operating Manual	\$9.80

OTHER TITLES

Beginner's Guide to Radio — 8th Edition (Gordon J. King)	\$9.00
Flowcharting and Basic (P. Edwards & B. Broadwell)	\$12.95
Music and the Synthesiser (Bruce Graham)	\$15.00
Programmable Pocket Calculators (H. Mullish & S. Kochan)	\$11.50
Filter Theory and Design: Active & Passive (A. Sedra & P. Brackett)	\$45.50
Electrical Principles for the Electrical Trades (J. R. Jenkinson)	\$9.95
The Handbook of Telephones & Accessories (John Sunier)	\$12.50
IC Array Cookbook (Walter G. Jung)	\$10.00
Towers' International Transistor Selector 2nd Edition (T. D. Towers)	\$8.50
Practical Antennas for the Radio Amateur	\$15.40
73 Dipole and Long-wire Antennas (Edward M. Noll)	\$7.50
73 Vertical, Beam and Triangle Antennas (Noll)	\$7.50
VHF Handbook for Radio Amateurs (Herbert S. Brier & William I. Orr)	\$9.40
Building Hi-Fi Speaker Systems (Philips) 7th Edition, 1980	\$10.75
Beam Antenna Handbook — New 5th Edition (William I. Orr & Stuart D. Cowan)	\$7.80
All About Cubical Quad Antennas — 2nd Edition (William I. Orr)	\$7.00
The Radio Amateur Antenna Handbook (William I. Orr & Stuart D. Cowan)	\$11.30
The Basic Book of Ham Radio (Editors of Consumer Guide and ARRL)	\$6.70
The New Penguin Dictionary of Electronics (E. C. Young)	\$5.95

We also carry a large range of overseas and local computer magazines.

For Mail Orders please add: \$1.20 Local \$1.75 Interstate

McGILL'S AUTHORISED NEWSAGENCY PTY LTD

187 Elizabeth Street, Melbourne. Phone: 60-1475-6-7

Prices Subject to Alteration

Column 80

by JAMIESON ROWE

Technical Director,
Dick Smith Electronics

TRS-80 & System 80 cassette interfaces

Although the System-80 computer has an inbuilt cassette tape deck, it also provides a socket for interfacing to an external recorder or other equipment like "light pens" or amplifiers. The software arrangements to do this are very similar to those for the TRS-80 machine.

To continue our look at the differences between the System-80 and TRS-80 machines, and how they affect operation, let's look now at the cassette interfaces. Here the two machines are very similar, except for a difference which arises from the fact that the System-80 has an inbuilt tape deck as well as the socket for an external recorder.

Essentially, the System-80 cassette interface is the same as that for the TRS-80, with an addition. So it is probably worthwhile to look first at the TRS-80 interface and its operation, and then see what has been added in the System-80.

A simplified circuit for the TRS-80 interface is shown in Figure 1. It is delightfully simple, as you can see. The recording

signal is produced by simply resistive mixing of the B0 and B1 outputs from a digital latch device, which is arranged to occupy the top address "EF" (hexadecimal) in the so-called "I/O address space" of the Z-80 microprocessor.

Such a simple circuit may be used because the software does all the real work, to encode the digital information as a signal capable of being recorded on a standard audio tape recorder. Built into the Level-II BASIC ROMs are driver routines which "know" how to feed bytes to I/O address FF, to "toggle" bites B0 and B1 of the latch, and produce a stream of bipolar audio pulses. These are fed out to the recorder via pin 5 of the DIN socket.

On replay, the corresponding stream of pulses from the recorder comes in via pin 4 and is passed to a decoder circuit. This is a little more complicated than the recording circuit, and we needn't go into the details here. Suffice to say that the incoming data is recovered by "reading" it from the same I/O address as before: FF hex.

The remaining part of the interface is used for software control of the tape recorder's motor. Here bit B2 of the FF output latch is fed to a driver and relay, with a pair of contacts connected to pins 1 and 3 of the DIN socket. When bit B2 is set to a 1, the relay is energised to close the contacts.

The simple interface is particularly flexible. It may be used to connect to all sorts of other equipment apart from a tape recorder: light "pens", amplifiers, power controllers and so on. All that is needed is the right software.

The interface in the System-80 uses the same basic circuit as that of Figure 1, but is complicated slightly by the need to arrange switching between the internal tape deck and the external recorder socket. As you can see from Figure 2, this has been done by adding a second relay. RLY1 effectively controls the internal deck, while RLY2 controls the external recorder.

The drivers for both relays are controlled as before by the bit B2 output from the FF output latch, but an additional latch at I/O address "FE" hex is used to allow software selection of the desired recorder. The bit B4 outputs are used to perform the actual selection, so that to select the internal recorder the software must reset B4 to 0. Conversely to select the external recorder, B4 must be set to a 1.

As no other bits are used at address FE, this means that a byte of "00" hex may be fed to FE to select the internal recorder, while a byte of "FF" may be fed to select the external recorder.

How does this difference affect BASIC programs that need to communicate with things like light pens and amplifiers via the external recorder socket? Well, if the programs were written originally for the TRS-80, they won't know how to set the FE latch to select the external recorder socket. But this is easily fixed:

(continued on p120)

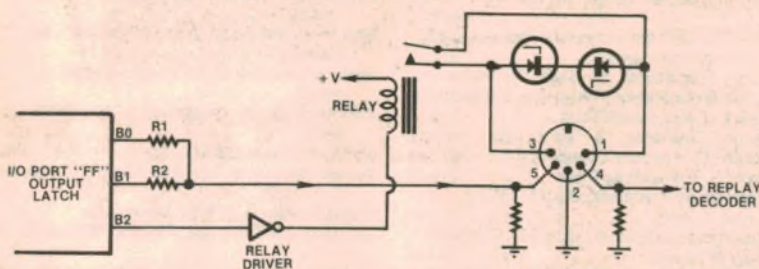

FIG. 1: TRS-80 CASSETTE INTERFACE

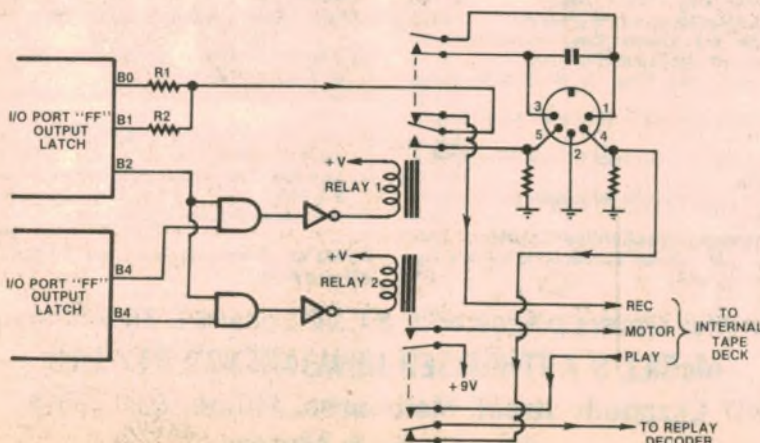

FIG. 2: SYSTEM-80 CASSETTE INTERFACE

**AT
LAST!**

A LABORATORY QUALITY 6.5MHz CRO AT A HOBBYIST PRICE!

Here's what 'Electronics Australia' had to say:

... this neatly styled little oscilloscope should be just the shot for the hobbyist who cannot afford an expensive CRO ... now a CRO has been placed within the financial reach of most hobbyists ... our overall impression of the Q-1280 oscilloscope is that it represents good value for money.

This is it! The new Dick Smith Q-1280 laboratory oscilloscope. With a useable bandwidth to beyond 6.5MHz, it's the ideal budget cro for everyone!

- HOBBYISTS
- AMATEURS
- SCHOOLS
- UNIVERSITIES
- SERVICEMEN

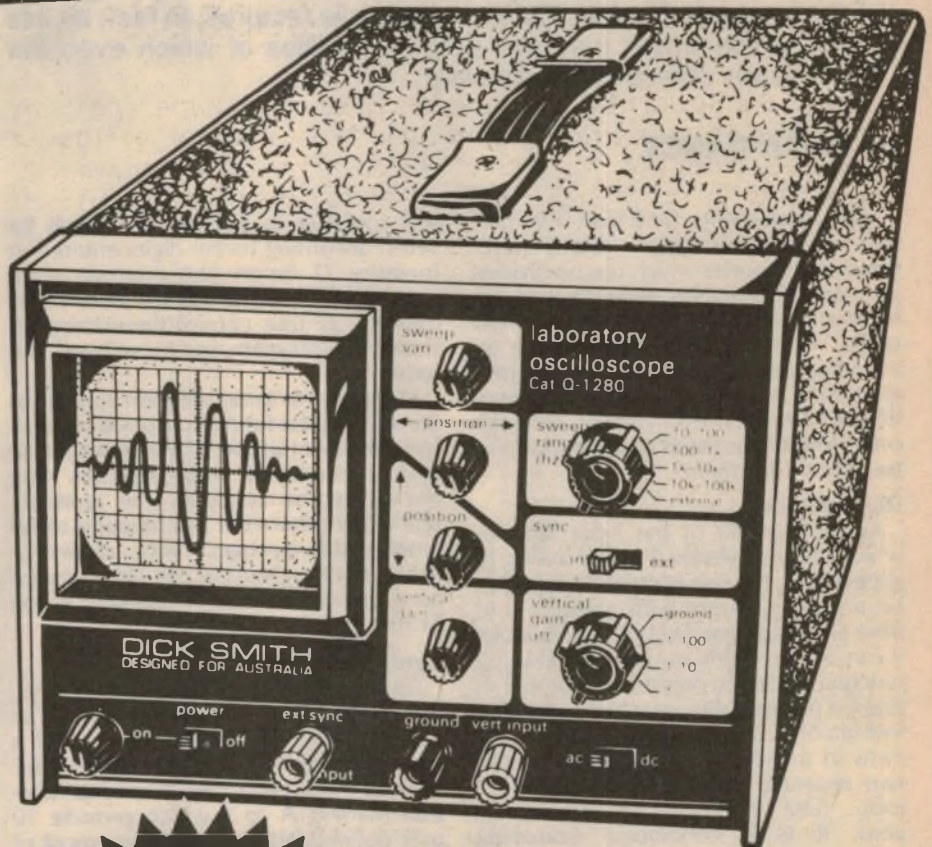

**COMES
COMPLETE
WITH
COMPREHENSIVE
USER'S
MANUAL**

**ALL THIS FOR
ONLY**

\$199⁰⁰

Cat. Q-1280

SPECIFICATIONS:

Vertical Deflection Sensitivity: 10mV/DIV
Horizontal Deflection Sensitivity: 500mV/DIV
Time base - Sweep Frequency: 10Hz to 100KHz in 4 ranges
Synchronising: Internal and external.
Power Requirements: 100/234V, 50/60Hz, approximately 10W
Dimensions: 202(w) x 160(h) x 306(d)mm. Weight: Approximately 3.8kg.

**\$6.00 Freight anywhere in Australia
THAT'S BELOW COST!**

DICK SMITH ELECTRONICS

NSW 125 York Street.
818 George Street.
182 Pacific Hwy.
30 Green Street.
613 Prince Hwy.
147 Hurst Hwy.
531 Pittwater Road.
145 Parramatta Road.

SYDNEY 290 3377
BROADWAY 211 3777
GORE HILL 439 5311
PARRAMATTA 683 1133
BLAKEHURST 546 7744
CHULLORA 642 8922
BROOKVALE 93 0441
AUBURN (Opening soon)

VIC 283 Korra Street
399 Lanedale Street.
656 Bridge Road.
QLD 168 Logan Road
842 Gympie Road
ACT 98 Gladstone Street
SA 80 Wright Street
WA 414 William Street.

WOLLONGONG 28 3800
MELBOURNE 67 9834
RICHMOND 428 1614
BURANDA 381 8233
CHEMERSIDE 59 8255
FYSHWICK 80 4944
ADELAIDE 212 1962
PERTH 328 8944

bankcard
welcome here

SHOPS OPEN 9AM to 5.30PM
(Saturday: 9am till 12 noon)
BRISBANE Half hour earlier.
ANY TERMS OFFERED ARE TO
APPROVED APPLICANTS ONLY
RE-SELLERS OF DICK SMITH
PRODUCTS IN MOST AREAS OF AUSTRALIA.



MAIL ORDER CENTRE: PO Box 321, NORTH RYDE NSW 2113. Ph 888 3200. PACK & POST EXTRA

The hidden charms of the Texas TI-58/59 calculators

Texas Instruments' programmable calculators are widely employed these days and offer the user many valuable features. In fact, as this article demonstrates they can provide facilities of which even the manufacturer seems to be unaware.

by BRIAN DANCE

Texas Instruments TI-58 and TI-59 programmable calculators have partitionable memories which can be divided as required between data registers for number storage and program memory space. They can be used in some interesting ways and even allow some programming facilities which are not mentioned in the instruction books, although one must be prepared to experiment to be able to use them.

Dsz function

As an example of the extra facilities which one can obtain if one is willing to experiment, the dsz function is stated to be available for use with registers 0 to nine only, whereas (with a little trouble) it can be used with any register. This dsz function is used to control the number of times a program passes around a loop of instructions; one can use two dsz functions in a program which may control two separate loops or a loop within a loop. (Dsz is decrement-and-skip-on-zero. It is a conditional branching instruction.)

When using the dsz function, one presses the second function button followed by the dsz button and the single digit of the register on which it is to operate. The next button is not connected with the dsz function and therefore if one wishes to use a register with a number exceeding nine, the correct digits of this register must be built up in the memory "synthetically", so that both digits of the register number are in the same line of the memory.

For example, if one wishes to use the dsz function with memory register 27, press STO 27 (so as to write 27 in a single line of the program memory) followed by two back-step operations, after which "STO" is overwritten by the dsz instruction. One has thus synthetically entered into the memory the dsz instruction followed by the digits 27, both digits being in the same line.

As an example of a very simple program using this technique, enter LBL A, X, 7, =, Pause, STO, 27, BST, BST, dsz, SST, A, R/S, RST. This program will multiply the number in the display by seven and

will continue to multiply the result by seven according to the digits entered in memory 27 before the program commenced. The digits initially entered in memory 27 thus control the number of times the program moves around the loop.

Although the same program can be used with the dsz function entered normally if a register numbered in the range 0 to nine is employed, these registers may not always be available. The synthetic technique allows the dsz function to be employed in a program with any one or more of 49 registers in the TI-58 or with an even wider range of registers in the TI-59.

Synthetic labelling

The TI-58 and TI-59 each have 45 keys, but most of these can be used for two or more operations through the use of a second function key. There are five user defined keys, each with a second function marked A to E which provide 10 user defined labels. In addition, most of the other keys and their second functions can be used to label points in a program. Although a few of the keys cannot be used as labels (such as the learn key, the insert, delete, indirect addressing and the digits), one nevertheless has about 60 of these common label keys plus the 10 user-defined labels.

One can synthetically build-up further merged instruction labels in the program memory by entering a suitable sequence of instructions. If, for example, one wishes to enter the label 62, one cannot do this directly, but it can be done by the key sequence RCL, 62, BST, BST, LBL, SST. The recall instruction followed by the digits 62 enters these digits in a line of the memory and the two successive backstepping operations take the program counter back to the correct place for the Label key to be used to overwrite the recall instruction. Thus one now has the label key followed by the digits 62 in a single memory line, so 62 is the label used. One can enter the following labels synthetically in a similar way, but not directly: 63, 64, 72, 73, 74, 82, 83, 84 and 92. Thus there are an additional 10 labels

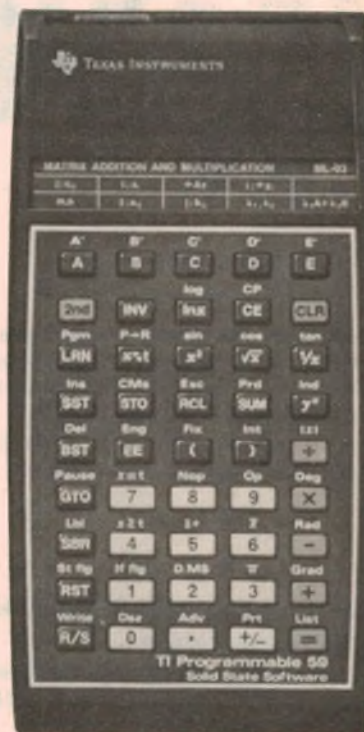

\$399 EXPANDABLE, AFFORDABLE, LEARN AS YOU BUILD MICROCOMPUTER

CASSETTE
INTERFACE

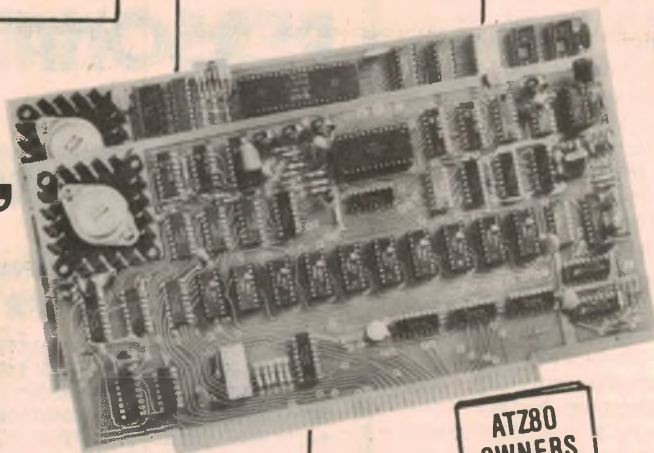

ATZ80
OWNERS
MANUAL

Z80
PROGRAMMING
COURSE

KEYBOARD

The 1980's is the age of computer technology. Update your knowledge of computer hardware and software with the ATZ80, S100 modular building blocks. Start with the basic Z80/CPU/VDU/Keyboard package and E-X-P-A-N-D later as your needs increase.

WHY Z80? It's the world's most powerful and popular 8-bit micro and consequently has by far the largest software support (and believe us, this counts!)

WHY S100? It has now evolved as the widest used standard supported by equipment manufacturers world wide. Another big plus is that each S100 card is a functional module, easy to service and, above all, easy to understand and use.

KIT OR ASSEMBLED/TESTED. The ATZ80 micromodular system is available in kit form or assembled and tested. By far the biggest advantage is the flexible expandability that means you build up the system you need when you need it. Start with the \$399 ATZ80/4 package and you can learn programming, build useful control systems such as a burglar alarm, time switch, robot controller even an intelligent visual display unit (VDU). If you need more memory, add the AT16K static ram board, the SECI cassette interface controller and you can load games programs such as Target, Space Trek or Microworld Z80 Basic... even the Microworld Z80 Editor/Assembler. You now have a professional quality computer system to challenge the "ready made" systems like the TRS80, Apple and The Sorcerer at a fraction of the cost!

NO EXPENSIVE EXPANSION INTERFACE REQUIRED! Why spend \$500 or more for a S100 interface for the so called "popular" computers? The ATZ80 is already on the S100 bus so you can spend your expansion dollars on more powerful hardware such as floppy discs or a high speed line printer.

THE ATZ IS VERSATILE.... whether you want a low cost teaching machine, a word processor, a small business system, a dedicated controller or even a full process control system you can select the modular building blocks to suit your needs... and save yourself a bundle as well.

THE ATZ80 IS A PROVEN AUSTRALIAN DESIGN, fully supported with service and technical backup. Designed by David Griffiths, the DGZ80 was described in ETI Nov., 1979 and is the most popular single board S100/Z80 CPU in Australia. Applied Technology, leaders in microcomputer kits since 1976, selected the DGZ80 as the most suitable kit for hobbyists, but other users include Govt Depts., Educational Institutions and industry. IBM even bought a DGZ80 for evaluation!

SPECIAL OFFER: \$399 ATZ80 STARTER'S KIT Package deal includes DGZ80/CPU Kit, DGOS Monitor Program in ROM, DG40/VDU kit, fully encoded ASCII keyboard, complete assembly instructions, Z80 programming course and detailed experiments/programs to run. You just connect a simple power supply (details provided) and a modified TV set or monitor.

SUPPORT MODULES

TCT16K Static Ram Kit
IA32K ROM (without EPROMS)
ET16B1 PCG (Graphics) Kit
SECI Cassette Interface
S100 Protoboard

Kit	Assembled/ Tested
\$259.00	\$ 299.00
-	\$ 110.00
\$140.00	\$ 165.00
-	\$ 27.50
-	\$ 21.75

PERIPHERALS

Micropolis 1043/Quad Density 5" Disc system
complete with drive, controller, cables, power
supply and software
8300 High Speed Printer
12" Monitor

\$1275.00
\$ 950.00
\$ 149.50

PACKAGING/HARDWARE

JC100 S100 Motherboard 9 slot
JC200 Cage Kit
EPS250 Heavy duty power supply kit
Computer desk unit and cabinet

\$49.50
\$49.50
\$65.00

(write for details)

SOFTWARE (SUPPLIED ON CASSETTE TAPE WITH OWNERS MANUALS)

Microworld Z80 12K Basic
Microworld Z80 Assembler
Games Pack 1
Utility Pack 1

\$14.75
\$14.75
\$14.75
\$14.75

All prices include Sales Tax.



APPLIED TECHNOLOGY PTY. LTD.

MAIL ORDERS TO:

PO Box 355, Hornsby 2077
Please add \$2.00 per order
towards cost of post and packing.

OFFICE/SHOWROOM

1a Pattison Avenue, Waitara 2077.
Hours: 9-5 Monday to Saturday
Telephone: 487 2711

AND NOW AT GOSFORD -

1 Debenham Road, West Gosford (behind the Pizza Hut)

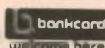

Microcomputer News & Products



Colour Graphics Board from Raydata

Raydata Pty Ltd has introduced a colour graphics circuit board which can interface a microprocessor to a standard PAL television receiver. The PAL Video Display Generator (PVDG) can generate up to eight colours, graphics, text, and sound effects, and can be connected to the antenna input of a PAL receiver. The PVDG is self-contained, and appears to the processor as 8K of static memory. It is Exorciser bus compatible and can be interfaced with the 6800 family and 6502 type microprocessors.

Video and colour information is generated by an on-board clock and is independent of the processor clock. In normal operation the composite video, colour and sound are modulated by an on-board modulator. The modulator will also work with black and white receivers, generating a four level grey scale. An output switch is provided to select either RF modulated output or composite video output.

The PVDG occupies 8K of memory and can be located in different areas of a system's memory using an on-board address selection switch. The 8K area of memory contains 6K of static RAM which is accessible to the processor. Data stored in this 6K area is shown on the display screen using a memory mapping.

Depending on which mode of operation is selected, the PVDG will interpret

Pictured at right is the new Pal Video Display Generator Board from Raydata.

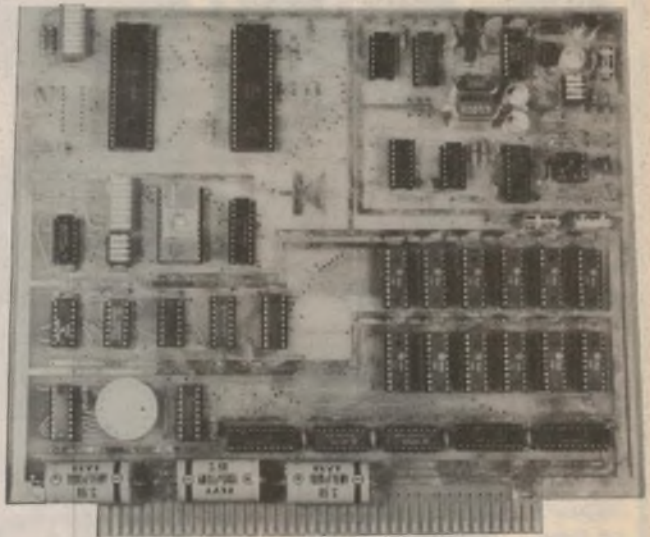

the data as colour, luminance, or text. A PIA occupies part of the remaining memory area, and provides 2 timers, a shift register and an 8 bit parallel port which can be used independently of the display generator.

The Display Generator provides 8 modes of graphics display (offering various combinations of resolution and colour displays), 2 semi-graphics modes for the display of combined text and graphics, and two text modes. Both text

modes provide 16 lines of 32 characters, either defined by the board's internal character generator or, in mode 2, defined by a plug-in EPROM. By using their own EPROM, users can define up to 256 characters of their own for display.

Further information on the Raydata Video Display Generator can be obtained by writing to Raydata, PO Box 477, Gosford, NSW, 2250.

More Micronews ▶

modular microprocessor systems

6800/6802/6809

- 6800/6802/6809 Disk or Cassette based systems
- Expansion cards for EXORcisers*, D2 kits, AIM-65, SYM-1 or other EXORciser compatible microcomputers.
- Motorola Micromodules* & MOKEP* products
- PERCOM EXORcisor compatible Disk Systems
- TSC & PERCOM SOFTWARE
- MEMORY IC's : 2114L, 6116 (2K x 8) & 4334 (1K x 4) CMOS RAMS, 2716 & 2732 EPROMS.

PP Pennywise Peripherals
Pennywise Peripherals

* EXORciser is a registered Trade Mark of Motorola Inc.
Suite 15, 96 Camberwell Road,
Hawthorn East, Vic. 3123.
PO Box 398,
Camberwell, Vic, 3124. Phone (03) 82 2389
Sydney Dealer (02) 89 3145

Send 50c in stamps for latest SF catalog & price list.

**First Birthday Sale.
Special Discounts
offered on all stock**

COMPUCOLOR II

**Ex
Stock**



features:

- Up to 32K User RAM
- Eight-colour display
- 32 lines of 64 char.
- 5" Mini Disk Drive
- 40 Tracks, 48 TPI

TELEVIDEO TVI-912

**Ex
Stock**



features:

- 24 lines
- 80 char. per line
- Transmission rates 75-19,200 Bd.
- 96 char. ASCII Upper & Lower Case
- 12" Monitor

MICROLINE 80 PRINTER

**Ex
Stock**



features:

- 80 char. per sec.
- 80 and 132 char. per line
- 9x7 DOT MATRIX character or graphics printing.

PLUG COMPATIBLE TO TRS-80

(TRS-80 is a regd. trade name of
The Tandy Corp.).

SPECIAL
5 1/4 DISKETTS
\$3.95 EACH (INC. TAX)

Gulton Microplot 44 from Tecnico



Gulton Industries Measurement and Control Division have introduced a 44 column fixed head thermal graphics printer designed to plot and print in conjunction with microprocessor systems. The new printer/plotter is available in a desk-top version (the Microplot 44T) and a panel mount data logging version, (Microplot 44L), and will accept data in digital form and plot the data with the grid and scale or print alphanumeric information.

The unit also offers individual dot addressing, double density printing, vector plotting and a 96 character ASCII character set. IEEE-488, RS232C and parallel interfaces are provided.

For more information on the Gulton Microplot 44 contact Tecnico Electronics, PO Box 50, Lane Cove, NSW, 2066, or PO Box 520, Clayton, Vic 3168.

Micronews continued ►

COLUMN 80 Continued

all you need to do is add one simple statement to the start of the program. The statement is:

OUT 254,255

If you don't want to modify your program, you can simply type in this statement yourself as a direct command, after you have CLOADED the program and before you tell it to RUN. This approach can also be used with SYSTEM (machine language) programs, which you mightn't feel up to changing.

Here all you need to do is load the program in the usual way, via the SYSTEM

command. Then when the tape stops and you get the second "*" prompt, press the BREAK key or reset button to return you temporarily to BASIC. You can then type in OUT 254,255 as a direct command, and follow this by typing SYSTEM again to get you back to where you were. Finally type a slash (/) and hit the NEWLINE key, and your program will run.

As you can see, the differences between the two machines are really quite small, and are very easy to adjust to when you know how.

from P114



HARDWARE

KIT	DESCRIPTION	PRICE
S/O9	6809 Computer w/128K Memory	\$3350.00
/O9	6809 Computer w/56K Memory	\$1660.00
69/A	6809 Computer w/8K Memory	\$760.00
69/K	6809 Computer Kit w/8K Memory	\$660.00
S/OO	S/O9 w/o Processor or Memory Card	\$560.00
CT-82	Terminal w/Monitor	\$995.00
MF69A	Mini Floppy Disk System	\$1295.00
DMF2	Disk System w/2.5m Capacity	\$2650.00
CDS-1	Winchester Hard Disk System	\$4835.00
SP-3	Daisy Wheel Printer (QUME)	\$3295.00
SP-5	Daisy Wheel Printer (QUME)	\$3515.00
PR-4O	Alphanumeric Printer	\$275.00
MP-O9	6809 Processor Board Kit	\$192.50
MP-O9A	6809 Processor Board (Assembled)	\$225.50
38O9	128K Memory Expansion for S/O9	\$2305.00
MP-32	32K Memory (assembled)	\$715.00
MP-16	16K Memory (assembled)	\$440.00
MP-8A	8K Memory (assembled)	\$258.50
MP-8M	8K Memory kit	\$220.00
MP-LA	Parallel Interface	\$45.00
MP-L2	Dual Parallel Interface	\$110.00
MP-N	Calculator Interface	\$65.00
MP-P	Power Supply	\$66.00
MP-QP	Circuit Board for SP-3 (assembled)	\$78.00
MP-R	Eprom Programmer	\$65.00
MP-S	Serial Interface	\$45.00
MP-SA	Serial Interface (Assembled)	\$66.00
MP-S2	Dual Serial Interface	\$110.00
MP-SX	Serial interface Expansion	\$27.50
MP-T	Interrupt Timer	\$52.25
MP-WP	IBM Selectric Interface	\$66.00
S-32	Universal Static Memory Card	\$115.00
MP-O9b	Processor Circuit Board	\$27.50
MP-8Mb	8K Memory Circuit Board	\$27.50
DMF2b	Controller Board for DMF2	\$434.50
DC3b	Controller Board for MF69A	\$165.00

PRICES SUBJECT TO ALTERATION
EXPORT PRICES UPON APPLICATION
ALL HARDWARE PRICES PLUS 15% ST WHERE APPLICABLE

SOFTWARE

ASMO9	Optimizing Assembler (5" or 8")	\$110.00
Flex O9	ver. 2.6:5 w/manual	\$38.50
Flex O9	ver. 2.6:5 w/o manual	\$11.00
Inventory	Program	\$110.00
Mail List	Program	\$110.00
Word processing	Editor & Text processor	\$165.00
Word Processing	Editor	\$110.00
Text processor		\$66.00
SP-O9-2	Text Editing System	\$38.50
SP-O9-3	Mnemonic Assembler	\$44.00
SP-O9-4	Basic	\$71.50
SP-O9-5	Debug Package	\$82.50
SP-O9-6	Extended Basic	\$110.00
SP-O9-7	Standard Precompiler	\$55.00
SP-O9-8	Extended Precompiler	\$55.00
SP-O9-9	Multi-user Basic	\$165.00
SP-O9-10	Sort/merge	\$82.50
SP-O9-11		\$66.00
* UniFLEX:-	Multi-user and Multi-tasking	\$495.00

SWTPC BUSINESS SOFTWARE: ACCOUNTS RECEIVABLE, GENERAL LEDGER, INVENTORY, PAYROLL, MAIL LIST AND MANY OTHERS.

FLEX for the EXORciser™

Runs on a Motorola EXORciser with EXORdisk™ II or III. Requires no hardware modifications with the possible exception of memory re-addressing. Uses the same boot as MDOS™.

FLEX Support Software

Extended BASIC
Standard BASIC
6809 Diagnostics Package
Text Processing System
Sort/Merge
68000 Cross Assembler
6809 Cross Assembler
6809 FLEX Utilities
6800 FLEX Utilities
6809 Debug Package
6800 Debug Package
FLEX for SWTPC

UniFLEX:- Multi-user and Multi-tasking



SOUTH WEST TECHNICAL PRODUCT CORPORATION

(COVERING AUSTRALASIA)

7a BURTON STREET, DARLINGHURST, N.S.W. 2010.

P.O. BOX 380 DARLINGHURST N.S.W. 2010. PHONE (02) 357 5111

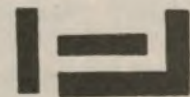
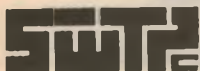

The NDK S-4000 Wordprocessing Printer

For all bulk wordprocessing applications where reliability, speed and sustained print quality are of prime importance.

The NDK S-4000 is supplied with a heavy duty 16 wire head producing single pass high quality 17 x 16 matrix characters at 75 characters/second for wordprocessing quality and 150 - 200 characters/second for drafts.

Four fonts (dot matrix, wordprocessing, super/subscript and Katakana) are supplied as standard. Typical scientific, mathematical and currency symbols are included as standard. The fonts can be intermixed as bold faced, enlarged (5 CPI, 17 x 23 matrix), reduced (12 CPI) or normal (10 CPI). Other fonts can be specified by the user. Each dot on the 16 x 16 matrix can be programmed by the host computer to produce special graphic effects (such as Letterheads and trade marks), FULL PAGE graphics can be produced by programming the 10 top wires of the head and executing half line feeds. The special patterns can be printed at the rate of 900 dot columns/second at a resolution of 4.7 dots/mm (120 dots per inch) both horizontally and vertically. A horizontal dot resolution of 240 dots per inch can be produced using half dot timing.

PRICE \$3190 (plus \$390 sales tax)

(Serial or Parallel interface, stand included in price)

16K Static Ram By California Computer Systems

Features:

- Fully Static (uses 2114 RAM chips)
- +5v operation only
- Bank select available by bank port and bank byte.
- Phantom line capability
- Addressable in 4k blocks
- 4k blocks can be addressed anywhere in 64k in 4k increments
- Fully buffered
- Meets IEEE proposed S-100 signal standards
- LEDs for board and bank selection
- Ideal for use with the SORCERER S-100 expansion unit.

PRICE \$370.00 (plus \$56.00 sales tax)

NEW CATALOGUES:

Hardware with description of some application software and summary of LIFEBOAT prices (about 60 pages) \$1.00.

LIFEBOAT ASSOCIATES catalogue which includes our range of Australian Commercial packages. Catalogue includes detailed description of CP/M operating system and list of known BUGS (about 112 pages) \$5.00

Purchase price of Catalogue includes membership of our mailing list club.

LIFELINES

A new magazine published monthly by LIFEBOAT ASSOCIATES which details latest software releases, known software bugs as well as REVIEWS of popular packages.

12 month subscription (including postage) \$36.00

JOHN F. ROSE COMPUTER SERVICES PTY. LTD.

33-35 ATCHISON STREET, ST. LEONARDS, N.S.W. 2065, AUSTRALIA
TELEPHONE: (02) 439 1220 TELEX: AA 27901

John F. Rose Computer Services Pty Ltd is the official Australian representative of LIFEBOAT ASSOCIATES the software supermarket.

Prices and specifications subject to change without notice.

Microcomputer News & Products

HANDHELD COMPUTER FROM UK

New Laboratories Ltd of Britain recently introduced their "NewBrain," claimed to be the most powerful handheld computer currently available. The NewBrain measures 280mm x 152mm x 50mm, and offers a full typewriter keyboard, a self-contained single line display of 16 characters, and interface connectors which allow the computer to be used with a video monitor, printer, cassette recorder or teletype.

A powerful Basic compiler is provided which allows floating point mathematic functions, string and logic functions, and full editing capabilities. Software extension modules can be plugged into the expansion interface of the extension boxes provided to house peripheral cards. A total of 4 megabytes of software may be added to the system in this way. Software under development includes an Assembler, Cobol, Fortran, and Pascal.

All NewBrain models have a dual cassette interface for program and data storage, designed to work with any audio tape recorder. The interface is said to be highly tolerant of wow, flutter, and phase distortion on playback, and loads and saves programs at 1200 baud. In addition each model has a bidirectional parallel port, a serial interface and analog I/O capabilities. A viewdata expansion module is also being developed, which will allow the computer to create and store viewdata graphics.

Enquiries should be made to the Managing Director of Newbury Laboratories Ltd, Mr Robert E. Smith. The address is King St, Odiham, Hampshire, RG25 1NN, Great Britain.

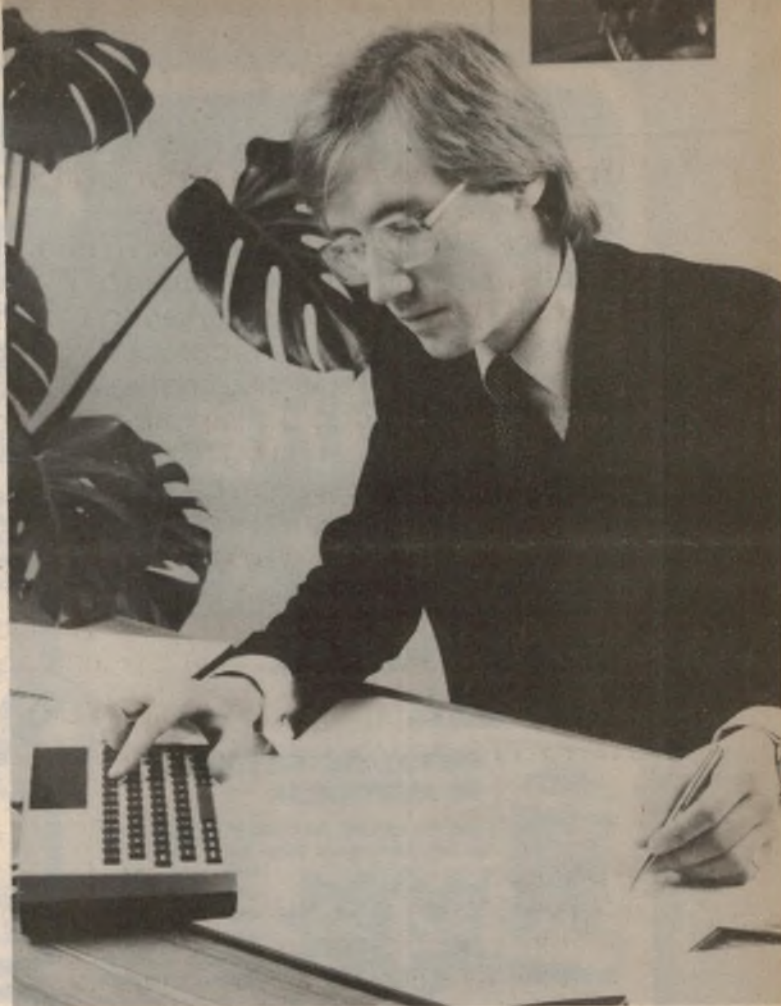

K&L Computing Systems introduces the feature packed Archives Business Computer.

This highly versatile desk top unit provides high technology at a competitive price. Suitable for handling all the day by day business requirements, its features include:

- An extremely fast Z80 4MHZ Processor
- CP/M Operating System
- S100 Expansion Bus
- 64K RAM Standard
- 744K Bytes Disk Storage (Expandable)
- 25 Line x 80 col. Display

Available with word processor and complete accounting package, or software can be written to customer's specifications.

Also, see K&L's range of Apple II Plus Computers, floppy disk drives, video monitors, interfaces and expansion options.

- Language card with compilers for Pascal and Fortran
- Z80 Softcard with micro-soft basic compiler and CP/M
- DOS 3.3 upgrade kits (143K Bytes per disk)
- Paper Tiger printer with graphics



COMPUTING SYSTEMS

385-387 BRIDGE ROAD,

RICHMOND, 3121. TEL: (VIC.) 429 2122

KL R002

Just Released! Ricoh RP1600 Printer, a top quality Daisy Wheel printer ideal for word processing applications, at a highly competitive price.

OFFICE HOURS:
W/Days 9 to 5.30,
Saturday
9 to 12.00



If you're really serious about finding GOLD...

These books tell all!



METAL DETECTING IN AUSTRALIA

You too can join the ranks of the rich - just go out and dig up some gold! This book tells you how, when, where and why. It is invaluable for the serious treasure seeker. Cat B-4520

\$4.50

THE AUSTRALIAN GOLDFINDER

Just released - this up-to-the-minute reference book shows you the latest way to make a fortune - electronically with a metal detector. How to use them, what to look for, even checking for 'fools gold'. Take it with you on your next trip! Cat B-4525



\$1.95

STOP PRESS

\$1,000,000 GOLD NUGGET FOUND BY AMATEUR PROSPECTOR EARLY OCTOBER IN VICTORIA! WILL YOURS BE NEXT???

DICK SMITH ELECTRONICS

NSW 125 York Street,
818 George Street,
182 Pacific Hwy,
38 Grass Street,
813 Princes Hwy,
147 Hume Hwy,
531 Pittwater Road,
145 Parramatta Road

SYDNEY 290 3377
BROADWAY 211 3777
GORE HILL 439 5311
PARRAMATTA 883 1133
BLAKENHURST 548 7744
CHULLORA 842 8922
BROOKVALE 93 0441
AUBURN (Opening soon)

VIC 283 Raine Street,
389 Lansdale Street,
858 Bridge Road,
QLD 186 Logan Road,
842 Gympie Road,
58 Gladstone Street,
80 Wright Street,
814 William Street

WOLLONGONG 28 3800
MELBOURNE 87 9834
RICHMOND 428 1014
BURANDA 381 8233
CHEERMSIDE 59 8255
FYSHWICK 80 4944
ADELAIDE 212 1882
PERTH 328 8944

MAIL ORDER CENTRE: PO Box 321, NORTH RYDE NSW 2113. Ph 888 3200. PACK & POST EXTRA.

IS THIS THE ULTIMATE?

THE DICK SMITH/D TEX SCANNER 1

GOLD FINDER

There are a lot of detectors around, but none can match the Scanner 1 Goldfinder. Check the features out - and then the price. It is far and away the best value metal detector in Australia today!

- ★ TWIN SEARCH COILS
- ★ GROUND REJECTION
- ★ DUAL MODE FULL RANGE DISCRIMINATION
- ★ ADJUSTABLE SENSITIVITY
- ★ MADE IN USA EXCLUSIVELY FOR DICK!



ONLY **\$480.00**

Cat X-1075



Terms available to approved applicants - or use your Bankcard!

HUGE PRICE/TECHNOLOGY BREAKTHROUGH!

TRACKER T-R

Most metal detectors can't tell treasure from rubbish. This one can, as the discriminator microprocessor can compare ferrous and non-ferrous metals. Other discriminator type detectors sell on the Australian market for \$300 to \$480.00 - look at this one!



~~\$125.00~~
\$99.00

Cat X-1065

This system uses a microprocessor circuit which replaces all the conventional complicated knobs - so it is very simple to use. It is NOT a 'toy' type detector with a BFO circuit; it is a true T-R (transmit-receive) type with highly sophisticated circuitry.

YES! A FULL TRANSMIT/RECEIVE FOR LESS THAN \$300.00!!!!

bankcard
welcome here

SHOPS OPEN 9AM TO 5.30PM
(Saturday 9am till 12 noon)
BRISBANE: Half hour earlier.
ANY TERMS OFFERED ARE TO APPROVED APPLICANTS ONLY
RE-SELLERS OF DICK SMITH PRODUCTS IN MOST AREAS OF AUSTRALIA.



Microcomputer News & Products

Computer Products from Dick Smith

Many of the Disk Operating Systems (DOS) programs provided for use on small computers are much harder to understand and to use than Basic, leading to difficulties when the users want to put their computers to serious use. As soon as they add floppy disks to allow faster and more efficient operation programming becomes much more complex than before.

Dick Smith Electronics sees this as a problem, and to provide some relief is now distributing a disk operating system for the System-80 and TRS-80 microcomputers which is said to be ideal for people who are used to programming only in Basic. The system runs on both computers, and can be adjusted to work with either 35 or 40 track disk drives of almost any make.

Called MICRODOS, the operating system loads into memory to become a "transparent" addition to the existing Basic interpreter in ROM. It adds a set of additional commands to Basic, so that all disk programming is done in Basic itself.

MICRODOS comes with a number of utility programs including a disk file manager, and a utility to allow the user to format new disks and to make copies etc. It also comes with a simple data file handling program, whose initial data is an explanation of MICRODOS itself. These utility programs are written in Basic, and can be listed and studied by

the user and modified for special applications if desired.

MICRODOS will be available from all Dick Smith Electronics branches and DSE resellers. The price is \$35 which includes the program on disk and complete documentation.

S-100 Cards

Three S-100 cards available from Dick Smith Electronics will be of interest to readers using an S-100 system or the Sorcerer or System 80 with S-100 expansion unit. The cards are a programmable music synthesiser, an I/O expander and a programmer for 2708 and 2716 EPROMs. All three products are from the US manufacturer SSM Microcomputer Products, and are available either in kit form or fully assembled and tested.

The SB1 Music Synthesiser is Programmable over a nine-octave range from 15Hz to 25kHz. The output level can be programmed over 15 different levels and the waveform of the note can be defined in 32 bytes of memory. Attack, sustain, and note duration are also programmable. The SB1 comes with full details of a high level music programming interpreter which may be used to drive up to eight SB1 cards simultaneously and is programmed in standard ASCII code to allow the user to write and correct musical compositions.

The IO4 I/O Expander board provides two latched 8-bit parallel output ports and two 8-bit parallel input ports, each with full handshaking facilities. Also provided are two independent serial communications ports, which may be programmed for baud rate (from 55-9600 baud) and data format, and may be set for either RS232C or 20/60mA current loop operation.

The PB1 EPROM programmer provides separate sockets for programming 2708 and 2716 EPROMs. The programming sockets may be set by DIP switch to occupy addresses within any 4K boundary of memory. Programming voltages are generated on the board, and selection of 2708 or 2716 programming is under software control.

Four sockets are also provided on the board for normal read-only operation of 2708 and 2716 devices. The board is supplied with full details of software routines required for checking EPROM erasure, programming and verification.

The kit version of the Music board is \$250, while the I/O expander and EPROM programmer cost \$190 in kit form. Assembled and tested versions of the boards are available at an additional cost of \$60. All three S-100 boards are available through Dick Smith Electronics branches and re-sellers in all states.

MICRONEWS
CONTINUED →

TANDY

COMPATIBLE

Printers, Expansion Units,
Disc Drive, Software.

**DIRECT FROM
THE U.S.**

Write for our Catalogue

**COMPUTER IMPORTS
PTY. LTD.**

P.O. BOX 7, PORT ADELAIDE,
S.A., 5015

PHONE (08) 26 88065

Computer Country Pty. Ltd.

"THE MICROCOMPUTER PROFESSIONALS"

Thinking of purchasing a microcomputer system or adding to the one you already have? Make a good investment - invest a little bit of time to talk to the professionals at Computer Country. Remember the quality of the after-sales hardware service and continual after-sales software and hardware advice you get is just as important as the price of the system you buy. Come and have a chat with the professionals of Computer Country just once and you'll realise how much help we can be in enabling you to get the most out of your microcomputer system.

Computer Country stocks a wide range of microcomputer hardware including the Apple, Northstar, Commodore, Texas Instruments, NEC, Impact Data and many more. We carry a wide range of software for many systems including the TRS-80. We can also help you in customising software for your specific application.

Our service department not only completely backs up all hardware purchased from us, but invites enquiries from those who have purchased elsewhere and have hard-to-fix problems.

MAKE A SMART MOVE - COME TO

Computer Country Pty. Ltd.

338 QUEEN STREET, MELBOURNE, VIC. 3000
Telephone: (03) 329 7533

Microcomputer News & Products

Accessories for the HP85

Users of Hewlett-Packard's HP-85 computer can now expand their systems by connecting plotters, printers and other peripherals. Hewlett-Packard has introduced a HP-IB interface module and three new read-only-memory circuits that plug into ports of the computer to provide the increased capabilities.

The first of the new ROMs provides general input/output facilities, enabling the HP-85 to control instruments and perform data acquisition over the HP-IB link. The HP-IB (Hewlett-Packard Interface Bus) is HP's version of the IEEE-488 standard interconnection scheme.

A second ROM allows the user to add a HP 2631B serial printer and HP 7225A graphics plotter. The printer/plotter ROM enhances the standard HP-85 CRT graphics by providing 50 additional Basic statements with features such as graphics formatting, digitising from plotters and full width print formatting.

A third new ROM, for matrix mathematics, provides a powerful set of statements for working with one and two-dimensional arrays as large as 60 by 60 with additional memory in place. The



matrix maths ROM allows the user to perform matrix multiplications with two arrays, perform arithmetic operations between corresponding elements of two arrays, copy arrays and sub-arrays and perform many other operations.

The HP-85 personal professional computer costs \$3700 tax-free. Price of the new enhancements are \$450 for the HP-IB interface, \$52 for the ROM drawer

needed to interface the ROMs to the computer, and \$165 each for the plotter/printer and matrix maths ROMs. The I/O enhancement ROM costs \$336.

Further information can be obtained from Hewlett-Packard Australia Pty Ltd, 31-41 Joseph St, Blackburn, Victoria, 3130.

Tandon Model TM-100 Mini-Floppy Disk Drives

Heads above the rest in disk technology.

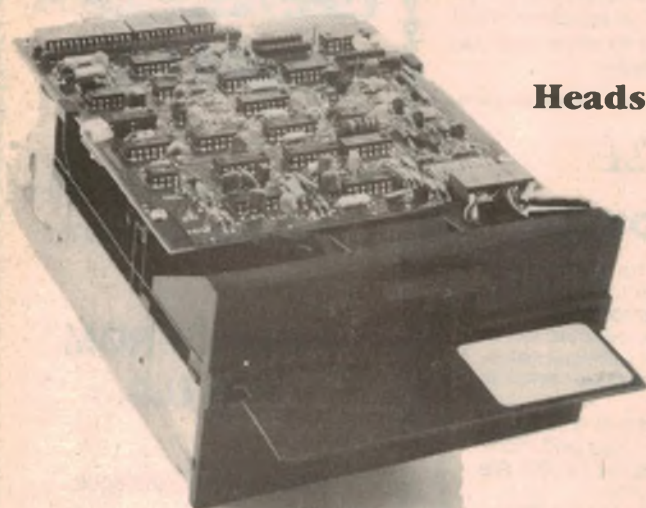

Tandon's TM-100 family of mini-floppies offer the absolute highest storage capabilities of any 5 1/4" high-speed, random access disk drive available in two single head and two double head models, all double density.

Unsurpassed Storage Capacity - Up to an incredible 1000K bytes information on 160 tracks. Recording density is 5877 BPI.

Advanced Dual-Head Design - Tandon Magnetics has for years been the leading designer and supplier of read/write heads to most major disk drive manufacturers.

Increased Throughput - Tandon's TM-100 have a track-to-track access time of only 5 milliseconds (an incredible 3 milliseconds double track density.)

Proven Reliability - Designed for total reliability, as demonstrated by more than 50,000 production models in operation.

TM100 SS -48.P.I.
TM100 DS -48 T.P.I.
TM100 SS -96T.P.I.

TM100 4 DS - 96T.P.I.
TM100-3M SS - 100T.P.I.
TM100-4M ds - 100T.P.I.

FROM \$325.00

Australian Representative

AE ADAPTIVE
ELECTRONICS P/L

77 Beach Road, Sandringham, Vic. 3191

Ph (03) 598 4422

BUILD NOW FOR CHRISTMAS!



Get ready for the Christmas festivities and save \$\$\$! You'll be surprised at how easy a Dick Smith Kit is to build; and your Christmas bill won't cost you a fortune!!!

NEW EA CHASER



\$69⁵⁰

Cat. K-3145

What a way to add life to your next Christmas party with this incredible Light Chaser. Features include reverse/forward chasing, variable flash rate control plus an invert/normal switch. This switch can make two lights appear to move instead of one at a time. The versatility is increased with 'auto reverse' & 'auto invert' functions. When either control is switched on, the unit will automatically invert or reverse the display at any set rate. All this makes it a worthwhile project that will save \$\$\$ and give hours of entertainment.

ETI STROBE

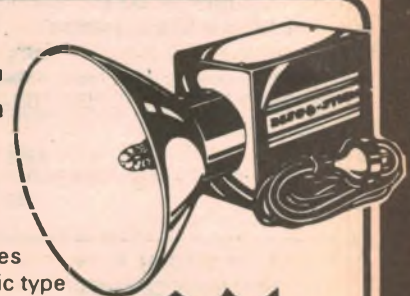

\$34⁵⁰

Cat. K-3152

Get your Christmas party swinging with this superb Disco Strobe. This popular kit contains up-to-date circuitry and comes complete with photographic type reflector, perspex safety guard and instructions. Vary the flash rate to the beat of your music.

EA MUSIC COLOR



\$69⁵⁰

K-3140

Turn your music into a light show. This unit will accept an audio input from almost any amplifier and uses the information to control 3 channels of colour. The ideal unit for your Christmas or New Year's party, disco, bands etc etc. Also makes an ideal present.

COLOURED GLOBES

Ideal for discos, parties etc. Use with your Music-Color. Available in 4 colours: yellow, red, blue, & green. **\$7⁹⁵ea**



SWIVEL BASE Globe Holder attaches to wall or ceiling. **\$3⁵⁰**

Cat. P-5620

HOLD IT!

Line socket for bayonet mount lamps makes it ideal for running wander light leads for loft & outside. Ideal for holding standard colour globes for parties, Xmas decorations outside etc.

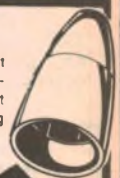

95¢

P-5510

OTHER EXCITING DICK SMITH KITS...

ACOUSTIC COUPLER

We've lost count of the number of customers who have asked for this project: well here it is! This acoustic coupler acts like a modem without any physical connection to the phone lines. It uses your standard telephone handset, placed over a small microphone & speaker in the coupler case, & transfers the information from your computer by sound. Hence the name, acoustic coupler. Now you can have your computer talk to another across the street, across the town - even across the country (or further!) It is a must for all serious computer users, and we hope to release the kit soon.



A must for everyone with a computer

\$75⁰⁰

Cat. K-3605

LEDS & LADDERS GAME



NOW ONLY \$15⁷⁵

One of our most popular kits of the past was the intriguing 'LEDS & LADDERS' game described in EA in 1975. Now EA have come up with a new version of the game which is not only easier to build, it is also easier to play! Can you climb out of the well without being plummeted down again?

AND NOW FOR THE BEST NEWS: This kit is actually \$1.00 cheaper than it was in 1976 - despite 4 years of inflation! Makes an ideal gift. **Was \$16.75 in 1976**

Cat. K-3390

DICK SMITH ELECTRONICS



SEE OUR OTHER ADVERTS IN THIS MAGAZINE FOR OUR STORE ADDRESSES AND RESELLERS

Microcomputer News & Products

8K PROMS from Texas Instruments

Texas Instruments Inc has announced two new bipolar 8K Programmable Read Only Memories (PROMs). The TBP24S81, organised as 2K x 4, features a maximum access time of 70ns, while the TBP28L86, organised as 1K x 8, is a lower power circuit dissipating 350mW, which is about 60% less than TI's standard high speed PROMs.

Like all Texas Instruments PROMs the new components use titanium-tungsten fusible links, allowing low programming voltages. The devices are supplied with a high logic level stored at each bit location, and are programmed by burning out selected links to establish a low logic level. Both devices are designed with three-state outputs to simplify system control and interfacing.

Both components are available now in sample quantities, and volume production will begin shortly. Additional information is available through TI sales offices Sydney, Melbourne and Perth.

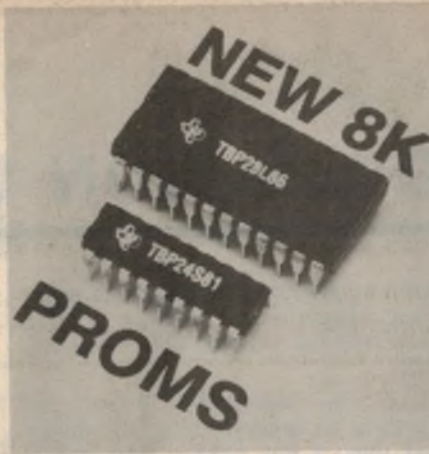

Pennywise peripherals moves house

Pennywise Peripherals have moved to new premises at Suite 15, 96 Camberwell Road, East Hawthorn, Victoria, 3123. Telephone (03) 82 2389. Postal address is PO Box 398, Camberwell, Victoria 3124.

They chose a more central location and larger premises to provide a better and broader service to their existing and future clients.

They are pleased with the growing acceptance of their products especially by professional users, and are proud to announce that they have recently been

awarded a contract by Telecom to supply several of their cards including their new 6909 single card computer.

Pennywise are now the Australian distributors of PERCOM Data Products, manufacturers of Exorciser (Motorola TM) compatible mini desk systems.

Microcomputer House

A new business handling Commodore computer systems and ancillary services has commenced operations in Alexandria, Sydney. The Microcomputer House will cater to businesses and hobbyists, offering Commodore systems backed by a wide range of Datasoft and other software. The address is 19 William Street, Alexandria, NSW, 2051.

Commodore users group in SA

A Commodore Computer Users Association has been formed in Adelaide. The group meets at 7.30pm on the first Tuesday of each month, usually at the Adelaide University Union Building, and contributes to the newsletter produced by the combined Commodore Users Associations of all states.

The group can be contacted by writing to Earle Rowan, PO Box 60, Clarence Gardens, South Australia, 5039

GET YOUR COMPUTER BOOKS FROM COMPUTER EXPERTS!

Now MICROCOMP offer a wide selection of computer books suitable for the business, educational and hobby computer users. Have a look at these titles!

PRENTICE HALL PUBLICATIONS

The Computer Solution:	\$12.00
Computers: Their Structure, Use and Influence:	\$21.50
Learning Basic Fast:	\$ 9.50
Computer Based Business Systems, Text and Cases:	\$ 7.95
Computer Games for Businesses, School and Homes:	\$14.75
Basic Primer:	\$11.95
Basic For Everyone:	\$15.95
How To Computerise Your Small Business:	\$10.75
Introduction to Computers In Business:	\$13.50
Introduction To The Computer, The Tool of Business:	\$12.95
Basic Programming Self Taught:	\$14.75
How To Program Your Programmable Calculator:	\$10.75
A Primer On Pascal:	\$14.75
Software Debugging For Microcomputers:	\$14.75
Introduction To The Computer:	\$18.95
Computers and Commonsense:	\$ 8.95

OSBORNE/MCGRAW HILL PUBLICATIONS

8080A/8085 Assembly Language Programming:	\$12.50
6800 Assembly Language Programming:	\$12.50
Z80 Assembly Language Programming:	\$12.50
6502 Assembly Language Programming:	\$12.50
Z8000 Assembly Language Programming:	\$12.50
Some Common BASIC Programs (book):	\$12.50
Some Common BASIC Programs — CBM/PET Edition:	\$12.50
The PET Personal Computer Guide:	\$15.00
PET and the IEEE 488 Bus (GPIB):	\$15.00

OTHER PUBLICATIONS

The PET Revealed:	\$30.00
PET Subroutines:	\$30.00
PET Machine Language Guide:	\$ 7.95

SPECIAL OFFER

16/32K Commodore CBM Toolkit:	\$70.00
8K Commodore PET Toolkit:	\$80.00
ADD TEN EXTRA COMMANDS TO YOUR SYSTEM	

Books are available off the shelf at our City Office or by mail order if required. Mail Orders may be paid by Bankcard/Master Charge/Visa Card by quoting card number and expiry date. Please add \$1.00 postage and packing for each item. Postage free on orders over \$50 (within Australia). If you require books not on the above list, please contact us — we may be able to help.



MICROCOMPUTER SYSTEMS DESIGNERS

B. S. MICROCOMP,
4th Floor,
561 Bourke Street,
MELBOURNE, 3000.
Tel: 614 1433/614 1551.



INFORMATION CENTRE

PAL PATTERN GENERATOR: I am interested in building the TV pattern generator which appeared on page 42 of the June 80 issue of EA. You mentioned in the text that including a PAL encoder section would make the unit unnecessarily expensive.

However, I am prepared to shoulder the additional expense as I would find the PAL pattern of great benefit in the alignment of the chroma section of a receiver.

Have you designed, or would you design an additional section for PAL alignment for those who would be interested? Even if the additional cost was \$150 it would be well worth it for me. (L.F., Hamilton, NSW)

● We have no immediate plans for a colour pattern generator at this time although we admit there would be some interest in such a unit. We shall reconsider the project.

TRANSISTOR-ASSISTED IGNITION: Just recently, I built your Transistor-Assisted Ignition and have had great success with it. I am also very interested in building a contactless ignition trigger to operate with your TAI, either infrared or magnetically induced. Could you please

inform me as to where I could obtain a circuit diagram or information that would help me with this. (B.L., Geebung, Qld).

● Back in September 1970, we described an optoelectronic distributor head using a low voltage lamp and a photo-transistor. (File No 3/TI/7). This design or a similar circuit could be adapted to the transistor assisted ignition although the advantage of quick changeover from electronic to conventional ignition would be lost.

300W AMPLIFIER: I have been getting Electronics Australia for some time and in the June 1980 issue I read about Richard Tymerski's 200-300W Playmaster amp module and the circuit interested me in many ways. I would like to know if this unit could be used as a "CB amp" driven from 12V or 13V power and if so could it still deliver the same 200W or 300W depending on the load. If so where could I purchase all the parts needed for the amp and the driver even if it is not recommended for CB use, as I am still interested in building one for my HiFi setup? (M.A., Buckleboo, SA)

● The Playmaster 300W amplifier is designed to operate from supply rails of

$\pm 70V$. The load lines and all of the specifications are calculated for this supply voltage. It is doubtful if the amplifier would work from a 12V supply, and even if it did, performance would probably be very unsatisfactory and way below specification.

The circuit board for the amplifier should be available from one of the suppliers listed on the last page of this magazine. Complete kits for the amplifier are available from Rod Irving Electronics, 42 High Street, Northcote, Victoria or Electronic Agencies, 115-117 Parramatta Road, Concord, NSW.

TV/CRO ADAPTER: I was very interested in your May article about converting a TV into a CRO. I wonder however whether some of the characteristics of a conventional CRO could be used, since at frequencies above 5kHz, 100 cycles of an input waveform have to be displayed, making the display very crowded. Is it possible to use the same principle as in a normal CRO with the input signal deflecting the electron beam and a variable sweep frequency? If so, could you design a suitable circuit? (L.B., Wellington, NZ)

● Unfortunately, it is very difficult to design a variable sweep oscilloscope around conventional television deflection components, although it has been done by several companies in the past.

Even so, the resulting instruments had a very modest bandwidth of typically no more than 10kHz.

RF IMPEDANCE BRIDGE: I am just about ready to put together my RF Impedance Bridge as described in August, 1979. In the article you mention that it is capable of identifying any reactive component when measuring antenna impedance. Could you give me an example please? I also believe that the Bridge may be used to sort out my 52 ohm coax cable from the 72 ohm roll which I put away some time ago without labelling them. Also, could you explain and interpret the readings on a GDO. For instance, I find that the meter on mine goes up, down, and at times moves sharply either side of a certain position on the dial. (J. M., Clayton, Vic.).

● As was mentioned in the article on the RF Impedance Bridge, it was an outcome of an earlier article describing a similar bridge, in June, 1971. In this

New idea for home hifi?

3-WAY STEREO: Thank you for an excellent magazine which has kept me — as a professional TV service man — up to date in my interests.

Intending to update my hifi system in the near future has given rise to some thought on a built-in sound system, and has resulted in the following ideas:

(1) Why have stereo in the very low frequencies when the ear cannot locate the sound source?

(2) Why have two output amplifiers of high power that are wide-range in frequency response, when only the mid and treble frequencies need stereo?

It seems a saving in expense and an improvement in quality could be obtained by using a high-power mono amplifier to handle the low frequencies and a separate stereo amplifier of much lower power to drive the treble and midrange speakers.

The stereo amplifier before the drivers would, of course, be a standard 2-channel design. However, each chan-

nel would be split into a further three channels by a filter before going to the bass amplifier and the treble and midrange speakers.

To my knowledge, this idea has not been brought forward or tried as yet. Would it be good enough for a future project? (S.F., Mooloolah, Qld).

● Everything that you describe is certainly possible and has been done many times in commercial equipment and in hifi journals. The single-channel bass concept has been used in stereo equipment for small apartments and recreational vehicles, as well as being applied to stereo jukeboxes.

We described a 2-channel active filter unit for this type of system in the February, 1978 issue, while the Super-Bass Filter described in the February 1980 issue is a related idea.

However, for most applications, conventional 2-channel stereo equipment is still the most cost effective.

earlier article, details are given as to how reactive measurements may be made when measuring antenna impedance.

Although it may be possible to make characteristic impedance measurements on coaxial cable by indirect means, we have not gone into this. However, it may be done with an SWR meter. A random length of cable is taken and one end plugged into the SWR meter and the other end is terminated in say, a 50 ohm load. With power applied from a transmitter, the SWR should read "1", if the cable is the 50 ohm variety. If a reading other than "1" is obtained, then a 75 ohm load should be tried and the procedure repeated.

From your description of the behaviour of your GDO, we suspect that you are referring to the meter needle as you tune across one of the higher frequency ranges. This "dipping" of the meter indicates that there are some inbuilt resonances in the unit. Further details of the uses and applications may be obtained from our article of February, 1969, describing a Solid-State Dip Oscillator.

RESISTOR IDENTIFICATION: Now that the new $\frac{1}{2}W$ resistors are the same size as the old $\frac{1}{4}W$ resistors there arises the question of which is which for those who have stocks of the older components.

Greg Swain's excellent article on passive components in the January issue did not seem to clarify this point.

If it is possible to distinguish the old $\frac{1}{4}W$ resistors from the new $\frac{1}{2}W$ type I am sure your readers would like to be informed about it through the pages of your magazine. (J. E., Bull Creek, WA).

● While the problem is a real one, we regret to say that there is no practicable way of distinguishing between the old styles of $\frac{1}{4}W$ resistor and the new $\frac{1}{2}W$ types. Different manufacturers follow different packaging systems, so physical configuration is not a reliable guide, although metal glaze resistors can usually be distinguished by the absence of the end caps which serve to attach the leads to a carbon film type resistor.

In any event, it is of no consequence that a $\frac{1}{2}W$ resistor is substituted for a $\frac{1}{4}W$ type as long as there is room on the board. Parts lists for "Electronics Australia" projects carry a note to this effect.

DIGITAL READOUT: I have a DX-160 receiver which is out of alignment. I would like to fit a digital frequency readout and was thinking of your frequency meter (Aug '78). Would it be possible to provide a direct reading of the receiving frequency using this instrument, or could you please suggest an alternative design that would do the job? I would also like to see more projects for amateur radio in your magazine. (G.O'S., Claremont, Tas).

● A digital readout can be fitted to the

Setting up a graphic equaliser

GRAPHIC EQUALISER: I have recently built a pink noise generator to calibrate the graphic equaliser described in May 1979. The circuit used was the pink noise generator section of the graphic analyser (EA, Feb., 1980), the only modification being the incorporation of a 20k potentiometer to reduce the output from about 5V to a level compatible with the input of my amplifier.

I have used the generator in conjunction with an omnidirectional electret microphone and a tape deck VU meter as outlined in the manual for the Dick Smith equaliser kit. Two problems have been experienced:

(1) A low frequency beat in the output. This does not appear to be too serious, although it does cause flickering of the VU meter.

(2) More serious is the fact that, with all the equaliser controls as maximum cut, increasing any octave control to 0dB causes so little change in the VU meter reading as to be useless for calibration. There is also little audible effect noticeable, although the equaliser seems to be functioning properly on both CRO analysis and with audible tests on normal program material.

Can you advise whether the problem is

receiver but the frequency meter that you mention is not really suitable for this application because intermediate frequency (IF) offset has to be taken into account. A circuit that does this for you was published in the "Circuit and Design Ideas" section in our August 1980 issue.

Another solution is to use one of the integrated circuits that is specifically designed for this type of application, such as the AY-5-8102 from the General Instrument Corporation. This device and the supporting literature are available from General Electronic Services at 99 Alexander Street, Crows Nest, NSW 2065.

COMPUTER DISPLAY: I have been getting your magazine for several years now and I find it very good. Among other projects I have constructed are the 40-40 amplifier and now the Dream 6800 computer. The only fault I can find with the 6802 kit is the video display. I realize that the cost had to be kept down, hence the very chunky graphics. However, I now want a screen with a much larger number of available dots so that the characters can be made smaller. Could you design a better VDU and/or a modified TV set that would fulfill this requirement? (A.G., Mandurah, WA)

● As you are aware, the Dream computer was designed mainly as an instructional computer for those people who have little or no knowledge of computers and programming them. The

an inherent characteristic of the generator if used in this way and, if not, where the trouble may lie? (P.A.T., Canberra, ACT).

● The slow beat in the output of the pink noise generator is due to the pseudo-random bit sequence used by the IC in the circuit. This normally does not create problems, since the signal is averaged over relatively long periods.

The apparently small effect on the VU meter reading when one of the octave controls is advanced is to be expected. Assuming equal energy per octave (which is what a pink noise signal gives), the overall signal contribution from any one octave is 1/10 of the RMS total. This means that the VU meter will only show a 3dB change if you boost a given control by 20dB, a figure arrived at by calculating the RMS value of the overall signal level.

Therefore, since any one equaliser control can only produce a small change in the VU meter, this method of setting the equaliser is not appropriate. The only method we can recommend involves using a graphic analyser as described in our February 1980 issue.

video display in the Dream is controlled by the system software that controls all the functions of the computer and if a change in the display format is required, then this would require a complete re-design.

BASEMENT FLYWHEEL: With respect to the article "Basement Flywheel Stores Solar Energy at 15,000rpm" (March, 1980). The system proposed by Dr Alan Millner has a motor-alternator which is claimed to do the power conditioning, ie convert the solar panel DC output or the stored energy in the flywheel to 115VAC for use in the house. But how can a flywheel gradually slowing down from 15,000rpm produce 60Hz (or 50Hz) AC output! Even if a multiple alternator producing 60Hz at 15,000rpm could be made, the frequency would change as it slowed down!

As the device is claimed to accept DC from solar cells and produce AC simultaneously it must in fact be a separate motor and generator with perhaps some common parts. Regarding the energy density (Watt hours/Kg) I doubt if the weight is particularly important in a stationary application.

Regarding Forum for February 1980 — "Energy Sources Storage" — according to Lead Battery Power No 23 of February '80 from the Australian Lead Development Association of Melbourne, the US Department of Energy project for a peak topping battery involves a 2MW (meaning MW-hour?) battery form C & D

RESISTORS

150 ohm, 5W	20c
10 ohm, 5W	20c
47 ohm, 5W	20c
12 ohm, 3W	20c
2.5 ohm, 3W	20c
33 ohm, 3W	20c
8 ohm, 10W	25c
4000 ohm, 10W	25c
100 ohm, 5W	20c
330 ohm, 10W	25c
220 ohm, 5W	20c
5 ohm, 5W	20c
220 ohm, 10W	25c
950 ohm, 3W	20c
115 ohm, 5W	20c
10 ohm, 5W	20c
1k ohm, 5W	20c
5000 ohm, 5W	20c
6.8k ohm, 3W	20c
3300 ohm, 10W	25c
6800 ohm, 10W	25c
1500 ohm DUAL, 21W	50c
50 ohm, 5W	20c
330 ohm, 5W	20c
1k ohm, 5W	20c
820 ohm, 5W	20c
12 ohm, 10W	25c
470 ohm, 7W	20c
4700 ohm, 4.5W	20c
5000 ohm, 10W	25c
8.2 ohm	5W
3.3k	7W
1 ohm	5W
10k	7W
2.5 ohm	3W

CAPACITORS

0.0039uF, 1500V	20c ea
6N8, 1500V	20c ea
0.0068uF, 1500V	20c ea
1200PF, 400V	10 for \$1
0.068uF, 400V	5 for \$1
2200PF, 630V	10 for \$1
0.47uF, 250V	10 for \$1
0.10uF, 400V	5 for \$1
0.082uF, 160V	10 for \$1
26k, 250V	10 for \$1
0.041uF, 400V	10 for \$1
0.033uF, 250V	5 for \$1
0.027uF, 100V	20 for \$1
220uF, 10V	10 for \$1
1uF, 350V	10 for \$1
470uF, 40V	5 for \$1
1000uF, 16V	1c for \$1
2.2uF, 200V	10 for \$1
0.047uF, 1500V	50c
47uF, 25V	4 for \$1
680uF, 40V	50c
22k, 100V	20c
330uF, 25V	25c
2.2uF, 200V	30c
470uF, 40V	50c
680uF, 35V	50c
0.015uF, 250V	25c
2500uF, 35V	\$1
1uF, 100V	25c
1000uF, 16V	50c
220uF, 16V	50c
2000uF, 63V	\$1
0.47uF, 400V	50c
680K, 250V	25c
012, 250V	25c
15NF, 250	10c
120K, 250V	20
10uF, 315V	25c
0.056, 250V	10c

Slide Pots	
250K-50K	3 for \$1
Dual 500K	3 for \$1
1 Meg	3 for \$1
2 Meg	3 for \$1
Including Fancy Gold Knobs	
25K dual	2 for \$1

SPECIAL	
100 mixed resistors, all useful	\$2
100 mixed capacitors, fresh stock	\$2

AUDIO LEADS	
3.5m to 3.5m, 7ft	75c
3.5m to 6.5m, 7ft	75c
6.5, 7ft	50c

MICRO SWITCH	
5A, 250V AC	75c ea

TUNING CAPS	
2 and 3 gang	\$1 ea
Min 2 gang	50c

FUSES	
0.5A, 2A, 3.25	10 for \$1
In line fuse holders	30c
RCA jack plugs and sockets	40c pair

L. E. CHAPMAN

122 PITT ROAD, NTH CURL CURL.
MAIL ORDERS: BOX 156, DEE WHY, NSW. 2099.
TELEPHONE 93-1848.

SPECIAL TRANSISTORS

AD161-162	\$2.50 pr
BSC 901A	\$1.50 ea
BC 548	10 for \$1
AD 149	\$3 pr

ELECTROS

470uF, 25V	5 for \$1
400uF, 10V	5 for \$1
47uF, 63V	5 for \$1
350uF, 16V	2 for \$1
27uF, 160V	5 for \$1
25uF, 63V	10 for \$1
22uF, 160V	10 for \$1
47uF, 16V	5 for \$1
47uF, 200V	5 for \$1
220uF, 10V	10 for \$1
68uF, 16V	10 for \$1
2500uF, 63V	2 for \$1

- Telescopic aerials, \$1.50
- Top quality, low impedance microphones, \$3.50
- 6 inch ferrite rods, 75c
- Rainbow lead, 5 strand, 20c per metre
- Line output transformers, 600 ohm, to 15 ohm, 20 watts, \$5
- Line output transformers, 1200 to 3/ohm, 5 watt, \$1
- Power supply units, filtered, 240 to 20 volt, \$12
- 240 to 15 volt transformers, \$3.50.

Power leads 240 volt, suit most tape recorders, radios, etc \$1 each

TV Stick Rectifiers 20SC, \$1.00.

Phillips Colour TV Convergence Boards, \$3 each.

455KC IF Transformers for valve radios, \$1 each. Also aerial and OSC coils, 75 cents each.

POTS ROTARY

½ Meg	30c
1 Meg	30c
100K	30c
100K Switch	50c
50K Double Pole Switch	50c
7.500	30c
10K Switch	50c
250K	30c
50K	30c
20K	30c
10K Min Pots	25c
50/Ohm	50c
½ or 1 Meg Switch	50c



BSR record changer or manual cueing device ceramic cartridge 11 inch turntable complete with base & perspex top \$55.00
P.P. NSW \$2.00
Interstate \$3.50
WA, Tas \$4.00

HOR Drive 3021 transformers for colour TV \$2
TV Colour Convergence Units 11270 44 x 6 \$3

PILOT LIGHTS
Screw in 6.3V 10 for \$10.50
24V 10 for \$1.00
Pilot light holders \$1.50

FRAME OUTPUT TRANSFORMER



Primary can be separated from secondary Lots of uses, battery saver etc \$2.00

TV TUNER VALVE TYPE

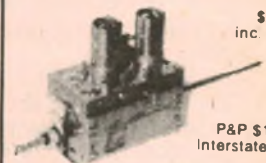

\$2.50 inc. valves.

P&P \$1.00 Interstate \$2.50

SUPER SPECIALS FM STEREO TUNER KITS

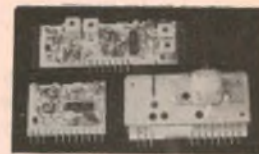

Sets of 3 modules include FM tuner, decoder and IF detector. Circuit diagram supplied. Can be used with amp modules.

ONLY \$18.00 P&P \$1.00

TRANSISTORS

2N3055	\$1.20
SE1002	4 for \$1
BF459	50
B544 DEE	50
C106 F1	50
TIP 110	50
608EK	4 for \$1
BC554813	10 for \$1
25B186	50
25A101	50
BD263	50
BSB405	50
25B77	50
25B303	50
AC187	50

VU & BALANCE METERS



STEREO VU \$3.00



12Kn 100uA \$2.00

PHILIPS TV TUNERS

Transistor NT3024, NT3030, NT3032. Colour — P&P \$1.



\$10 ea.

- Car radio suppressors, 3 for \$1
- 3 position slide switch, 50c
- Toggle switches, 25c
- 2 position push button switch, 50c
- 6 position push button switch, \$1
- 4 position push button switch, 75c
- Transistor ear plugs & leads, 3 for \$1
- In-line fuse holders, 4 for \$1
- 4 pole 2 position rotary switches, 50c

Pick up Cartridges BSR universal type Ceramic Stereo \$5
Audio Technica AT6 diamond stylus stereo \$12

DIODES

OA 626	4 for \$1.00
OA 662	4 for \$1.00
EM 410C	4 for \$1.00
DS 150A	50c
DSY 130YO	50c
OA 636	50c
HR 15	50c
Diodes 8YX 55, 600	30c
BY 188	30c

STEREO AMPLIFIER SOLID STATE 5 watts RMS per Channel \$25



PP NSW	\$1.50
Interstate	\$2.50
WA TAS	\$3.50

Special: 100 mixed capacitors, fresh stock, all useful. \$2.00

RECORDING LEVEL METERS

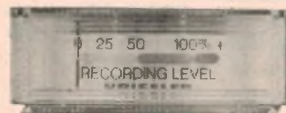

\$2.50

SUPER SPECIAL

GRAMOPHONE motor and pickup 3 speed stereo balanced arm.

240 volt \$9.75
PP NSW \$1.50
Interstate \$2.75
WA \$4

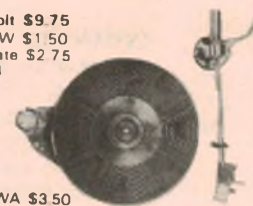

\$250 WA \$3.50

Miniature speaker and drive output transformers \$1 pr

Special mixed tag strips 10 for \$1

24V MOTORS

Reversible
Screw in 6.3V
Only \$2.50 ea.



batteries, to be ready for testing in late 1980. As you have acknowledged in the article the use of large inverters by Telecom Australia, I must point out the use of large stationary batteries for Telecom standby power. Our largest New Zealand Post Office batteries are twin 50V 7500 AH (in Auckland).

The life of these batteries can be 15-20 years but this is helped by:

1. Stationary use, so that they can use pure lead plates instead of lead-antimony. Car batteries are usually lead-antimony although some makes use lead with calcium or selenium for strength instead.

2. The batteries are floated on charge rather than working on a charge-discharge cycle. Deep discharge knocks battery life, eg from 1200 cycles at 20% discharge to 400 cycles at 80% discharge. (J.W., Wellington, NZ).

● The flywheel energy storage energy storage concept is still very much in the experimental stage, as our article makes clear. Presumably the developed system will have some means of maintaining the rotational speed of the flywheel within the limits required by the motor/alternator, which itself has yet to be produced on a commercial scale.

The weight of the flywheel is actually quite a critical factor, as increased weight means increased installation costs, materials costs, and increased demands on the flywheel bearing system. The cost of the flywheel is calculated on the basis of cost per kWh, so that the higher the energy density, the less the cost of the overall system. Flywheel energy storage can only be competitive with batteries if costs are kept down.

DREAM 6800: Without having to disassemble the Chipos monitor, is there any way I could get an assembly listing of the program? I wish to understand how the data is transferred from memory to cassette. Your assistance is appreciated. (C.S., Hunters Hill, NSW).

● An assembly language listing of the DREAM 6800 monitor is contained in Chipos, the software manual for the DREAM written by Michael Bauer. It is available from Dreamware, PO Box 343, Belmont, Vic 3216. The manual also lists the instructions of the Chipos monitor and explains what each instruction does, and provides a listing of Chipos subroutines and the entry points to them.

QUIZ MASTER: I recently built the Quiz Master featured in the October 1979 issue of EA. On completion, I switched it on and LED 1 came on. Pressing the reset button had no effect on the circuit. After spending some hours trying to find my mistake I concluded it was yours. I am inexperienced with digital electronics but on following the circuit and comparing it to the PCB layout I found some dif-

Want something? Read this!

"Electronics Australia" provides the following services:

PHOTOSTAT COPIES: \$3 per project, or \$3 per part where a project spreads over multiple issues (price includes postage). Requests can be handled more speedily if projects are positively identified, and if not accompanied by technical queries.

CHASSIS DIAGRAMS: for the few projects which require a custom metal chassis (as distinct from standard cases) dyeline plans showing dimensions are normally available. \$3 including postage.

PC BOARD PATTERNS: High contrast, actual size transparencies. \$3, including postage. Please specify positive or negative.

PROJECT QUERIES: Members of our technical staff are not normally available to discuss individual projects, either in person at our office or by telephone.

REPLIES BY POST: Limited to advice concerning projects published within the last three years. Charge \$3. We cannot provide lengthy answers.

undertake special research or discuss design changes. Nor can we provide any information on commercial equipment.

OTHER QUERIES: Technical queries outside the scope of "Replies by Post" and/or submitted without fee may be answered in these pages, at the discretion of the Editor.

COMPONENTS: We do not sell electronic components. Prices and specifications should be sought from advertisers or agents.

BACK ISSUES: Available only until our stocks are exhausted. Within six months of publication, face value. Seven months and older, if available, \$2 (includes storage fee). Post and packing 70c per issue extra.

REMITTANCES: Must be negotiable in Australia and made payable to "Electronics Australia". Where the exact charge may be in doubt, we recommend submitting an open cheque endorsed with a suitable limitation.

ADDRESS: All requests to the Assistant Editor, "Electronics Australia", Box 163, Beaconsfield, 2014.

ferences concerning the pin numbering of IC1. I attempted to service the board as to the circuit diagram but it still does not work.

Another thing I noticed is that there is no provision on the board for the 1000uF capacitor called for in the parts list.

By the way, it's good to see devotional records reviewed in a secular way. (N. H., Wavell Hts, Brisbane).

● The problems you are experiencing with the Quiz Master are not due to any errors in either the circuit or the board, although we do concede that the pin numbering around IC1 is not quite right. In fact what has happened here is that IC1a and IC1b are transposed between the circuit diagram and the actual PCB layout, but since these two gates form a flipflop of symmetrical design, this does

not pose a problem. As far as the reset not working is concerned, all we can suggest is that you prod around the circuit with a multimeter until you find the problem. To get you started, try these points:

(1) Check that input to IC3a goes low when the reset button is pressed, and that the output goes high. If the output of the inverter does not change with a change occurring at the input, then you will have to replace IC3.

(2) Check to see that pins 6, 9 and 10 of IC2 are all low when no button is pressed. If any of these pins is high, in particular pin 10, then the chances are that IC2 is defective.

We hope that the above points will provide the answer to the problem. The 1000uF capacitor is intended to be soldered between the supply pins on the PCB.

Notes & Errata

UNUSUAL AUDIO AMPLIFIER (February 1980, File No. 1/MA/53): The 555 PWM amplifier circuit on page 71 will not work unless the 1k resistor connected to pin 7 is replaced by a wire link. This changes the mark/space ratio but the circuit description is still valid.

EPROM PROGRAMMER (July 1980, File No. 2/CC/51): Two more errors in our program listing on page 72 have been found. Line 5060 should read PRINT "O" +P\$+" "; and line 5100 should read P\$=RIGHT\$(P\$,2): B=PEEK(30000+I): PRINT P\$;

PROSPECTOR METAL LOCATOR (November 1979, File No 3/MS/79): We

recommend that shielded audio cable not be used to connect the search coil since it is subject to significant changes in capacitance with temperature. This can cause uncontrollable drift. Our recommendation is to use a high quality cable such as 75-ohm coax.

DIGITAL CAPACITANCE METER (March 1980, File No 7/CM/13): it should be noted that only high quality RF coaxial cable should be used for the shielded cable in the meter and for the test leads. Normal audio cable is not suitable since it changes capacitance quite markedly with small changes in temperature. Suitable RF cable would be RG58 or 75-ohm coax.

MARKETPLACE

FOR SALE

FREE 10 unmarked transistors plus catalogue of cheap electronic components. Send SASE Electromania, 382 Glenferrie Rd, Malvern 3144, Vic

CASSETTES FOR MICROCOMPUTERS. Quality C10s 1-9 \$1.30 each, 10-49 \$1.10 each, 50-100 \$1.00 each. Post and Packing 60 cents any quantity. Guaranteed free from dropouts, else free replacement! Hutton, Box 158, Mt Waverley 3149.

16K RAM CARD, S-100 BUSS, \$250.00 Video-RAM card, S-100 BUSS, \$350.00 2716 EPROM \$14.00. Write to Clifford Kobayashi, 205/76 Roslyn Gardens, Elizabeth Bay, NSW 2011.

"AUSTRALIAN RADIO DX CLUB, the largest short-wave club in Australia with over 15 years of service and a full range of special publications available to members. Special membership fee for people under 18. Monthly magazine contains up to the minute news on Shortwave, Mediumwave and Utility Dxing. For a sample copy of our magazine send a 22c stamp to ARDXC PO Box 79, Narrabeen, NSW 2101 mentioning this ad."

ELECTRONIC ORGAN KITS. Musically minded and enjoy a challenge? Why not build your own electronic organ for half the cost of similar commercial models. Easy to assemble; ideal for home construction. Send \$1.00 for full details to Schober Organs (Aust), PO Box 22, Guildford, NSW 2161. Est 21 yrs.

"SORCEROR SOFTWARE. Create, edit, and save graphics instantly with Graphic-Ed (1/2K) Z80 code. Send \$12 cassette or \$6 listing, to Synapse Software, 42 Bay View Tce, Mosman Park, WA 6012."

FREE . . . List of bargain electronic components, ideal for hobbyists, servicemen, Radio Clubs, etc. Send 9"x4" SAE. Now!! Micronics, PO Box 175, Randwick, NSW 2031.

DREAM 6800 SOFTWARE. Naughts & Crosses, Random Tatstlotto Selection & TV Drawing Pad \$3/copy. Cheque/Money Order to T.S. Huett, PO Box 520 Woodridge, Qld 4114.

"SOUTH AUSTRALIAN Shortwave listeners spend your money carefully. For real value join the Australian Radio DX Club, now in its 16th year. Adelaide branch meets monthly. Every month receive our off-set illustrated magazine, reliable, accurate SW and MW news, schedules, equipment reviews, QSLs, loggings and propagation. Full range of member services. Giant new member kit. Discount membership rate for persons under 18. Write now to ARDXC, 12 High St, Cheltenham, SA 5014 enclosing a 22c stamp for a sample magazine."

LOOKING FOR MEMORY at the right price? Our range includes: CHIPS; 2708, 2708 CHIPOS, 2716, 2102, 2114, 4116 etc. S100 BOARDS; 16K static RAM, 64K dynamic RAM, 2708/2716 PROM card, floppy controller, PROM programmer and Z80 based CPU cards. We also handle floppy disc drives and an S100 card cage complete with mother board and power supplies. An EPROM programming and copying service is also available. For prices and more details, please send 9"x4" SAE to: G. J. Memory Products, PO Box 23, South Blackburn, Victoria 3130.

FOR HIRE

MICRO RENTAL Microcomputer systems of the most popular models are available in various configurations for hire. Dorf Microcomputer. Sydney (02) 922 1644 or (02) 960 1808 AH.

MICROCOMPUTERS FOR RENTAL. Commodore PETs (8K) at \$25 per week (minimum period 1 week). Software tapes and manuals included, plus BASIC instruction course and book. David B. Bates Microcomputer Consultant (02) 630 8652.

BUSINESS FOR SALE

ELECTRONIC SERVICE CENTRE in fast growing mid-north coast town. Servicing; CTV; Hi-Fi; cassette radio; medical; automotive tuning eqp. Several exclusive agencies. Sale includes separately reg burglar alarm company. In town service centre with plenty customer parking low rent and long lease. Unlimited potential for energetic and skilled electronic technician. Genuine sale reason. For genuine enquiries PH AH (065) 52 3638.

DISPLAY ADVERTS IN MARKETPLACE are available in sizes from a minimum of 2cm x 1 col rated at \$12 per col cm.

Please state classification: For Sale, Wanted, Reader Service, Position Vacant, Position Wanted, Business For Sale, etc.

CLASSIFIED RATES \$3 per line per insertion payable in advance. Minimum two lines.

CLOSING DATE is six weeks prior to the on-sale date. Issues are on sale the first Monday of each month.

ADDRESS all classified orders, copy, enquiries, etc. to: The Advertising Manager, **ELECTRONICS AUSTRALIA**, Box 162, Beaconsfield 2014.

WANTED

OPT — FERGUSON, type OP387/15 or "Playmaster Twin Ten" valve amp. (02) 918 2691.

PHASE LINEAR 4000 series one (4 channel) pre amplifier. PH (069) 21 1439.

POSITIONS VACANT

"BROADCASTING STATION 2VM Moree (NSW) has a vacancy for a Broadcast Technician. BOCOP or equivalent qualifications. Company house available. This is a good opportunity for a young technician to step up to his own station. Phone (067) 52 1155, or write to PO Box 389 Moree for full details."

A LONG ESTABLISHED FIRM operating in the Broadmeadows, Victoria area has 3 positions Vacant for Radio and Electronic Repair men. Trained to Army standards preferred. A trade test will be necessary. Wages negotiable. Contact the Manager Phone (03) 358 1160 between 8am-3.30pm.

SYDNEY OPERA HOUSE, ELECTRONICS TECHNICIAN, Grade III Positions No. S 311.

Salary: \$14,470 range \$14,781.

Qualifications: Essential — Several years practical experience in operation and maintenance of professional electronic equipment. Possession of Electronics and Communications Certificate, Television Operators Certificate or equivalent.

Applicants should have a thorough knowledge of electronic circuits together with an understanding of electronics systems. An ability to construct electronic projects and work with colour-coded components is required. **Desirable** — Experience working with Television/Audio systems.

Duties: The successful applicant will be required to maintain to specification a wide range of audio, video and digital electronic equipment, sometimes under operational conditions.

Conditions: 40 hours per week. Non-continuous shift work may be required for which appropriate allowances will be paid. Four weeks annual leave, Superannuation benefits (subject to certain conditions).

Inquiries: (02) 2 0588 ext 271 (Mr G. Wilson) or ext 296 (Mr R. Hill).

Applications forms may be obtained by phoning the Employment Officer, Sydney Opera House on (02) 20588 and are to be returned to this office by 14th November, 1980.

ALL ENQUIRIES WELCOME

ELECTROCRAFT PTY LTD

68 WHITING STREET, ARTARMON 2064

SUPPLIERS TO THE TRADE

Television Aerial & Distribution Equipment

CHANNEL—MASTER AERIALS:

Super Coloray 3111S
Coloray 3110
Single channel Yagis
Large range of UHF Aerials
HILLS — WIDE RANGE
EFC 1 — EFC 4
Airways anti-ghost 2010
215 8 Element
TL 1 — TL 4 Range
Many more in stock.

Hi Q Range

Ch 3 — 4 — 5A
MATCHMASTER Range
82/C/1 — 82/C/7
FMG 2 — FMG 6
FM Aerials wide range.
Marine & Caravan aerials
Masting single section.
1 8M — 6 7M
Telescopic 6M — 15M
Wall Brackets 228 mm

279 mm — 686 mm — 1016 mm

Clamps U Bolts
180 mtr rolls guy wire
Turnbuckles Roof Mts etc.
FM Traps Available

CABLE:

Electrocraft special — 2045 double screened 152 4 metre rolls 3 5 dB loss.
Check our price on this one.
We stock a wide range of cable to suit your needs

PHONE 438-4308

BRASS SHIPS CLOCKS
SMITHS 8 DAY 7 INCH
DIAMETER \$110

Post A \$1.75; B \$3.00; C \$3.60.

**GENUINE EX ARMY WRIST
WATCHES**
Complete with nylon band \$19.50
Post \$1.10

CHASSIS PUNCH SET
For perfect holes in metal
Cuts holes 5/8" 3/4" 7/8" 1" 1 1/8"
With tapered reamer size
3-14mm
\$37.95
P + P A \$1.95 B \$3.25
C \$3.65 D \$3.65

RECEIVER No. 210
2-16 M/cs \$75
Transmitter No. 11 suits 210 \$35
24 volt Power supply to suit above \$15
Or complete station with Headphones,
Mic. \$110

**EX ABC
MAGNETIC RECORDING
TAPES 1/4"**
PROFESSIONAL QUALITY
5" x 600' \$1.50
7" x 1200' \$2.75
P + P \$1.30
10 1/2" x 2400' \$7.95
P + P A \$1.65 B \$2.75 C \$3.10

**COLLINS INDEPENDENT
SIDEBAND TRANSCEIVER
TRC/75**
Fully synthesised transceiver with am.
upper, lower and independent sideband
operation 1KHz steps from 2MHz to
29.999MHz 1 microvolt sensitivity.
2.5KHz bandwidth ssb. 6KHz bandwidth
AM 1 RW PEP max output Fully
automatic tuning of both transmitter and
receiver from remote control unit.
Complete with automatic aerial coupling
unit, mic, headset, etc. 400Hz supply
Ideal for amateur use
PRICE \$750

**COLLINS SYNTHESISED 1
SB RECEIVER**
TRC/75 receiver section of transceiver
specification as above.
PRICE \$400

TELEPHONE WIRE
1 mile twin (2 miles) genuine ex-Army
Don. 8 perfect condition \$45.00 per
drum. \$6.00 cartage to rail freight
payable at destination.

**3" ASTRONOMICAL
REFLECTOR TELESCOPE**
117 X MAGNIFICATION FL 700MM
WITH 5 X 24MM FINDER SCOPE
AND TWO SECTION HARDWOOD
TRIPOD.
\$169.25
P&P A \$2.25 B \$4.10 C \$6.10

AERIAL CAMERAS
WITH 8" FL 3" DIAM. LENS F24 MARK
IV 2.9 LENS STOPS 11, 8, 5.6, 4, 2.9 —
\$75
\$2 cartage to rail freight. Payable to
nearest attended railway station.

PENTAC LENSES
3" DIAM. 8" FL WITH DIAPHRAGM
STOPS 11, 8, 5.6, 4, 2.9. MOUNTED IN
METAL HOUSING — **\$65**
POST: A \$1.85, B \$3.25, C \$4.10

NIBBLING TOOL
Cuts sheet metal like a punch and
die up to 18 G.A. Cuts Trims
Notches \$14.95 P + P \$1.45

SOLENOIDS
200 MA 24 volt 1/2in push movement.
\$2.50 P+P 80c

NIFE CELLS
1.2 volt, fully charged 4in x 3in x 1in 4
AH. **\$1.50 each P&P 80c**

CENTRE DRILLS
15/64 x 15/64
Carbon steel **\$4.00 doz.** Post 60c

ARTILLERY DIAL SIGHTS MK2
Can also be adapted as a Dumpty Level
or as base for a telescope has full 360°
5 1/2" diam. gunmetal rotating circle. Ad-
justable elevation and depression. Has
top grade 3/4" diam. object lens F.L. 10"
with cross hairs, eyepiece, 1/2" right angle
prism — height 10" — weight 3 1/2kgs.
With leather carrying case. Original cost
\$300
Our Special only **\$27.50**
P&P A \$2.25 B \$4.00 C \$6.00

**ZOOM SPOTTING
SCOPES**



30 x 30
LENGTH 12 1/2". HEIGHT
10"
WEIGHT 1 3/4 lb
\$32.50

45 x 40
Length: 16in
Height: 10in
Weight: 2lb
\$49.50

High grade coated lenses
Ideal for pistol and rifle ranges or
general viewing. Zooms in
from very low to high powers.
Complete with tripods
POST: A \$1.75 B \$3.00
C \$3.60

SPY TELESCOPES
8 x 17 mag size of a rifle cartridge ex-
tends to 8" Only **\$8.95 each**, post 60c.

AIRCRAFT INSTRUMENTS
Directional Gyros
AN5735-1 Air Operated.
\$35
Slip and Turn Indicators
\$17.50.
P&P
A \$1.65, B \$2.75, C \$3.10

**SMALL CLIP-ON
POCKET TELESCOPE**
15X **\$7.00, P+P 80c**

THEODOLITE
Kern Suisse Switzerland DK2
Two minute can be estimated
down to one minuted. Tested in
good working order. **\$750.00**

C42 set 36 to 60M/Hz with 24 volt power
supply headphone mic leads etc. **\$95.**
Or 42 set separate **\$65.**

BINOCULARS
PRISMATIC Coated Lenses. Brand new
Complete with case

8 x 30	\$42.00	
7 x 50	\$48.95	P&P
10 x 50	\$51.00	A \$1.75
12 x 50	\$53.00	B \$3.00
20 x 50	\$65.00	C \$3.10
20 x 65	\$130.00	
8x to 17x Zoom	\$150	

**MAGNESIUM DRY CELL
BATTERIES.** Suits PRC25 and dozens
of other uses. 15 volts long life.
Only **\$1.50 each, P & P A \$1.35, B
\$2.75 C \$3.60.**

ANEROID BAROMETERS
In brass case, made in London. **\$39.50**
P&P A \$1.65
B \$2.75
C \$3.10

POSTAGE KEY:
A: NSW
B: Vic. Qld. SA Tas
C: NT
D: WA

VALVES
BRAND NEW
6SN7 \$1.95 6BM8 \$1.95
5U4 \$1.95 6GV8 \$1.95
EF50 \$1.50 6AK5 \$1.95
1H6 \$1.50
2x2 \$1.50 832 \$5.00
P+P 80c
6x4 \$1.95
VR65 \$1.50

**STC HIGH IMPEDANCE
HEADPHONES**
3400 ohms, brand new, only **\$6.95 pair**
P&P A \$1.65 B \$2.75, C \$3.10.

**ZOOM SPOTTING
SCOPES**



High grade coated lenses
Ideal for pistol and rifle ranges or
general viewing. Zooms in
from very low to high powers.
Complete with tripods
POST: A \$1.75 B \$3.00
C \$3.60

TELESCOPES
25 x 30 \$13.50
P&P A \$1.30

CONDENSER LENS
2 1/2" diam 2" F.L. **\$1.50 each** or **\$2.50**
per pair P&P 80c.

IMPELLER PUMPS
New gunmetal body. Stainless Steel
Shaft. Neoprene Impeller Up to 15ft
Lift, suitable for almost any type of liquid.
Self priming. Ideal boat bilge pump, sul-
lage drains, etc. Approx. size 8" x 5"
3/8" **\$35.75, 1/2" \$61.00, 3/4" \$58.60.**
P+P A \$1.95, B \$3.50, C \$4.60

**Liquid filled
compass**



With magnified lens sight and degree
reader.
Only **\$7.95 each** Post \$1.30

**POLARITY & CURRENT
CHECKER**
3 volt to 400 volt Simple leads and
prods quickly determines positive or
negative with illuminated indicators, also
checks AC current and intensity, fully
insulated only **\$4.95, pp \$1.30.**

**COLLINS COMMUNICATIONS
RECEIVERS**
500Khz to 30Mhz
Type 51J4
\$37.00

**WRIST WATCHES
SWISS JAEGER**
Le Coultre ex RAAF rated one of the
world's best in smart chrome case with
black dial. Original cost \$250
SPECIAL \$49.50
Post \$1.30

**PRISMATIC
TELESCOPES**
15 x 50 Ex RAN — black enamelled
brass Length 16", weight 5kg Price
\$39.50.
\$2 cartage to rail, freight payable at
nearest attended railway station

**ZOOM FOCUSING
MICROSCOPES**
Zoom focusing microscopes battery
and mirror illuminated
750 x **\$31.75**
1200 x **\$47.95**
P&P A \$1.65, B \$2.75, C \$3.10.

DIRECTOR LEVELS
Ex Army No 9 with azimuth horizontal cir-
cle and vertical adjustment suits all types of
levelling in leather case
\$95
P + P A \$1.75 B \$3 C \$3.60.

**CLINOMETER MK6
0° TO 45°**
Precision calibrations set in solid
gunmetal frame spring ratchet ad-
justment. Approx size 7" x 6".
Complete in wooden case
\$37.50
P + P A \$2.15, B \$3.85, C \$4.85,
D \$4.85

**ROLA 77 MK 3
PROFESSIONAL
TAPE RECORDERS**
Ex ABC
In Good Working Condition
7 1/2 and 15 IPS
Original Price **\$2,500**
Special **\$650**

**16MM SOUND PROJECTORS
IN GOOD WORKING ORDER**
240 volts operated complete with
Speaker and Amplifier.
BELL & HOWELL **\$250**
\$1 Cartage to Rail. Freight payable at
nearest attended Railway Station.

**SELSYN MOTORS
MAGSLIP
TRANSMITTER 3" MK2 \$17.50**
Post Packing A \$1.75, B \$3.00, C
\$3.10

**MARCONI SIGNAL
GENERATOR**
Brand new type TF801A-1 Range 10
to 310MHz Continuous. Complete in
original case — with instruction book,
power leads, spare valves, etc.
\$600 value!
only **\$195**
\$2.00 cartage to rail. Freight payable
at nearest attended railway station.

Deitch Bros.
70 OXFORD STREET, SYDNEY 2010
SRRR NOC OD

ELECTRONICS AUSTRALIA

PRINTED CIRCUIT BOARDS AND FRONT PANELS

Some readers have indicated problems obtaining PC boards and front panels for projects. Many of our advertisers sell these items and advertisements in the magazine should be carefully checked in the first instance. Failing satisfaction from this source, the following is a list of firms to which we supply PC and front panel artwork. Some may sell direct, others may only be prepared to nominate sources from which their products can be obtained.

N.S.W.

Applied Technology Pty Ltd,
1a Pattison Avenue,
Waitara, NSW 2077

Dick Smith Electronics,
PO Box 321,
North Ryde, NSW 2113.

Electronic Agencies,
115-117 Parramatta Road,
Concord, NSW 2137.

RCS Radio Pty Ltd,
651 Forest Road,
Bexley, NSW 2207.

Radio Despatch Service,
869 George Street,
Sydney, NSW 2000.

VIC.

Kalextronics,
4 Burgundy Plaza,
101 Burgundy Street,
Heidelberg, Vic. 3084.

Rod Irving Electronics,
425 High Street,
Northcote, Vic. 3070.

S.A.

James Photronics,
522 Grange Road,
Fulham Gardens, 5024.

W.A.

Jemal products,
8/120 Briggs Street,
Welshpool, WA 6106.

TAS.

D & H Electronics,
108 Campbell Street,
Hobart, Tas. 7000.

N.Z.

E. H. Earl Ltd,
PO Box 834,
Wellington, NZ.

Marday Services,
PO Box 19 189,
Avondale,
Auckland, NZ.

Mini Tech Manufacturing Co Ltd,
PO Box 9194,
Newmarket, NZ.

Printed Circuits Limited,
PO Box 4248,
Christchurch, NZ.

ADVERTISING INDEX

ADVERTISER	PAGE
APF Electronics (Aust) Pty Ltd	107
Ace Radio	108
Adaptive Electronics	126
Adcola Products	100
Alkay Transformers	104
Ampec Engineering Co Pty Ltd	101
Anderson Digital Equipment	facing 33
Applied Technology	118
Archer Sound Systems	110
Associated Steel Equipment	37
Audio Engineers Pty Ltd	65
Audio Telex Communications Pty Ltd	93
Australian Government Recruiting	103
Autotron Australia	25
BS Microcomp	129
Bright Star Crystals	90
CQ Electronics	91
Cema (Distributors) Pty Ltd	26
Chapman, L. E.	132
Classic Radio	111
Computer Country Pty Ltd	125
Computer Imports Pty Ltd	125
Computerland Australia	2
Consolidated Marketing Corp Pty Ltd	22, 23
Creative Software	27
Cunningham, R. H. Pty Ltd	28
Danish Hi-Fi	36
Deitch Bros	135
Dick Smith Electronic Group	6, 10, 11, 63, 80, 81
Dick Smith Electronic Group	88, 115, 124, 128
Dindy Marketing (Aust) Pty Ltd	69
Electrocraft Pty Ltd	134
Electronic Agencies	52
Electronic Calculator Discounts	70
Ferguson Transformers Pty Ltd	70
Hagemeyer (Aust)	OBC
Instant Software	78
International Correspondence Schools	87
John F. Rose Computer Service Pty Ltd	122
K & L Computing Systems	123
Kalextronics	95
Logic Shop, The	120
Looky Video	84
McGills Newsagency Pty Ltd	113
Meditech	60
Melbourne House	82
Micro 80	127
National Panasonic (Aust) Pty Ltd	IBC, facing 104
Paris Radio Electronics	121
Pennywise Peripherals	119
Peterson Speaker Laboratories Pty Ltd	9
Philips	31, 57
Pitt Street Microcomputer Centre	117
RCS Radio	43
Radio Despatch Service	102
Radio Parts Group	71
Ray Cross Electronics	95
Rod Irving Electronics	47, 58, 73, 98
Rowe, H & Co	50
Software Source	84
Sony (Aust) Pty Ltd	IFC, facing 32
Stotts Technical College	21
Superscope (A'asia) Pty Ltd	facing 105
Tandy International Electronics	35, 67
Utilux Pty Ltd	74
Vicom International	96
Video Technics	109
Warburton Franki	16
Wireless Institute of Australia	90



Just Off The Presses

MICROPROCESSORS & PERSONAL COMPUTERS

Order your copy now!

Microprocessors and personal computers, little more than a dream a few years ago, are now changing the face of electronics. This book introduces the basic concepts, describes a selection of microprocessor and personal computer systems, and details a build-it-yourself computer designed especially for beginners.

Available from "Electronics Australia", 57 Regent St. Sydney. **PRICE \$5.00** OR buy mail order from "Electronics Australia", PO Box 163, Beaconsfield 2014. **PRICE \$5.70.**

SUBSCRIPTION SERVICE



**ELECTRONICS
Australia**

Subscription Rates
\$21.00 per year
within Australia
\$25.00 per year
elsewhere.

Make sure you receive every copy of the magazine by ordering it from your newsagent or the publisher. For publisher subscriptions post this coupon with your remittance to Electronics Australia Subscription Dept., John Fairfax & Sons Ltd, GPO Box 506 Sydney 2001. Subscription will start with first available issue.

Name

Address

Postcode Enclosed is for years

new class synchro-bias

SU-V8

Stereo Integrated DC Amplifier

Technics new Class 'A' amp. eliminates 'switching and cross-over distortion' with Class 'B' efficiency.



New Class A circuitry with synchro bias. Straight DC circuitry for direct coupling between DC power amp section and high-level input signals. Concentrated power block prevents distortion from electromagnetic induction. ICL phono EQ circuit with ultra-low noise FET's permits use of MC cartridge without pre-preamp or step-up transformer. Independent right and left power supplies using 2 transformers. 105 watts per channel power output at 8 Ohms from 20Hz - 20kHz. 0.007% THDF. Super bass brings the deepest bass sounds to life. Recording selector with 2-way dubbing. Remote action switches.

Technics
**Sounds
Alive**

Technics

UNTIL WE DEVELOPED THE STEREO GROOVE, HI-FI WAS PRETTY HO-HUM!



The world of hi-fi owes a lot to the original and continuing innovation of JVC. Few companies, if any, have done as much to help turn records and record-players into the virtual musical instruments they are today... or to lead the way in developing so many *firsts* in the more recent concepts of sound amplifiers, cassette decks and computer-designed speaker

systems. Hi-fi, as we know it today, had its beginnings in 1956, with JVC's development of the 45°/45° groove for stereo records. The fact that this system still remains as the world standard is, in itself, outstanding testimony to the technology of JVC. The development revolutionised not only the record-making industry, in which we've been involved since 1930; it also paved the way for enormous advancement in the design and engineering of record-playing equipment. Now, hi-fi has expanded to

THE QUARTZ LOCK TURNTABLE. MANY TIMES MORE ACCURATE.

It stands to reason that if your equipment is at the top end of the range, then your turntable must be capable of comparable performance. Only Quartz Lock ensures this, tying the speed of the turntable to the unvarying pulse of the atom, and providing a level of accuracy far in excess of conventional turntables.



MORE MILESTONES IN HI-FI.

To match the superb quality of Quartz Lock, we produced the S.E.A. graphic equalizer system. Then we refined it to such a degree it even compensates for the effect your furniture has on sound when it leaves the speakers! To expand the capabilities of tape, we designed ANRS and



R-S77. Super-A FM/AM Stereo receiver

embrace a wealth of highly-sophisticated electronic equipment; and it's not surprising that JVC has continued to play a leading role in so much of its development.



HR-3660 EA. VHS Colour Video Cassette recorder

THAT WASN'T OUR ONLY FIRST, EITHER.

We also pioneered Japan's television industry, introducing their first TV receiver just over 40 years ago. A more recent innovation is VHS, the home video recording system now gaining world-wide acceptance as *the* system for such equipment. In the course of staying ahead, we've introduced a number of world *firsts* of radical importance: the Quartz Lock turntable is one of them.

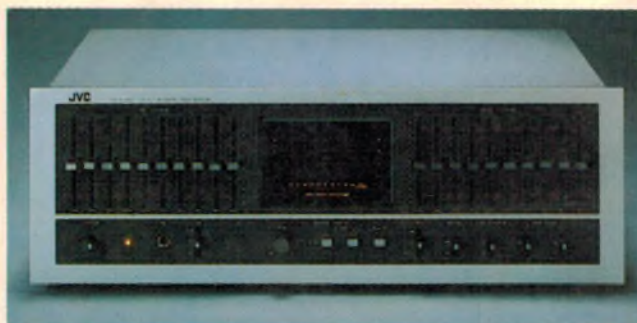

SEA-80. Stereo Graphic Equalizer

Super ANRS — automatic noise reduction systems which not only reduce distortion and 'hiss' but actually extend the dynamic range of the tape. Similarly, with speakers: at JVC we employ computers in their design to help provide the ultimate in sound reproduction.

AND NOW, SUPER-A.

In its own way, as significant a hi-fi development as the stereo groove. Imagine an amplifier which combines the *best* features of the two recognised amplifier classes (A and B)... an amp which combines the *efficiency* of one with the *low distortion* of the other. Some engineers said it couldn't be done; but not those at JVC. Enter the Super-A amplifier... the *latest JVC first!*

Distributed and Serviced by
HAGEMEYER



the right choice

THE FUTURE.

It's already with us. For instance, we were so far ahead in the new metal tape technology that our cassette decks were metal-compatible before the tapes were generally available. And now there's the JVC Electro-Dynamic Servo Tonearm, damping tonearm resonance by means of a purely electronic system and two 'thinking' linear motors. Who was it who dubbed JVC, 'the innovators'?