

# ELECTRONICS

**AUSTRALIA**

**VIDEO, HI-FI & COMPUTERS**

JANUARY 1981

AUST \$1.60\* NZ \$1.70

- High-power Loudspeaker for Musicians
- Electronic Aids for the Blind
- Automatic Light Dimmer
- Cylon Voice-Simulator



**Build this  
50 + 50W Mosfet  
Stereo Amplifier**

2086kHz	EMBRATEL, RJ, Brazil	6025kHz	DW, Cyclops, Malta	7275kHz	R. Tirana, Albania	9640kHz	Tirana, Albania
2340kHz	Yantai, China	6035kHz	TWR, Monaco	7285kHz	Warsaw, Poland	9645kHz	R. Berlin Int, GDR
2500kHz	OM, Czechoslovakia	6105kHz	Air Force, Taiwan	7295kHz	RFE/RL	9660kHz	Allouis, France
3235kHz	AIR Gambia, India	8110kHz	R. Caritas, Paraguay	7350kHz	EU, USSR	9670kHz	Sines, Portugal
3260kHz	Beira, Mozambique	6120kHz	Pori, Finland	7415kHz	Hanoi, Vietnam	9675kHz	Pori, Finland
3330kHz	R. Rwanda, Rwanda	6145kHz	Issoudun, France	7420kHz	EU/AS, USSR	9680kHz	Brno, Czech Rep.
3335kHz	Taipei (BCC), Taiwan	6155kHz	Vienna, Austria	8240kHz	Peking, China	9685kHz	Brno, Czech Rep.
3350kHz	Franceville, Gabon	6170kHz	Cairo, Egypt	8790kHz	Taipei, Taiwan	9690kHz	RFI, France
3377kHz	Osaka (NHK), Japan	6174kHz	Muscat, Oman	9009kHz	Tel Aviv, Israel	9700kHz	R. Sofia, Bulgaria
3385kHz	RRRI Kupang, Indonesia	6185kHz	R. Tirana, Albania	9150kHz	EU, USSR (SSB)	9705kHz	HCJB, Ecuador
3425kHz	Khumaltar, Nepal	6195kHz	Sokoto, Nigeria	9365kHz	Peking, China	9715kHz	R. Tirana, Albania
3965kHz	Allouis, France	6210kHz	Quetta, Pakistan	9435kHz	Tel Aviv, Israel	9720kHz	EU, USSR
4030kHz	Anadyr USSR	6340kHz	Turkiye Polis R., Turkey	9475kHz	Cairo, Egypt	9750kHz	AS/FE, USSR
4244kHz	EMBRATEL, RJ, Brazil	6450kHz	Hanoi, Vietnam	9495kHz	TWR, Monaco	9760kHz	Avlis, Greece
4285kHz	Vieng Xay, Laos	6920kHz	EU, USSR (SSB)	9525kHz	Warsaw, Poland	9810kHz	EU/FE, USSR
4420kHz	Kokchetav, USSR	7050kHz	Cairo, Egypt	9525kHz	Warsaw, Poland	9920kHz	Peking, China
4690kHz	R. NYAB, Bhutan	7075kHz	R. Tirana, Albania	9545kHz	France	11575kHz	EU, USSR (SSB)
4755kHz	Owerri, Nigeria	7110kHz	Bamako, Mali	9550kHz	Issoudun, France	11650kHz	Peking, China
4772kHz	R. Cenit, Ecuador	7120kHz	Tirana, Albania	9555kHz	EU/AS	11705kHz	Allouis, France
4790kHz	TWR, Swaziland	7130kHz	REE, Spain	9565kHz	RFE/RL	11725kHz	RFE/RL
4800kHz	Yakutsk, USSR	7145kHz	RFE/RL	9575kHz	Pori, Finland		Pori, Finland
4832kHz	R. Reloj, Costa Rica	7155kHz	RFE/RL	9580kHz	Rome, Italy		Bucharest, Romania
4843kHz	Pointe Noire, Congo	7180kHz	RFE/RL	9586kHz			Brno, Belgium
4853kHz	San'a, Yemen	7190kHz	RFE/RL				France
4880kHz	SABC, South Africa	7195kHz	Bucharest, Romania				RFE/RL
4881kHz	Than Hoa, Vietnam	7200kHz	Tirana, Albania				Brno, Finland
4886kHz	Muscat, Oman	7205kHz					Louis, France
4910kHz	Conakry, Guinea						E, Spain
4932kHz	Benin, Nigeria						EU/AS, USSR
4935kHz	R. Congo						Manly (VOA), USA
4935kHz	R. DRC						Budapest, Hungary
4959kHz	R. Liberia						Budun, France
4980kHz	Ejura, USSR						Sofia, Bulgaria
5000kHz	R. Albania						R. Monaco
5005kHz	Sibu, Indonesia						Berlin, Int, GDR
5015kHz	Arkhangelsk, USSR						Chernobyl, USSR
5041kHz	R. Myanmar						EU/AS, USSR
5057kHz	Gjirka, Albania						Seoul, Korea Rep.
5075kHz	R. Poland						EMBRATEL, Brazil
5300kHz	R. Luxembourg						Montreal, Canada
5815kHz	EU, USSR						Teheran, Iran
5910kHz	EU, USSR						Germany
5925kHz	AS, USSR						Germany
5930kHz	Prague, Czech Rep.						T. Belgium
5954kHz	R. Congo						Paris, France
5955kHz	CRF, Romania						Paris (SMA), Greece
5967kHz	R. Romania						EU, USSR
5975kHz	ISS, USSR						Berlin Int, GDR
5980kHz	R. Romania						Vienna, Austria
5990kHz	ISS, USSR						
5995kHz	Juba, Sudan						



ICF-2001

## Let your fingers travel the world.

Sony proudly presents an exciting world receiver with FM & AM that gives you the best value in its class. Frequency synthesized "calculator-type" tuning of the LW/MW/SW bands offers unprecedented convenience, versatility and wide frequency coverage.

We call it the ICF-2001. It captures broadcasts with a push of a button from virtually every source on the globe including marine, amateur radio and other fascinating short wave transmissions. Even citizen band.

Now world travelers can hear where they've been and where they're going. Or "practice" another language. Or literally share another culture. But you

don't have to be versed in complicated radio lore to enjoy your foreign adventures because our world traveler is marvelously easy to use.

Sophisticated technology such as a frequency synthesizer for extreme stability as well as a micro-computer gives you four different tuning methods for fast, easy operation. Direct Access, Memory, Auto Scan and Manual tune in the exact frequency you're searching for. They're push-button easy and only Sony gives you the communication spectrum at your fingertips.

Sony's ICF-2001 brings home the world. Bon voyage.

# ELECTRONICS

## AUSTRALIA

Volume 43, No. 1  
January, 1981

### AUSTRALIA'S HIGHEST SELLING ELECTRONICS MAGAZINE



This new light dimmer provides smooth "snap-on" free light dimming and can automatically fade lights up or down. Find out how to build it on p52.



Remember the dastardly Cylons in "Battlestar Galactica"? Well, we have devised a simple circuit to simulate the Cylon voice. Details on p74.

COMING NEXT MONTH — Find out what's coming by turning to p116.

#### On the cover

Our new Mosfet stereo amplifier steals the show on this month's front cover. On p42, we continue the circuit description, give the performance details, and begin description of the assembly procedure. (Photo by staff photographer Warren Webb).

#### FEATURES

- COLLISION AVOIDANCE IN OUTER SPACE** *The problem of space junk* ..... 12
- SUITING UP FOR THE SPACE SHUTTLE** *What the astronauts will wear* ..... 18
- ELECTRONIC AIDS FOR THE BLIND** *Electronic substitutes for sight* ..... 22

#### HIFI TOPICS AND REVIEWS

- AUDIO/VIDEO ELECTRONICS** *Analog or digital — pick the difference* ..... 30
- HIFI REVIEW** *Marantz PM-4 class-A/class-B stereo amplifier* ..... 36
- HIFI REVIEW** *Glanz MFG magnetic pick-up cartridges* ..... 40

#### PROJECTS AND CIRCUITS

- PLAYMASTER MOSFET STEREO AMPLIFIER PT. 2** *Full circuit details* ..... 42
- BUILD THE AUTODIM LIGHT DIMMER** *Dims lights automatically* ..... 52
- JBL 300 WATT LOUDSPEAKER SYSTEM** *For professional musicians* ..... 60
- CYLON VOICE SIMULATOR** *Fire the phasors in three millicentons* ..... 74
- DIGITAL STORAGE CRO ADAPTER** *Important addenda* ..... 77

#### MICROCOMPUTERS

- USING THE DREAM 6800 FOR RTTY DISPLAY** *More useful programs* ..... 78
- COLUMN 80** *Advantages and limitations of BASIC* ..... 113
- MICROCOMPUTER NEWS & PRODUCTS** *Improved System-80 from DSE* ..... 114

#### AMATEUR RADIO, CB SCENE, DX

- AMATEUR RADIO** *Electronics education — a highly desirable goal* ..... 93
- CB SCENE** *The 1980 NCRA Convention: far ranging effects* ..... 96
- SHORTWAVE SCENE** *Peking expands shortwave service* ..... 98

#### COLUMNS

- FORUM** *This didn't happen in Australia — or did it?* ..... 26
- THE SERVICEMAN** *Do it yourself — or servicing the hard way!* ..... 66
- RECORD REVIEWS** *Classical, popular and special interest* ..... 108

#### DEPARTMENTS

- EDITORIAL 3 — NEWS HIGHLIGHTS 4 — CIRCUIT AND DESIGN IDEAS 70 — LETTERS TO THE EDITOR 90 — NEW PRODUCTS 100 — BOOKS AND LITERATURE 106 — INFORMATION CENTRE 130 — MARKETPLACE 134 — NOTES AND ERRATA 77, 133**



# EXTENDED SALE

Special for  
Back to School  
or University



Save  
near  
**\$24**

## TI Programmable 58C

Here's a programmable calculator that offers more power, flexibility and capability and features TI's exclusive Solid State Software. With Master Library module with 25 programmes in math, statistics, and finance you can choose from 12 optional libraries. You can also programme the TI programmable 58C right from the keyboard. TI's Constant Memory feature retains data or programme information even when the calculator is turned off.

It has up to 480 programme steps or 60 memories with 4 types of display testing with independent test or "Y" register and 10 additional test registers.

Over 170 functions and operations in scientific, engineering, and statistical fields. Complete editing and error correction capabilities with single-step and back-step keys.

The TI Programmable 58C gives hard copy when used with the PC-100C thermal printer/plotter.

**\$122.99 + TAX = \$141.44**

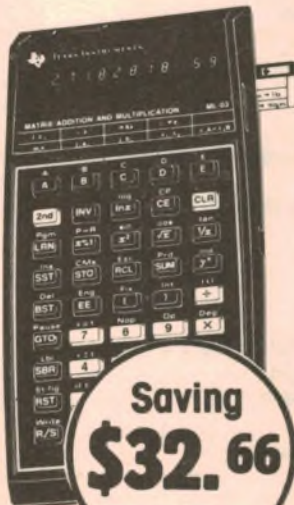

## The T.I. Programmable 59

A revolutionary new personal programmable calculator. 960 programme steps or 100 memories. Master library module plug in feature. 25 different programmes in key areas. Four types of display up to 10 additional test registers. 72 useful labels. Up to 6 levels of sub routines. Complete programme editing. Operates with PC-100C printer. Optional solid state software libraries.

**\$276.99 + TAX = \$318.54**

Saving  
**\$32.66**



Save  
Over  
**\$23**

**\$198.99 + TAX = \$228.84**

## PC-110C

The PC-110C printer plotter turns your programmable T.I.58C or T.I.59 into a high speed quiet printer calculator that prints, lists and traces your programme.

TEXAS INSTRUMENTS  
INCORPORATED

# silicon valley



ADELAIDE: 170 Sturt St, Adelaide.  
Telephone (08) 51 4080

BRISBANE: 22 Ross St, Newstead.  
Telephone (07) 52 1339

MELBOURNE: 208 Whitehorse Rd, Blackburn.  
Telephone (03) 877 5311

PERTH: Unit 1, 25 Brisbane St, East Perth.  
Telephone (09) 328 8091

SYDNEY: 23 Chandos St, St. Leonards.  
Telephone (02) 439 2965

NOTE: Offer closes 24th December, 1980



# Editorial Viewpoint

## And so into 1981 . . .

### EDITOR-IN-CHIEF

Neville Williams  
M.I.R.E.E. (Aust.) (VK2XV)

### TECHNICAL EDITOR

Leo Simpson

### ASSISTANT EDITOR

Greg Swain, B.Sc. (Hons, Sydney)

### TECHNICAL PROJECTS

Ron de Jong, B.E. (Hons, NSW), B.Sc.  
John Clarke, B.E. (Elect., NSWIT)  
Gerald Cohn  
Paul de Noskowski

### GRAPHICS

Robert Flynn

### PRODUCTION

Danny Hooper

### SECRETARIAL

Pam Hilliar

### ADVERTISING MANAGER

Selwyn Sayers

### CIRCULATION MANAGER

Alan Parker

In some respects, the transition from '80 to '81 is a mere statistic but it is also an appropriate time to take stock of the past, present and future.

Looking back, 1980 was a very successful year for "Electronics Australia". In September '79 and March '80 we had already chalked up two successive rises in audited circulation and, while we were content to quote a figure of 46,250+ for the latter part of 1980, we knew from our own records that sales were still climbing.

Our latest official figure for average monthly sales is 47,700+, the third consecutive increase and the highest circulation for nearly 10 years. We would stress that this is not figure dreamed up by an over-enthusiastic promoter; it is from a record of actual paid sales, audited and confirmed by an independent body — the Audit Bureau of Circulations.

Allowing for copies sold in New Zealand, and a much smaller number sold in other countries, actual paid circulation within Australia is about 43,000, to which must be added copies circulated to advertisers, contributors and other recipients.

But while circulation is the very life blood of an editor, it is gratifying also to note the enormous goodwill and support that has been forthcoming from the industry. It was climaxed by the December issue, which set an all-time record for advertising revenue. From this high point, we look forward with keen interest and optimism.

1981 is certain to launch the era of home video. Video cassette recorders faltered in 1980, for various reasons, but there is every sign that they will take off in '81, backed by a drastic reduction in taping costs. There will be — and are — video cameras for a new generation of home movie buffs, and projection TV systems for those who may want to display their efforts to greater advantage.

A bit further back, but virtually ready for launch, are video discs with their enormous implications, not only for home entertainment, but for education and training. And, behind them again, are video style audio discs and a new era in home hifi.

There will certainly be no lack of things to talk about and explain but I do wonder what will still entice the do-it-yourself hobbyist in this new world of highly sophisticated consumer electronics. Will he/she still be able to experience the thrill of that first simple project?

I sincerely hope so.

**Neville Williams**

### Registered for posting as a publication — Category B.

Printed by Magazine Printers Pty Ltd, of Regent Street, Sydney and Masterprint Pty Ltd of Dubbo, NSW, for Sungravure Pty Ltd, of Regent St, Sydney

### Editorial Office

57 Regent St, Sydney 2008.

Phone (02) 699 3622 Telex 25027.

Postal Address: PO Box 163, Beaconsfield 2014.

### Advertising Offices

Sydney — 57 Regent St, Sydney 2008.

Phone (02) 699 3622 Telex 25027.

Representative: Narciso (Chit) Pimentel.

Melbourne — 392 Little Collins St, Melbourne 3000 Phone (03) 602 3033.

Representative: Janis Wallace

Adelaide — Charles F Brown & Associates Ltd, 254 Melbourne St, North Adelaide 5006.

Representative: Sandy Shaw (08) 267 4433.

Perth — 454 Murray Street, Perth 6000.

Representative: Ashley Croft (09) 21 8217.

### Subscriptions

Subscription Dept, John Fairfax & Sons Ltd, GPO Box 506, Sydney 2001

Enquiries: Phone (02) 20944, ext 2589

### Circulation Office

21 Morley Ave, Rosebery, Sydney 2018.

Phone (02) 663 3911.

### Distribution

Distributed in NSW by Sungravure Pty Ltd, 57 Regent St, Sydney; in Victoria by Sungravure Pty Ltd, 392 Little Collins Street, Melbourne; in South Australia by Sungravure Pty Ltd, 101-105 Weymouth St, Adelaide; in Western Australia by

Sungravure Pty Ltd, 454 Murray Street, Perth; in Queensland by Gordon and Gotch (A Asia) Ltd; in Tasmania by Ingle Distributors, 93 Macquarie St, Hobart; in New Zealand by Gordon and Gotch (NZ) Ltd, Adelaide Rd, Wellington

### Copyright. All rights reserved.

Devices or arrangements shown in this magazine may embody patents. Information is furnished without responsibility for its ultimate use, or for failure of equipment to operate as expected, or for any damage, loss or injury which may be sustained. Material intended for publication is submitted at the sender's risk and, while care will be taken, responsibility for any possible loss will not be accepted by "Electronics Australia".

\* Recommended and maximum price only.

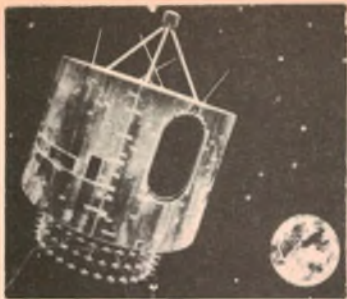

# News Highlights

## New chip casts doubts on technology embargo to Soviets

Dramatic evidence has come to light suggesting that the Soviet Union has made major gains in semiconductor and computer technology.

For years it had been believed that the United States held a 10-year edge over the Soviet Union in micro-electronics, but a recent disclosure indicates that the gap has been narrowed considerably.

In a rare glimpse at the state of Soviet micro-electronics technology, the Control Data Corporation has obtained through Hungarian sources a Soviet microprocessor. On the basis of tests conducted by Control Data on the device, which carries the serial number K5801K80,77, it is now believed that the Soviet Union is at most three years behind the US in the design and production of these devices.

This finding revives the larger question concerning the wisdom of maintaining the tight restrictions currently placed on the export of large mainframe computers to Eastern bloc nations. Computer systems, after all, are little more than clusters of microprocessor and semiconductor memory chips, which are widely available to almost anyone by mail order through specialty electronics stores.

Further, informed opinion puts Russian computer output last year at about the \$US6 billion (\$A5.1 billion) level, or about the size of the US computer industry, excluding the International Business Machines Corporation.

"All their flag waving notwithstanding, the technology possessed by the Russians, as well as their Czech, Hungarian, East German and Polish counterparts, is certainly very close to, if not on a par with, our own," noted Charles P. Lecht, the chairman of the Advanced Com-

puter Techniques Corporation and a member of the Hudson Institute.

To be sure, the Russian device is a copy of a microprocessor produced by the Intel Corp, the world's leading producer of single-chip computers. And like Intel's 8080A chip, it is a complete 8-bit processor unit designed for use in general-purpose computer systems.

The report goes on to state that, not only were the Russians able to copy the Intel chip, but also, based on an examination of the way the logic is laid out, they possess a thorough understanding of the internal architecture, or the specific logic functions and their interaction, of Intel's technology.

In conclusion, the report says, "There can be no doubt that Soviet semiconductor processes can provide them with just about any of the off-the-shelf devices used in this country."

The way in which Control Data was able to obtain the Russian device is also rather interesting.

It had been known for some time that the Hungarian national computer company, Videoton, which specialises in producing data terminals for the Russian Ryad line of computers, had been using Intel microprocessors in its development work for new computer systems.

What had not been known, however, was that the company, which has had a long-standing trading relationship with Control Data, had been purchasing these parts, quite legally as it turns out, in Munich.

Further, Videoton indicated to Control Data that, when and if it decided to put these products into production, it would not use the Intel part, but rather a Russian copy of the part, whereupon it turned over to Control Data a sample of the Russian chip for evaluation.

— New York Times, News Service.

## Helicopter or aeroplane?



Developed in the United States, the XV-15A can take off like a helicopter but cruises like a conventional aircraft by tilting its wingtip mounted engines and propellers. The aircraft was built by Bell Helicopter Textron, Fort Worth, Texas for NASA.

## New York students foul computer system

Unauthorised access to several Canadian computer systems has been traced back to a New York City school, according to a recent report in the US magazine "Radio-Electronics".

The Dalton school has a computer that is used to teach students ranging from the 4th to the 12th grades. But the computer is getting into systems operated by 21 Canadian businesses — systems to which the school does not even subscribe.

In one case, the unauthorised communications seized control of the systems used by Canada Cement La Farge, and destroyed some data in the process. The operations of other companies have also been disrupted.

The school's headmaster suggests that "It's possible that someone outside is using a phone that's been traced back to a school line". But the FBI is not convinced. Citing a possible scheme to defraud, the Bureau obtained a search warrant and seized computer printouts and a terminal log sheet. Results have not been reported.

## Talking dashboard!

A "talking" automotive diagnostics warning system employing speech synthesis technology has been demonstrated by National Semiconductor Corporation at a recent engineering show in Detroit. The device accepts inputs from a microprocessor and generates audible warning messages such as "low oil pressure", "low fuel" etc. Speech quality is said to be very good.

## Speech synthesis evaluation board from NS

Santa Clara, CA. — A fully-assembled circuit board for evaluating the operation and application of the DigitaLker speech synthesis chip set is now available from National Semiconductor Corporation.

The DT1000 evaluation board is said to be extremely easy-to-use, requiring only a 9V power supply and an inexpensive speaker to put it into operation. The highly-intelligible human voice qualities reproduced make synthesised speech especially useful in applications such as "talking" automotive dashboards, appliances, toys and games, telecommunications, and instruments and control systems.

The DT1000 contains all the components required to output speech upon demand: National's speech processor chip (SPC), two speech ROMs containing 138 individual words, output filter, audio amplifier, keyboard, and a COPS microcontroller and

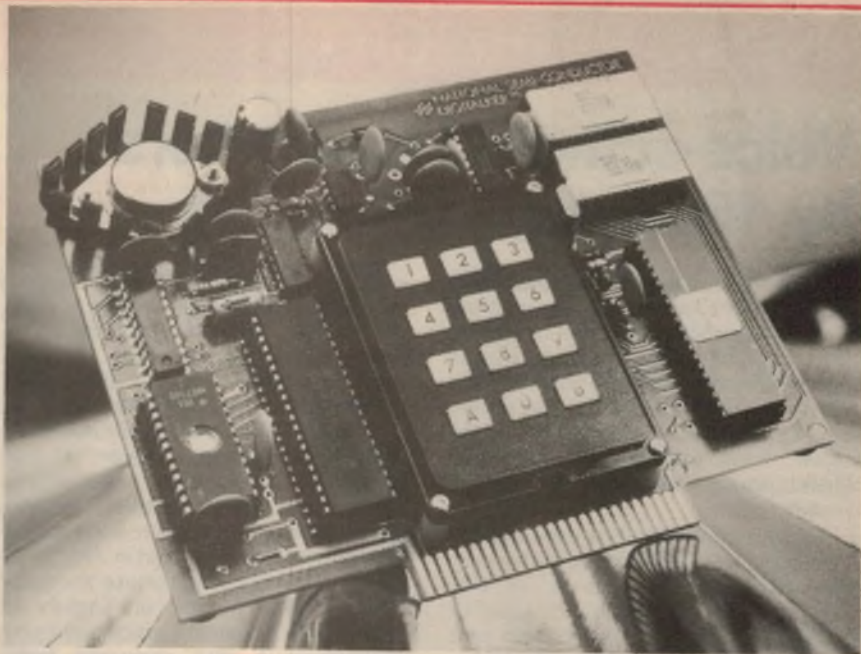

EPROM that contain stored data programmed to provide the various functions of the board.

The two speech ROMs enable the user to link words consisting of numbers and letters of the alphabet,

assorted useful nouns, verbs, tones and silence durations into phrases and sentences. The DT1000 can also be interfaced easily to any external processor system via a 22-pin edge connector.

## Automation — "key" to solar energy

Solar power will not become a viable source of electricity until large, highly automated factories are developed for the low-cost, mass production of solar photovoltaic cells. That was the message delivered by Dr George F. Mechlin, Vice President, Research and Development, the Westinghouse Electric Corporation, to utility executives representing the American Public Power Association at a recent conference in the US.

Speaking on the topic of "Seven Technologies that will Change our Lives in the 1980s", Mechlin called solar photovoltaics — which directly converts sunlight into electricity — a promising energy source. But he disagrees with solar subculture enthusiasts who believe solar energy could thrive as a decentralised "cottage industry".

"Whilst it may disappoint some solar advocates, like it or not, technological sophistication and economies of large scale are the key to success for the solar electric industry," said Mechlin. "Extremely advanced manufacturing techniques must be employed, including the use of robots, to bring the cost of solar cell production down to a level that the utility market — and the consumer — can live with."

In addition to solar photovoltaics, Mechlin identified fuel cells, coal conversion, lasers, robots, microprocessors and optics as the technologies that will have the most profound impact upon the way we live and work during the 1980s.

## Ingenius new space tool

AND IT ONLY COST 11¢ TO DEVELOP

A soda straw and a toy balloon may lead to an unusual tool for handling large metallic structures in space!

Those two unlikely items, costing a total of 11c, were used by an ingenious employee at NASA's Marshall Space Flight Centre, in the initial demonstration of his concept for a device known officially as a "pneumatically inflatable end effector".

The device, invented by Keith Clark, is designed primarily to serve as a mechanical "hand" to grasp and transport aluminium structural beams which would be fabricated in space by an automated beam-building machine carried in the Space Shuttle cargo bay.

The "end effector" is essentially a tough rubber balloon which — in its deflated state — would be inserted into the space between the triangular beam's trusses,



and then inflated to fill that space. Attached to the end of a remotely controlled mechanical manipulator arm in the Shuttle, the "inflatable" — as Clark calls it — could thus securely hold the beam in any position, or move it about as desired. — Copyright 1980, Science Syndication Services.

## French plan electronic phone directory

The French government has announced an ambitious plan to eliminate the telephone directory and substitute electronic terminals in the homes of all subscribers over the next 10 years. In all, some 30 million free terminals would have to be distributed.

The system is already being tested in several areas of France, with the first 250,000 terminals slated for use by 1981.

Each terminal is equipped with an alphanumeric keyboard, allowing the user to type out the category of information sought — "restaurants", for example — or to display the traditional alphabetical listing.

France says that the new system will be cheaper than printing and distributing phone books, and has the additional advantage of continuous updating.

## NEWS HIGHLIGHTS

### Voice-activated typewriters by 1983, says US report

Faster-than-expected progress in the development of speech recognition technology will result in the commercial availability of voice-activated typewriters by 1983 and they will be in "widespread" use by the end of the decade, according to a new 170-page report from International Resource Development Inc, a US market research firm.

A competitive battle is expected to develop between IBM, Xerox and Matsushita for dominance of this market in the mid-1980s, and the IRD report predicts that "more than one million typists and secretaries will be redeployed – or unemployed – as a result of the new machines".

The first commercial versions of the voice-activated typewriter will correctly recognise about 95% of "typical" business English as spoken by the average executive, predicts the report. The first IBM units – which IRD expects to be introduced in 1983

– will be equipped with a CRT screen which will display the words as they are spoken. Then the dictator – or "more likely his secretary" – must type in those words which the machine failed to recognise correctly.

Languages which are more phonetic than English are "much easier" to use in speech recognition applications; according to the report this will mean that Matsushita's voice-activated typewriter (also expected in 1983) will do a better job on Japanese than the IBM machine will do on English. A "very high quality" voice-activated typewriter is also expected from Xerox "not later than 1984", and Exxon is described as being a "dark – but fast – horse in the VAT race". Other potential suppliers of VAT equipment may include Olivetti and Wang, predicts IRD.

Also included in the report are predictions of rapidly-increasing use of speech recognition and voice syn-



Courtesy International Resource Development Inc.

thesis in home appliances and consumer products, including the "imminent" introduction of voice-recognition on TV channel tuners and automobile ignition locks. Texas Instruments' "Speak & Spell" product is expected to be followed by several new types of toys, educational devices and calculators which include speech output capabilities.

Further details on the IRD report, entitled "Speech Recognition and Computer Voice Synthesis", are available from International Resource Development, 30 High Street, Norwalk, Connecticut 06851.

### No-cash phone box for British Telecom

British Telecom is to test a new kind of public telephone which does away with coins and uses an inserted plastic card instead, purchased in advance. Called Cardphone, the system has been developed to help eliminate the damage caused to public telephones by thieves attempting to steal the cash box.

Cardphone relies on a form of holography which is said to make forgery impossible. Holographic patterns are laid down on the card during manufacture to give two effects – one is a series of embossed stripes, which are visible and which represent money units, while the other is an invisible microfine holographic pattern which represents a code known only to the manufacturer.

To use the phone box the caller inserts the card, which is read by the unit, and

the user can then see on a small screen what credit is left on the card. Should the handset not be lifted the card is returned within a few seconds. If it is lifted and a call made, the procedures are similar to a call from a conventional box except that, during the progress of the call, the display counts down.

A tiny heating element is used to remove the appropriate number of credit bars from the face of the card. It actually melts the embossed bars, but the surface damage does not affect the viability of the hologram on the card's surface.

If during the course of a call the card runs out of credit, it is possible to insert a second card without having the call discontinued.

### Joint venture for EMI & Sperry Ltd

EMI (Australia) Limited and Sperry Limited of the USA have announced the setting up of a jointly owned Australian company under the name C3 Pty Limited. C3 is a widely used acronym that stands for the combination of command, control and communications. The new company will provide computer software services, systems engineering, and training, primarily for defence programs and related business areas.

The Defence Systems Division of Sperry Univac is the largest supplier of military computers to the US Navy. These include the AN/UYSK-7 and AN/UYSK-20 Computers, which are the USN shipboard standards, the CP-901, which is on-board the P-3C ASW aircraft, and the UN/UYSK-10 which is on-board the S-3A aircraft. The Defence Systems Division of Sperry Univac also provided the systems engineering and software for many of the systems that utilise these computers.

EMI Electronics has more than 20 years of defence experience. Major contracts have included the Ikara anti-submarine warfare (ASW) missile control and guidance systems, the Sea King ASW helicopter weapons system trainer, the Destroyer Escort weapon systems modernisation, and the Mulloka shipboard active sonar system.

### New advances for car electrics

CONVENTIONAL VEHICLE WIRING harness could be replaced by coaxial cable within the next four years, according to UK's General Electric. Digital and analog data are carried in the central core while loads are switched on the outer sheath. The "Salplex" system has the capacity to accommodate auto electrical systems as they are updated, and also has a self-diagnostic feature.





# NEWS HIGHLIGHTS

## Stage 2 of army radio contract

Two major British companies are to undertake the important second stage of "Project Raven" the \$100 million program to replace the Australian Army's combat net radio system. Under contracts each valued at \$1 million, the Racal Electronic Group of companies and the Plessey Group will work on "Project Definition", the second stage of Raven, which calls for detailed equipment specifications and prototypes.

A new company, Racal-Milcom Pty Ltd, has been announced by Racal to manage its activities in Project Raven. Management of the new company with offices at North Ryde, New South Wales, includes

senior Racal technical and marketing staff from the UK and Australia.

Also on the local scene, engineers from Plessey Electronic Systems (a division of Plessey Australia Pty Ltd) will be involved in the work. Plessey says that several engineers will go to England to work within the Plessey Avionics and Communications Group. Later, members of the team will be involved in transferring the necessary technologies to Australia, to enable local manufacture of equipment should that prove necessary.

It is expected that only one of the two companies will be selected to manufacture the equipment.



## Hitachi develop portable fuel cells

Hitachi has announced the development of what it says are the world's first compact, portable methanol fuel cells. The new cells could be used to power various home appliances, as well as agricultural and engineering equipment in remote locations.

According to the company, a battery of fuel cells weighs only half as much as a lead-acid battery of the same size and generates 12V at 4A. Each cell generates electricity through the reaction of an oxidising agent with the fuel. Single cell voltage is 0.4V at 60mA.



*ACOUSTIC LEVITATION: Scientists at the Marshall Space Flight Center in the US are experimenting with a concept called acoustic levitation for suspending molting materials during processing in the low gravity environment of space. Photo shows a water droplet suspended in mid-air by sound waves.*

## Business Briefs:

- Continental Electronics, Dallas, USA has announced the acquisition of Rockwell's Collins Broadcast Products division. The Collins line includes AM and FM transmitters and audio consoles. Local distributor for Continental Electronics is **Rank Electronics Pty Ltd**, 16 Suakin St, Pymble, NSW 2073.

- A Telecom contract worth over \$250,000 has been awarded to **Aegis Pty Ltd**, a Melbourne-based electronics manufacturer. The contract covers the supply of direct reading cable fault locating instruments, Aegis type CZ8000. According to Aegis, the CZ8000 can locate shorts, crosses, earth faults etc in telephone cables up to a distance of 40,000 metres, with distance to the fault indicated directly in metres on a digital display.

- **GHE Electronics**, a Division of George Harvey Electronics Pty Ltd, has been appointed sole Tasmanian Agent for A&R Electronics Pty Ltd. GHE will maintain comprehensive stocks of Arlec products for immediate supply to customers. Their address is 162-164 Argyle St, Hobart 7000; and 76 York St, Launceston 7250.

- Two new sales engineers have recently been appointed by **Tektronix Australia Pty Ltd** as part of its Northern Region Test and Measurement Division. They are John Murt, who will be handling the whole of Tektronix T&M equipment, and Peter Green, who has been appointed as a TV and Communications Industries Product Specialist. Tektronix is located at 80 Waterloo Rd, North Ryde, NSW 2113.

## Non-Swiss movement

During program breaks, watchers on BBC television see a clockface surmounting a logo of one type or another. But back in the studio there is no clock and no camera producing the image.

It is all done electronically. A PROM stores one quadrant of a clock face, which is video fiddled to produce the basic clock dial.

A RAM-PROM-microprocessor team generates an image of the hour, minute and sweep second hands, which are then superimposed on the clock face to produce what appears to be a normal analog clock on viewing screens.

It must surely be the most modern old-fashioned clock in existence.

We wonder if they can re-program the PROMs for metric time!



**KIKUSUI 5650 50MHZ**

The Kikusui Model 5650 Oscilloscope is a general-purpose dual-channel portable oscilloscope with a 6-inch rectangular internal-graticule 80 mm x 100 mm (3.15 in. x 3.94 in.) CRT.

The vertical axis has a maximum sensitivity of 5mV/Div (or 1mV/Div when in the "5 x MAG" mode).

The trigger circuit is capable of selecting six different types of signal sources. It incorporates alternate trigger and level lock functions which simplify trigger operation.

50MHz 5mV 5 x MAG 1mV.10MHz, Alternate Time Base Alternate Trigger-500KHz Chop Frequency, Auto Level (Lock) Circuit Calibrated Delay Sweep — One Touch Triggered Delay, Variable Hold Off — B ends A. With CH1 Output Signal (5650E), One Touch X-Y Operation, Linear Focus.



**KIKUSUI 5531 35MHZ**

The Kikusui Model 5531 Oscilloscope is a wide band oscilloscope with a 5.5-inch (approx. 14cm) dome-mesh post-acceleration internal-graticule CRT. The 5531 is a dual channel type, with sensitivity 1 mV/DIV (with 5 x MAG) and bandwidth DC - 35 MHz for each channel.

For triggering, both channels (CH1 and CH2) can select trigger signal sources mutually independently. The 5531 has a TV sync separator to facilitate observation of TV signals.

35MHz 5mV 5 x MAG 1 mV.15MHz Automatic Selection Alternate /Chop (200KHz) and Chop Only Mode Delayed Sweep - One Touch Triggered Delay, Variable Hold Off, One Touch X-Y Operation, Auto Focus.



**KIKUSUI 5520 20MHZ**

The Kikusui Model 5520 Oscilloscope is a trigger-synchronised dual-trace portable oscilloscope with a 133 mm (5.24 in.) high-brightness low-distortion cathode-ray tube. Its sensitivity is 1 mV/DIV (5 x MAG), bandwidth 20 MHz, and sweep speed 40 nsec/DIV (under 5 x MAG mode).

20MHz 5mV 5 x MAG 1mV.10MHz, One Touch X-Y Operation, TV sync Separator (Trigger), Single Sweep Function.



**KIKUSUI 559A 5MHZ**

The Low Cost Model 559A is a highly reliable oscilloscope which employs a 133 mm (5.24 in.) round screen cathode-ray tube, low power consumption circuit, and robust housing. Ideal for educational use or as transmitter waveform monitor, etc.

5 MHz 10mV, 10Hz to 100 KHz sweep. External direct input for monitor use.

THERE ARE FOURTEEN OSCILLOSCOPES IN THE KIKUSUI RANGE FOR DETAILS CONTACT:

**THE DINDIMA GROUP PTY LTD**

P.O. Box 106, Vermont, Victoria, 3133, Australia. Telex No. 36819.  
Tel.: Vic., 873.4455; N.S.W., 439.7171; S.A., 332.5800



# PARTS FOR NEW KITS

If a kit you want to build is not listed, the parts may be available anyway. Check the Dick Smith Catalogue, or call in to your nearest Dick Smith store.

**NEW PLAYMASTER STEREO AMPLIFIER** (See EA Jan)  
See below for full details of this exciting new kit!  
Individual Special Parts:  
PCB (if glass) Cat H-8386 \$9.95  
Power Mosfets (2SK133 & 2SJ48 pr) Cat Z-1815 \$16.00 pr

**CYDON VOICE** (See EA January)  
PCB Cat H-8387 \$2.50  
XR-2206 IC Cat Z-6820 \$5.50  
All other parts are normal stock lines

**AUTODIM** (See EA Jan)  
PCB (avail mid Jan) Cat H-8388 \$3.50  
All other parts are normal stock lines

**ETI MOSFET AMPLIFIER MODULE** (See ETI January)  
PCB (available mid January) Cat H-8393 \$9.95  
Power Mosfets (low cost medium power types, as above) Cat Z-1815 \$15.00 pr

**SELECTALOT** (See EA December)  
PCB Cat H-8384 \$3.00  
All other components are normal stock lines

**AC MILLIVOLTMETER**  
PCB Cat H-8385 \$2.25  
All other components are normal stock lines

**SYSTEM 80/TRS80 INTERFACE** (See EA Nov)  
PCB Cat H-8633 \$9.90  
All other components are normal stock lines

PLEASE NOTE: ABOVE PROJECTS AND PRICES ARE SUPPLIED FROM MAGAZINE'S ESTIMATES ONLY

## COMING NEXT MONTH...



This is it: the superb new Playmaster Power Mosfet Stereo Amplifier, as described in the current issue of Electronics Australia. It's the latest in the incredibly successful series of Playmaster amplifiers (over 10,000 Twin 25's & Forty/Forty's built!) but this one really has everything:

- State-of-the-art POWER MOSFETS
- Low-noise FET input preamps
- Over 50 watts per channel output!
- Speaker switching plus loudness & muting controls
- And a brand new professional styling!

Kits should be available next month - if you built one of the old Playmaster Amplifiers, NOW is the time to upgrade your hi fi to the 1980's! Complete with our famous step-by-step instruction manual. Cat. K-3610

**UPGRADE NOW ONLY \$159<sup>00</sup>**

## AND ALSO NEXT MONTH...

With a little luck (and if Melbourne weather permits...) we plan to open our brand new Springvale store on February 1st. We're really excited about this store: it's the first store we have built from scratch! So electronics enthusiasts in Melbourne's Eastern Suburbs will have the very best in electronics.

**Dick Smith Electronics**  
Cnr Dandenong Road and Springvale Road, Springvale.

(Watch your local papers for the grand opening!)



# WIN A SYSTEM 80 COMPUTER!

- OR A SANYO CASSETTE DECK
- OR A TELEPHONE ANSWERING MACHINE
- OR ONE OF 100 BOOKS!

Spin our **Unbelievable Discount Sale** Main prize? There should be a copy in this magazine! As well as 8 pages jam-packed with unbelievable bargains, you'll also find details of our **Wholesale Give-Away!** We're giving away almost \$1800 worth of prizes - and entry is absolutely free! You don't even have to buy anything to enter - just fill out the entry form and post it to us, or drop it in to your nearest Dick Smith store or participating re-seller. **You could be a winner!**

If the mailer (or the coupon) has already been pinched, purchased or otherwise disappeared, you can get another copy of the mailer from your nearest Dick Smith store, Mail Order Centre or participating re-seller.



Permit TC80/1362

## NEW! TRIBAND BEAM: TH3JR \$265

DK - you've convinced us. We are going to re-introduce the superb MY-GAIN TH3JR 3-band beam. We thought you didn't want it any longer but you've certainly convinced us otherwise! And we believe our price is as good as you'll find anywhere: remember, this is a true My-gain TH3JR NOT an imitation! Cat. D-4304

## NEW! COMPUTER CASSETTE BARGAINS!

We've made a HUGE SCOOP PURCHASE of world renowned Memorex brand certified digital cassettes for computer data recording. These are professional quality (we've used them in our \$25,000 computerised photo-typesetter and they're perfect!) These cassettes are selling for **LESS than half** our normal computer cassette price - and they're much longer! Hurry - this is definitely a once-only offer. Buy now and save a fortune!

**SIMILAR TAPES SELL FOR \$12.00 EACH!**

OUR PRICE: **95¢!!!**

## NEW! FT902D - WITH NEW WARC BANDS



Most amateurs dream about a rig like this: now the dream is within your reach! All mode, digital readout, new WARC bands factory fitted, this superb transceiver represents the absolute state-of-the-art in amateur communications! Don't forget: we offer terms (to approved personal customers) and Reconnect.

Cat D-2853 **\$1175<sup>00</sup>**

## WANT TO RADICALLY IMPROVE YOUR HI FI?

Add a Playmaster Graphic Equaliser and Graphic Analyser to your system. You won't believe the difference they make to your hi fi! Even if you own a very mediocre system, you can make it sound fantastic: why waste money replacing the whole thing?

### GRAPHIC EQUALISER

Easy to build, easy to fit, easy to use! The graphic equaliser can adjust individual bands of frequencies in both channels to make up for system deficiencies, room effects, and so on. Build now and save! Cat K-3500

### GRAPHIC ANALYSER

TO GET THE MOST FROM AN EQUALISER you need to know where your system deficiencies and room effects are. The analyser tells you! So you end up with clear, pure sound! And this superb kit also doubles as a LED level meter: looks good, works really well! Cat K-3510

**EITHER UNIT NORMALLY SELLS FOR \$99.50 NOW \$89.50!!!**

TIMBER SLEEVE SHOWN IS OPTIONAL AT EXTRA COST FOR THAT PROFESSIONAL LOOK: ONLY \$8.50 (Cat H-3113)

## MOOMBOSS\* BARGAINS

**150-IN-1 EXP. KIT**  
Great fun for the beginner: huge number of practical electronics experiments with everything supplied. Housed in heavy protective case. Cat K-2030

**\$53<sup>00</sup> \$39<sup>50</sup>**

**SOLAR CALCULATOR**  
Amazing! No batteries at all - even works from indoor (fluoro) lights. Save a bundle now. Cat D-3050

**\$19<sup>95</sup> \$25<sup>00</sup>**

**CLOCK MODULE**  
It may be a super-sized type, but it still knows how to tell the time! Complete clock works on pcb. With data. Cat X-1052

**\$76<sup>00</sup> \$59<sup>00</sup>**

**PLEASE NOTE:** At time of going to press, all these items were in stock. However, not all items may be in all stores. Please ring store to check. Prices apply only while stocks last.

**BASE STATION MIC**

Just what you need for amateur radio CB stations, even PA use. Amplified mic, with meter. Cat X-1112

**\$29<sup>00</sup> \$22<sup>50</sup>**

**STOPWATCH/TORCH**  
Amazing value! Quartz accuracy stopwatch with lap timing, etc. (great for sports people) with a built-in torch as well. And look at how we've stopped the price! Cat X-1043

**\$35<sup>00</sup> \$25<sup>00</sup>**

**COEMASTER**  
A game that will sharpen your mind! Based on logic and intuition, find the answers from the clues provided. Cat X-1140

**\$29<sup>00</sup> \$22<sup>50</sup>**

**STOPWATCH/TORCH**  
Amazing value! Quartz accuracy stopwatch with lap timing, etc. (great for sports people) with a built-in torch as well. And look at how we've stopped the price! Cat X-1043

**\$35<sup>00</sup> \$25<sup>00</sup>**

**NO OZONE!! JUST GOOD IONS!**

Medical authorities tell us how good negative ions are for us: the effect is just like being near a mountain waterfall. But beware: some generators produce dangerous ozone too! Not the one checked by the University of New South Wales; it produces safe and beneficial negative ions ONLY! 240V operated, uses virtually no power!

**\$85<sup>00</sup>!**

Cat X-9000

## WATCH THIS SPACE

Each month, we're giving you a REAL special, something that is actually BELOW COST!

This month's special is in the stores now: call in and find out what it is. Next month, we'll tell you what you missed out on!

## DON'T THROW AWAY GOOD BATTERIES!!

Why waste money? Check out your batteries before throwing them out. They might still have plenty of life left in them! This checks all standard sizes, plus fuses, globe too! Easy to use. Cat Q-1525 **\$9.95**

**WE'VE SOLD HUNDREDS OF THESE!**

## CAR COSTS BEATING YOU? CDI COULD HELP

Thousands of happy motorists are saving money with CDI. You could join them! A Capacitor Discharge Ignition System could do any - or all - of these in your car:

- Increase spark energy giving better fuel combustion
- Help dirty or fouled plugs to fire - increasing time between plug changes
- Increase points life by lowering current through them - so car stays in tune longer.
- Give better cold and hot starts by maintaining firing voltage during cranking
- Help in wet weather driving

**COMPLETE KIT: (Cat K-3280) SAVE! WAS \$32<sup>50</sup> NOW: \$25<sup>00</sup>!**



## DICK'S PLUGPACKS

**3-6-9V @ 200mA**

- Polarity reversible
- 4-way connector

Ideal for all small electronic appliances - radios, calculators, toys, etc. Save you a fortune in batteries in a short time. Value! Cat M-9525 **WAS \$9.50... NOW ONLY \$6.90**

## NEED MORE OOMPH?

This brilliant 3-6-9-12 volt power supply pushes out a massive 1 amp - ideal for all those high current applications such as burglar alarms, larger toys, cassette recorders, etc. Screw terminals so you can use us on just about anything.

**\$24<sup>50</sup>** (Note: NOT a plug-pack) Cat M-9530



## MAJOR DICK SMITH RE-SELLERS:

- Listed below are re-sellers who stock a large proportion of our range. However, we cannot guarantee that they will have any or all of the items, or at the same prices, as those advertised on these pages.
- ATHERTON, QLD:** Tableland Radio Service 2 Jack Street, Phone 912 017
  - BENDIGO, Vic:** Sumner Electronics 95 Mitchell Street, Phone 431 977
  - BLACKHEATH, NSW:** Goodwin Electronics 123 Station Street, Phone 878 378
  - BROKEN HILL, NSW:** Crystal TV Rentals 68 Crystal Street, Phone 6837
  - CAIRNS, QLD:** Thompson Instrument Services 78-81 McLeod Street, Phone 512 404
  - COFFS HARBOUR, NSW:** Coffs Harbour Electronics 3 Coffs Harbour Plaza, Park Ave, Phone 525 684
  - DARWIN, NT:** Kant Electronics 42 Stuart Highway, Phone 814 749
  - DUBBO, NSW:** Selektia Sound 31 Tallegger Street, 828 978
  - EAST MAITLAND, NSW:** East Maitland Electronics Cr Lawe & High Streets, 337 327
  - FAIRY MEADOWS, NSW:** Trilogi Wholesale Elect, 40 Princes Hwy, Phone 831 218
  - GERALDTON, WA:** KB Electronics & Marine 361 Main Terrace, Phone 212 176
  - GOSFORD, NSW:** Tomorrow's Electronics & Hi Fi 68 William Street, Phone 247 246
  - HOBART, TAS:** Amra Electronics 123a Bathurst Street, Phone 348 232
  - KINGSTON, TAS:** Kingston Electronics & Records Channel Court, Phone 296 802
  - LAUNCESTON, TAS:** Advanced Electronics 5a The Quadrant, Phone 317 075
  - LISMORE, NSW:** Dacra Electric Magellan St & Buzsnes Hwy, Phone 214 137
  - MACKAY, QLD:** Stevens Electronics 42 Victoria Street, Phone 511 723
  - MARYBOROUGH, QLD:** Keller Electronics 218 Adelaide Street, Phone 214 559
  - MORUYA, NSW:** Coastal Electronics 43 Vulcan Street, Phone 742 545
  - MT GAMBIER, SA:** Trilogi Communications 5 Elizabeth Street, Phone 256 404
  - MUSWELLBROOK, NSW:** Silicon Chip Electronics Suite 3, 98 Bridge Street, Phone 43 1038
  - NAMBOUR, QLD:** Nambour Electronic Shop Shop 4, Lawan House, Ann St, Phone 411 604
  - NEWCASTLE, NSW:** Elektron 2000 181 Wharf Road, Phone 267 644
  - ORANGE, NSW:** MAW Electronics 48 McManera Street, Phone 676 481
  - ROCKHAMPTON, QLD:** Purely Electronics 15 East Street, Phone 21 058
  - SOUTHPORT, QLD:** Amateurs Paradise 121 Nearing Street, Phone 322 644
  - TAMWORTH, NSW:** Sound Components 78 Brisbane Street, Phone 661 363
  - TOOWOOMBA, QLD:** Hunts Electronics 18 Neil Street, Phone 326 944
  - TOWNSVILLE, Qld:** Tropical TV 49 Fulham Rd, Vicent Village, Phone 791 421
  - TRARALGON, Vic:** Power N' Sound 15 Franklin Street, Phone 743 638
  - WAGGA NSW:** Wagga Wholesale Electronics 82 Forsyth Street
  - WINDSOR, NSW:** Hawkesbury Electronic Centre 111 George Street, Phone 773 411
  - WODDONGA, VIC:** A & M Electronics 78a High Street, Phone 244 588
  - WHYALLA, NORRIE, SA:** Mailer Enterprises Shop 2, Forsythia Street, Phone 454 764

## WOULD YOU LIKE TO BE A DICK SMITH RE-SELLER?

How would you like to join the hundreds of successful Dick Smith re-sellers spread right across Australia? If you're interested, why not give our wholesale division a call - Sydney (02) 888 3200, 9AM - 5:30PM weekdays. It could be the start of something big.

## NOW IN STOCK! SUPERB 15MHz DUAL BEAM CRO FROM HITACHI

Yes! We searched the world to bring you this outstanding value for money! This superb example of state-of-the-art technology gives you an amazing set of specifications for the money

- Dual beam capability
- High sensitivity: (1mV/division)
- X-Y operation
- trace rotation
- Z-axis input
- 10x sweep magnifier
- 6 modes of vertical deflection operation!

ALL THIS FOR ONLY **\$638<sup>00</sup>**

Cat D-1242

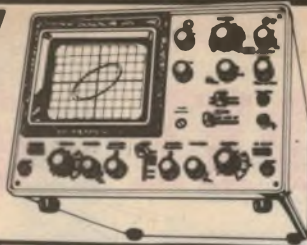

## DICK'S OWN BUDGET CRO FOR HOBBYISTS!

Want a quality CRO at a budget price? We've sold hundreds of this quality 6.5MHz CRO - ideal for hobbyists or the service bench

**\$199<sup>00</sup>**

Cat Q-1280



## FREE DATA SHEET AVAILABLE FOR THESE FLASHING LEDS

Yes, Flashing LED's! An amazing breakthrough in technology has placed a tiny integrated circuit INSIDE the LED so it flashes all by itself! And we have a specially prepared data sheet giving the LED specifications, plus 7 experimenter's circuits using them in different ways, even ways to make a conventional green LED flash alternately with the red flashing LED! (Data sheet available at all stores)

**\$1.50!**

Cat Z-4000



## ALL-CHANNEL TV ANTENNAS

With the new channels in Sydney & Melbourne, you're probably finding the old antenna just isn't up to scratch. Fix the problem yourself at a fraction of commercial installation costs with a new all-band antenna from Dick Smith

**\$34<sup>50</sup>**

The big gun for more difficult areas 75 ohm. Use co-ax or twinlead. Cat L-4030

**\$54<sup>50</sup>**

## UHF ANTENNA

Specially made for Dick to suit Australian standards. Adjustable directivity in 2 directions, very important for good UHF reception. Uses standard 300 ohm ribbon. Cat L-4028

**\$19<sup>95</sup>**

## STRICTLY LIMITED STOCK!

## 'COGNIVOX' FOR THE SORCERER: NOW OVER \$20 OFF!

'Cognivox' is a unique accessory for your IBM Sorcerer. Imagine being able to play a video game by calling out your moves! - and just as easily the computer can talk back to you! For the first time speech recognition and voice response are combined in a single low cost voice I/O terminal! You get the hardware necessary (including microphone and audio amplifier/speaker) plus a basic driver program, two applications program packs (8 programs), two sophisticated voice operated video games, plus a talking calculator program (converts your Sorcerer into a four function floating point calculator that talks! Incredible? Wait until you try it out!!)

Cat X-3150

was \$199<sup>00</sup>

**NOW ONLY \$175<sup>00</sup>!!!**

## WOULD YOU LIKE TO WORK WITH US?

Dick Smith Electronics is expanding - if you've been watching your local press you'll probably have noticed this already!

Opening new stores requires new staff. Good staff. Electronics enthusiasts who can be trained to become professional sales people and managers.

If you're talented and enthusiastic, we offer good wages and conditions. If you're above average, promotion can be very rapid. (One of our salesmen became general manager three years later!)

No matter what area you live in, if you'd like to work with us, drop us a line. When we open a store in your area, we'll be in touch...

Send your application to:  
The Personnel Manager,  
Dick Smith Electronics Pty Ltd  
PO Box 321,  
North Ryde, NSW 2113

## A 600 MHz DFM UNDER \$200?

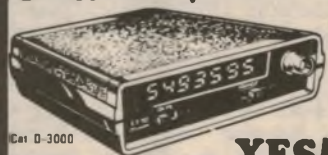

Cat D-3000

Sounds almost impossible to believe? Yes, a beautifully made, 7 digit 600MHz digital frequency meter for less than you paid for your 100MHz version last year! Battery operated. (use Nicads if you like). Highly accurate, and tiny fits into one hand! Hurry, strictly limited stock of this item - don't say you weren't warned!

**YES!  
ONLY  
\$199!**

Ni-cad batteries (4 req)  
Cat S-3300 \$2.05 ea  
Power supply charger  
Cat M-9525 \$9.50

## INCREDIBLE UNDER \$100 FOR A 3 CHANNEL DIG. PROP. RADIO CONTROL???

Yes! It's another bulk import bargain from Dick Smith. Where else can you find such incredible value! We've sold hundreds of these and small wonder!

For under \$100, you get the 3 channel digital proportional radio control transmitter, a sensitive receiver, battery case & switch, PLUS 3 SERVOS!

(Spare servos available shortly for other models etc - you can use the same transmitter/receiver without having to change over servos too!)

COMPARE THE PRICE ELSEWHERE!!

**\$99**

Cat X-1230

## HARD OF HEARING?

This could be the answer: a telephone amplifier! Just stick the suction to your phone (no electrical connection, so it's quite legal) and it will amplify anything you say as well as anything being said. So it is ideal for conference-type listening too. Another Dick Smith exclusive import and just look at our low, low price!

**\$12<sup>50</sup>**

Cat X-1174

## TWO NEW BARGAIN CALCULATORS: BUDGET POCKET/ PURSE CALC.

LCD METRIC CONVERSION CALC. Cat Q-3025

Sell having Metric troubles? Work out conversions with this beauty. And it's also a great memory calc with auto shut off too!

**\$19<sup>95</sup>**

**\$9<sup>95</sup>**

Cat Q-3015

## NOT ENOUGH TV OR FM SIGNAL? AMPLIFY IT!

Add a meshhead amplifier. It could be the difference between good reception and zilch! This is NOT a bit ready to install (anyone can do it). Includes the meshhead amplifier itself, plus mains power supply to suit.

Large range of other TV antenna accessories also available.

**\$39<sup>50</sup>**

INCLUDES POWER SUPPLY!

Cat L-4200

Cat L-4200

## BUILD ONE OF THESE BARGAIN KITS

### 9kHz WHISTLE FILTER

Get rid of those annoying inter-station whistles from your tuner. This 9kHz whistle filter is just the thing to do it. Easily added to most hi fi amplifiers. Suits the new station separators.

**\$49<sup>75</sup>**

**\$14<sup>50</sup>**



Cat K-3497

### AUDIO MIXER

A really versatile mixer, ideal for all sorts of applications, including movie sound! Has autolock, VU meter & tone controls. Really professional!

**\$49<sup>00</sup>**

**\$35<sup>00</sup>**

### MORSE KEYS

For really fast Morse code speeds most amateurs use a Keyer. Until now, it was those who could afford them! Build your own and save a fortune! Has built-in monitor, variable speed, etc. A bargain!

Cat K-3470



**\$39<sup>00</sup>**

**\$29<sup>50</sup>**

### MORSE TRAINER

Know someone who wants to learn Morse? Maybe even you? Build this simple and economical code practice oscillator. Code is printed on top of lid so it's easy to learn! (Key extra)

**\$5<sup>00</sup>**

**\$3<sup>50</sup>**

## A MUST FOR EVERY KIT BUILDER...

Do you suffer from burnt fingers when soldering PCB's? Your troubles are over with this unique soldering station from Dick Smith. Not only does it hold the PCB firmly and securely at any angle you want it, your roll of solder and soldering iron are also within easy reach. It's mounted on a heavy cast base so it won't tip up leaving you both hands free to concentrate on the assembly job.

Once you've used it, you'll wonder how you ever soldered PCB's without it!

Cat T-5700

**\$19<sup>50</sup>**

## WANT TO KEEP SOMEONE AMUSED OVER THE HOLIDAYS?

Here's a great idea, and it won't break the bank, either. Give them a copy of Dick Smith's Fun Way Into Electronics - there are two volumes to choose from. Even complete beginners can build safe electronic projects that actually do something! And when they go back to school, they're all ready for school projects as well! Elsewhere in this magazine there's a full page showing you both the Fun Way books and the kits. Check it out: you could solve those holiday boredom problems very easily - and start your youngsters off on a career in electronics!

## JUST RELEASED!

Imagine! A FULLY APPROVED telephone answering machine UNDER \$200!!!

Yes! Dick Smith now has this superb telephone answering machine, fully approved by Telecom Australia for connection to Telecom phone lines, at a true Dick Smith Direct Import Price. Don't pay \$300 or more - now every business, every busy person can afford a telephone answering service. Here's what it does:

- Great incoming calls with your own prerecorded message
- Allows callers to record their own message to you
- Allows you to monitor incoming calls without answering unless you want to!

BUT THAT'S NOT ALL!!!!

With the optional Remote Beeper you can actually dial your number from any other phone and listen to any messages that have been recorded! Imagine how handy that would be for busy people on the move: you can capture important calls without having to go to the office!

## FULLY APPROVED PHONE ANSWERING MACHINE



ANSWERING MACHINE  
(Cat X-2173)

**\$199<sup>00</sup>**

REMOTE BEEPER  
(Cat X-2174)

**\$39<sup>00</sup>**

# DICK SMITH ELECTRONICS

NSW 145 Parramatta Rd  
613 Princes Hwy  
818 George St  
531 Pittwater Rd  
147 Hume Hwy  
162 Pacific Hwy  
30 Gore Street  
125 York Street  
263 Keira Street

AUBURN 648 0558  
BLAKEHURST 546 7744  
BROADWAY 211 3777  
BROOKVALE 93 0441  
CHULLORA 642 8922  
GORE HILL 439 5311  
PARRAMATTA 683 1133  
SYDNEY 290 3377  
WOLLONGONG 28 3800

ACT 96 Gladstone St  
QLD 166 Logan Road  
824 Gympie Rd  
SA 60 Wright Street  
VIC 399 Lonsdale St  
656 Bridge Road  
Ondenong Rd  
WA 414 William St

80 4944  
391 6233  
59 6255  
212 1962  
67 9834  
428 1614  
Open soon  
328 6944

DICK SMITH MAIL ORDER CENTRE:  
PO Box 321, North Ryde NSW 2113. Phone (02) 888 3200

SERVICE CENTRE, LANE COVE & WATERLOO RDS, NORTH RYDE NSW 2113  
PHONE (02) 888 3200. HOURS 9AM TO 5PM, MONDAY TO FRIDAY ONLY.

## COMPUTER HOTLINE

Want to know more about our computers? Or maybe you're having problems and need advice. For friendly, helpful information on System 80 or Sorcerer computers, or on any of our peripherals, phone our Computer Hotline: Monday - Friday, 9 - 5.30 on Sydney (02)

**888 2002**

## BUYING BY MAIL?

ORDER VALUE: P&P  
\$5 (min) to \$9.99 \$1.00  
\$10.00 to \$24.99 \$2.00  
\$25.00 to \$49.99 \$3.00  
\$50.00 to \$99.99 \$4.00  
\$100 or more \$5.50

NOTE: These charges apply to goods sent by post in Australia only. Large and bulky items cannot be sent by post. If you prefer, we will dispatch your order by Comat Road Freight to anywhere in Australia for only \$6.80 - that's below what it costs us! Large and bulky items are normally sent by Comat unless you specify differently (eg by rail or air - you pay freight on delivery)

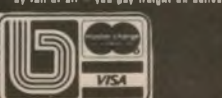

SHOP HOURS 9AM TO 5.30PM MONDAY TO FRIDAY, NOON SATURDAY (Brisbane stores half hour earlier). Some stores are open on late shopping nights: please phone your local store to check before coming in!

# Collision avoided in outer

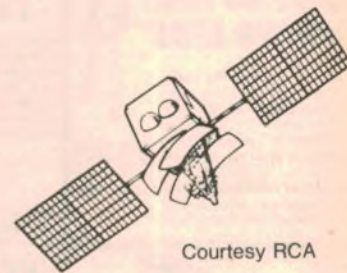
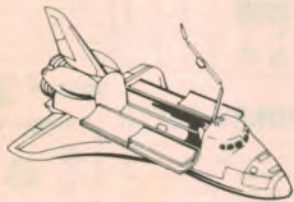

Courtesy RCA

With an estimated 300-500 new objects placed in Earth orbit each year, collisions in space have become a worrying possibility. Steps must be taken to control the amount of space debris if costly, and perhaps even fatal, mission failures are to be averted in the Space Shuttle age.

Space is infinite; yet the space in Earth's orbit is finite, and collisions in space between man-launched objects have become a threat. As the number and size of orbiting space stations continue to grow, there is increasing danger that they will hit some fragment of space "junk" — spent rockets, dead payloads, fragments from explosions and collisions in space, and the like. This "junk" could threaten smaller spacecraft because of the increasing number of fragments from collisions of pieces of debris.

If the number of such nonfunctional objects launched originally from Earth continues to grow, as it has since 1975, a collision can be expected within the next 5-10 years. By 1995, about three such collisions will probably have occurred. In fact, it is possible that collisions between debris too small to track and larger objects have already taken place. A section of a solar panel was damaged, apparently by an impact, on Geos 2, a US land-use satellite in geosynchronous orbit. The Soviet Cosmos 954, in low orbit, suffered a sudden depressurisation thought to be caused by a collision with debris. The mishap eventually forced Cosmos 954, a surveillance satellite with a nuclear power source, into an uncontrolled re-entry over Northern Canada in 1978!

In another incident, the US Pageos balloon, after nine years in orbit, suddenly broke up in a region of high collision probability.

Fortunately, there are ways to control the spread of potentially harmful objects and to limit any collision damage they might do. Satellites can be retrieved and returned to Earth when their useful life is ended. Space junk can be directed to a special orbit. New satellites can be either placed at orbital altitudes where the danger of collision is low or designed to re-enter after the mission is completed. Space launches can be

planned to minimise the release of nonfunctional objects and the explosions of those objects.

The effects of damage to functioning spacecraft can be reduced by fail-safe design: redundant load paths, higher margins of safety, fewer but stiffer and stronger structural members. In addition, shielding can be added to protect against dust-sized debris.

Whatever methods are selected for controlling debris in space, it is important that they be applied in a co-ordinated way to avert costly and fatal mission failures in the Space Shuttle age. The self-perpetuating nature of space collisions adds urgency: when a space fragment collides with an object, its impact creates more fragments, which can cause more collisions, still more fragments, and so forth.

Of the 10,000-15,000 objects estimated to be in Earth orbit, only about 4600 can be detected and tracked by Earth-based sensors. Of the tracked objects, only about 1000 are classified as payloads — satellites launched for such purposes as relaying telecommunications, observing weather, surveying the land and sea, making astronomical observations, and aiding navigation. Of the payloads, only about 235 are still operating.

Because there have been many breakups in space and because the known population of fragments is heavily weighted toward smaller objects, it is certain that the great majority of orbiting man-launched objects are small. Their size makes them no less hazardous, however. Tiny fragments moving at an average of 10km/s carry ample energy to penetrate and demolish spacecraft parts (Fig. 1).

Most objects are at altitudes between about 300 and 2300km. This is the altitude range in which there has been the greatest activity in space. The latest figures show more than 2300 announced payloads have been placed in orbit — 1338 by the Soviet Union and 959 by the United States, with a handful launched by other nations. However, though the Soviets have orbited the most payloads, they claim only half of the 1000 still in orbit, because they have often followed a policy of steering their satellites either to fiery destruction in the atmosphere or to a controlled re-entry and recovery when the mission is ended.

The payload launches have left a legacy of spent rocket stages; shrouds that covered the payloads during ascent; interstage fairings; segments of clamp rings jettisoned at stage separations; and pyrotechnic fragments that now constitute a

**Donald J. Kessler** NASA Johnson Space Centre

**Preston M. Landry**

North American Air Defence Command

**Burton G. Cour-Palais**

NASA Johnson Space Centre

**Reuben E. Taylor** NASA Johnson Space Centre

# dance space

*Fig. 1: The destructive power of impacts like those found in space was demonstrated when a small plastic projectile moving at almost 7.8km/s produced this crater in an aluminium block during tests at the General Motors Defence Research Laboratory. The projectile was similar to the small cylinder in the photo. Its mass was just 6.4g as opposed to 11.5kg for the block!*



significant part of space junk. These objects approximately equal the number of payloads in orbit. The objects disappear gradually as they lose altitude, re-enter the atmosphere, and burn up.

Sixty per cent of the tracked orbiting fragments come from explosions in space – either accidental, as in the US Delta launch vehicle mishaps, or intentional, as in “killer satellite” tests by the Soviet Union. About three-fourths of these fragments are objects of US origin, primarily because these explosions were at high altitude and some of the debris may take thousands of years to re-enter the atmosphere. The Soviet Union, in contrast, tends to place payloads in lower orbits, and explosion fragments generated at lower altitudes burn up in the atmosphere soon after the events (Fig. 2).

How fast is the orbiting population of space junk increasing? With 120-150 new payloads launched each year, the junk grows by between 300 and 500 objects, or about 11%, per year (Fig. 3).

## Sensors identify space objects

What is known about all man-launched objects in space is derived largely from a record of Earth satellites kept by the North American Air Defence Command (NORAD). The command, with a worldwide network of sensors – optical, electro-optical, conventional radar, phased-array radar, and interferometer sensors – can detect varying sizes of objects in space. Generally, the higher the altitude, the larger an object must be to be detected.

In low Earth orbits, NORAD radar sensors routinely detect objects with reflectivity characteristics comparable to metal spheres with diameters of 10cm and larger. At geosynchronous altitudes of 35,800km, optical sensors detect objects as small as 2.5m. The planned electro-optical sensors will detect objects as small as 0.7m at geosynchronous altitudes.

Still, many objects are too small or too far out to be catalogued. Their presence is inferred from launch data, from uncorrelated single “sightings” by sensors, and from knowledge that breakups have occurred.

Explosions are the largest single source of objects in space. A total of about 2000 tracked objects are from 11 accidental explosions of US rockets. Some of these rockets were presumably dead in space for as long as three years before they exploded. They functioned properly during launch, but

an unknown engineering problem caused the spent stages to become time bombs in space. Once such a problem is identified, a procedural change can do more than any other single action to limit explosions – and the resultant increase in the debris in orbit. Such a change – leaving vents on the spent stage open to prevent pressure buildup – was applied to the Delta rocket last March.

The relatively small number of observed fragments generated by the Soviet Union's eight antisatellite tests may be misleading, since high-intensity explosions typically produce a very large number of small, unobservable fragments. Thus, the Soviet contribution to total debris may be much larger than that of the US rocket explosions. Conceivably, the fragments produced by many antisatellite explosions could start a chain reaction of events, ending in the fragmentation of so many satellites that much of near-Earth space would be unusable. For other reasons, the United States and the Soviet Union have conducted preliminary talks to ban antisatellite satellites, although these talks have not led to a formal treaty.

What are the chances for a collision in space? Because of uncertainties in the normally monitored orbital parameters of objects in space, calculating probabilities of collisions between these objects is related more to random events than to events that can be anticipated. This is even more true for uncatalogued objects, for which the significant parameters are the number of such objects and the altitude of their orbits. Thus, collision probabilities can be found by expressing collision rates in terms of flux, or impacts per unit area per unit time. This probability is mainly a function of altitude.

For the Space Shuttle, for example, collision probabilities are low in the 200-400km normal altitude range – less than one chance in 10,000 or 0.0001, per year (Fig. 4) – but at 1000km, where the catalogued population is denser, the probability increases to 0.0003 per year.

The collision rate is proportional to the spacecraft's area. A hypothetical space station of 100m diameter would be subject to a collision rate about 30 times that of the Space Shuttle; at 500km, the collision rate would be 0.005 per year. Allowing for growth in the number of objects in space and an orbital lifetime of 10 years for each, the probability of collision between one of the tracked objects and the space station approaches 0.1, or one chance in 10.

Of course, the tracked objects are only a fraction of all in

# Collision avoidance in outer space . . .

space. A multitude of particles smaller than 10cm are produced by every space explosion. Even a 1mm-diameter particle travelling at a relative velocity of 10km/s – the average collision velocity in space – can penetrate most spacecraft structures.

A high-intensity explosion – one in which the explosive charge is in contact with some part of the spacecraft – produces 1000-1 million fragments of less than 1cm. The Soviet antisatellite tests were probably of this type. These tests produced a relatively small number of observable fragments. A low-intensity explosion generally produces fewer and larger fragments. The unplanned explosions of US rocket motors were probably of this type; the explosions took place after most of the rocket fuel had been used.

The size distribution observed at low altitudes is a key to the distribution of the unobserved population at high altitudes. Below 400km, objects as small as 4cm diameter can be detected. In general, they are not observed until atmospheric

drag reduces their altitudes. The rate at which drag acts is inversely proportional to the diameter of the object, for a constant mass density.

From the number-size relationship at low altitudes, the number of 4cm objects at higher altitudes can be inferred. The number-size relationship turns out to be very close to the number of fragments that were recovered from a low-intensity ground explosion of an Atlas missile. In the densest region of orbital debris – the altitude between 600 and 1100km – the Atlas data predict that the population of objects that are larger than 4cm diameter is three times that of the observed population.

In the near future, most fragments may come from collisions instead of explosions, and the size distribution of these fragments has been measured from experiments on hypervelocity impacts. Based on the estimated population greater than 4m, the current probability of collisions between any two orbiting objects is 0.06 per year, or one chance in 17 per year.

A typical collision will involve a fragment 4-40cm in diameter and a payload or rocket body 3-4cm in diameter and will eject an average of 300kg of fragments. By 1995, if past trends continue, the orbital debris in the altitude between 600 and 1100km will have increased to the point where approximately three such collisions will have occurred. The consequences of these collisions would be to produce a distribution of fragments that include 10 million particles with diameters 1mm and larger. The probability of collision of an operational payload with these particles would exceed that with natural meteoroids for most spacecraft in this region.

Fig. 2: The largest part by far of the catalogued space objects is made up of explosion fragments. Payloads and mission-related objects (spent rockets, shrouds, etc) constitute only about 40% of the objects.

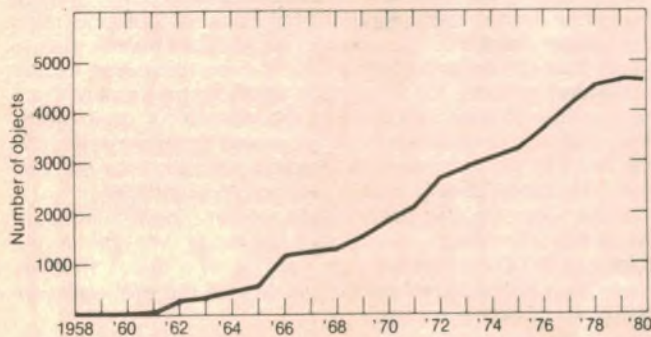
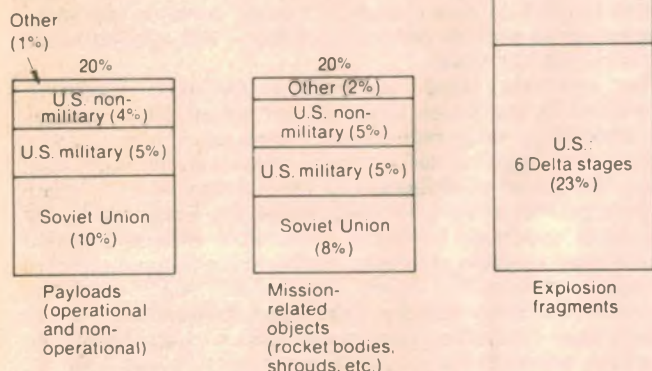

Fig. 3: The space object population has risen steadily since the first Soviet Sputnik launch in 1957. Much of the population is a result of space explosions, although in the future collisions may contribute even more. The curve shown represents only the observed population of objects at a given time – the unobserved population is estimated to be two to three times greater.

## Collision insurance: shielding

The large space structures that have been proposed – solar power generation satellites, communications platforms, and space stations – will have high probabilities of being hit by the larger space objects, particularly in the 400-4000km altitude range. Although such collisions may not ruin the mission, they could disable or eliminate a portion of the supporting structure of the spacecraft. Redundant designs then would be necessary. Smaller spacecraft would require protection of critical components – such as pressurised containers, fuel cells, and electronics packages – against impacts with smaller particles. In these cases, shielding would be necessary.

The shielding and structural redundancy needed to provide an acceptable low probability of significant damage depends on how the space structure's designers define "significant damage". Most of the 4-15km/s impact studies have been made with solid projectiles simulating meteoroids. However, the observed damage patterns and the shielding techniques and equations developed from them are applicable to impacts with explosively generated fragments.

If the satellite structure is very thick compared with the projectile, the projectile spherical, and the mass density of both

## What's in orbit

Natural and man-made objects in space include the following:

- Planets, moons, asteroids, meteoroids, and other natural bodies.
- Operational payloads.
- Nonoperational payloads.
- Nonfunctional mission-related objects, such as rockets and stages of rockets, shrouds, clamps and fasteners.
- Fragments resulting from explosions and collisions.

The nonoperational payloads, nonfunctional mission-related objects, and fragments are generally referred to as debris or "space junk".



# NOW the low cost answer to model control

## The DICK SMITH three channel digital proportional radio control

Imagine! A fully digital proportional 3 channel radio control system for under \$100.00! Compare elsewhere at \$150 and more. This outstanding system features three individually controlled channels, with 'trim' offset controls. Two channels are joystick controlled, the third a slider control (ideal for throttle, etc.)

- Complete with receiver, battery holder and three servos (spare battery holders and servos available so you aren't tied to just one model!)
- Ideal for models of all types: boats, planes, vehicles, etc.
- Top range transmitter and ultra-sensitive receiver
- Crystals are changeable for different operating frequencies
- Requires 10 pen light cells. Cat. S-3003: 22 cents each

GET INTO RADIO CONTROL MODELS NOW!

### A MASTERPIECE IN STATE-OF-THE-ART RADIO TECHNOLOGY

**DICK SMITH**  
Electronics



**DIRECT IMPORT  
YOU REAP THE BENEFIT!**

**SEE OUR OTHER ADS FOR  
FULL ADDRESS DETAILS**



Complete with transmitter;  
receiver; battery holder; 3 servos

**DICK BREAKS  
\$100 BARRIER**

**only \$99**

Cat. X-1230

P&P \$4

# Collision avoidance in outer space . . .

similar, a hemispherical crater will form in the satellite and the projectile will be destroyed. Some spray will be ejected from the lip of the crater. If the mass densities are very dissimilar, the crater will be nonhemispherical, and it will be deeper or shallower, depending on whether the projectile or the satellite has greater density.

If the satellite structure is not thick enough, debris will break through the bottom of the crater, and this may cause further damage inside the satellite. However, a thick shield often cannot be justified because it adds too much weight.

Instead of a heavy thick shield, it is possible to design the satellite with two thin shields. The first shield would act as a bumper to break up the incoming projectile. The second shield, placed at an optimum distance from the bumper shield, would absorb the resulting debris cloud. A two-wall thin shield could withstand the same impact as a single-wall thick shield that was four-five times heavier.

For example, if an unmanned spacecraft  $10\text{m}^2$  in cross-sectional area is to last for 10 years with a 90% probability of surviving the possible 1995 debris flux, a single shield of aluminium would have to be 9mm thick and weigh 970kg. By contrast, a double thin-shield would have a total thickness of 1.2mm with a separation of 76mm between shields, and it would weigh but 185kg, including the supporting structure for the outer shield. Thicknesses are based on protecting against a particle of 2mm diameter – sufficient for survival among the projected space debris by 1995.

A more difficult problem is protecting a manned space sta-

tion. For a 90% probability of survival for 10 years, a craft  $100\text{m}^2$  in cross-sectional area must be protected against 6mm-diameter fragments. A single aluminium shield would be 28mm thick and would weigh 31,000kg. The combined double-shield thickness would be 4mm and would weigh 5000kg including the support structure. If the survival probability is increased to 99% for a 10-year mission – as it may be for a craft in which people live and work – the fragment diameter to be defended against increases. The corresponding thickness and weight for both single and double shielding would increase by a factor of about 10.

## Cleaning up debris with the Shuttle

NASA's Space Shuttle may offer a way to control the spread of space debris. What is envisioned is a satellite service capability that would use the Space Shuttle to collect space debris and return it to Earth, or perhaps move objects in space to other orbits where there may be less traffic. Such a capability could provide a broad range of services required by the general community of satellite users. Included would be the repair and maintenance of orbiting spacecraft, observation of orbiting systems, and the retrieval of satellites for return to Earth.

With the Shuttle, a service crew could observe damaged hardware on a satellite with TV cameras, and the video images could be transmitted to ground stations for evaluation by design experts. The experts would then suggest how repairs might be made. The same service crews could also routinely resupply propellants and other expendable items to satellites, repair and replace failed components, and reconfigure sensors to modify a satellite's functions. They could retrieve satellites, rocket bodies or other objects with a remote manipulator. Because it is reusable, the Shuttle itself will not add to the junk already in orbit.

NASA is considering a demonstration of space retrieval on an early Shuttle flight. This will allow analysis on the ground of a satellite that has been in low orbit for a known period of time. Satellite designers will then be able to estimate more precisely the micrometeoroid flux and the total of orbiting fragments of less than 1mm diameter. Solar-cell damage over a relatively long time will also be assessed, as will deterioration of electronic circuits, including components, terminals, and solder joints.

## Reducing the objects in space

Another way to reduce orbiting debris is to prevent explosions in space. Less debris would, by itself, dramatically reduce collision probability without any cut in the numbers of payloads launched. For example, if only the 235 operational payloads in Fig. 4 were in orbit, the collision probability for any particular spacecraft would be reduced to about 1/20th of the present value. With a *small* number of *large* objects to be tracked, collision avoidance through manoeuvring would then become more practical.

A reduction in spent rockets, dead payloads, and large shrouds is just as important as preventing explosions. Removal of these nonessential objects could significantly decrease the frequency of collisions and greatly lower the projected fragment flux. Most of the objects already in orbit can be removed only by retrieval, possibly by the Space Shuttle. However, future launches can be planned to minimise the number of released objects, and to see those that are released re-enter the atmosphere once their usefulness is completed. In some cases, discarded objects will re-enter automatically if the launch is timed appropriately.

For example, a rocket motor can be made to re-enter inexpensively when the payload is transferred from low Earth orbit to geosynchronous orbit. The transfer always leaves an orbiting rocket motor with a perigee of a few hundred kilometres and an apogee at 35,800km, producing a hazard between these two extremes. The orbital lifetime ranges from

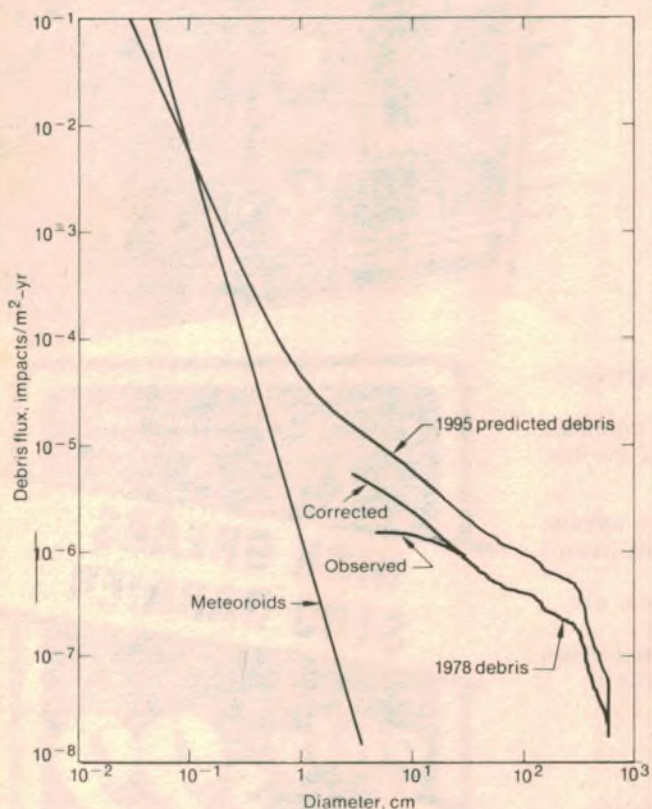
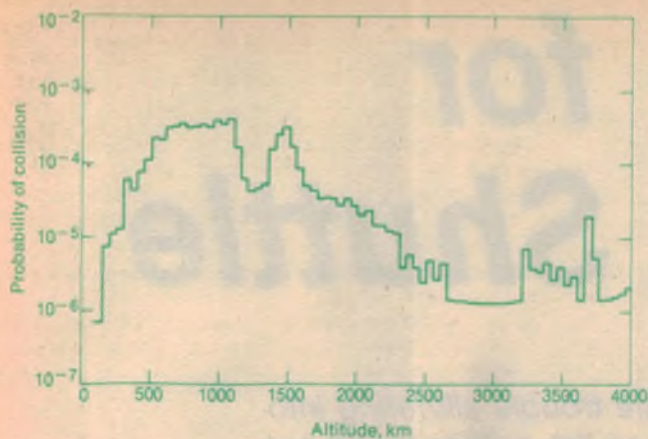

Fig. 5: Graph showing the possible collisions in space for the predicted 1995 debris as compared with that for the known 1978 debris (altitude range 600-1100km). The 1978 debris has been corrected by using Atlas booster ground explosion data, the corrected debris being greater than the observed debris because of the uncertainty in detecting fragments less than 10cm diameter. Collisions are expressed in terms of flux, or the number of impacts per year for an object with a  $1\text{m}^2$  cross section.



As the Space Shuttle climbs above the Earth, the probability of its colliding with an orbiting object varies with altitude. The graph here is based on tracked objects in a catalogue kept by the North American Air Defence Command.

hundreds of years to a year, depending primarily on the time of launch. After launch, lunar and solar perturbations cause the perigee to oscillate. If the perigee oscillates upward after launch, the orbital lifetime is very long. However, if the oscillation is downward, the increased atmospheric drag at perigee causes re-entry much sooner, usually within a year or two. Whether the oscillation is up or down depends on the time of launch. Thus, with proper scheduling of the launch, rocket motors can be made to re-enter the atmosphere fairly quickly.

Because the amount of debris in geosynchronous orbit is rapidly growing and because this orbit is so important to communications satellites, it warrants special protection. From geosynchronous altitude, re-entry to the atmosphere requires more energy than would be required to place the object in a higher orbit. Therefore, it has been suggested that a "garbage dump" be formed at an altitude slightly above geosynchronous altitude.

Since the collision probability in geosynchronous orbit is less than in lower orbits, it might be wise to wait until satellites could be retrieved from geosynchronous altitude. The low inclination and nearly circular orbits of geosynchronous satellites would simplify clean-up. This may not be the case in a garbage dump where orbital instabilities could create a large problem.

### A space sanitation department?

Meanwhile, new data is needed to describe the current distribution of space junk as small as 1mm diameter and to project future distribution accurately. Such data could come from a satellite designed to measure the flux objects smaller than 10cm, from an optical experiment on the ground, or laboratory measurements of fragment distributions from explosions and collisions.

Once guidelines are established, a management structure is required to administer them. This "Space Object Management Office" could require a "Space Environmental Impact Statement" from each space user. This would call for a description of the objects to be placed in space and how they would be disposed of on completion of their mission. The office could have the authority to limit certain activities or simply to tax the users who polluted space. The revenue could pay for the cleanup or for protecting other users.

The trend to launch large, modular structures may bring about a total solution to the space debris problem. If space could be cleaned up or the debris controlled, these fewer large structures could be placed in nonintersecting or manoeuvrable orbits so collisions would be impossible. ☺

Reprinted with permission from IEEE Spectrum, June 1980. Copyright © June 1980

## SPECIAL PURCHASES

### NEW PLESSEY-FOSTER & AWA HI-FI SPEAKER SYSTEMS POWER RATING 50 WATTS RMS FREQUENCY RANGE 30 to 18000 CYCLES

This HI-FI speaker system uses the top of the range Foster COOF05 8" woofer which is a free edge cone speaker with a resonant frequency of 27 cycles and a 2" voice coil, weight 3577G (magnet weight 607G). Two AWA 4" tweeters with ceramic magnet & curve-linear cones are supplied also crossover components, grille cloth, innabond lining & cabinet plans. (Cabinet not supplied.)

**\$59.00**

(List price was over \$100)  
Post & packing NT & NSW \$3.50 per kit  
Qld, Vic \$5.50; SA, WA \$8.00 per kit  
Foster COOF05 8" woofer max power  
80W available as separate unit at \$47.50 +  
post & pack as kit.



### RANK-ARENA 2 WAY SPEAKER

- 10 Watts RMS
- 8 ohm impedance
- 8" woofer with tweeter
- Supplied with leads and plugs
- Teak finish

A similar system available in walnut finish. Dimensions 18"H, 11"W, 9 1/2"D. Freight extra per rail air or road transport.



### NEW RANK-ARENA FM-AM TUNER AMPLIFIER

MODEL RA402. Output 24 watts RMS. (12 X 12) Response 50hz to 50Khz. Mag or ceramic inputs. High & low filters. Loudness control. Provision for 4 speakers.

**\$147.00** Freight Extra

### SPEAKER GRILLE FABRIC AT 1/2 PRICE

AVAILABLE IN LIGHT & MID BROWNS. WIDTH 54"

**\$4.80** Per YARD. Post & Pack \$1.75.  
Send two 20c stamps for samples

### NEW EMI RECORDING TAPE

HIFI LOW NOISE  
At less than 1/2 list price  
HDP12 5" reel 1,200ft  
double play 2.95 4 for \$10.00.  
PP \$2.00



### EMI SUPER C90 CASSETTES

8 for \$10. P&P \$2.00



### NEW STANDARD BSR RECORD CHANGERS MODEL C129R

**\$36.00**

Fully automatic turntable plays up to six records automatically and single records automatically or manually as required. 11" turntable. Cue & pause control. Record speeds 33 1/3, 45 and 78 rev/min. Finished in black with silver trim. Player and changer spindles supplied. Fitted with ceramic cartridge. Post & packing extra. NSW \$2.70; Vic, Qld, SA \$3.70; WA \$4.70 (registered post \$2 extra if required).  
Spare cartridge and stylus for above \$4.50 (list price \$10.00).

### NEW AWA HI-FI SPEAKER KITS 8" 2 WAY 3 SPEAKER SYSTEMS

AT LESS THAN 1/2 LIST PRICE

POWER RATING, 20 WATTS RMS. IMPEDANCE 8 OHMS Frequency range 46 TO 18,000 CYCLES

Supplied in kit form (less cabinet) each kit comprises: One AWA 8WAC 8in bass unit, two AWA 4MBC 4in tweeters with ceramic magnets & curve-linear cones, crossover components, grille cloth, innabond lining and cabinet plans.

CABINETS AVAILABLE

**\$20**

Post & packing extra: NSW \$2.50; Interstate \$3.50. PER KIT

## CLASSIC RADIO

245 PARRAMATTA RD., HABERFIELD 2045

PHONES 798-7145, 798-6507

# Suiting up for the Space Shuttle

*In space, the Shuttle astronauts will have little trouble slithering into their space suits. On Earth it's not so easy, as the author found out when he visited the Johnson Space Center in Houston, Texas.*

by **BEN KOCIVAR**

Obviously, the odds are impressively against my getting there, but I recently took a faltering step toward outer space. Here at the Johnson Space Center, I tried on one of the new computerized spacesuits — Extravehicular Mobility Unit (EMU), as they're officially called—Shuttle astronauts will wear next year when they leave their ship for the airless, weightless world. These amazing suits will sustain



*In full-dress space suit, author Kocivar tastes the life of a Shuttle astronaut. To see how he got into the suit, see the photos on p21.*

and protect them as they repair and deploy satellites, build space platforms, and do other way-out jobs.

The bulky outfit I confronted looked about like the one astronaut Neil Armstrong wore when he stepped onto the surface of the Moon. But in fact, the new suit is a tremendous improvement. For one thing, Apollo suits had to be custom-built for each astronaut. The new model is a kind of off-the-rack outfit, designed for men or women. Combinations of the various parts — upper-torso section, arms, pants, gloves, boots — make possible thousands of sizes. Prime contractor for the EMU is United Technology's Hamilton Standard Division, Windsor Locks, Connecticut. A major subcontractor, ILC Dover of Frederica, Delaware, is fabricating the suit.

The Apollo suit and its backpack life-support system had to be put on separately. Donning them took more than an hour, and two astronauts had to help each other into the rigs. This new suit has the backpack fixed to the rigid fibreglass upper-torso unit, and that section hangs on a special adjustable rack called an airlock adapter plate. The astronaut can get into the whole suit unaided. He will make four connections, check out functions, and be ready to step out in about five minutes. Or so they told me.

But before I got approval to try one on, Fred Keune, Hamilton Standard's manager in Houston, threw me some disquieting questions.

"Have you had a recent flight physical? Do you suffer from claustrophobia?"

I had seen films of astronaut John Young slithering in and out of the spacesuit as he floated weightless inside the cabin of a NASA 707 while it flew a parabolic flight path to create zero G. He did it twice in 30 seconds, grinning all the time.

## **Tight fit**

Now it was my turn. I started out

grinning. But it took three men to help me into the pants and a couple more tugging and directing me into the upper torso. Claustrophobia hit when my head got stuck wiggling through the metal neck ring while my upstretched arms were trying to fit into the sleeves. When I got the upper ring past the back of my head, my nose was rammed against the front. I was getting a frantic sense of being hooked like that. Maybe they'd have to cut me out! Finally, after 15 minutes, I struggled through. By now, I was sweating, and puffing so hard my ribs were banging against the torso shell. "It's easier when you're weightless," Keune assured me.

Next, they locked the pants to the torso with a ring-shape bearing connector at the waist. Finally, they put the helmet on me and sealed me in. Then came relief: They turned on the cooling system that piped chilled water through tiny tubes in my special full-length underwear. And they turned on the air. It flowed in over my head and down into the suit, then back up and out (in space, pure oxygen will be used). In five minutes the suit was pressurized to 129kPa, 28kPa above atmospheric pressure. The weight of the torso and backpack was still supported by a special rack similar to the airlock adapter plate. When I finally stepped away it was with extreme caution. The outfit weighs 50kg, and just standing up was a chore.

The training suit I wore is exactly like the ones to be used in space. Its backpack, however, only simulated the size and shape of the real backpack. My cooling water and air supply came through umbilicals from machines in the next room.

The suit and real backpack will weigh an even heftier 106kg. The backpack will hold a portable life-support system (PLSS) that will supply seven hours of oxygen for breathing, suit pressurisation, and ventilation. After passing through the suit, the used oxygen will go through a contaminant-control cartridge, which

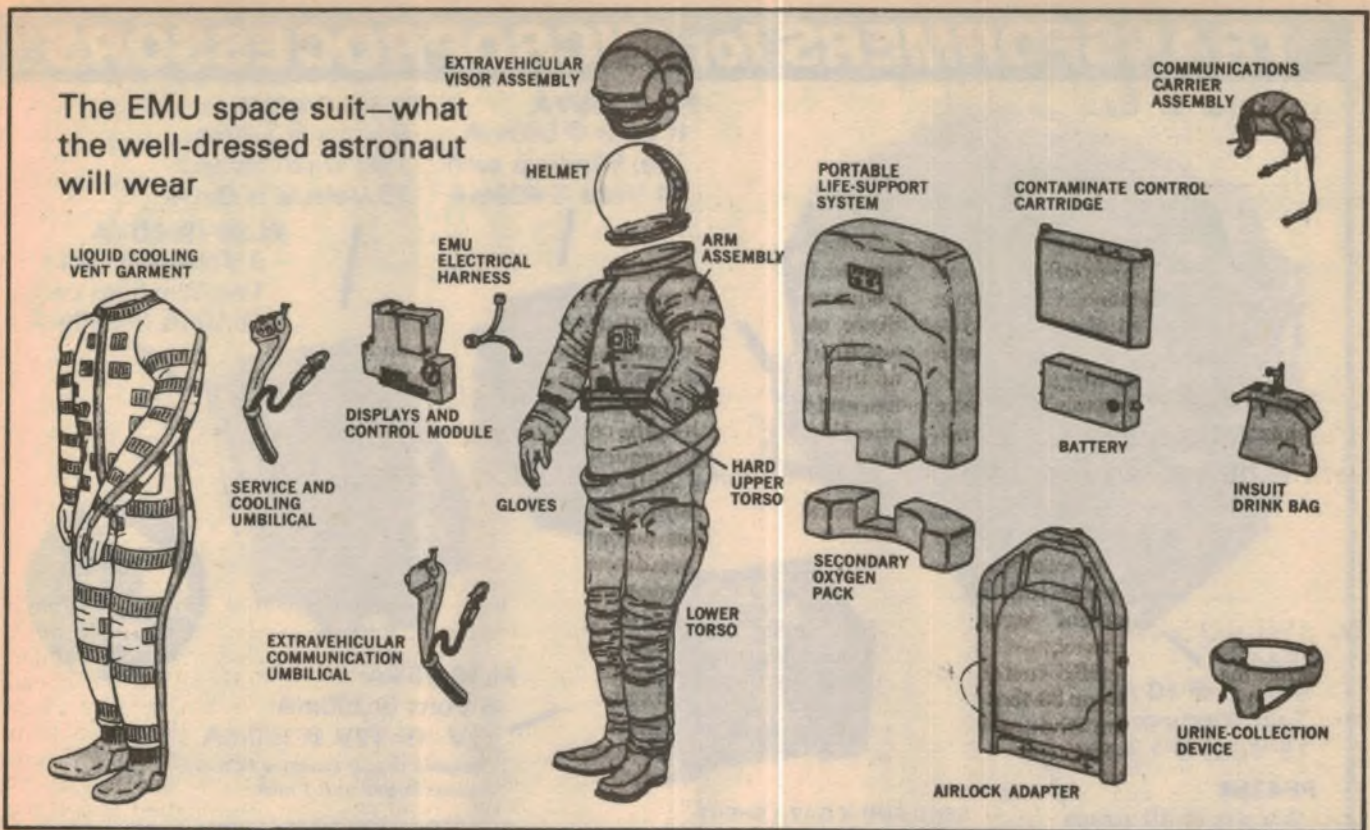

contains a bed of lithium hydroxide, a whitish powder that absorbs the carbon dioxide and converts it to lithium carbonate, plus water vapour and heat. The now-pure oxygen goes to a water separator, which removes the humidity, and then passes to the fan. But before it's recirculated back to the suit, the oxygen is cooled to about 50 degrees by a sublimator — a cooling device that rejects large amounts of heat because the water goes directly from solid ice to vapour as it contacts the vacuum of space.

Jocelyn Johnson, a graduate mechanical engineer who is test engineer on the PLSS, briefed me on its workings and told me about a backup: "There's a secondary oxygen pack that can supply an extra half hour of emergency oxygen," she explained.

(Last April, an oxygen-fed fire in this backup pack burned the lower torso of a suit, injuring a lab technician. Fortunately, he's now back at work. Despite more than 2000 attempts, the fire could not be duplicated. Engineers are now replacing an aluminium regulator module with a more fire-resistant one made of monel metal.)

The backpack also holds a two-way radio. Two mouth-side mikes and earphones are inside the plastic bubble

helmet, which also has a visor plated with real gold to protect the eyes.

A manned manoeuvring unit (MMU) attaches to the pack. With this on, the astronaut can power himself around in space via jets of nitrogen gas. It adds another 113kg to the outfit, but out there, of course, weight is irrelevant.

### Up-front controls

A small display and control module (DCM) mounts to the chest of the upper torso. Many of the controls for the

Apollo suits were in back and astronauts had to grope to find them. "This is the interface between the astronaut and his life-support system," Kevin Taylor, an electronics engineer, told me. There are controls for water, pressure, fan, radio, and other items. I also noticed an LED display. "That can be programmed to give instructions in words 12 characters long at a time," Taylor told me. The display is tied into a thumb-size microprocessor in the backpack, which monitors all the life-support functions,

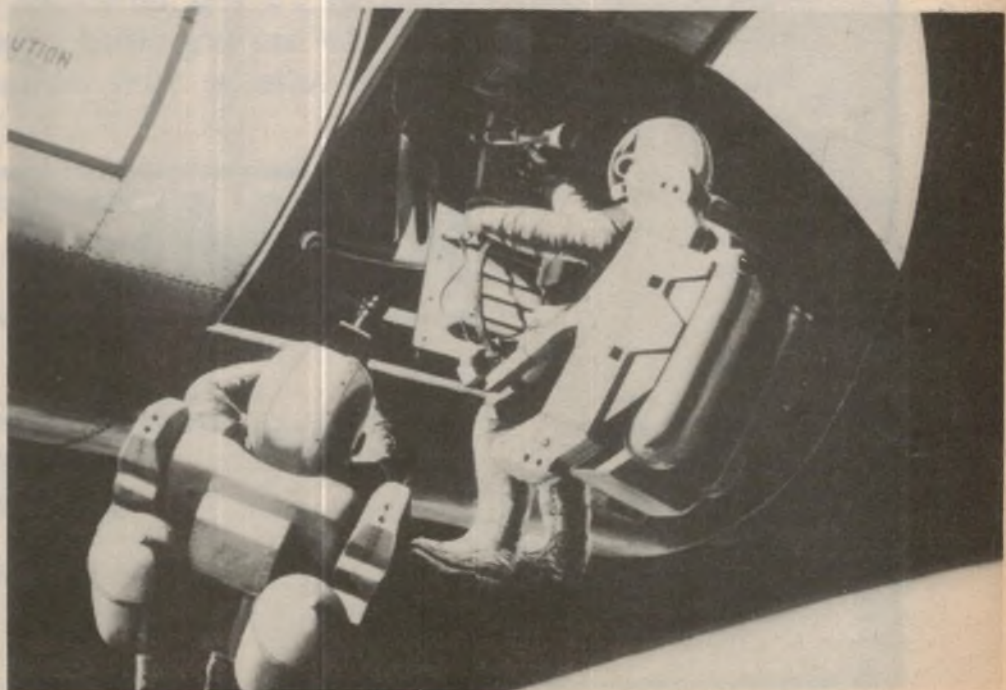

Right: the real Shuttle astronauts will wear the complex space suits when they leave the shirt-sleeves world of the Shuttle to perform tasks in space. Nitrogen-powered mobility units are shown on their backpacks.

# TRANSFORMERS for MICROPROCESSORS



**PF4405**  
 9 Volts @ 10 Amps  
 Two Windings each  
 15 Volts @ 1 Amp

**PF4354**  
 9 Volts @ 10 Amps  
 9 Volts @ 1 Amp  
 Two Windings each  
 15 Volts @ 1 Amp

**PL158/15VA**  
 8 Volts @ 500mA  
 Two Windings each  
 14 Volts @ 400mA



**PL30-9/40VA**  
 9 Volts @ 3 Amps  
 Two Windings each  
 15 Volts @ 500mA



**PL30-9/60VA**  
 9 Volts @ 5 Amps  
 Two Windings each  
 15 Volts @ 550mA



**PL161/5VA**  
 8 Volts @ 200mA  
 12V-0-12V @ 150mA  
 Designed to suit standard PCB grid  
 - pins centred at 0.1 inch.



SEND FOR A DATA SHEET

FERGUSON TRANSFORMERS PTY LTD  
 331 High Street  
 CHATSWOOD, NSW. 2067  
 Tel: (02) 407-0261  
 Melbourne: (03) 329-6415



## SPECIAL OFFER

Mixed bag of Kemet tag tantalum capacitors \$6.99 plus tax. Each bag contains an assortment of 15 tag tantalum capacitors on a .2" staggered lead spacing. All are preferred capacitances, from .1 $\mu$ F thru to 100 $\mu$ F, 6 thru to 35 volts,  $\pm$  10% tolerance.

# KEMET®



**General Electronic Services Pty Ltd**

PO Box 579, 99 Alexander Street,  
 Crows Nest, NSW, Australia 2065

Telephone: 439 2488

Cables: SERVO SYDNEY

Telex: AA25486 SERVO



First the long johns – but for cooling, not warmth. Chilled water circulates through tiny tubes in them, protecting the astronauts from the sun's heat.



Next the pants. They're a laminate designed for thermal protection: two layers of plain-weave fabric, five of aluminised Mylar, and one of nylon.



Now into the torso. It's an eight-layer fibreglass layup covered with the same laminate the pants are made of. The attached backpack rests in a special rack.



He's stuck! The Kocivar proboscis is a bit bigger than even the size-large torso section can accommodate. The company now has an extra-large size.

alerts the wearer if something goes wrong, and tells him what to do – automatically. "A failure is displayed for 10 seconds, accompanied by a warble tone, then a corrective-action message follows," explained Taylor.

There are two sources of electric power for the suit. One is in the Shuttle's airlock compartment, where astronauts will begin and end each extravehicular foray. The second, a 4.4kg silver-zinc battery, is for use outside the Shuttle. Made by Hamilton Standard with components from Yardney Electric of Long Island, NY, the small battery on the

pack provides 23.7 amp-hours at 17 volts.

So far, \$33.9 million has been contracted for research, development, 19 suits, and seven life-support systems. More than 55 such suits are currently planned. If these sound like big numbers, keep in mind that the Space Shuttle program so far has cost \$8.67 billion. And the EMU suits are a key part of its success.

Reprinted from "Popular Science" with permission. Copyright© 1980 Times Mirror Magazines, Inc.

# WANTED RIPPED OFF TAPE BUYERS

Are you tired of paying too much for your cassettes and accessories? Your problems are over . . . for one dollar!

**\$1.**

You receive:

- One sample Dindy Super C46 cassette with a 5 year guarantee.
- One copy of Dindy News, the cassette user's journal, packed with info, accessories and bargain-priced cassettes (all brands, of course) at prices up to 50% off retail.
- A special introductory offer too good to refuse.



To: DINDY MARKETING  
15 BOUNDARY STREET  
P.O. BOX 55, RUSHCUTTERS  
BAY, SYDNEY 2011

20,000 people have bought over 1,000,000 cassettes from us. They all can't be wrong. \$1 spent could save you hundreds.

Mr/Mrs/Miss .....

Address .....



P/code

PP6004/EA03/1-81

# Electronic aids

Being blind will never be easy, but applications of modern electronic technology to the problems of the visually handicapped are bringing a ray of hope to many lives. One of the foremost companies in this field is Wormald International Sensory Aids (WISA). They are literally in the business of finding substitutes for sight.

By PETER VERNON

A young man sits at a desk preparing a program for a computer. When he's finished he walks into another room, types the instructions into the computer and checks the printed output. If there are any errors he locates them and makes the appropriate corrections. Once back at his desk he prepares any modifications that may be necessary and later feeds them into the computer. Not unusual – except that the young programmer has been totally blind for the past five years.

Developments in electronic technology are bringing a new independence and confidence to the visually handicapped. Through the work of a small group of dedicated people, the blind now have available to them a wide range of electronic aids which enable them to read ordinary text, to move about freely, and to hold jobs which allow full expression of their abilities.

The ability to use a typewriter or calculator, to operate a computer terminal or telephone switchboard, to read text without prior translation into Braille, to move about freely – to simply do the sorts of things that sighted people take for granted – is expanding opportunities for the blind in education, employment, and recreation. For many blind people, the difference between dependence and independence can be an electronic device which substitutes in some small way for the visual information of which they are deprived.

Providing these aids is a business that anyone would think twice about entering. The market is a small one, and not noted for its affluence. Because of the small quantities involved, and the need to tailor each instrument to the individual user, production costs are high. Furthermore, any instrument will receive almost constant use. The equipment must be highly reliable, and service back-

up must be fast and efficient. Overall, profitability is minimal, while responsibility is at a maximum.

Worldwide, only a handful of people work in this field, but some of the most significant new developments are taking place in Australia.

Recently, I had the opportunity to visit Wormald International Sensory Aids, a little-known division of a company which is most commonly associated with fire and security alarms. The Sensory Aids division is in another business altogether – researching and developing devices which allow blind people to overcome their handicap and live full and useful lives.

At WISA's North Parramatta headquarters I saw some remarkable technology put to use. The company was established specifically to research and develop aids for the blind, and is now applying electronics to fill the needs of this often ignored minority.

WISA offers both imported and locally developed equipment, but providing the equipment is only one step. To use a sensory aid competently requires at least 50 hours of hard training, and the company gives training courses for instructors, as well as working closely with organisations for the blind, chiefly the Guidedogs Association, to define needs and produce solutions. WISA provides an integrated service, from initial product development to production, service and support and training of instructors.

Equipment available from WISA may be divided into three types. There are aids to mobility, such as the Sonicguide and Mowat sensor – both designed and produced by Wormalds; aids to reading and study, like the Optacon Visualtek, the time compression tape recorder, and the talking calculator, Speech Plus, from Telesensory Systems Inc in the United States, and recreational aids – the Game Centre – which allows the blind to enjoy competitive games while almost incidentally sharpening auditory discrimination and teaching the layout of a numeric keypad.



Above: a talking switchboard adapter for blind switchboard operators. It uses a microprocessor-based control unit to scan the status of panel lights on the switchboard, and generates audible commands using synthesised speech.



# for the blind



*Sonicguide uses ultrasonics to provide the user with distance and position information on nearby objects.*

The Optacon — for Optical-to-Tactile Converter — is an instrument which converts the image of a printed letter into a pattern of vibrating rods which can be felt with the tip of one finger. With one hand the user moves a small camera containing an image-sensing array across a line of print while he rests the index finger of the other hand on the Optacon's tactile array. With practice reading speeds of 90 words per minute can be attained.

The Optacon is a portable, battery-powered unit, weighing less than 2kg, and is about the size of a small tape recorder. The camera is approximately 6cm long, and contains two miniature lamps and an integrated array of 144 photo-transistors. The lens can be easily detached to allow the attachment of accessory lenses for viewing a page in a typewriter, a calculator display, or a computer video terminal.

The Optacon gives the blind immediate, independent access to printed information. Different type styles and languages can be read, as well as graphs and diagrams, because the Optacon reproduces in tactile form exactly what is under the camera lens. It has, for example, been particularly appreciated by students in advanced mathematics courses, because it enables them to read complex equations directly, without rely-

ing on cumbersome Braille transcriptions.

With the ability to read print directly, blind people can carry out many everyday tasks that were previously impossible. They can read their own bank statements and bills, identify package labels and follow printed recipes. Personal letters can be read privately, and the range of reading materials available to them is extended beyond books which are either recorded or in Braille.

Reading is obviously important, but for the blind simple things — such as avoiding an over-hanging branch on a walk down the street — are major problems. Traditionally, two "primary" aids to mobility have been available: the guide dog, and the long cane. Guide dogs are expensive (training costs over

several years can run to \$4500), and not everyone wants to be "the other end of a dog's lead". The long cane is a specialised and carefully thought out technique, but provides no warning of obstacles above waist height — a major cause of injury to cane users.

The Sonicguide is intended to overcome these problems. The guide is a mobility aid and environmental sensor which operates on the basis of reflected ultrasonic sound. When converted into audible stereophonic sound, the reflected signals provide the user with information about the distance, position, and surface characteristics of objects within his immediate environment, up to a range of about five metres.

The aid's ultrasonic transmitter and receivers are built into a spectacle frame

## How Sonicguide Works . . .

Sonicguide consists of a spectacle frame which carries the transmitter, two receivers and the earpieces, and an electronics and battery module about the size of a cigarette packet. An ultrasonic transmitter in the centre of the spectacle frame radiates high frequency sound waves in front of the wearer. The ultrasonic frequency varies between 80kHz and 40kHz over a 250ms period.

When the radiated sound hits an object it is reflected back towards the user and received by two transducers mounted on either side of the transmitter. Because of the periodic frequency shift of the transmitter, the received frequency will differ from the transmitted frequency in proportion to the time it takes sound to travel from the transmitter to the object and back again.

The frequency difference is detected by mixing the transmitted frequency with the received frequency, producing a beat note which is in the audible range. The distance to the object can thus be determined by the pitch of this audible note. The Sonicguide is calibrated so that a frequency of 950Hz corresponds to a distance of one metre. The beat frequency is higher for a large distance, and reduces as the distance to the object decreases.

The receivers are deflected slightly outwards so that sounds produced by objects to either side of the user will be louder in the ear nearer to the object. This process is modelled on the process of sound localisation in normal hearing, and allows the direction of an object reflecting ultrasound to be determined in the same way.

A rough surface can be thought of as a series of small, flat areas at varying distances from the user. These tiny variations in distance affect the pitch of the reflected signal. By interpreting the pitch and tonal properties of the signal, the Sonicguide user is able to judge the surface qualities of objects, and receive a wealth of information about the environment. As one user said "It's the closest thing that I can imagine to seeing".

The Sonicguide is battery powered, and a spare battery is provided with each unit. Also available is an automatic battery charger which will accept two batteries at once. The charger has two pushbuttons, one for each battery, and if the appropriate button is pushed an intermittent tone will indicate that the battery is charging, while a continuous tone indicates that the battery is fully charged.

## Electronic aids for the blind . . .

which encourages the user to develop the same head movements and posture as a sighted person. Normally, when you're blind, you don't lead with the chin, but keep your head down, to avoid injury to the face from unseen obstacles. Once the Sonicguide is mastered the user is assured of safer and more confident travel.

In outdoor situations WISA recommends that the Sonicguide be used in conjunction with a long cane or a guide dog unless the area of travel is both familiar and free from hazards at ground level which the Sonicguide may not detect owing to the masking effect of the ground surface. Whatever primary aid is used, the Sonicguide provides sufficient information to enable the experienced user to navigate smoothly and to identify fixed landmarks.

In addition to distance and direction, the Sonicguide signals provide a wealth of information about objects within its beam. It is possible, for example, to distinguish between a bush with small, close leaves and one with large, sparse leaves. A brick wall, a paling fence, a hedge, and a glass shop front all have distinctive patterns of returned sound which can be recognised with experience.

Indeed, the trained user of the Sonicguide has a degree of discrimination which is astonishing. One user was able to tell the difference between her instructors because one had a beard which made the sonic return "fuzzier" than that of his clean-shaven mate! There is in fact a blind electronics enthusiast who is able to locate components on circuit boards and solder them in place, relying on the ultrasonic reflection from the board, the components, and the tip of the soldering iron.

The Sonicguide was developed over 10 years in five universities and more than 16 blind rehabilitation centres in four countries. It was first manufactured in Christchurch, New Zealand, by Wormald Vigilant Ltd, and more recently by Wormald International Sensory Aids Ltd. In Australia, about 30 people are trained to use the aid each year.

The Mowat sensor is a similar but less sophisticated device working on the same principle. It is a handheld instrument which uses ultrasonic sound to detect objects with a narrow beam. The entire sensor vibrates if an object is present, and the vibration rate increases as the user approaches the object!

The sensor has two range settings controlled by a sliding thumb switch on top of the case. On the short range setting the sensor will respond only to objects less than one metre away. On long range, objects of sufficient size will cause a response at a maximum distance of four metres.



*A blind computer operator uses an Optical-to-Tactile Converter – the Optacon – to read a CRT terminal. The machine converts the image of a letter into a pattern of vibrating rods which are read with the index finger of the left hand.*

The beam of the sensor is narrow in the horizontal plane to enable the user to accurately determine the direction of an object by scanning in a similar manner to a sighted person using a flashlight. In the vertical plane the beam is more extensive to provide the best possible sensitivity to overhead and ground level objects. The beam proportions approximate the height to width ratio of a human being, enabling the user to accurately locate clear pathways through doors or between parked cars.

The Game Centre, developed by Telesensory Systems Inc is a collection of eight electronic games specially designed for the blind. It uses a microprocessor to generate synthesised speech and other audible cues that provide all the needed game information.

With the Game Centre the blind person can play noughts and crosses, Blackjack, and Paddleball, an audible variation of television tennis games, as well as tests of reaction time and memory. One

person can play against the machine, or two people can compete against each other.

Other aids available from WISA are the Speech Plus talking calculator, Visualtek reading aids, a time compression cassette recorder, and a voice output switchboard adapted for blind telephone operators.

The calculator is a standard four-function calculator which incorporates a speech synthesis board with a 24 word vocabulary. Each key is announced as it is pressed, and the result of the calculation is also announced. The keyboard is designed for easy operation by the blind, with special key spacing and shaping. Built-in rechargeable batteries give six to eight hours of use, and the calculator will tell you when its batteries are running low.

Visualtek is an aid which enables partially sighted people to read and write. The system uses a television monitor, a camera, and a high-magnification lens.



The Visualek reading aid. It displays magnified images on a TV screen so that partially sighted people can read and write.

Like Sonicguide, Mowat uses ultrasonics to locate objects. It is designed to allow the user to locate narrow doorways and pathways etc.



Anything that can be seen by the camera can be viewed at up to 60 times its original size on the video monitor screen. Anyone with some vision can use a Visualek system, including people with peripheral or tunnel vision, glaucoma, cataracts, and many other visual problems.

The new electronic aids are not a panacea. Long and arduous training is necessary before they can be used effectively, and much depends on the determination of the individual. Help and support are available from instructors trained by WISA, and from the many organisations working with the blind, but success can only come from the blind person's own efforts.

The measure of the value of technology is in how well it contributes to the quality of life — not in a narrow material sense but in the sense of greater self-esteem, confidence, and ability. From any point of view, aids for the handicapped pass this test. As the work of Wormald International Sensor Aids demonstrates, electronics can be applied to bring a new independence, freedom, and confidence to the handicapped.

For further information on the products featured in this article contact Wormald International Sensory Aids, 31 Grose St, North Parramatta, NSW 2151. Telephone 683 2487.



NORTHERN TERRITORY  
DEPARTMENT OF  
TRANSPORT AND WORKS

DARWIN

**ENGINEER**

**\$18799 - \$20710**

**SENIOR TECHNICAL  
OFFICER**

**\$19900 - \$20399**

(Plus District Allowance: with dependants \$1570; without dependants \$900)

An Engineer Class 2 or Senior Technical Officer Grade 3 is required to act as Section Head for the Radio Section. It is a key position affecting communications throughout the Northern Territory and as such is essential that applicants have both technical and managerial ability of a high order.

The objective of the Radio Section is to provide a radio communication service to meet the needs of Northern Territory Government Departments and Authorities by the provision of technical advice for the forward planning, programming, purchasing, installation and maintenance of radio communication equipment and in addition the Section is charged with ensuring that relevant radio licencing regulations are observed and complied with by Northern Territory Government Departments and Authorities.

The Section is also responsible for the purchasing, installation and maintenance of the Department of Transport and Works radio communications equipment as well as being the licence holder for the Department.

The successful applicant will as Section Head direct and co-ordinate the work of the Radio Section, including workshops, mobile repair group and out-posted units and advise clients on their requirements for new and/or updated equipment. Negotiate with manufacturers and users to ensure new equipment complies with standards. Formulate standards for the development and training of radio personnel.

Applicants should possess either educational qualifications admitting to Graduate Membership of the Institute of Engineers, Australia or an approved technical college certificate or other approved qualifications and requisite experience. A sound knowledge of modern practices and trends in the radio communications field is desirable.

Please quote vacancy No: OP100.

**Excellent conditions of service are offered which include six weeks annual leave, leave airfares south every two years, generous sick leave and long service leave entitlements and an assisted housing scheme.**

Written applications providing full details of qualifications and experience should be forwarded to:-

Recruitment Officer (Operations)  
Department of Transport and Works  
P.O. Box 2520 DARWIN NT 5794

by no later than Friday 30th January 1981.



# FORUM

Conducted by Neville Williams

## This didn't happen in Australia — or did it?

For some strange reason, there seems to be a mood abroad to relive the past. There have been signs of it in our own columns and, of late, a contributor has been reminiscing in the columns of the Australian IREE "Monitor". Now the "RCA Engineer" has come to the party with a story which is new to me, anyway.

Having been a witness, at first hand, to the introduction of wireless sets and wireless entertainment to the community, I thought I had seen or heard about most of the goings on in the period. What I missed personally, I tended to pick up from our former Assistant Editor, Phil Watson, who shared the same era.

More than that, we both experienced it in country situations, where the arrival of the very first wireless in the town was an historic occasion; where reception was a constant battle against thunderstorm static; where you listened expectantly but grudgingly, knowing that you were running down the heavy and expensive batteries.

I remember my late father growing weary of the traditional box with a lift-up lid and bakelite panel; of accumulators, batteries and even depression-style home-made wet batteries spread around the floor. How, with infinite patience, he transferred the works into a home-made console cabinet and replaced the bakelite panel with one hand-cut, drilled and fashioned from heavy plate glass.

It didn't work any better but it was certainly an unfailing conversation piece.

A book could be written — maybe should be written — about those days!

But, as I said above, the story in "RCA Engineer" has no parallel in my experience. It was penned by a now-retired RCA employee G. F. (Gordon) Rogers who lived, at the time, in north-western Carolina, USA.

Gordon tells how, in the winter of 1930/1, he became dissatisfied with the old uneconomical battery powered radio that served the family up to that time. So he was in a receptive mood when the opportunity came to acquire an unserviceable mains powered receiver using four type 26 valves, a 27 and a 71-A. This was painstakingly reconditioned and put back into service.

I met with a few such receivers a little later than this, when I started work in the "big smoke". But they certainly had no place in the country areas with which I was most familiar. There were no power mains and very few other services. You ran your own messages, chopped your own wood, grew your own vegetables, caught your own rainwater and buried your own night-soil!

But I should explain about those valves, for those who would not know what the numbers signify.

On the Australian/American scene, the 26 (or 226) was the first well known valve intended for mains operation. It did not boast the luxury of one of the new-fangled indirectly heated cathodes. It still had a directly heated filament rated at 1.5 volts at 1.05 amp, and relied on the heavy filament wire to store heat

between half-cycles of mains current.

The filament was earthed via the tapping on a potentiometer wired across the filament supply. Part of the setting-up procedure, if valves were replaced, or as they aged, was to adjust the pot. for minimum hum. As I recall, it was never better than a tolerable minimum, rendered so because the horn and primitive cone loudspeakers of the era boasted very little low frequency response.

But no amount of pot. juggling could make a 26 acceptable in the role of detector/first audio stage. That was where the 27 scored. It was a triode, very like the 26 in other respects, but it did have a new-fangled indirectly heated cathode.

As for the 71-A, it was a reworked version of the old 01-A triode battery valve, still with the same directly heated filament. It could be used in the audio output socket with a centre-tapped AC filament supply only because the amplification factor of this final stage was so low (three times) that filament hum didn't have much of a chance to make itself heard.

Under maximum rated conditions (plate 180V at 20mA) the 71-A boasted an "undistorted" power output of 0.79W.

Well, finding himself with this kind of receiver and this order of power output, Gordon Rogers felt he had to share it with neighbours — particularly those whose homes were not connected to the electric power mains.

Accordingly, using a single overhead wire and an earth return, he connected his neighbour's loudspeaker to the receiver and obtained gratifying results. Within a month, six other neighbours were knocking on his door, requesting a similar connection. The additional wiring was duly installed.

If there was no publicity about such enterprise in Australia, it may well have been because it would have been thoroughly illegal. Here, as in Britain, transmission and communication by wired circuits across property boundaries has traditionally been regarded as a Government monopoly, not to be sur-



Gordon Rogers, formerly attached to the Consumer Electronics Division of RCA, now retired. A friendly gesture in 1931 led to an audio system serving 600 homes via 400 miles of line.

rendered lightly. In the USA, the ground rules are different.

The rules for listening to radio were also very different in those days. You didn't try to talk above it, or clatter dishes while the radio was on. You sat in deathly silence, listening to every word the man said – or to what you thought he said, through a Reiss carbon microphone, indifferent circuitry, an overloaded output stage and a distortion-ridden loudspeaker!

Even so, Gordon Rogers found that eight homes sharing the output of one poor little 71-A was a bit tough so, within a year, he set about building a new receiver – a superphet using the new 50 series valves (57, 58 etc) and ending up in a 47 type output pentode. It was choke fed and coupled to the lines through blocking capacitors.

The 47 offered a supposed 2.7 watts of "undistorted" power – but only into an ideal 7000-ohm load. It soon became evident that, with all the loudspeakers in circuit, the effective load was a lot lower than 7000-ohms and the power available nothing like the rated figure.

So, skipping over the new 59 output pentode (a notoriously unreliable bottle) he substituted the even newer glamour output triode, the 2A3. It offered somewhat higher power output (3.5 watts) at lower distortion but, more importantly, into a lower nominal load (2500 ohms).

At about this time, with the gradual raising of power output and the gradual expansion of the system, Gordon Rogers realised that he had inadvertently been radiating IF energy. Whatever other effects it might have had, the energy got back into his own receiving antenna and produced whistles and instability on some stations. So better filtering had to be devised.

## MORE AUDIO POWER

Next step was to substitute an output stage using push-pull 2A3 output valves matched to the lines through a hand-wound output transformer. This was so successful that it became necessary to provide a 10,000-ohm wire-wound potentiometer at each location to serve as a volume control.

The trouble was that the pots themselves absorbed too much of the power. The most remote subscribers didn't have enough left, while the pots close to the receiver tended to burn out. So they all had to be replaced with 25,000-ohm types.

At this stage, the system had 15 subscribers served by about five miles of line but, just then, a supply of "bargain" magnetic cone loudspeakers became available at \$2.85 each. In no time at all, Gordon Rogers found himself trying to cope with a couple of hundred new customers.

He tried to keep pace with the demand by using four, and then eight, 2A3s in push-pull parallel – adding up to a

21-valve receiver with 60 watts of power output. But even that wasn't enough to cope with 200-plus loudspeakers located as much as 15 miles from the source.

There was no choice but to get into the realm of professional type valves with a pair of 830-B (60W) triodes operating at plate voltage of between 1000 and 1250. The 2200V CT power transformer, the main filter choke and the filament transformer all had to be wound by

hand, then placed in vacuum and impregnated with a combination of hot beeswax and resin.

(How did I get into this . . . etc?)

Unfortunately, the 830-Bs did not stand up too well to the rigours of continuous service and they were replaced by a second-hand pair of 204-As, audio valves with a dissipation rating of 500 watts. But these, in turn, had to be discarded in favour of a pair of 250W 212-Ds.

## TV at the 1948 Royal Show



In the November issue, D.H. of Kurri Kurri, NSW, asked us about a television display at the 1948 Royal Easter Show. We replied that, short of making a special search of newspaper files for the period, we could not answer the question.

Would you believe, however, that our former Assistant Editor Phil Watson not only remembered the occasion but he recalled the circumstances and produced three pictures that he had taken of the exhibition.

He reminded us that, at the time, the radio industry in Australia was deliberately maintaining a low profile on the subject of television. Executives felt that TV was years away in Australia (6 years, to be precise) and that premature publicity would only deter people from buying new receivers and radiograms.

But the Pye/Astor group had different ideas and they brought out an English 405-line chain, which was set up at the Sydney Showground. It was a closed circuit system, thus avoiding any possible hitches in regard to an RF channel.



The camera was focussed, for much of the time, on people entering the pavilion but, at other times, it was taken up on the roof to relay the ring events to the monitors below.

Some saw in the venture an attempt to influence Australia to adopt the English 405-line system and to purchase existing UK hardware. Fortunately, the ultimate choice was the CCIR 625-line system, which Britain itself later adopted.

As for the people who appear in the pictures . . . we wouldn't have a clue. But we wouldn't be surprised if someone writes in to say I recognise . . .

# MR BUSINESSMAN!

here at last from DICK SMITH is a

## STOCK CONTROL & PRICING SYSTEM

especially designed  
for Australian  
conditions



No, not just another software package imported from overseas, but one that has been written (at great expense)

by Australians for Australian businesses

In fact it has been modelled closely on the Stock Control and Pricing System used so successfully by Dick Smith Electronics.

The original system runs on an IBM computer costing more than \$50,000 — but you can have the same benefits for less than one tenth of this cost (yes, for both the computer hardware and the software!)

While you're in one of our stores why not check out the many features of the System 80 and its peripherals?

You, and your business can benefit from this amazing system for less than you think!

### HERE ARE JUST SOME OF ITS OUTSTANDING FEATURES

- Capacity for up to 1200 stock lines!
- Machine-language sorting for FAST operation!
- Ability to print out price lists as well as stock status reports and other listings (all dated!)
- Fast stock and financial status reports on the screen!
- Simple "menu-driven" operation — no special training required!
- Prints out stock count sheets for stocktaking, then gives you a printed analysis of all discrepancies!
- Special Australian Sales Tax feature (optional)!
- Easily expandable — so you're not forced to change to another system as your business expands!

**ALL THIS  
FOR ONLY**

**\$275!**

(Program & Data Disks with comprehensive User Manual)

Cat X-3750

**DICK SMITH  
Electronics**



**SEE OUR OTHER ADS FOR  
FULL ADDRESS DETAILS**

## FORUM — continued

By way of power supply for these last-named tubes, Gordon Rogers purchased a couple of obsolete pole transformers from a supply authority and used them in conjunction with 866 mercury vapour rectifiers. A further pole transformer, partially rewound, served as an output transformer to handle the 350-400 watts of audio power.

With this equipment and a further updated tuner, the system reached its peak at the end of four years, with 600 homes, and 400 miles of single-wire transmission lines extending over three counties. The most distant customer was 24 miles from the receiver!

(In fact, it had also stirred similar initiatives elsewhere in the USA. By 1936, when Gordon Rogers delivered a paper on his system to a student AIEE Conference at Clemson College, he stated that at least a dozen other systems were in operation).

In its early stages, the network had a distinctly personal character and switching was devised, supplemented by a valve type tone generator, which allowed the network to be used in an intercom mode. However, as the network spread, the increasing load on the line, plus the intrusion of power mains earth currents rendered the intercom role less and less practicable. In addition, it became clearly undesirable to interrupt the regular program for personal reasons.

Even so, when atmospheric static rendered ordinary radio programs inaccessible, as often happened in those days during summer, a local program was often substituted — local talent live, phonograph records, and community announcements.

Not surprisingly, for the scale of the system, Gordon Rogers learned lessons about reticulation the hard way.

Initially he used any wire that he could get his hands on — mainly discarded fencing wire. Apart from resistive losses, poor connections and voltage surges across the connections caused corresponding current in the earth circuit, producing a form of radio interference.

Ultimately, and by common agreement, a levy had to be struck on all users to buy copper wire, and more attention given to the earth returns.

Subsequently, as the system grew in size and power, an earth problem of another kind was encountered. The audio signal would get into telephone circuits, even though they might be separated by as much as a quarter-mile. To overcome this problem, it became necessary to rearrange the customers in groups and manipulate the phase of the outgoing signal so that earth currents would cancel, rather than add.

And, of course, there were all the expected problems with open, shorted and leaky lines, and the need to develop equipment which would allow operators to spot faults and correct them as quickly as possible.

It was on-the-spot, hands-on training for a man who went on to join RCA in 1946 and to hold a series of responsible positions in that company until his retirement.

But it is fascinating to reflect upon the way radio came to 3000 country folk in Carolina, USA; people who, in many cases didn't bother with newspapers, and whose initial musical preference was invariably for "Hill-Billy" and "Fiddlin'" programs.

After a few years, their requirements had broadened to a point where they needed to make their own choices on their own radio.

Wired audio, a venture that grew out of a sudden impulse, had played out its role!

## printed circuits

- Accurately machine printed etched
- Phenolic & fibreglass-gold tin plated
- EA R & H ET Philips Mullard available
- Specials to your drawing
- POSTAGE small 80c large \$1.10

255	2.80	247	2.80	ET1476	4.00
80LBRI2	2.80	80DC10	4.80	80TRS11	2.80
80TC12	2.80	80BM10	2.80	80AW10	3.00
80ST10A	4.50	80TM8B	2.80	80ST10B	2.80
568	2.80	327	2.80	EA80TM8A	5.00
ET1475	4.00	ET1457	3.00	ET1147	3.00
80LPG9	3.50	80B7	2.50	ET1326	2.80
80TR9	3.50	250	2.50	80DM9	4.50
ET1324	3.50	80LL7	2.80	564	10.50
80PC7	3.00	80LL7	2.80	80M07	3.00
563	2.80	80CH7	4.80	80M07	3.00
80PP7B	2.50	467	4.00	565	3.50
80G6	4.80	80PP7A	5.00	149	2.80
80D6	3.00	578	2.50	80RF5	2.80
80PA6	12.00	78AF2	3.00	636	16.00
80BB3	2.80	77CB12	2.60	ET58820	10.00
454	3.00	ET135	3.00	78EK3	3.30
80AW4	4.00	80HHS6	2.80	781A2	2.60
80C14	2.80	325	2.50	ET716	4.00
466	6.00	80PC4	3.00	ET245	2.50
80AU3	3.00	562	3.30	78S3	2.60
264	2.50	453	2.80	77PH12	2.60
322	2.80	566A	2.50	80PG6	5.00
80S1	2.50	80GSP3	2.80	80HLA5	2.50
ET560	2.80	496	5.00	80TV8	3.30
ET151	2.50	496G	6.50	566B	3.00
79DID	2.80	80CM3A	3.20	80F3	2.80
79TI11	2.80	561	2.80	ET152	2.80
ET262	2.50	80GA3B	3.20	726	8.00
ET150	2.80	79SB10	2.80	80CM3B	2.80
79PG9	3.00	ET452	4.50	455	3.00
ET573	2.80	80SA3	4.50	80GA3A	5.00
79QM9	3.00	79EB12	2.80	ET474	2.80
79RR8	4.20	ET270	2.80	ET321	3.50
79BT9	2.60	ET261	2.50	79FE11	2.80
79AC9	3.50	ET146	2.50	79PC12	2.50
ET576	4.20	79MD9	2.80	ET263	2.50
ET730	3.50	ET577	2.80	ET260	2.50
ET252	3.00	79PS10	2.80	79PS11	2.50
79WF8	3.20	79SF10	2.50	ET606	3.00
79PS6	2.80	79TT7	2.60	ET473	3.50
ET451	2.50	79SF9	2.60	79R18	2.80
6800	8.50	ET574	2.80	79AI9abc	4.20
79UPS6	2.50	ET814	2.80	79W9	2.80
ET144	3.50	79SR8	2.80	ET731	3.00
79R05	3.00	79UT8	3.00	ET575	2.50
77E02A	3.50	79FR6	3.50	ET725	3.50
ET320	2.50	79FR5	3.50	79TRF5	2.50
ET595	2.80	ET472	3.00	79M8	2.80
491	4.50	79C17	4.80	ET148	2.50
79PS3	2.60	79SA5	8.00	ET724	2.50
79P1B	2.80	ET254	2.50	79KB7	2.80
79C1A	3.00	79E02C	2.50	ET651	4.50
142B	4.00	ET249	2.80	ET471	5.50
79S1	4.50	ET253	4.20	79EQ2B	4.00
79IT2	5.00	559	3.80	ET594	2.50
78S12A	5.50	78Se3	4.00	ET470	3.20
78N10	2.60	79P1A	2.80	79A3	3.00
78D10C	2.50	558	2.50	721	3.00
ET813	3.50	142A	8.00	79P2	3.20
ET812	2.80	79W3	2.60	78C1B	2.80
ET556	6.00	78SB12	3.00	557	3.00
78BB09	3.50	781M12	3.00	79UP1	5.00
650B	2.60	78C11	3.10	79C11	2.60
718	2.60	78DT10B	2.80	78S12B	2.50
590B	8.00	ET143	2.80	78UP10	7.00
78E09	2.50	ET593	3.20	78DT10D	2.50
ET391A	2.50	78DB11	2.80	78DT10A	6.50
ET591C	2.50	555	4.00	ET141	4.20
78UT9	16.00	650A	4.00	ET490	2.80
78UMB	2.60	553	3.00	78UP9	6.00
		590A	8.00	650C	2.60
		ET605	7.00	138	3.80

### ALL SILICON 30/60w PA PORT AMP

6 1/2" W x 8 1/2" D x 3 1/4" H 12 — 16V, two inputs 5 & 100mV 125, 250, 500 ohm output only No 763A \$70 ea. 240V operation \$33 extra. Freight collect.

COILS and IF's All \$2.50 ea plus post 60c  
3/4" W x 3/4" D x 2" H

MAIL cheque or money order  
(add postage) direct to —

## RCS radio pty ltd

651 FOREST RD BEXLEY  
NSW 2207 587 3491

## Meanwhile, over at Waverley, NSW . . .

While we were busy typing up this instalment of "Forum", a long time member of the Waverley Radio Club called in to our office to look at some back issues. In the course of conversation, he showed us an old copy of the Club magazine which mentioned a public display of Baird-style television, which we remember seeing.

It prompted us to look up an old copy of "The Australian Wireless Review" (January, 1923) showing members of the Waverley Club, gathered around equipment of the era. By their appearance, they had just come from church: hair, short back and sides, and neatly combed; best suits, clean shirts, ties; even one mature gentleman with a stiff, winged collar. But back to the quote from the Club journal:

"We pass on now to 1930. Mr Gordon Wells and Mr Pickering, 2KI, had a hankering to find out about television, and eventually the first television transmission in Australia took place between Mr Pickering's home at North Bondi and the Club rooms at Waverley, in 1933. Mechanical scanning was used by the two experimenters.

"In 1936, the Wireless Institute of Australia held an amateur exhibition at the Presbyterian Assembly Hall, and the first public television demonstration was conducted by Mr Gordon Wells and Mr Maurice Lusby. Miss Gladys Moncrieff can truthfully claim to be the first woman to be televised in Australia."

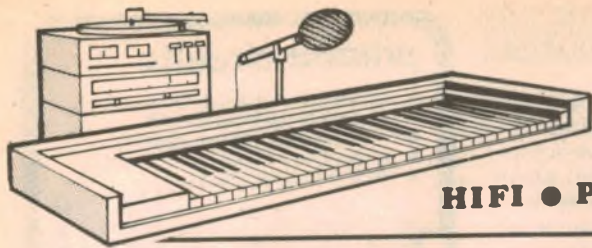

# AUDIO ~ VIDEO ELECTRONICS

HIFI • PROFESSIONAL AUDIO • ENTERTAINMENT

## Analog or digital master — pick the difference if you can

In an effort to resolve arguments about the relative merits of various disc recording systems, Astor Records have released a Vanguard Audiophile recording which contains two versions of a single performance of the Haydn Symphony No. 100 in G Major, "Military". One is from an analog tape master, the other from a digital tape master.

by NEVILLE WILLIAMS

The recording is by the Mostly Mozart Festival Orchestra which is introduced in the jacket notes as the backbone of the Mostly Mozart Festival; this has been conducted annually in the Lincoln Centre, New York, since 1970. The orchestra became a permanent entity in 1979 and is conducted here by Johannes Somary.

In audiophile circles, the traditional symphonic recording has been accepted as "refreshing" after some other "system comparison" releases. It has been criticised as lacking reverberation, and for not being this version rather than that version. But, if you want to put your powers of perception to the test, I doubt that you'll want to quibble too much about those secondary aspects.

An inner sleeve contains generous, conventional notes on the composer and the work, plus additional information on the conductor and orchestra. It indicates that the recording was made at Vanguard's 23rd St Studio (Masonic Temple), New York.

Technical notes on the same liner indicate the use of Neumann KM-86 microphones, and a Vanguard custom-built console with transformerless microphone inputs and a claimed dynamic range of 127dB. Its output was split to two master tape recorders, which therefore should have received an identical input signal. Subsequent processing to vinyl was kept as uniform as possible, with the analog and digital the only major difference.

For the analog master, a "state of the art" MCI JH-110-B recorder was chosen and Ampex master tape recorded at 200 nanowebers with Dolby A noise reduction. Quoted response was 30Hz to 24kHz (+0.5dB, -2.0dB), dynamic range

78dB, harmonic distortion 0.5%, and wow and flutter .035%.

For the digital master, Vanguard used a Sony PCM 1600, with a quoted response 20Hz to 20kHz (+0.5dB, -1.0dB), dynamic range greater than 90dB, harmonic distortion less than 0.05%, wow and flutter unmeasurable.

### OVERSEAS TESTS

In fact, a couple of days before I received the record for review, I had read an article in the US "High Fidelity" magazine (November '80) detailing a series of panel evaluations of comparative discs involving analog, direct cut and digital masters. This Vanguard album was one of the discs used.

The organisers, Leonard Marcus and R. Derrick Henry, went to a great deal of trouble in setting up the tests. Two kinds of equipment were used, representative of a high quality domestic system and also a state-of-the-art professional system.

The tests were conducted at two centres, Massachusetts and New York, and involved 14 carefully selected judges, including well placed professional musicians, professional hifi buffs and critics, and audio engineers. All tests were double-blind, so that neither the organiser nor the judges were aware of which version was being played at any given time.

In the face of all this preparation, it would be gratifying to be able to point to a definitive result. But no such result appears to have emerged. Some preferred that phrase in this recording, but this phrase in that recording. Opinions differed between judges and it is clear that



they were expecting different things and listening to different things, according to their respective backgrounds.

Their judgments were presumably being affected also by repetition, fatigue and conditioning, so that they reacted differently at different times to the same passage.

In saying this, it is necessary to emphasise that they were not listening to examples of gross distortion or gross unbalance. Each recording was, presumably, a prime example of a particular technology. What the judges were looking for were subtle, second-order differences which can readily be swamped by subjective reactions.

By way of example, one of the judges was Malcolm Frager, prominent concert pianist and a recording artist for Telarc. He was invited to compare the analog and digital version of the Haydn Symphony, played on matched turntables by matched cartridges. Indeed, the cartridges were interchanged periodically in an effort to anticipate or show up any subtle, unmeasured differences.

By sheer error, the operator failed to turn one disc over so that Frager spent some time vainly picking and choosing between analog and analog. When the mistake was corrected, he proceeded to nominate discerned differences between analog and digital but, in the process, professed to like some of the very analog segments that he had previously rejected!

In New York, two two-man panels voted strongly for the analog version but the third panel came out just as strongly



in favour of the digital. More than that, their judgments were based on a different reaction to the same sounds, centring mainly on the percussion and the "edge" to the strings and trumpets.

A couple of quotes give the clue to their thinking:

Concerning percussion in the digital version, particularly in the second movement —

"A trifle imposing and off-putting . . . the cymbal clashes register as events, rather than music."

"The percussion instruments seem much more present — aggressively so . . . but out of proportion and almost seem to distort."

Concerning the strings —

"As the music got louder in the tutti passages of the digital recording, the strings developed a glassy or buzzy coloration and the sense of space collapsed."

The contrary view: ". . . heard the analog side as buzzy strings, fuzzy reeds, wiry, irritating sounds; and the digital side as less electronic, far clearer, much better sense of space and depth and strings that almost sound like strings in the soft passages!"

Taking up the remarks about percussion, it seems to me that cymbal clashes are indeed "events" and it is a tribute to the digital system that they came through as such. It would hardly have the capacity to highlight them, whereas the analog system, with its admittedly higher THD and intermodulation distortion could suppress them.

It would be a very back-handed compliment to analog if the reviewer was really saying: "I prefer analog because it mutes the percussion to my liking."

The flat contradiction in regard to string tone could carry the same implications. The sound of massed strings can be an extraordinarily difficult one to record and reproduce. I suspect that massed strings, even in real life, may present an intermodulation hazard for some listener's ears.

If one assumes that some distortion will be present in a reproduced recording, it may become a matter of which kind of distortion you prefer: hard and open, or muted and buried!

Those conducting the panel for "High Fidelity" magazine introduced another variable in the way of uncertainty about

Look carefully and you may notice that this month's Toshiba model is carrying a small cassette player, equipped with headphones. In fact, that's what it is: a compact, quality stereo player with cue and review functions and auto shut-off. But it also has a tuner pack which can be plugged in, in lieu of a cassette. Do this and the KT-S2 becomes a personal FM stereo receiver. Headphones, case and carrying strap are provided. [Toshiba (Australia) Pty Ltd, PO Box 452, Lane Cove, NSW 2066.]

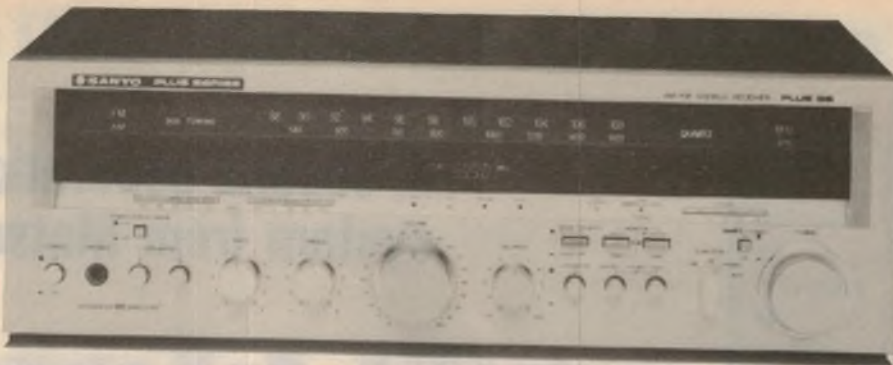

## NEW RANGE — a big plus for Sanyo!

A whole new range of hi-fi equipment currently being marketed by Sanyo Australia Pty Ltd is being described as their "Plus Series". According to Sanyo, it has been designed "for the discerning audio buyer" who wants a high standard of performance combined with a wide range of features.

Their new "Plus 75" receiver has a full complement of the usual facilities, plus others that are not so common. It has a conventional analog tuning dial for those who like this "see what you're doing" facility but it is combined with digital frequency display plus a quartz-locked reference circuit that clamps the oscillator to the appropriate 100kHz increment for the selected channel.

Another feature, unusual for a receiver, is an in-built pre-preamplifier for use with moving coil cartridges. Sanyo claim for it a signal/noise ratio of 70dB, or 97dB when used in moving magnet mode. Comprehensive signal jacks on the rear panel allow the tuner/preamplifier to be separated from the main power amplifier for easy inclusion of external signal processing devices.

The power amplifier is DC coupled, with an output of 75W RMS per channel into 8 ohms, 20Hz to 20kHz, with a THD not exceeding 0.03%. Recommended retail price is \$700.00.

The Plus 55 receiver, pictured above, has many of the features of the Plus 75, but is rated at 55W RMS per channel with a THD not exceeding 0.04%. It is priced at \$555.00 and, like the Plus 75, carries a maker's warranty of five years. [For further information on Sanyo products: Graeme Boucher, Sanyo Australia Pty Ltd, 225 Miller St, North Sydney 2060. Tel (02) 436 1122.]

the vertical tracking angle of the stylus: whether this had been optimised in some of the sessions for the Vanguard recording.

If the VTA was wrong, might this have disadvantaged the analog version and made the digital version sound better by hiding some of its imperfections!

That sounds like a classical example of hypothesising about the hypothetical!

Such uncertainties aside, I wonder whether tests like this really get to the heart of the matter.

As we have said on other occasions, if the engineer can fit the program accurately to the dynamics of an analog master tape, and avoid multi-generation copies, he can get a very good end result. But how typical will it be of analog recordings generally, where the ideal prerequisites may not always be met?

For different reasons, direct-cut recordings demand a special effort on the part of artists and engineers alike to secure an accurate fit to the dynamics of the disc, without noticeable inhibition or caution in the performance. The real question about direct cut is not how good it can be in the best case, but how successful is it as a general approach to record making.

The digital master tape system seems to offer the best of both worlds but invites the reservation that there has to be something wrong with a signal that you take to pieces and put back together again! Ironically, this very principle is at the heart of present-day stereo FM transmission and tomorrow's super-quality video style discs.

(Continued on p34)



## A second-generation digital recording system from Matsushita

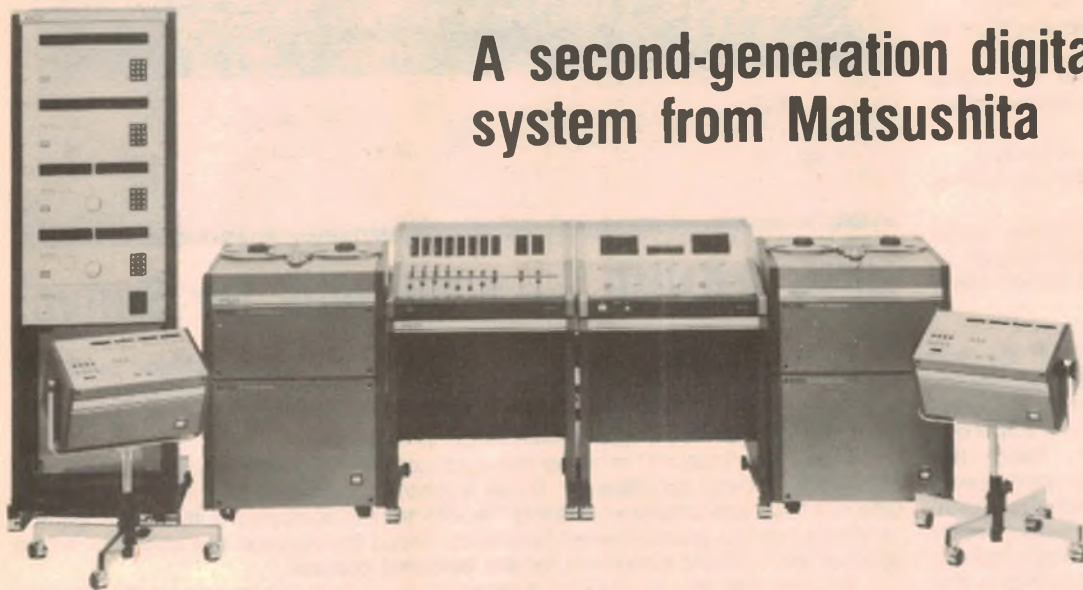

*The two digital tape recorders will be apparent in this picture, each with its trolley mounted remote control. In between is the digital mixing console (left) and the edit console. On the far left are the preview units.*

What appears to be a "second generation" type of digital mastering equipment has been announced in Japan by Matsushita, the parent company of National/Panasonic and Technics brand equipment. It packs 20 tracks of information on to 6.35mm (1/4in) tape, running at 38cm (15in) per second.

Manufacturers of disc records have been using digital mastering equipment for a couple of years, with Soundstream and Sony well to the fore. However, the PCM (pulse code modulated) equipment to date has mainly been in the form of modules which are patched into existing audio chains.

Matsushita are claiming a world first for their new system in that it brings together the equipment necessary to record four separate channels of top quality audio in digital form, to edit manually and electronically, dub, re-record and provide analog and preview and main signals ready for the cutting lathe.

The two PCM recorders shown in the above picture are free-standing units, provided with trolley mounted remote control units. They are normally used with 26cm (10.5in) reels carrying a 1-hour length of tape. The tape transport system uses the isolated loop method for low wow and flutter and for precise control of the tape path.

Two consoles are pictured between the tape recorders, the one on the left being a digital mixer. It has blend, fade and pan facilities for four digital signals off line, and four from auxiliary sources, including sound effects and digital reverberation. Peak reading LED signal level indicators are provided for all inputs and outputs.

Its primary role is to blend the inputs into two digital output channels, as for

normal stereo. Four stereo output ports are provided. The console also has its own in-built D/A converter so that an analog signal (20Hz to 20kHz  $\pm$  0.5dB) is available for monitoring or other purposes.

Matsushita stress that the processing of all signals is in digital mode and there is therefore no degradation of any signal in terms of dynamic range, distortion or frequency response.

The second console is an editor, which is intended to accept two stereo digital signal pairs and to blend them into one new stereo digital master signal for re-recording. The system uses IBGs (inter-block gaps) for precise timing and a time code conforming to SMPTE practice.

With the aid of an in-built memory bank, the console can rehearse for the operator each splice that it has been set up to make. The cross-fade is performed electrically at settable slopes and with an accuracy of 11 microseconds, allowing signal splices to be made which are subjectively undetectable. Again, because the operation is performed on digital signals, and only monitored in analog form, there is no deterioration in signal quality.

The equipment set up in the rack on the left comprises four digital preview units, each capable of handling one stereo pair of signals.

Digital signals can be passed straight

through, with minimal signal delay. However, a large in-built solid-state memory system can split off and delay signals, as required, for periods between 0.1 and 1.6 seconds in 0.1 second steps. This, with no loss of quality.

The availability of the preview unit allows a cutting lathe to sample the incoming signal at some desired time ahead of when it will reach the cutter, thus allowing the lathe to vary groove spacing by an appropriate amount. In short, the preview unit takes over the function otherwise performed by an advance head on an analog system.

While this hardware is in line with what one would expect, the real surprise centres on the tape track configuration.

Matsushita lays down no less than 20 tracks side-by-side on 6.35mm tape.

Two tracks, each 48 microns wide, adjacent to the tape edges, are used for analog recording. Two of the tracks carry a stereo analog pair for aural cueing or high-speed aural review. A third track is for cueing signals and a fourth for time code.

In between these analog tracks are 16 tracks, each 24 microns wide. Matsushita do not say how or why, but each audio channel is served by four digital tracks. They do claim that redundancy is such that signal dropouts are not likely.

The sampling rate is quoted as 50.4kHz and the quantification 16-bit linear.

What kind of heads could there possibly be to read this order of track density? Here another surprise:

Matsushita have developed "thin-film" heads, using IC technology, in

*(Continued on page 35)*

# What do **SCOPE** Irons Do Best?

1.

**Provide intense heating power :**

The heating concept located right behind the tip provides tremendous heat output to get the iron hot fast; then keeps the temperature under your control to complete every joint faster.

3.

**Put this heating power right at the tip :**

A perfect iron has its heat source right at the surface of the tip — inefficient irons have their's up the barrel. The Superspeed range generate their heat on the copper tip itself, hence the intense concentration.

2.

**Let you control the power :**

Should you encounter a heat sink which would rapidly drain away tip heat (e.g. thick metal or a need for plenty of molten solder) your finger switch provides another burst of heat to keep the copper tip at correct temperature. Normally only heavy irons have this capacity and take a long time to heat — and cool.

4.

**Lets the tip run cool when not actually soldering :**

The tip stays tinned longer and lasts much longer because the iron switches off when switch released. This feature plus a low heat conductivity stainless barrel keeps the handle cooler.

## HOW DO **SCOPE** IRONS HEAT SO FAST?

ILLUSTRATION BELOW SHOWS A CUT-A-WAY SECTION THROUGH A **SUPERSPEED** BARREL.

6.4mm dia.  
REPLACEABLE  
COPPER TIP  
(Instrument Tip  
also available)



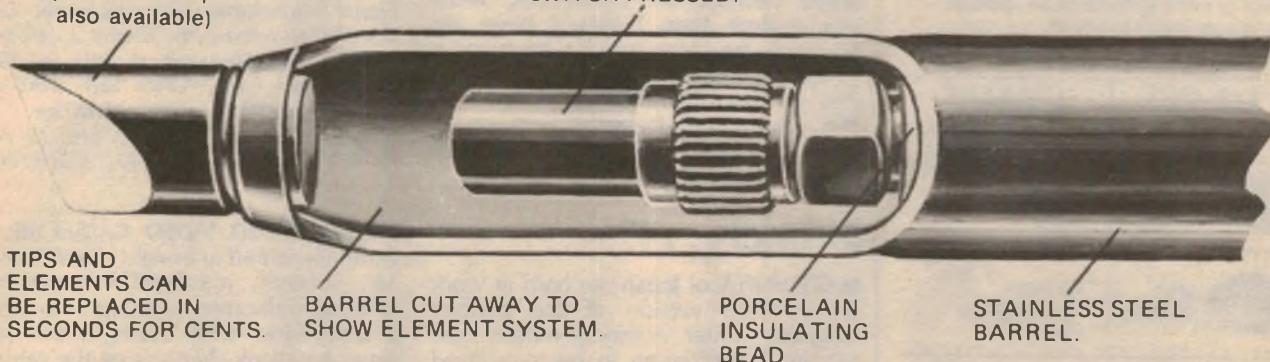

CARBON HEATER ELEMENT  
MOVES FORWARD & HEATS  
RAPIDLY WHEN FINGER  
SWITCH PRESSED.

ALL IRONS SHOWN  
BELOW USE THE  
SAME HEATING PRINCIPLE.

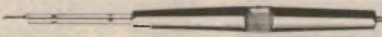

THE TEMPERATURE IS CONTROLLED BY FINGER OR TRIGGER SWITCH.

### WHICH SCOPE IRONS DO THIS?

<p><b>MINI SUPERSPEED 20-75 WATTS</b> 5 Second Heating</p>  <p>MANUAL TEMPERATURE CONTROL</p> <p>OPERATES FROM SCOPE TRANSFORMER CODE : M.S.</p>	<p><b>SUPERSPEED 150 WATTS</b> 5 Second Heating CODE : S.S.</p>  <p>MANUAL TEMPERATURE CONTROL</p> <p>OPERATES FROM SCOPE TRANSFORMER</p>
<p><b>RECHARGEABLE CORDLESS 60W</b></p>  <p>USES TWO NICKEL CELLS 6 SECOND HEATING CODE : C60</p> <p>3 RECHARGE ADAPTORS ★ AUTO CIG. LIGHTER ★ 240V. ADAPTOR ★ 3.3V. ADAPTOR</p>	<p><b>12 VOLT HOBBY IRON 200W</b></p>  <p>WORKS FROM CAR BATTERY SAFE EVEN IN WET CONDITIONS CODE : HI</p> <p>(6.4 Metre Lead)</p>

FOR MORE INFORMATION CONTACT :

## SCOPE LABORATORIES

3 WALTON STREET, AIRPORT WEST, 3042 TELEPHONE : (03) 338-1566 TELEX AA38318

N.S.W. : (02) 546-6144, S.A. : (08) 223-2261, Qld. : Brisbane (07) 221-1933, Townsville (077) 71-3448, Rockhampton (079) 27-3370, TAS. : Hobart (002) 34-2811, Launceston (003) 31-5545, W.A. : (09) 381-4155

OVERSEAS DISTRIBUTORS:

N.Z. : Wellington 85-9578, P.N.G. : Port Moresby 255300/255028/257796, P.N.G. : Lae 422172.







# fact: a Genuine Shure upgrade stylus is unquestionably the biggest bargain in hi-fi

We strongly urge you to check your stylus for wear at least once a year to protect your records and maintain the highest standards of listening pleasure.

Regardless of when (or where) you purchased your Shure cartridge, there is a Genuine Shure replacement stylus available which will bring your cartridge right back to its original specifications.

Even better, you may actually be able to improve its performance significantly over the original with a Genuine Shure upgrade stylus...at surprisingly low cost!

For example:

IF YOU OWN:	UPGRADE WITH:
 <b>V15 Type III SERIES</b>	 <b>VN35HE Hyperelliptical stylus</b>
 <b>M95 SERIES</b>	 <b>N95HE* Hyperelliptical stylus</b>
 <b>M70 SERIES</b>	 <b>N72EJ Biradial (Elliptical) stylus</b>  <b>N72B Spherical stylus</b>
<b>ANY M91, M92, M93</b>	<b>N91ED* stylus</b>
<b>ANY M71, M73, M75</b>	<b>N75 TYPE 2* Series styli</b>
<b>ANY M44 Series</b>	<b>N55E stylus</b>
<b>M3D, M7D</b>	<b>N21D* stylus</b>

\*Before purchasing any replacement stylus be certain your turntable is compatible with the tracking force of the stylus you select.

**Always insist on a Genuine Shure replacement stylus. Look for the name "Shure" on the stylus grip.**

  
**AUDIO ENGINEERS PTY LTD**  
342 Kent Street,  
Sydney, 2000 NSW

HAWKAE147/TP

But the real merit of the digital mastering system is not resident in hunches or one-off comparisons. It lies in whether the flexibility and durability of digital master tapes will show up as an overall pattern of consistently more listenable disc pressings.

After all that, what can I say as an individual reviewer about the Vanguard disc? I heard it alone on a deliberately typical good-but-not-pretentious system. I didn't fiddle with vertical tracking angle (I never do). I just played it and listened to it as a normal disk submitted for review.

Both sides were good by present-day standards but there were enough surface prickles to compromise the recording in terms of ultimate quality. I would not put the digital side into quite the same class as the best Telarc digitals, taped on Soundstream equipment, cut at half speed by JVC and pressed by Teldec in Germany.

But I would still give my vote to the digital because the differences, while less evident than I would have anticipated, are those which I have come to expect from digitally sourced pressings — a bass with more weight and bite, and a more open treble.

At which point, it is over to you to decide for yourself.

## In brief...

**MATSUSHITA of Japan** are hard at work on a video version of the contact magnetic printer. A special master tape carrying the program to be transferred

cycles through a printing zone in intimate contact with blank tape. A high frequency field in the printing zone causes the pattern on the master tape to print onto the blank tape, without itself being significantly changed. It operates at a speed such that it can produce 12 VHS video cassettes — two hour or four hour — in four minutes. To date, copies have had to be produced on a master/multiple slave system that operates in real time: four hours to copy a bank of four-hour cassettes.



*With inflation and the exchange rate pushing up the price of the prestige Rega Planar 3 turntable, Concept Audio have decided to release the Planar 2. Still very much a prestige unit, it sells for \$335 motor and base, \$445 with arm and \$490 complete with cartridge. For details: Concept Audio Pty Ltd, 22 Watle Rd, Brookvale 2100. (02) 938 3700.*

**PRE-RECORDED VIDEO CASSETTES** are normally rented or bought over the counter. Recently, a cable-TV firm in Santa Rosa, California came up with a new and ingenious idea. During hours when there are blank channels on the cable, it

## Hifi sound plus a TV slide show

Even though their VHD video disc is still awaiting full-scale launch, the Victor Company of Japan (JVC) are already zeroing in on a follow-up development: AHD or Audio High Density Disc.

They reason that tomorrow's phono record should not be just the soundtrack of a film or TV show but a logical extension of present-day hifi listening. Their newest disc is seen as a further application — of the present capacitance type video disc, with the same dimensions, the same playing speed and intended for a compatible audio/video player.

The proposed AHD disc will have three channels of top quality digital audio, two of them providing a basic stereo pair, the third being an optional extra signal to provide an augmented stereo sound field; this could improve the perception of both position and depth.

Indeed the system provides four tracks altogether, holding out the option of surround sound. However, JVC see it as being used to carry visual images-on-TV "slides" — of the performance. With the right kind of memory store, the fourth track could build up a new full colour still picture every second. However, this would call for a needlessly expensive solid-state memory. As well, JVC tests have shown that each picture should be left on the screen for 5 to 10 seconds.

The four tracks on the AHD disc will be pure digital, with a clock rate for the composite signal of 6.14MHz, and a sampling rate for each audio track of 47.25KHz. On the basis of 16-bit linear encoding, this will ensure an effective dynamic range of 90dB and redundancy sufficient to obviate dropouts.

Manufacturers who produce the VHD disc player should have no problems in extending their role to take in the AHD format.



Backing up the announcement from Philips in our last issue, the Sony Corporation have supplied this photograph of their new compact disc and system. The disc has a diameter of 120mm and a thickness of 1.2mm and is currently single-sided, carrying up to 1 hour of program in stereo. It employs digital encoding and decoding using a laser, with a sampling frequency of 44.1kHz and 16-bit linear quantisation. The system provides ample precaution against error effects, plus scope for text and programming data in encoded form for visual display, and for track selection and pre-programming.

is planning to distribute programs intended especially for copying by clients, in the home. Customers would ready their VCRs to accept any scheduled future they may want — then go to bed and forget it. At the appropriate time, the cable-TV company would interrogate

computerised controllers in each home, which could switch on the VCR and, of course, transfer the appropriate charges to the client's account. Next morning, the client's private copy of the feature would be ready to add to their video library.

## A new generation recording system

(Continued from page 32)

which printed multi-turn coils replace the traditional wound variety. Accuracy is vastly improved and the use of glass and ceramic on the surface in contact with the tape minimises wear problems.

The replay heads involve similar constructional technology but appear to utilise the Hall Effect principle. The system has a potential resolution of 22 KBPI (kilobits per inch), suggesting a substantial performance margin at the system tape speed of 38cm/s.

Performance parameters for the system, overall and including the tape

recorder suggest a frequency response of 20Hz to 20kHz  $\pm 0.5$ dB. Harmonic distortion over the whole range at +4dBm 0.05%. Dynamic range, better than 90dB.

The above report is based on preliminary data obtained from Matsushita in Japan. At the time of writing, no further information is available in Australia. However, the equipment is clearly branded Technics and it would be logical for those requiring further data to seek it through National Panasonic (Aust) Pty Ltd, 95 Epping Road, North Ryde, NSW, 2113.



Built-in clock functions are fairly common, these days, in video and audio recorders. However, Akai have released as separate units timers similar to those used in its complete systems. At a basic level, they can substitute for a clock radio, but turning on a complete hifi system in any desired mode. They can also initiate an unattended recording and even be used to switch on lights in an unoccupied house. The DT-100 is a basic crystal locked timer but the DT-200 (pictured) is microprocessor controlled with a 7-day pattern and memory functions. Details from R. Taylor, Akai Marketing Services Aust Pty Ltd, Unit 11, Eden Park, Waterloo Rd, North Ryde NSW 2113. Phone (02) 887 2311.

**SWITCHCRAFT**

## CONNECTORS & ELECTRONIC COMPONENTS

Superb quality and reliability from one of the oldest and most experienced manufacturers in the USA.

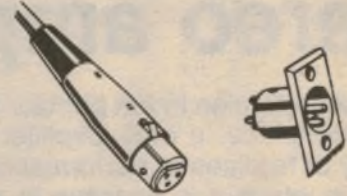

QG Audio Connectors  
Die Cast Shell, PA & General Applications  
Available Nickel or Mat Black

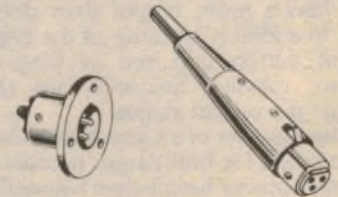

QGP Professional Audio, Non-Reflective Vel-Tone Finish, Positive Ground, Die Cast Zinc Shell

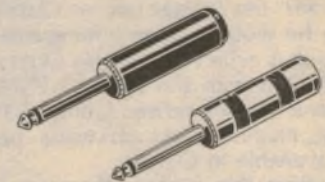

Phono Plugs, Available Plastic or Brass Handle, Wide Range of Configurations

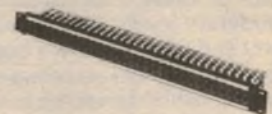

JP Series — Modular Jack Panels, Black Anodised Up to 40 Configurations

AUSTRALIAN DISTRIBUTORS

## AUDIO TELEX COMMUNICATIONS PTY LTD

SYDNEY  
1 Little Street  
Parramatta, 2150  
Tel: 633 4344

MELBOURNE  
7 Essex Road  
Mt Waverley, 3149  
Tel: 277 5311

BRISBANE  
394 Montague Road  
West End, 4101  
Tel: 44 6328



# HIFI REVIEW

## Marantz PM-4 Class-A/Class-B stereo amplifier

To attract attention in the popular 50 to 75 watts per channel area of the marketplace, a new amplifier must offer something different in the way of facilities or performance. Such an amplifier is the Marantz PM-4, in which it is possible to select either conventional Class-B operation of the output stage, or the increasingly popular Class-A mode.

For a given power supply capacity, Class-B operation yields a higher efficiency and hence more output than does Class-A. In addition, because of the high quiescent current incurred in Class-A operation, massive heatsinks are required for the output stages.

Thus the designer of a Class-A amplifier has to provide for both larger heatsinks and a larger power supply than he would require for a Class-B amplifier of similar output power.

Conversely, if he were to utilise the same heatsinks and power supply capacity for the design of a Class-B amplifier, he would realise a far greater output to that achieved with his Class-A design. So it is with the Marantz PM-4, which has a Class-A power rating of 15 watts per channel, and 60 watts per channel available in Class-B.

In providing this facility, the user is given freedom of choice according to his moods and requirements. Probably he will elect to normally operate his Marantz PM-4 in Class-A for listening to music at moderate levels; but should he throw a party and wish to drown out the conversation, he only has to release the Class-A/Class-B pushbutton to quadruple the PM-4's available power output and

increase the sound pressure level by 6dB for all to enjoy (?).

At this point it should be noted that the PM-4's gain remains constant (as it should in this reviewer's opinion) irrespective of which Class is selected. Thus it is necessary to advance the volume control to utilise the increased power available.

By maintaining constant gain it becomes possible for the listener to instantly change from Class-A to B (and vice versa) to note any differences in sound quality, without being disturbed by changes in level.

Designed in the USA and produced in Japan, the Marantz PM-4 retains the characteristics of other Marantz amplifiers, in that it has the typical Marantz quality finish on all visible surfaces together with Marantz' adherence to symmetrical front panel layout. Similarly its construction is solid, with conventional sheet-metal side panels being replaced by two massive heatsinks continuing all the way from front to rear.

The natural – albeit with a slightly golden tint – anodised front panel is clearly labelled with the functions of the various controls and switches, the lettering sizes having been carefully chosen so

that they are neither too small to read nor oversized as sometimes occurs in other designs.

Rotary knobs are provided for input selector, volume, bass and treble controls. Both bass and treble controls are detented for 11 separate positions. Four simulated keyswitches control the functions of tone control defeat, tape copy, tape monitor and mode selector, whilst six small pushbuttons look after the remaining functions of speaker selection, power, Class-A/Class-B, loudness and subsonic filter.

Such features give the impression that this is a high quality product, even before it is switched on to evaluate its performance. Overall dimensions of the PM-4 are 416 x 117.5 x 334mm (W x H x D), and the mass is 9.5kg.

Preamplifier facilities include the ability to directly accept the output of a "moving coil" cartridge, without the need for an external step-up transformer. This position is marked PHONO 1 MC, providing a quoted input impedance of 100 ohms, together with a quoted sensitivity of 0.2mV. Marantz' figure for weighted signal-to-noise ratio is 64dB for MC, in contrast with their 84dB figure for conventional moving magnet cartridges.

On the rear panel there is the usual array of RCA sockets neatly grouped in a logical way. Facilities are included for two tape decks, although DIN sockets are not provided. Loudspeaker connections are made to shrouded screw-type terminals which are a little "fiddly" to in-

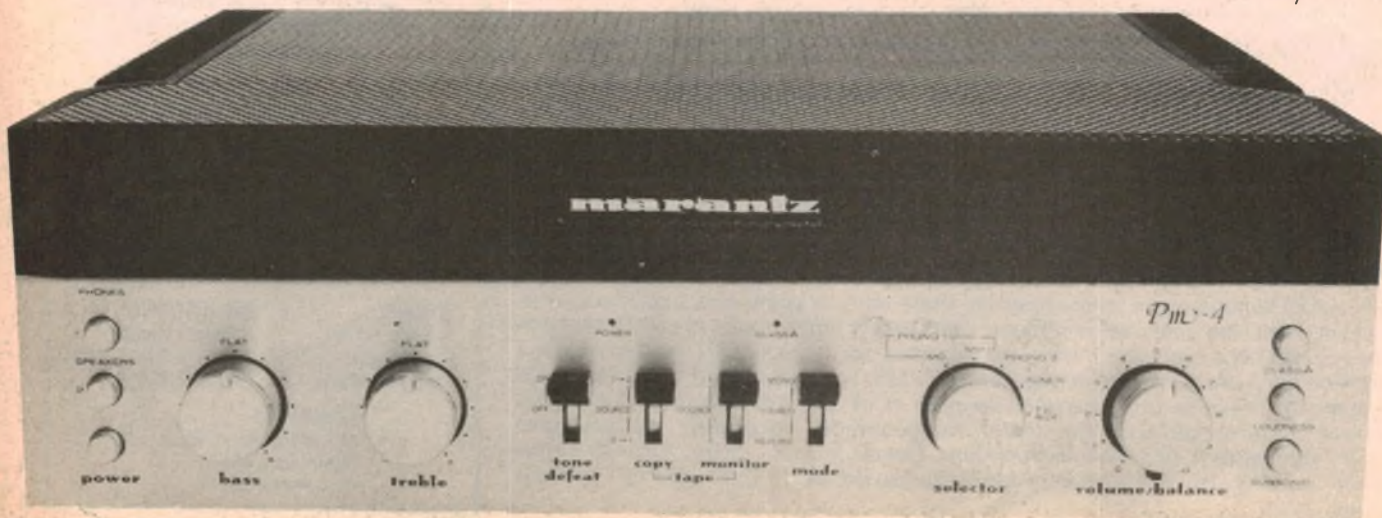

**PUT A CONCERT  
IN YOUR CAR  
WITH DICK SMITH  
CAR STEREO**



**\$45**

Cat A-5940

**\$129**

Cat A-6480

**\$99**

Cat A-6486

### DELUXE AM RADIO

An 8 transistor radio with push button tuning for only \$45? Yes it's true. A similar radio to this one was sold by this company in 1976 for a massive \$79 — our direct import buying allows us to beat inflation!

Complete with all bits and pieces, including a large speaker, this radio will fit most cars in the standard cut-out aperture. Powered by your battery (12V DC negative earth) this radio produces a massive 5 watts output. All you need is an antenna and you'll be listening to your favourite stations in no time at all.

### AM + FM STEREO + CASSETTE

The FET front end plus its small size are only two of the outstanding features of this AM/FM cassette stereo. Measuring only 120(d)x180(w)x44(h)mm it will fit into most fascia cutouts, the small size has been accomplished by placing the tuner dial in the cassette flap! Indicator lights tell you when you have FM stereo and when you have a tape playing. Ideal for any 12V DC negative earth vehicle. Use with any of the speakers shown below.

### AUTO REVERSE STEREO

No more troubles with turning the tape over at end of play — this unit automatically plays the other side. If you wish to fast forward or reverse the tape then it is easy — the controls lock down and then pop out at the end of the tape. Ideal for under dash installation the unit works from 12V DC negative earth. The 4 IC and 2 diode construction boasts a healthy 8 watts maximum output — enough power for even the most avid audiophile. Can be used with any of the speakers shown below.

### Dual Cone Speakers



Cat A-7080

**\$29<sup>90</sup>**

A massive 280 gram magnet, plus 4 ohm impedance and a rating of 20 watts — ideal for those high power systems. Excellent bass and treble response.

### Co-axial Speakers

For top quality sound from the in-built tweeter and bass unit. Handles 20 watts into 4 ohms and comes complete with superb grille.

**\$39<sup>50</sup>**

Cat A-7000

### ALL NEW EQUALISER/AMPLIFIER



Cat A-6665

**\$79<sup>00</sup>**

Boost up your power to 25 watts per channel and at the same time be able to control 7 different frequencies! The slider controls will enable you to set-up the sound that you like thereby compensating for any deficiencies in the cars acoustics. One pair or two pairs of speakers may be used and if using two pairs there is a fader between the front and rear speakers. Use with 12V DC negative earth.

### Rear Shelf Speakers



Cat A-6980

**\$16**

Rated at 4 ohms impedance and 8 watts power. Mount on your rear shelf or can be removed from box for flush mounting.

### Flush Mount Speakers



**\$18**

Cat A-6985

130mm diameter speakers with a rating of 4 ohms and 10 watts maximum power. Soft padded speaker grille for that touch of luxury. Mount on rear shelf or in doors.

All speakers are sold and priced as pairs



**SEE THE OTHER DICK SMITH ADS IN THIS MAGAZINE FOR STORE ADDRESSES & PHONE NUMBERS**

# The moving coil replacement from Stanton Magnetics... the revolutionary 980LZS!



Now from the company to whom the professionals look for setting standards in audio equipment comes a spectacular new cartridge concept. A low impedance pickup that offers all the advantages of a moving magnet cartridge without the disadvantages of the moving coil pickup. At the same time it offers exceedingly fast rise time—less than 10 micro seconds—resulting in dramatic new crispness in sound reproduction—a new "openness" surpassing that of even the best of moving coil designs. The 980LZS incorporates very low dynamic tip mass (0.2 mg.) with extremely high compliance for superb tracking. It tracks the most demanding of the new so called "test" digitally mastered and direct cut recordings with ease and smoothness at 1 gram  $\pm \frac{1}{2}$  -  $\frac{1}{4}$ .

The 980LZS features the famous Stereohedron™ stylus and a lightweight samarium cobalt super magnet. The output can be connected either into the moving coil input of a modern receiver's preamps or can be used with a prepreamp, whose output is fed into the conventional phono input.

For "moving coil" audiophiles the 980LZS offers a new standard of consistency and reliability while maintaining all the sound characteristics even the most critical moving coil advocates demand. For moving magnet advocates the 980LZS provides one

more level of sound experience while maintaining all the great sound characteristics of cleanliness and frequency response long associated with fine moving magnet assemblies.

From Stanton... The Choice of The Professionals.

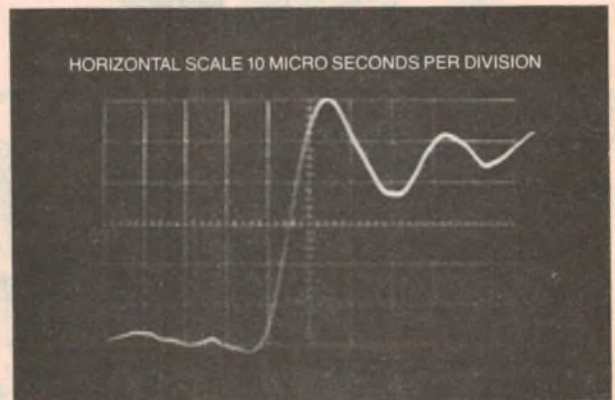

Actual unretouched oscilloscope photograph showing rise time of 980LZS using CBS STR112 record.



## STANTON

THE CHOICE OF THE PROFESSIONALS™

IMPORTERS AND EXPORTERS OF AUDIO EQUIPMENT



**SOUNDEX** PTY. LTD.

Head Office: 156 Railway Pde., Leederville, Western Australia, 6007. Telephone: 381 2930. Telex: AA 93241 ANSB. LRP.  
NSW Office: 7 Jordan Rd., Wahroonga, 2076. Telephone: 487 2543.



## MARANTZ PM-4 STEREO AMPLIFIER

sert conductors into but are a good safety feature to avoid electric shock. Three two-pin AC sockets on the rear panel have been disconnected by Marantz as a safety feature to comply with Australian standards.

Just above the front control panel is a standard headphones outlet, let into the folded over portion of the perforated metal top cover.

Removing this top cover proved to be an exercise in patience and ingenuity. Eleven crosshead screws have to be released or removed, and two of these are inaccessible behind the front panel. To release the front panel requires that a further five screws together with a minimum of six knobs be removed.

On removal of this top cover, a very neat interior is revealed with no waste space and yet little overcrowding as occurs in some amplifiers. As no service notes nor schematic circuit diagram were supplied with this amplifier, we are unable to comment on the circuit design. However, on inspection it appears that the designers have opted for using all discrete circuitry rather than employing integrated circuits.

Three main printed circuit boards are used, with the large one appearing to contain the power supply, power amplifiers and protection circuitry. One of the subsidiary boards appears to be used for the tone control stages, whilst the other apparently contains the preamplifier and input selection circuitry.

Several small cards are located at strategic points, covering details such as headphones outlet, pushbutton switches, mono-stereo switching and tape input/output circuitry.

The main board contains two relays which appear to mute the amplifier at switch-on and switch-off. In addition the PM-4 appears to have fast acting electronic protection against short-circuits, over-driving and other excessive loading.

Power rating of the PM-4 is quoted for both the Class-A and Class-B modes. In Class-A, Marantz claim an output of 15 watts per channel into 8 ohm loads, whilst in Class-B power delivery should be 60 watts per channel into the same 8 ohm loads. There is just one total harmonic distortion figure, which is 0.015%, apparently applying to both classes of operation. One wonders just exactly what bonuses Class-A is supposed to offer over Class-B?

Performance testing, using a regulated 240 volt AC source, was carried out after our standard one-hour preconditioning at 40% of maximum Class-B power output. In Class-B mode, maximum power at onset of clipping with both channels driven is 75 watts into 8 ohms, 47 watts into 16 ohms and 90 watts into 4 ohms. With only one channel driven, the respective figures were 85 watts, 52 watts and 120 watts.

At the rated output of 60 watts per channel into 8 ohms, distortion was 0.017% at 1000Hz rising to 0.07% at 20kHz. Whilst slightly outside Marantz' specifications, these are very good figures and only suffer marginal further deterioration at 70 watts output per channel into the 8 ohm loads. As usual, distortion increased slightly with the 4 ohm loads, and decreased slightly for 16 ohm loads.

Tested in the Class-A mode, maximum

Tape and Tuner inputs is  $-1\text{dB}$  down at 10Hz and 60kHz. RIAA equalisation on the phono inputs is well within  $\pm 0.3\text{dB}$  between 20Hz and 20kHz. Unweighted signal-to-noise ratio for the high level inputs is 89dB with respect to 60 watts into 8 ohms, and the phono s/n ratio is 75dB with respect to the same power at an input level of 10mV at 1kHz, using a typical magnetic cartridge as the input termination.

Phono input overload at 1kHz was 320mV, essentially the same as Marantz' figure of 330mV, both very satisfactory figures.

The tone controls – providing the

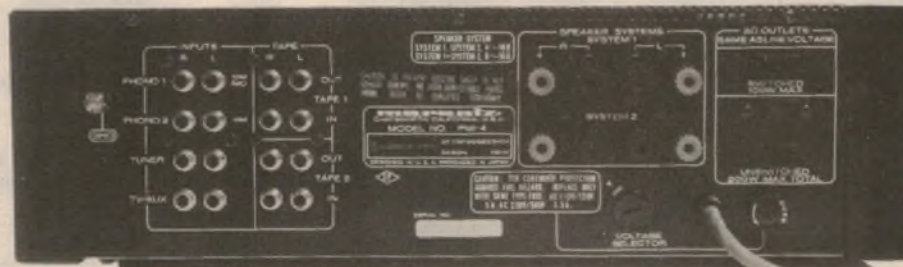
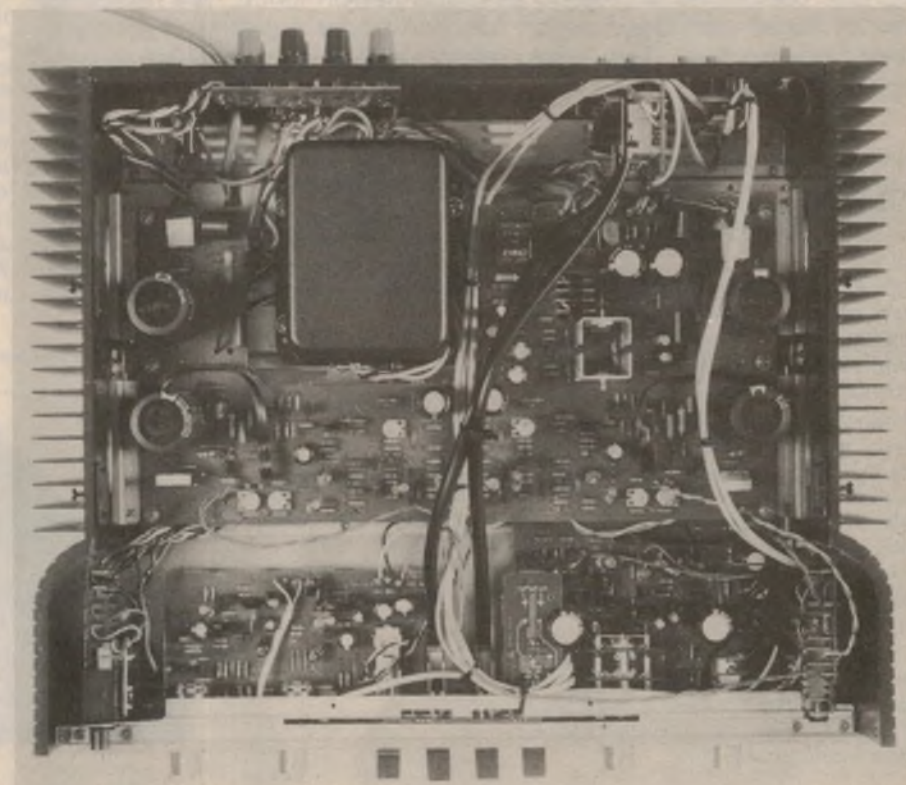

power with both channels driven to the onset of clipping was 20 watts into 8 ohms. Reducing the level to the manufacturer's rating of 15 watts, distortion was only 0.013% at 1000Hz (the same figure was obtained for the Class-B mode at this level), rising to 0.03% at 20kHz, slightly better than the 0.06% registered in the Class-B mode for the same level. Raising the level by 1dB to 17 watts incurred only a slight increase in distortion.

Frequency response for the Auxiliary,

usual "shelf" characteristics at low and high frequencies – provide for changes up to  $\pm 10\text{dB}$  at 100Hz and 10kHz, as per Marantz' specification.

Reducing the level by 1dB at 25Hz and 3dB at 10Hz, the subsonic filter is only operative on the phono inputs. On these same inputs the separation between channels was 80dB at 100Hz, 70dB at 1kHz, 51dB at 10kHz and 43dB at 20kHz.

The sensitivity of each input was found

(Continued on page 133)



# HIFI REVIEW

## Glanz MFG phono cartridges

Glanz is a new name to the Australian hifi scene, heralding a range of magnetic cartridges with good all-round performance. We reviewed three of these cartridges which function under a patented principle called "moving flux". This gives rise to a stylus system which is very easy to change.

While we have seen only the sketchiest explanation in the owners' handbooks for these Glanz cartridges, it appears that the "moving flux" principle is a new variation on the well-tried moving-magnet principle. While this is claimed to give improvement in performance by the manufacturers, the only really apparent difference to the user is the method of stylus assembly fixing.

While most moving-magnet cartridges have a "slide-out" stylus assembly, these "moving flux" cartridges have a stylus assembly which unclicks "up and out" (with the cartridge upturned). It also pushes back into place in a very positive fashion which is reassuring to the user as well as probably contributing to consistent performance.

Another good feature of the stylus assembly on each cartridge is the flip-down stylus guard which is very handy and unlikely to be lost, as is the case with a detachable guard.

pedance of 47k — as found on most of today's amplifiers.

It should be mentioned that the quoted inductance of 120mH is low compared with competitive cartridges, whose inductance usually lies

The CBS STR100 test record yielded somewhat conflicting results with the three cartridges, in that the MFG-11T cartridge produced the flattest response closely followed by the middle range MFG-31L with the premium MFG-71L cartridge showing a broad peak of approximately +4db centred around 15kHz, although in the other channel the corresponding peak was only 2db. The magnitude of the peak in the MFG-11T and -31L was of the order of 3db centred at around 14kHz in each case. All cartridges exhibited the characteristic

*Housed in plastic cases, the Glanz cartridges are each supplied with a small screwdriver and mounting hardware.*

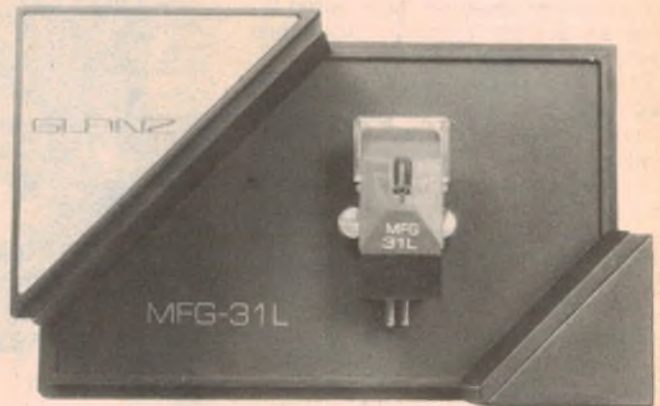

MODEL	MFG-11T	MFG-31L	MFG-71L
Stylus assembly colour	beige	brown	black
Output level @ 1kHz (mV/cm/sec)	0.84	0.84	0.7
Frequency response	±2.5db, 10Hz-20kHz	±2db, 10Hz-20kHz	±1db, 10Hz-20kHz
Channel separations @ 1kHz	20db	23db	25db
Stylus tip	elliptical diamond titanium bonded	solid diamond, line contact	solid diamond, line contact
Compliance	35 × 10 <sup>6</sup> cm/dyne	45 × 10 <sup>6</sup> cm/dyne	50 × 10 <sup>6</sup> cm/dyne
Recommended tracking force	1.75gms	1.5gms	1.25gms
Recommended retail price	\$23.00	\$42.00	\$95.00

Like most cartridges the Glanz units have a composite construction with metal shield and precision-moulded body. The Glanz has standard 12.7mm mounting centres and standard colour-coded output terminals which are also identified with "L", "R" and "E" designations. Both the cartridge bodies and stylus assemblies are colour-coded and clearly labelled for easy identification.

Each cartridge has a mass of 5½grams, and the inductance of each coil is 120mH, with a recommended load im-

somewhere between 400 and 800mH.

This low inductance means that the cartridges will be tolerant to high cable capacitance, and lower than normal resistive loading. Incidentally, we measured all three cartridges and found that their inductance was, if anything, a little less than the quoted figure.

A nice touch is that an individual calibration curve is supplied with each cartridge, providing the purchaser with the feeling of a quality product. The major cartridge specifications are tabulated on this page.

magnetic cartridge "droop" of 0.5 to 1.5db in the region of 4 to 8kHz.

Crosstalk measurements indicate a high standard of performance, with all cartridges achieving at least 28db rejection at 1kHz. By 12kHz, separation had diminished to 11db in the case of the budget-priced MFG-11T, 14db in the case of the MFG-31L and 17db for the MFG-71L. Unlike many other cartridges, the separation suffered minimal further deterioration as the test frequencies were increased to 20kHz.

*(Continued on page 89)*

# A pro doesn't fiddle on stage.

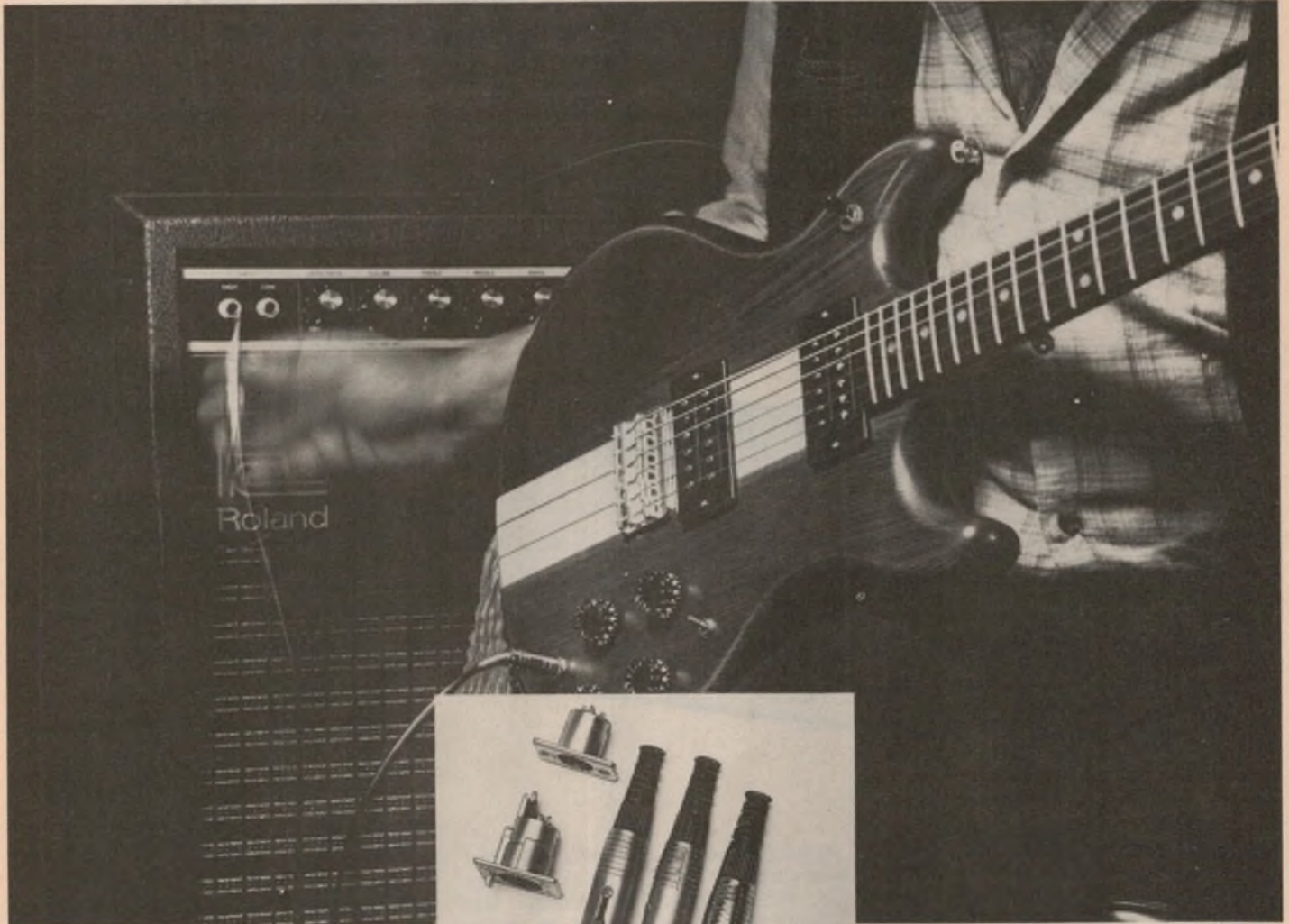

The crackle and hum of a loose audio connector is a pain for any performer. Especially when he's up on stage trying to give his best — and he has to keep running back to his amp to wiggle and fiddle a loose-fitting plug.

The Swiss attacked this problem and produced the superb range of connectors from Neutrik (pronounced NOY-TRICK).

They're built as solidly as a bank vault, as precisely as a Swiss watch.

The pins are anchored in high-temperature-resistant materials.

Once they're plugged in, they stay in. They are completely

## NEUTRIK AUDIO CONNECTORS

Compatible with all XLR-type connectors in 3-, 4- and 5- pins.

R. H. Cunningham import some of the world's finest audio products — like Sennheiser microphones and headphones; radio mikes; voice synthesiser; loudspeakers — and more. Post this coupon for our Professional Audio Products Catalogue — free.

Name .....

Address .....

Are you a Musician/Engineer/Educator/  
Broadcaster/ Hi Fi Enthusiast/Other:

B&B/RH136/AM

isolated, to substantially reduce microphone noise.

The cable is tightly gripped, to withstand 100 lbs. of stress. Yet they're simply made and quick to assemble.

Yes, they do cost more than other connectors. But when you're up on stage and totally reliant on your equipment — the few extra cents won't matter a crotchet.

**R.H. Cunningham**  
PTY.LTD.

Audio equipment for professionals  
146 Roden Street, West Melbourne, 3003.  
4-8 Waters Road, Neutral Bay, N.S.W., 2089.

Here are the full circuit details on the

# Playmaster Mosfet Stereo Amplifier

In this article on the new Playmaster Mosfet Stereo Amplifier we continue the circuit description, give details of the performance and begin description of the assembly procedures.

by LEO SIMPSON



Having detailed the features of the new amplifier last month together with a broad description of the Mosfet power amplifier circuit, we now move to the input stages and describe the features in this section of the amplifier. Refer to the complete circuit diagram.

The phono preamplifier is similar to that featured in the previous Twin Twenty Five and Forty Forty stereo amplifiers with the addition of a few worthwhile refinements. Q1 and Q2 form a differential amplifier with balanced output to drive a TL071 Fet-input operational amplifier. The TL071 is pin-for-pin compatible with the 741 op amp but has the advantage of higher slew rate capability which can result in lower distortion under high input signal conditions. The purpose of using transistors to drive the op amp is to improve the resultant signal-to-noise ratio of the circuit, as well as increasing the loop gain. The latter feature allows more negative feedback to be applied which also reduces distortion.

Collector current of the two input transistors is set at about  $87\mu\text{A}$  by the common  $82\text{k}\Omega$  emitter load resistor. This value of current is not as low as used in some preamplifier designs but is about optimum for best noise performance with the complex source impedance presented by a typical magnetic cartridge. As another measure to minimise input noise, the collectors of Q1 and Q2 operate at low voltage.

As an option, we have specified an alternative to the two BC549 low-noise transistors in the form of the LM394 supermatch pair. This six-lead device contains two junction isolated ultra-well-matched transistors. The major advantage of this device is very low offset voltage and very low drift. However, we are using it for its low noise and high gain.

A  $56\text{k}\Omega$  resistor sets the input resistance for the preamplifier at close to  $50\text{k}\Omega$  while the series  $1\text{k}\Omega$  input resistor and  $47\text{pF}$  shunt capacitor act as an RF suppression network. This helps prevent

RF breakthrough from CB radios and mains-radiated interference.

No input capacitor is provided for the preamplifier. We reasoned that since the input bias current to Q1 is typically less than 500 nanoamps, far less than normal signal currents, the capacitor could be dispensed with.

The series network consisting of the  $1\text{k}\Omega$  resistor and  $.001\mu\text{F}$  capacitor between the collectors of Q1 and Q2 ensures stability of the preamplifier at high frequencies. At the same time, the  $15\text{k}\Omega$  resistor connected from the output terminal of the op amp to the positive 15V rail provides a standing current of 1mA to minimise cross-over distortion from the class-B output stage of the TL071.

Five components are used in the equalisation network ( $56\text{k}\Omega$ ,  $560\text{k}\Omega$ ,  $.0056\mu\text{F}$ ,  $.0012\mu\text{F}$  and  $150\text{pF}$ ) to give an RIAA response which is typically within  $\pm 1\text{dB}$  of the RIAA curve from 30Hz to 20kHz, with normal component tolerances of 10% for the capacitors and 5% for the resistors. Much closer adherence to the RIAA curve can be achieved by using the same component values but with tolerances of 1 or 2%.

In addition, we have provided for bass rolloff below 30Hz, as determined by the ratio of the reactance of the  $10\mu\text{F}$  capacitor to the  $1\text{k}\Omega$  resistor terminating the feedback network at the base of Q2. While this does not provide the  $7950\mu\text{s}$  time-constant recommended by the IEC (and yet to be adopted by the RIAA), the additional rolloffs in later stages of the amplifier combine to give a bass rolloff which is very close to the IEC recommendation.

As such, the Playmaster amplifier has more than adequate rumble filtering without the need for special filter stages.

It may be thought that the combination of exceedingly high open-loop gain in the preamplifier together with the internal 6dB/octave high frequency compensation (rolloff) of the TL071 operational amplifier makes the circuit a "sitter" for the occurrence of transient intermodulation distortion. However, the RIAA equalisation means that the negative feedback around the circuit also decreases at the rate of 6dB/octave (albeit with an inflection at about 1kHz),

# PLAYMASTER MOSFET STEREO AMPLIFIER

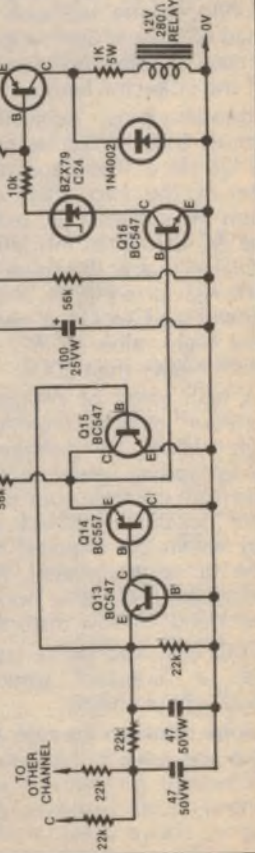
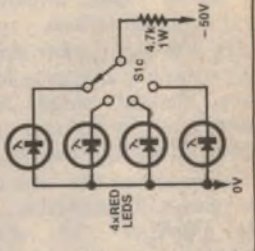
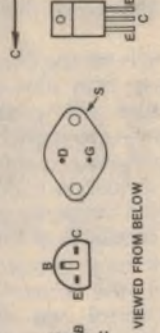
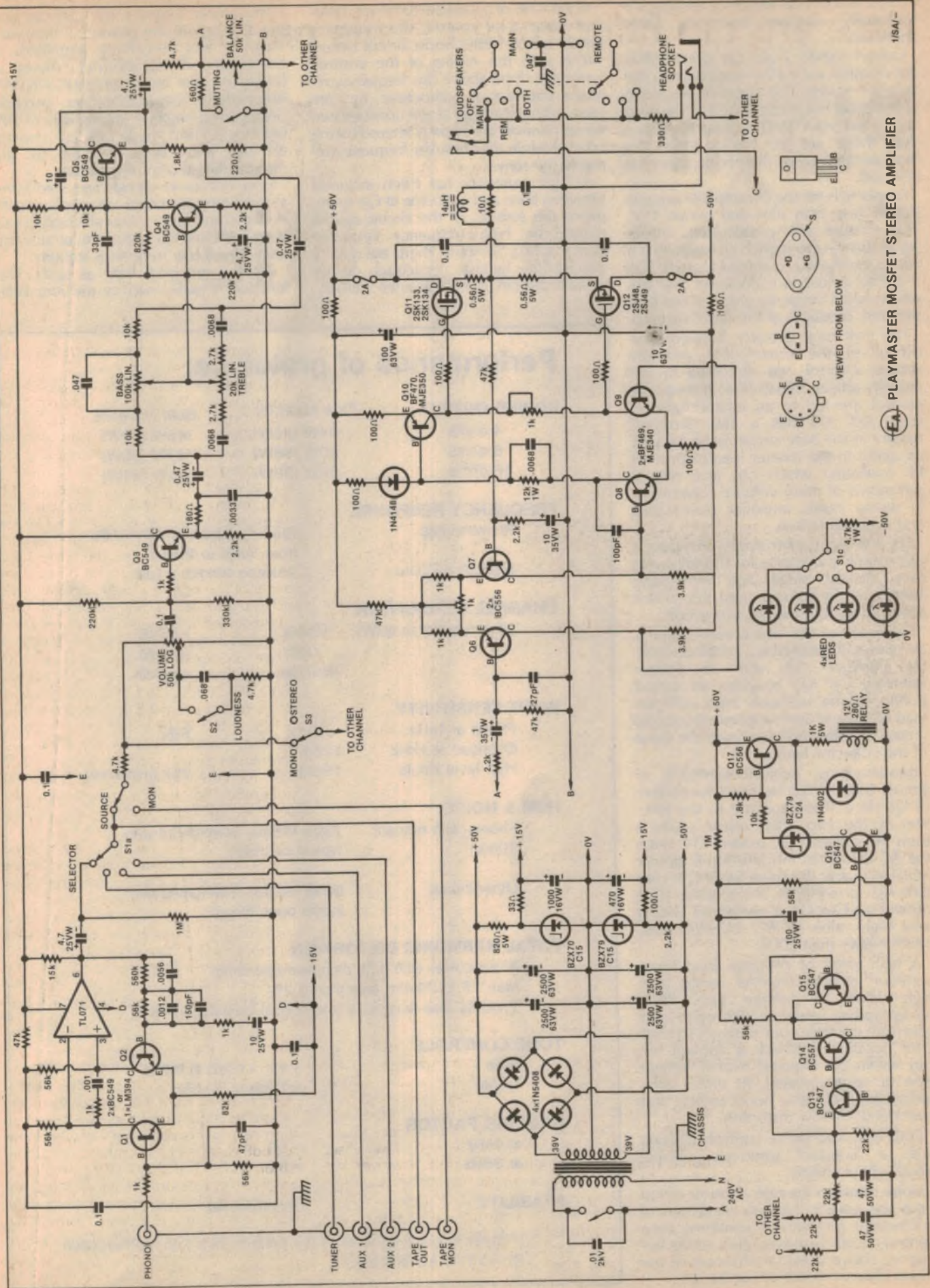

VIEWED FROM BELOW

so that the overall negative feedback is essentially constant over the audio spectrum.

Output signals from the preamplifier are coupled via a 4.7 $\mu$ F capacitor to the Selector switch. The negative electrode of the capacitor is connected to the zero supply rail via a 1M $\Omega$  resistor to ensure that there are no clicks from the loudspeakers when the phono source is selected.

Supply rails for the preamplifier are just slightly less than plus and minus 15V. This enables the preamplifier output signal to swing to quite high levels which allows a generous overload margin. This overload margin is maintained over the whole audio range, by virtue of the high slew rate capability of the TL071 op amp.

The switching circuitry between the output of the preamplifier and the volume control was discussed in last month's article. Signals from the volume control are fed to an emitter-follower stage Q3. Q3 has a 1k $\Omega$  "stopper" resistor in the base circuit and a .0033 $\mu$ F capacitor in the emitter load to prevent RF oscillation which can give rise to symptoms of noisy volume controls or, in worse cases, amplifier overheating and eventual failure.

Q3 acts as a buffer stage, providing a low source impedance for the following tone control stage and minimising loading on the volume control so that it provides smooth progressive action.

Operation of the tone control circuit is as follows. Basically it is a common emitter amplifier, Q4, with an emitter follower, Q5. Q5 provides an output buffer for the relatively high collector load of Q4 and also supplies a bootstrap voltage to effectively increase the value of the collector load.

Bootstrapping, positive feedback of almost 100%, is applied from the emitter of Q5 via a 10 $\mu$ F capacitor to the junction of the two 10k $\Omega$  resistors which form the collector DC load of Q4. Since the AC voltage at this junction is almost equal to that at the collector of Q4, very little AC current flows in the lower 10k $\Omega$  resistor and so Q4 is presented with a very high value of AC collector load, much higher than 20k $\Omega$ .

A high value of collector load for a common emitter amplifier results in a high value of voltage gain. Thus bootstrapping results in high open-loop gain from the tone control stages so that, after negative feedback is applied we can obtain the required overall voltage gain of approximately 10 times, adequate bass and treble boost and cut and commendably low distortion.

Both bass and treble controls operate with a "constant turnover, variable slope" characteristic.

Slope refers to the rate of boost or cut from the circuit; this is a maximum of 6dB/octave for any conventional tone control circuit. Turnover refers to the frequency above which, in the case of the treble control, boost or cut occurs.

In the case of a variable turnover, constant slope tone control, the frequency above which treble boost or cut occurs varies with the setting of the control, while the slope above this frequency remains constant at 6dB/octave. By contrast, with a variable slope constant turnover control, the slope is altered by the control while the turnover frequency remains the same.

A 33pF capacitor has been included between base and collector of Q4 to improve the stability of the circuit and to rolloff the high frequency response above 30kHz. Similarly, there are quite a few 0.1 $\mu$ F bypass capacitors dotted around the circuit to guarantee stability.

The power supply is not quite as simple as it was in the previous Playmaster Twin 25 and Forty-Forty amplifiers. A centre-tapped transformer drives a bridge rectifier and four 2500 $\mu$ F/63VW electrolytic capacitors to provide positive and negative supply rails of 50V (nominal). From these rails are derived the plus and minus 15V rails for the preamplifier and tone controls.

Two 15V zener diodes are used here, along with additional decoupling with resistors and large value electrolytics to keep hum and noise to a minimum and also ensure low frequency stability.

There is no pilot light as such. This function is performed by the four LEDs

## Performance of prototype:

POWER OUTPUT	One channel	Both channels
4 ohms	64W (72W)	45W (60W)
8 ohms	50W (56W)	42W (50W)
16 ohms	37W (38W)	31W (31W)

FREQUENCY RESPONSE	
Phono inputs	RIAA equalisation within 1dB from 30Hz to 20kHz
High level inputs	25Hz to 20kHz $\pm$ 1dB

CHANNEL SEPARATION		
(with respect to 50W)	10kHz	-40dB
	1kHz	-47dB
	100kHz	-50dB

INPUT SENSITIVITY		
Phono at 1kHz	2mV	56k
Overload at 1kHz	120mV	
High level inputs	190mV	36k (minimum)

HUM & NOISE		
Phono (with respect to 10mV)	73dB (75dB) unweighted with typical cartridge	
Other inputs	80dB (82dB) unweighted with inputs open circuit	

TOTAL HARMONIC DISTORTION	
At full power with both channels operating from 25 to 20kHz: less than 0.2%	
Typically less than 0.05% at normal listening levels	

TONE CONTROLS	
Bass	+12, -13dB at 50Hz
Treble	$\pm$ 10dB at 10kHz

DAMPING FACTOR	
at 1kHz	> 50
at 30Hz	> 50

STABILITY	
	Unconditional

(Figures in brackets refer to the performance with the Ferguson PF 4361/1 transformer.)

# SENSATIONAL MICROPROCESSOR TECHNOLOGY

Contains 1,000's of transistors!

**7 DAY SATISFACTION GUARANTEE - money back if not satisfied.**

**\$29<sup>50</sup>**

Cat. X-1158  
P&P \$3.00

## MINI ORGAN



What better way for your children to encounter the delights of organ playing than with this superb 'up-to-the-minute' advanced technology organ.

After inserting 6 penlight cells (Cat. S-3003 at 22¢ each) or an optional 9V DC adaptor (Cat. M-9525 at \$6.90 - special price until the end of February) just switch the unit on and make your choice of mode.

Set the switch to auto play and by pressing one of eight numbered keys the organ will play a tune from the ROM in the I C. Switch to manual and you can play your own compositions.

And now for the most stunning feature of this organ, by utilizing the in-built RAM you can record directly onto the I C up to 96 notes and spaces and then hear your composition by switching to replay! This advanced organ will give hours of entertainment PLUS encourage your child to become another Bach or Handel.

**This amazing I C chip contains: READ ONLY MEMORY, RANDOM ACCESS MEMORY, AUDIO AMPLIFIER, TIMING CIRCUITS - in fact everything needed to give the amazing versatility of this organ. The only other components in the whole unit are a resistor and a capacitor!!!**

**These are the tunes that your mini organ will play for you:**  
★ Yankee Doodle ★ Dixie ★ Silent Night ★ Oh Susanna  
★ Happy Birthday ★ London Bridge is Falling Down ★  
The Yellow Rose of Texas ★ She'll be Coming Round the Mountain.

SEE THE OTHER  
DICK SMITH ADS  
IN THIS  
MAGAZINE FOR  
STORE  
ADDRESSES &  
PHONE NUMBERS



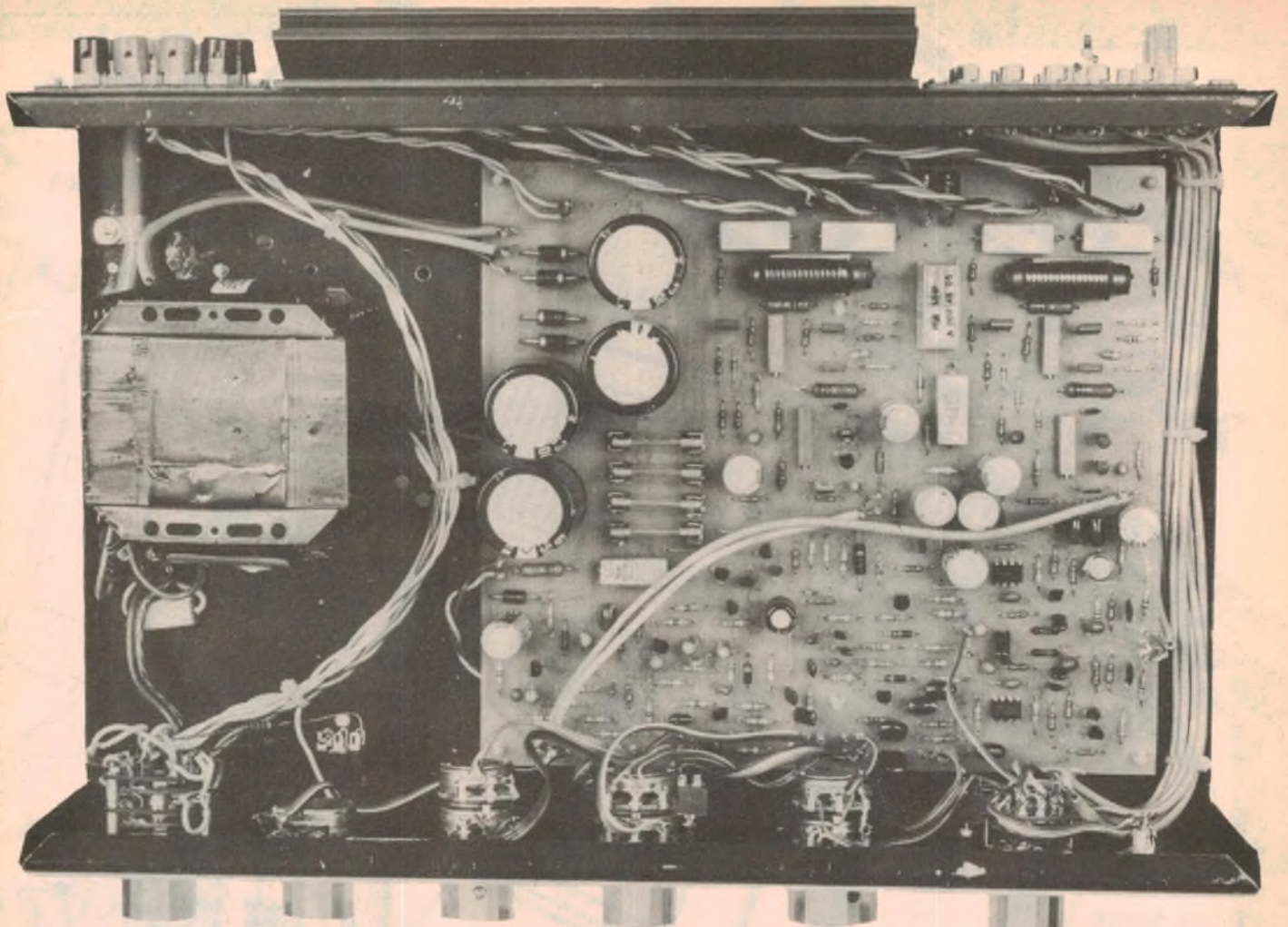

This photo shows the internal layout of the amplifier with the optional Ferguson transformer which is fitted with a copper strap to reduce hum radiation to a minimum.

connected to the selector switch to indicate the signal source in use. These LEDs are fed via a common  $4.7\text{k}\Omega$   $1\text{W}$  resistor from the negative  $50\text{V}$  rail.

This completes the circuit description apart from the loudspeaker protection which may be regarded as optional. However, we strongly recommend that it be included since it adds little to the overall cost. As such, it is a small price to pay to prevent the possible destruction of expensive loudspeakers if an amplifier fault does occur.

Four general purpose transistors, two diodes and one high voltage transistor are employed in the loudspeaker protection circuit. Q17, a BC556 which has a collector voltage rating of  $80$  volts, drives the relay via a  $1\text{k}\Omega$   $5\text{W}$  resistor. A diode across the relay/resistor combination protects Q17 against inductive kickback from the relay when it is de-energised.

Q16 controls Q17 via a  $10\text{k}\Omega$  resistor and  $24\text{V}$  zener diode which we can regard as a short circuit for the moment. When Q16 conducts, so does Q17.

Base bias for Q16 is supplied by a network consisting of two  $56\text{k}\Omega$  resistors, a  $1\text{M}\Omega$  resistor and a  $100\mu\text{F}$  capacitor. At initial switch-on of the amplifier the

$100\mu\text{F}$  capacitor has zero charge, so no forward bias is applied to Q16 and the relay is off. After about three seconds, the capacitor is charged sufficiently to allow Q16 and Q17 to conduct and energise the relay. So the loudspeakers are connected to the power amplifiers, after three seconds delay.

Q13, 14 and 15 monitor the outputs of the power amplifiers for DC fault conditions. They operate in the following way:

Both channels of the amplifier are monitored via a low-pass filter network consisting of four  $22\text{k}\Omega$  resistors and two  $47\mu\text{F}$  non-polarised electrolytic capacitors.

Typically, the DC offset voltage at the amplifier outputs can be adjusted to be between  $\pm 5$  millivolts or better with the aid of the trimpots connected between the emitters of Q6 and Q7 in each channel. However, even if the offset voltage was several hundred millivolts, it would not affect the monitoring network. It is only if one of the amplifier outputs goes negative or positive by two volts or more, that the monitoring circuit reacts.

If one of the amplifier outputs goes negative by two volts or more, Q13 is forward-biased, turning on Q14 which removes the bias from Q16. Thus Q17

and the relay are turned off, disconnecting both loudspeakers. Similarly, if one of the amplifier outputs goes positive by two volts or more, Q15 is forward-biased, which again turns Q6, Q17 and the relay off.

The zener diode between Q16 and Q17 makes the protection circuitry disconnect the loudspeakers, very shortly after power is removed from the amplifier. If the zener diode was not included, the relay would not de-energise until the main amplifier supply rails had dropped to only a few volts. By that time, which may be 30 seconds or more, the power amplifier input stages, Q6 and Q7 are about to lose control of the output stage.

While this does not mean dire consequences for the loudspeakers, due to the low voltages involved, it does mean that the DC offset voltage at the output of each power amplifier may momentarily increase to  $\pm 50$  millivolts or more. If the relay disconnects the loudspeakers when this relatively large DC offset voltage is present, the loudspeakers will produce an audible click. Since that is not "refined" we added the zener diode between Q16 and Q17 to make sure that the relay drops out when the



amplifier supply rails drop below about 30 volts. At this voltage, the amplifier input stage has full control of the output and there is no click from the loudspeakers when they are disconnected.

Incidentally, while some readers may regard the loudspeaker protection circuitry as optional and elect not to incorporate it, the foregoing discussion about offset adjustment does not lead to the same conclusion about the offset adjustment trimpots. These should be left in even if the loudspeaker protection is omitted.

And now for a brief discussion on the performance of the new amplifier. Two sets of figures are provided for power output and signal-to-noise ratios. The slightly lower figures refer to the performance with the Jones JT 320 C-core power transformer while the higher figures refer to the Ferguson PF 4361/1 which is a conventional transformer with a copper strap to minimise flux leakage.

While the differences in power output are relatively small, reflecting the improved regulation of the bigger conventional transformer, the improved signal-to-noise ratios are very worthwhile and constitute a readily audible benefit. In subjective terms, the Ferguson transformer with copper strap renders the hum output of the amplifier virtually inaudible while, in very quiet rooms and with the gain well advanced, the other transformer does cause audible hum from the loudspeakers.

We estimate that the current cost of parts for this project is about

**\$160**

including sales tax

Another advantage of the Ferguson transformer is that it has a pair of 15V windings which may be used in either of two ways. For situations where the mains voltage is consistently above 250VAC, these two windings may be connected together in series and then in series with the main primary winding to reduce the secondary voltage. As well as reducing heat dissipation within the amplifier this will probably also improve long-term reliability.

Alternatively, the start of one 15V winding can be connected to the finish of the other 15V winding and the centre-tap so formed connected to the chassis earth. In this mode the two windings function as an electrostatic screen which can minimise any common-mode noise superimposed on the mains.

Note that the alternatives listed above are just that — alternatives. You must not try to do both. That is, both windings must be connected together. You can-

## PARTS LIST

### CHASSIS & HARDWARE

- 1 plated steel chassis 370 x 111 x 245mm (W x H x D) with cover
- 1 front panel to suit
- 1 Ferguson PF 4361/1 transformer or JT 320 C-core
- 1 printed circuit board 221 x 203mm (80sa10)
- 1 3-pole, 4-position rotary switch
- 1 4-pole, 4-position rotary switch
- 1 100k $\Omega$  (lin) potentiometer (dual gang)
- 1 50k $\Omega$  (lin) potentiometer
- 1 20k $\Omega$  (lin) potentiometer (dual gang)
- 6 1k $\Omega$  trimpots
- 1 50k $\Omega$  (log) potentiometer (dual gang) with 40% loudness tap
- 6 knobs to suit front panel controls
- 4 DPDT miniature toggle switches
- 1 SPDT miniature toggle switch
- 1 6.5mm stereo headphone socket without switch (plus insulating washers)
- 2 6-way RCA socket panels, Ralmar M241 or similar
- 2 4-way spring loaded terminal panels, Ralmar ST3 or similar
- 1 single-sided heatsink, Ritronics, or similar, 190mm long
- 6 Richco CBS-6N plastic PC board supports
- 4 sets mounting hardware for TO-3 transistors
- 1 binding post for chassis earth
- 1 3-way insulated terminal block
- 8 solder lugs
- 10 plastic cable ties
- 1 rubber grommet
- 1.5 metres 3-core mains cable (7.5 amp)
- 1 3-pin mains plug
- 1 mains cable clamp
- 4 adhesive rubber feet
- 0.5 metres tinned copper wire
- 1.5 metres 10-way ribbon cable
- 2.0 metres figure-8 shielded cable
- 1 12V DPDT relay (FEME A002 45 05) or similar
- 8 PC board mounting fuse clips
- 4 2-amp 3AG fuses
- 2 x 14 $\mu$ H chokes (see text)
- 60 printed circuit board pins

### SEMICONDUCTORS

- 4 x 1N5408 power diodes
- 1 x 1N4002 power diode
- 2 x 1N914, 1N4148 signal diodes
- 1 x BZX79/C24 zener diode
- 1 x BZX70/C15 zener diode
- 1 x BZX79/C15 zener diode
- 4 x 3mm red light-emitting diodes
- 6 x BC549 NPN transistors
- 3 x BC547 NPN transistors
- 5 x BC556 PNP transistors
- 1 x BC557 PNP transistor
- 4 x BF469, MJE340 NPN transistors
- 2 x BF470, MJE350 PNP transistors

- 2 x LM394 NPN super-matched pairs or 4 x BC549 (see text)
- 2 x 2SK-133 or 2SK-134 Mosfet power transistors
- 2 x 2SJ-48 or 2SJ-49 Mosfet power transistors
- 2 x TL071 BiFet op amps

### CAPACITORS

- 4 x 2500 $\mu$ F/63VW electrolytics
- 1 x 1000 $\mu$ F/16VW electrolytic
- 1 x 470 $\mu$ F/16VW electrolytic
- 4 x 100 $\mu$ F/100VW electrolytics
- 1 x 100 $\mu$ F/25VW electrolytic
- 3 x 47 $\mu$ F non-polarised electrolytics
- 2 x 33 $\mu$ F/50VW electrolytics
- 6 x 10 $\mu$ F/25VW tantalum or low leakage electrolytics
- 6 x 4.7 $\mu$ F/25VW tantalum or low leakage electrolytics
- 2 x 1 $\mu$ F/35VW tantalum or low leakage electrolytics
- 4 x 0.47 $\mu$ F/35VW tantalum or low leakage electrolytics
- 14 x 0.1 $\mu$ F greencap (metallised polyester)
- 2 x .068 $\mu$ F greencap
- 4 x .047 $\mu$ F greencap
- 6 x .0068 $\mu$ F greencap
- 2 x .0056 $\mu$ F greencap
- 2 x .0033 $\mu$ F greencap
- 2 x .0012 $\mu$ F greencap
- 2 x .001 $\mu$ F greencap
- 1 x .01 $\mu$ F/240VAC metallised paper
- 2 x 150pF ceramic
- 2 x 100pF polystyrene
- 2 x 47pF ceramic
- 2 x 33pF ceramic
- 2 x 27pF ceramic

### RESISTORS (all 1/4W/5%)

- 3 x 1M $\Omega$ , 2 x 820k $\Omega$ , 2 x 560k $\Omega$ , 2 x 330k $\Omega$ , 4 x 220k $\Omega$ , 2 x 82k $\Omega$ , 10 x 56k $\Omega$ , 8 x 47k $\Omega$ , 1 x 33k $\Omega$ , 4 x 22k $\Omega$ , 1 x 15k $\Omega$ , 9 x 10k $\Omega$ , 6 x 4.7k $\Omega$ , 4 x 3.9k $\Omega$ , 4 x 2.7k $\Omega$ , 8 x 2.2k $\Omega$ , 3 x 1.8k $\Omega$ , 12 x 1k $\Omega$ , 2 x 560 $\Omega$ , 2 x 220 $\Omega$ , 2 x 180 $\Omega$ , 15 x 100 $\Omega$ .

### OTHER RESISTORS

- 2 x 12k $\Omega$  (1W), 1 x 4.7k $\Omega$  (1W), 1 x 2.2k $\Omega$  (1/2W), 1 x 1k $\Omega$  (5W), 1 x 820 $\Omega$  (5W), 2 x 330 $\Omega$  (1/2W), 4 x 100 $\Omega$  (5W), 2 x 10 $\Omega$  (1W), 4 x 0.47 $\Omega$  (5W).

NOTE: Resistor wattage ratings and capacitor voltage ratings are those used for our prototype. Other voltage ratings may be used if available, provided the ratings are not exceeded. Where voltage ratings are not quoted, as for greencaps, they should be 50V or more. "Low leakage" electrolytics specified as an alternative to tantalum are the recently released Elna RBLL series or equivalent ultra low leakage types.



Bill Edge's

# ELECTRONIC AGENCIES

**bonkcard**  
welcome here  
115-117 Parramatta Road Concord 2137  
(Corner Parramatta Rd & Lloyd George Ave)  
Tel: 745 3077 (two lines)

what else do we carry?  
HARDWARE \* TOOLS \* WIRE \* SEMIS  
VALVES \* HI-FI \* KITS \* PA EQUIPMENT  
MIKES \* SPEAKERS \* CAR RADIOS  
CAR CASSETTES \* INTERCOMS \* BOOKS

**MAIL CHARGES**  
\$1 packing charge plus the following:  
FREE \$10-\$24.99  
\$5-\$9.99  
\$10-\$24.99  
\$25-\$49.99  
\$50-\$99.99  
\$100 or more

into kits?  
get into Electronic Agencies!  
TV or FM masthead amp  
If you're having trouble with your TV or FM reception, this simple kit could solve your problems. Gets the signal up above the noise and 'snow'. (Note

**TRADING HOURS**  
9am-5.30pm  
Mon-Fri 9am-noon  
Saturday 10am-2pm  
Sunday

look at these brilliant new kits!

## Engine Analyser kit

Keep your car in tune and save fuel. This unit measures RPM, dwell and battery voltage on any 4, 6 or 8 cylinder petrol engine. Complete kit



**\$55.50**

DEAR CUSTOMERS. Please phone us before coming in to check that what you're after is in stock and that the price is correct.

Bill Edge and staff

We at Electronic Agencies believe that we have the best range of kits in stock in Australia. This page shows just a few of the proven designs we carry. All kits include fibreglass PCB boards at no extra cost, all parts and full instructions.

## Win your fortune! "Selectalott"

Why bother thinking up numbers when this great little kit can do it for you? 40 LEDs tells you what to pick. Who knows? You could even win! Great conversation piece (also useful for picking dishes in Chinese restaurants!)



**\$22.95**

## NEW Utilux line connectors

This series of multi way line connectors is just the thing for wiring looms in amplifiers, power supplies, in fact just about anything. And look at these prices! All are sold as a plug & socket pair. 2 way 75c, 3 way 98c, 6 way \$1.40, 12 way \$1.50. They're so new we don't even have a picture!

## build these superb speakers & save!

The ETI 4000 speakers have set a new standard for build it yourself audio.

Complete kits (all speakers, crossover etc.)

ETI 4000-1 4 way **\$459** pair  
ETI 4000-2 3 way **\$360** pair

### Cabinets.

Fully assembled & veneered.  
For 4000-1 per pair \$300.00 For 4000-2 per pair \$200.00  
Note "Freight on" only



Incredible quality!

## NEW wideband receiver kit

Four ranges from broadcast to 30MHz. Complete kit (see EA Nov 1980 for details). only:

**\$65.00**

## Drill speed control

The easiest way to get more use out of your electric drill. Complete kit only

**\$13.50**

## ETI438 LED level display

8 LEDs give a graphic indication of how your amp's performing—lets you know when clipping's occurring before you destroy your speakers! PCB and all parts

**\$11.95**

## ETI467 4-input preamp

Suits virtually any power amp needing 1V drive. Three band tone controls for the flexibility needed for guitars, keyboards etc. PCB board and all parts except power transformer.

**\$29.50**

## Dual power supply

Perfect for preamps, equalisers or for experiments with op amps ± 15V output. without transformer

**\$9.50**

## Own a microwave?

This simple to build kit checks any microwave oven for harmful leaks. ETI 724

Complete kit only: **\$14.95**

## 300W of power! - Playmaster quality

Playmaster 300 watt Amplifier (EA June 1980). The 300 watt module kit includes heatsink, thermal cutout, nuts, bolts PCB and components. All you need is a soldering iron, drill, cutters etc. You'll also need a multimeter (we have them from \$9.50).

**\$85.00**

### MODULE KIT POWER SUPPLY TO SUIT 300 WATT AMPLIFIER

Includes transformer and all parts to construct the complete power supply **\$52.95**

SPRITE FAN (100mm 240VAC)

Recommended by EA for the project. **\$29.50**

## CHASSIS & HARDWARE PACK FOR THE 300 WATT AMP

This pack includes all you'll need to finish off the amplifier kit (except the case & fan). **\$9.95**

CASE: The ideal case for this project is the rack mounting ETI4000 case for ~~\$55.00~~ or the wooden sided ETI4000 case for ~~\$48.00~~

MATT BLACK SPRAY . . . 125 g can . . . **\$2.80**

300 WATT LOUDSPEAKER PROTECTOR KIT **\$12.95**

Cheap insurance at only . . . . . (includes PCB and all components)

## TV CRO adaptor

Like a CRO? Don't like the prices? This could be the answer. Converts your TV (colour or B & W) to a useful audio frequency oscilloscope.

**\$29.40**  
(without mains adaptor)

## Simple car alarm

Easy to build and install, highly reliable. At only \$12.50 it's cheap insurance.

**\$12.50**

## Digital Capacitance meter

Inexpensive digital meter measures from 1pF to 99.00uF in three ranges

Complete kit (see EA Sept 1980)

**\$59.90**



# ROD IRVING ELECTRONICS

425 HIGH STREET, NORTHCOTE 3070, MELBOURNE VICTORIA. Ph. (03) 489 8131.

## NEW PRODUCTS



**JUST WRAP™**

- 30 AWG wire
- 0.25" square posts
- Daisy chain or point-to-point
- Built-in cut-off
- Includes 60 ft wire
- No stripping or sitting required—just wrap!

Part No.	Color	Price
JW-1-B	Blue	\$24.99
JW-1-W	White	24.99
JW-1-Y	Yellow	24.99
JW-1-R	Red	24.99

**JUST WRAP™ Replacement Wire**

Part No.	Color	50 ft roll	Price
R-JWB	Blue	50 ft roll	\$4.99
R-JWW	White	50 ft roll	4.99
R-JWY	Yellow	50 ft roll	4.99
R-JWR	Red	50 ft roll	4.99

## SCOTCHCAL FRONT PANELS FOR ETI & EA PROJECTS:

ETI 452 Guitar Practice Amp	\$4.80
Series 4000 Any colour	\$12.50
MOVING Coil Pre Amp	\$2.00
577 Power Supply	\$2.00
455 Loud speaker protector	\$2.70
Variable power supply	\$2.70
Linear ohmmeter	\$2.50
Muscle activity meter scale	\$1.40
ETI 576 Electromyogram	\$2.80
561 Metal Detector	\$2.50
EA Capacitance meter	\$3.50
EA Flash exposure meter	\$4.25
EA Sound triggered flash	\$3.50
EA Slave flash	\$1.20
EA Playmaster graphic analyser	\$8.50
EA Metal Detector 79md9	\$3.90
EA Pulse generator	\$4.80
EA Square wave oscillator	\$2.50
EA RF Z Bridge	\$3.25
EA Thyristor tester	\$2.40
EA Quartz frequency ref	\$2.70
EA Multi monitor	\$1.90
EA Experimenters Supply	\$2.80
EA Quiz master	\$3.70
EA Variable wiper delay	\$1.10
EA Playmate stereo Amp	\$4.50

ALL FRONT PANELS AVAILABLE FROM DAY OF RELEASE OF MAGAZINES WHEN ORDERING FRONT PANELS. SPECIFY COLOUR OF LETTERING FIRST. THEN COLOUR OF BACKGROUND

## KITS

### TV PATTERN GENERATOR

Kit of parts as featured in Electronics Australia June, 1980. Dot, Greyscale, Crosshatch, Raster Check

Complete Kit	\$48.49
Kit without case	\$36.90
Pack and post	\$2.50

### EPROM PROGRAMMER KIT

Kit of parts as featured in Electronics Australia July, 1980. Programs 2708, 2716 and 2532. Use with TRS80, Sorcerer, and CompuColor. Kit does not include connector from the programmer to computer.

Complete Kit	\$72.49
Kit without case	\$59.99
Pack and post	\$2.50

### DIG CAPACITANCE METER

Kit of parts featured in Electronics Australia March, 1980. Four digits.

Complete Kit	\$52.49
Kit without case	\$39.99
Pack and post	\$2.50

## COMPONENTS

4116 RAMS	\$8.00
2114 RAMS	4.30
2708 EPROM	8.50
741's 10 up	2.50
555's 10 up	2.90
BD139 10 up	5.50
BD140 10 up	5.50
SC141D 10 up	11.00
SC151D 10 up	21.10
RED LEDS 10 up	1.40
RED LEDS 100 up	11.00
YELLOW LEDS 10 up	2.30
8 PIN I/C SKTS 10 up	2.00
BC548	0.15 ea
BC549	0.19 ea
MJ802	3.80
6 800/50V CAPS (LUG)	4.50
5 600/40V CAPS (PCB)	1.90

## KITS & CIRCUIT BOARDS

### ETI SERIES 4000 AMP

● Complete Kit	\$179.00
● Quality front panel to suit above	10.90
● ETI 470 kit of parts	19.90
● ETI 480 kit of parts 100w (incl. bracket)	19.75
● ETI 470 PS kit of parts (includes relay, not transformer)	19.50
● Transformer to suit	22.90
● ETI 471 pre-amp	45.50
● ETI 585R ultra sonic RX	15.95
● ETI 585T ultra sonic TX	8.95
● EA 79 SF9 sound flash trigger	15.00
● All parts available for DREAM computer project.	
● P.C.B.'s (all quality fibreglass boards)	
ETI 574 disco strobe	2.80
ETI 549A metal detector	2.75
DREAM circuit board	10.90



**SCHUGART SA 400**  
5in Minifloppy Drive  
\$399.00 Tax Inc  
\$347.00 ex

**RITRON COMPUTER GRADE P/S**  
+5V reg 10a 16V unreg @ 1A  
KIT \$79.95 inc  
Built and tested \$99.50

**ETI636 MOTHERBOARD**  
7 Slot Motherboard \$77.00  
Built and Tested \$95.00  
ACTIVELY TERMINATED

### INTERSIL LCD \$32.50 3 1/2 DIGIT PANEL METER KITS

Build a working DPM in 1/2-hour with these complete evaluation kits. Test these new parts for yourself with intersil's low cost prototyping kits complete with A/D converter and LCD display (for the 7106) or LED display (for the 7107). Kits provide all materials including PC board, for a functioning panel meter ICL7106EV (LCD).

## COMPUTER COMPONENTS

Attention Sorcerer & TRS 80 owners. Memory expansion kits available. We also offer full service on the popular computer projects and systems.

**SPECIAL 4116 RAM OFFER**  
8 OFF PRIME SPEC 4116 I/Cs \$64.00  
16 4116s for \$120.00  
STATIC RAM KIT 16K S-100

KIT FORM	\$239.00
ASS & TESTED	\$269.00

All front panels available for ETI & EA projects in scotchcal from July '79. Phone for details.

## DIP PLUGS

Ideal for use with flat ribbon cable or to mount components on

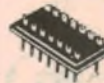

14 pin	\$0.80
16 pin	\$0.90
24 pin	\$1.20
40 pin	\$4.00

## COMPUTER COOLING FANS

Muffin fan 4 3/4" square	
110V	\$39.50
240V	\$26.50

Range of larger fans available. Send for details

## POWER TRANSFORMERS

SPECIALLY DESIGNED FOR MICROCOMPUTERS

● Good regulation electrostatic shield	
● RI 810	
8V @ 10A 2x15V @ 1A	\$22.50
● RI R20	
8V @ 20A 15V @ 1A	\$35.50
15V @ 3A	

## 20 TURN CERMET TRIM POT



### SPECTROL 43P ACTUAL SIZE

STOCK RESISTANCE VALUES  
10R. 20R. 50R. 100R. 200R. 500R. 1K. 2K. 5K. 10K. 20K. 50K. 100K. 200K. 500K. 1M. 2M.

1—9	\$1.40
10—99	\$1.30
100	\$1.20

Values may be mixed

## Hexadecimal Keypad

\$24.50/each



19-key pad includes 1-10 keys ABCDEF and 2 optional keys and a shift key

Ideal for dream project

## MULTIDIALS



Dials to suit 10 T Pots	
Model 21 1 8" dia	\$16.50
Model 16 9" dia	\$12.50
Model 18 1" x 1 75" dia	\$20.60

## P.C. EDGE CONNECTORS



S100 gold plated wire wrap	\$6.90
S100 solder tail	\$6.50
D2 Motorola bus	
43/86 solder tail	\$6.34
43/86 gold plated wire wrap	\$7.40

## DREAM

ELECTRONIC AUSTRALIA MICROCOMPUTER PROJECT

Kit for main board (including programme 2708) \$115.00

Also available re-designed 6802 PCB \$11.90

PCB (fibre glass) only	\$10.90
2708 programmed	\$15.50
Key Pad 19 keys	\$22.50
Kit (less key pad)	\$94.00
PCB for power supply	\$3.50

## 10 TURN POTENTIOMETERS

Stock resistance values

50R 100R 200R	
500R 1K 2K 5K	
10K 20K 50K	
100K	
Spectrol model 534 1/4" shaft	
Price 1—9	\$8.50
10 + values may be mixed	\$7.90

HEAVIER ITEMS ADD ADDITIONAL POSTAGE EXTRA HEAVY ITEMS SENT COMET FREIGHT ON PRICES SUBJECT TO CHANGE WITHOUT NOTICE. SEND 60c & SAE FOR FREE CATALOGUE  
MAIL ORDERS: PO BOX 135, NORTHCOTE, VIC 3070. MIN PACK & POST \$1.00  
PRICES CURRENT UNTIL FEB 7 1980

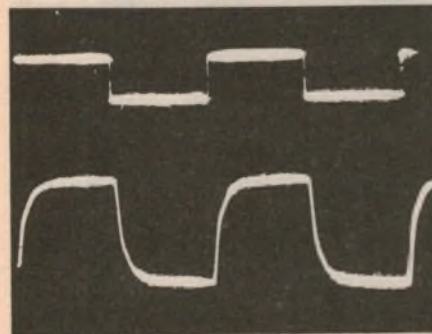
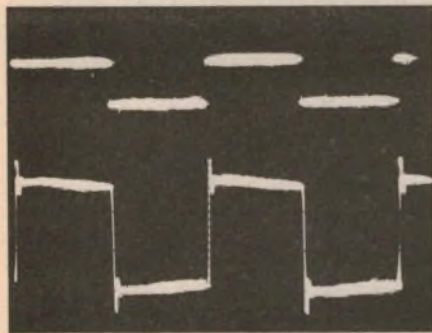
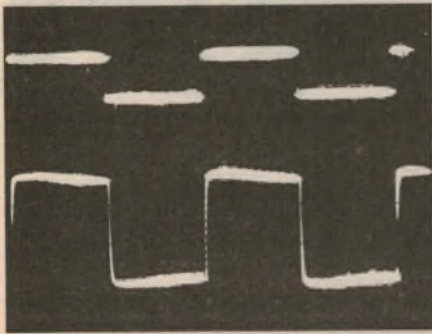

From the top, these square wave oscillograms show the transient performance of the complete amplifier at 50V P-P: 1kHz into 8 ohms; 1kHz into 8 ohms shunted by 1uF; 10kHz into 8 ohms and below, 10kHz into 8 ohms shunted by 1uF. In each case, the top waveform in each photo is the input signal.

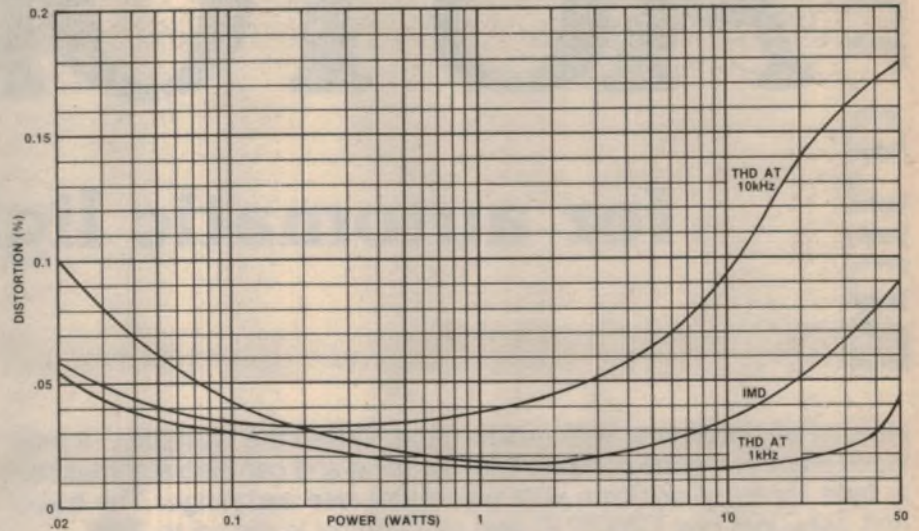
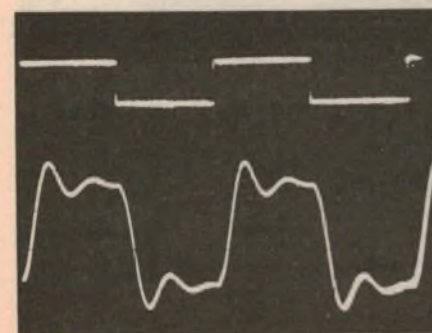

Above is a set of curves showing the distortion performance of the amplifier while below are the tone control and loudness characteristics.

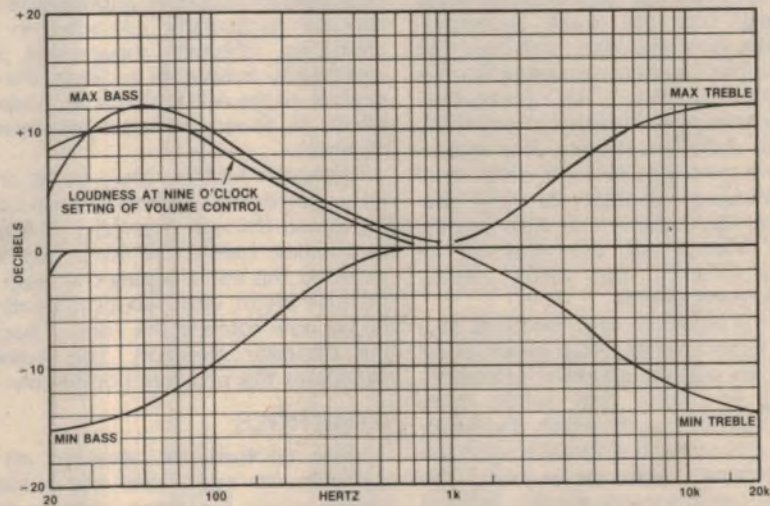

transformer should be terminated directly to the PC board, with the appropriate holes enlarged if necessary. Check this point before beginning assembly.)

You will need about 60 PC pins or stakes, allowing for a few spares, in case some roll into cracks in the floor. Use pins or stakes which are a tight fit into the PC holes. Those stakes with square shanks are preferable. For ease of assembly, insert all PC pins first, before other components, because it is often necessary to use some force in this job. For the same reason, insert the fuseholder clips before installing adjacent components.

Low noise cracked carbon or metal film resistors of 1/4W or 1/2W rating may be used throughout except where we have noted otherwise on the circuit diagram. Insert all the resistors so that their colour code bands run in the same direction. This makes components checking easier.

Ensure that tantalum and aluminium electrolytic capacitors are correctly inserted, otherwise they will be reverse polarised and rendered ineffective. Tantalum capacitors are coded with a dot (as shown on the PC layout diagram) or plus sign to indicate polarity.

Take great care in inserting the transistors correctly, according to the PC layout diagram. Note also that the orientation of the two TL071 op amps is not identical — they point in different directions.

The 14μH chokes are wound with 15 turns of 18B&S enamelled copper wire on a special grade of ferrite rod 30mm long and 10mm diameter. Ordinary ferrite rod used for AM radio antennas is not suitable.

Next month we shall complete the details of construction and give a trouble-shooting procedure.

# AUTODIM

## for automatic light dimming

Here is a light dimmer with a difference. Called the "Autodim" it provides smooth, "snap on" free light dimming and can also automatically fade lights up or down with adjustable rate and range. The basic unit uses just one CMOS IC and can control loads up to 2kW.

by RON DE JONG

Light dimmers are very popular these days especially the small architrave-mounting dimmers. But one function these simple dimmers cannot perform is automatic dimming. This particularly useful feature was included in our three previous Autodim circuits, the last of which we published in 1976. Because of the continuing popularity of these projects we have come up with a new design offering all the features of previous circuits, but using readily available components.

Since the Autodim also functions as a normal light dimmer it can provide soft lighting for parties, watching television, listening to music and other more private activities upon which the Editor will not allow me to elaborate. With the "autodimming" feature as well, the Autodim can automatically dim lights at an adjustable rate and to an adjustable level, all at the flick of a switch.

In fact, the automatic dimming feature makes the Autodim ideal for use as a night light for young children, where the almost imperceptible dimming provided by the fade function creates a relaxing "sunset" effect while the child is falling asleep. The steady and controlled dimming rate could also be used to advantage in theatrical work, where slow "fade up" and "fade down" can make for a really professional performance.

Other possible applications are in photographic studios for producing special lighting effects; in industrial applications where heat or light must be applied at a controlled rate; and in applications where expensive high power lamps, such as projector lights, must be operated on a "soft start" basis to minimise surge failure and prolong life.

One very important feature of the Autodim is that, unlike many commercial dimmers, it provides electromag-

netic interference (EMI) suppression. EMI can be particularly annoying in city areas, so effective suppression is a worthwhile feature. In addition, the dim control on the Autodim has no "snap-on" effect as found in some commercial dimmers.

To explain further, "snap-on" is an effect whereby the dimmer control has to be turned through (typically) 30-40% of its rotation before the lamp begins to glow. At this initial setting the lamp will be quite bright, although it can be dimmed by now rotating the control back in the opposite direction. The Autodim eliminates this problem completely.

### CONTROLS

Three controls are provided on the Autodim, viz "rate", "dim" and a function switch which has three settings; either "Fast On", "Variable" (Var), or "Off". When the function switch is in the variable position the dimming level is set by the dim control, just as in a normal dimmer. The rate at which the dimming level changes is controlled by the rate control, which provides a range in dimming time from around two seconds to three minutes.

The "fast-on" and "off" positions of the function selector are provided for extra convenience. In the fast-on position the light dimmer turns full on immediately while in the off position the dimmer will dim down to off from a set dimming level at a rate set by the rate control.

Just to round things out we also have a "Fade" function which is selected by turning the rate control to the off position. The fade function causes the light to dim down very slowly with a fixed dimming time of 30 minutes from full brightness.

All of the features described above are achieved with just one standard CMOS IC at the heart of a Triac power control

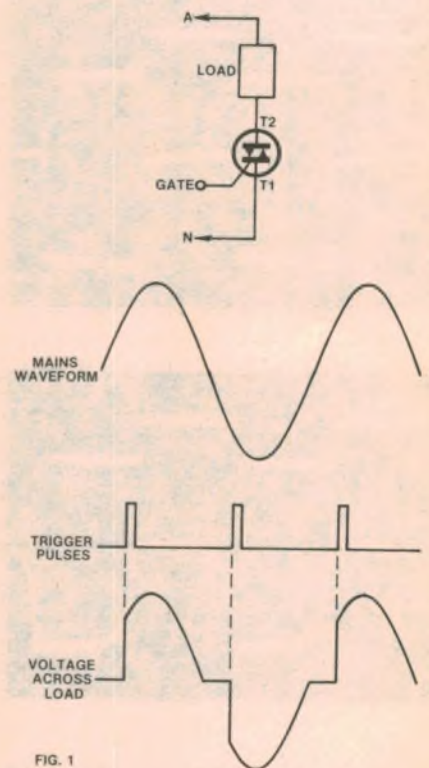
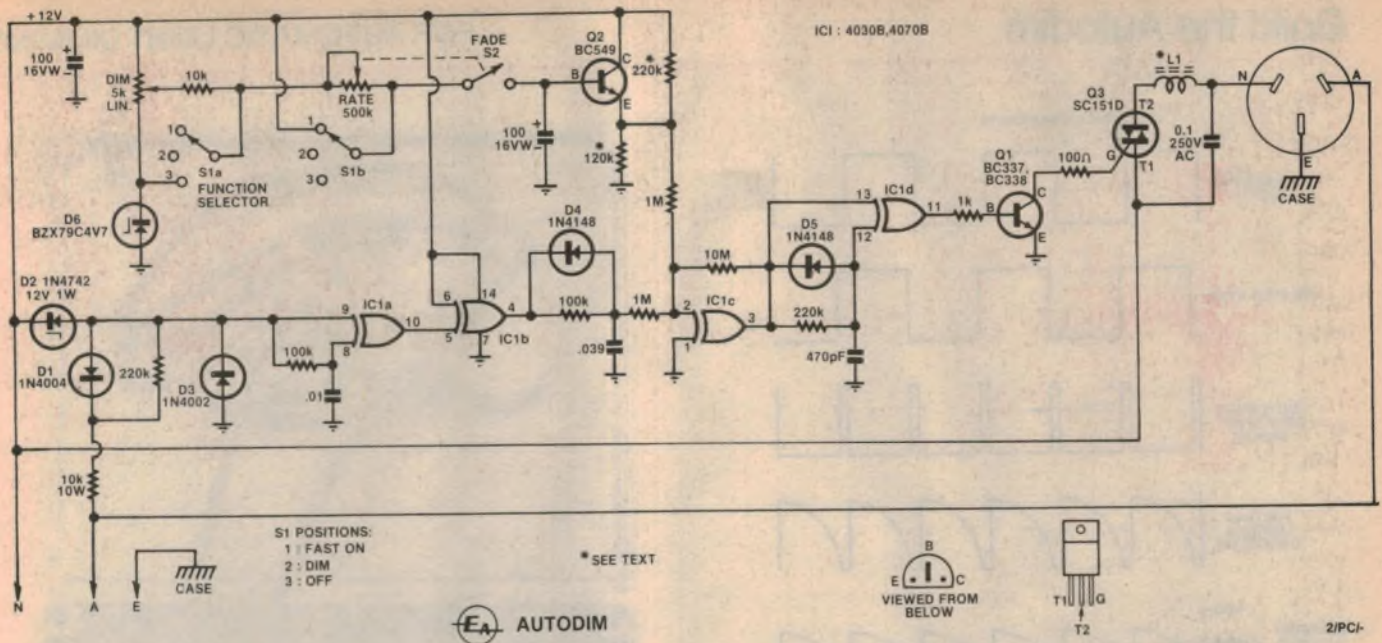

FIG. 1

circuit. A Triac is a bidirectional switching device which is universally used in AC power control applications such as dimmers, motor speed controllers, heat controllers etc. Since it is bidirectional it has no anode or cathode as such, but has two terminals called T1 and T2 plus a control terminal called a gate. When a brief trigger pulse is applied to the gate the Triac turns fully on and remains on until the load current drops to zero, ie at the end of each mains half cycle.

Power control can thus be achieved by "firing" the Triac at a set time or "firing angle" after the start of each mains half cycle. This is referred to as phase control and is illustrated in Fig. 1 which shows a Triac connected to a load, together with typical trigger and load voltage waveforms. Note that power is delivered to the load only after the Triac has fired, and can be varied simply by altering the firing angle of the trigger pulses.



Variable light dimming is achieved by means of a phase-controlled Triac power control circuit.

### THE CIRCUIT

Refer now to the circuit diagram to see how these trigger pulses are generated.

The first step is to derive a suitable synchronisation signal so that the trigger pulses will remain in phase with the mains. In this circuit, sync is obtained from the power supply which consists of a 10k/10W resistor, diodes D1 and D3, 12V zener diode D2, and a 100uF capacitor. This produces a nominal 12V across the 100uF capacitor (which is actually 0.6V less than the zener clipping voltage due to the voltage drop across D1 when it conducts).

The sync signal is taken from the junction of diodes D2 and D3 where the signal is a square wave version of the mains, clipped to 0V by the zener diode on negative half cycles and to +2V by the zener and the 220kΩ pull up resistor across D1 on positive half cycles. The positive transitions of the square wave mark the zero crossing points for the positive half cycles while the negative transitions mark the zero crossing points for the negative half cycles. What we now need to do is convert this square wave signal to a series of brief pulses marking each transition.

The way in which this is achieved is best understood by reference to the waveforms of Fig. 2. First, the square wave signal is fed to one input of IC1a, an exclusive-OR (XOR) gate, and to the other input via a simple RC delay network consisting of a 100kΩ resistor and a .01μF capacitor. Since the output of an XOR gate is high only when its two inputs are at different logic levels, brief pulses will be generated at the zero-crossing points with a pulse width equal to the time delay introduced by the RC circuit (ie about 1ms).

So far, we have a synchronisation signal

consisting of brief pulses generated at each zero crossing. Now we have to provide variable delay of these sync pulses so as to obtain variable firing angle and hence controlled light dimming.

If we wanted a simple light dimmer, this could be readily achieved with another RC delay circuit consisting of a potentiometer and a capacitor. However, because we want the delay to increase or decrease automatically, we need a voltage controlled delay circuit. A potentiometer and a capacitor can then be used to provide a gradually increasing or decreasing control voltage to provide the automatic dimming function.

The voltage controlled delay circuit us-

ed consists of IC1b and IC1c plus associated components. IC1b is connected as an inverter and drives an RC circuit consisting of a 100kΩ resistor and .039μF capacitor, together with D4. The output of IC1b is an inverted version of the sync signal so it is low for 1ms at the beginning of each half cycle and high for the remainder.

Thus, at the beginning of each half cycle D4 is forward biased and the .039μF capacitor is discharged. Following the pulse, the voltage across the capacitor rises slowly as it is charged via the 100kΩ resistor, generating the sawtooth waveform shown in Fig. 2.

This voltage is then applied to one input of IC1c via a 1MΩ resistor. Another



The Autodim can function as a conventional light dimmer, and can be used to automatically fade lights up or down. It can accommodate loads up to 2kW.

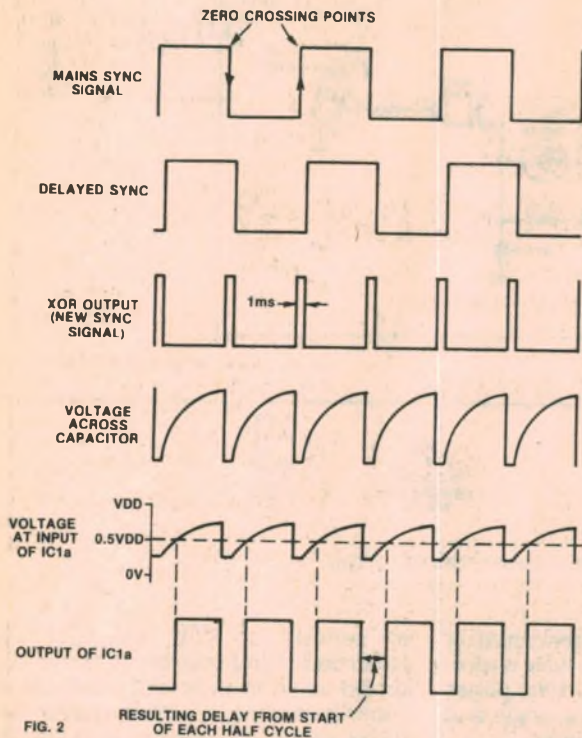
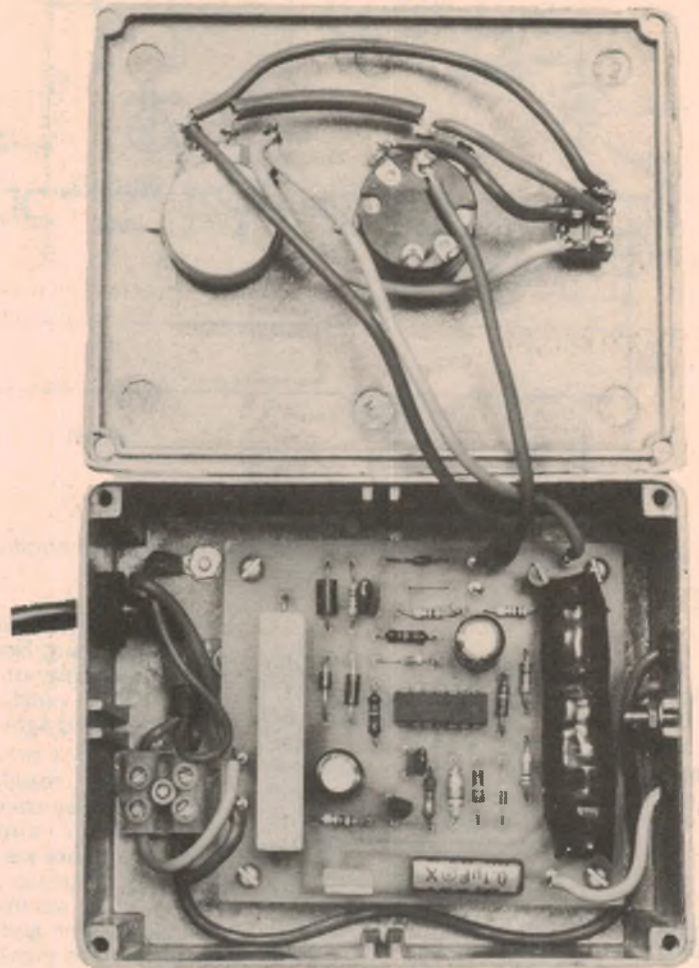

FIG. 2 RESULTING DELAY FROM START OF EACH HALF CYCLE

RIGHT: Inside the completed Autodim. Keep all mains wiring neat and tidy.



1M $\Omega$  resistor is also connected to this point and supplies what is in effect a bias voltage from transistor Q2. Since the transition voltage for CMOS is  $\frac{1}{2}V_{cc}$  – ie below  $\frac{1}{2}V_{cc}$  is a logical low and above it is high – the output of IC1c will go high the instant that the voltages summed together at its input reaches  $\frac{1}{2}V_{cc}$ .

By varying the bias voltage from Q2, the transition point can be varied during each charging cycle, and the output of IC1c will go high sooner or later as required.

A 10M $\Omega$  resistor is included between output and input of IC1c to provide positive feedback to ensure reliable comparator action. This is necessary because at the transition point, the gate functions as a high gain amplifier and would otherwise become quite unstable with a slowly rising input signal.

Now, as mentioned earlier, we require an RC circuit to provide us with a slowly changing voltage. The RC circuit we have used consists of the 100 $\mu$ F capacitor and 500k $\Omega$  potentiometer connected to the base of Q2. Disregarding switches S1 and S2 for the moment the 500k $\Omega$  pot acts as a "Rate" control since, by changing its resistance, we can vary the rate at which the 100 $\mu$ F capacitor charges and hence the rate at which the light dims (or brightens).

The other side of the "Rate" pot goes

to a voltage divider consisting of a 5k $\Omega$  linear pot and zener diode D6. Since the 100 $\mu$ F capacitor will eventually charge to the voltage set by the 5k $\Omega$  pot, and hence to a set dimming level, the pot is called the "Dim" pot. Zener D6 sets a convenient lower limit to the voltage range of the pot.

Function selector switch S1 also controls the operation of the circuit, and has three positions labelled "Fast On", "Dim" and "Off". In the "Dim" position the circuit functions as described above, while in the "Fast On" position S1b pulls the 100 $\mu$ F capacitor straight up to the supply voltage, immediately turning the lamp on to full brilliance. In the "Off" position, S1a switches the charging circuit to the minimum voltage, and the 100 $\mu$ F capacitor slowly discharges to this voltage (ie the lamp fades to off) at a rate set by the "Rate" pot.

The "Fade" function is obtained by switching S2, the switch on the back of the Rate potentiometer, off. The 100 $\mu$ F capacitor is then disconnected from the charging circuit and will very slowly discharge via the base of transistor Q2,

resulting in a dimming time from full on to off of 30 minutes.

To remove any loading effects on the RC charging circuit we have connected a buffering stage between it and the voltage controlled delay stage. The buffer consists of transistor Q2 connected as an emitter follower with a 120k $\Omega$ /220k $\Omega$  voltage divider as the load. The purpose of the voltage divider is to set the minimum bias voltage and hence maximum delay in the firing angle: if the minimum bias is too high the lamp will not completely extinguish, and if it is too low the trigger pulses will be delayed right into the next half cycle, causing the light to flicker.

Due to component variations the minimum bias value may have to be adjusted by altering the 120k $\Omega$  and 220k $\Omega$  resistor values. The bias level must be set so as not to cause flicker when the lamp is almost completely dimmed out. If the resistors are altered, the 120k $\Omega$  resistor should not be changed to less than 100k.

IC1d and transistor Q1 form a simple monostable which generates the actual triggering pulse used to fire the Triac.



For servicing and constructing electronics, when it comes to checking things out you need all the help you can get LEADER

have the top reputation for precision and advanced, practical design.

When it comes to test gear—

when you want to get it right first time—and don't want to pay a fortune—look to LEADER. At Vicom, naturally.

# LEADER

## Top value gear for your test bench

### LEADER'S BRIDGE

Features digital readout of measured values  
A highly efficient bridge for broad and accurate measurements of Resistance, Capacitance and Inductance

**LCR740 \$305**

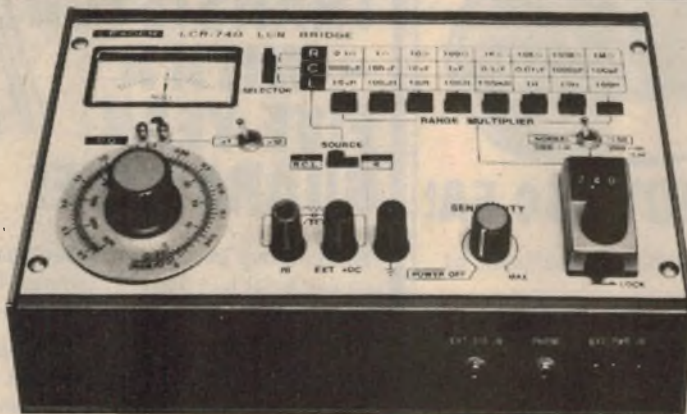

**Specifications:**  
**Distortion measurement**  
 Range—0.3%, 1%, 3%, 10%, 30%, 100% full scale  
**Input Voltage Range—**  
 0.35 to 30Vrms  
**Highpass filter—**Cutoff at 500Hz; 6dB/octave attenuation  
**Accuracy—** ± 5% full scale  
**Power supply—**100, 115, 230V; 50/60Hz. 5VA approx.

### LEADER'S DISTORTION METER

20Hz-20KHz range  
Measures distortion, signal-to-noise ratio and S/N as well as signal levels in all audio frequency circuits.



**Specifications:**  
**Resistance measurement:**  
 Range—0.0001 to 11M in eight ranges with 10% extension in each range.  
**Capacitance measurement:**  
 Range—1pF to 11,000 microfarads in eight ranges with 10% extension in each range  
**Inductance measurement:**  
 Range—0.1 to 1100H in eight ranges with 10% extension in each range

Lightweight, has easy to grip high impact handle and arc-over protection. Indispensable if you're working in TV servicing areas

**Input impedance:**  
 20,000 ohms per volt **Range:**  
 40,000 volts **Accuracy:**  
 ± 3% full scale. **Length & Weight:** 385 mm 300 g approx

### Leader's High Voltage Probe—

**LHM 80A \$43**



### Leader's Dip Meter—

Almost essential if you're into Ham, CB or other communications operation. Determines IC network frequency resonance and can be used to adjust wave traps, find parasitic oscillations and align receivers.

**Frequency Range:** 1.5 to 250 MHz in 6 bands. **Power supply:** 9V battery. **Oscillator:** Uses 1.15 MHz crystal. **Semiconductor complement:** 2 transistors and 1 diode. **Size and Weight:** 175(H) x 65(W) x 50(D), 0.5 kg approx.

**LDM 815 \$99**



### Vicom International Pty Ltd

68 Eastern Road,  
 South Melbourne, Vic. 3205  
 Phone (03)6996700

339 Pacific Highway,  
 Crows Nest, N S W 2065  
 Phone (02)4362766

Brisbane 352522. 3415377  
 Townsville 7722633

Wollongong 291455  
 Cairns 541035

Perth 77 0511  
 Adelaide 43 7981

Wagga 212125  
 Melbourne 8368635

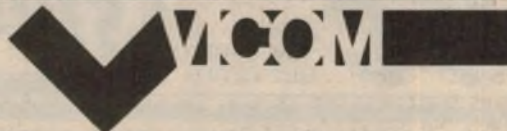

# 1%

## METAL FILM:

### BUT THEY'RE NOT 35¢ EA!



In the past, if you wanted a 1% resistor from us you had to pay 35¢ each! So most people settled for 5 or 10 percent resistors and circuits were designed to accommodate high variations. Now look at the price: Dick Smith Electronics now import high stability, precision made 1% tolerance metal film resistors: and they sell for a **maximum** of 6 cents each (one off!) Why would you still use five or ten percent resistors in your circuits when you can use 1% metal film types for practically no more?

# 6c

 In One-Off Quantities.

## EVEN LESS IN BULK

**MANUFACTURERS, DESIGN LABS, ETC:**

Need large quantities of precision 1% metal film resistors? Dick Smith offers special prices for quantity buyers (and there are even bigger savings for OEM quantities).

# 5c\*

 IN 100 UP QUANTITIES**1% pack**

300 computer-selected 1% metal film resistors, specially prepared for the design laboratory or the professional hobbyist.

**NORMAL VALUE OVER \$15.00 ONLY**  
**\$12.90**



## A BETTER TRANSISTOR - WITH A FIVE YEAR GUARANTEE!

You can buy good, old, garden variety BC548's (or their equivalents) just about anywhere. They're cheap and they are popular.

Trouble is, they're too popular. With so many different manufacturers, standards went out the window. One man's 'prime spec' BC548 is another man's reject.

We decided to change all that. We found a manufacturer who could make transistors as good as any that were on the market.

And if we were prepared to pay a little extra he would make them even better.

We paid a little extra - and we got a better BC548.

The good news is that you don't pay any extra. We're selling our own branded BC548's (we call them DS548 to distinguish them from the rest) at the same price - perhaps even lower - than you're probably paying now.

And just to make things easy, we're even branded the leads so you won't make mistakes.

They're so good we're prepared to back them with a full five year guarantee: as long as they are used within specifications, we'll replace any of our DS series transistors that fail within five years!

Does anyone else give you that sort of guarantee?

## AND THEY COST LESS!

DS 547/548/549

# ONLY 14c

EVEN LESS FOR BULK DS 557/558 17c each

5 year guarantee applies only to transistors mentioned above

## DICK SMITH Electronics



### SEE OUR OTHER ADS FOR FULL ADDRESS DETAILS

# Build the Autodim

FOR AUTOMATIC LIGHT DIMMING

This pulse is obtained as follows: when the output of IC1c goes low, both inputs of IC1d will pull down simultaneously and so its output will also be low. However, when the output of IC1c goes high, one signal input to IC1d will be delayed by the RC circuit comprised of the 220k $\Omega$  resistor and the 470pF capacitor. The resulting short positive pulse on the output of IC1d turns on transistor Q1, which in turn fires the Triac.

The duration of the trigger pulse is about 100 $\mu$ s which is quite long enough to reliably trigger the Triac. The 1k $\Omega$  resistor between IC1d and Q1 limits the current drawn from the gate, while the 100 $\Omega$  resistor between the gate of the Triac and the collector of Q1 limits the trigger current to 100mA.

The only item not discussed so far is the EMI suppression circuit. This consists of RF choke L1 and a 0.1 $\mu$ F 250VAC capacitor acting together as an LC filter to effectively damp the rapid turn-on currents generated by the Triac. This circuit is optional but we have found that it virtually eliminates interference to AM tuners.

## CONSTRUCTION

We assembled our Autodim in a standard diecast aluminium case measuring 55 x 95 x 120mm (D x H x W). Of course it is not necessary to use exactly the same box, and some readers may wish to house the Autodim with other equipment, or build up a bank for use as stage light controls. Note, though, that the Autodim must be housed in a metal case which is securely earthed to guard against the possibility of electric shock.

Most of the components are mounted on a small PC board coded 80ad12 and measuring 84 x 74mm. An actual size artwork for the PC board is shown elsewhere in this article for those interested in making their own board. Alternatively, finished boards can be purchased from most kit suppliers.

Construction is best started by fitting all the hardware to the case. As can be seen from the accompanying photograph, the PC board, mains cord clamp and mains terminal block are all mounted on the base of the case, while the two control pots and the toggle switch are mounted on the case lid. The mains output socket is mounted on one end of the case, nearest the toggle switch.

Drill centres for the front panel can be obtained from the actual size front panel artwork included with this article.

Use a grommet for the mains cable entry hole and secure the cable with a clamp. The mains active and neutral conductors are terminated to the insulated terminal block, while the earth wire connects to a solder lug bolted securely to the base of the metal case. Don't forget

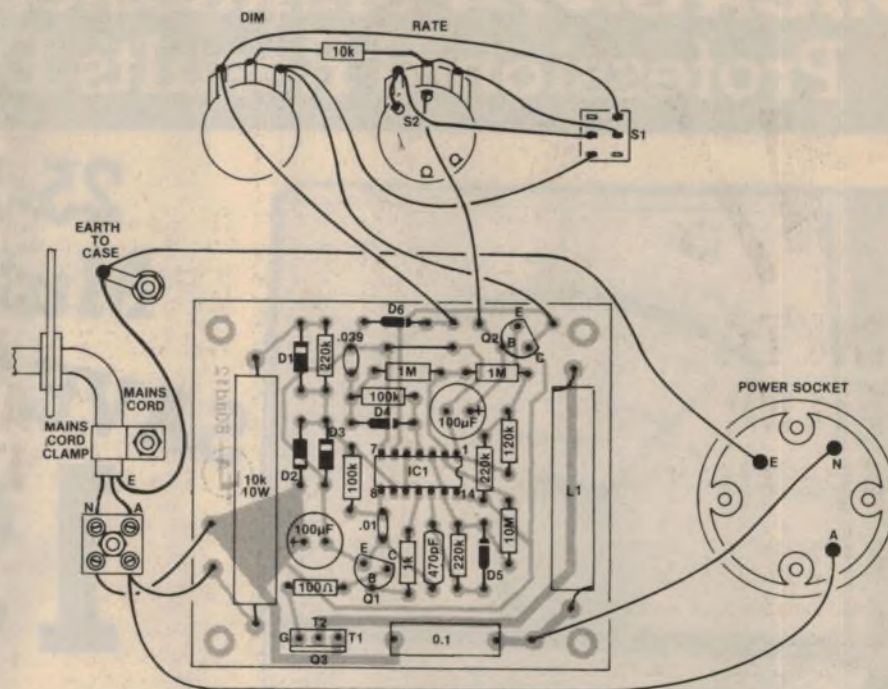

Follow this diagram carefully when wiring up the Autodim. Heatsinking must be provided for the Triac if the unit is to be used with loads greater than 300W.

## PARTS LIST

- 1 diecast aluminium box, 120 x 95 x 55mm
- 1 surface mounting mains socket
- 1 PC board, 80ad12, 84 x 74mm
- 1 mains cord and plug
- 2 mains cable clamp
- 1 RF choke (see text)
- 3 small rubber grommets
- 1 large rubber grommet
- 1 5k potentiometer (1in)
- 1 500k switch potentiometer (1in)
- 1 DPDT centre position off toggle switch
- 1 2-way mains terminal strip
- 4 10mm brass spacers
- 2 knobs to suit potentiometers

### SEMICONDUCTORS

- 1 SC151D Triac, plus mounting hardware if required.
- 1 4030B CMOS quad XOR gate
- 1 1N4002 diode
- 1 1N4004 diode

- 2 1N4148 diodes
- 1 1N4742 12V zener diode
- 1 BZX79C4V7 zener diode
- 1 BC337, BC338 NPN transistor
- 1 BC549 NPN transistor

### CAPACITORS

- 2 100 $\mu$ F 16VW electrolytics
- 1 0.1 $\mu$ F 250VAC metallised dielectric
- 1 .039 $\mu$ F greencap (metallised polyester)
- 1 0.01 $\mu$ F greencap
- 1 470pF polystyrene or ceramic

### RESISTORS (1/4W 5% unless stated)

- 1 x 10M $\Omega$ , 2 x 1M $\Omega$ , 3 x 220k $\Omega$ , 2 x 100k $\Omega$ , 1 x 120k $\Omega$ , 1 x 10k $\Omega$ , 1 x 1k $\Omega$ , 1 x 100 $\Omega$ , 1 x 10k $\Omega$  10W.

### MISCELLANEOUS

- Machine screws and nuts, mains rated hook-up wire, solder lug etc.

to run an additional earth wire from the solder lug to the earth terminal on the mains output socket.

Note that these wiring details should be followed exactly for safety's sake. Again, in the interests of safety, the wires to the mains output socket should all pass through grommetted holes.

Next, mount the various components on the PC board following the overlay

diagram provided. Pay particular attention to the orientation of polarised components and mount the 10k/10W resistor slightly above the board to allow air to circulate under it. Observe the usual precautions when soldering in the CMOS IC: do not handle the pins, connect, the barrel of your soldering iron to the PCB 0V pattern and solder in the two supply pins (pins 7 & 14) first.

# ATTENTION DO-IT-YOURSELFERS!

## MICRONTA® Multitesters Give You Professional Results Everytime



### 25-Range Multitester

SAVE \$10

# 1995

Regular Retail Price 29.95

- Colour Coded Dial
- 20,000 Ohms/Volt

Tandy makes it easy to start saving by doing your own testing and is a must for do-it-yourself kit builders. Large 10cm 3-colour mirrored scale for rapid identification, 6-pin jacks including output jack. Measures: DC Volts: 0-0.6-3-15-60-300-600-1200 at 20,000 ohms/volts. AC: 0-15-60-150-600-1200 at 10,000 ohms/volt. Current: 0-60  $\mu$ A, 3-30-300 mA. DC Resistance: Rx1, Rx10, Rx100, Rx1000. Decibels. -20 to +63 in 5 ranges. Accuracy:  $\pm 3\%$  DC,  $\pm 4\%$  AC. 14x9.8x3.8cm. With leads. Requires 1 "AA" battery. So complete your workbench at low Tandy prices! 22.202

## Multitester Carry Cases

Inexpensive cases to organise and protect your sensitive test equipment. They take most Tandy testers as well as corresponding leads, manuals and extra batteries. Two cases, large and small: 22-153/4 . . . . . 6.95 & 5.95

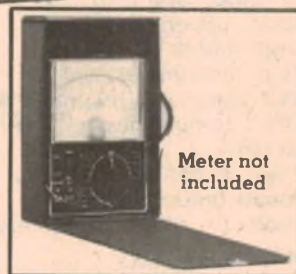

Low As  
**5.95**  
Each



# TANDY

ELECTRONICS

Available at all Tandy Stores and Participating Dealers Around Australia or Mail Order Department, P.O. Box 229, Rydalmere, N.S.W. 2116

The Triac is mounted close to one edge of the board and should use the case as a heatsink if large loads are to be driven. Given this heatsinking, the Autodim can drive loads up to about 2kW, while loads up to about 300W can be handled without heatsinking.

**Important note: the metal tab of the Triac is at mains potential and must be fully isolated from the case using mica washers and a plastic insulating bush. If you do decide to heatsink the Triac, we strongly recommend that you use two mica insulation washers (together with heatsink compound) to increase the breakdown voltage, and that you mount the device using a nylon screw and nut.**

Inductor L1 is not available commercially but is quite easily made. A 50mm length of 10mm diameter ferrite rod is required, though if a longer length has been obtained it can be readily cut to size by filing a groove around the circumference and then snapping the rod as if it were glass.

Wind a layer or two of plastic insulation tape around the rod first, then close-wind a layer of 22B&S enamelled copper wire over the tape. The actual number of turns is not critical; use as many as will fit comfortably.

Next wind another layer of insulation tape around the coil making sure that the tape is wound firmly. If this is not done, the inductor will emit a buzzing sound due to the currents being switch-

We estimate that the current cost of parts for this project is about

**\$25**

including sales tax.

ed by the Triac. The leads can now be scraped clean with a knife or razor blade, tinned, and the assembly soldered to the board.

Now mount the PC board using 10mm spacers and complete the wiring to the PC board and to the front panel controls. Because the circuit operates at mains potential, all wiring should be run only in mains-rated cable.

The front panel for our prototype was made using "Scotchcal" photosensitive aluminium. You can either use the artwork provided to make your own front panel, or purchase a finished panel from the usual retail outlets.

Before switching on, make a final check of all wiring and the PC board assembly. Satisfied that all is correct, plug a 240V lamp into the unit, rotate the rate control to minimum, and test the various functions. First, switch the function switch to "Fast On" to test that the lamp comes on at full brilliance. Now switch to the "Var" position and rotate the Dim control — the unit should behave just like a normal light dimmer.

Next, advance the "Rate" control and

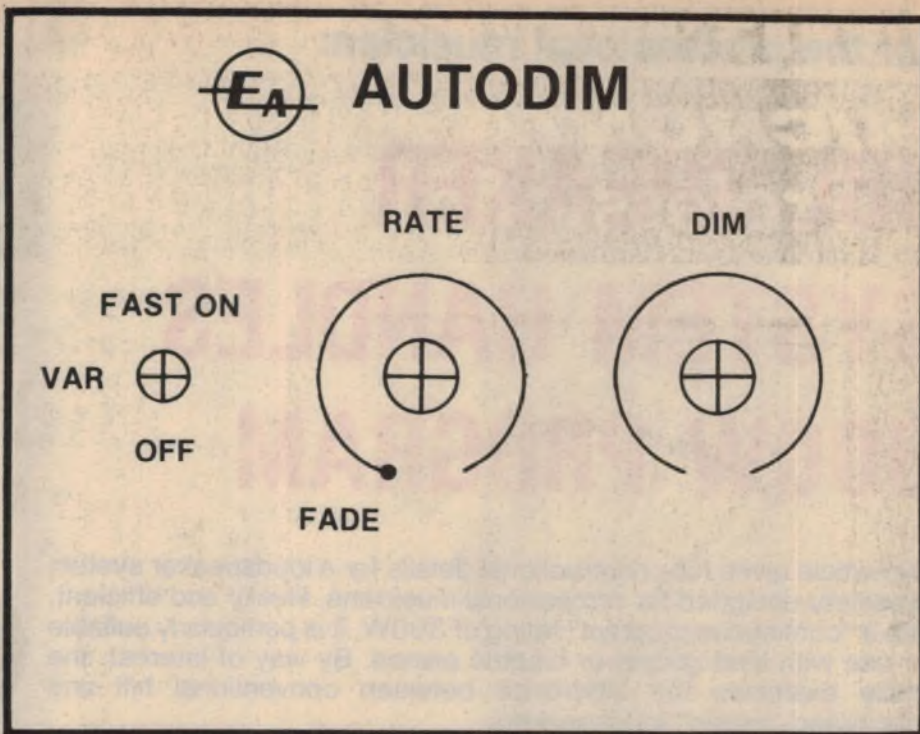

Here are actual size artworks for the front panel and the PC board.

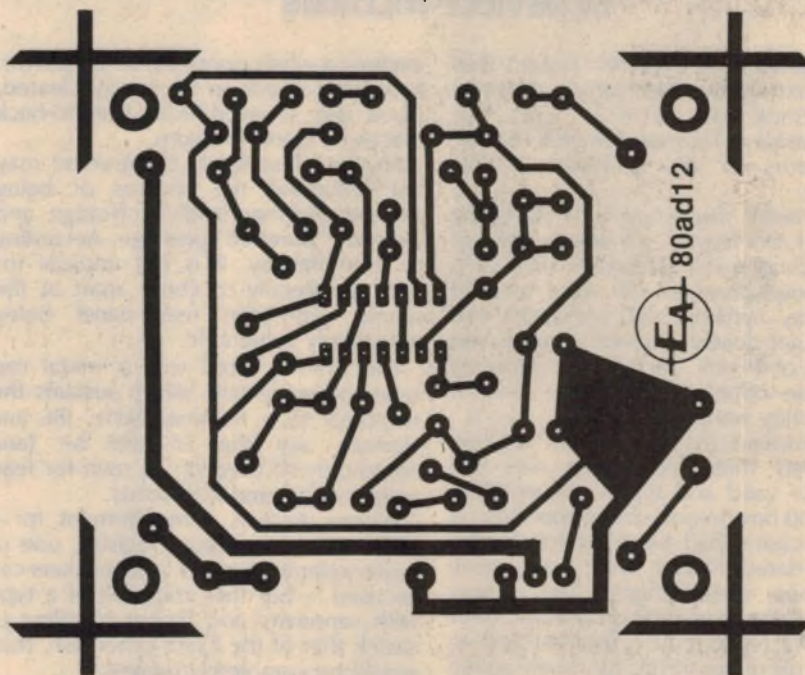

check that it controls the rate at which dimming levels change. The automatic slow fade function is checked by switching the "Rate" control to the "Fade" position.

Finally, a few words are in order concerning troubleshooting the Autodim. Because there is no isolation transformer, and because the circuit operates directly from the mains, most of the circuit can be at active potential. This means that servicing will be quite hazardous, so be very careful if you have any long term plans for staying alive!

If you do have to service the Autodim, we strongly recommend the use of an isolating transformer to minimise the

danger of a fatal shock. You don't even have to use a transformer with a 240V secondary. A transformer with a secondary voltage down to 50V would be ideal for servicing although, naturally, the lamp brightness will be markedly reduced.

Note that where a low voltage isolation transformer is employed, the 10kΩ/10W resistor should be reduced accordingly. For example, if the transformer secondary is 120V, then the resistor value should be halved to 4.7kΩ (the nearest preferred value). If the transformer secondary is rated at 50V, then the resistor should be reduced to  $10 \times 50/240 = 2.2k\Omega$ .

For the professional musician:

# JBL SPEAKER SYSTEM HANDLES 300W PROGRAM

This article gives full constructional details for a loudspeaker system especially designed for professional musicians. Husky and efficient, with a "continuous program" rating of 300W, it is particularly suitable for use with lead guitars or electric pianos. By way of interest, the article examines the difference between conventional hifi and specialised "music" loudspeakers.

by NEVILLE WILLIAMS

An earlier version of this system was presented in the Electronics Australia Year Book of 1976/77, with the cooperation of Harman Australia Pty Ltd, distributors of JBL products in this country.

In a recent discussion with Managing Director, Bill Martin, we asked whether any musicians still assembled their own stage loudspeakers; we were assured that they certainly did. Musicians and groups get closely involved in makes and models of drivers, the type of enclosures they can cope with, and the kind of sound they want to produce.

It transpired that the system we had described three years ago was still basically valid and typical, except that the K130 bass/middle driver specified on that occasion had been superseded by an up-dated model with even more ambitious specifications. The power rating of the new E130 is up from 250W to 300W (continuous program) and an extra 1dB of sensitivity has been added to the K130's already high figure of 104dB.

## THE ENCLOSURE

In regard to the enclosure, we discussed this at some length with John Barclay, who is National Manager for the Professional Division of Harman Australia. He said that, for the role under discussion, the E130 could be regarded as a direct replacement for the K130. It could therefore be used in an enclosure built to the dimensions, as published earlier.

John did stress, however, that, with its extra sensitivity and power rating, an E130 can place enormous stresses on the

enclosure when operating at full power. Everything needs to be solidly cleated, glued and screwed, with front-to-back braces for good measure.

Anything less firmly constructed may not withstand the stresses of being trucked and manhandled off-stage, and violently "pumped" on-stage. According to John Barclay, it is not unusual for cabinets literally to come apart at the seams, with the rear panel being particularly vulnerable.

The E130 is fitted with a metal cap over the voice coil, which sustains the response to a nominal 6kHz. JBL and Harman say that it can be (and commonly is) used on its own for lead guitar, vocals and keyboards.

Where there is a requirement for a more prominent upper register, one or more separate tweeter loudspeakers can be used — but they must be of a type with sensitivity and power handling to match that of the E130; otherwise, they would be completely useless.

More about this point later.

But why the distinction . . . vocal, lead guitars, keyboards? Surely a good system should be good for anything — hifi, guitars, electric pianos, organs, public address and what have you! It's a point that may puzzle hifi fans and one that warrants clarification.

The long and the short of it is that there are important distinctions between optimised "hifi" and optimised "music" loudspeakers involving such qualities as frequency response, distortion, sensitivity and overload characteristic.

A loudspeaker intended for a hifi system has to be capable of reproducing a wide variety of sound, from the deepest notes of a grand organ to the



*Fitted with corner protectors, flush side handles and castors, the prototype system is rigid, rugged and no more bulky than it needs to be for the job of making a really big noise from lead guitar or keyboard input. A semi-transparent black grille cloth provides the necessary finish, while still giving a hint of the hefty drivers behind.*

shimmering near-supersonics of a cymbal. It should have no obvious peaks or troughs in its frequency response, otherwise it will impart its own "colouration" to instrumental or vocal sound.

Distortion must also be as low as possible at all likely power levels, from a whisper to full volume in the particular listening situation — almost invariably a home environment.

## HIFI LOUDSPEAKERS

To meet these needs, designers of hifi loudspeakers have tended to favour the use of voice coils much longer than the magnetic gap, such that a fixed number of turns remains in the gap, even during extensive cone excursions. The method provides good linear cone drive and accords with compact enclosure design, but it markedly reduces sensitivity, thereby necessitating considerable audio drive power.

For this reason, domestic hifi amplifiers are more likely these days to be in the 20-60W per channel class than 5-20W. In short, sensitivity is sacrificed in the knowledge that extra drive power (in this range, anyway) can be secured without too much hassle.

Nor does a hifi loudspeaker manufacturer have to worry unduly about overload. With the onset of overload distortion, most hifi listeners will react automatically and "turn down the wick" before damage occurs.

A specialised "music" loudspeaker

system differs from the foregoing on almost every count. Consider, for example, the matter of frequency response:

A music speaker is not required to reproduce the sound of any instrument but only that of which it virtually forms a part. Needs vary with the type of instrument, as the following examples should indicate:

**Church or classical electronic organ:** Bass should be well sustained down to 32Hz, middles smooth, upper treble tapered off to minimise risk of the instrument sounding too "reedy".

**Popular electronic organ:** For theatre-style recitals, much the same as for a classical organ. For group work or a "zingy" solo sound, more sustained treble is desirable but a bass roll-off at 50Hz might be acceptable.

**Bass guitar:** Bass sustained to about 40Hz, treble response not important above 2500Hz.

**Hawaiian steel guitar:** Bass sustained to about 50Hz, treble about 5000Hz.

**Lead and rhythm guitar:** Bass sustained to about 50Hz, strong middle response to 6000Hz at least.

**Electric piano:** Broadly similar requirements to lead and rhythm guitar, above.

If a brighter than average sound is required, the response can be extended to 10,000Hz or more by the addition of one or more tweeters having an appropriate power rating.

**Voice, vocals:** Smooth response from 50 to about 7000Hz. Can be similar system as for lead guitar, electric piano, provided the middle and treble is not too peaky, rendering the voice harsh or sibilant.

Looking at these requirements, it is evident that the loudspeaker system for a recital organ or bass guitar must have a fundamental response down to the 30-40Hz region, combined with the ability to generate acoustic power appropriate to the environment. For large auditoriums it adds up to one or more powerful bass drivers, a bulky enclosure and power amplifier with an appropriate output rating.

To meet this specific need, JBL offer a number of specialist bass drivers, of which the E140 is typical. With a diameter of 15 inches, it has a nominal frequency response from 40-2500Hz and a power rating of 200W RMS continuous tone, or 400W continuous program. For a bass guitarist, it could probably be used alone but, for a recital organ it would have to be supplemented by adequately rated drivers covering the mid and upper range.

For all other applications, it is evident that the bottom octave can be compromised, if not sacrificed, and this



## "HOW TO TURN ELECTRONIC THEORY INTO PRACTICE AND MAKE IT PAY..."

"If you understand and enjoy radio and electronics and want to extend your knowledge and experience, then we at Stott's can help you.

Stott's have home-study courses for complete beginners in Radio theory and basic Electronics through to the standards needed to maintain and service Colour Television.

Anyone who has these skills at their fingertips can make it pay by turning a fascinating hobby into a lucrative part or full time profession."

Athol H. Kelly B Com (Hons) A A S A F C I S  
Principal Stott's Technical Correspondence College



**Stotts**



The name to trust in  
correspondence education.

TECHNICAL CORRESPONDENCE COLLEGE

Melbourne, 159 Flinders Lane, 3000 Tel: 63 6212

Sydney, 383 George Street, 2000 Tel: 29 2445

Brisbane, 290 Adelaide Street, 4000 Tel: 31 1627

Adelaide, 85 Pirie Street, 5000 Tel: 223 3700

W. Perth, 25 Richardson Street, 6005 Tel: 322 5481

Hobart, 1st Fl, 29 Argyle Street, 7000 Tel: 34 2399

Singapore, P.O. Box 3396, Singapore 1

Please send me free, and without obligation,  
full details of the following courses:

(PLEASE PRINT)

MR MRS MISS \_\_\_\_\_ AGE \_\_\_\_\_

ADDRESS \_\_\_\_\_

POSTCODE \_\_\_\_\_

Stott's undertake that no sales counsellor will visit you

The Stott's range of courses in  
Electronics is

- Intro to Electronics
- Digital Electronics for Technicians/ Servicemen
- Microprocessors
- AM Radio Receivers
- Radio/TV Servicing
- Colour Television
- Radio for Amateurs
- Amateur and Novice Radio Operators Certs
- Electrical Mechanics

A full range of Hobby and Business courses also available

ALA/ST1929/EA1-81

## Sensitized Copper Board Riston 3000 Coated

(Fibreglass Base)

	Single	Double
36 x 24	\$45.00	\$57.00
24 x 18	\$22.50	\$30.00
18 x 12	\$12.50	\$16.00
12 x 12	\$ 8.00	\$10.75

OTHER SIZES ON APPLICATION

Developer \$4.25 litre  
Concentrate (1 = 4) \$9.50 litre

All plus 15% ST & Freight if applicable

### BPF

## Colour Computer

Full business and games capability.  
Console Monitor Power Supply.  
\$865 + ST if applicable.

# KALEX

101 Burgundy St,  
Heidelberg 3084  
(03) 458 2978  
Telex AA 37678

and at MELTON (03) 743 1011

ELECTRONIC COMPONENTS & ACCESSORIES

## FOR MUSICIANS: A 300W loudspeaker

has important implications. The driver cone suspension can be stiffened, raising the natural system resonance to around 50-60Hz, and a more compact enclosure can be designed around these new parameters. While such a system will still produce plenty of output from low frequency drive, it will tend to be less "fundamental" in its quality. (It will also absorb a lot of punishment!)

A driver reflecting this philosophy is the one which forms the basis of the present system, the JBL E130. Also a 15-inch type with a 4-inch voice coil, it has a nominal frequency range of 50-6000Hz and a power rating of 150W continuous tone or 300W continuous program.

The fact that fundamental output is not required below about 50Hz has another important implication: cone travel will be less, the voice coil can be shorter (hence more of it in the magnetic gap) and efficiency can be improved.

In fact, JBL tend to major on high acoustic efficiency in all their musical instrument speakers by: (1) using large — and expensive — magnets; (2) by making voice coils no longer than necessary and (3) by winding many of the coils with square section wire, thereby putting 25% more conductor in the air gap. The resulting difference is nothing short of startling.

By way of comparison the JBL L-166 hifi system, a fairly sensitive unit by ordinary hifi standards, is credited with a sound pressure level of 89dB at a distance of one metre, on axis, with 1W drive.

But the E140 bass driver, mentioned earlier, is rated at 100dB at one metre on axis, also with 1W drive — a difference of 10dB! This is equivalent to a ratio of 10:1 in amplifier power, meaning that a musician could obtain the same sound pressure level from an amplifier one-tenth the size, or ten times the power level from an amplifier of given size! Subjectively, it will sound twice as loud.

### EVEN MORE SENSITIVE

This is impressive enough but the E130 driver — rated to 50Hz — offers an SPL of 105dB or 5dB better again than the E140! Considering the sound pressure levels which professional on-stage musicians may want to create, it is not surprising that they are willing to pay large money for a sensitivity advantage over conventional hifi systems, of around 30:1, or 40:1.

(For a further discussion on loudspeaker efficiency, see page 32 of the November 1980 issue: "Loudspeakers, what happens to the watts?")

High-power, high sensitivity loudspeakers are expensive, but they are still a lot more economical and more manageable than a ten-fold (or more) increase in the power of already large

stage amplifiers.

And, finally, there is the matter of power rating and overload. With the type of driver under discussion, the designer can arrange that the voice coil tends to move out of the gap as the cone approaches the limits of permissible travel. Instead of threatening the cone structure, excessive drive peaks tend to be rounded off, giving the system a "soft" overload characteristic — even if it happens at a very high volume!

In point of fact, the overload rating of the specialist JBL music speakers is not set by cone travel, but is a heat rating on the voice coil.

Thus the E130 is rated to operate quite safely, in terms of cone travel, with an amplifier delivering a nominal 150W RMS continuous tone — this at or around the frequency where the system impedance is lowest and the effective drive power is highest. But because the heating power of program material — even on stage — is lower than continuous tone, the continuous program rating is 300W.

Considering the sensitivity of the E130, that would represent a very substantial level of sound!

### NATURE OF DRIVE

In passing, John Barclay stresses that the 300-watt program rating assumes clean drive. He states, as one of the hazards for stage loudspeakers, amplifiers which are inadequate for the job in hand and which are operated into overload by overenthusiastic musos. If the peaks are squashed into square waves and the "softer" passages exaggerated, the heat load on the voice coil can reach destructive limits.

What John Barclay is saying, in effect, that the use of a 300W amplifier does not give automatic protection for a 300W loudspeaker. If the amplifier is abused and overloaded, so also will be the loudspeaker.

While the natural response of the E130 is quite reasonable for a high powered driver — nominally to 6000Hz — it needs reinforcement at the top end for a deliberately bright sound. The problem is that no ordinary tweeters would be adequate, because both sensitivity and power rating would be far below that of the E130. JBL's answer to this need is what JBL refers to as the "2901 High Frequency Power Pack".

The term "power pack" is explained by the fact that it is a three-element package comprising a high frequency driver, and a high-pass network and treble control intended to be mounted in a position which will provide access as necessary.

The actual tweeter is a high efficiency compression driver, with integral horn loading and a frontal high frequency lens

## DICK SMITH ELECTRONICS



# NOW OPEN

# 7 DAYS\*

## On Parramatta Rd

Yes! Dick Smith Electronics, your one-stop electronics supermarket, has a branch open 7 days per week! Now you won't be caught short looking for a .001uF greencap to finish a project on Sunday afternoon. Just call into Dick Smith Electronics — Auburn!

\*Open 9AM — 5.30PM Mon-Fri, 8.30 — 12 noon Sat & 10AM — 2PM Sunday

**145 Parramatta Rd,  
Auburn Ph 648 0558**



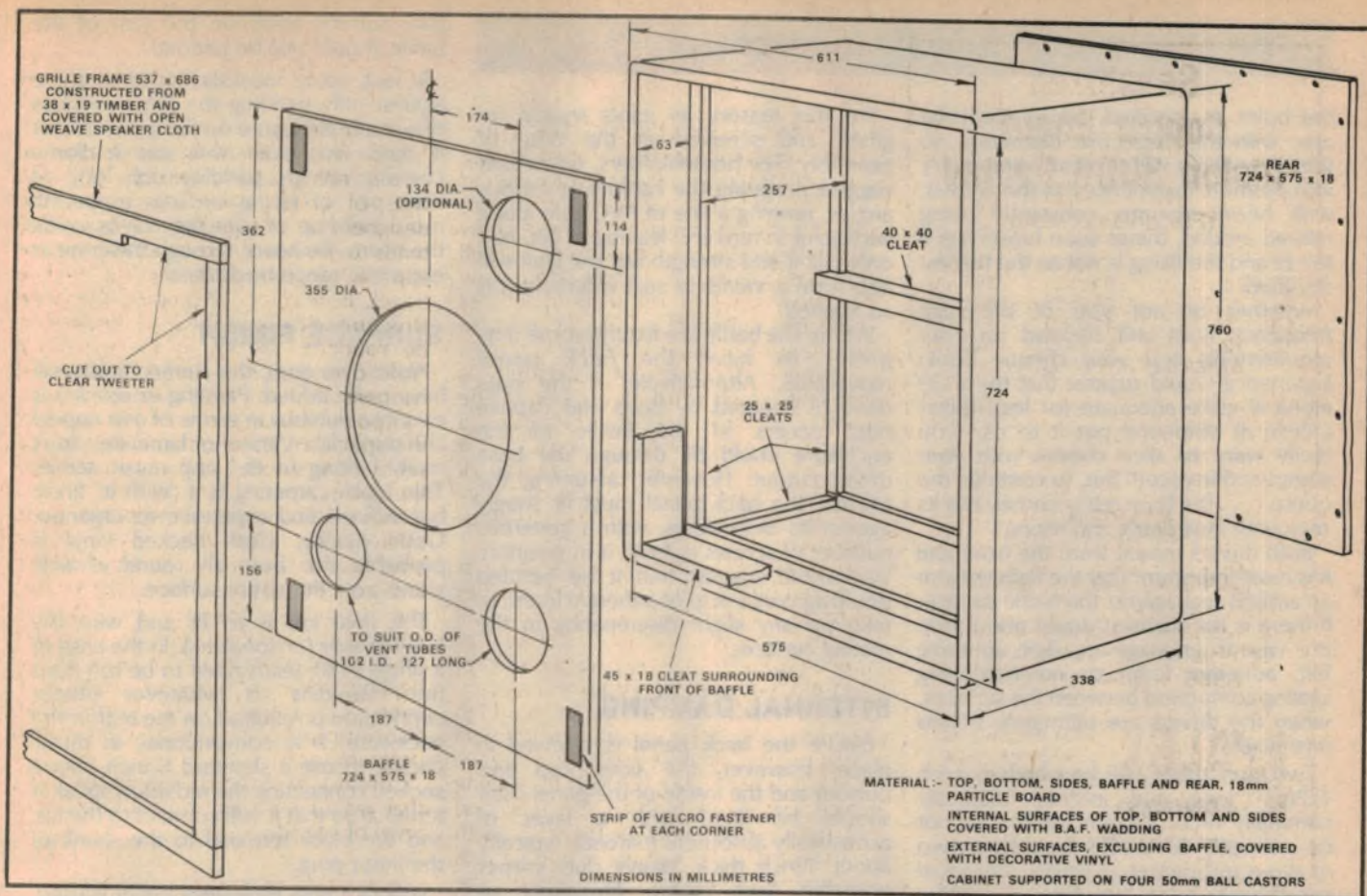

While these plans show one practical way of assembling the 250W music system enclosure, other constructional methods are possible, depending on the facilities available. It is even permissible to vary the proportions slightly to suit timber sizes

or the dimensions of a vehicle, but the actual internal volume must remain the same. The drivers mount from the front and, provided the E130 is retained by bolts and captive nuts, the back panel could be made a fixture. See text regarding sealing.

to ensure wide dispersion of the sound. With aluminium voice coil and an impregnated phenolic diaphragm, it has a nominal impedance of 16 ohms but is suitable for use with either 8-ohm or 4-ohm main drivers, and with power ratings up to 300W RMS. The unit measures 134mm across the front face and is 292mm deep.

## TREBLE RESPONSE

The network is designed to take over above 3kHz and the manufacturer's curve suggests that the 2901 treble driver is about 2.5dB down at 10kHz, and about 7dB down at 15kHz. While the treble driver can be mounted separately from the bass driver, JBL suggest that it should most logically be mounted high up on the baffle of the main enclosure. Since the 2901 driver is sealed off at the rear, it will not suffer any pumping by pressure in the main enclosure.

Unfortunately, the 2901 is an expensive unit and anyone keen to augment the treble response of the E130 may be wise to discuss other possible options with Harman Australia Pty Ltd, at Unit 13A-2, 6-8 Byfield St, North Ryde, NSW 2113. Phone (02) 887 3233.

So much for the design philosophy behind musical instrument loudspeakers

and the particular pair of drivers chosen for the system described here.

Turning now to construction of the enclosure, dimensional drawings for this and other JBL systems have been available for some time from Harman Australia in the form of an informational kit. It is available for \$10.00 from the address given earlier.

Overall dimensions of the relevant enclosure there represented were 30in (762mm) high, 24in (610mm) wide and 12½in (318mm) deep. The material specified was ¾in (19mm) void-free plywood or high density particle board. Internal volume neglecting cleats, padding and speaker displacement, came out at about 3.8cu ft or 108 litres.

For those who have the original JBL informational kit, it would be possible to work entirely from it, following the dimensions, assembly method and finishing details, as set out.

What we describe in this article is essentially a variation from that original data, evolved for the local market, largely as a result of collaboration between Harman Australia and Wasp Industries Limited. This company has accumulated a lot of experience in manufacturing music cabinets and systems for the Australian market.

The enclosure as illustrated is

somewhat deeper overall than the JBL design, but it allows the fret and baffle to be set back to gain vital protection during transport and use. In fact, the proportions of the enclosure could be varied somewhat to suit timber cutting sizes but the actual internal volume must not be altered.

Another point is that the JBL specifications suggest the use of 19mm material for the enclosure walls, whereas locally available particle board is normally 18mm thick. The difference should not be significant, provided everything is solidly assembled and braced.

## EXTRA CLEAT

Incidentally, the extra cleat around the inside lip of the cabinet is optional, its purpose being partly functional, partly cosmetic. It does lock and seal the baffle firmly in position and it does increase the thickness of the exposed front edge as a precaution against abuse. It also makes the enclosure look a lot more massive than it really is!

While it would be possible – and even convenient – to cut the holes with the baffle already fixed in position, it may be wiser to prepare the baffle fully beforehand to guard against the possibility of an inadvertent error. Cut

## FOR MUSICIANS: A 300W loudspeaker

the holes as specified, taking particular care with the respective diameters, so that everything will fit neatly and firmly into position. Experience has shown that, with heavy systems constantly being moved around, things soon loosen up if the fit and the fixing is not to the highest standard.

Whether or not you fit the high frequency horn will depend on your requirements and your cheque book. Experience would suggest that the K130 alone is quite adequate for lead guitar unless, as someone put it to us, "you really want to slice cheese with your strings at thirty feet!" But, to continue the quote, "... the horn really comes into its own with keyboards and Moog".

Both drivers mount from the front and it is most important that the flanges form an airtight seal against the baffle surface. If there is the slightest doubt about this, it is wise to envisage a gasket, adhesive felt, adhesive foam or non-hardening sealing compound between the surfaces, when the drivers are ultimately bolted into place.

Two port tubes will be needed, each 127mm long and internal diameter nominally 4in or 102mm. Results will not be adversely affected if the tube is two or three millimetres oversize. Individual constructors may be able to obtain suitable scraps of large diameter cardboard tubing, or plastic drainage tubing, or even make up their own by glueing and rolling sufficient layers of stout paper or light card.

Alternatively, rectangular port tubes could be fabricated from scraps of plywood or masonite, securely pinned and glued at the corners and then glued into matching cutouts in the baffle. The length would have to be the same as for the round tubes but the internal cross-sectional area would have to be manipulated to about 8170 sq mm or 12.6 sq ins.

### BAFFLE: FLAT BLACK

After pinning, glueing and sealing the port tubes into position, the whole front of the baffle and the inside of the tubes should be painted flat black. The baffle should now be ready to build into the cabinet.

While we have assumed the use of cleats, the main enclosure can be assembled in any way which will ensure that it is completely rigid and airtight, except for the deliberate air path through the twin ports. This is important acoustically since, with the internal pressures generated by a speaker of this power rating, panel rattles or the whistling of air through cracks can be very obvious. Furthermore, a relatively bulky enclosure, manhandled frequently into vehicles and on to platforms, will soon loosen up if not put together rigidly.

For this reason, all joints should be glued and screwed at the time of assembly. For homebuilders, we would suggest propping the cabinet at various angles, running a line of PVC glue along each joint in turn and leaving to set. Not only will it add strength but the glue will also form a meniscus seal wherever it is so applied.

Where the baffle is a fixture, some may prefer to have the back panel removable. Alternatively, if the bass driver is secured by bolts and captive nuts, access to the inside of the enclosure could be through the base driver cutout. However, assuming the former, the back panel must fit snugly against its own cleats, with a generous number of screws to hold it in position. We would suggest that it be bedded down against a strip of adhesive foam, to take up any slight discrepancy in the mating surfaces.

### INTERNAL DAMPING

Before the back panel is screwed in place, however, the sides, top and bottom and the inside of the panel itself should be lined with a layer of acoustically absorbent material, typically about 1-inch thick. Heavy duty carpet underfelt (not foam), fibreglass, or bonded acetate are all suitable for the purpose, glued and/or stapled firmly into position, so that they will not droop against the inner ends of the port tubes.



*While not obvious from this picture, the E130 is a large and heavy loudspeaker requiring a 355mm cutout and weighing 10.1kg. The metal dome cap is not just decorative; it holds up the response to about 6kHz. It is available in 4, 8 and 16 ohms versions. The 2901A treble power pack is compatible with all three.*

Bare surface areas on the rear of the baffle should not be padded.

In fact, some musicians tend to argue against fully padding the inner surfaces of a music enclosure on the grounds that it tends to "dull" the sound. Some compromise by padding only one of each pair of facing surfaces to permit more build-up of standing waves inside the box to be heard through the cone as extra mid range brightness!

### SURFACE FINISH

About this time, the surface finish will have to be added. Painting or staining is easy but dubious in terms of eye appeal and durability. Veneer or laminates don't really belong to the pop music scene. Thin black carpeting is a "with it" finish but difficult and expensive to organise. Good quality, cloth backed vinyl is probably the best all round choice, glued over the entire surface.

The final job is to fit and wire the loudspeaker (or speakers). In the case of a single E130, leads need to be run from the terminals to whatever output connection is required on the rear of the enclosure. It is conventional, in music circles, to use a standard ¼-inch phone socket, connecting the red (plus) speaker terminal so that it will connect to the tip, and the black terminal to the shank of the input plug.

Where a high frequency driver is used, as well, this will have to be interconnected, along with its splitter network. In the prototype unit, as pictured, black wires run to the respective speaker negative terminals, a white wire to the high frequency driver plus, and a red wire to the E130 plus.

For those planning to build their own enclosures, the lumber, oddments and finishing materials would have to come from the usual handyman supply sources. At this point in time, we do not know of any pre-cut panel kits for the particular JBL system described here.

JBL loudspeakers are distributed in Australia by Harman Australia Pty Ltd, Unit 13A-2, 6-8 Byfield St, North Ryde 2113. Phone (02) 887 3233. They can be obtained from, or ordered through, Harman/JBL dealers in all states. Harman advise that the recommended user price for the E130 driver is \$259.00. Recommended user price for the 2901 High Frequency Power Pack is \$459.

A finished enclosure, similar to that pictured, is obtainable from Wasp Industries Ltd, 39 Chalder St, Marrickville, NSW 2204. Phone (02) 560 3488. They can advise about interstate outlets. Price of the cabinet is \$185.00 with rubber feet or \$195.00 fitted with castors, as pictured.

The same company can supply the driver(s) separate, or the complete system ready to operate for the cost of the individual units: enclosure \$185 or \$195; E130 \$259; 2901 (optional) \$459.

# What's so hard about a DICK SMITH Kit?

**Just choose a kit.**



Everything from audio amplifiers to car ignitions with degree of difficulty for your guidance.

**Full instructions PLUS guide to kit construction included**



**all parts supplied**

Just follow the simple, step-by-step instructions. You'll find all the parts are supplied - even nuts, bolts and even solder!



**It's finished & it works**

And it looks so good your friends will never believe that you actually built it yourself! Settle back and wonder why you never built anything before!

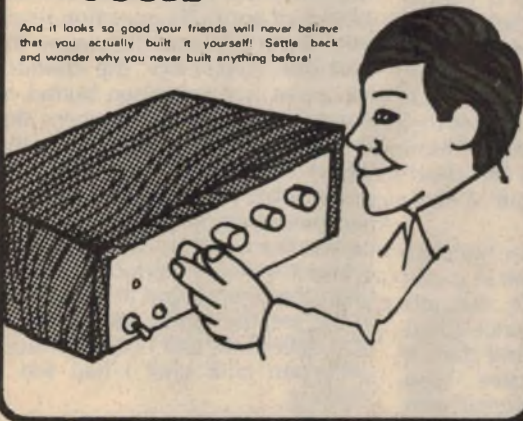

**GUARANTEE**

All Dick Smith kits are made from brand new and guaranteed components. Each kit is made up in consultation with the major electronics magazines, and includes latest amendments.

If by chance you cannot get your kit to work, many of the major kits include a 'sorry Dick, it doesn't work' coupon which allows you to have the kit serviced in our laboratories for a token fee.



**The first step?**

*send for our*

**FREE**

**Colour Kit Catalogue**

Our colour kit catalogue contains detailed illustrations of most of our kits - and it's yours free for the asking.

16 pages of kits for all tastes and budgets. Send for your free copy today!

(also available to personal callers at any of our stores and many re-sellers)



**MAIL ORDER CENTRE**

P.O. Box 321, North Ryde, NSW  
2113, Australia.

**Dick, send me my FREE Colour Kit Catalogue.**

Name .....

Address .....

Postcode .....

**DICK SMITH ELECTRONICS**



SEE OUR OTHER ADVERTS IN THIS MAGAZINE FOR OUR STORE ADDRESSES AND RESELLERS

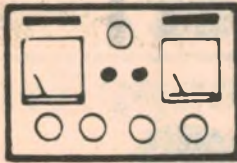

# The Serviceman

## Do it yourself — or servicing the hard way!

As professional servicemen we are inclined to take for granted a lot of the incidental information, details, and general know-how which we have acquired over the years. But, if we are inclined to sell ourselves short on our skills, or if others are tempted to accuse us of profiteering, this month's story gives food for thought.

In particular, the story emphasises the wide range of minor problems, which can arise in a typical service situation, and which the average serviceman has learned to take in his stride.

It was sent to me by a retired electronics engineer, who hoped it might prove interesting. His technical background is a mixed one, but it did involve some servicing in the TV monochrome era.

With the advent of colour, and changed circumstances, he retained an interest in the subject, but with diminishing involvement on the practical side. So what did he do when his own colour set blew its top?

What follows is my somewhat shortened version of what he typed up for me — still essentially in his words. He also supplied a copy of the circuit but the Editor says that there is no way he could accommodate a couple of large diagrams, as well as the rather lengthy story. If you do have access to the circuit, you can follow through in detail but, even without it, the story still makes sense. Here it is:

This is about a Rank Arena 26in colour set, the 2601. It is about five years old and, until now, had not missed a beat. It all started while my wife and I were watching a "who-dun-it" show; there was an almighty crack from inside the set and the picture collapsed to a thin bright line. We never did find out "who-dun-it"!

It was obviously an EHT flashover. I pulled the back off the set and had a quick look for signs of tracking or burning. I found nothing, and decided to give it away for the night.

Next morning, with the brightness control turned down, and one eye on the EHT leads, I gingerly switched on, to be greeted by the expected horizontal line. I checked again for signs of burning or

tracking but found nothing. So I let it run, hoping that I would see what happened when it did.

I had almost concluded that it wasn't going to happen — when it did! SPLAT! Being only inches from it made it quite startling and my finger on the power switch reacted automatically. But I did see it. It had occurred on the rear of the tripler assembly, at the top, from somewhere near where the EHT lead emerges to a terminal about 25mm away.

Now I had to make a decision. Should I take the easy way out and call in a serviceman, or should I tackle the job myself? It was several years since I had done any TV service work, and then it had been confined to valve type monochrome sets. My experience with colour sets had been confined to superficial things; I had never tackled a real fault.

On the other hand I had a CRO, a multimeter and transistor tester, stocks of resistors, capacitors, etc, plus a service manual for the set. This, coupled with a certain amount of personal pride, finally persuaded me to "ave a go"!



"I need a new vibrator for my old car radio — that one was hard to unplug!"  
("Radio-Electronics")

The first thing was to examine the tripler. By undoing three screws I was able to view the back of it, without disconnecting any leads.

There are two terminals on the back. One, at the top right, I identified as the 8kV input terminal from the line output transformer and the other as a chassis connection (via a small choke). The EHT lead emerged from the top of the case at the top left.

The case proper is of moulded plastic, with the diodes and capacitors buried in a block of epoxy. Examination revealed a tiny hole in the epoxy just below the EHT lead exit. Apparently, the conductor at this point had not been buried deeply enough and it was from here that the EHT voltage had flashed over to the centre (earthy) terminal.

One other point was that the flashover had been through the air, not along the epoxy; there was no sign of a track. This set me thinking. I was faced with the problem that there were at least two faults in the set; the tripler and the failed vertical deflection, and I couldn't tackle the deflection fault until I had the tripler working.

### A DOUBLE TRIP?

To replace the tripler meant a trip to the maker's service department on the other side of the city. Then, when I tracked down the deflection fault, I would probably have to make another such journey for more replacement parts.

If only I could get the tripler working for long enough to find the deflection fault, I could save myself a trip. (I might even save the tripler). I decided to try covering the hole with suitable insulating material.

My choice was that handyman epoxy, "Five Minute Araldite". I mixed up a small quantity and dumped it on top of the hole, covering an area about the size of a 1c piece, and as deep as I could make it.

But, of course, the mix began to spread, changing from a small thick blob to a large thin one. So I turned the tripler upside down and watched the mixture reverse its flow.

Anyhow, for the next five minutes, I turned the tripler first one way up, and

then the other, but I ultimately finished up with a small mountain of epoxy with its peak about 3mm above the hole.

I re-fitted the tripler and switched on. Nothing terrible happened and, after about five minutes I assumed that my idea had worked. So it was time to look at the vertical deflection problem. Here I struck snag number two. When the picture had collapsed it had produced the characteristic bright white line, but now I was hard put to it to find the line.

I had turned the brightness down while checking the tripler and expected it to reappear when I re-set the brightness. Instead, I had to turn it full up, together with the contrast and colour controls, to get even a weak line.

My first reaction was that the tripler was still faulty, such that it was now delivering less than the rated 25kV. I had no EHT probe and, in the old days, I would simply have held the EHT lead near the chassis and judged the performance from the length of the spark.

But solid state systems don't take kindly to such abuse. I connected a well insulated test probe to the chassis via a 10M resistor and gingerly pushed it towards the bare end of the EHT lead which I had unclipped from the tube. When this produced a spark at somewhere around 30mm, I felt fairly confident that the EHT system was working.

## A DOUBLE FAULT

So where did I go from here? I now had two faults; lack of deflection and poor brightness. I decided that the deflection fault might be the one to tackle first, since it was a total failure. So I stoked up the CRO and prepared to do battle.

It was then that I encountered what our friend, Bugs Bunny, would refer to as a "revolting development"; the service manual contained no waveforms, apart from a few sweep generator alignment patterns. I was on my own.

There are two relevant boards in this set; the "deflection board", consisting mainly of vertical and horizontal oscillators and wave shaping stages, and the "deflection out board", consisting of vertical and horizontal driver and output stages.

I started at the input to the second board, connecting the CRO to the underside of the "V1" input pin. This gave a saw-tooth waveform of 1V p-p and I concluded that this was probably a reasonable reading.

Moving to the base of TR410 I found very little signal, and this was my first real clue. Reaching for the multimeter I found that the collector voltage was less than half the indicated value, and that there was no voltage difference between base and emitter.

So TR410 looked like the culprit. Taking it off the board I used a simple ohmmeter test ("Testing Transistors with a Multimeter", EA November 1968) to confirm this.

The question now was, how to replace it. The type number (SP5450) meant nothing to me and I felt fairly certain that it would be available only from the makers. But was it the only fault in the deflection chain? I didn't fancy travelling all the way to the service department for one transistor, only to find that I needed something else.

Could I replace it with something I had on hand? It was a small plastic type similar in appearance to the popular BC548 (BC108). Since I had some BC548s, I thought it might be worth trying one.

## HALF A CURE!

Unfortunately, the result was inconclusive. Certainly it made the deflection system work, but only to the tune of about 20mm on the screen, and about 2V p-p on the CRO at the yoke terminals. Also, the voltages around the stage, while closer to the circuit values were still not right.

So, was the BC548 completely unsuitable, or was one of the other transistors faulty? With direct coupling, complex feedback networks, and no waveforms to guide me, I was stumped.

At about this time I became aware of something else; a probable explanation for the lack of brightness. With a picture only 20mm high it was not possible to recognise any images, but I was aware that something was different.

Then I woke up. All I was seeing was blobs of blue and red colour. There was no suggestion of any outlines, and there was no green. I concluded that what I was seeing was chroma only, with no luminance. The lack of green puzzled me for a while until theory came to the rescue. Green is derived from the luminance signal.

By now I was seriously questioning the wisdom of having tackled the job in the first place. I still had two faults, one of which, the lack of luminance, created visions of all kinds of way-out faults in what was, to me, a strange and complex circuit. If only I had some waveforms as a guide.

This last thought prompted my next step. I rang the maker's service department, contacted a sympathetic technician, and put the situation to him. In particular, I wanted to know whether I could get a set of waveforms, but I was also hoping that he may offer some comments about the specific faults.

The waveform situation was a bit dicey. Apparently there had never been a set of waveforms for this model; everyone had used those from the 22in model which, he claimed, were "very close". But 22in manuals were on back order, and not expected for a couple of weeks.

Driven by frustration, I made so bold as to suggest that perhaps they could make

# APF IMAGINATION MACHINE



## IM-1

Two great achievements — a powerful state-of-the-art personal computer and a thrilling home entertainment centre in one single package ● User-programmable in BASIC ● With loads of pre-programmed software for educational entertainment and home and personal management ● Features — 9K RAM, 10K ROM ● 53 key typewriter-style keyboard ● 32 characters x 16 line screen format ● Alpha numerics in 3 colour modes with up to 8 colours ● Built-in sound synthesizer with a range of 3 octaves including flats and sharps ● Six function built-in cassette tape deck ● 2 game-style hand-held controllers ● Unique shift key for "BASIC keyboards" ● Expandable for floppy disk, printers and more.

## PERIPHERALS

### Expansion Box

- Expansion interface that easily plugs into machine and requires no additional power supply.
- 4 universally adaptable ports for peripheral drive cartridges.

## SERIAL INTERFACE

### SI-232

Allows connection to serial (RSC32C) devices including printer and modem.

## 8K RAM Memory Cartridge R8-K

- Instantly increase Imagination Machine's RAM memory by 8193 bytes.

## FI-100

Allows connection of up to 2 5¼" disk drives.

## D-100 Mini-Floppy Disk Drive

- Provides 73,000 bytes of external storage.

## Coming Soon —

Parallel interface PI-100, serial printer, telephone modem.

- 12 — Optional games cassettes including Space Destroyers.
- 23 — Optional computer programs in cassette including Maths, Spelling and Business Programs.

## RADIO PARTS GROUP

562 SPENCER ST. MELBOURNE  
1103 & 1097 DANDENONG RD.  
EAST MALVERN VIC.



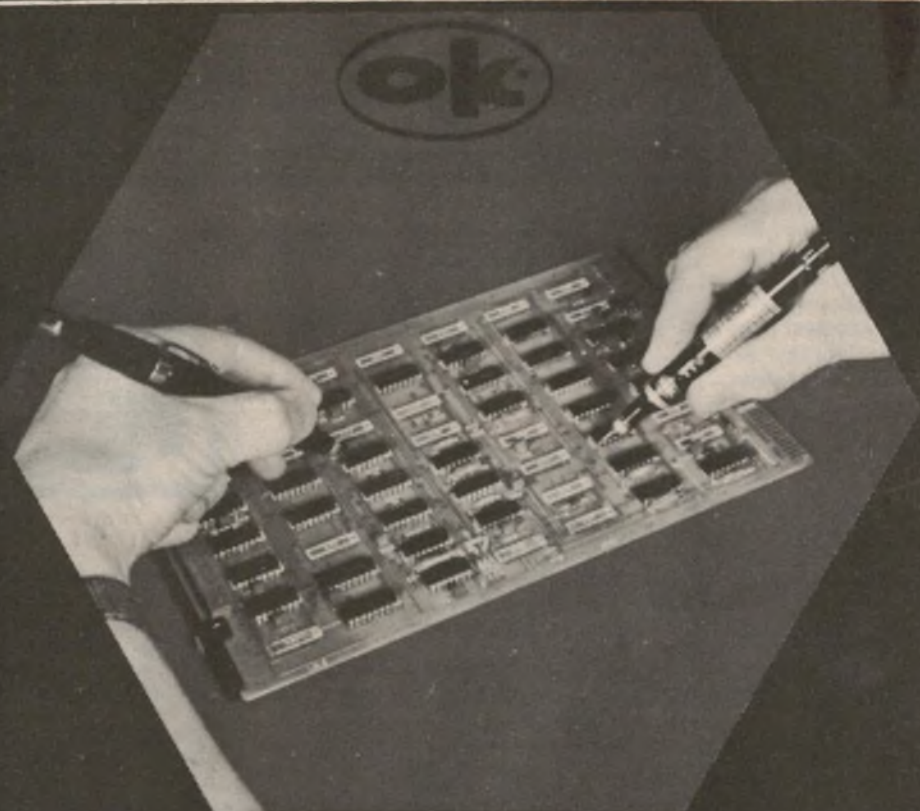

## Digital IC Probe & Logic Pulser

### PRB-1 DIGITAL LOGIC PROBE

Compatible with DTL, TTL CMOS, MOS and Microprocessors using a 4 to 15V power supply. Thresholds automatically programmed. Automatic resetting memory. No adjustment required. Visual indication of logic levels, using LED's to show high, low, bad level or open circuit logic and pulses. Highly sophisticated, shirt pocket portable (protective tip cap and removable coil cord).

- Automatic threshold resetting • DE to > 50 MHZ
- Compatible with all logic families 4-15 VDC • 10Nsec. pulse response
- Supply O.V.P. to  $\pm 70$  VDC • 120 K  $\Omega$  impedance
- No switches/no calibration • Automatic pulse stretching to 50 Msec
- Open circuit detection • Automatic resetting memory
- Range extended to 15-25 VDC with optional PA-1 adapter

### PLS-1 LOGIC PULSER

The PLS-1 logic pulser will superimpose a dynamic pulse train (20 pps) or a single pulse onto the circuit node under test. There is no need to unsolder pins or cut printed-circuit traces even when these nodes are being clamped by digital outputs.

PLS-1 is a multi-mode, high current pulse generator packaged in a hand-held shirt pocket portable instrument. It can source or sink sufficient current to force saturated output transistors in digital circuits into the opposite logic state. Signal injection is by means of a pushbutton switch near the probe tip. When the button is depressed, a single high-going or low-going pulse of  $2\mu$  sec wide is delivered to the circuit node under test. Pulse polarity is automatic: high nodes are pulsed low and low nodes are pulsed high. Holding the button down delivers a series of pulses of 20 pps to the circuit under test.

- High input impedance (off state) 1 meg ohm • Multi mode-single pulses or pulse trains
- Low output impedance (active state) 2 ohms • Automatic polarity sensing
- Output pulse width 2  $\mu$ sec nominal • Automatic current limiting; 7 amps nominal
- Input over voltage protection +50 volts • Automatically programmed output level
- Finger tip push button actuated • Circuit powered
- Power lead reversal protection • No adjustments required
- Multi-family RTL, DTL, TTL, CMOS, MOS and Microprocessors.

PRB 1	DIGITAL LOGIC PROBE	PA 1	HIGH VOLTAGE ADAPTER
PC 1	POWER CORD, Alligator Clips	PT 2	REPLACEMENT PROBE TIP(2)
PC 2	POWER CORD, Micro Hooks	PLS 1	LOGIC PULSER

## AMPEC ELECTRONICS PTY. LTD.

1 Wellington St, Rozelle, 2039. PO Box 132, Rozelle 2039. Ph (02) 818-1166.

Available from: **NSW** Radio Despatch Service, 211-0191. David Reid Electronics, 29-6601. Electronics (Distributors) 636-6052. Martin De Launay, 29-5834. Applied Technology, 487-2711. **VIC:** Stewart Electronics, 534-3733. Ellistronics, 602-3282. John Pearce, 528-5240. Ritronics, 489-8131. **QLD:** N.S. Electronics, 36-5061.

**WA:** Reserve Electronics, 275-2377. Taimac, 328-1988.

me a photocopy of the waveforms and he readily agreed. As for the other faults, he advised that the failed transistor was critical and that it was essential that it be replaced with the correct type. He felt sure that would fix the trouble, but suggested that I obtain replacements for the other three as a precaution.

As for the lack of luminance, he clearly didn't believe me, maintaining that I couldn't possibly assess what was going on with only 20mm of deflection.

And so the trip was duly made and four replacement transistors obtained, along with a copy of the waveforms. The storeman explained that two of the original transistor types were not available and substitutes had been provided.

Back home I sorted them out and realised that I had another problem. The substitute transistor for TR410 was different physically from the original. It was obviously a small power transistor, with a heatsink flange (TO220 package instead of the SOT-30).

I was afraid the storeman had made a mistake but, in any case, it was a bit of a set-back. I didn't know the pin connections and I could not be sure that my own limited references would be of much help.

Then there was the size of the pins. These were punched from sheet metal and were too large for the holes in the board, drilled for the wire type. I found as many pin diagrams as I could and they all agreed, so I checked the transistor in the tester on that basis. When it gave what seemed a sensible reading, I assumed they were correct.

Then I tackled the mounting holes. I was fortunate in finding a suitable size number drill and with this in an "egg beater" I gently attacked the board from the copper side, though not without some misgivings.

### STILL NO LUMINANCE

So I finally fitted the transistor and switched on. It was with mixed feelings that I viewed the screen as the tube warmed up. The good news was that the deflection system was back to normal, but the bad news was that my previous diagnosis was confirmed; I had chroma but no luminance.

So I turned my attention to the "video out" board; another bewildering array of transistors for the uninitiated. As nearly as I could work out it consisted of three video (luminance) amplifiers (TR701, TR704, TR706) feeding three output transistors (green, red and blue; TR707-708-709). The luminance signal was fed to these latter three via their emitters, and the green, red, and blue signals from the chroma board to their bases.

There were also three other transistors in the video chain: a brightness limiter

(TR705), a pulse clamper (TR703), and an "ARC" stage (TR702), whatever that meant.

The whole lot direct coupled!

Now the CRO and the test patterns came to the rescue. I found that the video signal at the base of the third video stage (TR706) was normal at about 5V p-p, but seemed to vanish from that point on.

The multimeter confirmed that all was not well with this stage. It is a PNP transistor, working "upside down" as an emitter follower. According to the circuit it was supposed to have 6.4V on the emitter and 6V on the base.

The actual readings were 7.2V on the emitter, 8.6V on the base, and .03V on the collector. Fairly obviously the stage was drawing very little current, but whether the wrong voltages were cause or effect I didn't know. Naturally the transistor was a prime suspect so I pulled it out and tested it. It tested OK.

That meant that the wrong voltage on the base was biasing the stage off; it had no forward bias. But where was the wrong voltage coming from?

I pulled the board out and went over it with the meter, checking everything I could think of, including the transistors as best I could with them in situ. I could find nothing wrong.

### BRUTE FORCE!

Since it was the excessive voltage on the base of TR706, I wondered whether it would be possible to brute force this voltage back to normal, not so much as a cure, but to establish whether that was the only fault.

On impulse, I picked up a 5k resistor and bridged it from the base to the chassis. The chroma level came up significantly, but there was no luminance. So I bridged it with another 5k, making it 2.5k. This did nothing to the chroma (apparently I was getting all there was) but, on turning the colour control right down, I detected a faint monochrome picture.

Substituting a 1k resistor proved the point, but I had overshot; the brightness control could not hold it down. Finally I settled for a 1.8k which gave me a perfect monochrome picture. Then when I turned the colour up, I had a perfect colour picture.

At least, it looked perfect. But I didn't imagine that the makers had put in a whole swag of components, which I had now by-passed, just for the fun of it. My trick might let me watch a program, but it wasn't the answer.

On the other hand, it did seem to clear the video board, and that was a step forward. Looking at the circuit again, I tried to work out where the excessive TR706 base voltage might be coming from. It

was connected to the collector of the previous stage (TR703), thence to the board's 19V rail via a resistor network. It also connected to one of the interconnecting cables (G3, G4) running to the deflection out board.

Of these two pins, G4 had 200V p-p horizontal pulses on it (which appeared to be about right from the circuit), and G3 had about 15V DC on it. Unfortunately there was nothing to indicate what this should be.

Tracing the G3 line back through the deflection out board brought me to a network associated with the 19V rail, including a couple of diodes (D558, D562). I had long since given up trying to rationalise the circuit, it was far too complicated. All I could do was look for likely suspect components, and the diodes seemed like a good bet.

For one thing they were on the same board as the other failure had occurred and, next to transistors, they were the most likely to be damaged by a surge. I tried D558 first, mainly because it was easiest to find, and it seemed to be OK.

### A FAULTY DIODE

Its mate, D562, wasn't so easy to find, partly because it was physically far removed from D558, in spite of its electrical proximity, and partly because D558 was shown with reverse polarity on the circuit. It took me some time to sort this out and convince myself that the circuit really was wrong.

When I found D562 and put the meter across it, the result was not immediately conclusive.

I pulled one end out of the board to make sure, confirmed the reading, and knew I was on the right track. It was only a tiny diode, a small signal type, and I had nothing like it. I settled for a 1A, 600V PIV power diode, since it didn't seem to perform anything more than a DC function.

And that was it. Everything came back to normal and I found it hard to believe that one fiddling little diode had caused me all that bother. But it had; it was leaky enough to connect the 19V rail to G3, instead of isolating these two points.

As a story, this may sound all relatively straightforward. It wasn't. It was spread over a number of days, I made wrong assumptions, and followed false trails.

Was it all worth it? In terms of straight out cash; yes, even if I did buy three transistors I didn't need. After all, I did save the price of a tripler. In terms of man-hours? No; it would have been quicker and cheaper to call a serviceman. In terms of frustration? Well, how do you put a price on that?

Would I do it again? There were many times during the exercise when I swore that I never would. But if the set went dead tomorrow I imagine I would stick my neck out again. With hindsight, the experience was invaluable. ☺

# CIRCUIT & DESIGN IDEAS

We invite readers to submit circuit ideas and solutions to design problems. Explain briefly but thoroughly the circuit's operating principle and purpose. Sources of material must be acknowledged and will be paid for if used. As these items have not necessarily been tested in our laboratory, responsibility cannot be accepted.

Conducted by Ian Pogson

## A novel application for Mini Scamp

I have devised a way in which the Mini-Scamp microcomputer may "read" a potentiometer. The potentiometer controls the frequency of an oscillator connected to my Mini Scamp's terminal input, as shown in the diagram. Power for the oscillator is taken directly from the computer's +5V supply.

In order to read the potentiometer, I have written a short subroutine. The subroutine develops a count when "sense B" goes low. When "sense B" goes high the count is stopped and is then proportional to the period of the oscillator. This hex number is put in AC before the subroutine returns to the calling program. While it is not possible to select the oscillator components to give numbers over the full range of 0-X'FF from a potentiometer, the computer itself can be used to scale readings in order to achieve this.

This idea has applications in things like

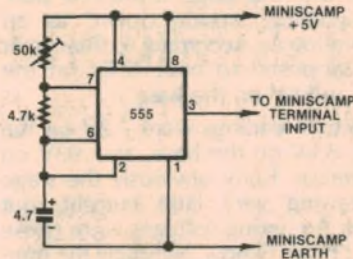

servos - for feedback into the computer, or it could be used to measure resistor or capacitor values by substituting the unknown for one of the oscillator components. The values of the components in the oscillator are those I used but they are open to experiment. Finally, the basic idea may be used with computers other than Mini Scamp simply by adapting the software.

(By Mr A. Partridge, 223 George Street, Launceston, Tasmania 7250.)

Address	Code	Label	Mnemonic
020	08		NOP
021	C400	Start	LDI 0
023	01		XAE
024	06	*1	CSA
025	D420		ANI X'20
027	9CFA		JNZ *1
029	06	*2	CSA
02A	D420		ANI X'20
02C	9C0A		JNZ *3
02E	C401		LDI 1
030	70		ADE
031	01		XAE
032	C400		LDI 0
034	8F01		DLY 1
036	90F1		JMP *2
038	01	*3	XAE
039	3F		XPPC 3
03A	90E5		JMP Start
03C			

Note: Subroutine is completely relocatable. Must be called with P3.

## Phase meter for audio frequencies

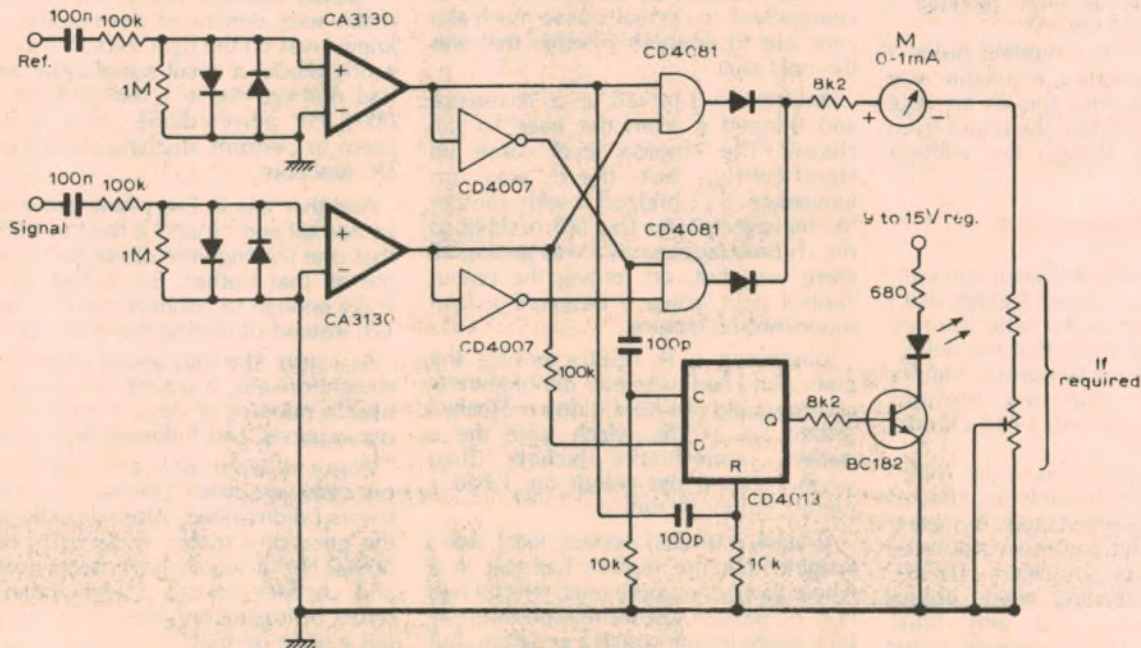

A standard multimeter can be used to make phase measurements at audio frequencies with the circuit shown. The meter is calibrated for a full scale deflection of 180° and a LED indicates when the phase difference is greater than

180°. The 4013 flipflop is reset at the start of a positive excursion of the reference signal and a clock pulse is provided at the start of a negative excursion.

If the data input of the flipflop is high

when the clock pulse occurs, the LED is switched on for half a cycle. The values shown are for a 12V supply.

(By N.G. Boreham, in "Wireless World", August 1979).



# LEADER TEST INSTRUMENTS

**We've made a name  
for being ahead in reliability,  
user-designed features and economy.**

**But that's just the start!**

## **1. Reliability.**

Since 1954 we've built our reputation on equipment that keeps on functioning under a wide range of extreme operating conditions. We do this by only using components rated in excess of power requirements; by extensive pre-testing of designs and by rigid quality control at every stage of production.

## **But there's more yet.**

LEADER offers you the biggest range of specialized gear for audio applications. Including audio generators, distortion meters, frequency counters, wow and flutter meters.

## **2. User-design features.**

Compare our panel layouts with the others. You'll see how everything falls to hand easily with LEADER. Note the colour coding. Experts call this "ergonomic design". We think it's just good sense.

## **3. Economy.**

LEADER gear is as practical in its price structure as it is in all other departments. Check our prices. Check around. Dependability and value is precisely what makes us so popular with schools, laboratories and work shops.



Model LBO-520. A dual trace oscilloscope with a 30MHz bandwidth a 5mV/cm sensitivity. Delay triggering and a 130mm, post acceleration, CRT produces a bright, sharp display. Display offers chop, act, add and subtract, Ch1, Ch2, also X-Y:

**When it comes to good test gear look to**

# LEADER

# VICOM

**Vicom International Pty. Ltd.**  
68 Eastern Road,  
South Melbourne, Vic 3205  
Phone (03)6996700

339 Pacific Highway,  
Crows Nest, NSW 2065  
Phone (02)4362766

Brisbane 35 2522; 341 5377  
Townsville 772 2633

Wollongong 29 1455  
Cairns 54 1035

N Z 28 7946  
Adelaide 43 7981

Wagga 21 2125  
Melbourne 836 8635

# thinking of building the Playmaster MOSFET amp?



## check out the one with the toroidal transformer

Yes! A complete kit for the brand new Playmaster MOSFET amplifier—but with a difference. The Electronic Agencies' kit comes with an exclusive toroidal transformer—at no extra cost! Toroidal transformers have been known for their lower hum, lighter weight and better regulation for years. Now you can have the benefit of these advantages in the Playmaster MOSFET amp—the most advanced build-it-yourself amplifier yet.

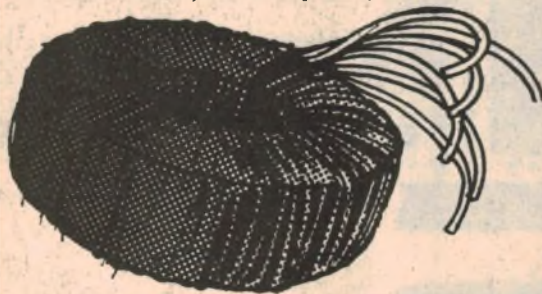

Apart from our exclusive toroidal transformer, our kit includes all parts, deluxe fibreglass PC board, heavy duty pre-punched chassis, silk-screened anodised aluminium front panel and full instructions. The complete amp is as described in December and January EA—including the speaker protection circuitry.

If you've been waiting for the right kit amplifier to come along, wait no more. Once you've seen and heard this fantastic amplifier and seen how easily you can build it you'll have to get one. We even make that easy. Simply pick up the phone, say "I want a Playmaster MOSFET amp kit" and give us your Bankcard number and it'll be on its way. Or you can call in person (phone first to make sure we have some in stock) and use cash or Bankcard.

### features

- 50 Watts RMS per channel at less than 0.075% overall distortion.
- MOSFET output stage for minimal distortion and maximum stability.
- Deluxe pre-punched chassis with quality anodised front panel.
- Exclusive toroidal transformer and fibreglass PC board included at no additional cost.
- Loudspeaker switching.
- Loudness control.
- Mute switch.
- Four inputs plus tape monitor.
- Speaker protection built in.

**Superb  
value at \$159.00**

Stocks due mid to late January—phone us to check.

Bill Edge's

**ELECTRONIC  
AGENCIES**

See our other ad for more fantastic  
kits and full mail order details.  
115-117 Parramatta Road Concord 2137  
(Corner Parramatta Rd & Lloyd George Ave)  
Tel. 745 3077 (two lines)

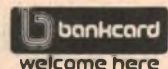

### A low cost voltage controlled amplifier

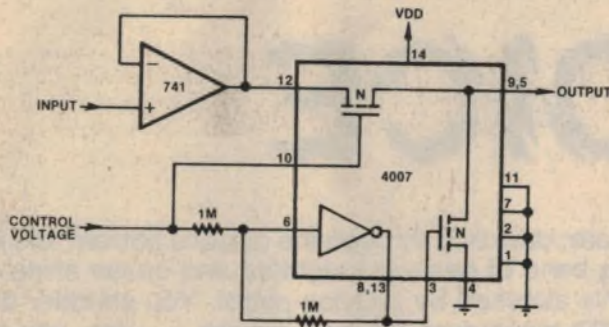

While working on the design of a low cost and simple voltage controlled amplifier (VCA) for a synthesiser, I came up with this circuit. It has since been superseded in my design by a low distortion VCA involving pulse width modulation techniques.

However, I present the original circuit for those readers who may have less critical applications for it. Its operating principle is quite simple. The input signal, buffered by a 741 (or similar device), is fed into the voltage

divider formed by the two FETs. The inverter and the two resistors form a unity gain, high impedance inverting buffer so that the control voltage is fed directly to the series FET and ( $V_{DD} - \text{control voltage}$ ) is fed to the shunt FET.

As the control voltage is raised from 0V to  $V_{DD}$  the output varies from very well cut off to complete signal transmission, if the output is buffered.

The 741 is required on the input since the input impedance of the divider can drop as low as  $1k\Omega$  with  $V_{DD} = 5V$  and  $V_C = 2.5V$ , and as low as  $400\Omega$  with  $V_{DD} = 9V$  and  $V_C = 4.5V$ . The 741 must have a dual supply since all signals have zero offset.

To avoid distortion the signal level should be kept below about 20mV RMS. This conforms with the  $V_{SS} - 0.3V$  limit set for the 4007 CMOS device.

(By Mr P. V. Wilson, 8 Pullen Crescent, Springvale, Victoria 3171.)

### Lightning protection for high-pass filter

Referring to the high pass filters which appeared over my name in Circuit & Design Ideas for May, 1980, I would like to draw attention to a desirable addition to the circuit. Two 100k resistors should be placed as shown to act as static leaks, otherwise the capacitors may be damaged by lightning discharges in the area.

(By Mr R. D. Champness, VK3UG, 31 Helms Court, Benalla, Vic 3672.)

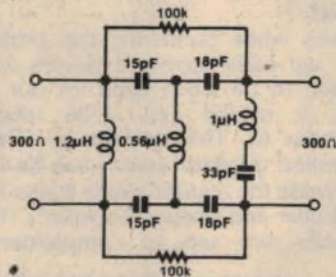

### PROJECTS & CIRCUITS NO. 2

Available from "Electronics Australia", 57 Regent St, Sydney. **PRICE \$3.00** OR by mail order from "Electronics Australia", PO Box 163, Beaconsfield, 2014. **PRICE \$3.70.**

### DISCOVER the exciting world of EXPLORATION!



See our spectacular display of telescopes, binoculars, microscopes, weather equipment, build-it-yourself kits, books, charts and atlases.

☆ Send 60c to Box 568, Crow's Nest, 2065 for a complete informative catalogue. ☆

**Astro-Optical Supplies Pty. Ltd.**

11 CLARKE STREET, CROWS NEST, SYDNEY, N.S.W. 2065 PH 43 4360  
200 BOURNE STREET, MID CITY ARCADE, MELBOURNE, VIC PH 563 2761

### Modification adds versatility to Electronic Keyer

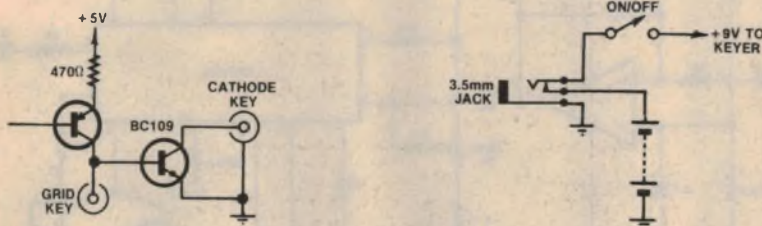

I built the Electronic Keyer as described in "Electronics Australia" in April 1978, from a kit obtained from Dick Smith Electronics. It works perfectly with my Drake TR3 which uses grid block keying. However, my Ten-Tec Argonaut requires the equivalent to cathode keying. By using one RCA socket mounted adjacent to the existing output jack and one inexpensive NPN transistor connected as shown, I can drive either, or even both transmitters simultaneously. The transistor is physically hung between the two RCA sockets, with the emitter lead soldered to the earth tag on the new socket. I have used this arrangement in-

termittently for about one year.

Also, I have added provision for an external power supply, as I find that the switch invariably seems to have been left in the "on" position when I come to use the keyer, requiring considerable inconvenience in having to change the battery. I use a 3.5mm jack of the variety whose plug breaks a normally closed contact when the plug is inserted. The battery is taken via this contact. Although I have not used a "plugpack", I can see no reason why one should not be satisfactory.

(By Mr C.R.W. Ashton, VK5DQ, PO Box 313, Morphett Vale, SA 5162.)



suitable for typical low impedance dynamic or electret microphones and may be connected to the high level (typically 150mV) input on a domestic stereo amplifier. Since the Exar 2206 has a relatively high current drain of about 20 milliamps maximum, we elected to provide a mains power supply. Alternatively, you could run the device from batteries, preferably rechargeable.

As a further alternative, the device could be made completely self-contained with its own amplifier and loudspeaker system. A suitable low power amplifier circuit could be adapted from the Playmaster 3W + 3W described in January 1980 issue of "Electronics Australia".

The microphone preamplifier has a nominal gain of 150 and an input impedance of 1k $\Omega$ . The two 22k $\Omega$  resistors connected to pin 3 set its output at pin 6 to the half supply point. A 220pF capacitor in parallel with the 150k $\Omega$  feedback resistor roll off the frequency response above 5kHz which is desirable for this application.

Output from the 741 is coupled via a

## PARTS LIST

- 1 Printed circuit board 100 x 56mm (80RM12)
- 1 Single-pole single-throw switch
- 4 x 1N4002 rectifier diodes
- 1 x LM340T-12 three terminal regulator
- 1 x  $\mu$ A741 operational amplifier IC
- 1 x XR2206 function generator IC
- 1 x 1M $\Omega$  linear potentiometer
- 1 x 5k $\Omega$  trimpot

### CAPACITORS

- 1 x 100 $\mu$ F 25VW aluminium electrolytic.
- 1 x 220pF polystyrene
- 1 x 10 $\mu$ F 16VW tantalum
- 1 x 4.7 $\mu$ F 25VW tantalum
- 1 x 2.2 $\mu$ F 25VW tantalum
- 1 x 1 $\mu$ F 25VW tantalum
- 1 x 0.18 $\mu$ F greencap
- 3 x 0.1 $\mu$ F metallised polyester

### RESISTORS

- 1 x 150k $\Omega$ , 1 x 56k $\Omega$ , 1 x 47k $\Omega$ , 2 x 22k $\Omega$ , 2 x 4.7k $\Omega$ , 3 x 1k $\Omega$ , 1 x 220 $\Omega$ .

0.1 $\mu$ F capacitor to the modulation input on the 2206. The internal voltage controlled oscillator is varied in frequency by a variable resistance connected to pin 7 and is set to the desired frequency range by the capacitor between pins 5 and 6. The "carrier" waveform from the VCO can be set to triangle (sawtooth) or sinewave by the resistor and switch between pins 13 and 14.

The power supply is quite straightforward and uses a 12VAC plugpack or equivalent transformer to drive a bridge rectifier and 1000 $\mu$ F capacitor. The

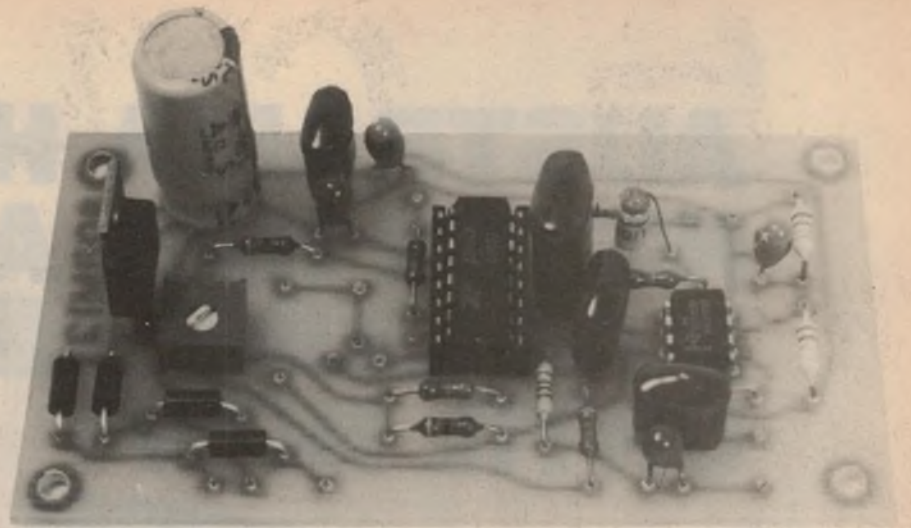

At right is the PC layout while above is a completed PCB. Below is the actual size artwork for the PC board.

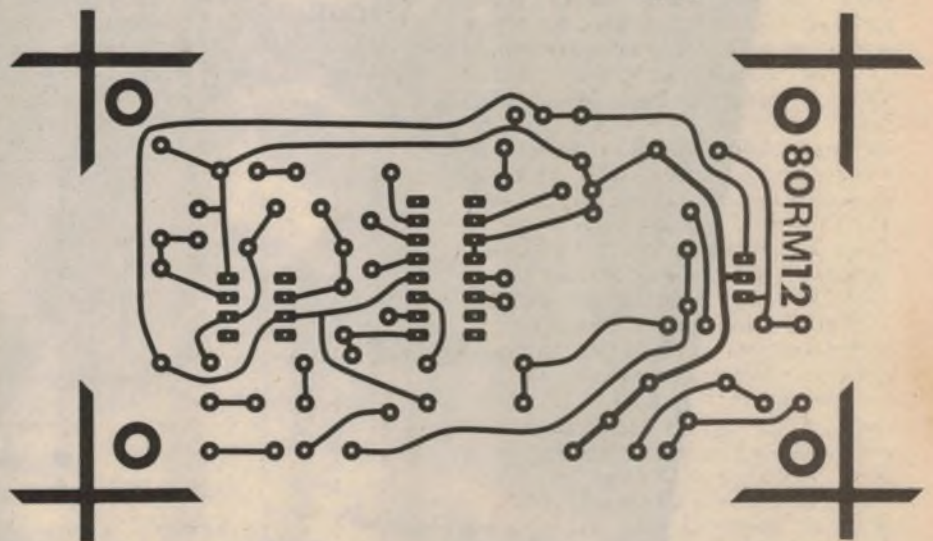
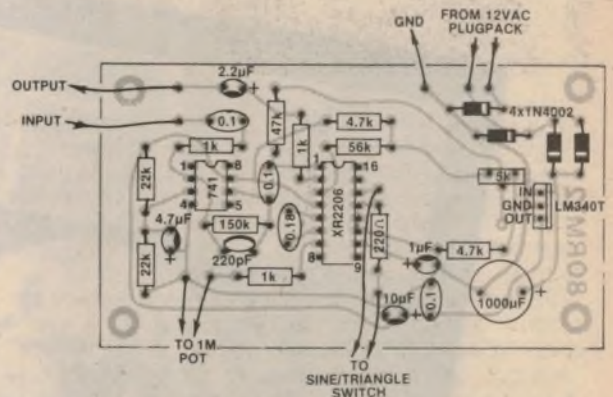

filtered DC is then fed to a 12-volt three terminal regulator which is desirable for best performance from the 2206.

Construction of the unit should only take an hour or so, this being made simple through the use of a printed circuit board which measures 100 x 56mm and is coded 80rm12.

When all the components have been mounted, all that remains to do is to connect the external potentiometer and switch to the board. The microphone input should be fitted with a socket suitable for the plug on the end of microphone lead.

If you have not already done so, connect the output lead from the plugpack to the PCB. Now connect the unit to an amplifier and connect a microphone to the input of the unit. Now, apply power to the unit and you should hear the VCO frequency in the speakers. If you don't then chances are that you have a frequency that is beyond 18kHz, or else you have been lucky enough to have a null condition from switch on.

If you are able to hear a tone, then it will have to be nulled out by the trimpot. Having done this you can proceed to turn your voice into that of an invading Cylon warrior.

# AUSTRALIA HAS NEVER HAD A MAGAZINE LIKE THIS UNTIL NOW!



## AT THE FRONTIERS OF KNOWLEDGE

The adventure of science is all around us. Now there is an Australian magazine to share it with you.

## AWAKENING A SENSE OF WONDER

The first issue of Omega examines the joining of mind and computer . . . the destiny of mankind in space . . . new insights into ESP, the origins of the universe, the UFO debate . . .

## BRINGING SCIENCE TO LIFE

Startling new light on our changing climate . . . research into sexuality and smell . . . the latest technology of communications . . . a magnificent fold-out feature on medicine's future . . .

## GIVING NEW ANSWERS

Australia's secret role in the nuclear balance of terror . . . cancer: does personality put you at risk? . . . first-ever look at the surface of Venus . . . Australian quest to defeat a deadly virus . . .

**LOOK FOR IT AT YOUR NEWSAGENT'S**

**TOMORROW'S MAGAZINE TODAY!**

Omega is more than an entertainment, it's an adventure. More than a magazine, it's a unique experience. Try it.

# Digital Storage CRO Adapter: Addenda

A shortcoming in the design for the Digital Storage CRO Adapter described in the November issue has been brought to our attention. Due to propagation delays in the 4040 ripple counter, there could be addressing errors in the memory when used at high clocking rates. To alleviate this problem, we have produced an alternative circuit.

The changes involve replacement of the 4040 with two four-bit synchronous counters, IC13 and IC14, and an open collector inverter package, IC15. The two counters are connected to count synchronously by connecting the ripple

carry output from IC13 to the "T enable" of IC14. The ripple carry output from IC14 gives the "end of memory" signal. The double inversion of this signal with IC15a and IC15b provides drive for the CMOS input, pin 8 of IC1b.

Similarly a buffer is required for the input to IC12d, connected between the wiper of S4 and pin 12 of IC12d. Note that the address outputs to S4 have been changed from the original circuit to comply with the front panel artwork of the Digital Storage CRO Adapter. The change involves moving all the switch contacts to one address bit higher with respect to the address counter. The least significant bit, A0, is now not connected to the switch and the most significant bit to the switch is now the ripple carry output signal from IC14, via the inverters, indicating the start and finish of memory.

Two alternatives are available to enable the conversion. Firstly a Veroboard lashup containing IC13, IC14 and IC15 can be wired to the IC pads where IC7 is located. Alternatively, a new PC board coded 81dc2b having identical dimensions to the 80dc10 board originally used will be available, and more details on this PC board will be published in a coming issue.

The Veroboard version has dimensions 115 x 40mm. Follow the overlay provided to aid you in the layout of components. Links of non-insulated wire make the interconnections that the veroboard tracks cannot provide. Breaks in the veroboard tracks can be achieved with a small sharp drill and twisted by hand at the positions indicated.

To wire the Veroboard to the PC board, it will be necessary to refer to the article of the November 1980 issue, in particular the PC board overlay and circuit diagram.

Most of the wiring from the Veroboard goes to the IC7 pads on the PC board with the exception of IC15c which is inserted between the wiper of S4 and pad number 32 of the PC board. Remove the wire from pad 32 on the PC board going to the wiper of S4. The wiper of S4 goes to IC15c pin 5 and pin 6 to pad 32 of the PC board.

Wires to pads 33 to 40 on the PC board should be removed and rewired such that wire 40 on S4 goes to pad 39 on the PC board; wire 39 to pad 38; 38 to 37; 37 to 36; 36 to 35; 35 to 34; 34 to 33; and wire 33 on S4 to IC15b pin 4.

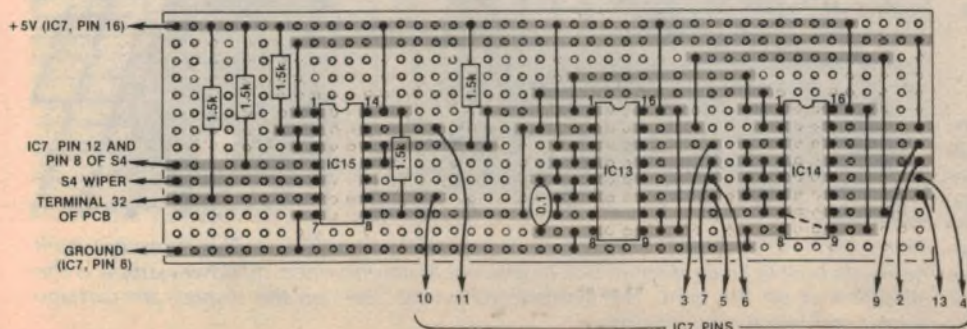
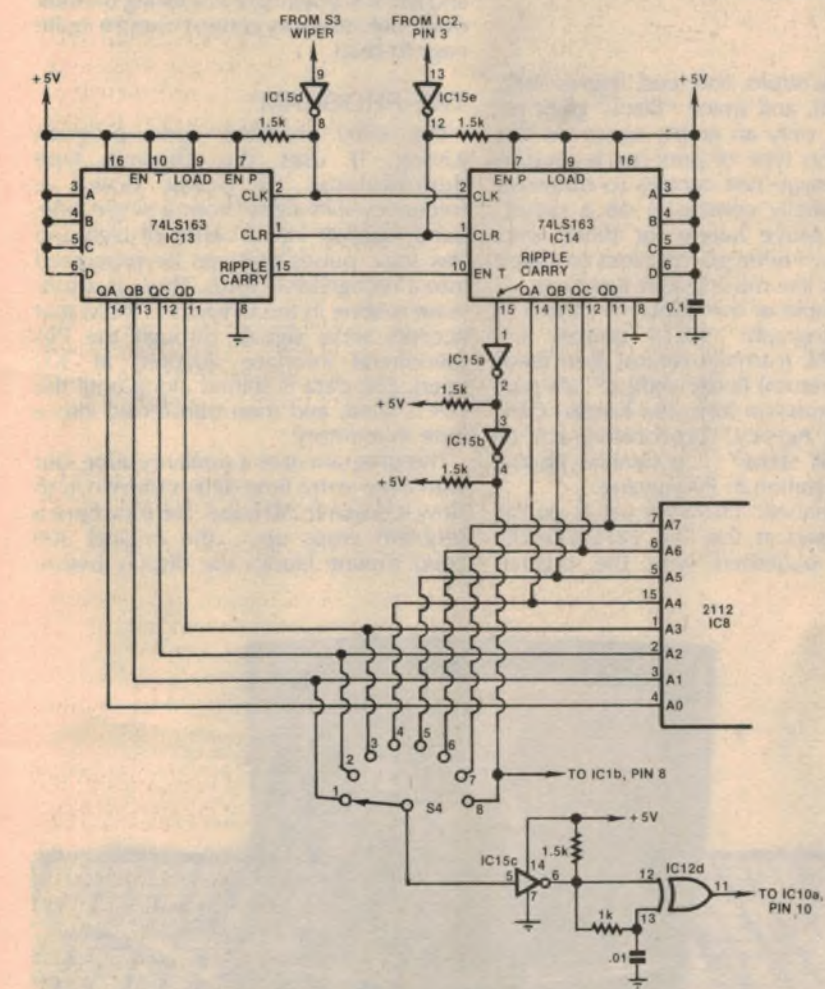

Above left is the revised memory address counter while at left is the suggested Veroboard layout which can be wired to the existing PC board.

# Using the DREAM 6800 for RTTY-display

For users of the DREAM 6800 we have a double helping this month, thanks to Tom Moffat of Tasmania and Graham Leadbeater from Victoria. This article describes two methods of interfacing a teleprinter to the DREAM, or other small 6800 system and in addition gives details of a program which will convert the DREAM into a radioteletype machine without the need for a printer.

The first program allows DREAM 6800 users to listen in on teletype transmissions with a communications receiver, using the DREAM to demodulate the teletype signals and display the messages received. The second program allows a teletype machine to be used as a printer for the DREAM, providing a handy way of getting a hard copy listing of the contents of the computer's memory. Both programs were submitted by Tom Moffat of Fern Tree, Tasmania, and the explanation here is given in his own words:

Radioteletype signals seems to be everywhere on the HF bands, carrying diplomatic messages, overseas news services, weather, all kinds of things. Many radio amateurs are also getting in on the act, using RTTY instead of CW or single sideband to communicate with their counterparts around the world. The casual listener is usually forced to ignore these signals, because of the lack of a teletype machine and demodulator circuitry to make sense of them. So RTTY remains in the realm of "specialist communications".

Now any "Dream 6800" computer owner can "tap in" to these signals, using only the computer, a communications receiver (such as a Yaesu FRC-7 or Drake SSR-1) and a piece of audio cable to connect them together. Admittedly the basic system is rough, and the results will not be top quality. But it will allow you to get a taste of RTTY, to decide if it's worth pursuing further. Using a proper RTTY demodulator, the results are first class.

## DISPLAY

The program develops a "moving marquee" type display of 16 characters at a time, marching right to left across the centre of the screen as each new character appears on the right. It's designed to simulate a teletype tape printer, showing a character on the screen for every character received including the "non-print" characters such

as carriage return, line feed, figures shift, letters shift, and space. "Blank" gives no character, only an empty space on the screen. This type of print-out is used in some teletype test centres to diagnose what's actually coming in on a circuit, and will prove handy for those who already own teletype machines to check out things like missing shift functions.

An example of the display is shown in the photograph: "ACTS (space) OF (space) THE (carriage return) (line feed) (carriage return) (letter shift) U". It's part of a transmission from the Korean Central News Agency, "provocative acts of the United States" ... a familiar phrase from this station in Pyongyang.

The alphabetic character set is similar to that used in the "TV TYPEWRITER" program published with the original

"Dream" articles. Other characters have been constructed under the same system to represent upper case characters such as apostrophe, comma, etc. Since the characters are constructed in a 3x5 dot matrix they're not particularly elegant, and some such as W and M look downright confusing on their own, but taken in context they're quite easy to read.

## THE PROGRAM

The 6800 machine code program (Listing 1) uses the Dream's tape demodulator to break down a frequency-shift signal from a single sideband receiver into a series of high and low logic pulses that can be processed into a recognisable form. There is a software routine in the Dream's EPROM that accepts serial signals through the PIA (peripheral interface adapter) at 300 baud. The data is shifted along until the PIA is filled, and then transferred into a byte in memory.

This program uses a similar routine, but with a few extra time delays thrown in to slow it down to 50 baud. Here's where a problem crops up ... the original 300 baud routine blanks the display before



The author's DREAM 6800 displaying a radioteletype message. The computer itself has been built in an aluminium box to prevent RF interference. Its power supply is the smaller unit on the right. The symbols following "the" on the display are carriage return and line feed indicators.



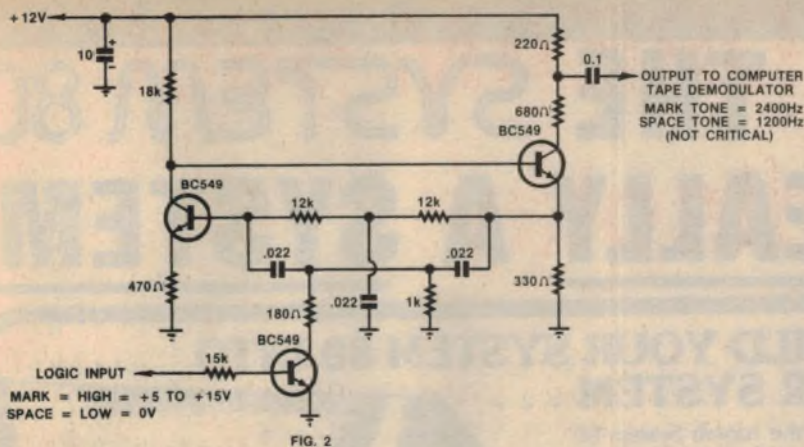

FIG. 2

inputting the data. But we require the display to remain operating to allow the teletype characters to appear on the screen.

When the display is being written the computer itself is stopped for about 8ms while the display circuitry has direct access to the memory. This occurs once every 20ms, or once every television frame.

Now it just happens that 50 baud teletype signals are made up of pulses 20ms long (see Fig. 3), so an 8ms interrupt can occur during each pulse without causing too much trouble. But if an interrupt begins just before a teletype pulse begins, the teletype pulse will be read 8ms late. So the program timing has been arranged to read the teletype pulse 4ms early if the interrupt has not occurred, or 4ms late if it has occurred. This means there is a built-in 20% timing distortion, and explains why the results are not perfect when FSK signals are fed straight into the computer. The system is also limited to 50 baud only, since with any other speed interrupts would be occurring all over the place, and not in step with the incoming teletype signals.

Once a character is accepted into the PIA it's first checked to see if it's a figures or letters shift character. If it is it refers the computer to one of two look-up tables, one for letters (starting at hex 0280) and the other for figures (starting at hex 02C0). The contents of each table are arranged in binary order, and the numerical value of each RTTY character is used to determine its location in the table. The character is then loaded from the table and displayed using a routine in the Chip-8 EPROM.

Shifting the existing display characters down the line proved a problem... this was solved by attacking the display buffer directly with a series of machine code shift-lefts. Each display byte is shifted four times per character. Character spacing can be increased by changing the data at hex 0231 from 04 to 05 or 06 or whatever, but by doing this the number of characters that can be displayed at one time is reduced.

Since the character set is contained entirely in software, the user can make

changes at will, substituting say an American weather symbol set for the existing upper case "European" standard. If you read Russian you can throw out all 64 characters in both look-up tables and substitute the Russian "Cyrillic" character set (there is plenty of Russian teletype around, if you want to try this). Two bytes are used for each character, arranged in the following way:

3	2	1
8	5	4
9	6	7
12	11	10
15	14	13

= "A"

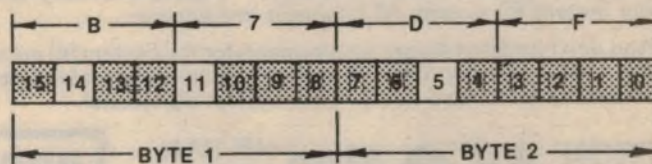

The characters are stored in the table in binary numerical order, but with the bits reversed, as the characters are shifted into the PIA back to front. So the character "E" at hex 0282 is called by 00001, although its teletype representation is 10000. Similarly 00010 calls "LINE FEED" at hex 0284 which in teletype code is 0100. The rest of the "letters case" characters, A, SPACE, S, I, U, etc, follow up to hex 02C0 where the "figures case" table begins, arranged in the same way. Some characters, such as BLANK, LINE FEED, and SPACE appear in both tables since they are valid for either case.

### USING THE PROGRAM

With the audio from the receiver connected to the Dream's tape input, run the program from 0200. Receiver noise should cause a string of gibberish to march across the screen, and the speaker will emit a 1200Hz "beep" with the first pulse. Within a few seconds the computer should interpret a noise pulse as a letters or figures shift character and the screen will then begin showing alphanumeric characters, although making no sense.

Now try to tune in a teletype signal in such a way that the high and low tones straddle the tape input's centre frequency of 1800Hz. If the computer is equipped with a LED on the tape input it

should be flickering in step with the teletype pulses. Vary the tuning slightly and the display should begin to make some sense. If it doesn't the copy may be "upside down"; switching to the other sideband and re-tuning will turn it over.

Some frequencies to try first are the Australian weather station AXM around 11.030 and 13.020MHz. This station transmits coded weather information which shows up as groups of five figures and/or oblique strokes. Occasionally it sends TIROS satellite predictions, followed by plain language details of frequencies and modes. Other wide-shift 50-baud services such as the Japanese newsagency should provide fairly good copy.

### IMPROVEMENTS

It will soon become evident that this system of receiving teletype leaves a lot to be desired. The shift isn't optimum, every noise pulse causes an error, and there's that built-in 20% timing distortion. All these problems can be fixed by using a proper teletype converter to feed the Dream.

These devices are designed to recover teletype signals from a noisy environ-

ment, and many use a chip called a UART to rebuild mangled signals into clean ones. They also allow conversion of 45-baud amateur signals into 50-baud-signals the Dream can copy. There are many published designs for top class converters... many can be bought as kits or purchased ready to go. And they're designed to drive a mechanical teletype machine if you decide to go into RTTY that far.

A suitable demodulator circuit was published in the March 1977 issue of "Electronics Australia" (File No. 2/TT/1).

Every converter design has a logic signal somewhere in it that can be tapped off to drive the Dream, either directly or indirectly. Directly means digging into the computer to gain access to the PIA after the tape demodulator. The indirect method is easier... the logic signal from the teletype converter is used to drive a simple Kansas City Standard modulator, which is then fed into the Dream's tape input in the usual way. This can be built on a scrap of Veroboard and tucked away somewhere alongside the RTTY converter, providing a permanent feed to the computer. Fig. 2 gives a suitable circuit for this application.

Once you get a mechanical teletype machine, you'll find you use the computer for "sniffing around" for interesting signals, and then turn on the teletype on-

**AT LAST...**

# THE SYSTEM 80 IS REALLY A SYSTEM!

## NOW YOU CAN BUILD YOUR SYSTEM 80 INTO A SUPERB COMPUTER SYSTEM...

This is Australia's fastest selling microcomputer: the superb System 80 available only through Dick Smith Electronics (& authorised re-sellers).

However, until now, there has been a problem. The System 80 hasn't really been a system at all. Like a car without a tow-bar: useful, but limited in what you could do with it.

Now all that has changed: we're proud to announce the release of the System 80 Expansion Interface. The System 80, through its S-100 expansion interface, now has the potential to be used with hardware and software devices from over 200 manufacturers. S-100 is fast becoming the industry standard, which means you aren't tied to any single one supplier for add-ons. A single supply source means that prices can — and usually are — sky-high because there is no competition.

So now we expect the System 80 to really boom — not just to hobbyists, who've had it all their own way until now — but to businesses, to students, to housewives, to industry... There are virtually no limits to the System 80 system. All it takes is imagination.

And don't forget: software requirements for the System 80 are virtually the same as for the TRS-80: so most of the thousands of programs written for it will also run on your System 80 system!



**SAVE HUNDREDS OF DOLLARS OVER EQUIVALENT COMPUTERS AND HARDWARE!**

**FROM ONLY \$695<sup>00</sup>** (4K RAM, LEVEL II Cat X-4003)

**16K RAM, LEVEL II \$750<sup>00</sup>** MODEL (Cat X-4005)

### BUDGET MONITOR

The System 80 will run with any TV set: but in case you need a monitor, check this one out! P.S This monitor will also work with most other micro-computers. Compare our prices and **SAVE!**

USE WITH ANY COMPUTER!

**\$149<sup>50</sup>**

Cat X-1196

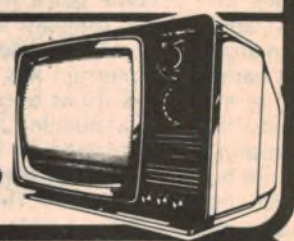

## NEW SYSTEM 80 SOFTWARE —

### FOR FUN & EDUCATION

Here are five recently released software tapes for the System 80 (also suitable for the TRS-80 Level II). They're fun to play and they're educational, too.

#### X-3688 "DEATH TRAP"

In this fast-moving realtime graphics game you have to control the motion of a constantly-moving point on the video screen and avoid randomly-appearing "mines" until an "escape window" appears. You can't cross your own trail, or hit the sides of the screen either. If you escape, you get further tries — only it gets tougher! Has sound effects. Requires 16K.



**\$9.95**

#### X-3692 "SPEED READING COURSE"

A set of programs supplied on two cassettes, designed to help readers of all-ages to improve their reading skills. The programs have been developed from the West Australian Reading Development Scheme. Requires 16K.

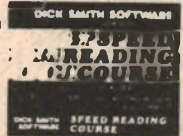

**\$19.95**

#### X-3694 "LEARNING FUN 1: SCURVE INVADERS"

Combines basic maths drill with the ever-popular "Space Invaders" game. Before being able to take each shot the player feeds in the "correct data". Sound effects, three levels of difficulty. Requires 16K.



**\$9.95**

#### X-3696 "LEARNING FUN 2: HANGMAN/CONCENTRATION"

Two programs. Hangman is complete with animated graphics "man" getting hung. The words chosen by either the program or a second player. Concentration: two players or teams have to match prizes behind numbers on the screen, then try to guess the mystery food word. Requires 16K.



**\$9.95**

#### X-3698 "LEARNING FUN 3: ALPHABET COUNTDOWN/RHYME TIME"

In Countdown sets of words taken at random from a large group must be placed in alphabetic order. Rhyme Time displays a series of unfinished rhymes, and the player has to type in the missing word from the clues given in the rhyme itself. Requires 16K.



**\$9.95**

## BARGAIN PRICED MINI DISK DRIVE

\$200 less than Tandy's equivalent! You'd pay over \$1000 more from Tandy for a 4-drive system! This incredible drive is world-famous Pertec brand: offers higher capacity than Tandy drive and will work with System 80 or TRS-80. Ask for more info. at your nearest Dick Smith store!

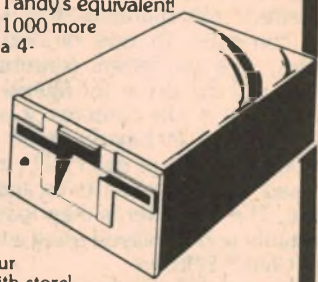

**\$379**

X-3230

## DISK PRICES TUMBLE!

Unbelievable prices for either hard or soft sectored mini diskettes. Suit virtually all disk drives available. Buy from Dick and save a fortune!

Hard Sector (X-3510)  
Soft Sector (X-3510)

**WERE \$5.95 EA! NOW:**  
1 - 10: \$4.95  
10 - 100: \$3.85  
100 UP: \$3.50

Trade enquiries welcome

## ITOH 8300P BUDGET PRINTER

For budget printing, you can't go past this one! Uses standard tractor-feed paper, gives high quality print from its 7x5 dot matrix. Up to 240mm paper, prints 125 chars/sec. For either System 80 or TRS-80. Cat X-3255.

40/80/132 CHAR/LINE

Uses Printer interface  
and cable below

**\$970**

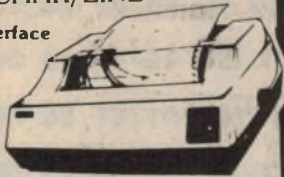

FAN-FORM COMPUTER PAPER  
TO SUIT ABOVE PRINTER. 2000 SHEETS.

Cat X-1189

**\$35.00**

## LETTER QUALITY DAISY WHEEL PRINTER

For top quality print, try this: it's over \$300 cheaper than Tandy's daisy-wheel, and is capable of proportional printing! Limited stocks

Takes standard  
stationery!

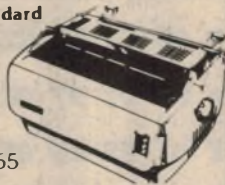

Cat X-3265

**\$1995<sup>00</sup>**

## PROGRAM CASSETTES

Popular C-10 computer cassettes (just the right size for programs!) with computer-quality tape. Suitable for all 'compact cassette' type units (which everyone uses!) Cat X-3500

**\$1.95**

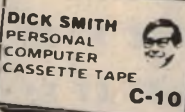

## SAVE A FORTUNE ON MEMORY IC'S

Were almost \$100 more twelve months ago! Fast 250nS 4116

RAMs, for upgrading your 4K or 8K to 16K, 16K to 32K or 32K to 48K. 8 IC's in pack. With full instr. Cat X-1186

**\$59<sup>95</sup>**



Also available individually:  
Cat Z-9310 ... \$7.90 ea.

## DON'T NEED FULL S-100 EXPANSION?

Use this parallel printer interface if you don't need full S-100 expansion. Save a bundle! Uses similar connecting cable to S-100 interface

**\$49<sup>50</sup>**

## PRINTER CABLE

Cat X-4013

Fitted with edge connector at one end, 57N-36 plug at other: suits virtually all Centronics-type printers. Use with either S-100 interface or parallel printer interface.



**\$39<sup>50</sup>**

Cat X-4014

## SOUND OFF

Add sound to your System 80 programs! Includes amp, programs and full instructions. You can add sound to existing programs too! Also suits TRS-80.



**\$19<sup>50</sup>**

Cat X-3648

## MICROSOFT™ EDITOR/ASSEMBLER PLUS!

Editing, assembling & debugging power you've never had before! Equivalent of Tandy's Editor/Assembler and T-bug products but in one package and at less than half the price! And it's far more powerful! Suits System 80 & TRS-80.



**\$39<sup>95</sup>**

Cat X-3680

## LIGHT PEN BARGAIN!

The best value around. Gives your System 80 or TRS-80 an eye. Easy to use, has simple programs

**\$9<sup>95</sup>**

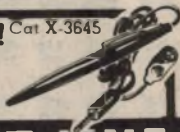

## COMPUTER HOT LINE ...

Want to know more about our computers? Or are you having troubles? We've set up a special computer hot line just to help you out. Call between 9AM & 5PM on Sydney area code 02.

**888 2002**

## SOFTWARE for System 80 or TRS-80

GAMES AND EDUCATIONAL SOFTWARE  
CURRENTLY AVAILABLE

**TIME TREK** ..... \$17.95  
You're boldly going where no man has gone before. Mind you those pesky Klingons attack you from time to time, so you'll need fast reflexes as well as sharp wits. Nine levels of difficulty. Cat X-3650

**STIMULATING SIMULATIONS** ..... \$17.95  
No less than 10 different games: all fascinating and original. An Auction, Forest Fire, Monster Chase, Nautical Navigation, Lost Treasure, Business Management, Gone Fishing, Rare Birds, Space Flight and Diamond Thief. Cat X-3652

**ELECTRIC PAINTBRUSH** ..... \$17.95  
This is a special machine language graphics interpreter program which lets you program dazzling graphics displays using simple high-level commands. Easy—and fun! Cat X-3654

**BRIDGE CHALLENGER** ..... \$17.95  
Keen on Bridge? This game never gets tired of playing with you. Ideal for practising and improving your level of play—whether you're an expert or just a beginner. Needs a 16K machine. Cat X-3656

**MICROCHESS** ..... \$22.50  
Think you're a wizz at chess? This program will put you to the test! But think out your moves carefully: the computer is out to beat you! One of the top selling chess programs in the USA. Cat X-3658

**BLOCKADE** ..... \$17.95  
You'll need fast reflexes and good co-ordination for this one. It's written in machine language so it can give really high speed graphics. Try to force your opponent into a collision with a moving wall, without running into a wall yourself! Cat X-3659

**PUNTER'S DREAM** ..... \$12.50  
Place your bets, please the race is about to start! Study the form of the various horses before placing your bets. Then the race is on! The program looks after the betting accounts of up to nine punters, and can even cream off a percentage for the house! You get a realistic simulation of racetrack probabilities. Use it for fun, or to improve your strategies! Needs a 16K machine. Cat X-3660

**BANDITO** ..... \$14.95  
Like playing the one-arm bandits down at the club? Here's one you can play seated at your friendly System 80! Tell the machine how much you want to spend, and it will feed it through. Watch the handle go down, the reels spin, and your money go! Then experience that familiar thrill when you hit a jackpot! Needs a 16K machine. Cat X-3661

**MATHS/SPELLING** ..... \$9.95  
Here's a great way to coach spelling and maths: imagine how much more interesting the lessons are if the computer is giving the problems! Help stamp out illiteracy and poor spelling—this great program can help you do it! Cat X-3662

**AIRMAIL PILOT** ..... \$12.95  
You're back in the early days of aviation. You must get the mail through in the shortest possible time. Your cloth-covered bi-plane must take you through unpredictable winds and electrical storms—can you make it? Cat X-3663

**INTERLUDE** ..... \$22.50  
This is the adults-only game for your computer. After the kids have gone to sleep, let the computer give you ideas for the rest of the night! It comes with a comprehensive instruction manual! (Note: this program is NOT available to any person under 18 years of age). Do not purchase this program if you are easily offended. Needs a 16K machine. Cat X-3675

**SIMUTEK 1** ..... \$17.95  
Not just one, but FIVE superb space fantasy games. Includes Graphic Trek 2000 (try to dock the Enterprise with the space station without being shot down!), Invasion Warg (protect the Earth), Star Wars (get in to the Death Star, plant a Bomb and get out again!), Space Target (a battle game) and Saucers (an action graphics game). Complete with instruction book. Needs 16K. Cat X-3685

**POKER PETE** ..... \$15.95  
Like a game of poker? He's a pretty shrewd player—hard to beat, although it can be done. Has really intriguing graphics; needs 16K machine. Cat X-3664

## NOW AVAILABLE SYSTEM 80 TECHNICAL MANUAL

48 pages of data, technical information, service data, minor modifications, etc. etc. Great for technically minded people with their own computer.



**\$14<sup>95</sup>**

Cat. B-6210

# DICK SMITH ELECTRONICS



SEE OUR OTHER ADVERTS IN THIS MAGAZINE FOR OUR STORE ADDRESSES AND RESELLERS

## DREAM 6800 RADIOTELETYPE RECEPTION AND DISPLAY

ly when there's something worth printing out. And then there's the lack of noise. During last year's Tasmanian "Hamfest" the author's RTTY display had to be shut down whenever a speaker was trying to deliver a lecture, because the old teletype machine was drowning him out. Next time around this problem won't exist, because the teletype will be left at home, and the Dream will be carrying the whole show.

### DOING IT THE OTHER WAY

If you have a teletype machine and converter, you can use them to provide a nice clear listing of a program within the Dream computer. In this case the Dream's tape output is connected directly to the converter's audio input and the converter is set for wide shift. The program prints out a hex listing of a given block of memory. (Editor's note: the programs supplied with this article were printed this way.)

Each line begins with an address, followed by 16 bytes in hexadecimal form. The output is at 45 or 50-baud, and each character is preceded by a figure or letters shift. The transmission speed is set by the data at hex 00E0... "OC" for 50-baud "OD" for 45-baud. The print-out isn't fast, but it does give a good readable result. and it's much easier than skipping through the memory with the function key, writing down the contents of each byte.

The program, (Listing 2) again in 6800 machine code, was written so as to occupy as little memory space as possible because it has to share the memory with the program to be printed out. To use it first load the program in question (providing it doesn't itself use the hex 0080-0100 area). Then load the print-out program into 0080-0100. Next load into hex 0002-0006 the start and finish addresses of the program to be printed, in the same way you would to dump it on-to tape. Now run from 0080; the screen will blank out and the teletype will begin churning out its print-out. This may take several minutes. When it's finished the teletype will stop and the screen will come on again, the same way it does after a tape dump.

If you're a licensed amateur you can use this program (running at 45-baud) to send a Dream program by radio to a friend hundreds of miles away.

### ANOTHER WAY

For those who want hard copy but do not need the radioteletype interface described above, here is another method of interfacing a teleprinter to the DREAM or other 6800-based system. This program, from Graham Leadbeater of Ringwood, Victoria, prints out the contents of memory on a Baudot teleprinter. Although originally written

### 50 BAUD RADIOTELETYPE RECEPTION AND DISPLAY PROGRAM, DREAM 6800 MACHINE CODE, MARCH 1, 1980 -----

```
0200 BD C0 79 86 3F BD C2 FE CE 80 12 A6 00 2B FC BD
0210 C2 F3 BD C2 F5 C6 06 0C 69 00 46 BD C2 F3 BD C2
0220 F3 BD C2 F3 BD C2 F5 5A 26 E7 46 46 46 36 01 01
0230 C6 04 CE 01 97 0C 69 00 09 8C 01 6F 26 F8 5A 26
0240 F1 CE 01 6F 86 05 08 08 08 08 08 08 08 08 E6 00
0250 C4 F0 E7 00 4A 26 EF 32 16 DE 32 86 1F 10 26 03
0260 CE 02 7E 86 1B 10 26 03 CE 02 BE DF 32 86 3C 97
0270 2E 86 0E 97 2F 17 BD C1 98 C6 05 BD C2 24 20 88
0280 00 00 F3 CF E3 8E B7 DF 0D 80 C5 46 E9 2E F6 DA
0290 2A 22 D6 DD BB DE F4 92 B6 DE 93 4F F2 4F B7 5A
02A0 49 2E F1 1E F2 48 BF DA B7 DA 4B DA 93 DE 5E DE
02B0 F6 DE D7 DD F6 CE 00 00 B7 FA B5 5A 56 DA 54 00
02C0 00 00 E7 9F E3 8E 03 80 0D 80 00 24 F7 DF 24 9F
02D0 2A 22 41 24 3E D9 AA D4 48 00 B1 1A 08 20 0A 20
02E0 E7 CF 0B A0 08 A0 F3 9F 6B A4 F7 CF F6 DF 49 25
02F0 E7 DF 41 1E EF EE 00 54 40 00 91 12 1C 70 00 00
0080 BD C3 41 DF 12 96 13 84 0F 26 14 86 D0 8D 47 8D
0090 45 86 C4 8D 41 8D 3F 96 12 8D 18 96 13 8D 14 86
00A0 C8 8D 33 DE 12 A6 00 8D 0A DE 12 08 9C 04 26 D3
00B0 7E C3 60 36 44 44 44 44 8D 03 32 84 0F 36 80 0A
00C0 2B 06 86 FE 8D 10 20 04 86 F6 8D 0A 32 CE 00 ED
00D0 08 4A 2A FC A6 00 CE 80 12 36 C6 08 A7 00 37 C6
00E0 0C BD C2 F5 5A 26 FA 33 46 5A 26 F0 32 39 EC EE
00F0 E6 C2 D4 E0 EA CE CC F0 C6 F2 DC D2 C2 DA 01 01
```

*These two program listings enable the DREAM 6800 to display radioteletype (RTTY) signals.*

for the D2 kit the author has also provided a version of the program for the DREAM, and sufficient information to allow the program to be adapted to run on the new 6802 D3 kit as well.

The advantages of hard copy are well known but the means to obtain it do not come cheap. If you can afford a modern Line Printer or ASCII Machine such as the

Teletype ASR33, then read no further. For those of us who must compute on a "shoe-string" the choice is narrowed down to a simple machine like the DUOPRINT (See EA Nov 1978) or a surplus telegraph machine such as the Teletype Model 15 or the Creed Model 7 teleprinter. (The former is usually regarded as the more reliable). These machines



**A  
SPECIAL  
News  
Report**

..... FOR IMMEDIATE RELEASE .....

SEND \$2 FOR OUR NEW CATALOGUE OF  
MICRODOT HARDWARE: S100 & HOBBY  
INSTANT SOFTWARE: CP/M & HOBBY  
MEDITECH PROFESSIONAL SYSTEMS

**INTERTEC UNVEILS ITS NEW COMPUSTAR™ MULTI-USER MICROCOMPUTER SYSTEM  
"CLAIMS MAINFRAME PERFORMANCE AT MICROCOMPUTER PRICES"**

**AUSTRALIAN PRICES START AT \$3,353.00 + SALES TAX**

(Columbia, SC) - Intertec Data Systems Corporation has announced its new multi-user "shared-disk" microcomputer system called the CompuStar. The new system, the result of over a year of intensive research into hardware and application requirements, represents what Intertec believes to be a major breakthrough in the microcomputer industry.

Employing some unique design concepts, the microcomputer-based CompuStar system truly rivals the performance of mini and mainframe systems . . . and at only a fraction of their cost!

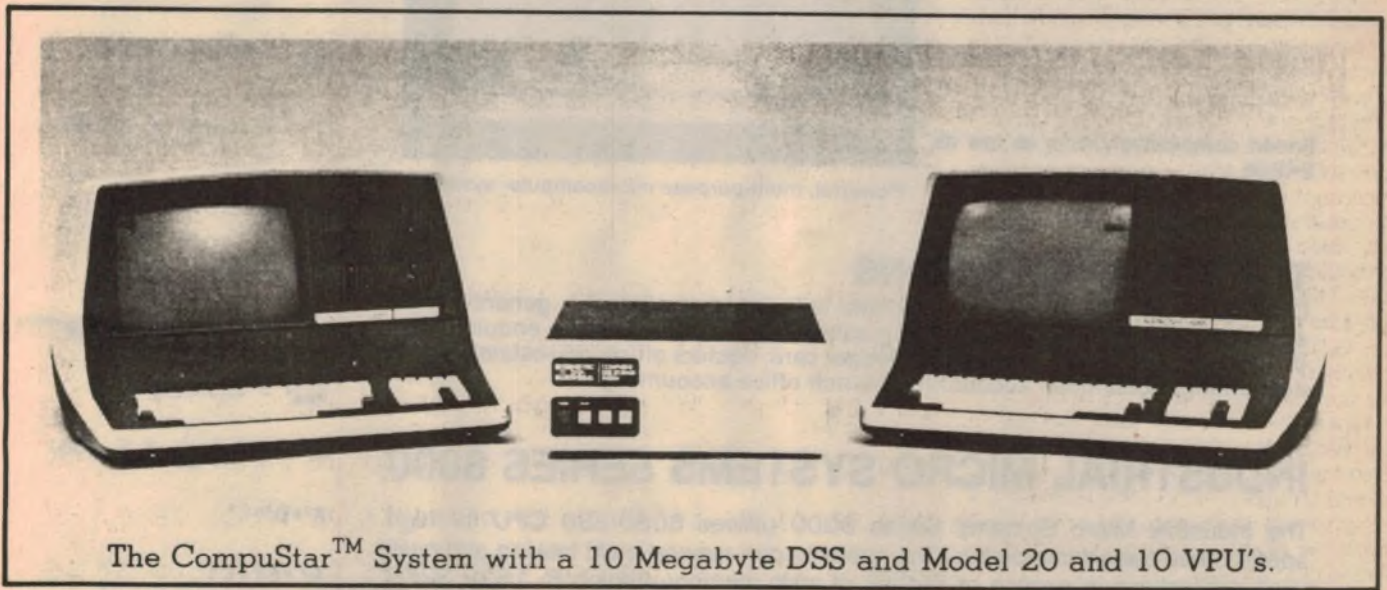

The CompuStar™ System with a 10 Megabyte DSS and Model 20 and 10 VPU's.

The CompuStar Multi-User system consists of a network of video display terminals (called Video Processing Units) which employ their own internal microprocessor and dynamic RAM. The terminals are tied together in a "network" fashion to "share" the resources of a single winchester or other hard disk device. In this manner, the CompuStar allows true multi-user capability by permitting the sharing of a common data base while at the same time allowing individual users the capability to maintain restricted data bases.

MICROWORLD 54 POWER STREET HAWTHORN VIC 3122 TELEX:AA38466 PHONE:03 819 2411



# MENSA COMPUTERS PTY. LTD.

Suite 3, 454 St. Kilda Road, Melbourne, 3004. Telephone: (03) 26-5683, 26-6150.

## FINDEX — The Real Computer



### THE WORLD'S FIRST PORTABLE MICROCOMPUTER Battery or mains operated

RAM 48K to 2 megabytes, bubble memory to 2MB, gas plasma display, optional audio, printer, mass storage mini floppys to 800K bytes, hard disk to 195 megabytes, acoustic coupler, S-100 bus, battery optional, CPU with real time clock. For dynamic businessmen on the move. Ideal for real estate agents, insurance brokers and accountants.

### SUPERBRAIN™ SERIES

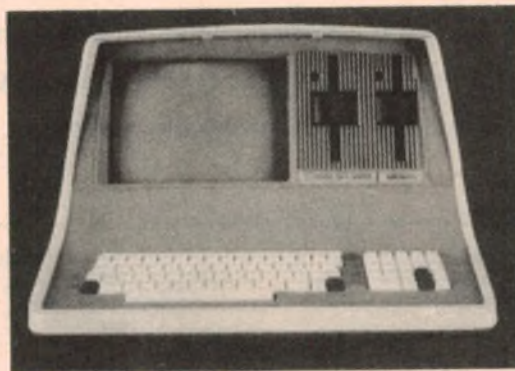

Priced competitively from as low as \$4995.

Powerful, multi-purpose microcomputer systems.

### TYPICAL APPLICATIONS

Debtors ledger and statements, creditors ledger and remittances, general ledger and trial balance, order entry/invoicing, sales analysis, payroll/wages, enquiry, word processing, mailing, record keeping, ledger card, doctors office, real estate, agency accounting, hotel/motel accounting, branch office accounting.

### INDUSTRIAL MICRO SYSTEMS SERIES 8000

The Industrial Micro Systems Series 8000 utilises 8080/280 CPU for high speed S100 based computing. The systems can support multi tasking and multi user applications in excess of 500KB of main memory utilising 8, 16 or 32KB memory Boards. We offer 64KB RAM, one 5¼" SSSD floppy, 32 megabytes of Hard Disk, 16MB fixed and 16MB removeable, Televideo 912B Screen, Anaden 150CPS printer, two RS232 points with cabling etc, CPM or MPM and a complete IMS Software Package comprising Debtors, Creditors, Order Entry, Inventory and General Ledger.

Special Price \$26,243.

Dealers for Opal in Victoria.  
Sole Distributor for Findex, Victoria and NSW.

### SUPPLIERS FOR NDKS S-4000

#### MATHEMATICS

$$F(\omega) = aT \frac{\sin \omega T/2}{\omega T/2} e^{-j\omega T/2}$$

$$e_{rms}^2 = 4KTR(f_2 - f_1)$$

$$L_1 = 10 \log \frac{1}{80} \times S_n \text{ (dB)}$$

$$A^2 + B^2 = C^2$$

$$A^2 + B^2 = C^2$$

$$F(\omega) = aT \frac{\sin \omega T/2}{\omega T/2} e^{-j\omega T/2}$$

$$e_{rms}^2 = 4KTR(f_2 - f_1)$$

$$L_1 = 10 \log \frac{1}{80} \times S_n \text{ (dB)}$$

$$A^2 + B^2 = C^2$$

$$A^2 + B^2 = C^2$$

$$F(\omega) = aT \frac{\sin \omega T/2}{\omega T/2} e^{-j\omega T/2}$$

$$e_{rms}^2 = 4KTR(f_2 - f_1)$$

$$L_1 = 10 \log \frac{1}{80} \times S_n \text{ (dB)}$$

$$A^2 + B^2 = C^2$$

$$A^2 + B^2 = C^2$$

$$F(\omega) = aT \frac{\sin \omega T/2}{\omega T/2} e^{-j\omega T/2}$$

$$e_{rms}^2 = 4KTR(f_2 - f_1)$$

$$L_1 = 10 \log \frac{1}{80} \times S_n \text{ (dB)}$$

$$A^2 + B^2 = C^2$$

$$A^2 + B^2 = C^2$$

## USING A TELETYPE MACHINE WITH THE DREAM 6800

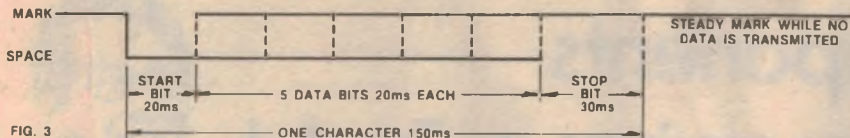

FIG. 3

are limited in their speed and character font, use the clumsy five-bit Baudot code and would be quite unsuitable for a word processor or small business system. They are, however, ideal for the hobbyist who wants documentation for his programs and data and who doesn't mind waiting a few extra seconds to get it.

Machines are often available at disposals shops and are sometimes sold by Telecom Australia. You should be

bits/sec). Usual practice is to convey the data to the machine in a 20mA current loop.

Mark = Current on – Magnet operated  
Space = Current off – Magnet released

A mark condition should be maintained while no data is being sent.

At the computer end we have the data in eight-bit words (bytes) five bits of which must be shifted out, one bit at a time and used to open or close the current loop.

This makes printing very slow and it would be inconvenient to add an ACIA if your system hasn't got one already. Another possibility is to use five bits from a PIA port and connect the to a UART. Both the ACIA and UART will then need to be fed with a clock signal which determines the baud rate. But the simplest method is to use a single bit of a PIA port to control the loop and arrange for the program to serialise the data and add the start and stop bits. Thus a few lines of program can save some expensive IC's and a lot of wiring. It does mean, however, that your system cannot be doing anything else while it is printing but for this memory dump application it doesn't matter. Therefore, this method was chosen as being the least hardware-dependant.

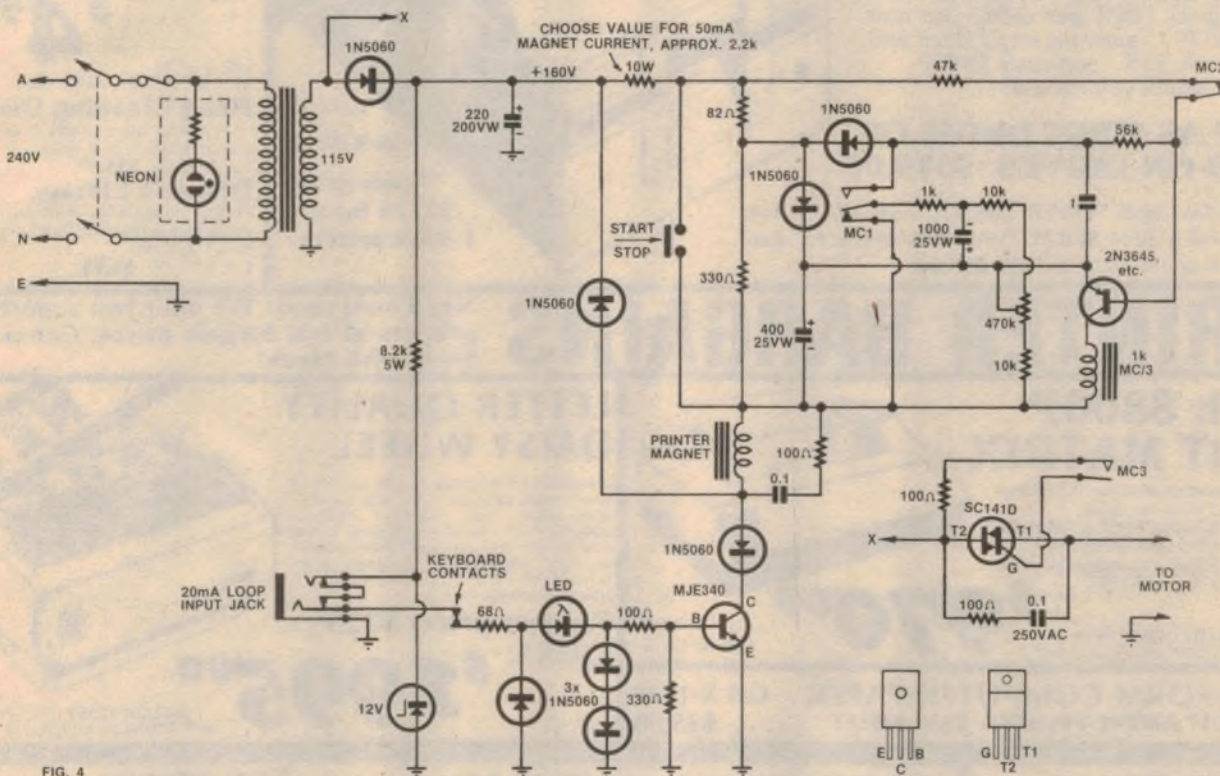

FIG. 4

This circuit enables a DREAM 6800 to drive a teletype machine.

able to pick up a good one for \$40 odd if you shop around. There are also a few Siemens Model 100's reaching the market, these are ideal if you can get one.

### THE INTERFACE

Connecting a machine to a computer system is no problem. At the printer end we have an electromagnet which must be operated and released by the incoming data, one bit at a time, and at the correct rate for the machine (usually 50

Logic 1 = Mark – Loop closed  
Logic 0 = Space – Loop open

We must also send a start bit (always a space) before the data and at least one and a half stop bits (always marks) after it. Fig. 3 shows this graphically. There are a number of ways in which this can be done. While we could use an ACIA or Asynchronous Communication Interface Adapter, it is not really suited to a five-bit code but could be used by programming or wiring the three most significant bits high to make a long stop element.

Fig. 5 shows the interface circuit. Bits one and two were chosen as they are the first spare bits on the Dream 6800 PIA. The reason for the "Enable" bit is that the monitor program in the DREAM initialises all spare PIA bits low which would make the printer "run open" until the program was started. Note that this interface is not intended to break the high voltage circuit to the machine's magnet. The printer must be equipped with its own power supply and control circuit and connect to the computer in-

# The Supermarket for TRS-80 Add-on Components In stock now. Huge savings on Tandy!



Even if you bought a TRS-80, you don't have to pay Tandy's prices for peripherals. Much of Dick Smith's System 80 hardware is completely compatible with the TRS-80. Compare our prices: and save a fortune!

## SAVE OVER \$1000\* ON A DISK SYSTEM

Why pay over \$220 extra **per drive** and yet get only half the storage? Our disk drive gives 100K **per side** - yet cost only \$379!! Tandy's is single sided and gives only 55K - but costs \$699!! Which would you choose?

**USE AS FIRST DRIVE OR  
ADD-ON DRIVES: \$379.00**

You'll also need: POWER SUPPLY (suits one or two drives) Cat X-3234 **\$60.00** DAISY CHAIN CABLE (suits one to four drives Cat X-3232 **\$55.00**

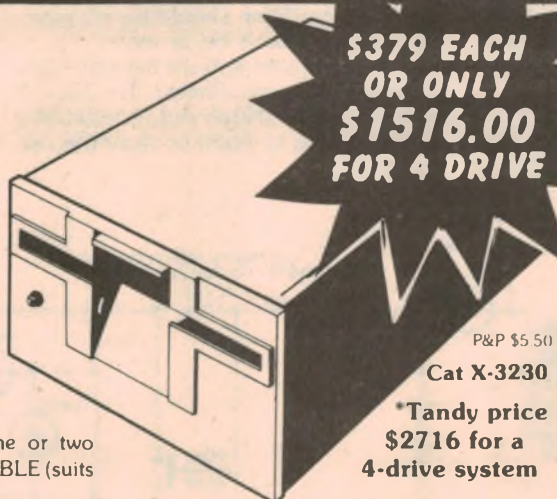

**\$379 EACH  
OR ONLY  
\$1516.00  
FOR 4 DRIVE**

P&P \$5.50

Cat X-3230

**\*Tandy price  
\$2716 for a  
4-drive system**

## CHECK OUR PRICES FOR DISKS!

Mini floppy disks, individually tested against defects  
Tandy charge \$7.95 ea!

OUR PRICE: **\$4<sup>95</sup>**

- Cat X-3505 (or from \$3.50 ea 100 plus) **Head Cleaning Disks**  
Keep your drive heads in tip-top condition Pack of 2 disks  
Cat X-3516 **\$34.95**
- Diskette Library**  
Protect valuable files from dust and damage. Each library box holds up to 10 diskettes  
Cat X-3515 **\$5.95**

## PRINTER BARGAINS

Need hard copy? We offer two superb printers at real bargain prices. Compare these with Tandy!

### Itoh 8300P DOT MATRIX

For economical dot matrix printing, you can't beat this value  
125chars/sec print, 80 columns on standard fan-form paper (see below). Tandy's cheapest full width printer is almost \$1500!



**\$970<sup>00</sup>**

BELOW COST FREIGHT ANYWHERE IN AUSTRALIA \$6.00

Cat X-3255

### LETTER QUALITY DAISY WHEEL

Try and match this value (Tandy can't!) For word processing and other top quality applications, uses standard business stationery, 25 chars/second print speed (much faster than a golfball!) and is capable of fully proportional printing! Uses economical daisy wheels for easy font changes or replacements.



Tandy's price: \$2299...  
OURS: **\$1995<sup>00</sup>**

BELOW COST FREIGHT ANYWHERE IN AUSTRALIA \$6.00

Cat X-1265

**FAN-FORM COMPUTER PAPER** Cat X-1189  
**TO SUIT ABOVE PRINTER, 2000 SHEET** ... **\$35.00**

### TRS-80 DOS PATCH

Changes the Tandy DOS from 35 to 40 racks - so you can take full advantage of our bargain drive above.

**\$19<sup>50</sup>**

Cat X-3550 P&P \$2.00

### MICRODOS

A simple, easy-to-understand Disk Operating System for business applications, etc using BASIC programs.

**\$35<sup>00</sup>**

Cat X-3555 P&P \$3.00

### LIGHT PEN BARGAIN!

The best value around. Gives your System 80 or TRS-80 an eye. Easy to use, has simple programs.



**\$9<sup>95</sup>**

P&P \$1.00

### SOUND OFF

Add sound to your TRS-80/System 80 programs! Includes amp programs and full instructions. You can add sound to existing programs too! Also suits TRS-80!



**\$19<sup>50</sup>**

P&P \$2.00

Cat X-3648

# DICK SMITH ELECTRONICS

<b>NSW</b>	145 Parramatta Rd	<b>AUBURN</b>	648 0558	<b>ACT</b>	98 Gladstone St	<b>FYSHWICK</b>	80 4944
	813 Prince Hwy	<b>BLAKEHURST</b>	546 7744	<b>QLD</b>	186 Logan Road	<b>BURANDA</b>	391 8233
	818 George St	<b>BROADWAY</b>	211 3777		824 Gympie Rd	<b>CHEMERSIDE</b>	59 8255
	531 Pittwater Rd	<b>BROOKVALE</b>	93 0441	<b>SA</b>	80 Wright Street	<b>ADELAIDE</b>	212 1982
	147 Hume Hwy	<b>CHULLORA</b>	642 8922	<b>VIC</b>	399 Lonadale St	<b>MELBOURNE</b>	87 9834
	182 Pacific Hwy	<b>GORE HILL</b>	439 5311		858 Bridge Road	<b>RICHMOND</b>	428 1814
	30 Grace Street	<b>PARRAMATTA</b>	883 1133	<b>WA</b>	Dardanoong Rd	<b>SPRINGVALE</b>	Open soon
	125 York Street	<b>SYDNEY</b>	290 3377		414 William St	<b>PERTH</b>	328 8944
	263 Kara Street	<b>WOLLONGONG</b>	28 3800				

**DICK SMITH MAIL ORDER CENTRE: PO Box 321, North Ryde NSW 2113 Phone (02) 888 3200**

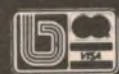

**SHOPS OPEN 9AM to 5:30PM**  
(Saturday 9am till 12 noon)  
**BRISBANE: Half hour earlier**  
**ANY TERMS OFFERED ARE TO APPROVED APPLICANTS ONLY**





# DRIVING A TELETYPE MACHINE WITH THE DREAM

terface via a low voltage, non-inductive 20mA loop. Fig. 4 shows such a circuit. The Teletype Model 15 has a 110 volt motor and the stepdown transformer can also power the control circuit. No provision has been made to provide access to the data generated by the machine's keyboard but the keyboard contacts are in series with the control loop to allow you to type a heading on a page before you dump the data.

An interface circuit for the Creed Model 7 was published in the July 1977 issue — of "Electronics Australia" (File No. 2/TT/4.)

## THE PROGRAM

A listing of the program which I have named "TYPEBUG" is shown in Fig. 6a, it is suitable for any 6800 system, all you need is one bit of a PIA port and EO bytes of RAM to hold the program. A few bytes of scratchpad RAM are also required.

To run the program, use your monitor to enter the start and finish addresses (inclusive) of the block to be dumped into A002-3 and A004-5 respectively. Start the program at 0100. A long mark is sent followed by a 140ms break to start the TTY motor. It is recommended that you equip your machine with the automatic motor start/stop circuit incorporated in Fig. 4. Two "Carriage return" and three "Line feed" characters are output to get some clear paper. The data is now printed followed by CR CR LF LF LF FIGS. The program then jumps to monitor.

This program was written for the D2 kit but can be adapted for other systems as follows:

To Relocate;

The data at 0110-1 is the start address plus BF

The data at 015D-E is the start address plus CA

The data at 017C-D is the start address plus CF

Location of Output Port;

The data at 0101-2 and 01B3-4 is the address of the PIA used to output the data. (8004 for the D2).

Which bit of output port;

The data at 01AD is output for a mark

The data at 01B1 is output for a space Baud Rate;

The data at 01B6-7 is the start address of a subroutine to delay for the duration of one-bit. For a D2 Kit and a 50Bd machine, use the 20ms delay in J-Bug (E0DD). For other systems and/or other Baud rates provide your own subroutine wherever convenient. The Index Register is available.

Scratchpad Ram;

Nine bytes are required and may be located anywhere. For the D2, I have used A002-5 and A040-4. If your scratchpad is located somewhere else, you

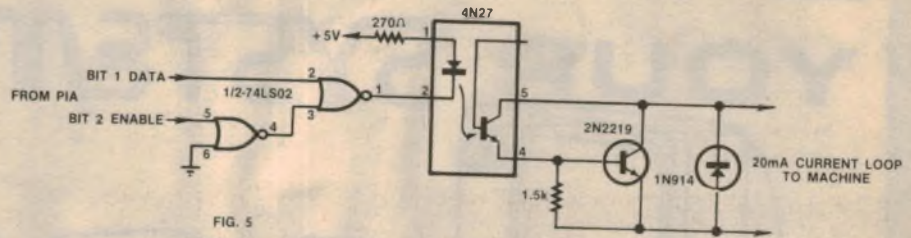

This circuit provides a 20mA loop output from a DREAM 6800 PIA port.

```

0100  CE 80 04 6F 01 86 FF A7 00 C6 04 E7 01 A7 00 CE
0110  01 BF C6 11 8D 49 7F A0 40 B6 A0 02 8D 4F B6 A0
0120  03 8D 4A 86 C8 8D 7F 86 C8 8D 7B FE A0 02 A6 00
0130  8D 3B FE A0 02 BC A0 04 26 07 C6 06 3D 1E 7E E0
0140  8D 08 FF A0 02 B6 A0 03 27 0C 85 01 26 00 85 0F
0150  26 05 C6 03 20 02 C6 04 8D 02 20 8D CE 01 CA F7
0160  A0 41 A6 00 8D 40 08 7A A0 41 26 F6 39 B7 A0 42
0170  44 44 44 44 8D 05 B6 A0 42 84 0F CE 01 CF 08 4A
0180  2A FC A6 00 2A 10 7D A0 40 26 1B 7C A0 40 36 86
0190  FE 8D 13 32 20 10 8A 80 7D A0 40 27 09 7F A0 40
01A0  36 36 F6 8D 01 32 FF A0 43 44 24 04 C6 FF 20 02
01B0  C6 F0 F7 8D 04 BD E0 DD 4D 26 EF FE A0 43 39 FF
01C0  FF FF FF FF FF FF 8D FF FF FF 00 00 C4 C4 C4 F6
01D0  6C 6E 66 42 54 60 6A 4E 4C 70 C6 F2 DC D2 C2 DA
    
```

Fig 6a, above is the listing for Typebug while Fig 6b, below is for TypeDream.

```

0340  CE03 E8C6 08D7 208D 427F 0040 9602 8D48
0350  9603 8D44 86C8 8D77 86C3 8D73 DE02 A600
0360  8D36 DE02 9C04 2607 C606 8D1C 7EC3 6003
0370  DF02 9603 270C 8501 26E2 850F 26DA C603
0380  2002 C604 8D02 20C4 CE03 EAD7 41A6 008D
0390  3E08 7A00 4126 F639 9742 4444 4444 8D04
03A0  9642 840F CE03 EF03 4A2A FCA6 002A 107D
03B0  0040 261B 7C00 4036 86FE 8D13 3220 108A
03C0  807D 0040 2709 7F00 4036 86F6 8D01 327D
03D0  0020 26FB 4424 04C6 0720 02C6 05F7 8012
03E0  C601 D720 4D26 E839 80FF 00D0 C4C4 C4F6
03F0  6C6E 6642 5460 6A4E 4C70 C6F2 DC02 C2DA
    
```

will need to insert the appropriate data in

```

0117-8  0133-4  0160-1  0187-8
011A-B  0136-7  0168-9  018C-D
011F-20 0143-4  016E-F  0199-A
012C-D  0146-7  0177-8  019E-F
End of Program;
    
```

The data at 013F-40 is the entry address for the monitor program. (E08D for the D2).

## THE DREAM 6800

We could adapt TYPEBUG to the DREAM 6800 using the above information but virtually everything would need to be changed, first, the program would have to be re-located because 0100-01FF is the DREAM video page. The program would be best positioned at the top of memory — arranged to finish at 03FF. Second, the DREAM's PIA is at a different address (8012). Third, special attention

must be given to the other PIA bits as these control the bleeper and audio interface. Fourth, the DREAM monitor, CHIPOS, is entered at C360.

We could adapt to all this but there are several reasons why it would be less than ideal. For a start, we can save space by omitting the PIA set-up routine, CHIPOS does this for us, and the DREAM scratchpad is located 0000-7F so we could also save space by using the direct addressing mode. Then there is the timer. The DREAM has a 20ms interrupt timer which is just what we need but it must be used in a different way to a simple delay subroutine.

To save the Dreamers a few sleepless nights, I have re-shuffled the program into a new version named TYPEDREAM. It is listed in Fig. 6b, it is 20 bytes shorter and is located 0340-FF. 0002-3 and 0004-5 are used for the start and finish addresses respectively. Note that

# E-X-P-A-N-D YOUR SYSTEM 80

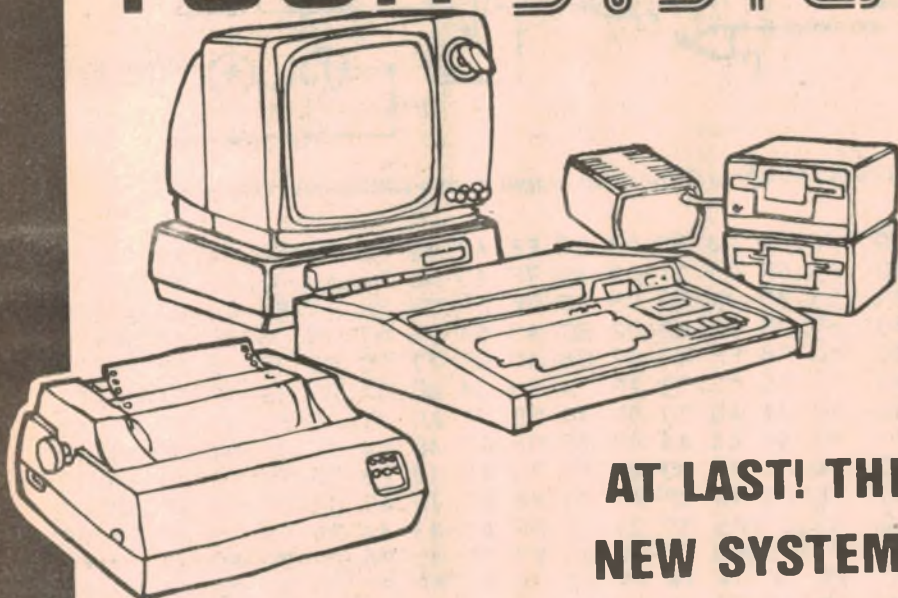

## AT LAST! THE NEW SYSTEM 80

## S-100 EXPANSION INTERFACE

Here's what  
it can do for your System 80:

- Give you a standard Centronics parallel printer port. (Suits most printers including our Dot Matrix (X-3255) and Daisy Wheel (X-3265) printers.
- Give you an RS-232C port with full 'handshaking' logic for connection to modems, etc.
- Give you the option of fitting extra memory: fit a RAM CARD with another 16K or 32K (available separately) — plus you can still fit another S-100 add-on board.
- Give you a floppy disk controller (up to four drives) with external data separator for improved reliability
- Gives you the ability to use a cheap teleprinter instead of a parallel printer. Save a bundle!
- Gives you S-100 compatibility: so you can use many of the peripherals from hundreds of manufacturers: why be tied to one source of supply?

**AND IT'S \$\$\$\$ CHEAPER THAN TANDY!**

Apart from the massive savings on the computer itself, our expansion unit is over \$119 less than Tandy's (theirs is \$618.95 including RS-232C interface). And it offers you much more!

Sent anywhere in Australia for \$6  
Below cost!

Cat X-4010

**ONLY  
\$499<sup>00</sup>**

Terms available to  
approved applicants

### 16K RAM CARDS TO SUIT S-100 INTERFACE

Comes with 16K fitted; with room for another 16K. You can have a 48K computer!  
And the savings can be massive!

Card (including 16K RAM) **X-4016 \$199.00**  
(Tandy charge \$220.00!!)

Second 16K RAM **X-1186 \$59.95**  
(Tandy charge \$220.00!!)

## IF ALL YOU WANT IS A PRINTER INTERFACE . . .

We've got this economical parallel interface allowing you to run any Centronics-type printer direct from the System-80 — no expansion interface needed. And again, the price is a big saving over Tandy's!

Printer Interface:  
Cat X-4013

**\$49<sup>50</sup>**

Connecting Cable:  
(suits Printer Interface  
or S-100 Interface)

**\$39<sup>50</sup>**

Cat X-4014

**DICK SMITH  
Electronics**



**SEE OUR OTHER ADS FOR  
FULL ADDRESS DETAILS**

## DREAM 6800 TELETYPE

TYPEDREAM is actually a machine-code program.

### THE PRINT FORMAT

The program can print the data in one of four different formats. Fig. 6a includes the usual one with 10 bytes per line and one space between each byte. The format at Fig. 6b is intended for CHIP-8 programs and prints eight groups of two bytes per line. The listing in Fig. 6c shows a format which may be useful when disassembling machine code programs. It uses a lot of paper but gives you room to write comments. Fig. 6d is a similar format intended for CHIP-8 programs. The table in Fig. 7 shows how to convert the program for these options.

FORMAT	TYPE BUG		TYPE DREAM	
	014D	0151	0379	037D
a	00	D5	00	DA
b	DD	D5	E2	DA
c	00	00	00	00
d	DD	00	E2	00

FIG. 7

In conclusion, it should be noted that the program is of limited use in a standard D2 Kit and of only slightly more use in a standard DREAM 6800. The reason being that it occupies nearly half of the

available memory in a D2 and nearly one third of the DREAM memory. This doesn't leave much room for anything to print. (You could make the program print itself of course). Thus, it is really intended for systems involving at least 2 or 3K of RAM.

So before you rush out and buy a teleprinter, make sure your budget will stand a few extra RAM bugs.

```

C400 7D
C401 80
C402 81
C403 2A
C404 FB      0200 6A10
C405 B6      0202 6B00
C406 80      0204 6DBA
C407 80      0206 223A
C408 84      0208 224A
C409 7F      020A 7A10
C40A 7D      020C 223A
C40B A0      020E 7D02
C40C 53
C40D 27
C40E 01
C40F 39
    
```

Above are figs 6c and 6d respectively.

(Editor's Note: See RAM Expansion for the DREAM 6800 described in December 1980.)

## Glanz phono cartridges reviewed from p40

1kHz output voltages were in all cases slightly higher than those specified by Glanz. This is commendable since for every dB increase in cartridge output level, the overall signal-to-noise ratio of an ideal playback system is likewise improved. As increases in output level usually result in performance trade-offs elsewhere we commend the Glanz achievement in this area.

Square wave response at 1kHz was essentially the same for all three cartridges with slight overshoot followed by two or three damped oscillations. Sinoidal waveform deteriorated slightly above 5kHz for the MFG-11T, 6kHz for the MFG-31L and 7kHz for the MFG-71L. This is consistent with the performance of competitive cartridges.

All three cartridges tracked the +15db test track on CBS STR110, and also the +12db drum test track on W. & G. 25/2434, although they all showed some traces of mistracking on the +16db drum test. These results were obtained at the tracking forces shown in the specifications above. At these same settings, all performed quite well on the high frequency trackability test tracks of the

Shure "Audio Obstacle Course" disc. Naturally all exhibited slight problems on the very highest level test tracks of this record, although roughly equalling competitively priced cartridges.

Sound quality of the cartridges is clean and pleasant, with the MFG-71L producing a noticeable order of improvement over the MFG-11T. Interestingly, the MFG-31L did not sound that much better than the MFG-11T, nor appreciably poorer than the MFG-71L. This probably means that its sound really does lie between the two extremes - as does its price.

Our overall impression of these Glanz cartridges is very favourable. They perform well and appear to be carefully manufactured.

Recommended retail prices for the cartridges are \$23.00 for the MFG-11T, \$42.00 for the MFG-31L and \$95.00 for the premium MFG-71L. Further information can be obtained from the Australian distributor for Glanz Cartridges: R. H. Cunningham Pty Ltd, 146 Roden St, West Melbourne, Vic 3003; or their interstate offices. (P. de N.)

## LOOPY VIDEO

418 BRIDGE ROAD, RICHMOND, 3121  
Phone: 429 5674 P.O. Box 347

Second hand video recorders and tapes, cheap. Also new.

### OSI HARDWARE FOR OHIO COMPUTERS

Superboard II ..... \$395.00  
SII Covers/VDU Stands (perspex) ..... \$18.95  
RF Modulators 5/9V ..... \$19.95  
EPROM with Single Key Basic & Cursor Control ..... \$49.95

### OSI SOFTWARE FOR OHIO COMPUTERS

Over 100 titles for C1P/SII; enquire C2/4P Categories are: Games, Education, Business, Text, Instructions (Modifications), and Utilities.

K.2 Catalogue. Brief description of all programs, free hints. New enlarged version. \$3.50 PLUS \$1.00 P&P.

#### Example of titles:

I.25 RTTY for C1P ..... \$76.95  
G.37 Nuclear Sub (2 tapes Adventure) ..... \$18.95  
U.24 Sound Effects ..... \$9.95  
U.19 Cursor/Editor C2/4 ..... \$11.95  
U.20 Mini Assembler ..... \$9.95

Now available blank digital tapes C10 each. Less for lots of 10 or 100.

Mail orders allow postage, eg: OSI Software

1 or 2 \$1.00, 3-5 \$1.50, 6-9 \$2.00, 10 or more items \$2.50

All prices INCLUDE sales tax. Prices subject to change without notice.



## 'DREAM INVADERS!'

This exciting action game, written by Michael J. Bauer, is a must for all owners of a DREAM-6800. Level of difficulty increases as the game progresses, so it suits everyone from beginner to seasoned Space Invaders fans. (Note: 2K RAM needed; Details of simple low-cost RAM expansion provided.)

Cassette plus instructions ..... \$10.  
(incl. post; allow 2 - 3 weeks delivery; foreign orders add \$1.)

Commented program listing (6800 code) also available ..... \$5 extra.

### DREAMWARE

PO Box 343  
Belmont VIC. 3216



#### USER GROUP

Subscribers to the DREAM-6800 monthly newsletter receive lots of programs and ideas, plus regular feature on learning to program in the CHIP-8 language.

6 month subscription ..... \$15  
Single issues ..... \$3  
Back issues ..... \$4

Send cheque or money-order to:-

'NSW 6800 User Group'  
27 Georgina Ave  
Keiraville NSW 2500



# Letters to the editor

## On sub-editors & their captions

May I say how delighted I was to read the caption on the photograph on page 58 of the August 1980 issue of "Electronics Australia". I refrained from conveying to you this delight for fear that someone might resent the lightheartedness of some poor sub-editor who has to breath life into some of the more severe contributions. But I see from the November issue that the fellow is still alive and well by his captioning of the illustration on page 85.

Just a couple of comments: please don't stop publishing the boring shots. They are reassuring to the budding hobbyist who wants to know if the original looked like the creation he has produced. And please keep up the honesty without ridicule.

By the way, although perhaps unintentional, the piece on page 7 in the November 1980 issue about the pacemaker being sold with a lifetime guarantee is priceless. It makes an ideal Irish joke rebuttal.

John E. Wood,  
Cooma East, NSW.

**COMMENT:** That "poor sub-editor" is actually two different people. Leo Simpson must be blamed for the August caption, while Greg Swain has accepted responsibility for the caption in the November issue.

## More on the DREAM 6800 please

In the September issue of "Electronics Australia" I noticed under a heading of "More wanted on the DREAM 6800" that the author, Mr D. Willaton, was not at all impressed by the extreme lack of further articles concerning "DREAM".

Since reading the article I have compiled a fairly comprehensive breakdown of the CHIP 8 instructions incorporating example programs of each, which in my opinion should help to clear up the mystery surrounding their use.

In the article I have also included a few machine code programs which should aid the user in preparing programs. One of the programs I have written is a "Hexadecimal Conversion Calculator" which I'm sure will be of great benefit to those not too well informed on the subject.

I have also sent to EA an advertisement for the sale of this article, at a price of \$10.00, for those eager to understand CHIP 8 programming.

T. Huett,  
PO Box 520, Woodridge,  
QLD 4114

## Ooh my goodness! . . . It was "Kurri"

Thank you for featuring my letter of September 10, 1980 in Forum in the November 1980 issue.

I would like to point out that while I have actually visited Come-by-Chance (NSW), I have never been to "Kum Kum" NSW. I understand that a kumkum is some sort of Arabian jar; I have no connection with such a vessel. "Come, Come" are the opening words of a song in a Franz Lehar operetta, but I don't remember which one.

After living in this town for nearly five years I have heard many jokes about hot "kurri" and double curry, but your renaming of the community has given me something to think about. But not for long. Instead of Kum Kum for me it will be Go Go, as I am leaving town in the New Year.

Thanks again for the chuckle.  
Denis Hauville,  
Kurri Kurri, NSW

**COMMENT:** Blame the Editor-in-Chief. He learned to read when old English ecclesiastical script was all the go and he gets his "m"s and "rri"s all mixed up.

## Parts for the EA atomic bomb

I am a regular reader of your magazine and compliment you on the many and varied projects you publish. However, I have reason to complain about the recent Fissionmaster 80 AB10 project published in the October issue.

I have tried all my usual sources to obtain parts for this project and have had a complete lack of success.

The Dick Smith and Tandy catalogues have been searched in vain for Part No. U235. In fact I understand Dick Smith refuses to lift a hand in this direction — a complete change of face for the ex-trovert of the electronics industry.

I must admit I was amazed at this situation as in the past you have carefully

researched the problem of parts availability, often suggesting substitute parts or suppliers.

Also, I note that EA normally holds a disposition of supporting anti-pollution, environmental issues and was surprised to notice in this project that you did not opt for the Fussionmaster 80 model.

Looking to future projects, could you please let us know whether you are presently developing an "H" (Hydrogen) or "N" (Neutron) version of this project or even a delivery system, as I am sure readers would be eagerly awaiting any developments in this area.

In regard to adapting previous projects, could you please advise whether the Control Timer (80c4) would be suitable as a triggering device, allowing the constructor sufficient time to leave the area (or country) prior to detonation.

Dr No,  
Parts Unknown.  
(P.A. Ward, Marion, SA.)

## A telex:

Attn: Neville Williams  
For some years I have intended to send you a carefully crafted letter to express my appreciation of your magazine.

For years I have procrastinated. This telex, although brief, will suffice to express the sentiment.

The magazine has been of great value, recreationally and professionally for many years.

Regards, Ian Cousins, Eudunda, SA 5374.

**COMMENTS:** Many thanks for your telex, I. C. It's always good to hear from an appreciative reader.

## Overseas TV standards

I am prompted by the letter from DH, featured in the November issue "Forum" section, concerning TV standards, to offer the following unofficial definitions of the major colour television systems in use around the world.

I read this many years ago in the UK and can claim no original thinking, but you and some readers may generate a chuckle at it:

- NTSC (USA) — Never Twice the Same Colour;
- SECAM (France) — Something Essentially Contrary to the American Method;
- PAL (Germany) — Peace At Last.  
C. R. Ashton (VK5DQ),  
Morphett Vale, WA 5162.

**COMMENT:** For those readers who haven't seen it before, it can be amusing. In the days when the phrases were generated the mood was one of intense, even bitter, national and commercial rivalry.

# Spotlight on precision.



The Sanwa name has long been associated with high quality reliable test instruments and has gained wide acceptance in many areas including Telecom, military establishments, research, educational, trade and hobbyists. The above represents a selection of some of the more popular instruments from the comprehensive Sanwa power line up.

**The "NOSWEAT" Insulation and Low  $\Omega$  Meter  
PDM 500c**

- One man operation—no handle to crank.
- No wearing parts—solid state for long trouble-free life.
- Large easily read scale.
- Simple push-button operation.

**High Performance—Rugged Construction  
460 ED**

- 10 $\mu$ A movement in a heavy-duty case.
- 12A A.C./D.C. measurement capability.
- Maintenance simplified with detachable indicator block.
- Polarity reversal switch.

**Top of the Line—for Lab and Bench  
N501**

- VTVM performance with constant 1M $\Omega$  impedance on A.C.V. ranges.
- 2 $\mu$ A taut band suspension movement.
- High resolution of 0.05 $\mu$ A/1mV
- Fuse and diode protection.

**Hot Favourite for Temperature Measurement  
TH-510**

- Thermometer measuring—50°~300°C in dual ranges.
- N-1 type accompanies a pointed tip probe. S2 type a flat tip probe for surface temperature.
- Constant voltage IC circuit.
- Minimal current consumption (3mA) increases service life of battery—150-hour continuous use.

**Low Cost 3-in-1 Logic Pulse Scale  
YX-380TR** NEW

- Instant L.E.D. indication of pulses in excess of 0.5 VRMS. 0-30MHz (using optional probe).
- DC and AC simultaneously indicated on meter and logic probe.
- Multitester function may be expanded with optional hFE adaptor and HV probe.

**Versatility Plus Sensitivity  
BX808M** NEW

- High sensitivity 30 $\mu$ A meter movement.

- Simultaneous measurement of A.C. and D.C. signals.
- A.C. signals may be measured even when mixed with D.C.
- Provides logic pulse analysis facilities with pulse and DCV range.
- Instant L.E.D. indication of pulses exceeding 0.5 RMS 0-30 MHz.

**Popular Choice of Hobbyists & Servicemen  
U-60D**

- Easy to read wide scale.
- 44 $\mu$ A diode protected movement.
- Optional temperature probe for -30° to 150°C.
- Plug in shunt adaptor optional for 1A, 5A and 25DCA.

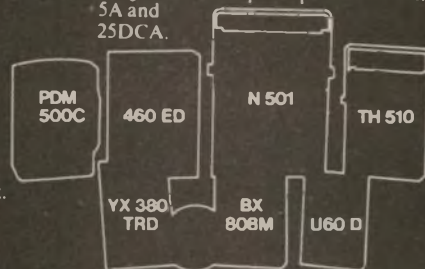

Available nationally from



**WARBURTON FRANKI**

• ADELAIDE (08) 356-7333 • BRISBANE (07) 52-7255 • HOBART (002) 28-0321  
• MELBOURNE (03) 699-4993 • PERTH (09) 277-7000 • SYDNEY (02) 648-1711  
• AUCKLAND N.Z. (09) 77-0924 • WELLINGTON N.Z. (04) 69-8272

WF 718/86

WIN A TRIP TO  
HONG KONG CONTEST  
BUY NOW AND ENTER!

# ~~FRG-7~~ ~~FRG-7000~~

NOW IT'S THE BRAND NEW

# FRG-7700

We've sold thousands of the superb Yaesu 'FRG's. Now there's a brand new model: the superb FRG-7700 . . . All mode (even FM) and a brilliant new design. Isn't it time you up-dated your communications receiver (FM is great with converters!)

State-of-the-art noise blanker eliminates most types of pulse interference which can obliterate weak signals

Calibrated S-meter aids in logging DX stations (S1 to +80dB)

Built-in digital display gives both accurate frequency and time indication

Timing feature allows control of receiver and external equipment (such as a tape recorder)

Function switch giving control of digital display — including sleep timing

Selectable AGC control giving fast or slow AGC

Optional twelve channel memory for instant recall of any stored frequency — without any other controls: even the band switch is over-riden

Built-in front panel speaker, giving clean, sharp audio — maximum output 1.5 watts

All amateur bands marked on switch for easy identification — including the new WARC bands

Complete provision for all modes: CW, LSB & SSB, FM and three positions of selectivity on AM!

An audio tone control, too — for the most discerning ears

Silky smooth main tuning knob for minimum backlash, superb control and ease of use

A fine tune control for absolute memory frequency control — plus an FM squelch

Full LF/MF/HF band coverage — from 150kHz to 30MHz!

Of course, the front panel is only half the story. Take a look inside the new Yaesu FRG-7700 and you'll find a superb state-of-the-art circuit, giving you outstanding performance and ease of use. And the really good news: the FRG-7700 is actually cheaper than the model it replaces. A better receiver for less money! And with the optional memory unit, the FRG-7700 gives you the ability to store up to 12 commonly used frequencies — recalled at the touch of a button! (It even holds them when the unit is turned off!) The all-mode Yaesu FRG-7700 is the receiver for the 80's — a worthy successor to the world famous FRG-7 & 7000.

## YAESU FRG-7700 RECEIVER

Cat. D-2840

P&P \$5.50

# \$525

Terms available from  
\$55 dep & 25.74 mth  
(24 months)

OPTIONAL 12 CHANNEL MEMORY UNIT Cat. D-2842  
\$145.00 P&P FREE IF PURCHASED WITH ABOVE UNIT

**DICK  
SMITH  
ELECTRONICS**

<b>NSW</b>	146 Parramatta Rd	<b>AUBURN</b>	648 0558	<b>ACT</b>	96 Gladstone St	<b>FYSHWICK</b>	80 4944
	613 Princes Hwy	<b>BLAKEHURST</b>	546 7744	<b>QLD</b>	186 Logan Road	<b>BURANDA</b>	391 8233
	818 George St	<b>BROADWAY</b>	211 3777		824 Gympie Rd	<b>CHERMESIDE</b>	59 6255
	531 Pittwater Rd	<b>BROOKVALE</b>	93 0441	<b>SA</b>	60 Wright Street	<b>ADELAIDE</b>	212 1902
	147 Hume Hwy	<b>CHULLORA</b>	642 8922	<b>VIC</b>	399 Lansdale St	<b>MELBOURNE</b>	67 9834
	162 Pacific Hwy	<b>GORE HILL</b>	439 5311		656 Bridge Road	<b>RICHMOND</b>	428 1614
	30 Grosvenor St	<b>PARRAMATTA</b>	883 1133		Dandenong Rd	<b>SPRINGVALE</b>	Open soon
	125 York Street	<b>SYDNEY</b>	290 3377	<b>WA</b>	414 William St	<b>PERTH</b>	328 6944
	283 Kaire Street	<b>WOLLONGONG</b>	28 3800				

**DICK SMITH MAIL ORDER CENTRE: PO Box 321 North Ryde NSW 2113 Phone (02) 888 3200**

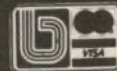

**SHOPS OPEN 9AM to 5:30PM**  
(Saturday: 9am till 12 noon)  
**BRISBANE: Half hour earlier.**  
ANY TERMS OFFERED ARE TO  
APPROVED APPLICANTS ONLY

# AMATEUR RADIO



by Pierce Healy, VK2APQ

## Electronics education — a highly desirable goal

Educational assistance for those wishing to learn electronic theory and radio communication is available through amateur radio organisations as a service to the community.

The desire to expand their own knowledge of radio communication and electronics, and to assist others with similar interests, is a fundamental aim among those who embrace amateur radio as a hobby.

With the rapid expansion of electronic technology it is desirable that we have more than a passing acquaintance with electronic theory. This is particularly so if we wish to understand computerised or electronically controlled devices, now widely used in commerce and industry, and increasingly in the home and for entertainment.

Thirty years ago the need for radio theory education for those attending school was evident to New South Wales amateurs in the teaching profession. The result was a "Youth Radio Scheme", sponsored by the NSW Division of the Wireless Institute of Australia. Within a short time the scheme was adopted in all states.

Over the ensuing years many amateurs assisted in the work involved, many be-

ing members of the teaching profession and many changes evolved, both in the subject matter taught and the age groups participating.

State education authorities saw advantages to be gained from the scheme and in a number of cases curricula included YRS activities.

These activities included the formation of school radio clubs which, under YRS guidelines and supervised by teachers or amateurs, played an important part in providing education facilities supplementary to normal school subjects.

Another aspect is that the certificates issued for examinations, in the various grades of YRS study, are readily recognised by commercial, industrial, and government organisations requiring apprentices or cadets with a proven interest in radio and electronics.

Today many former YRS students are following careers in electronics and associated fields.

The YRS principles have been adopted as the basis for classes conducted by radio clubs throughout Australia, and

details were even requested by some overseas organisations.

While, originally, the main aim of YRS was to assist those wishing to obtain their amateur operator's licence, some clubs cater for many other phases of electronics, including construction projects, according to the needs and wishes of members.

To assist in overcoming examination "jitters", trial examinations are organised, where candidates can get experience under controlled examination room conditions. This facility has assisted many, in all age groups, to gain their novice amateur licence (NAOCP) issued by the Radio Branch, Department of Communications.

In fact, one aspect arising from YRS experience was the recommendation to the Radio Branch, through the WIA federal executive, that they adopt the multiple choice type examination, the method now used by the Radio Branch.

The YRS also provides for interchange of ideas and information between school clubs. A quarterly magazine, "Zero Beat", contains news of club activities, study material, and projects suitable for both beginners and advanced members. Components at very reasonable prices are often made available for these projects.

Study kits and text books written by qualified officers of the scheme are also available at reasonable cost.

Thus the YRS provides an insight into the electronic technology of the 1980s and the effect of that technology on our way of life. In addition, it can provide the initial basis for a career in that field as well as a fascinating hobby activity in amateur radio.

For more details and information, write to:—

NSW. State Supervisor YRS, Ken Hargreaves, VK2AKH, 52 Merlin Avenue, Floraville 2280.

VICTORIA. State Supervisor YRCS, Roy Hartkopf, VK3AOH, 34 Toolangi Road, Alphington 3087.

QUEENSLAND. WIA, GPO Box 638, Brisbane 4001.

SOUTH AUSTRALIA. State Secretary YRS,



*A group of Sydney amateur radio operators recently staged a mock funeral outside the ABC television studios at Gore Hill to protest against the use of Channel 0 for multicultural TV broadcasts. Amateurs claim that Channel 0 will seriously curtail their activities on the 6-metre band.*

# AMATEUR RADIO

Maxine McEvoy, 5 Tyne Avenue, Kilburn 5042.

WESTERN AUSTRALIA. WIA, GPO Box N1002, Perth 6001.

TASMANIA. WIA, PO Box 1010, Launceston 7250.

Information may also be obtained, about classes, from amateur radio clubs listed in last month's issue of these notes.

For those who find it convenient, a visit to the Central Coast Amateur Radio Club field day at Gosford on Sunday, February 22, 1981 (details in this issue) will provide an opportunity to see a YRS display, and discuss any aspects you desire with officers of the NSW YRS committee.

Remember the young, and the not so young, are catered for in this amateur radio community service.

## MUSEUM OF APPLIED ARTS AND SCIENCES

Another educational facility available to students, and the general public, is the amateur radio station VK2BQK at the Museum in Harris Street, Ultimo (off Broadway) Sydney. The station is part of a display of radio equipment and illustrations showing developments since the 1920s.

The station is manned during weekends by members of the MAAS Amateur Radio Club. Questions from visitors about the station, and amateur radio, will be answered by the operators.

Arrangements may also be made with the Museum administration for student groups to be given a practical demonstration and talk on the fundamental principles of transmission and reception of radio signals, and the part amateur radio has played in the development of communication by radio.

Another educational facility provided at the Museum deals with computers.

## WIA NEWS

Federal executive of the Wireless Institute of Australia have been advised by the Postal and Communications Department, that favourable consideration has been given to the Institute's submission relating to amateur operators using F5 emission in the 1215-1300MHz band.

(F5 emission:— Frequency or phase modulation; television vision only.)

The letter, in part, reads:—

"Noting that the amateur service is accorded secondary status in this band, the Department had carried out a number of negotiations with other users whose services might be subject to interference from proposed amateur operations. Resulting from these negotiations, the Department is prepared to allow the use of F5 by AOCIP and AOLCP amateurs in

the band concerned on a trial basis for a period of six months.

"Amateur operators using or intending to use the 1215-1300MHz band should note the existence therein of radar facilities operated by the Department of Defence and Department of Transport, and it is most important to avoid interference to these services."

It should be remembered that the portion below 1240MHz was not allocated to the amateur service at WARC 79.

## CENTRAL COAST FIELD DAY

The Central Coast Amateur Radio Club's 24th annual field day will be held at the Gosford Showground, Showground Road, Gosford, NSW, on Sunday, February 22, 1981. This field day attracts the largest attendance of amateurs, families, and friends, of any similar event in Australia.

All amateurs, their families, friends, and those interested in amateur radio are invited to attend.

Registration: Men \$4, Ladies \$2, Children 16 years and under \$1 (includes morning and afternoon tea, event entry and outings).

Pensioner concession: 50% on production of appropriate pensioner concession cards.

Family groups: Mother and father and two or more children in one car \$7.

Food service: Tea, coffee and biscuits available in dining room 8am to 5pm at no additional charge if registration card is shown. Take away food bar will be open for purchases 9am to 3pm. You may bring your own lunch and avail yourself of tea or coffee at lunch time.

Event entry: If you are planning to enter any radio event (including junior events) please fill in an event registration card before parking your car. Cards will be available just inside the car park.

Scramble rules: No operation in showground or 1km radius. No operation on Gosford repeaters or within 1km of repeater sites. Log extract to event entry registration before 10am showing time of contact, station worked, mode, frequency and full serial numbers. Incomplete or late logs are not eligible. Scoring: one point per station per band regardless of mode. You may work the

## BRIGHT STAR CRYSTALS PTY LTD

35 EILEEN ROAD, CLAYTON, VICTORIA, 546 5076  
(ALL MAIL TO:— P.O. BOX 42, SPRINGVALE, VIC. 3171)

INTERSTATE AGENTS  
ROGERS ELECTRONICS  
ADELAIDE PHONE 42 6666  
J. E. WATERS PTY LTD  
SYDNEY PHONE 666 8144



BSC TELEX AA36004.

## WATCH CRYSTALS



## SPECIFICATIONS

- |                                 |   |
|---------------------------------|---|
| 1. Nominal Frequency            | 32.768KHz   |
| 2. Frequency Tolerance          | $\pm 30\text{ppm}/28^\circ \pm 1^\circ\text{C}$               |
| 3. Drive Level                  | 1 $\mu$ W max   |
| 4. Series Resistance            | 31.0k ohms max  |
| 5. Q Factor                     | 40000 min   |
| 6. Parabolic Curvature Constant | Less than $-0.04\text{pp m}/^\circ\text{C}$<br>(Refer Fib. 1) |
| 7. Turnover Temperature         | $28.0^\circ\text{C} \pm 5^\circ\text{C}$                      |
| 8. Capacitance Ratio            | 700 max   |
| 9. Storage temperature Range    | $-30^\circ\text{C} \sim +80^\circ\text{C}$                    |
| 10. Operating Temperature Range | $-10^\circ\text{C} \sim +60^\circ\text{C}$                    |
| 11. Aging rate                  | Less than $\pm 5\text{ppm}/\text{year}$                       |
| 12. Shock                       | Less than 5ppm for 50cm<br>Hammer Shock Test                  |
| 13. Package size.               |   |

DILMOND INSTRUMENTS  
HOBART PHONE 47 9077  
FRED HOE & SONS PTY LTD  
BRISBANE PHONE 277 4311  
WEST TEST ELECTRONICS  
PERTH PHONE 337 6393

## SO YOU WANT TO BE A RADIO AMATEUR?

To achieve this aim, why not undertake one of the Courses conducted by the Wireless Institute of Australia? Established in 1910 to further the interests of Amateur Radio, the Institute is well qualified to assist you to your goal. Correspondence Courses are available at any time. Personal classes commence in February each year.

For further information write to  
**THE COURSE SUPERVISOR,**  
**W.I.A.**

P.O. BOX 123,  
ST. LEONARDS, NSW 2065



# AMATEUR RADIO

same station on several bands.

Outings: (a) Reptile Park. (b) Bus tour (departs 1.30pm). Obtain complimentary tickets for either outing by presenting registration card to "Tickets" near announcer. Transport to and from reptile park is by private car. Reptile park tickets are valid for any time of the day 22/2/81 only. Bus tour tickets are limited to one bus load on a first come basis.

Disposals: Obtain catalogue forms and lot numbers in advance of the field day from Bill Smith, VK2TS, RMB 4525 Gosford 2250. [Phone after hours (043) 74 1207.] Forms and lot numbers also available at showground on Saturday 21/2/81. All items for disposal must be booked in before 9.30am 22/2/81. Late arrivals or equipment improperly tagged or catalogued may be refused.

Displays: Any company, club or person wishing to display or sell at the field day must contact the club in advance at PO Box 238, Gosford 2250 before 9/1/81 or telephone Ray Wells (043) 24 1611, 7.30am to 3.30pm weekdays only.

Trains: The following trains will be met at Gosford station: 7.25am and 8.30am from Sydney; 7.33am from Newcastle. For return transport to station in afternoon, contact information table.

If it rains: The field day will be held wet or dry; there is plenty of shelter in the showground.

Calls present: Bring your QSL card for the calls present board.

Parking: Off street in showground, please observe separate in and out gates.

Special attractions: Trade displays and ladies stall.

Event point score system: Starting in an event - one point. Finish in event in allotted time but not in first four placegetters - one additional point. Placegetters: additional points as follows: 1st - eight; 2nd - six; 3rd - four; 4th - two.

## PROGRAM:-

8.00am-1.00pm Registration.

8.00am-5.00pm Tea and coffee available in dining room (show registration card).

8.00am-8.30am: Mobile scramble (a) MF/HF; (b) VHF/UHF; see scramble rules.

9.00am-3.00pm: Food bar open.

9.30am: Disposals booking in closes. See disposal information.

9.30am: Mobile fox hunt (a) 28.45MHz; (b) 146MHz. Assemble in Showground Road opposite Dwyer Pavillion.

9.45am-10.30am: Mobile fox hunt. See rules.

10.00am: Disposals opens. Children's events on grass near entrance gate.

10.00am-10.30am: Junior pedestrian fox hunts (16 years or younger) 2m AM

(144.4-144.7MHz) see rules.

10.30am: Quiz sheets available at name tags table; return before 1.30pm. Neatness counts to break ties. Judge's decision final.

11.00am, 11.30am, 12 noon: Open pedestrian fox hunts, 2m AM 144.4-144.7MHz. See rules.

1.00pm: Lucky number draw; numbers must be claimed within 10 minutes of announcement of draw; register numbers at information table if leaving the showground.

1.15pm: Long mobile fox hunt (a) 28.45MHz; (b) 146MHz. Assemble in Showground Road opposite Dwyer Pavillion.

1.30pm-3.30pm: Long mobile fox hunt, see rules.

2.00pm-2.30pm: Junior pedestrian fox hunts (16 years or younger) 2m AM 144.4-144.7MHz, see rules.

4.15pm: Prize presentation. Advise information table if leaving early to arrange delivery of prizes.

Conditions of entry: Your entry to the showground is on the condition that you do not transmit in the showground and you are requested not to transmit within 1km radius of the showground to reduce interference.

Fox hunt rules: 1. Field day and event registration is a prerequisite to entering any fox hunt. 2. The event start will not be delayed for stragglers. 3. The transmitters will be turned off at the advertised finish time of the event; pedestrian fox hunts will be 15 minute events. 4. Hand held "sniffers" will be required at the end of mobile events. 5. The transmitting aerial must be found; aerial, feedline and transmitter must not be disturbed. 6. Any person disturbing aerial, feedline or transmitter or behaving in an unseemly or dangerous manner will be disqualified. 7. Entrants must observe all motor vehicle laws and road rules.

## RADIO CLUB NEWS

Here is updated information on clubs as given in past months.

Radio clubs and other organisations, as well as individual amateur operators, are invited to submit news and notes of their activities for inclusion in these columns. Photographs will be published when of sufficient general interest, and where space permits. All material should be sent to Pierce Healy at 69 Taylor Street, Bankstown.

EASTERN ZONE VIC DIV WIA: Meetings are held on the last Monday of the month at the Latrobe Valley airfield at 7.30pm. Secretary F. E. S. Mair, VK3BSM, PO Box 339, Moe 3825. Phone (051) 27 4229 (AH). WIA members, non-members and aspiring radio operators are welcome.

Note: The Eastern Zone Wireless Club no longer exists.

SOUTHERN PENINSULA AMATEUR RADIO CLUB: Membership is open to all well behaved persons interested in amateur radio. Call signs of the club are VK3BSP and VK3VKR. The club is a member of the WIA.

Club meetings commence at 7.30pm local time on the first and third Mondays of each month, holidays included, at the Rosebud Primary School.

On-air meetings of club members and guests each Sunday at 0000UTC on 28477kHz and 1930 local time Tuesdays on 3620kHz.

Secretary, R. J. Whitehead, 7 Spensley Street, Rosebud, Vic 3939.

ILAWARRA AMATEUR RADIO SOCIETY: From a report by Lyle Patison, VK2ALU, in the November IARS newsletter, "The Propagator", it was learned that the large dish antenna used for moon-bounce experiments, prior to vandals damaging the building and equipment, has been moved from Dapto to its new site. After being separated from its counterweight assembly and support tower, the 10m diameter parabolic reflector was moved in one piece.

All components of the antenna structure will now be checked and painted ready for erection. As a lot of work still has to be done by the Wollongong University staff (and any amateurs who could like to help), it is expected that it will be several months before the E-M-S station will be operational again.

Lyle also mentioned E-M-S tests being made on 1296MHz by Swedish station SK2GJ using a 30m diameter dish antenna and VK1ZT and ZL1BQ both using 3m diameter dish antennas. 

TADIRAN

# The Fail-Safe 10-Yr Lithium Batteries

BY TADIRAN ISRAEL ELECTRONICS

Power CMOS with single cell.  
Nominal Voltage 3-4V per cell.

TECNICO ELECTRONICS

P.O. Box 50, Lane Cove, N.S.W. 2066, Tel. (02) 427 3444  
P.O. Box 520, Clayton, Vic. 3168, Tel. (03) 544 7833

# The Australian CB SCENE



## 1980 NCRA CONVENTION: "Far ranging effect on CB"

The CB event of the year has just taken place, as I write, namely the 1980 NCRA Convention. A featured speaker on the occasion was Mr Ross Ramsay, the First Assistant Secretary of the Radio Frequency Management Division, Department of Communications.

If you have never attended a National NCRA meeting, you don't know what you have missed. There is a unique "air" about the meetings, particularly the annual Convention. The atmosphere is at once relaxed and tense for, regardless of what critics of the NCRA say, the decisions made at its meetings have far ranging effects on the over-all CB scene.

One very basic example of this was the original recommendation that certain channels be set aside for calling, emergency and trucker use. The use of these channels these days is automatic, but I wonder how many operators remember where the original concept of reserving these frequencies for their specific purposes came from?

**EUROPEAN SUPPORT:** The National Director received three telegrams on the day before the convention and I quote the contents:

- "The National Citizens Band Council of Ireland is behind the NCRA to get 42 channels and wish Reni Barnes and the NCRA all the best in the AGM stop. Pat McManus President NCBCI"
- "Full support in your campaign for 42 channels and best wishes to yourself, Jan Christensen and Reni Barnes in the NCRA AGM stop. Kevin O'Neill International Liason Officer World Personal Radio Congress (Northern Hemisphere)"
- "The 15,000,000 members of the European CB Federation support the claims of the NCRA for 42 channels stop. Pat McManus Vice President ECBF."

**SOUTH PACIFIC AWARD:** There were numerous nominations for the NCRA SP CB Merit Award for 1980 but I have pleasure in announcing that it was won by Mr Bob Saint, of the Lima Alpha Club of Sydney. Bob's prizes were: a Cobra GTL-A 148 mobile rig, a 3-metre fibreglass whip, a spring base and a trophy commemorating the event. Congratulations, Bob.

You could have knocked me down with a feather (literally) when I was then called up to be presented with a trophy, the NCRA-South Pacific Radio Special Recognition Award for my on-going services to the NCRA and my on-going services to CB via the pages of my column in this magazine.

**GUEST SPEAKERS:** Mr Ross Ramsay, the First Assistant Secretary of the Radio Frequency Management Division of the Department of Communications (the old P&T) addressed the meeting and answered questions from the floor. By his side, giving support and providing additional information was Mr Col King, the Queensland State Superintendent of the Radio Branch. Ross went to no end of trouble getting to the meeting and I would like to thank both him and Col for taking the time and trouble to be there.

Unfortunately, there were few earth-shattering revelations to be made, due mainly to the fact that the current inquiry into the CBRS is still going on.

Ross did make two outstanding statements, however, and I feel that they warrant wide publicity. The first is that the Department recognises the effects of current propagation conditions on the 27MHz band in relation to the amount of overseas traffic ending up here in Australia. The Department's view is that it is still illegal to actively seek overseas DX and will take action against anyone initiating DX calls.

However if an overseas contact drops into your lap, eg a "breaker into your local QSO, then it is not expected that you will ignore that contact. Basically it means that so long as you are using your authorised call sign, and do not deliberately initiate an overseas contact, and as long as your equipment is standard and you are not using a beam or amplifiers to hold the contact, the Department is unlikely to take any action against an Australian operator communicating overseas.

The second noteworthy statement made by Ross related to the role played by the NCRA in regard to the improvements made to the Service since its inception. Ross made no bones about the fact that the Association has been instrumental in changing the Departmental attitude not only to specific aspects of the CBRS but also to its overall attitude to the Service itself.

He said that the NCRA submissions are always looked at carefully in gauging the attitudes and wishes of the CB operators of Australia, and its recommendations are considered seriously.

He, like members of the NCRA realises that the Association is currently in a bit of a trough and joins with us in hoping that it may soon regain the support which it deserves from CB operators generally. Clearly, the Department prefers to speak with one group representing the ideas of many individuals rather than to "fragmented groups".

The regard in which the Department holds the NCRA is clearly evident by the fact that the 1978 Convention was addressed by the then Minister for P&T, Mr Staley and the 1980 Convention was addressed by the head of the Frequency Management Division of the Department, Ross Ramsay. It is obvious that the Government recognises the contribution made by the Association. I urge you to please think carefully about joining and thereby supporting it in its endeavour to help YOU. If you would like more information about joining, either as an individual or as a club, write to the NCRA, PO Box 406, Fortitude Valley, 4006.

Just by way of a change from all the "official" material, Mr Bernie Bischa of Olbis Industries, Brisbane, addressed the meeting on the history, the present state and the future of the CB industry. Thanks, Bernie, for your contributions.

**CHANGES IN NCRA:** The Convention made several important changes to the Association. The Association is now structured on a direct National to club and Individual member basis. This not only reduces the operating costs of the organisation, it also guarantees an immediate and regular contact between

the National Executive and the members. Two delegates are to be appointed in each State to represent the NCRA at club meetings etc, and these delegates will also represent their States at the Annual National Council meetings.

The NCRA has finally officially recognised the work being done by all the Emergency Monitoring Groups instead of just the one. All affiliated groups are now entitled to send representatives to the National Assembly and to elect from amongst themselves a representative to sit on the National Council and to vote on matters of mutual interest. This also applies to the trucker groups.

What it boils down to is that both CREST and Truckers Radio Australia have lost their automatic right to sit on the National Council of the NCRA without giving the much needed financial support which everyone else must give to be able to be represented. It is hoped that, in this way, the National Assembly and Council will have a much broader representation by these groups.

This of course does not mean that the NCRA no longer recognises either CREST or TRA and the great work they are doing. It simply means that the Association recognises the work done by all such organisations and is giving them all equal opportunity to be represented both on and by the NCRA.

**PIRATE MENACE:** The SES in Queensland recently staged a mock rescue out in the "scrub". It was a full scale exercise involving a lot of time and man-power. The "rescue" was greatly hampered by radio pirates causing havoc on and around the SES frequencies. Had the exercise been real, lives could, and almost certainly would, have been lost. All I can say to those people who carry on in the same manner is: If you must work out of band, whether you be a CB operator or an amateur operator originally, for goodness sake learn where the emergency frequencies are and stay away from them.

**THE MAIL BAG:** I received a letter from the Waratah State REACT Team asking me to include some information in the December issue. Unfortunately, it was received too late. Please remember that I must have the information about eight weeks ahead of the date that the issue comes out. I need time to peruse, plan and type up the right amount of material to fill the space. There is no fun in having to re-do it, to include a last-minute letter. Then it has to be mailed to Sydney, checked, typeset, made up into pages, printed and finally distributed Australia-wide in the last days of the month prior to publication.

Please continue to write to me, but also bear that in mind. And please take care of yourself over Christmas.

If you would like to write to me, the address, as always (courtesy of the NCRA) is: Jan Christiansen, Australian CB Scene, PO Box 406, Fortitude Valley, 4006.

## ELECTRONICS AUSTRALIA

# projects & circuits

Number 2

### AUDIO PROJECTS

LOUDSPEAKER PROTECTOR FOR HIFI SYSTEMS .....	12
DIGITAL METRONOME WITH ACCENTED BEAT .....	22
REMOTE TV HEADPHONES .....	29
TOROID FILTER CUTS RADIO, TV BREAKTHROUGH .....	37
SIMPLE MIXER FOR PICK-UP AND MICROPHONE .....	42
UNIVERSAL HEADPHONE UNIT .....	65
ACTIVE FILTER UNIT FOR CROSSOVER NETWORKS .....	78
VOICE-OPERATED RELAY .....	87

### POWER SUPPLIES AND POWER CONTROL

SPEED CONTROL FOR ELECTRIC DRILLS .....	15
FULLY PROTECTED, REGULATED POWER SUPPLY .....	58
MOODLIGHTING WITH THE VARILIGHT MK 2 .....	62

### AUTOMOTIVE PROJECTS

A CONTROL UNIT FOR INTERMITTENT WIPER ACTION .....	6
AN UPGRADED CAPACITOR DISCHARGE IGNITION SYSTEM .....	18
A DWELL METER FOR ENGINE TUNE-UPS .....	26
TACHO FOR TUNE-UPS .....	46
A TRAFFICATOR REPEATER FOR CARAVANS AND TRAILERS .....	70

### CB PROJECTS

POWERMATE: 13.6V SUPPLY FOR TRANSCEIVERS .....	10
PREAMPLIFIER FOR 27MHz .....	54
SHORT-WAVE CONVERTER FOR THE 27MHz BAND .....	73

### MISCELLANEOUS

10GHz RADAR BURGLAR ALARM .....	2
MODEL TRAIN CONTROL WITH SIMULATED INERTIA .....	32
MULTI-BAND VERTICAL AERIAL .....	45
AN ELECTRONIC ROULETTE WHEEL .....	49
AN IN-CIRCUIT TRANSISTOR TESTER .....	68
MODULAR DIGITAL CLOCK .....	82
NOVEL "LEDS AND LADDERS" GAME .....	90
SIMPLE PROXIMITY SWITCH FOR A NOVEL DOOR CHIME .....	94

### CIRCUIT & DESIGN IDEAS

HEE-HAW SIREN FOR TOYS .....	36
MODEL TRAIN SIGNALLING SYSTEM .....	48
MICROPHONE PREAMPLIFIER .....	67
TEMPERATURE ACTUATED SWITCH .....	81
WATER LEVEL ALARM .....	89
2-PHASE CMOS CLOCK OSCILLATOR .....	93
ECONOMICAL CRYSTAL OVEN .....	96

Available from "Electronics Australia", 57 Regent St, Sydney.  
**PRICE \$3.00** OR by mail order from "Electronics Australia", PO  
 Box 163, Beaconsfield 2014. **PRICE \$3.70.**

# SHORTWAVE SCENE



by Arthur Cushen, MBE

## Peking expands shortwave service

It is 30 years since Radio Peking commenced a short-wave service. Since then, the station has rapidly advanced to become one of the leaders in international broadcasting, with programs beamed to all five continents.

A meeting of the Central Broadcasting Administration was held in Peking recently, with 200 delegates attending. According to the BBC Monitoring service, China now had 99 central and local broadcasting stations, more than 500 transmitters and relay stations, and over 90 VHF FM repeaters. The Central People's Broadcasting Station produces two national program networks, broadcasts programs for national minorities, broadcasts to Taiwan, and produces special music programs on VHF FM.

China's International Broadcasting Station opened in 1950. Radio Peking now broadcasts in 38 foreign languages as well as in Standard Chinese and four other dialects for foreign nationals of Chinese descent.

Television started in China in 1958. All the provinces, municipalities and autonomous regions, with the exception of Tibet, now have television stations. A television service for Tibet is under construction. The Central station and an increasing number of local television stations carry programs in colour. China has 38 television stations, more than 230 television transmitters and over 2000 low power repeaters.

There are over 2300 wired radio networks, which relay their own programs to meet local needs. In addition, they relay the major programs from Central and Provincial radio stations.

Radio Peking broadcasts in English to New Zealand and Australia 0830-1030UTC on 9860, 11720, 15120 and 17630kHz.

### LIBERIAN RADIO

The Liberian Broadcasting Corporation has been renamed the Liberian Broadcasting System, according to the BBC Monitoring Service. The short wave transmitter ELBC has recently been reactivated and is using 3255kHz with the power of 50kW. Reception is around dawn.

According to the official announcement, the Liberian Broadcasting System will receive 60% of its budget from the Central Government and the remaining 40% by commercial revenue. The decree, which is now in effect, empowered the Head of State to undertake an expansion program to provide facilities for the Liberian Broadcasting System. The American Ambassador to Liberia said that the United States would contribute \$11.7 million to the project, \$5.5 million of which had already been provided. The total cost of the new broadcasting system is estimated at \$18 million dollars.

### EL SALVADOR SIGNALS

Signals from El Salvador in Central America are being received at the moment, with Radio Nacional operating on 9555kHz. Reception has been possible after 0400UTC when jamming is not present on the frequency, and the station gives announcements in Spanish at regular intervals. The station generally closes at 0500UTC with announcements in English and Spanish, but at times broadcasts 24 hours a day. Peter Jones of Hamilton, reporting in the "New Zealand DX Times", comments that there is a tendency by the station to play disco music.

### NEW ALGERIA FREQUENCY

Radio Algiers, broadcasting from Algeria, has retimed its English transmission to 2100-2130UTC and is heard on the new frequency of 15365kHz. This channel is clear of other transmissions at the time of reception, and provides fair reception throughout the English broadcast. At 2130UTC, a broadcast in French is noted.

The station announces that it also operates on long wave as well as on 7140, 9610 and 11740kHz. Radio Algiers has a reputation for operating on unannounced frequencies.



Featuring press-button frequency tuning, the new Sony IFC2001 shortwave receiver is ideal for blind listeners. Here the author demonstrates how one simply presses buttons on a calculator-style keyboard to automatically tune to a desired frequency. (Photo courtesy "The Southland Times".)

Notes from readers should be sent to Arthur Cushen, 212 Earn Street, Invercargill NZ. All times are UTC (GMT). Add eight hours for WAST, 10 hours for EAST and 12 hours for NZT. In areas observing daylight saving time, add a further hour.

# SHORTWAVE SCENE

## HANDICAPPED AID IN AUSTRALIA

The Handicapped Aid Program has been in operation throughout the world since 1974, with activities centred in the United States, Canada, United Kingdom, New Zealand and other countries. It is interesting to note that there is a promotion for the Handicapped Aid Program during 1981, the International Year of the Disabled Person, in Australia.

Under the guidance of the "Southern Cross DX Club", the project is being organised by a disabled listener in Tasmania, Mr Robin Harwood of 5 Helen Street, Launceston, Tasmania. The idea is to organise interested groups to help handicapped people with radio listening activities.

There are many ways in which these groups can help the handicapped listener, from erecting an antenna to giving practical and technical help so that the disabled person can gain more enjoyment from radio listening. Australian readers wanting further information on the Handicapped Aid Program should write to Mr Harwood, who will be happy to pass on details of future plans.

## OSLO FREQUENCIES

Radio Norway has introduced two new frequencies for its transmissions to various parts of the world: 9685kHz is now used from 0300UTC and 11920kHz from 0500UTC. Both frequencies are beamed to North America.

Transmission to Australia and New Zealand is best received 0700-0830UTC on 9590, 11850 and 21730kHz, and 1100-1230UTC on 15345 and 21730kHz. A further transmission 1300-1430UTC on 11850, 17840 and 21730kHz should give fair reception in Western Australia. The programs are all in Norwegian except on Sundays when the last 30 minutes is in English.

During the coming year the station plans to cover various aspects of life in Norway in its English program.

## UGANDA SCHEDULE

The Uganda Broadcasting Corporation at Kempala is often heard on short wave, but verification and other information from the station is often difficult to obtain. Ray Crawford of Invercargill New Zealand provides the latest schedule, recently received from the station: 15325kHz 0300-0430UTC to USA and NZ; 6030kHz 0855-1100UTC to East and Central Africa; 6030kHz 1355-1600UTC to East and Central Africa; 9685kHz 1615-1745UTC to Southern Africa; 15250kHz 1800-1900UTC to Western Africa; and 9685kHz 1930-2100UTC to North Africa, M East and Europe.

English is broadcast 0300-0430, 1615-1745, 1800-1900 and 1930-2100UTC.

## LISTENING BRIEFS

### EUROPE

**MONACO:** Trans World Radio on 9495kHz at Monte Carlo has altered its opening time and is now heard from 0725UTC. The transmissions are of gospel programming and the station requests reception reports from listeners. Another frequency used by Monte Carlo is 11750kHz and this has been noted in Russian 1800-1825UTC, mixed with the BBC.

**PORTUGAL:** Radio Japan is relaying its programs through the Sines transmitters for reception in Europe, with a new frequency (11790kHz) being used at 2200UTC. This 30 minute program consists of English for the first 15 minutes, with the balance in Japanese, and is part of the General Overseas Service. The transmission at 0700UTC continues on 15130kHz, but suffers interference from Radio Moscow Home Service.

### AMERICAS

**CANADA:** Radio Canada International is using some new frequencies for afternoon reception in the South Pacific. The English broadcast 0400-0427UTC is now on 5960, 11770 and 11845kHz. The latter frequency gives the best reception; 11770kHz suffers from jamming, while 5960kHz is too low for summer reception in the South Pacific. During the Monday transmission, "DX Digest" is broadcast in which Ian McFarland compers an interesting 25 minutes of news.

**CHILE:** A move to daylight time in Chile has resulted in transmissions being heard opening one hour earlier. At 0900UTC, Radio Nacional on 9550 and Radio Minería on 9750kHz open transmission, while at 0930UTC the new station, Radio Patagonia on 6080kHz, commences its day's operation.

**PERU:** Two relatively new stations have been heard in New Zealand with broadcasts during the evening reception period. Radio Moyabamba using 5015kHz has been heard by Steven Greenyer of Invercargill at 1100UTC. The program is of popular folk music with some religious content. On the nearby channel of 5025kHz, Radio Quillabamba is observed at 1030UTC with typical Peruvian folk music.

**SURINAM:** Radio Apintie is reported to have started a test broadcast with programs beamed towards Holland. The broadcasts are every Thursday, Friday and Saturday 0430-0630UTC, and use a special antenna beamed to Holland. The power is 3½kW, but there are plans to boost this to 40 or 80kW.

The frequency, according to the World Radio Handbook, could be 4795kHz but recently the transmission has been heard on 5015kHz. Leigh Morris of Palmerston North, NZ was able to verify this station during a test broadcast when the power was only 50W.

## CQ electronics

and get your components

SHOP 'N' TOWN CENTRE 101 REGENT STREET 1  
30 CAMPBELL STREET CENTRAL RAILWAY

blacktown.

sydney.

621 5809

698 8079

TRANSISTOR INSULATING KITS  
5 FOR \$1.00  
2 PACKS \$1.50

2708 450mS ONLY  
WHILE THEY LAST \$6.50  
QUALITY BRAND

FUSES  
3 AG-20A, 25A, 30A  
IDEAL FOR CARS  
ANY 3 FOR \$1.00  
REED SWITCHES  
NORMALLY OPEN  
6 FOR \$1.00

ARE YOU HAVING TROUBLE FINDING COMMON CATHODE REPRODUCERS  
\$1.95  
0.5" IN  
HAVE THIS AS - INDSO PHILIPS (S11013)

T03 TRANSISTOR COVERS  
5 FOR \$1.00  
T03 TRANSISTOR INSULATING KITS  
5 FOR \$1.00

EPROM \$72.50 PROGRAMMER KIT  
SUPPLIED IN OUR OWN STANDARD INSTRUMENT CASE - LEAD TO MAKE \$2.00  
NOT SUPPLIED: SUITS T280, T280E AND 10MPCOLOR II

LOOK  
4116 - 200NS.  
16K DYNAMIC MEM.  
8 FOR \$40.00  
WHILE STOCKS LAST

VALUE!!  
6-3V FLYING LEAD SLOBS  
ONLY 20 FOR \$1.00  
200 FOR \$7.00  
FOR USE WITH ABOVE: 1428N \$2.25 20 FOR \$1.00

COMBINATION SECRETS  
3.5+3.5+2.5  
10 FOR \$1.00  
3.5+2.1 DC  
10 FOR \$1.00

SPECIAL ICs  
HD0165 \$3.95  
8251 \$4.95  
MC1314 \$6.00  
MC1315 \$6.00

74LS02 \$1.00  
74LS04 \$1.00  
74LS08 \$1.00  
74LS10 \$1.00  
74LS93 \$1.00  
74LS126 \$1.00  
74164 \$1.00

T.V. PATTERN GENERATOR KIT  
\$49.50 AT \$7.00  
SUPPLIED IN OUR OWN INSTRUMENT CASE

THERMISTORS  
G 55 B  
GLASS BEADS  
180 Ω to 500 Ω  
300 Ω - 20°C  
3 FOR \$1.00

SPECIAL OFFER  
Z80 CPU + CTC + PCO  
ALL FOR \$29.00 !!

SPECIAL!  
DUAL GATE MOSFET  
CA 40673  
3028A \$1.00 \$2.25

8888 \$22.50  
FOUR DIGIT EVENT COUNTER  
0.5" LED DIGITS - SV SUPPLY  
4-MHz MAX. INTR. FREQUENCY  
ADD POWER SUPPLY AND TIME BASE FOR FREE QUOTE

Capacitors and resistors, integrated circuits, Wires and cables, semiconductors, tubes, kits, Radio and TV valves, plugs and sockets, pots, Manufacturers of PC boards and disco lighting.  
Prices subject to change without notice.  
Pick and postage within Australia \$1.00  
02-621 5809 CQ ELECTRONICS P.O. BOX 557 BLACKTOWN 2148  
WRITE



# NEW PRODUCTS

## Yaesu FT-480R 2-metre Amateur Transceiver

The latest two-metre transceiver to come to us from the range of Yaesu equipment is the model FT-480R; a combined FM, SSB, and CW unit in a case no larger than customarily used for a mobile FM unit. For the amateur who craves a change from the two-metre FM scene, but without losing touch with it, this set may well be the answer.

The first impression of the FT-480R is one of a vast — almost bewildering — array of facilities, mainly in the frequency selection system. Useful though they all undoubtedly are, learning to drive the beast calls for a good deal more than a few minutes fiddling with the controls and a cursory glance through the manual.

Basically it is a PLL system, actuated by either a continuously rotatable tuning knob or a scanner, with a seven-digit readout. To this is added a choice of six stepping rates; three in the FM mode and three in the SSB/CW mode. The latter are 10Hz, 100Hz, and 1kHz in all models, while the FM steps vary according to the model, to suit individual country bandplans.

Our review unit was a model "A", designed for the American market, and featured 1kHz, 20kHz, and 100kHz steps. This model is not very suitable for Australia (which uses 25kHz spacing for repeater and nominated simplex channels) and seriously restricts the usefulness of the scanning facility.

The preferred version would be the model "C", with 1kHz, 25kHz, and 100kHz steps, while there is a model "E" with 1kHz, 12.5kHz, and 25kHz steps. The agents advise that future shipments will be model "C" but that, in any case, it is a simple matter to change any model to any other model by shifting a few diodes, and that this information will be available.

In fact, a diode chart is given on page 36 of the manual and apparently applies to the PLL control unit circuit and to diodes D04, D06, D07, D11, D51, and D53 (listed as D4004, D4006, etc. and shown dotted and/or with an asterisk). Type "C" on this chart is shown as having a 12.5kHz step, but this should be shown as 25kHz. We understand that changing to the 25kHz step requires only the addition of D4006.

Scanning is controlled by two small buttons on the microphone (one "UP"

and one "DWN"). A press and release action produces a single step, and holding the button down for half a second initiates scanning. The scanner may be set to stop on either an occupied or blank channel, or may be stopped by pressing the "UP", "DWN", or PTT button.

There is a lock button on the microphone to inhibit scanning, once a desired frequency has been selected. This is very desirable, since it is all too easy to activate the scan buttons accidentally and lose the incoming signal.

tion, but it seriously hampers the scanning function. Even if there are no signals within the amateur band, scanning will be halted by various out-of-band signals, such as paging systems, harmonics from entertainment channels, etc.

We have been advised that this can also be corrected by a few simple changes, and prospective buyers are urged to clarify this point.

When searching for a busy channel, the scanner does not necessarily stop right on frequency, but rather when the signal first opens the squelch. This is no problem when scanning the memory, or (generally) when scanning in 25kHz steps, since only very strong signals would be heard 25kHz away. This is why it is important to have a model programmed for the Australian bandplan.

Most of the controls are on the front



Interesting features of the Yaesu FT-480R 2-metre transceiver are an LED S-meter and digital frequency readout. The unit may be operated in CW, FM or SSB mode.

There is a four-position memory and the scanner may be directed to this instead of scanning the whole band. There is also a "priority" facility whereby a selected frequency, stored in the memory, is checked every five seconds while listening to another frequency set up by the main dial.

One surprising — and rather disturbing — feature is the total coverage. This exceeds the amateur band by 0.5MHz at each end; from 143.5 to 148.5MHz. Not only does this risk out-of-band opera-

tion, but there are three switches on the underside below it. One is the repeater offset switch, one is the scan stopping mode selector, and one is for satellite working. While all are readily accessible, they are not visible, and the user would have to remember both the switch identity and its position.

(With a little ingenuity it should be possible to fit a small angle bracket on which this switch plate could be mounted at 90° to its present position,

*(Continued on page 101)*

## Home burglar alarm uses ultrasonics



The A&R AM469 Home Burglar Alarm can detect any movement within a range of 8 metres. Supplementary detectors can be connected if more comprehensive protection is required.

A & R Electronics Pty Ltd has recently released the AM469 Home Burglar Alarm, now being marketed under their Arlec Brand.

Designed and manufactured in Australia, the AM469 is a completely self contained home and office security system using the ultrasonic "Doppler" technique to detect any movement within a range of 8m. To obtain immediate protection the AM469 is simply plugged into the mains supply and switched on.

When triggered, the alarm sets off an ear-splitting siren to frighten the intruder(s) and to warn neighbours that a thief is on the premises.

In normal operation the AM469 pro-

vides automatic delay periods to allow the householder time to leave the premises and return without triggering the alarm. A secondary control switch on the unit allows the alarm system to be set for instantaneous triggering.

Also included is circuitry and connecting points for supplementary detectors such as pressure mats, window foils and magnetic door switches if a more comprehensive system is required.

The unit is supplied with a low voltage AC adapter, and also operates from standby batteries to ensure protection in the event of a mains failure.

Further information is available from A & R Electronics Pty Ltd, 30 Lexton Rd, Box Hill, Vic 3128.

## Teach yourself about power Mosfets



Recently released by Hewlett-Packard is a "Designer's Kit" containing two of HP's new HPWR-6501 power Mosfet transistors, together with supporting literature. The literature shows the designer how to drive the new transistors, and shows how they may be used in a switching power supply circuit.

Included in the kit (type HPWR-6900) are a capabilities brochure, a technical data sheet, a 100kHz Switching Power Supply Application Note, and two Application Bulletins - "Power Mosfet Gate Drive Ideas" and "Power Mosfet Reliability Tests and Results".

For further information contact Hewlett-Packard's authorised distributors, VSI Electronics (Australia) Pty Ltd, 21 Chandos St, St Leonards, NSW 2065.

## Yaesu FT-480R transceiver ctd from p100

making it visible to the operator. This point would seem to be most important for mobile operation.)

The satellite switch enables the transmitter frequency to be varied while transmitting but, when "on", it inhibits a number of other functions. One - not mentioned in the manual - is the repeater offset function. This is a nasty trap for the uninitiated!

The repeater offset is the conventional 600kHz up or down, but there is provision for split frequency operation to take care of odd offsets, as in New Zealand at present. (This is another function inhibited by the satellite switch.)

In the SSB mode either sideband can be selected by the mode switch. There is a noise blanker to control impulse noise, and a clarifier to cope with off-frequency signals. The latter allows the receiver frequency to be changed to suit the incoming signal, without changing the transmitter frequency.

All memory functions, including the setting of the main dial, are retained when the set is turned off with the panel switch, provided power is retained at the input terminals.

The set uses a novel form of "S" meter. It consists of a line of 10 LEDs which light

progressively with signal strength. The system has a very fast response, most evident on heavily deviated signals, but would seem to be less useful on weak signals than a conventional meter.

The specifications for the set are typical of modern two-metre equipment. The FM transmitter output is 10W (or 1W in the low position), and the SSB transmitter input 30W PEP. Carrier and unwanted sideband suppression is quoted as better than -40dB, and spurious emission as not less than -60dB.

The receiver sensitivity is quoted as (SSB, CW) 0.5uV for 20dB S/N, and (FM) 0.35uV for 20dB QS. Selectivity is given as 2.4kHz at -6dB and 4.1kHz at -60dB for SSB, CW, and 14kHz at -6dB and 25kHz at -60dB for FM.

The set is designed to operate from a 12V car electrical system (negative chassis) or from an external mains power pack (not supplied). Current consumption is 0.5A on receive, and 3A on transmit.

The instruction manual is quite comprehensive, and well written - a pleasant change from some of the fractured English we have seen in the past. As well as operating instructions, it contains a fairly detailed circuit description, plus no

less than 10 pages of maintenance and alignment instructions. There is also a complete list of parts and three large, clear, lift-out circuits.

Tested on air, in the FM mode, the set behaved exactly as one would expect from the specifications and did all the things it was supposed to do if the right buttons were pressed. All reports on signal quality were good.

Unfortunately, reports on SSB transmissions were not favourable, indicating significant distortion and residual carrier. A hasty phone call and a quick trip to the nearest Dick Smith outlet produced a second unit, with the first one packed off to the service department.

This time there was no argument; signal quality was reported as "excellent" and "as good as FM". On receive, some slight drift - 100Hz or so - was noticed over the first 15 minutes (on a cold morning) but the clarifier and the 10Hz steps coped with it quite easily.

To sum up: A very nice set, well thought out, beautifully finished, and with a wide range of facilities. It would seem to be an excellent approach for anyone wanting to add SSB and CW facilities to their two-metre activities, and without sacrificing mobile capability.

Our review model came from Dick Smith Electronics. Price quoted: \$543. (P.G.W.)

# ZX80

COMING  
SOON

## 8K

# BASIC ROM

Fantastic new options for **sinclair ZX80**



**THE CHIP** a drop-in replacement for the existing 4K BASIC ROM, comes with a new keyboard template and a supplementary operating manual. Designed for high-level, full facility computing.

### KEY FEATURES INCLUDE —

- Full floating-point arithmetic to 9-digit accuracy.
- Logs, trig, and their inverse functions, graph plotting facility.
- Animated displays using PAUSE n.
- Full set of string-handling facilities.
- n dimensional arrays, cassette LOAD and save with named programmes.

### AND ZX80 16K-BYTE RAM PACK

Complete module designed to provide massive add-on memory capacity.

The 16K-BYTE RAM pack can be used for program storage or as a database. Yet it costs up to half the price of competitive additional memory.

Measuring 3 in × 3 in × 1.25 in approx., the RAM pack plugs into the existing expansion port on the rear of the Sinclair ZX80 via an edge connector. No additional power supply is needed.

**SINCLAIR EQUIPMENT (AUSTRALASIA) PTY. LTD.**

308-312 High Street, Kew, Vic., 3101. Tel. 861 6224.

SE3



## Microcomputer News & Products

### Quiet Thermal Printer from Tecnico

Gulton MCS division has introduced the AP-40 TM, a fixed head thermal printer mechanism designed for output requirements preferring text format.

The AP-40 TM provides two fixed, 20-column dot-matrix thermal printheads and a paper drive. The drive roll is the only moving part, providing the quiet, highly reliable, maintenance free operation typical of thermal printers. No electrics are included. The AP-40 TM interfaces easily with any microprocessor system.

The two Gulton printheads provide 40 columns of 5 x 7 characters 279mm high and 2.03mm wide, or tall characters (5 x 14), 5.59mm high and 2.03mm wide. Half-step or half-size characters and bold characters of normal height are also inherent in the design. Print speed is 150 lines per minute.

For further information contact Tecnico Electronics, PO Box 50, Lane Cove 2066 or PO Box 520, Clayton 3168.

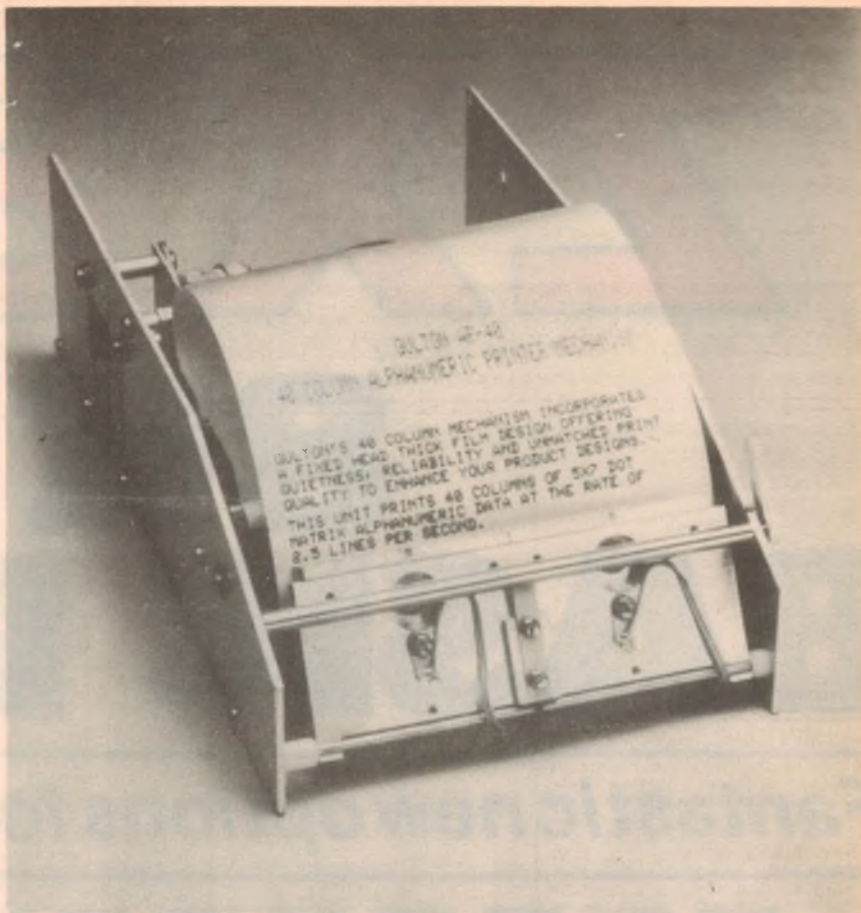

MICRONEWS CONTINUED →



## MICROCOMPUTER PRODUCTS

130 Military Road, Guildford,  
NSW 2161. Phone (02) 632-6301,  
(02) 632-4966. Telex AA25958.

### ANNOUNCING

#### THREE NEW IEEE 5100 CPUS FROM GODBOUT!

**Z80** Our New Recommended CPU  
Unkit - \$236.25 ASSM \$309.75

**8085** - Enquire about the special features of this card.  
Unkit - \$246.75 ASSM \$341.25

**8085 & 8088** - Yes! At last a Hybrid 16 bitter on S100!  
Unkit \$309.75 ASSM \$446.25

*(Prices shown are exclusive of sales tax. Prices and specifications subject to alteration without notice).*

#### • WE ARE S100 SPECIALISTS

If you are computing, interested in hardware or software, if you are a businessman, an engineer, educator, student or hobbyist - see us before you make any rash decisions you will regret!

#### • COMING SOON - PROGRAMMING COURSES - CALL FOR DETAILS •

Trading hours Mon-Sat 9AM to 6PM.

See previous ads in EA and ETI.

## New Products

### IFR automatic transmission test set



Vicom, Australian distributor for the IFR Incorporated Company of Wichita Kansas, has released the IFR-2000 Transmission Test Set which is suited for production line testing, testing of radios and communications systems, and general programmable automatic telecommunications purposes.

Measurement of AM, FM and SSB frequencies to 1GHz are possible with this unit. Standard features include:

- A digitised spectrum analyser/oscilloscope display with 256 x 1024 resolution and two stored waveforms;
- 200kHz to 1GHz generator coverage;
- 60kHz to 1GHz receiver coverage with optional preamp;
- "EZE TEST" Basic interpreter;
- Dual tone audio generator with sine, square and ramp outputs;
- 16K of static RAM;
- 1DC-100A cartridge drive.

The measurement functions include percentage AM, deviation, power to 100 Watts, and frequency error. The receiver features three programmable bandwidths, plus LSB and USB.

Further information from the Marketing Director, Professional Division, Vicom International Pty Ltd, 68 Eastern Rd, South Melbourne, Vic 3205.

### Real-time audio analyser



Dindima has introduced the ABACUS Arta 600 third octave real-time audio analyser for applications in the audio and acoustic areas. The instrument is used in conjunction with an oscilloscope to display the real-time intensity and spectral distribution of audio signals.

An internal pink noise generator is built

into the instrument, allowing the user to quickly determine a system's frequency response. Applications include loudspeaker and microphone response measurements; amplifier, tone control and filter response checks; signal and hum tracing; loudspeaking crossover design; and numerous other applications in audio circuit design and installation.

Enquiries should be directed to Mr Andrew Reid, Marketing Director, The Dindima Group Pty Ltd, PO Box 106, Vermont, Vic 3133.

### New IC for motor speed control

A monolithic IC specifically designed to provide low cost motor speed regulation of low voltage DC motors is now available from National Semiconductor Corporation, and features less than 1% system motor speed change with respect to voltage, load and temperature change.

Designated the LM1014, the new circuit has remote stop (pause) and output short circuit protection. Four externally set temperature coefficients allow the user to program the IC for variations in temperature. The LM1014 can operate from a wide power supply range (+5 to +20 volts) and achieves excellent speed regulation under a variety of torque and temperature conditions.

If the output current exceeds a preset limit, the base drive to an external PNP transistor is automatically switched off and the supply voltage must then be reconnected to restart the motor.

Additional information from N. S. Electronics, PO Box 89, Bayswater, Vic 3153. Telephone (03) 729 6333.

### 50W switching power supplies from HP

Through the use of 200kHz MOS power FET switching technology, Hewlett-Packard has designed a new family of 50 watt power supplies featuring reduced size and weight, and improved reliability. Designers can choose from eight different models specifically developed to power microprocessor-based products such as microcomputers and peripherals, communication devices and test equipment.

A key feature of the design is that selectable input voltage ranges make the supply adaptable to worldwide use. In addition, the supply is "brownout-proof" and has overvoltage and short-circuit protection. Power system management is provided by the remote shutdown terminal.

### Non-contact current meter



Tecnico Electronics has announced the development of a hand-held non-contact current meter, called the F.W. Bell Model CG100D "Current Gun Plus". The instrument reads DC, AC and AC-on-DC up to 200A, from DC to 400Hz.

Readout is via a 3½-digit LCD display located in the top of the handle. The unit can be clamped around conductors up to 19mm in diameter and can read through any non-magnetic insulation. Jacks are provided for use with an oscilloscope.

Further information is available from Tecnico Electronics, PO Box 50, Lane Cove, NSW 2066.

### 200VA-300VA power transformers

Ferguson Transformers are now offering a range of transformers designed to AS3159 "Approval and Test Specifications for Electronic Sound and Vision Equipment". They are suitable for amplifiers in the 100W to 300W range.

Each transformer has two similar heavy duty secondary windings and two 15V auxiliary windings rated at 500mA.

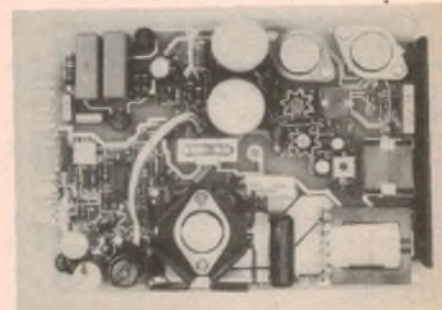

Three groups make up the family, including models with single, triple, and five or six outputs.

Additional information from Hewlett-Packard Australia Pty Ltd, 31-41 Joseph St, Blackburn, Vic 3130.

# WE'LL GET YOU INTO ELECTRONICS.

## ONE WAY OR ANOTHER.

At International Correspondence Schools, we have at least 16 career courses you can take in electronics and other inter-related fields, like computers and television. These are the fields of the future that you

should progress in now. And they are all ideally suited to home study. And ICS, being the largest institution of its kind in the world, has access to the latest world-wide developments and its teachers are amongst the best in Aus-

tralia. So, if you're interested in one or more of the courses below, mail the coupon to ICS, and we'll send back everything you need to begin a more successful career.

**1 Basic Electronics** course for a sound knowledge of radio theory and the industrial applications of electronics.

**2 Electronics Technician** course, with specialist courses in Audio, Radio and Hi Fi; Communications/Broadcasting; Electronic Computer Servicing; Industrial Electronics. Approved by TETIA.

**3 Electronic Instrumentation and Control Systems** course for electronics technicians interested in industrial instrumentation and control.

**4 Electronic Technology**, a program that will fit the ambitious technician for a wide variety of jobs.

**5 Electronics Maintenance** for basic principles and electronic theory, followed by a practical section of maintenance procedures and techniques.

**6 Radio-Electronic Telemetry** covers electrical and electronic aspects of telemetering. Employment opportunities abound in this very modern field.

**7 Amateur Radio Operator's Certificate of Proficiency** prepares you for the examination leading to the Certificate of Proficiency issued by the Postal and Telecommunications Department.

**8 Digital Electronics** course, as new as today, gives you a thorough understand-



ing of the applications of integrated circuits in electronic equipment.

**9 Data Processing**, Various courses including Electronic Computer Servicing.

**10 TV Servicing** courses, in black and white, and PAL colour. Approved by TETIA.

**11 TV Principles** course for basic television technology. And TV engineering course for complete practical coverage of television engineering.

**12 Electrical Engineering Technician** course, is especially for those who want to make a start in the industry or want a broad technical knowledge.

**13 Electrical and Electronic Drafting** is designed for experienced draftsmen wishing to enter this specialised field.

**14 Automobile Electrician** gives you the basics of servicing the automobile's electrical system.

**15 Industrial Electrician** course gives comprehensive training on all aspects of the electrician's work.

**16 Electrical Mechanic** course prepares you for external examinations.

**International Correspondence Schools**  
(A'asia) Pty. Ltd., 400 Pacific Highway,  
Crows Nest, N.S.W. 2065. Tel: (02) 43 2121.

Please send me, without cost or obligation, information about the ICS courses in Electronics.

or, I am interested in a (Please specify) ..... course.

Mr/Mrs/Miss ..... (Please Print)

Address ..... Postcode .....

Occupation ..... Age ..... Phone .....

Tick here if currently full time student.

Write to your nearest ICS city: **International Correspondence Schools.**  
**Sydney:** 400 Pacific Highway, Crows Nest, NSW 2065. Tel: (02) 43 2121  
**Melbourne:** 18-20 Collins Street, Melbourne, VIC. 3000. Tel: (03) 656 1950  
**Brisbane:** 131 Elizabeth Street, Brisbane, QLD, 4000. Tel: (07) 221 0178  
**Adelaide:** 28 Grenfell Street, Adelaide, S.A. 5000. Tel: (08) 219 4154  
**Perth:** P.O. Box D157, Perth, W.A. 6001. Tel: (09) 321 8530  
**New Zealand:** 182 Wakefield Street, Wellington C.I. N.Z.

224 226 



## New Products

Various connection configurations are possible for the latter windings. They can be used independently, in series or parallel, or earthed to act as an electrostatic shield. One winding can even be connected in series with the primary to reduce the output of the heavy duty secondaries by approximately 6%, or both can be used to gain a 12% reduction.

Type PF4361 is rated at 200VA and provides 35V at 2.5A on each heavy-duty secondary; type PF4362 is rated at 300VA and provides 35V at 4A on each secondary; and type PF4363 is also rated at 300VA but produces 47V at 3A on each of its heavy-duty secondaries.

Additional information is available from Ferguson Transformers Pty Ltd, 331 High St, Chatswood, NSW 2067.

### Fast charger for NiCd batteries

Vicom International Pty Ltd, Australian representatives for Redifon Telecommunications of the UK, has released a battery charger capable of rapid recharging of nickel cadmium cells. The new charger is intended for professional users of portable radio equipment.

Some rapid NiCd chargers cause permanent damage to a battery by exceeding critical areas of temperature and pressure towards the end of the charge period. The Redifon system will recharge a battery in less than 20 minutes from a fully discharged state to 95% of the nominal capacity, and completely avoids

critical areas of temperature and pressure.

According to Vicom, the Redifon NiCd charger utilises pulse charging techniques under the control of a microprocessor. The microprocessor monitors the cell, and can vary the amount of charge by up to 600% between the fully-charged and partially-charged states.

For further information contact Vicom International Pty Ltd, 68 Eastern Rd, South Melbourne, Vic 3205.

### Acme has RS-232C cable assemblies

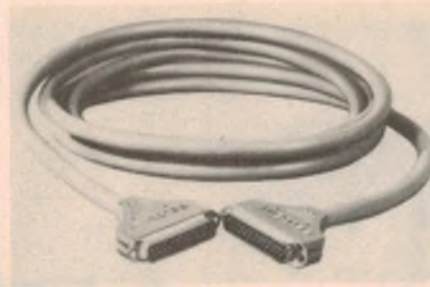

Acme Engineering now have stocks of Belden Corporation of America's new 25 conductor moulded cable assemblies. These assemblies are designed and built to meet EIA standard RS-232C and types A to M standard interfaces.

Belden's rugged and proven 8459 Cable (UL style number 2576) is used in these assemblies. This cable passes the FR-1 vertical flame test and is suitable for

critical interfaces. Positive pin-to-pin mating using subminiature "D" type male and female connectors means no mix-up.

Acme Engineering currently stock these assemblies in five standard lengths from 1.5m up to 21m. Bulk cable is also available in lengths up to 300m.

For further information contact Acme Engineering Co Pty Ltd, 2-18 Canterbury Rd, Kilsyth, Vic. 3137.

### Low-cost, high-power infrared LEDs

A new series of low-cost, high-power infrared light emitting diodes has been introduced by Motorola. Designated the MLED93/94/95 series, the gallium arsenide units are packaged in the TO-92 plastic case, and provide a 3mW to 7mW typical output for an input of 100mA.

The new infrared emitters are said to be ideal for industrial processing and control operations such as shaft or position encoders, end of tape detectors and optical coupling applications. Because of their wide-angle light dispersion the diodes are also well suited for TV remote control applications.

The diodes are available from Total Electronics, 310 Queen St, Melbourne, Vic. 3000.

### New instrument checks bar codes



An instrument which uses a laser beam to check bar coding on consumer goods is now available from Plessey Communications Systems. Plessey says that the Laserchek 2711 is the only instrument capable of providing symbol measurements on curved, flat and irregular packaging surfaces, including all substrates and printing processes.

The Laserchek 2711 is intended for diagnostic measurement of UPC (Universal Product Code) and EAN (European Article Number) symbols, and can be used by product manufacturers for symbol quality assurance and by printers to calculate printing adjustments during press runs. The instrument consists of two main components: a hand-held scan head and a computer console.

For precision soldering.  
Light weight.  
High power.



Fitted with non-seize tips

From your radio parts supplier or:

**Royston Electronics**

N.S.W (02) 709 5293 OLD (07) 391 8011  
VIC (03) 543 5122 S.A. (08) 42 6655  
TAS (002) 34 2233 W.A. (09) 381 5500

SD2C

#### ADCOLA STANDARD

No frills.  
Just high performance.  
3mm S 30  
5mm S 50

#### ADCOLA DUOTEMP

Temperature control at your fingertips.  
3mm D 30  
5mm D 50

Fully automatic 'THERMATIC' also available.

**ADCOLA**

## New Products

The scan head contains the optical components for laser scanning and has push-button controls. Included in the computer console is a digital readout, a printer, and indicator lamps which indicate the selected function. A cable connects the scan head to the console.

For further information, contact Plessey Communications Systems Pty Ltd, 122 Arthur St, North Sydney, NSW 2060.

### Micro-controlled burglar alarm



Tandy Electronics has introduced the "Safehouse RF Field Disturbance Alarm System", a compact unit for protection against intruders. Tandy claim that it will

detect any movement to a distance of 15 metres away. It can also be used with window and door contact switches.

The RF Alarm System operates from the mains supply, and incorporates a built-in rechargeable battery, which is automatically activated should power failure occur. It is armed and disarmed with a four-digit code which one programs into its keyboard, with red LED's indicating the unit's mode.

A siren horn (not included) is required to complete an installation.

The Safehouse Alarm is available from Tandy Electronics Stores and participating dealers throughout Australia.

### Improved version of LF351 op-amp

An improved version of the popular LF351 operational amplifier is now available from National Semiconductor Corporation.

Designated the LF351A, the new device features a guaranteed input voltage drift of  $20\mu\text{V}/^\circ\text{C}$ , with a gain bandwidth product of 3MHz and a slew rate of  $10\text{V}/\mu\text{sec}$ . The corresponding typical figures for the LF351 are

$10\mu\text{V}/^\circ\text{C}$ , 4MHz and  $13\text{V}/\mu\text{sec}$ .

Also available is a lower spec version, designated the LF351B-1. Additional information from N. S. Electronics, Cnr Stud Rd and Mountain Hwy, Bayswater, Vic 3153.

### LED displays

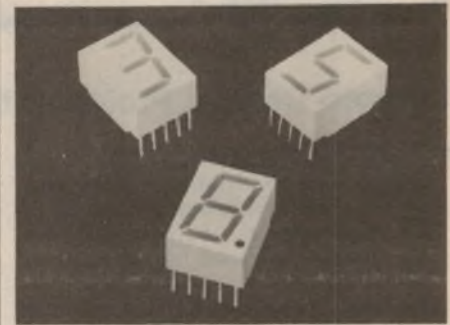

Hewlett-Packard has introduced a new range of 14.22mm high, 7-segment LED displays, claimed to be the brightest yet from HP. The new displays have a more efficient size-to-package ratio, and occupy no more panel space than HP's older 11mm displays.

Colours available are red, yellow and green. The displays are TTL compatible and are available in a variety of electrical configurations.

Units are in stock at HP's authorised distributor, VSI Electronics (Australia) Pty Ltd, 21 Chandos St, St Leonards, NSW, 2065.

## RADIO DESPATCH SERVICE

869 George St, Sydney 2000 Near Harris St.

Phone 211 0816, 211 0191

### DIGITAL MULTIMETERS

— By "Soar" — "Fluke" —

"B & K Precision" Wide Range Carried

Panel Meters — For Projects, P/Supplies, Etc  
Various Sizes Available

Meter and Test Equipment Probes, Ezi-Hook, Kleps, Prods and Test Leads Carried

Instrument Cases — For Projects, Etc, Available in Aluminium Diecast and Plastic Types

### TEXAS CALCULATORS

	Excl S.T.	Incl S.T.
TI 30 SP	20.00	22.10
TI 1750	16.40	18.15
TI BAIL	40.97	45.35
TI 50	36.40	40.30
TI 55	53.35	59.00
TI Programmable 58C	132.00	149.00
TI Programmable 59	265.00	299.90
PC 100C Printer	210.00	237.00
Library Modules	33.32	36.90

### OSCILLOSCOPES FOR THE 80'S



Hitachi Oscilloscope V-152 DC-15MHz  
Dual-Trace \$595.00 Ex/Tax \$661.93 Inc/Tax  
V-302 DC-30MHz  
Dual-Trace \$955.00 Ex/Tax \$1062.43 Inc/Tax  
V-550 DC-50MHz  
Dual-Trace \$1795.00 Ex/Tax \$1996.93 Inc/Tax

Two Types of Probes Extra  
AT 10 AB 1.5 10 to 1 \$20.00 Ex/Tax \$22.25 Ea Inc/Tax  
AT 10 AC 1.5 10 to 1 and 1 to 1 SWITCH \$40.00 Ex/Tax \$44.50 Ea Inc/Tax

Trio Oscilloscopes CS-1580A-II  
130mm CR Tube  
DC-15MHz Dual Trace  
With PC-27 Probes  
SPECIAL OFFER \$610.00 Ex/Tax \$701.50 Inc/Tax

Model CS-1630  
130mm CR Tube  
DC-30MHz Dual Trace  
Probes Extra \$1295.00 Ex/Tax \$1489.25 Inc/Tax

"Coline" Model SP 100 Oscilloscope Probe  
10:1 Ratio — Switchable Complete  
With 1.5m Cable Lead and Accessories \$30.00 Ex Tax \$34.50 Inc/Tax



Hirose and Ansley Ribbon Cable Connectors Fitted Same Day

"Taionic" Model: MLB-1 Logic Probe  
DTL-TTL HTL-CMOS  
Imp: 100k ohms Freq:  
10MHz \$19.45 Ex/Tax \$22.38 Inc/Tax

We specialise in PC Boards for ETI and EA projects. Scotchcal front panels for recent ETI and EA projects.

### MAIL ORDER CUSTOMERS

Packing	\$1.00
Postage Min	\$1.00
Postage Interstate Min	\$1.50

Open: Mon-Fri 8am to 5.30pm. Thursday night late shopping till 8.30pm. Saturday 8am to 11.45 am.

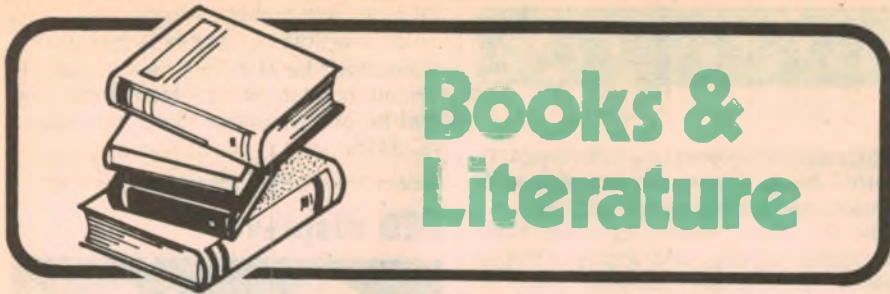

# Books & Literature

## Remote Control Projects: the basics

**REMOTE CONTROL PROJECTS** by Owen Bishop. Published June 1980 by Bernard Babani (Publishing Ltd) London. Stiff paper covers, 164 pages 180mm x 108mm illustrated by circuits and diagrams. Price in Australia \$5.85.

Like other books in the Babani constructional range, this one is intended for readers who need some guidance in the choice of methods and circuits but who can cope with layout and construction on their own initiative.

After a few pages of generalities on remote control, the Author devotes a couple of chapters to an ultrasonic transmitter and receiver and to sequential control. Then follow chapters on visible light and infra-red systems.

This done, the Author lays the foundation for more ambitious projects with chapters on multiple pulse concepts, channels and decoding, power switching, dual control and pulse position modulation and decoding.

There is a brief description of a radio control transmitter and receiver, brief coverage of microprocessor concepts and a few pages of device diagrams and connections.

In summary, a useful guide book, provided you're not looking for complete constructional data. Our copy came from the Technical Book & Magazine Co Pty Ltd, 289 Swanston St, Melbourne, Vic 3000. (W.N.W.)

## Electronics & Communications Course

**ELECTRONIC COMMUNICATION** by Robert L. Shrader. Fourth edition, 1980. Published by McGraw Hill Inc. Hard covers, 195mm x 235mm, 799 pages. Illustrated with photographs and diagrams. Price \$15.00.

This book presents in one volume a complete electronics and communications course. The material covered is based on the practical and theoretical requirements for the US Federal Communications Commission radio licence examinations, and several chapters are devoted to radio laws, regulations and operating procedures in the United States. This however does not significantly affect the value of the book as a comprehensive text book.

The book is primarily intended for

technical schools and colleges, and begins with fundamental theory, progressing to questions of circuit design and operation particularly of those systems which require licensed operators. The material is well presented and clearly written, and unlike many text-books this one does not take the reader's level of mathematical competence for granted, but includes the basic information required to work the problems presented.

There are 35 chapters, ranging from introductory concepts to detailed discussion of radio communications theory.



Separate chapters are provided on television, microwaves, radar, shipboard radio equipment and basic digital circuits. Radio propagation and antenna design are also well covered.

Each chapter includes questions designed to test the reader's understanding of the material presented, and concludes with sample questions taken from the FCC commercial licence examination. The FCC Amateur licence examination is covered in an Addendum which reproduces a typical examination paper.

It is difficult to convey the amount of information provided by this book. In addition to the material already mentioned, both vacuum tubes and solid-state devices are discussed, and separate chapters are included on the design of power supplies, measuring instruments and amplifiers. Practical and theoretical considerations in the design of radio transmitters and receivers are covered in several chapters.

The material in the text is supported by eight appendices including standard component values and markings, tables of trig and log functions, FCC rules and regulations, a table of Q signals as used by radio operators and a list of

radiotelegraph operating signals.

All in all this will prove a useful book to anyone interested in the field of electronic communication. It can also serve as a textbook in basic electronics, a comprehensive guide to FCC regulations, or a reference book for radio operators. Whatever your interest in electronics, take a look at this one.

Our review copy came direct from the publishers, but copies should also be available from technical bookshops and newsagents. (P.V.)

## Electrical & Electronic Drawing

**ELECTRICAL AND ELECTRONIC DRAWING, PART 3**, by James F. Lowe. Published by McGraw-Hill Book Company Australia Pty Ltd. Soft covers, 198 pages, 240mm x 180mm, illustrated by diagrams and photographs. Price \$11.10.

James Lowe is head teacher of electrical trades at Newcastle Technical College and this is the final book in a series designed to give electrical students an understanding of electrical and electronic drawing. While the first two books were concerned with drawing techniques, this volume is intended to show the student how to translate given information into a valid schematic diagram.

The book is structured into 11 chapters or units, each one ending with a set of exercise questions for the student to perform. The first unit introduces the reader to the use of ink as a drawing medium and then four main areas of drawing design are covered:— Motor Starters and Controllers — Switchboard Development and Layout — Electronic Control and Power Circuits — Printed Circuit Artwork Production.

The large number of diagrams presented are very well drawn and reproduced and the accompanying text is well written. The review copy came from the publishers. (R.F.)

## ARRL Manual for amateurs

**THE ARRL OPERATING MANUAL** by Robert Halprin. Published 1980 by the ARRL. Stiff paper covers, 154 pages 275mm x 210mm, illustrated by photographs and diagrams. Price in Australia \$8.00 approx.

Being published by the American Radio Relay League, this book is intended for use by amateur operators in the USA, although it also has notations which take some note of the conventions and regulations in Canada.

Australian amateurs and would-be amateurs could read it with interest but with due allowance to the material which does not apply here.

The introductory chapters 1 & 2 are in-

tended to enthuse and are universal. Chapter 3 on Rules and Regulations would not directly apply although chapters 4 & 5 on traffic handling and emergency would now find some parallel here.

The remaining chapters may also require some "Australianisation" but would at least point in the right direction: DX, Contests, Awards, FM & Repeaters, VHF/UHF, Satellites, RTTY & SSTV, Microcomputers, SW Listening, Reference Section, Index.

If you're keen to get closer to amateur radio, you won't begrudge the purchase price. Our copy from Technical Book & Magazine Company Pty Ltd, 289-299 Swanston St, Melbourne 3000. (W.N.W.)

## Building hifi loudspeakers

**BUILDING HIFI LOUDSPEAKER ENCLOSURES** by M. D. Hull, C. Eng, AMIERE. Published January 1980 by Philips Eindhoven. Stiff paper covers, 232 pages 210mm x 148mm, freely illustrated. Price in Australia \$9.00 plus postage where appropriate.

If you have the impression that you have heard of this book before, you are quite correct. It was first published in 1969 and is now in its seventh edition. Revised and up-dated, it is a very readable and useful book — provided you don't expect it to be what it is not.

After a brief introduction, section 2 deals with the generalities of sound and sound reproduction, while section 3 deals at length with dynamic loudspeakers. The sections are freely illustrated with graphs and diagrams but the treatment is basically descriptive and readable.

Section 4, on loudspeaker enclosures, retains the emphasis on sealed systems that has dominated the Philips approach in the past. This is a perfectly legitimate preference but, if you are looking for any real enlightenment on vented system design, you will find nothing substantial here. Two or three specific examples of Philips-based vented systems are given but the driver specifications do not even list the parameters necessary to work out enclosures by the Thiele method.

While thorough, the constructional sections of the book are slanted heavily towards enclosures and networks based on the present range of Philips drivers. The presentation is strongly reminiscent of what has been published on other occasions in brochures and magazines.

What is certainly more general is a chapter on listening room acoustics — a subject that is too frequently passed over.

Our copy came from the Elcoma Division of Philips, 67 Mars Rd, Lane Cove, NSW 2066. Phone 02 427 0888. Elcoma advise that 50c should be added to the abovementioned price to cover postage, if ordered direct from them. (W.N.W.)

# BOOKS

Just some of the books from the biggest range of radio and electronics books in Australia. If the book you require is not listed below, it can be ordered from us.

## NEW NEW NEW

Latest editions of some of the most popular book on the subject:	\$
The Silicon Civilisation (A. Burkett/E. Williams)	19.50
Telecommunications System Engineering — Analog and Digital Network Design (Roger L. Freeman)	49.40
Amateur Operator's Handbook — Revised (Dec. 78) (Postal & Telecommunications Department)	3.60
WIA Australian Radio Amateur Call Book 1980	2.95
RPG and RPGL Programming: Applied Fundamentals — A Job Approach to Learning (W. Bux/E. Cunningham)	22.95
ARRL Handbook 1980 Edition	14.95
World Radio TV Handbook 1980 Edition	16.95

## HOWARD SAMS BOOKS

Introduction to Bimolecular Electronics (E. Buks-tein)	8.75
Regulated Power Supplies (Irving M. Gottlieb)	13.50
Audio IC Op-Amp Applications (Walter G. Jung)	10.75
TV Antennas and Signal Distribution Systems (M. J. Salvati)	13.50
Video Tape Recorders (Jerry Kybett)	13.50
Modern Recording Techniques (Robert E. Runst-tein)	14.25
Understanding CMOS Integrated Circuits (Roger Meilen/Harry Garland)	7.50
FM From Antenna to Audio (Lenard Feldman)	7.00
Stereo High-fidelity Speaker Systems (Art Zuckerman)	8.50
How To Read Schematic Diagrams (Herrington)	7.50
IC Op-Amp Cookbook (Walter G. Jung)	17.50
TTL Cookbook (Lancaster)	12.95
TV Typewriter Cookbook (Lancaster)	13.50
The Cheap Video Cookbook (Lancaster)	7.95
CMOS Cookbook (Lancaster) 1st Edition 1977	14.25
Active Filter Cookbook (Lancaster)	19.95
IC Timer Cookbook (Jung)	13.50
So You Want to be a Ham (Hertzberg)	8.95

## MICROCOMPUTERS/ MICROPROCESSORS BOOKS

The Computer Solution (Behan/Holmes)	11.95
Microprocessors and Microcomputers: Their Use and Programming (Eric Huggins)	12.50
Introductory Experiments in Digital Electronics and 8080A Microcomputer Programming and Interfacing Book 1 — (Rony/Larsen/Titus)	17.50
Introductory Experiments in Digital Electronics and 8080A Microcomputer Programming and Interfacing Book 2 — (Larsen/Rony/Titus)	14.75
Fortran 77 — featuring Structured Programming (Meissner)	13.95
TEA: An 8080/8085 Co-resident Editor/Assembler (Titus)	11.95
TRS-80 Interfacing — Book 1 (Titus)	11.95
Basic Programming Self-taught (Hirsch)	12.95
Interfacing and Scientific Data Communications Experiments (Rony/Larsen/Titus/Titus)	7.95
Basic Programming Primer (M. Waite/M. Pardee)	11.95
Programming in Pascal — Revised Edition (P. Grogono)	11.50
Learning Level II — CompuSoft Learning Series (David A. Lien)	20.00
Computer Programming for the Complete Idiot (Donald McCunn)	9.95
A Bit of Basic (Dwyer/Critchfield)	7.25
Programming the 6502 (Zaks) (Sybex)	17.60
Programming the Z80 (Zaks) (Sybex)	18.60
6502 Applications Book (Zaks) (Sybex)	17.60

## LATEST ADAM OSBORNE BOOKS

An Introduction to Microcomputers — Volume 0 — The Beginner's Book	13.50
An Introduction to Microcomputers — Volume 1 — Basic Concepts	19.20
An Introduction to Microcomputers — Volume 3 — Some Real Support Devices	21.20
Accounts Payable and Accounts Receivable	23.00
Payroll with Cost Accounting in Basic	23.00
6800 Programming for Logic Design	15.50
6800 Assembly Language Programming	19.20
8080 Programming for Logic Design	13.50
Z80 Programming for Logic Design	13.50
Z8000 Assembly Language programming	19.20
6502 Assembly Language Programming	19.20
The 8086 Book includes the 8088	22.50

## AMERICAN RADIO RELAY PUBLICATIONS

The Radio Amateur's VHF Manual	7.20
Understanding Amateur Radio	8.80
The Radio Amateur's License Manual	6.20
A Course in Radio Fundamentals	7.20
FM & Repeater for the Radio Amateur	8.80
Single Sideband for the Radio Amateur	7.20
Ham Radio Operating Guide	7.20
Electronic Data Book	7.20
Solid State Design for the Radio Amateur	12.80
Learning to work with Integrated Circuits	4.00
Weekend Projects for the Radio Amateur	6.20
The ARRL Operating Manual	9.80

## OTHER TITLES

Flowcharting and Basic (P. Edwards/B. Broadwell)	12.95
Music and the Synthesiser (Bruce Graham)	15.00
Programmable Pocket Calculators (H. Mullish/S. Kochan)	11.50
Filter Theory and Design: Active and Passive (A. Sedra/P. Brackett)	45.50
Amateur Antenna Tests and Measurements (Hooton)	11.95
Australian Electrical Wiring Theory & Practice (Pethebridge)	14.55
Electrical Principles for the Electrical Trades (J. R. Jennesson)	9.95
IC Array Cookbook (Walter G. Jung)	10.00
Hi-Fi Stereo Handbook (W. Boyce)	15.95
Towers' International Transistor Selector 2nd Edition (T. D. Towers)	8.50
Practical Antennas for the Radio Amateur	15.40
73 Dipole and Long-wire Antennas (Edward M. Noll)	7.50
73 Vertical, Beam and Triangle Antennas (Noll)	7.50
Building Hi-Fi Speaker Systems (Philips) 7th Edition, 1980	10.85
Beam Antenna Handbook — New 5th Edition (William I. Orr/Stuart D. Cowan)	7.80
All About Cubical Quad Antennas — 2nd Edition (William I. Orr)	7.00
The Radio Amateur Antenna Handbook (William I. Orr/Stuart D. Cowan)	11.30
The Basic Book of Ham Radio (Editors of Consumer Guide and ARRL)	6.70
The New Penguin Dictionary of Electronics (E. C. Young)	5.95
Transistor Substitution Handbook No. 17	7.95

We also carry a large range of overseas and local computer magazines.

For Mail Orders please add: \$1.20 Local \$1.75 Interstate

**McGILL'S AUTHORISED NEWSAGENCY PTY LTD**

187 Elizabeth Street, Melbourne. Phone: 60-1475-6-7

Prices Subject to Alteration



REVIEWS OF RECENT

# Records & Tapes

CLASSICAL • POPULAR • SPECIAL INTEREST

## SCHONBERG — Pierrot Lunaire: prominent artists but . . .

**SCHONBERG — Pierrot Lunaire.** A setting of 21 out of 50 poems by the French poet Albert Giraud translated into German by Otto Erich Hartleben. Yvonne Minton (mezzo); Pinchas Zukerman (violin and viola); Lyn Harrell (cello); Michel Debost (flute and piccolo); Antony Pay (clarinet); Daniel Barenboim (piano) conducted by Pierre Boulez. CBS Stereo Masterworks 76720.

Pierre Lunaire was the first work to draw general attention to the destruction of music proceeding in Vienna in the name of atonalism or 12-tone music. Schonberg was the leader of the self-styled Second Vienna School, with Alban Berg and Anton Webern as his lieutenants, even though the styles of these two developed entirely differently from that of the Master.

This happened before World War I. It is significant that, from then to the present, the method, which led later to a still more debased form known as serialism, has achieved little popularity among regular concert audiences.

True there are frequent performances to small coterie audiences and it has also created a long list of talentless imitators who use its anti-musical properties to mask their own deficiencies. Of these, alas, there are some in Australia anxious to jump on the bandwagon in a quick ride to success — locally, at any rate. They are almost completely neglected abroad.

One of Schonberg's most enthusiastic supporters has been Pierre Boulez, who conducts the present performance to "commemorate the inaugural concerts of IRCAM, the institute of research into acoustics and other musical phenomena which Boulez is masterminding in Paris." The quote, for what it must be worth to the average reader, is from the English Gramophone magazine. The cast, a specially eminent one, was chosen to celebrate the occasion, the Gramophone goes on.

For a vocal line Schonberg devised "sprechgesang" a method of declaiming the text, while sliding up and down toward and away from a note written in



the score. Yvonne Minton happily ignores this and goes straight for the note indicated. Anyone who can remember an early 78 recording of the Pierrot by Inghelbrecht may recall the really awful caterwauling this sprechgesang produc-

ed, when performed strictly according to its inventor's instructions, and will be deeply grateful for her temporising her part. In between the sung notes she introduces a kind of parlando which is infinitely more tolerable.

As for the work itself, the occasional bright gleam of real music that shines from time to time is reminiscent only of a phosphorescent glow emerging from a heap of decay.

Except for Miss Minton's contribution, I am too modest about my understanding of the subject to praise or criticise the work of the other distinguished performers. But their names should be sufficient to attract those interested in this sort of thing or who would like to try it for the first time. (J.R.)

## MASSENET — Cendrillon: "a true delight"

**MASSENET — Cendrillon (Cinderella).** Complete opera with — among the excellent cast — Frederica von Stade, Janr Bernie, Jules Bastin, Ruth Welting and many others, with the Philharmonica Orchestra and the Ambrosian Opera Chorus conducted by Julius Rudel. CBS Masterworks No. 79323 on Three Stereo Discs with extensive and informative brochure and the libretto in English, French and German.

The well-known fairy tale, Cinderella, has been set in operatic form countless times by many composers of varying merit. Massenet's neglected version is among the best and it is difficult to understand why it has disappeared so quickly from the operatic repertoire, even in its native France.

Other works by this composer are also just as sadly neglected and, for the most part, he is remembered only by his fine operas Manon and Werther, the violin solo known as the "Meditation from Thais" and a couple of palm court suites from his other works. Perhaps this excellent recording may revive interest in

this opera in the form of theatrical performances.

There are many versions of the tale in different languages but Massenet chose the old French one — and perhaps the best known — by Perrault. This is also the best known version among British children though even they may notice a few differences.

Although Massenet's music has been called saccharine, his choice of subjects sentimental, and his output much too facile, he wrote some memorable melodies and some fine theatrical scenes. He provided singers with grateful vocal parts and scored for orchestra superbly, but he has been edged out by his more forceful if less elegant rival composers. Yet discriminating musicians can enjoy the immaculate workmanship and refinement of line and harmonies, at the same time as accepting Wozzeck and Jenufa.

This set is a true delight, beautifully sung and played and recorded to perfection. I need make only one qualification of this statement. The part of the Prince was written for a soprano; here it is sung — and not too eloquently — by a tenor, Nicolai Gedda. But even this wicked gaffe didn't manage to destroy my enjoyment of the whole.

Reviews in this section are by Julian Russell (J.R.), Paul Frolich (P.F.), Neville Williams (W.N.W.), Leo Simpson (L.D.S.), Norman Marks (N.J.M.), Greg Swain (G.S.), and Danny Hooper (D.H.)



The Cinderella is Frederica von Stade, singing in a rather lighter voice than usual, indeed a voice which reminds one of the requirements of a good Melisande. If you want to sample it, play her aria which is easy to find at the beginning of side two. Yet, when necessary, she can imbue this same voice with genuine passion, supplied without stint in the right places by the composer. The Fairy Godmother, Ruth Welting, is a high coloratura singing with ease two arias of daunting difficulty — backed with a gossamer background of quite enchanting delicacy and accuracy. In fact, the ensembles all through the opera are all beautifully performed from gossamer fairy texture to the impressive if not entirely serious pomp of the Royal Court.

The gauche intrusion of Gedda — as the Prince — can be dismissed by enjoyment of Rudel's conducting of a charming work by musicians who share his enjoyment of this most attractive score. The whole is an example of the French style at its best, despite the foreigners among the performers. Highly recommended. (J.R.)

☆ ☆ ☆

**RAMEAU: La Danse — 3rd entree of "Les Fetes d'Hebe".** Jill Gomez and Anne-Marie Rodde, sopranos; Jean-Claude Orliac, tenor; Marilyn Sansom, cello; Nicolas Kraemer, harpsichord; Monteverdi Choir & Orchestra; conducted by John Eliot Gardiner. World Record (Erato) stereo disc R 06068.

This is an extensive extract from a major opera-ballet of Rameau's written in 1739. As other stage-works of the time, it was enormously popular and performed in concert form just as regularly as in a full production. There is not anything



much in the way of dramatic continuity in such a piece — it really is nothing more than a pastoral love scene, interspersed with all kinds of choruses and dances, one of the feasts of Hebe, cup-bearer to the Greek gods.

In the extracts we hear, arranged for modern performance by John Eliot Gardiner and recorded in London's Henry Wood Hall, Mercury (in disguise) courts the shepherdess Egle; the music is characteristic of Rameau at his most accomplished and its great rhythmic and tonal variety is enchanting. Orliac proves an elegant tenor, capable of coping with the counter-tenor register and Miss Gomez sings very gracefully. The choral

## MUSIC ON THE ALLEN ORGAN — "a must"

**VIRTUOSO ORGAN MUSIC** at Holy Redeemer Catholic Church, Burton, Michigan, USA. Carlo Curley. Stereo disc, no brand, DLW-1022 (From Allen Organs Aust, 32 Woodhouse Rd, Doncaster East, Vic 3109. Phone 03 842 5477. \$8.00 plus 90c P&P in metropolitan Melbourne, \$1.60 elsewhere).

Carlo Curley has the reputation of being a somewhat flamboyant organist but, listening to this performance, I think it fairer to describe him as an accomplished musician with complete assurance and complete empathy with the instrument.

The organ itself is an Allen 603 two-manual classically voiced electronic, which is all the more impressive because it has been installed in a church that seems to have had no provision for organ chambers, enclosures or anything. The multiple loudspeaker enclosures are either attached to the walls or located on the floor.

But the sound is extremely clean with powerful but well defined bass. It sounds like a big classical pipe organ in its voicing, except that the voicing is so uniform,

singing, while excellent, is recognisably in the English tradition. Generally, the instrumental contributions are of far greater interest and if there is a slight lack of subtlety in some of the strong contrasts in dynamics and pace, this may in fact help may listeners. In any event, the performance is first-rate, the recording likewise and Mr Gardiner to be congratulated. (P.F.)

☆ ☆ ☆

**WOLF — Italienische Liederbuch.** Christa Ludwig (mezzo); Dietrich Fischer-Dieskau (baritone), Daniel Barenboim (piano). Two DGG stereo Discs 2707 114.

Those to whom the songs of Hugo Wolf appeal — and they are legion — will find much to revel in among the rich selection on DGGs handsomely presented box of the Italian in Liederbuch. If one sought a severe criticism, Fischer-Dieskau has a slight edge on his partner Christa Ludwig in the matter on interpretation, though what Miss Ludwig lacks would be churlish to mention.

She starts a bit unsteadily in her first song, with her tendency to vibrato a little stronger than usual, but settles down to the most severe critic's satisfaction from the second and there on. She shows that she can move from the skittish to the solemn to the tragic in the rest of her contributions.

Fischer-Dieskau is, of course just Fischer-Dieskau, beyond everything but the most niggling criticism. He has been



The 2-manual Allen Digital Computer organ, System 603, as featured.

so well defined and so completely under control that it can hardly be an acoustic source!

The tracks: Suite Gothique (L. Boellmann); Elfes (J. Bonnet); Introduction, Trumpet Voluntary (J. Stanley); Fantasy in F Minor (W. A. Mozart); Cantilene (G. Pierne); Concerto IV (Ernst/Bach).

Recording engineer Don Westfield deserves special mention for a disc that is notable both for its quietness and its dynamic range. A beauty!

If you're an electronic organ buff, this is a must. But, if the contents appeal, you'll enjoy it anyway. (W.N.W.)

accused of faults ranging from too careful phrasing to unsuitable tonal use of his voice. But that he is one of the most intelligent singers of today, gifted with an expressive voice and, when he turns it on, disarming charm that not even the most churlish critic can deny.

This issue contains 46 of the brief songs that make up the cycle, so that mention of some at the expense of others is manifestly impossible in the space available here. Are some better than others? Yes. But remember they are sung by human beings and not computers and perhaps unceasing perfection might even become boring after a while. The most carping, pinpricking critic is not likely to make anything but the slightest objection to a rare phrase, without forgetting his and the performers' humanity in doing so. I am satisfied to take the whole exercise as a whole and, despite my tepid response, to some of the composer's work my major reaction was one of enjoyment.

Before concluding this notice I mustn't forget to mention Barenboim's faultless accompaniments to all the songs — this without exception. He fits perfectly into his soloist's mood, sometimes encouragingly, at others with discreet modesty. That he adds immensely to the success of the whole recital is unquestionable. The sound is great, always faithfully responsive to the combination's slightest and most subtle needs. If you are a Wolf fan you cannot afford to neglect this issue. (J.R.)

## RECORDS & TAPES — continued

**BEETHOVEN — Symphony No 6 in F Major (The Pastoral).** Cleveland Orchestra conducted by Lorin Maazel. CBS Masterworks Stereo Disc SBR 235969. On cassette also.

Ever since I first heard it many, many years ago, Bruno Walter's Pastoral has always been my favourite and the one to which I mentally compare all others. To me he caught the pastoral quality of the work better than has any other conductor of it who has followed him. And it must be remembered that there have been some very fine performances among them. Even all those years ago, back into the earliest days of LP, when sound as so inferior to that of today, Walter's nuancing was beautifully in-

flected, the mood unfailingly serene — except of course for the little storm sequence — and the whole performance the ultimate in refinement.

But here is a formidable competitor for my affection. Maazel's interpretation is different from Walter's but none the less beguiling. For instance Maazel takes the first movement a little faster than did Walter, but he never makes it sound more hurried than a saunter through a landscape, brisk enough to keep a late Spring chill out, and with short stops to enjoy something that delights him. His nuancing has all the charm of Walter's and has the added merit of the lovely sound CBS's engineers have given him.

Except for a couple of slight smudges, the Cleveland Orchestra has preserved

## BOITO, VERDI-Digital

**BOITO: Mefistofele, Prologue. VERDI: Te Deum.** Robert Shaw, The Atlanta Symphony Orchestra and Chorus; John Cheek, Bass. Digital master stereo, Telarc DG-10045 (From PC Stereo, PO Box 272, Mt Gravatt, Qld 4122).

Telarc have provided for a distinctly different listening group with this coupling of Boito's Mefistofele and Verdi's Te Deum. John Cheek may seem rather young and rather too good looking for a convincing Devil, while Robert Shaw and the Atlantic Orchestra might seem to lack "heavyweight" status. But it adds up to a convincing performance, nevertheless.

In saying this, I have in mind that a substantial reason for buying this particular album would be interest in its technical background: digital mastering, half-speed cutting, and processing by Teldec in Germany. What emerges is a

dead quiet recording, soft passages which are barely audible and stunning climaxes, with room shaking bass. If the music is to your liking, you won't be disappointed, especially as Telarc provides full notes, and the words in Italian and English.

But it will not be everybody's idea of music to enjoy or demonstrate and, if you have any doubts on that score, look back over some of the other Telarc releases which have been reviewed in these columns. (W.N.W.)



all the precision it won during its many years direction under that wonderful classicist and martinet George Szell.

The only word that occurs to me to describe Maazel's second movement is entrancing and the rustics have a great time running around in the sunny scherzo. I would remind those who think Maazel understates the storm music in this movement that he is following Beethoven's own markings which indicate unquestionably that the composer had a sudden summer squall in mind and most certainly not a tempest. It is not even difficult to imagine the revellers running for shelter, emerging again when the sun comes out, with a few bars of chorale like gratitude.

The Finale is one long benediction. If you demand a quibble from me about this altogether lovely performance you will have to wait for the very last bars where that treacherous brass tube, the French horn, produces a tone that comes very close to braying. (J.R.)

★ ★ ★  
**FORWARD MARCH.** Sir Charles Groves with The Royal Liverpool Philharmonic Orchestra. World Record Club WRC 06903.

Originally released by EMI, this WRC record gives march enthusiasts eleven of the best known British march tunes from such composers as Elgar, Coates, Walton, Bliss and Walford Davies. Although the music is well played by a world class orchestra, it lacks something of the pizzazz and brass "edge" that one would expect from a military brass band. But I quibble.

The composers and titles are as follows: Elgar; Pomp and Circumstance No. 1 — Coronation March — Pomp and Circumstance No. 4 — Imperial March in G. Coates: Knightsbridge March — The Dambusters March. Walton: Crown Imperial — Orb and Sceptre. Bliss: March from "Things To Come". Holst: Marching Song. Walford Davies: RAF March Past. (N.J.M.)

## The Imagination Machine



TRADE ENQUIRIES WELCOME.

## APF APF APF APF

**IM-1** Your Life Will Never Be The Same — Two great achievements — a powerful state-of-the-art personal computer and a thrilling home entertainment centre in one single package

- User-programmable in BASIC
- With loads of pre-programmed software for educational entertainment and home and personal management
- Features — 9K RAM, 14K ROM
- 53 key typewriter-style keyboard
- 32 characters x 16 line screen format
- Alpha numerics in three colour modes with up to eight colours
- Built-in sound synthesizer with a range of three octaves including flats and sharps
- Six function built-in cassette tape deck
- Two game-style hand-held controllers
- Unique shift key for "BASIC keywords"
- Expandable for floppy disk, printers memory and more.

**\$995** inc colour monitor. Tax paid.

Distributed by **APF ELECTRONICS (AUSTRALIA) PTY LTD**

**VICTORIA**  
Calculator Supermarket, 435 Bourke Street, Melbourne. Phone: 67 6412  
Kalextronics, 101 Burgundy Street, Heidelberg. Phone: 458 2976  
Radio Parts Group, 562 Spencer Street, West Melbourne. Phone: 329 7888  
**S AUSTRALIA**  
Granville Distributors, 28 Gordon Street, Glenelg. Phone: 295 4779.

**NSW (Metro)**  
Australian Electronic Industries, 1-3 Sydenham Road, Brookvale. Phone: 938 4243  
**NSW (Country)**  
Aviologistics A'Asia Pty Ltd, 1 Carter Road, Brookvale. Phone: 929 4011.

**THE VERY BEST OF GILBERT AND SULLIVAN.** *Morrison Orpheus Choir and The Band of HM Royal Marines.* World Record Club WRC 06038.

Two famous groups of musical talent combine on this record to give a first class sampling of some of the best known items from *The Mikado*, *Pirates Of Penzance*, *The Gondoliers*, *Iolanthe* and *HMS Pinafore*.

The combination might sound a little off-putting to G&S purists but the sounds of a big brass band and a large male voice choir only add to the "Britishness" of the music as a whole.

There are nearly 40 titles in all so we can hardly list the lot but the favourites are there, making it an ideal present for someone who would like the top 40 of yesteryear! (N.J.M.)

★ ★ ★

**SOMETHING TO REMEMBER YOU BY.** Your Hit Songs. Okihiko presents the Yoshitaka Akimitsu Trio. Stereo, Audiolab ALJ-1070. [From M.R. Acoustics, PO Box 165, Annerley, Qld 4103. Phone (07) 48 7598]



Made from a dbx master tape.

Produced entirely in Tokyo by Audio Lab Inc, this album features Yoshitaka Akimitsu on Steinway-D piano, Ikuo Ikezawa on string bass and Hiroshi Sunaga on drums. But, if the setting and the players are Japanese, not so the style and the music. Yoshitaka Akimitsu plays romantic, cocktail piano as well as anyone you're likely to hear, while the music will be immediately recognisable:

Something To Remember You By - To Each His Own - Laughing Mam'selle/Count Every Star - Gypsy Medley - It's Been A Long, Long Time - Some Sunday Morning - It's Magic - Harbour Lights - Anytime Medley - Be My Love - Waltz Medley.

It's the kind of sound that merges softly with candlelight but the quality is such that you can turn it up and enjoy it, too. The drums in the background don't count for much but the piano really has dynamic range and bite.

How come? Presumably because the signal was fed to the master analog tape via dbx, thereby reducing its dynamic range by 2:1. It was restored to normal by reverse processing en route to the cutter, thus avoiding both the potential crushing and the noise threshold of the tape. Sufficient to say, the end result is very good indeed. If you like cocktail piano, you'll really enjoy it. (W.N.W.)

## Bouncing, rocking Gospel

**GET IN TOUCH WITH THE WORLD.** **Heaven Connection.** Newpax NP33069 (From Word Records Aust, 18-26 Canterbury Rd, Heathmont, Vic 3135).

If you want a record with 10 bright, bouncy, rocking Gospel tracks, have a listen to this one. Unfortunately the sleeve does not carry the lyrics but the diction of the vocal group makes up for the omission.

The tracks are: That Will Be The Greatest Day Of All - Get In Touch With The World - Find It In The Word - The Lord Will Go Before You - Praise Him, Raise Him - The Rock - Free At Last - Nobody Else But Jesus - Love Will Last - Time Won't Mean A Thing.

The overall musical and technical quality is superb. (N.J.M.)

★ ★ ★

**WITH YOUR LOVE.** Chris Christian. Stereo, Myrrh MSB 6614 (From Word Records Aust, 18-26 Canterbury Rd, Heathmont, Vic 3135).

Ten mainly rocking tracks make up this record with such titles as: With Your Love - Praise The Lord - Already Livin' In Heaven - You Are The One I Need - Sunday Words - Fine Love - Love's The Only Way To Survive - Love That Comes Too Late - Heed The Call - Pray Away.

The words and music for most of the tracks have been written by Chris Christian and the sleeve carries the lyrics and what sounds like a somewhat tongue in cheek list of credits.

**ACROSS COUNTRY Presents Australian Country at its Best.** Astor Records. Stereo ILP 4996. Also on cassette 4ILP 4996.

As the title suggests, this album is aimed squarely at genuine country and western fans. It features, on 14 tracks, a line-up of established Australian talent, including Johnny Chester, Lee and Christine Conway, The Bushwacker Band, Ken Brumby, Cash Backman, and the Hawking Brothers.

With so many different artists featured, one's reaction to the album tends to be somewhat ambivalent. Inevitably, there are some tracks that appeal, and some that do not. Even so, this review must be favourable, especially as the album includes Cash Backman's "When I Dream".

Also featured are: Lord I'd Forgotten - Believe It Or Not - And The Band Played Waltzing Matilda - Blue Eyes Crying In The Rain - Here's To Old Ned Kelly - I Fought The Law - The Way I Love You - Amanda (spelt wrongly on the record label as "Amada") - Lonely Women Make Good Lovers - Eighteen Yellow Roses - No Money Blues - Rain Rumbles Down - The World's Greatest Mum.



The overall excellent quality was marred, on the review pressing, by surface noise affecting tracks one and two on side one. (N.J.M.)

★ ★ ★

**TOTALLY FREE.** Dale Evans. Stereo, Word Records WSB 8803 (From Word Records Aust, 18-26 Canterbury Rd, Heathmont, Vic 3135).

Dale Evans, wife of cowboy star Roy Rogers, brings a surprisingly young and vigorous voice to ten Gospel tracks. Her diction is such that you don't miss a word on any of these titles:

Satisfaction Guaranteed - Love Held My Saviour - A Mother's Prayer - He's Such A Wonderful God - Jesus Is Lord Of All - Top Of The Mountain - Springtime Holiday - Something Wonderful Happened - Your Touch - He Is Love.

The backing vocals are provided by The Backyard Kids Choir and The West Los Angeles Sanctuary Choir.

Dale Evans' background in Country and Western music shows through in some of the tracks and, overall, I would see the appeal mainly to the in-betweens. (N.J.M.)

Recording quality is quite OK. (G.S.)

★ ★ ★

**STORMY MONDAY,** Lou Rawls, Les McCann. World Record Club WRC 06767. (605 Camberwell Rd, Hartwell Vic 3124. Tel. 29 3636)

Two of the great names in jazz get together on this enjoyable album of blues classics. Originally recorded by Capitol in January 1962, this new release under the World Record Club banner sounds very fresh, both in quality and content.

Les McCann on piano is backed by Leroy Vinnegar and Ron Jefferson, with these titles: Stormy Monday - God Bless The Child - See See Rider - Willow Weep For Me - I'm Gonna Move To The Outskirts Of Town - In The Evening - 'Taint Nobody's Biz-Ness If I Do - Lost And Lookin' - I'd Rather Drink Muddy Water - Sweet Lover.

The whole album has a very relaxed and intimate atmosphere that would go well with late night listening.

A more recent release of Les McCann only goes to show that he certainly has lost none of the style exhibited here. (N.J.M.)

# The Dick Smith Daisy Wheel

**If you just  
bought any  
other printer  
you'll eat your  
heart out!**

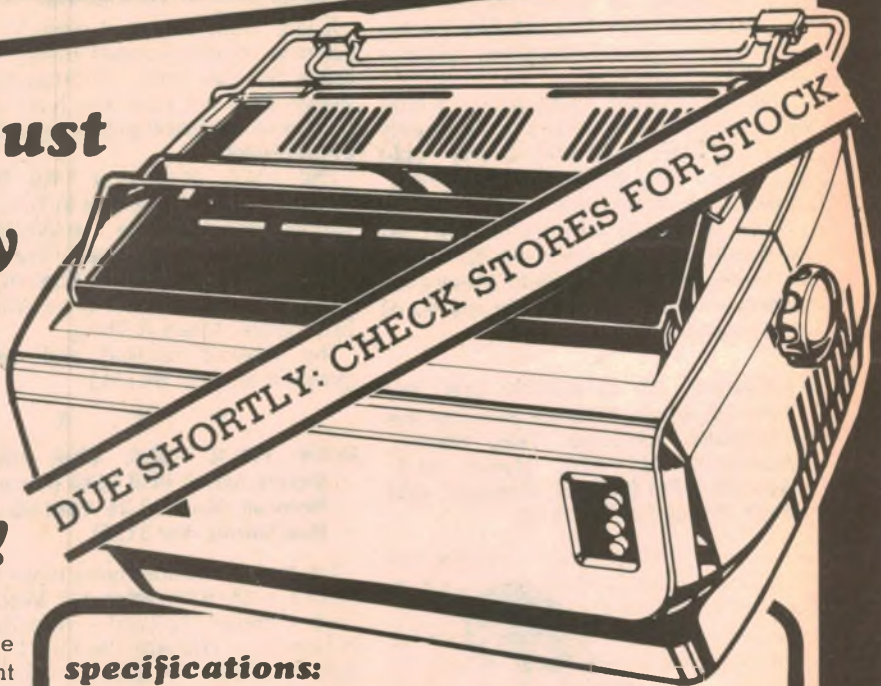

When you want letter-quality printing you are usually talking big money. If you've just bought a word processor printer you'll know what we mean.

In fact, if you've just bought a word processor printer you'd better not read any further. You might get too upset!

The new Dick Smith Word Processor Printer gives you superb print quality (even three carbons down!) at a brisk 25 characters per second. It uses standard Diablo-type daisywheels, giving you low cost replacement and a large variety of fonts. It uses standard business stationery, up to 400mm wide, prints with proportional spacing, in two directions — if you wish. It's hundreds of dollars less than its nearest competitor and thousands of dollars less than many others!

## specifications:

Print speed: 25 characters per second; Carriage return speed: 1000ms; Line feed speed: 40ms (4 25mm); Characters per line: 136 (2.5mm pitch) 163 (2.0mm pitch); Resolution pitch: space 0.2mm, line feed 0.5mm; Form width 398mm maximum; Printing width: 345mm maximum; Number of printing characters: 96; Number of copies: original plus 3 copies; Noise level: below 65db with cover; Print Wheels: Diablo-compatible plastic; Ink ribbon: cloth or multi strike; Interface: Centronics-type parallel; Operating conditions: 5-36 degrees C, 10-90% RH; Power requirements: 240v/50Hz, 70 watts; Dimensions: 625mm (w) x 380mm (d) x 258mm (h); Mass: 19.5 kg including cover, power supply

Credit terms available to approved applicants

**\$1995**

**All this for only**

Cat. X-3265

**We also offer outstanding value on this**

## DOT MATRIX PRINTER

**Fantastic value for less than \$1,000!!!**

This incredible dot matrix printer uses inexpensive fan fold paper. Upper and lower case with 125 characters per second print speed and a one line buffer memory, plus lots more



Cat X-3255

## SYSTEM 80 OWNERS. DON'T NEED S-100 EXPANSION?

Use this parallel printer interface if you don't need full S-100 expansion. Save a bundle! Uses similar connecting cable to S-100 interface. Cat X-4013

**\$49.50**

## PRINTER CABLE

Fitted with edge connector at one end, 57N-36 plug at other: suits virtually all Centronics-type printers. Use with either S-100 interface or parallel printer interface.

Cat X-4014

**\$39.50**

**DICK SMITH  
Electronics**



**SEE OUR OTHER ADS FOR FULL ADDRESS DETAILS**

# Column 80

by JAMIESON ROWE

Technical Director,  
Dick Smith Electronics

## Advantages & limitations of BASIC programming

Nowadays most people who start writing computer programs do so in BASIC, as this is the language provided on the majority of personal and small business computers. BASIC is just fine for getting used to programming concepts and for a lot of general programming, but it does have limitations.

Thanks to the modern personal and small business computer, large numbers of people are finding that they too can now afford the benefits of computers. They're also finding that they can even write their own programs, to get the computer to do the jobs they want, in the way they want them done.

Largely the reason why they can write their own programs is because the new machines are provided with an inbuilt "interpreter" program, which lets you program the machine not in its intrinsic binary code or "machine language", but in an easy-to-use "high level" language. In most cases the high level language provided by the interpreter is BASIC, which as you may know is an acronym standing for "Beginners All-purpose Symbolic Instruction Code".

This is really a tremendous development when you think about it, because all of the early computers had to be programmed directly in machine language — a tedious, time consuming and involved process even for those who had mastered its intricacies. For beginners it was virtually impossible.

Compared with machine language, BASIC is a dream. It is easy to understand and to learn, and is therefore an easy way for newcomers to get familiar with the basic ideas of computer operation and programming. Not only that, but it is also quite suitable for writing many general-purpose interactive programs for things like accounting, stock control, record keeping, computer-aided instruction and games.

But like other high-level languages BASIC does have limitations. One of these is limited flexibility. In providing an interpreter program for a computer, the designer can only give it a finite "vocabulary". In other words, there has to be a definite limit to the number of high-level "commands" that the interpreter is capable of translating into machine language.

The larger and more "powerful" the

BASIC interpreter, the bigger its command vocabulary. Hence an interpreter which occupies say 12K bytes of memory (like the Microsoft interpreter in the System-80 and TRS-80 Level II machines) tends to provide a larger set of commands than one which occupies only say 4K bytes. But these are only differences in degree; the vocabulary is always finite. And because each high-level command provided by the interpreter is basically equivalent to a pre-determined sequence of the computer's actual machine language instructions, this vocabulary must always be less flexible than the machine language itself.

Sooner or later you become aware of this, as you find yourself wishing for a command or function that "isn't there", or that one of the existing commands would do something slightly different.

Perhaps to let you print things out in a slightly different format, or to provide an extra string function which is equivalent to one of the existing numerical functions. Or an additional mathematical function.

Of course you can always try another high-level language, like PASCAL, FORTH, FORTRAN and so on; there are quite a few to choose from. As all of them tend to provide different commands and functions, there's always a chance that you may find what you want. But if you can't, you may have to resort to assembly language — perhaps in the form of a special subroutine which is "called" from your high-level program.

Perhaps you've thought of trying other high-level languages, or looking into assembly language, but have been scared off by all sorts of baffling talk about compilers, interpreters, assemblers, editors, hexadecimal numbers and so on. If so, I may be able to help. Over the next few months in this column I'll try to explain some of these things, in simple language, with the idea of removing a lot of the mystery. Why not come along for the ride? 

### EA Magazine Holders



The binders and magazine holders are available over the counter from Electronics Australia, 57 Regent Street, Sydney, NSW — Price: \$5.10 binders. \$4.50 holders.

Mail orders should be sent to Electronics Australia, PO Box 163, Beaconsfield, NSW 2014.

Prices including postage are:

Binders: \$6.20 NSW; \$7.90 other states; or six for \$32 NSW, \$34 other states, A\$36.60 NZ.

Holders: \$5.40 NSW; \$5.50 other states; or six for \$28.30 NSW, \$30.40 other states, A\$32NZ.

# Microcomputer News & Products



## Improved System-80 from Dick Smith Electronics

With a success like that of the low cost System-80 Computer (over 2000 units sold in the first five months), many companies might have been content to "rest on their laurels"; but not so Dick Smith Electronics. In response to customer feedback and comments from staff and dealers, DSE's technical people consulted with the manufacturer on ways to improve the product. As a result, they have now announced the release of a new "improved" System-80 machine.

Most obvious feature of the new machine is that it now has a built-in level meter, for monitoring the playback level from program tapes being loaded via the internal tape deck. Along with the meter is a convenient level control, allowing the user to compensate for recording level differences between tapes.

DSE claims that these two additions effectively solve all normal tape loading problems — probably the biggest single cause of trouble with all small computers.

Also provided on the new System-80 are two keys which were not present on the original model: a TAB or "forward arrow" key, and a CLEAR key. These make the machine easier to use, and give it improved compatibility with programs writ-



On the improved System-80 the right hand SHIFT Key has been replaced by the BACK SPACE and new TAB keys.

ten for the Tandy TRS-80 Level II machine.

Despite these improvements to the System-80 Computer, its price is remaining the same. Price for the unit with 4K bytes of user RAM (X-4003) is still \$695, while that for the 16K version (X-4005) is still \$750.

Both versions of the new machine are

still entirely compatible with the S-100 Expansion Unit (X-4010) and other matching expansion hardware. They are also fully compatible with earlier machines.

The new System-80 will be available mid-January from all Dick Smith Electronics branches and resellers.

More Micronews ►

## modular microprocessor systems 6800/6802/6809

- 6800/6802/6809 Disk or Cassette based systems
- Expansion cards for EXORcisers\*, D2 kits, AIM-65, SYM-1 or other EXORciser compatible microcomputers.
- Motorola Micromodules\* & MOKEP\* products
- PERCOM EXORcisor compatible Disk Systems
- TSC & PERCOM SOFTWARE
- MEMORY IC's : 2114L, 6116 (2K x 8) & 4334 (1K x 4) CMOS RAMS, 2716 & 2732 EPROMS.

**PP** Pennywise Peripherals  
Pennywise Peripherals

Suite 15, 96 Camberwell Road,  
Hawthorn East, Vic 3123  
PO Box 398, Camberwell, Vic 3124. Phone (03) 82 2389  
Sydney Dealer (02) 89 3145  
Brisbane Dealer (07) 52 8735

Send 50c in stamps for latest SF catalog & price list.

\* EXORciser is a registered Trade Mark of Motorola Inc.

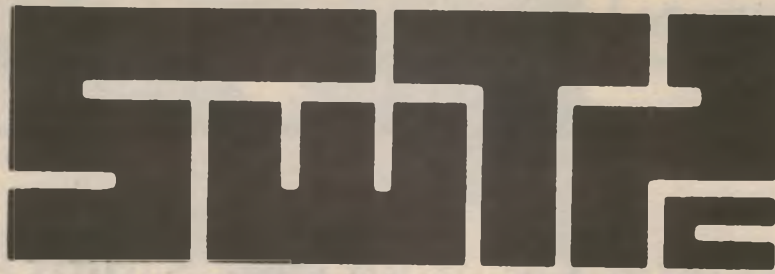

## HARDWARE

KIT	DESCRIPTION	PRICE
S/O9	6809 Computer w/128K Memory	\$3350.00
/O9	6809 Computer w/56K Memory	\$1660.00
69/A	6809 Computer w/8K Memory	\$760.00
PP132	characters 6540 printer	\$2350.00
S/OO	S/O9 W/O Proces/Mem card	\$560.00
DT-80	Terminal w/monitor	P.O.A.
8209	Terminal w/monitor	\$1050.00
8212	Terminal w/monitor	\$1175.80
DMF2	Disk System w/2.5m Capacity	\$2650.00
CDS-1	Winchester Hard Disk System	\$4835.00
SP-3	Daisy Wheel Printer (QUME)	\$3295.00
SP-5	Daisy Wheel Printer (QUME)	\$3515.00
PR-40	Alphanumeric Printer	\$275.00
MP-O9	6809 Processor Board Kit	\$192.50
MP-O9A	6809 Proces/Board (Assem)	\$225.00
D5-2	double side/double density 720KB	\$1395.00
38O9	128K Memory Expansion for S/O9	\$2305.00
MP-32	32K Memory (assembled)	\$715.00
MP-16	16K Memory (assembled)	\$440.00
MP-8A	8K Memory (assembled)	\$258.50
MP-8M	8K Memory kit	\$220.00
MP-LA	Parallel Interface	\$45.00
MP-L2	Dual Parallel Interface	\$110.00
MP-N	Calculator Interface	\$65.00
MP-P	Power Supply	\$66.00
MP-QP	Circuit Board for SP-3 (assembled)	\$78.00
MP-R	Eprom Programmer	\$65.00
MP-S	Serial Interface	\$45.00
MP-SA	Serial Interface (Assembled)	\$66.00
MP-S2	Dual Serial Interface	\$110.00
MP-SX	Serial interface Expansion	\$27.50
MP-T	Interrupt Timer	\$52.25
MP-WP	IBM Selectric Interface	\$66.00
S-32	Universal Static Memory Card	\$115.00
MP-O9b	Processor Circuit Board	\$27.50
MP-8Mb	8K Memory Circuit Board	\$27.50
DMF2b	Controller Board for DMF2	\$434.50
DT52	double track density 1-9MB	\$1850.00

PRICES SUBJECT TO ALTERATION  
EXPORT PRICES UPON APPLICATION

ALL HARDWARE PRICES PLUS 15% ST WHERE APPLICABLE

## SOFTWARE

ASMO9	Optimizing Assembler (5" or 8")	\$110.00
Flex O9	ver. 2.6:5 w/manual	\$38.50
Flex O9	ver. 2.6:5 w/o manual	\$11.00
Inventory	Program	\$110.00
Mail List	Program	\$110.00
Word processing	Editor & Text processor	\$165.00
Word Processing	Editor	\$110.00
Text processor		\$66.00
SP-O9-2	Text Editing System	\$38.50
SP-O9-3	Mnemonic Assembler	\$44.00
SP-O9-4	Basic	\$71.50
SP-O9-5	Debug Package	\$82.50
SP-O9-6	Extended Basic	\$110.00
SP-O9-7	Standard Precompiler	\$55.00
SP-O9-8	Extended Precompiler	\$55.00
UniFLEX	Multi-tasking BASIC	\$150.00
SP-O9-10	Sort/merge	\$82.50
SP-O9-11		\$66.00
* UniFLEX:- Multi-user and Multi-tasking		\$495.00

### SWTPC BUSINESS SOFTWARE: ACCOUNTS RECEIVABLE, GENERAL LEDGER, INVENTORY, PAYROLL, MAIL LIST AND MANY OTHERS.

#### FLEX for the EXORciser™

Runs on a Motorola EXORciser with EXORDisk™ II or III. Requires no hardware modifications with the possible exception of memory re-addressing. Uses the same boot as MDOS™.

#### FLEX Support Software

Extended BASIC  
Standard BASIC  
6809 Diagnostics Package  
Text Processing System  
Sort/Merge  
68000 Cross Assembler  
6809 Cross Assembler  
6809 FLEX Utilities  
6800 FLEX Utilities  
6809 Debug Package  
6800 Debug Package  
FLEX for SWTPc  
UniFLEX:- Multi-user and Multi-tasking



## SOUTH WEST TECHNICAL PRODUCT CORPORATION

(COVERING AUSTRALASIA)

7a BURTON STREET, DARLINGHURST, N.S.W. 2010.

P.O. BOX 380 DARLINGHURST N.S.W. 2010. PHONE (02) 357 5111

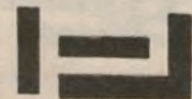
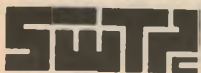

## Microcomputer News & Products

### NEW PORTABLE DATA TERMINAL FROM ADE

A portable data terminal made by Texas Instruments has been introduced to the Australian market place by ADE. It is being widely used as an on-the-spot aid in selling insurance.

The 745 data terminal has been featured in a national sales campaign by the large insurance company, Aetna Life and Casualty Ltd, and is used extensively by the company's agents.

Aetna has 230 agents around Australia, of which over 90 use the terminal, and it is the first insurance company in Australia to use the advanced technique of answering customer queries through remote data terminals.

According to ADE, the terminal has its own carrying case and incorporates an acoustic coupler, designed to cradle or hold a normal telephone handset. This allows the terminal to communicate with the company's mainframe computer in Sydney. Interstate users connect to the mainframe through their regional branches.



The terminal will output data at a rate of 30 characters per second, using a quiet 5 x 7 dot matrix printhead which features contrast control. The speed may be changed to 10 characters per second as an option. The communication format is all in ASCII.

Other possible users include journalists who can type out their copy and send it directly to the newspaper's computer

from their home or from the story location.

For further information contact Anderson Digital Equipment Pty Ltd, Mount Waverley, Vic. Phone (03) 543 2077 or Sydney (02) 848 8533.

MICRONEWS  
CONTINUED →

### SORCERER OWNERS

#### A COMPLETE TAPE-BASED ACCOUNTING SYSTEM!!!

ACCX is the NEW Software Source Accounting package designed by Australians for Australian conditions. Simple, easy-to-learn input module allows anyone, with or without accounting knowledge to enter the daily (or monthly or yearly) accounts. ACCX will do the rest and produce everything your accountant will need — cashbook/journal — general ledger — profit & loss statement — balance sheet. Keeps a chart of accounts on tape — allows editing to delete unused accounts or to add new ones. Update or alter any transaction at any time.  
3 programs: includes STRINGSAVER (\$37.50 value) FREE  
ACCX complete package \$150.00

#### BASIC MOD 1.01

THE BETTER BASIC UPGRADE Gives you full line editing, renumbering and block deleting facilities. Edit lines of any length — not limited to the width of the screen. Full crash recovery. Totally compatible with your original ROMPAC. Many other features. Call or write for full details.  
Available only for Exidy Standard Basic version 1.0. Include ROMPAC with order \$125.00

#### USE YOUR SORCERER'S GRAPHICS CAPABILITIES!!

Tape-based machine language program allows instant definition of graphic characters. Powerful macro command allows you to define 24 characters as a block. Numeric keypad becomes a special keypad for drawing lines and curves. Inverse, flip, rotate, tilt, mirror, translate. Study the makeup of any character. Easy to read 17 page booklet explains exactly how Sorcerer graphics work and how to define your own shapes.  
GRAFIX \$24.50

We have an extensive range of software for the Sorcerer, both tape and disk based. CP/M 2.2 available for Sorcerer. Disk based word processors and languages — Fortran, Cobol, Basic, C, etc. Also disk drives, disks, memory expansion, printers, paper, S-100 expansion. Sorcerers, monitors, etc. etc.

Write for FREE catalogue:

**Software  
Source**

PO BOX 364  
EDGECLIFF  
NSW 2027

NEED SOME SPECIALISED SOFTWARE? CALL US WE CAN  
HELP — SOFTWARE SOURCE. PHONE (02) 33 4536

## Next Month\* in “Electronics Australia” Dual Trace Adapter for Oscilloscopes



*Held from January due to lack of space, this adapter will provide dual-trace operation with any single-trace oscilloscope.*

PLUS

### A Fully-Protected 6-amp Charger

\*Our planning for this issue is well advanced but circumstances may change the final content. However, we will make every attempt to include the article mentioned here.



# SAVE A BUNDLE ON MICROCOMPUTER MODULES

**16K RAM KIT ON S100 BUS**  
**\$209.00**

No, this is not a misprint! The AT16K RAM kit uses low power 2114 RAMS to achieve the lowest cost memory yet released in Australia. Board can be configured in 4K blocks and can be located at any 4K boundary. Has built in phantom and can be strapped for write protect. Kit comes with full manual and all components including sockets for all IC's. AT16K KIT \$209.00 (\$239.00 assembled and tested).

**SCVT-100 KIT**  
**\$189.50**

As described in EA October this full featured S100 terminal is a ready to use serial terminal including cassette interface, baud rate generator and keyboard port.

**EA MODEM KIT**  
**\$69.50**

Get your computer on line with this 300 baud acoustic coupled Modem. Ideal for any microprocessor system with a serial output/-input capability, this Modem is a must for serious experimentors.

**AT MICRO MODULES**  
**\$399.00**

Based on the S100 bus and designed around the Z80 microprocessor, these powerful cards are the ideal starting point for microprocessor users. The ATZ80 is an ideal starting point and you can add cards as your needs increase.

## The advantages of the ATZ80 Micromodule approach:

No doubt you can see for yourself the ATZ80 Micromodules represent probably the most flexible and cost effective approach to building up a modular, expandable Z80 based Micro-computer System on the S100 Bus. Applied Technology have been leaders in the Microprocessor Kit market in Australia since 1976 and consequently these products benefit from the vast experience gained. All products sold are backed up with full warranty and service support. New products are continually in development and during 1980 expansion moves have included a new outlet at Gosford (N.S.W.) a factory for assembling micromodules and further research and development facilities are now operational. Special courses in microprocessor practical applications are also available through Applied Technology training division and details will be supplied on request.

The Micromodule approach enables the user to configure a powerful Z80 based computer to suit any particular requirement from process control, education, development tool, to complete business system.

## ATZ80 OPTION PRICING:

	Kit	Assembled/ Tested
DGZ80	\$199.00	\$249.00
DG640	\$149.00	\$159.00
AT16K	\$209.00	\$239.00
ATPCG	\$140.00	\$165.00
JC100 Mother Board	\$49.50	
JC200 Card Frame	\$49.50	
JC300 Power Supply	\$69.50	
USCI Cassette Interface		\$25.50
Clare C70 Keyboard		\$165.00
Clare C72 Keyboard		\$179.50
DGOS IN 2516 ROM		\$40.00
Microworld Basic		\$25.00
Microworld Assembler		\$35.00
Games Tapes		\$15.00
1043 Disc System		\$1275.00
8300 Serial Printer		\$950.00

All prices include Sales Tax.



**APPLIED  
TECHNOLOGY  
PTY. LTD.**

### MAIL ORDERS TO:

PO Box 355, Hornsby 2077

Please add \$2.00 per order  
towards cost of post and packing.

### OFFICE/SHOWROOM

1a Pattison Avenue, Waitara 2077

Hours: 9-5 Monday to Saturday  
Telephone 487 2711

### AND NOW AT GOSFORD -

1 Debenham Road, West Gosford (behind the Pizza Hut) 043-24 2711

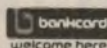

**The Rolls  
Royce of  
personal  
computers**



**or the basis  
for a  
fine  
business  
system**

# Yet the Sorcerer will still cost you less!

**Looking for a really serious small computer? Feature for feature, dollar for dollar, the Sorcerer is way out in front. When you've finished playing with the others, move up to the Sorcerer.**

**Features:**

- Up to 48K RAM on board — with full S-100 expansion for a huge number of peripherals, etc.
- User-definable graphics and full upper & lower case character set as standard; also special character set.
- Plug-in ROM PACS™ give you instant changeover for special applications: Word processing, software development, etc. Or your own custom programs, using the EPROM PAC.
- Numeric keypad as well as full 63 key ASCII set.
- Centronics-type printer interface & RS-232C communications port built-in as STANDARD!

**FROM ONLY \$1340**

Credit terms available to approved applicants

Cat. X-3000 8k Memory <b>\$1340</b>	Cat. X-3001 16k Memory <b>\$1395</b>
P&P \$5.50 per unit	

## look at our prices for peripherals

**Video Monitor**



**Suits Sorcerer, Tandy TRS-80, Apple etc.**

Why waste money on overpriced monitors? This unit has large 30cm diag. screen plus it simply connects to your computer via an RCA socket. 240V AC or 12V DC operation.

**\$149<sup>50</sup>**

X-1196  
P&P \$5.50

**S-100  
Expansion  
Unit**

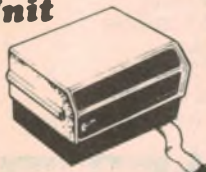

**Use other manufacturer's peripherals with your Sorcerer & S-100**

For the serious computer owner. Contains powerful computer power supply plus buffer/interface circuit to protect the computer in case of damage to the S-100. Plus many more benefits.

**\$575**

X-3010  
P&P \$5.50

**Floppy  
disc  
drives**



Need more storage? Floppies are the way to go. Quality Micropolis disk drives added on to your system can give up to 1260K bytes capacity!

Start with the Micropolis 1043 — it comes with the controller board to plug into your S-100 expansion unit. This gives you 315K.

If you want more capacity, use the Micropolis 1023 drive: it uses the 1043 controller board, so it's cheaper — much cheaper (\$600 to be precise!) You can add up to three 1023 drives, bringing your total capacity to over one and a quarter megabytes! Compare the cost of our 1 26M system with others — and be pleasantly surprised.

X-3205 \$1350.00 X-3208 \$750.00

**Sorcerer  
ROMPACS™**



Just plug them in — they instantly re-program the Sorcerer for specific uses. No problems!

**WORD PROCESSOR PAC™**

Want professional quality Word processing at a fraction of the cost of commercial systems? Your Sorcerer, Word Processor Pac™ and our daisy-wheel printer... and you're there!  
**Cat. X-3085 \$275.00**

**DEVELOPMENT PAC™**

If you're serious about developing your own software, this is a MUST! It turns the Sorcerer into a powerful, dedicated development system for Z-80 assembly language programming.  
**Cat. X-3090 \$139.50**

**EPROM PAC™**

The Sorcerer is ideal for dedicated uses: this PAC allows an EPROM to be used to control the computer. Ideal for all types of control systems, etc.  
**Cat. X-3095 \$75.00**

# DICK SMITH ELECTRONICS

SEE OUR OTHER ADVERTS IN THIS MAGAZINE FOR OUR STORE ADDRESSES AND RESELLERS



## NEW HARDWARE AND SOFTWARE FROM CROMEMCO

Cromemco's new 16FDC Disk Controller Board provides full read/write format capability for any combination of single or double-sided, single or double-density, 127mm or 200mm floppy disks. The 16FDC can control up to four 127mm drives and up to four 200mm drives simultaneously. The 16FDC provides a complete system for floppy disk operation including serial I/O for an RS-232 terminal and a ROM with bootstrap and diagnostic routines. It is designed for use with the industry standard S-100 bus and is compatible with the complete line of Cromemco computer systems.

The 16FDC includes an 8-channel interrupt system which is connected to the flag bits of the disk controller, the serial

I/O, and a set of interval timers. One of the interrupt inputs can optionally be connected to a 512ms crystal controlled clock for real time interrupt capability.

Another recent release by Cromemco is their new high resolution graphics software package. The Cromemco graphics system can be used to display colour or black and white images with up to 756 x 482 point resolution on a high quality RGB monitor.

The graphics software package is designed to work with Cromemco's 48KTP and 16KTP (two port) memory boards and will operate with one or two pages of two port memory. Two pages of 48K bytes of RAM are required for complete utilisation of all available software options.

For those using the graphics software package, the subroutine calls provided are sufficient to fully utilise all the capabilities of the Cromemco SDI high resolution graphics interface board.

The SDI colour graphics software package is available either on 127mm or 200mm diskettes.

For additional information, please contact Adaptive Electronics Pty Ltd, 77 Beach Road, Sandringham, Victoria 3191. Phone (03) 598 4422.

## COMPUTER HARDWARE BY MAIL ORDER

Substantial savings on personal computer hardware through mail order marketing is now being offered by Direct Computer Sales of Sydney, a new company run by a group of microcomputer enthusiasts.

Specialising in the Apple computer, the company provides full after sales service and will be expanding its range of computers to include the best of the currently available systems.

The company will be innovative in its marketing strategy in selling Australia wide. Its office will be open on weeknights so that customers can save on their STD calls.

Enquiries can be directed to (02) 908 2235 7-10pm week nights and from 9am to 10pm Wednesdays. Their address is 32 Lloyd Avenue, Cremorne, NSW 2090.

## EAST TAPE LOADING FOR THE TRS-80

A new release for the TRS-80 software market is this program from Palomar Software in the US. Marketed in Australia by Cisa Microcomputing, the program offers the user the ability to save and load tapes at up to 4½ times the normal speed.

It will allow Basic programs as well as

System tapes to be saved at these higher speeds. There is also a facility for saving array data, both numerical and string types.

Apart from saving and loading tapes at much higher speeds, the program also offers the user a series of printer options. It will allow the use of the Radio Shack parallel printer, a serial printer connected to the RS-232 output of the expansion interface unit and the use of a serial printer connected to the cassette port via a suitable interface.

Costing \$29.95, the program is available from Cisa Microcomputing, 159 Kent Street, Sydney 2000. Phone (02) 241 1813.

## PASCAL & VISICALC FOR THE COMMODORE PET

BS Microcomp announce the release of PASCAL and VISICALC for the Commodore Pet micro-computer. Both packages require a 32K computer and disk drives. Commodore's PASCAL is the full UCSD version and is a powerful disk based compiler system. VISICALC is a well known package developed by Personal Software Inc of the USA. Both packages will retail for \$400 and are available from BS Microcomp, 4th floor, 561 Bourke Street, Melbourne 3000.

MICRONEWS  
CONTINUED →

\$ THE LOGIC

SHOP PTY.LTD.

## NEW YEAR STOCK- TAKE SPECIALS!

### COMPUCOLOR II

Ex  
Stock



features:

Up to 32K User RAM  
Eight-colour display  
32 lines of 64 char.  
5" Mini Disk Drive  
40 Tracks, 48 TPI

### TELEVIDEO TVI-912

Ex  
Stock



features:

24 lines  
80 char. per line  
Transmission rates 75-19,200 Bd.  
96 char. ASCII Upper & Lower Case  
12" Monitor

### MICROLINE 80 PRINTER

Ex  
Stock



features:

80 char. per sec.  
80 and 132 char. per line  
9x7 DOT MATRIX character or  
graphics printing.

### PLUG COMPATIBLE TO TRS-80

(TRS-80 is a regd. trade name of  
The Tandy Corp.).

**SPECIAL**  
**5¼ DISKETTS**  
**\$3.95 EACH (INC. TAX)**

\$ THE LOGIC

SHOP PTY.LTD.

212 HIGH ST, PRAHRAN,  
VIC 3181. TEL (03) 51 1950  
91 REGENT ST, CHIPPENDALE,  
NSW 2008. TEL (02) 699 4919  
SHOP 16 CIVIC ARCADE,  
ADELAIDE ST, BRISBANE QLD  
TEL (07) 312330

## Microcomputer News & Products

### National Microcontrollers



National Semiconductor, has announced five new members of its highly successful COPS family of single chip microcontrollers. Fabricated using low-power N-channel technology, the new devices, designated COP444L/COP445L, COP410L/COP411L and COP404L operate at extremely low power levels, and operate from a single 5V supply.

Both the 444L, which is housed in a 28-pin package and has 23 I/O lines, and the 445L, housed in a 24-pin package

with 19 I/O lines, have  $2K \times 8$  bits of ROM on board, and  $128 \times 4$  bits of RAM.

The 410L with 19 I/O lines in a 24-pin package and the 411L with 16 I/O lines in a 20-pin package, contain one-quarter the memory of the 444L and the 445L. The 404L is a ROM-less version of the 444L/445L. Available in a 40-pin DIP package, it may be used with external PROM for prototyping and low volume applications.

For further information contact E. Schoell (03) 729 6333 or C. Mason (02) 439 6865.

### 16K RAM from Royel

A recently developed 16K static RAM module from US Synertek Systems is directly compatible with Motorola's Bus as well as the System 65 Microcomputer Development System. It may also be implemented in user designed systems, in Motorola Bus compatible card cages, or expand to the MBC-020 microcomputer board.

The module, identified as the MBC016, is available in two speed versions — 500ns access and 300ns access — in addition to two power versions — the 5V 3.5A and the 5V 2.5A.

Address select switches allow each 8K memory section to be independently placed in any 8K address range. Also there is a separate write-protect for each 8K section.

For further information please contact the Australian Distributors, Royel Micro Systems Pty Ltd, 27 Normanby Road, Notting Hill, Victoria, 3168. (03) 543 5122 or 15/59 Moxon Road, Punchbowl, NSW 2192. (02) 709 5293.

### Interface for MicroCon

MicroPro Design have recently released another interface for use with their MicroCon microprocessor system. This interface allows the MicroCon to act as a slave computer to larger systems, employing the IEEE488 (hp-GPIB) bus. In this way the MicroCon is able to control and monitor systems using the other interfaces available. This means that such computers as the CBM and PET etc can be inexpensively interfaced to sensors etc. The MicroCon is able to have its program loaded by the host computer allowing it to perform the control or data acquisition function independently of the operation being performed by the host system.

For further information contact MicroPro Design Pty Ltd, PO Box 153, North Sydney, NSW 2060. Phone (02) 438 1220.

MICRONEWS  
CONTINUED →



# Cromemco

## Tomorrow's computers now

Cromemco offers you a wide choice in high-capability computers with outstanding features such as high speed, many card slots to allow for broad system expansion, wide card support, fast memory and our much-admired Cromemco software.

Further, Cromemco computers are of a rugged, all-metal construction that immediately tells you these computers are built to be dependable and long-lived.

### OBSOLESCENCE INSURANCE

The nature of their construction also promises versatility and long life. Built with easily-accessible card slots, these computers can be configured to meet the needs of an almost endless variety of applications.

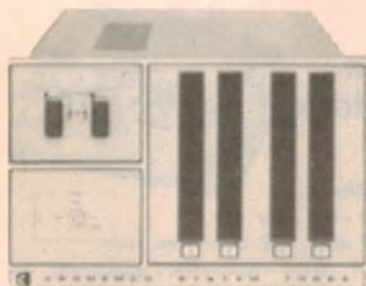

**SYSTEM THREE**  
Two to four disks. Up to 512 Kilobytes of RAM/ROM Up to 4.8 Megabytes of disk.



**Model Z-2**  
Up to 512 Kilobytes of RAM/ROM



**SYSTEM ZERO WITH DDF**  
Two Disks  
Up to 512 Kilobytes of RAM/ROM  
780 Kilobytes of disk storage.

- |                        |                                 |
|------------------------|---------------------------------|
| NEW ★ LISP             | NEW ★ SELF-TEST DIAGNOSTICS     |
| NEW ★ RPG 11           | NEW ★ HIGH RES COLOUR GRAPHICS  |
| NEW ★ CROMIX (UNIX)    | NEW ★ INTELLIGENT I/O PROCESSOR |
| NEW ★ REPORT GENERATOR | NEW ★ SDI GRAPHIC SOFTWARE      |
|                        | NEW ★ BUSINESS SOFTWARE         |

Available from —  
**3 BANK STREET, SOUTH MELBOURNE, VICTORIA, AUSTRALIA, 3205.**  
**TELEPHONE (03) 690 2284. TELEX 30458. INSYST.**



**Model Z-2H**  
11 Megabytes of hard disk storage  
Up to 512 Kilobytes of RAM/ROM  
780 Kilobytes of floppy disk storage



**System Two**  
Up to 512 Kilobytes of RAM/ROM  
780 Kilobytes of disk storage.

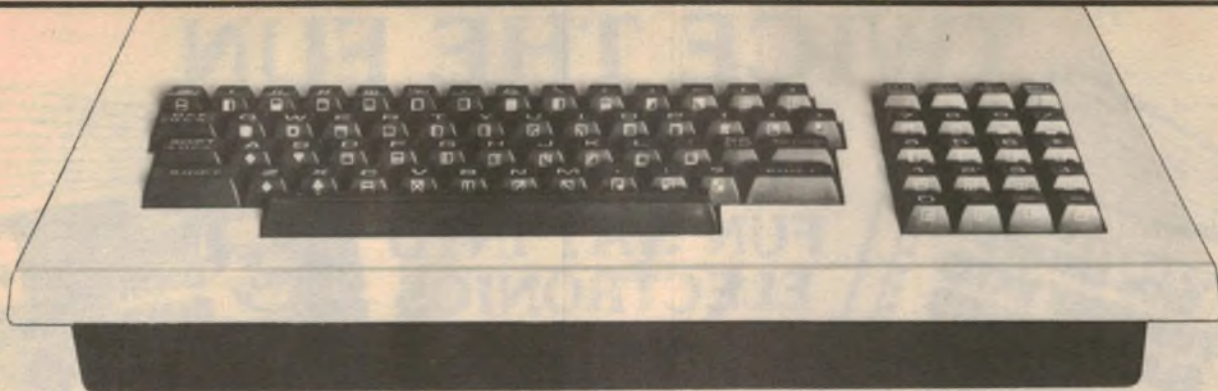

# Get your hands on our big new PET 3008 keyboard for only \$999\*

At last it's here: the Commodore PET you've been demanding! It's called the PET 3008. It boasts all the many features of our PET 2001, plus something you've been itching to get your hands on. A new, big, typewriter-style keyboard!

To celebrate its arrival, Commodore offers you a great deal. To begin, the price is slashed to \$999\*. So straight away you save \$196 on the Normal price of \$1195.

Not bad for a start. And there's more...

## FREE, C2N CASSETTE UNIT WITH EVERY PET 3008 SOLD

That's right.

Get your new PET 3008 with the big typewriter-style keyboard now, and your dealer will throw in, absolutely free, a C2N external cassette unit.

Retail value? \$126.50.

So all up on your PET 3008 purchase you save a whopping \$322.50. Naturally, it's a strictly limited offer (either that, or we go broke!)

So whatever you do, don't miss out. See your authorised Commodore Dealer very, very soon!



## SAME GREAT DEAL ON THE PET 2001

We mustn't leave out the many people who fancy the PET 2001's calculator-style keyboard. So:

COMMODORE PET 2001, normally.....	\$1195
OUR SPECIAL PRICE NOW.....	\$999
<hr/>	
YOU SAVE.....	\$196
PLUS FREE C2N CASSETTE UNIT, NORMALLY.....	\$126.50
<hr/>	
TOTAL SAVING.....	\$322.50

# commodore

For the name of your nearest authorised Commodore Dealer, write or phone;

**COMMODORE INFORMATION CENTRE**

**3 Campbell Street, Artarmon, NSW 2064 Telephone: (02) 437 6296**

\*Prices and saving may vary slightly from Dealer to Dealer. Offer ends February 28, 1981 or earlier if stocks run out.

MSL 395a

# TWICE THE FUN

## WITH DICK SMITH FUN WAY INTO ELECTRONICS Vol. 1 & Vol. 2



Cat. B-2600

Post and packing: \$1 per book.

**\$4.95**



Cat. B-2605

**\$6.95**

For the absolute beginner this book is a must. 20 projects from a beer powered radio to a continuity tester, all built without the need to solder. The unique 'breadboard' method of construction enables you to follow the circuit via the wires and because every project is battery powered they are perfectly safe! Learn electronics the FUN WAY.

**Kits for Fun Way 1.** For projects 1-10 all the parts to build any one of the projects, including breadboard. Cat. K-2600 @ \$6.90. For projects 11-20 Cat. K-2610 (this is used in conjunction with Kit 1) @ \$7.50. Buy the book and both kits for only \$17.50. Cat. K-2615 and save \$1.85 on the individual prices!

Our 7 day money back guarantee means you can not loose. If you're not completely happy with either book, you may return the book in its original condition within 7 days for a full refund of the purchase price. What could be fairer?

**SCHOOLS, RE-SELLERS ETC:**  
Ask about our incredible discounts for bulk quantities on either books or kits or both!

### FUN WAY TWO KITS: EASY, SAFE & ECONOMICAL!

#### MULTI-PURPOSE LED FLASHER . . . . \$2.75

A really simple kit that can be used as a warning device, electronic jewellery, etc. Cat K-2621

#### DING DONG DOORBELL \$4.00

Welcome visitors to your home with this integrated circuit doorbell! Cat K-2622

#### MORSE CODE TRAINER \$4.00

This simple oscillator circuit lets you learn Morse code the easy way! Cat K-2623

#### UNIVERSAL TIMER \$5.00

Use it as an egg timer, a dark-room timer, etc. in fact, it's got a lot of applications! Cat K-2624

#### ELECTRONIC DICE . . . \$4.75

Throwing a dice is old hat: do it electronically! Simple circuit has other uses too. Cat K-2625

#### MONOPHONIC ORGAN \$7.50

Easy to build, and easy to play! And it even has 'vibrato' - just like the big ones! Cat K-2626

#### POCKET TRANSISTOR RADIO \$7.50

Simple to build, and it's nice and small! Listening is so much more fun! Cat K-2627

#### TOUCH SWITCH \$4.90

One touch on, next touch off - or 'on while touched'. Dozens of uses in the home. Cat K-2628

#### MOSQUITO REPELLER \$4.50

Don't get eaten by mozzies, scare them away electronically. Take it anywhere. Cat K-2629

#### SIMPLE AMPLIFIER \$6.00

A useful little amplifier for all those projects needing audio amplification. Cat K-2630

#### WIRELESS MIC. . . . \$6.50

A tiny transmitter that can be received on any FM receiver. A great little kit! Cat K-2631

#### LIGHT ACTIVATED SWITCH \$4.90

Highly useful for alarms, night light switches, etc etc. Sensitive and reliable. Cat K-2632

#### METAL/PIPE LOCATOR \$6.00

A simple BFO circuit you can use to find metals, pipes, wiring etc - maybe gold! Cat K-2633

#### SOUND ACTIVATED SWITCH \$6.50

Picks up sound waves and trips a relay. Use as a telephone bell extender, too. Cat K-2634

#### HOME/CAR BURGLAR ALARM \$6.00

Learn how burglar alarms work when you install your own! For home or car. Cat K-2635

#### ELECTRONIC SIREN \$4.50

Great for alarm use - or where any warning is required. Good for kids toys, too! Cat K-2636

#### LED LEVEL DISPLAY \$8.50

This fascinating project shows you the audio level of any amplifier. Cat K-2637

#### INTERCOM UNIT \$8.50

Communicate! Build this intercom and talk between rooms, etc. Cat K-2638

#### LED COUNTER MODULE \$7.50

Learn how digital circuits work by building a counter. Count slot car laps, etc. Cat K-2639

#### SHORTWAVE RECEIVER \$6.50

Listen in to the exciting world of shortwave radio: amateurs, foreign countries! Cat K-2640

# DICK SMITH ELECTRONICS



SEE OUR OTHER ADVERTS IN THIS MAGAZINE FOR OUR STORE ADDRESSES AND RESELLERS

## Microcomputer News & Products

### New NEC Spinwriter

Warburton Franki announce the addition of the NEC Spinwriter to its list of computer peripherals. The Spinwriter which has enjoyed enormous success in overseas markets, is a high quality character printer using the unique "thimble" print element. Claiming to be faster than the "golf ball" with better quality than the "daisy wheel", the "thimble" is a durably, specially reinforced plastic element providing up to 128 characters.

Ideally suited to applications such as word processing, graphing and plotting and communications, the Spinwriter comes in Ro and KSR versions with several popular interfaces. All currently available models will be supplied and fully supported by Warburton Franki in every state. Although with a claimed

MTBF of 3000 hours, service is not expected to be a major element in the distribution agreement.

Further information from Warburton Franki, at any of the nationally located offices.



### Expander for TRS-80

DeForest Software have announced the release of an expansion unit that will allow the TRS-80 to operate with high resolution graphics. Use of this unit requires no modification to the computer or the expansion interface unit. It is attractively cased and incorporates its own power supply. It can be plugged into either the computer or the expansion interface unit, and is completely buffered. Software to generate fine line graphics is included with the hardware.

Further information from DeForest Software, 26 Station Street, Nunawading, Melbourne, Vic 3131.

MICRONEWS CONTINUED →

## System-80 and TRS-80 Users

10 × Quality Verbatim  
Diskettes in Plastic  
Filing Box . . . . \$55.80

**SPECIAL** the famous NEWDOS+ with 3.0 Super Zap  
and Book TRS-80 Disk &  
Other Mysteries . . . . \$106

<b>Complete Business System</b> (Tandy Basic)	
Osborne/McGraw Hill	
System Text books: Accts Pay/Rec	\$ 20
General Ledger	20
Programs: Creditors	90
Debtors	90
General Ledger	90
+ Cash Book	50
Invoicing	90
All linked together: \$400 (save \$50)	
(ie. enter data once/automatic posting)	

Send for complete list of Programmes

## PITT ST MICROCOMPUTERS

BOX A344 SYDNEY SOUTH, PITT ST SYDNEY 2000  
Office Hrs: 10am-6pm, Mon-Fri; Ph: (02) 569 8228

## COMP-SOFT MICROCOMPUTER SERVICES

**FREE \$50 WORTH OF SOFTWARE WITH EVERY OSI COMPUTER**

Superboard (4K RAM, 10K ROM, 24 × 32, VDU, RS232)  
C1P (Superboard — Case — Power Supply)  
C4P (8K, RAM, 10K, ROM, 64 × 32 VDU, RS232)  
C4P MF (24K RAM, 64 × 32 VDU, Mini Floppy)  
C8P DF (32K RAM, 64 × 32 VDU, Dual 8" — Floppies)

**NEW C1P & SUPERBOARD  
EPROM MONITORS**

Cursor control, single key basic etc \$49 incl tax

### TV/MONITORS

Black and White \$129.00\*  
Colour \$429.00\*

\* Including tax  
Suitable for most computers.

### C30 CASSETTES only:

1 — 10 99c each  
10 — 50 89c each  
50 — 79c each



**MICROLINE 80  
PRINTER  
\$745 + ST**

- 80 Char/Sec
- 80 and 132 Char/Line
- 9 × 7 dot matrix
- character or graphics printing

**235 SWAN STREET, RICHMOND, 3121. PHONE: (03) 428 5269**

# Australia's first under \$300 COMPUTER...

**\$295**  
INCL. ZX80 BASIC  
MANUAL



Remember — all prices shown include sales tax, postage and packing.  
N.B. Your Sinclair ZX80 may qualify as a business expense.

## sinclair ZX80 -British made.

Until now, building your own computer could cost you around \$600 — and still leave you with only a bare board for your trouble. The Sinclair ZX80 changes all that. For just \$295 you get **everything** you need including leads for direct connection to your own cassette recorder and television. The ZX80 really is a complete, powerful full-facility computer matching or surpassing other personal computers costing much more. The ZX80 is programmed in BASIC and you could use it for anything from chess to running a power station.

Two unique and valuable components of the Sinclair ZX80: the Sinclair BASIC interpreter and the Sinclair teach-yourself BASIC manual. The unique Sinclair BASIC interpreter: offers remarkable programming advantages — unique 'one touch' key word entry. The ZX80 eliminates a great deal of tiresome typing. Key words (RUN, PRINT, LIST etc) have their own

single key entry. Unique syntax check. Only lines with correct syntax are accepted into programs. A cursor identifies errors immediately, preventing entry of long and complicated programs with faults only to discover them when you run.

Excellent string handling capability — takes up to 26 string variables of any length. All strings can undergo all rational tests (e.g. comparison). The ZX80 also has string input to request a line of text; strings do **not** need to be dimensioned. Up to 26 single dimension arrays. FOR/NEXT loops nested up to 26. **Variable names** of any length. BASIC language also handles full Boolean arithmetic, conditional expressions, etc.

Exceptionally powerful edit facilities, allows modification of existing program lines. **Randomise function**, useful for games and secret codes. **Timer under program control**. PEEK and

POKE enable entry of machine code instructions.USR causes jump to a user's machine language sub-routine. **High resolution graphics** with 22 standard graphic symbols. The Sinclair teach-yourself-BASIC manual 96 page book free with every kit.

**Fewer chips, compact design, volume production means MORE POWER FOR YOUR DOLLAR!** The ZX80 owes its low price to its remarkable design; the whole system is packed onto fewer, newer more powerful and advanced LSI chips. A single SUPER ROM, for instance, contains the BASIC interpreter, the character set, operating system and monitor. And the ZX80's 1K byte RAM is roughly equivalent to 4K bytes in a conventional computer because the ZX80's brilliant design packs the RAM so much more tightly. (Key words occupy just a single byte). You can add to the memory via the expansion port, giving a maximum potential of 16K.

**ORDER FORM:** SINCLAIR EQUIPMENT (AUSTRALASIA) PTY. LTD.  
308 High St., Kew 3101, Vic. Tel. 861 6224.

Quantity	Item	Item Price	Total
	Ready-assembled Sinclair ZX80 Personal Computer(s). Price incl. ZX80 BASIC manual, excl. mains adaptor.	\$295.00	
	Mains Adaptor(s) (600Ma at 9V DC nominal unregulated).	\$16.00	
	Memory Expansion Board(s) takes up to 3K bytes.	\$ 28.50	
	RAM Memory chips — standard 1/2K bytes capacity.	\$ 10.00	
	Sinclair ZX80 Manual(s) free with every ZX80 computer	\$ 15.00	
I enclose cheque/Bankcard/Diners Club/Amex		TOTAL	

Name \_\_\_\_\_ EA I

Address \_\_\_\_\_ Postcode \_\_\_\_\_

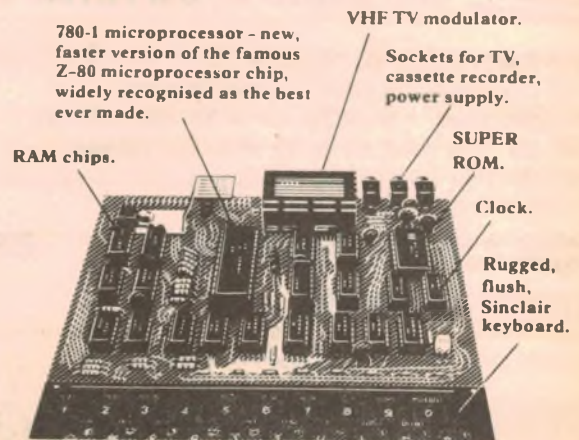



# ZX80

COMING  
SOON

# 8K BASIC ROM

Fantastic new options for **SINCLAIR ZX80**



**THE CHIP** a drop-in replacement for the existing 4K BASIC ROM, comes with a new keyboard template and a supplementary operating manual. Designed for high-level, full facility computing.

## KEY FEATURES INCLUDE —

- Full floating-point arithmetic to 9-digit accuracy.
- Logs, trig, and their inverse functions, graph plotting facility.
- Animated displays using PAUSE n.
- Full set of string-handling facilities.
- n dimensional arrays, cassette LOAD and save with named programmes.

## AND ZX80 16K-BYTE RAM PACK

Complete module designed to provide massive add-on memory capacity.

The 16K-BYTE RAM pack can be used for program storage or as a database. Yet it costs up to half the price of competitive additional memory.

Measuring 3 in × 3 in × 1.25 in approx., the RAM pack plugs into the existing expansion port on the rear of the Sinclair ZX80 via an edge connector. No additional power supply is needed.

**SINCLAIR EQUIPMENT (AUSTRALASIA) PTY. LTD.**

308-312 High Street, Kew, Vic., 3101. Tel. 861 6224.

SE3

## Microcomputer News & Products

### Quiet Thermal Printer from Tecnico

Gulton MCS division has introduced the AP-40 TM, a fixed head thermal printer mechanism designed for output requirements preferring text format.

The AP-40 TM provides two fixed, 20-column dot-matrix thermal printheads and a paper drive. The drive roll is the only moving part, providing the quiet, highly reliable, maintenance free operation typical of thermal printers. No electrics are included. The AP-40 TM interfaces easily with any microprocessor system.

The two Gulton printheads provide 40 columns of 5 x 7 characters 279mm high and 2.03mm wide, or tall characters (5 x 14), 5.59mm high and 2.03mm wide. Half-step or half-size characters and bold characters of normal height are also inherent in the design. Print speed is 150 lines per minute.

For further information contact Tecnico Electronics, PO Box 50, Lane Cove 2066 or PO Box 520, Clayton 3168.



MICRONEWS CONTINUED →



ACOUSTIC ELECTRONIC DEVELOPMENTS PTY LTD

# MICROCOMPUTER PRODUCTS

130 Military Road, Guildford,  
NSW 2161. Phone (02) 632-6301,  
(02) 632-4966. Telex AA25958.

## ANNOUNCING

### THREE NEW IEEE 5100 CPUS FROM GODBOUT!

**Z80** Our New Recommended CPU

Unkit - \$236.25 ASSM \$309.75

**8085** - Enquire about the special features of this card.

Unkit - \$246.75 ASSM \$341.25

**8085 & 8088** - Yes! At last a Hybrid 16 bitter on \$100!

Unkit \$309.75 ASSM \$446.25

*(Prices shown are exclusive of sales tax. Prices and specifications subject to alteration without notice).*

#### • WE ARE \$100 SPECIALISTS

If you are computing, interested in hardware or software, if you are a businessman, an engineer, educator, student or hobbyist - see us before you make any rash decisions you will regret!

#### • COMING SOON - PROGRAMMING COURSES - CALL FOR DETAILS •

Trading hours Mon-Sat 9AM to 6PM.

See previous ads in EA and ETI.



## Microcomputer News & Products

### New Keyboard Encoder

Using an N-MOS silicon gate process, National Semiconductor has developed a single 28-pin integrated circuit that contains everything necessary to interface a detached keyboard to a CRT terminal. Designated the MM57449, the device reduces the usual 18 to 24 connections to only 5, and has the capability of handling up to 144 keys.

For a typical 96-key keyboard layout, the MM57449 requires no external components: it provides simple, direct interface, with serial transmit and receive to a 12 x 8 matrix keyboard.

To expand to 144 key capability, an inexpensive 4-12 line decoder (74LS154) is attached, and a direct connection can then be made to a 12 x 12 matrix keyboard. The encoder features the entire 128 character ASCII set, numeric pad and function encoding on chip, and a two key lockout feature that prevents more than one key being activated at the same time.

The MM57499 — which has its own oscillator, utilising the 3.54MHz NTSC

colour burst crystal — also has an on-chip baud rate generator. TTL compatible, the device operates from a single 5V supply.

For further information contact Ed Schoell (03) 729 6333 or Chris Mason (02) 439 6865.

### CLUB NEWS

● The NSW 6800 Users Group has advised that since their formation, their newsletter has now stabilised at about 10 to 12 pages per issue with a typical format of four games programs, a teaching program, circuit ideas, machine code routines and utilities and a monthly instalment on how to program.

Three back issues are currently available, at \$3 per issue. A six issue subscription costs \$15. Contact Graeme Samways, NSW 6800 Users Group, 27 Georgina Avenue, Keiraville 2500.

● The Australian ZX80 Users Club has just been formed. For membership details and free introductory newsletter please write to 24 Peel Street, Collingwood 3066. The Australian ZX80 Users Club newsletter will include discussions of the ZX80, sample programs, programming tips, discussions and news of developments, marketplace for goods and facilities specially provided for the ZX80.

● The Geelong computer club has announced that it now has a new postal address. The new address is: Geelong Computer Club, PO Box 6, Geelong, Victoria 3220.

The club meets at 7.30pm on the second Thursday of each month at the premises of Tybar Engineering, Hampton Street, Newtown, Geelong.

● Yet another club is promoting the use of the ZX80. It is the AUSTRALASIA ZX80 USERS GROUP, which aims to produce a newsletter containing members' program listings, subroutines, reviews of software, etc. For information contact Tony Mowbray, 87 Murphys Ave, Keiraville, NSW 2500.

● A new TRS-80 users group has been formed in Canberra, for those owning or interested in TRS-80 and System 80 computers.

The group meets on the third Thursday of each month at 7.30pm at the Uranbi Village Community Centre, Crozier Circuit, Kambah. The format of the meetings is informal with pre-arranged talks by members of the group being presented. The current group project is to gain an inventory of public domain software held by members.

The group can be contacted by writing to Bill Cushing, 10 Urambi Village, Kambah, ACT 2902 or by phoning (062) 31 6399.

## HAVE YOU EVER WONDERED ABOUT THE COMPETENCE OF MICROCOMPUTER SUPPLIERS?

We at B. S. MICROCOMP certainly have. Many of our customers came to us because we were the only people who seemed to know what we were talking about. Given the appalling ignorance and gross deception sometimes displayed by Microcomputer Suppliers, it is no wonder that many potential purchasers of Microcomputers have put off making a decision.

At MICROCOMP we strongly believe that customer service is the most important priority. When you buy a Commodore Microcomputer from us you also get our continuing support. We are happy to help with software and hardware problems experienced by our clients. Our product range is continually expanding and now includes the complete range of Commodore Microcomputers, a wide selection of computer books and other computer requirements such as floppy disks and continuous stationery.

Do yourself a favour — talk to MICROCOMP about your Microcomputer requirements — we will give you a straight answer.



MICROCOMPUTER SYSTEMS DESIGNERS

**B. S. MICROCOMP,**  
4th Floor,  
561 Bourke Street,  
MELBOURNE, 3000.  
**Tel: 614-1433/614-1551**





## INFORMATION CENTRE

**DIGITAL STYLUS TIMER:** I refer to the Digital Stylus Timer article described in the October 1980 issue. The paragraph on page 55 beginning "Since the reset pulse..." is absolute nonsense.

The fact is that after resetting to the zero state, the first flipflop of the 4020, IC3, goes high for the count of one, the second flipflop for the count of two and so on until the 14th flipflop which goes high for a count of two to the power 14, which is 8192.

The strapping from the 4020 to IC4 is correct for a count of 9000. This with the toggle action of IC2a gives the correct count of 18,000 for one output pulse every six minutes.

I would also question the flashing rate for the decimal point. It is regretted that an otherwise excellent technical article is marred by incorrect technical statements. (R. W., Hobart Tas).

● We admit that the explanation of how the divide by 9000 is achieved is perhaps misleading. You are correct in saying that Q14 of IC3 goes high on the count of

8192, but it should be kept in mind that the actual frequency division is twice this figure, that is 16,384. This is where confusion can lie. Q14 goes high after 8192 negative edges of the clock pulse and stays high for 808 more, when at this time Q4, Q6, Q9, Q10 and Q14 are all high, bringing the output of IC4 low. This results in the reset pulse to IC3 which lasts for half a clock cycle.

The clock rate of IC3 is 25Hz supplied from IC2a, which divides the 50Hz mains frequency. Consequently the frequency at Q4 of IC3 is 25Hz divided by 16 (two to the power four) giving 1.56Hz. This is further divided by two with IC2b to give 0.78Hz, driving the decimal point.

**AUXILIARY BATTERIES:** You must have been reading my thoughts to have an article on a Car Battery Voltage Monitor (October 1980 issue). I am using it for a different purpose: to monitor the voltage of an auxiliary battery used for camper vans, caravans etc.

I have recently bought and installed a

battery isolator used for charging both batteries (auxiliary and main) at the same time, using the existing alternator in a Kombi van. The auxiliary battery is used for internal lighting and a portable compressor type refrigerator drawing 4.5 amps. A number of answers to some questions would be of interest to a great number of caravanners.

Do both batteries receive the proper charge irrespective of the charged state? Should the existing alternator regulator be adjusted to overcome the voltage drop across the diodes? As present day regulators are virtually non-adjustable, an electronic one would possibly be a better proposition or separate regulators, one for each battery. (O. G., Rhodes, NSW).

● The diode battery isolator prevents the batteries from discharging each other and at the same time allows each battery to charge independently of the other. Consequently each battery will charge according to its discharge state voltage. The maximum voltage that the batteries will charge to is the regulator voltage minus the diode drop. This drop is not important in most cases although ideally the regulator should be adjusted to compensate for the diode voltage drop. Separate regulators are not necessary.

**TUNE UP TACHO:** I wish to offer what I have done to the tune up tachometer circuit, described in October 1975, to improve the accuracy when used with CDI systems. I originally built the tachometer and was very happy with it. I later fitted CDI to the car and found no real problems setting the idle speed of the engine.

Recently, however, I built another tachometer for permanent installation in the car with 5000 rpm as FSD. The accuracy with the CDI was appalling. Upon conversion to standard ignition, the accuracy was good. Looking at the parameters of the SAK140 used in the tachometer circuit, the zener diode on the input, pin 1, seems to clamp at 3V. Under normal ignition this 3V would be easily obtained from the points via the 15kΩ resistor.

With the CDI approximately 12V are across the points and the zener is not clamping at all. The error I had was; actual engine RPM, 2000 and the indicated reading was 2900 RPM. I then fitted a

## Power Saver: EA Misconception?

**POWER SAVER:** Your power saver published in August 1980 is ingenious, though why it works at all beats me. I thought that for a given load, a drop in voltage resulted in increased current, though there may be a grey zone under no-load conditions.

However with a refrigerator, the fact that you even hoped for a saving suggests a misconception. Refrigerator compressors work hard when running; typically 5psi suction, 140psi discharge and lower ambients result in longer off-cycles, not significantly lighter running loads.

As all heat losses have to be pumped out via the refrigerant and because of controlled operating conditions, the motor design is optimised for cost/efficiency. This means that the wire enamel is highly stressed mechanically, electrically, chemically (it runs immersed in oil and freon) and thermally. Attaching a device with a spiky waveform may punch a hole in the already stressed enamel and would certainly punch a hole in the warranty.

Just as well lousy power factors do not register on the watt/hour meter. I have a feeling the Power Saver concept could

be connected into a power factor meter somehow. (B. J., Walkerville, SA).

● As pointed out in the article, the design was produced in response to articles and devices featured in American magazines. Claims are made for these commercial devices that they will significantly reduce domestic power bills. We cited the case of a refrigerator, not because we expected significant power savings, but because specific or implied claims are made for these devices when used with refrigerators.

For example, in the November 1980 issue of an American electronics magazine (which happens to be on sale in Australia at selected newsagents) a typical power factor controller is advertised which is claimed to be suitable for use with refrigerators, air conditioners and other appliances. While close reading of the advertisement does not reveal a specific claim that power will be saved when used with a refrigerator, there is an implied claim that the device "cuts the cost of running electric appliances by as much as 50%". Our statements in the article in the August 1980 issue should dispel any doubts that readers may have on this score.

1k $\Omega$  resistor in parallel with the 15k $\Omega$  resistor via a miniature switch so that the tacho would be compatible with either ignition configuration. Maybe this modification could help others over the RPM error problem. (L. M., Mackay, Qld).

● Thank you for your information. This modification to increase the reference zener current by using a 1k $\Omega$  resistor rather than the 15k $\Omega$  resistor when operating from CDI also applies to Transistor Ignition systems as well.

**DREAM 6800:** I have built (or at least tried to make) the Dream 6800 but so far the experience has been more like a nightmare. With IC1, 2, 3, 4, 7 and 9 removed, according to Michael Bauer's cookbook instructions the best result my video monitor could manage was: On some channels, there is a flicker of white on the far side of the screen; on other channels, a series of white rectangles go steadily across the screen, left to right and the image is not vertically stable either.

Is this due to the clock circuit – a doubtful looking birds nest – or what?

With the other ICs plugged in, the white rectangle becomes a mixture of black and white – somewhat like your picture of the system's random number generator (see page 83, May 1979 issue – Ed) but with no 4-digit address evident.

The speaker bleeps continuously, even though PB6 is only at about 0.5V. It goes silent if PB6 is jumped to earth. Additionally, lines PA0 to PA7 are all high – about 3.4V. Does this suggest a defective PIA? (M.H., Glen Waverley, Vic).

● It sounds like your problem is with the clock circuit. An incorrectly functioning clock circuit will upset the timing of the horizontal sync and produce a result such as you describe. If you are using the substitute clock circuit described in the August 1979 issue, are you aware of the Errata published on Page 133 of the September 1979 issue? The connections to the 7437 were shown incorrectly in the original circuit; pins 4 and 6 should be swapped over.

Even with this correction made however, the substitute clock circuit is at best a compromise, subject to the problems of a "birds nest" hookup. If at all possible, try to obtain the 6875 chip.

All this assumes that the problem is not in your direct video connection to the TV set. The video signal from the Dream is a composite video/sync waveform with an amplitude of 1V peak to peak, with positive video and negative sync. It is possible that the polarity of the video waveform within your set is opposite that of the Dream video, which would result in poor sync and a reversed picture. Also, the electrolytic coupling capacitor used to couple the video signal to the TV must be a low leakage type, to avoid upsetting the bias of the following

## Transistor-Assisted Ignition

**TRANSISTOR IGNITION:** I have a query regarding the TAI system presented in the December 1979 edition of "Electronics Australia". The problem concerns the fact that the generator light on my car stays on faintly once the car has been started and is normally operating.

This light continues to stay on even while the car is moving. The fact that the light is on, even though only faintly does not seem to affect the normal charging circuit of the car. The fan belt has been checked and is tensioned according to the manufacturer's specification. This problem does not occur when the car is returned to its conventional ignition system.

I have constructed two of the TAI systems and, together with two friends who have also constructed kits, all have the same effect on the generator lights in other cars. All units seem to be working very well otherwise.

Have you come across this problem before and if so, can you suggest a reason for its cause and a possible cure? (N.A., Fraser, ACT).

● The reason your generator light remains faintly on is probably due to the point at which you have made the +12V connection for the TAI, and is unrelated to battery charging. This can be quickly shown to be true by connecting the +12V from the TAI directly to the battery for a brief test. If the system works without causing the light to glow then the problem is in fact due to your connection.

In most cases, a suitable connection should be found on the fuse panel. Test the connection point first though, it

should be off when the ignition is switched off and it should be on in both the on and start positions of the ignition switch.

**TRANSISTOR-ASSISTED IGNITION:** I fitted a TAI to my car (Mazda 626) about four months ago, and as it did not work as well as expected I did some experimenting with it.

Firstly the problems:— 1. when starting from cold it was necessary to use more choke than in standard form; 2. the fuel consumption increased by about 10%; 3. the motor was not willing to spin any more freely; 4. the coil temperature did not increase noticeably.

Having ready access to proper engine diagnostic equipment I checked out the ignition in both modes. In the normal mode the spark collapsed after about 1ms and in the TAI mode this was occurring at 0.6ms (as designed). I decided to increase this to 0.9ms by increasing the 0.1 $\mu$ F timing capacitor to 0.15 $\mu$ F. Having done this I checked the ignition pattern, and up to 4000rpm (as far as I went) the BUX80 was switching before primary resonance occurred.

With this modification the choke use has been reduced, the fuel consumption is slightly better than in standard form, the motor spins more freely but the coil still does not run very hot!

The only explanation I can think of for the success of this modification is that a 4-cylinder car needs as long a spark time as possible (within reason) to prevent noticeable power loss due to longer periods between firings when compared with V8 and 6-cylinder engines. (A. K., Cessnock, NSW).

stage. (See P84 of the July 79 issue for further details.)

The first point to note about the PIA is that it is capable of sourcing only a very small current, so measurements made with a relatively low impedance multimeter may be inaccurate. PB6 may be high, even though your multimeter measures only 0.5V. Also, the lines PA0-PA7 will be configured as inputs, unless programmed otherwise. The CHIP-8 interpreter normally does this as part of the keyboard scanning routine, but with the clock circuit malfunctioning, this may not happen. Unless the PIA is initialised by a program, the internal pull-up resistors on the A lines will take all the lines high.

Thus, your measurements do not necessarily suggest a defective PIA. As long as the normal handling precautions have been observed the device is probably all right. The problem could be that gate 20b is faulty, enabling the speaker continuously. Also, note that the 2N4250 transistor which switches the oscillator (IC24) should be connected upside

down, as described on p87 of the May 1979 article.

Our advice is to concentrate on getting a steady video display, with ICs 1, 2, 3, 4, 7 and 9 out of the circuit. Check the substitute clock circuit wiring, or if possible obtain a 6875 clock chip. With the clock working correctly it is likely that your problems with the PIA will disappear.

**AIR IONISER:** I would like to congratulate you on the very high standard of your magazine, of which I have been a regular reader for some years.

May I mention the idea of an air ioniser as a possible project. I have had some experience with the use of these and they do seem to live up to some of the claims of their manufacturers. (N. W., Hawera, NZ).

● We have no plans for an air ioniser project at the moment. The commercial examples we have seen of these devices all seemed to generate ozone which is far more objectionable than any lack of negative ions.

## RESISTORS

150 ohm, 5W	20c
10 ohm, 5W	20c
47 ohm, 5W	20c
12 ohm, 3W	20c
2.5 ohm, 3W	20c
33 ohm, 3W	20c
8 ohm, 10W	25c
4000 ohm, 10W	25c
100 ohm, 5W	20c
330 ohm, 10W	25c
220 ohm, 5W	20c
5 ohm, 5W	20c
220 ohm, 10W	25c
950 ohm, 3W	20c
115 ohm, 5W	20c
10 ohm, 5W	20c
1k ohm, 5W	20c
5000 ohm, 5W	20c
6.8k ohm, 3W	20c
3300 ohm, 10W	25c
6800 ohm, 10W	25c
1500 ohm DUAL, 21W	50c
50 ohm, 5W	20c
330 ohm, 5W	20c
1k ohm, 5W	20c
820 ohm, 5W	20c
12 ohm, 10W	25c
470 ohm, 7W	20c
4700 ohm, 4.5W	20c
5000 ohm, 10W	25c
8.2 ohm	5W
3.3K	7W
1 ohm	5W
10K	7W
2.5 ohm	3W

## CAPACITORS

0.0039uF, 1500V	20c ea.
6N8, 1500V	20c ea.
0.0068uF, 1500V	20c ea.
1200PF, 400V	10 for \$1
0.068uF, 400V	5 for \$1
2200PF, 630V	10 for \$1
0.47uF, 250V	10 for \$1
0.10uF, 400V	5 for \$1
0.082uF, 160V	10 for \$1
26k, 250V	10 for \$1
0.041uF, 400V	10 for \$1
0.033uF, 250V	5 for \$1
0.027uF, 100V	20 for \$1
220uF, 10V	10 for \$1
1uF, 350V	10 for \$1
470uF, 40V	5 for \$1
1000uF, 16V	10 for \$1
2.2uF, 200V	10 for \$1
0.047uF, 1500V	50c
47uF, 25V	4 for \$1
680uF, 40V	50c
22K, 100V	20c
330uF, 25V	25c
2.2uF, 200V	30c
470uF, 40V	50c
680uF, 35V	50c
0.015uF, 250V	25c
2500uF, 35V	\$1
1uF, 100V	25c
1000uF, 16V	50c
220uF, 16V	50c
2000uF, 63V	\$1
0.47uF, 400V	50c
680K, 250V	25c
0.12, 250V	25c
15NF, 250	10c
120K, 250V	20
10uF, 315V	25c
0.056 250V	10c

<b>Slide Pots</b>	
250K-50K	3 for \$1
Dual 500K	3 for \$1
1 Meg	3 for \$1
2 Meg	3 for \$1
Including Fancy Gold Knobs	
25K dual	2 for \$1

<b>SPECIAL</b>	
100 mixed resistors, all useful	\$2
100 mixed capacitors, fresh stock	\$2

<b>AUDIO LEADS</b>	
3.5m to 3.5m, 7ft	75c
3.5m to 6.5m, 7ft	75c
6.5, 7ft	50c

<b>MICRO SWITCH</b>	
5A, 250V AC	75c ea.

<b>TUNING CAPS</b>	
2 and 3 gang	\$1 ea
Min 2 gang	50c

<b>FUSES</b>	
0.5A, 2A, 3.25	10 for \$1
In line fuse holders	30c
RCA jack plugs and sockets	40c pair
1A, 10 for	\$1

# L. E. CHAPMAN

122 PITT ROAD, NTH CURL CURL.  
MAIL ORDERS: BOX 156, DEE WHY, NSW. 2099.  
TELEPHONE 93-1848.

## SPECIAL TRANSISTORS

AD161 162	\$2 50 pr
BSC 901A	\$1 50 ea
BC 548	10 for \$1
AD 149	\$3 pr

## ELECTROS

470uF, 25V	5 for \$1
400uF, 10V	5 for \$1
47uF, 63V	5 for \$1
350uF, 16V	2 for \$1
27uF, 160V	5 for \$1
25uF, 63V	10 for \$1
22uF, 160V	10 for \$1
47uF, 16V	5 for \$1
47uF, 200V	5 for \$1
220uF, 10V	10 for \$1
68uF, 16V	10 for \$1
2500uF, 63V	2 for \$1
100MFD, 350V chassis mount	\$1

- Telescopic aerials, \$1.50
- Top quality, low impedance microphones, \$3.50
- 6 inch ferrite rods, 75c
- Rainbow lead, 5 strand, 20c per metre
- Line output transformers, 600 ohm, to 15 ohm, 20 watts, \$5
- Line output transformers, 1200 to 3/ohm, 5 watt, \$1
- Power supply units, filtered, 240 to 20 volt, \$12
- 240 to 15 volt transformers, \$3.50

Power leads 240 volt, suit most tape recorders, radios, etc. \$1 each.

TV Stick Rectifiers 20SC, \$1.00.

Philips Colour TV Convergence Boards, \$3 each

455KC IF Transformers for valve radios, \$1 each. Also aerial and OSC coils, 75 cents each

## POTS ROTARY

½ Meg	30c
1 Meg	30c
100K	30c
100K Switch	50c
50K Double Pole Switch	50c
7.500	30c
10K Switch	50c
250K	30c
50K	30c
20K	30c
10K Min Pots	25c
50/Ohm	50c
½ or 1 Meg Switch	50c
½ 1 meg dual Concentric tapped at 100K	\$1
2 meg ganged double pole switch	\$1
1 5 meg dual ganged	50c
2 meg ganged log	\$1
1 meg dual ganged	\$1
½ meg dual ganged LIN	75c
25K, 50K dual ganged Concentric double switch	\$1
200K single line	30c

HOR Drive 3021 transformers for colour TV \$2  
TV Colour Convergence Units 11270 44 x 6 \$3

**PILOT LIGHTS**  
Screw in 6.3V 10 for \$1.50  
24V 10 for \$1.00  
Pilot light holders \$1.50

## SPEAKER SYSTEMS



Incl two 6 x 4 speakers, 5W RMS, \$4.75 ea  
P&P: NSW \$1.80, Interstate \$2.80, WA \$4  
(For singles or pairs)

## TV TUNER VALVE TYPE

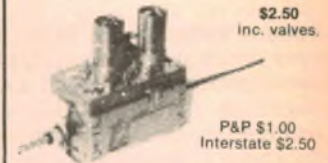

\$2.50 inc. valves.  
P&P \$1.00  
Interstate \$2.50

## SUPER SPECIALS FM STEREO TUNER KITS



Sets of 3 modules include FM tuner, decoder and IF detector. Circuit diagram supplied. Can be used with amp modules.

ONLY \$22  
P&P \$1.00

## TRANSISTORS

2N3055	\$1 20
SE1002	4 for \$1
BF459	\$0 50
BS44 DE6	50
C106 F1	50
TIP 110	50
608EK	4 for \$1
BC554813	10 for \$1
2SB186	\$0 50
2SA101	50
BD263	50
BSB405	50
2SB77	50
2SB303	50
AC187	50

## VU & BALANCE METERS



STEREO VU \$3.00



12Kn 100uA \$2.00

## PHILIPS TV TUNERS

Transistor NT3024, NT3032, Colour - P&P \$1.



\$10 ea.

- Car radio suppressors, 3 for \$1
- 3 position slide switch, 50c
- Toggle switches, 25c
- 2 position push button switch, 50c
- 6 position push button switch, \$1
- 4 position push button switch, 75c
- Transistor ear plugs & leads, 3 for \$1
- In-line fuse holders, 4 for \$1
- 4 pole 2 position rotary switches, 50c

Pick up Cartridges BSR universal type Ceramic Stereo. \$5  
Audio Technica AT6 diamond stylus stereo \$12

## DIODES

OA 626	4 for \$1.00
OA 662	4 for \$1.00
EM 410C	4 for \$1.00
DS 150A	50c
DSY 130YO	50c
OA 636	50c
HR 15	50c
Diodes BYX 55, 600	30c
BY 188	30c

## STEREO AMPLIFIER SOLID STATE 5 watts RMS per Channel \$25



PP NSW	\$1 50
Interstate	\$2 50
WA TAS	\$3 50

Special: 100 mixed capacitors, fresh stock, all useful \$2.00

## SPEAKER SPECIALS

- 15 ohm 4" - 2 for \$2.
- 5x3 15 ohm 2 for \$2
- 6x9 15 ohm \$5 each
- 5x7 15 ohm \$4 each
- 8x4 15 ohm \$4 each
- 6x4 15 ohm \$3 each

## SUPER SPECIAL

GRAMOPHONE motor and pickup 3 speed stereo balanced arm.

240 volt \$9.75  
PP NSW \$1 50  
Interstate \$2.75  
WA \$4

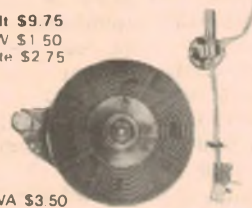

\$250 WA \$3 50

Miniature speaker and drive output transformers \$1 pr

Special mixed tag strips 10 for \$1

## 24V MOTORS

Reversible  
Only \$2.50 ea.





**SPACE INVADERS:** I am interested in constructing a replica of the video game "space invaders" but cannot find any retail outlet or even any information concerning the relevant IC chip. I plan on using my colour television as the VDU. Could you tell me where I would be able to obtain this IC, or any other information about this matter which may help me. (I. R., Glenfield, NSW).

● We would guess that the "space invaders" games use a readily available microprocessor such as the Z80, with a program stored in mask-programmed ROM, not any special chip. We know of no source programmed ROMs for these games which would be available to the general public. In fact, such a device or devices is likely to have licence agreements or other commercial protection.

**SPIKE PROBLEMS:** I have a permanent problem with projects that never seems to be mentioned. To be brief, take two examples: an ultrasonic receiver and a timer activated by a light dependent resistor. Both are operated from rectified AC. In both cases, they are falsely activated by spikes in the power supply, eg, switch the washing machine or a light in the same supply circuit on or off and the circuits are activated.

I have tried various capacitors from .001 $\mu$ F to 1000 $\mu$ F across the outputs of the filtered supplies but have met with very little success. (P. B., Beacon Hill, NSW).

● Mains-borne "spikes" are more likely to trigger a circuit via capacitive coupling or direct-radiation from the mains wiring and transformer leads and not via the power supply. In these circumstances, additional filtering on the power supply will have no effect. Two solutions we could offer are screening the mains wiring behind a metal shield or modifying the circuits concerned to reduce their high frequency response, particularly at radio frequencies.

**DOLBY ADAPTER:** Have you ever published a project for an add-on "Dolby" adapter unit to enable a non-Dolby cassette deck to be equipped with Dolby features. I have a very good cassette deck which was manufactured just prior to Dolby noise reduction being introduced. It seems a pity to discard such a good deck just to obtain another with Dolby facilities. If you have not published such a project, do you know of a commercially available Dolby adapter? (G. B., Newcastle, NSW).

● We have not published a circuit for a Dolby noise reduction unit. Cassette decks equipped with such units are now so inexpensive that such a project would have only limited appeal. As far as we know there is no commercially available Dolby adapter, probably for the same reason. ☺

## Want something? Read this!

"Electronics Australia" provides the following services:

**PHOTOSTAT COPIES:** \$3 per project, or \$3 per part where a project spreads over multiple issues (price includes postage). Requests can be handled more speedily if projects are positively identified, and if not accompanied by technical queries.

**CHASSIS DIAGRAMS:** for the few projects which require a custom metal chassis (as distinct from standard cases) dyeline plans showing dimensions are normally available. \$3 including postage.

**PC BOARD PATTERNS:** High contrast, actual size transparencies: \$3, including postage. Please specify positive or negative.

**PROJECT QUERIES:** Members of our technical staff are not normally available to discuss individual projects, either in person at our office or by telephone.

**REPLIES BY POST:** Limited to advice concerning projects published within the last three years. Charge \$3. We cannot provide lengthy answers.

undertake special research or discuss design changes. Nor can we provide any information on commercial equipment.

**OTHER QUERIES:** Technical queries outside the scope of "Replies by Post" and/or submitted without fee may be answered in these pages, at the discretion of the Editor.

**COMPONENTS:** We do not sell electronic components. Prices and specifications should be sought from advertisers or agents.

**BACK ISSUES:** Available only until our stocks are exhausted. Within six months of publication, face value. Seven months and older, if available, \$2 (includes storage fee). Post and packing 70c per issue extra.

**REMITTANCES:** Must be negotiable in Australia and made payable to "Electronics Australia". Where the exact charge may be in doubt, we recommend submitting an open cheque endorsed with a suitable limitation.

**ADDRESS:** All requests to the Assistant Editor, "Electronics Australia", Box 163, Beaconsfield, 2014.

## Marantz PM-4 . . .

to be essentially as per Marantz' specification, ie 2.5mV (at 1000Hz) on the moving-magnet phono inputs and 150mV on the high level inputs.

Under normal load conditions the PM-4's ability to handle square waves was excellent, as expected. However, when the 8 ohm load was shunted with a capacitor of 0.25 $\mu$ F or greater, a small damped oscillation was visible at the transition from half-cycle to half-cycle. Most other amplifiers would behave similarly which is quite satisfactory.

Tests for stability with sinusoidal input signals and capacitance shunting the load revealed no stability problems, but showed up an interesting effect in that at high output levels — at frequencies above 1kHz — with shunt capacitors approaching 0.5 $\mu$ F or larger, the quick acting electronic protective circuits were triggered into inserting a series of short duration dips into the positive and

negative peaks of the waveform. Presumably this was due to drive to the output stages being momentarily interrupted.

Listening tests confirm what the performance tests indicate — that the Marantz PM-4 is a high performance amplifier. For the limited time that we were able to listen to the PM-4 in a home environment, we found it very difficult to tell the difference between the Class-A and B modes of operation. On only a few of the very best quality records did we feel that we could perhaps discern a slight improvement in the upper high frequency region, when the Class-A function was selected.

Recommended retail price of this Marantz PM-4 stereo amplifier is \$599. Further details can be obtained from high fidelity retailers or the Australian Distributor, Marantz (Australia) Pty Ltd, 32 Cross Street, Brookvale, NSW 2100.

## Notes & Errata

**4K RAM EXPANSION FOR DREAM 6800** (December 1980, 2/CC/57): Table 1, depicted below, was inadvertently omitted from the article.

E	A10	A11	RAM 1	RAM 2	RAM 3	RAM 4
L	L	L	0000-03FF			
L	H	L		0400-07FF		
L	L	H			0800-0BFF	
L	H	H				0C00-0FFF
H	X	X	NOT SELECTED			

**ACOUSTICALLY-COUPLED MODEM** (September 1980, File No. 2/CC/53): The capacitor setting the free running fre-

quency of the PLL, IC7, which is connected to pin 9 should be .033 $\mu$ F as mentioned in the text rather than .0033 $\mu$ F shown on the circuit diagram, PC overlay and parts list.

**SELECTALOTT** (December 1980, 3/EG/19): The orientation of IC1, as shown on the overlay diagram on page 55 is wrong. IC1 should be shown the other way around, ie pins 16 and 8 swapped. The circuit diagram is correct.

**LOW VOLTAGE CHASER** (November 1980, Circuit & Design Ideas): The three-terminal regulator should be LM320T-12 not LM30T-12.

# MARKETPLACE

## FOR SALE

**AMIDON CORES** — Large range of ferromagnetic cores for all receiver and transmitter applications. Send large SASE for data/price list to: RJ & US Imports, Box 157, Mortdale, NSW 2223.

**"AUSTRALIAN RADIO DX CLUB**, the largest short-wave club in Australia with over 15 years of service and a full range of special publications available to members. Special membership fee for people under 18. Monthly magazine contains up to the minute news on Shortwave, Mediumwave and Utility Dxing. For a sample copy of our magazine send a 22c stamp to ARDXC PO Box 79, Narrabeen, NSW 2101 mentioning this ad."

**DREAM 6800 CHIP** 8 Instructions Manual. This will help you to understand the language. Plus a few helpful programs. Send \$10 cheque/money order to T. Huett, PO Box 520 Woodridge 4114, Bris. Qld.

**SYSTEM 80 OWNERS** . . . Did you build the RS-232 Printer Interface in Nov 80 EA and couldn't get it to operate? So did we! Send \$20 for machine language cassette, diode, hardware alteration instructions, power supply details and all operating instructions. Advanced Services, 118 Queen St, Melb 3000. Ph (03) 67 1760.

**COLLINS KWM2 TRANSCEIVER** & P/S, very clean, can be heard on air \$650.00 ono. (066) 86 2718

**PRINTED CIRCUIT BOARDS** made to customers own layout. Enquiries, Cost etc. Write PO Box 272, Edgecliff, NSW 2027 or Telephone (02) 358 6342, Sydney.

**TRS-80 LEVEL II 16K** race horse speed ratings guide in two parts. Requires interface for two tape recorders and copy of the Adelaide Sunday Mail. Masterfile data contains results for last 15 weeks approx 2000 entries. Inquiry file allows 150 entries on race day taking account time weight distance track condition. Full documentation tape much more. Send \$50 cheque money order, Geoff Egel, 18 Sturt St Loxton, 5333.

**LEARN THE EASY WAY.** Cassettes, Basic electronics, Communications, Basic astronomy, Radio astronomy. \$6 each \$1 P&P. Wallace, PO Box 363, Wauchope, NSW 2446.

**CRO** True DB portable, ex trig 7MHz plus new spare CRT and FG valves. \$250 Box 437, Gawler, SA 5118.

**FLOPPY DISC SYSTEM.** Dual 8" memorex 651 drives in 19" rack including power supply. Plus 100 discs approx \$650.00. Phone Melbourne (03) 579 1205.

**OSCILLOSCOPE BWD 1722**, 17" screen, 17B/2 4 channel plug-in, 17D/1 differential plug-in, 17E time base. \$500.00. Phone Melbourne (03) 579 1205.

**CB & HAM DISPOSAL SALE** AM fr \$39 SSB fr \$109 Rigs all types coming in daily Park Disposals, 32 Park St, Sydney 2000. Ph (02) 264 7515.

**TRS-RACING SYSTEM** level 1 4k. Let your computer select winners! Full documentation, program tape, certified data tape. Send \$45 cheque money order to Softsell, Box 1173, Dubbo, NSW 2830.

**SPARE EXCHANGE PANELS** HMV models 211 & 212. No further use out of Business best offers PO Box 1210 Coffs Harbour 2450.

**RACK SLIDES**, new, heavy duty ball bearing support. \$10 pair. Phone Melbourne (03) 579 1205.

## WANTED

**MORSE.** Learner wants cassette recordings of fast copperplate morse from written text (newspaper or novel) Will pay \$20 per tape. Write stating price required to 132 Ross Road, Queanbeyan 2620, or Phone after January. (062) 65 3688 (W)

**TRIO W50 VALVE AMP** or power transformer, for same (03) 336 1909 AH.

**FAIRCHILD** IC's 9616, 9617. Phone Melbourne (03) 579 1205

## FOR HIRE

**MICRO RENTAL.** Microcomputer systems of the most popular models are available in various configurations for hire. DORF MICROCOMPUTER. Sydney, (02) 922 1644, or (02) 960 1808 (AH).

**MICROCOMPUTERS FOR RENTAL.** Commodore PETs (8k) at \$25 per week (minimum period 1 week). Software tapes and manuals included, plus BASIC instruction course and book. David B. Bates Microcomputer Consultant, Ph (02) 630 8652.

**DISPLAY ADVERTS IN MARKETPLACE** are available in sizes from a minimum of 2cm x 1 col rated at \$12 per col cm.

**Please state classification:** For Sale, Wanted, Reader Service, Position Vacant, Position Wanted, Business For Sale, etc . . .

**CLASSIFIED RATES** \$3 per line per insertion payable in advance. Minimum two lines

**CLOSING DATE** is six weeks prior to the on-sale date. Issues are on sale the first Monday of each month

**ADDRESS** all classified orders, copy, enquiries, etc. to The Advertising Manager, **ELECTRONICS AUSTRALIA**, Box 162, Beaconsfield 2014.

## POSITIONS VACANT

**PATENTEE**, (private individual) requires practical help with Electronic device. Share profits Mr J. K. Reddyhough, 20 Killocoat St, Carnarvon, WA 6701.

## BASIC ELECTRONICS

Basic Electronics, is almost certainly the most widely used manual on electronic fundamentals in Australia. It is used by radio clubs, in secondary schools & colleges, and in WIA youth radio clubs. Begins with the electron, introduces and explains components and circuit concepts, and progresses through radio, audio techniques, servicing, test instruments, etc. If you've always wanted to become involved in electronics, but have been scared off by the mysteries involved, let Basic Electronics explain them to you.

Available from "Electronics Australia", 57 Regent St, Sydney **PRICE \$3.50** OR by mail order from "Electronics Australia", PO Box 163, Beaconsfield, 2014 **PRICE \$4.20.**

## FUNDAMENTALS OF SOLID STATE

Fundamentals of Solid State has been reprinted, revised and updated showing how popular it has been. It provides a wealth of information on semiconductor theory and operation, delving much deeper than very elementary works but without the maths and abstract theory which make many of the more specialised texts very heavy going. It begins with atomic theory, diode types, uni-junction, field effect and bipolar transistors thyristor devices, device fabrication and microcircuits. A glossary of terms and an index complete the book. Fundamentals of Solid State has also been widely adopted in colleges as recommended reading — but it's not just for the student, it's for anyone who wants to know just a little bit more about the operation of semiconductor devices

Available from "Electronics Australia", 57 Regent St, Sydney. **PRICE \$3.50** OR by mail order from "Electronics Australia", PO Box 163, Beaconsfield, 2014. **PRICE \$4.20.**

ALL ENQUIRIES WELCOME

**ELECTROCRAFT PTY LTD**

68 WHITING STREET, ARTARMON 2064. PHONE 438 4308

## MARINE TV ANTENNAS VHF-UHF-FM

**SR-20M:** 82-Channel (VHF-UHF-FM/AM) Marine TV antenna with solid-state preamplifier attached directly to elements. The Sensor SR-30M has a bidirectional reception pattern providing outstanding performance on stations in different directions. The Sensor's sleek design and rugged construction makes it particularly suitable for cruisers, houseboats and sailing auxiliaries. Features weathertight Cycolac housing, anodised aluminum elements and stainless steel hardware 75 ohm only, 12VDC power supply, 15ft coax



cable, TV set cord, band separator and 46in piece of anodised aluminum masting. All hardware included.

Sensor antennas have elegant modern styling which blends with the decor of any home setting. Compact unobtrusive design makes it ideal for homes, camper trailers, mobile homes. Optional: 240VAC, 50Hz power supply.

<p><b>BRASS SHIPS CLOCKS</b> SMITHS 8 DAY 7 INCH DIAMETER \$110</p> <p>Post A \$1.75; B \$3.00; C \$3.60</p>	<p><b>SOLENOIDS</b> 200 MA 24 volt, 1/4in push movement \$2.50 P+P 80c</p>	<p><b>POSTAGE KEY:</b> A NSW B Vic Qld SA Tas C NT D WA</p>	<p><b>WRIST WATCHES</b> <b>SWISS JAEGER</b></p> <p>Le Coultre ex RAAF rated one of the world's best in smart chrome case with black dial Original cost \$250</p> <p><b>SPECIAL \$49.50</b> Post \$1.30</p>																					
<p><b>GENUINE EX ARMY WRIST WATCHES</b> Complete with nylon band \$19.50 Post \$1.10</p>	<p><b>NIFE CELLS</b> 1.2 volt, fully charged 4in x 3in x 1in 4 AH \$1.50 each P&amp;P 80c</p>	<p><b>VALVES</b> <b>BRAND NEW</b> 6SN7 \$1.95 6BM8 \$1.95 5U4 \$1.95 6GV8 \$1.95 EF50 \$1.50 6AK5 \$1.95 1H6 \$1.50 2x2 \$1.50 832 \$5.00 P+P 80c 6x4 \$1.95 VR65 \$1.50</p>	<p><b>PRISMATIC TELESCOPES</b></p> <p>15 x 50 Ex RAN — black enamelled brass. Length 16", weight 5kg Price \$39.50.</p> <p>\$2 cartage to rail, freight payable at nearest attended railway station.</p>																					
<p><b>CHASSIS PUNCH SET</b> For perfect holes in metal Cuts holes 3/8" 1/2" 5/8" 1" 1 1/8" With tapered reamer size 3-14mm <b>\$37.95</b> P + P <b>A\$1.95 B\$3.25</b> <b>CS\$3.65 DS\$3.65</b></p>	<p><b>CENTRE DRILLS</b> 15/64 x 15/64 Carbon steel \$4.00 doz. Post 60c</p> <p><b>ARTILLERY DIAL SIGHTS MK2</b> Can also be adapted as a Dumpy Level or as base for a telescope has full 360° 5 1/2" diam gunmetal rotating circle Adjustable elevation and depression. Has top grade 3/4" diam object lens FL 10" with cross hairs, eyepiece 1/2" right angle prism — height 10" — weight 3 1/2kgs With leather carrying case. Original cost \$300 Our Special only \$27.50 P&amp;P A \$2.25 B \$4.00 C \$6.00</p>	<p><b>STC HIGH IMPEDANCE HEADPHONES</b> 3400 ohms, brand new, only \$5.95 pair P&amp;P A \$1.65 B \$2.75 C \$3.10</p>	<p><b>ZOOM FOCUSING MICROSCOPES</b> Zoom focusing microscopes battery and mirror illuminated 750 x \$31.75 1200 x \$47.95 P&amp;P A \$1.65, B \$2.75, C \$3.10</p>																					
<p><b>RECEIVER No. 210</b> 2-16 M/cs \$76 Transmitter No. 11 suits 210 \$35. 24 volt Power supply to suit above \$15. Or complete station with Headphones. Mic \$110</p>	<div style="text-align: center;">  <p><b>ZOOM SPOTTING SCOPES</b></p> <p>30 x 30 LENGTH 12 1/2" HEIGHT 10" WEIGHT 1 1/2 lb <b>\$32.50</b></p> <p>45 x 40 Length 16in Height 10in Weight 2lb <b>\$49.50</b></p> <p>High grade coated lenses Ideal for pistol and rifle ranges or general viewing. Zooms in from very low to high powers. Complete with tripods. POST A \$1.75 B \$3.00. C \$3.60</p> </div>	<p><b>DIRECTOR LEVELS</b> Ex Army No 9 with azimuth horizontal circle and vertical adjustment suits all types of leveling In leather case <b>\$95</b> P + P <b>A\$1.75 B\$3 C\$3.60.</b></p>																						
<p><b>EX ABC MAGNETIC RECORDING TAPES 1/4"</b> PROFESSIONAL QUALITY 5" x 600' \$1.50 7" x 1200' \$2.75 P + P \$1.30 10 1/2" x 2400' \$7.95 P + P A \$1.65 B \$2.75 C \$3.10</p>	<p><b>SPY TELESCOPES</b> 8 x 17 mag size of a rifle cartridge extends to 8" Only \$8.95 each, post 60c</p>	<p><b>TELESCOPES</b> 25 x 30 \$13.50 P&amp;P A \$1.30</p>	<p><b>CLINOMETER MK6 0° TO 45°</b> Precision calibrations set in solid gunmetal frame spring ratchet adjustment. Approx size 7" x 6". Complete in wooden case <b>\$37.50</b> P + P A \$2.15, B \$3.85, C \$4.85, D \$4.85</p>																					
<p><b>COLLINS INDEPENDENT SIDEBAND TRANSCEIVER TRC/75</b> Fully synthesised transceiver with am. upper, lower and independent sideband operation. 1KHz steps from 2MHz to 29.999MHz 1 microvolt sensitivity. 2.5KHz bandwidth ssb 6KHz bandwidth AM 1 RW PEP max output. Fully automatic tuning of both transmitter and receiver from remote control unit. Complete with automatic aerial coupling unit, mic, headset, etc. 400Hz supply. <i>Ideal for amateur use</i> <b>PRICE \$750</b></p>	<p><b>AIRCRAFT INSTRUMENTS</b> Directional Gyros AN5735-1 Air Operated. <b>\$35</b> Slip and Turn Indicators <b>\$17.50</b> P&amp;P A \$1.65 B \$2.75 C \$3.10</p>	<p><b>CONDENSER LENS</b> 2 1/2" diam 2" F.L. \$1.50 each or \$2.50 per pair P&amp;P 80c</p>	<p><b>ROLA 77 MK 3 PROFESSIONAL TAPE RECORDERS</b> Ex ABC In Good Working Condition 7 1/2 and 15 IPS Original Price \$2,500 Special \$650</p>																					
<p><b>COLLINS SYNTHESISED 1 SB RECEIVER</b> TRC/75 receiver section of transceiver specification as above <b>PRICE \$400</b></p>	<p><b>SMALL CLIP-ON POCKET TELESCOPE</b> 15X \$7.00. P+P 80c</p>	<p><b>IMPELLER PUMPS</b> New gunmetal body, Stainless Steel Shaft, Neoprene Impeller Up to 15ft Lift, suitable for almost any type of liquid. Self priming. Ideal boat bilge pump, surge drains, etc. Approx size 8" x 5" 3/4" \$35.75, 1/2" \$51.00, 3/8" \$56.50. P+P A \$1.95 B \$3.50 C \$4.60</p>	<p><b>16MM SOUND PROJECTORS IN GOOD WORKING ORDER</b></p> <p><b>BELL &amp; HOWELL \$250</b> \$1 Cartage to Rail. Freight payable at nearest attended Railway Station</p>																					
<p><b>TELEPHONE WIRE</b> 1 mile twin (2 miles) genuine ex-Army Don 8 perfect condition \$45.00 per drum. \$5.00 cartage to rail freight payable at destination.</p>	<p><b>THEODOLITE</b> Kern Suisse Switzerland DK2 Two minute can be estimated down to one minute. Tested in good working order. \$750.00</p> <p>C42 set 36 to 60M/Hz with 24 volt power supply headphone mic. leads etc. \$95. Or 42 set separate \$65</p>	<p><b>Liquid filled compass</b></p> <div style="text-align: center;">  </div> <p>With magnified lens sight and degree reader. Only \$7.95 each Post \$1.30</p>	<p><b>SELSYN MOTORS MAGSLIP TRANSMITTER 3" MK2 \$17.50</b> Post Packing A \$1.75, B \$3.00 C \$3.10</p>																					
<p><b>3" ASTRONOMICAL REFLECTOR TELESCOPE</b> 117 X MAGNIFICATION FL 700MM WITH 5 X 24MM FINDER SCOPE AND TWO SECTION HARDWOOD TRIPOD. <b>\$169.25</b> P&amp;P A \$2.25 B \$4.10 C \$6.10</p>	<p><b>BINOCULARS</b> PRISMATIC Coated Lenses. Brand new Complete with case</p> <table border="0"> <tr><td>8 x 30</td><td>\$42.00</td><td></td></tr> <tr><td>7 x 50</td><td>\$48.95</td><td>P&amp;P</td></tr> <tr><td>10 x 50</td><td>\$51.00</td><td>A \$1.75</td></tr> <tr><td>12 x 50</td><td>\$53.00</td><td>B \$3.00</td></tr> <tr><td>20 x 50</td><td>\$65.00</td><td>C \$3.10</td></tr> <tr><td>20 x 65</td><td>\$130.00</td><td></td></tr> <tr><td>8x to 17x Zoom</td><td>\$150</td><td></td></tr> </table>	8 x 30	\$42.00		7 x 50	\$48.95	P&P	10 x 50	\$51.00	A \$1.75	12 x 50	\$53.00	B \$3.00	20 x 50	\$65.00	C \$3.10	20 x 65	\$130.00		8x to 17x Zoom	\$150		<p><b>POLARITY &amp; CURRENT CHECKER</b> 3 volt to 400 volt Simple leads and prods quickly determines positive or negative with illuminated indicators, also checks AC current and intensity, fully insulated only \$4.95, pp \$1.30</p>	<p><b>MARCONI SIGNAL GENERATOR</b> Brand new type TF801A-1 Range 10 to 310MHz Continuous. Complete in original case — with instruction book, power leads, spare valves, etc. <b>\$600 value!</b> only \$195 \$2.00 cartage to rail. Freight payable at nearest attended railway station.</p>
8 x 30	\$42.00																							
7 x 50	\$48.95	P&P																						
10 x 50	\$51.00	A \$1.75																						
12 x 50	\$53.00	B \$3.00																						
20 x 50	\$65.00	C \$3.10																						
20 x 65	\$130.00																							
8x to 17x Zoom	\$150																							
<p><b>AERIAL CAMERAS</b> WITH 8" FL 3" DIAM LENS F24 MARK IV 2.9 LENS STOPS 11, 8, 5.6, 4, 2.9 — \$75 \$2 cartage to rail freight Payable to nearest attended railway station</p>	<p><b>MAGNESIUM DRY CELL BATTERIES</b> Suits PRC25 and dozens of other uses 15 volts long life Only \$1.50 each P &amp; P A \$1.35, B \$2.75 C \$3.60</p>	<p><b>Machetes, genuine ex-army, brand new with bakelite handle and canvas scabbard, only \$8.</b> P&amp;P A\$1.55 B\$2.75 C\$3.10</p>	<p><b>Deitch Bros.</b> <b>70 OXFORD STREET, SYDNEY 2010</b> SORRY NO C O D</p>																					
<p><b>PENTAC LENSES</b> 3" DIAM 8" FL WITH DIAPHRAGM STOPS 11, 8, 5.6, 4, 2.9 MOUNTED IN METAL HOUSING — \$65 POST A \$1.85, B \$3.25, C \$4.10</p> <p><b>NIBBLING TOOL</b> Cuts sheet metal like a punch and die up to 18 G.A. Cuts Trims Notches \$14.95 P + P \$1.45</p>	<p><b>ANEROID BAROMETERS</b> In brass case, made in London. \$39.50 P&amp;P A \$1.65 B \$2.75 C \$3.10</p>																							



Just Off The Presses

## MICROPROCESSORS & PERSONAL COMPUTERS

Order your copy now!

Microprocessors and personal computers, little more than a dream a few years ago, are now changing the face of electronics. This book introduces the basic concepts, describes a selection of microprocessor and personal computer systems, and details a build-it-yourself computer designed especially for beginners.

Available from "Electronics Australia", 57 Regent St. Sydney. **PRICE \$5.00** OR buy mail order from "Electronics Australia". PO Box 163, Beaconsfield 2014. **PRICE \$5.70.**

### ELECTRONICS AUSTRALIA

#### PRINTED CIRCUIT BOARDS AND FRONT PANELS

Some readers have indicated problems obtaining PC boards and front panels for projects. Many of our advertisers sell these items and advertisements in the magazine should be carefully checked in the first instance. Failing satisfaction from this source, the following is a list of firms to which we supply PC and front panel artwork. Some may sell direct, others may only be prepared to nominate sources from which their products can be obtained.

#### N.S.W.

Applied Technology Pty Ltd,  
1a Pattison Avenue,  
Waitara, NSW 2077.

Dick Smith Electronics,  
PO Box 321,  
North Ryde, NSW 2113.

Electronic Agencies,  
115-117 Parramatta Road,  
Concord, NSW 2137.

RCS Radio Pty Ltd,  
651 Forest Road,  
Bexley, NSW 2207.

Radio Despatch Service,  
869 George Street,  
Sydney, NSW 2000.

#### VIC.

Kalextronics,  
4 Burgundy Plaza,  
101 Burgundy Street,  
Heidelberg, Vic. 3084.

Rod Irving Electronics,  
425 High Street,  
Northcote, Vic. 3070.

#### S.A.

James Phototronics,  
522 Grange Road,  
Fulham Gardens, 5024.

#### W.A.

Jemal products,  
8/120 Briggs Street,  
Welshpool, WA 6106.

#### TAS.

D & H Electronics,  
108 Campbell Street,  
Hobart, Tas. 7000.

#### N.Z.

E. H. Earl Ltd,  
PO Box 834,  
Wellington, NZ.

Marday Services,  
PO Box 19 189,  
Avondale,  
Auckland, NZ.

Mini Tech Manufacturing Co Ltd,  
PO Box 9194,  
Newmarket, NZ.

Printed Circuits Limited,  
PO Box 4248,  
Christchurch, NZ.

## ADVERTISING INDEX

Advertiser	Page
APF Electronics (Aust) Pty Ltd	110
Acoustic Electronic Developments Pty Ltd	126
Altronic Distributors Pty Ltd	7
Ampec Electronics Pty Ltd	68
Applied Technology	117
Astro-Optical Supplies Pty Ltd	73
Audio Engineers Pty Ltd	34
Audio Telex Communications Pty Ltd	35
BS Microcomp	128
Bauer, Michael	89
Bright Star Crystals	94
CQ Electronics	99
Cema (Distributors) Pty Ltd	2
Chapman, L. E.	132
Classic Radio	17
Comodore Australia	121
Comp-Soft Microcomputer Service	123
Cunningham, R. H. Pty Ltd	41
Deitch Bros	135
Dick Smith Electronic Group	10, 11, 15, 28, 37, 45, 56, 62, 65, 80, 81, 86, 88, 92, 112, 118, 122, 129.
Dindima Group Pty Ltd, The	9
Dindy Marketing (Aust) Pty Ltd	21
Electrocraft Pty Ltd	134
Electronic Agencies	49, 72
Ferguson Transformers Pty Ltd	20
General Electronic Services Pty Ltd	20
Hagemeyer (Aust) Pty Ltd	OBC
Informative Systems	120
International Correspondence Schools	103
Kalextronics	62
Logic Shop, The	119
Looky Video	89
McGills Newsagency Pty Ltd	107
Mensa Computers Pty Ltd	84
Micro 80	127
Microworld	83
Northern Territory Govt. Dept. Transport & Works	25
Paris Radio Electronics	115
Pennywise Peripherals	114
Pitt Street Microcomputer Centre	123
RCS Radio	29
Radio Despatch Service	105
Radio Parts Group	67
Rod Irving Electronics	50
Royal International	104
Scope laboratories	33
Sinclair Equipment Aust. Pty Ltd	124, 125
Software Source	116
Sony (Aust) Pty Ltd	IFC, IBC
Stanton Magnetics, Inc.	38
Stotts technical College	61
Tandy International Electronics	58
Technico Electronics	95
Vicom International	55, 71
Warburton Franki	91
Wireless Institute of Australia	94

## SUBSCRIPTION SERVICE



**ELECTRONICS  
Australia**

#### Subscription Rates

**\$21.00 per year  
within Australia**

**\$25.00 per year  
elsewhere.**

Make sure you receive every copy of the magazine by ordering it from your newsagent or the publisher. For publisher subscriptions post this coupon, with your remittance, to Electronics Australia Subscription Dept., John Fairfax & Sons Ltd, GPO Box 506, Sydney, 2001. Subscription will start with first available issue.

Name . . . . .

Address . . . . .

Postcode . . . . . Enclosed is . . . . . for . . . . . years

# The year of the bioelectronic tonearm.

Fully automatic and electronically controlled  
for the ultimate in high fidelity sound reproduction.

Turntable technology is at its peak. Motors, platters and cabinets have almost all reached their performance limits. Only the tonearm remains as the last great challenge to turntable perfection. And Sony has revolutionized that with the Biotracer Tonearm.

Biotracer has dismissed tonearm resonance. Those wayward harmonics that used to break up the romance between the listener and his music. By combining a micro-computer,

velocity sensors and three linear motors in the tonearm to control every movement. All unnecessary tonearm movement caused by its own resonance or eccentricities in a record, like warping, are immediately detected by horizontal and vertical sensors. A microcomputer responds to the slightest variation and directs Biotracer's linear motors to compensate.

Sound reproduction is clear. Rich bass is richer. And high frequencies more brilliant.

All other turntable functions are also automatically orchestrated by the microcomputer. Record selection is automatic. So is repeat, lead in and out, and even stylus muting whenever it is lifted up or down.

A linear torque BSL motor, together with a quartz crystal lock and Magnedisc servo system, assures stable speed and precise platter rotation.



And Sony has paid attention to the little things. Like convenient total front panel operation including stylus force adjustment when the dust cover is down.

All of your music will live up to your wildest expectations. Because Sony has now perfected the entire turntable system. Even the tonearm.

The new PS-X75 turntable with Biotracer. A new year for your music.



PS-X75

The PS-X75's cabinet is made of SBMC (Sony Bulk Molding Compound) to stifle howl. And gel filled insulators absorb acoustical energy and prevent feedback between turntable and speakers.

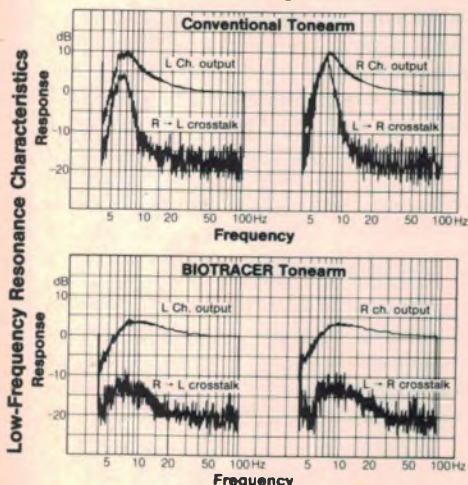

SONY®

# UNTIL WE DEVELOPED THE STEREO GROOVE, HI-FI WAS PRETTY HO-HUM!



The world of hi-fi owes a lot to the original and continuing innovation of JVC. Few companies, if any, have done as much to help turn records and record-players into the virtual musical instruments they are today ... or to lead the way in developing so many *firsts* in the more recent concepts of sound amplifiers, cassette decks and computer-designed speaker

systems. Hi-fi, as we know it today, had its beginnings in 1956, with JVC's development of the 45°/45° groove for stereo records. The fact that this system still remains as the world standard is, in itself, outstanding testimony to the technology of JVC. The development revolutionised not only the record-making industry, in which we've been involved since 1930; it also paved the way for enormous advancement in the design and engineering of record-playing equipment. Now, hi-fi has expanded to



R-S77. Super-A FM/AM Stereo receiver

embrace a wealth of highly-sophisticated electronic equipment; and it's not surprising that JVC has continued to play a leading role in so much of its development.



HR-3660 EA. VHS Colour Video Cassette recorder

## THAT WASN'T OUR ONLY FIRST, EITHER.

We also pioneered Japan's television industry, introducing their first TV receiver just over 40 years ago. A more recent innovation is VHS, the home video recording system now gaining world-wide acceptance as *the* system for such equipment. In the course of staying ahead, we've introduced a number of world *firsts* of radical importance: the Quartz Lock turntable is one of them.

## THE QUARTZ LOCK TURNTABLE. MANY TIMES MORE ACCURATE.

It stands to reason that if your equipment is at the top end of the range, then your turntable must be capable of comparable performance. Only Quartz Lock ensures this, tying the speed of the turntable to the unvarying pulse of the atom, and providing a level of accuracy far in excess of conventional turntables.



## MORE MILESTONES IN HI-FI.

To match the superb quality of Quartz Lock, we produced the S.E.A. graphic equalizer system. Then we refined it to such a degree it even compensates for the effect your furniture has on sound when it leaves the speakers! To expand the capabilities of tape, we designed ANRS and



SEA-80. Stereo Graphic Equalizer

Super ANRS — automatic noise reduction systems which not only reduce distortion and 'hiss' but actually extend the dynamic range of the tape. Similarly, with speakers: at JVC we employ computers in their design to help provide the ultimate in sound reproduction.

## AND NOW, SUPER-A.

In its own way, as significant a hi-fi development as the stereo groove. Imagine an amplifier which combines the *best* features of the two recognised amplifier classes (A and B) ... an amp which combines the *efficiency* of one with the *low distortion* of the other. Some engineers said it couldn't be done; but not those at JVC. Enter the Super-A amplifier ... the *latest JVC first!*

Distributed and Serviced by...  
**HAGEMEYER**



the right choice

## THE FUTURE.

It's already with us. For instance, we were so far ahead in the new metal tape technology that our cassette decks were metal-compatible before the tapes were generally available. And now there's the JVC Electro-Dynamic Servo Tonearm, damping tonearm resonance by means of a purely electronic system and two 'thinking' linear motors. Who was it who dubbed JVC, 'the innovators'?