

AUSTRALIA'S NUMBER ONE ELECTRONICS MAGAZINE

ELECTRONICS

AUSTRALIA

VIDEO, HI-FI & COMPUTERS

OCTOBER, 1982

AUST \$2.00 * NZ \$2.50

Registered by Australia Post — publication No. NBP0240.

DIGITAL READOUT FOR SHORTWAVE RECEIVERS



- ADD SPEECH TO YOUR COMPUTER
- SHURE V-15 TYPE V REVIEWED

DICK SMITH "WIZZARD"
VIDEO GAME
REVIEW

Power you can taste.



Sony's new TA-AX5 amplifier with memory is a high fidelity feast.

Its multiple memory lets you create your own acoustic "flavours." Bass and treble tone settings, turnover frequencies, high and low filter are all programmable.

At a touch you can instantly recall the recipe for bittersweet country, hot 'n' spicy rock, or a well-seasoned Stravinsky. And electronic displays graphically show you everything the amp is cooking up.

Sony's Audio Signal Processor means that every function is touch controlled. This knives through the usual maze of audio circuitry for a streamlined design of the future. Pure and simple, it sounds delicious.

The ideal companion for this tasty new amplifier is Sony's ST-JX4 synthesizer tuner. Why not make a reservation for two?

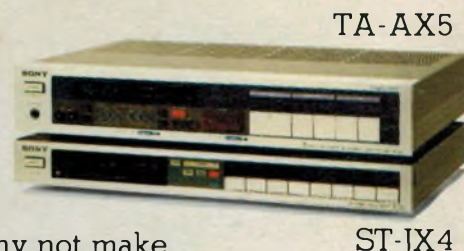

TA-AX5

ST-JX4

SONY
THE ONE AND ONLY

SON 0118

ELECTRONICS

AUSTRALIA

Volume 44, No. 10
October, 1982

AUSTRALIA'S LARGEST SELLING ELECTRONICS MAGAZINE

Computer speech synthesiser

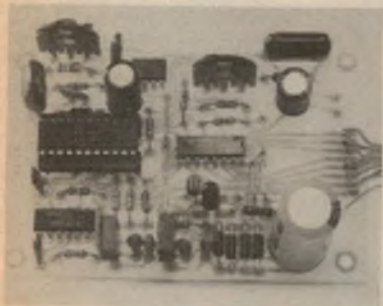

Based on the Votrax SC-01 chip, this speech synthesiser can be used with any computer that has a Centronics printer interface. Details page 72.



Our Car Computer has a rival! It's called "Voyager", it comes fully assembled, and we tell you all about it on pages 26-28.

COMING NEXT MONTH! - Find out what's coming by turning to page 107.

On the cover

Want to add digital frequency readout to a shortwave receiver that uses an old-fashioned analog dial? This unit features a bright 4-digit LED display, 1kHz resolution, and a fast 0.2s update time. Construction starts on page 48.

FEATURES

AMPLITUDE MODULATION <i>The basic concepts</i>	12
SPARKRITE VOYAGER CAR COMPUTER <i>Alternative to the EA kit</i>	26
ALL ABOUT PROTOTYPING BOARDS <i>From brainwave to circuit</i>	108
EA/ELLISTRONICS SCULPTURE CONTEST <i>Win a CRO!</i>	111
50 AND 25 YEARS AGO <i>People who hear radio broadcasts!</i>	127

HIFI, VIDEO AND REVIEWS

A CHICKEN OR EGG DILEMMA FOR CHERRY PIE	36
SHURE V-15 TYPE V PHONO CARTRIDGE <i>3-page in-depth review</i>	44

PROJECTS AND CIRCUITS

DIGITAL READOUT FOR SW RECEIVERS <i>For fast, accurate tuning</i>	48
REMOTE DISPLAY FOR THE CAR COMPUTER <i>Solves space problems</i>	66
COMPUVOICE SPEECH SYNTHESISER <i>Add speech to your computer</i>	72
ELECTRONIC STARTER FOR FLUORESCENT LAMPS <i>Instant turn-on</i>	82
EASY-TO-BUILD FREEZER ALARM <i>It could save your bacon</i>	90

PERSONAL COMPUTERS

SPECIAL FEATURE: FLOPPY DISK DRIVES <i>The various formats</i>	14
WIZZARD VIDEO GAME REVIEW <i>Also a personal computer</i>	128
MICROCOMPUTER NEWS <i>New disk controller from AED</i>	132

COLUMNS

FORUM <i>What do you expect from a personal computer?</i>	32
THE SERVICEMAN <i>Fuses, focus and frustration</i>	86
SHORTWAVE SCENE <i>Thirty years of publication</i>	104
RECORD REVIEWS <i>Classical, popular and special interest</i>	122

DEPARTMENTS

EDITORIAL 3 — NEWS HIGHLIGHTS 6 — LETTERS TO THE EDITOR 99 — BOOKS AND LITERATURE 100 — NEW PRODUCTS 112 — INFORMATION CENTRE 138 — MARKETPLACE 142 — NOTES AND ERRATA 141.



Whatever tune you want to play – Philips Connectors can help you.

● EUROCARD ● D CONNECTORS ● RIBBON CABLE CONNECTORS

Whether you're interested in Eurocard connectors for small-signal circuitry or heavy duty use in conditions of severe vibration; rigid, compact connectors for instrumentation; or a comprehensive system for interconnecting electronic modules, that can be tailored to your specific requirements; we're playing your tune.

At Philips Elcoma you'll find our F068 Eurocard series, F161 D series,

F095 and F03 series cover almost every use for connectors there is. And if you have a specific connector problem, we have the expertise right here in Australia, to solve it. Our quality is internationally approved and meets DIN, IEC and German Military (VG) standards ... because nothing less than the best can carry our name.

So call Philips Elcoma right now and discuss your needs. Chances are we can make great music together.

We'll keep you well connected.

For more information phone:

Sydney 427 0888

Melbourne 542 3333

Brisbane 44 0191

Adelaide 243 0155

Perth 277 4199

or write to **Philips Electronic Components and Materials**
P.O. Box 50, Lane Cove NSW 2066



**Electronic
Components
and Materials**

PHILIPS



Editorial Viewpoint

The standards, they are a - falling . . .

EDITOR-IN-CHIEF

Neville Williams
F.I.R.E.E. (Aust.) (VK2XV)

EDITOR

Leo Simpson
B. Bus. (NSWIT)

ASSISTANT EDITOR

Greg Swain, B.Sc. (Hons. Sydney)

TECHNICAL PROJECTS

John Clarke, B.E. (Elect. NSWIT)
Peter Vernon, B.A. L.L.B. (NSW)
Jeff Skeen
Colin Dawson

PRODUCTION

Danny Hooper

GRAPHICS

Robert Flynn

SECRETARIAL

Pam Hilliar

ADVERTISING MANAGER

Selwyn Sayers

CIRCULATION MANAGER

Alan Parker

Attention all you keen ABC-watchers out there! How many of you regard the ABC technical standards as being second-to-none in Australia? A large number of people do watch the ABC but many must be disappointed in the declining standard of presentation. This topic was prompted by a recent critical review of ABC news presentation in the "Sydney Morning Herald" (1st September). The article was entitled "And Jim Dibble reaches for the telephone, smiling bravely".

While one might discount the newspaper article because of connections between the SMH and the Seven network, the criticisms were only too true. Nowadays there are so many technical blunders on the ABC that they do not even bother to acknowledge or apologise for them. Recently, for example, the ABC were showing preview scenes for a coming series which were plagued with intermittent loss of picture and sound. This happened on several different occasions.

One sometimes gains the impression that no one at the station is actually monitoring the signal going to air. Or were the preview scenes factual and was the subsequent series intended to be shown with dropouts?

This evidence of declining standards is not a recent phenomenon. It's been going on for years. It is true that there have been some cutbacks in the ABC's budget but that is no excuse. And while some of the technical problems are due to lack of maintenance, others are presumably caused by a sheer lack of care.

I am certain that there are a great many people in the ABC who work diligently to produce a fine result. I am just as certain that there must be a fair proportion who could not care less. And this even becomes evident in the production of some ABC shows. Compare, for example, the indifferent presentation of the series "Towards 2000" with the thoughtful and informative presentation of "Countrywide" or the highly polished presentation of the "Saturday Show".

And while one may not like what is broadcast on the commercial networks there is no doubt that their technical standards are high and their presentation is really slick. Technical problems are rare, or at least, rarely seen.

While I prefer to watch the ABC, it is obvious that their technical performance is patchy. It should set and keep the highest standards. It is, after all, our national broadcasting network. We should be able to feel justly proud of it.

Leo Simpson

Editorial and Advertising Office

57 Regent St, Chippendale 2008.
Phone (02) 699 3622 Telex 25027.
Postal Address: PO Box 163, Chippendale, 2008.
Advertising Sales Manager: Sel Sayers.

Melbourne — 392 Little Collins St, Melbourne 3000. Phone (03) 602 3033.
Representative: Mark Christian.

Adelaide — Charles F. Brown & Associates Ltd, 278 Halifax St, Adelaide, 5000.
Representative: Sandy Shaw (08) 267 4433.

Perth — 454 Murray Street, Perth 6000.
Representative: Ashley Croft (09) 321 8217.

Circulation Office

Unit 3B, Sydneygate, Waterloo 2017.
Phone (02) 699 2388

Subscriptions

Subscription Dept, John Fairfax & Sons Ltd,
GPO Box 506, Sydney 2001.
Enquiries: Phone (02) 20944, ext 2589.

Distribution

Distributed in NSW by Magazine Promotions, 57 Regent St, Chippendale; in Victoria by Magazine Promotions, 392 Little Collins Street, Melbourne; in South Australia by Magazine Promotions, 101-105 Waymouth St, Adelaide; in Western Australia by Magazine Promotions, 454 Murray Street, Perth; in Queensland by Gordon and Gotch (A'asia) Ltd; in Tasmania by Ingle Distributors, 93 Macquarie St, Hobart; in New Zealand by Gordon and Gotch (NZ) Ltd, Adelaide Rd, Wellington.

Registered by Australia Post — publication No. NBPO240

Copyright. All rights reserved.

Devices or arrangements shown in this magazine may embody patents information is furnished without responsibility for its ultimate use, or for failure of equipment to operate as expected, or for any damage, loss or injury which may be sustained. Material intended for publication is submitted at the sender's risk and, while care will be taken, responsibility for any possible loss will not be accepted by "Electronics Australia".

Printed by Magazine Printers Pty Ltd, of Regent Street, Chippendale and Masterprint Pty Ltd of Dubbo NSW for Magazine Promotions, of Regent St, Chippendale.

ISSN 0313-0150

* Recommended and maximum price only.

PRICES SLASHED ON POPULAR LINES . . .

FAMOUS AMPEX CASSETTES

★ **STILL SOME LEFT!!!** ★

Cat.	Type	WAS	NOW	10 UP
C-3078	C-45 ELN	\$1.99	\$1.50	\$1.35
C-3080	C-60 ELN	\$1.99	\$1.79	\$1.79
C-3082	C-90 ELN	\$2.49	\$2.49	\$2.24
C-3086	C-60 EDR	\$2.25	\$2.25	\$2.00
C-3088	C-90 EDR	\$2.99	\$2.99	\$2.69



SAVE ON 'TIME & FUN' The latest LCD games.
LOWEST PRICES YET — WAS \$29.95!

MONKEY

Can you stop the monkey from stealing the coconuts? Cat. Y-1016

SLEEP WALKER

Stop the sleep walker from injuring himself on his nightly wanderings. Cat. Y1013

PIRATE

Protect your ship and passengers from marauding pirates. Cat. Y-1014

SAFARI

Fight through the jungle and natives to the safety of the helicopter. Cat. Y-1015

ESCAPE

Dodge the warden and escape from the jail to freedom. Cat. Y-1017

CONDOR

You are a caveman protecting your pet dinosaur from the condors. Cat. Y-1012

BANANA

Stop the pedestrian slipping on the banana skin. Cat. Y-1018

PANCAKE

Catch the pancakes before they hit the floor and give them to the customer. Cat. Y-1019

All at the one great price — only \$24.50 each!!!

WHAT A BARGAIN! ZX81 PRINTER

This printer is designed to match the famous ZX-81 computer. We only have a few of these quality printers left, and as you can see the price is fantastic! Grab one now, or you'll miss out!

~~was \$199.00~~ **SAVE \$40.50!!!**
now an amazing \$149.50

GOT SOMETHING TO SAY?

Cat. Y-1020



MORE GREAT STOCK CLEARANCES

50K Sliders

Linear pot, 73mm length, 45mm travel
was 95¢

now 75¢ KNOBS TO SUIT

8mm slider 15mm deep 'chromed' plastic, black face
 Cat. H-3780

60¢

10 up 40¢
 Black anodised knob 16mm deep, 10mm dia
 Cat. H-3782

50¢

10 up 45¢

Clock Divider IC

AY-3-8112 Type Clock, Frequency divider IC
 Cat. Z-6832 ~~\$17.50~~
\$12.50

WIRE WOUND POT

Throwaway Price! ~~was \$2.95~~
 7.5k
 Cat. R-6923
only \$1.75

GREAT VALUE!

TANTALUM CAPACITORS

Cat. R-4715	35V	47uF	60¢	10 up 55¢
Cat. R-4740	35V	4.7uF	60¢	10 up 55¢
Cat. R-4750	25V	10uF	70¢	10 up 65¢
Cat. R-4760	16V	22uF	70¢	10 up 65¢

SAVE \$10!!!
 95H90 500MHz Divider IC
 Cat. Z-5360 ~~\$19.95~~
now \$9.95!

TUNER MODULE

Loop stick antenna fitted for AM stage, complete with chassis mounting screws. Overload protection, built in FM mute, signal & tuning circuits. Built in 19kHz & 38kHz notch filters for MPX stage. Phase linear ceramic filters in the FM IF section. Geared 5 gang (FM3/AM2) variable capacitor. The FM front end employs a FET (2SK55), high image rejection over 54 decibels. All in all a GREAT BARGAIN!
 Cat. F-4610

~~was \$72.00~~
now only \$59!

LAST CHANCE!

1" (IMPERIAL) POTS

Okay everyone, this is your last chance to obtain those hard-to-get 1" standard pots. Grab some while they last, you never know when you'll need them!



Phone (02) 888 3200 with your order and Bankcard details IT IS SO SIMPLE!

TRY A NEW LANGUAGE? MMS FORTH!

You can customise and expand FORTH into virtually any language you like — yet it runs from 10 to 20 times faster than ROM BASIC! Comes with excellent documentation on disk, with its own DOS, written in FORTH. Minimum 16K and one disk drive. Cat. X-3668

OR FORTRAN?

Ideal for science and engineering applications, Fortran has become one of the most widely used programming languages ever. Fortran code is exceptionally fast, compact and modular. Includes full ANSI standard Fortran X3.9-1966, except the COMPLEX data type. Requires 32K, disk based. Cat. X-3669

Cat. X-3668 and X-3669 are designed to run on System 80/TRS 80 computers

and both only \$199 each!

WANT TO KNOW ABOUT PASCAL?

A superb book written by one of the US leading experts. The first 5 chapters lead you into basic definitions needed to use and understand PASCAL. Although the book concentrates on standard PASCAL, a more recent version called LIPS is mentioned where applicable. THE book for learning PASCAL. Cat. B-2355
only \$14.95

LOOK AT THESE!

\$18.00 WORTH OF RESISTORS FOR \$12.90!

YES! Save a fortune on this one — a specially selected pack (no rubbish) of 300 precision metal film resistors, worth \$33 more at normal prices! 1% tolerance, high stability, low temperature coefficient. A must for all serious uses (test equipment, etc). Cat. R-7015

ONLY \$12.90

THE GIANT HANDBOOK AT THE TINY PRICE!

This book is the be all, end all of electronics manuals. It is so popular that we are sold out nearly all the time. Right now though, we have a large stock holding. So be quick! Cat. B-1780

~~was \$19.95~~

now only \$14.95!



QUICK CONNECTORS? We've got 'em!!!

QUICK CONNECTOR

Cat. P-5012 **80¢**
 (Pack of 10)

DOUBLE ADAPTOR

Cat. P-5026 **80¢**
 (Pack of 6)

MINI CONNECTOR

Cat. P-5036 **80¢**
 (Pack of 15)

BULLET TERMINAL

Cat. P-5006 (Male) **95¢**
 (Pack of 10)

PLASTIC COVER TO SUIT ABOVE

Cat. P-5007 **50¢**
 (Pack of 10)

MALE CONNECTOR

Cat. P-5016 **80¢**
 (Pack of 10)

COVER FOR P-5012 & P-5016

Cat. P-5022 P-5016 **80¢**
 (Pack of 10)

ROUND LUG 3/16" HOLE

Cat. P-5032 **80¢**
 (Pack of 12)

BULLET TERMINAL (Female)

Cat. P-5008 **95¢**
 (Pack of 10)

PLASTIC COVER TO SUIT ABOVE

Cat. P-5009 **50¢**
 (Pack of 10)

DON'T BUY A DECADE BOX!

Why pay \$50 or more when, for just \$5.95, you can have one of our great resistance substitution wheels. Large, easy to read value selection makes life so easy! Complete with leads and insulated crocodile clips. Cat. Q-1410

WAS \$7.95

SAVE \$2.00!!!
\$5.95

SAY IT ELECTRONICALLY!

This amazing counter-sized moving letter display can attract real attention to your promotional campaign. The Times Square Display, is a programmable running display of 235 characters and is extremely simple to operate. The computer operates from 240V, but with the addition of two AA sized batteries, it will maintain your message in memory even when turned off, or when the power supply is cut. Complete with power supply, mounting bracket, keyboard and full instructions.

~~\$250~~ **\$199**

FANTASTIC NEW EXP BREADBOARD

Now circuit designing is as easy as pushing a lead into a hole. ★No soldering. ★No de-soldering. ★No heat sensitive components. ★No wasted time. Designed to accept transistors, IC's, LSI packages, resistors, capacitors, LEDs, trimmers, relays etc. It is ideal for all hobbyists as a test run for that special project.
 Cat. P-4615

ONLY \$12.95

PROTECT YOUR RECORDS

Dust is the enemy of your records and stylus. Now you can protect them with this superb record cleaner. Has soft felt pad that won't damage the record and comes with fluid and brush for keeping the pad clean. Great value, great price!

Cat. C-7092

Why pay more? \$4.50

DID YOU SEE DICK'S TV SPECIAL?

Packed into 130 pages of this book is the compelling story of Anderson and Hitchcock, 2 Australian aviators who died in the Tanami Desert in 1929, when their plane, the 'Kookaburra' made a forced landing. Beautifully illustrated with many before unpublished photographs. GREAT VALUE!

\$6.00
 Cat. B-9580



**OPENING SOON
IN LIVERPOOL!**

... YOU REAP THE BENEFIT!!!

SAVE \$50 ON COMPUTER CHESS!
WAS \$249⁰⁰

There have been chess games, and there will be more chess games no doubt! BUT this is the one that tops them all! It does everything you could possibly want a chess computer to do — including playing against itself! It has 12 skill levels and a learn mode.
 Cat Y-1256

NOW ONLY \$199⁰⁰
 Inc. computer, power supply, chessmen and instructions

GOLD IS ON THE WAY UP AGAIN! FIND YOUR SHARE WITH THESE BEAUTIES!!

Techna T/R A true discriminator
 A great unit for beginners! Ideal to throw in the car when you go away for a weekend or on holiday. Provides endless hours of fun and the whole family can join in as well. Lightweight and very easy to use.
 Cat Y-1066
\$99 WAS \$149

and the 'Rolls Royce' D-TEX DETECTOR
 If you want the ultimate in metal detectors, then this is the one for you, but you must be prepared to put plenty of effort into it. The unit has full discrimination between trash and treasure and has two waterproof search coils.
 Cat Y-1076
\$399 WAS \$485

'HANDS OFF' PERSONAL TWO WAY RADIO

 Cat. D-1150

It's a first for hands free communication! This unit features a lightweight headphone which lets you communicate to others up to 400m away (even further if you use its tiny antenna)! Has unique VOX automatic switching system — you don't have to push any primitive buttons! All you do is talk & the radio transmits the message. Great for construction workers, hikers, skiers, masseurs etc.

fantastic value!!! \$89⁹⁵ ea

GREAT NEW KIT FOR HOBBYISTS ETC. PROTOTYPER

Invaluable for designers, experimenters, hobbyists, useful for school projects, great as a teaching aid — Includes Oscillator, led drivers, switches, debounce circuit all on board. This side unit has a separate power supply. The power supply can be varied or fixed, 5V and 1.25V to 10V. It has an easy connector strip — every workshop should have one. Cat K-3465.

ONLY \$69⁵⁰

AMAZING TECHNOLOGY!

VOTRAX TYPE 'N TALK

With this advanced speech synthesiser your computer can now talk to you simply and clearly with an unlimited vocabulary. By adding a truly flexible and easy to use speech facility to any computer, it opens up whole new fields of applications: computers for the blind, language teaching, computer-aided teaching for small children and the illiterate. And of course Type 'N Talk is great fun for computer games. The Votrax is supplied with 240V power supply and user manual. You only supply a speaker and a cable to connect to your computer! Cat X-3290

ONLY \$525⁰⁰ YES! IT ACTUALLY SAYS IT FOR YOU!

MAKE A NOISE THIS XMAS... BUILD AN ELECTROCHUNE

ONLY \$75⁰⁰

A mini synthesiser with a 23 note touch keyboard. It even has a built-in amplifier and speaker with separate volume controls. Complete with plugpack and full instructions.
 Cat K-3506

FOR SUPER 80 OWNERS FIRST BOOK OF SUPER 80 PROGRAMS

New from Dick Smith Electronics, this superb handbook gives you a collection of handy Super 80 programs all written in BASIC. Most of the programs are for your amusement, but there are some business orientated programs which could apply in small business situations. Learn more about the Super 80 and the actual programming of the computer. And look at the great price! Cat B-3606

ONLY \$4⁹⁵

HAVEN'T BUILT ONE? See Page 19. You could save a fortune!

DON'T FORGET — IT'S ONLY 11 WEEKS TILL CHRISTMAS!

OWN AN ANSWERING MACHINE? Get rid of hangups with APE TAPES!
 Callers won't be able to resist leaving a message after they hear the voices of the personalities on these tapes. Fits any answering machine. Cat Y-2172.
ONLY \$8⁹⁵

CAR BATTERY CHARGER
 Don't wait till you get a flat battery, charge up now with this handy little charger. You simply plug into the AC socket and connect the long leads to your battery with the heavy duty clips provided. You can charge your car or boat battery overnight with the massive 4 amp charge rate, this will get you going again. Cat M-9800.
ONLY \$33⁷⁵

DICK SMITH WIZZARD
 The ultimate TV game with a computer built in. See page 129 for details.

Build your own speakers AND SAVE!
 We have limited supply of these superb B' boxes. Covered in walnut vinyl veneer they'll look great anywhere. Can be used with any speakers of your choice or with our speaker kit (Cat C-2046) which gives you a woofer, mid-range, tweeter, crossovers, wiring harness and instructions.
 Box kit Cat C-2626
WAS \$82 \$69⁰⁰

MATH MARVEL
 The exciting way to learn maths! Poses problems and maths games and incorporates an audio high score and indicator. From Texas Instruments, it's just right for grades 1 to 6. Cat Y-1321.
WAS \$35 NOW \$29⁵⁰

CRAIG TRANSLATOR
 Convey your thoughts and words into another language. Great for travelling overseas politicians, students etc.
 Cat Y-1340
3 FREE MODULES TO SUIT:
 French Y-1341 \$19⁵⁰
 Japanese Y-1342 \$19⁵⁰
 German Y-1343 \$19⁵⁰
 Italian Y-1344 \$19⁵⁰
 Spanish Y-1348 \$19⁵⁰
All worth \$29 ea.

Need a powerful relay?
 We have scrap purchased from others and now you're reaping the benefits. 12V coil - 160 ohms will handle 10A at 120V AC.
 Cat S-7140
\$3⁵⁰

SORCERER PROGRAMS FOR ALL USER'S MANUAL
 This great book welcomes you to the world of machine language programming and will help you to use your Sorcerer computer and all the power that it is capable of. Cat B-6106.
ONLY \$17⁵⁰

FOR TRAVELLERS OR AMATEURS.. WORLD TIME DUAL MELODY ALARM
 Tell the time anywhere in the world! This fantastic new watch not only displays local time but the times in 20 different time zones. It has dual melody alarm, night light and a world graphic display also. Terrific value! Cat Y-1051.
ONLY \$64⁹⁵ \$55⁰⁰

LCD WORLD CLOCK
 Great for radio hams, telephonists, international businessmen or anyone who wants to know the time anywhere in the world! Has LED, easy to read scale dial. Cat Y-1054.
ONLY \$19⁹⁵

READ THESE? Interfacing the S-100 Bus.
 Expand the utility and power of your system with the great book. Various chapters describe its mechanical and functional design, logical and electrical relationships and more.
 Cat B-2341
\$16⁰⁰

Programming the Z-80
 This handy book has been designed as an educational text and a self-contained reference manual. It gives a thorough introduction to machine language programming from basic concepts to advanced data structures and techniques. What more could you ask for?
 Cat B-2364
ONLY \$10⁹⁵

5/8 2 Metre Whip
 Fits on standard 1/2" base (Cat D-4056). 1.3m long — fibreglass construction. Cat D-4205.
ONLY \$15⁵⁰

JUST RELEASED! YM24 SPEAKER MIC
 Plugs directly into your 207 or 208. Operate hand held with a minimum of fuss — very small and light. Cat C-1111.
and its only \$32⁵⁰



News Highlights

When it has to get there fast — send it by carrier pigeon

When it absolutely has to be delivered on time, Lockheed Corporation, one of the most advanced space and computer technology companies in the world, turns to — carrier pigeons.

"The first reaction to using pigeons was just what you would think — laughter," said research chemist Werner Deeg, who volunteered to train the birds. "They said, Lockheed with pigeons? You must be crazy. We have an image to protect."

But Lockheed Missile and Space Co, perhaps best known for "birds" such as the Trident nuclear missile, has found a use for carrier pigeons at the company's mountaintop research centre outside Santa Cruz, California.

The Felton test base uses pigeons to fly

daily microfilmed prints of graphics design projects over the mountains separating them from Lockheed's Sunnyvale headquarters. The graphics design systems enable Felton's designers to draft directly onto a video screen, automatically storing the information in a computer at Sunnyvale.

Previously there was no fast, economical way for the Felton designers to retrieve daily work copies from the system. The company's mail carrier had to travel over 80km of twisting mountain roads, so delays of up to one day were common.

A computer specially acquired to transmit the needed designs from Sunnyvale to Felton is now only used as a back-up for the pigeons because, at \$10 a print, it is too expensive to run.

Satellite terminal for British Army



The British Army is currently testing a compact terminal for spoken and telegraphic communication by satellite. Known as "MANSAT", the unit can be transported and operated by one person.

Speech and 50-baud telegraph facilities are provided by the terminal, operating in the 7-8GHz band. The operator can wear a headset with built-in microphone or connect a small telegraphic data terminal with keyboard and printer to the backpack.

Under field conditions the equipment can be set up and contact established with a base station, via satellite, in under two minutes.

Amateur Dx-pedition

An international expedition of radio amateurs proposes to visit Heard Island (75°E, 53°S) during the first three months of 1983. Aims of the "DX-pedition" are to make at least 50,000 world-wide radio contacts during the four week stay, to circumnavigate the island, scale the 2745m mountain "Big Ben", and make a film of the journey.

A number of Australian and international DX organisations are sponsoring the expedition, and the Wireless Institute of Australia has agreed to act as trustee for donations. Call sign for the expedition will be VK0HI.

More donations are needed to meet the costs of the DX-pedition. Contact the WIA, Box 10, West Perth, WA, 6005.

SONY UNVEILS COMPACT DISC PLAYER

Sony unveiled the first production versions of its revolutionary compact audio disc player during mid-August. Then it cast a shadow over the unveiling by announcing that it is to delay the full launch of the system in Europe until next year.

Compact discs, jointly developed by Philips in the Netherlands and Sony in Japan, promise sound quality presently unobtainable with conventional hifi systems. Each disc, measuring only 12cm in diameter, can store an hour's programming on a single side, coded digitally in the form of microscopic pits.

These tiny pits — formed in a reflective metallic surface — are buried beneath a protective plastic layer and are read by a laser beam. Unlike conventional LPs, the discs do not deteriorate with repeated playings and are unaffected by surface scratches, dust or finger marks.

Sony attributes the delay to its inability to produce sufficient players to support an early launch.

Computer war danger — expert warns

Donn B. Parker, a world authority on computer security, has sketched a scenario for the computer wars of the future — which has nothing to do with Space Invaders.

Speaking at a recent computer security conference in Monaco, the US expert warned that the threat of nuclear war could soon be joined by the prospect of intentionally caused economic collapse brought on by manipulation of selected computers.

Parker predicted that wars fought by and against computers could involve alteration of global weather forecasts to

manipulate commodities markets, secret alteration of computer files that control the distribution of energy within a country, or perhaps a shut-down of the Electronic Funds Transfer network, which already moves US\$600 billion between international banks each day.

Many of the computer systems used by governments and businesses are inadequately protected, Parker argues. Increasing centralisation and sheer volume of information handled by computers and the growing use of international data links pose problems which have yet to be looked at, he claims.

Moree earth station upgraded for Intelsat V

The Overseas Telecommunications Commission's satellite earth station, Moree 1, is being extensively upgraded to allow its use with Intelsat V, the newest generation of communications satellites.

Scientists from the CSIRO Division of Radiophysics are collaborating with OTC engineers. Based on extensive work on radio telescopes, the CSIRO scientists have designed a new feed horn for the 27.5m diameter parabolic dish antenna. The redesigned feed horn directs microwave transmissions to the antenna sub-reflector (in the centre of the dish) with high precision and efficiency.

Manufacture of the new feed horn and sub-reflector was a co-operative effort between private industry, the Radiophysics Division's own laboratories and Government owned workshops.

The Intelsat V satellites now coming into operation have twice the channel capacity of the Mark IV series they replace, allowing the equivalent of two television channels and 12,000 two-way telephone circuits within each satellite's bandwidth.

View at right shows the Moree 1 Earth Station antenna prior to upgrading with the new feed horn.



A tribute to Doug Ferguson

Many people in the Australian electronics industry were saddened, recently, to learn of the death of Doug Ferguson, founder and Managing Director of Ferguson Transformers Pty Ltd, Chatswood, NSW. He will be remembered by associates and employees alike as a friendly, unassuming man who said what he meant and meant what he said.

I recall a particular day in 1945, when Doug called into our office in Elizabeth Street, Sydney — a young fellow of about my own age, keen to plan for the future. After the usual courtesies, he said:

"I'm thinking of getting into transformer manufacture for the kit market. What do you think?"

I had met Doug, some years earlier, when I was with Amalgamated Wireless Valve Company, and Doug was running a small radio service business which later blossomed into small-scale receiver manufacture. He was a good customer

for Radiotron valves.

In answer to his question, I told him that the ordinary power transformer market was well served but that a unique opportunity was opening up to design and market vibrator type transformers for car radios and other battery powered receivers and amplifiers.

Doug took up the suggestion and, shortly afterwards, the first of many projects using a Ferguson transformer appeared in "Radio & Hobbies", as our magazine was then called. The association has continued right up to the present day, although Ferguson transformers had their most obvious presence in the valve-type stereo Playmasters of the '60s.

Doug is no longer with us but the company he founded and the name which he left behind will continue to be known and respected in the Australian electronics industry.

Neville Williams

CSIRO tracks volcanic ash cloud

Australian scientists have developed a method of tracking the clouds of ash released by volcanic eruptions. The clouds pose a severe threat to aircraft and have several times fouled jet engines.

A team from the CSIRO and the Western Australian Institute of Technology in Perth has developed a method which allows the clouds to be tracked as they disperse and rise into the altitudes used by large passenger jets.

The basis of the method is interpretation of pictures received from weather satellites. Unfortunately, as the clouds disperse at the heights where they are dangerous, they become very difficult to detect. In fact, the only satellite which is able to provide enough data is the United States NOAA 7. This is able to record both visible light and heat from the atmosphere, and land or water surfaces.

The key to distinguishing the volcanic ash clouds was the realisation that they had a high mineral content which gave them a characteristic thermal emission pattern. The difference is slight, however, and a two-day programming effort was required to show up the difference on a computer display.

The team capped a week of discovery on Thursday, July 22, by tracking, at the request of the Department of Aviation, a cloud of ash released by an eruption in Bali. The cloud was detected 1200km north-west of North West Cape and about 500km south of Java.

News from the video disc front

In Britain there has been a slow build-up of interest in the Laserversion disc player. Standard systems are selling for £450, with deluxe remote control models at around £500. Discs are selling at around £15-16.

A new video disc production process has been introduced at Philips Blackburn, England, plant. Instead of stamping out the discs a liquid organic lacquer is poured into a master mould. The lacquer hardens when it is exposed

to light, transferring the master information to the lacquer layer.

In the United States, RCA has introduced a new range of Selectavision video disc players, including a low-cost model and two versions with stereo sound. The cheapest machines are now selling at around US\$300. Some reports suggest that this price cutting has been a contributing factor in the decision to postpone the worldwide launch of the VHD disc system.

25th Jamboree on the Air

Thousands of scouts and guides throughout the world will participate in the 25th Jamboree on the Air during the weekend of 16th-17th October.

The annual Jamboree on the Air is a joint effort, worldwide, by Scouting groups and radio amateurs, the latter making their communication skills and equipment available to allow Scouts to talk to fellow Scouts in other towns, states, and countries.

The 25th Jamboree on the Air will commence in Australia at 0001 hours local time Saturday, 16th October, 1982, and terminate at midnight Sunday, 17th October, 1982. As in past years the official opening will be an address by the Chief Scout and Governor General of Australia over the national headquarters official scout amateur radio station VK1BP in the grounds of Government House, Canberra, at 1400 hours (2pm) Saturday.

Amateurs willing to assist can obtain full details from their local Scout or Guide headquarters.



New standards on motor vehicle EMI

New standards published recently by the Standards Association of Australia include AS 2557, dealing with electromagnetic interference limits for motor vehicle ignition systems. The standard was requested by the Department of Communications, supported by Telecom and road transport authorities. It covers only spark type ignition and not other sources of interference.

The standard is intended to limit interference from motor vehicles to mobile communications systems and traffic control equipment and to permit the detection of offending vehicles.

According to John Dixon of the Department of Communications and chairman

of the SAA committee which produced the standard, present legislation does not require compliance with interference standards but legislative changes to the regulations are under consideration.

Benefits of the standard include less interference to communications such as mobile radio and public mobile telephone services and possibly less interference to broadcast reception in houses and shops adjacent to heavy traffic.

Copies of the standard can be purchased from offices of the Standards Association of Australia at a cost of \$5.80 plus \$1.25 postage and handling.

New speech synthesiser uses less memory

National Semiconductor Corporation has announced a new speech synthesiser chip which is said to use 50% less memory and provide higher quality speech than its predecessor, National's Digitalter 1.

Other features of the new device include a wider power supply range, and pitch and inflection controls. Words stored in read only memories can thus be put together with external control of pitch and inflection, allowing smooth, natural speech cadences.

The new DT3101TD synthesiser chip provides natural sounding speech at data rates as low as 800 bits a second. Previous speech synthesiser circuits often require data rates at four times this speed.

Vacation camp has electronic projects

Each Christmas, a vacation camp for school students interested in electronics and/or photography is held at Mt Victoria, NSW. Known as CAMTEC, the camp is run by the Scripture Union, an interdenominational Christian organisation.

At CAMTEC, campers can construct electronic projects, study microcomputer programming, operate amateur radio station VK2BCT, and take, develop and print black and white photographs.

The camp is for boys in high school years 7 to 9 and will run from the 14th to 21st of January, 1983. Cost will be approximately \$70.

For further information contact the Scripture Union, 1298 York St, Sydney 2000, phone (02) 290 1944.



Omega station now operational

The Australian Omega navigational station is now on the air and fully operational. It commenced operation officially at 10am on August 16th.

The Australian facility is the last link in a worldwide network of eight Omega stations. The others are in Norway, Liberia, North Dakota, Hawaii, La Reunion (a French island in the Indian Ocean), Japan and Argentina.

The Omega station, at Darriman in Victoria, was designed by officers of the Department of Aviation and the Department of Transport and Construction. It took three and a half years to build and includes a 427 metre high tower, the tallest structure in Australia.

The change to excellence in sound...



needn't cost you a fortune.

Denon, the name associated worldwide with professional audio equipment has available in Australia their range of superb quality turntables. A speed control system, with magnetic detection of impulses recorded on the inner rim of the turntable platter, coupled with a highly responsive A.C. servo motor maintains smooth and constant rotation.

Denon turntables are the result of 30 years of research and technology, giving you the ultimate

combination of performance, reliability and cosmetic styling.

See the range of turntables at your Denon dealer now, you'll find their prices rather exciting as well. *optional tone arm and cartridge

DENON

Professional Audio Brand.



AMALGAMATED WIRELESS (AUSTRALASIA) LIMITED
554 Parramatta Road, Ashfield, NSW 2131 Phone 797 5757

Canberra 80 5200	Melbourne 560 4533	Launceston 44 5155	Adelaide 272 2366	Brisbane 44 1631	Townsville 79 6155	Perth 271 0888
---------------------	-----------------------	-----------------------	----------------------	---------------------	-----------------------	-------------------

**NEW STORE
opening October
in Carlingford**

AT "NEVILLE'S CORNER" CNR CARLINGFORD & PENNANT HILLS
ROAD, NEXT TO KENTUCKY FRIED CHICKEN

MR HOWARD -



DESPITE TWO SAVAGE INCREASES IN SALES TAX AND HEAVY DEVALUATION OF THE AUSSIE DOLLAR, WE ARE STILL PASSING ON GREAT SAVINGS! OUR GREAT PRICES CAN'T LAST FOREVER SO ACT NOW! (BEFORE MR. HOWARD DOES - AGAIN!)

Reed Switch/ Magnet Assy.

Grab some of these before the Canberra boys grab the shirt off your back!!

A bulk buy of these has enabled us to pass on great savings!! Quality dry reed insert in tough plastic housing with screw terminations. Matching magnet assembly closes SPST reed contacts when near reed.

- 10 million operations
 - Comes with instructions
 - Double sided foam tape inc.
 - Screw mount as well!
- Staggering value. Jaycar has a complete range of Burglar alarm components - call in!!

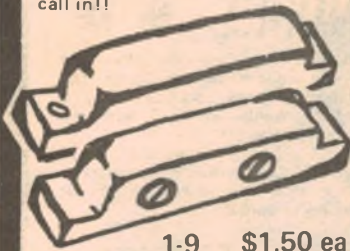

1-9 \$1.50 ea
10-99 \$1.40 ea
100+ \$1.25 ea

Rectangular LEDs ***

These are quality 2mm thick polished LEDs (similar to Siemens) - not the cheaper 3mm thick unpolished LEDs. Colours available: Red, Yellow Green. Normally \$0.60 for this quality BUT NO!!

Not \$0.40 not \$0.30 but as low as \$0.20 each!

1-9 25 cents ea
10-99 22 cents ea
100+ 20 cents ea

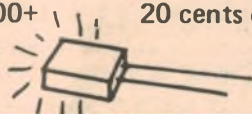

Zener Diodes

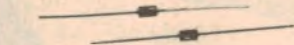

Improve your Dowry with these! The following values only (5% 1 watt).

9V1, 10V, 13V, 16V, 20V, 22V, 24V, 30V, 39V & 56V.

**15¢ each
\$1 for 10!**

WBDN 100 holes \$2.50
WBTN 640 holes \$8.95
WB2N 840 holes \$12.95
WB4N 1680 holes \$24.50
WB6N 2420 holes \$39.50

DPDT ** Footswitches

Double-Pole Double Throw Footswitches.

We had to import these ourselves to get the quality at a reasonable price.

Heavy duty. Ideal for any music-affects-pedal application.

\$6.95

EXPERIMENTER BREADBOARDS

Ample stocks of these boards plus the range has been extended.

Weller SPARES

We stock genuine factory spare parts for the famous Weller temperature controlled soldering irons.

SW-60D Switch assembly \$29.50
HE-60D Heater element 24V \$27.50
HO-60 Handle \$5.95
BA-60 Barrel/Nut assembly \$7.50
TC-20B Plug socket \$7.50

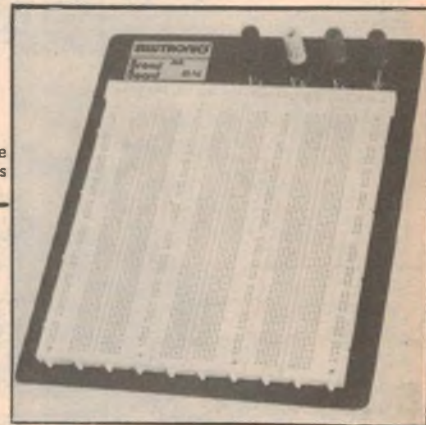

TRULY GREAT BARGAINS - ****

FROM GENERAL ELECTRIC

Smoke Detector

CONSUMER FLOP - CONSUMER FLOP CLUB, HOTEL, HOSTEL & MOTEL MANAGERS

PLEASE NOTE

One of the greatest consumer flops of the last decade was the Ionization Chamber Smoke Detector. Even though it is a brilliant product (reliable compact easy installation, fail-safe etc) it just did not sell. Human nature being what it is finds safety oriented products just not worth the investment. We all know that accidents and fires never happen to US!! As smoke is the greatest killer in a fire, the market research gurus thought that such a product would have wide appeal. When they were \$49.50 no one wanted them. The price fell to a very reasonable \$29.50 and still they stayed on the suppliers shelves. We have now been instructed to clear them for less than 1/2 of \$29.50

- Contains Americium 241 Ionization Chamber
- 9V Mallory Duracell included
- Contains very loud solid state buzzer
- 12 month factory warranty



GENERAL ELECTRIC

Grab One NOW \$14.50

* FAMOUS * GENERAL ELECTRIC

BURGLAR ALARM SLASHED!!!
HUGE SCOOP PURCHASE - ONCE SOLD FOR OVER \$100

Slashed to
\$29.50



Amazingly low price for a full feature ultrasonic proximity/burglar alarm.
+ Completely self contained + 12 month manufacturer guarantee + Instant or delayed alarm + Handsome imitation woodgrain + Cabinet measures 180Wx85Hx100D + Programmable multi-code disable switch + Single 9V Alkaline battery* lasts one year + Unit beeps when battery gets low + Contains receiver element designed for greater sensitivity without false triggering + Uses State-of-the-art LSI circuitry + Worth the money in parts alone + Comprehensive 24 page manual included + Comes complete with 4 window deterrent stickers + Absolutely no installation needed * Battery extra
SAVE A FORTUNE - COMPARE WITH UNITS OVER \$100
Below cost distress stock - Factory orders to sell.

car DC-DC inverter

Very low cost 12V DC/DC Inverter. Plugs into car cigarette lighter and powers 6V, 7 1/2 and 9V equipment @ 800mA.

\$4.95 1/2 PRICE!!



MUFFS SCARCE - GRAB NOW!!!

ONLY \$5.95 for a set of two
(One for each ear)

The Sennheiser HD414 Earmuffs are now back in stock. Who needs a pair of mangy muffs around the ears? Spruce up your Headphones with these bright Blue earmuffs.

EAT YOUR HEART OUT!



NEW STORE
Opening October
in Carlingford
 AT "NEVILLE'S CORNER" CNR CARLINGFORD & PENNANT HILLS ROAD, NEXT TO KENTUCKY FRIED CHICKEN

JAYCAR VALU-PACKS. QUESTIONS RAISED IN PARLIAMENT

In the last few months Jaycar's valu-packs have become legendary. Trimpot packs sold out in days. Photocells - well we THOUGHT we had a lot! We kept the pot packs going for about 6 weeks but the staff threatened to go on strike! (We ran out anyway).

Now we have more!!

The Treasury are wondering how we can do it! Could we be getting them from the bottom of the harbour? Are we applying the right sales tax? The Opposition is demanding a Royal Commission but we think the Government will tough it out. Subscribe to Hansard for further news!

Lamp Bezel Pack

- IT HAD TO HAPPEN

Only Jaycar would have the audacity to offer a Lamp Bezel Pack!! This fantastic pack contains an assortment of incandescent bezels (MES and Lilliput) neon bezels and LED bezels. Over 20 in all!! The average price of each bezel is \$1.50 So you will gasp when we tell you the price -

\$7.95

Alligator Clip Pack

HEATH ROBINSON EZ HOOKS

These aren't on the protected list! A bulging bag of gorgeous grippers. From gnat-like nippers to finger chompers. Grab a bag now before they grab you! Over 25 clips in each bag. VALUE AT \$7.95 but they're only -

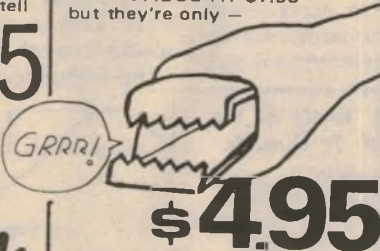

Great for battery chargers, paper clips and 000's other uses!

Silver Mica Pack

SUPERB VALUE

Probably the most stable capacitors of the lot. Pack of 100 SM's in values ranging from 33pF to 1000pF @ 100V. Silvered Micas are hard to get now and are normally VERY expensive. Worth well over \$40 but yours for only:

\$8.95



Thermistor Pack

NEW LOW PRICE

470 ohms @ 25 degrees C NTC THERMISTORS - were \$0.20 each (which was cheap) now:

\$1 for 10

NIXIES * *

If you are over 30 you will know what these are. To the uninitiated they are basically a Valve version of a 7 segment LED display! In the 60's they were the ONLY type of electronic display around Grab one for your kids. Great curiosity value.

ONLY \$1.00 each

SO 239

UHF PANEL SOCKET

1/2 Normal Price **\$1.20**

1-9 75c
10+ 59c



Useless adaptors *

We have double female. We also have the opposite! And some weird combinations in between. Each adaptor is solid metal and high quality and we can't see the reason why some were over made and we're sick of looking at 'em. You get 12 in a bag and if you only use ONE once they will owe you nothing. Once sold for \$3 each, but we won't insult you by claiming \$36.00 'value'. A bag will cost you \$3.95.

MR HOWARD - EAT YOUR HEART OUT!

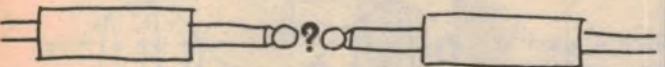

TAKE CARE OF TO-3 MONTH

Spruce up those hard working TO-3's with our upgrade pack. Each pack consists of the following:

- 6 quality McMurdo TO-3 Covers
- 6 quality McMurdo TO-3 Sockets
- 2 Beryllium Oxide high conductivity TO-3 washers



OVER \$8 VALUE FOR **\$3.95!!**

Factory Seconds YOU come FIRST

We have secured a smallish quantity of 5 pin DIN to 4 RCA audio leads that are on the wrong side of the Q.C. inspection. Shame though. Because the DIN plug is ALL METAL and GOLD plated. So are the RCA plugs. Problem is that the gold plating is bubbling on the gold DIN plug. (As far as we can see the 4 gold RCA's are PERFECT.)

An ordinary NICKEL PLATED lead set like this costs around \$4.75. The gold versions normally are around \$9.95. You can have one of these for \$3.95 and that's better than Nickel any day! Worth it for the 4 x RCA's alone!

\$3.95



RCA PIN PLUG x 4

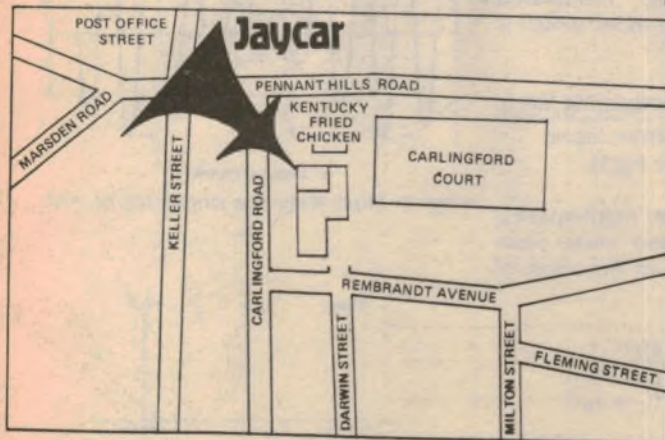

JAYCAR

125 YORK ST SYDNEY 2000
 Ph. 2646688 Telex: 72293
 Mail Orders To:
 Box K-39 Haymarket 2000

MINIMUM MAIL ORDER VALUE \$5.00

POST AND PACKING CHARGES
 \$5-\$9.99 (\$1.20) \$10-\$24.99 (\$2.40)
 \$25-\$49.99 (\$3.50) \$50-\$99.99 (\$4.60)
 \$100 up (\$6.20)

NEW SHOP HOURS
 Mon-Fri 8.30 to 5.30pm
 Sat 8.30 to 12.00pm
 Thurs night to 8.30pm



Amplitude the basic

So you think you know all about radio? Many people take the terms AM and FM for granted, without really knowing what they mean. In the first of two articles the author explains the basics of the Amplitude Modulation method of radio transmission.

by **ELMO V. JANSZ, VK7CJ**

Radio stations broadcasting to the public do not operate in the audio frequency range. The audio frequencies, the range of human hearing, lie in the range 20Hz to 20kHz, although this varies with the individual.

Audio frequency information is used at the receiving end so we may ask "Why don't we transmit in the range 20Hz to 20kHz?"

There are a number of reasons: If all the broadcasting stations in a given locality transmitted simultaneously at audio frequencies, the airways would be blanketed by frequencies within the range 20Hz to 20kHz, and they would interfere with each other's transmission.

Also, from the basics of antenna design, the optimum size of an antenna is one-half or one-quarter of a wavelength. Calculating the value of a half wavelength at audio frequency gives 7,500,000 metres at 20Hz and 7,500 metres at 20kHz. These figures are obviously physically impractical.

How is the problem overcome? The answer lies in imposing the audio frequency information to be transmitted on to a higher frequency signal called a "carrier". When this compound signal is received the two signals are separated in the receiver and the original audio information is recovered. Each station broadcasts using a different carrier frequency, so we can select the transmission of interest and eliminate all others by means of tuned circuits in the receiver.

The process of imposing audio frequency information on another signal of much higher frequency is called "modulation". The compound waveform, after the modulation process has taken place, is called the "modulated signal". There are, very broadly, two basic types of modulation — Amplitude

Modulation (AM) and Frequency Modulation (FM). In this article we shall have a closer look at amplitude modulation.

In amplitude modulation the amplitude of the carrier is varied in accordance with the amplitude of the audio signal. Fig. 1 shows the three waveforms involved. Fig. 1a shows the audio information or modulating signal, Fig. 1b shows the carrier waveform and Fig. 1c illustrates the modulated carrier waveform.

For those who are mathematically inclined the unmodulated carrier can be expressed by an equation of the form:

$$y = B \sin 2\pi f_c t$$

where f_c is the frequency of the carrier in Hz. Similarly, the modulating signal can be represented by:

$$y = A \sin 2\pi f_m t$$

where f_m is the frequency of the modulating signal in Hz.

Modulation index

An important term, which is used in dealing with amplitude modulated signals is the Modulation Index which is defined as follows:

$$m = \frac{\text{Peak value of Modulating Signal}}{\text{Peak value of Carrier Signal}}$$

in this case $m = A/B$ (See Fig.1).

Again, using a little more mathematics, the composite modulated wave form can be represented by an equation of the form:

$$v = V_C \sin 2\pi f_c t + \frac{1}{2} m V_C \cos 2\pi (f_c - f_m) t - \frac{1}{2} m V_C \cos 2\pi (f_c + f_m) t$$

where V_C is the peak value of the unmodulated carrier, represented so far by

B . V_C is the accepted jargon in communications.

Frequency spectrum

Let us now look at this equation more closely and try to interpret its various components in more down to earth physical terms. The modulated wave form is seen to have three frequency components; f_c , $(f_c - f_m)$ and $(f_c + f_m)$. If this modulated wave form is examined on a spectrum analyser — an instrument used to analyse the various frequency components present in a compound wave form, a frequency versus voltage spectrum as shown in Fig. 2 will result.

The frequency $(f_c + f_m)$ is called the

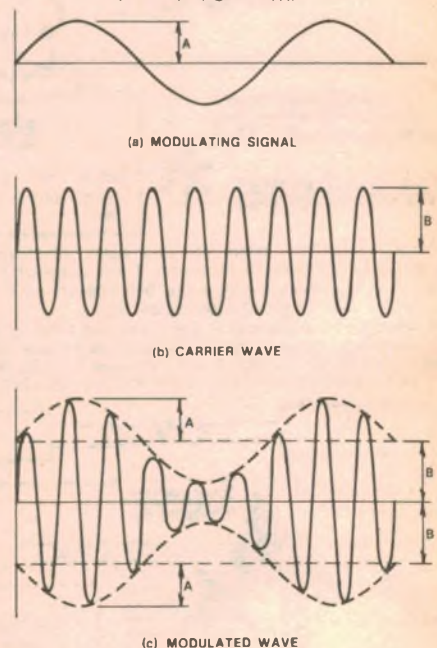

Fig. 1: illustrating the principles of AM.

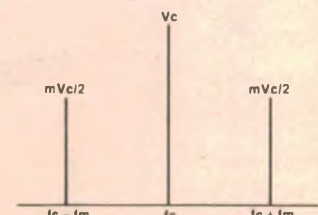

Fig. 2: frequency spectrum of an AM waveform.

modulation: concepts

upper side band, while the frequency ($f_c - f_m$) is called the lower side band. These are the frequency components that are used in single side band transmissions. The amplitudes of the side bands are each equal to $\frac{1}{2}mV_c$. Observe that this quantity depends on the modulating factor m .

Power content

The total power content of the amplitude modulated signal can be represented by an expression as follows:

$$P_t = \frac{1}{4} m^2 P_c + \frac{1}{4} m^2 P_c + P_c \text{ Watts}$$

where

P_t = Total Power

P_c = Carrier Power

m = Modulation Factor

Each of the terms $\frac{1}{4} m^2 P_c$ represents the power of each side band. The above expression is normally simplified into the form:

$$P_t = P_c (1 + \frac{1}{2}m^2) \text{ Watts.}$$

This is a very useful expression in communications work, for it gives the total power of a modulated signal in terms of the carrier power P_c and modulation factor m .

We'll work through a little problem to illustrate the above ideas. We are given the carrier power as being equal to 60 watts and the modulation factor is 100%. We wish to find the total power of the modulated signal and the power in each side band.

$$\text{We use } P_t = P_c (1 + \frac{1}{2}m^2)$$

$$P_c = 60W, m = 100\%$$

$$\text{Therefore } P_t = 60 (1 + \frac{1}{2})$$

$$m = 100\% \text{ is } m = 1.$$

$$\text{Hence } P_t = 90 \text{ Watts.}$$

We know that the power in the upper and lower side bands are equal — each being equal to $\frac{1}{4}m^2 P_c$. In this case, power in LSB = power in USB = $\frac{1}{4} \times 60 \times 1 = 15$ watts.

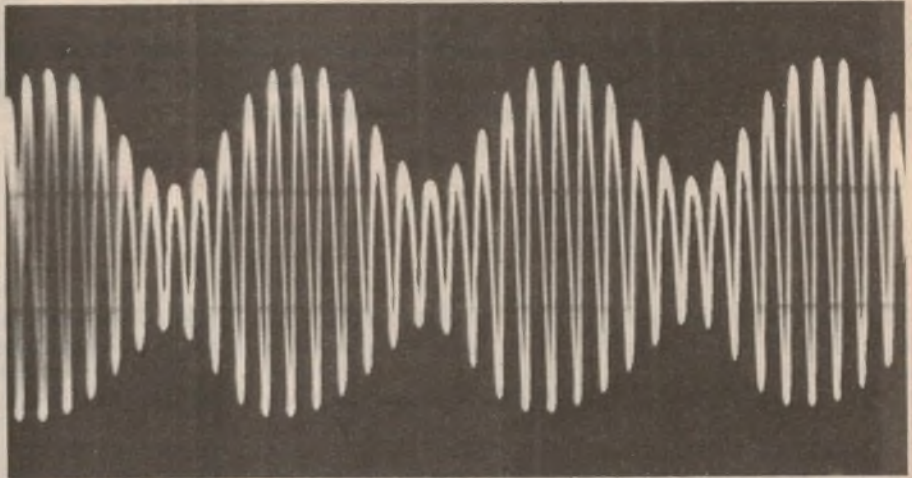

Taken from the screen of an oscilloscope, this photograph shows a modulated carrier waveform. Compare this picture with Fig 1 (c).

Conclusions

The above figures bear out some startling facts. Two-thirds of the total power is in the carrier, while only one-third of the total power is contained within the side bands. Such a system is not very efficient.

The significance of the presence of the sidebands is that each transmitting station occupies a band of frequencies rather than a single frequency, and the receiver must be capable of passing this band of frequencies for accurate signal reproduction. Actually, only one of the two sidebands, together with the carrier,

is sufficient for accurate reception, allowing a saving in spectrum space. Single-sideband (ssb) transmissions are widely used in point-to-point communications.

Other methods have been developed to make better use of the available power. Some of these are Double Side Band Limited Carrier, Single Side Band Suppressed Carrier, etc.

Amplitude modulated broadcasts are susceptible to interference, or noise, because of the modulation method used. This is one of the reasons for the popularity of frequency modulation (FM), which we will be looking at in the second article.

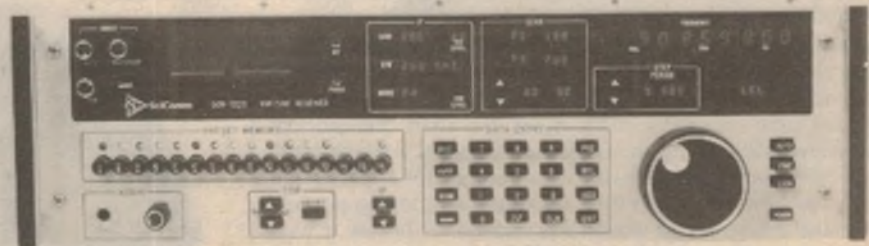

Illustrating the modern trend in communications receivers, this VHF-UHF unit distributed by Vicom International provides program scanning and monitoring functions over a range of 20-1200MHz. It uses a microprocessor to control search and memory functions.

Floppy disk drives add versatility

Floppy disk systems are not cheap, but the advantages they offer frequently make them worth their cost. This article provides a handy guide to the various configurations.

by **SCOTT PARKER**

THE MORE YOU USE YOUR COMPUTER, THE MORE YOU learn about it. You will soon want to put the computer to practical use. Unfortunately, complicated tasks require a sizeable amount of computer memory and you will soon need more memory than is available with your computer's internal RAM. Also, you will want a fast method for saving and loading your computer programs. You can enter programs using the computer's keyboard, but for long and complicated programs this method is tedious and time-consuming.

The solution to those problems is to add a mass-storage device to your computer. A mass-storage device, such as a floppy-disk system or an audio cassette recorder, will increase your computer's memory capacity. In addition, a mass-storage device provides a non-volatile method of storing programs and data.

Chief among the advantages of a floppy-disk system over cassette tapes are higher speed and faster access time. Yes, a cassette recorder is cheap, fairly reliable, and easily adaptable to a personal computer. But it is slow, with a typical data-transfer rate between 30 to 150 characters-per-second (CPS). This means it may take as long as five minutes to load 10K of RAM. A floppy disk is faster and has other distinct advantages.

Access is faster since the read/write head in a floppy-disk system can reach a desired block of information without the need to pass through preceding data; that is termed random-access. On the other hand, data stored on a cassette tape is recorded serially, so all data preceding a desired block of information must first pass by the read/write head.

Let's illustrate what long access times can mean. A typical audio cassette used for small personal computers operates at a speed of 1.875 inches-per-second, and a 60-minute or 500-foot tape can store 500K bytes. To read one side of a cassette would take 30 minutes. Suppose you were to enter a list of names and addresses into your computer and then store it on cassette tape. If you then wanted to retrieve a particular name and address that was in the middle of the list, it would take 15 minutes to locate the address. A floppy-disk system with its random-access capability would retrieve that particular address in less than one second.

Once the particular block of information was located, the cassette recorder would transfer the data to the computer at a

much slower rate than a floppy-disk system would. Stating it another way, a cassette system may have a data-transfer rate of 500 bits-per-second, compared to 15,600 bits-per-second for a 5¼-inch floppy disk, and 31,000 bits-per-second for an 8-inch floppy disk. (Eight bits are required for each character transferred. Also, bits-per-second is commonly referred to as baud rate.) In addition, most cassette recorders require manual operation, whereas a disk drive runs automatically after the disk is inserted.

Each 8-inch floppy disk can store up to 500K bytes (single-sided, double-density) or one megabyte (double-sided, double-density) of data. The smaller 5¼-inch diskette can store about 180K bytes (single-sided, double-density) or 360K bytes (double-sided, double density).

What is a floppy disk?

The flexible or floppy disk was introduced in the late 1960s by IBM to replace keypunch cards. It is soft and easily bent:

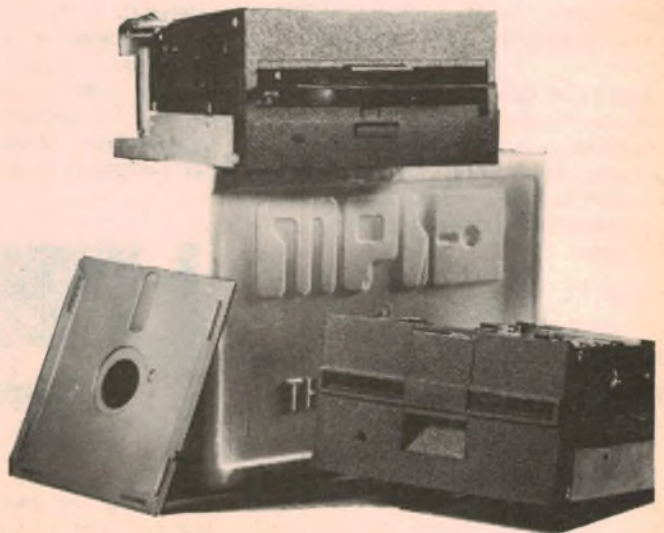

These large capacity MPI 5¼-inch drives feature high speed access. (Photo courtesy of Daneva Australia Pty Ltd.)

hence the name "floppy disk". The disk is currently available in two sizes, 8-inch (203mm) and 5¼-inch (135mm). The smaller 5¼-inch floppy disk is commonly referred to as a minifloppy diskette. The size is a measure of the sides of a non-removable square cardboard jacket that houses and protects the .003-inch thick, flexible Mylar disk. The disk is coated on both sides with a layer of magnetic oxides and revolves inside the protective jacket. The 8-inch disk rotates at 360rpm while the minifloppy runs at the slightly slower speed of 300rpm.

During reading or recording, a read/write head makes light contact with the disk surface. When data is not being written to or read from the disk, the read/write head is lifted from the disk surface to reduce wear.

As shown in Fig. 1, the jacket does not totally cover the Mylar disk. There is a slot to allow the read/write head to contact the oxide, a centre hole to permit the drive-motor spindle to rotate the disk; an index hole to provide specific timing information, and a notch (optional on the 8-inch disk, always present on the 5¼-inch disk) for "write-protection" to avoid accidental erasure of data recorded on the disk.

The "write-protect" notch is similar to the plastic tab on cassette tapes; when the tab is snapped off, the tape cannot be re-recorded. On a 5¼-inch floppy disk, the "write-protect" notch is covered to write-protect the disk and thus prevent wiping out programs and data stored on it. The procedure is reversed with the 8-inch disk. If the optional write-protect notch is present, it is covered to write-enable the disk.

Tracks and sectors

In some ways a floppy disk is similar to a phonograph record. A record stores music within grooves on a plastic surface; a floppy disk stores data as a sequence of magnetic pulses on a smooth magnetic surface. To read, or sense, the music on a phonograph record, a needle rides in the spiral groove and its mechanical vibrations are converted into electrical signals. In a disk system, there are no grooves; instead there are invisible tracks along which magnetic pulses are recorded. To read that data, a magnetically-sensitive read/write head is placed over the track while the disk is rotated. When data is to be stored on a floppy disk, the read/write head either changes the magnetic state of the oxide area it is contacting or else makes no changes; that produces the equivalent of a logic "1" or "0".

Continuing the analogy to a phonograph record, music is recorded in one continuous groove or track on the record surface, starting from the outermost edge of the record to the centre hole. That arrangement is fine, since the music will be played from start to finish — generally without the need for interruption. In a floppy-disk system, a great deal of data will be stored and fast access to any particular section of the data is essential. Now think how difficult it would be to locate a particular passage exactly on a phonograph record. It's not easy, but fortunately it's not often necessary.

To allow more rapid access of data on a floppy disk, a series of concentric tracks is arranged, with each track located at a specific distance from the centre (or the edge) of the disk, as shown in Fig. 2. Now each track can be identified easily or addressed by its specific location. Although there is a standard number of tracks (77) in the IBM 8-inch disk format, some manufacturers use different numbers of tracks. Some floppy disks are single-sided, with data stored on one side of the disk, while others are available with tracks and data stored both sides (double-sided floppies).

Although it is easier to locate a specific section of data using concentric tracks instead of a single continuous track, let's consider some of the drawbacks. If an 8-inch disk is divided into 77 tracks and various blocks of data (files) are assigned to

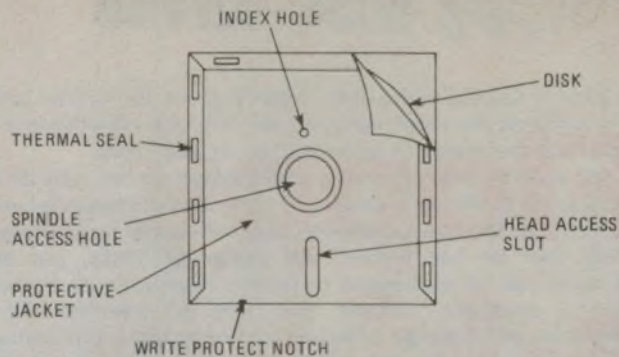

Fig. 1: A minifloppy diskette. On 203mm (8-inch) disks, the write protect notch is optional.

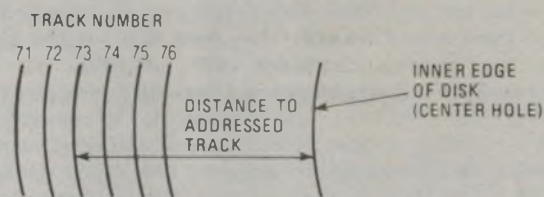

Fig. 2: The disk surface is divided into a series of concentric tracks to allow faster data access.

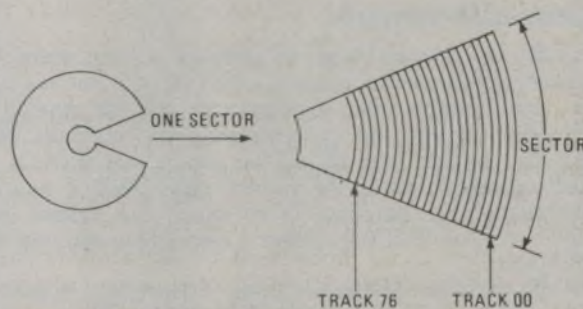

Fig. 3: Each track is divided into sectors for more efficient storage of data.

individual tracks, there may be some degree of inefficiency. It is possible that one file may contain a relatively small amount of data; thus the track assigned to this file would barely be used. Another file may be much larger and use almost an entire track. A third file may require a bit more than one track and thus be assigned two entire tracks, again with little data on the second track.

To improve efficiency, tracks are divided into sectors, as shown in Fig. 3. Now data can be placed, and located quickly, by assigning a specific track and sector as its address. In the IBM format, for example, each 8-inch disk is divided into 77 tracks with 26 sectors per track for a total of 2002 sectors. Each sector holds 128 bytes or 1024 bits of information. Thus, a short file might fill a dozen sectors while a larger file could use an entire track of 26 sectors.

To locate the sectors on the surface of the floppy disk, either soft-sectoring or hard-sectoring is used. A soft-sectored disk has a single index hole; sector locations are identified by information recorded on the disk. That information must be stored within the sector and thus reduces the disk's actual storage capacity. A hard-sectored disk (Fig. 4) uses a number of punched holes to act as index markers; this scheme is about 25% more efficient in data storage. Hard-sectored disks contain 10 to 16 holes (32 holes in the case of some 8-inch disks) in addition to the index hole that is centred between two of the sec-

Floppy disk drives

tor holes. Circuits in the disk controller sense the shorter spacing between the index hole and the holes on either side of it and thus the system is aware of the starting point.

Still another analogy to the phonograph record: Just as an audiophile builds up a distinctive collection of choice records lovingly, so too can a computer buff collect pre-programmed disks that he has written and perfected. Disks, just like records, can be exchanged to permit other users to borrow special programs without the need to develop them. However, to exchange software via floppy disks, the formats of the disks must be compatible. In other words, you can not purchase software recorded on a 5¼-inch hard-sectored disk and enter it into your computer if your floppy-disk system requires soft-sectored disks.

One final analogy. Audiophiles take precautions when they handle their prized records; they hold the records by the edges to prevent fingerprints, dirt, or body oils from penetrating the record grooves and thus mar the fidelity of the sound. Floppy disks are considerably more vulnerable to careless handling; a dust particle or a strand of human hair deposited on the surface of a floppy disk could damage a number of sectors or impair good contact between the read/write head and the oxide coating. For that reason, users are advised to store the disk in its original envelope after use.

Floppy-disk formats

To promote the exchange of software among users, the computer industry has adopted the IBM 3470 format as a standard. Unfortunately, that standard can only be applied to 8-inch disks. If you are contemplating the purchase of a floppy-disk system, you should be aware that there is no industry-standard format for 5¼-inch disks. Also, if you are contemplating the purchase of an 8-inch disk system, you should make sure that the system is compatible with the IBM 3470 format.

The IBM 3470 format is shown in Fig. 5. The disk is divided into 77 tracks or concentric circles, with the count (00) starting at the outer edge; the innermost track is No. 76. Each track is subdivided into 26 sectors. Thus, there are 2002 sectors on a standard single-density 8-inch disk. The sectors are identified by soft-sectoring. Each sector is further subdivided into four sections: one to identify the sector and track number, one to accommodate 128 bytes (or 1024 bits) of data, and two gaps to separate the ID and data sections. The ID and data sections are further broken down so that in addition to containing the ID and data information, they contain pulses that are used to synchronise the controller circuitry to allow for variations in the rotational speed of the floppy disk. The ID and data sections also contain error-checking bits so that the controller circuitry can recognise an error when it occurs.

When a blank floppy disk is first purchased, its surface is non-magnetised and thus it must first be formatted to organise tracks and sectors. The microcomputer performs this function upon command, using the pulse representing the index hole as the reference point. After the disk has been formatted, it is ready to have information written on it or read from it. An unformatted 8-inch disk has a capacity of 400K bytes while its IBM 3470 formatted version can accommodate 256K bytes.

As previously stated, there is no standard format for the 5¼-inch minifloppy diskettes. The number of tracks and sectors can and does vary. For example, 5¼-inch diskettes for the Apple II computer were originally formatted with 35 tracks, each subdivided into 13 sectors with 256 bytes-per-sector. Later, that format was modified to 35 tracks with 16 sectors-per-track, resulting in a net increase of 24K of storage capacity. Diskettes for the Heath H89 computer are formatted with 40 tracks and 10 sectors-per-track.

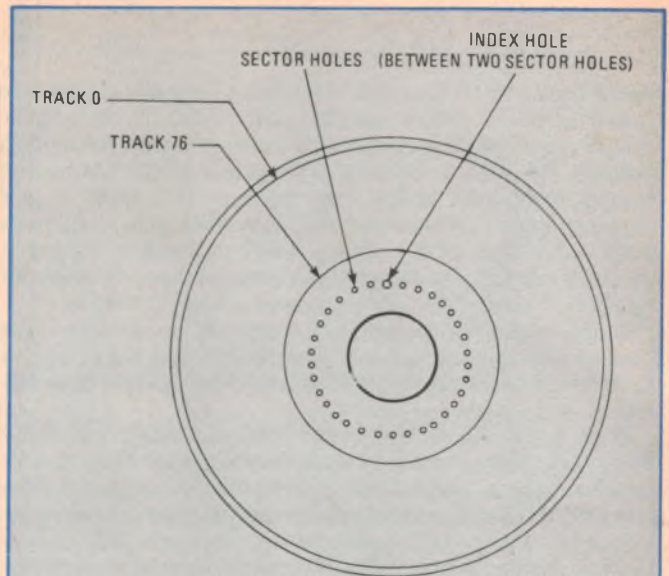

Fig. 4: Hard sectored disks use sector holes.

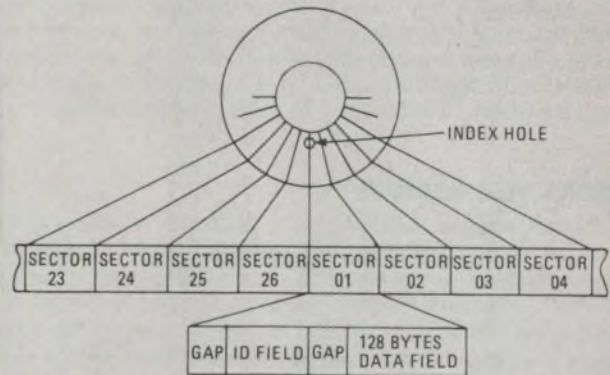
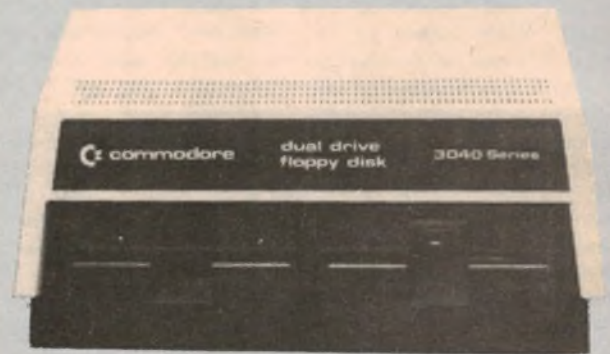

Fig. 5: The IBM 3470 format – standard for 8-inch disks.



Commodore 5¼-inch drives – a package offered by the computer manufacturer.

A 5¼-inch minifloppy diskette has an unformatted capacity of 110K bytes. With soft-sectoring, this figure drops to 80.6K bytes. The minifloppy diskette can be formatted with anywhere from 35 to 77 tracks and 10 to 16 sectors-per-track.

Single density, double density

Data is placed on a disk using frequency modulation (FM). A 250kHz clock generator produces pulses that repeat every four microseconds to form data cells on the surface of the Mylar disk. When writing data to the disk, if a data bit is supplied during the interval between clock pulses, a magnetic

semiconductors! semiconductors! semiconductors!

Here's the Highlights!

16K D RAMS \$1.25	4K STATIC RAM \$1.20	ITT EQUIVLNT PN2222
32K E PROM \$4.00	CMOS CD4511 .75	AND PN2222A .08
SILICON RECT IN4005 .05	ITT EQUIVLNT PN2907 AND PN2907A .08	SPEECH SYNTHESIS EVALUATION KIT \$90.00

Plus all these!

SCHOTTKY	SN74LS155 .26	SN74LS446 2.30	SN7410 .19	SN75173 1.33	1N967 .01	TIL302 3.00	SCR & TRIACS
SN74ALS00 .30	SN74LS156 .26	SN74LS448 2.30	SN7412 .19	SN75188 .33	1N968 .01	TIL304 3.00	TIC116F .81
SN74ALS02 .30	SN74LS157 .21	SN74LS449 2.30	SN7414 .31	SN75189 .25	1N970 .01	TIL306 5.50	TIC126D .55
SN74ALS04 .30	SN74LS161 .26	SN74LS490 .43	SN7418 .25	SN75452 .23	1N973 .01	TIL308 5.50	TIC246D .70
SN74ALS05 .30	SN74LS163 .26	SN74LS541 .49	SN7420 .19	SN75461 .23	1N4735 .01	TIL309 5.50	
SN74ALS08 .30	SN74LS164 .26	SN74LS600 2.75	SN7426 .30	SN75473 .38	2N2222 .01	TIL312 .75	MPU/CPU
SN74ALS09 .30	SN74LS165 .34	SN74LS601 2.75	SN7437 .25	SN75492 .45		TIL313 .75	TMS9902 3.20
SN74ALS10 .30	SN74LS166 .34	SN74LS602 2.75	SN7438 .25	LM301 .16		TIL321 .75	TMS9981 12.50
SN74ALS11 .30	SN74LS174 .23	SN74LS603 2.75	SN7442 .27	LM307 .16	TRANSISTORS	TIL322 .75	HD6802 3.75
SN74ALS12 .30	SN74LS175 .23	SN74LS604 2.75	SN7443 .45	LM311 .28	TIP29A .25	TIL327 .75	HD6821 2.10
SN74ALS15 .30	SN74LS181 .90	SN74LS605 2.75	SN7446 .52	LM317 .75	TIP29C .33		
SN74ALS20 .30	SN74LS183 1.80	SN74LS606 2.75	SN7450 .19	LM318 .67	TIP30A .33		
SN74ALS21 .30	SN74LS189 1.80	SN74LS607 2.75	SN7451 .19	LM324 .28	TIP31 .31	SOCKETS (MACHINE)	OP AMPS
SN74ALS30 .30	SN74LS192 .37	SN74LS610 19.50	SN7472 .25	LM337 .95	TIP31A .23	L PROFILE	TL060 .35
SN74ALS32 .30	SN74LS193 .37	SN74LS611 19.50	SN7473 .25	LM339 .25	TIP31C .27	SOLDER	TL061 .35
SN74ALS33 .35	SN74LS194 .29	SN74LS612 19.50	SN7474 .25	LM358 .23	TIP32C .31	14 PIN .85	TL064 .99
SN74ALS37 .35	SN74LS195 .29	SN74LS613 19.50	SN7475 .25	LM3900 .30	TIP33 .49	16 PIN .90	TL066 .35
SN74ALS38 .35	SN74LS196 .35	SN74LS620 .85	SN7476 .25	MC1458 .25	TIP33A .49	18 PIN .95	TL071 .31
SN74ALS74 .40	SN74LS197 .29	SN74LS621 .95	SN7480 .39	MC1488 .30	TIP33B .53	20 PIN 1.00	TL072 .57
SN74ALS00 .14	SN74LS219 1.80	SN74LS622 .78	SN7483 .37	MC3486 1.25	TIP33C .53	24 PIN 1.20	TL080 .26
SN74LS01 .15	SN74LS221 .27	SN74LS623 .78	SN7486 .25	MC3487 1.25	TIP34 .53	40 PIN 1.50	TL081 .23
SN74LS02 .15	SN74LS240 .42	SN74LS625 1.15	SN7490 .27	NE555 .18	TIP34C .90	64 PIN 3.50	TL082 .46
SN74LS03 .15	SN74LS242 .29	SN74LS626 1.15	SN7491 .39	NE556 .35	TIP35C 1.02	L PROFILE	TL084 .85
SN74LS04 .15	SN74LS243 .33	SN74LS627 1.15	SN7494 .41	RC4136 .55	TIP41A .55	W/WRAP	
SN74LS08 .15	SN74LS244 .42	SN74LS628 .85	SN7495 .29	RC4558 .20	TIP41B .36	14 PIN 1.50	MEMORY
SN74LS10 .15	SN74LS245 .60	SN74LS629 1.20	SN7496 .33	TL188 1.02	TIP41C .65	16 PIN 1.70	TMS2516 3.50
SN74LS11 .15	SN74LS251 .28	SN74LS630 38.70	SN7497 1.35	TL430 .30	TIP42B .37	18 PIN 1.90	TMS2532 4.00
SN74LS12 .15	SN74LS257 .26	SN74LS631 38.70	SN74111 .30	TL441 1.25	TIP42C .55		TMS4044-45 2.30
SN74LS14 .15	SN74LS259 .29	SN74LS640 .57	SN74121 .27	TL442 1.10	TIP49 .47		ITT4116 1.25
SN74LS20 .15	SN74LS261 .95	SN74LS642 .77	SN74122 .33	TL489 .44	TIP50 .47		TMS4164-20 5.00
SN74LS21 .15	SN74LS266 .21	SN74LS643 .77	SN74123 .33	TL490 .81	TIP110 .38		2114 1.20
SN74LS22 .15	SN74LS273 .35	SN74LS644 .77	SN74128 .33	TL494 1.96	TIP111 .44	SOCKETS	4716 1.25
SN74LS26 .17	SN74LS275 2.45	SN74LS646 3.40	SN74132 .33	TL496 .50	TIP112 .46	(DIP)	
SN74LS27 .17	SN74LS279 .23	SN74LS647 3.40	SN74136 .33	TL497 1.00	TIP115 .38	WIRE WRAP	
SN74LS28 .17	SN74LS280 .29	SN74LS668 .47	SN74144 2.05	TL505 1.70	TIP120 .40	8 PIN .10	
SN74LS30 .15	SN74LS283 .29	SN74LS669 .47	SN74148 .55	TL507 .53	TIP122 .38	14 PIN .17	
SN74LS32 .15	SN74LS290 .23	SN74LS670 4.7	SN74150 .88	UA78L12 1.19	TIP125 .48	16 PIN* .20	PROGRAMMED
SN74LS33 .15	SN74LS293 .26	SN74LS674 6.20	SN74157 .29	UA709 .20	TIP141 1.15	18 PIN* .20	SPEECH I.C's
SN74LS40 .27	SN74LS295 .33	SN74LS682 1.65	SN74161 .47	UA723 .20	TIP141 1.15	20 PIN* .21	VM61002 6.80
SN74LS42 .27	SN74LS297 7.05	SN74LS690 1.50	SN74164 .47	UA741 .18	TIP145 1.15	28 PIN* .30	VM71003 3.65
SN74LS49 .45	SN74LS298 .29	SN74LS691 1.50	SN74165 .47	UA747 .31	TIP148 1.15	40 PIN* .42	TMS5220 9.99
SN74LS51 .15	SN74LS299 .99	SN74LS692 1.50	SN74166 .47	UA748 .21	TIP2955 .47	EDGE GRIP	
SN74LS55 .15	SN74LS323 .83	SN74LS693 1.50	SN74173 .50	UA7805 .39	TIP3055 .49	PROFILE	
SN74LS56 .99	SN74LS347 .52	SN74LS698 1.50	SN74174 .40	UA7806 .39	2N3791 .40	SOLDER	
SN74LS73 .17	SN74LS348 .33	SN74LS697 1.50	SN74178 .68	UA7812 .39	2N5671 1.00	8 PIN .10	OTHER
SN74LS74 .17	SN74LS366 .26	SN74LS698 1.50	SN74179 .68	UA7815 .39	2N6328 1.00	14 PIN .17	SN76477 1.65
SN74LS75 .25	SN74LS367 .26	SN74LS699 1.50	SN74180 .47	UA7912 .44		16 PIN .20	SN76487 1.10
SN74LS76 .25	SN74LS368 .26		SN74182 .50	UA7915 .44		18 PIN .20	SN76488 2.27
SN74LS83 .38	SN74LS373 .53		SN74191 .47			20 PIN .21	3N201 .67
SN74LS86 .15	SN74LS374 .53	DIGITAL	SN74192 .45			22 PIN* .23	
SN74LS90 .25	SN74LS375 .25	SN74S00 .23	SN74193 .45	DIODES		24 PIN .23	
SN74LS91 .29	SN74LS377 .35	SN74S02 .23	SN74195 .33	1N459 .01		28 PIN* .30	
SN74LS93 .29	SN74LS378 .23	SN74S04 .23	SN74197 .51	1N746 .01		40 PIN* .42	
SN74LS95 .29	SN74LS379 .25	SN74S74 .41	SN74251 .51	1N747 .01		FACE GRIP	
SN74LS96 .35	SN74LS382 1.37	SN74S86 .41	SN74259 1.90	1N748 .01		L PROFILE	
SN74LS109 .19	SN74LS384 3.05	SN74S113 .41	SN74279 .41	1N749 .01		SOLDER	
SN74LS112 .19	SN74LS385 .33	SN74S133 .25	SN74283 .65	1N750 .01		8 PIN* .10	
SN74LS113 .19	SN74LS386 .21	SN74S153 .61	SN74284 1.80	1N751 .01		14 PIN* .17	
SN74LS114 .23	SN74LS390 .29	SN74S163 1.60	SN74290 .49	1N752 .01		16 PIN* .20	
SN74LS122 .23	SN74LS393 .29	SN74S174 .99	SN74365 .35	1N753 .01		18 PIN* .20	
SN74LS123 .23	SN74LS398 .37	SN74S241 1.40	SN74393 .83	1N754 .01		20 PIN* .21	
SN74LS125 .23	SN74LS399 .25	SN74S257 .65	SN75107 .68	1N755 .01		22 PIN* .23	
SN74LS126 .23	SN74LS422 .33	SN74S258 .65		1N756 .01		28 PIN* .30	
SN74LS132 .26	SN74LS423 .41	SN7400 .19		1N757 .01		40 PIN* .42	
SN74LS136 .15	SN74LS440 2.30	SN7402 .19	LINEAR	1N758A-10 .01		* - GOLD	
SN74LS138 .23	SN74LS441 2.30	SN7404 .21	SN75113 1.05	1N759 .01		AVAILABLE AT	
SN74LS139 .23	SN74LS442 2.30	SN7405 .21	SN75114 .77	1N914 .02		ADDITIONAL	
SN74LS151 .19	SN74LS443 2.30	SN7406 .25	SN75115 .77	1N964 .01		COST	
SN74LS153 .19	SN74LS444 2.30	SN7407 .25	SN75116 1.48	1N965 .01			

THIS IS A ONCE ONLY, NEVER TO BE REPEATED OFFER !

- * Minimum order value \$25.00.
- * Prices subject to change without notice.
- * All prices plus Sales Tax if applicable.

ADD \$3.00 POST & PACKING

We have just rationalised our product base, and need to liquidate this stock to make way for new products. Enquire about our full semiconductor range: HITACHI, ITT etc. Excellent products at competitive prices.

OFFER APPLIES TO OCTOBER ONLY OR WHILE STOCKS LAST

STC-Cannon Components Pty Ltd

VIC.

248 Wickham Rd.,
Moorabbin, Vic., 3189
Phone: (03) 555 9566
Telex: AA30877

N.S.W.

605 Gardeners Rd.,
Mascot, N.S.W., 2020
Phone: (02) 693 1666
Telex: AA26304

W.A.

396 Scarborough Beach Rd.,
Osborne Park, W.A., 6017
Phone: (09) 444 0211
Telex: AA93748

S.A.

66 Humphries Tce.,
Kilkenny, S.A., 5009
Phone: (08) 268 7088
Telex: AA88095

QLD.

Cnr. Montague Rd. & Victoria St.,
West End, Qld., 4101
Phone: (07) 44 6667
Telex: AA43025

SP1081

Floppy disk drives

transition will occur as the read/write head contacts the oxide surface of the disk; that corresponds to a logic 1. If no data bit is sent, there will be no magnetic transition and thus the oxide is unchanged, representing a zero, as shown in Fig. 6.

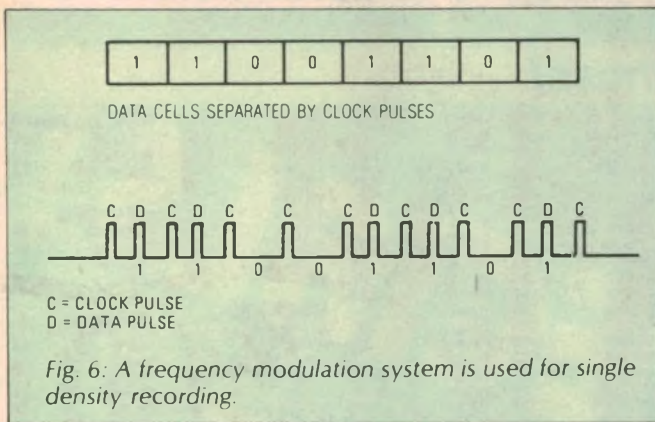

When reading data from the disk, the stream of pulses would include the 250kHz clock pulse and pulses representing ones and zeros. When a data cell includes a clock pulse and a data pulse, the presence of the two pulses identify a logic 1; the presence of only the clock pulse indicates a logic 0. That encoding technique is called FM encoding and is commonly referred to as single-density.

With FM encoding, the IBM 3470 format specifies a recording density of 3408 bits-per-inch. Thus, with 77 tracks, 26 sectors, and 128 bytes-per-sector, a total of 256,256 bytes can be stored on a single-sided 8-inch disk.

To double the storage capacity, a double-density technique was developed based on an MFM (Modified FM) encoding. Basically, many of the clock pulses are removed and the presence of a pulse signifies a logic 1 while the absence represents a logic 0. Synchronisation is accomplished by inserting a clock pulse at certain intervals. By eliminating many of the clock pulses, more room for data is available within each sector and twice as much information can be stored on a given length of track using MFM encoding rather than FM. Of course, there is a tradeoff... more sophisticated pulse-circuitry is required for clock timing and data writing.

Other techniques have been developed to increase the storage capacity of disks even farther. One scheme involves the use of drives with two read/write heads, one for each side of the disk. Thus, data can be stored on both sides of the disk. Some manufacturers have even introduced a quad-density recording technique that they claim will offer four times the storage capacity of a single-density drive.

Table 1 lists the unformatted storage capacity for both 5¼ and 8-inch disks using various data storage techniques. As shown, a single-sided single-density minifloppy (5¼ inch) provides 128,000 bytes of storage capacity while a double-sided double-density 8-inch disk provides almost two megabytes. In practical terms, a single-sided minifloppy would hold the equivalent of 30 single-spaced typewritten pages while the 2-megabyte capacity of a double-sided double-density 8-inch floppy could hold as many as 400.

Those storage capacities, however, are for unformatted disks. After the disk is formatted, the data-storage capacity decreases depending on the formatting technique used. The actual storage capacity of a double-density 8-inch disk formatted with 77 tracks and 26 sectors-per-track is around 1.1 megabytes. A dual-drive, double-density, double-sided 8-inch disk drive system can store over two million bytes.

Obviously, the added capacity of the double-sided double-

sided double-density technique is a definite asset. However, drawbacks include the lack of standardisation. Thus, a double-density diskette prepared on one system very often cannot be used with another disk system. Double-sided drives also have a drawback. Here, two read/write heads are used — one acting as the pressure pad for the other. Excess head wear and/or diskette damage is more likely to occur than with single-sided systems.

Access time and transfer rate

In addition to storage capacity, access time and transfer rate are important specifications for a disk drive. Access time is the time it takes for the drive to access data in a random manner. Thus, the access time depends on the time it takes for the read/write head to arrive at the proper track (track-to-track seek time) and then wait for the data in the proper sector (latency time). Specifications for disk drives generally list an average access time derived by using one half the unit's poorest access time. Maximum, or worst, latency time is when the read/write head arrives at the proper track just as the correct sector passed by. In that case the head must wait for a full rotation of the disk and thus produces the maximum delay.

Typical average track-to-track seek times vary from 3ms to 100ms for an 8-inch disk drive and 3ms to 25ms for a 5¼-inch disk drive. Latency time (average) for an 8-inch drive is about 85ms and about 100ms for a minifloppy. Total access time for an 8-inch drive might range from 150ms to 300ms and about 400ms to 600ms for a minifloppy.

The transfer rate, or speed at which the disk drive can transfer its data to the computer, is another measure of disk-system performance. Obviously, a quick access time and rapid transfer rate means the computer can start to perform its operations with less time wasted. Typically, a single-sided minifloppy can transfer data at a 15 kilobytes-per-second rate and at twice this speed with double-density techniques. An 8-inch disk can transfer data at typical rate of 62.5 kilobytes-per-second, although models are available with transfer speeds as high as 125 kilobytes-per-second.

Disk-system components

So far we've talked about the floppy disk and the disk drive. However, a complete floppy-disk system consists of more components, as shown in Fig. 7. So, let's list all of the components that make up a complete disk system.

5¼-inch Floppies			
Type	Sector Type	Unformatted Storage Capacity (Kilobytes)	Transfer Rate (Kilobytes Per Second)
Single-density/ single-sided	Soft	128	15.6
Single-density/ dual-sided	Soft	256	15.6
Double-density/ single-sided	Soft	512	31.2
8-inch Floppies			
Single-density/ single-sided	Soft	400	31.2
Single-density/ dual-sided	Soft	800	31.2
Double-density/ single-sided	Soft	800	62.4
Double-density/ dual-sided	Soft	1,600	62.4

Table 1: Storage capacity for various disk formats.

SUPER 80 PRICE SLASHED

Because such a huge number of SUPER 80 Computer Kits have been sold, many of the development costs have been amortised. Therefore where possible, we have slashed our prices accordingly.

it had to happen!

Are you fed up with 'built up' projects?

Why not build this very high quality kit computer and save over 50% on equivalent built up units!

A FULL SIZE COMPUTER KIT

You are supplied with a full board including power-on EPROM monitor, 16K of RAM, cassette interface (relay activated) for universal control of any tape recorder, TV modulator and direct video output PLUS full size professional keyboard — not a 'feel less' toy.



OVER 2,000 SOLD!

SAVE \$50!

ALL THIS FOR ONLY

\$245

Cat. K-3600

~~WAS \$295~~

OUR MOST POPULAR KIT EVER!

Any extra parts shown in illustration are sold as separate, chargeable items

OPTIONAL EXTRAS

Transformer (M-2325)	\$24.50
BASIC Interpreter (tape) (K-3602)	\$13.25
IC Socket Set (K-3603)	\$13.25

Yes, this would make the fully assembled computer with above options

ONLY \$296.00!

THE FANTASTIC

SUPER 80

Construction details and a full copy of the EA article is supplied with each kit. We also have available two very comprehensive manuals to assist in construction and programming:
 SUPER 80 Technical Manual (B-3600) \$9.50
 SUPER 80 BASIC Handbook (B-3602) \$9.50
 This book has over 50 separate versatile commands. Features arithmetic and integer functions, user-defined functions, machine language routines, text editing, string operations. Also contains 25 error codes to assist you in programming

- ★ ★ ★ ★ ★ ★ ★ ★ ★ ★ ★ ★ ★ ★ ★ ★
- ADVANCED OPTIONS AVAILABLE:
- | | |
|--|---------|
| Lower Case Generator Option (K-3607) | \$50.50 |
| BASIC in EPROM (K-3604) | \$50.75 |
| S-100 Expansion Unit (K-3606) | \$21.00 |
| Metal Case (H-3200) | \$41.25 |
- ★ ★ ★ ★ ★ ★ ★ ★ ★ ★ ★ ★ ★ ★ ★ ★

DICK SMITH ELECTRONICS

See page 98 for address details



Bill Edge's

ELECTRONIC AGENCIES

115-117 Parramatta Rd. Concord 2137
(Corner Parramatta Rd & Lloyd George Ave)
Telephone (02) 745 3077 (two lines)
117 York St. Sydney Phone 29 2098

TRADING HOURS
BOTH STORES
Mon-Fri 9am-5:30pm
9am-8pm
Thursday 9am-12pm
Saturday

bankcard
welcome here

TEST EQUIPMENT ★ SEMICONDUCTORS ★ COMPONENTS ★

NEW

Mail Orders:
PO Box 188
Concord
2137

MAIL CHARGES
\$5.59-99
\$10-\$24.99
\$25-\$49.99
\$50-\$99.99
\$100 or more

what else do we carry? HI-FI ★ KITS ★ TEST EQUIPMENT ★
All prices correct and goods in stock at time of going to press. Please phone to check current availability

\$2.00
\$3.00
\$4.00
\$5.00
\$6.50

All heavy or bulky items
(over 20 kg) sent Come,
Road Freight \$10.00
anywhere in Australia.

PEERLESS SPEAKERS

Woofer

- CE2132 KD120 WFX-PP 12" WOOFER 100W RMS POLYPROPYLENE CONE \$92.00
- CE2118 KPI00 WFX-PP 10" WOOFER 90W RMS POLYPROPYLENE CONE \$57.50
- CE2116 EP825 WFX-PP 8" WOOFER 50W RMS POLYPROPYLENE CONE \$47.00

Midrange

- CE2092 KA20 DMR DOME MIDRANGE 100W RMS \$49.00
- CE2090 KU45 MRF CONE MIDRANGE 80W RMS \$28.00

Tweeters

- CE2020 KO10 DTD DOME TWEETER 100W RMS \$27.50
- CE2018 LK10 MDT DOME TWEETER 50W RMS \$17.00

All these Peerless speakers are used in the PAS25.60.100 Kits featured in this magazine previously



"CAR ALARM"

Look at the features

- Built in siren, 120 db at 1 metre
- Built in Vibration sensor
- Triggered by current drain if doors are opened
- On off switch is hidden in car and is wired to negative of coil which means when switch is on car cannot be started
- Auxiliary normally open lead supplied for boot/bonnet or stereo

LE8595 \$75.00



FREEZER ALARM KIT

See EA Oct 82

KE1627 \$21.50

This beaut little kit will buzz you when your freezer fails. Complete with box and all parts



SPEAKER GRILL CLIPS

Have you ever noticed how expensive speaker grills are held on. They use a plastic clip in plug and socket. Now you can have them on your speakers instead of velcro tape

CE2761 \$1.99 Set of 4 FOR 1 SPEAKER BOX



2 STORES — CONCORD AND SYDNEY

OPEN THURSDAY TILL 8 pm

DIGITAL READOUT KIT

See EA Oct 82

This readout will be featured in a future project. It covers from broadcast band right up to 30 mhz short form kit — case and panel not supplied

KE4076 10 mhz Version \$41.00 add
KE4077 for 30 mhz \$7.50



SPEAKER PROTECTOR KIT

See ETI Oct 82

The ultimate in speaker protectors. Needs no power supply, unit runs from amplifier output signal. Suits amplifiers from 20-1000 watts. Parts list only kit

KE2077 \$18.50 mono.



EPROM PROGRAMMER KIT

See ETI Oct 82

No more loading programmes through push button switches. This unit will load a programme directly from disc or cassette. Loads in minutes. Suitable for most eproms

KE1890 \$43.50



300 WATT INVERTER KIT

See June 82 EA

Run your 12 volt appliances in your car. Great for power strikes. Kit includes everything even handles

KE4085 \$195.00



DC-DC INVERTER KIT

See ETI Sept 82

Suitable for running ETI power modules ETI470, ETI477, ETI480, ETI499 from 12 volts. Full kit.

KE1700 \$35.00

STEREO SYNTHESIZER KIT

Refer E/A Sept '82

KE3020 \$55.00

This kit gives you stereo sound from a mono source, like your video



"SCREAMER"

Operation voltage 6-12 volts S.P.L. 120 db at 1 metre alternate frequency 12 khz 15 khz very ear piercing sound

LE8922 \$34.50



"SIREN"

12 volt operation S.P.L. 116 db at 1 metre

LE8924 \$22.50

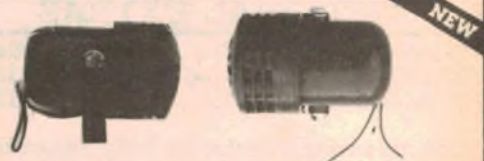

SAVE PETROL AND MONEY

Transistor Assisted Ignition Kit and Breakerless Ignition Kit combined work extremely well to save you petrol and money

Transistor Assisted Ignition Kit KE1825 Breakerless Ignition Kit KE1850 BUY BOTH TOGETHER FOR ONLY \$49.00

ELECTRIC FENCE KIT

See EA Sept 82

KE1635 \$15.00

Coil not included

AUDAX SPEAKER KIT

Speaker kit includes 2 200 mm bextrene coned woofers and 2 25 mm dome tweeters and crossovers. Cabinet kit includes 2 enclosures with input panels, grills and badges

Other manufacturers who have used Audax speakers include Monitor Audio, Mission, Meridan, IMF, Bozak, KEF and AMW

CE2450 Speaker Kit \$199.00 pair.
CE2490 Cabinet Kit \$99.50 pair.

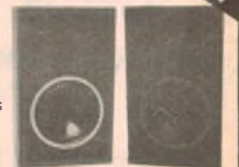

6 HOUR TURNAROUND ON MAIL ORDERS

Floppy disk drives

1. The floppy disk itself.
2. A disk-drive assembly to rotate the disk and position the read/write head to the desired track position. Inside the cabinet that houses the drives is a power supply to provide the operating voltages to power the drives.
3. A disk controller to specify head position, control the drive motor, check and correct errors, and perform other functions.
4. Interface circuits to connect the computer control-signals properly to the disk controller.
5. Programs (software) to control the operation of the disk drive, such as specifying to which track and sector of the disk data should go, handling the actual reading and writing of data, and monitoring that the data transfer is correct. Those programs are called disk-operating systems (DOS's) and they operate with a file management system (FMS) to identify files of data and route data to individual tracks and sectors on the disk.

The disk controller has the responsibility of read/write head positioning, sector identification, disk-motor control, head loading and unloading, error detection and correction, and of controlling the transfer of data to the interface circuits between the disk drive and the main computer. In most instances, the interface board contains the disk controller circuitry. This board mounts inside the computer and is connected to the disk drive(s) by a ribbon cable.

The disk-operating system (DOS) controls the operation of the controller circuitry. It resides on a floppy disk. One of the functions of the DOS is to transfer data and programs between the computer and the floppy-disk system. Thus, when you first turn on the computer system, it is necessary to load the DOS from the floppy disk into the computer. That task is handled by a short program called a bootstrap loader. The bootstrap loader is contained in a ROM, usually on the interface board. Depending on the computer system, the bootstrap program is called up by a simple keystroke on the computer's keyboard. Once the system has been "booted", the computer and floppy-disk system are ready to accept operator commands. The DOS takes care of labelling the files, editing, error detection, and file copying. A file-management system designates the track and sector allocations on the disk for files.

Since the DOS occupies a rather substantial portion of a diskette, a system with only a single floppy-disk drive is rather limited. Thus, it is common for packaged computers, such as those offered by Radio Shack, Apple, and others, to include two or more floppy-disk drives. One disk controller can generally handle several disk drives.

After the diskette is inserted through the front door of the floppy-disk drive and the door is closed, the drive spindle grips the centre of the diskette and the motor brings the disk up to full rotational speed. The DOS directs the controller circuitry to position the read/write head to track 00 and the index hole, in conjunction with an optoelectronic sensor, generates a location pulse for timing. As the floppy disk spins, the heads are carefully positioned above the desired track. Then, the read/write head is pressed against the oxide coating with the help of pressure pads on the opposite side of the disk. That is called "head loading" and it is directed by the DOS. When a different track is desired, the read/write head is unloaded (lifted off the surface of the disk), moved to a different track, and loaded once again.

Before the read/write head is actually loaded, a sensor inside the drive senses the write-protect notch and determines whether the floppy disk can be written to. Of course, during a read operation, the notch is not sensed. When the read/write head is loaded, a LED on the front panel of the drive alerts the user that the drive is in operation and the disk should not

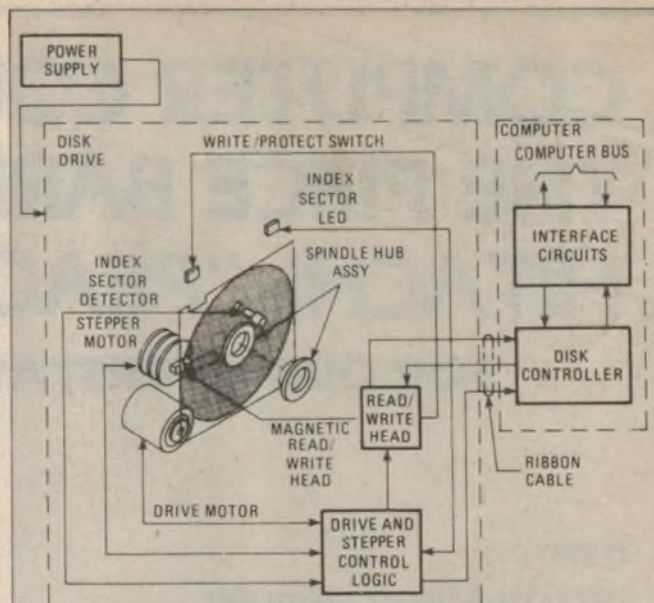

Fig. 7: Components of a floppy disk drive system.



be removed. When the drive completes its operation, the read/write head is unloaded, the LED goes out, and the disk may be removed.

Just as a computer is useless without proper software, so, too, is a disk drive. A well-prepared disk-operating system (DOS) is required to keep track of what is stored on the disk, and where it is located. The DOS handles such tasks as transferring programs from one device to another, locating read/write errors, providing a means to make backup copies of a diskette, and other chores.

Although basically similar, most DOS's are unique in their own way, and vary from one manufacturer to another. The DOS must be configured for the particular computer system it is to be used with. Also, if you decide to buy software on disk, the software must be compatible with the DOS. That condition also includes high-level languages such as BASIC.

Disk errors

Disk errors are categorised as either soft or hard errors. Hard errors are caused by defects on the disk surface; soft errors are due to program or processing troubles or power-line tran-

COMPUTER COUNTRY BREAKS THE PRICE BARRIER ON HITACHI "PEACH" EQUIPMENT

FOR OUR INTERSTATE CUSTOMERS ONLY

ITEM	REC RETAIL EX TAX	COMPUTER COUNTRY EX TAX
Hitachi Microcomputer 24K, ROM, 32K, RAM, Microcoft Level 3 Basic	\$1495	\$1199
Hi-Resolution Colour Screen	1149	950
MPI Disk Drive (includes cable)	537	475
Disk Drive Controller Card	175	150
Green Phosphorous Monitor	370	250
Star Dot Matrix Printer	565	499
16K RAM Card	139	120
Light Pen	320	280
Dual Double Density Double Sided Disk Drive Unit with Controller (1.5 Megabyte capacity)	2005	1700

These prices do not include sales tax, add 20% if applicable. Sale prices are effective till October 31 or until prior sale of existing stock.

Service on the "Peach" is available nationwide through the Peach network of dealers.

Terms are cheques with orders. Freight is collect. For schools and government departments who require terms. Please add 2% service charge for 7 days nett with official purchase order.

Come to

Computer Country (Nationwide) Pty Ltd

338 QUEEN STREET, MELBOURNE, VIC 3000.

Ph: (03) 329 7533.

sients. An example of a soft error is what is commonly called a seek error, which occurs when the read/write head appears at the wrong track. Part of the disk-controller's job is to locate and correct those disk errors. For example, the disk controller will compare the track being read with the track number that was called for by the DOS and determine whether a discrepancy exists. If a deviation is noted, the disk controller will initiate a new positioning routine.

A soft error is also classified as a recoverable error, one that the disk controller can spot and (sometimes) correct. A hard error is a non-recoverable error; the controller can detect it but cannot correct it.

It is estimated that a soft-sector disk system has an error rate of one per 108 bits during a read operation; one per 1011 bits during a read operation is the estimate for a hard-sectored disk. Under normal usage a disk is expected to last about two years; a track is considered to be worn or defective when its output level drops to 20% of its original value.

Is a backup copy necessary?

A backup is an exact duplicate copy of a disk. A backup copy is almost mandatory since it can be expected, sooner or later, that a disk will become defective due to wear, or dust contamination, or possibly due to the read/write head's damaging the oxide coating of a disk. When that calamity occurs, and a backup copy has not been made, it will be necessary to reconstruct the lost information (if still available) and prepare a new disk.

How critical the data is, how often it changes, and how costly the loss will determine how frequently a data backup copy should be made. Large investment houses or banks might back up data every hour; small-business users perhaps only once a week. To make creating backup copies convenient, the DOS usually contains a command for duplicating disks.

Selecting your disk drive

Computers and their peripherals are costly. So selecting a computer, printer, disk drive, or other accessory demands a hard look at the future, as well as the present. Among the questions to be answered are: What capacity do, and will, you need? A novice, or someone interested in games, can possibly be content with a cassette system and need not invest in a floppy system at all. Others, requiring a mass-memory storage capacity of, say, 250K bytes may settle for a single-drive unit — bearing in mind that an 8-inch disk holds twice as much data as a 5¼-inch diskette at less than double the cost. Generally, a single disk controller and DOS can operate up to three drives; thus it is common to start with a minimum investment and gradually add more drives to it.

Is the disk-drive hardware and software you have selected compatible with your computer? Your computer, keyboard, printers, and display must interface with the disk-system's electronics and DOS. Is the software you intend to use available for the disk system you are about to purchase? How important to you is access time and data transfer rate? Is size critical? Are there any unusual environmental considerations?

And, of course, there are basic considerations that must always be evaluated. How long has the manufacturer, whose units you are considering, been in business, what is his reputation, what is his warranty policy? Are there local places for service or must units be shipped back to the factory? Will spare parts be readily available? Also, it's wise to ask dealers and members of computer clubs about the experiences with the models you are considering. Do they have a good record in their field? Don't hesitate to ask questions before the final purchase . . . once you've bought the disk system, you'll be tied to it for a long time.

Reprinted with permission from *Radio Electronics*, October, 1981. Copyright © Gernsback Publications, Inc.

**AS FEATURED IN SEPT
ELECTRONICS AUSTRALIA!**

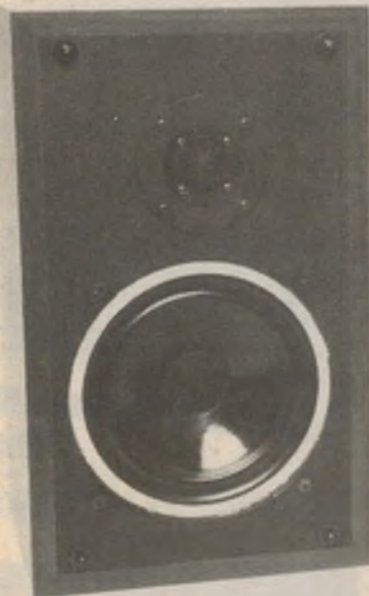

AUDAX

THE COMPACT 200, A QUALITY SPEAKER SYSTEM THAT DOESN'T COST THE EARTH.

We've designed the Compact 200 for the home constructor so you get top quality at a low price. We supply speakers and electronics and you make the cabinets, or if you wish you may purchase speakers, electronics and assembled cabinet kits. Either way the job is simple and the results are great. Two top of the range Audax drivers are used, the HD 100 D 25 tweeter and the HD 20 B 25 J 4 C 9 Bextrene Bass/Mid driver. They are teamed with a crossover network specially designed to exploit the natural characteristics of both drivers and with a cabinet of compact size which still enables the bass/mid range driver to work with great efficiency. The result, a low colouration compact speaker system with a well extended and controlled frequency response. A speaker system to team with the best of source material. (And watch out for our sub-woofer to team with the compact 200 coming up soon)

SPEAKERS, ELECTRONICS KIT \$199 rrp
CABINETS (PER PAIR) \$99.50 rrp

Interstate and country mail orders through our Sydney or Melbourne offices please add \$6 postage for speakers/electronics kit and \$15 freight for 2 cabinets

Available from — NSW — **Electronic Agencies** 115 Parramatta Rd. Concord ph: 745 3077 and 123 York St. Sydney ph: 29 2098 **Northpoint Hi Fi** 100 Miller St. Nth Sydney ph: 922 7780 **Newcastle Hi Fi** 642 Hunter St. Newcastle ph: 2 2400. **The Soundlounge** Wallis St. Forster ph: 54 7447 **Taree Photographics & Hi Fi** 105 Victoria St. Taree ph: 52 1488 **Portsonic Hi Fi** William St. Pt Macquarie ph: 83 4667 **Vic — Ellistronics** 289 La Trobe St. Melbourne ph: 602 3499; **J. H. MaGrath's & Co.** Melbourne ph: 663 3731; **Rod Irving Electronics** 425 High St. Northcote ph: 489 8131; **Trevor Lees** 114 High St. Kew ph: 862 2315 **QLD — Jacques Electronic Systems** 193 Given Terrace Paddington. Brisbane ph: 369 8594 **TAS — Beta Electronics** 131 Bathurst St. Hobart ph: 34 8232

AUDAX LOUDSPEAKERS Head Office — 32 Wilson St, Oakleigh Vic. 3166 ph: (03)543 5266 (AH) 579 5196 Sydney — PO Box 181 Granville 2142 ph: (02) 682 4133.

ROD IRVING ELECTRONICS FANTASTIC OCTOBER KIT SELLOUT

Post & Pack \$2.50 small kits, heavier kits add extra postage — Prices subject to change without notice. Send 60c and SAE for pricelists. Phone (03) 489 8131. — MAIL ORDERS: PO Box 235, Northcote, Vic 3070.

ON SCREEN GRAPHIC ANALYSER \$109.00

The On Screen Graphic Analyser links your hifi to your TV set.

Features:

Six colour bar graph display (Standard PAL receiver)

Ten vertical bars in the display corresponding to the 10 octave bands

Gives you the best sound quality your system can deliver

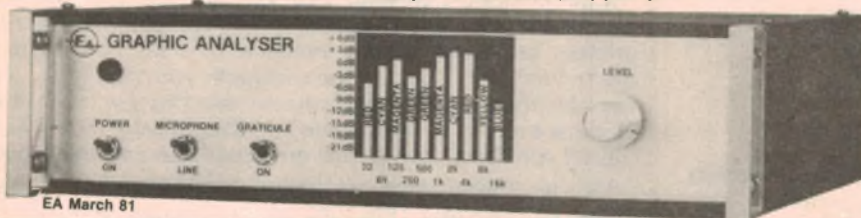

EA March 81

CAR BATTERY MONITOR \$8.50

Fiat Battery! Don't get left out in the rain. Install a voltage monitor which monitors the state of your battery at a glance. EA, October 80.

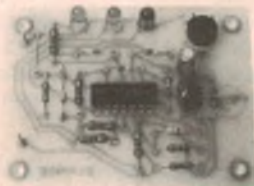

UNIVERSAL RELAY BOARD \$12.50

Operating a relay to switch heavy current or mains voltages is a common requirement in electronic control applications. This project permits a relay to be switched in a variety of ways and from a variety of inputs. ETI May 81



CUDLIPP

\$12.00

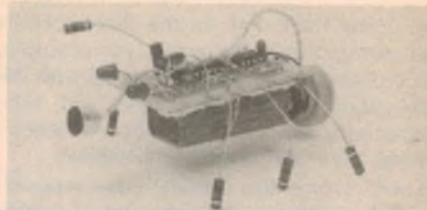

A fascinating Electronic Cricket with just two ICs. The Cudlipp can be used to bug your Home, Office or Board Room. Great fun. EA February 82

FM WIRELESS MICROPHONE \$7.50

HOBBY ELECTRONICS May 81



AM TUNER \$89.00

ETI 475 September 80



\$8.00

MINI DRILL SPEED CONTROLLER

Here's an easy to assemble project for a simple speed regulator for miniature DC electric drills. ETI July 81



LOW FUEL INDICATOR EA March 81

\$14.95



ELECTROMYOGRAM \$89.00

ETI Top Projects Vol 6



SLOT CAR POWER SUPPLY \$18.50

ETI December 81



SERIES 4000 SPEAKER KITS

Speakers \$450.00
Speaker Boxes \$220.00
Crossover Kits \$179.00



EPROM PROGRAMMER EA July 80



\$72.50

HUMIDITY METER. \$19.50

ETI 256



BRIDGING ADAPTER

ETI March 82

\$9.95



SLIDE CROSS FADER \$79.00

EA November 80



EPROM PROGRAMMER

\$39.50

No need for a Micro with EA's great Eprom Programmer suitable for 2716/2758 Eproms.

With Textool Sockets \$51.00
EA January 82



DUAL TRACKING POWER SUPPLY

\$83.50

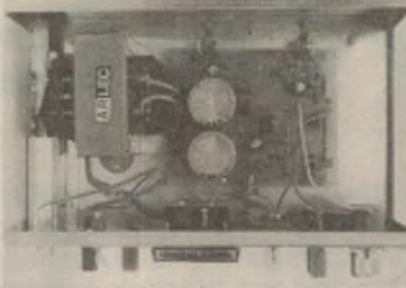

Built around positive and negative 3-Terminal Regulators, this versatile dual tracking Power Supply can provide voltages from $\pm 1.3V$ to $\pm 22V$ at currents up to 2A in addition, the Supply features a fixed +5V 0.9A output and is completely protected against short circuits, overloads and thermal runaway EA March 82

SOUND TRIGGERED FLASH

\$26.50

This easy to build sound or light operated flash trigger has many features. Catch those spectacular and humorous moments like that time your mother-in-law slipped on the moss covered patio and broke her neck ETI 568 October 80



ELECTRONIC METRONOME

\$16.90

Great new Metronome Circuit with low current drain (less than one milliamp) drives a Loudspeaker and a Led indicator EA January 82



VOICE OPERATED RELAY

\$14.95



EA's great new Voice Operated Relay can be used to control a tape recorder, as a VOX circuit for a transmitter, or to control a slide projector. EA April 82

"LE GONG"

\$14.95

The "Le Gong" Doorbell with those unmistakable chimes generated by the LSI! A must for the man who has everything! EA February 81



3 1/2 DIGIT LCD CAPACITANCE METER



Handy pocket size Digital Capacitance Meter, runs off a 9V battery and measure 1pF to 1999uF in just three ranges EA March 82

\$69.00

LED LEVEL METER

\$27.00

Build a Led level Meter with simultaneous peak and average display plus 60dB dynamic range. This kit is ideal for any application requiring a wide dynamic range level display ETI 458 June 81



DIGITAL THERMOMETER: 3 1/2 DIGIT LCD

\$69.00

Measure temperatures from below freezing point to around boiling point. EA February 82



FUNCTION GENERATOR \$79.50

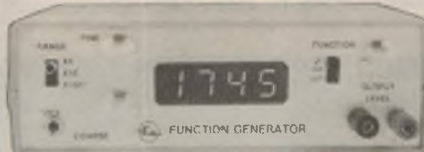

This Function Generator with digital readout produces Sine, Triangle and Square waves over a frequency range from below 20Hz to above 160kHz with low distortion and good envelope stability. It has an inbuilt four-digit frequency counter for ease and accuracy of frequency setting EA April 82

LOTTO/POOL'S SELECTOR

\$22.50

You have to be in it to win it. Take the chance out of winning the Pools as well as Lotto and build the great new Pools/Lotto Number Selector EA July 81



LARGE SCREEN TV STORAGE CRO ADAPTER

\$109.00

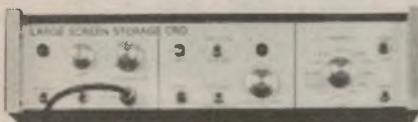

For a low cost Storage CRO with Synchronised Display, Electronic Graticule, One-Shot Triggering and Optional Storage of up to four Screen Displays it can't be beaten. EA February 82

LOW OHMS METER

\$34.50

How many times have you cursed your Multimeter when you had to measure a low-value resistance. Well alas, with the "Low Ohms Meter" you can solve those old problems and in fact measure resistance from 100 Ohms down to 0.005 Ohms. ETI 158 November 81



ELECTRONIC ORGAN

\$59.00

"Electrotune" ... it's not for your car. It's a 23-note Organ with Special Effects. Singalong with this fun to build Organ and amaze the family and neighbours like never before. EA July 81



SOUNDBENDER

\$29.00

Have great fun creating your own recording effects with music and voice. The Sound Bender can receive from Electric Guitar, Microphones, etc. ETI February 82



300W AMP MODULE \$63.00



Blow the doors off your house with the Playmaster 300 Watt Amplifier and your neighbours for that matter also. EA June 80

ETI 660 WITH OPTIONS

Kit inc PCB, ICs, S.Kts \$99.00
Colour Option \$13.50
Video Modulator In \$14.50
Pluggack to Suit BVAC/1A \$11.95
Set of 4 (2114 Rams) \$17.00
3K Upgrade \$17.00
18 Keys plus Scotchcal Labels \$29.00
ETI October 81



An English design based on a custom microprocessor

Voyager Car Computer

Following hard on the heels of EA's car computer project published in July, August and September, 1982, is the fully assembled Sparkrite Voyager which is made in England and sold in Australia by Jaycar Pty Ltd. It is very well designed and presented and is supplied with a full installation kit.

by LEO SIMPSON

When we first saw the Sparkrite Voyager car computer, we were "cheesed off" to say the least. After the many frustrating months spent in the development of our own Car Computer based on readily available electronic components we were now faced with a commercial unit which seemed to offer all the features of the EA unit and a few more to boot.

Euphemistic expressions such as "Aaarggh!!" and "Gad" and "Pon my soul" were heard to be uttered in the EA office.

Having made these unofficial sounds, an official reaction had to be delivered to the people from Jaycar. Accordingly,

acknowledge that while our Car Computer has generated a great deal of interest, there are probably quite a few readers who would wish to purchase a fully assembled unit at some extra cost.

And so it was that your Editor found himself spending a pleasant late winter's day installing the Voyager on his ancient but much-loved 1973 Kingswood. In fact, some of the EA wags were heard to make sly comment about the proposed installation "doubling the value of the Kingswood".

These idiots were ignored.

The presentation of the Voyager is such that it should blend well with the interior styling of most cars. The external

ceed with this assumption in mind.

Sixteen pushbuttons and a three-position slide switch control the Voyager. The four immediately underneath the five-digit display are used for calibration and time-setting while the other 12 are set in four columns each of which is headed under one of the four titles: Log, Now (meaning instantaneous), Trip and Alarm.

The three buttons in the LOG column are fairly self explanatory: Distance, Fuel and Average Consumption. These are overall values since the computer was last reset which would normally be done at the beginning of a long holiday journey or when the fuel tank is filled.

Similarly, the buttons in the NOW column are explanatory and give instantaneous values for Speed, Time (12-hour) and fuel consumption. The TRIP buttons are Speed (average for a trip), Time (since starting the trip) and Distance (to the present time). Speed and Time alarm functions are also provided.

Fuel tank range and time remaining functions, as featured in the EA com-



The Voyager car computer can display fuel consumption in three ways: Miles/gallon, miles/litre and litres/100km.

we dropped the whole into the nearest wastepaper basket and proceeded to forget the whole matter. At least, that is what we would have liked to do. Having lived with our pet project for so long and having finally seen it come to fruition, we wanted little to do with this interloper.

Naturally, good sense prevailed and we meekly agreed to review the Voyager. In any event, we had to

housing is a low-sheen black finish which will match the vinyl upholstery found in many later model cars. Similarly, the gold finished buttons and highlights on the control panel will certainly not look out of place.

Anyone considering purchase of the Voyager will almost certainly be familiar with the EA Car Computer and will inevitably draw comparisons. We will pro-

puter, are not provided.

No less than six small incandescent lamps provide illumination of the control buttons just mentioned but there are no LEDs (as on the EA job) to show which function is currently being displayed.

In appearance, the Voyager looks considerably more compact than the EA unit but the actual measurements indicated that the only real difference is in the

depth and this may or may not be an advantage, depending on the actual installation. Dimensions are 200 x 70 x 90mm (W x H x D) but the practical depth will depend on the mounting arrangement used.

There is a subsidiary "heatshield" inside the main case so that even if the unit is subject to direct sunlight, the electronic componentry should not overheat. Even so, I am not sure that I would like to see the unit exposed continuously to Australian sunlight on the dashtop of a closed car. I have seen what that can do to tape cassettes. Imagine what a Salvador Dali painting of cassettes would be like and you have a good idea of what happens.

Inside, the circuitry is contained on a sandwich of two double-sided PC boards. One board carries the 16 pushbuttons and six incandescent lamps and clips to the other with the aid of a two-way and a 13-way connector. The main board carries seven ICs, a three-terminal regulator and 13 transistors.

The 40-pin microprocessor chip is a dedicated Motorola device, with mask-programmed ROM plus RAM, with a power down feature for some of the RAM. The clock is derived from a 4.194304MHz crystal which is built around a 4521 oscillator and 24-stage divider IC. This IC gives one-second pulses for the various housekeeping functions.

The keyboard is connected directly to the data lines of the microprocessor while the fuel and distance sensors are interfaced via a quad op amp IC for signal amplification and shaping.

The five-digit vacuum fluorescent display is multiplexed and interfaced to the address lines via octal buffer ICs. Also connected to the address bus is a 144102 RAM Chip. High voltage and heater supply for the vacuum display is provided by a ringing-choke inverter using a potcore transformer.

The audible alarm device is a piezoelectric device made by Toko, Japan. The only other high-technology component is the 10-lead monolithic resistor array which is adjacent to the microprocessor.

Clearly, the Sparkrite Voyager design points up the advantages of a custom-designed microprocessor with mask-programmed ROM over the EA design which uses readily available chips. The advantages translate to a design with one major chip instead of three, and a smaller PC board. On the other hand, in justification, the EA design was produced with the average hobbyist in mind, who may even want to "burn" his own ROM. Certainly, all the bits and pieces for the EA job should be available for quite a few years to come.

One cannot help but be impressed with the completeness of the installation

kit for the Voyager. It arrives well packed in polystyrene foam with full instructions. There is a comprehensive installation instruction sheet, an operating manual and a circuit diagram. A number of different mounting options are possible for the computer itself while a full set of hardware is provided for the sensors.

Installation

The fuel sensor is a turbine with an optical pickup, very similar to the EA transducer. It is supplied with plastic tubing and plastic fuel pipe clamps, adaptors and a T-piece. Installation was a fairly straightforward process although I unfortunately had to completely remove the fuel pump because the brass union was "frozen" onto the steel fuel pipe. Resealing steel fuel pipe connections against slow fuel leaks is a problem but teflon tape wrapped around union threads is an effective solution.

I also used a number of small nylon cable ties to keep the wiring within the engine compartment neat and tidy. These were not supplied but can be purchased cheaply enough.

The speed pickup device is a coil with a thousand turns and a bolt through the centre which is positioned within 50mm of magnets strapped to the drive shaft. Four magnets are supplied. Four are used for a front-wheel drive installation (or rear engine) and two for a conventional rear drive car. Each magnet is held in a

twice actual consumption, which was a little unnerving.

I immediately concluded (having realised what had happened) that the saddle arrangement was a poor design feature and it was not until I later consulted the installation diagrams that I realised my mistake (fool). I tell this story merely to emphasise how easy it is to make a mistake.

The hardest part of the whole installation was drilling a suitable hole for the wires through the engine compartment bulkhead. The manufacturers suggest a 1/2-inch hole and supply a grommet to fit but few domestic electric drills will take a bit of this size. I used a 3/8-inch drill and fitted a suitable grommet. You have to pick the site fairly carefully too, to avoid pipes and cables. Unfortunately, the spot I chose to drill went right through a gusset which must have been 3mm thick and seemed especially tough, probably because it was a welded section. If only I had been 2cm to the right . . .

Electrical connection

Voyager supply a number of Scotchlok connectors for breaking into the automotive electrical system without cutting and stripping wiring. This has a considerable advantage in that they are quick and easy. However, my car uses Utilux quick-connect terminals on the rear of the fuse panel so I elected to use more of these to facilitate easy removal

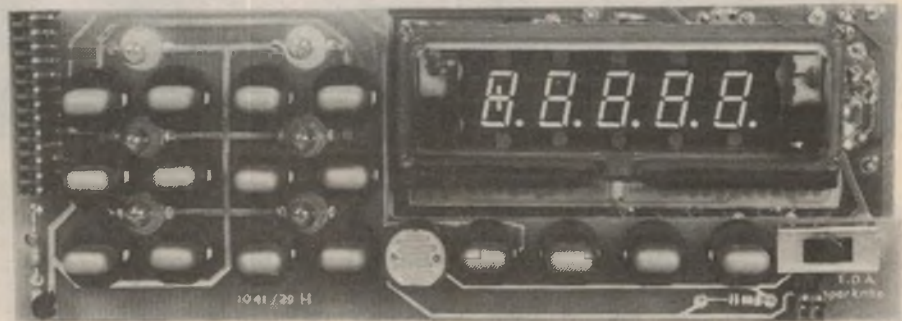

The keyboard and mainboard are sandwiched together by connectors at each end. Six incandescent lamps illuminate the keyboard during night driving.

plastic saddle arrangement which has a loop through which is passed a long nylon cable strap. This holds the magnets very securely.

After some days of using the computer I found that I had made a mistake in installing the magnets. This was annoying since it had seemed straightforward enough at the time. In fact I had made two mistakes. First I had used four magnets instead of two and I had passed the strap underneath the magnets rather than over them. The result was that two of the magnets were flung off while driving at 80km/h. This immediately gave rise to readings of half actual speed and

of the computer wiring if need be. Voyager also supply two inline fuseholders which use solderless connections and so are very easy to install.

As mentioned before, there are a number of mounting options for the computer itself. Most of these make use of a double ball-joint system which allow the computer to be held in any attitude to suit the driver. One arrangement even allows the system to be console mounted on top of a swan-neck which looks very jazzy. Each mounting system involves the use of a slide-in foot assembly. This together with a 13-way connector (which is clearly labelled

"wrong way" to indicate incorrect polarity — very thoughtful) facilitates quick and easy removal.

In fact, on reflection, the Voyager is far too easy to remove. Will it represent the prime "burglar bait" for 1983? I intend to install the unit more permanently "in dash" to reduce this possibility and make the unit less visible to sharp-eyed and nimble-fingered pilferers.

Driving experience

How did it go in actual use? Well, every function worked without any hitch although one must avoid the temptation to look at the display when traffic conditions are heavy. The range of fuel consumption figures is just as wide as would be returned by the EA car computer. For example, consumption can rise to 60 or 70 litres/100km when accelerating heavily and rise to ridiculous figures in the high hundreds when coming to a complete stop.

the dash to the left of the numerals when indicating fuel consumption. This always looked like a minus sign to me so there tended to be a mental double-take every time I glanced at the display. I must also admit to finding the metric units for fuel consumption much easier to mentally absorb while driving. When you put your foot down you expect a numerically higher figure and that is what you get.

I tried using the "MPG" function as an alternative to "litres/100km" and found that did not make sense when driving as it is an inverse function. And I say that even though I must admit to converting back to MPG from metric units when I calculate consumption figures.

The third option for fuel consumption, "miles per litre" is just too silly for words. Not only is it an illogical mixture of units but it gives values which are silly, as I found when I switched across to it inadvertently while driving.

There is certainly no doubt that a car computer such as this can be a worth-

sumption rather than the absolute values. Ideally, a computer should give both analog and digital displays so that there is little need for the driver to divert his attention from the road.

I have not used the time or speed alarms but they could be useful on a long trip, particularly the speed alarm. The headlight alarm is very good, with its six-chime warning which is effective without being too insistent or annoying.

A very good feature of the Voyager concerns what might be called an "interrogate" facility. Even with the ignition off, you can wake up the computer by pressing any of the Log, Now or Trip buttons for more than one second. The computer will then light up for six seconds to show the time or whatever. Very handy. But if your kids happen to touch the buttons while you are out of the car, and the ignition is off, they cannot accidentally reset any of the parameters held in memory.

All in all, I was impressed. A great deal

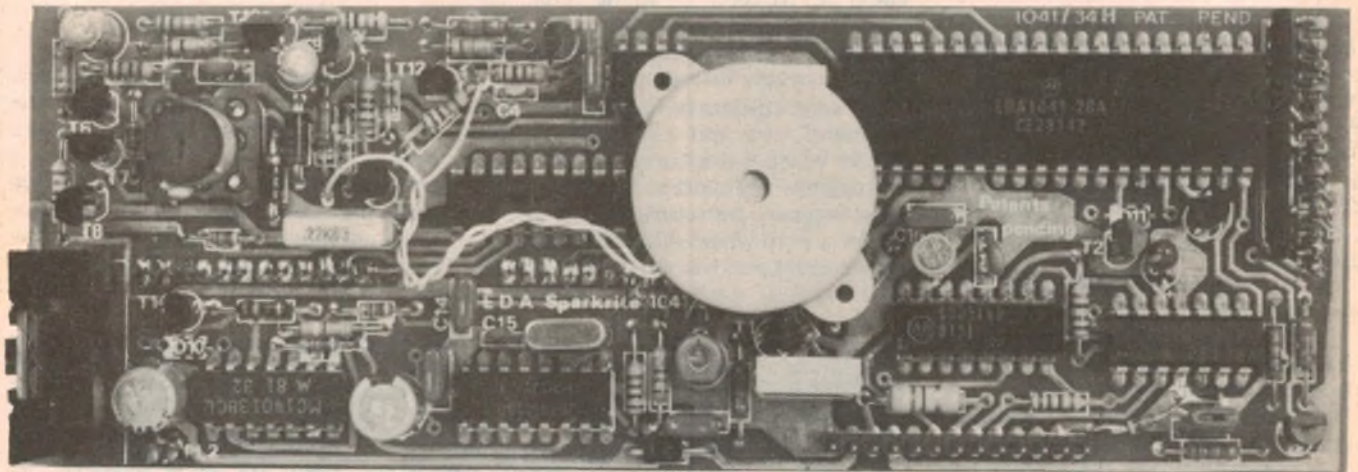

There is a small delay after the ignition is turned on before the computer display lights up. This is probably due to the thermal lag in the heater for the vacuum fluorescent display. Strangely, the display is actually green but it has been fitted with a red filter which renders it orange and somewhat less attractive than it otherwise would be. I think a green filter would have been better.

The brightness of the display is controlled by an LDR. This seems to work well since I was not at all conscious of its operation. Even so, in strong sunlight (coming in from the side of the car) the display is unreadable (as is the LED display in the EA car computer). That is another point that needs to be considered in installation — how to best shield it from ambient light.

The high voltage inverter does make a buzzing sound while in operation but this is not obtrusive and most drivers would probably be unaware of it.

One point that I did find offputting was

The component side of the main Voyager board: The custom microprocessor is at top right and the large disc is the piezoelectric alarm.

while aid to economical driving habits, provided you take notice of the display. I was surprised at just how frugal a big six-cylinder car with auto transmission can be when driven at light throttle settings. Figures around 8 litres/100km (35mpg) could be readily achieved by "driving with an egg under your foot" without holding up traffic at all but aggressive "cut-and-thrust" driving is precluded. Not a bad thing at all.

With consistently careful driving, following the feedback provided by the computer, the average driver who covers around 16 to 20,000 kilometres per annum could well recover the cost of this car computer inside two years.

To be realistic though, the digital display is not the most appropriate medium to illustrate this useful feedback. An analog display would be more useful most of the time as the driver is more interested in the trend of fuel con-

of thought has gone into the production of this unit and most electronic enthusiasts should have no real problems in making a neat and tidy installation (no more than I did, anyhow). In their advertisement Jaycar state that the typically competent EA reader would do the installation in three to four hours. As a non-typical (dare I say competent?) example, I took the best part of a whole day. Sure, someone with experience of a few installations would probably only take an hour or so, especially if the car could be put on a hoist.

Anyone who opts to pay \$39.50 for a complete installation will get good value for money and without any grease under the fingernails or barked knuckles.

Similarly, at \$199 fully assembled and tested, the Sparkrite Car Computer must be rated good value for money. It is a difficult choice: build the EA job or buy the Sparkrite? (L.D.S.)

**MASSIVE
BREAKTHROUGH!**

CAR COMPUTER BELOW \$200

SEE REVIEW
OCTOBER EA
PAGES: 26,27,28.



COMPLETELY BUILT
AND TESTED —
NOT A KIT!!

MADE
IN ENGLAND!
— QUALITY!!



**only
\$199
complete**

CONTAINS EQUIVALENT OF
THOUSANDS OF TRANSISTORS
— USES MASSIVE CUSTOM
LSI CHIP TO ACHIEVE
LOW PRICE

Never before has such a comprehensive car performance computer been offered at such a low price!! Once again miracle microprocessor technology has enabled us to pass enormous savings on to you!! But don't let the low cost fool you. The "Voyager" car computer IS THE MOST COMPREHENSIVE PRODUCT THAT WE HAVE SEEN. No other car computer matches this one AT EVEN TWICE THE PRICE! You could buy a \$20,000 Holden and not get a better car computer!! Just check the features. We are sure that you will calculate that the "Voyager" represents outstanding value!

FEATURES

- INSTANT FUEL CONSUMPTION IN LITRES/100KM AND MPG!! (MOST OTHERS HAVE ONLY ONE OF THE ABOVE) JUST SWITCH FROM ONE TO THE OTHER AS YOU DRIVE ALONG.
- INSTANT SPEED, TIME AND OTHER FUEL DATA.
- VISUAL AND AUDIBLE EXCESS SPEED ALARM.

INSTALLATION

The "Voyager" comes complete with an unbelievable array of mounting configurations, on dash, under dash or stalk mount. ALL installation hardware is supplied (even a roll of insulation tape!) as well, of course, as the speed and fuel sensors. A lavishly illustrated installation manual is provided as well as a comprehensive operators manual. If you do not want to install the unit yourself we can do this for you for a guaranteed \$39.50*. (A few exotic cars excluded!). A typically competent EA/ETI reader would do the job in 3-4 hours.

* Sydney metropolitan area only.

VOYAGER OPERATING FEATURES



JAYCAR

125 YORK ST SYDNEY 2000
Ph. 2646688 Telex: 72293
Mail Orders To:
Box K-39 Haymarket 2000

POST AND PACKING CHARGES: \$3.85 up to \$20, \$10.84 up to \$240, \$25.84 up to \$350, \$50.89 up to \$400, \$100 up to \$500.

NEW SHOP HOURS: Mon-Fri 9:30 to 5:30pm, Sat 9:30 to 12:00pm, Thurs night to 9:30pm.

YOUR BUDGET PROBABLY WON'T STRETCH TO AFFORD OUR PROFESSIONAL SERIES ALL ALUMINIUM RACK CABINETS

NOW YOUR PREAMPS, AMPS, CONTROL MODULES MONITOR PANELS ETC. CAN LOOK EVERY BIT AS GOOD AS TECHNICS, NAKAMICHI AND OTHER TOP MANUFACTURERS

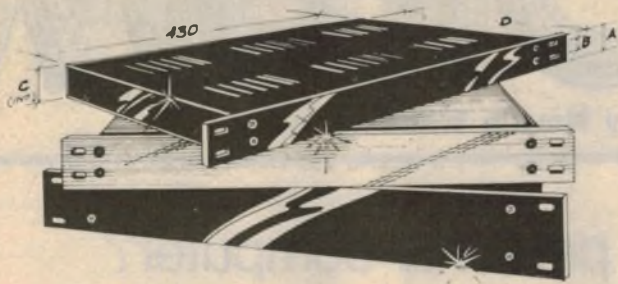

Cat No.	Finish	A	B	C	PRICE	5 or More
H 0401	Natural	44	34	38	\$39.50	\$38.00
H 0402	Natural	88	57	82	45.00	42.50
H 0403	Natural	132	89	126	49.50	45.00
H 0411	Black	44	34	38	39.50	38.00
H 0412	Black	88	57	82	45.00	42.50
H 0413	Black	132	89	126	49.50	45.00

Beware of other rack boxes that do not conform to international rack sizing.

ALTRONICS RESELLERS

Please note that resellers may not have all the items advertised in stock, and as resellers have to bear the cost of freight, prices may be slightly higher than advertised. ALTRONICS reseller prices should however represent a considerable saving over our competitors' prices.

SOUTH AUSTRALIA	QUEENSLAND
CITY ADN Electronics 212 5505 Protronics 212 3111	CITY Delsound P/L 229 6155
SUBURBAN PROSPECT Jensen Electronics 269 4744	SUBURBAN SALISBURY Colourway Wholesale 275 3188 FORTITUDE VALLEY St. Lucia Electronics 52 3547
ELIZABETH GROVE A.E. Cooling 255 2249	BIRKDALE Wholesale Sound Accessories 207 2502
CHRISTIES BEACH Force Electronics 382 3366	COUNTRY CAIRNS Thompson Instrument Services 51 2404
KESWICK Freeway Electric Wholesalers 297 2033	TOWNSVILLE 72 2015
VICTORIA CITY All Electronic Components 667 3506 Eli-tronics 602 3499	ROCKHAMPTON Purely Electronics 21058
SUBURBAN FOOTSCRAY Acron Electronics 689 1911	GLADSTONE Pump Electronics 72 4321
CHELTENHAM Talking Electronics 550 2386	GYMPIE TV and Appliance Services 82 1671
HUNTINGDALE Stewart Electronics 543 3733	IPSWICH R & B Electronics 281 8001
SOUTH CROYDON Tristram Electronics 723 3860	TOOWOOMBA Hunis Electronics 32 9677 Down's Radio and TV 32 1044
COUNTRY SHEPPARTON G.V. Electronics 21 8966	NAMBOUR Nambour Electronics 41 1604
MILDURA Electronic and Digital Services 33 3380	NT DARWIN Radio, Paris Darwin 81 8508 Keele Electronics 81 4749 81 1491
NEW SOUTH WALES CITY Radio Dispatch 211 0191 Electronic Agencies 23 2098 Alyse 264 6688	ALICE SPRINGS Farmer Electronics 52 2967 Ascot Electronics 52 1313
SUBURBAN LEWISHAM Profax Electronics 569 9770	TASMANIA HOBART Beta Electronics 34 8232
CONCORD Electronic Agencies 745 3077	KINGSTON Kingspan Electronics 29 6802
DEE WHY David Ryall Electronics 982 7500	AVOCA Preston TV 84 2166
WAITARA Applied Technology 487 2711	WEST AUSTRALIA ALBANY BP Electronics 41 2681
MATTRAVILLE Creative Electronics 666 4000	GERALDTON Gerrard TV and Radio 21 2727
COUNTRY BROKEN HILL Creative Electronics 48103	WYALKATCHEM D & J Peak 81 1132
COFFS HARBOUR Coffs Harbour Electronics 52 5684	MANDURAH Kenronics 35 5277
PENRITH King Electronics 21 2407	KALGOORLIE Today's Electronics 215 212
NEWCASTLE D.G. & Spence 69 1625	ACT Scotronics 54 8334 Electronic Components 80 4654
WINDANG Marsons Electronics 96 1956	
GOSFORD Tomsons Electronics 24 1246	
KURRI KURRI Kum Electronics 37 2141	

THE BRILLIANT MARC NR 82 FI

FEATURING: Digital frequency Display, SSB/CW, FM/AM reception, B.F.O., Double Conversion, Double Super-het, crystal controlled (VHF) Local Oscillator, 4 inbuilt antennas and good looks, you will spend hours just learning how to drive it!

FREE DELIVERY ANYWHERE IN AUSTRALIA
OCTOBER ONLY



See Review in Electronics Australia August 1982

- 3 Way Power
- Digital Tuning
- HI FI SOUND
- 4 Inbuilt Antennae

only \$349

SPECIFICATIONS:
Semi-conductors: 1-LSI, 4-IC's, 7-FET, 34-Transistors, 42-Diodes
Frequency range:
LW 145-360 KHz SW3 9-22 MHz VHF3 88-108 MHz
MW 525-1600 KHz SW4 22-30 MHz VHF4 108-136 MHz
SW1 1.6-3.8 MHz VHF1 30-50 MHz VHF5 144-176 MHz
SW2 3.8-9 MHz VHF2 68-86 MHz UHF 430-470 MHz
Power supply: AC 240V 50Hz. DC 12V (8 x "D" cells). Ext. DC 12V Car/Boat.
Speaker: 12.5cm Permanent Dynamic Speaker (3.2 ohm)
Antenna: Ferrite Bar Antenna for LW, MW and SW1
3 x Telescopic Antenna for SW, VHF and UHF
Controls: Power ON-OFF switch - Digital display ON-OFF switch - Tape-Radio switch, Wide-Narrow band selector switch, AM band selector (LW/MW/SW1/SW2/SW3/SW4), VHF band selector (VHF1/VHF2/VHF3/VHF4/VHF5/UHF), Ant. Selector (Telescopic ANT./EXT. ANT.), Tuning control (direct gear drive), volume control, Bass control, Treble control, Squelch control, BFO pitch control, RF gain control, Antenna adjuster control, Mode switch (USB-NOR-LSB/CW)
Terminals: Ext. Speaker/Headphone Jack, Tape IN-OUT jack, VHF/UHF ANT. connector (coaxial), SW EXT. ANT. terminal (Screw), Ext. battery jack
Meter: Tuning Meter
Digital Frequency Counter Section:
Display: LW/MW/SW-1 KHz SW2-4/VHF1-5 MHz
Control: SW Calibrator Dimensions: 452mm (W) x 288mm (H) x 130mm (D)

RESELLERS WANTED IN ALL AREAS (including WA)

Phone: STEVE WROBLEWSKI (09) 381 7233 for details

NEW 24 HOUR 7 DAYS P/WEEK PHONE ORDER SERVICE FOR BANKCARD HOLDERS

Take advantage of "off peak" low STD phone rates and phone your order to our new recorded 24 hour order service. Give your name, address with postcode, phone number, bankcard number and expiry date then your order—and presto your order will be processed and back to you in a flash—Please nominate Jetservice if you want overnight delivery

\$2 DELIVERY AUSTRALIA WIDE We process your order the day received and despatch via Australia Post. Allow approx. 7 days from day you post order to when your receive goods. Weight limited 10kgs.

\$4 DELIVERY AUSTRALIA WIDE We process your order day received and despatch via Jetservice for delivery next day.

BANKCARD HOLDERS CAN PHONE ORDER UP TO 8PM (EST) FOR NEXT DAY DELIVERY - SOUNDS INCREDIBLE DOESN'T IT? Alright you cynics just try us! Weight limit 3.3kgs. Jetservice cannot deliver to P.O. box numbers (Australia Post would have a fit).

\$10.00 HEAVY HEAVY SERVICE - AUSTRALIA-WIDE All orders over 10kgs must travel on the heavy service, that is - road express. Delivery time 7 days average.

ALTRONICS

105 STIRLING ST., PERTH FOR INSTANT SERVICE

(09) 328 1599

All Mail Orders:

Box 8280 Stirling St., Perth WA 6000

ALTRONICS ... ALTRONICS ... ALTRONICS ... ALTRONICS ...

ALTRONICS ... ALTRONICS ... ALTRONICS ... ALTRONICS ...



FORUM

Conducted by Neville Williams

What do you expect of a personal computer?

Before investing in a new motor car, a wise person will give due consideration to a whole range of factors: price, size, comfort, road handling, reliability, economy, re-sale value, and so on. One may have to accept certain limitations, consciously and with good grace. But I wonder whether the same degree of perception is brought to bear in the purchase of a personal computer.

This complete departure from recent themes in "Forum" was triggered by a letter from M.L. in Cairns, Queensland, who also signs himself "EA 2650 owner".

The letter was headed: "Please publish! Do you have the courage?"

Perhaps I should observe that challenges to an editor to publish or publish "unaltered" have little practical influence on the fate of a letter. If the contents are timely and appropriate, they will receive favourable consideration; if they are not, the space will more likely be allocated to someone else's effort, challenge notwithstanding.

As it transpired, M.L.'s letter did give us reason to stop and think — although not involving the degree of trepidation that he seems to have anticipated. After a preliminary inquiry about another matter altogether, he takes up his main theme:

M.L.'s PROBLEM

As you have published quite a few build-it-yourself computer projects, 2650/Dream and now the Super-80 computer, I was wondering when the immoral practice of publishing these projects will cease.

The immorality could be tolerated if you published the following warning with each project: "Professional programs are not available for this project. It is not compatible with ready bought computers using the same CPU"

As I have since found out from a retired professor in electronics, the 2650 chip was originally developed for intelligent terminals and many firms had overstocked this item. So I am wondering if you were paid to shift dead stocks.

I had to stop and think because, although digital history, for us, covers lit-

tle more than a single decade, a great deal has happened in that time and one tends to forget the context. Some of what M.L. has to say must be looked at against an historical background, rather than through the eyes of October 1982.

We can all be very wise after the event!

Ten years ago, personal computers, as such, did not exist and our then editor, Jamieson Rowe, was trying to satisfy his curiosity about the new world of digital electronics by lunch-time access to (as I recall) a PDP-8 professional computer owned by our parent company. If it had been a Jules Verne time machine, it could not have been held in greater awe!

At that stage, the idea of an individual owning a computer of any description was a "pipe dream" — and I use the phrase deliberately, not as a cliché. With

prices as they were, we even used to debate the chances of ever possessing one as an editorial team; what chance our readers?

The only practical "poor man's" answer was a logic trainer of one kind or another and a number of these were developed and described in EA and other technical journals.

But, in August 1974, Jim Rowe came up with what we believed at the time to be the first-ever microcomputer for home construction, intended primarily to serve in an educational role. In fact, because it used an eight-bit word format, Jim had the bright idea of calling it the "EDUC-8" pronounced "Educate". Unfortunately, not every one caught on and we were frequently asked for back issues describing the "E-duck-eight"!

It transpired that, quite unknown to us, the American magazine "Radio-Electronics" had been preparing a constructional article around a microcomputer using the Intel 8008 chip. This was published about the same time and with the same objective in view: an affordable unit for tuition and self-education, and a huge forward step from a logic trainer.

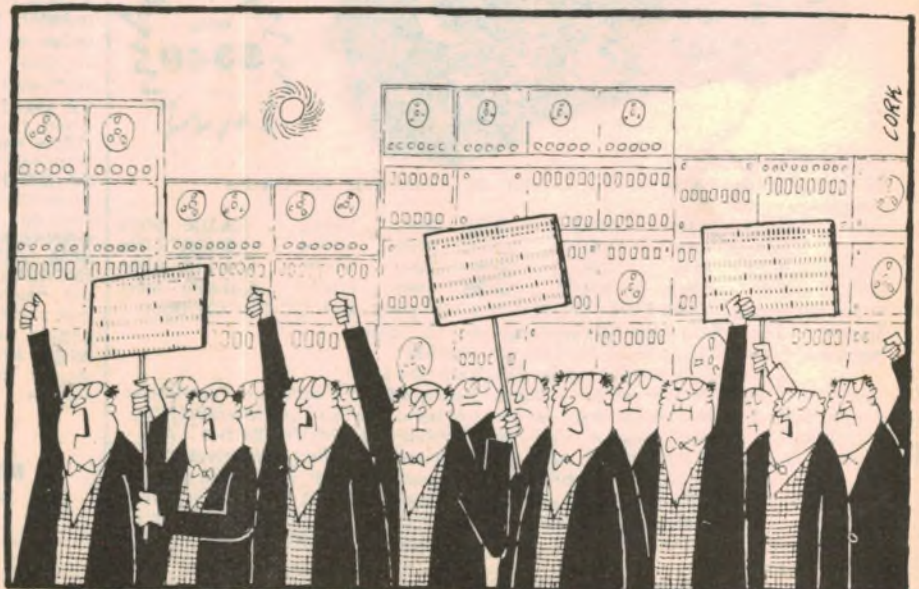

"We want justice . . . 01001100 11100001"

About three years later, in March 1977, Jim Rowe came out with another personal computer using the Signetics 2650 chip, distributed in Australia by Philips. It created a lot of interest among computer hobbyists – and I stress this word – so much so that EA staff member David Edwards was inspired to produce another 2650 "Mini" computer system in May 1978.

That's all history now but, on receipt of M.L.'s letter, I rang Jim Rowe and put to him the question:

"Why the special interest, in those days, in the 2650?"

His answer was quite unequivocal:

"Because the 2650 seemed to lend itself particularly well to a hobby computer of the type readers were looking for."

"Was the 2650 originally designed for use in an intelligent terminal?"

"Yes, but so were a number of other chips in those days, many of which ended up in limbo. It just so happened that the 2650 had the potential to become the heart of a quite powerful little micro. (Anyway, the Z-80 is the progeny of a long line of intelligent aunts)."

"Is it true that the 2650 was in glut supply at the time?"

"Quite the contrary; Philips had only a few samples in Australia and I'm pretty sure that they didn't realise that they had such a potentially interesting device in their catalogue. I had to lean on them to get them to bring in sufficient stocks to support the project."

WHAT WE SAID:

These statements are confirmed by the article in the March 1977 issue, which refers to the 2650 and 2608 ROM having been in short supply, with the 2650 representing a particular problem. It went on: "Happily this situation has now changed for the better. Just a few weeks ago, we learned from Philips Industries that the 2650 and 2608 chips were now readily available and at low cost."

Unfortunately for M.L., none of this accords with his story about the 2650 having been misapplied and used only because "many firms had overstocked the item". Further, that we might have been "paid to shift dead stock".

You know, I've seen people get upset about allegations less serious than that!

Looking back over the files for the same period, I was reminded of the "Mini Scamp" microcomputer, presented in the April 1977 and subsequent issues by Dr John Kennewell, of the Physics Department of Newcastle University (NSW). Using the National Semiconductor 15P.8A/5000 SC/MP microprocessor

chip, it was summarised as "the ideal way of getting into the exciting world of microcomputers at low cost".

Again, in a series beginning April 1979, we described the "DREAM" computer, using the 6800 chip and designed by Michael Bauer of the Division of Computing Mathematics at Deakin University. It was described as having been "designed especially for beginners" with a strong emphasis on tuition and self-education.

Indeed, this theme motivated and dominated all the early approaches to home-built computers: to acquire one at an affordable price, to discover what computing was all about and to gain hands-on experience. To acquire a computer was an end in itself.

DIFFERENT SITUATION

Since then, however, personal computers have become progressively more accessible, in homes, clubs, schools and even in computer shops outside of school hours. With the greater familiarity has come the consciousness that, beyond the learning stage, personal computers can fill a useful role. As I implied, right at the outset, the role may not be well understood but the expectation is there.

It would seem that this is at the root of M.L.'s disappointment. He has become involved in a 2650-based computer, has learned something of the technology and now wants to put it to everyday practical use. As a source of software programs, he had high hopes of a users group. But, alas: according to M.L.: "The 2650 users group has folded after one issue of their bulletin."

I can understand M.L.'s disappointment but the 2650 simply didn't belong to the era of plentiful wide-ranging commercial software. It was certainly not promoted to hobbyists on that basis and I fail to see how any charge of business morality could be justified.

When questioned further on the matter, Jim Rowe put it this way:

"In its day, the 2650 was a good chip, and one that even had certain advantages. But, when Tandy and other companies opted for the Z-80 and other such chips, the 2650 fell behind."

"It's rather like the tape recorder situation. One might own an open-reel deck that's fine for making your own recordings; but try to buy pre-recorded open-reel tapes, these days!"

"The market emphasis has swung to cassettes."

And that brings us to the present crop of personal computers, including the "Super-80", based on a Dick Smith kit.

M.L. has this to say:

"I wonder if the Super-80 is even partially compatible with the 8080 or other System 80 sets? You have often written

Train as an Electronic Tradesman

The Army has a limited number of opportunities for men and women to train as Electronic Tradesmen.

Successful applicants will be trained as specialists in many aspects of Army electronics, which include installing, maintaining, modifying and repairing military communications equipment, radar equipment and laser sight systems. After basic training and trade assessment 12 months formal electronic training will begin.

Enlistment is for 6 years which includes further training and the experience necessary to obtain civil recognition as an Electronic Tradesman. Full adult pay is received during training.

Applicants must be over 17 but under 35 years of age on the day of enlistment. Parental consent is required for applicants under 18 years of age.

All applicants must have completed Year 10 with good results in English, Mathematics and Science/Physics. The normal Army medical and selection standards must be met. Since the number of applicants is limited you should phone an Army Careers Advisor; call at your nearest Commonwealth Employment Service or send the coupon for more information.

212 1011 (Sydney); 635 1511 (Parramatta); 254 76 (Newcastle); 28 6492 (Wollongong); 216 111 (Lismore); 61 3731 (Melbourne); 21 1588 (Geelong); 55 2248 (Albury); 43 8008 (Bendigo); 31 1240 (Ballarat); 226 2626 (Brisbane); 71 6784 (Townsville); 212 1455 (Adelaide); 34 7077 (Hobart); 31 1005 (Launceston); 82 2333 (Canberra); 325 6222 (Perth).

Army Adult Tradesman Scheme, GPO Box XYZ in your capital city.

Name _____

Birthdate / / _____

Address _____

Postcode _____

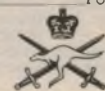

Army Adult Tradesman Scheme

Authorised by Director General of Recruiting, Dept. of Defence. AAT115.251.92

CHRISTMAS GREETINGS



**TO OUR
NEW ZEALAND
CUSTOMERS**

**BUILD YOUR
OWN COMPUTER
KIT THIS
CHRISTMAS**

The DICK SMITH SUPER 80

a professional
sized computer
you build yourself!
COMPLETE WITH INBUILT
POWER SUPPLY



\$445 NZ

Senous computer users and first time users alike can use this incredible computer. Works with any TV set and is extremely easy to build. AND you get a huge 9K of BASIC — comparable with computers costing \$1,000 or more! Cat K-3600

ACCESSORIES FOR THE SUPER 80

BASIC ON CASSETTE

The BASIC program for Super 80 on cassette. Cat K-3602

~~WAS \$29.90~~

NZ \$14.50

SAVE ALMOST 50%!

EPROM BASIC

If you don't have time to wait for a cassette to load then the EPROM is the way to go. A set of 3 EPROM IC's with the BASIC and monitor programs already stored inside them. Cat K-3604

~~WAS \$120~~
SAVE \$40!

NZ \$79.50

IC SOCKET SET

It is essential to use the IC socket set when building the SUPER 80 to facilitate any necessary repairs in the future. Cat K-3603

NZ \$18.50

S-100 EXPANSION

Socket required for S-100 expansion. Cat K-3606

NZ \$29.75

SUPER 80 MANUALS

These two comprehensive manuals will assist you in the construction and programming of your SUPER 80

SUPER 80 TECH MANUAL Cat B-3600 \$13.95 NZ

~~WAS \$12.90~~ SAVE \$3.55

SUPER 80 BASIC H/BOOK Cat B-3602 \$12.95 NZ

~~WAS \$40.00~~ SAVE \$6!

**GIVE YOUR
KIDS A HEAD
START ...**



DICK SMITH'S COMPUTERS FOR KIDS

Written for kids in a language they'll understand, this fantastic book provides an ideal way of getting them started. Cat B-6190

ONLY \$875 NZ

QUALITY AUTO - RANGING DIGITAL M. METER



At last — a fantastic full auto-ranging budget priced multimeter! Ideal for field, lab, shop, home or bench applications. Incredible value! Cat Q-1446

**LOOK AT
THIS PRICE**

ONLY \$69.00 NZ

**IDEAL
GIFT**

A WATCH IN A PEN!

A superbly styled pen with an LCD digital watch. Great for those who don't like to wear watches. Uses standard Parker refill. Cat Y-1030

\$19.50 NZ

4 Chan. Control

Be the envy of your fellow modellers and bring life to your models with this great digital proportional radio control! Cat Y-1240

ONLY \$279 NZ



The Dick Smith SYSTEM 80

**NEW MODEL!
EXTRA FEATURES!**

NZ's top value personal computer

There's never been a personal computer with all the features of the System 80 at such a ridiculously low price. Features like 16K memory (expandable to a max. 48K), built in cassette deck, flashing cursor, upper and lower case video display and lots more. Cat X-4005

ONLY \$1295 NZ

**WHY
PAY MORE?**

ECONOMY GREEN

PHOSPHOR MONITOR

For all senous computer users, this is the monitor for you. Provides a sharper, brighter image without giving you eye-strain. Cat X-1198

\$395 NZ

A DISCRIMINATING GOLD DETECTOR FOR

\$249.50!



Cat Y-1066.

Highly recommended for beginners, this amazing unit separates trash from treasure. Lightweight, handy and very easy to use.

Stop Press...
**AMAZING DICK SMITH WIZZARD
PERSONAL COMPUTER COMING SOON!**

DICK SMITH Electronics

98 Carlton Gore Rd, Newmarket,
AUCKLAND 1. Ph: 504 409

SHOP BY PHONE
USE YOUR
BANKCARD OR
VISA-CARD



DSE/A354/PAI

SAVE \$\$\$\$\$!

POST AND PACKAGE CHARGES:	CHARGES:
ORDER VALUE	\$1.00
\$5 - \$9.99	\$2.00
\$10 - \$24.99	\$3.00
\$25 - \$49.99	\$4.00
\$50 - \$99.99	\$5.50
\$100 or more	

Mail orders: PO Box 9452 Newmarket

about the incompatibility of VTRs; the computer business is in a worse shambles.

"Do something at least to write some translator Esperanto so that BASIC programs can be universally used."

Yes, we have deplored the incompatibility of VTRs. In fact, over the years we have deplored many things: the incompatibility of early 78rpm records, of 33 and 45rpm records, of quadrasonic systems, of TV standards and channels, of hifi rating systems, of audio tape specifications, and so on.

It would have been logical and convenient (superficially, anyway) if everything had been tidy and uniform in those areas, and I guess the same remark could apply to computers and programs.

But, behind a great many of the glaring inconsistencies which have plagued and characterised the electronics industry is the matter of patents and it is certainly true of the computer field — from personal to large business mainframes — in the guise of copyright.

In short, lack of compatibility in programs and software is not peculiar to a few home-built designs. It occurs industry wide and at all levels.

What M.L. presumably does not realise is that companies are not free to duplicate one another's programs, interpreters or compilers under pain of infringement of copyright. They either have to enter into an appropriate royalty arrangement or create variants of their own which may then become a candidate for copyright.

And there are also practical considerations, of which an elementary example occurred in Tandy's Level I and Level II computers. To make best use of the facilities in each, there were deliberate differences in the BASIC programming.

Again, there are evident differences in the approach to copyright in two com-

puters distributed by DSE. In the System 80, the designers chose to pay (and pass on) copyright charges giving them access to Tandy/Microsoft interpreter and thereby to Tandy software. Yet the designer of the Super 80 decided to do otherwise.

All these were commercial decisions with which individuals may agree or disagree, but the charge of "immorality" is somewhat misplaced.

As for M.L.'s remark about some computer "Esperanto" to help bridge the gap between software programs, we have seen at least one recent example of such technology. The big question-mark hanging over it is the possibility of it breaching copyright.

"Immorality" of the reverse kind!

So, like it or not, we face the situation where individual computers have their own specifications, their own capabilities, their own limitations and, of course, their own price level. They are offered without software, with a certain range of software, or claimed compatibility with software from other sources.

The wise purchaser will not just go out and buy a thing called a computer — any more than he would go out and buy a thing called a motor car.

The wise purchaser will give some thought to its role beyond the "I'd like one" stage.

Is it likely to be most used for mathematics or a teaching aid? For home management or small business? For indexing or filing? As a typing aid or word processor? For graphics where colour may be vital? Or mainly for games?

If M.L. can be upset because his humble 2650 kit computer no longer lives up to his expectations, how will you feel if a much more costly acquisition turns out to be a digital white elephant — because you didn't think far enough ahead?

Another problem: He can't read Japanese!

J.C. of Macquarie, ACT, is a very unhappy computer buyer, for reasons quite different from those of M. L. He is quite sure, he says, that most of us have had a good natured giggle, at the quaint Japanese-English that one encounters in the owner's manual for an inexpensive Japanese product.

But it is not easy to be amused when the product is a computer plus peripherals, running well into four figures.

The Japanese manuals appear to be well prepared, says J. C., but the English language manuals (?) are poorly presented, full of "ambiguities and incomprehensions" and incomplete.

"One knows that there exist such functions as Insert, Kill, List, Print, &c but must guess as to how they may be implemented; and there are a dozen or more error codes but absolutely no clue as to what they mean."

J.C. concludes: "I was all prepared to start hunting for a Japanese speaking person to help me translate, but why should I have to? I paid for documentation in the purchase price.

It's a pity because, otherwise, it's a damn good machine."

UV LIGHT BOX

- 4 X 20" UV Tubes
 - Electronic Timer
 - Sliding Tray
 - Safety Micro-switch
- \$295.00 (+S.T.)

DEVELOP/ETCH TANK

- Rigid PVC
 - Heater
 - Standard Hose Fittings
 - 24" Wide 12" High
- \$195.00 (+S.T.)
- 2 Compartment
\$285.00 (+S.T.)
- 3 Compartment

IDEAL 'IN HOUSE' EQUIPMENT FOR USERS OF:

- RISTON 3000 or other Printed Circuit Board
- 3M Scotchcal
- 3M Image 'N Transfer
- Electroplating

DISTRIBUTOR ENQUIRIES WELCOMED

KALEX

101 Burgundy St,
Heidelberg 3084
(03) 458 2976
Telex AA 37678
MELTON
(03) 743 1011

ELECTRONIC COMPONENTS & ACCESSORIES

- SPECIALIST SCHOOL SUPPLIERS ●



Audio-video Electronics

HIFI • HOME VIDEO • PROFESSIONAL AUDIO

A chicken-or-egg dilemma for Cherry Pie!

In case you should conclude that the writer of the above headline has at last gone around the bend, I hasten to confirm that the producers of Cherry Pie audiophile records are indeed facing a chicken-or-egg situation: should they take full advantage of modern recording technology now, or wait for playback equipment to catch up?

by NEVILLE WILLIAMS

The basic problem is not a new one. Arguments about the relative merits of recording and playback equipment have been in progress for almost as long as there have been modulated grooves on cylinders and discs.

What makes it newsworthy right now is that it's affecting audiophile recordists and audiophile listeners — you and you and you — and it's doing so right here in Australia.

In fact, it was brought to my attention by a phone call from Graeme Rule, Managing Director of Cherry Pie Records in Sydney, who said his piece, and ended

up with the question: "How do you read the situation?"

I could offer no new or instant answers, but I could undertake to talk about it in print, and this is what I am doing.

As I remarked a few lines back, the basic problem has been with us from the earliest days of recording. For as long as I can remember, there have been arguments about whether particular records are really "unplayable", or whether they only appear to be, because available pickups aren't equal to the task.

Recording engineers, with their exotic

lathes, amplifiers and cutting heads, have always liked to believe that they've held the technological initiative, and that they still hold it. Perhaps we should ask a company like Ortofon, who have a foot in both camps!

But, to start from scratch (no pun intended) the original groove is inscribed in the surface of a cylinder or disc by a cutting stylus which is subjected to a considerable amount of audio drive power. (This is particularly true of the electrical recording systems which were widely adopted in the late '20s).

With sufficient audio power applied, the tip of a recording stylus can be made to vibrate very freely in vertical, lateral or oblique mode, depending on the recording format. In so doing, it cuts a groove which contains a complex pattern of cyclic waveforms, serrations, kinks and corners. At least, that's what they look like under a microscope!

When copies of a recording reach the consumer, the groove has to be traced by a playback stylus — cyclic waveforms, serrations, kinks and corners alike — in order to recover the original audio signal. And here a problem arises.

MECHANICAL PROPERTIES

Even though a playback system may employ electrical amplification, the stylus itself, tracing a groove, is still a mechanical device involving a certain tracking weight, moving mass, compliance, stiffness, resonance and so on. More than that, additional mechanical qualities are introduced by the supporting arm and headshell, the turntable and even by the disc itself.

The combination of such characteristics determines whether the playback stylus can, in fact, trace a given groove, accurately or at all! The cyclic waveforms maybe have too great an amplitude, the serrations may be too fine, the kinks too devious and the corners too abrupt!



The Sydney Wind Quintet: Michael Scott — flute; Josef Hanic — oboe; Gabor Reeves — clarinet; Gordon Skinner — bassoon; Anthony Buddle — horn.

For sure, the recording industry follows certain frequency and amplitude conventions to help matters along (the RIAA standards) but the above remark still stands.

Minor mistracking can result in reduced treble response and/or a certain harshness in high frequency musical tones. More serious mistracking, with the stylus "rattling" in the groove will produce obvious distortion — plus record wear. In an extreme case, a stylus may simply jump tracks or, worse still, carve its way through a groove wall.

EARLY PROBLEMS

In the later '20s and early '30s, considerable argument followed the adoption of electrical recording methods. It became possible for engineers, not only to extend frequency response, but to record at a higher level, in the interests of signal/noise ratio. They had to restrain their enthusiasm, however, in the knowledge that many record buyers were still using mechanical phonographs with massive acoustic tonearms and an extremely stiff stylus mechanism.

In fact, the shadow of the acoustic phonograph remained on the disc record industry right through until after World War II. Phono pickups were lighter and stylus mechanisms more compliant than their acoustic counterparts, but that was scarcely much of a recommendation. They still used steel needles or other removable styli, screw chucks and suspension systems that were stiff and heavy.

Towards the end of the era, companies like Decca in the UK (with frrr) and, on a limited scale, AWA (Radiola) in Australia, tried to break through the traditional constraints with 78 rpm discs using finer grooves, improved specifications and a better moulding formulation. But they had to let it be known that such discs were really only suitable for use with what then passed for audiophile pickups.

After that, of course, we went through the exquisite agonies attending the birth of the LP disc, followed shortly afterwards by LP stereo. One could write a whole book about lower mass steel needles, magnetic chucks and jewel styli, including "cranked" designs intended to add a bit of compliance of their own.

And I guess, too, that a book could be written about the efforts of companies like Acos/Cosmocord to create a true audiophile version of the ubiquitous crystal/ceramic cartridge.

At about the same time Goldring (UK) were trying to re-exploit the magnetic principle, with innovative — if not always successful — ideas.

And, for good measure, every now and again, another company would come up with yet another idea: highly exotic, loudly proclaimed, then forgotten!

At right: the Funai video system. Below: the Eiki Analyser projector.



HANIMEX A-V ON SHOW

At a recent presentation in the Sydney Opera House complex, the audio visual Division of Hanimex displayed some of the products currently available.

Prominently on display was the portable video system (pictured above) manufactured in Japan by Funai but carrying the Hanimex logo for Australia. Claimed to be the lightest portable video system currently available, it uses a video cassette similar in size to an audio cassette.

For those requiring more conventional portable video equipment, Hanimex offer a VHS format system produced by a major Japanese manufacturer.

For further details of these items, or for a copy of the Hanimex Audio Visual Products catalog, contact Bert Heyman, Manager A-V Division, Hanimex Pty Ltd, 108 Old Pittwater Rd, Brookvale, NSW 2100. (02) 938 0230.

Dwarfing the video, however, was a display of Eiki 16mm film projectors, which Hanimex say now claim 76% of the Australian market. The one pictured at the right is the Eiki "Analyser", especially intended for the study of sportsaction, etc.

But the Eiki units on display ranged from a normal portable projector to a large pedestal model for auditoria, with others featuring autothread slot

loading, infrared control and automatic repeat.

An interesting demonstration was given of the "Soundpacer" cassette deck which can replay speech tapes at up to twice normal speed, while preserving the natural pitch of the voice.

Other items included slide projectors, overhead projectors and accessories, a combined cassette player and PA amplifier, and induction loop headsets, cameras, calculators, a Teletext adaptor and a variety of other items.

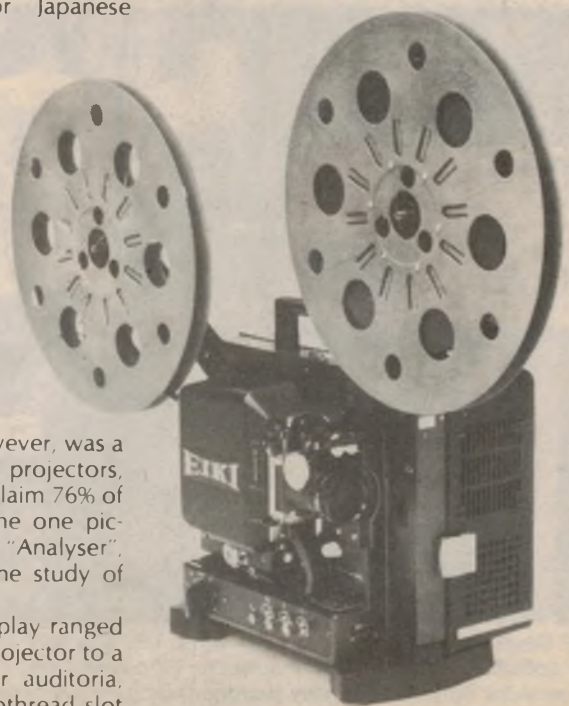

AUDIO-VIDEO ELECTRONICS — continued

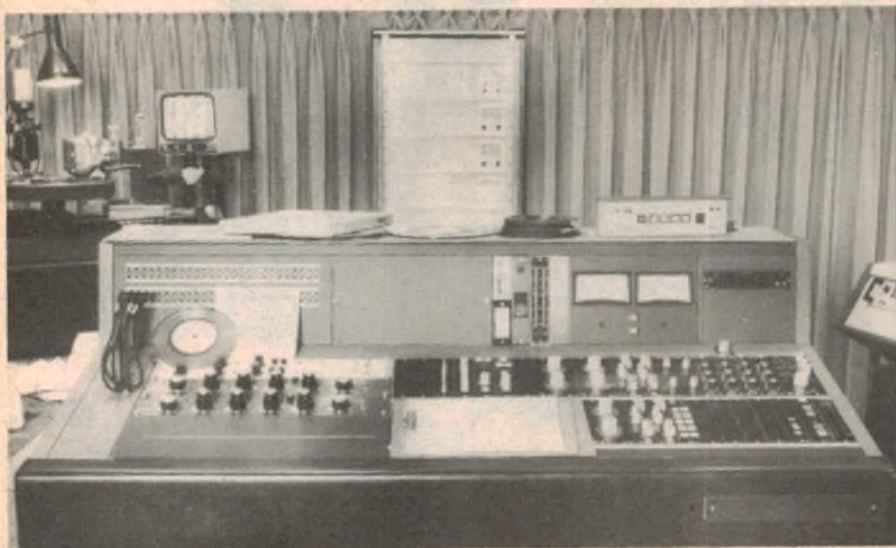

The console in Festival's recording centre provides all the necessary facilities for patching, equalising and monitoring the signals fed to the recording lathe (rear left). The rack behind the console contains the power amplifiers for driving the cutter and monitor loudspeakers, plus other ancillary equipment.

Why? Because dedicated audiophiles — many of them executives of these same companies — were seeking to recover from the record grooves every last vestige of signal information which recording engineers had managed to impart to them.

Yes, it's been a long, dogged quest, with the end of the playback rainbow always just a bit further down the track.

And now we've arrived at the borders of Digital Land, where everything promises to be different. But

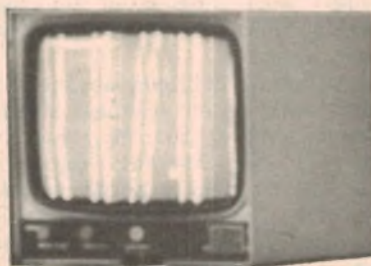

A close-up of the monitor screen (top left) displaying grooves as seen through the optical microscope.

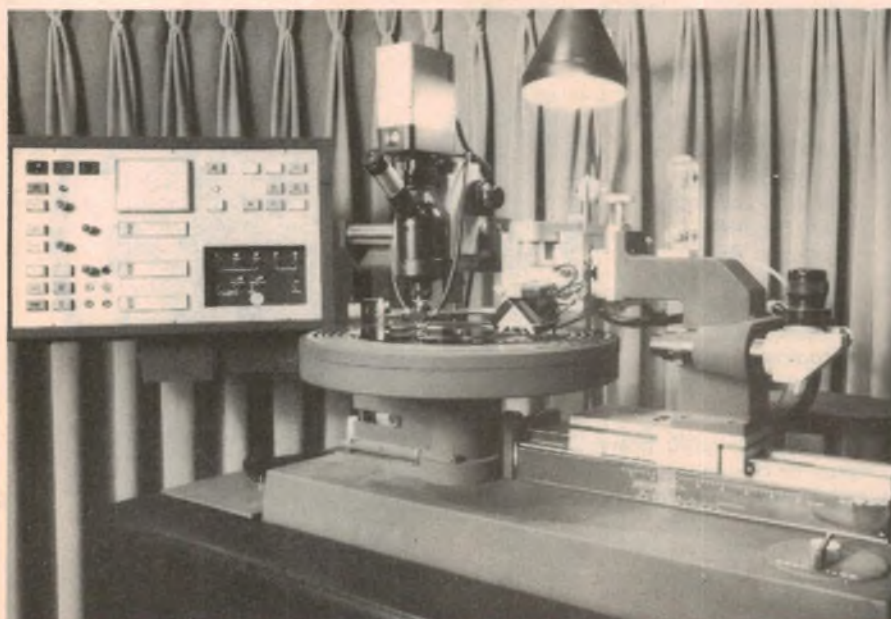

The Neumann VMS-80 recording lathe, the only one of its kind in Australia. Note the optical microscope and the macro TV camera which displays the grooves on a TV monitor screen, normally accommodated on the pedestal at right. The panel (left) is the logic control system for the automatic groove spacing.

notwithstanding that, we're still questing; still arguing about traditional methods. How much further can we refine the principle of recovering a signal with a tiny coil or a tiny magnet attached to a diamond stylus?

The latest burst of activity followed the emergence of digital tape master recordings. Phono cartridge designers suddenly found themselves with some more catching up to do.

While ever engineers had to make their master recordings on analog tape decks, they had to be content with a dynamic range of around 70dB, if the signal level was to remain in the dynamic "window" set by background noise at one extreme and by overload at the other. But, after mix-down and processing, the dynamic range from a typical disc was more likely to end up around 60dB.

Recording engineers were well aware of the limitations of analog tape mastering and a few hardy souls reverted to direct-to-disc recording. It sounded fine but the practical difficulties were well nigh prohibitive.

DIGITAL MASTERING

Digital tape mastering proved to be a very attractive alternative, because it offered the convenience of a tape master, together with a high degree of signal "transparency" — zero wow and flutter, low noise, low distortion and a dynamic range of around 90dB.

Once on digital master tape, the performance can be re-played and examined as many times as necessary. It can be pre-set precisely to the anticipated dynamic window of the disc and fed to a lathe with computer-controlled variable groove pitch. For good measure, the groove can be — and commonly is — cut at half-speed, for improved high frequency definition.

(For sure, some audiophiles have reservations about digital mastering for other reasons, but that is another subject. In any case, an engineer who so prefers can record on analog, using dbx compression/expansion and end up with much the same dynamic range.)

The American Telarc organisation was one of the first to exploit high dynamic range in disc recordings. They have since turned out a whole string of advanced technology albums, usually recorded, in the first instance, on a Soundstream digital master tape deck.

The transfer to disc has normally been done by the JVC Cutting Centre, using state of the art equipment, and with both tape and disc operating at half normal speed. The final pressings of these and other audiophile discs are normally done with top quality virgin vinyl by — or supplied by — Teldec of Germany.

The best known — and the most

The change to excellence in sound...



needn't cost you a fortune.

Denon, the name associated worldwide with professional audio equipment has available in Australia their range of advanced magnetic tapes. The result of 30 years of research and technology offers the listener true excellence in sound.

Six dynamic tapes – the LX, DX1, DX3, DX5, DX7 and DXM provide a range to suit any requirement in high grade recording and reproduction.

See the exciting range of tapes at your Denon dealer now, you'll find their prices rather exciting as well.

DENON

Professional Audio Brand.



AMALGAMATED WIRELESS (AUSTRALASIA) LIMITED
554 Parramatta Road, Ashfield, NSW 2131 Phone 797 5757

Canberra	Melbourne	Launceston	Adelaide	Brisbane	Townsville	Perth
80 5200	560 4533	44 5155	272 2366	44 1631	79 6155	271 0888

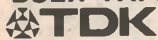
AMSMAIL
ORDER
CENTRE**TAPES CHEAP!****BULK TAPES DISCOUNTED**

SA-X C90	SUPER AVILYN	10 for \$49
	DUAL COATING	10 for \$49
SA C90	SUPER AVILYN	10 for \$39
AD C90	ACOUSTIC DYNAMIC	10 for \$30
D C90	DYNAMIC	10 for \$24

maxell

UDXL IIS C90	EPITAXIAL	12 for \$58
UDXL II C90	EPITAXIAL	12 for \$49
UDC 90	ULTRA DYNAMIC	12 for \$38
LN C90	LOW NOISE	12 for \$28

BASF

CRO ₂ C90	CHROMDIOXIDE	10 for \$48
FE C90	FERROCHROME	10 for \$38
LH C90	LOW NOISE	10 for \$25

VIDEO — OPEN REEL — METAL
MAXELL, TDK, BASF, AKAISEND FOR COMPLETE TAPE PRICE
LISTS — FREE**HI-FI SYSTEMS**AMPLIFIERS, TUNERS, TAPE DECKS,
TURNTABLES, SPEAKERS,
HEADPHONES, RECEIVERS

OUR RANGE INCLUDES:

Sansui **PIONEER**
marantz **AKAI**

SOUND DYNAMICS KSW

CAR SOUNDRECEIVERS, TAPE PLAYERS,
BOOSTERS, EQUALISERS, SPEAKERS
— INCLUDING **PIONEER** **Voxson**
ACCESSORIESCARTRIDGES, STYLII, CLEANERS,
DEMAGNETISERS, DISCWASHERPARABOLIC STYLUS —
COMPLETE RANGE**ortofon**MOVING COIL
AND MAGNETIC
CARTRIDGES**RING OR WRITE FOR
FREE PRICE LISTS!****TAPE ORDERS:**ADD: PACK AND POST \$3.00
PER ORDER AND SEND
CHEQUE/MONEY ORDER TO:**AMS**MAIL ORDER CENTRE,
135 HAWTHORN ROAD,
CAULFIELD, VIC 3162
(03) 528 1149STOCK AT PRICES SHOWN AVAILABLE
AT TIME OF GOING TO PRESS**AUDIO-VIDEO ELECTRONICS — continued**

notorious — of the albums was a recording by the Cincinnati Orchestra, with Erich Kunzel conducting, of Tchaikovsky's "1812 Overture". The bells were recorded separately at a Memorial Carillon in Ohio, while the cannons were 19th century pieces by an antique arms group — the Fifth Virginia Regiment. Mixed into the final track, they provided a series of 16 thundering reports with an ignition crack at around 2000-3000Hz and a follow-up boom which reaches down to around 6Hz.

WORDS OF WARNING

When Telarc first issued the recording, they saw it as something of a milestone in disc technology. An outer wrapper on the jacket carried the message:

"Audio's toughest challenge: This special version of the 1812 Overture demonstrates the incredible dynamic range that can actually be transcribed to disc from the original digital master recording."

An inner leaflet warns that the disc "tests the limits of playback technology".

It warns the newcomer to be cautious in the first playing "until a safe playback level can be established".

It stresses the need to have the pickup correctly adjusted but indicates that, even so, "particular cartridges or cartridge/turnarm combinations may mistrack".

Whatever other rewards Telarc may have received from the 1812 Overture, they certainly got plenty of publicity. The album became famous (or notorious) with audiophiles, worldwide. It prompted articles, macrophotographs and endless discussions about trackability.

It also helped fuel a spirited argument as to whether wide dynamic range is desirable or manageable in a home listening situation.

That's all history now, but the Cherry Pie situation belongs to the present.

Cherry Pie is a small Australian record company which has traditionally placed what emphasis it could on recording quality. They have tended to concentrate on musically sophisticated jazz and folk artists and small classically orientated groups.

In recent times, they have built up a close working relationship with the engineers of Festival Records in Sydney, attracted by the equipment which that company now has available.

The association was climaxed, recently, by the opportunity for Cherry Pie to record a recital by the Sydney Wind Quintet — the Quintet-in-Residence at the NSW State Conservatorium of Music. Each player is the Lecturer in his respective instrument and each one is a concert and solo artist in his own right.

Since coming together in August 1980, the Quintet has arranged extensive engagements with the ABC, plus tour commitments interstate and overseas.

The original recording was made on a Sony model 1610 digital recorder and proved to be of such a quality that Cherry Pie decided that it warranted world release, in full competition with audiophile recordings from any country.

They had at their disposal the Sony 1610, Sony digital editing equipment, a Neumann VMS-80 recording lathe (the only one of its kind in Australia), a Neumann SK-74 cutter and a FAL-7 rack. Quality presses were available, operating at reduced speed under manual control, plus virgin vinyl produced by an associated company.

The recording was duly transferred to a master disc and a few trial pressings were run. They sounded good on Festival's own playback equipment, so about half-a-dozen of the test pressings were passed by Graeme Rule to personal friends who he knew to have prestige hifi equipment.

But the reports weren't quite what he expected. Most said "fine" but two insisted that the discs were badly distorted on loud passages.

Back at Festival, the same two discs played perfectly.

Further investigation revealed the disturbing fact that the two audiophiles who had complained were using moving coil cartridges — different brands, but favoured because they were reputed to be "more musical" than moving magnet types.

A TRACKING PROBLEM

When it became apparent that they faced a tracking problem, the owners tried again, with increased playing weight. One cartridge did manage to cope, with the tracking weight at the manufacturer's maximum recommended figure; the other still couldn't track the loud passages, extra weight notwithstanding. It was at this stage that Graeme Rule rang me, as noted at the start of the article. Should they market the record in its present form, or re-cut at a lower amplitude? And what was my attitude to moving coil cartridges?

The claims about the "musicality" of moving coil cartridges go back at least as far as the original Ortofon moving coil designs, with our former Editor, the late John Moyle, one of their keen protagonists. "Listen to those strings", he would say.

The problem is that, historically and on a per-dollar basis, moving coil cartridges have often not shown up as well, on measurement, as their moving magnet counterparts in terms of compliance and

A COMPACT MUSIC SYSTEM FROM SANYO



Described as a "Floorgram", this new JXT45 music system from Sanyo offers a useful range of facilities for \$399. It provides AM-FM/stereo radio reception, with in-built cassette recorder, sockets for stereo microphones and

headphones, plus a phono deck. The wood-grain look rack and speakers are included.

effective stylus mass. These are the very qualities that determine trackability and the need to resort to extra tracking weight.

And that leads naturally to speculation (and argument) as to whether the somewhat elusive "musicality" is worth having if the price is reduced ability to cope with high amplitude deviations? In short, is musicality worth having, if you can only have it at moderate levels?

It was against this background that I took delivery of a couple of test pressings of the Sydney Wind Quintet recital. Anticipating the material, and on inspection of the grooves, it was immediately obvious that there was no massive bass content, resembling that in the "1812 Overture". If the grooves did pose tracking problems, they had to be in the middle and upper register (involving effective stylus mass) rather than low down (involving low frequency compliance).

Largely because the phono deck was set up that way, my first playing of the test pressing was with the Ortofon Concorde STD, a moving magnet cartridge. There was no hint of mistracking and, without all the prior discussion, I would not have expected any.

So to a moving coil cartridge — the Ortofon MC-20 Mk II. It sounded very clean and very comfortable, completely in line with our review of the cartridge in September '81.

Following that, we checked all the heavy passages with two other moving magnet cartridges on hand — a Goldring G-900 IGC, and a Shure V-15 Mk III with a stylus which has played a lot of records. Again, there were no problems.

Finally, we got out a venerable Shure M-55 and played the disc right through. It sounded its age, but it didn't mistrack. And that had to be a complete anti-

climax. Why had two out of six audiophiles encountered tracking problems with a pressing that proved to be not all that fearsome?

For sure, we are talking about a tiny sample, with the possibility of faulty cartridges. Even so, the exercise did point up a couple of inhabitants of Audiophile Land happily using "musical" cartridges which couldn't cope with an audiophile recording! Presumably they, and others like them, will have been bitterly disappointed at the "distortion" which they think they have heard in some modern pressings.

While I certainly don't regard recordings as being uniformly beyond reproach, I do wonder how many may have been damned because of tracking problems in cartridges and peak signal overloads in preamplifiers.

As it is, Graeme Rule tells me that his company has decided to release the Sydney Wind Quintet recording in its present form but with the endorsement that it can be expected to play satisfactorily only with cartridges having high compliance and low tip mass.

Audiophile pressings are scheduled for release through Festival in mid-October and should be available in all shops which carry classical records.

They'd better be good — otherwise everyone concerned will have a cherry red face!

FOOTNOTE: Just as I was rounding off this article, I had a phone call from a dealer who handles a lot of audiophile records. "Tell me," I said, do you hear of many problems with phono cartridge trackability?"

"Fortunately, not many," he replied, "but I will say this — and please don't quote me by name — there are two or three quite expensive moving coil cartridges around that have real problems in this area!"

VIDEO RECORDING "BUGS"



Are you plagued with BUGS in your TV-FM or Video cassette, the performance is dependant on the level & quality of the signal being fed into the equipment. Regardless of how much you spend on your TV/FM receiver or Video Cassette, your equipment will only perform as well as the *Antennae system will allow.*

You could be down in signal level & require an amplifier for more gain which would allow you extra outlets. Or ghosting problems, a change of aerial could rectify this & give you Ch. 0. Whatever your problems don't go to the super market for your advice & parts, the salesman is a nice guy, but knows little about aerial problems. We can talk of many thousands of installations in Australia since 1956.

We have the largest stocks of antenna equipment available. Sixty different types of VHF Aerials 16 types of UHF Aerials 12 types of FM aerials from 5 different manufacturers. Aerials from \$19 Amplifiers from \$56 Rotators from \$97.

**DOWN CONVERTORS UHF to
VHF \$95.
FIELD STRENGTH METERS
From \$350.**

Trade Supplied.

**ELECTROCRAFT
MANUFACTURING PTY LTD**

Free verbal advice given Phone or call.
438 4308 or 438 3266
68 Whiting St ARTARMON 2066 Hours
8am to 5pm Mon: to Friday.
Off Street Parking at rear.

NEW STORE
Opening October
in Carlingford

AT "NEVILLE'S CORNER" CNR CARLINGFORD & PENNANT HILLS RD. NEXT TO KENTUCKY FRIED CHICKEN



JAYCAR FOR

NOT ONLY DO WE STOCK HARD-TO-GET SEMICONDUCTORS - WE STOCK HARD-TO-GET PASSIVES TOO!!

CMOS

- 4000 Dual 3 Input NOR Gate
- 4001 Quad 2 Input NOR Gate
- 4002 Dual 4 Input NOR Gate
- 4006 16 Stage Static Shift Register
- 4007 Dual Complementary Pair Plus Inverter
- 4008 4 Bit Full Adder
- 4009 Hex Buffer (Inverting)
- 4010 Hex Buffer (Non Inverting)
- 4011 Quad 2 Input NAND Gate
- 4012 Dual 4 Input NAND Gate
- 4013 Dual D Flip Flop
- 4014 8 Stage Static Shift Register
- 4015 Dual 4 Bit Static Register
- 4016 Quad Analog Switch
- 4017 Decade Counter/Divider
- 4018 Reconfigurable Divide by N
- 4019 Quad AND OR Select Gate
- 4020 14 Stage Binary Counter/Divider
- 4022 Divide by 8 Counter/Divider
- 4023 Triple 3 Input NAND Gate
- 4024 7 Stage Binary Counter/Divider
- 4025 Triple 3 Input NOR Gate
- 4026 Decade Counter-7 Seg Output
- 4027 Dual JK Flip Flop
- 4028 BCD to Decimal Decoder
- 4029 Programmable Up/Down Counter
- 4030 Quad 2 Input EXCLUSIVE OR Gate
- 4031 64 Stage Static Shift Register
- 4032 Triple Serial Adder
- 4034 8 Stage TRI STATE Universal BUS Register
- 4035 4 Bit Shift Register
- 4038 Triple Serial Adder (Negative Logic)
- 4040 12 Stage Binary Counter
- 4042 Quad Clocked D Latch
- 4046 Microprocessor Phase Lock Loop
- 4047 Low Power Mono Astable Multivibrator
- 4049 Hex Inverting Buffer
- 4050 Hex Buffer (Non Inverting)
- 4051 8 Channel Analog Multiplexer
- 4053 Triple 2 Channel Analog Multiplexer
- 4055 Quad Analog Switch
- 4066 1 of 16 Analog Switch
- 4068 8 Input NAND Gate
- 4069 Hex Inverter
- 4070 Quad 2 Input EXCLUSIVE OR Gate
- 4071 Quad 2 Input OR Gate
- 4073 Triple 3 Input AND Gate
- 4075 Triple 3 Input OR Gate
- 4076 Quad D Flip Flop
- 4077 Quad EXCLUSIVE NOR Gate
- 4078 8 Input NOR Gate
- 4081 2 Input AND Gate
- 4083 Quad 2 Input NAND Schmitt Trigger
- 4411 Decade Counter 7 Seg Output
- 4500 4501 Triple Gate
- 4502 Strobed Hex Inverter
- 4503 Hex 3 Stage Buffer (Non Inverting)
- 4508 Dual 4 Bit Latch
- 4511 BCD to 7 Seg Decoder/Driver
- 4512 8 Channel Data Selector
- 4514 4 to 16 Line Decoder/4 Bit Latched
- 4517 Dual 64 Bit Static Shift Register
- 4518 BCD Up Counter
- 4520 Dual Binary Up Counter
- 4526 Programmable 4 Bit Binary Counter
- 4528 Dual Mono Multivibrator
- 4538 Dual Mono/Precision Multi
- 4543 BCD to 7 Seg Latch/Decoder/Driver/LCD
- 4553 3 Digit BCD Counter
- 4557 1 to 64 Bit Variable Length Shift Register
- 4581 4 Bit
- 4582 Look Ahead Carry Block
- 4584 Hex Schmitt Trigger
- 74C02 Quad 2 Input NOR Gate
- 74C04 Hex Inverter
- 74C14/40106 Hex Schmitt Trigger
- 74C922 16 Keyboard Encoder

SUPPORT

- 8255 PPI \$9.95
- 5303 UART \$12.95
- 1771 Floppy Disk Controller \$19.95
- 1488 RS232 Quad Line Driver \$1.50
- 1489 RS232 Quad Receiver \$1.50
- 8131 6 Bit Comparator (Negative Out) \$4.95
- 81LS97 Octal Buffer \$2.35
- 81LS98 Octal Buffer (Inverting) \$2.35

74LS TTL

- 40 74LS00 Quad 2 Input NAND Gate
- 35 74LS01 Quad 2 Input NOR Gate
- 48 74LS02 Quad 2 Input NOR Gate
- 40 74LS03 Quad 2 Input NAND Gate (oc)
- 38 74LS04 Hex Inverter
- 95 74LS05 Hex Inverter (oc)
- \$1.10 74LS08 Quad 2 Input AND Gate
- 35 74LS10 Triple 3 Input NAND Gate
- 20 74LS11 Triple 3 Input AND Gate
- 90 74LS12 Triple 3 Input NAND Gate (oc)
- \$1.00 74LS13 Dual NAND Schmitt Trigger
- 95 74LS14 Hex Schmitt Trigger
- 50 74LS20 Dual 4 Input NAND Gate
- \$1.20 74LS21 Dual 4 Input AND Gate
- 50 74LS27 Triple 3 Input NOR Gate
- 75 74LS30 8 Input NAND Gate
- \$1.45 74LS32 Quad 2 Input OR Gate
- \$1.25 74LS33 Quad 2 Input NOR Gate (oc)
- 28 74LS42 1 of 10 Decoder
- \$1.18 74LS47 BCD to 7 Seg Decoder/Driver (oc)
- 35 74LS48 BCD to 7 Seg Decoder/Driver
- \$2.20 74LS49 BCD to 7 Seg Decoder/Driver
- 90 74LS73 Dual JK Flip Flop with Clear
- \$1.18 74LS74 Dual D Flip Flop with Preset & Clear
- \$1.25 74LS75 4 Bit Bistable Latch
- 80 74LS76 Dual JK Flip Flop
- \$2.20 74LS78 Dual JK Flip Flop
- \$1.95 74LS83 4 Bit Full Adder
- \$2.95 74LS85 4 Bit Magnitude Comparator
- 50 74LS86 Quad 2 Input EXCLUSIVE OR Gate
- \$1.95 74LS90 Decade Counter
- \$1.65 74LS92 Divide by 12 Counter
- 70 74LS93 4 Bit Binary Counter
- \$1.55 74LS95 4 Bit Shift Register
- \$1.75 74LS107 Dual JK Flip Flop
- 75 74LS109 Dual JK Edge Triggered Flip Flop
- 60 74LS112 Dual JK Edge Triggered Flip Flop
- 95 74LS122 Retriggerable Monostable with Clear
- \$1.75 74LS123 Dual Retriggerable Monostable with Clear
- 50 74LS125 Quad BUS Buffer Tri State (enable)
- 80 74LS126 Quad BUS Buffer Tri State (enable)
- \$2.95 74LS138 1 of 8 Bit Decoder/Multiplexer
- 70 74LS139 Dual 2 to 4 Line Decoder/Multiplexer
- 48 74LS148 8 Line to 3 Line Priority Encoder
- 48 74LS151 1 of 8 Selector/Multiplexer
- 65 74LS153 Dual 4 Line to 1 Line Selector/Multiplexer
- 60 74LS155 Dual 1 of 4 Decoder
- \$1.25 74LS156 Dual 1 of 4 Decoder (oc)
- 50 74LS157 Quad 2 Input Multiplexer (Non Inverting)
- 65 74LS158 Quad 2 Input Multiplexer (Inverting)
- 80 74LS160 BCD Decade Counter Asynch Reset
- \$1.75 74LS161 4 Bit Binary Counter Asynch Reset
- \$2.20 74LS163 4 Bit Binary Counter Synchron. Reset
- \$2.50 74LS164 8 Bit Shift Register
- \$1.95 74LS165 Parallel Load 8 Bit Shift Register
- \$1.95 74LS166 8 Bit PISO Shift Register
- 95 74LS173 4 Bit D Type Register
- \$5.00 74LS175 Quad D Type Flip Flop
- \$1.50 74LS190 Up/Down Decade Counter
- \$1.25 74LS191 Up/Down Binary Counter
- \$2.50 74LS192 Up/Down Decade Counter Dual Clock
- \$1.95 74LS193 Up/Down Binary Counter Dual Clock
- \$1.50 74LS194 4 Bit Left Right Shift Register
- \$1.50 74LS221 Dual Monostable Multivibrator
- \$1.50 74LS240 Octal Tri State Driver
- \$1.50 74LS241 Octal Tri State Driver
- \$3.50 74LS244 Octal Buffer/Driver
- 70 74LS245 Octal Buffer/Transceiver
- \$6.50 74LS257 Quad 2 Input Multiplexer Tri State
- \$3.50 74LS258 Quad 2 Input Multiplexer Tri State
- \$3.50 74LS259 8 Bit Addressable Latch
- \$2.50 74LS266 Quad EXCLUSIVE NOR Gate (oc)
- \$1.65 74LS273 Octal D Type Flip Flop
- 50 74LS365 Hex Buffer with Common Enable
- 55 74LS366 Hex Inverter with Common Enable
- 70 74LS367 Hex Buffer 4 Bit and 2 Bit
- \$1.50 74LS368 Hex Inverter 4 Bit and 2 Bit
- \$2.95 74LS373 Octal D Type Transparent Latch
- \$2.50 74LS374 Octal D Type Flip Flop
- \$3.50 74LS393 Dual LS93

SPEECH SYNTHESISER

- DT1050 National Digitaltalker Processor & ROM Set \$95.00
 - DT1057 National Digitaltalker Second ROM Set \$69.00
- Sand SAE for more details NOTE New low price Data sheets included in chip set

LINEAR DEVICES

- 35 ZN414
- 40 TL061
- 40 TL062
- 60 TL064
- 40 TL071
- 60 TL072
- 40 TL074
- 50 TL075
- 40 TL081
- 40 TL082
- 60 TL084
- 60 TL085
- 85 LM234
- 60 LM301
- 35 LM307
- 60 LM308
- 50 LM311
- 45 LM319
- 50 LM324
- 95 LM334
- \$1.45 LM339
- \$2.95 LF347N
- \$1.95 LM348
- 95 OM350
- 75 LM361
- 65 LM380
- \$1.00 VNB8AF
- 50 RCY71
- 75 JDT9203
- \$1.25 40411
- 85 MJ15003
- 75 MJ15004
- 55 25349(P)
- 75 25J50
- 60 BV648
- 75 BU700
- \$1.10 ZSK134(N)
- 55 BU105
- 75 MP5A05
- 92 TP31A&B
- \$1.45 TP324
- \$2.95 TP325A
- \$3.95 TP3305
- 75 MPF102
- 85 MPF105/2N5459
- MPF105/2N5485
- MP5A55
- 95 2N3773
- 95 2N4258
- 75 2N5484
- 95 2N5807
- 95 8F469
- 95 8F470
- \$1.00 MJE340
- \$1.98 2N5591
- \$1.98 2N5245
- 45 2N6027-D13T1
- 75 TT800
- 65 2N3566
- \$1.65 25K135
- \$8.50

DISCRETE DEVICES

- \$3.00 RC547
- 15 RC548
- 15 RC549
- 15 RC550
- 65 RC556
- 47 RC557
- 65 RC558
- 65 RC559
- 65 RC639
- 95 RC640
- \$1.50 RC766A
- 95 RC140
- 95 MJ2955
- 90 2N3055
- \$1.20 2N3442
- \$1.20 2N3569
- 95 2N3638
- 85 2N3643
- 78 2N3645
- 95 2N3773
- \$1.98 2N4258
- 75 2N5484
- 95 2N5807
- \$1.65 2N5589
- \$1.65 2N5590
- \$1.98 2N5591
- \$1.98 2N5245
- 45 2N6027-D13T1
- 75 TT800
- 65 2N3566
- \$1.65 25K135
- \$8.50

SPECIAL FUNCTION

- SAB0600 Door Chime \$9.95
- AY-1500 \$9.50
- TEA 1022 PAL Colour Encoder \$17.50
- TEA 1022 Bucket Brigade \$29.50
- EXAR 2206 Function Generator \$5.95
- MOC 3020 TRIAC Opto Coupler \$2.50
- MM 5837 Noise Generator \$3.90
- TA 7205P Audio Amp \$4.50
- 7216A Frequency Display Driver \$47.50
- SN 76488NF Sound Effects Generator \$5.95
- AY-10212 Top Octave Synthesiser \$19.50

Z-80A/6800

- 2.80A CPU 4MHz \$8.50
- 2.80A PIO 4MHz \$8.50
- 2.80A CTC 4MHz \$8.50
- 2.80A SIO/4MHz \$20.95
- 2.80A SIO/1.4MHz \$20.95
- 2.80A SIO/2.4MHz \$20.95
- 2.80A DART 4MHz \$32.95
- 2.80A DMA 4MHz \$20.95
- 6800 CPU \$11.00
- 6810 RAM \$4.95
- 6821 PIA \$4.95

ZENER DIODES 1 WATT

From 3.3V to 33V 35

MEMORIES

- 2102 1K x 1 RAM \$1.95
- 2114 3 1K x 4 RAM 350ns \$2.45
- 4116 16K x 1 Dynamic RAM 250ns \$2.50
- 6116 2K x 8 CMOS RAM \$12.50
- 2708 1K x 8 EPROM \$7.95
- 2716 2K x 8 EPROM (Single +5V) \$6.50
- 2532 4K x 8 EPROM (Single +5V) \$14.95
- 2564 8K x 8 EPROM (Single +5V) \$35.00

VOLTAGE REGULATORS

- 7805 5V Regulator TO 220/amp \$1.05
- 7805 5V Regulator TO 220/amp \$1.65
- 7812 12V Regulator TO 220/amp \$1.05
- 7812 12V Regulator TO 220/amp \$1.65
- 7815 15V Regulator TO 220/amp \$1.05
- 7815 15V Regulator TO 220/amp \$1.65
- 78L12 12V Regulator 100mA \$1.00
- 78L15 15V Regulator 100mA \$1.00
- LM309 1.5 amp 5V TO 3 \$7.50
- LM317T 2.30V adjustable 1 amp TO 220 \$2.80
- LM317KC 2.30V adjustable 3 amp TO 3 \$6.50
- LM337K 3 amp variable 2.30V TO 3 \$9.50
- LM396K 10 amp variable 1.25 15V TO 3 \$19.50

LED'S

- 5mm Red 15 3mm Yellow 28
- 5mm Green 26 Rectangular Red 40
- 5mm Yellow 30 Rectangular Green 40
- 5mm Orange 28 Rectangular Yellow 40
- 3mm Red 18 Flashing Red 49
- 3mm Green 28 Flashing Red 45

BRIDGE RECTIFIERS

- WD4 6P
- PD4 \$2.95
- MDA3504 \$4.50

OPTO

- COY89 Infra Red LED \$1.25
- FND500 \$1.35
- BPW50 Infra Red Diode \$2.95
- FN0507 \$1.75
- LT302 7 seg Display \$1.45
- LT547 \$2.95
- LT303 7 seg Display \$1.45

DIODES

- IN4002 8 BA102 25 BYX21L 200R \$1.90
- IN4006 20 BA114 25 OA91 12
- IN5404 35 BA215-219 25 OA202 50
- IN914 5 BR100 95 OA697 20
- 8AW62 29 BYX21L 200 \$1.90
- 5082-2800 \$2.75

IC SOCKETS - SOLDER

- 8 Pin 25 18 Pin 35 24 Pin 50
- 14 Pin 30 20 Pin 38 28 Pin 60
- 16 Pin 35 22 Pin 40 40 Pin 70

QUALITY WIRE WRAP IC SOCKETS

- 14 Pin 85 22 Pin \$1.40
- 16 Pin \$1.05 24 Pin \$1.75
- 18 Pin \$1.35 28 Pin \$2.25
- 20 Pin \$1.45 40 Pin \$2.65

DIL PLUGS AND COVERS

- 14 Pin Plug 85 16 Pin Cover 25
- 14 Pin Cover 25 24 Pin Plug Only \$2.50
- 16 Pin Plug 95

SOLDER TYPE

- 14 Pin Plug 85 16 Pin Cover 25
- 14 Pin Cover 25 24 Pin Plug Only \$2.50
- 16 Pin Plug 95

CRYSTALS

- Case Style HC 33/U 4.9152MHz \$6.50
- 1.000MHz \$12.50
- 5.000MHz \$5.50
- 1.8432MHz \$9.50
- 8.867238MHz \$5.50
- 2.000MHz \$7.50
- 10.000MHz Parallel Resonant \$9.50
- Case Style HC 18/U 12.000MHz \$9.50
- 4.000MHz \$6.50
- 16.000MHz \$5.50
- 4.43MHz \$6.50
- 20.000MHz \$7.50

MINIMUM MAIL ORDER \$5.00

CARLINGFORD PHONE 872 4422

NEW STORE
opening October
in Carlingford

AT "NEVILLES CORNER" CNR CARLINGFORD & PENNANT HILLS RD. NEXT TO KENTUCKY FRIED CHICKEN

NUMBER 1 COMPONENTS

JAYCAR PASSIVE COMPONENTS

We regret to advise that we have had to pass on drastically increased costs due to the devaluation of the Australian dollar and the savage sales tax increase. Most of the prices on this page had not changed in 18 months. In some cases our cost has increased 50% whereas our increases average about 10%. We haven't got the heart to pass on to you the costs that were passed on to us! Our quality is first class - so remember that if someone offers you a component that may APPEAR cheaper. Jaycar components are 100% prime spec and guaranteed. They are the same parts that were used in TV stations, telephone exchanges and other industrial equipment. NOTE! We have saved space in some places by saying that components conform to "E12". This means that we have 12 values in each "decade" i.e. 10, 12, 15, 18, 22, 27, 33, 39, 47, 56, 68, 82 and back to 10 in other words, 22pF, 220pF, 2200pF and so on.

POTENTIOMETERS

POTENTIOMETERS CARBON ROTARY
 Jaycar rotary pots did not go metric. We keep the plain shaft types with 3/8th bush mount. Most have a flat machined on the shaft.

LINEAR	LINEAR	SINGLE GANG LINEAR	LOG
500 ohms	1k	1k	1k
1k	5k	5k	5k
5k	10k	10k	10k
10k	25k	25k	25k
25k	50k	50k	50k
50k	100k	100k	100k
100k	250k	250k	250k
250k	500k	500k	500k
500k	1M	1M	1M
1M	2M	2M	2M

Price 1 - 95 cents each 10 - 85 cents each



LINEAR	LOG
1k	1k
5k	5k
10k	10k
25k	25k
50k	50k
100k	100k
250k	250k
500k	500k
1M	1M
2M	2M

Price 1 - 95.25 cents each 10 - 81.95 cents each

QUAD GANG LINEAR	LOG
5k	5k
10k	10k
25k	25k
50k	50k
100k	100k
250k	250k
500k	500k
1M	1M

Price 1 - 95.25 cents each 10 - 81.95 cents each
 Quad gang with switch 100k log (only) \$3.95 each

CARBON SLIDER CONTROLS
 45mm type - some with tap

LINEAR	LOG
2k	1k
1k	5k
50k	50k
100k	250k

Price 1 - 95.25 cents each 10 - 52.50 cents each
 30mm type 5k linear only \$1.95 each
 60mm type 10k log only \$3.95 each

WIREWOUND POTS
 3 watt rating (linear) 1/2" shaft 3/8th bush

10 ohms	25 ohms	50 ohms	100 ohms	500 ohms	1k 5k
---------	---------	---------	----------	----------	-------

Price 1 - 95.45 cents each 10 - 52.95 cents each

Jaycar stocks two types of trimmers. The low cost "skelton" type and the high quality "PIPER" European made dust proof type.

MINIATURE VERTICAL ISKELETON

100 ohms	250 ohms	500 ohms	1k 2k 5k 10k 25k
50k 100k 250k 500k			

Price 1 - 9.42 cents each 10 - 40 cents each

LARGE VERTICAL (PIPER) TYPE

100 ohms	200 ohms	500 ohms	1k 2k 5k 10k 20k
50k 100k 200k 500k 1M 2M			

Price 1 - 9.48 cents each 10 - 45 cents each

SMALL HORIZONTAL (PIPER)
 100 ohms 500 ohms 1k 2k 5k 10k 20k 50k 100k
 Price 1 - 9.45 cents each 10 - 42 cents each

CERMET (Ceramic/Metal Fdm/Oxide)
 High stability trimmers in a small package. 1/3rdW dissipation dustproof. 100ppm T.C. 5mm lead spacing (1" grid).
 100 ohms 500 ohms 1k 2k 5k 10k 20k 50k 100k
 Price 1 - 9.65 cents each 10 - 60 cents each



MULTITURN TRIMMER POTS
 (Sometimes called 10 turn) Jaycar multi-turn trimmers feature Cermet element, leadscrew drive with overside clutch, sealed design and industry standard pin spacing.
 100 ohms 500 ohms 1k 2k 5k 10k 20k 50k 100k 1M
 Price 1 - 9.51.95 cents each 10 - 51.75 cents each

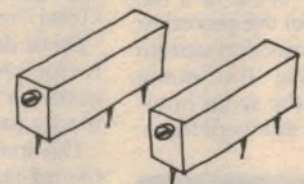

RESISTORS

RESISTORS We stock 1/4 and 1/2 watt 5% carbon film in the E12 series i.e. 10, 12, 15, 18, 22, 27, 33, 39, 47, 56, 68, 82. From 1 ohm to 10 M-ohm.

1/4W 5% 1 - 9.5 cents each 10 - 4 cents each
 1/2W 5% 1 - 9.5 cents each 10 - 4 cents each
 These are QUALITY OEM grade carbon film resistors - NOT junk.

METAL FILM We only stock 1/4W but in the extended resistance range E24 i.e. 24 resistance values per decade.
 1, 11, 12, 13, 15, 16, 18, 20, 22, 24, 27, 30, 33, 36, 39, 43, 47, 51, 56, 62, 68, 75, 82, 91.
 Resistors between 10 ohms and 1 Megohm have a temperature coefficient of 50ppm/°C tolerance and conform to MIL-R10509F RN60D style.
 Values below 10 ohms and above 1 Megohm are Breysslag 2% types.
 Prices: Below 10 ohms and above 1M - 1 - 9.25 cents each 10 - 20 cents each

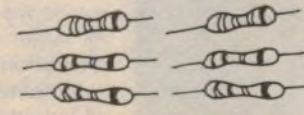

CAPACITORS

TANTALUM BEADS Also called "TAG" tantalums. This is a brand name that has become a description.

VALUE	VOLTS	1 - 9	10 -
0.1uF	35	55	50
0.22uF	35	60	55
0.33uF	35	60	55
0.47uF	35	60	55
1uF	35	60	55
1.5uF	35	60	55
2.2uF	35	60	55
3.3uF	35	60	55
4.7uF	35	60	55
6.8uF	35	60	55
10uF	25/35	65	60
22uF	25	65	60
33uF	16	70	65
47uF	10	70	65
100uF	3	70	65

ROLL CAPACITORS
 Logical and economical replacements for Tantalums.
 0.1uF, 0.15uF, 0.22uF, 0.33uF, 0.47uF, 0.68uF
 Price 1 - 9.32 cents each 10 - 30 cents each
 1uF, 1.5uF, 2.2uF, 3.3uF
 Price 1 - 9.35 cents each 10 - 32 cents each
 4.7uF - 38 cents each 1 - 9
 6.8uF - 40 cents each 1 - 9
 10uF, 22uF, 33uF
 Price 1 - 9.45 cents each 10 - 42 cents each
 47uF - 50 cents each 1 - 9
 100uF - 60 cents each 1 - 9

TRIMMER CAPACITORS
 Features: Fully sealed. Top adjustable. Solid dielectric. 5mm lead spacing. Colour denotes capacitance range. Temperature coefficient N750 ppm/degree C (average).
 0 (1MHz C max) 500
 2.0 7pF BLUE
 5.2 30pF GREEN
 6.8 45pF YELLOW
 9.8 60pF BROWN
 Price 1 - 9.65 cents each 10 - 60 cents each



POLYSTYRENE Jaycar Polystyrene dielectric capacitors are used where stability is important. They exhibit low dielectric leakage as well.
 Range 33pF thru 1000pF (IEC E12 Series)
 most are 100V rated.
 Price 1 - 9.30 cents each 10 - 28 cents

CERAMIC Jaycar capacitors are generally NP0, 50V plate 10% types.
 Range 1pF - 1000pF (IEC E12 Series) and 2200pF, 3300pF, 0.0047uF, 0.0056uF, 0.0068uF, 0.0082uF, 0.01uF, 0.022uF, 0.033uF, 0.047uF, 0.1uF, 0.22uF, 0.33uF, 0.47uF.
 Price 1 - 9.15 cents each 10 - 12 cents each
 100pF 3kV 50 cents each
CERAMIC TRIMMER
 1 - 12pF 25 cents each
 4 - 70pF 25 cents each

BIPOLAR ELECTROLYTICS Quality made by ELNA FB type

1 - 9	10 -
22uF 25V	55 50
47uF 50V	60 55
68uF 50V	60 55
10uF 50V	60 55
22uF 50V	65 60
47uF 50V	80 72

ALUMINIUM ELECTROLYTICS

Both axial (AT) and single ended radial (RB) types kept. We keep a large range of the now popular RB types. Each capacitor is fitted with a durable vinyl jacket which has the value and polarity clearly marked.

AXIAL TYPES		RADIAL (RB) TYPE	
Capacitance	Voltage	1 - 9	10 -
1uF	25	28	26
3.3uF	25	28	26
4.7uF	25	28	26
4.7uF	63	32	30
10uF	16	36	34
10uF	63	36	34
25uF	25	38	36
25uF	63	36	34
47uF	10	36	34
47uF	63	36	34
100uF	10	40	38
100uF	25	38	36
100uF	63	40	38
350	100uF	\$3.50	\$3.00
10	470uF	80	75
50	470uF	\$1.20	\$1.10
10	1000uF	\$1.10	\$1.00
63	1000uF	\$1.80	\$1.70
16	2500uF	\$1.95	\$1.85
35	2500uF	\$2.45	\$2.35
16	3300uF	\$1.95	\$1.80
35	4700uF	\$2.95	\$2.60

Capacitance	Voltage	1 - 9	10 -
0.47uF	63	28	26
1uF	50	28	26
2.2uF	50	28	26
4.7uF	25	28	26
4.7uF	50	36	34
10uF	25	28	26
22uF	50	36	34
25uF	25	28	26
33uF	25	30	28
47uF	16	28	26
47uF	25	30	28
82uF	50	36	34
100uF	16	30	28
100uF	25	32	30
100uF	63	50	46
220uF	25	55	50
220uF	50	75	70
220uF	50	85	80
330uF	25	78	72
470uF	35	78	72
470uF	63	\$1.30	\$1.25
1000uF	16	55	52
1000uF	25	82	78
2500uF	35	\$1.45	\$1.40
2500uF	80	\$5.45	\$5.20
4000uF	75	\$7.50	\$6.95
5600uF	40	\$4.95	\$4.45
8000uF	75	\$9.95	\$9.25
10000uF	40	\$7.25	\$6.85

GREENCAPS - our new specially Metallized Polyester. Our Greencaps (many of which are BLUE) are prime spec OEM quality - not necessarily the cheapest we can buy! Jaycar Metallized Polyester (sometimes also called "Mylar") caps exhibit high Q and low inductance and generally have 100 - 125V working voltage.
 Values: 1uF thru 47uF (0.001uF - 0.47uF) in IEC E12 Series as well as the following values:
 1.0uF, 2.2uF and 3.3uF
 Price: 1uF (0.001uF) thru 22uF (0.022uF) 1 - 9.22 cents each 10 - 20 cents each
 27uF (0.027uF) thru 56uF (0.056uF) 1 - 9.24 cents each 10 - 22 cents each
 68uF (0.068uF) thru 220uF (0.22uF) 1 - 9.32 cents each 10 - 30 cents each
 270uF (0.27uF) 40 cents each 1 - 9
 330uF (0.33uF) 40 cents each 1 - 9
 390uF (0.39uF) 45 cents each 1 - 9
 470uF (0.47uF) 60 cents each 1 - 9
 1000uF (1.0uF) \$1.45 each 1 - 9
 2200uF (2.2uF) \$1.45 each 1 - 9
 3300uF (3.3uF) \$2.45 each 1 - 9

630V GREENCAPS High Quality. Relatively small size

1 - 9	10 -
10nF (0.01uF)	32
22nF (0.022uF)	38
33nF (0.033uF)	42
47nF (0.047uF)	49
60nF (0.060uF)	60
220nF (0.22uF)	88
330nF (0.33uF)	\$1.10
470nF (0.47uF)	\$1.30

JAYCAR

125 YORK ST SYDNEY 2000
 Ph. 2646688 Telex: 72293
 Mail Orders To:
 Box K-39 Haymarket 2000

POST AND PACKING CHARGES
 \$5.80 99 (1.20) \$10.24 99 (2.40)
 \$25.84 99 (3.30) \$50.99 99 (4.60)
 \$100.00 (5.20)

NEW SHOP HOURS
 Mon-Fri 8.30 to 5.30pm
 Sat 8.30 to 12.00pm
 Thurs night to 8.30pm



HIFI REVIEW

Shure V-15 Type V phono cartridge

The V-15 Type V, successor to the V-15 Type IV, has just been released by Shure as their top-of-the-line cartridge. By using a beryllium cantilever, Shure claims 80cm/sec tracking ability at 5kHz. Other features include a free test record and alignment gauges.

Shure Brothers have created quite a reputation in the hi-fi field with their range of phono cartridges. Top of the range has been the V-15 series of cartridges the last of which was the Type IV, released in 1978. This incorporated the Shure dynamic stabiliser, a damped carbon fibre brush that reduced the effect of tone arm resonances and also allowed the cartridge to track accurately over record warps.

Now, after a gap of four years, Shure has released another model in the V-15 range, the Type V. Resemblances to the Type IV can be seen in the continuing use of the dynamic stabiliser and the retention of the Type IV's tip geometry.

The V-15 Type V is a moving magnet design, like all Shure cartridges, and uses a "Hyperelliptical" nude diamond tip. This is a broad contact tip, similar in principle to the Shibata CD4 tip, and is used because it results in lower tracing distortion compared with conventional spherical and biradial tips. By using a thin-wall beryllium shank, and a smaller diamond tip, Shure have decreased the effective moving mass of the Type V's

stylus assembly by 40% compared to the Type IV.

This gives a two-fold benefit. Firstly, the stylus tip resonance has been moved from 21kHz (in the Type IV) to 33kHz, giving a flatter response in the audio band. Secondly, with less mass to accelerate and decelerate, the tip can maintain intimate contact with the groove at higher recorded velocities. Therefore the tracking ability is improved with Shure claiming that the Type V will track an 80cm/sec signal at 5kHz and a 60cm/sec signal at 10kHz. These are extremely high figures, indicating that the V-15 Type V should be able to accurately track any signal found on a commercially available record.

Another feature of the cartridge is the Side Guard stylus protection system which protects the stylus against side thrust. These can occur if the tonearm is bumped while playing a record or if the stylus contacts the edge of the record or turntable platter. The protection system operates by withdrawing the entire stylus tip and shank into the stylus housing upon application of a sideward force.



The V-15 Type V – Shure's latest top-of-the-line cartridge.

Also included in the purchase price of the V-15 Type V is the Shure TTR117 Trackability Test Record. The seven tests on this record allow the system to be adjusted to its optimum point and then the level at which mistracking occurs to be found. This level gives a trackability factor for the cartridge which is combined with the indentation factor for the tip (listed on the record jacket) to produce a new performance parameter called the "Total Trackability Index" (TTI).

Shure defines TTI as: $TTI = \text{Trackability Factor} \times \text{Indentation Factor}$ and provides notes on the record jacket covering the theory behind the TTI parameter.

The indentation factors listed on the record jacket are the results of Shure's research into the relationships between tracking force, tip geometry and record wear. A cartridge stylus indents (deforms) the record vinyl as it passes, however providing the indentation is not too deep, the vinyl will spring back and resume its original shape. If the vinyl does not spring back, the modification to the record groove will obviously cause distortion on subsequent replays.

Different tip geometries have different contact areas, so that a tracking force which causes damage with one tip will cause no damage when used with a tip of larger contact area. The depth of indentation relates directly to the rate of wear of record grooves and its reciprocal ($1/\text{indentation depth}$) can be considered as a measure of the relative gentleness with which the stylus treats the record.



This audio test record is included in the purchase price of the V-15 Type V and allows the system to be adjusted for optimum performance.

Shure call this the "indentation factor" of the stylus tip.

The reference against which other styli tips are compared is a $15\mu\text{m}$ spherical tip. This is given an indentation factor of 1.00 at a tracking force of 1 gram. Tips with a larger contact area, eg $3.8 \times 100\mu\text{m}$, have indentation factors as high as 1.26 meaning that there is less wear on the record groove for the same stylus pressure. (Remember that the indentation factor is an inverse quantity and as such a high factor corresponds to low wear.)

Another way of looking at this indentation factor, according to Shure, is to say that 100 plays of a record on the standard spherical stylus will result in the same amount of record wear as 126 plays on the larger contact stylus with both set to the same tracking force.

Shure claims that this Total Trackability Index "is a single number that fully describes the dynamic performance of a cartridge over the entire audio range". While this description seems to be a little ambitious, it does appear that Shure has come up with a usable method for taking into account not only the tracking ability of the cartridge but also the record and tip wear caused by the tracking force and tip geometry. Cartridges that require heavier tracking forces or have inferior tip geometries are penalised by giving them a lower indentation factor which results in a lower Total Trackability Index.

The V-15 Type V we reviewed arrived in a small plastic case containing not only the cartridge, but two alignment aids. Printed information included a small booklet, written in promotional style, describing various features of the cartridge and two leaflets which provided instructions for removing the cartridge from its holder and installing it in the tone arm. A third leaflet is a computer printout of the results achieved by the cartridge during Shure's quality control tests. These tests include output level, channel balance, separation at 1kHz and 10kHz, phase and frequency response.

Mounting the cartridge is easy, thanks to the use of plastic "nuts" rather than the more conventional metal ones. The plastic nuts slide into keyways on the cartridge body and are held there, by the keyways, while the mounting screws are inserted and tightened.

Despite a scarcity of English on the alignment gauge instruction sheets, the diagrams are quite clear, which is a great help when using the gauges for the first time. One gauge is a flat metal plate which contains the cartridge holder, the other is a grey, dummy stylus.

The latter alignment gauge allows the user to check whether the headshell is parallel to the record surface, a necessity if the best stereo separation is to be ob-

tained. Small adhesive shims are also provided which allow the cartridge to be tilted if the headshell is of the fixed variety and cannot be rotated.

The second alignment gauge allows the cartridge to be aligned for minimum lateral tracking distortion. This adjustment is normally achieved indirectly by adjusting the stylus overhang distance but according to Shure, theoretical analysis has shown that when the cartridge is aligned so that it is tangent to the groove at two places on the record, 66 and 120.7mm from the record centre, minimum overall distortion due to lateral tracking error is achieved. The second alignment gauge, called the Duo-point Alignment Gauge, adjusts the cartridge at these distances so that it meets the above criteria for minimum distortion.

With the cartridge mounted, we used the Shure TTR117 test record to optimise the system. The first test band on the record contains tests for identifying the



These alignment gauges allow adjustment for minimum lateral tracking distortion (left) and ensure that the headshell is parallel to the record surface (right).

left and right channels and checking the channel level and balance. The second test band contains tones for checking the phasing of the cartridge and speakers. The third test band is a skating compensation check which allows the antiskating adjustment to be optimised.

The commentary provided with the above tests is excellent, and the results of the tests are quite audible and unambiguous. An example of this is the skating test where a harsh, rasping tone suddenly appears in one channel or the other when the antiskating control is set either too high or too low.

The second side of the record contains trackability and tonearm resonance tests.

As the tracking ability of the Type V is a

major selling point, Shure have gone to a lot of trouble with the trackability test. In fact more than half the second side of the record is devoted to this one test.

Firstly there is a verbal description of what to listen for. Next, there are three demonstration bands of increasing level, which have increasing amounts of distortion. Then a tone band with no distortion for use as a comparison. Finally, there is a lengthy introduction to the tests and then the tests themselves.

They comprise six bands of tones of increasing level, with tones cycling through three intensity peaks. The tones in each band consist of a mixture of three sine waves, with frequencies of 200Hz, 2.1kHz and 17kHz, mixed together in proportions similar to that found in normal program material. At the highest level, the peak recorded velocities are 3.3, 21.0 and 20.0cm/sec respectively, for the three frequencies.

Unfortunately, even with the aid of all the information on the record, we were

unable to determine accurately the onset of mistracking. The three tones combine to produce a sound which, if anything, masks the sound of the cartridge mistracking rather than enhances it. The first demonstration by Shure of mistracking on the test record shows this problem clearly.

This is surprising, for a great deal of emphasis is placed upon the results of this trackability test by Shure. In fact it is this test more than any other, which is supposed to show the superiority of the Type V over other cartridges. To attempt to do this with a test that does not give clear cut results seems strange indeed.

Despite repeated comparisons between the two demonstration tracks, one "with mistracking" and one without, we

How to get 50% more sound without turning up the volume.

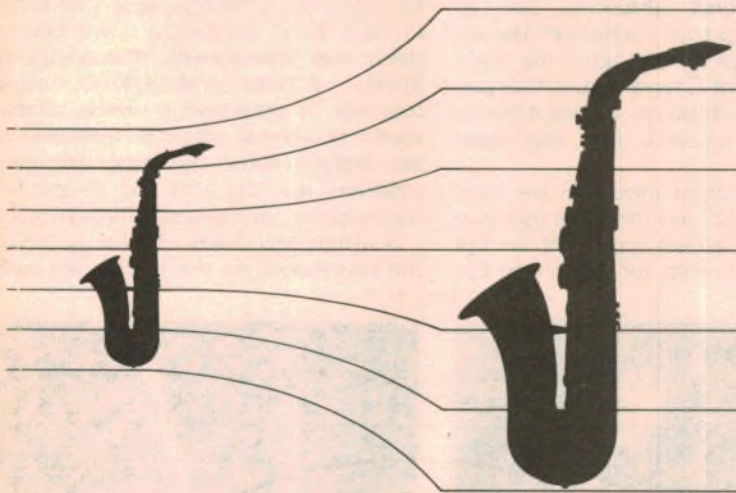

A dbx Dynamic Range Expander restores the music dynamics that were lost in the recording process—giving you up to 50% more sound. The technology is based on a technique originally developed by dbx for professional recording studios.

There's a whole range of sound in a live performance that you never hear from your stereo system. And it's not a question of turning up the volume.

The problem is in the records you play.

When recording engineers master a record, they electronically eliminate up to half the music. They literally compress the sound to make it "fit" on the vinyl record.

Fortunately, there's one solution to the problem: dbx Dynamic Range Expanders.

A dbx Dynamic Range Expander in your system restores most of the lost music. And it reduces annoying record surface noise by as much as 20 dB. So instead of a compressed 50 or 60 dB of dynamic range, you get a full 75 to 90 dB. The loud passages begin to thunder. The softs are truly subtle. All your music comes to life.

And you can use a dbx Dynamic Range Expander not only with your records, but also with tapes and FM broadcasts.

Visit your authorized dbx retailer for a demonstration of the 1BX, 2BX and 3BX Dynamic Range Expanders. Then select the model that's best for your system.

Because there's a lot more to music than has been reaching your ears.

dbx

Making good sound better

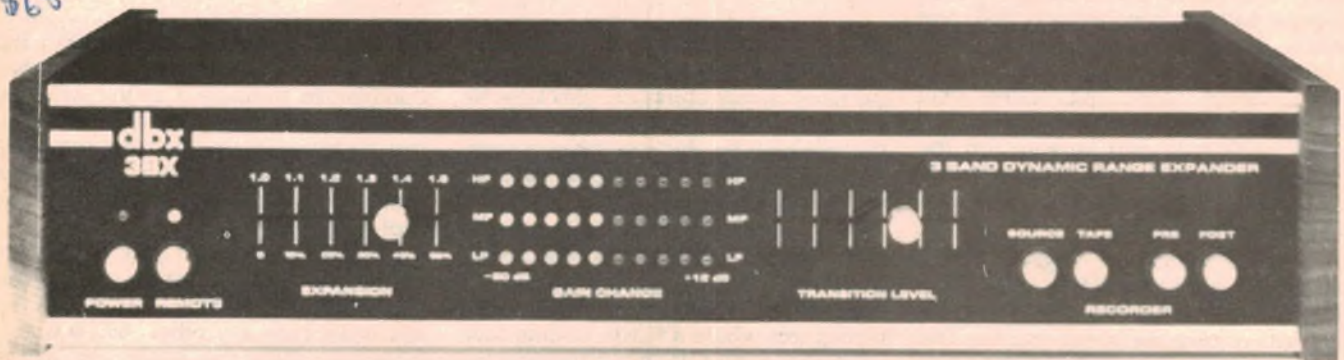

AUDIO ENGINEERS PTY LTD
342 Kent Street
SYDNEY NSW 2000

NOMIS ELECTRONICS P/L
689 South Road
BLACK FOREST SA 5035

AUDIO ENGINEER QLD
47 Castlemaine St
MILTON QLD 4064

AUDIO ENGINEERS (Vic)
2A Hill Street
THORNBURY Vic 3071

ATHOL M. HILL P/L
Unit 5, 66 Wellington Street
PERTH WA 6000
HAWKINS AE165

SHURE V-15 TYPE V CARTRIDGE

could not pick the difference. All who heard the tones remarked that they sounded "woody" or harsh by their very nature. Nor could we pick any difference by close examination of the signals with the aid of an oscilloscope. We had two samples of the record, by the way, and they were identical in this respect.

With the final test on the record, the tonearm resonance test, we had trouble finding the resonance. This was mainly due to the effectiveness of the dynamic stabiliser fitted to the Type V which damped the resonance peak to the point where it was virtually unnoticeable. The dynamic stabiliser brush must be regarded as one of the best features of the Type V for not only does it reduce the effects of warps and resonances very effectively, it also cleans the record and helps neutralise static charge at the same time.

To gauge the tracking ability of the V-15 Type V we used more conventional test records than the TTR117, these being the CBS STR110, the W&G 25/2434 and the Shure Audio Obstacle Course-ERA III. Played with the dynamic stabiliser on, and at the recommended tracking force of 1.5 grams (corresponding to a one gram force on the stylus tip), the Type V coped with all but the most severe peaks on each record. These were the +18dB 300Hz test on the CBS STR110, the +16dB drum beat on the W&G 25/2434 and the level 5 violin track on the Shure ERA III.

Clearly this places the V-15 Type V amongst the leading cartridges as far as tracking ability is concerned, particularly since it achieves these results with a stylus force of only one gram. The square wave response of the cartridge was also excellent – possibly the best we have seen. The small amount of ringing present on the leading edges of the square wave had a frequency of around 40kHz, definitely well out of the audio band. There was some slight rounding of the square wave but this is of little consequence.

Manufacturer's figures for the Type V are a mass of 6.6 grams, a DC resistance of 950Ω (typical) and an inductance of 330mH (typical). The recommended load for the cartridge is 47kΩ in parallel with 250pF although Shure states that capacitances between "100 and 400pF will cause negligible change" in performance.

The overall frequency response showed a drop of 3dB at 20kHz, and a small resonance peak of +2.5dB at 14kHz which appears to be caused by the electrical resonance of the cartridge inductance and the load capacitance. There was a slight mid-high frequency droop in response centered around 6-8kHz but

below 1kHz the response was within 0.5dB.

Channel separation was excellent, being 30dB at 1kHz, 23dB at 10kHz and 24dB at 20kHz. The only place where adequate channel separation was not maintained was around the electrical resonance point where the separation dropped to a low 7.5dB at 17kHz. This is not good at all and may point to a small fault being present in the review model. In any case, fault or not, there still appears a need to shift the electrical resonance frequency to a point somewhere outside the audio range.

One method for shifting the resonant frequency would be to reduce the capacitive loading of the cartridge. By using the minimum value stated by Shure, 100pF, the resonant frequency could

human hearing, although the same probably cannot be said for any inter-modulation products that may be present.

Performance and listening tests were carried out with the V-15 Type V mounted in a variety of record player and tonearm combinations. Except for the SME Series 3 arm, there was no difference in any of the measured performance parameters of the cartridge between tonearms. When mounted in the SME tonearm, the V-15 Type V tracked marginally better but still not good enough to verify Shure's claims.

Listening tests showed that the V-15 Type V performed best in the SME tonearm, delivering a very clean, transparent sound with excellent overall balance between high and low frequencies.

To sum up our test results, we were still a little disappointed with the tracking

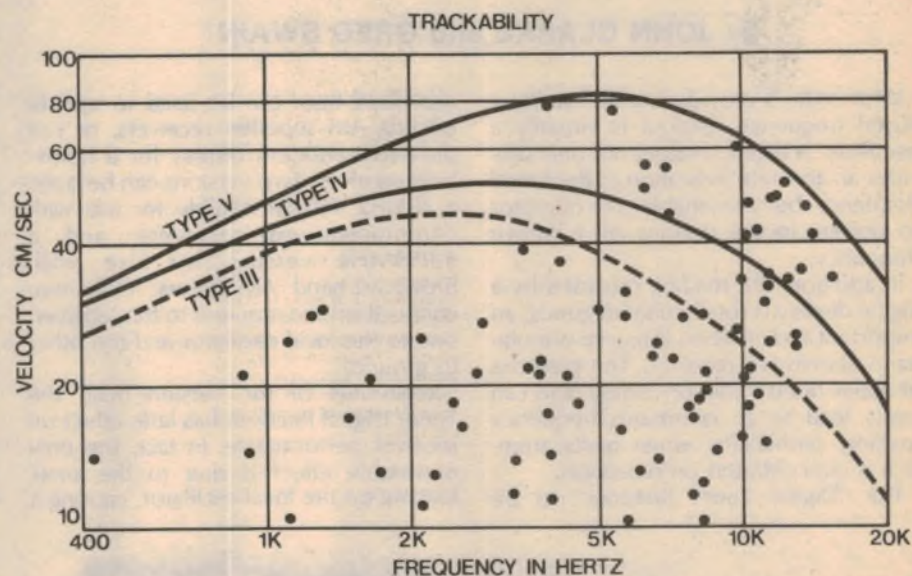

This graph shows the tracking ability of the V-15 Type V compared to its predecessors, the V-15 Type IV and the V-15 Type III. The dots represent actual recorded velocities of signals on difficult-to-track records.

be shifted to almost 28kHz. Shifting the resonant frequency outside the audio band would be difficult, however, for anyone whose turntable leads already possessed more than about 200pF capacitance.

Output level for the V-15 Type V was measured as 0.90mV/cm for the left channel and 0.93mV/cm for the right channel, both measurements being taken at 1kHz. This represents a channel balance of 0.25dB at this frequency.

Below 10kHz there was very little distortion on sine waves, however above 10kHz it was a different story. As the test frequency approached the electrical resonance frequency, the sine wave became quite distorted. The effects of this distortion are unclear. Certainly any harmonic distortion produced will be outside the range of normal

ability of the V-15 Type V. That is not to say it isn't good – it's just not as good as the Shure literature led us to believe. (By way of comparison, no cartridge we have tested has managed to accurately track all the test records used.) Also we feel that the frequency response should have been flatter and that the sine wave distortion above 10kHz was too high. On the credit side the dynamic stabiliser worked very well, the channel separation was excellent (except at one point) and the overall sound of the cartridge (in the SME tone arm) was very smooth.

Recommended retail price of the Shure V-15 Type V is \$389 which includes the TTR117 test record. Further details can be obtained from high fidelity retailers or from the distributors – Audio Engineers Pty Ltd, 342-344 Kent St, Sydney, NSW, 2000. (J.S.)

Locate stations quickly & accurately

Digital readout for shortwave receivers

Want to add digital frequency readout to an AM radio or shortwave communications receiver that uses an old-fashioned analog dial? This unit features a bright four-digit LED display, 1kHz resolution, and a 0.2s update time that's fast enough to follow the tuning knob.

by JOHN CLARKE and GREG SWAIN

With today's crowded radio bands, a digital frequency readout is virtually a necessity. A digital readout not only provides an accurate indication of the tuned frequency, but also enables the operator to quickly locate stations of a known frequency.

In addition, the reading provided by a digital display is totally unambiguous, an important factor when listening to a multi-band shortwave receiver. The plethora of scales often found on analog dials can easily lead to an erroneous frequency reading, particularly when one's attention is concentrated on reception.

The "Digital Tuner Readout" to be

described here can be used to update existing AM superhet receivers, or can provide a modern display for a home-built receiver. Two versions can be built: a 30MHz version suitable for use with communications receivers; and a 9.999MHz version for use with broadcast-band AM tuners. Only two connections are required to the receiver, one to the local oscillator and the other to ground.

Regardless of the version built, the Tuner Digital Readout has little effect on receiver performance. In fact, the only noticeable effect is due to the small loading on the local oscillator, causing it

to shift frequency slightly. This will cause the tuning dial on the receiver to be slightly off scale but, since we are now using the digital readout, this will be of little consequence.

Resolution of the four-digit display is 1kHz over the full range of frequencies to 30MHz. For frequencies above 10MHz, the unit overranges and the most significant digit is not displayed when the range switch is set to the divide by one position. The most significant digit can be displayed simply by switching to the divide by 10 position, which gives a resolution of 10kHz.

Decimal point switching is employed in the design so that the display always indicates the tuned frequency in MHz. This facility is unnecessary if the unit is to be used only with a broadcast-band tuner.

By now, some readers will be wondering why our design appears to be so complicated. After all, why use 19 integrated circuits when an LSI chip (such as the AY-3-8112 as used in the Playmaster AM-FM Tuner-Clock) is



The Tuner Digital Readout can be used with broadcast-band AM tuners and communications receivers.

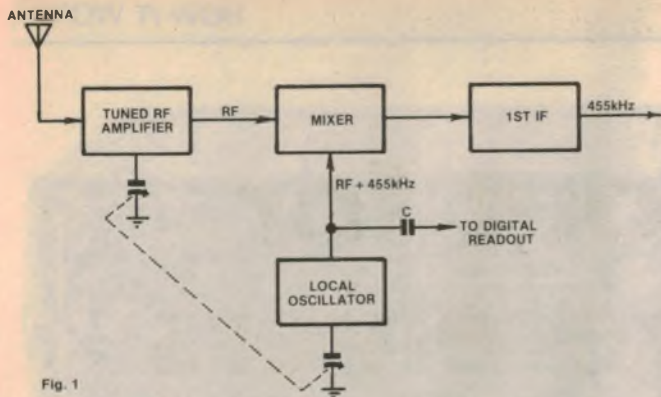

Fig. 1

Basic scheme for a superhet receiver front end. The local oscillator frequency is always 455kHz higher than the tuned signal frequency.

SPECIFICATIONS

RANGES (FULL SCALE)	0-10MHz and 10-30MHz (optional).
DISPLAY	Four digit.
RESOLUTION	1kHz with division switch set to divide by one; 10kHz with division switch set to divide by 10.
SENSITIVITY	Less than 100mV from 500kHz to 30MHz.
OFFSET FREQUENCY	Prototype set to 455kHz, but any offset frequency can be programmed.

available to do the job? The answer is that we have deliberately opted not to multiplex the LED displays, since this can cause noise problems within low signal circuitry of the accompanying tuner.

In short, the advantages of multiplexing have been rejected in favour of tuner performance. And while 19 ICs may sound a lot, the devices used are all low in cost and readily available.

Other advantages of our new design include selectable IF offset, which means that it is adaptable to almost any superheterodyne receiver. By comparison, the AY-3-8112 does not have adjustable IF offset and can only display the tuned frequency in 10kHz steps (later versions possibly have the necessary 9kHz resolution now required by the broadcast band).

At this stage, we should warn readers that the unit is not suitable for use with Wadley loop receivers or the "Electronics Australia" Deltahet receivers.

Since the incoming frequency source is derived from the local oscillator, a conventional superheterodyne receiver must be used. This will include virtually all broadcast-band tuners and most general communications receivers.

Superheterodyne tuners

Before discussing the circuit operation, let's first examine the basic principle of a superheterodyne receiver.

Fig. 1 shows the general block diagram of a superhet receiver front end. The antenna feeds signal frequencies to a tuned RF stage, which selectively amplifies the particular tuned frequency. Tuning is commonly achieved by adjusting one gang of the dual-ganged capacitor, the second gang being used to control the local oscillator frequency. Both gangs work in unison, such that the local oscillator frequency is always 455kHz (the most common figure) higher than the tuned signal frequency.

Signals from the tuned RF amplifier and the local oscillator are mixed together in the mixer, the output of which consists of the original frequencies plus sum and difference frequencies. Virtually all superhet receivers reject the sum frequency and filter the 455kHz difference frequency at the first intermediate frequency (IF) stage.

It is important to realise that the tuned RF signal is not a single sine wave but consists of a range of signals centred about the tuned frequency. This range, in combination with various other factors, determines the maximum possible audio bandwidth of the receiver.

The local oscillator provides the only pure sine wave signal and it is this that is used to drive the digital readout, as shown in Fig. 1. However, the digital readout is unusual in that it is not set to zero at the beginning of a count sequence. Instead, it is "offset" (or preloaded), the amount of offset being equal to the intermediate frequency of the receiver being measured.

In other words, the circuit is basically a specialised type of frequency meter which measures the receiver's local oscillator frequency and subtracts the IF to display the actual frequency to which the receiver is tuned.

Block diagram

Fig. 2 shows the general arrangement of the Tuner Digital Readout. Essentially, it can be broken into three parts: input amplifier and divider chain to process the local oscillator signal; a crystal-controlled timebase; and a counter section.

As shown, the local oscillator input frequency is amplified and then divided by either 100 or 1000, depending upon the position of the division switch. A 4MHz crystal-controlled oscillator forms the timebase, which is divided by 80,000 to obtain a 50Hz clock signal. This 50Hz clock signal is then fed to a timing circuit to derive a 5Hz gating signal plus control signals for the counter, latch and preload circuitry.

When the division switch is in the divide by one position, the counter is preloaded with 9545, which is the appropriate offset for a 455kHz IF. Why

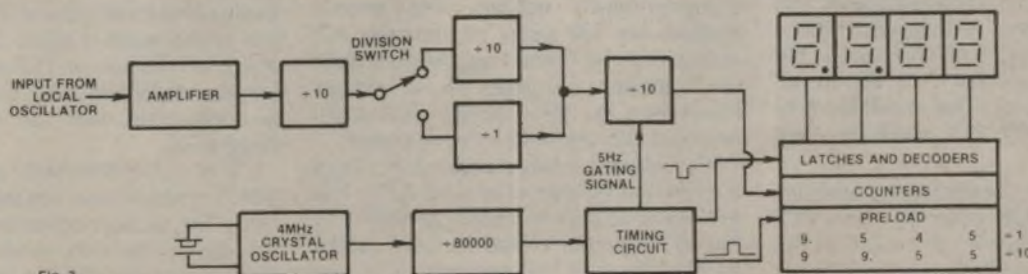

Fig. 2

The circuit is basically a DFM that is offset by an amount equal to the intermediate frequency of the receiver being measured.

9545? The answer is that if we add 9545 and 455 we obtain 10,000 and, since the counter overranges, the display will read 0000.

By thus adding the IF to the counter preload, the counter is effectively zeroed.

Similarly, when the division switch is set to divide by 10, the counter is preloaded to 9955. This number is arrived at by rounding off the theoretical preload number of 99545 to the four most significant digits. Since counter resolution is only 10kHz in the divide by 10 position, this has no effect on the accuracy of the display.

After preloading, the gating signal allows the local oscillator signal to be counted. When counting stops, after 100ms, the latches store the BCD count and subsequently decode it to drive the seven-segment LED displays.

An example will serve to illustrate how preloading works. Let's assume that the division switch is set to divide by one and that the receiver is tuned to Sydney station 2SM on 1269kHz. The local oscillator will thus be on 1724kHz (or 1.724MHz). This frequency is fed to the counter, which counts up from 9545, on through zero and up to 1269.

Circuit details

A FET preamplifier stage and an emitter-coupled-logic (ECL) IC form the front end of the design, while low power Schottky (LS) TTL ICs are used as dividers. CMOS devices are used for the counters and decoders, however, since decoders with latching are not available in TTL.

Two separate FET preamplifiers are shown on the circuit diagram. The circuit enclosed within the dotted lines is recommended if the display is to be used with shortwave receivers, or if the leads to the local oscillator are relatively long (greater than 200mm). It is built on a separate small (38 x 24mm) PCB designed to mount inside the receiver, close to the local oscillator.

In this remote buffer stage, input signals from the local oscillator are coupled in via a 15pF capacitor to the gate of a 2N5485 N-channel FET arranged in common source configuration. The 1kΩ source resistor is bypassed with a .0047μF capacitor and this gives the stage a gain of around unity at the frequencies of interest. This is sufficient to drive the following ECL amplifier stage into clipping.

The alternative preamplifier, consisting of FET Q1, is built onto the main PCB along with the rest of the circuit. In this case, Q1 is arranged as a source follower with the gate connected to ground via a 1MΩ resistor and self-biased by a 1kΩ source load. This arrangement should

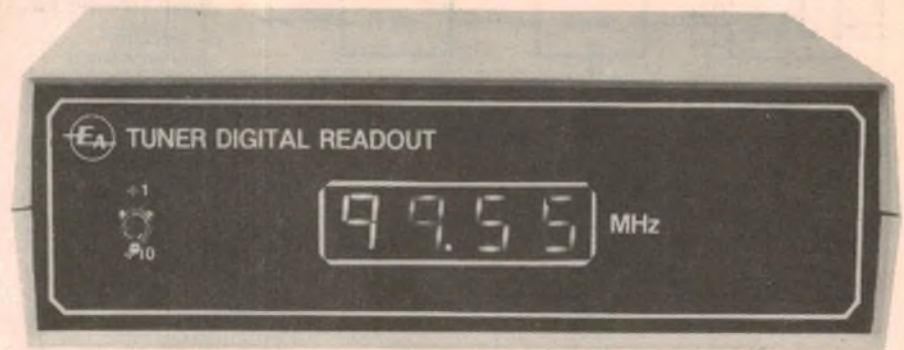

This view shows the prototype displaying the divide by 10 preload value.

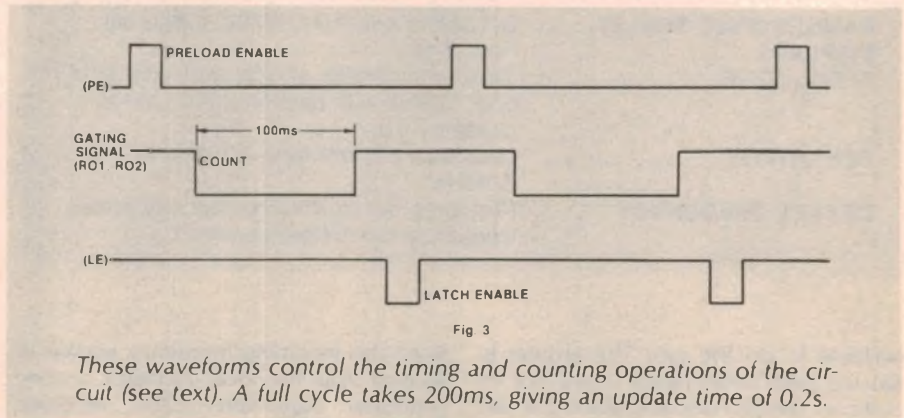

These waveforms control the timing and counting operations of the circuit (see text). A full cycle takes 200ms, giving an update time of 0.2s.

work satisfactorily with broadcast band tuners, provided the leads to the local oscillator are kept short, but note that the input coupling capacitor must be increased to 47pF to compensate for the lower gain of the circuit.

The FET output is AC-coupled to cascaded ECL line receivers IC1c, IC1b and IC1a, which comprise an MC10116 triple differential line receiver IC. If this part of the circuit appears familiar, that's because an identical arrangement was used in the front end of the EA 500MHz DFM in the December 1981 issue!

Essentially, each ECL line driver receiver consists of an NPN differential pair with a constant current source in the "tail" and resistor collector loads. The collector of each transistor is buffered by an emitter follower, which provides complementary outputs. The emitter outputs are left open, so that the ECL outputs can be ORed together to reduce the number of gates in a design. However, in this design pull-down resistors are required on each output.

ECL outputs usually swing ±0.2V about a reference voltage of around 3.7V. This reference voltage is actually provided by the 10116 on pin 11 and we have used it to bias the first line receiver, IC1c, via two 1kΩ resistors. A 0.1μF capacitor and a 10μF tantalum capacitor provide decoupling of the reference voltage.

The stage following IC1b is IC1a which operates as a Schmitt trigger by virtue of the positive feedback network consisting of the 220Ω and 1kΩ resistors. Input signals to this Schmitt trigger must exceed its two hysteresis trigger levels before the output of the trigger will change, so this stage provides a good deal of noise immunity as well as squaring up the waveform.

The ECL outputs of IC1a are converted to TTL levels by transistors Q2 and Q3, both 2N4258 high speed switching transistors. Since the ECL outputs from pins two and three swing ±0.2V about 3.7V, then either Q2 or Q3 will be on. Thus, when pin two goes low Q2 turns on and when pin three goes low Q3 turns on. Since one transistor is always on, the current through the 22Ω resistor remains virtually constant at around 35mA. The output of this stage is taken from the 100Ω collector resistor of Q2 and will swing between 0.1V and 3.2V, making it directly compatible with the following TTL stage (IC2).

IC2 is a 74LS196 high speed counter which contains two separate divider circuits. The section consisting of CK1 and Q1 divides by two, while the CK2/Q3 section provides division by five. By connecting the Q1 output to CK2 the counter divides by ten and, in this configuration, will operate up to 40MHz.

SERIES 5000

As designed by ETI



SERIES 5000 PREAMPLIFIER — SPECIFICATIONS

Frequency response:	High-level input: 15Hz-130 kHz, +0, -1 db Low-level input — conforms to RIAA equalisation, ± 0.2 dB
Distortion:	1kHz <0.003% on all inputs (limit of resolution on measuring equipment due to noise limitation).
S/N noise:	High-level input, master full, with respect to 300 mV input signal at full output (1.2V): >92 dB flat >100 dB A-weighted. MM input, master full, with respect to full output (1.2V) at 5 mV input, 50 ohm source resistance connected: >86 dB flat >92 dB A-weighted. MC input, master full, with respect to full output (1.2V) and 200 μ V input signal: >71 dB flat >75 dB A-weighted



N.B. Picture is only of original heatsink supplied with this project. Our one is tapped from the rear so that no screw heads are visible. New picture next month.

Please note that the "Super Deluxe" Heatsink for the power amp was designed and developed by Rod Irving Electronics and is being supplied to other kit suppliers. This product costs \$1,200 to develop so that your amplifier kit would have a professional finish as well as sound. We also have a new range of rack mounting boxes which will be released soon.

SERIES 5000 POWER AMPLIFIER — SPECIFICATIONS

Power output:	100W RMS into 8 ohms (± 55 V supply).
Frequency response:	8 Hz to 20 kHz, +0 -0.4 dB 2.8 Hz to 65 kHz, +0 -3 dB NOTE: These figures are determined solely by passive filters.
Input sensitivity:	1V RMS for 100W output.
Hum:	-100dB below full output (flat).
Noise:	-116 dB below full output (flat, 20 kHz bandwidth).
2nd harmonic distortion:	<0.001% at 1 kHz (0.0007% on prototypes) at 100 W output using a ± 56 V supply rated at 4 A continuous. <0.003% at 10 kHz and 100 W.
3rd harmonic distortion:	<0.0003% for all frequencies less than 10 kHz and all powers below clipping.
Total harmonic distortion:	Determined by 2nd harmonic distortion (see above).
Intermodulation distortion:	<0.003% at 100 W. (50 Hz and 7 kHz mixed 4:1).
Stability:	Unconditional

EXTRA FEATURES OF OUR KITS POWER AMPLIFIER

- KIT PRICE \$270.00 P & P \$8.00
- 1% Metal Film Resistors are used where possible
 - Prewound Coils are supplied
 - Aluminium case as per the original article
 - All components are top quality
 - Over 200 Kits now sold
 - We have built this unit and so know what needs to go into every kit
 - SUPER FINISH Front panel supplied with every kit at no extra cost to you
 - We are so confident of this kit that we can now offer it assembled and tested so that people who do not have the time can appreciate the sound that this amplifier puts out. This is done on a per order basis delivery approx. two weeks after placement.
The price is only \$399.00

*All parts available separately for both kits.

PREAMPLIFIER

- KIT PRICE \$230.00 P & P \$8.00
- 1% Metal Film Resistors are supplied
 - 14 metres of Low Capacitance Shielded are supplied (a bit extra in case of mistakes)
 - English "Lorlin" Switches are supplied no substitutes as others supply
 - We have built and tested this unit and so know what needs to go into every kit
 - Specially imported black anodised aluminium knobs
 - Again as with the power amp we are offering this kit A & T at a price which we do not believe there is a commercial unit available that sounds as good. Same delivery as the P.A.
All the above for only \$399.00



SERIES 4000 SPEAKERS FROM ETI

SERIES 4000/14-WAY SPEAKERS

A no compromise, top-line system designed by David Tilbrook and described in the February 1980 ETI. Those who own them or have heard them universally praise them for clarity of sound, superb stereo imaging and smoothness of response. Employing Philips' latest range of low distortion drivers and a specially-designed crossover network (another Tilbrook masterpiece) these speakers are the equal of other systems costing up to three times the price. The 4000/1 will handle 100 W continuous, up to 400 W peak. PLEASE CHECK PRICES AND AVAILABILITY

ROD IRVING ELECTRONICS

425 HIGH STREET NORTHCOTE 3070 MELBOURNE (03) 489-8131

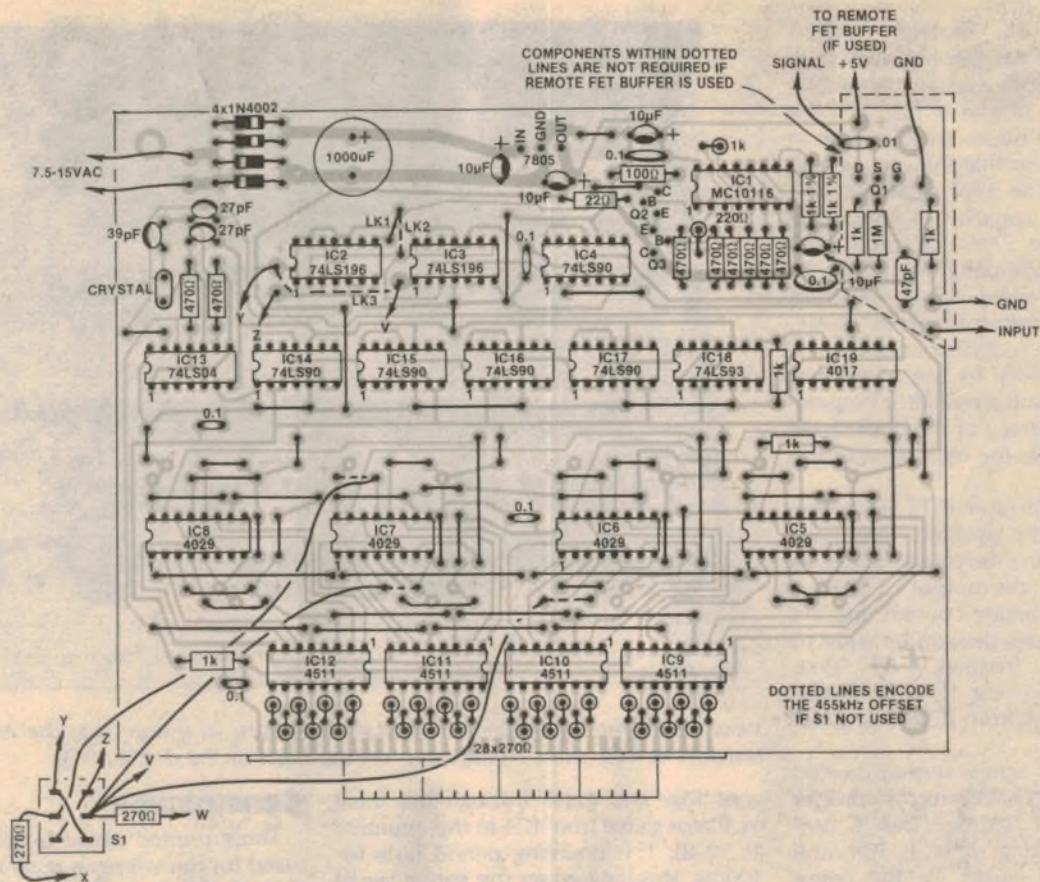

Parts layout diagram for the main PCB (30MHz version). The links shown dotted are used only in the 10MHz version.

Note that IC2 is used only for the 30MHz version. For broadcast band applications, IC2 is left out of circuit and the signal from Q2's collector applied direct to the input (pin 8) of IC3.

IC3 can be set to either divide by ten or to follow the input signal (divide by one). If IC2 is not used, then IC3 is permanently set to divide by ten. In the 30MHz version, switch S1a is used to select the division by switching the "count" input (pin 1) of IC3 either high or low. When pin 1 is held high the IC divides by ten in exactly the same manner as IC2. When the "count" is held low, the clock is disabled and the Q3 output follows the D3 input, also connected to the output of IC2. Consequently the IC divides by one.

IC4 also divides by ten. In this case, however, a 74LS90 IC is used rather than the more expensive (but faster) 74LS196 in the previous stages. The Q4 output is disabled (reset to zero) when the RO1 and RO2 inputs are brought high by the carry out (CO) of IC19, which controls the gating function. A 1kΩ pull up resistor at the output of IC4 ensures that the voltage levels of this TTL output are compatible with the CMOS clock input of IC5.

IC5, IC6, IC7 and IC8 are 4029 preset-

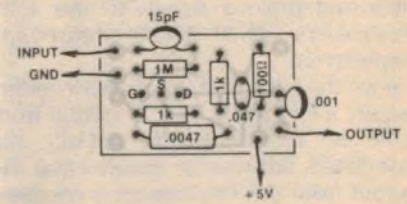
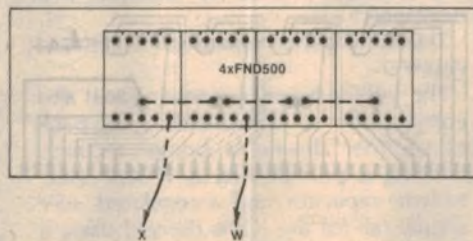

Parts layout diagrams for the display board (left) and the remote FET buffer stage (right). Make sure that the displays are inserted the right way round.

table decade counters interconnected in a ripple clocking mode. In other words, the carry out, CO, of the first stage is connected to the clock (CK) input of the following stage and so on. These counters have jam load, or preload, inputs whereby instead of counting up or down from zero, they can count from a predetermined number. This number is loaded into the jam inputs, J1-J4, in BCD code.

When a high signal is applied to the preload enable (PE) of each counter, the binary number programmed on the J1-J4 pins is loaded into the counter. When the preload enable is subsequently brought low, the counters begin to count.

Switching between the two preload

numbers is achieved with division switch S1a and S1b. In the divide by one position, J1 of IC6 and J4 of IC7 are brought to ground, and J3 of IC7 is connected to +5V. The converse applies for the divide by 10 position. In addition, the division switch is used to switch the display decimal points which are driven via separate 270Ω resistors.

The BCD outputs of the 4029 counters are decoded by 4511 BCD to seven-segment decoder drivers (IC9, IC10, IC11 and IC12). The decoder ICs read the count when the latch signal goes low and retain this count when the latch enable (LE) subsequently goes high. The decoded outputs of the ICs drive common-cathode FND500 LED displays via 270Ω current-limiting resistors.

Clock signals are derived from a crystal-controlled oscillator consisting of a 4MHz series-mode crystal and 74LS04 TTL inverters IC13a and IC13b. A 470Ω feedback resistor biases each inverter in the linear mode, so that they act as high gain amplifiers. The 39pF capacitor provides the correct capacitive load for the crystal, while the 27pF capacitors limit the maximum operating frequency of the circuit to prevent the crystal from operating in a spurious harmonic mode. IC13c buffers the oscillator output.

It is not necessary to use a trimmer capacitor to adjust the oscillator frequency, since the accuracy of the untrimmed crystal far exceeds the resolution of the display.

IC14, IC15, IC16 and IC17 each successively divide the oscillator frequency by 10. This division ratio totals 10,000, so the frequency at the output of IC17 is 400Hz. IC18 is a binary counter and the QC output provides division by eight to give an output frequency of 50Hz. Because the following IC is a CMOS device, the output from IC18 has a 1kΩ pull-up resistor.

The 50Hz signal is now further divided by IC19, a 4017 CMOS decade divider with 10 decoded outputs. This IC provides the 5Hz gating signal to IC4, and provides control signals for the count and latch operations. Each of the 10 decoded outputs go high in sequence for a period of one clock cycle and we have used the "1" and "3" outputs for the latch and preload signals to the 4511 decoders and 4029 counters respectively.

Since the latch enables of the decoders require a low signal, the "1" output from IC19 is inverted with IC13d. The associated 1kΩ resistor ensures that the output from the TTL inverter is compatible with the CMOS inputs of the decoders. Fig.3 shows the waveforms used for timing the counting operation.

First, the preload enable goes high for 20ms and the counters are preloaded ready to begin counting. Then, 20ms later, the CO output (pin 12) of IC19

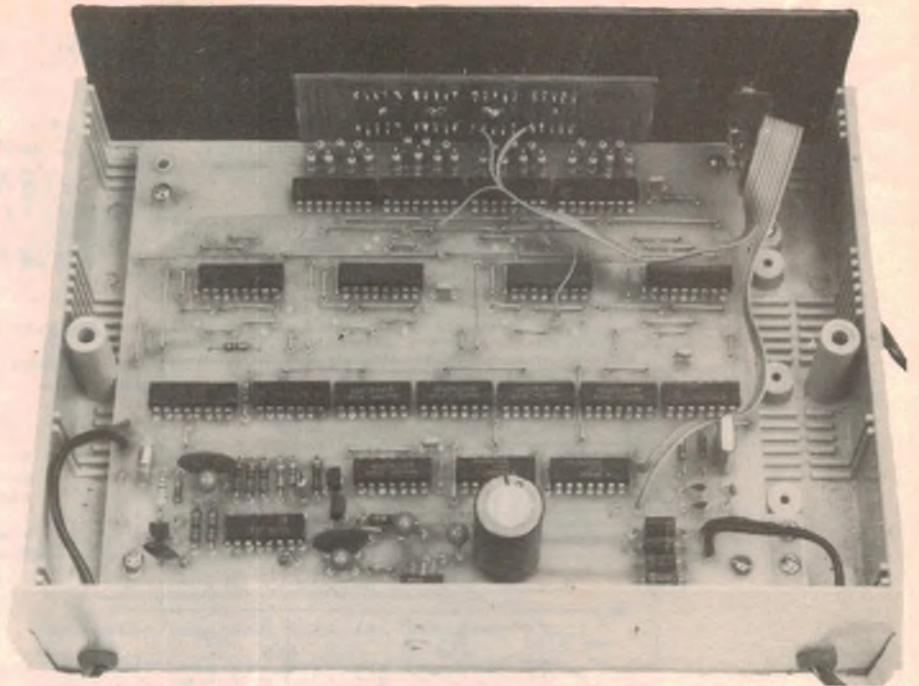

View inside the assembled prototype. Take care to ensure that the end-mounted resistors do not short connections on the back of the display PCB.

goes low and gates through the local oscillator signal from IC4 to the counters (IC5-IC8). This counting period lasts for 100ms, stopping when the gating signal subsequently goes high again. Finally, after a further 20ms, the latch enable to the decoders (IC9-IC12) goes low and the counted value is latched and displayed.

This cycle is then repeated for the next count.

The power supply is conventional and consists of a 7.5-15VAC plug-pack transformer driving a bridge rectifier. Filtering is provided by a 1000μF electrolytic capacitor and a regulated +5V supply rail for the ICs is derived using a 7805 3-terminal regulator. The 10μF tantalum capacitors ensure regulator stability and improve the transient response, while the 0.1μF decoupling capacitors prevent false triggering of the ICs due to supply line transients.

Construction

Three printed circuit boards (PCBs) are used for the wiring: a main board coded 82fc8a (160 × 125mm); a display board coded 82fc8b (93 × 33mm); and a small preamplifier board coded 82fc8c (38 × 23mm). The display board carries the four FND500 displays and is soldered at right angles to the main board to keep internal wiring to a minimum.

As explained previously, the remote preamplifier board (82fc8c) is necessary if the display is to be used with shortwave receivers or if the leads to the local oscillator would otherwise be fairly long. The preamplifier on the main board should be sufficient for most broadcast

Below is an actual size reproduction of the front panel artwork, but with the trim marks deleted so that it will fit on the page. Panel trim is 197 × 60mm.

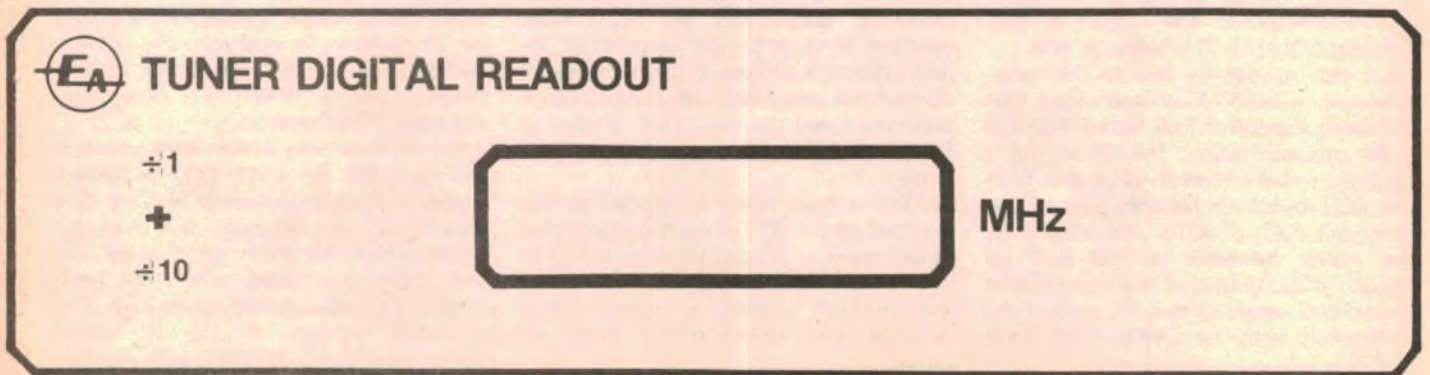

NEW KITS

SAVE A FORTUNE... Build it yourself from a Dick Smith Kit!

Why pay for commercial equipment when, with just a few hours of your time, you can build it yourself with the aid of a Dick Smith Kit? Because you supply the labour, you can save \$\$\$! AND what's more, it's great fun. So have a go and do it yourself. Your friends will never believe you built it!



UNIVERSAL DC TO DC INVERTER

Hundreds of uses for this fantastic inverter just by rearranging the coil winding as explained in the instructions supplied. Any voltage is available up to 1400V if necessary, just by varying the secondary winding. Produce 40V rails to drive a 100 watt audio module, etc. Cat K-3276

\$49.50

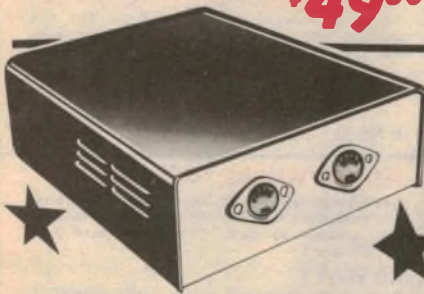

FLUORESCENT INVERTER

This remarkably compact inverter operates from 12V source and can drive up to 40 watts of fluorescent tube, (2 x 20w or 1 x 40w). A special pre-wound coil is included with a highly efficient E-core. Our TUO-4 casing is supplied with the kit also. Cat K-3275.

\$49.50

"Compu-voice" (EA Speech Synthesiser Kit)

Now you can have the advantages of a full phoneme - type speech synthesiser for a fraction of the normal cost! With features like: Unlimited vocabulary, variable pitch control (vary the speech from baritone to a soprano), easy to program AND it works with any computer fitted with a Centronics type parallel printer port such as the Dick Smith System 80 and Super 80, and the Tandy TRS 80. Fantastic value! Cat K-3530. See EA Oct. 82

Case to suit Cat H-2505 only \$12.50
Transformer to suit Cat M-2851 only \$3.90

★ **FLUORESCENT STARTER** ★

Replace your old faulty starter with this superb kit. All solid state — fits into the carcass of your old starter. This is our smallest kit ever — even the instruction manual is small! It is also one of our **LOWEST PRICED** kits! At this price it's a steal! Cat K-3082.

\$9.75

ONLY **\$4.80**

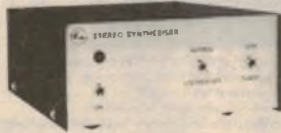

STEREO SYNTHESIZER

If you've compared mono and stereo sound, you'll be aware of the advantages of stereo reproduction. Now you can enjoy the benefits of stereo sound from your video cassette recorder, TV or AM tuner with this Stereo Synthesizer. Easy to build, you can choose between normal and synthesized stereo sound and between two different monophonic sound sources. Cat K-3420

ONLY **\$52.50**

LCD PANEL METER MODULE

This is an economical, yet high quality and very accurate voltmeter using a large LCD for easy reading and low power consumption. Comprehensive data & instructions indicate the versatility of the single chip that this kit has been built around, (the ICL 7106). Use as a normal panel meter for all the uses of an analogue panel meter but with the added advantage of non-ambiguous readings. The number of uses is only limited by the inventiveness of the user. Cat K-3450

ONLY **\$29.50**

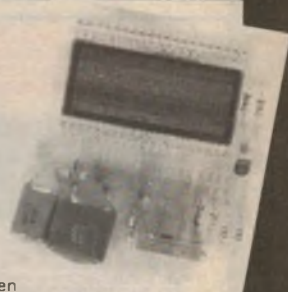

DICK SMITH DELUXE COUNTER

The experimenter's delight! Every hobbyist at some time needs a counter. Here's one that won't break the bank. A deluxe fibreglass PCB with all the counter components supplied — and you can use this as a base for a huge number of projects. Operates from 5 to 15V supply. Exclusive to Dick Smith Electronics, with our own specially prepared instruction manual showing not only how to build it, but a number of experiments too! Cat K-3451

ONLY **\$29.50**

YOU REAP THE BENEFIT!

LAST CHANCE TO BUILD THESE EXCITING KITS ... STOCKS ALMOST GONE!

EA METAL LOCATOR

ONLY **\$19.50**

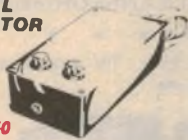

Want to make an economy detector? This must be the one. It uses the latest digital integrated circuitry and is very simple to make AND it won't break the bank! Significantly simpler circuitry means simpler operation too! Cat K-3504. See EA Nov 79.



Make a bit of noise with **THE HOT CANARY**

Give your budgie something to worry about. This kit uses just one CMOS IC to generate the beautiful whistling and chirping of two canaries! Comes complete with zippy box and speaker. Cat K-3395. See EA May 81.

ONLY **\$15.50**

SOUND LEVEL METER

ONLY **\$35.50**



This great unit will measure noise in its many forms. Measures levels of less than 20dB to levels greater than 120dB with fast or slow response times. This allows you to measure peak or average levels. An easy kit to build, it's mounted in a zippy box and is battery powered. Cat K-3476. See EA May 81.



CORE BALANCE RELAY

Protect your equipment AND YOUR LIFE! This circuit breaker detects earth fault currents and then trips a relay which cuts the power. The relay cannot be reset until the fault has been corrected. The unit is portable, designed to run on 240V and comes complete with special front panel and double power outlet. Cat K-3315. See EA April 81.

WAS ~~\$52.00~~ NOW **\$45**



CAR STEREO BOOSTER AMP

Upgrade the power of your car's stereo radio or cassette to 1.5 W RMS per channel! Install this unit in the existing speaker cables and connect to 12V and earth and away it goes. Easy to build, can be matched to wide variety of stereo systems. Cat K-3493. See EA Jan 79.

ONLY **\$29.50**

PARTS FOR NEW KITS

SCR C122E	Cat Z-4332	\$1.85
IC TL 071	Z 6030	\$1.25
IC 4049	Cat Z-5649	80c
RCA Socket 6 way	Cat P-1446	\$1.70
Transformer 2155	Cat H-2155	\$5.95
F x 22402 pot core/pair	Cat L-1436	\$4.85
Bobbin to suit above.	Cat L-1437	45c
Case TUO-3	Cat H-2744	\$6.20
SC01 Speech Synthesiser chip	Cat P-2670	\$69.50
IC 74LS 367	Cat Z-5292	\$1.00
IC 74121	Cat Z-5260	80c
Volt/reg 7812	Cat Z-6552	\$1.30
Volt/reg 7805	Cat Z-6545	\$1.30

Display 7 seg	FND 500	Cat Z-4150	\$1.40
IC 4511		Cat Z-5730	\$1.60
IC 4029		Cat Z-5629	\$2.00
7 way tag strip		Cat H-6407	25c
5 pin din plug		Cat P-1550	85c
5 pin din socket		Cat P-1552	65c
IC socket 14 pin DIL		Cat P-4140	32c
Display 4117		Cat Z-4117	\$1.85
Clock case		Cat H-3194	\$4.99
Bridge rectifier PA40		Cat Z-3334	\$5.25
Transistor Tip 32		Cat Z-2024	99c
Transformer 2000		Cat M-2000	\$19.95
Case (metal)		Cat H-2455	\$20.50

DICK SMITH Electronics

bankcard welcome here

Terms available to approved applicants through



SEE PAGE 98 FOR ADDRESS DETAILS



**Powerful New
6000 RPM
Mini Drill
for PC
Work**

Tons of Torque.
Just the shot for
PCB work.
12V DC
operated
from external
Power Pack
1.2mm
chuck
capacity.
Supplied c/w
1mm drill bit.

- T2302 \$12.95
Drill Bits:
 T2320 (0.8mm) ... \$1.25
 T2325 (1.0mm) ... \$1.25

CRYSTALS	Y 1000	1 000	5mm Pinout	11.50
	Y 1003	1-8432		9.50
	Y 1006	2-000		7.50
	Y 1010	3-57945		3.00
		Solder		
		Type		
	Y 1012	4-000	12-3mm Pinout	5.00
	Y 1015	4 194		5.00
Parallel Resonant	Y 1017	5-000		5.00
	Y 1018	6 000		5.00
	Y 1019	8 000		5.00
Frequencies	Y 1020	10 000		5.00
Quoted	Y 1025	12 000		5.00
in MHZ	Y 1030	16 000		5.00

D25 SERIES CONNECTORS
 Universal 25 Pin Computer Series

- P 0900 Male 25 Pin \$5.50 NOW \$3.95
 P 0901 Female 25 Pin \$5.50 NOW \$4.50
 P 0905 Backcover \$3.50 NOW \$2.50



**SAVE
NEARLY
30%**

VINYL BINDER

Holds 12 magazines, each on a spring out wire rod. Just the shot for each year's set of Electronics Australia, ETI or any of your favourite magazine.

Suits all A4 size publications (275 x 210). Very smart Royal Blue colour with beautiful gold embossing.

- B 9999 ... \$5.50
THIS MONTH

\$5.00 each
 4 or more \$4.50 each



ALTRONICS JIFFY BOXES

Incredible savings

Black plastic body with 22 g aluminium lid and 4 st. screws supplied. These utility boxes are used in dozens of E.T.I. and E.A. projects.

Box	Dimensions	Were	Now	10up
H 0101	150x 90x50	\$2.75	\$2.45	\$1.90
H 0102	195x113x60	\$3.75	\$3.40	\$2.90
H 0103	130x 68x41	\$2.20	\$1.85	\$1.60
H 0105	83x 54x28	\$1.50	\$1.25	\$1.00

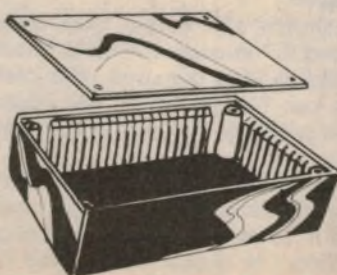

PRICES SLASHED

with Premium Grade Quality Imports from Altronics

Why Pay More?

**Incredible Value
Dainichi Loudspeakers**

DAINICHI WIDE RANGE 25 Watt



200 mm (8 in.). This superbly smooth high power speaker comes from Dainichi, one of Japan's finest speaker manufacturers (they produce OEM Speakers for Pioneer). Max. input power 25W 8 OHM Z. Resonant fo 60 HZ. Huge 10 OZ Magnet frequency response 40 HZ-18 KHZ.

- C 2001 \$19.50
 4 or more \$17.00

CONE TWEETER 50 WATT



50 watt max. power 8 OHM Z. Amazing performance budget price. Frequency response 2 KHZ-18 KHZ. 110 mm Diam. Hole centres 79 mm. Australia's best value at this price.

- C 3020 \$7.50
 4 or more \$7.00

WEATHERPROOF SIREN HORN

12V DC operated - Deafening Siren Wall. Super handy for audio signalling, security systems etc. Current drain 500MA approx. Completely weatherproof. Attractive off-white PVC finish.



- S 5058 ... ~~\$19.50~~ NOW \$15.00 ea.

PIEZO ALARM

Similar to "Sonalert" type. Absolutely ear piercing sound. Recommended voltage 5-15V DC. Ideal for almost all audio signalling applications. i.e. fire, water and gas signalling, computer alarms, etc.

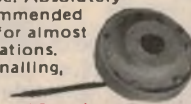

- S 5066 ... ~~\$4.95~~ NOW \$4.50 each

**New 10mm Digit LCD
Clock Module**



Uses the new NEC UPD833G LSI and quality EPSON LCD display. Size 60 x 38 x 10mm, operates from 1.5V DC. Display selectable to 12 or 24 hour format. AM/PM Display.

Inbuilt control timer selectable to 15, 30, 60 and 120 minute intervals. Stop watch facility to 24 mins duration. Alarm timer, Snooze timer, Sleep timer. An incredible diversity of applications. i.e. clock radio, travellers watch, stop watch, digital alarm clock, sleep timer, snooze timer, appliance timer, sequential controller, dual time clock.

And the best news is the low price!

- Y 1020 \$16.50

MINI TOGGLE SWITCHES

OEM QUALITY 250V 2 AMP RATED



		PRICE	10 UP
S 1010	SPDT	\$1.20	\$1.00
S 1025	SPDT Centre off	1.40	1.20
S 1020	DPDT	1.40	1.20
S 1030	DPDT Centre off	1.95	1.75

DIL Switch Bargains

GOLD PLATE SELF WIPING CONTACTS



- S 3050 4 way \$1.25 ea.
 S 3060 8 way \$1.75

KEY OPERATED SWITCH



19.5 mm mounting hole required. Supplied with two keys. Hundreds of applications for security type applications.

- S 2500 ... \$6.95

NOW ONLY \$5 EACH

MINI BUZZER 5-15V DC



Handy little solid-state audio "Buzzer" or signalling device. Just the shot for communicator panels, or for timer alarms or in the car. Polarity conscious.

- S.5062 ... \$1.00

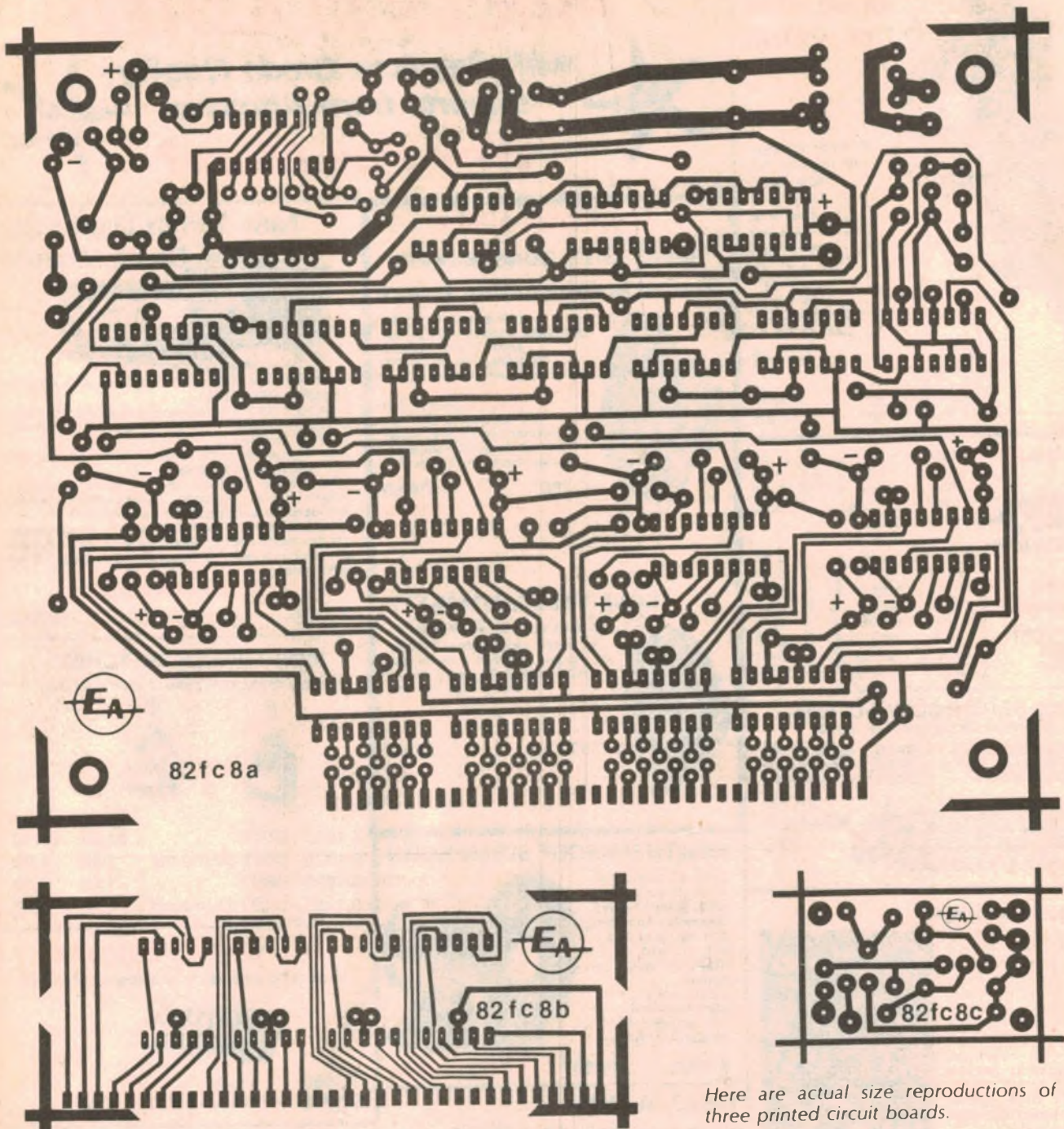

Here are actual size reproductions of the three printed circuit boards.

band applications, provided that the interconnecting leads are kept short.

Start construction by assembling the main PCB (82fc8a) according to the parts overlay diagram. If the remote FET buffer stage is to be used, then the components enclosed by the dotted lines should be left out. Install link LK1 for the 30MHz version, but do not install any of the links shown dotted.

For the 10MHz version, omit IC2, switch S1 and link LK1, and install all the links shown dotted on the overlay diagram. These include LK2, LK3, and the three preload encoding links located

above and below IC6 and IC7. In addition, pin 5 of the most significant digit should be connected to +5V via a 270Ω resistor so that the decimal point is displayed.

As shown, the dotted links adjacent IC6 and IC7 encode a 455kHz offset (or preload) if S1 is not used. This preload value can be altered to any value the reader wishes (if necessary), as explained later.

Although LS TTL ICs are specified in the parts list, standard TTL devices may be used if LS versions are unobtainable. Standard TTL draws about three times

the power of LS versions and, if used throughout, an extra 100mA will be drawn by the circuit.

All the ICs face in the same direction except for CMOS ICs 9, 10, 11 and 12. When soldering the CMOS ICs, solder the power supply pins (8 and 16) first to enable the internal static protection diodes. The barrel of your soldering iron should be connected to the earth track on the PCB with a small clip lead before soldering.

The CMOS ICs are recognised by their 4029 and 4511 type numbers.

Note that many of the resistors are

**THINKING ABOUT
BUYING A SCOPE?**

FOR PERFORMANCE & VALUE AARON HAS TO BE YOUR FIRST SCOPE CHOICE

All these scopes are dual trace and incorporate the latest features such as high brightness rectangular CRTs.

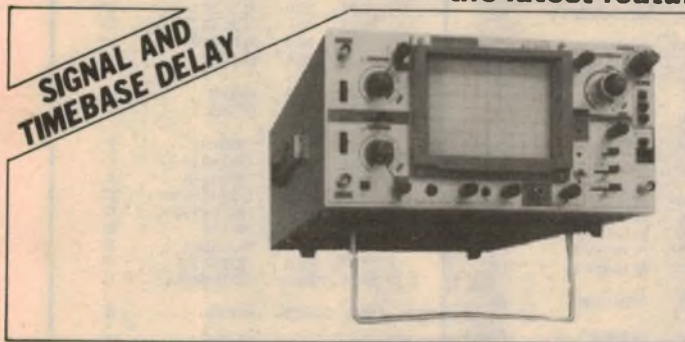

- 7.7nS risetime
- Single sweep
- Trigger delay
- TV sync
- X-Y, dual, chop, add, subtract etc.

45MHz/1mV
BS625 **\$990.00**



- 21 range timebase
- 100mS-1 μ S trigger delay
- Front panel trace rotate
- X-Y, dual, chop, add, subtract etc.

35MHz/1mV
BS635 **\$790.00**

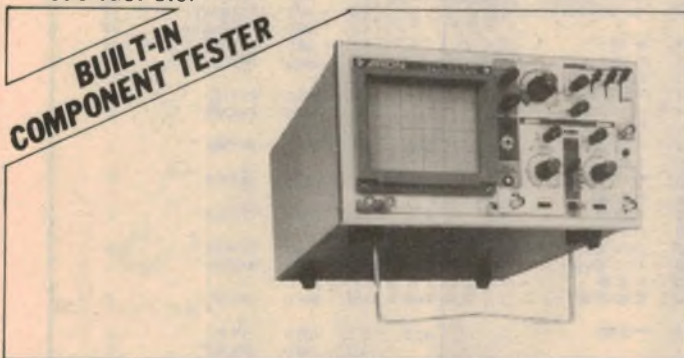

- Check components on screen
- 19 range timebase
- Triggerable to over 30MHz
- 17nS risetime

20MHz/5mV
BS601 **\$550.00**



- 2 hour operation from built-in NiCad battery
- Automatic recharging
- Auto trigger free run
- TV sync

15MHz/2mV
BS301 **\$720.00**

QUICK SPEC CHECK

MODEL	BWIDTH	SENS	SIG DEL	TRIG DEL	SCREEN	T BASE
625	45MHz	1mV	Y	Y	150mm	0.2 μ S - 0.5S/div
635	35MHz	1mV	N	Y	150mm	0.1 μ S - 0.5S/div
601	20MHz	5mV	N	N	150mm	0.5 μ S - 0.5S/div
310	15MHz	2mV	N	N	95mm	0.5 μ S - 0.5S/div

All prices are plus sales tax if applicable and subject to change without notice

AARON

COLINE SP100 PROBE

Professional 100MHz probe offering x1, ref, x10 positions. 1.5m lead with BNC connector and selection of tips.

Complete in heavy duty plastic pouch. **\$25.00**



ELMEASCO

Instruments Pty. Ltd.

P.O. Box 30, Concord
N.S.W. 2137
13-15 McDonald Street,
Mortlake, N.S.W.
Telephone (02) 736 2888
Telex 25887

P.O. Box 107, Mt Waverley
Victoria 3149
21-23 Anthony Drive,
Mt Waverley, Victoria
Telephone (03) 233 4044
Telex 36206

Adelaide: (08) 271 1839
Brisbane: (07) 369 8688
Perth: (09) 398 3362

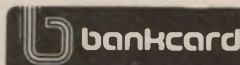

MAIL COUPON FOR FREE GUIDE

Please send me a copy of your shortform oscilloscope guide.

NAME _____

ADDRESS _____

POSTAL CODE _____

TELEPHONE _____

N.S.W. George Brown 519 5855 • DGE Systems (049) 69 1625 • Radio Despatch 211 0191 • Vimcom (042) 28 4400
VICTORIA Radio Parts 329 7888 • Browntronic 419 3986 • G.B. Telespares 328 4301 • Elanco 428 4345 • Ellistronics
02 3282 QUEENSLAND L.E. Boughen 36 1277 • Colourview Wholesale 275 3188 • Audiostatics 44 7566 • Electronic
Shop (075) 32 3632 • Nortek (077) 79 8600 • W.G. Watson (079) 27 1099 S.A. Protronics 212 3111 • Trio Electrix 51 6718
W.A. Atkins Carlyle 321 0101 • Henco Eng 381 4477 • Brookes 276 8888 • Protronics 362 1044 A.C.T. Actiec
(062) 00 6576 N.T. Thew & McCann (089) 84 4999 T.A.S. G.H.E. Electronics 31 6533 & 34 2233

TRANSFORMER SELECTION GUIDE

This selection guide covers transformers for connection to 240V, 50Hz mains with secondaries from 1.5 to 115V. All are designed to Australian Standard C126 or the relevant clause of that standard as applicable. They are all manufactured in Australia. Prefixes indicate the method of construction — popular types being illustrated.



Many of the transformers have twin secondaries enabling different voltages/currents to be obtained from the same transformer. Many are also suitable for centre tapped configurations and these are denoted by an asterisk. The column headed VA relates to total VA of the transformer concerned and should not be exceeded. If no suitable transformer is listed, we would be pleased to discuss your requirements and quote.

- Power, Auto & Step Down Transformers.
- Distribution to 100kVA.
- Battery Chargers & Eliminators.
- Power Supplies.
- Constant Voltage Transformers.
- Motor Starters.
- Discharge Lighting Control Gear.
- Emergency Control Gear.

Made in Australia and guaranteed by:



FERGUSON TRANSFORMERS PTY LTD.
331 High Street, Chatswood NSW 2067
Telephone: (02) 407-0261
Telex: AA25728
MELBOURNE: (03) 328 2843

TOTAL				TOTAL					
VOLTS	AMPS	V.A.	TYPE NO.	CONSTRUCTION	VOLTS	AMPS	V.A.	TYPE NO.	CONSTRUCTION
1.5	1.11	20.0	PL15-18/20VA	LP	25.0	0.5	12.5	PF2565*	C
	2.22	20.0	PL15-18/20VA	LP	26.0	10.0	350.0	PF3783	C
3.0	1.11	20.0	PL15-18/20VA*	LP	27.0	4.0	120.0	PF3788	C
	2.22	20.0	PL15-18/20VA	LP	28.0	4.0	112.0	PF3577	C
	8.0	120.00	PF3788	C		10.0	350.0	PF3783	C
4.0	1.0	6.0	PPB4/1000	PA	30.0	0.17	5.0	PL30/5VA*	PCB
4.5	1.11	5.0	PL9/5VA	PCB		0.4	12.0	PL30/12VA*	PCB
	1.11	20.0	PL15-18/20VA	LP		0.67	20.0	PL30/20VA*	LP
	2.22	20.0	PL15-18/20VA	LP		1.33	40.0	PL30/40VA*	LP
6.0	0.4	2.5	PF2851	C		2.0	60.0	PL30/60VA*	LP
	0.83	5.0	PL12/5VA	PCB		4.0	120.0	PF3788*	C
	1.11	20.0	PL15-18/20VA*	LP	31.0	5.0	200.0	PF4361	C
	2.22	20.0	PL15-18/20VA	LP		8.0	300.0	PF4362	C
	3.33	20.0	PL12/20VA	LP	32.0	1.88	60.0	TS32/60B	E
	4.0	120.0	PF3788*	C		1.88	60.0	TS32/60VA	E
	6.67	40.0	PL12/40VA	LP		3.9	125.0	TS32/125B	E
	10.0	60.0	TS6/60B	E		3.9	125.0	TS32/125VA	C
7.5	0.67	5.0	PL15/5VA	PCB		9.4	300.0	TS32/300VA	C
	1.11	20.0	PL15-18/20VA	LP		9.4	300.0	PF4244*	C
	2.22	20.0	PL15-18/20VA	LP		9.4	300.0	TS32/300B	E
	2.67	20.0	PL15/20VA	LP		15.6	500.0	TS32/500EC	E
	5.33	40.0	PL15/40VA	LP		31.55	1000.0	TS32/1000EC	E
8.0	1.0	6.0	PPB8/1000	PA	32.5	10.0	350.00	PF3783	C
9.0	0.56	5.0	PL9/5VA*	PCB	33.0	5.0	200.0	PF4361	C
	0.56	5.0	PL18/5VA	PCB		8.0	300.0	PF4362	C
	1.11	20.0	PL15-18/20VA*	LP	35.0	5.0	200.0	PF4361	C
	1.33	12.0	PL18/12VA	PCB		8.0	300.0	PF4362	C
	2.22	20.0	PL15-18/20VA	LP		10.0	350.0	PF3783	C
	2.22	20.0	PL18/20VA	LP	36.0	0.06	2.5	PF3787*	C
	4.44	40.0	PL18/40VA	LP	40.0	0.13	5.0	PL40/5VA*	PCB
	6.67	60.0	PL18/60VA	LP		0.5	20.0	PL40/20VA*	LP
	10.00	120.0	PF4405	C		1.0	40.0	PL40/40VA*	LP
	10.00	130.0	PF4354	C		1.5	60.0	PL40/60VA*	LP
10.5	1.11	20.0	PL15-18/20VA	LP		1.5	60.0	PF3993*	C
12.0	0.2	2.5	PF2851*	C		5.0	350.0	PF3783	C
	0.42	5.0	PL12/5VA*	PCB	42.0	5.0	350.0	PF3783	C
	0.42	5.0	PL24/5VA	PCB		6.0	300.0	PF4363	C
	0.5	6.0	PPB12/500	PA	44.0	6.0	300.0	PF4363	C
	1.00	12.0	PL24/12VA	PCB	47.0	6.0	300.0	PF4363	C
	1.11	20.0	PL15-18/20VA*	LP	52.0	5.0	350.0	PF3783*	C
	1.67	20.0	PL12/20VA*	LP	56.0	2.0	112.0	PF3577*	C
	1.67	20.0	PL24/20VA*	LP		5.0	350.0	PF3783*	C
	3.33	40.0	PL12/40VA*	LP	58.5	5.0	350.0	PF3783	C
	3.33	40.0	PL24/40VA*	LP	62.0	2.5	200.0	PF4361*	C
	5.0	60.0	PL12/60VA	LP		4.0	300.0	PF4362*	C
	5.0	60.0	PL24/60VA	LP	63.0	5.0	350.0	PF3783	C
	5.0	60.0	TS12/60B	E	65.0	5.0	350.0	PF3783*	C
	5.0	60.0	TS12/60VA	C	66.0	2.5	200.0	PF4361*	C
	8.0	120.0	PF3788	C		4.0	300.0	PF4362*	C
	10.42	125.0	TS12/125B	E	70.0	2.5	200.0	PF4361*	C
12.6	1.0	12.5	PF2565	C		4.0	300.0	PF4362*	C
13.5	1.11	20.0	PL15-18/20VA	LP	84.0	3.0	300.0	PF4363*	C
15.0	0.33	5.0	PL15/5VA*	PCB	88.0	3.0	300.0	PF4363*	C
	0.33	5.0	PL30/5VA	PCB	94.0	3.0	300.0	PF4363*	C
	0.8	12.0	PL30/12VA	PCB	115.0	0.26	30.0	TS115/30VA	C
	1.11	20.0	PL15-18/20VA*	LP		0.26	30.0	TS115/30B	E
	1.33	20.0	PL15/20VA*	LP		0.52	60.0	TS115/60B	E
	1.33	20.0	PL30/20VA	LP		0.52	60.0	TS115/60VA	C
	2.67	40.0	PL15/40VA	LP		1.09	125.0	TS115/125B	E
	2.67	40.0	PL30/40VA*	LP		1.09	125.0	TS115/125VA	C
	4.0	60.0	PL15/60VA	LP		1.74	200.0	TS115/200VA	C
	4.0	60.0	PL30/60VA	LP		1.74	200.0	TS115/200B	E
	8.0	120.0	PF3788	C		2.61	300.0	TS115/300B	E
16.0	18.0	300.0	PF4244	C		2.61	300.0	TS115/300VA	C
16.5	1.11	20.0	PL15-18/20VA	LP		4.35	500.0	TS115/500EC	E
18.0	0.12	2.5	PF3787	C		8.7	1000.0	TS115/1000EC	E
	0.28	5.0	PL18/5VA*	PCB		17.4	2000.0	TS115/2000EC	E
	0.67	12.0	PL18/12VA*	PCB					
	1.11	20.0	PL18/20VA*	LP					
	1.11	20.0	PL15-18/20VA*	LP					
	2.22	40.0	PL18/40VA*	LP					
	3.33	60.0	PL18/60VA*	LP					
	4.0	120.0	PF3788	C					
20.0	0.25	5.0	PL40/5VA	PCB					
	1.0	20.0	PL40/20VA	LP					
	2.0	40.0	PL40/40VA	LP					
	3.0	60.0	PL40/60VA	LP					
	3.0	60.0	PF3993	C					
24.0	0.21	5.0	PL24/5VA*	PCB					
	0.5	12.0	PL24/12VA*	PCB					
	0.83	20.0	PL24/20VA*	LP					
	1.25	30.0	TS24/30VA	C					
	1.25	30.0	TS24/30B	E					
	1.67	40.0	PL24/40VA*	LP					
	2.5	60.0	PL24/60VA*	LP					
	2.5	60.0	TS24/60B	E					
	2.5	60.0	TS24/60VA	C					
	4.0	120.0	PF3788*	C					
	5.2	125.0	TS24/125B	E					
	5.2	125.0	TS24/125VA	C					
	8.33	200.0	TS24/200B	E					
	8.33	200.0	TS24/200VA	C					

* Centre Tapped Secondary
LP Low Profile
C Conventional
E Enclosed
PCB Printed Circuit Board Mounting
PA Plug Adaptor

CUT THIS PAGE OUT AND KEEP IT HANDY.

PARTS LIST

- 1 Pac-tec case (or equivalent), 205 × 159 × 65mm
- 1 printed circuit board, code 82fc8a, 160 × 125mm
- 1 printed circuit board, code 82fc8b, 94 × 34mm
- 1 Scotchcal front panel, 197 × 59mm
- 1 4MHz series mode crystal
- 1 7.5-15VAC 500mA plugpack transformer
- 4 6mm spacers

SEMICONDUCTORS

- 1 MC10116 triple differential line receiver
- 1 74LS196 high-speed decade counter/divider
- 5 74LS90 decade counter/dividers
- 1 74LS93 divide-by-eight counter
- 1 74LS04 hex inverter
- 4 4029 presettable decade counters
- 4 4511 BCD to 7-segment latch decoder drivers

- 1 4017 decade counter/divider
- 1 7805 3-terminal 5V regulator
- 4 1N4002 1A silicon diodes
- 1 2N5485 VHF FET
- 2 2N4258 PNP transistors
- 4 FND500 common cathode displays

CAPACITORS

- 1 1000µF/25VW PC electrolytic
- 1 10µF/25VW PC electrolytic
- 1 10µF/25VW tantalum
- 2 10µF/10VW tantalum
- 4 0.1µF monolithic
- 2 0.1µF ceramic
- 1 .01µF metallised polyester
- 1 47pF polystyrene
- 1 39pF NPO ceramic
- 2 27pF NPO ceramic

RESISTORS

- (¼W, 5% unless stated)
- 1 × 1MΩ, 5 × 1kΩ, 2 × 1kΩ 1%, 8 × 470Ω, 29 × 270Ω, 1 × 220Ω, 1 × 100Ω, 1 × 22Ω.

30MHz VERSION ONLY

- 1 74LS196 high speed decade counter/divider
- 1 DPDT toggle switch
- 1 270Ω ¼W resistor

REMOTE FET PREAMPLIFIER

- 1 printed circuit board, 82fc8c, 38 × 24mm
- 1 2N5485 VHF FET
- 1 .047µF metallised polyester capacitor (greencap)
- 1 .0047 polystyrene capacitor
- 1 .001µF ceramic capacitor
- 1 15pF ceramic capacitor
- 1 1MΩ resistor (¼W, 5%)
- 2 1kΩ resistors (¼W, 5%)
- 1 100Ω resistor (¼W, 5%)

MISCELLANEOUS

Rainbow cable, hookup wire, machine screws and nuts, solder, etc.

mounted end on. These include two adjacent to IC1, and 28 adjacent to ICs 9, 10, 11 and 12. The remaining resistors are mounted in the conventional manner.

The FND500 displays are mounted on the display PCB after the three wire links have been installed. These wire links are mounted underneath the displays, so be sure to mount them flush against the PCB. Take care with the orientation of the displays – the ribbed edge of each display is the top.

Construction of the remote preamplifier board (82fc8c) is straightforward. Make sure that you insert the FET the right way round, though!

Initially, the two main PC boards were designed to suit a standard Pac-tec case. Subsequently our prototype was installed in a case from Dick Smith Electronics. This case has almost identical external dimensions but internal details are different. This necessitated the contriving of two small brackets to mount the PC board, as the photographs show.

We designed a silver-on-black Scotchcal front panel label to provide an attractive finish. Carefully affix the Scotchcal label to the smooth side of the front panel, and drill and cut the mounting holes for the division switch and LED displays. The cutout for the displays can be made by first drilling a series of holes around the inside perimeter and then filing the rectangle to shape.

Proceed cautiously with this step, periodically offering the front panel to the display board so that you can judge how much progress has been made. Always file inwards, otherwise the file

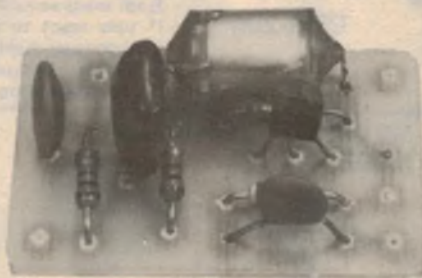

Larger than life-size photo of the remote FET buffer stage.

may tear the Scotchcal away from the plastic panel.

The display PCB can now be soldered to the main board. Carefully butt the two boards together at right angles, so that the edge buses line up, and lightly solder tack the two end pads. Test the assembly in the case, readjust as necessary, then solder all the pads together. Inspect the completed assembly carefully to ensure that the resistors on the main board do not foul connections on the display PCB.

Next, complete the wiring according to

We estimate that the cost of components for this project is approximately

\$41

for the 10MHz version (excludes case and front panel). Add \$2.50 for the remote FET preamplifier and \$5 for parts for the 30MHz version.

the parts overlay diagrams and mount the PCB assembly in the case using 6mm standoffs and machine screws and nuts. Use rainbow cable for the connections to switch S1 and don't forget the two connections to the back of the display board. The use of PC stakes will greatly facilitate external wiring connections to the main PCB.

A heatsink is required for the 3-terminal regulator and this is provided by using a 196 × 56mm aluminium sheet to replace the plastic rear panel supplied with the case. The regulator is bolted to an L-shaped bracket which, in turn, is bolted (or rivetted) to the rear panel. Two grommeted holes provide entry for the plugpack leads and the oscillator signal leads.

With construction completed, short the signal input on the main PCB to ground and switch on. If all is working correctly, the unit should display the offset value – 9545 in the divide by one position, and 9555 in the divide by 10 position. If there is no display, or the unit appears to be faulty, check the power supply to all ICs and check carefully for any missing links on the main PCB.

Note that the input must be shorted right at the main PCB for this test, irrespective of whether you are using the on-board FET preamplifier or the remote preamplifier. It is not sufficient to short the remote ends of the input leads, since the leads could act as an antenna and pick up electrical noise from the immediate environment to give a random display. This electrical noise will be swamped when the input leads are connected to a signal source.

**NEW STORE
opening October
in Carlingford**

AT "NEVILLE'S CORNER" CNR CARLINGFORD &
PENNANT HILLS RD. NEXT TO KENTUCKY FRIED CHICKEN

Great Products - Great Prices!



LCD panelmetersBACK.....

We have been unable to keep up with the demand for these, that is why you have not seen them in our ads for the last few months.

DPM-200 - 3½ digit display with annunciators (pictured).

0.6" high. 200mV full scale. Each unit supplied with data sheet.

DPM-05 (Not illustrated). 3½ digit display with "plus", "minus" and "low batt". Annunciators with 0.5" readout. Both units sample at 3/second.

If you want to express any physical measurement in a bright easy to read display these are for you. They contain all analogue-to-digital electronics and LCD drive circuitry. Send SAE for more information.

DPM-05 **\$39.50**

\$49.50

DPM-200

good news

LOW COST IC INSERTERS EXTRACTORS

Up until now these have cost a fortune!!

Features:

- CMOS SAFE conductive plastic
- Exclusive bent pin alignment guides in handle . 8 to 40 pins.
- Ground strap can be connected.
- One hand operation.

INSERTERS

CIT820 8-20 pin ONLY \$5.95
CIT2428 24-28 pin ONLY \$6.95
CIT3640 36-40 pin ONLY \$8.95



from
\$2.95

EXTRACTOR

Deceptively simple looking device. One piece metal construction. 8-40 pins

ET-840 ONLY \$2.95

IMPORTANT!!
Don't be conned into buying a non conductive inserter/extractor. The possible static damage to your MOS I.C.'s could cost you a fortune!!



MOVING COIL CARTRIDGE MODEL MC-100



LOW COST BUT HIGH QUALITY!

- ½" standard mount
- Does not need transformer
- Samarium Cobalt magnets for high output
- Frequency Response 15Hz - 35kHz
- Whopping 2.5mV out (1kHz/50mm/s)
- Compliance 8×10^{-6} cm/dyne
- 2.0 gram tracking force
- 0.6mil Diamond stylus
- Supplied with mounting hardware

STAGGERING
VALUE

\$49.50

LOW COST WALKIE TALKIES

What can we say?

Only \$19.50 for a pair!

Both voice and
morse transmission

ONLY

\$9.75 ea

INNER EAR MINI PHONE

MODEL MT310

FEATURES: Samarium Cobalt magnets
102dB/mW
Weight 15 grams
Response: 50Hz-20kHz
Impedance: 32 ohms

Unit fits into the cusp of your ear. Can be worn under motorcycle helmets. Unbelievably clean sound.

ONLY \$19.50

AM/FM STEREO CAR CASSETTE

Unbelievably low price! (Pre Budget tax) That's right! An AM/FM Stereo Radio and Cassette!

Features:

- * 2 x 7 watts
- * One lever operation (fast forward and eject)
- * Tape run indicator
- * FM Stereo indicator
- * Auto stop
- * Adjustable pitch controls
- * Mounting hardware included.



STAGGERING
VALUE ONLY

\$69.50

HI-VOLTAGE HITACHI MOSFETS

V_{DD} 160V



The Hitachi complimentary Power Mosfets are very popular in Hi Fi and PA amplifiers. Up until now the very highest voltage versions have been hard to get. We now have these devices as well as the popular 2SK134 and 2SJ49 (140V) types.

The 2SJ50 and 2SK135 enable you to use higher rail voltages for higher power.

2SJ49 & 2SK134 **\$6.50 ea**

2SJ50 & 2SK135 **\$8.50 ea**

Carlingford
Phone: 872 4422

JAYCAR

125 YORK ST SYDNEY 2000
Ph. 2646688 Telex: 72293
Mail Orders To:
Box K-39 Haymarket 2000

POST AND PACKING CHARGES
\$5.99 (B1 20) \$10.24 (99 \$2 40)
\$25.84 (99 \$3.50) \$50.99 (99 \$4.80)
\$100 up (\$6.20)

NEWSHOP HOURS
Mon-Fri 9.30 to 5.30pm
Sat 8.30 to 12.00pm
Thurs night to 8.30pm

Don't forget to remove the shorting link when you have completed your tests.

Installation

Installation simply involves connecting the signal input to a suitable point on the local oscillator of the receiver, and making the necessary ground connections. The majority of local oscillator circuits use a single transistor, although the exact circuit configuration will differ from one receiver to another. Additionally, some receivers employ separate oscillator and mixer circuits, while others employ self-oscillating mixers.

If a circuit diagram of the receiver is available, then the necessary information can be gleaned from this. If no circuit diagram is available, you will have to experiment by testing various locations around the oscillator. Generally, a direct connection to either the emitter or collector of the transistor will provide a usable signal. Select the point that affects the oscillator frequency the least.

If the remote FET preamplifier is used, it should be secured close to the local oscillator and short leads run to the oscillator output. On no account should screened cable be used to connect from the local oscillator to the buffer amplifier, since the extra capacitance will upset the local oscillator operation. Use hookup wire instead. The 1kΩ resistor in the earth leg of the on-board FET buffer amplifier was added to remove earth loop problems that may occur between the receiver and Tuner Digital Readout. Replace the resistor with a link if this problem is not evident.

Some readers may wish to alter the 455kHz preload value to suit receivers which have a different IF. To accommodate this, the main PCB has been

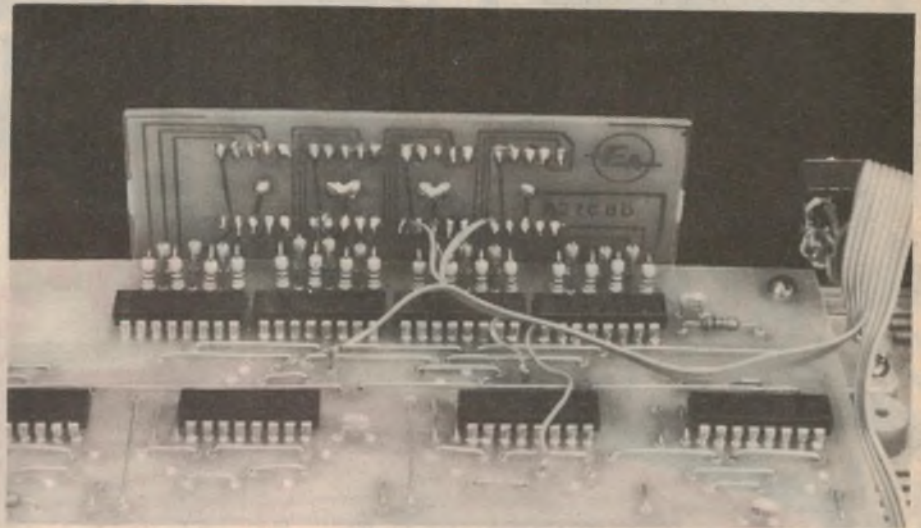

Close-up view showing how the display board is attached to the main PCB. Unused holes in the main PCB allow different IF offsets to be programmed (see text).

	J4	J3	J2	J1
0	0	0	0	0
1	0	0	0	1
2	0	0	1	0
3	0	0	1	1
4	0	1	0	0
5	0	1	0	1
6	0	1	1	0
7	0	1	1	1
8	1	0	0	0
9	1	0	0	1

Fig. 4

designed so that linking can be used to select any offset required. Links from J1, J2, J3 and J4 (ICs 5 to 8) can be connected either to the positive supply rail

or to the ground rail. These rails are clearly marked with + and - symbols on the track side of the PCB.

To calculate the preload value for the divide by one range, all you have to do is subtract the receiver's IF from 10,000 (eg. a 455kHz IF gives a preload value of 9545). The appropriate preload is then programmed into the J1-J4 pins of ICs 5 to 8 according to Fig. 4. A 5, for example, is programmed by tying J1 and J3 to +5V, and J2 and J4 to ground.

Similarly, the preload for the divide by 10 range is calculated by subtracting the IF from 100,000 and then rounding off to the four most significant digits. But it will usually not be necessary to program your own preload values. Most receivers use a 455kHz IF, so you can use the linking arrangement shown in the parts overlay diagram.

★ BRIGHT STAR CRYSTALS

Specifications, Dimensions and data sheets available on request

BULK ORDERS: In addition to our normal range we can supply quantity orders (100 up) at very competitive prices. All we ask is 50% of cost with order balance 30 days.

DELIVERY: 5-6 weeks from receipt of Order. Ring for quote: (03) 546 5076. Telex: AA 36004.

NEW NSW AGENT: APP Master Communications, Sydney (02) 682 5044

BRIGHT STAR CRYSTALS

35 EILEEN RD, CLAYTON, VIC
ALL MAIL TO: PO BOX 42, SPRINGVALE 3171



CRYSTAL OVENS AND OVEN OSCILLATOR UNITS



WATCH CRYSTALS

CRYSTAL UNITS FOR QUARTZ CRYSTAL CLOCK

AT LAST! THE E.A. CAR COMPUTER— YOU CAN SAVE A FORTUNE!



NOW IN STOCK!



Easy installation in your car's electrical system. PCB pins supplied for instant and reliable connection.

Professional quality silk-screened front panel (not just a Scotchcal panel as on some other kits). Ensures ultra long life and is virtually immune from scratch marks.

Our kit comes complete with specially designed case INCLUDED IN THE PRICE (don't pay \$30 extra!!) Also included at no extra charge is a special mounting bracket to mount the computer either on or under the dashboard.

Large brightness matched LED readouts for top readability in most light conditions.

Specially imported multi-colour push button switches (as specified in the EA article) to make selection very easy while you're driving.

Inside: Two computer-grade double sided fibreglass printed circuit boards with plated-through holes for minimum soldering. Don't be caught with a PCB without plated-through holes: you'll regret it when you start construction!

YES! The kit you've been waiting for is now a reality. Electronics Australia's new Car Computer is the ideal way to find out how your car is performing — and how much it is costing you to run it!

Now you'll be able to check fuel consumption — instantly — and find out exactly how much damage a lead foot does to your pocket.

All those questions you ask yourself as you're driving along can be answered — electronically — in a fraction of a second ...

- How much fuel is left?
- Can I make it to the next town?
- How far have I travelled?
- How long has it taken?
- How long have I got to go this trip?
- How far have I got to go?
- How much fuel have I used/am I using/will I use?
- What's my exact speed (much more accurate than the speedo!)?

Amazing technology: how is it done?

A few years ago a device such as this would have been virtually impossible to build — especially build yourself.



Dick Smith searched the world for the most important components — the fuel and speed sensors — and the brilliant design engineers at Electronics Australia did the rest! The result: a magnificent kit which really can save you a lot of money! Simply because it can show you how to drive really economically.

OUR KIT ONLY
Cat K-3400
\$93⁵⁰ sensors extra

Special Computer Quality PC Board

Yes: we've not only made our board with plated through holes (as recommended by EA) we've also had a solder mask and component position overlay printed. You'll find it difficult to make an error!

Low Noise IC

We've arranged a special purchase of low-noise Schmitt trigger IC's (as used in the front end). Your Dick Smith car computer will be less prone to noise problems than other kits!

It will give you 12 different readings:



TIME

Either the time elapsed since the start of the journey (accurate to one minute) or the time remaining to complete the journey at your average speed since commencement (updated every minute or kilometre travelled).

FUEL

It will show you the amount of fuel you have used — or the amount of fuel you have left — or even how much fuel your tank can take at the moment!

DISTANCE

Your choice of distance travelled, or the distance remaining on this journey — or the distance possible with the amount of fuel you have left.

SPEED

Your exact present speed (much more accurately than your speedo can show!) or your average speed since the start of the journey.

CONSUMPTION

Either your present (instantaneous) consumption (lead footers: be prepared to be shocked!) or your average consumption since the start of your journey.

AND EVEN MORE REASONS WHY YOU SHOULD BUY YOUR KIT FROM DICK SMITH ELECTRONICS!



Exclusive!

Our unique 'Sorry Dick, it doesn't work' repair service. In the unlikely event that you can't get your kit working successfully, our Service Department will, for a fixed fee, repair, adjust your kit* as necessary to get it working properly. This fee includes all parts necessary.
*Sorry Dick, it doesn't work' service available on specifically nominated kits, and we reserve the right to return your kit, with your service fee, should it be so badly wired or damaged as to make repair uneconomic.

Exclusive!

Our unique construction manual. We have a technical writer prepare a special step-by-step construction manual for most of our kits — so you don't have any problems. Everything is clearly and logically presented, with all construction information from the magazine — plus any other 'traps for young players' we discover along the way. We discover any problems before they affect you!



EXCLUSIVE!!!

SOLE AUTHORISED AUSTRALIAN AGENTS FOR THE FAMOUS

MORAY FUEL FLOW SENSOR

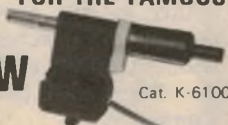

Cat. K-6100

(The one recommended by Electronics Australia) Don't be fooled — the ONLY fuel flow sensor to give optimum results with the car computer is the fully imported Moray unit. And Dick Smith Electronics are the sole authorised Australian agents for this magnificent device. It delivers an incredible 1500 pulses per 0.1 litres (other kits may be supplied with inferior sensors delivering only 130 pulses/0.1 litres). So with the Moray sensor you get incredibly increased accuracy.

\$69⁵⁰

DRIVELINE SPEED SENSOR

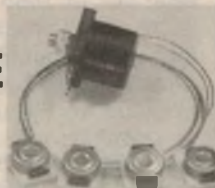

More accuracy — Easier installation
Knowing how incredibly difficult it can be to cut successfully a speedometer cable without risk of damage, we've decided to use the alternative (and, we think, much better) driveline sensor. A lot easier to install, it is not subject to the problems of speedo cables. And a further BIG advantage: when your speedo cable breaks (as they ALL do eventually) you'll still have a very accurate speedometer. (Not possible if you use the other sensor).

Cat. K-6102

\$8²⁵

SPECIAL OFFER: Buy both sensors and get the speed sensor for \$3.00! YES: The exclusive Moray Fuel Flow Sensor plus the Driveline Sensor at the bargain price of just \$72.50! This makes the complete Dick Smith Car Computer only \$166.00 — with nothing else to buy!

DICK'S PRICE

\$166

REMOTE DISPLAY OPTION

A number of customers have told us they'd love to own a car computer but that the project was simply too big to put on their dashboard. So we've solved that little problem...

This is the exclusive Dick Smith Electronics car computer remote display option. It simply connects in parallel to the existing displays in the main computer (these can be disabled if you like) and also with five of the push buttons (you select the readings you want the most). And all it measures is a tiny 110 x 70 x 50mm — complete with its own mounting bracket.

Included are the four LED displays, five push buttons and the PCB's, plus enough rainbow cable to connect it all together. If you really want to have all functions displayed, there's plenty of room on the front panel to add at least another four small push buttons. Complete with full instructions — and remember, it's not available anywhere else!

NOTE: This important option is only available from Dick Smith Electronics



Cat K-3405

\$21⁵⁰

DICK SMITH Electronics

SEE PAGE 98 FOR ADDRESS DETAILS

DSE/A312M/LM



Drive a compact car? Build this . . .

Remote display for the Car Computer

Been wondering where on earth you were going to mount the Car Computer in the crowded instrument console of your late-model compact? Well, here's an easier answer: Dick Smith Electronics has developed a neat little remote display/control option, which houses all main functions in a box only 110 x 70 x 50mm.

by JAMIESON ROWE

Coming at a time of steadily rising petrol prices and heightened awareness of the effect of poor driving habits on fuel consumption, EA's Car Computer project has created a tremendous amount of interest. Judging from the many enquiries from our customers regarding DSE's kit for the project, there are obviously many motorists keen to use it to monitor the performance of both their car and themselves.

The only problem is space. Considering the complex functions it performs, EA has squeezed the Car Computer into a remarkably compact case — it measures only 205 x 158 x 65mm. But this is still rather big when you are talking about mounting it somewhere in, or on, the instrument console of a compact modern car.

Quite a few customers have told us

that they'd love to build up the Car Computer and try it out, but they just couldn't fit it into their car's console in a position where it could be used conveniently.

As soon as this problem became apparent, the technical people in our kit department started looking at the Car Computer to see if they could find a solution. After a bit of head scratching, they came up with an idea that I think is pretty neat. It's a remote display/control option, housed in the same tiny 110 x 70 x 50mm box used to house the June 1979 Car Clock kit (H-3194).

This box is so small that you should be able to fit it easily into almost any instrument console! Even sitting on the top, it's so tiny that it won't cause any problems.

Inside the box is a second set of four

LED displays, which is wired in parallel with the one in the main unit so that it duplicates the Computer's readout. Or if you wish, the display LEDs in the main unit may be left out, so that the remote display works alone. If the main unit must be mounted under the seat or somewhere else out of sight, this would be a sensible move as it will give a brighter readout on the remote display.

Also in the remote box are five pushbutton switches, which are again wired in parallel with five of the buttons on the front panel of the main Computer.

Although there are 12 buttons on the main unit, two of these are used only for initial calibration and another three are used only at the start or finish of trips. This leaves only seven, and of these five tend to be used more than the other two during typical driving. These are Hour.Min or Time (0), Litres or Fuel (1), l/100km or Consumption (4), Remaining (8) and Average (9).

It is these five buttons that are currently extended to the remote box. However you don't have to stick with these five if you don't wish. You can use the five buttons in the remote box to perform any of the functions, just by altering the connections. And if you really must have more than five buttons on the remote box, there's room to add at least four more alongside those already there. In short, there's quite a lot of room for individual variations.

Assembling the remote box is very straightforward, as all the parts are supported by two small PC boards which also perform most of the wiring. The larger of the two boards mounts the four 7-segment LED displays, while the smaller board mounts the five

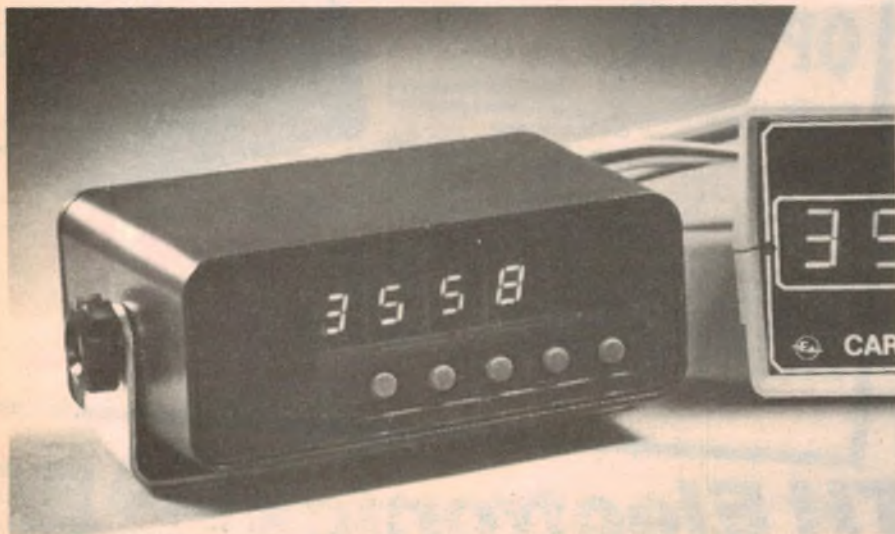

The remote display option is housed in a small plastic case measuring 110 x 70 x 50mm. Unit is compact enough to mount on virtually any dashboard!



Five functions are duplicated on the remote display unit: hour.min, litres, l/100km, REM and AV (average).

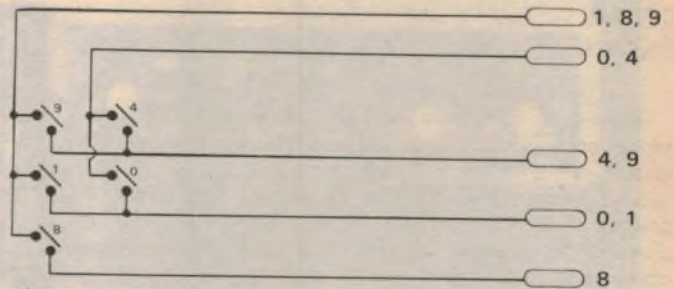
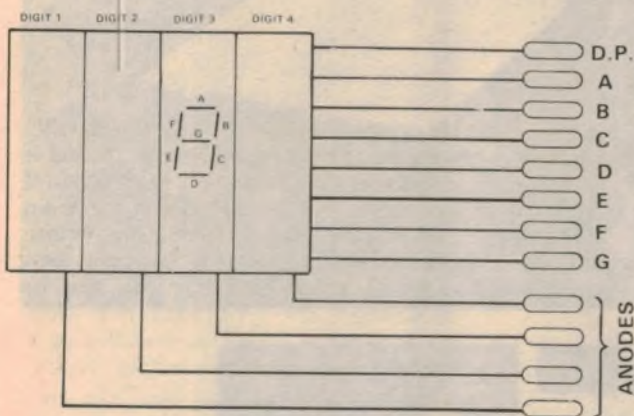

The circuit consists of four LED displays wired in parallel with the existing displays, together with five pushbutton switches wired in parallel with the five most useful function switches.

pushbuttons. Or more strictly, it forms part of the pushbuttons, as these use conductive plastic pads to link electrodes etched on the PCB itself.

As you can see from the overlay diagram for the display PCB (Fig. 2), the only things to mount on the board apart from the displays themselves are four wire links. These go underneath the displays, and therefore must be fitted to the board before mounting the LEDs.

It's even simpler with the switch PCB, as you can see from its overlay diagram (Fig. 3). There's no actual wiring at all if you elect to use the buttons for the same five functions as we have nominated. You'll only have to cut tracks and add additional wiring if you want to change their functions.

Connecting the remote unit up to the main Car Computer is also very straightforward. All you need is a length of 17-conductor ribbon cable. One end of the cable is wired to the connection points on the two remote unit PCBs, while the other end is wired to the corresponding points on the front panel PCB of the main unit. The correct connection points are shown on the accompanying overlay diagram (Fig. 1).

Using "rainbow" ribbon cable for this

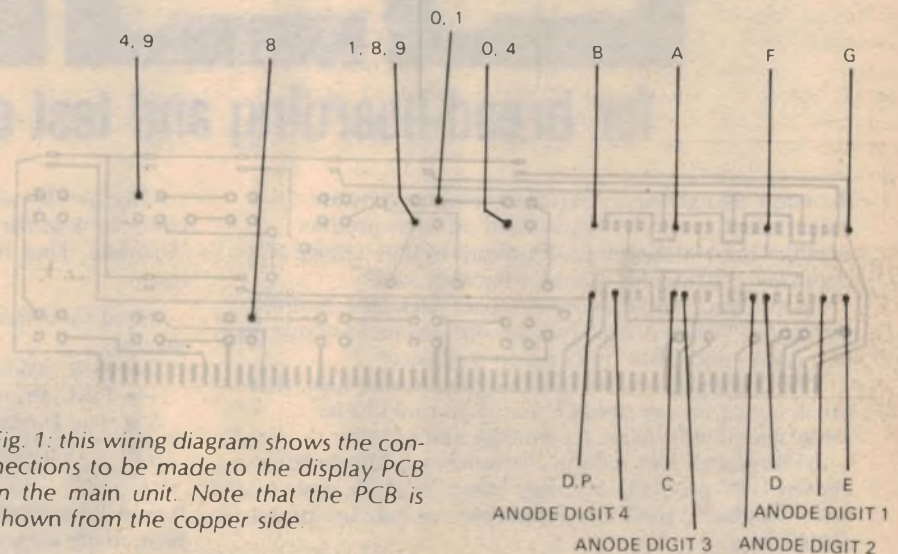
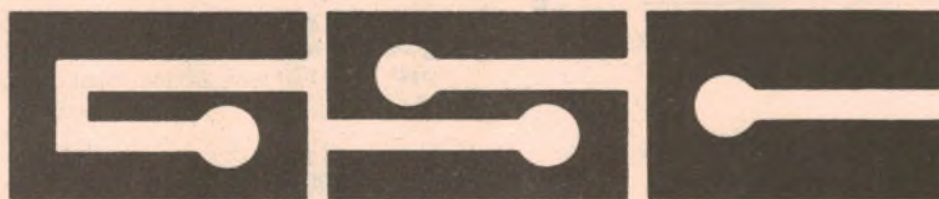

Fig. 1: this wiring diagram shows the connections to be made to the display PCB in the main unit. Note that the PCB is shown from the copper side.

job helps you make the connections without errors. After making the connections at one end, jot down the colour coding you have used on a piece of paper. Then just follow the same coding at the other end, and Bob's your uncle! (as the saying goes — I've never been sure why this is relevant, even though I do have an uncle named Bob).

By the way, if you don't like the idea of

the remote unit permanently connected to the Car Computer, you can cut the cable and use a suitable plug and socket combination. Although they're not cheap, a DB-25 plug and socket would be very suitable. These are sold through Dick Smith outlets as P-2690 for the plug and P-2691 for the socket, with a matching backshell for the plug available as P-2682. You could mount the socket



for bread-boarding and test equipment

Recently, an extensive study was conducted by an independent research organization on what product qualities most influence professionals in their choice of electronic instruments. Know what they said?

Lower price. Small more compact packages. Simpler operation. Which is exactly what our product philosophy has always been. But that's no co-incidence!

GSC products are not just designed for the task, they are designed for the market, and engineered to be innovative in approach, technology and value.

More than a half million customers worldwide have chosen GSC products over any other. We have gone to a lot of trouble to build our reputation, and we are proud of our success.

That is why we think it is worth your time to take a closer look at the GSC products now available in Australia. They have proven our philosophy time and again.

Send for a free catalogue on the following product groups.

- GSC solderless bread boards
- GSC Proto-Board® solderless bread boards
- The Logical Force™ digital troubleshooters
- GSC pulse and function generators
- GSC MAX frequency Counters

You will see the features, the prices and the benefits that have made these products so popular.

For further information and free catalogue please contact — Australian Distributor



COMMQUIP PTY. LTD.

The Electronics and Communications Professionals.

PO Box 74, Leederville, WA 6007
 9 Douglas St. West Perth, Western Australia
 Telephone (09) 328 9451 Telex AA94918

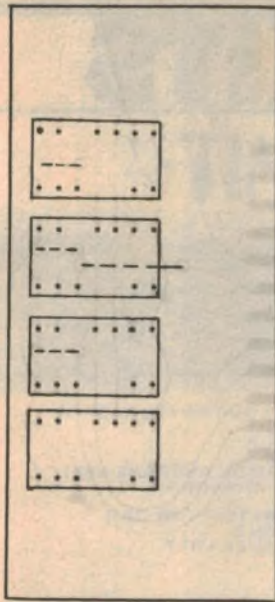

DISPLAY PCB

COLOUR CODE

- A
- F
- B
- ANODE DIGIT 4
- C
- ANODE DIGIT 3
- D
- E
- D.P.
- G
- ANODE DIGIT 2
- ANODE DIGIT 1

Fig. 3: wiring details for the switch PCB. Note that the copper pattern can be cut in three places if you elect to use different switches. Do NOT cut the tracks if you elect to use the same switches (ie 0, 1, 4, 8 and 9).

Fig. 2: parts overlay for the display PCB. When you attach the rainbow cable, write down the colours in the space provided. This will help you when you assemble the connector and also when you solder the wires to the back of the display PCB inside the Car Computer.

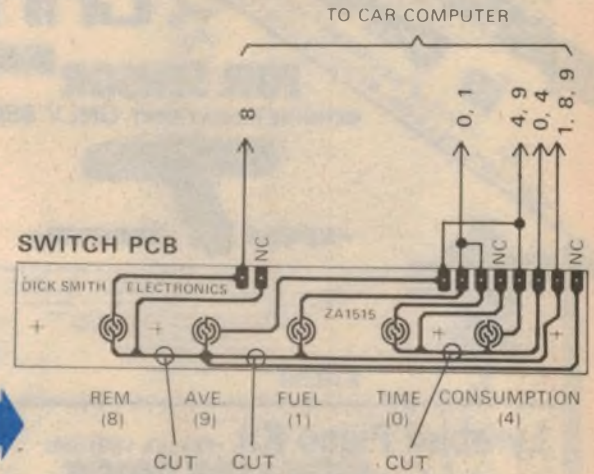

This view shows the prototype with the front panel removed to reveal the LED displays and the switch PCB.

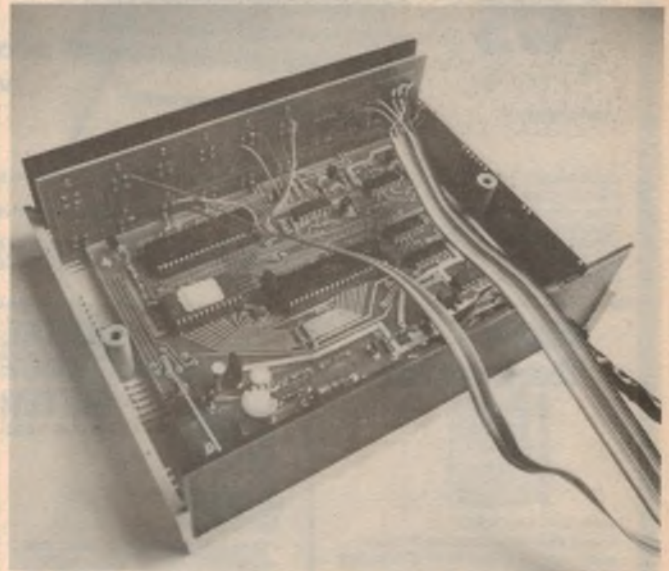

Right: connections to the display PCB in the main unit are run using 17-conductor rainbow cable. Cable entry is via a slot filed in the top of the rear panel.

on the back panel of the main unit, with the cable from the remote unit terminated in the plug.

Just remember that if you use a plug and socket, you'll be doubling the chances of making a mistake with the connections. So you'll need to be twice as careful!

Extra switches

Note that if you want to add some extra buttons to the remote unit, you'll need some conventional miniature pushbutton switches. The low cost S-1102 buttons available from all Dick Smith outlets would be ideal. To mount them in the front panel you'll have to make matching 7mm diameter mounting holes, lining these up neatly with the

existing buttons.

Whether or not you decide to leave the displays out of the main unit is entirely up to you. It'll probably depend on where you're planning to mount the main unit in your car, and the likelihood of you changing to a larger vehicle where you may not need the remote unit. Even if you leave them out, you can always add them in later on if you wish.

That's about it. Like all good ideas, the remote display/control option is really very simple and straightforward. It's also pretty low in cost, too, at only \$19.95. But the most important thing is that it should allow many more people to obtain the advantages of a Car Computer in their car - no matter how small!

Basic Electronics

For the beginner or the hobbyist, this reference book is almost certainly the most widely used manual on basic electronics in Australia.

Begins with the electron, introduces and explains components and circuit concepts, details the construction of simple receivers. Separate chapters on test instruments, servicing, amateur radio, audio techniques, stereo sound reproduction.

Available from "Electronics Australia", 57 Regent St, Chippendale. PRICE \$3.50 OR by mail order from "Electronics Australia", PO Box 163, Chippendale 2008. PRICE: \$4.40.

**NEW STORE
opening October
in Carlingford**

AT "NEVILLE'S CORNER" CNR CARLINGFORD &
PENNANT HILLS RD. NEXT TO KENTUCKY FRIED CHICKEN

JAYCAR KITS

CAR COMPUTER KIT

FUEL SENSOR

GENUINE MORAY UNIT ONLY \$59



FROM
\$99.50



speed sensors



\$19.50

Two types available. Both operate with the E.A. Car Computer and give much the same results. The speed cable unit is handy for front wheel drive or cars which have no tailshaft. This unit does require the speed cable (outer sheath) to be cut. It does not affect the operation of the speedometer in any way and can be used with tailshaft cars also. The magnet coil unit is only really suitable for cars fitted with tailshafts, but the speed cable is not touched.

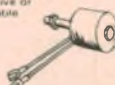

\$14.50

- FUEL ECONOMY (INSTANTLY AS YOU TRAVEL ALONG) IN LITRES/100KM.
- AVERAGE ECONOMY OVER A TRIP.
- AMOUNT OF FUEL USED SO FAR.
- AMOUNT OF FUEL NEEDED (BASED ON AVERAGE USE) TO COMPLETE TRIP. ALSO TIME REMAINING.
- ELAPSED TIME
- SPEED IN K'S/HR. MORE ACCURATE THAN CAR
- DISTANCE TRAVELLED/REMAINING
- HOW FAR YOU CAN GO ON THE FUEL LEFT

Ref: JULY/AUG 82

Lyrebird Piano Kit REF: EA 11/81-1/82

NEW LOW PRICE

\$475

SAVE \$50!!!



7% OCTAVE (88 NOTE) VERSIONS \$589

* Stand \$75 extra

Because we are shipping keyboards and other expensive components in bulk due to high demand, we can pass savings onto YOU. You can now have a magnificent "Lyrebird" six octave touch sensitive piano for only \$475!! That's a staggering \$50 off the old price. REMEMBER!! THE LYREBIRD OUTPERFORMS READY BUILT PIANOS COSTING UP TO THOUSANDS OF DOLLARS MORE. WHY PAY MORE WHEN YOUR CONSTRUCTION KNOWLEDGE CAN SAVE YOU A FORTUNE?

BOTH PIANO KITS FEATURE I.C. SOCKETS PROVIDED AT NO EXTRA CHARGE!!!

pricing * * * * information

All Electronics including both PCB's plated-through, programmed EPROM, 1% metal film resistors, high spec components and YOUR CHOICE of either speedometer cable speed sensor OR tailshaft sensor. (Please specify) **\$99.50**
Pre-Punched case with, special silk screened panel and multi-way connector. **\$29.50**
'MORAY' High resolution Fuel Sensor **\$59**
IF PURCHASED TOGETHER **ONLY \$159**
- WITH EXCLUSIVE LITRE/100KM-MPG CONVERSION CHART

Digital EA282 Thermometer



Ref: EA Feb 1982
Read the temperature in your room (or outside) from 0 degrees C to 100 degrees C in fact to within 0.1 degree C. Fantastic resolution on a bright easy-to-read display.

\$69

INC CASE

DIGITAL CAPACITANCE METER



Ref: EA March 1982

This kit once again uses the amazing DPM 200 LCD /driver module. Capable of measuring capacitance from 1pF to 19.99uF. It is a must in every workshop or lab.

\$69

HEART RATE MONITOR

Ref: EA 7/82

NOW \$69

WAS \$79
SAVE \$10



This unit enables you to measure your own pulse instantly and accurately. It is light enough even for joggers to carry. A must for people who may have heart problems. Complete kit including LCD Display.

NEW!!! ETI 644 DIRECT-CONNECT COMPUTER MODEM



Ref: ETI SEPTEMBER 82
Switchable BAUD RATE, more reliable and faster than most acoustic modems. All components for this unit including plated-thru PCB's and Telacom approved line coupling transformer.

ONLY \$ 159

Digital Storage CRO Adaptor

Ref: Feb 1982 EA

Not only can you avoid buying an expensive CRO, but you can have the features of the REALLY expensive ones!!!



- Can display very slow waveforms
- One shot triggering
- Inbuilt graticle shows on TV screen
- Crystal locked timebase
- DC 100kHz bandwidth
- capable of storage operation

\$170

EA dual tracking P/S



1% resistors used NOT 2%
At last!! A dual-tracking power supply with fixed +5V reg. at a reasonable price!! YOU PAY NO MORE FOR A QUALITY JAYCAR KIT!!

EXCLUSIVE!!
US-MADE
10 TURN 25%
LINEARITY POT
used for greater accuracy

\$84.50

Ref: EA March '82

NEW!!! LCD TACHO KIT

ref: EA May 1982



\$49.50

- USES NEW DPM-06 DISPLAY
- FITS INTO YOUR DASHBOARD
- RPM, DWELL DISPLAY

NEW!! EA STEREO SYNTHESISER

Ref: EA SEPT 82

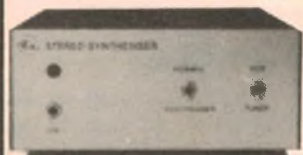

Creates a very realistic stereo sound from AM tuners, TV or video. Very easy to build SHORT FORM KIT **ONLY \$39.50**

-QUALITY RESULTS

500MHz Digital Frequency Period Meter

REF: EA Dec '81 - Feb '82



Tilting Bail to suit ONLY \$4.95

NOW BACK IN STOCK!!!

The best version of this kit in Australia is now back in stock. Why settle for an inferior kit at the same price as ours?

Other people may appear to be selling this kit for less. But you GET less!! Exclusive Jaycar features:

- Heavy gauge front panel. Pre-punched and silkscreened. (NOT Scotchcal).
- All metal film resistors used 1% 50ppm
- Thermalloy heatsink for +5V regulator

Beware of advertised units that do not conform to the original design. They may have inferior performances.

500MHz option only \$26 extra
50MHz Version \$119



Ref: EA April 1982

Function Generator

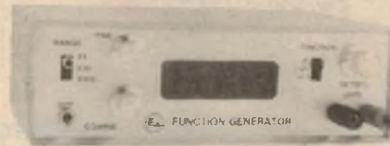

Unit pictured with EA Panel

"Pigeon Pair" companion to the new 500MHz DFM. Low distortion generator of sine, square and triangular waveforms. From below 20Hz to over 160kHz. Inbuilt 4 digit frequency counter in deluxe Pac-Tec case. Only \$85
JAYCAR EXCLUSIVE - 1% 50ppm metal film resistors used for stability and it's still only \$99!!!

Only \$99

SPECIAL JAYCAR PANEL SUPPLIED

NEW STORE
opening October
in **Carlingford**
AT "NEVILLE'S CORNER" CNR CARLINGFORD & PENNANT HILLS RD. NEXT TO KENTUCKY FRIED CHICKEN

19" RACK-MOUNT GRAPHIC EQUALISERS

10 band (octave)



\$139 STEREO MODEL 2010 MkII (A)

19" Rack Mount. Matches the ETI 5000 series components. Makes a logical addition to your 5000AMP/Preamp combination. Based on the ETI 485 Graphic Equaliser but updated with state-of-the-art IC's. Incredible Performance. Only \$139 which includes the 19" rack cabinet.

(1/3 OCTAVE) 28 BAND



MONO MODEL \$225
2801 MkII (A)

This professional instrument is used for total control of acoustic problems. Many hundreds of these are in use by live P.A. operators, Disco installations, recording studios and even the audiophile who demands the ultimate in control.

The kit uses state of the art I.C.'s for low noise, high slew rate and sharp band pass filters. Because it's a kit you save a fortune over built-up units which generally cost over three times the price of this unit.

NOW INCLUDES CANNON INPUT/OUTPUT CONNECTORS.

As used by Warren Cann of 'Ultravox

syntom



Original design from the UK magazine "Electronics and Music Maker" April 1981. Self-contained unit produces a variety of fixed and falling pitch effects. Trigger by tapping the unit itself or by striking a drum to which the unit is attached. The Jaycar "SYNTOM" comes complete with high quality predrilled moulded all ABS box 152 x 80 x 47mm with professional silk-screened front panel.

FEATURES: Decay from less than 0.1 second to several seconds, pitch control, sweep control and volume on/off.

Only \$36.50

GOOD-BYE 3002



This 2x300W RMS P.A. Head is a classic road amp. Ruggedly constructed, 19" rack mount makes an ideal main P.A. or foldback unit. Great for Disco use as well.

We are discontinuing this amp because it is becoming too expensive to make. The metalwork costs alone now account for well over 50% of the unit. Because of this we have reluctantly decided to discontinue the unit. You can grab one now while they last for only \$399.

~~\$489~~ \$399

Send SAE for full spec. sheet.

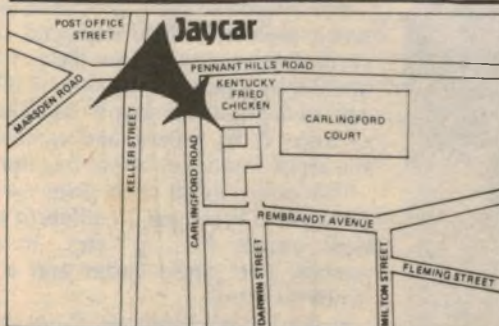

ETI 160 POWER SUPPLY
13.8V @ 10A



Oodles of regulated high current! Great for powering your high power mobile or linear at home!! Can also charge up a car battery pretty smartly too!! The Jaycar kit comes with Beryllium Oxide washers to help get the heat out of the two MJ15004 series regulator transistors. Complete kit includes box.

ONLY \$79

ETI 330 CAR ALARM



This 'current sensing' car alarm is almost immune from false triggering. The latest Jaycar kit includes a predrilled diecast box (not a flimsy plastic box supplied by others). Don't be misled by cheap "versions". Ours is the original.

Only \$29.50

JAYCAR

125 YORK ST SYDNEY 2000
Ph. 2646688 Telex: 72293
Mail Orders To:
Box K-39 Haymarket 2000

MINIMUM MAIL ORDER VALUE \$5.00

POST AND PACKING CHARGES
\$5.99 up to \$120; \$10.24 up to \$150; \$12.49 up to \$200; \$15.74 up to \$300; \$18.99 up to \$400; \$22.24 up to \$500; \$25.49 up to \$600; \$28.74 up to \$700; \$31.99 up to \$800; \$35.24 up to \$900; \$38.49 up to \$1000

NEW SHOP HOURS
Mon-Fri 9:30 to 5:30pm
Sat 9:30 to 12:00pm
Thurs night to 9:30pm

Add speech to any computer with the

Compuvoice computer speech synthesiser

The time has come for computers to speak for themselves! Our speech synthesiser project can be used with any computer that has a Centronics type parallel interface and adds a versatile, easy to use voice — with an almost unlimited vocabulary.

by **PETER VERNON**

Talking computers are not new — systems with limited vocabularies have been available, at a price, since the 1960s. What is new is the low cost and versatility of single chip speech synthesisers.

Apart from the challenge to experimenters and the sheer fun of speaking computers, voice synthesis has some serious applications. Obviously, speaking computer terminals are useful for conveying information to a user who cannot sit with eyes glued to the screen. Speech can also provide computer facilities to the blind and visually handicapped, and there are a number of talking calculators available for this purpose.

Voice Input/Output also seems to be the coming thing for consumer items. Already announced in Japan are a television set which responds to voice commands, and a microwave oven that actually tells you "dinner is ready"!

What is lacking though, is a low cost set-up for the experimenter. Tandy's voice synthesiser for TRS-80 machines, and the Type 'N-Talk for the System-80 are available, but these devices cost over \$500, and are designed for use with particular computers.

Both devices are based on chips from the Votrax division of the Federal Screw Works, a United States company which also manufactures the Votrax SC-01 single chip speech synthesiser.

This project is based on the SC-01 chip, and can be connected to any computer which has a Centronics-compatible parallel output port. With our design you can have a computer-controlled speech synthesiser for around \$100-\$150, depending on what sort of case, loudspeaker and connectors you choose.

Since the Votrax chip produces individual sound units, or "phonemes" on command, and these can be strung together in any combination, our speech synthesiser can produce any word at all, unlike systems such as the National "Digitalker" which store whole words in ROM, and hence have a fixed and limited vocabulary.

Votrax SC-01

The 22-pin Votrax SC-01 chip contains a phoneme controller and a series of filters which form an electronic analog of the human vocal tract. The phoneme controller translates a six-bit phoneme code into a series of parameters for the vocal tract model, while two inflection bits control the pitch of the noise tone sources fed to the filters.

Overall, the output pitch of the phonemes is controlled by the frequency of the clock signal, set with an external resistor/capacitor combination. We did not make use of the two inflection inputs (pin 2 and 3 of the SC-01) as we have found that the automatic inflection provided by the chip itself is satisfactory.

A phoneme sound is produced when a six-bit phoneme code is placed on the control register input lines (P0 to P5) and latched by a pulse on the strobe (STB) input. Each phoneme sound has a duration of from 47 to 250ms, and variations in the clock frequency affect this duration.

The six-bit digital code gives 64 possible codes. There are 25 different consonant sounds ("c", "p" etc), 36 vowel sounds, two pause codes and a "stop synthesis" code.

In the English language, there are five vowels ("a", "e", "i", "o", "u"), so some of the 36 vowels of the SC-01 are the same

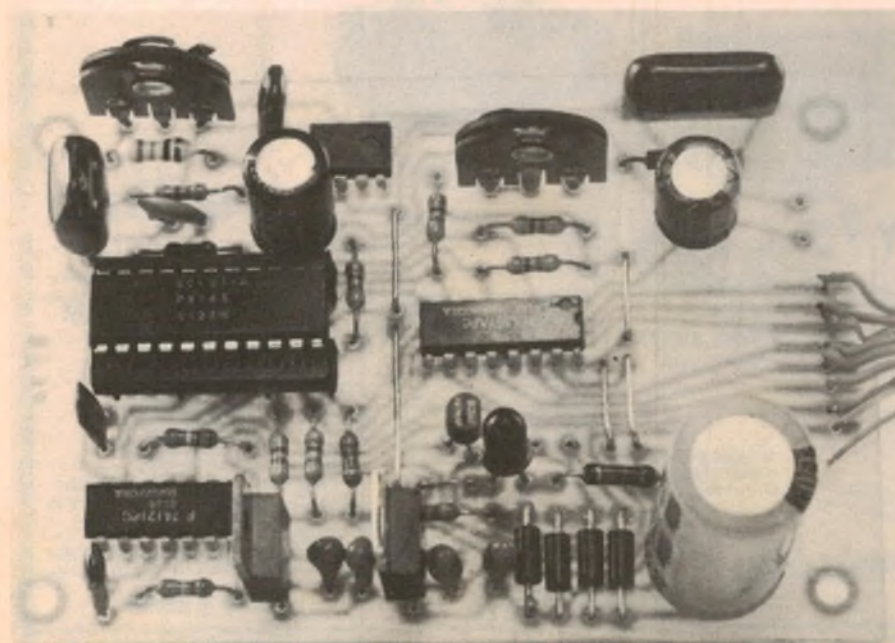

The speech synthesiser can be connected to a standard Centronics port.

OMEGA MAKES YOU A PROMISE!

We aim to inform you, stimulate you, excite and entertain you like no other Australian magazine. Buy the latest issue and see if we don't keep our word!



OMEGA

**ON SALE
AT YOUR
NEWSAGENT**

TOMORROW'S MAGAZINE TODAY

It's at home

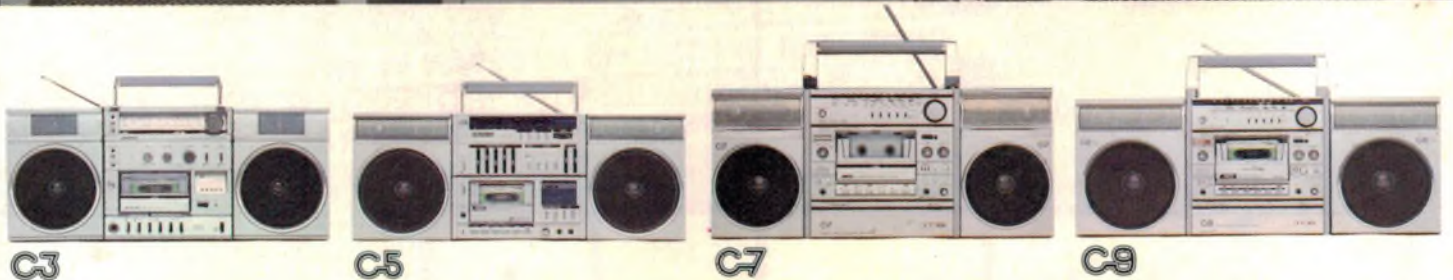

Up till now, about the only place you could hear great sound outdoors was at a rock concert.

 **SANYO**
That's Life!

But now Sanyo has answered that problem beautifully, with a new range of portable Stereo Radio/Cassette Recorders, with detachable speakers. The quality of sound is, in a word, amazing.

So now, enjoying great sounds in the great outdoors, or anywhere else for that matter, is as easy as picking up one of these new Sanyos.

anywhere.



PH420K



PH460K



PH480K



PH492K

In addition, Sanyo are now distributors in Australia for Fisher Equipment, and we are pleased to announce their new range of portable Stereo Radio/Cassette Recorders, with detachable speakers.

Obviously, there's not enough room here to go into details, so we'd like to suggest you see your nearest Fisher retailer.

As they say, hearing is believing.
But, that's life.



FISHER

Distributed by Sanyo Australia Pty Ltd

WATCH OUT FOR THE OCT/NOV ISSUE OF

video MAG



NATIONAL
NV-300 VCR
REVIEWED

ON
SALE
OCTOBER
13TH

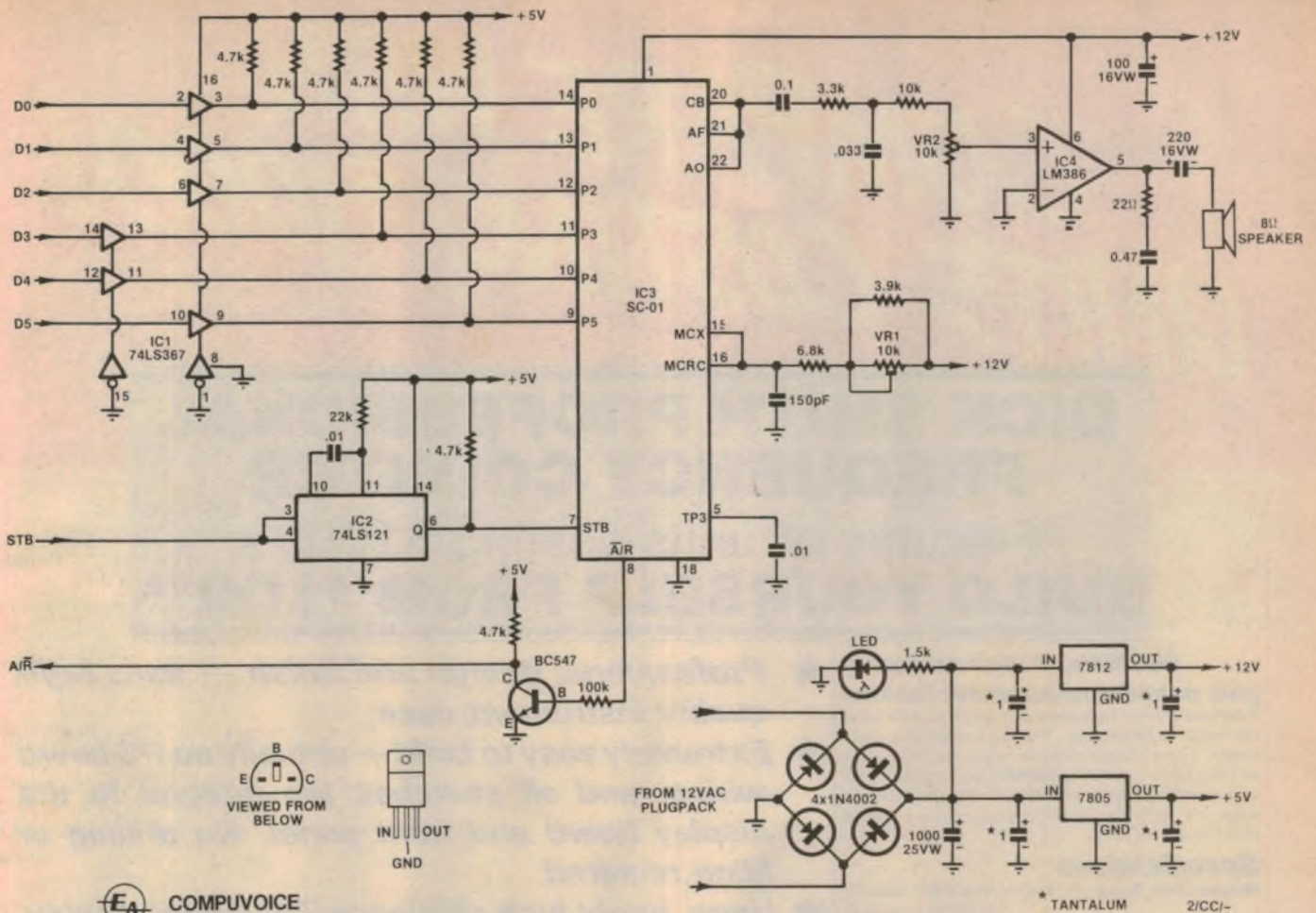

Fig. 1: the full circuit diagram is shown above. Note that inflection inputs of SC-01 are not used.

basic sound with differing durations. For example, while EH is the phoneme symbol for the "eh" sound in "ready", EH1, EH2 and EH3 are the same sound with progressively shorter durations. EH3 is the shortest, as in "jacket". Table 1 shows the various phoneme symbols, the sounds they make and the ASCII character for each phoneme.

By selecting the appropriate phonemes in the correct order, any word in the English language can be produced by the SC-01, plus words in many other languages. (Swahili is a bit beyond the SC-01 because it can't produce the nasal click sounds, but French and German should be quite feasible with careful programming.)

How it works

As shown in Fig. 1, a data buffer (IC1) drives the phoneme code inputs of the SC-01, with external pull-up resistors on the buffer outputs to ensure compatibility with the synthesiser chip. The data is latched on the rising edge of the positive-going strobe pulse on pin 7 of the SC-01, the STB input line.

The SC-01 requires some setup time before it can accept the strobe signal. The data on the phoneme input lines

must be stable for at least 450ns before the rising edge of the strobe pulse and the logic level on the STB input must be low for approximately 100 microseconds (72 clock periods) before it goes high for the strobe pulse.

Many strobe pulses used with printer interfaces do not fulfil these requirements, which is the reason for the inclusion of IC2, a monostable which "stretches" the strobe pulse from the printer interface to around 100 microseconds before passing it to the SC-01.

The A/R output of the SC-01 is at logic 1 when the synthesiser is ready to accept data, and goes to a logic 0 while a phoneme is being produced. This line serves the same purpose as the BUSY signal produced by a printer.

The A/R line produces a CMOS compatible signal, swinging almost to the full supply voltage of the SC-01. This is not suitable for connection to the TTL circuitry of the typical printer port, so a transistor is used to translate this level to +5V. The transistor also inverts the A/R signal, so the final output is 1 when a phoneme is sounding and 0 when the synthesiser is ready to accept a new phoneme code. This corresponds with most printer drivers.

An external capacitor/resistor combination on pins 15 and 16 of the SC-01 set the frequency of the internal clock circuit of the speech synthesiser. The frequency of the clock (nominally 720kHz) affects the pitch of each individual sound and also the rate at which phonemes are sounded. By varying VR1 through its range, the speed of speech can be controlled, from "chipmunk style" to very slow.

The SC-01 has three audio outputs which can be configured to drive simple class-A or complementary class-B amplifier stages. In our version, these three outputs are connected together, passed through a simple RC filter and fed to an IC power stage, IC4. This is an LM386 which is capable of delivering up to 700 milliwatts into an 8Ω load. It has an internal network giving a fixed gain of 20. A Zobel network across the amplifier output consisting of a 22Ω resistor and 0.47µF capacitor helps ensure circuit stability.

A 12VAC plug pack adapter provides the power supplies for the project. The TTL circuits of course require 5V, while the CMOS Votrax chip and the integrated circuit amplifier require a supply voltage between 7V and 14V. We have chosen 12V.

COMPARE WITH UNITS COSTING \$1000!

DICK SMITH PROFESSIONAL FREQUENCY COUNTER

Features of units costing \$1000's
BUILD YOURSELF FROM \$102⁹⁵

500MHz, 7 digit resolution plus period measurement feature.

A completely new frequency and period counter using the latest IC technology. The low component count makes it very reliable and extremely easy to build. It will measure frequency to 500MHz (with optional pre-scaler) and period both with a 7 digit resolution. It rivals the performance of commercial units costing many times the price.

Specifications

Ranges (Full Scale): 0-10MHz, 0-50MHz and 10-500MHz (optional).

Operating modes: Switch selectable frequency or period measurement.

Sensitivity: 10mV RMS to 30MHz, 100mV RMS at 50MHz, typically less than 200mV on 500MHz range.

Input Impedance: 1M ohm/50pF on 0-10MHz and 0-50MHz ranges, 75 ohm on 10-500MHz range.

Resolution: 1Hz on 0-10MHz range; 10Hz on 0-50 MHz range, 100Hz on 10-500MHz range.

Gating Times: 0.1s, 0.1s, 1s and 10s; update times 0.2s longer.

Accuracy: Typically better than .005% ± 1 count uncalibrated.

Power Requirements: 240 V AC, 7W.

High quality, professional looking case.

Quality slide controls for ease of operation

Exclusive pre-punched and printed front panels, no drilling required

with EXCLUSIVE DICK SMITH simplified circuit board wiring, step-by-step instructions & quality pre-punched & printed front panel.

**High Intensity Display
BNC input sockets**

- ★ **Professional design and finish — uses high quality instrument case.**
- ★ **Extremely easy to build — virtually no PC board wiring, and all switches are integral to the display board and front panel. No drilling or filing required.**
- ★ **Huge, bright high efficiency 7 segment display.**

Based on Electronics Australia design Dec. 81 issue.

Basic 50MHz Kit. Cat K-3439. **\$102.95**

Deluxe Instrument Case. Cat H-2505 **\$12.50**

500MHz Pre-Scaler Cat K-3432 **\$31.50**

and covered by our 'Sorry Dick, it doesn't work' guarantee!

Also available: **SAVE \$\$
FUNCTION GENERATOR**

This superb kit produces sine/triangle and square waves over a frequency range from below 20Hz to over 160kHz! It features a four digit LED readout enabling accurate frequency setting. This kit makes an ideal companion to our frequency counter kit at left.

Cat K-3520. See EA April 82

**AMAZING VALUE
AT ONLY**

\$54⁷⁵

**CASE
EXTRA**

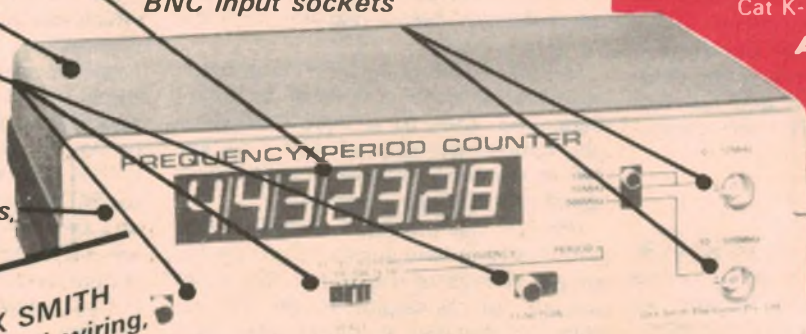

**DICK SMITH
Electronics**

See Page 98 for address details



DSE/A326/PAI

We are presenting the project as a PCB only, leaving constructors to make their own decisions about a box for the synthesiser and loudspeaker.

Begin construction with the power supply section, taking care that the diodes, regulators and electrolytic capacitor are installed with the correct polarity, as shown in the component overlay diagram. We have included a LED in the +5V line as a "power on" indicator, and this too must be correctly oriented.

When this section is complete (not forgetting the bypass capacitors on the input and output of both regulators) connect the plugpack and check the voltages supplied by the regulators. If all is well, disconnect the plug pack and continue with construction of the speech synthesiser.

Install the resistors and capacitors as shown on the overlay diagram, again taking care that the electrolytic and tantalum capacitors are correctly oriented. The two 10kΩ trimpots can also be installed at this point.

As shown on the circuit diagram, VR1 controls the clock frequency of the Votrax chip, affecting the pitch and duration of the sounds produced. VR2 is the volume control, and may be replaced with a 10kΩ potentiometer mounted on the front of the case if you require an accessible volume control. Keep the wiring to the potentiometer as short as possible if you elect to do this.

We found in practice that once the trimpot is adjusted for a comfortable volume level further adjustment was unnecessary, so we did not mount an external volume control.

There is one transistor to be installed, and this must, of course, be mounted the correct way round. The circuit diagram shows the lead configuration.

At this stage the integrated circuits can be installed – except for the SC-01. We elected to use a socket for the Votrax chip but had difficulty finding a source of 22-pin IC sockets. As an alternative, we obtained a strip of single-in-line wirewrap sockets and cut two lengths to suit. Molex pins could also be used.

Install IC1, IC2 and IC4, and whatever socket you decide to use for IC3 (the SC-01). Before proceeding connect the plugpack and power up again. Check for 12V on pin 1 of the socket and ground on pin 18. Turn off the power.

The Votrax chip is a CMOS device, and is sensitive and very expensive as you will be aware if you purchase this kit. Do not remove it from its conductive foam or foil package until you are ready to install it in its socket. Take the usual precautions against static discharge (ground yourself by touching an earthed appliance before handling the SC-01)

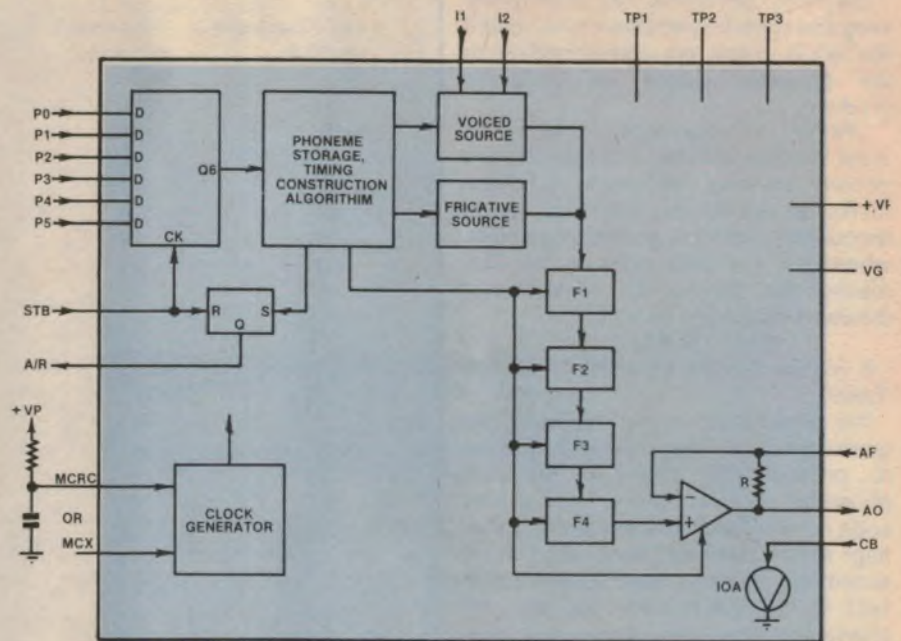

Internally the SC-01 consists of a phoneme storage unit and a series of digital filters, simulating the human vocal tract.

The component overlay diagram is shown at right.

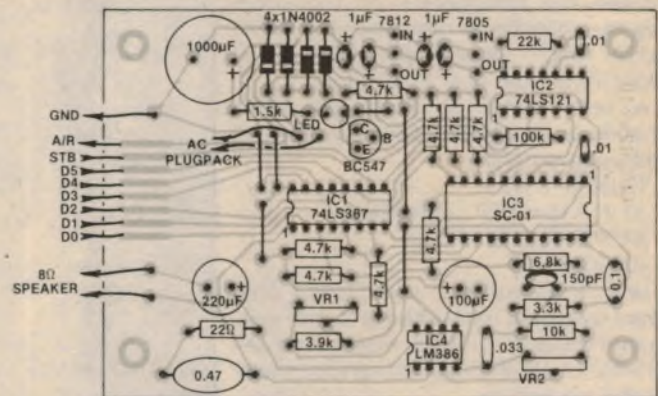

and try not to touch the pins of the chip as you install it.

Our synthesiser is connected to the computer by a ribbon cable terminated in a 34-way double-sided edge connector. There are six data input lines to the board, a strobe signal and a BUSY signal from the synthesiser to the computer, in addition to the ground connector. The

pin connections we have shown in Fig. 3 suit the standard Centronics parallel format as used by most computer systems that incorporate a parallel printer port, including the System-80 expansion interface, the Super-80 printer interface and our TRS-80 parallel interface project (September 1981).

Programming in phonemes

As shown in Table 1, each phoneme that the SC-01 can produce may be represented in three ways. Column one of the table shows the six-bit hexadecimal code for each basic sound, while column two shows the Votrax "phoneme symbol".

Column three shows the particular ASCII character whose six lowest bits correspond to the hexadecimal phoneme code. For instance, the hexadecimal 01 code corresponds to the phoneme code "EH2" and the ASCII code for "A" (ASCII "A" is 41 in hexadecimal – the six lowest bits give us 01, the hex phoneme code). Column four of the table gives one example of a word in

PIN	FUNCTION
1	STROBE
3	DATA D0
5	" D1
7	" D2
9	" D3
11	" D4
13	" D5
15	" D6
17	" D7
19	not used
21	BUSY (from synthesiser)
23-33	not used
2-24	GROUND
26-34	not used

Centronics edge connector pin-outs

which each corresponding phoneme (bracketed) occurs.

The most convenient way of programming the speech synthesiser is to send it the ASCII characters corresponding to the phoneme codes we want to produce.

"LPRINT", a statement contained in most versions of Basic, will transmit to a printer anything between quotation marks, except for the quotation marks themselves and a few control characters, whether it is a valid word or not. This means that driving the speech synthesiser is as simple as writing;

```
LPRINT "JB#X#57"; "?";
```

If you try this the synthesiser will say "hello".

The semi-colons in this statement are quite important. The SC-01 will continue to produce the sound of the last phoneme code it receives until a new code is sent. Basic normally sends a Carriage Return character after each LPRINT statement, and a carriage return (OD in hex) is the ASCII code for the "N" phoneme. The first semi-colon suppresses the transmission of a carriage return, while the "?" represents the STOP code which silences the synthesiser. Don't forget the final semi-colon.

A test routine to make phoneme sounds or complete words can use the following program;

```
10 INPUT A1$
20 IF A1$="END" THEN END
30 LPRINT A1$; "?";
40 GOTO 10
```

Line 20 allows us to exit the test program by typing END. Otherwise the program continues to loop, asking for a sequence of ASCII codes and sending them to the synthesiser.

Words can also be constructed by selecting the phoneme codes which correspond to each syllable of the desired word and constructing a string of the equivalent ASCII codes for transmission to the speech synthesiser.

Several lists of words and their corresponding phoneme codes have been published, such as in Byte magazine for June 1981. Unfortunately lack of space prevents us from publishing our own list this month. Look for it in the next issue

Phonemes can be put together to produce almost any word. But the problem then is to translate the phoneme code to ASCII. We have solved that problem by using the computer.

We have produced a program (listing 1). This takes a sequence of phoneme codes, looks up the corresponding ASCII code, and then sends it to the speech synthesiser. It was developed on a Super-80 fitted with a printer interface board and driven by the parallel printer program published in EA, May 1982.

Users of other computers will notice a couple of differences in the string hand-

Table 1: Votrax phoneme codes

Hex Code	Phoneme Symbol	ASCII Character	As in Example
00	EH3	@	jack(e)t
01	EH2	A	(e)nlist
02	EH1	B	h(ea)vy
03	PAO	C	no sound
04	DT	D	bu(tt)er
05	A2	E	m(a)ke
06	A1	F	pa(i)l
07	ZH	G	plea(s)ure
08	AH2	H	h(o)nest
09	I3	I	b(i)t
0A	I2	J	(i)n
0B	I1	K	(i)t
0C	M	L	(m)at
0D	N	M	su(n)
0E	B	N	(b)ag
0F	V	O	(v)an
10	CH	P	(ch)ip
11	SH	Q	(sh)op
12	Z	R	(z)oo
13	AW1	S	l(aw)
14	NG	T	thi(ng)
15	AH1	U	f(a)ther
16	OO1	V	l(oo)king
17	OO	W	b(oo)k
18	L	X	(l)and
19	K	Y	tric(k)
1A	J	Z	(j)u(dg)e
1B	H	(left square bracket)	(h)ello
1C	G	(slash)	(g)et
1D	F	(right square bracket)	(f)ast
1E	D	(up arrow)	pai(d)
1F	S	(back arrow)	pa(ss)
20	A	(space)	t(a)me
21	AY	!	j(a)de
22	Y1	"	(y)ard
23	UH3	#	miss(i)on
24	AH	\$	m(o)p
25	P	%	(p)ast
26	O	&	c(o)ld
27	I	'	p(i)n
28	U	(m(o)ve
29	Y)	an(y)
2A	T	*	(t)ap
2B	R	+	(r)ed
2C	E	,	m(ee)t
2D	W	-	(w)in
2E	AE	.	d(a)d
2F	AE1	/	(a)fter
30	AW2	0	s(a)lty
31	UH2	1	(a)bout
32	UH1	2	(u)ncle
33	UH	3	c(u)p
34	O2	4	b(o)ld
35	O1	5	ab(oa)rd
36	IU	6	y(ou)
37	U1	7	J(u)ne
38	THV	8	(th)e
39	TH	9	(th)in
3A	ER	:	b(ir)d
3B	EH	;	r(ea)dy
3C	E1	<	b(e)
3D	AW	=	c(a)ll
3E	PA1	>	pause
3F	STOP	?	no sound

Compuvoice: Program listing 1

```

00010 CLS
00100 DIM B$(50),B(50)
00110 PRINT "ENTER PHONEME CODES"
00120 PRINT "SEPARATED BY SPACES."
00130 PRINT "PRESS RETURN AT END."
00140 PRINT"TO QUIT PRESS RETURN"
00150 PRINT "WITH NO ENTRY"
00160 C=0:PRINT
00170 INPUT A$
00180 A$=A$+" "
00200 IF LEN(A$)=0 THEN GOTO 400
00210 C=C+1
00220 FOR I=1 TO LEN(A$)
00230 IF A$(;I,I)<>" " THEN NEXT I
00240 B$(C)=A$(;I,I-1)
00250 A$=A$(;I+1)
00260 GOTO 200
00400 IF C=0 THEN GOTO 700
00410 FOR A=1 TO C
00420 READ A$,D
00430 IF A$="OUT" THEN GOTO 600
00440 IF A$<>B$(A) THEN GOTO 420
00450 B(A)=D:RESTORE:NEXT A
00460 PRINT"IN ASCII CODES THAT'S"
00470 FOR A=1 TO C
00480 E=B(A)
00490 LPRINT[A1 E];
00500 PRINT [A1 E];
00510 NEXT A
00520 LPRINT"?";
00530 GOTO 160
00600 PRINT "ERROR - NO ";B$(A);" CODE":END
00700 PRINT "NO ENTRY?":END
01000 DATA "EH3",64,"EH2",65
01010 DATA "EH1",66,"PA0",67
01020 DATA "DT",68,"A2",69
01030 DATA "A1",70,"ZH",71
01040 DATA "AH2",72,"I3",73
01050 DATA "I2",74,"I1",75
01060 DATA "M",76,"N",77
01070 DATA "B",78,"V",79
01080 DATA "CH",80,"SH",81
01090 DATA "Z",82,"AW1",83
01100 DATA "NG",84,"AH1",85
01110 DATA "OO1",86,"OO",87
01120 DATA "L",88,"K",89
01130 DATA "J",90,"H",91
01140 DATA "G",92,"F",93
01150 DATA "D",94,"S",95
01160 DATA "A",32,"AY",33
01170 DATA "Y1",34,"UH3",35
01180 DATA "AH",36,"P",37
01190 DATA "O",38,"I",39
01200 DATA "U",40,"Y",41
01210 DATA "T",42,"R",43
01220 DATA "E",44,"W",45
01230 DATA "AE",46,"AE1",47
01240 DATA "AW2",48,"UH2",49
01250 DATA "UH1",50,"UH",51
01260 DATA "O2",52,"O1",53
01270 DATA "IU",54,"U1",55
01280 DATA "THV",56,"TH",57
01290 DATA "ER",58,"EH",59
01300 DATA "E1",60,"AW",61
01310 DATA "PA1",62,"STOP",63
01320 DATA "OUT",64

```

What Can You Do

with Boschert's 3 terminal regulators? Plenty!

These flexible, efficient, 25KHz 3-terminal switching regulators provide a single, adjustable, regulated output from raw positive DC sources.

You can even get a negative output from a positive input.

They are complete functional blocks and no complex circuitry is necessary to make them operate.

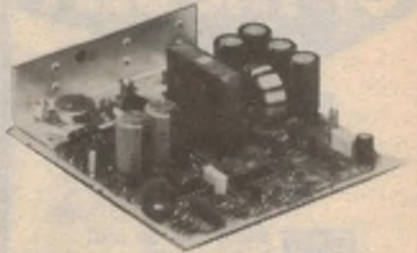

Model	Input	Output
3T12AP4030	+10 to 40V	+4.5 to 30V, 12A
3T12AP6030	+20 to 60V	+4.5 to 30V, 12A
3T5AN4030	+10 to 40V	-4.5 to -30V, 5A
3T20AP6015	+20 to 60V	+4.5 to 30V, 20A

Here are some ideas

Battery Charger

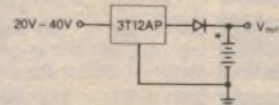

Set V_{out} —no load to 13.8V for float charging a 12V lead acid battery, or to 14.4V for a fast charge. I_{lim} sets max charge current

Supply with High Isolation

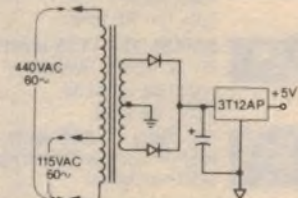

60Hz transformer provides low ground leakage current, high isolation — can conform to UL544 leakage spec

Single Input Voltage — Multiple Outputs

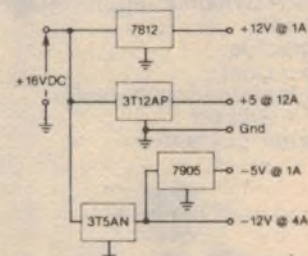

7812 and 7905 are commercially available three terminal I.C. regulator circuits

Price: 5 and 12A versions \$120, 20A version \$155.

Sales Tax and freight is additional. Quantity discount is available.

AMTEX ELECTRONICS
11 Spring Street,
CHATSWOOD 2067 (02) 411 1323

NEED A DC/DC CONVERTER? HERE'S TEN OF THE BEST

SM3D — 3 watt
12 volt input 50 volt output

SM25D1 — 25 watt
Designed for Eurocard
20-60 volt input
5, 12, 15, 24, 50 volt output.

SM60D — 60 watt
Bench mounting.
Designed for small radio
systems

SM100D — 100 watt
20-60 Volt input
5-50 volt output

SM100D1 — 100 watt
12 volt input 24 volt output

SM100D2 — 100 watt
High isolation 5KV impulse
Meets IEC 255/4 Class III

SM110D1 — 110 watt
Low cost 24 volt to 12 volt
designed for mobile use

SM135D1 — 135 watt
AC/DC meets Telecom
specification 1238
Very low RF noise.

SM135D2 — 135 watt
DC-DC meets Telecom
specification 1238
Very low noise.

SM200D — 200 watt
High power 20-60 volt input
5-50 volt output

Designed and manufactured
in Australia by Scientific
Electronics.

- High Efficiency 70% – 85%
- Wide Dynamic Input Voltage Range.
- Versatile
- Low Cost
- Complete local back up and support.
- 5 year guarantee



Scientific Electronics

6 Holloway Drive, Bayswater, Victoria 3153.
Tel: (03) 762 5777 Telex AA36308

Distributors

Victoria. Electro Technics 699 2716

N.S.W. Electronic Developments, 438 2500

S.A. Graphic Electronic Industries, 42 6655

Qld. Fred Hoe & Sons 277 4311

W.A. W.J. Moncrieff Pty Ltd., 325 5722

THE POWER SUPPLY SPECIALISTS

Compuvoice speech synthesiser

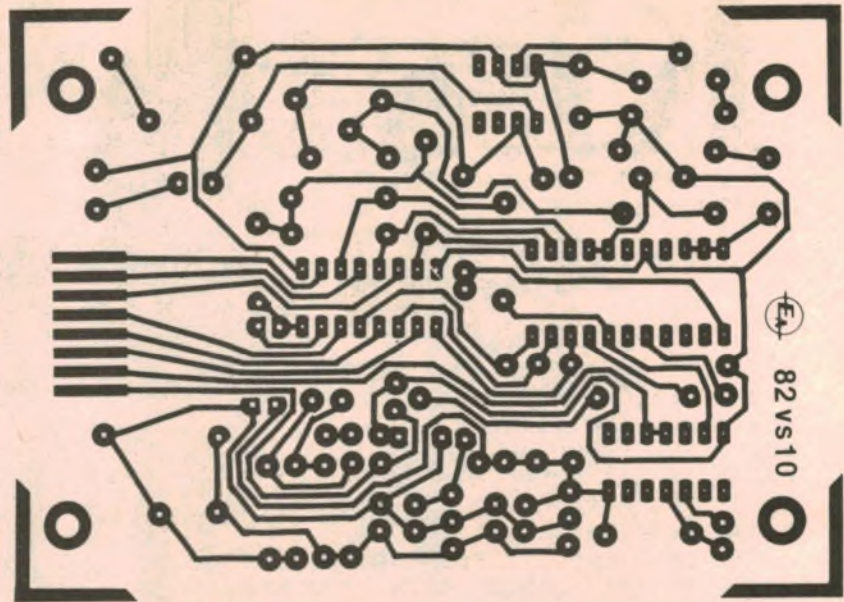

The full size printed circuit board pattern is shown above.

ling statements of Super-80 Basic, and will need to make the changes which follow.

First of all, Super-80 Basic uses the same arrays for numbers and strings (alphabetic characters). In line 100 of listing 1, B0(50) is used to dimension a string array — so change this to DIM B0\$(50) for use with other versions of Basic. You may also have to insert a CLEAR 100 statement to clear sufficient space for the string arrays used in the program. All string variables in Super-80 Basic consist of a letter followed by a number, which may not be required in other Basic versions.

In line 230 of the program, A0\$(I,I) is equivalent to MID\$(A0\$,I,1). It returns the character in position I of the string. In line 240, A0\$(I,I-1) is equivalent to LEFT\$(A0\$,I-1), and returns the first I characters of the string, less one. Line 250 of the listing has A0\$=A0\$(I+1) and is replaced by A0\$=MID\$(A0\$,I+1,100). The "100" is arbitrary — it just makes sure that we get all the characters from position I+1 to the end of the string.

Finally, LPRINT [A1 E] in Super-80 Basic is equivalent to LPRINT CHR\$(E) in other versions of Basic.

The program in listing 1 displays the ASCII character corresponding to each phoneme code as it is spoken. By noting down these ASCII characters and placing them in DATA statements any sort of vocabulary can be created.

COST ESTIMATE: \$90. This does not include the cost of a loudspeaker, plugpack supply or case.

PARTS LIST

- 1 Printed circuit board, code 82VS10, 105mm x 71mm
- 1 loudspeaker
- 1 45cm length of 9-way ribbon cable
- 1 34-way printed circuit board edge connector to suit Centronics type parallel interface
- 1 12V AC plug pack
- 1 22-pin socket (see text)

SEMICONDUCTORS

- 1 74LS367 hex bus driver
- 1 74LS121 monostable multivibrator
- 1 SC-01-A speech synthesiser
- 1 LM386 audio amplifier
- 1 BC547 NPN transistor
- 1 7805 +5V voltage regulator
- 1 7812 +12V voltage regulator
- 4 1N4002 diodes
- 1 light emitting diode

CAPACITORS

- 1 1000µF/25VW electrolytic
- 1 220µF/16VW electrolytic
- 1 100µF/25VW electrolytic
- 4 1µF tantalum
- 1 0.47µF greencap
- 1 0.1µF greencap
- 1 .033µF greencap
- 2 .01µF greencap
- 1 150pF ceramic

RESISTORS (¼W, 5% unless stated)

- 1 x 100kΩ, 1 x 22kΩ, 1 x 10kΩ, 1 x 6.8kΩ, 8 x 4.7kΩ, 1 x 3.9kΩ, 1 x 3.3kΩ, 1 x 1.5Ω, 1 x 22Ω, 2 x 10kΩ large vertical trimpots.

Kiss the hiss goodbye.



Say hello to the world's quietest tape. New **BASF Chrome II.**

The new BASF Chrome II – like no other tape on the market today.
And why? Because it's made like no other tape.

Perfectly shaped and uniformly-sized particles of pure chromium dioxide provide a purity in sound never before possible. An absolute minimum of background noise with outstanding high frequency response ratios. With BASF Chrome II you hear all of the music and none of the tape.

And isn't that what everyone is looking for?

So, give the hiss a big miss and say hello to the world's quietest tape.
The BASF Chrome II.



BASF Chrome II.

Put a BASF in yours.

Now available from most leading Hi-Fi retailers.

BLUE LABEL SYSTEM 80



OVER 9000 SOLD!

AUSTRALIA'S BEST VALUE IN PERSONAL COMPUTERS

Cat. X-4005

Look at these great features:
 ● 16K Memory (expandable to 48K with X-4020 Expansion Unit) ● Full upper and lower case video display capability ● Built-in speaker ● Built-in cassette deck with level control ● Works with any standard TV set or monitor ● Flashing cursor ● Huge range of software programs (compatible with most Tandy TRS-80 programs) AND SO MANY MORE FEATURES!!!



READ WHAT EA HAVE TO SAY

“Overall, we are very impressed with the Blue Label System 80. On a dollar per function basis it probably represents the best value around for a ready-built computer. Other systems can be bought for less, but ultimately they are not as powerful or as readily expandable as the System 80. There is also the matter of software, and here the System 80 really scores, with hundreds of compatible programs available for the TRS-80 as well as those specially written for the System 80.”

7 Day Trial Offer
 ★ If you're not completely happy, ★
 ★ you can return the System 80 ★
 ★ within 7 days in original condition ★
 ★ and packing for a full refund. You ★
 ★ owe nothing — not even an ★
 ★ explanation! ★

WAS \$750.00! **\$699**
 \$16.24 per week

ALSO AVAILABLE SYSTEM 80 YOU REAP MARK II THE BENEFIT!

When cassette operation is too slow for business usage, this System 80 is the answer. Great features include: Inbuilt 12K Microsoft BASIC — numeric keypad for extra fast finger input — Provision for full expansion to 48K of memory, to 4 floppy disk drives, printer and RS 232 communications ports — Full upper and lower case video display — Screen print facility (obtains printout of any 'page' on screen) — High bandwidth direct video output — and much, much more. Why not drop in and see just what the System 80 Mark II Computer can do!

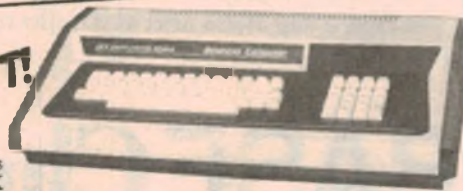

WAS \$1495!

\$17.77 per week Cat. X-4100

\$765

“the best



SYSTEM 80 EXPANSION UNIT

A new model — with more features AND \$100 cheaper than the previous model! The first row of 16K RAM is fitted as standard in this unit, with provision for an extra 16K (which gives the System 80/Expansion unit a mighty 48K total memory!) Also standard is a floppy disk controller capable of controlling up to 4 single density disk drives.

Cat. X-4020

ONLY \$425



DICK SMITH GREEN PHOSPHOR MONITOR



NEW IMPROVED MODEL

If you're seriously into computers, then this is the monitor for you! Provides a sharper, brighter image, and you avoid eye fatigue! Suited for the professional or the serious hobbyist.
 Cat. X-1198

ONLY \$239

WHY PAY MORE?

BLACK & WHITE ECONOMY MONITOR

This economy monitor gives a clear, sharp image and can be used with most computers on the market. Compare the price, you'll be pleasantly surprised!
 Cat. X-1196

\$155

value around for a ready built computer."

ELECTRONICS AUSTRALIA,
June 8, 1982

DICK SMITH SYSTEM 80 DISK DRIVES

Our disk drives go much further... for so much less! These superb disk drives cost much less than the Tandy disk drives and they incorporate a high-quality drive mechanism, together with matching inbuilt 240V power supply!

Each drive has high storage capacity — 40 tracks and is suitable for both single and double density recording. With double density recording, you can store more than 180K bytes per diskette! Drive 0 (Cat. X-4060) and Drive 1 (Cat. X-4061)



CHEAPEST PER BYTE!!!

\$495 each



DOT MATRIX PRINTER

How's this for value! A tractor-fed impact type dot matrix printer for way under the cost of most thermal printers! It uses ordinary fan-fold sprocketed paper and features an incredible single hammer print-head, which means fewer moving parts — and fantastic reliability! And you have to see the high resolution graphics to believe them — software selectable! Dick's done it again!

VALUE! \$399

The DICK SMITH DAISY WHEEL PRINTER

Improve the appearance of your correspondence with this quality printer! It delivers ultra-sharp, clean copy at **THREE TIMES** the speed of a golf-ball typewriter (40 c.p.s) with fewer moving parts than other daisy wheel printers to improve reliability. If you buy a daisy wheel anywhere else, you're wasting money!



\$1999

AND NOW SPEECH!

with the VOTRAX Synthesizer

With this advanced speech synthesizer, your computer can now talk to you simply and clearly — with an unlimited vocabulary!

Just think of the applications: computers for the blind, language teaching, computer-aided teaching for small children and the illiterate. And of course, Type-N-Talk is great fun for computer games.



Supplied with 240V power supply and user manual.
Cat. X-3290

only \$549

\$12.75 per week

PRINTER CABLES Parallel Printer Interface

The low cost way to obtain a Centronics-type printer port from your System 80 computer without the need for a full expansion unit! Plugs into the expansion interface connector on the rear of the System 80. Cat. X-4013

ONLY \$56.50

Quality Printer Cable

This is a universal cable, ideal for connecting a printer or other device to the printer interface or the X-4020 expansion unit. Fitted with edge connector one end and 57N-36 plug the other.

\$42.50

AND MUSIC! Fred Sound Synthesizer

Give your System 80 the ability to produce music with this Sound Synthesizer. It plugs directly into the expansion connector with the audio output connecting directly into the AUX, TAPE or TUNER facilities of most HI-FI amplifiers. Cat. X-3280

VALUE! \$172.50



YOUR LAST CHANCE TO WIN A STANZA!!!

Hurry! It could be your last chance to win a great Datsun Stanza. All you have to do is purchase a System 80, Sorcerer or VIC-20 and fill in the entry coupon supplied. It's that simple! Good Luck!



HFC Finance available on selected items to approved customers. All prices quoted are taken per week over a 12 month period.

DICK SMITH Electronics

See page 98 for address details



bankcard
welcome here

Novel circuit provides instant turn-on

Electronic starter for fluorescent lamps

Do your fluorescent lights go blink, blink, blinkety-blink when you switch them on? This substitute electronic starter solves that problem and gives a smooth, rapid start every time you switch on. All the parts are housed in a standard starter case so the light wiring does not have to be modified.

by LEO SIMPSON

Are you one of those poor unfortunates who has to rise in the dead of the night for what the Americans euphemistically call a "comfort break"? And do you find the blinkety-blink flashing of a fluorescent light switched on in pitch dark a trifle off-putting, if not to say, blinding? As luck would have it, this problem is made worse when temperatures are low, which adds to the misery.

This new electronic starter not only solves the problem of random flashing and temporary blindness when fluorescent lights are switched on but also reduces RF interference. It may also contribute to extended tube life. With that list of advantages we realise that you are just rearing to know how it works, so let

us first discuss how a fluorescent light works and starts normally.

There are a surprisingly large number of fluorescent light circuits including instant start, rapid start, lead-lag ballast and so on but the configuration most commonly found in domestic and commercial lighting installations is still the starter-preheat system shown in Fig. 1.

While this circuit looks fairly simple, it is in fact quite complicated in operation, as are most types of fluorescent light circuit. However, we will attempt to give as straightforward a description as possible. Essentially, the circuit has two modes of operation, start and run. In the start mode, the starter is involved (no, we're not putting you on) and in the run mode, the starter is effectively out of circuit.

Everyone is familiar with the ubiquitous fluorescent light tube but few people are aware of their make-up. Basically, the glass tube has a filament heater at each end and contains a minute quantity of mercury and a mixture of inert or noble gases at very low pressure.

The filament heaters are usually made of triple-coiled tungsten wire which is coated with an emissive material such as barium or strontium oxide. In the start mode, current is passed through the two filaments to raise them to red heat. At this temperature they emit electrons freely (thermionic emission) which rapidly disperse in the tube so that an electric discharge can occur through the inert gas when a high voltage is applied between the two filament electrodes.

The electric discharge first occurs through the inert gas which rapidly heats up and thereby vaporises the small quantity of mercury. The mercury atoms are then excited by the arc discharge and they release energy which is mainly in the form of ultraviolet radiation at a wavelength of 253.7 nanometres.

This ultraviolet radiation then impinges onto the white phosphor coating on the inside of the tube which then "fluoresces" to emit visible light. About 20% of the ultraviolet radiation is transformed to visible light while the rest is liberated as heat.

We can now return to the circuit of Fig. 1. When the electric discharge is established in the fluorescent tube, it has a low and essentially negative resistance. Effectively, this means that once the arc is started the current will rapidly increase until the tube overheats and burns out. To prevent this, a "ballast" is connected in series with the tube. The ballast is an iron-cored inductor which "saturates" at a predetermined current level and

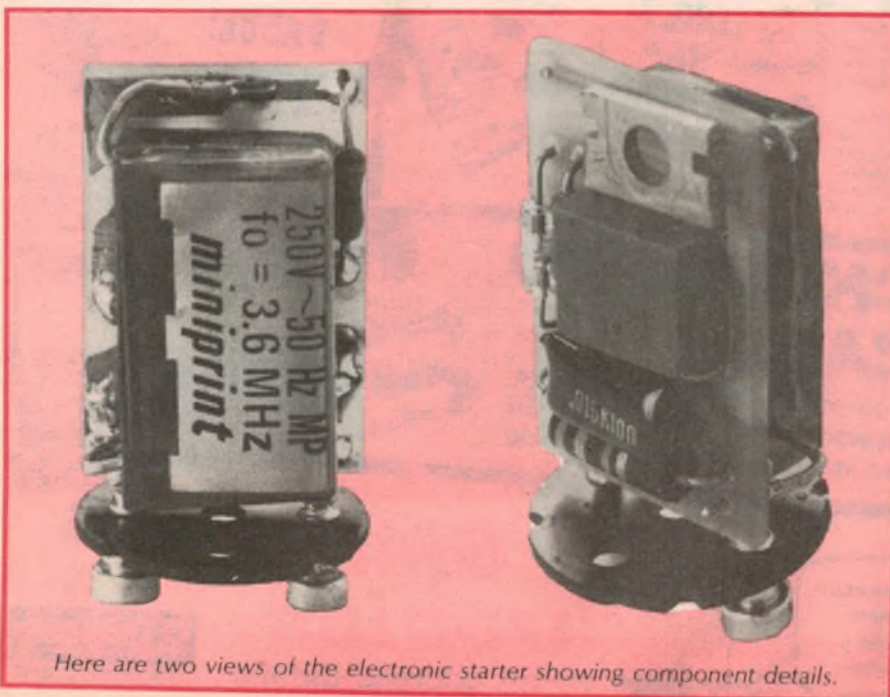

Here are two views of the electronic starter showing component details.

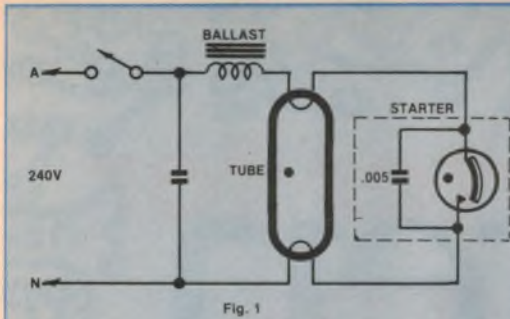

Fig. 1: Common fluorescent starter circuit.

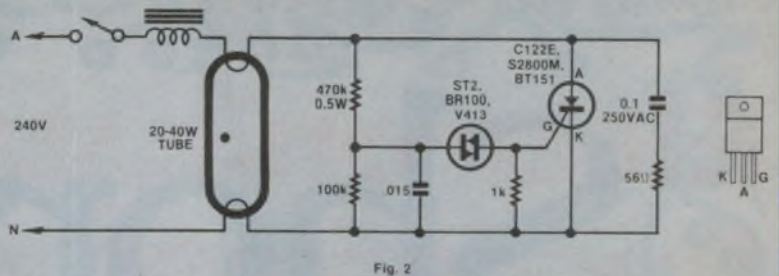

Fig. 2: Circuit diagram for our electronic "instant" starter.

thereby limits the current through the tube to a safe level.

So that is how the ballast functions in the "run" mode. In normal operation, the tube actually strikes and extinguishes during every mains half-cycle so that it actually flashes at a rate of 100Hz.

Power factor correction

The purpose of the capacitor across the mains input is to correct the low power factor of the ballast. In other words, the capacitor compensates for the lagging current of the ballast and makes the overall loading of the circuit appear more resistive. These power factor correction capacitors are not normally present in fluorescent light fittings in home installations but are generally required for those used in commercial and industrial situations.

As well as limiting the current through the tube to a safe value during the "run" mode, the ballast also plays a crucial part in the "start" mode. This mode occurs as follows:

When power is first applied, a small current flows via the ballast, tube filaments and starter bulb which is filled with argon (or some other inert gas). Within a few milliseconds the ionising and resultant heating of this gas causes a set of bimetallic contacts in the starter to close and a relatively heavy current then flows through the tube filaments and ballast.

While the tube filaments heat up and begin emitting electrons, the starter bulb then cools again and the bimetallic contacts open to interrupt the filament current. The ballast does not like this and generates a large peak voltage which then fires the fluorescent tube, if all goes well.

In practice, though, the starter usually needs more than one attempt to fire the fluorescent tube. For example, the mains voltage may be a little low, the ambient temperature may also be low and the starter may interrupt the filament current just when it was low or passing through zero, in which case, little or no peak voltage would be generated by the ballast.

Typically then, the starter needs several "strikes" before the tube fires reliably. This is why fluorescent lights

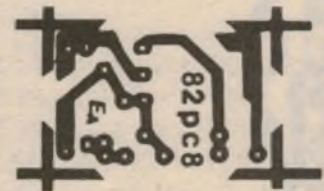
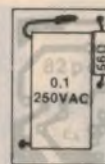
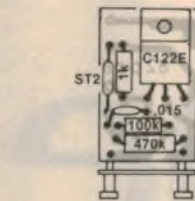

Component overlays for both sides of the PC board.

characteristically flash several times, in that annoying fashion we all know so well, when they are first turned on. And it also explains why the light generally fires straight away if you switch it off and then on again, after a period of operation.

Note that the circuit of Fig. 1 shows a capacitor internally connected across the starter. The capacitor is usually a ceramic or Mylar dielectric type of about .005 μ F and is included to suppress RF interference which occurs at the moment of contact opening. The capacitor also provides some suppression of the RF interference produced by the electric discharge in the fluorescent tube itself.

Apart from this secondary suppression of RF interference by the starter capacitor, the starter plays no further part in the circuit operation once the tube has fully fired.

Flashing is not good

Not only does the initial flashing of fluorescent tubes annoy nocturnal humans but it may also seriously degrade tube life, due to excessive cycling of the filaments. To explain, the usual reason for eventual tube failure is that the filament emissive material becomes exhausted or the filament goes open circuit. If a tube is run continuously (ie, never turned off) its life will be almost twice that for a tube which is run with a cycle of three hours per start.

The answer to this problem is not to

We estimate the current cost of parts for this project to be approximately

\$5

This includes sales tax.

Shown above is the full-size pattern for the PC board.

replace the tubes continuously but to replace the starters more often or at least, replace the starter when the tube is replaced. Inevitably, though, the starter will noticeably deteriorate long before the tube approaches the end of its life. So this is where our electronic starter comes in. It will not deteriorate, it will give a reliable start every time and should give a longer tube life (although we have no data to support this theory at the time of writing).

Offsetting all the advantages of the electronic starter is its higher price. At around \$5 it is a lot dearer than a conventional starter. We would not advocate replacing every starter in your home with this new device but there are probably one or two lights, say in your kitchen or bathroom, with which you will gain a worthwhile benefit.

Fig. 2 shows a fluorescent light fitting with the electronic starter in place of the conventional type. Essentially, the electronic starter is a silicon controlled rectifier (SCR) which feeds half-wave rectified AC to the filaments, via the ballast.

As the filament current drops to zero, at the end of every alternate half-cycle, the SCR turns off and the ballast generates a high voltage peak which then fires the tube. In effect then, the electronic starter gives the fluorescent tube a stream of repeated "strikes" until the tube fires sufficiently well to sustain conduction and give full illumination.

In practice, the tube comes on immediately the power is applied but at a relatively low level of brightness. Then, after one or two seconds it comes up to full brightness without flicker or any other drama. At the same time, the ballast makes a louder than normal buzzing noise during the brief turn-on period and thereafter makes no more noise than is normal.



Shorten the Circuit.

**Your Complete Computer System
for Printed Circuit Board Design Automation.**

**COMPLETE DESIGNS IN HOURS, NOT WEEKS
FULL DOCUMENTATION
CAMERA READY ARTWORK**

For a demonstration and information on
our Design Automation seminars, phone
Daro Office Systems Pty. Ltd.
Sydney Mike Avey (02) 699 3877,
Melbourne Ian Allen (03) 690 6600.

- Single or multi-user
- Indepth training
- Complete systems
from \$16,200.

DARO
AUTOMATION SYSTEMS.

The method of triggering the SCR is as follows: Mains voltage is applied via the ballast and tube filaments to a voltage divider network consisting of a 470kΩ and a 100kΩ resistor, to charge a .015μF capacitor. When the voltage across the capacitor rises to about 30V, the ST2 or equivalent Diac (a four-layer semiconductor) device breaks down and dumps the capacitor's charge into the SCR gate. This fires the SCR which then continues to conduct until the ballast current drops to almost zero at the end of the mains half-cycle.

The resulting voltage peak generated by the ballast is damped by the RC network across the SCR. This has the desirable effect of preventing damage to the SCR (by limiting the peak voltage) and also lengthening the time for which high voltage is applied to the tube so that a "strike" can occur.

Looking at it another way, the 0.1μF capacitor could be regarded as providing a series resonant network, in conjunction with the inductance of the ballast. This resonance is then excited by the voltage spike, generated by the back-EMF action of the ballast, and is damped by the 56Ω resistor plus the series resistance of the ballast itself.

The 1kΩ resistor connected between gate and cathode of the SCR prevents any likelihood of spurious triggering of the SCR when the tube is in the "run" mode. Note that once the tube is fired and running, the voltage across the electronic starter is low enough at about 100VRMS to prevent the starter from playing any further part in circuit operation, as with a conventional starter.

There is, however, a further bonus provided by the electronic starter in the form of the 0.1μF snubber capacitor. This has the effect of improved suppression of RF interference from the fluorescent tube. The electronic starter also produces much less "hash" at initial turn-on than a conventional starter so it all adds up to a much "quieter" fluorescent light, in the RFI sense.

We should point out that this circuit has already appeared in the June, 1982, issue of "Elektor" and may or may not be subject to a patent application in this country.

Construction

While the foregoing circuit description may have been fairly long and detailed, the construction of the electronic starter is quite easy and straightforward. In fact most hobbyists will probably have the job finished inside 10 minutes. That does not allow for soldering iron warm-up time.

As shown in the photographs, the starter circuitry is mounted on a small PC

board, coded 82pc8 and measuring all of 19 x 29mm. Huge, isn't it! When the components are assembled, onto both sides of the board, the whole assembly is then shoe-horned into a conventional starter case.

Start construction by cannibalising a conventional starter. You need to remove the starter innards without damaging the circular lid which carries the two connector pins. Clip off the starter lamp and capacitor but leave the leads long enough, say about 5mm or so, so that they can be soldered to the PC board assembly.

For obvious reasons, you should not use a starter with a metal case.

Six components are mounted on the component side of the board, while two are mounted on the copper pattern side. Mount the small components first on the component side. Note that the Diac is a non-polarised component so it can be installed either way around.

Don't use an ST4!

It is most important that you use a Diac in this circuit and not the GE asymmetrical trigger device, the ST4. Make sure you are not fobbed off with this device, as seems to be common practice amongst uninformed counter staff. **The ST4 will not work.** There, you have been warned. We obtained BR100 Diacs from Jaycar but parts suppliers should have no

problems laying in any one of the Diac types we have listed.

The SCR should be rated at a minimum of 500V and any one of the types listed will do nicely. Bend the three leads close to the SCR body before installing. Take care when doing this. Use a pair of long nose pliers to avoid undue strain on the case/lead join.

Now install the capacitor and resistor on the copper side of the board, as shown in the photographs and wiring diagram. The capacitor must be rated at 250VAC, as specified.

Finally, solder the board to the starter lid terminals. Then carefully check all connections visually. You could also use a multimeter, switched to the "ohms" ranges, to check the circuit components for continuity. The Diac should read open circuit and the SCR should be 570kΩ between anode and cathode (this is the value of the resistor string).

Now carefully slide the whole assembly into the starter case. This is a squeeze but it will fit. You are now ready to test the unit.

We have tested several prototypes of the starter on 20W, 40W and 65W lamp fittings but we are not certain whether the circuit is really suitable for 65W fittings. To be on the safe side we recommend that you try the unit on a 20W or 40W fitting. Just remove the existing starter, carefully install the electronic one and turn it on. You should be greeted by a smooth and fuss-free start. If not, the most likely fault is a dud SCR.

If the tube is old and will not fire with the electronic starter, do not leave it switched on, otherwise the ballast will burn out.

We should make a special note about the use of this starter in a dual 20W fitting which use two starters and one ballast. In some fittings, the electronic starter will not work, depending on the characteristics of the ballast and the polarity of the two starters. In view of this uncertainty, we do not recommend that the starter be used in these fittings, as well as the 65W fittings mentioned earlier.

PARTS LIST

- 1 fluorescent starter (to be cannibalised)
- 1 PC board, 19 x 29mm, code 82pc8
- 1 C122E, BT151 or S2800M 500V SCR
- 1 ST2, BR100 or V413 Diac
- 1 0.1μF/250VAC metallised dielectric capacitor
- 1 .015μF metallised polyester capacitor (greencap)
- 1 470kΩ/½W resistor
- 1 100kΩ/¼W resistor
- 1 1kΩ/¼W resistor
- 1 56Ω/¼W resistor

AN INTRODUCTION TO DIGITAL ELECTRONICS

Here are the chapter headings:

- | | |
|--------------------------------|------------------------------|
| 1. Signals, circuits and logic | 12. Basic readout devices |
| 2. Basic logic elements | 13. Multiplexing |
| 3. Logic circuit "families" | 14. Binary arithmetic |
| 4. Logic convention and laws | 15. Arithmetic circuits |
| 5. Logic design: theory | 16. Timing & Control |
| 6. Logic design: practice | 17. Memory: RAMs |
| 7. Numbers, data & codes | 18. ROMs & PROMs |
| 8. The flipflop family | 19. CCD's & magnetic bubbles |
| 9. Flipflops in registers | 20. D-to-A converters |
| 10. Flipflops in counters | 21. A-to-D converters |
| 11. Encoding and decoding | |

Available from "Electronics Australia", 57 Regent St, Chippendale. Price \$4.50 or by mail order from "Electronics Australia", PO Box 163, Chippendale, 2008. Price \$5.40.

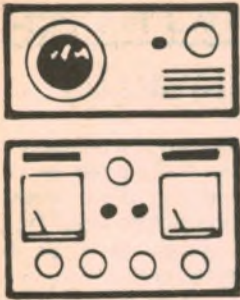

The Serviceman

Contributions month: fuses, focus and frustration

It's contributors' month this month, mainly because the response to the request panel in the previous month's notes has been quite surprising. In fact there is still some backlog, but this batch has helped reduce it. At the same time, other peoples' stories help broaden one's outlook and provide an insight into how they cope with the unusual.

The first contribution comes from J.E. of Bull Creek, WA. (I wonder what the local wags call it!) Anyway, it is one of a couple that J.E. has submitted, but I will hold the other one over this time, to give the rest of the mob a fair go. J.E. writes as follows.

The beginning of this story is not unfamiliar. The family monochrome TV set had failed completely — no picture and no sound — and had been replaced with a colour set. Then someone had suggested that it should be possible to repair the monochrome set — and had even suggested that it should not cost more than \$15! Would I have a look at it?

With the exception of portable models, monochrome TV receivers are seldom worth repairing, especially if they are relics of the valve era. I was assured that this was a portable set, and the owner offered to deliver and collect it. The fact that it had failed completely suggested that it would be either easily fixed or obviously beyond economic repair.

NO VALVE HEATERS

When the set was delivered it turned out to be a 10 year old 58cm (23in) valve model. Its only pretension to portability was that it had an inbuilt antenna and was on castors!

When it was tried it was found that not even the heaters glowed. The mains fuse was intact, but a heater fuse, which consisted of just over 25mm of about 8A tinned copper wire on a tag strip, had blown; not violently, but just melted and parted.

This fuse was replaced with 10A fuse wire and the set seemed to work satisfactorily, but the question was, why did the fuse blow? The heater wiring was checked visually, and also at 500V DC,

but no fault showed up.

During the removal of the chassis to make these heater checks it was found that the manufacturer had supplied a spare mains fuse and a length of fuse wire for the heaters. Although the latter looked appreciably lighter than the original, it was used to replace the 10A fuse wire, which had had to be removed, along with the valves, for testing the heater wiring insulation.

When the chassis was replaced and turned on the new heater fuse came up to a lovely red glow, and then failed. Had the fault returned or was the fuse too light? Reference to the manufacturer's diagram showed that the fuse wire should be .014in diameter, whereas the spare fuse wire was only .010in diameter, and that originally fitted was .013in diameter. Which was correct?

The total current drawn by the picture tube and valve heaters was about 7A,

and .010 tinned copper wire has a rated fusing current of about 10A and a safe working current of about 7A — so why should it fail?

Valve heater resistance, when cold, is about one fifth of that when hot. At the instant of switch-on, therefore, the current could be in excess of 35A. Because of its thermal inertia a fuse will withstand some overload, but its survival would depend on the amount of overload and its duration.

The heater fuse was therefore replaced with .014 tinned copper wire, as specified by the manufacturer, which has a rated safe working current of about 10A and which showed no signs of overheating when the set was turned on.

Why did the original fuse fail? I can only assume that it was just a little too light, causing it to overheat and oxidise a little each time the set was turned on. Eventually, it deteriorated to the point where it failed completely.

Well, thank you J.E., and I think your summary of the failure is pretty well spot on. The only point I could add is that fuses which are repeatedly overheated and cooled can also suffer from metal fatigue, but whether that was a factor in this case I wouldn't like to say. If it was, it was probably only minor.

In broader terms though, it seems surprising that the set was, apparently, originally written off for such a trivial fault. I can only assume that the owner was secretly hankering for a colour set and chose to regard the drastic symptoms, ie, total failure, as indicative of a catastrophic fault, and therefore ease his conscience in regard to the cost of the new set.

FRUSTRATION PLUS

The next story comes from Mr G.W. of Clarence Park, SA, and could probably be best titled, "Frustration Plus". Anyway, here is how he tells it.

The fault I am about to describe was one of the most trying I have encountered for some time. I should explain that I work for a tertiary institution in the capacity of an audio-visual technician. Although, in this position, I have



"I tried to claim for ceiling damage but the assessor wouldn't hear of it!"

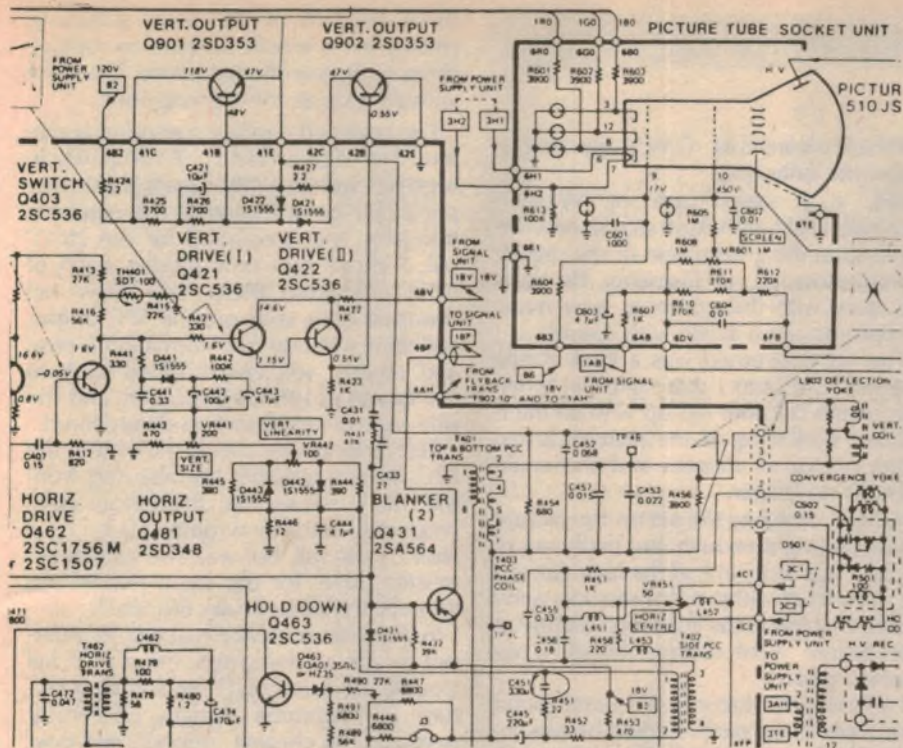

Sanyo CTP6603 vertical scan circuitry. C451, part of an RC circuit across the side pincushion transformer, turned out to be the culprit.

seen many "curly" faults, I feel that this one takes the cake!

The set concerned was a Sanyo CTP6603 with the complaint that vertical scan had collapsed to about one quarter of normal height with some edge distortion — this latter clue proved to be a fairly important; one in retrospect but, at the time, I merely noted that the fault involved the vertical section and headed there.

First, I made a voltage check at the midpoint of the class-A vertical output stage (Q901, Q902). This revealed about 8V instead of the 47V indicated on the circuit and my first thought was that there must be some fault within the DC-coupled vertical section, which consists of a Miller integrator with a transistor switch (Q403) which drives a compound emitter follower (Q421, Q422) which, in turn, drive the output pair already mentioned.

At this point the oscilloscope was brought into service to check waveforms. This confirmed my suspicions, as the output waveforms were nothing like those on the circuit. Feeling that there must be a DC fault in the vertical chain I began checking the transistors one by one. This proved inconclusive; they all checked out OK but I recalled recent comments in the Serviceman's notes about transistors checking OK, but still being faulty.

So I decided to replace them one at a time. Eventually, with all the small signal transistors replaced with no effect, I replaced the output pair. This involved additional time as I had no similar tran-

sistors, and had to improvise with a pair of 2N3055s which had been checked for high voltage. Another blank.

After yet another cup of coffee for deliberation (I sometimes wonder what the nervous state of electronics technicians would be, if deprived of that oft-needed period of inspiration), I felt that there must be some loading of the output stage. I therefore disconnected the link between the output stage and the yoke/convergence circuits, but this produced the same low voltage and incorrect waveforms at the output stage.

At this point it occurred to me that some component in the vertical output stage was still faulty so I mocked up the output circuit on the output transistors themselves, leaving the original components on the board — still no help. By this stage I had spent a whole day on the set, and decided to go home and meditate on my findings.

This produced a thought concerning AC and DC feedback loops from the end of the deflection loops and convergence yokes. Anyway, next morning, armed with a determination that the fault was not going to beat me, I connected the output stage back to the yoke circuits and investigated voltages and waveforms around the feedback circuits — these latter being rather odd configurations.

However, even when the feedback was disabled (wiper of vertical size trimpot VR441 to chassis) the situation did not vary much. By this time I was grasping at straws; a DC and AC-coupled cir-

COLOUR TV CHANGE OVER MODULES

THORN 4KA		
P/supply, Scan excluding tripler	\$57	
Vertical	\$33	
Chroma	\$39	
Signals Complete	\$63	
THORN 3500		
Convergence	\$53	
Vert-Audio	\$33	
Horizontal	\$57	
Power Supply	\$42	
Video	\$33	
Chroma	\$45	
HMV — EMI C211		
Power Supply	\$38	
Horizontal	\$45	
Vertical	\$22	
HMV — EMI C221		
Power Supply	\$32	
Horizontal	\$42	
Vertical	\$24	
PYE T29-T30-34		
Signals	\$53	
Scan	\$53	
Varicap Tuner ENV77405	\$48	
PHILIPS K9-K11-K12-K2		
Power Supply	\$53	
U190 Power supply	\$18	
U240 Sound	\$15	
U260 CHR-LUM	\$10	
U270 Ref Comb	\$15	
U280 Demod	\$12	
U330 Line	\$18	
U335 Frame	\$18	
K12 Sync	\$24	
K12 I.F.	\$20	
K12 Matrix	\$27	
KREISLER 59-1-2-3		
Power Supply	\$53	
Power Supply control	\$18	
Chroma Demod	\$27	
Frame	\$30	
Line	\$30	
Ref Comb	\$27	
CHR Lum	\$27	
Remote	\$30	
RANK 2201-2601		
Deflection Boards	\$48	
PWC 296	\$21	
PWC 411	\$22	
PWC 367	\$15	
LUXOR		
Power Supplies	\$30	
SHARP		
Horizontal	\$24	
Vertical	\$12	
Chroma I	\$23	
Chroma II	\$24	
<i>Other modules available for most makes and models. Complete changeover chassis for Sharp, Luxor, Blaupunkt and others.</i>		
PARTS ON SPECIAL		
Thorn Thick Films		
TF 302	\$7 TF 401	\$9
TF 303	\$6 TF 402	\$9
TF 501	\$8 TF 502	\$8
LARGE RANGE OF TV SPARES IN STOCK — NEW AND SECOND-HAND		
Phone for availability:		
TRADE TELEVISION AND VIDEO SERVICES		
159 Queens Parade, Clifton Hill, 3068. Ph: (03) 489 1168		

cuit with feedback around the lot makes stage-by-stage fault finding very difficult.

At this stage I decided to check the yoke and pincushion transformers for shorted turns, feeling that if there were shorted turns this would load the output stage — even though it seemed that I had proved that these circuits were not loading the output stage, there was the possibility of feedback masking the test in some way.

Unfortunately, after more time spent removing and checking these with a shorted turns tester, they proved to be OK. (Incidentally, I regard a shorted turns tester as invaluable. It has saved me the time and expense of buying replacements unnecessarily on several occasions. My own unit was built from the July 1972 EA circuit.)

By now I had reached something of an impasse. So far I had followed the theory that the output stage was being loaded, even though previous tests seemed to disprove this. In desperation I decided to press on by testing every passive component in the yoke and convergence circuits.

Well, to cut another long story short, some time was spent checking each one until I came to C451, a 330 μ F bipolar electrolytic forming part of an RC network across a winding (pins 1 & 2) of the side pincushion transformer, T402. Imagine my feeling of relief, mixed with frustration, when I found it neither opened or shorted, but dried out to a value of about 5 μ F.

THE CURE — AT LAST!

Gingerly I strapped a pair of 500 μ Fs back to back to replace it and with bated breath switched on — to be greeted with a perfect picture! How? Why? Frankly, I don't really know, particularly as I cannot see exactly what its function is in the circuit. The best theory I can come up with is that it provides waveform correction and, without this correction, the circuit is upset.

But why it had such a marked effect, and why it upset waveforms when both the feedback injection, and connection between the output stage and the yoke circuits were broken, is anybody's guess. I guess I'll leave that to the academics to discuss and postulate over.

Well, I'm afraid I must pass on that one also G.W., but the story does emphasise that modern sets are so complex that it is often impossible to grasp the working details, or follow the design engineer's reasoning. And, as I've demonstrated in these notes previously, even the agents' service departments are often at a loss to follow some circuits in detail.

Which means that G.W.'s approach is often the only one.

OK, that takes care of Western Australia and South Australia, so now we have something from one of my regular contributors, J.L. of Tasmania. He starts his story with the question; how many symptoms can a single fault cause?

The set concerned was a Rank Arena model 2230, and I was called in when the owner became fed up with an intermittent darkening of the picture. It had gone on for six months and she could stand it no longer.

When I switched the set on the picture came up bright enough, but badly out of focus. I was lucky in that the fault elected to show itself within a few minutes and I noted that the focus improved slightly as the picture went darker, though it remained poor.

I adjusted the focus control and found that a pin sharp picture could be obtained with the control near its centre position. When the brightness later returned to normal, the owner expressed surprise at the clarity of the picture. Apparently the set had been out of focus all its life, and no one had ever noticed!

Apart from the brightness variations, I had noticed another fault; rather severe side pincushion distortion, that was marginally worse when the picture was dark. The SPC control worked, but only over a limited range, and nowhere near enough to correct the distortion.

My first point of attack was the SPC transistor, TR415. With the set operating "normally", the collector voltage was about 56V, some 10V lower than that shown on the circuit diagram, with the base and emitter around the 2V mark. But under fault condition, the collector dropped to 30V and the base and emitter shot up to around 12V.

The TR415 collector is fed from the 120V rail, and this rail barely changed between the normal and fault conditions, so the fault had to be related to the bias on this stage. One unusual feature of this part of the circuit is that the bias is derived, not from the collector rail, but from the 18.5V rail (19V on other Rank models), and therein lay the clue to all the troubles.

When the fault was present the 18.5V rail shot up to 26V. With a normal picture the rail dropped back to 20.1V. The Serviceman has often noted faults in Rank 19V rails, so I turned back through the various articles and found a reference, in the June 1981 issue, to the very fault I was now seeing.

In that case one of the diodes in the 19V regulator network (D555, D559 & D560) had gone O/C. In my case one was obviously intermittent. However, as

these are part of the zener stabilising chain I felt it would be wise to replace them with new diodes having the same voltage drop as the existing ones.

This revealed a rather surprising condition. Both diodes had a 1.3V drop which, together with the 18V across the zener, put 20.6V on the base of the regulator transistor and accounted for the 20.1V rail. I chose two new diodes, each of 0.5V, and fitted them. The 18.5V rail dropped back spot on, the SPC output collector went up to a normal 66V, base and emitter voltages dropped back to the figures shown on the circuit, and the side pincushion distortion disappeared.

Reference to the circuit shows that the SPC drive transistors are also fed from the 18.5V rail so that the output transistor was not only wrongly biased by a fault on the rail, but was also getting excessive drive, for the same reason. No wonder the picture was distorted.

In the various Serviceman articles referred to above, the symptoms of 19V rail trouble are given as; (1) no sound or picture, (2) brightness changes, (3) vertical overscan, (4) chroma dropout, and now (5) side pincushion distortion. Where will it all end?

A good question, J.L., but one which I wouldn't try to answer. However, the point which does seem to emerge is that, with any Rank Arena set of this vintage, the 19V rail should be checked as a matter of routine, particularly as it can suffer from quite small voltage changes and produce the most subtle faults. Anyway, I was glad my notes helped with your problem, J.L.

And finally, we shoot up to Queensland for a short, but interesting story from J.E., a professional serviceman on the Gold Coast. (There's a coincidence, but this is obviously not the J.E. from Western Australia.) Anyway, he writes;

The customer complained about his mantel radio that, "It works fine on 4GG (1200kHz) but whenever I try to tune 2MW (990kHz) it blows the mains fuse in the meter box." Intrigued, we removed the chassis and found that the original tension spring on the dial cord had apparently broken and been replaced by the customer.

Unfortunately, he had substituted a longer spring he had found "lying around the house." As 990kHz was approached it stretched and neatly shorted the active and neutral lugs on the on/off volume pot!

Fair enough, J.E., and I imagine that was good for a chuckle when you found it. At the same time, it points up the potential danger of people fiddling with things they don't understand. Anything which runs foul of mains terminals must be regarded as creating a risk to life or property, even though all ended happily in this case.

MAGRATH'S OCTOBER MONEY SAVERS SEMICONDUCTORS

See 6 pack Specials for super prices, on asterisked products.

4011B	19c	*74LS04	20c	*LM340T 5	51c
*4016B	30c	*74LS14	40c	LM340T 15	60c
4023B	19c	74LS47	72c	LM386N	60c
4028B	55c	*74LS90	42c	LM555	25c
*4066B	44c	74LS161	53c	LM741N DIP	23c
*4511B	69c	81LS95	87c	LM741 DIP	36c
4520B	74c	81LS98	88c	*74C02	20c
7406	20c	LM301A DIP	35c	74C89	11.50
7414	33c	LM308 DIP	49c	*74C107	30c
74164	48c	*LM324	42c	*UA317UC REG	11.20
74365	37c	LM339 DIP	42c	*KBPC602 6A 200V BR	11.00
*74LS00	20c	*LM340KC 12	11.20	*S6006L 6A 600V SCR	80c



Engraving made easy with "Gravilo"

NEW

Easy to hold
Easy to use

\$29.00

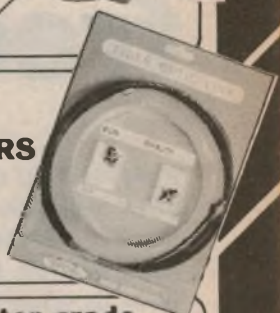

Save money with the GE Ni-Cd rechargeable system.

DOUBLE CHARGER BC 2A \$10.08

MA21 charges 2 or 4 AA cells \$1.44

MC22 charges 2 C cells \$1.44

MD23 charges 2 D cells \$1.44

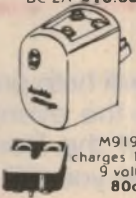
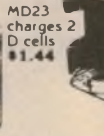

Modules snap onto charger for recharging batteries.

GE Ni-Cd batteries

2GC1 AA (pen cells) \$7.52

2GC2 C cells \$8.64

2GC3 D cells \$8.64

GC9B 9 volt \$10.08

uP SPECIALS

6821 PIA \$2.50 ea.
6800 MPU \$5.00 ea.

6802 MPU \$7.12 ea.
with clock and RAM

POWER W/W RESISTORS

Fireproof, inorganic construction
Easy to install

PW5 0.1 ohm to 4.7K ohm
24c ea.
PW10 1.0 ohm to 5.6K ohm
36c ea.

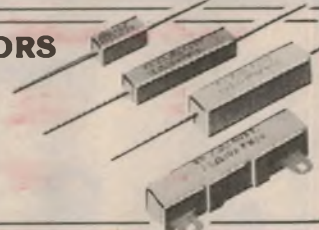

Evaluation kit AMPHENOL ZINC DIECAST OPTICAL FIBRE CONNECTORS

Can be hermetically sealed eliminating RF and EMI

Evaluation kits — one receiver, one transmitter and 2 metres of cable \$26.50.

MEMORY BARGAINS

HM6116P-3 2K x 8 CMOSRAM	\$7.50
MB2716 2K x 8 EPROM	\$3.00
MB2764 64K EPROM	\$12.00
MBB118 16K DYNAMIC RAM (Intel 2118) 120ns	\$4.00

Computer grade Electrolytics at affordable prices.

3300uF 40V	\$3.75
4700uF 40V	\$4.30
10,000uF 16V	\$3.90
10,000uF 25V	\$4.40
10,000uF 40V	\$6.60
10,000uF 63V	\$7.65
10,000uF 100V	\$13.00
22,000uF 25V	\$6.60
33,000uF 25V	\$8.40
47,000uF 16V	\$8.20
47,000uF 25V	\$10.70
100,000uF 16V	\$13.50

MAGRATH'S 6-PACK SPECIALS

6 for the price of 5

DIGITAL & LINEAR

6x4016B	\$1.50
6x4066B	\$2.40
6x4511B	\$3.45
6x74LS00	\$1.00
6x74LS04	\$1.00
6x74LS14	\$2.00
6x74LS90	\$2.10
6xLM324	\$2.10
6xLM340KC 12	\$6.00
6xLM340T-5	\$2.55
6xUA317UC Regulator	\$6.00
6xUA348PC Op Amp	\$4.25
6x74C00	\$1.00
6x74C107	\$1.50
6x74C04	\$1.00
6x74C02	\$1.00

LEDs

6xMV5053S 35c

BRIDGES

6xKBPC602 6A 200V \$5.00

SCRs

6xS6006L 6A 600V \$4.00

DIODES

IN4002 100 per pack \$4.50

IN4148 100 per pack \$3.50

TRANSISTORS

6xPN2222A 25c

CAPACITORS

	Normal Price	Special Price Per Pack of 6
STETTNER 3.12 pf CERAMIC TRIMCAPS	50c	\$2.50
ELECTROLYTICS		
2.2Mfd 25V RB s	16c	80c
10Mfd 16V RB s	16c	80c
10Mfd 25V RB s	16c	80c
25Mfd 25V RB s	17c	85c
47Mfd 16V	20c	\$1.00
47Mfd 25V RB s	22c	\$1.10
100Mfd 10V RB s	20c	\$1.00
100Mfd 25V RB s	26c	\$1.30
220Mfd 25V RB s	36c	\$1.80
POLYESTERS		
001Mfd 100V Greencaps	8c	40c
0047Mfd 100V Greencaps	8c	40c
01Mfd 100V Greencaps	14c	70c
012Mfd 100V Greencaps	14c	70c
022Mfd 100V Greencaps	14c	70c
033Mfd 100V Greencaps	14c	70c
039Mfd 100V Greencaps	14c	70c
056Mfd 100V Greencaps	14c	70c
068Mfd 100V Greencaps	14c	70c
1Mfd 100V Greencaps	14c	70c
HARDWARE		
RCA Plugs	20c	\$1.00
RCA Chassis sockets	35c	\$1.75
3.5mm Plugs mono	20c	\$1.00
3.5mm Chassis sockets	35c	\$1.75
MS102 Push to make switch	35c	\$1.75
Philips Carbon Resistors		
1/4W 50 per pack	\$1.00	
1/2W 50 per pack	\$1.00	

BULGIN MAINS CONNECTORS

For computer equipment, consumer appliances, any 240V application.



P590 \$1.00

P597 \$1.84

10A 240V AC Hot condition
Keyway prevents cross mating
SEMKO & VDE approved.

LOW COST, QUALITY VIDEO MONITOR



BM12A

- Input signals: Composite video signal Negative SYNC 1.0 P-P, 75 ohm.
- CRT size: 31 cm diagonal
- Green Phosphor — P31
- Video Amp Bandwidth 15MHz
- Display Format: 1920 characters max. (80 char. X 24 lines)

\$153.45

SUPER VALUE

Amphenol BNC Panel Jacks for RF applications

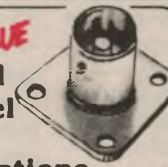

Panel Jack \$1.25
Cable Jack \$3.00

CONNECTOR SPECIAL

Flat Cable 50 way, standard disc drive interface connector 225F-A50-3 \$4.50



ELECTRICAL INTERFERENCE UPSETTING YOUR CIRCUITS?



The Bulgin mains filter protects personal micro's and any other TTL, CMOS or memory circuits.

- Incorporates 3 pin mains inlet connector
 - Fully screened
 - Conforms to British & European specifications
- 3 Amp & 6 Amp \$14.00
10 Amp \$17.00

MAGRATH'S EXCLUSIVE

Ask about other 6-Pack Specials
There's lots more

J.H. MAGRATH
208 Little Lonadale Street,
Melbourne, Vic., 3000.
Telephone: (03) 663 3731

Add Sales Tax if applicable
Prices valid until stock sold
Prices subject to alteration

Don't let frozen food go to waste!

Build this simple freezer alarm

Inexpensive and easy to build, this freezer alarm will help prevent your valuable frozen goods from being ruined in the event of a freezer failure. A buzzer warns you the moment the freezer's temperature becomes higher than normal — while you still have time to save the goods.

By COLIN DAWSON

By allowing maximum advantage to be taken of "specials" and bulk purchasing, freezers are now a popular method of cushioning the spiralling cost of small goods. However, any cost advantage gained in this way can be immediately lost in the event of a freezer failure. Tens or even hundreds of dollars worth of small goods can be ruined as a result of a blown fuse or carelessly leaving the freezer door ajar.

This simple circuit is designed to guard against that possibility. It can be built for an outlay of around \$20, uses readily available components, and is battery operated so that it will still work in the event of mains failure. Battery life, in normal circumstances, is around six months.

Of course, it's not only in domestic situations that our Freezer Alarm could save frozen foodstuffs. Owners of small corner stores usually have hundreds of dollars worth of stock stored in freezers, so any device that will effectively indicate a freezer failure has to be a worthwhile business investment. It could save both your ice cream and your customers!

Most of the circuit is housed in a plastic utility zippy box which can simply sit on or near the freezer to be monitored. A small probe mounts inside the freezer and is connected to the rest of the circuit by two wires. A test switch, situated on the front panel, checks the battery condition and verifies correct circuit operation.

Long battery life has been achieved by operating the circuit on a 1:10 duty cycle. In other words, the circuit is active for one second and then passive for 10 seconds. Current drain is $50\mu\text{A}$ in the passive state and $400\mu\text{A}$ during the active monitoring state, resulting in an average current drain of around $80\mu\text{A}$.

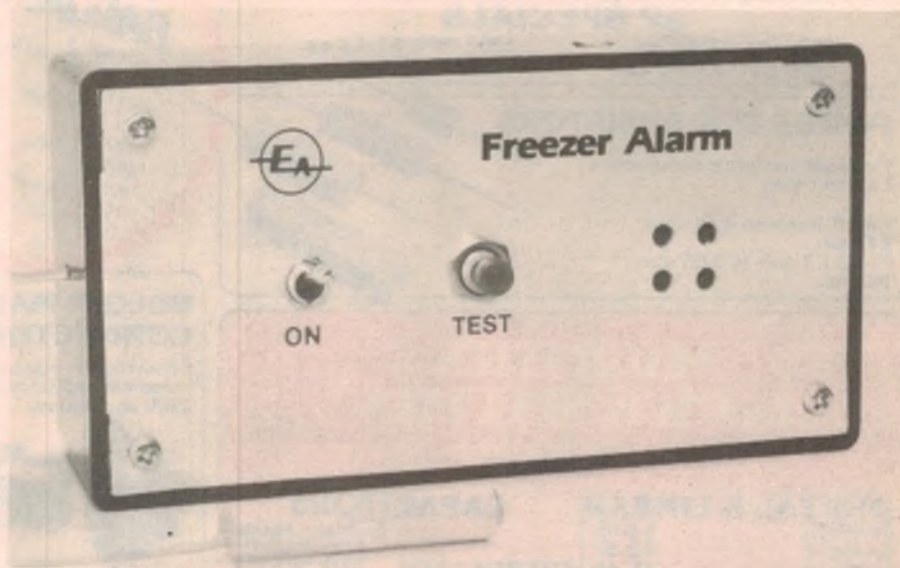

The complete Freezer Alarm is housed in a small plastic box, and the panel we have prepared gives it a professional appearance. The sensing probe, which is normally in the freezer, is shown in front of the box.

This increases to around 5mA (peak) when the alarm is triggered, due to the current drawn by the buzzer.

The one second on, 10 seconds off duty cycle is a compromise between reduced power consumption and the effectiveness of the alarm. When triggered, the buzzer will sound for one second every 10 seconds. This should prove satisfactory for most situations, although some readers may decide to increase the off period to reduce power consumption even further. The one second on period, however, can probably be regarded as a minimum.

Circuit diagram

The circuit diagram is straightforward and consists of a 7555 timer (IC1), a comparator (IC2), and a transistor driving

a buzzer. IC1 is a CMOS version of the familiar 555 timer IC, and is wired here as an astable multivibrator to provide the 1:10 duty cycle. This 1:10 duty cycle is set by the $1\text{M}\Omega$ and $100\text{k}\Omega$ timing resistors and the $10\mu\text{F}$ electrolytic capacitor.

Here's how the 7555 works: Initially, the $10\mu\text{F}$ capacitor is charged to $\frac{1}{3}$ supply voltage (ie $\frac{1}{3}V_{\text{CC}}$) and the pin 3 output of IC1 is high. The $10\mu\text{F}$ capacitor now charges via the $1\text{M}\Omega$ and $100\text{k}\Omega$ timing resistors and, when it reaches $\frac{1}{3}V_{\text{CC}}$ 10 seconds later, the output at pin 3 goes low. The $10\mu\text{F}$ capacitor then discharges via the $100\text{k}\Omega$ resistor and pin 7 and, when its voltage falls to $\frac{1}{3}V_{\text{CC}}$ after about one second, the pin 3 output goes high again and the timing cycle is repeated.

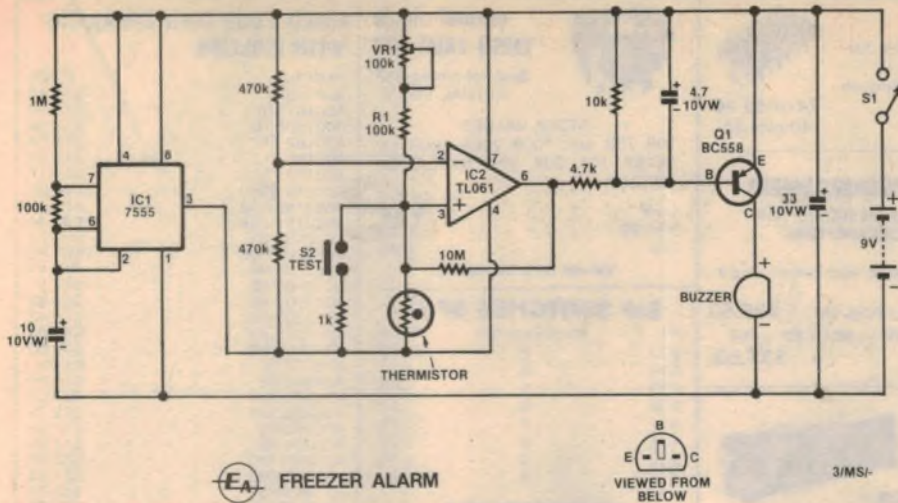

EA FREEZER ALARM

B
E — B — C
VIEWED FROM
BELOW

3/MSI-

The circuit is a relatively simple one and its operation should be easy to follow from the text. The basic sensing mechanism is associated with IC2, IC1 being used to give the 1:10 duty cycle and extended battery life.

As can be seen, the common rail for the comparator circuit (IC2) is connected to pin 3 of the 7555, rather than direct to the negative supply rail. This means that the comparator circuit is activated only when pin 3 of the 7555 goes low for one second at the end of each 10 second timing interval.

Hence we have the 1:10 duty cycle referred to above. When the output of the 7555 is high, the comparator circuit is off and the only current drawn from the battery will be that drawn by the 7555 itself. That is why we have used a 7555 in place of the familiar 555 — because it is a CMOS device, its current consumption is far lower.

Comparator IC2 consists of a TL061 Fet-input op amp which is used to compare the sensor voltage (from the probe) with a reference voltage. In this circuit, the non-inverting input is used as the sense input, and the inverting input biased to $\frac{1}{2}V_{cc}$ by two 470k resistors. Since both resistors have the same temperature coefficient, the output from this voltage divider will be virtually independent of ambient temperature.

A second voltage divider consisting of the 100k resistor and a negative temperature coefficient (NTC) resistor biases the sense input (pin 3) of IC2. As the temperature rises, the resistance of the thermistor decreases, and thus the voltage on the sense input also decreases — ie the voltage across the thermistor is inversely proportional to temperature. By comparing the two voltages on the inputs to the comparator, it is possible to determine when the temperature of the probe exceeds a certain value, as preset by trimpot VR1.

Normally, the voltage on pin 3 is higher than the reference voltage on pin 2, so the output of IC2 is high and PNP transistor Q1 is held off. However, when

the critical temperature is exceeded, the voltage on pin 3 drops below that on pin 2 and the output of the comparator swings low. Transistor Q1 now turns on and drives a piezo-electric buzzer connected between the collector and the negative supply rail.

Positive feedback for comparator IC2 is via a 10M resistor connected between pins 6 and 3. This gives the comparator a degree of hysteresis and is necessary to ensure reliable triggering at the critical temperature. Note that the output of IC2 goes high whenever the pin 3 output of the 7555 is high, so Q1 is held off during the 10s passive period. The only time pin 6 of IC2 can go low is during the 1s active period, and then only if an over-temperature condition is detected.

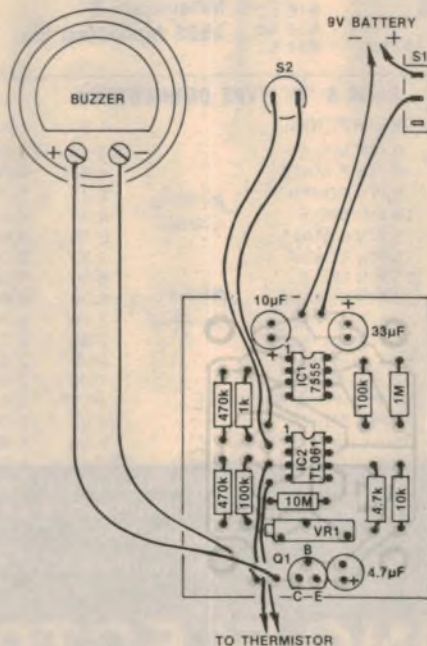

Above is the component layout on the printed board while at right is the board pattern shown actual size.

The 4.7k resistor on the output of IC2 limits the transistor base current to a safe value while a 10k pull-up resistor further ensures that the transistor is normally biased off. However, because the output IC2 does not swing fully to the supply rails, a click is produced by the buzzer each time the TL061 is activated by the 7555 unless further precautions are taken. The 4.7µF capacitor between the base of Q1 and the positive supply rail filters out these clicks, so that the buzzer remains silent until triggered.

Multi-turn trimpot VR1 allows the voltage on pin 3 of the comparator to be adjusted independently of temperature effects, so that the freezer alarm can be set to trigger at the required temperature. In addition, pushbutton switch S2 has been included to provide a battery check and test function. This switch and a series 1k resistor are wired across the thermistor and, when S2 is depressed, a temperature high is simulated.

Power for the circuit is derived from a small 9V battery (Eveready type 216, or similar). A 33µF 10VW electrolytic capacitor is added to give a low supply output impedance.

Construction

The first area of construction to be dealt with is the actual freezer probe. For this, you will require a 40mm length of plastic tubing with an inside diameter of approximately 5mm. This is used to house the thermistor; we found the body of a cheap ball point pen ideal for the purpose.

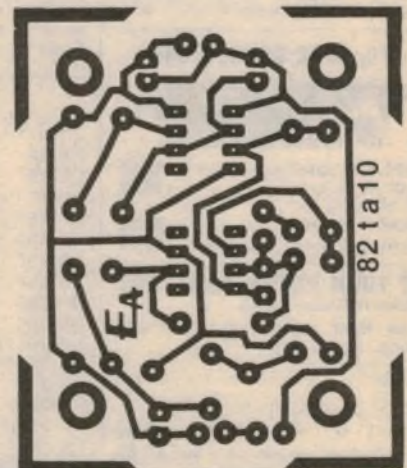

We estimate that the current cost of components for this project is approximately

\$21

This includes sales tax but does not include the 9V battery.

CLAMP METER

MODEL YF-700

Top of the range model AC Voltage 150V 300V 600V AC Current 6A 15A 60A 150A 300A Resistance 5kΩ (Midscale 200Ω)

was \$49.99

NOW ONLY

\$43.55

DISCOUNT

DISC DRIVES COMPUTERS

PRINTERS	
ITOH 1500 PARALLEL (DAISYWHEEL)	\$1515 + TAX
ITOH 1500 SERIAL (DAISYWHEEL)	\$1555 + TAX
ITOH 8510 PARALLEL	\$910 + TAX
ITOH 8510 SERIAL (GRAPHIC ETC)	\$1015 + TAX

RITRON COMPUTER GRADE P/S
+5V reg 10a 16V unreg (r 1A
KIT \$79.95 inc
Built and tested \$99.50

ETI636 MOTHERBOARD
7 Slot Motherboard \$90.00
Built and Tested \$120.00
ACTIVELY TERMINATED

INTERSIL LCD \$35.50 3 1/2 DIGIT PANEL METER KITS

Build a working DPM in 1/2-hour with these complete evaluation kits. Test these new parts for yourself with Intersil's low cost prototyping kits complete with A/D converter and LCD display (for the 7106) or LED display (for the 7107). Kits provide all materials including PC board, for a functioning panel meter ICL7106EV (LCD)

P.C. EDGE CONNECTORS



S100 gold plated wire wrap	\$8.50
S100 solder tail	\$6.90
D2 Motorola bus	
43 86 solder tail	\$8.50
43 86 gold plated wire wrap	\$11.50

10 TURN POTENTIOMETERS

Stock resistance values
50R 100R 200R
500R 1K 2K 5K
10K 20K 50K
100k
Spectral model 534 + shaft
Price 1 9 \$9.90
10 + values may be mixed \$9.50

DIP PLUGS

Ideal for use with flat ribbon cable or to mount components on
14 pin \$1.50 24 pin \$2.90
16 pin \$1.90 40 pins \$5



POWER TRANSFORMERS

SPECIALLY DESIGNED FOR MICROCOMPUTERS

- Good regulation electrostatic shield
- RI 810 8V @ 10A x 15V @ 1A \$28.50
- RI R20 8V (r 20A 15V (r 1A 15V (r 3A \$37.50

20 TURN CERMET TRIM POT



SPECTROL 43P ACTUAL SIZE

STOCK RESISTANCE VALUES
10R 20R 50R 100R 200R 500R 1K 2K 5K 10K 20K 50K 100K 200K 500K 1M 2M
1-9 \$1.50
10-99 \$1.40
100 \$1.10
Values may be mixed

Hexadecimal Keypad \$29.50



19 key pad includes 1-10 keys ABCDEF and 2 optional keys and a shift key
Ideal for dream project

MULTIDIALS



Dials to suit 10 T Pots
Model 21 1 8" dia \$16.50
Model 16 9" dia \$12.50
Model 18 1" x 1 75" dia \$21.50

RS232 & "D" TYPE CONNECTORS

PART NO	DESCRIPTION	1-9	10-25	25+
DE 9P	9 PIN MALE	\$3.50	\$3.50	\$3.10
DE 9S	9 PIN F MALE	4.50	4.20	3.90
DE 9C	9 PIN COVER	2.20	2.10	1.90
DA 15P	15 PIN MALE	4.50	4.20	3.90
DA 15S	15 PIN F MALE	5.10	4.90	4.70
DA 15C	15 PIN COVER	2.30	2.10	2.00
DB 25P	25 PIN MALE	5.90	5.60	5.10
DB 25S	25 PIN F MALE	6.90	6.60	6.10
DB 25C	1 pc Grey Hood	2.40	2.20	2.00
DB 25C2B	2 pc Black Hood	2.80	2.70	2.50
DB 25C2G	2 pc Grey Hood	2.70	2.50	2.40
DC 37P	37 PIN MALE	7.90	7.50	7.10
DC 37S	37 PIN F MALE	10.90	9.90	9.10
DC 37C	37 PIN COVER	4.90	4.50	4.10
DH S	Hardware set (2 Pairs)	2.10	1.90	1.80



cermet single TURN TRIM POT

Spectral model 63P ACTUAL SIZE

STOCK VALUES
10R 20R 50R 100R 200R 500R 1K 2K 5K 10K 20K 50K 200K 500K 1M 2M
1-9 \$1.00
10-99 0.90
100 0.80
Values may be mixed

DIP SWITCHES SPST

P N	No of Switches	Price
SD3	3	\$1.60
SD4	4	1.70
SD5	5	1.90
SD6	6	2.30
SD7	7	2.40
SD8	8	2.50
SD9	9	2.70
SD10	10	3.00

DIP SWITCHES SPST

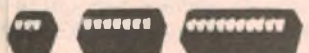

TEXT TOOL

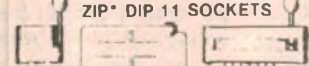

16 Pin Zip* Dip 11 \$11.50
24 Pin Zip* Dip 11 12.50
40 Pin Zip* Dip 11 17.50
Zero Insertion Pressure

INCREDIBLE MEMORY AND DISC DRIVE PRICES

2708	1.9	10.25	25+
2716	4.90	4.00	3.90
2732	4.90	4.20	3.90
4116 (200ns)	8.00	7.50	7.00
4164 64K Dynamic	1.95	1.80	1.75
MS8725P (2K x 8)	11.00	10.00	9.50
Static	10.00	9.00	8.50

(As used in new 64K Static S100 PCB)
ALL PRICES INCLUDE SALES TAX

DISK DRIVES

MPI 51 \$275.00 + 17.5% ST
MPI 52 \$385.00 + 17.5% ST
MPI 91 \$415.00 + 17.5% ST
MPI 92 \$515.00 + 17.5% ST

Mitsubishi 8"
\$625 including tax.

BUILD YOUR OWN SPEAKERS WITH PHILLIPS

PART No	PRICE
AD0140T8	\$11.86
AD01610T8	\$16.95
AD01605-TB	\$16.54
AD0162-T15	\$18.78
AD0162-T15	\$13.03
AD0162-TB	\$13.77
AD0210-SQ8	\$42.00
AD02160-SQ8	\$45.00
AD02161-SQ8	\$33.46
AD10100-W8	\$52.72
AD12100-HP8	\$85.10
AD12100-M15	\$79.11
AD12100-M8	\$79.11
AD12100-W8	\$53.99
AD12200-W8	\$73.12
AD12250-W8	\$83.00
AD12650-W8	\$59.00
AD2273-T8	\$5.03
AD4060-W8	\$19.06
AD5060-SQ4	\$22.05
AD5060-SQ8	\$22.05
AD5080-W8	\$17.59
AD5061-M8	\$17.08
AD70601-W8	\$22.00
AD70620-M8	\$21.54
AD7063-M8	\$20.78
AD70630-M8	\$20.78
AD70650-W8	\$26.96
AD7066-W8	\$26.96
AD80601-W8	\$20.24
AD8061-W8	\$20.24
AD80652-W8	\$26.20
AD8066-W4	\$27.66
AD8081-M8	\$9.81
AD97110-M8	\$41.11
ADF1600-8	\$19.44
ADF500-4500-8	\$19.44

DIODES

	10-99	100+
IN4001	6c	5c
IN4002	6c	5c
IN4004	7c	6c
IN4148	5c	4c
IN5404	30c	25c
IN5408	35c	30c
IN4007	12c	11c

HEATSINKS

High Thermal Capacity Black Anodised

	1-4	5-9	10-49	50-99	100-500
	\$	\$	\$	\$	499 per \$
HS1 - 38mm	1.85	1.75	1.50	1.35	1.00 0.90
HS2 - 75mm	3.00	2.90	2.50	2.00	2.00 1.50
HS3 - 150mm	5.80	5.40	4.90	3.80	2.90 2.70
HS4 - 225mm	8.10	7.60	7.10	5.90	4.50 4.30
HS5 - 300mm	8.90	8.40	7.90	6.50	4.90 4.60

Unanodised

HS11 - 38mm	1.40	1.20	1.00	0.90	0.80 0.70
HS12 - 75mm	2.50	2.20	1.90	1.60	1.25 1.20
HS13 - 150mm	4.90	4.50	4.00	3.20	2.45 2.40

BLANK CASSETTES T.D.K.

TDK ADC60	1 for \$3.60	10 for \$26.00
TDK DC60	1 for \$2.10	10 for \$18.00
TDK ODC60	1 for \$3.50	10 for \$31.00
TDK SAC60	1 for \$3.50	10 for \$31.00
TDK SAXC60	1 for \$5.70	10 for \$46.00
TDK DC90	1 for \$2.40	10 for \$21.00
TDK ADC 90	1 for \$3.50	10 for \$30.00
TDK SAC 90	1 for \$4.20	10 for \$39.00
TDK ODC90	1 for \$4.70	10 for \$45.00
TDK SAXC90	1 for \$5.50	10 for \$49.00
TDK DC120	1 for \$4.50	10 for \$37.00
TDK ADC120	1 for \$5.40	10 for \$46.50

Please debit my Bankcard.
Bankcard No.
Expiry Date
Name
Signature

Post & Pack \$2.50 small kits, heavier kits add extra postage.
Prices subject to change without notice. Send 60c and SAE for free price list and inclusion on all future mailing lists.

MAIL ORDERS: PO Box 235, Northcote, Vic 3070. Min P & P \$1.00.
Ph: (03) 489 8131.

ROD IRVING ELECTRONICS

425 HIGH STREET, NORTHCOTE 3070, MELBOURNE, VICTORIA. Ph (03) 489 8131. Telex No. 38897

The length of 40mm is by no means critical, but there is probably no point in making it any smaller. Solder two wires to the thermistor leads and slide the assembly into the tube. The length of the wires will depend on how far the alarm is to be located from the freezer. We used about 1.5m and this should prove sufficient in most cases.

The thermistor used in the prototype was obtained from Dick Smith Electronics (Catalogue No. R-1792). Its specifications include a resistance of 47kΩ at 25°C and a working range from -25°C to +125°C, which make it ideal for this application. While it should be possible to use other thermistors with similar specifications, it may be necessary to change the value of the 100kΩ series resistor to obtain correct operation over the required temperature range.

The thermistor also warrants some comment. It needs to be as small as possible so as to interfere with the door seal as little as possible, and also moderately flexible to withstand normal movement. We used two wires peeled off together from a length of rainbow cable, but this may be a trifle wasteful for the home constructor. Very light duty figure-8 cable is probably the next best choice, or you may use just enough rainbow cable to reach the outside of the freezer, and then join this neatly to a length of figure-8 cable.

The temperature probe will need to be a waterproof assembly, as any moisture will cause erroneous alarms. Also, the thermistor should be just protruding from one end of the tube to ensure good thermal contact (this will prove an advantage in the calibration procedure). To seal the tube, pot both ends of the

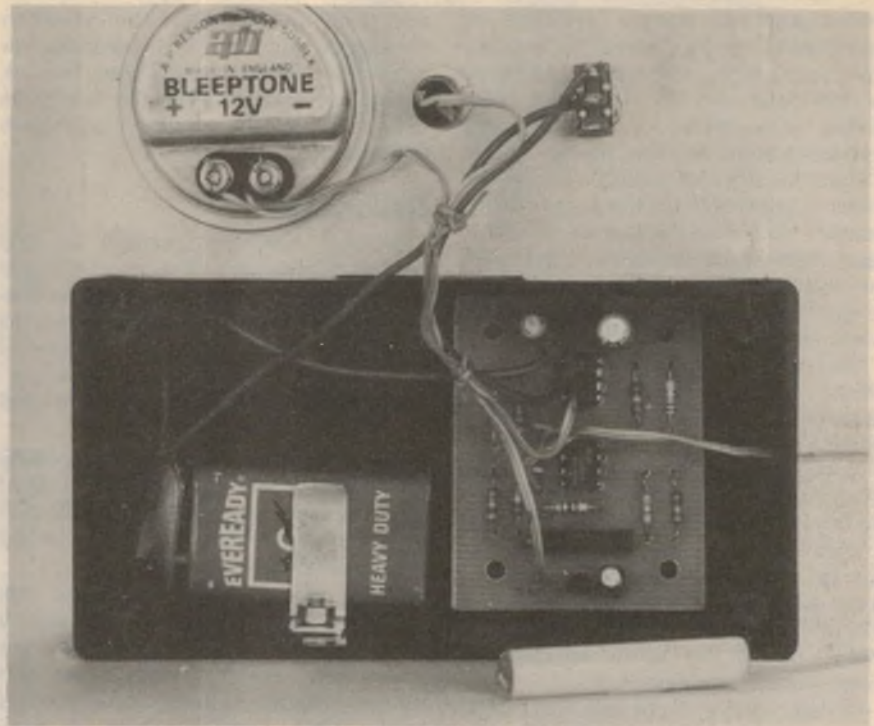

This picture gives a good idea of how the various sections fit together in the plastic box. Note that the battery should be mounted so that it does not foul the piezo-electric buzzer.

tube with an epoxy or silicone adhesive. This done, put the probe aside and turn to the printed circuit board (PCB).

The PCB is coded 82ta10 and measures 59 x 48mm. Before embarking on its assembly, note that the 7555 timer IC is not fitted until after the calibration procedure has been completed. Instead, a wire link must be temporarily fitted between the holes intended for pins 1 and 3. This allows IC2 to operate continuously and makes calibration much

easier to carry out.

Begin assembly of the PCB by fitting the resistors, followed by the TL061 op amp, the transistor and the multi-turn trimpot. Finally, mount the three electrolytic capacitors. Note that the semiconductors and capacitors are all polarised, so make sure that you fit them the right way round.

For those situations where the freezer alarm will meet the critical eye of house guests, we have prepared a Scotchcal

MASTER ELECTRONICS NOW! The PRACTICAL way!

This new style course will enable anyone to have a real understanding of electronics by a modern, practical and visual method. No previous knowledge is required, no maths, and an absolute minimum of theory.

You learn the practical, way in easy steps mastering all the essentials of your hobby or to start or further a career in electronics or as a self-employed servicing engineer.

All the training can be carried out in the comfort of your own home and at your own pace. A tutor is available to whom you can write personally at any time, for advice or help during your work. A Certificate is given at the end of every course.

You will do the following:

- Build a modern oscilloscope
- Recognise and handle current electronic components
- Read, draw and understand circuit diagrams
- Carry out 40 experiments on basic electronic circuits used in modern equipment
- Build and use digital electronic circuits and current solid state chips
- Learn how to test and service every type of electronic device used in industry and commerce today. Servicing of radio, TV, Hi-Fi and microprocessor/computer equipment.

New Job? New Career? New Hobby? Get into **Electronics** Now!

Post coupon now:

The Australian School of
Electronics Pty. Ltd.,
(Inc. in Victoria)
PO Box 108, Glen Iris,
Victoria, 3146
A Registered
Correspondence College



FREE
COLOUR BROCHURE

Please send your brochure without any obligation to:

Name _____

Address _____

Post Code _____

EA 10 82

Simple freezer alarm

front panel to greatly enhance its appearance. If you intend to use the front panel, it should be affixed to the lid of the case and the following holes drilled: 4 x 4mm for the mounting screws; 6.5mm for the power switch; 7.5mm for the test switch; and several holes as applicable for the piezo-electric buzzer. Note that the buzzer is held in place with epoxy adhesive – the holes are simply to allow the sound to escape. In fact, the buzzer can be glued in place when all the holes are drilled.

Attention can now be turned to the plastic utility (zippy) box. All that is required is to drill a hole at one end of the box for the sensor wires and to install a battery clip. The size of the hole required for the sensor wires will depend on the wires you have used – we found 2.5mm large enough. The battery clip can be manufactured from a piece of scrap aluminium of approximately 10 x 35mm. Before mounting the battery clip, make sure that the battery will clear the piezo-electric transducer.

All that remains of construction for the moment is to complete the wiring. This includes wiring to the sensor probe, the piezo-electric buzzer, the power switch, the battery and the test switch. The PCB can now be clipped into the integral supports in the case or, if you prefer, installed using machine screws and nuts.

To test the unit, set the multi-turn trimpot fully clockwise (keep turning the adjusting screw until you hear the clicks) and temporarily short out the fixed 100k Ω (R1) resistor with a wire link. Now switch the freezer alarm on. The buzzer should immediately emit a continuous alarm tone and you should be able to cancel this by adjusting the trimpot anti-clockwise.

Correct circuit operation can now be verified by pushing the test button or by heating the sensor slightly. In both cases, the alarm should re-trigger. The circuit is

now ready for calibration, but first switch the unit off and remove the shorting link across the 100k Ω resistor. (Note: The link is only necessary to allow the unit to be tested with the probe at room temperature.)

Calibration

Freezers normally operate in the temperature range -15°C to -18°C and the freezer alarm should be calibrated to trigger at about 5°C above this. Prior to calibration, the probe should be placed in the freezer for several hours or, preferably, overnight. The alarm should be switched off during this period.

Note that the probe should be placed somewhere near the bottom (or back) of the freezer so that it will be unaffected by temperature fluctuations due to the freezer door being opened.

When the probe temperature has stabilised, switch the unit on and slowly turn the trimpot clockwise until the alarm just sounds. Finally, turn the trimpot $2\frac{1}{2}$ to 3 turns anti-clockwise again. Your Freezer Alarm is now calibrated to trigger at approximately 5°C above the normal temperature of the freezer (one complete turn of the trimpot is equivalent to a temperature change of around 2°C).

We should point out here that freezers in domestic refrigerators usually operate at higher temperatures than stand-alone freezers, a typical figure being -5°C . In this case, the Freezer Alarm should be calibrated to trigger at around 0°C . You can do this by immersing the probe in an ice-water mixture and then suitably adjusting the trimpot so that the unit just triggers.

With calibration completed, remove the wire link from the printed circuit board and install the 7555. This is a CMOS device, so the usual precautions should be taken: earth the barrel of your

PARTS LIST

- 1 printed circuit board, code 82ta10, 59 x 48mm
- 1 plastic utility case, 40 x 68 x 130mm
- 1 Scotchcal front panel, 125 x 63mm
- 1 SPST miniature toggle switch
- 1 SPST momentary contact pushbutton switch
- 1 9V piezo-electric buzzer
- 1 9V battery and clip
- 1 ballpoint pen tube, or similar (see text)

SEMICONDUCTORS

- 1 7555 CMOS timer
- 1 TL061 Fet-input op amp
- 1 BC558 PNP transistor

CAPACITORS

- 1 33 $\mu\text{F}/10\text{VW}$ PC mounting electrolytic
- 1 10 $\mu\text{F}/10\text{VW}$ PC mounting electrolytic
- 1 4.7 $\mu\text{F}/10\text{VW}$ PC mounting electrolytic

RESISTORS (5%, $\frac{1}{4}\text{W}$)

- 1 x 10M Ω , 1 x 1M Ω , 2 x 470k Ω , 2 x 100k Ω , 1 x 10k Ω , 1 x 4.7k Ω , 1 x 1k Ω , 1 x 100k Ω multi-turn trimpot, 1 x 47k Ω NTC thermistor (see text)

MISCELLANEOUS

- Hook-up wire, rainbow cable, machine screws and nuts, scrap aluminium for battery clamp, epoxy adhesive, solder, etc.

soldering iron to the negative supply rail on the PCB (use a small clip lead), and solder the supply pins (1 and 8) first.

As a final check, switch the unit on and press the test switch. There should be 10 seconds of silence and then the alarm should sound for one second. If this is the case, your Freezer Alarm is ready for service but don't forget to check the battery condition at regular intervals.

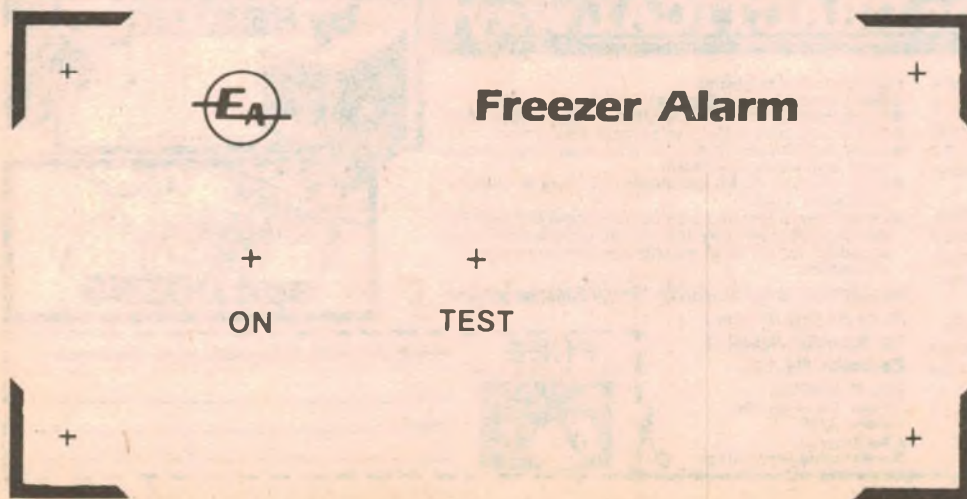

The front panel, shown actual size. These should be available from various component retailers when this article appears.

**NEW STORE
opening October
in Carlingford**

AT "NEVILLES'S CORNER" CNR CARLINGFORD & PENNANT HILLS RD. NEXT TO KENTUCKY FRIED CHICKEN

AUDIO KITS - -JAYCAR IS No1 sub woofer sensation

Ref: Electronics Australia June-August 1982

THE SUB- WOOFER MODEL SW 250



Recall Notice
Some subwoofers sold in August did not conform to our published specs. The free air resonance may be over 32Hz. If your unit was supplied before the 1st of September and DOES NOT have a silver label on the back magnet please return it to us for free replacement.

ONLY \$79.50

This unit has been extremely popular with audio enthusiasts right across Australia! EA have designed a special crossover/booster amp just for this unit. Now you have no excuse to build a subwoofer system to enjoy those thrilling low notes from pipe organs, synthesizers, 1812 cannons etc!!

SPECS:
Diameter 10" (250mm) Cast Frame. QT=0.39. VAS=631
Power Handling = 100WRMS.
Free-air Resonance 32Hz ±1Hz
Voice Coil = 2" (51mm). Dia.
Magnet Assy = 3kg (6.6lbs).
A FREE SUB-WOOFER CABINET DESIGN IS PROVIDED WITH EACH UNIT!!

THE ENCLOSURE

ONLY \$79.50

This compact 63 litre vented enclosure was specifically designed around the parameters of the SW250 Sub-Woofers. It follows the theory pioneered by the work of Thiele, Small and Snyder. The Jaycar enclosure is easy to build and is made of high quality durable materials. The heavy walled cabinet is covered with an attractive black vinyl veneer. All timber is pre-cut and the black grille is already made. Assembly takes less than one hour.
NB. The photo shows the prototype which was finished in white. The production units are only available in black. Freight anywhere in Australia only \$10.00.

AMPLIFIER/FILTER UNIT

AMPLIFIER/FILTER UNIT.
Amplifier Module \$79
Transformer to \$39.50

ONLY \$79



Metal case specially made to suit including front panel, hardware etc (not a twin 25 case). Only \$29.50 \$148.00
Buy the lot for only \$125.00 if you purchase the enclosure and woofer at the same time.

REF. EA JULY 1982

State-of-the-art power Mosfet technology combined with an active low pass filter results in a sub-woofer amp without equal anywhere!!

FEATURES: Around 100WRMS Drive capability.
Low pass (sub-woofer) filters on board.
Can hook-up to pre-amp out or power-amp out.
Power supply on board.

(Transformer needed. ONLY \$39.50)

- EA KITS**
- Li Gong - Electronic Doorbell Ref: EA3/81 \$14.95
 - PC Birds - Duelling Canary Sound Ref: EA5/81 \$14.50
 - Cutlisp Cricket - Circuit drives you crazy Ref: EA2/82 \$12.50
 - Vocal Canceller - Insert your voice onto records Ref: EA4/82 \$19.50
 - VOX Relay - Open doors with a handclap Ref: EA4/82 \$14.50
 - Metronome - Stick to the beat when learning Ref: EA2/82 \$16.95
 - Fuzzbox - Funky guitar sound Ref: EA1/81 \$19.50
 - EPROM Programmer - Cheap EPROM programming Ref: EA1/82 \$59.00
 - Guitar Booster - Play your guitar on the Hi Fi Ref: EA6/82 \$14.50
 - Onscreen Graphic Analyser - a must for the audiophile EA9/81 \$106.00
 - Cassette Deck Audio Test Unit Ref: EA10/81 \$45.00
 - Musicalau IV - Coloured lighting for your Hi Fi \$85.00
 - Photon Tornado - Alien invaders game Ref: EA9/81 \$29.50

KITS

- ETI KITS**
- 445 - General Purpose Preamp \$8.00
 - 449 - Balanced Microphone Preamp \$9.50
 - 581 - 15V @ 200mA Power Supply. Transy included \$17.50
 - 330 - Car Alarm - works well \$29.50
 - 452 - Sound Bender - Datakit \$24.50
 - 446 - Audio Limiter \$12.00
 - 479 - Bridging Adaptor ET13/82 \$9.95
 - 499 - 150W MOSFET P.A. Amplifier ET13/82 \$79.50
 - 498 - Preamp for above \$39.50
 - 480/50 - 50W Economy amplifier - quality version \$23.00
 - 480/100 - 100W Economy amplifier - quality version \$27.00
 - 158 - Low Ohms Meter ET11/81 \$20.50
 - 729 - UHF Masthead Amplifier \$35.00
 - 735 - UHF Converter \$32.50
 - 417 - 5000 Series MOSFET Module - Quality \$59.00
 - 478MC - 5000 Series Moving Coil Preamp \$29.50
 - 478MM - 5000 Series Moving Magnet Preamp \$19.50
 - 458 - 5000 Series Peak Reading Level Meter \$29.50
- JAYCAR STOCKS QUALITY KIT VERSIONS OF MOST EA, ETI & HOBBY ELECTRONICS**

- HOBBY ELECTRONICS KITS**
- HE102 - Guitar Phaser August 1981 \$26.50
 - HE103 - Transistor Tester July 1981 \$9.50
 - HE104 - Simple AM Tuner July 1981 \$7.50
 - HE105 - Basic Amplifier July 1981 \$9.75
 - HE106 - Wireless Microphone July 1981 \$6.50
 - HE107 - Electronic Dice August 1981 \$5.95
 - HE108 - Power Supply August 1981 \$11.95
 - HE110 - Unmistakable! September 1981 \$6.95
 - HE111 - Ohmmeter September 1981 \$10.95
 - HE112 - Micrometer September 1981 \$12.00
 - HE113 - Water Alarm September 1981 \$9.50
 - HE114 - Digital Counter/Display October 1981 \$13.95
 - HE115 - Reaction Timer ***** November 1981 \$6.95
 - HE116 - OP Amp Tester October 1981 \$3.95
 - HE117 - House and Car Alarm October 1981 \$16.95
 - HE121 - Scratch and Miss Filter October 1981 \$8.50
 - HE122 - Alien Invaders November 1981 \$13.95
 - HE126 - NiCad Charger November 1981 \$8.95
 - HE127 - Siren September 1981 \$3.95
 - HE128 - Foghorn September 1981 \$5.95
 - HE129 - Simple Timer November 1981 \$6.95
- ***** HE114 also required for complete operation.

MARC NR82 MULTIBAND RECEIVER

AS REVIEWED IN ELECTRONICS AUSTRALIA AUGUST 1982
Virtually continuous coverage from 145kHz to 470MHz in all modes. AM, FM, SSB, CW. Built-in VFO, Squelch, RF Gain, Antenna trim and dozens more features!!
Measures a huge 484(H)x355(W)x165(D)mm and weighs 5 kilos (plus batteries!!) Fantastic performance from one radio.



\$10 freight anywhere in Australia.

**12 *
band
GREAT
VALUE
only
\$349**

Fluoro Light STARTER *

**** NEW KIT ****

Ref: Electronics Australia October 1982.
Simple little circuit fits into an old plastic fluoro lamp starter. Lights turn on without a flicker. Great for bathrooms.



ONLY \$4.95

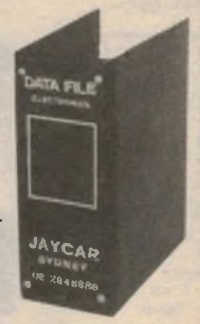

magazine binder
LOW IMPORT PRICE
ONLY \$4.95
4 up \$4.50

Keep your precious (and expensive) magazines in order for easy reference. Smart blue colour with gold lettering. Heavy gauge and richly chromed metal fittings.

CARLINGFORD
PHONE 872 4472

JAYCAR

125 YORK ST SYDNEY 2000
Ph. 2646688 Telex: 72293
Mail Orders To:
Box K-39 Haymarket 2000

MINIMUM MAIL ORDER \$5.00

PRINT AND PACKING CHARGES
\$3.99 (\$1.20) \$10.24 (\$3.40)
\$25.49 (\$1.50) \$50.99 (\$4.60)
\$100 up (\$6.20)

NEW SHOP HOURS
Monday 8.30 to 5.30pm
Friday night to 8.30pm

ROD IRVING ELECTRONICS

425 HIGH STREET, NORTHCOTE 3070, MELBOURNE, VICTORIA. Ph (03) 489 8131. Telex No. 38897

Electric fence



Check our prices

Ultrasonic Rule



\$49.00

Car Computer



\$109

Tacho/dwell meter with digital display



\$62

12/240 volt Inverter



\$55

Universal preamplifier for MM/MC cartridges



\$35

DIGITAL ENGINE ANALYSER

\$48.50

Engine Analyser Kit

Eprom Programmer

\$55.00

Analogue and Digital Storage CRO Kit

\$189.00

Function Generator

\$79.50

STEREO SYNTHESIZER

\$55.00

Dual Tracking Power Supply

\$83.50

Power Monitor

\$18

Portable 3 1/2 Digit Heart Rate Monitor

\$79.00

100w Sub-Woofer Amplifier

\$85.00

ETI 5000 Pre Amp \$239



Come in and hear the fantastic combination of the ETI5000 power amp & preamp playing through the ETI4000/1 and 2 speaker systems. EX STOCK.

ETI POWER AMP ONLY \$279

The front panel is now better finished than ever and has no holes visible. The fins themselves are tapped from the rear. Complete kit price is just \$275. Remember the super finish front panel at no extra charge. EX STOCK. We have now sold 150 of this kit and expect to sell hundreds more.



LE GONG

Fantastic doorbell using the new Siemens SAB 0600 chip. Kit of parts \$15

INCREDIBLE!!!

E/A has really done it this time. Display your Hi/Hi response on your colour TV. It will really impress your friends. Kit of parts \$99



Over 200 Sold

			\$			\$	
ET729	UHF TV Masthead Amp	Apr 81	36.00	HE106	FM Radio Microphone	May 81	6.50
ET730	UHF TV Converter	May 81	37.50	HE107	Electronic Dice	Jun 81	5.95
ET760	Video Mod. to suit 660 Micro	Spt 81	14.50	HE108	Power Supply		11.95
ET1501A	Negative Ion Generator	Apr 81	39.00	HE110	Unmistakabel		6.90
	Dream 6800		109.00	HE111	Ohm meter		19.90
	Dream 6802		109.00	HE112	Micromixer		11.90
	Pwr. Supply to suit Dream Micro Kit		29.50	HE117	House and Car Alarm		16.90
	Hex Keypad 19 Keys		28.50	HE121	Scratch and Hiss Filter		9.00
79T111	Transistor Assisted Ign	Nov 79	34.00	HE127	Siren		3.90
79IP56	Universal Power Supply	Jun 79	29.50	ET043	Heads or Tails	Oct 76	3.50
80CT12	Bipolar Train Controller	Dec 80	28.00	ET044	Two Tone Doorbell	Oct 76	4.50
80CM3A	Digital Capacitance Mtr.	Mar 80	52.50	ET047	Morse Practice Set	Dec 76	3.50
80PG6	TV Pattern Generator	Jun 80	52.50	ET048	Buzz Board	Dec 76	3.90
80TV8	TV CRO Adapter	Aug 80	29.00	ET061	Simple Audio Amp	Oct 76	5.50
80LL7	Leds & Ladders	Jul 80	19.50	ET062	Simple AM Tuner	Mar 77	6.50
80BM10	Car Battery Monitor	Oct 80	6.50	ET063	Electronic Bongos	Nov 79	5.00
80SA10	Stereo Amp Mosfet	Jan 81	169.00	ET065	Electronic Siren	Dec 79	5.50
80DC10	Digital Storage Cro Ad.	Nov 80	78.00	ET066	Temp Alarm	Dec 79	4.90
80LS12	Selectalot	Dec 80	22.50	ET068	LED Dice	Oct 76	5.90
80LBR12	Light Beam Relay	Nov 80	13.00	ET072	Two Octave Organ	Jan 78	8.50
80FB12	Guitar Fuzz Box	Dec 80	19.50	ET084	Car Alarm	Jan 77	12.00
80TM8A	Digital Engine Analyser	Aug 80	48.50	ET147	Electronic Dummy Load	Oct 80	89.00
80PP7A	Eprom Programmer	Jul 80	72.50	ET149	2 Tone Generator	Jul 80	34.90
80RM12	CylonVoice Stimulator	Jan 81	18.50	ET157	Crystal Marker	Oct 81	34.50
80RAM12	RAM Expansion for Dream	Dec 80	39.00	ET158	Low Ohms Meter	Nov 81	29.50
80PA6	Playmaster 300W Amp Module	Jun 80	63.00	ET256	Humidity Meter		19.50
80TRS11	TRS 80 Printer Serial In	Nov 80	15.00	ET257	Universal Relay Board	May 81	12.50
81DC2	Le Gong Doorbell	Feb 80	15.00	ET258	Mini Drill Speed Controller	Jul 81	8.00
81GA3	Colour Graphic Analyser	Mar 81	99.00	ET326	Exp. Scale LED Voltmeter	Spt 80	12.50
81IR4A	Infra Red Relay	Apr 81	39.00	ET327	Turn/Hazard Indicator	Oct 80	22.00
81SP1	RS232 TRS80 System 80 In	Feb 81	15.00	ET328	LED Oil Temp Meter	Jan 81	15.50
81SW1	Oscilloscope Switch	Feb 81	58.00	ET329	Exp. Scale Vehicle Ammeter	Feb 81	19.00
81OC3B	Digital/Analog Store. Cro.	Mar 81	169.00	ET330	Car Alarm	Jul 81	27.50
81WS10	Wind Speed Indicator	Oct 81	43.50	ET332	Electronic Stethoscope	Aug 81	34.00
81P6	Pool/Lotto Selector	Jun 81	24.50	ET432	LED Level Meter		11.95
81A010	Audio Test Unit Cass Deck	Oct 81	47.50	ET445	General Purpose Preamp	Jul 76	8.50
81MC8	Musicolour IV	Aug 81	79.00	ET455	Loud Speaker Protector	Mar 80	25.50
81SG9	LED Sandglass	Spt 81	22.50	ET458	LED Level Meter	Jan 81	27.00
81C19	Digital Clock Thermometer	Spt 81	80.00	ET466	300W Amp Module	Feb 80	63.00
81SS11	Slide Cross Fader	Nov 81	80.50	ET467	4 Input Mike Preamp	Jul 80	27.50
81GA9	Photon Torpedo Game	Spt 81	23.50	ET470	60W Amp Module Series 4000 TPV 6		26.00
81SW7	Train Steam Whistle	Jul 81	17.50				45.50
81H4A	Heart Rate Monitor	Apr 81	84.00	ET471	Audio Preamp Series 4000 TPV 6		24.00
81SP5	Sound Pressure Meter	May 81	37.00	ET472	Power Supply for Series 4000 TPV 6		54.00
81OR7	Electronic Organ	Jul 81	59.00	ET473	Moving Coil Preamp Series 4000 TPV 6		Spt 80
81CH12	Christmas Decoration	Dec 81	15.00				89.00
81fm10a	500MHz Digital Freq. Mtr.	Dec 81	135.00	ET475	AM Tuner	Nov 80	84.00
HE102	Guitar Phaser	Jun 81	25.00	ET476	Series 3000 Amp 25W Stereo	Nov 80	84.00
HE103	Transistor Tester		9.40	ET477	Series 5000 Pwr. Amp Mod 150W	Jan 81	58.00
HE104	AM Tuner	May 81	7.50		Series 5000 Pwr. Amp Complete Kit		275.00
HE105	Basic Amplifier	May 81	9.50	ET478MC	Moving Coil Preamp (5000)	Spt 81	18.50

Post & Pack \$2.50 small kits, heavier kits add extra postage
Prices subject to change without notice. Send 60c and SAE for pricelists. Phone (03) 489 8131.
MAIL ORDERS: PO Box 235, Northcote, Vic 3070.

Please debit my Bankcard.
 Bankcard No.
 Expiry Date
 Name
 Signature

ROD IRVING ELECTRONICS

425 HIGH STREET, NORTHCOTE 3070, MELBOURNE, VICTORIA. Ph (03) 489 8131. Telex No. 38897

MIXER PREAMP TRANSFORMER **\$26.50**

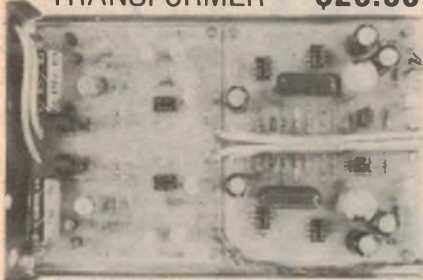

Easy construction and versatile operation this Preamp was for coupling with the 300W "Brute" Power Amp ETI 467 July 80

AUDIO TEST UNIT FOR CASS DECKS **\$47.50**



EA October 81

CRYSTAL MARKER **\$34.50**
(INC 1MHZ X) ETI 157 October 81



TV PATTERN GENERATOR **\$57.50**

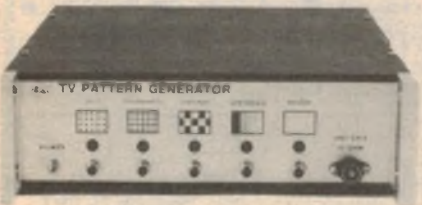

Adjust your TV for a first-class picture with EAs crystal controlled TV Pattern Generator EA June 80

BIPOLAR TRAIN CONTROLLER **\$28.50**
EA December 80

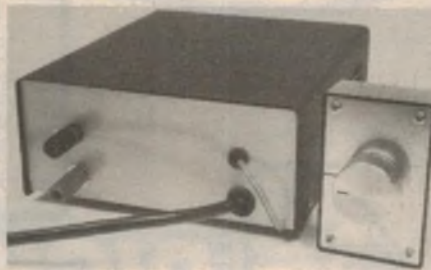

SLOT CAR POWER CONTROLLER (WITHOUT CASE) **\$70.00**

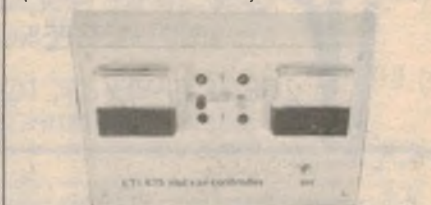

ETIs Slot Car Controllers will put more zip in your slot cars zap Plus Power Supply as indicated ETI December 81.

ETI 477 MOSFET MODULE **\$58.50**



Remember the great ETI 5000 power amp With this module as the hub of the ETI 5000 and a transformer you get an amazing power output of 150W RMS.
Plus Power Supply (No Trans) **\$49.00**
Plus Transformer **\$39.50**

PC BIRDIES **\$14.50**



Granny's Birthday - PC Birdies.
Granny's got a birthday coming up and you don't know what to give her! Her cat ran away her dog starved and the fish turned upside down Well here's the perfect gift. A no-nonsense, no maintenance companion The PC Birdies - She'll whistle, sing and dance for hours to this amazing electronic canary. EA May 81

DIGITAL COUNTER DISPLAY **\$13.50**
HE 114 HOBBY ELECTRONICS
October 81

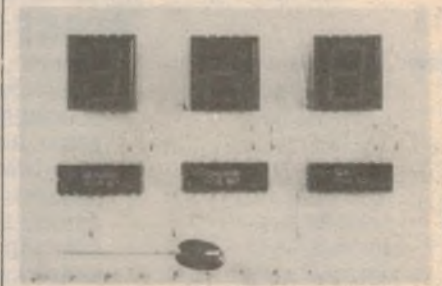

TRANSISTOR ASSISTED IGNITION **\$32.50**
EA November 79



WIND SPEED INDICATOR **\$43.50**
October 81



ETI 50W MODULE **\$17.50**
ETI 100W POWER AMP **\$22.00**
VERSATILE EPROM CARD **\$115.00**
MOVING COIL PREAMP **\$24.50**
MOVING MAGNET PREAMP **18.50**
DREAM 6800 **\$109.00**
445 STEREO PREAMP **\$8.25**

MUSICOLOR IV **\$79.00**

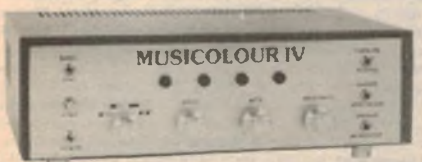

Add excitement to parties card nights and discos with EAs new Musicolor IV light show This is the latest in the famous line of Musicolors and it offers features such as four channel "Color Organ" plus four channel light chaser front panel LED display internal microphone single sensitivity control plus opto-coupled switching for increased safety EA August 81

ETI SERIES 5000



Power Amp **\$289.00**
Pre-Amp **\$239.00**

NEW LOCATION FOR OUR PARRAMATTA STORE

NEW STORE ADDRESS:
Cnr SMITH & GEORGE STS. PARRAMATTA

OPENS EARLY OCTOBER
For details of our other stores see below

- ★ ON SITE PARKING
- ★ CLOSE TO PUBLIC TRANSPORT
- ★ CLOSE TO WESTFIELD SHOPPING CENTRE



Dear Customers,

Quite often the products we advertise are so popular they run out within a few days. Or unforeseen circumstances might hold up shipments so that advertised lines are not in the stores by the time the advert appears. And very occasionally, an error might slip through our checks and appear in the advert (after all, we're human too!). Please don't blame the store manager or staff, they cannot solve a dick strike on the other side of the world, or fix an error that's appeared in print! If you're about to drive across town to pick up an advertised line, why not play it safe and give the store a call first - just in case. Thanks



Dick Smith and Staff

DICK SMITH Electronics

MAIL ORDER CENTRE
PO BOX 321, NORTH RYDE NSW 2113
Telephone orders: (02) 888 3200

POST & PACKING CHARGES

ORDER VALUE	CHARGE	ORDER VALUE	CHARGE
\$5.00-\$9.99	\$1.40	\$50.00-\$99.00	\$4.60
\$10.00-\$24.99	\$2.40	\$100.00 or more	\$6.20
\$25.00-\$49.99	\$3.50		

Charges are for goods sent by post in Australia only — not airmail overseas or road freight

SPEEDY PHONE/BANKCARD ORDER SERVICE

Just phone through your order and
Bankcard details — it's so simple!
(02) 888 3200



MAJOR RESELLERS

These are our major resellers. However, we cannot guarantee they will have advertised items in stock or at the prices advertised.

Atherton QLD: Jive Sue's Radio Service, 55 Main St, 91 1208 ● **Bendigo VIC:** Sumner Electronics, 7 Edward St, 43 1977 ● **Ballina NSW:** A. Cummings & Co, 91-93 River St, 86 2285 ● **Broken Hill NSW:** Crystal TV Rentals, 166 Argent St, 6897 ● **Cairns QLD:** Thompson Instrument Services, 79-81 McLeod St, 51 2404 ● **CoFs Harbour NSW:** CoFs Harbour Electronics, 3 CoFs Plaza, Park Ave, 52 5684 ● **Darwin NT:** Kent Electronics, 42 Stuart Hwy, 81 4749 ● **Darwin NT:** Ventronics, 24-26 Kavanagh St ● **East Maitland NSW:** East Maitland Electronics, Cnr Laws & High Sts, 33 7327 ● **Geraldton WA:** KB Electronics & Marine, 361 Main Terrace, 21 2176 ● **Gladstone QLD:** Purely Electronics, Shop 2, Cnr Herbert & Auckland Sts, 72 4321 ● **Gosford NSW:** Tomorrow's Electronics & Hi-Fi, 68 William St, 24 7246 ● **Kingston TAS:** Kingston Electronics Channel Court, 29 6802 ● **Launceston TAS:** Advanced Electronics, 5a the Quadrant, 31 7075 ● **Lismore NSW:** Decio Electric, 3A 6-18 Carrington St, 21 4137 ● **Mackay QLD:** Stevens Electronics, 42 Victoria St, 51 1723 ● **Maryborough QLD:** Keller Electronics, 218 Adelaide St, 21 4559 ● **Mt Gambier SA:** Hutcheson's Comm, 5 Elizabeth St, 25 6404 ● **Mildura VIC:** McWilliam Electronics, 40 Lemon Ave, 23 6410 ● **Morwell VIC:** Morwell Electronics, 128 George St, 72 7423 ● **Nambour QLD:** Nambour Electronics, Shop 4, Lowan House, Ann St, 41 1604 ● **Orange NSW:** M & W Electronics, 173 Summer St, 62 6491 ● **Penrith NSW:** Acorn Electronics, Shop 12, 541 High St, 36 1466 ● **Port Macquarie NSW:** Hall of Electronics, 113 Horton St, 83 5486 ● **Rockhampton QLD:** Purely Electronics, 15 East St, 21 058 ● **Southport QLD:** Amateurs Paradise, 121 Nerang St, 32 2644 ● **Toowoomba QLD:** Hinnis Electronics, 18 Neil St, 32 9677 ● **Townsville QLD:** Tropical TV, 49 Fulham Rd, Vincent Village, 79 1421 ● **Traralgon VIC:** Power in Sound, 147 Argyle St, 74 3638 ● **Wagga NSW:** Wagga Wholesale Electronics, 82 Forsyth St ● **Wodonga VIC:** A & M Electronics, 78a High St, 24 4588 ● **Whyalla SA:** Mellor Enterprises, Shop 2, Forsythe St, 45 47 64

STORE LOCATIONS

NSW	145 Parramatta Rd	AUBURN	648 0558
	755 Terrace Level	BANKSTOWN SQ.	707 4888
	613 Princes Hwy	BLAKEHURST	546 7744
	552 Oxford St	BONDI JUNCTION	387 1444
	818 George St	BROADWAY	211 3777
	531 Pittwater Rd	BROOKVALE	93 0441
	147 Hume Hwy	CHULLORA	642 8922
	162 Pacific Hwy	GORE HILL	439 5311
	396 Lane Cove Rd	NORTH RYDE	888 3200
	30 Grose St	PARRAMATTA	683 1133
	6 Bridge St	SYDNEY	27 5051
	125 York St	SYDNEY	290 3377
	173 Maitland Rd	TIGHES HILL	61 1896
	263 Keira St	WOLLONGONG	28 3800
	Tamworth Acde & Kable Ave	TAMWORTH	66 1961
ACT	96 Gladstone St	FYSHWICK	80 4944
VIC	399 Lonsdale St	MELBOURNE	67 9834
	260 Sydney Rd	COBURG	383 4455
	656 Bridge Rd	RICHMOND	428 1614
	Springvale & Dandenong Rds	SPRINGVALE	547 0522
	205 Melbourne Rd	GEELONG	78 6766
	Ross Smith Ave & Nepean Hwy	FRANKSTON	783 9144
QLD	293 Adelaide St	BRISBANE	229 9377
	166 Logan Rd	BURANDA	391 6233
	842 Gympie Rd	CHERMSIDE	59 6255
SA	60 Wright St	ADELAIDE	212 1962
	435 Main North Rd	ENFIELD	260 6088
	Main South & Flagstaff Rds	DARLINGTON	298 8977
WA	414 William St	PERTH	328 6944
	Wharf St & Albany Hwy	CANNINGTON	451 8666
TAS	25 Barrack St	HOBART	31 0800

All Dick Smith stores are open from 9am to 5.30pm (Saturday 9am to 12 noon) except Queensland stores which open and close half hour earlier. Many stores are open for late night trading. Phone your nearest store for details

STORE HOURS



Letters to the editor

Micro Invaders: the author replies

As a regular reader of your magazine I must admit astonishment at the intemperance of your review of my recently published book, "Micro Invaders". It was a marked contrast to the sort of straightforward book review I am used to reading in your columns.

Of course book reviews are intended to reflect opinion but when they descend to abuse I feel obliged to reply. I am taken to task by your reviewer for suggesting that the appeal of fibre optics over copper cable rests partly in the availability of its raw material and its requirement for fewer repeaters. I regard the first matter as self-evident and as for the second would point your reviewer to work by British Telecom engineers who have recently set world records in fibre optic transmission.

If that assessment of the potential of fibre optics "displays a woeful lack of understanding of the technology involved" I would direct your reviewer to the many telecommunications authorities throughout the world now using fibre optics. A few days before reading your review I was discussing just those advantages of fibre optics with the Hong Kong telephone authority. It intends to cable the whole city with fibre optics.

I am quite prepared to swap technical notes with your reviewer on any of the technologies discussed in "Micro Invaders" but that is not the point of the book. It is intended for a non-technical readership wanting a picture of what is happening technologically in the office, home and industry. There has been a strong reaction to the book, both for and against its opinions. No one has yet

challenged its accuracy in describing the technology.

There appears to be a furphy in technical writing that only the experts can understand high technology. Fortunately, that is false. Often when the unnecessary buzz words are culled and ordinary English is used, it is possible to describe technology in terms which can be understood by most people. I have never subscribed to the view that understanding technology should be the province of the few. One of the difficulties in publishing technical magazines is communicating beyond the boundaries of those in the know to those who would like to be. If the secrets of electronic technology remain locked up by the experts, can you wonder that there is fear and distrust about the effects of technology?

Incidentally, an international edition of "Micro Invaders" will be published in the United States next year. If your reviewer promises not to hurl it around the room, I'll sent him another copy.

Ian Reinecke,
Chippendale, NSW.

Comment

Surely, the mere fact that raw materials for a technology are plentiful is no particular attraction in itself. After all, sand is also the raw material for solar cells but that does not make them cheap to manufacture.

As far as the comparison between boosters required for optic or conventional cables is concerned, it is only just recently that optic cables have begun to look competitive.

cinogenic potential for man. The grinding or cutting of beryllium oxide washers can give rise to dusts.

I believe the notation "perfectly safe if not EATEN" should be withdrawn and "dusts from beryllium oxide should not be breathed" inserted.

R. C. Jones,
Industrial Hygiene Branch,
Department of Industrial Relations,
Lidcombe, NSW.

Beryllium — don't breathe the dust either

I noticed with interest in your June 1982 issue, p49, that an advertisement for Jaycar indicated that beryllium oxide washers were "perfectly safe if not EATEN".

In fact beryllium oxide in the form of dust is an extremely toxic material having a threshold limit value of $2\text{mg}/\text{m}^3$ as beryllium and is stated by the American Conference of Governmental Industrial Hygienists as an industrial substance suspect of car-

Where your assessment "displays a woeful lack of understanding" is that it neglects the main advantage which is bandwidth, while ignoring the difficulties of manufacture and installation. The greater potential bandwidth of optic cables means that they are capable of much higher rates of information or data transmission. At the same time, the optic mode means that information transmission is unaffected by very "noisy" electrical environments and "crosstalk" between adjacent optic cables is negligible.

We agree that technical writing can and should use terms which can be understood by most people. We try to do this as much as possible in this magazine. However, this purpose is not served by trivialising the issues being discussed, by drawing false analogies or by skating over the difficult bits. Any explanation must be technically correct.

In fact, that is the great challenge in writing on technical matters for the general public. How do you make it understandable to the completely uninformed while not insulting the intelligence of the informed reader? We stand by our review.

In this month's Book Review pages there is yet another example of an "intemperate" review so you have not been singled out.

Two antennas — two channel 10's:

I am a regular reader of your magazine and thought the following may be of interest to your readers.

Living in Zillmere, a northern suburb of Brisbane, I constructed a TV antenna for Channel 10 ("TV Antenna Design Data", "Radio, Television and Hobbies" May, 1962) to pick up Channel 10 Nambour, a translator (horizontally polarized) taken from SEQ 8 Maryborough. Even though the output power of this translator would assumably be relatively low, I was surprised with the quality of reception.

Also, realising there is a Channel 10 in Toowoomba (also horizontally polarized), I thought this channel would interfere with the Channel 10 from Nambour. However, on rotating the aerial toward Toowoomba, the Channel 10 from Toowoomba was received with amazing quality. The rotation angle between each Channel 10 is 90° , hence, I conclude this is the reason for no cross interference between channels.

I have since constructed another Channel 10 antenna, and now have one directed towards Nambour (65km away) and the other to Toowoomba (Bunya Mountains 130km away) and now receive two different programs on the SAME channel, simply by switching from one antenna to the other.

Rex Garton,
Zillmere, Qld.



Books & Literature

Radio handbook

RADIO HANDBOOK. Twenty-second edition by William I. Orr, W6SAI. Published 1981 by Howard W. Sams & Co, Inc. Hard covers, 1200 pages, 234 mm x 160 mm. ISBN 0 672 21874 7. Price in Australia \$39.95.

Any book that has been around for 47 years and that has reached its 22nd edition must have high reader appeal, and a perusal of the pages of the Radio Handbook indicated why this is so.

The book contains a huge amount of information, both theoretical and practical, for the radio amateur or prospective amateur.

The early chapters provide an introduction to amateur radio, DC and AC theory, active devices (both semiconductor and valve) and their use in special circuitry.

From there the subjects covered are all that one would expect in a text book for amateur radio: AM, FM and SSB; The design and construction of receivers and transmitters for the HF and VHF bands; Radiation and propagation; Antennas; Mobile equipment; Specialised communications systems and techniques; Test equipment and so on.

The text is well written and the illustrations, both photographic and line drawings, are clear and well reproduced.

Although primarily intended for radio amateurs, the Radio Handbook would also be of use to other readers interested in radio communications.

Our copy came from McGill's Authorised Newsagency Pty Ltd, 187-193 Elizabeth Street, Melbourne, Vic 3000. (R.F.)

ZX81 programming

"THE ART OF PROGRAMMING THE 1K ZX81" by M. James and S. M. Gee. Soft covers, 86 pages, 110 x 170mm. Published by Bernard Babani Ltd 1982. ISBN 0 85934 084 8. Price \$5.85.

This book is intended for ZX81 users who, having read the Sinclair manual, find that they are still not able to formulate their own programs. It is assumed that the reader has some knowledge of BASIC, although the meaning of many

functions are reviewed for those who are less than proficient in this respect.

Presented in a readable style, the book acknowledges that programming the ZX81 can be daunting for the newcomer — especially within the constraints of the 1K memory. Almost all of the programs presented are for games, the premise being that the Sinclair manual provides an explanation of many calculation routines. Additionally games are an "enjoyable medium for learning" and more serious programs, such as business or household management will not fit into the 1K of memory. Some of the games include Lunar Lander, Hangman and Cannon-ball.

Although the operation of most of the routines are explained, this is only a small book and does not dwell on any subject at any length. Consequently, some explanations are not particularly detailed. Chapters are included on Randomness, Graphics and Moving Graphics. The final chapter is entitled "Hints and Tips", and in the interest of making the most of the limited memory it discusses various space saving techniques. For most users, this may well prove the most useful aspect of the book. In summary, a handy book for frustrated ZX81 users — particularly those with a preference for games. (C.D.)

Computer design

MICROCOMPUTER DESIGN AND TROUBLESHOOTING: by Eugene M. Zumchak. Soft covers, 347 pages, 135mm x 226mm, illustrated with diagrams. Published by Howard W. Sams & Co Inc 1982. ISBN 0 672 21819 4, Price \$26.75.

This book is part of the Blacksburg Continuing Education Series, and lives up to the generally good reputation of that range. In seven lengthy chapters the author covers suitable microprocessors in controller functions, development systems, interfacing to commonly used memory chips, hardware design and testing, troubleshooting procedures and software design.

The book's great strength is in hardware. Unlike other publications this one considers different "families" of

microprocessors, chiefly the 8085 and the 6502. It gives full details of interfacing techniques including parallel and serial ports, the S-100 bus and the IEEE-448 interface.

The often vexatious question of using devices from different families together is fully covered, and the text is well-supported with diagrams and circuits of typical microprocessor equipment. The sections on EPROM programming will be particularly valuable to the home constructor.

Software design is less fully covered, and in general terms only. Documentation, design philosophy and techniques are given passing consideration.

The only fault with this book is that it does not make any mention of the increasingly popular SS-50 bus. Many will also consider it expensive, too, for a soft cover publication.

Our review copy came from McGill's Authorised Newsagency Pty Ltd, 187-193 Elizabeth St, Melbourne, Vic 3000. (P.V.)

Telephone manual

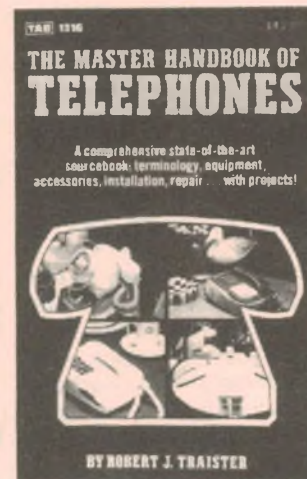

THE MASTER HANDBOOK OF TELEPHONES, by Robert J. Traister. Published 1981 by Tab Books Inc, Blue Ridge Summit, Philadelphia. Soft covers, 210 x 121mm, 357 pages, illustrated with many photographs. ISBN 0 8306 1316 1. Price \$17.50.

This is a comprehensive survey of the domestic telephone scene in the USA. A myriad of telephones are described and discussed, as well as telephone answering devices and accessories such as amplifiers, silencers, extension ringers and wireless telephones.

However while it may be of great interest to readers in the USA the book is completely irrelevant to Australia. And wonder of wonders, here is a book about telephones with not one telephone circuit, apart from the odd amplifier schematic from Radio Shack.

Our copy came from McGill's Authorised Newsagency, Melbourne. (L.D.S.)

(continued on page 103)

K-NAR COMPUTER CARDS

S100 Z80 SYSTEM CARD SPECIALISTS

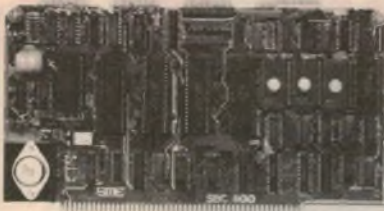

SBC-800



FDC-II



DRC-II

You know the SME Systems boards as the most powerful and technically up-to-the-minute manufactured in Australia today.

Using K-NAR's mail order system can save you dollars. Compare our prices on these high performance cards.

SBC-800

4Mhz Z-80 CPU, two serial RS232 ports, software programmable Baud rate gen., Centronics parallel port, 22 prog. I/O lines, real time clock (battery backed), 2K CMOS RAM, power on reset/power fail detect, battery backed as standard, etc. List Price \$495. Our Price \$395.

SBC-400

4Mhz Z-80 CPU, 1K Static Ram, RS232 I/O with Sync/Async, Centronics interface, 4Ch. counter/timer, Soft Prog. Baud rate generator, 2K CP/M BIOS EPROM option. List Price \$395. Our Price \$315.

FDC-II

Enhanced floppy disk controller, IBM 3740 compatible, operates 5 & 8" and single/d. density drives, handles up to 4 drives, runs multi-density CP/M2.2 & MP/M 2. Vectored interrupt operation optional. List Price \$465. Our Price \$370.

DRC-II

The board for multi-user installations. 64/256K dynamic RAM card, bank select, fast 4Mhz operation, on-board memory prom, dip-switch selectable boundaries, bank mode allows up to 8 boards on bus, hidden refresh, phantom disable. List Price \$600. Our Price \$475.

CRC-48

Fool-proof memory system. State-of-the-art CMOS memory card with memory protection, on board battery back-up, compatible with DRC-II, write protection enable/disable, can be used as complete EPROM card or any combination of EPROM or CMOS ram. List Price \$525. Our Price \$420.

VDC-8024

The low cost alternative to stand-alone terminal. Flexible 80x24 memory mapped video display board with full ASCII, semi graphics, Inverse & half intensity video, flicker free screen updating. Battery backed option offers diagnosis of system shut downs. List Price \$325. Our Price \$265.

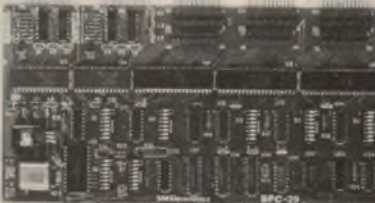

SPC-29



SBC-400



CRC-48



VDC-8024



MPC-6 DARTBAUD

MPC-6 DARTBAUD

For Multi-user systems. Multi-channel RS232 Intelligent I/O card with full I/O buffering and high level input/output drivers. 6 channels, on-board Z80 processor, software programmable baudrates, 6K buffer memory (battery backed). User programmable features for system tailoring. List Price \$725. Our Price \$575.

SPC-29

High performance dual serial & 9 parallel port I/O CARD, with full I/O address decoding. Switch selectable baud rates. Link patch area, programmable modes for strobed/latched I/O. List Price \$295. Our Price \$235.

PACKAGE SPECIAL

Try this for value

SBC-800 • FDC-II • DRC-II

& 5-slot motherboard with mini-cage. Monitor/BIOS EPROM.

Special package price \$1425*

K-NAR

COMPUTER CARDS

PO Box 412, Dandenong, 3175 Phone (03) 795 5858
 Authorised distributor of SME Systems products.

* Prices subject to change without notice. All prices excluding tax. For retail prices add 17.5%.
 All boards fully assembled and tested and backed by 90-day guarantee.

To K-NAR Computer Cards

Please send me product data sheets.
 (I enclose 4 stamps)

I wish to order
 My cheque/order form is enclosed
 Please debit my Bankcard No.
 Name _____
 Address _____

Signature _____

Please include me on your new product mailing list. I am mainly interested in systems for
 Hobby, Industrial use Education
 Business Process control Other



"He started with Dick Smith's Fun Way — look at him now!"

Tomorrow's world will be a world of electronics and knowledge will be vital. Your child can gain that knowledge and have fun along the way with Dick Smith's Fun Way Electronics.

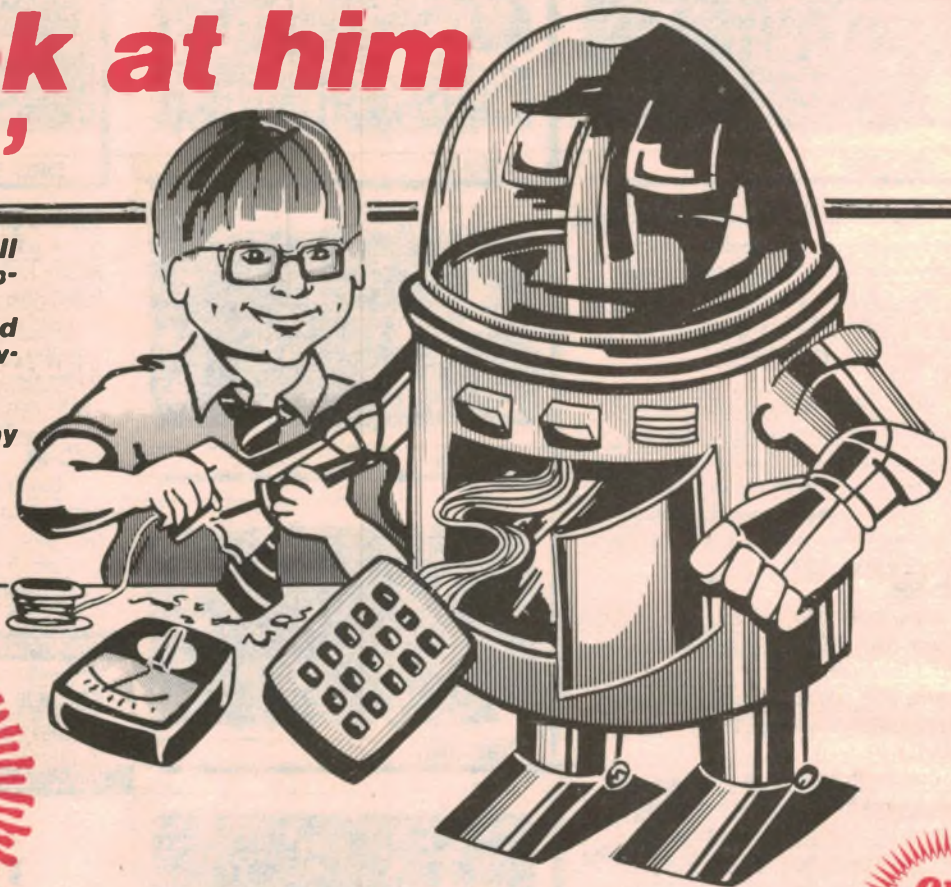

OVER 20,000 SOLD!

Fun Way Into Electronics Volume 1.

4th printing of this amazing book. 72 pages packed with exciting projects that can be built by raw beginners in the fields of electronics. All projects in the book are completely safe as they are battery operated and there is no soldering involved. AND all projects are fully illustrated so mistakes are virtually impossible. Don't miss out! Cat B-2600

Fun Way Into Electronics Volume 2

After mastering Fun Way Vol. 1, why not go further. Learn about PCB's and soldering with this great second edition. 130 pages packed with more projects plus the basic laws of electronics, component codes, assembly hints etc are fully explained. Cat B-2605

Vol. 1 Kit projects 1-10

All you need to build the first 10 projects from Fun Way Vol. 1. Great value. Cat K-2600

ONLY \$7³⁰

Vol 1 Kit projects 11-20

Contains more specialised components which together with components from kit 1, will enable you to make any of the projects in the book. Cat K-2610

ONLY \$7⁹⁹

Vol 2 Kits

All the kits for building the projects in Fun Way Vol 2 starting from a low low \$2⁹⁹

ONLY \$4⁹⁵

ONLY \$6⁹⁵



7 DAY TRIAL OFFER

Buy either book, or both, and after a 7 day examination if you are not completely satisfied you may return them in their original condition for a full refund!

ASK ABOUT OUR SPECIAL DISCOUNT FOR SCHOOLS



DICK SMITH Electronics
See page 98 for address details



Books Ctd from P100

Aerial projects

AERIAL PROJECTS, by R. A. Penfold. Published 1982 by Bernard Babani Ltd, London UK. Soft covers, 178 x 113mm. 84 pages, illustrated with circuits and diagrams. ISBN 0 85934 080 5. Price \$5.85.

Shortwave listeners are the main target of this small book. The author considers some practical aerial designs such as long wire, dipoles and ground plane aeriels. Active, loop and ferrite rod aerial designs are also presented and these are easy to build.

The third and last chapter in the book presents some designs for aerial accessories such as a HF Band Preselector, Variable Attenuator, Tunable Notch Filter and an Aerial Tuning Unit.

In short, an inexpensive text of interest to the shortwave listener. Our copy came from the Technical Book & Magazine Company, Pty Ltd, Melbourne. (L.D.S.)

Everyday science

SCIENCE IN EVERYDAY LIFE, by W. C. Vergara. Published 1982 by Sphere Books Ltd, London. Soft covers, 197 x 130mm, 306 pages, ISBN 0 7221 8720 3. Distributed in Australia by Thomas Nelson Australia, 480 La Trobe St, Melbourne. Price \$6.95.



"Science in Everyday Life" could generally be regarded as being written in popular vein. A more caustic view is that it is written for scat-brained televievers who have a concentration span of less than five minutes. It is really quite useless and consists a long string of items of about a page or so headed by rivetting questions such as "Why does bread go mouldy?" or "Do ants build roads".

Even if one regarded such a mine of trivia as being useful, it is not readily accessible. While there is an index of sorts, there is no list of contents, no chapter headings and no general theme.

Help save trees. Leave this book on the retail shelves. (LDS).

NEW BOOKS

NEW — NEW — NEW

Latest editions of some of the most popular books on the subject.

World Radio TV Handbook 1982 Edition — order now from our advance shipment	
Airfreight copies here now	\$17 95
The Radio Amateur's Handbook — 1982 Edition A must for the Radio Amateur and Professional	\$14 95
RSGB Handbook Volume 1	\$21 85
RSGB Handbook Volume 2	\$18 90
Reference Data for Radio Engineers (New Edition) ITT	\$39 95
Australian Amateur Operator's Handbook — Postal and Telecommunications Department	\$3 60
Radio Handbook — Orr New 22nd Ed.	\$39 95
The 10 Meter FM Handbook — Heil	\$7 10

Computer Books

The Basic Handbook — Lien	\$17 95
Learning Basic Fast — DeRossi	\$13 95
TRS-80 Interfacing Book 1 — Tilus	\$11 95
Basic Programming Primer — Waite & Pardee	\$12 70
Microcomputer Interfacing with the 8255 PPI Chip — Goldsbrough	\$11 95
Atari Sound and Graphics — Moore A self teaching guide	\$13 95
Computer Reference Guide's Software Handbook — Australian buyers' guide to all types of software products for minicomputers	\$27 65
Fast Basic — Beyond TRS-80tm Basic — Grazer	\$20 95
TRS-80 Color Basic — Albrecht	\$13 95
TRS-80 Programs and Applications for the Colour Computer — Baker	\$21 95
Basic Programming on the BBC Microcomputer — Cryer	\$15 95

Adam Osborne Books:

8080 Programming for Logic Design	\$13 30
Some Common Basic Programs	\$21 00
8080A 8085 Assembly Language Programming	\$22 40
Z80 Programming for Logic Design	\$13 30
6800 Assembly Language Programming	\$22 40
Intro to Microcomputers — Volume 3: Some Real Support Devices	\$21 00
Z80 Assembly Language Programming	\$23 80
6502 Assembly Language Programming	\$23 80
The 8086 Book	\$23 80
Intro to Microcomputers — Volume 1: Basic Concepts 2/e	\$22 40
6809 Assembly Language Programming	\$23 80
Z8000 Assembly Language Programming	\$28 00
Interfacing To S 100 IEEE 696 Microcomputers	\$21 00
Practical Basic Programs	\$22 40
8089 I/O Processor Handbook	\$13 95
Some Common Basic Programs — Pet/CBM Edition	\$21 00
68000 Microprocessor Handbook	\$13 95
Osborne 4 & 8 Bit Microprocessor Handbook	\$27 95
Osborne 16-Bit Microprocessor Handbook	\$27 95
Osborne CP/M User Guide (New edition due late '82)	\$22 35
CRT Controller Handbook	\$13 95
Apple 11 User's Guide	\$23 75
Business System Buyer's Guide	\$13 95
VISICALC Home and Office Companion	\$22 40
Assembly Language Programming for the Apple 11	\$18 15
Some Common Basic Programs — Atari Edition	\$21 00
Some Common Basic Programs — TRS-80 Edition	\$22 40
Pet/CBM Personal Computer Guide	\$21 00
Microprocessors for Measurement and Control	\$22 40
6502 Assembly Language Subroutines	\$22 35
CBASIC User Guide	\$23 75
68000 Assembly Language Programming	\$23 80
Science & Engineering Programs — Apple 11 Edition	\$22 40
Intro to Microcomputers — Volume 0: Beginners Book	\$17 50
Your Atari Computer	\$23 75
Practical Basic Programs — Apple 11 Edition	\$22 40
Practical Basic Programs — TRS 80 Edition	\$22 40
Some Common Basic Programs — Apple 11 Edition	\$21 00
Wordstar Made Easy	\$16 75
Pet Fun and Games	\$16 75
A User Guide to the Unix System	\$22 40
Trade Secrets	\$27 95
Some Common Pascal Programs	\$21 00
Practical Pascal Programs	\$22 40
Discover Forth	\$21 00
6809 Microcomputer Design Guide	\$27 95
CP/M User Guide 2nd Ed	\$18 20
The HP-IL System: An Introductory Guide to the Hewlett-Packard Interface Loop	\$23 80
PET/CBM Im & THE IEEE 499 BUS (GPIB) 2nd ed.	\$22 40
Practical Basic Programs — IBM PC Ed	\$22 40
Pet Personal Computer Guide	\$21 00
CBM Im Professional Computer Guide	\$21 00

Byte Books new series on Computers

K2FDOS — A Floppy Disk operating System for the 8080 — Welles	\$27 60
Ciarcia's Circuit cellar — Ciarcia	\$11 20
Tracer — 6800 Debugging Program — Grappel	\$8 40
Link 68 — an M6800 Linking Loader — Grappel	\$11 20
RA6800ML — Relocatable Macro Assembler	
Hemenway	\$35 00
Byte Book of Pascal — Liffick	\$35 00
Build your own Z80 Computer — Steve Ciarcia	\$22 05

Sybx Computer Books:

Programming the 6502 (Vol 1)	\$17 95
Programming Exercise for the 6502 (Vol 2)	\$17 50
6502 Applications Books (Vol 3)	\$17 50
6502 Games Book (Vol 4)	\$17 50
Basic Programs for Scientists & Engineers	\$19 95
CP/M Handbook (With MP M)	\$18 95
Easing into Pascal with UCSD Systems	\$19 95
Fifty Basic Exercises	\$17 50
Fifty Pascal Programs	\$17 95
Introduction to Pascal (Including UCSD Pascal)	\$19 95
Introduction to Personal & Business Computing	\$9 50
Microprocessor Interfacing Techniques	\$23 50
Microprocessors: From Chips to Systems	\$17 50
Microprogrammed APL Implementation	\$45 95
Pascal Handbook	\$24 95
Pascal Programs for Scientists & Engineers	\$22 50
Programming the Z800	\$19 95
Programming the Z80	\$19 95
Your First Computer — A Guide to Business & Personal Computing	\$11 95

Howard W. Sams Books

TTL Cookbook (Lancaster)	\$12 95
TV Typewriter Cookbook (Lancaster)	\$13 50
The Cheap Video Cookbook (Lancaster)	\$10 75
Active Filter Cookbook (Lancaster)	\$19 95
Transistor Substitution Handbook	\$7 95
TTL Cookbook (Lancaster)	\$12 95
IC Op Amp Cookbook — Jung — New 2nd Edition	\$19 95
Applesoft Language — Blackwood	\$12 95
The S-100 and other MicroBuses — Goodwin & Poe	\$11 95
Pascal Primer — Fox & Waite	\$22 95
Intimate instructions in Integer Basic — Blackwood	\$9 95
Experiments in Artificial Intelligence for Small Computers — Krutch	\$11 95
Basic Business Software — Brooner	\$15 95
Microcomputer Dictionary — Sippl	\$18 95

Other Titles

Practical Transformer Design Handbook — Lowdon	\$32 95
Complete Handbook of Robotics — Safford Jr	\$11 50
How to Build your own Working Robot Pet — DaCosta	\$9 95
The Active Filter Handbook — Tedeschi	\$11 50
How to Design & Build your own Custom TV Games — Heiserman	\$13 50
Piano Servicing & Tuning & Rebuilding — Arthur Reblitz	\$21 00
Hi-Fi Loudspeakers & Enclosures — Cohen	\$25 50
How to build your own self-programming Robot — David Heiserman	\$9 95
Fairchild — CMOS Data Book	\$9 95
Motorola M6800 Microprocessor Applications Manual	\$16 70
Motorola MC6800 16 BIT Microprocessor User's Manual	\$25 00
Motorola Programming the 6800 Microprocessor	\$11 05
National CMOS Databook	\$7 50
National Linear Databook	\$11 25
National Logic Databook	\$10 00
National Audio Radio Handbook	\$6 25
Video Games — Len Buckwalter	\$5 95
Videocassette Recorders Theory & Servicing — McGinty	\$20 00
Electronic Projects in Audio — Penfold	\$7 50
Electronic Projects in The Car — George	\$8 95
Electronic Projects in The Home — Bishop	\$7 50
Electronic Projects in Music — Find	\$8 95
Electronic Projects in Photography — Penfold	\$8 95
Electronic Projects in The Workshop — Penfold	\$7 50
Electronic Test Equipment Projects — Ainslie	\$8 95
More Electronic Projects in The Home — Find	\$8 95
Projects in Radio & Electronics — Sinclair	\$7 50
The Video Manual — Cheshire	\$20 00

Just a few of the thousands in stock. Call in or write. Prices subject to fluctuation. Correct at time of going to press.

If the book you require is not listed below, it can be ordered from us.

MAIL ORDERS BY RETURN
PLEASE ADD \$1.50 per parcel postage (Vic)
\$2.50 per parcel interstate

TECHNICAL BOOK & MAGAZINE CO.

295-299 Swanston St, MELBOURNE 3000. Ph. 663 3951.

Shortwave Scene

by Arthur Cushen, MBE



Shortwave Scene celebrates 30 years publication

Over the past 30 years this column has presented news for shortwave listeners, covering a wide variety of subjects as the world of radio listening progressed from the valve radio to the transistorised digital read-out receiver of today.

In October, 1952 the writer took over this column from Ray Simpson. At the same time other listeners were featuring in the magazine including Ted Tinning with "Broadcast Band News", while Australian "Radio World" had a feature by Les Keast and the Australian DX Club publication "Skyrider" was being edited by Graeme Hutchins.

In the October 1952 issue the lead story covered the new international service of Radiodifusion National Belge and published a conversion chart from metres to kilocycles. The only transmission from Radio Nederland was broadcast from Holland in English at 0230UTC – reported in the page as 1.30pm AEST, and of course the frequencies were listed in kilocycles. The column was called "Short-wave Notes" and the magazine was then "Radio and Hobbies".

By October, 1962 the feature had been retitled "On Shortwave", and all times were being shown in GMT, while the name of the magazine was then "Radio Television & Hobbies". The lead story that month reported that Radio Canada had added a further 50kW transmitter to its shortwave services. Radio Japan had just introduced its General Service broadcasting hourly in English; and a reception report of TI4NRH in Costa Rica brought back memories of one of the first five shortwave stations in the world. The BBC General Overseas Service had just introduced "Shortwave Listeners' Corner".

Looking back 10 years to October, 1972 the feature was called "Listening around the World" and the name of the magazine was "Electronics Australia". The highlight of that month was the report that Radio Canada International was using 250kW transmitters at Sackville for its service to the South Pacific, as well as to most other areas in the world: Israel was reported as testing new transmitters to Europe, Sierra Leone was being heard on 3316kHz and Radio

New Zealand had a special transmission to Antarctica.

In the first issue in October, 1952 a brief summary of the writer's listening achievements reported that he had 906 broadcast verifications and 1455 on shortwave. Now some 30 years later the broadcast verifications total 2544 and 5301 on shortwave, giving a total of 7845 verifications from 272 countries. Interest in radio listening has increased tremendously over the years, receivers have been designed to make locating stations as simple as dialling a telephone and the power of shortwave broadcasters has been increased to such an extent that though a reliable service cannot be guaranteed, listeners can generally find acceptable listening conditions at any time of the day and night.

WORLD COMMUNICATION YEAR

After four years of discussion within the United Nations, the UN General Assembly has finally decided that 1983 will be World Communication Year. The purpose is the development of communications, particularly to increase the scope and effectiveness of communications as a force for economic and social development. Activities will focus on national communication policies and implementations. The aim is to seek ways to use communication technology to promote the harmonious development of economic, social and cultural policies. The lead agency co-ordinating the World Communication Year 1983 is the International Telecommunication Union and information is available from WCY-83 Secretariat, Palace of Nations, CH1211, Geneva, Switzerland.

SOUTH AMERICAN NEWS

ECUADOR: Radio Dif del Ecuador Guayaquil on 4656kHz has been heard at 1015UTC with news in Spanish and at 1040UTC has the National Anthem and full station announcements with a network news bulletin carried at 1045YUC.

Steven Greenyer and Owen Cullen, reporting in the NZ DX Times, state that Radio La Voz del Napo has been heard with weak signals on 3280kHz at 1045UTC. On 3380kHz Radio Iris opens at 1100 at good strength.

VENEZUELA: Radio Tachira, San Cristobal on 4830kHz has been heard before 10000UTC at good strength. On 4800kHz, Radio Lara opens at 10000UTC with a good signal while Radio Continente is also noted on 5030kHz at the same time.

ELBC MONROVIA

The long established Liberian Broadcasting Corporation, operating from Monrovia, has been heard on 3255kHz at 0515UTC and at 0600 with English commercials and full station identification. At 0700 the station carries a news bulletin in English, according to the NZ DX Times. Some information about the return of this station to shortwave broadcasting is given in Sweden Calling DXers which gives the slogan as Liberian Broadcasting System. After a break from 1980 the station returned to the air in 1982. The reason for the break in transmission was that the station was awaiting spare parts and some staff were being trained in the United States. Broadcasts on 3255kHz are at 0530-0900UTC and 1600-2400 and on 6090kHz at 0800-1730UTC.

INDONESIAN SIGNALS

Signals from Indonesian stations, particularly those outside the usual short wave bands are being well received at the moment. Two signals, RRI Biak, Irian Jaya on 5451 and RRI Pekanbaru on 5886 are being received as early as 0900UTC. Dene Lynneberg in the DX Times reports reception of these two signals in Indonesian. Another transmission from Irian Jaya is also being received from RRI Jayapura on 9613kHz which is also heard around 0900UTC and at 0915 has a local news bulletin and at 1000UTC relays news from Jakarta. RRI Medan has been noted on 3375 and 4764kHz with both frequencies closing at 1658UTC. RRI Surakarta using 4931kHz has been heard at 1140UTC with popular Indonesian music.

TURKISH FOR AUSTRALIA

After some months of inactivity the Voice of Turkey is again broadcasting to Australia in English and Turkish. The transmissions are on 17715kHz with English at 2200-2255UTC followed by Turkish to 0300UTC. At the same time a broadcast to North America in Turkish is carried on 11900kHz. The 100kW transmitter on 17715kHz has recently been rebuilt for this transmission.

NEW CLUB FORMED

A new club "DXers Australia" has been formed in eastern Australia with headquarters in Melbourne. The new group is publishing a magazine titled "DXers Calling" with Sam Dellit of Melbourne as Editor. Chris Martin of Sydney is editing the mediumwave section, Ray Crawford of Gladstone, Queensland, verification information, Harry Weatherley of Melbourne, Shortwave News, and Geoff Cosier of Melbourne will be covering international news. The club is seeking membership in the South Pacific Association of Radio Clubs. The address of "DXers Australia" is PO Box 80, Forest Hill, 3131 Victoria.

FRANCE BEAMS TO LATIN AMERICA

As indicated in the August issue, Radio France International is expanding its programs and this month commenced a service to Latin America. The broadcasts are from 2200-0200UTC in French, Spanish and Brazilian Portuguese from transmitters in France at Allouis and Issoudun.

From January 1984 with the opening of four transmitters at the relay base in Monsinery, French Guyana, RFI will be able to cover the whole of Latin America and will broadcast a 21-hour daily service in French, Spanish and Brazilian.

The target area of the relay base will be the Antilles, the Caribbean, Central America and the east and north coasts of South America, according to a BBC Monitoring Service report.

Notes from readers should be sent to Arthur Cushen, 212 Earn Street, Invercargill NZ. All times are UTC (GMT). Add eight hours for WAST, 10 hours for EAST and 12 hours for NZT. In areas observing daylight time, add a further hour.

DO YOU WANT TO BE A RADIO AMATEUR?

The Wireless Institute of Australia, established in 1910 to further the interests of Amateur Radio, conducts a Correspondence Course for the A O C P and L A O C P. Examinations conducted by Telecom Throughout the Course, your papers are checked and commented upon to lead you to a successful conclusion.

For further information, write to

**THE COURSE SUPERVISOR
W.I.A. (N.S.W. DIVISION)**

P.O. BOX 1066
PARRAMATTA, N.S.W. 2150.

INTERESTED IN ELECTRONICS? THEN WHY NOT TURN YOUR HOBBY INTO A CAREER?



Alan Mulraney, Stott's Graduate, in his workshop

In this fast-changing electronic world people with interest and training are going to be in demand. Turn your interest into a lucrative career in any one of the following fields:

**Computers • Industrial Controls • Medicine
Radio Communications • Domestic Radio & Television**

Electronics plays an important role in these and many other fields. With a Stott's Home Study Course, training is easy, and will prepare you for a career in the manufacture, installation, commissioning, sales or servicing of electronic equipment.

You'll have experienced, professional instructors who will guide you through an integrated theory/practical program. They'll give you individual attention and advice, and prompt replies to all test assignments and queries. And best of all, you'll study at your own pace, in your own home.

Send the coupon today. It may be the smartest move of your life.

Stotts

TECHNICAL CORRESPONDENCE COLLEGE

Melbourne, 159 Flinders Lane, 3000 Tel. 63 6212
Sydney, 383 George Street, 2000 Tel. 29 2445
Brisbane, Suite 3 65 Mary Street, 4000 Tel. 221 3972
Adelaide, 85 Pirie Street, 5000 Tel. 223 3700
W. Perth, 25 Richardson Street, 6005 Tel. 322 5481
Hobart, 1st Fl. 29 Argyle Street, 7000 Tel. 34 2399

The name to trust in correspondence education.

Please send me free, and without obligation, full details of the following courses:

_____ (PLEASE PRINT)

MR MRS MISS _____ AGE _____

ADDRESS _____

_____ POSTCODE _____

Stott's undertake that no sales counsellor will visit you

**The Stott's range of courses
in Electronics is:**

Intro to Electronics
Digital Electronics for
Technicians Servicemen
Microprocessors
AM Radio Receivers
Radio TV Servicing
Colour Television

ALA ST3596 EA10 82

DON'T FORGET TO CHECK WITH US BEFORE YOU BUY A COMPUTER OR OTHER PRODUCTS

ROD IRVING ELECTRONICS

425 HIGH STREET, NORTHCOTE 3070, MELBOURNE, VICTORIA

64K SS50 STATIC NOW AVAILABLE \$399 + tax

64K S100 STATIC NOW AVAILABLE \$399 + tax

MASSIVE PRICE CUTS ON BIG BOARD COMPUTER

16K EPROM CARD-S 100 BUSS



**\$89.50
KIT**

BLANK PC BOARD
\$49
USES 2708's

Thousands of personal and business systems around the world use this board with complete satisfaction. Puts 16K of software on line at **ALL TIMES!** Kit features a top quality soldermasked and silk-screened PC board and first run parts and sockets. Any number of EPROM locations may be disabled to avoid any memory conflicts. Fully buffered and has WAIT STATE capabilities.

OUR 450 NS 2708'S
ARE \$5.90EA WITH
PURCHASE OF KIT

ASSEMBLED
AND FULLY TESTED
ADD \$36

S100 COMPUTER PRODUCTS

32K S-100 EPROM CARD

NEW!



\$99.95

KIT
USES 2716's
Blank PC Board - \$59
ASSEMBLED & TESTED
ADD \$30

SPECIAL: 2716 EPROM's (450 NS) Are \$5.90 EA. With Above Kit,

- KIT FEATURES
1. Uses +5V only 2716 (2Kx8) EPROM's
 2. Allows up to 32K of software on line
 3. 16K S-100 Compatible
 4. Addressable as two independent 16K blocks
 5. Cromemco extended or Norstar bank select
 6. On board wait state circuitry
 7. Any or all EPROM locations can be disabled
 8. Double sided PC board solder masked, silk-screened
 9. Gold plated contact fingers
 10. Unselected EPROM's automatically powered down for low power
 11. Fully buffered and bypassed
 12. Easy and quick to assemble

*** AVAILABLE AGAIN ***



- 16K Dynamic Ram Board
- Fully Expandable to 64K
- Assembled, tested and guaranteed
- S100 Compatible

16K Dynamic RAM Board assembled and tested
Special \$269 plus tax (4Mhz) \$299 plus tax (4Mhz)
This must be the best offer available on quality tested
dynamic RAM boards

32K Assembled and tested \$289 plus tax (4Mhz)
48K Assembled and tested \$309 plus tax (4Mhz)
64K Assembled and tested \$329 plus tax (4Mhz)

16K STATIC RAM KIT-S 100 BUSS

KIT \$189
A&T \$219



- KIT FEATURES
1. Addressable as four separate 4K Banks
 2. ON BOARD BANK SELECT Circuitry Common to all Standard Banks up to 16K on line
 3. Uses 16K 450NS 2716 Static Ram
 4. ON BOARD SELECTABLE WAIT STATES
 5. Double sided PC Board with solder masked and silk screened. Being first run product, no design
 6. Address and Bank lines fully buffered
 7. Includes All parts and sockets
 8. Production is complete to order
 9. Price is for 16K of RAM
 10. Blank PC Board is not included in any Price of Kit

BLANK PC BOARD \$49

16K STATIC RAM KIT \$22

16K STATIC RAM KIT & CAPS \$29

ASSEMBLED & TESTED ADD \$30

OUR #1 SELLING
RAM BOARD!

16K STATIC RAM SS-50 BUSS

PRICE CUT!

**\$199 KIT
A&T \$219**

FULLY STATIC
AT DYNAMIC
PRICES

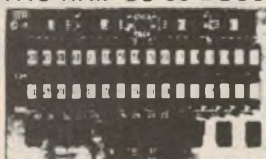

32K STATIC ALSO AVAILABLE

- KIT FEATURES
1. Addressable on 16K Boundaries
 2. Uses 2716 Static Ram
 3. Bank Full Speed
 4. Double sided PC Board Solder mask and silk screened layout Gold fingers
 5. All Parts and Sockets included
 6. Low Power Under 1.5 Amps Typical

FOR SWTPC
6800 BUSS!

BLANK PC BOARD - \$49 COMPLETE SOCKET SET -
\$22 SUPPORT IC'S AND CAPS - \$45

NOW A \$99 Computer!

Plugs into any TV!
ETI 660

No one would have dreamed of a low cost, high performance computer system that plugs into a TV! The ETI 660 is a complete system that includes a monitor, keyboard, and printer. It's the only computer system that can be used with any TV. The ETI 660 is a complete system that includes a monitor, keyboard, and printer. It's the only computer system that can be used with any TV.



As with all other products, please check the price. We expect the kit to be in stock some time in Oct 1983.

ETI636 7 SLOT MOTHERBOARD WITH ACTIVE TERMINATION
Kit of Parts \$89.00 Assembled and tested \$115.00 inc tax
RITRON COMPUTER GRADE POWER SUPPLY +5V Reg. 10A
± 16V Unreg. Kit of parts \$89.90 inc tax A&T \$109.00 inc tax
Write for kit of other power supplies. Tax free prices also available.

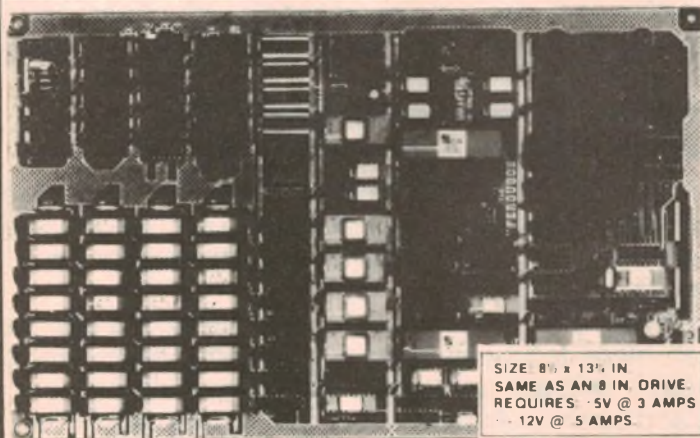

SINGLE BOARD COMPUTER KIT

NOW ONLY \$499 + TAX (17 1/2%)

Also available,
Blank PCB's with Roms Assembled & Tested
\$599 + TAX

THE FERGUSON PROJECT. Three years in the works, and maybe too good to be true. A tribute to hard headed, no compromise, high performance, American engineering! The Big Board gives you all the most needed computing features on one board at a very reasonable cost. The Big Board was designed from scratch to run the latest version of CP/M. Just imagine all the off the shelf software that can be run on the Big Board without any modifications needed! Take a Big Board, add a couple of 8 inch disc drives, power supply, and an enclosure, and you have a total Business System for about 1/3 the cost you might expect to pay.

FEATURES: (Remember, all this on one board!)

64K RAM

Uses industry standard 4116 RAM's. All 64K is available to the user, our VIDEO and EPROM sections do not make holes in system RAM. Also, very special care was taken in the RAM array PC layout to eliminate potential noise and glitches.

Z-80 CPU

Running at 2.5 MHZ. Handles all 4116 RAM refresh and supports Mode 2 INTERRUPTS. Fully buffered and runs 8080 software.

SERIAL I/O (OPTIONAL)

Full 2 channels using the Z80 SIO and the SMC 8116 Baud Rate Generator. FULL RS232! For synchronous or asynchronous communication. In synchronous mode, the clocks can be transmitted or received by a modem. Both channels can be set up for either data-communication or data-terminals. Supports mode 2 int. Price for all parts and connectors: \$65

BASIC I/O

Consists of a separate parallel port (Z80 PIO) for use with an ASCII encoded keyboard for input. Output would be on the 80 x 24 Video Display.

REAL TIME CLOCK (OPTIONAL)

Uses Z 80 CTC. Can be configured as a Counter on Real Time Clock. Set of all parts \$19

PFM 3.0 2K SYSTEM MONITOR

The real power of the Big Board lies in its PFM 3.0 on board monitor. PFM commands include: Dump Memory, Boot CP/M, Copy, Examine, Fill Memory, Test Memory, Go To, Read and Write I/O Ports, Disc Read (Drive, Track, Sector), and Search. PFM occupies one of the four 2716 EPROM locations provided. It does not occupy any of the 64K of system RAM!

Bankcard
Mail Orders
Welcome

Please debit my Bankcard
Bankcard No. _____
Expiry Date _____
Name _____
Signature _____

General enquiries (03) 489-8131. Mail order enquiries (03) 481-1436. Altronics Wholesale (03) 489-7099. (Tax Exempt Enquiries)

Prices subject to change without notice. Send 60c and SAE for free Price lists. MAIL ORDERS PO BOX 235, NORTHCOTE, Vic. 3070. Minimum pack and post \$5.00. Telex AA38897. PLEASE WRITE OR RING FOR THE BEST POSSIBLE PRICES ON DISC DRIVES, PRINTERS AND OTHER COMPUTER COMPONENTS.

Coming Next Month * * *

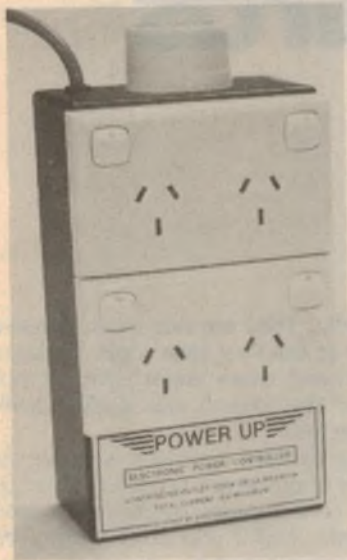

Power Controller

Called the "Power Up", this clever gadget will automatically switch on all your hifi gear whenever one item, plugged into a controlling outlet, is switched on. Build it and forget about manipulating all these separate on/off switches.

TV Distribution Systems

Held over from last month, this article describes how to provide multiple outlets for TV antennas and VCRs. It's easy - when you know how!

TI-99/4A colour computer

Texas Instruments' new TI-994A colour computer should prove a hot competitor in the under \$500 home computer market. Don't miss our in-depth review in next month's issue.

ON SALE:
Wednesday, November 3rd

* Our planning for this issue is well advanced but circumstances may change the final content. However, we will make every attempt to include the articles mentioned here.

Software for the Super-80 Computer

\$5.00*

An "Electronics Australia" publication

"Software for the Super-80" was compiled from submissions to the Super-80 Software Competition judged earlier this year. The book has 48 pages, of the same size as this magazine, featuring 17 Basic programs in printed listing form. They represent a useful range of exercises which will be of use to all Super-80 owners.

Available from "Electronics Australia", 57 Regent St, Chippendale. PRICE \$5.00 OR by mail order from "Electronics Australia", PO Box 163, Chippendale, 2008. PRICE \$5.00 plus \$1.00 for packaging and posting anywhere in Australia.

Here Are The Program Headings:

- | | |
|----------------------------|----------------------------------|
| 1 Poker machine simulation | 10 Lotto number selector |
| 2 Printing demonstration | 11 Triangle solutions |
| 3 Calendar calculator | 12 Mortar attack game |
| 4 Othello game | 13 Caves & Monsters |
| 5 Investment analysis | 14 Amateur radio Q-code tutorial |
| 6 Guessing game | 15 Caravan park directory |
| 7 List and sort | 16 Super Pokey game |
| 8 "Fred the shrink" | 17 Tattsлото selector |
| 9 Simple maths drill | |

To: Electronics Australia, PO Box 163, Chippendale, 2008

Please send me _____ copies of "Software for the Super-80 Computer" at \$6.00 each (includes post and packing)

NAME

ADDRESS

..... POSTCODE

I enclose cheque/postal order to the value of \$

Please charge my Bankcard \$

Bankcard Number 496

Expiry Date Cardholder Signature

If you are using Bankcard, be sure to include your full address (not a PO Box)

From design to printed circuit:

Prototyping boards make life easy

Just how does the modern experimenter go about developing an experimental circuit? How do we here, at Electronics Australia, set about converting somebody's brainwave into a working electronic circuit? With the complexity of modern circuitry, many of the time honoured methods are no longer appropriate, having been replaced by quicker and easier methods.

Once upon a time, in the days of simple circuits — well, relatively — and discrete components (valves even!) mocking up an experimental circuit was comparatively easy. One simply strung the various components together by soldering their terminals to convenient lengths of wire, sometimes involving four or five connections to one terminal, or even a "mid-air" junction.

The result was never a thing of beauty; in fact, it was commonly referred to as a "bird's nest", or even a "rat's nest" if one wanted to be particularly disparaging. But appearance wasn't the point; the point was to prove the validity of the circuit concept or, if it didn't work, to change it until it did.

Unfortunately, making changes was not always that easy. With four or five leads it was always the one buried deepest in the solder which needed to be changed, with the result that the whole junction flew apart and had to be re-made. A messy process at best.

Worse still was one's tentative attempt to add just one more wire to a mid-air junction already terminating four or five leads. With care, it was possible to apply just enough heat to melt a tiny area of solder and tack on the new lead without disturbing the existing junction. But if one applied too much heat . . . splat; solder and leads flew in all directions.

Even so, it wasn't too bad while components were relatively large and had only a few connections to them. But as they became smaller, and ICs appeared with centipede-like leg assemblies, the old soldering approach became impractical. Try soldering four or five leads to a single IC leg and see how you get on. Worse still, try changing one of the connections to modify the circuit and you'll find yourself in real trouble. And, apart from anything else, it takes time to make soldered connections, even if everything doesn't fly apart.

So what's the answer? Well, we still build bird's nests, but much more scien-

tifically. They are not much prettier to look at, but they are a whole lot easier to build and, more importantly, to modify when the original idea doesn't work as expected.

The modern approach is to use some form of prototype board of which there are several sizes available, in several brands. And if you don't know what a prototype board is — well that's why we are writing this article. Some idea of what it looks like can be gleaned from the photographs, and we will try to fill you in on the mechanical details and how to use it.

As can be seen from the photograph, a typical board assembly may consist of three separate boards; a narrow board top and bottom, with a larger board in between. The narrow boards have two horizontal rows of holes, in groups of five, and the large board has two rows of holes in vertical groups of five, with a gutter between them.

Each hole is, in fact, a precision socket with nickel plated contacts designed to accept typical component pigtailed between 0.3 and 0.8mm diameter (22 to 30SWG), or IC legs. And in the latter regard the sockets are spaced to match the standard 0.1in separation for IC pins.

But the most important aspect of these sockets is that they are connected together in convenient groups, thus pro-

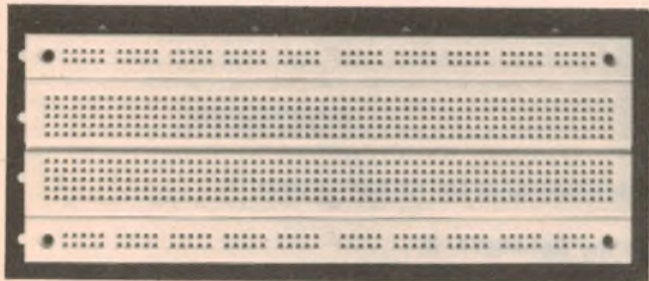

The WB-1 prototype board shown above can accommodate seven 14-pin ICs. Price is \$17.40 from Ellistronics Pty Ltd.

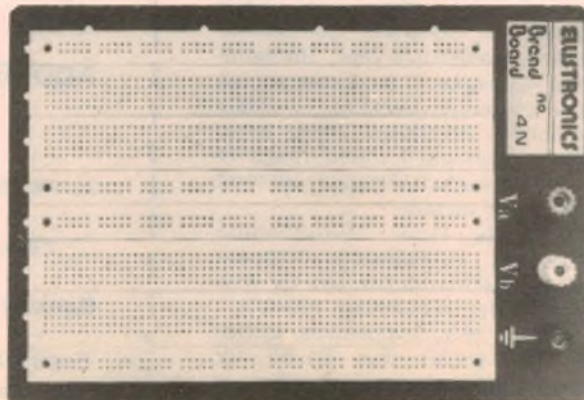

The model 4N provides twice the area, baseplate and terminals, for less than twice the price — \$27.60.

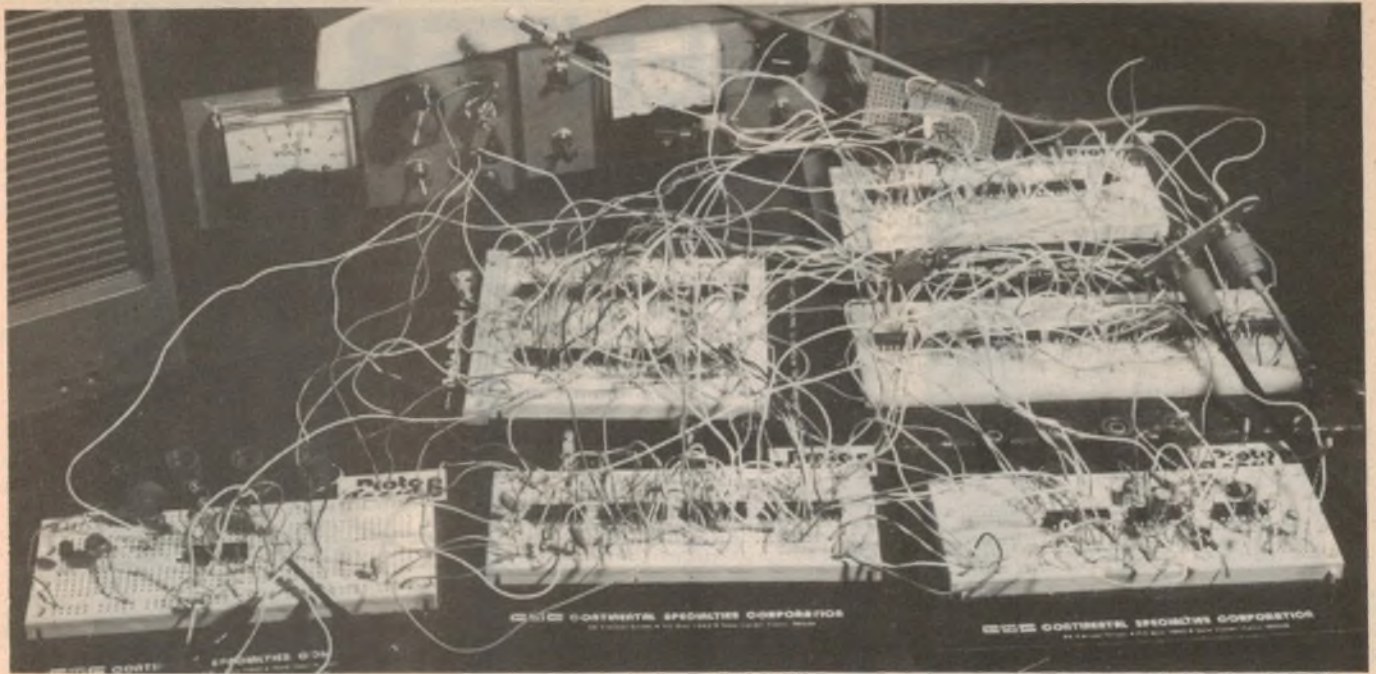

"Rats nest": working prototype of our Large screen Storage CRO Adapter (EA, February 1982).

viding the means to connect several leads or pigtails together with no more effort than pushing them into the appropriate sockets. In the case of the main board each vertical group of five holes is connected together and, in the two narrow boards, the connections are made horizontally, both within the groups of five and between them.

However, each of the two runs in these boards is separate from the run above or below it, and each run is broken at the centre. These runs are usually used as supply rails and the break in the centre may be used to insert de-coupling components, such as resistors or chokes.

Typically, the bulk of the circuit would be built on the large, main board, with the ICs fitted horizontally, straddling the gutter. In the case of the board illustrated, some seven, 14 pin, ICs could be accommodated along the gutter, which would imply a fairly complex circuit.

And once the IC is fitted across the gutter, each leg has four vacant contacts connected to it, making it a simple matter to connect this number of leads to it. In practice, many more than four connections can be made to any one point, as more groups of holes are brought into use to accommodate individual components.

Interconnecting leads are best made from single strand plastic insulated wire — not stranded hookup wire — within the gauge limits already mentioned. An excellent source of such wire is an odd length of multicore telephone cable, such as two-pair (four conductors), six-pair (12 conductors), or larger if you can get it. The larger groups have the advantage of a larger range of colours. Short lengths are available from component retailers, or you may be able to cadge

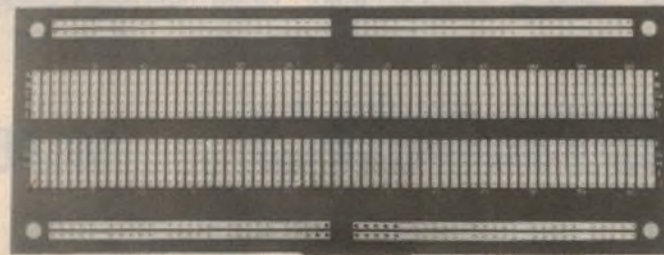

For prototypes that may come in for rough handling, these printed boards offer convenience and ruggedness.

some from your friendly Telecom technician.

The board we have used for illustration is about the minimum configuration needed for serious experimental work, but larger versions are available. A double arrangement of this board is a popular size, and is available mounted on a metal ground plane, to provide a measure of shielding, and fitted with power supply terminals. And, if this isn't big enough, several boards can be used.

As we implied earlier, this is the system we now use, almost exclusively, in the EA workshop, to convert someone's pencilled circuit into a working prototype. Not only is it quick and easy to set up, but equally easy to modify. And make no mistake, few circuits work exactly as intended first time; they usually need many hours work to achieve the desired result.

What is usually regarded as our biggest "bird's nest" was that created in developing the Large Screen Storage CRO Adapter, described in the February 1982 issue (File No 7/C/35). This involved no less than six prototype boards, 40 ICs, and a host of resistors, capacitors, and other minor components. It looked horrible, but it worked, and was subse-

quently built up on the printed board we presented to our readers.

There are a number of variables in the actual prototype board hardware available. Some brands offer gold plated contacts as an option over the nickel plated variety, and some offer different terminal arrangements on the metal ground plane.

There are also printed board versions, and the one illustrated is identical in size, and uses the same "circuit", as the board already described. The main purpose of this version appears to be as an intermediate prototype between the bird's nest and the final printed board.

Such an intermediate stage is not usually necessary, but may be desirable where a prototype needs to be extensively field tested. A bird's nest may be good enough to evaluate performance on the bench, but would hardly stand up to rough handling likely to be encountered away from the workshop.

So there it is. If you are a serious experimenter, but haven't tried the prototype board yet, you are in for a pleasant surprise. Our bet is that you will try your hand at a lot more circuits, and a lot more variations, when you find just how easy it is to try them out this way. ☺

EXPERIMENTER KIT

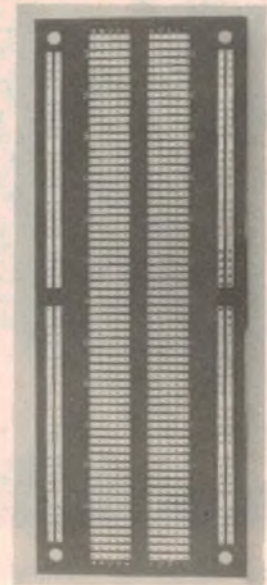
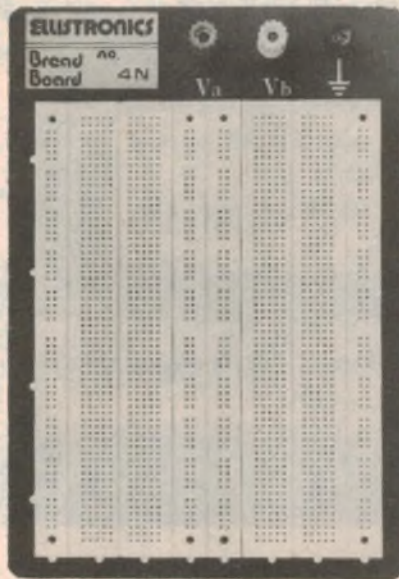
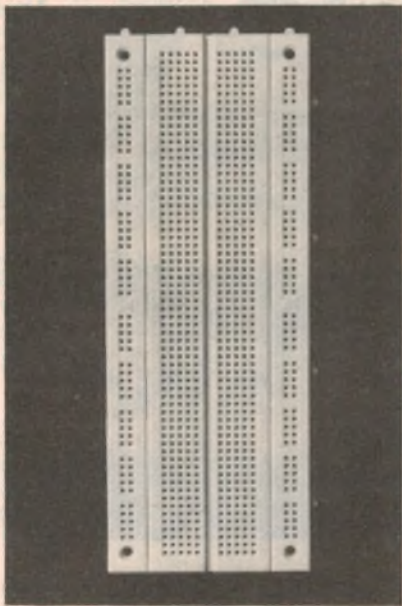

SPECIAL PRICE IN CONJUNCTION WITH ELECTRONICS AUSTRALIA
COMPETITION — \$11.75

ELECTRONICS SOLDERLESS BREADBOARD

Designed around two interlocking modular units, the WBDN is a distribution strip for power etc. and contains 100 contacts grouped in clusters of five. The WBTN is the terminal strip containing 640 contacts in two separate rows of five intercon-

nected contacts each separated by a .300" median. Contacts are made from non-corrosive nickel silver alloy and are reliable for more than 10,000 insertions. The boards accept all DIP size including RTL, TTL, DTL, CMOS and most passive

devices and interconnect with 20 to 29 awg solid wire. All boards are interlocking and elements are mounted on ground plane. Ideal for H.F., High Speed, Low Noise application.

		RETAIL PRICE
WBDN	Distribution Strip	\$1.80
WBTN	Terminal Strip	6.80
WB2N1	1 Distribution + 1 Terminal Strip	8.35
WB2N	2 Distribution + 1 Terminal Strip	10.30
WB2NB*	2 Distribution + 1 Terminal Strip	14.50
WB4N3*	1 Distribution + 2 Terminal Strips	17.00
WB4N1*	3 Distribution + 2 Terminal Strips	20.50
WB4N*	4 Distribution + 2 Terminal Strips	23.00
WB6N*	5 Distribution + 3 Terminal Strips	31.50
WB8N*	7 Distribution + 4 Terminal Strips	44.50
WB16N*	10 Distribution + 8 Terminal Strips	83.50
WB24N*	20 Distribution + 12 Terminal Strips	126.50
Experimenter Board	A drilled and etched circuit board to match WB2N	1.60

*WB2NB thru to WB24N are mounted on an aluminium base plate complete with non scratch rubber feet and appropriate binding posts.

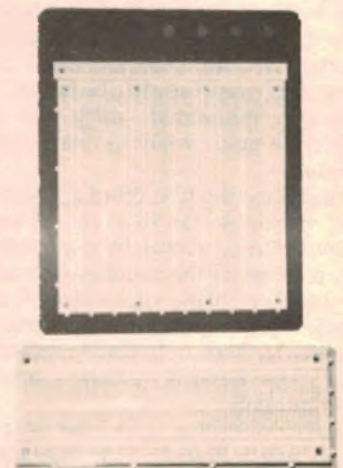

Available from: **VICTORIA:** Rod Irving (03) 489 7099 Kalex (03) 458 2976 Truscott Electronics (03) 723 3860 Billco (Project Electronics) (03) 791 8655 Ballarat Electronic Services (053) 359 584 **SOUTH AUSTRALIA:** Electronic Equipment (08) 212 5999 **WESTERN AUSTRALIA:** Altronics (09) 328 1599 Atkins Carlye (09) 277 0511 **NEW SOUTH WALES:** Electronic Developments (02) 438 2500 Jaycar (02) 264 6688 Bill Edge (02) 745 3077

ALL PRICES PLUS 20% SALES TAX

Win this CRO

EA/Ellistronics Sculpture Contest

"Electronics Australia" and Ellistronics are determined to put a little art into electronics. We are looking for the most artistic "creation" that can be produced on a prototype breadboard, using junk-box components — like our sculpture shown below, tentatively titled "Obe-wan Kenobe versus the Sandworm of Krakos".

Judging will be on the basis of a black and white photograph of your art-work — *don't* send us the actual work! We'll be looking at originality rather than the complexity of the design so there's no need to spend up big. Your entry must be on a breadboard though.

Entries will be judged by the editorial staff of "Electronics Australia" and chance plays no part in the competition. Entries will close on 31st December 1982 and the winners will be notified and their names published in a later issue.

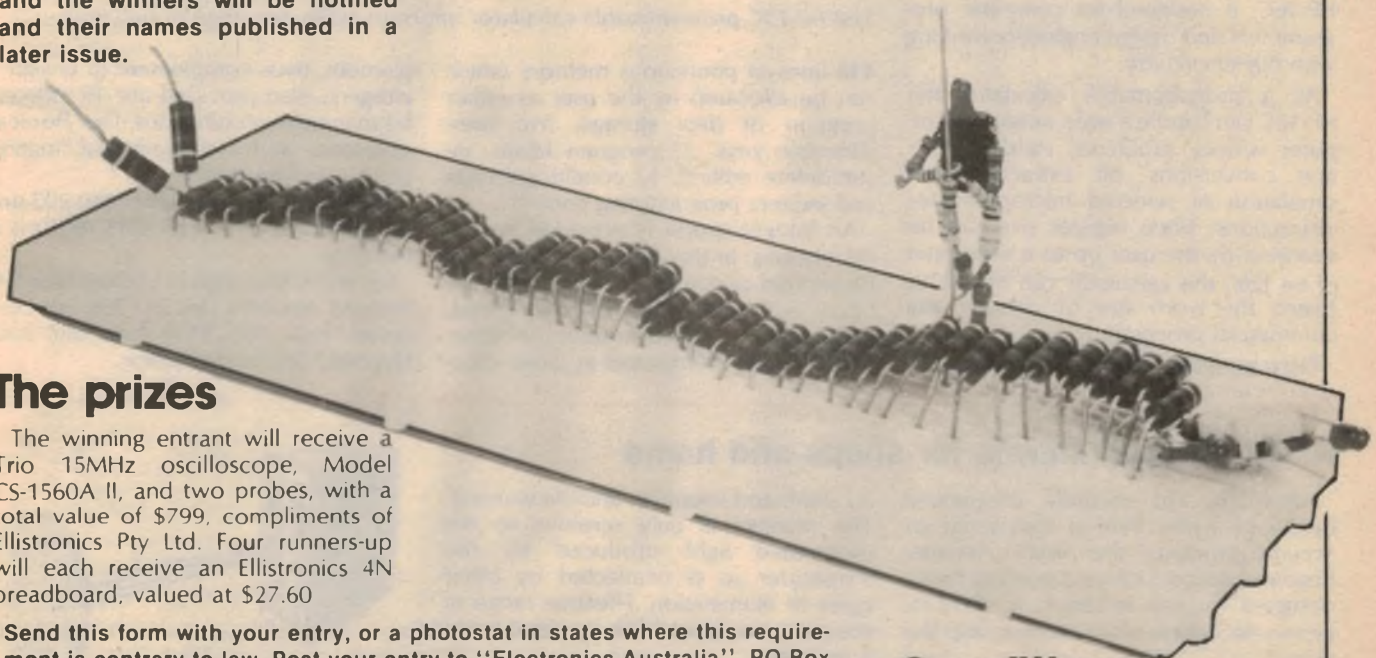

The prizes

The winning entrant will receive a Trio 15MHz oscilloscope, Model CS-1560A II, and two probes, with a total value of \$799, compliments of Ellistronics Pty Ltd. Four runners-up will each receive an Ellistronics 4N breadboard, valued at \$27.60

Send this form with your entry, or a photostat in states where this requirement is contrary to law. Post your entry to "Electronics Australia", PO Box 163, Chippendale, NSW 2008. To arrive before 5pm, December 31, 1982.

NAME:

ADDRESS:

Post Code

Conditions

The prizes are not redeemable for cash. The decision of the judges is final and no correspondence will be entered into. All entries become the property of "Electronics Australia".

Employees, and their immediate families, of Magazine Promotions Pty Ltd, John Fairfax and Sons Ltd or Ellistronics Pty Ltd and their associated advertising agencies are not eligible to enter the competition.

New Products ...

Product reviews, releases & services

Two new calculators from Hewlett Packard

Hewlett-Packard has introduced two new programmable calculators, the HP-15C, and the HP-16C, designed for computer programmers and digital design engineers.

Both calculators feature a compact design with a liquid crystal display, low power consumption, continuous memory, and built-in self test. The new HP-15C has a wide range of built-in functions for maths, science, and engineering applications. Matrix and complex number operations, for example, are built-in.

Up to 64 matrix elements, distributed among five different matrices, can be stored in the calculator's memory. Other functions including arithmetic and exponential, logarithmic, and hyperbolic functions operate on complex or real numbers. Other features are an "integrate" function and conventional maths, scientific, and statistical operations on the one calculator.

The second new calculator, the HP-16C, is designed for computer programmers and design engineers working with digital circuitry.

As a programmable calculator the HP-16C can handle a wide range of computer science problems, including format conversions, bit extraction and simulation of selected microprocessor instructions. Since register size can be specified by the user up to a maximum of 64 bits, the calculator can be set to match the word size of virtually any commercial processor.

Programming features include up to

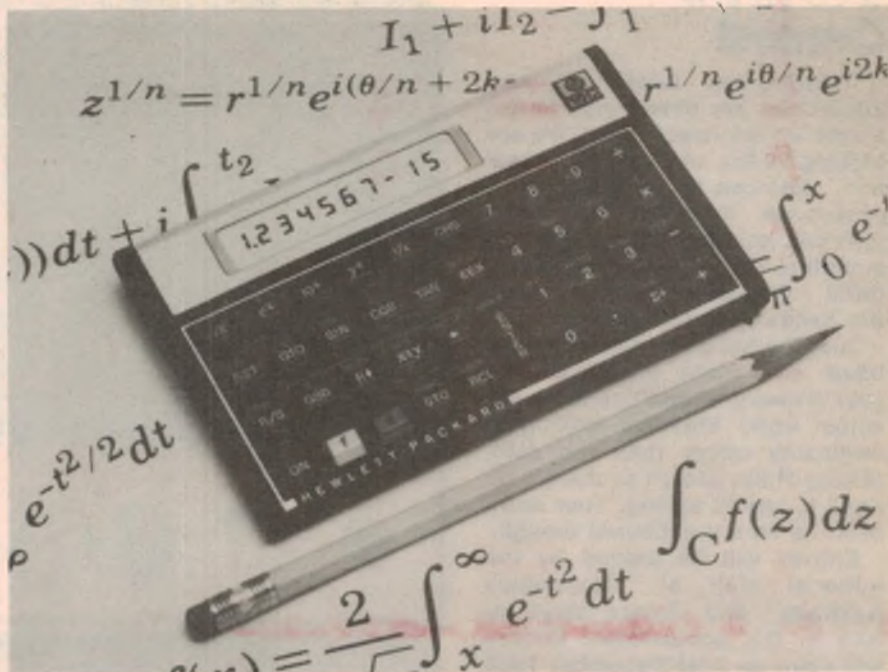

The HP-15C programmable calculator offers an extensive range of functions.

448 lines of continuous memory which can be allocated by the user as either program or data storage, five user-definable keys, 25 program labels, insert/delete editing, 12 conditional tests and indirect programming control.

An integer mode is provided for bit calculations. In this mode, numbers can be entered or converted in four different bases — hexadecimal, decimal, octal, and binary. Users can select whether numbers are interpreted as ones com-

plement, two's complement or unsigned integers. Also provided are 18 different bit manipulation functions, four Boolean operators, and a conventional floating-point calculator mode.

The calculator can retain up to 203 program lines or 101 16-bit data registers in memory.

For more information contact Hewlett-Packard Australia Ltd, PO Box 36, Doncaster East, Vic 3109 or your local Hewlett-Packard distributor.

Arlec infrared alarms for shops and home

Arlec Pty Ltd recently announced details of a new item in their range of security products, the AM471 Security Beam; a compact infrared warning beam designed for use in shops, medical or factory reception areas, studios, and the home.

The security system consists of a solid state transmit and receive unit which projects a modulated beam of IR radiation across the passage way or area to be protected. A prismatic reflector opposite the transmitter reflects the beam to the receiver to complete the security circuit.

An interruption of the beam will trigger

an alarm and sound an audible warning. The receiver is only sensitive to the modulated light produced by the transmitter so is unaffected by other types of illumination. Effective range of the system is adjustable between 0.5 and 8 metres.

Power for the unit is supplied from the mains via a 9V AC adapter. Installation is simplified because the transmitter and receiver is contained within one unit, allowing all wiring to be confined to one side of the secured area.

The AM471 is supplied complete with the transmit/receive unit, an adjustable mounting bracket, reflector, AC adapter,

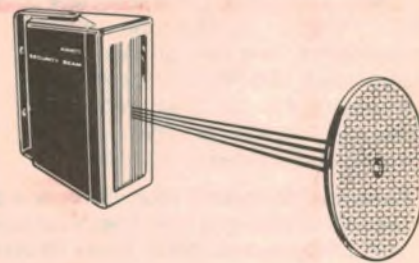

The Arlec infrared security system.

sound generator and 20m of connecting wire.

For more information contact Arlec Pty Ltd, 30 Lexton Rd, Box Hill, Vic 3128 (03) 840 1222.

SAVE A FORTUNE ON SCANNERS

Why pay \$500 or more for a scanning receiver? Dick Smith has them from \$285! Get into the exciting world of scanning - it's the latest and fastest growing hobby in the world!



★ The new **DICK SMITH PRO 40 SCANNER**

NOW IN STOCK!!!

Compare with similar performance elsewhere at nearly twice the price! The new PRO 40 Scanner from Dick Smith represents the state-of-the-art in computerised scanning receivers!

- ★ Completely solid state computer-controlled circuitry — no expensive crystals to buy — complete with backup battery for stored frequencies.
- ★ Specially prepared Australian instruction manual (written and produced by our own engineers). Other scanners often have hard-to-understand foreign instruction manuals.
- ★ Touch-type splashproof keypad for direct entry of all operational commands, frequencies etc.
- ★ Ideal as either a base or mobile scanner (operates from 12V — beware of others that don't operate from 12V!) with its own self-contained whip antenna or external plug-in antenna.
- ★ Complete with mobile mounting bracket and DC power cable.

LOOK AT THESE SPECIFICATIONS:

Frequencies covered	68 to 88MHz — 136 to 174MHz — 360 to 512MHz
Scanning steps	5, 10, 12.5, & 25kHz (depending on band)
No. of channels	40
Power supply	12 to 16 volts DC (battery memory backup 9V)
Scan rate	Approx 18/sec
Cat D-2805	

AND LOOK AT OUR LOW, LOW PRICE

★ **\$399** \$9.27 per week ★



FAMOUS BEARCAT 20/20 SCANNER

Catch all the action with this incredible receiver! It covers most of the VHF and UHF bands.

Listen to ... Aircraft, amateurs, pagers, business radio, marine and harbour, UHF CB, taxis and more. Cat D-2810.

\$485 ONLY \$11.27 per week

TOP NAME

BEARCAT 150 FB SCANNER

Listen to an amazing range of stations — ones you never get to hear. It's the latest hobby all over the world, and it's now in Australia.

You can hear ... Fascinating broadcasts, emergency services, taxis, ambulances, security patrols, aircraft, satellites and more.

Cat D-2800 **\$285** \$6.62 per week

EXCLUSIVE TO DICK SMITH

\$12⁹⁵

Dick Smith's Australian Radio Frequency Handbook

Now available for the first time in Australia, up-to-date and thorough listing of virtually all the VHF/UHF radio users we've been able to find. Yes — find out who is where — and where to listen for all the excitement! Plus much more information besides — air band, manne band, how to use a scanner, amateur radio and CB, etc. It's a MUST for anyone interested in radio or electronics. Where else can you get this sort of information?



Cat B-2323

DICK SMITH ELECTRONICS

SAVE \$\$\$

HORNET II 40 ch AM/SSB

The latest in 40 channel CB technology. The quality of this unit is even better than the high standard set by its predecessor, the Hornet I, our most popular CB ever!

ONLY \$239⁵⁰



Cat D-1710
DOC APP
NO 249A006



Terms offered above are to approved applicants over a 12 month period.



The stores below stock this complete list of Dick Smith Amateur Radio equipment. All other Dick Smith stores stock some amateur equipment but may not be able to give you the service of 'Ham Shack' stores listed.

- ★ Sydney 125 York St 290 3377 ● Sydney 6 Budge St. 27 5051 ● Gore Hill 162 Pacific Hwy 439 5311 ● Melbourne 399 Lonsdale St. 67 9834 ● Springvale cnr Springvale & Dandenong Rds. 547 0522 ● Richmond 656 Budge Rd. 428 1614 ● Buranda 166 Logan Rd. 391 6233 ● Cherside 842 Gympie Rd. 59 6255 ● Perth 414 William St. 328 6944

New Products

Maintenance free industrial batteries

Chloride Batteries Australia has announced the release of a maintenance-free series of industrial batteries, the Exide RE Systems Battery Series. Based on the recombination electrolyte principle, the batteries are completely sealed, and offer a number of advantages to the user. (Refer. "A True Maintenance Free Battery", EA, January 1982.)

Chloride claim that after the battery is discharged to zero potential (usually a disastrous accident) it will recharge with little or no loss of capacity. It is also highly tolerant of overcharging, and will hold a charge in storage for 18 months or more at 25°C ambient temperature.

Claimed life is up to 1200 charge/discharge cycles and five to six years float service life. The one battery

can thus provide both standby and charge/discharge cycling duty.

The new series batteries are completely sealed, releasing neither gas or acid. There is no need for "topping up" — in fact there is no way into the battery at all.

Electrolyte is held in close contact with the plates by absorbent separators of specially produced felted fibreglass so there is no free electrolyte in the battery. This last feature has won the Exide RE series approval by the Department of Transport for carriage on aircraft — an important factor for makers and users of battery powered equipment such as wheelchairs.

Batteries of the RE Series range from 6V models providing from 1.2 to 10 ampere-hours and 12V models with from 1.2 to 24 ampere-hours storage. Additional models are in development.

For more information contact Chloride Branch offices in all capital cities or the head office at 147-149 Woodpark Rd, Smithfield, NSW 2164.

Applicator for thermoplastic adhesives

The Homelec Gluefix 2000 glue gun offers a convenient way of applying thermoplastic adhesives for hobbyists, servicemen, and home handymen.



The glue gun uses solid sticks of glue which are melted by an electrically heated nozzle as it is applied to the job. It is powered from a 100-240V supply and is double-insulated for safety.

Applications include tile fixing, carpentry and home repairs, hobbies, arts and crafts. It is one of the few methods of gluing plastics. Although recommended for use with ceramics it may be less useful here, as it is not possible to achieve an invisible join with the hot glue.

Apart from the strength of the bond created, advantages of the glue gun include mess-free application of precise amounts of glue and the speed with which a neat, professional job can be performed. Price is around \$20, including four sticks of glue, with an eight piece pack of replacement glue sticks at \$1.75.

The Homelec Gluefix 2000 is available from hardware stores in all states.



Just part of the range of Exide maintenance-free industrial batteries.



DAVID REID ELECTRONICS

**IF YOU'RE INTO ELECTRONICS
COME IN AND SEE US!**

WE'RE A POSITIVE FORCE IN SYDNEY AND THE LARGEST
ELECTRONICS DISTRIBUTOR IN NEW ZEALAND — WITH
THOUSANDS OF ELECTRONIC PRODUCTS, COMPONENTS AND
ACCESSORIES

YOU'LL SEE THE SIGN

DAVID REID ELECTRONICS LIMITED

Takapuna • Auckland City • Te Papapa
Hamilton • Palmerston North • Lower Hutt
Wellington • Christchurch • Dunedin

NORRIE 1476

Spectrum Control RFI filters from Rifa

The Spectrum Control range of RFI filters is now available from Rifa Pty Ltd.

With the increasing awareness of the problems of radio frequency interference, these products should find a ready market. The Spectrum Control range includes hermetic seal filters and capacitors, connector contact filters, multi-circuit filters, knitted wire shielding gaskets, ventilation panels which provide shielding from interference and many other products designed to solve EMI problems.

For more information on the Spectrum Control range contact Mr W. Scott, Rifa Pty Ltd, 202 Bell St, Preston, Vic. Phone (03) 480 1300.

JAYCAR QUALITY MEANS PERFORMANCE RESULTS

FROM \$495

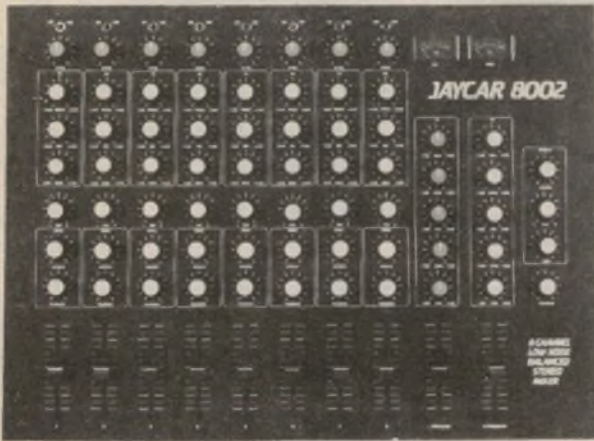

8 CHANNEL MIXER KIT

The Jaycar 8002 Mixer was originally conceived to be the successor to the very popular ET1414 Master Mixer. The 414 was basically configured as a 'stage' mixer and suffered from a number of severe technical limitations - notably poor signal-to-noise figures. Enormous advances in Audio IC's have occurred since the 414 was designed. Jaycar engineers have taken advantage of this. The incredibly low noise and distortion figures of the 8002 are a testimony to the sound basic design of the mixer coupled with the performance capability of these IC's. Whilst the 8002 is the ideal 8 channel compact stage mixer, other applications have been kept in mind. AS A "STUDIO" MIXER. The prime requirement of a studio mixer is that it must be quiet - i.e. have good S/N. Due to the fact that the "miracle" 5534 IC's are used in the 8002 studio applications are entirely feasible. In addition to this, metal film resistors are used in critical signal areas. AS A DISCO MIXER. The balanced input feature of the 8002 is not really necessary for disco use. This section can easily be bypassed with either a moving magnet (Dynamic Cartridge) preamp, or a mixing coil preamp. The sensible format of the 8002 and tremendous equalization facilities should make this mixer popular for disco use.

- Balanced (600 Ohm) Mic. Inputs/Line Inputs.
- Cannon Connectors included in the price.
- Bass, Mid & Treble Equalization on each Input.
- "Effects" (i.e. Echo etc.) capability.
- Foldback and Stereo Pan on ALL 8 Inputs.
- 60mm Slide Faders used throughout.
- 19" Rack Mount capability (or Console Mount).
- Professional Black Front Panel with Format borders & multi-coloured knobs to assist function identification.
- VU Metering.

Send SAE for full details + details on use as stage mixer

"BLACK MONOLITH"



ONLY \$299

Once again, imitation is the sincerest form of flattery. The Black Monolith 5000 Mosfet Power Amp has the following EXCLUSIVE features:

- Beryllium Oxide (Space Age ceramic) TO 3 washers. (Not flimsy mica!)
- Jig drilled and extruded heavy gauge, anodized heatsink bracket.
- SUPERFINISH front panel. STILL THE BEST now with blind tapped holes.
- New heavy duty heatsinks for the driver transistors. 100% extra heatsink area and black anodized for greater efficiency. (Not in original design)
- Ventilation holes in metalwork at critical points. (Not in original design)
- Extra 3 pin DIN socket on rear panel (total 2) to power new 5000 components. (1/3rd Octave 5000 series Equaliser coming soon!). Not in original design but now a must with the new additions in the family.

IF YOU THINK THAT YOU CAN SAVE MONEY ON THESE KITS ASK YOUR SUPPLIER IF HE WILL GIVE YOU ALL OF THESE FEATURES AT THE PRICE MAKE SURE THAT YOU GET IT IN WRITING!!

A PRICE RISE ON BOTH KITS (i.e. SALES TAX AND METALWORK ETC) IS EXPECTED SOON! BUY THE BEST FOR NO MORE.

Write in (SAE) for a new glossy leaflet on both amps.

SPECIFICATIONS

POWER OUTPUT Around 100W RMS into 8 ohms
FREQUENCY RESPONSE 8Hz to 20kHz, +0 - 0.4dB
 2.8Hz to 65kHz, +0 - 3dB
 Note: these figures are determined solely by passive filters

INPUT SENSITIVITY 1V RMS for 100W output
HUM -100dB below full output (flat)
NOISE -116dB below full output (flat, 20kHz bandwidth)
2nd HARMONIC DISTORTION <0.001% at 1kHz (0.0007% on prototypes) at 100W output using a +56V supply rated at 4A continuous <0.003% at 10kHz and 100W
3rd HARMONIC DISTORTION <0.0003% for all frequencies less than 10kHz and all powers below clipping
TOTAL HARMONIC DISTORTION Determined by 2nd harmonic distortion (see above)
INTERMODULATION DISTORTION <0.003% at 100W (50Hz and 7kHz mixed 4:1)
STABILITY Unconditional

"BLUEPRINT"

5000 PREAMPLIFIER

"One Swallow does not make a spring"

Neither does a few gold RCA sockets!

Several of our competitors are imitating our "Blueprint" preamp by adding a few bits and pieces, notably gold plated RCA sockets to their standard kits. Unfortunately they have missed the point. We supply gold plated sockets in our "Blueprint" preamp but only where it makes sense to do this, i.e. on the inputs - NOT the outputs. 16 gold sockets are provided by us. This, however, does not make a "Blueprint". THIS DOES:

- Low capacitance screened cable - 12 metres of it. NOT Taiwanese cable as supplied in other kits. Our cable costs us NEARLY 5 TIMES MORE than the Taiwanese stuff!
- Original ETI designed front panel. Not an "ADAPTION". Our front panel is by far the nicest!
- Factory pre-tinned PCB's to reduce chances of dry or noisy solder joints.
- Quality LEDs, polished finish, multicoloured display
- IC sockets on line amp board
- Special rear panel
- Special low noise selection LM394H NDT CH device in M.C. preamp.
- Thermalloy (U.S. made) heatsink on 7805 regulator.
- English Lorlin selector switches
- Apart from the 16 gold RCA's we throw in a pair of gold plated line RCA plugs - worth \$5
- Special Nylon rear panel grommets

So don't "Swallow" the facts before they are properly digested!! You can't make a silk purse out of a sow's ear. Send SAE for full specs.



BLUEPRINT \$275

SPECIFICATIONS

Frequency Response High level input: 10Hz-120kHz, 10 - 1dB
 Low level input: conforms to R.I.A.A. equalisation +0.2dB (see detail on phone spec.)
 1kHz: 0.002% on an input level of 100mV (measured on measuring equipment due to noise limitations)
Distortion High level input: master full, with resistors to 300mV input level at full output (1.2V)
 92dB flat, 100dB A weighted
 MC input: master full, with respect to full output (1.2V) at 50mV input (100 ohm source) resistance connected 86dB flat
 92dB A weighted
 MC input: master full, with respect to full output (1.2V) at 200mV input signal 71dB flat 75dB A weighted

ETI 478MM Moving Magnet input stage Gain 10x
 Approx. 10 R.I.A.A. Equalisation +0.2dB
Frequency Response 0.001% 1kHz, 10mV RMS input
Total Harmonic Distortion 2dB with respect to 5mV RMS input signal, i.e. 120mV RMS
Noise Total equivalent input noise: 122mV /A, input shorted, 2.8mV flat, input shorted
 10V, 3mV, 10mV
S/N ratio Flat 75dB 87dB 93dB
 A-weighted 78dB 92dB 95dB

ETI 478MC Moving coil input stage Gain 20
 7Hz - 120kHz 0 - 1dB
 0.002% 1kHz, 30mV input
Frequency Response 0.002% 1kHz, 30mV input
Total Harmonic Distortion 10dB equivalent input noise
Noise 82mV /A, input shorted
 42mV /A, input shorted
 18mV flat, after R.I.A.A. eq. input shorted
 18mV /A, after R.I.A.A. eq. input shorted

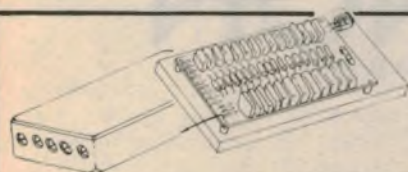

Ioniser Kits

from \$15

NOW AT "NEVILLE'S CORNER" CNR CARLINGFORD & PENNANT HILLS RD. NEXT TO KENTUCKY FRIED CHICKEN - PHONE 872 4422

Bulk component purchasing has enabled us to permanently reduce our prices. SHORT FORM KIT. Get up and running at low cost. Capable of generating intense electric fields from 240V supply. Parts supplied include: PCB, all capacitors, diodes, resistors, mains plug, cord, fuse stand, offs and baseboard. Will work as ioniser but case and higher efficiency emitter head not supplied.

WAS \$24.50 NOW ONLY \$15.00!!
 SAVE NEARLY 40%

FULL KIT. Similar to above except that fully pre-drilled quality ABS case and high efficiency emitter head included! Construction takes less than 2 hours and you end up with a built-up unit that compares with units well over \$100!! We sold 00's at \$45 but now - \$29.50. Save nearly 35%

SAVE NEARLY 35% - ONLY \$29.50

JAYCAR

125 YORK ST SYDNEY 2000
 Ph. 2646688 Telex: 72293
 Mail Orders To:
 Box K-39 Haymarket 2000

POST AND PACKING CHARGES
 \$5.99 (51.20) \$10.24 (99.15) 40
 \$25.49 (99.15) 50 \$50.99 (99.15) 40
 \$100 (99.15) 20

NEW SHOP HOURS
 Mon. F.R. 8.30 to 5.30pm
 Sat. 8.30 to 12.00pm
 Thurs. night 8 to 10pm

The change to excellence in sound...

TU - 750

TU - 710

PMA - 750
80W + 80W

PMA - 710
40W + 40W

DR - F7

DR - 170

needn't cost you a fortune.

Denon, the name associated worldwide with professional audio equipment has available in Australia their range of high quality integrated stereo amplifiers, tuners and cassette tape decks, incorporating the most advanced features at competitive prices.

High performance amplifiers, analog and digital tuners, and cassette tape decks featuring both Dolby "B" & "C", are the result of 30 years of research and technology, offering you the

ultimate combinations of performance, reliability and cosmetic styling.

See the exciting range of amplifiers, tuners and cassette decks at your Denon dealer now, you'll find their prices rather exciting as well.

DENON

Professional Audio Brand.



AMALGAMATED WIRELESS (AUSTRALASIA) LIMITED

554 Parramatta Road, Ashfield, NSW 2131 Phone 797 5757

Canberra
80 5200

Melbourne
560 4533

Launceston
44 5155

Adelaide
272 2366

Brisbane
44 1631

Townsville
79 6155

Perth
271 0888

New Products

Wattmaster Alco digital time switch

Wattmaster Alco Pty Ltd has released a new model in its range of digital electronic time switches. The "Digital 2" from Wattmaster is said to be the first portable digital electronic time switch on the Australian market.

The unit is capable of 12 programmable switching instructions, which can be selected on a daily or weekly basis or for several days in succession. Using this last feature, switching instructions for a number of days can be entered without affecting memory capacity.



Portability is achieved by the use of an adapter plug which provides power for the switch unit as well as for the device being switched. Switching capacity is 10A at 240V.

The Digital 2 can operate attached equipment for any period from one minute to 24 hours, and is programmed in increments of one minute. It is said to be ideal for any application requiring accurate switching for up to one week in advance.

For further information contact Mr Jon Cronly, Wattmaster Alco Pty Ltd, 11 Rachel Close, Silverwater, NSW, 2141. Phone (02) 648 1332.



40-channel CB from Standard Components

Standard Components Pty Ltd has announced the release of the Electrophone Model TX470 UHF 40-channel transceiver.

Designed by Cybernet, Japan, the TX470 is said to be ideally suited for mobile installations such as in trucks and farm equipment. It has been extensively tested under field conditions.

The TX470 also makes provision for the fitting of Selcall or Quiet Line facilities, which allow only specially coded calls to be received.

A compatible command module, the GB590, is also available, providing a built-in power supply, front mounted loudspeaker and a clock.

For more information contact Standard Components, PO Box 174, Leichhardt, NSW, 2040.

Extruded aluminium instrument cases

A range of panel mounted instrument cases of extruded aluminium are now available from Amalgamated Instrument Co. Five sizes are available, with perspex or aluminium front panel inserts and internal slots for mounting circuit boards. More information is available from the company, PO Box 134, Terrey Hills, NSW 204 2084. Phone (02) 450 2661.

Altronics multimeters: special school offer



Altronics of Perth is giving away 200 of their popular Q1002 multimeters to high schools that offer electronics courses.

There is a limit of one multimeter per school, and Altronics intend that the multimeters be awarded as end of year prizes to outstanding students. Jack O'Donnell, manager of Altronics, stresses that the meters are completely free of charge to schools (Altronics will even pay the postage).

High schools which qualify for the offer should send a request on a school letterhead to Altronics, 105 Stirling St, Perth, WA 6000.

Portable impedance measuring unit

Sennheiser has released a new battery-powered impedance measurement unit, the ZP3. It is said to be ideal for use in situations where impedances must be measured frequently, either in the field or workshop. Applications include

ELLISTRONICS	Breadboard system
IZUMIYA I.C INC.	Printed Circuit Aids
ARLEC	Transformers and accessories
OK MACHINE & TOOL CORPORATION	Wire wrap tools & equipment
TOYO	Mini lathes and drills

PRODUCTS AT COMPETITIVE PRICES INCLUDE:

★ Complete range of transistors, resistors and capacitors
 ★ Meters and instruments ★ LED and LCD Displays ★ Plugs, sockets, cables
 ★ Boxes and printed circuit boards ★ Tools and hardware ★ Books and magazines.

BILLCO ELECTRONICS

Shop 2, 31 Pultney Street, Dandenong, Victoria, 3175. Telephone: (03) 791 8655

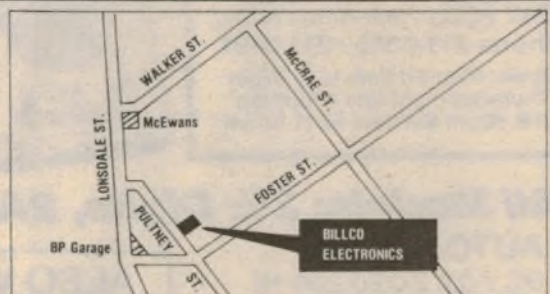

Bill Street & Co's new shop at Dandenong is the answer to every electronic enthusiast's needs.

You are invited to inspect the self service display of components and equipment ranging from a variety of kits for the amateur, to Hi Power Rating S.C.R.'s and Diodes, etc for industry.

HOURS OF TRADING:

Mon. — Thurs.	8.30am — 5.30pm
Friday	8.30am — 9.00pm
Saturday	8.30am — 12 noon

buy 30 years of experience in electronics

R.H. Cunningham suppliers and innovators in the audio and broadcasting product field. have the professional expertise in both the technical and service areas to support the products they sell.

1. SENNHEISER directional lavalier microphone MKE40
2. SENNHEISER high quality directional studio microphone MD 419
3. König and Meyer music and microphone stands and accessories
4. SENNHEISER HMD 414X microphone/headphone combination
5. Neutrik Modular audio connectors

All of the above products are available from

R.H. Cunningham
PTY LTD.

146 Roden St., West Melbourne, Vic. 3003 Tel. 329 9633 Telex 31447
4-8 Waters Rd., Neutral Bay, NSW 2089 Tel. 909 2388 Telex 21707



RHC 014

RADIO DESPATCH SERVICE

869 George St., Sydney, NSW 2000 (Near Harris Street)
Phone 211 0816 • 211 0191
Open: Mon-Fri 8am to 5.30pm
Thursday night late shopping till 8.30pm Sat 8am to 11.45am

SOAR DIGITAL MULTIMETERS



ME-533

\$42.00
Including Tax

\$35.00
Tax Exempt



ME-532

\$48.00
Including Tax

\$40.00
Tax Exempt

(WITH CONTINUITY BUZZER)

All Models: 3 1/2 Digits, 2AA Cells and Test Leads included

AUTO RANGE

DC V 0.2 2.0 20 200 1K
AC V 2 20 200 600
OHM 200 2K 20K 200K 2M
DC A 0 - 200 MA
AC A 0 - 200 MA

NEW LOWER PRICES

Mail order NSW \$3.50
Interstate \$4.50

ALSO WITH CONTINUITY BUZZER AND 10 AMP AC/DC RANGE ME-531

STAR VALUE

\$72.00

Including Tax

\$60.00

Tax Exempt

COME AND SEE US NOW!



MAIL ORDERS TO: RADIO DESPATCH SERVICE

869 George St., Sydney 2000

Phones: (02) 211 0191 • 211 0816

New Products

measurement of loudspeakers, line transformers, deflection coils, and audio transformers.

The meter is fitted with six switchable measuring ranges from 20Ω to $2M\Omega$ and displays impedance values on a large $3\frac{1}{2}$ -digit LCD readout. Indication of capacitive or inductive loads is provided and the meter can also be used for purely resistive measurements.

Maximum measurement error is said to be less than 5%, and the meter can be used to measure sensitive components such as recorder heads, sound, pick-ups, and microphones without risk of damage. Power is supplied from two 9V batteries.

For more information contact R. H. Cunningham Pty Ltd, PO Box 4533, Melbourne, Vic 3001 or PO Box 214, Neutral Bay Junction, NSW 2089.

Parameters to distribute Greenpar CRO probes

Parameters Pty Ltd has been appointed distributor for the Greenpar range of oscilloscope probes. Manufactured in England, the Greenpar range includes 1:1, 10:1, 1 and 100:1 fixed and switched attenuation types, covering the frequency range from 15MHz to 250MHz.

Cable length is 1.2m or 1.5m, and specially designed strain relief mouldings at each end add strength. Earth leads are attached with a screw fitting for easy removal.

For further information contact Parameters Pty Ltd, 41 Herbert St, Artarmon, NSW, 2064.

Transceivers, SWR meter from Imark

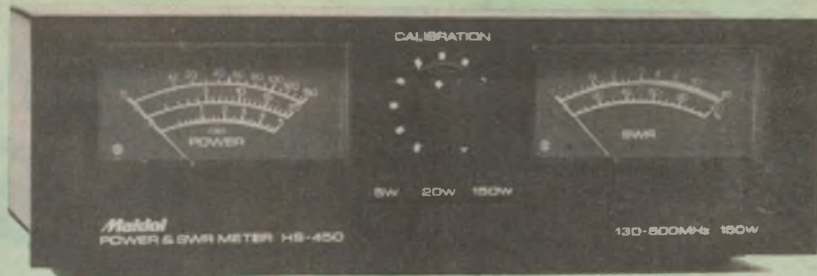

Imark Pty Ltd has released a repeater modification kit for the Sawtron 880 UHF CB transceiver. Repeater operation on UHF Citizens' Band is now permitted, and provides much greater coverage than normal simplex operation.

The Imark repeater kit when switched to repeater mode will automatically provide the repeater transmit offset for all eight permitted repeater channels. When an attempt is made to operate in the repeater mode on a simplex-only channel the transceiver will operate only in the simplex mode.

The kit is approved by the Department of Communications and is supplied complete with fitting instruc-

tions. Estimated installation time is 15 minutes from a competent technician. Price is \$20, not including fitting.

Also from Imark is the Maldol HS450 Power and SWR Meter, covering the frequency range 130-500MHz and providing three power measuring ranges: 5W, 20W and 150W, with an accuracy of $\pm 10\%$.

The HS450 is fitted with "N" type RF connectors, and insertion loss is said to be less than 0.5dB. The input impedance is 50Ω .

For further details of the repeater kit (Part number 904 905) or the HS450 contact Imark Pty Ltd, 167 Roden St, West Melbourne 3003. Phone (03) 329 5433.

Hand-held aviation band transceiver

A new phase locked loop synthesised frequency aeronautical band receiver has been introduced by Vicom International Pty Ltd. The hand-held receiver covers the VHF aeronautical band between 118 and 136MHz and offers 720 channels, selected by a digital thumb-wheel switch.

Features of the receiver include an adjustable squelch level control and low

power consumption (with up to six hours of continuous operation from rechargeable nicad batteries). Housed in a lightweight aluminium case, the unit is supplied complete with a flexible antenna, nicad battery pack, and an AC charger. It is said to be ideal for general aviation use, local flying clubs, and gliding clubs.

More information is available from Vicom International Pty Ltd, 57 City Rd, South Melbourne, (03) 62 6931 or 339 Pacific Highway, Crows Nest, NSW, (02) 436 2766.

TOYO

PRECISION EQUIPMENT FOR THE ELECTRONICS INDUSTRY

The TOYO mini drills and lathe offer a high level of accuracy comparable with larger machine tools.

The MINI LATHE (as illus) is fitted with a 240 volt motor, speed range from 250-3000 rpm. It has a swing of 100mm and is 250mm between centres. Weighs 15kg

Basic Price \$435

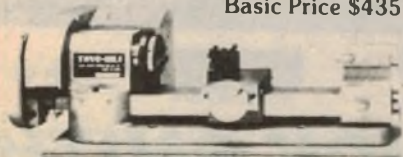

Accessories available
*Prices & Tax

The MINI DRILL comes in two models. MINI DRILL I, a standard speed drill offering 6 speeds from 850-3100 rpm, with a 6.5mm drilling capacity. Weight 5.4kg, ideal for model makers, instrument and repairers, etc. The high speed MINI DRILL IH has 2 speeds 8,000 + 12,000 rpm with a drilling capacity from No. 80 to 6.5mm and weighs 5.4kg, is suited for drilling printed circuit boards etc.

A machine vice is included with both models

Mini Drill I \$165

Mini Drill IH \$165

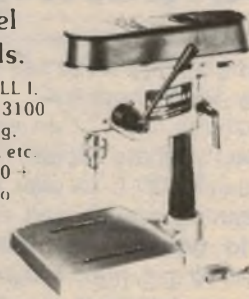

For brochures, prices and information contact

MELBOURNE MACHINERY CO. (SALES) PTY LTD
51 Queensbridge St, South Melbourne, Vic (03) 61 2911.

Efficient production line soldering

starts
here!



The
NEW

Dick Smith Temperature Controlled Soldering Station

At last – A professional quality temperature controlled iron at a budget price! Yet it has even more features than those irons you'd pay \$\$\$\$ more for!

Features like . . . an exclusive temperature meter to show you exactly what's happening . . . fully controllable temperature from around 200 C to over 500 C . . . self contained iron stand, tip cleaning sponge and a bit well.

And more! . . . It's fully approved by the Electricity Authority. Easy to use, light weight – so that operators don't suffer from the fatigue problems of earlier irons.

If your need is fast, efficient soldering, you need the new Dick Smith Temperature Controlled Soldering Station.

around \$20 less than
equivalent units at **ONLY \$65**



Specifications

Operating Voltage: 240V AC
Iron Wattage: Nominal 50 watts
Iron Element Voltage: 24V
Iron Barrel Potential: Nominally earth
Temperature Range: 200 to 500 (degrees C), fully variable
Temperature Indication: Moving Coil Meter
Tips available: Fine, Medium & Thick

Electricity Authority Approval No. N 1188 T2000

Accessories Supplied:

Iron Stand
 Cleaning Sponge
 Tip Well

Accessories

Replacement Tips:		
Medium Chisel	Cat T-2002	\$3 ⁰⁰
Thick Chisel	Cat T-2004	\$3 ⁰⁰
Fine Chisel	Cat T-2006	\$3 ⁰⁰
Replacement Sponge	Cat T-2010	\$1 ⁴⁵

Generous quantity discounts available.
 Contact: D.S. Distributors on (02) 888 3200

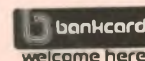

DSE/A359/LM

DICK SMITH Electronics

See page 98 for address details

New Products

Switch-mode power supply

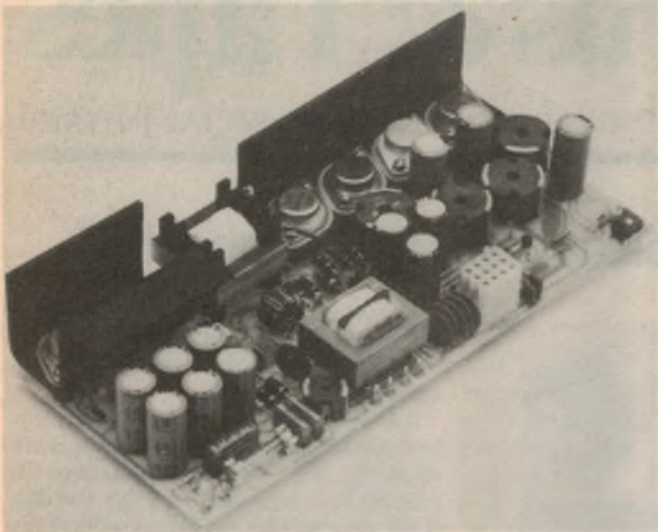

Scientific Electronics, Australian designer and manufacturer of a wide range of power supplies, has released details of the SM130AD1, a highly efficient multi-rail switch mode power supply.

The SM130AD1 is available in two versions. The standard version provides four output rails of +5V at 15A, +12V at 4A, -12V at 2A and +24V at 2A. All outputs are protected against short circuits and the +5V and +12V outputs incorporate over voltage protection. An output signal is available to warn of a falling supply voltage, making the unit ideally suited for microprocessor based systems.

Equipment manufacturers can also order the power supply unit with voltage outputs according to their own specifications.

Other features of the power supply units are a claimed 70% efficiency at full load, 130W output, compact size and light weight. Each unit from Scientific Electronics carries a five year guarantee and servicing and back up are available locally.

For more information contact Mr Peter Lloyd, Scientific Electronics, 6 Holloway Drive, Bayswater, Vic 3153. Phone (03) 762 5777.

70kHz-250MHz grid dip meter

Parameters Pty Ltd now has available the Trio DM-801 dip meter designed for the testing and adjustment of radio equipment and antennas operating in the frequency range 70kHz to 250MHz.

Applications of the DM-801 include measurement of the resonant frequency of antennas and tuned circuits using either inductive or capacitive coupling, use as a signal generator, as a field strength meter and an inductance or capacitance indicator.

The ability to be capacitively coupled to the tuned circuit under test is said to be unique to the DM-801. With the DM-801, resonant frequency of shielded and toroidal coils can be measured by simply touching the capacitance probe to the circuit under test.

Other features of the DM-801 include wide frequency range, internal storage of coils, probe, earphone and ground clip lead, battery power, amplitude modulation, and sockets for crystal checking.

For more information contact Parameters Pty Ltd, 41 Herbert St, Artarmon, NSW 2064 or 53 Governor Rd, Mordialloc, Vic 3195.

Neutrik 3,4,5,6 Pin Plugs

Not only do we offer you a bigger range, we also offer a choice of finishes. There's black with gold contacts, black with silver contacts, and silver with silver contacts.

PLUS We have right-angle male and right-angle female cable connectors.

PLUS Neutrik offers a professional lockable phone jack. Mates with all 1/4" 2 and 3 circuit phone plugs.

PLUS Neutrik also has male and female PC-Board, mounting connectors with both vertical and horizontal contacts.

PLUS Neutrik has NLE connectors with 240 volt power offering 5 amps maximum. Approved by the S.E.C.

PLUS The Neutrik series of modular components representing a unique and economical approach to assembly in-line accessories for various applications. Unified thread permits all combinations; standard O-ring available to fit modules to enable alignment of latching sections.

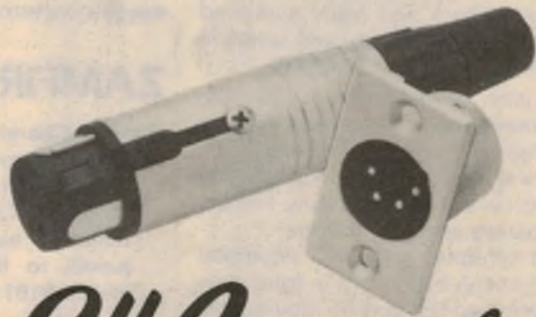

R.H. Cunningham

PTY. LTD.

146 Roden St, West Melbourne, Vic. 3003. Ph. 329 9633. Telex. AA31447
4/8 Waters Rd, Neutral Bay, N.S.W. 2089. Ph. 909 2388. Telex. AA21707

Send for our new free Neutrik connector brochure showing the full range of quality products.

NAME _____

ADDRESS _____

P/C _____

(Please print)

Return this coupon to:

R. H. Cunningham Pty. Ltd. P.O. Box 4533, MELBOURNE.

RH-C016



REVIEWS OF RECENT

Records & Tapes

CLASSICAL • POPULAR • SPECIAL INTEREST

RAVEL CONCERTOS: "Masterpiece for piano, orchestra"

RAVEL: Piano Concerto in D-Major for the Left Hand. Piano Concerto in G-Major. Jean-Philippe Collard, piano, with Francois Merville (cor anglais). Orchestre National de France, conducted by Lorin Maazel. Stereo, World Record Club R-09873.

The sound of the first few bars of this so often recorded coupling are disappointing but don't let this discourage you from listening to the rest.

If you miss the rest — all of it — you will be missing something you will wish you hadn't. Personally I prefer it to any other recorded coupling of these two pieces that I have so far heard.

My objection to the first few bars is due to the somewhat anaemic quality of the very first sforzando chord and, immediately thereafter, the lack of balance between piano and orchestra. The piano almost disappears!

But let me reassure you that this is soon righted and you will — if you are like me — sit back and enjoy approved tempos, technical security, and sensitive feeling for much important detail.

By the way, to make things clear, the lapses I mentioned above refer only to the G major and not the concerto.

By the way, the pianist, Collard, has an English name but he is actually French. His first names are Jean-Philippe.

He is a sensitive, very well equipped artist, never too expressive in long slow solos. In the two fast outside movements he is brilliant and I never heard a hint of a stumble, no matter how fleetly he is playing.

He takes the middle movement, marked *adagio assai*, rather more slowly than is usual. Most other pianists prefer to take it a little faster than Ravel's marking suggests.

But the melody's long, Bach-like shape stands up well to this statement of it and Collard is careful to avoid dynamic and tempo variations quite in keeping with the composer's intentions. He is accompanied with the same elegance that he at all times displays himself.



The Concerto in D for the left hand alone was commissioned by an Austrian pianist who lost his right arm during World War I. Ravel replied with a work that is not only extremely musical but technically intricate. It is played here with such bewildering ease that anyone not in the know would swear Collard was using two hands.

There are a few resemblances to the G major concerto, especially in the slow

Gershwin phrase that won such popularity in the earlier work and did much to send the audience away whistling it.

The performance is a masterpiece for both piano and orchestra, neither work allowing the listener's attention to wander for a moment. To enjoy the disc don't concentrate on either concerto's more showily difficult sequences; enjoy also Collard's ravishing soft passages.

There is one non-musical point I should like to make. The design of the record sleeve is awful. Not only are the portraits of the pianist and conductor unrecognisable but neither's name is mentioned on the first side and you'll only discover them by carefully studying the small print on the reverse side.

I mention this because the usual quality of WRC art is so good; and, more importantly, because a potential buyer, looking at a display of new releases, might not bother with more than a glance at this cover, so missing something really good inside. (J.R.).

ZAMFIR — But what on earth is a Rae?

ZAMFIR-George Orchestra; Roumanian Radio-Symphony Orchestra; Paul Popescu (conductor); and the Madrigal Choir. The Rae player's name is not given but everything points to its being Zamfir. Philips Stereo 9101 (analog).

Who is Zamfir and what is his instrument, called in his native Rumanian, a Rae? I must confess that I had no idea until I watched that great film "Picnic at Hanging Rock" on TV, recently. In this, the instrument is used for the excellent background music.

Then I learned from the sleeve of the disc sent to me by Philips for review, that Zamfir is a Rumanian musician and that Rae is his countrymen's name for a very large, gracefully curved type of pan's pipe. Not one of those little things that Mozart used in *The Magic Flute* but something that looks like a giant sized

geometrical gadget. When the tops of the pipes are blown across, they produce a sound rather like the low register of a recorder.

It is used by Zamfir as a solo instrument in, of all unexpected compositions, a *Mass For Peace*. Usually it is so recorded that the support of the Roumanian Orchestra passes unnoticed. But one feature is immediately obvious.

Zamfir is a master of this mellow toned instrument. He can produce alluring slow sounds and passages that could challenge the *presto* of a flute. But to me it sounds oddly out of place in a *Mass*. A moments reflection will remind you that a pan's pipe was a pagan instrument anyway!

The whole of this *Mass* consists of only four parts — a *Kyrie*, *Gloria*, *Sanctus* and *Agnus Dei*. Musically, it is a mixture of orthodox liturgical and what passed for modern in the early 1920s.

In parts it is beguilingly soft, quite enchantingly so; in other parts, it can

Reviews in this section are by Julian Russell (J.R.), Paul Frolich (P.F.), Neville Williams (W.N.W.), Leo Simpson (L.D.S.), Norman Marks (N.J.M.), Greg Swain (G.S.), and Danny Hooper (D.H.).

assert itself almost pugnaciously. Its usually bland sound can become surprisingly shrill.

And there are long passages that sound much more like a waltz than a Mass.

The first band on the reverse side, which concludes the Credo on the first, sounds more like a lively Balkan dance than anything else. However there is a most refined choral opening to the Sanctus.

The cover picture which seems to have been taken from a dully coloured stained glass window has great charm. And so will the contents to those who like musical freaks. (J.R.)

☆ ☆ ☆

DELIUS — Florida Suite; Dance Rhapsody; Over the hills and far away. Royal Philharmonic Orchestra conducted by Sir Thomas Beecham. World Record Club Stereo R 08083.

A rather unlovely sleeve disguises much enjoyable music on WRC's reissue of some Delius pieces under the name of Florida Suite. This is a four-piece confection first produced in 1859, and now in a revised edition by Sir Thomas Beecham. Apart from the unattractive yellow and green cover there are large portraits of Beecham with black beard and Delius with front hair! You have to look hard to recognise them.

Those Delians who do not know the Florida Suite are in for a pleasant surprise. It is an early work and shows only few of the composer's later musical characteristics. Try it on your friends and see if they can guess who wrote it. By the way it is, alas, one of only two works that Beecham recorded in stereo.

Yet despite its age its sound can still be enjoyed. The bloom on the strings, the delicately controlled woodwind and perfect balance of the orchestra remind one with regret of Beecham at his best.

The Florida Suite consists of four movements — Daybreak; By The River; Near The Plantation and At Night. It is all mellifluous and wherever one spots hints of Delius' later scoring habits and his tendency to "slippery" modulation, Beecham must always be suspect.

I say this because Beecham's manner of conducting Delius' music was very odd. I have heard him labour long at rehearsals to get a movement or even a passage the way he wanted it and at the same night's performance play it quite differently — yet it still sounded lovely!

But one thing is clear — here is an original mind striving to make itself heard. It could never justly be dismissed as a mere student work. Beecham treats it as quite grown up.

One has to hurry forward 57 years to catch up with the composition of the next piece on the disc, the Second Dance Rhapsody. It is a now well known

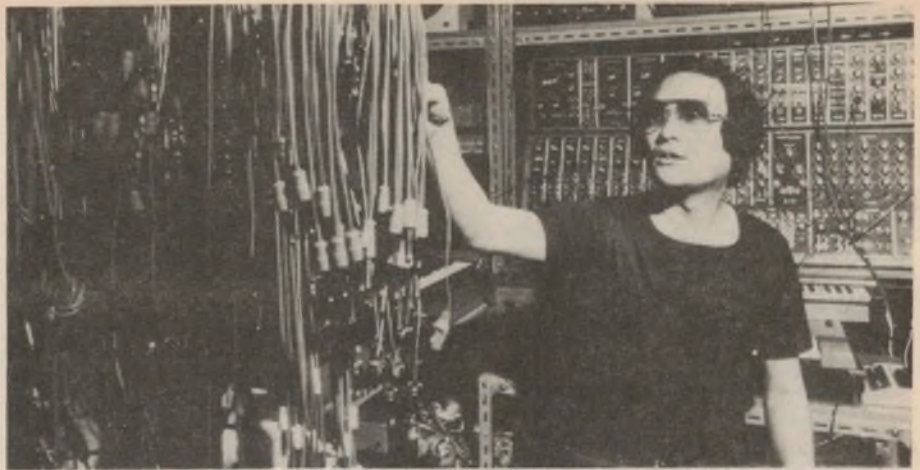

Desert trek or a space odyssey?

GRAND CANYON SUITE, Grofe. SYNCOPATED CLOCK, Anderson. Isao Tomita and the Plasma Symphony Orchestra. RCA Red Seal stereo ARL1-4317.

If you want to get some idea of the complexity of "orchestral" textures which engineer/musicians can now create with a room full of synthesisers, you could do worse than study a recording by Isao Tomita.

Born in 1932 in Tokyo, he majored in the history of art at Keio University but, at the same time, developed a passionate interest in music and electronics. He published a number of successful compositions but hit the world headlines in 1974 with a huge-selling album "Snowflakes are Dancing" — an interpretation of the music of Claude Debussy on synthesiser.

This was followed by electronic interpretations of "Picturers At An Exhibition" (Moussorgsky), "Firebird" (Stravinsky), and "The Planets" (Gustave Holst). Now we have the coupling "Grand Canyon Suite"/"Syncopated Clock" — the latter a very short item, virtually a novelty fill.

For the Grand Canyon Suite, Tomita lists the composition of his electronic orchestra — violins, viola, cello, double bass, piccolo, flute, oboe, English horn, clarinets, bassoons, trumpet and so on, through to the "kitchenware", to novelty instruments, chorus and whistlers. To produce these sounds, he draws on synthesisers identified as Moog, Roland, Yamaha, Synclavier, and so on. If you

buy the record, the listing is there for you to study.

composition in Delius' mature style, although this also was "edited" by Beecham. There are not surprises. Just good Delius in genial mood and spreading charm in every bar.

It was composed in 1916 and we again retreat, this time to 1857 to date the next composition: Over The Hills And Far

buy the record, the listing is there for you to study.

But, alas, when I was playing the record, a member of my family walked through and, with a certain disdain, remarked: "I'd rather have the real thing!" At that point in the recording, I must confess to a similar reaction.

Tomita uses the traditional instrumental sounds to produce an orchestral foundation but his superimposed improvisations change the whole scene. In fact, the interplay of colour, light and shade on the Painted Desert sounds more like music for a space odyssey, while a solo synthesised harmonica contracts the procession of mules to something more like one man and his donkey!

Not that Tomita lacks initiative and musical skills, or the equipment the ability to produce an enormous variety of synthetic and authentic sounds; it's just that your reaction will depend entirely on whether you're interested in Grofe or Tomita!

As mentioned earlier, "Syncopated Clock" is a novelty fill using an amazingly convincing chorus of whistlers. But for the notation that the sound was produced by "Moog III, Program 8", one would be prepared to believe that a group of male voice choristers had suddenly changed the whole mode of their music making.

As for the sound quality, it's very clean, as it should be when the signals are coming from an array of electronic oscillators. (W.N.W.)

Away. But there is little in it to suggest an early work. It is a work that very aptly indeed succeeds in musically describing its title all the way from the ground to the peak.

As I stated above the sound is still good, good enough for any true Delius lover to acquire. (J.R.)

RECORDS & TAPES — CONTINUED

WEBERN — Six Orchestral Pieces played by the London Symphony Orchestra conducted by Pierre Boulez. CBS Stereo 76911. (Analog).

I think that, by now, regular readers of this column will have gathered that I have no love for the music of the Second Vienna School and its disciples. I find it, for the most part, as ugly as German expressionistic painting.

And I might mention, spitefully, that I find satisfaction in its overwhelming rejection by the great majority of regular concertgoers. That most of it, but with significant exceptions, can be described as music at all is to me an insult to the muse.

I suppose that, in time, real music will be born again but, until then we have to keep returning only too often to the increasingly dusty 19th century romantic museum and the all too frequent repetitions of the baroque — which of course also has its splendid exceptions.

These remarks are prompted by the fact that Boulez found the time (11 years) to produce a set of Webern's miniscule pieces.

The selection on this disc comprises six dwarf compositions, the longest a symphony that lasts nine minutes. The rest of the works are made up of a few

brief bars too numerous to mention even by name.

I suppose they are well played but their compression and contortions make it too difficult for me to judge. However, I can write with a clear conscience that they are neat. (J.R.)

FOOTNOTE: I didn't know what I was letting myself in for when I accepted Rachmaninoff's complete piano music to review. Later I found it consisted of seven LPs. I am therefore afraid there will be some delay before my review appears. My apologies.

A NEW HIFI DEMO DISC?

BEETHOVEN: Piano Sonatas, Opus 57, Appassionata. Opus 111, The Last Great piano sonata. Carol Rosenberger; Rosendorfer Imperial Concert Grand. Digital stereo, DMS Delos, DMS 3009. [From P.C. Stereo Pty Ltd, PO Box 272, Mt Gravatt, Qld 4122. Phone (02) 343 1612].

Some time ago I reviewed Carol Rosenberger's first Delos digital release "Water Music of the Impressionists" (Liszt, Debussy, Griffes, Ravel) DMS 3006. Others seem to have shared my enthusiasm for that recording because, since then, it has received frequent mention as a notable and very acceptable audiophile disc.

Now we have Carol Rosenberger with two noteworthy Beethoven sonatas.

I am not about to draw comparisons between this and other performances of the works, partly because I lack the resources — and the incredible memory — of our regular classical reviewer, Julian Russell. More than that, reactions to individual performances of such works are highly subjective, as becomes apparent when one even glances back over past reviews.

One thing is certain. Carol Rosenberger possesses in generous measure the physical resources to cope with the emotional passions and turbulence of the Opus 57 "Appassionata", written in the summer of 1806, when Beethoven's mind was in a turmoil, as revealed by his letters to the "immortal beloved".

More than that, she has at her command the magnificent Bossendorfer Imperial Concert Grand, with its enormous power in the bass register. And, to record the sound, a Soundstream digital master tape system plus the combined disc production resources of Ortofon, Mobile Fidelity Sound Labs and JVC.

FANDANGO, Herb Alpert. A&M LA 37810. Festival release.

It is a long time since I've heard the unmistakable trumpet style of Herb Alpert, with it's distinct south of the border flavour.

This disc is described on the label as an Audiophile record. I could not find any reference on the label to half-speed mastering or to other such technique but the quality is superb: alive, with excellent balance and with virtually no background noise.

Recorded at CBS studios in Mexico City and A&M studios in Hollywood, the 11 tracks are: Fandango — Margarita — Push And Pull — California Blues — Quiereme



They are used to the full in the opening movement Allegro assai.

Then suddenly, the passions subside into the calmness of the Andante. Carol Rosenberger is contemplative and tender; the huge Bosendorfer is bell-like in its quality and the digital recording preserves perfectly the lingering echoes of each note. As I listened, I couldn't help but recall past arguments about the supposed limitations of digital with low level sound!

And then, as if to underscore the dynamic range of the recording, as well as the inspiration and vitality of the composer, comes the turbulent Finale.

As an encore, you have Sonata opus 111 on the other side — described by Beethoven's biographer Wilhelm von Lenz as the "Testament Sonata... the master's great farewell to the piano sonata, his final statement in that form". Or, as Virgil Thompson put it: "representing the whole gamut of dynamic violence and delicacy and deep song, with its undercurrent of musical meditation."

The last incidentally, is a quote from Carol Rosenberger's own essay on the composer, the instrument and the sonatas, occupying best part of six volumes of small type on the handsome double-fold jacket.

Unless I miss my guess, this new recording, datelined 1982, is going to follow "Water Music of the Impressionists" into the published lists of recommended audiophile recordings. (W.N.W.)

LOOPY VIDEO

MAIL ORDER DEPARTMENT: PO Box 254, Heidelberg, 3084.
Phone: (03) 435 3004, Monday — Saturday 1.00pm to 6.00pm

NEW PRICES:

OHIO SOFTWARE & HARDWARE

OHIO SOFTWARE:
K1 Hardware Catalogue (incl new boards) \$1.98
K2 Software Catalogue (over 200 pieces) \$2.98

OHIO HARDWARE:
C4P, VIDEO BOARD (converts C1P Series 7) \$130.00
COLOUR BOARD — C1P — Series 2
H13A Short Kit, including documentation \$35.00
H13B = H13A and tracks for 5v to 12v DC \$39.00
H13A Colour and RF out. Assembled and Tested \$85.00
H13B = H13A Assembled and Tested includes 5v to 12v tracks \$89.00

OPTIONS:
SOUND — Parts Kit \$2.50
incl assembled and tested \$18.00
VIDEO — Parts Kit \$2.50
incl assembled and tested \$15.00
5v to 12v DC — No Kit available (Specialised) — incl assembled and tested \$24.00

COMBINATIONS:
Sound and 12v assembled and tested \$36.00
Video and 12v assembled and tested \$35.00
All 3 mods (H13B) assembled and tested \$45.00
"H13B — Deluxe" — All mods assembled and tested (\$89 and \$45) \$129.00

Note: All prices include sales tax.

COMPUTER EARS — SPEECH PROCESSOR for PET, OHIO, VK101, TANDY, APPLE NASCOM — Specify \$49.00

Write for **SALE Price List — FREE.**

Tal Como Soy – Route 101 – Coco Loco – Aria – Angel – Sugarloaf – Latin Medley.

There is no mention of the other artists but they all do a great job of creating a fresh Latin sound for you to enjoy. (NJM)

DEVOTIONAL

COUNTRY SONRISE; various artists. The Word 20 Series, TWE 6007. [From Word Records Australia, 18-26 Canterbury Road, Heathmont Vic 3135. Phone (03) 729 3777.]

For those that like their Gospel music with a distinct country and western flavour, this record would be compelling listening, with 20 tracks from 20 different artists, known mainly for their prominence in the country music scene.

The sound quality overall is good, considering that there must have been a considerable difference in the age of the original recordings.

Some of the artists and their songs are as follows: Ray Price, I Saw The Light; B. J. Thomas, Using Things And Loving People; Lester Flatt, What A Friend We Have In Jesus; Jimmie Davis, This Little Light Of Mine; The Cathedrals, The Last Sunday; Wanda Jackson, Heaven's Gonna Be A Blast; Roy Clark, He Is My Everything; Tennessee Ford, I Like The Old Time Way; Roy Rogers & Dale Evans, I'll Fly Away; Stuart Hamblen, This Old House.

Each track is supported by a brief note on the jacket, either about the composer or the artist(s). The record is one of a whole series from Word, each containing 20 tracks. Some of them feature individual artists such as Burl Ives and Pat Boone. (N.J.M.)

☆ ☆ ☆

PAT BOONE, Whispering Hope. The Word Twenty Series TWE 6008, [From Word Records Australia, 18-26 Canterbury Road, Heathmont Vic 3135. Phone (03) 729 3777].

This is another album in Word's 20 series, with 20 Gospel tracks from Pat Boone, mainly old-time Gospel favourites.

The sleeve notes give an interesting and frank insight into some of the problems that Pat Boone has had to face in coming to grips with his Christian faith and the conflicting demands made on him in the tinsel world of show business.

Some of the titles are: Whispering Hope – Yield Not To Temptation – Have Thine Own Way Lord – I Walked Today Where Jesus Walked – Saviour, Like A Shepherd Lead Us – How Great Thou Art – Let the Lower Lights Be Burning – Blessed Assurance, Jesus Is Mine – What A Friend We Have In Jesus.

Pat Boone's style in these old hymns may not set the world on fire, but he sings them with obvious feeling and sincerity. (N.J.M.)

MPI Hi-D Mini Drives

freedom
of choice

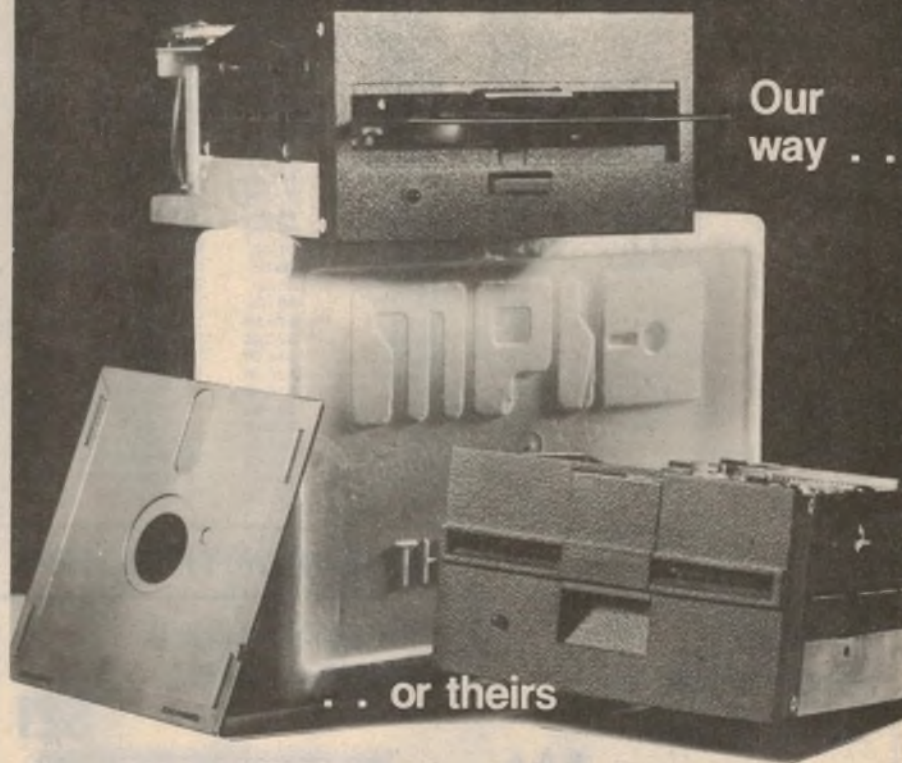

Professional, push-button disk eject, or industry standard flip-front . . . Either way, MPI builds the quality in. Head load for media protection, 6mSec track-to-track and a choice between 48, 96, 100TPI, single or double sided 5¼" Floppy Drives.

TRUE FREEDOM OF CHOICE.

Authorised Dealers:

Sydney: (02) E&M Electronics 51 5880, Applied Technology 487 2711, QT Computers 29 5599, Micro Repair 747 1061, Computer Components 868 3614. **Wollongong:** (042) Macelec 29 1455. **Brisbane:** (07) Ballec 36 5183. **A.C.T.:** (062) Ortex 80 5283. **Boulevard 48 5411.** **Perth:** (09) Micro Controls 325 2444. **Electronic Systems 335 7313.** **Adelaide:** (08) DC Electronics 223 6946. **Micro'80 211 7244.** **Melbourne:** (03) Stewart Electronics 543 3733, Ellistronics 602 3282, Ritronics 489 8131, Pennywise Peripherals 82 2389, De Forest Software 877 6946, Comp-Soft 428 5269. **Tasmania:** Coastal Computers (004) 31 3259.

daneva australia pty ltd.

66 Bay Road, Sandringham, Vic., 3191.
Ph: 598 5622. Telex: AA34439



ROD IRVING ELECTRONICS

Each month we are trying to have available as many new kits and PCB's that appear in Electronics Australia. Please ring for details.

Minimum P & P \$1.50

NEW IC's & SPECIALS

DESCRIPTION	PRICE	DESCRIPTION	PRICE	DESCRIPTION	PRICE	DESCRIPTION	PRICE
XR2206	\$6.50	SC151D	\$2.00	6502A	\$11.00	10 4017 FOR	\$9.00
XR2207	\$5.50	TL074	\$2.90	6503	\$10.00	10 4026 FOR	\$15.00
XR2211	\$6.90	AY-3-8910	\$14.50	6504	\$10.00	10 4051 FOR	\$6.00
CA3059	\$4.90	AY-5-2376	\$19.50	6505	\$10.00	10 4081 FOR	\$3.00
NE5534	\$1.95	MN3001	\$17.50	6507	\$10.00	10 4040 FOR	\$11.00
NE5534A	\$2.50	82S123	\$3.90	6520	\$5.50	6800	\$7.90
RC4136	\$1.25	BPW50	\$1.95	6521	\$5.90	6802	\$11.00
BU126	\$1.95	MDC3011	\$2.95	6522	\$9.90	6809	\$19.00
BU326A	\$1.95	MDC3020	\$2.50	6522A	\$11.00	6821	\$3.50
TIP120	\$0.90	MDC3021	\$2.60	6532	\$12.50	6840	\$7.90
2N6122	\$0.80	D3242	\$15.90	6545	\$22.50	6850	\$5.00
2N6125	\$0.90	D3245	\$10.90	6551	\$12.90	7805	\$0.80
BC108	\$0.30	Z80CPU	\$8.00	2650	\$21.00	7812	\$0.80
BD139	\$0.45	Z80ACPU	\$10.00	2651	\$23.00	7815	\$0.80
BD140	\$0.45	Z80CTC	\$7.00	TR1602	\$7.50	7824	\$0.90
BUX80	\$3.90	Z80ACTC	\$8.00	5303	\$5.25	7905	\$1.50
2114	\$1.95	Z80PIO	\$5.00	10 74LS00 FOR	\$2.00	7912	\$1.50
4116	\$1.95	Z80APIO	\$6.00	10 74LS02 FOR	\$2.00	7915	\$1.50
4164	\$9.50	Z80SIO	\$18.00	10 74LS04 FOR	\$2.00	7924	\$1.50
6116	\$11.00	Z80ASIO	\$20.00	10 74LS10 FOR	\$2.00	8080	\$7.00
8725	\$10.00	Z80BCPU	\$18.00	10 74LS30 FOR	\$2.00	8085	\$9.00
2708	\$4.90	Z80DMA	\$20.00	10 74LS32 FOR	\$2.00	8212	\$2.50
2716	\$4.90	1771	\$18.00	10 74LS367 FOR	\$4.00	8216	\$2.50
2732	\$8.00	1791	\$59.00	10 74LS368 FOR	\$4.00	8224	\$4.00
2764	\$25.00	1793	\$59.00	10 74LS240 FOR	\$7.50	8255	\$5.50
2N3773	\$3.50	1795	\$59.00	10 74LS241 FOR	\$7.50	8155	\$9.00
MJ802	\$3.50	1797	\$59.00	10 74LS242 FOR	\$7.50		
C106D	\$0.60	2N414	\$1.95	10 74LS244 FOR	\$7.50		
SC141D	\$1.10	6502	\$10.00	10 4000 FOR	\$2.00		

bankcard
welcome here

THIS MONTH'S KITS

EA DIGITAL
READOUT FOR
SW RECIEVERS

P.O.A.

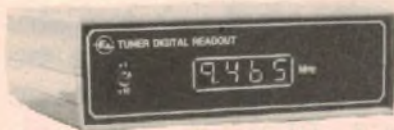

EA EASY-TO-BUILD
FREEZER ALARM

\$21



EA ELECTRONIC STARTER
FOR
FLUORESCENT
LAMPS

\$5



EA GUITAR BOOSTER

\$15



EA THEREMIN

\$30



OVER 200 NOW SOLD

EA INVERTER
INCLUDING TRANSFORMER

\$186



SILVERTONE NEWS

Newsletter of Silvertone Electronics
Specialists in Radio Control

Radio Remote Control

**CUSTOM MADE, HI SECURITY, LOW
POWER RADIO CONTROL UNITS**

IDEAL FOR THE RADIO REMOTE SWITCHING OF
A MYRAID OF MECHANICAL DEVICES
INCLUDING

- Doors and Gates
- Lights
- Cameras
- Slipways
- Vehicles

A FULL DIGITAL SYSTEM, BINARY CODED FOR
MAXIMUM SECURITY WITH SWITCH SELEC-
TABLE CODING

For details contact

**SILVERTONE
ELECTRONICS**

6/2 SCHOFIELD STREET,
RIVERWOOD, NSW 2210
Phone 533 3517

8/2 Schofield Street, Riverwood, NSW 2210
Telephone: 533 3517

ITOH 8510A!

**THE MOST REMARKABLE
DOT-MATRIX PRINTER
FOR UNDER \$1000!**

FULL CHARACTER SET WITH MATHS SYM-
BOLS, GRAPHICS AND LOWER CASE
DESCENDERS.

120 CHARS PER SECOND BI-DIRECTIONAL
LOGIC-SEEK PRINT.

FULL PRECISION PROPORTIONAL PRINTING FOR
LETTER-QUALITY WORD PROCESSING.

UP TO 136 COLUMNS ON 9½ INCH PAPER.
(15-INCH MODEL AVAILABLE).

NEGATIVE LINEFEED CAPABILITY.
TRACTOR & FRICTION FEED BUILT IN.

AVAILABLE FROM:

*Software
Source Pty Ltd*

89 Oxford Street,
Bondi Junction. 389 6388
P.O. Box 364, Edgecliff 2027.
DEALER ENQUIRIES INVITED

50 & 25 YEARS AGO

"Electronics Australia" is one of the longest running technical publications in the world. We started as "Wireless Weekly" in August 1922 and became "Radio and Hobbies in Australia" in April 1939. The title was changed to "Radio, Television and Hobbies" in February 1955 and finally, to "Electronics Australia" in April 1965. Below we feature some items from past issues.



October 1932

The Tariff Board enquiry: The matter of variable condensers was before the board and a witness gave evidence that the Australian-made condensers were not sufficiently accurate. So the chairman asked a certain importer what was the degree of accuracy built into the British-made condenser, to which he got the prompt reply of, "To within one-quarter of a micro-microfarad."

The representative of an Australian firm jumped to his feet and exclaimed that the Australian-made condensers were even more accurate, being checked to within a quarter of one percent. And there wasn't anyone in the room smart enough to point out that the Australian condenser was only one-fifth as accurate as the imported job.

☆ ☆ ☆

After death — what?: Miss Clara M. Codd will say at 7.30 on Sunday nights during October from 2GB; and Mr Harold Morton will give his version at 8. In November there will be discourses on reincarnation, and in December on evolution.

☆ ☆ ☆

The Voices: It has been brought to our notice — the editor brought it to our notice (we hear from an unreliable source) — that the number of people being admitted to lunatic asylums suffering from radio reception is on the increase. These people assert, against all bribes offered by psychologists, that they can hear broadcast programs without the aid of a broadcast receiver: they say that even against their inclinations, which should be pretty strong, they hear broadcast programs at all hours of the day and night, and can sleep only between 11.30 pm and 7.30 am, when the local stations are off the air.



October 1957

TV tower: The new aerial at ABN TV station in Sydney is now in use. The structure consists of a tower 335ft high upon which is mounted the 99ft TV aerial. This has two sections operated in parallel by separate, air-filled, coaxial cables, eight bays in all, and with a gain of six times.

Each section can be operated separately if desired. Above this aerial is a 70ft steel pole for future use — it could for instance support an FM aerial. Total height to the top of the pole is 504ft.

☆ ☆ ☆

Space travel soon: Space travel is only 20 years away according to Mr H. Ward, director of the NZ Physical Laboratory.

Mr Ward, who is a member of the New Zealand International Geophysical Committee, said that although earth satellites to be launched shortly were only 20in in diameter, larger satellites of three or four feet were already under consideration.

☆ ☆ ☆

New era in warfare: "A missile was fired at the Air Force Missile Test Centre's Cape Canaveral launching site today. Shortly after the launching, the missile exploded. There were no casualties. Valuable information was gained as a result of the test." This terse announcement by the US Air Force recently was widely interpreted as heralding a new era in warfare — the era of the awesome Intercontinental Ballistic Missile (ICBM).

The test missile, though not specifically identified by the Air Force, was reported by the press to be the 5000 mile, ocean-spanning Atlas on its first flight from the Missile Test Centre in Florida. This "ultimate weapon" would bring American retaliatory striking power within a scant 20 minutes of Russia.

New product from Dick Smith

Wizzard Video Game

+

Personal Computer



Many people cannot make up their minds whether to buy a personal computer or a video game console. The Wizzard from Dick Smith is a third possibility. It is primarily a video game console but has the capability to be upgraded to a personal computer with the addition of a Basic interpreter cartridge.

If you or other members of your family are video games fanatics you will naturally be interested in this latest release from Dick Smith Electronics. It is called the Wizzard and the improbable spelling is not a printing error. The Wizzard can be had with a range of games cartridges (each at extra cost) which have a high degree of animation and make good use of graphics and colour capability.

As well, each game has music and sound effects.

The Wizzard console is largely finished in matte black plastic with fake woodgrain end-panels. Dimensions are 355mm x 60mm x 230mm (W x H x D). There are two joystick controllers and these are attached to the console via a coiled cord which can extend about 60cm. A button on each side of the joystick controller provides a "fire" controller while a 24-way pressure sensitive keyboard (like the Sinclair ZX81) is also a feature. In the normal games mode, a coloured plastic cover is slid over these keyboards and only two of the "buttons" are used. In the computer mode each joystick controller is clipped into the console to form a 48-way keyboard in a more or less conventional "QWERTY" format.

In the games mode, the joystick controllers are quite effective although their capability of moving an object in any of

16 directions does not appear to have been fully utilised in any of the games we tried. The joystick controller actually only has eight contacts in its membrane but the software interpolates between these (when two contacts are closed) to give 16-direction capability. The "fire" buttons are also effective but strangely, they are not mentioned or described in the instructions. This means that unless you happen to discover their operation by accident, you are likely to use the adjacent contact keyboard buttons instead, because of the labelling of the keyboard

This is a frame from one of the Tennis games. Some of the detail on the review sample was different including the name "Wimbledon", to Wimbledon. Notice that the ball casts a shadow.



overlays. And using the keyboard for games is a real chore. As with other video games in this price range, the sound effects are produced from the TV set loudspeaker rather than in the console.

All the circuitry inside the console is accommodated on a double-sided PC board measuring approximately 300 x 125mm. The microprocessor used as a version of the Mostek 6502A in conjunction with what would appear to be a CRT controller and PIA of unknown make. The mains power supply is external to the unit and plugs in via a 5-in DIN socket.

The games cartridges use 2716 and 2732 EPROMs and plug into an edge connector slot on the side of the Wizzard console. The TV antenna connection is via a cable fitted with a 75Ω plug and the connection can be made per-

YOU'D BE
CRAZY TO BUY
A TV GAME



before you see
the amazing
DICK SMITH

WIZZARD

the
**Home
Entertainment
Computer**
that's years ahead!

Yes — an absolutely up-to-date design. Most of the TV game consoles around were designed at least 2 years ago. And in electronics, that's an eternity!

Compare the quality

Amazing picture quality with over 49,000 dots — over twice as good as the largest selling TV game. You'll be amazed at the clarity, the detail — just like the screens NASA use in the space shuttle!

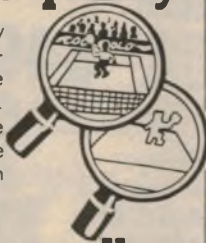

Space age Controllers



GREAT FEATURES —
GREAT PRICE!

Not just simple sticks: full space-age guiding devices with 48 keys as well. You get incredible control capability — far more than possible with other games. And slide-in overlays for controllers: you can see exactly what to do! When the controllers are placed in the console, they form a standard typewriter-style 'QWERTY' keyboard — that's versatility!

Fantastic game Cartridges

21st century games — like you've never played before. And every cartridge has many games — up to 32 in each! You'll never be satisfied with anything less after playing the WIZZARD. Every cartridge has a built-in demonstration program to show you how to play the game. And plays music, too — it's that advanced!

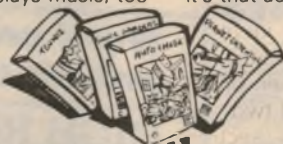

Compare the price

The best part of all: the Dick Smith WIZZARD is around \$200 cheaper than the closest comparable computer! Yes, you not only save a fortune by buying the Dick Smith WIZZARD — you get much greater flexibility and enjoyment!

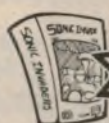

FREE
GAMES (CERTIFIED NORTH \$2.99) SUPPLIED WITH WIZZARD

7 Day Trial Offer

if you're not completely happy, you can return the WIZZARD within 7 days in original condition and packing for a full refund! You owe nothing — not even an explanation. So why not try the WIZZARD, today!

DICK SMITH Electronics

See page 98 for address details

The one with the inbuilt personal computer

The Dick Smith WIZZARD has an inbuilt personal computer facility! Just plug in the optional 'BASIC' cartridge and the WIZZARD becomes a powerful personal computer, complete with 17K of memory (that's more than you get with many personal computers! Learn how to run your own programs. Finance, home-work, anything!



'BASIC' CARTRIDGE Available soon — watch our ads for details!

\$6.85 weekly over 12 mths to approved customers



DICK SMITH WIZZARD

Cat. Y-1600

ONLY \$295

Great range of cartridges!

- Tank Attack (Cat. Y-1610)
- Wimbledon Tennis (Cat. Y-1620)
- Auto Chase (Cat. Y-1630)
- Plant Defender (Cat. Y-1650)
- Air/Sea Attack (Cat. Y-1660)
- Skiing cartridge available soon (Cat. Y-1670)

All \$39.95 each

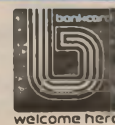

Mail Order Centre: PO Box 321, North Ryde 2113
Phone: (02) 888 3200

SORCERER DISPLAY STOCK

**SAVE OVER
\$440!**
WAS \$1395
NOW \$950
FULLY GUARANTEED!



HFC
\$21.88
per week

* Latest model,
not superseded.

* Full new
computer warranty

* Genuine demo models, some
with imperceptible case marks

* Act quickly and you'll reap the benefit!

**OVER
2000
SOLD!**

Cat X-3002

**FAMOUS
EXIDY
SYSTEMS**

Word Processor Pac Cat X-3085

This word processor pac features automatic text wrap-around, automatic checking of drastic commands, a powerful search function, automatic commands and macro programming. Includes a comprehensive instruction manual.

\$199

Word Processor Keytops

A special set of red keytops to replace some of the keys on the Sorcerer numeric keypad, for use in word processing applications. Cat X-3086

\$12⁵⁰

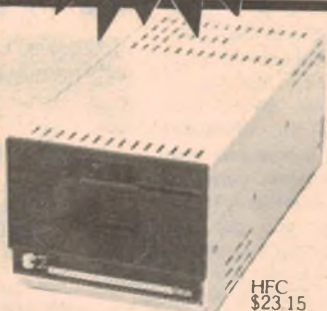

HFC
\$23 15
per week

**FDS DISK
DRIVE SAVES
YOU \$100's!**

The FDS Disk Drive comes with CPM as standard. It has a storage capacity of 308K Bytes and has its own controller system and logic to run itself and up to two other drives! Add it to your Sorcerer and you have the lowest cost CPM system available in Australia! Cat X-3220

**and it's only
\$995**

was \$1290!

**'Daisy Chain' cable
for Exidy FDS \$49⁹⁵**

This cable enables you to connect up to 4 X-3208 add-on drives to your Floppy Disk Subsystem. Cat X-3222

**UTILITIES
EDOS**

Adds disk operating commands and many enhancements to ROMPAC™ BASIC. Requires X-3205 Disk System. Cat X-3602

\$47⁰⁰

Tutorial Pack

Basic Tutorial takes you through all you need to know to start writing your first BASIC program. Teaches you the basic instructions of BASIC language. Cat X-3607

\$17⁹⁵

Machine Coder

Teaches you the basics of machine language programming, it teaches you from the very first steps of Monitor Commands right through to the more complex Z-80 instruction set and coding of your own programs! Cat X-3608

\$22⁹⁵

**Word processor quality
printer under \$2000!!!**

See page 81
for details

**HIGH RESOLUTION
MONITOR**

With this monitor added to your computer system, you'll be able to use it for almost limitless applications: for accounts/statistics, education, medical, amusement and for any purpose data and video display. The anti-glare screen with its jitter and ghost free image makes viewing much easier and sharper and allows 80 characters with 24 lines. A must for the serious computer hobbyist or professional! Cat X-1200

\$349

HFC
\$8.04
per week

**YOU LAST CHANCE
TO WIN A STANZA**

Hurry! It could be your last chance to win a great Datsun Stanza. All you have to do is purchase a System 80, Sorcerer or VIC-20 and fill in the entry coupon supplied. It's that simple! Good Luck!



**DICK SMITH
Electronics**

See page 98 for address details



Finance available on selected items to approved customers. All prices quoted are taken per week over a 12 month period.

Wizzard video games console

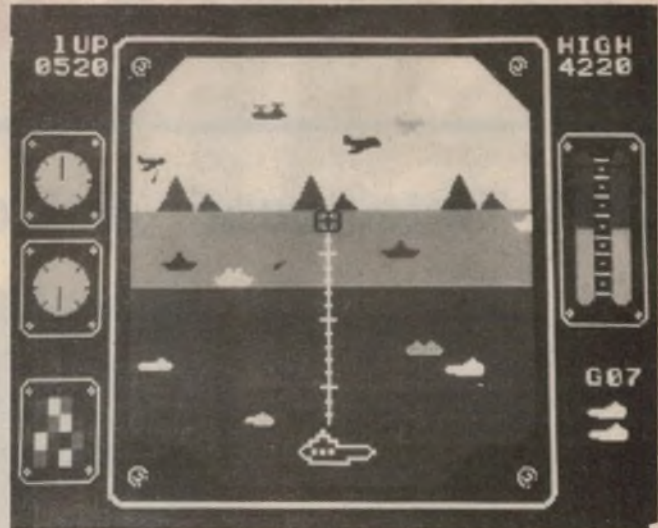
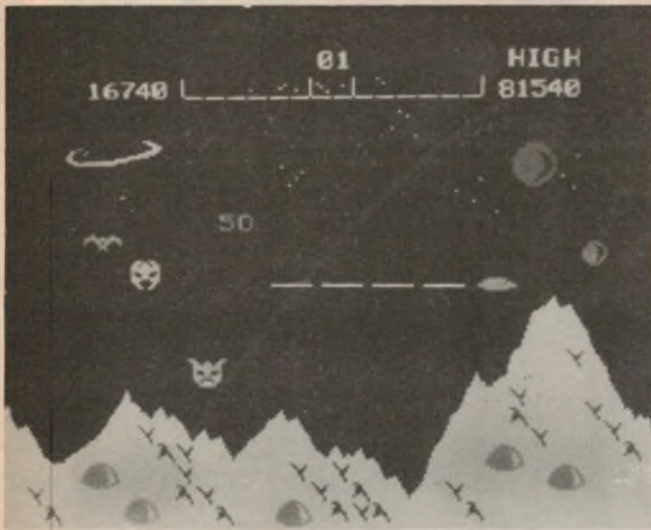

These photos are frames from the Planet Defender and Air/Sea Attack game cartridges. Note the good graphics resolution.

manently via the supplied antenna switch box. The inbuilt RF modulator is set to Australian channel one.

Each games cartridge is supplied with an instruction sheet which lists the game features and the multiple versions which can be for one or two players. We tried a selection of game cartridges and can report that they are quite impressive in comparison with competing video game systems. The colour and graphics capability are used to good effect and in some cases quite cleverly.

Probably the best of the games is the Tennis. This has 16 versions on the one cartridge and includes versions where one player is handicapped so that youthful and ancient players are more evenly matched. Rather than showing a two-dimensional court, an orthogonal projection is used to simulate a three-dimensional game where the ball can go over the players' heads and it casts a shadow!

As might be expected, the players' positions are controlled by the joystick and their choice of forehand or backhand play is determined by their position vis-a-vis the ball. Velocity of play is also affected to some extent by the use of the joystick.

This game really does go a long way towards simulating an actual game, even to the amount of tension and perspiration it can produce!

Sound effects for the various games are fairly predictable and in line with those on comparable video games. Each game has its own signature tune which is played at the beginning and end of each set. This begins to pall quickly, especially if one is losing repeatedly in one-sided games with the machine.

Picture quality on most of the TV sets we tried with the Wizzard was very

good. The exception to this was one set which was affected by bad herringbone interference. However, the other sets were so good that we are inclined to suspect that the latter set was faulty.

Having discussed the games we can pass on to what is perhaps the main feature of the Wizzard and that is the computer option. With the addition of a Basic cartridge the unit will function as a personal computer. On the basis of its features, the Wizzard Basic would appear to be roughly comparable to that in the Tandy TRS-80 (level II) in that it has a full range of mathematical functions (with floating point arithmetic) plus string functions.

The sound facility of the Wizzard is programmable by SOUND commands which control the volume and pitch of four channels (giving chord capability) over a range of 2½ octaves (30 notes). Graphics characters can be created using the CHAR command to fill in an 8 x 8 matrix. These special characters can then be placed anywhere in 32 x 24 grid on the screen using the PLOT command.

The Basic interpreter is resident in 8K

EPRAM in the cartridge. Total RAM in the Wizzard is 17K of which about 11K is available for user programs. A cassette interface and deck will shortly be available to clip on to the side of the Wizzard console. And the inclusion of LPRINT and LLIST statements in the Basic also suggests that a printer interface may also be in the pipeline.

Naturally, colour can also be added with a COLOR command.

An expansion interface will also be available eventually, to plug into the cartridge connector. This will ultimately give the machine a total memory capability of 48K in RAM.

While it all sounds very promising as a well-optioned personal computer, it is too early to judge the final product. At the time of writing we had only a few hours to try a preliminary Basic cartridge which did not have all the features mentioned above. Nor was the supporting Basic manual, presently being prepared, available.

The Wizzard looks as though it could eventually be a worthy competitor to

Continued on p141

microbee now in N.Z.!



The MicroBee is now in New Zealand.

Check-Point Computers provide NZ enthusiasts with sales and support for the MicroBee computer in both kit and built up form. MicroBee will be available to NZ enthusiasts in the following forms:

16K kit MicroBee	\$750NZ
16K Assembled & tested	\$829NZ
32K Assembled & tested	\$990NZ

So call in at our showroom or order your MicroBee direct using Visa or Bankcard.

Check-Point Computers
36, Main Road Tawa (04)326 988
Mail Orders to: P.O. Box 54068,
Plimmerton, Wellington New
Zealand.

Microcomputer News



New "intelligent" disk controller from AED

AED Microcomputer Products has released a new S100 floppy disk controller board which, they claim, offers superior performance and features to alternative designs. Designed by George Morrow of Morrow Designs, the board is fully compatible with the IEEE 696 specifications for the S100 bus.

The controller transfers both operating instructions and data to and from the system memory by Direct Memory Access, providing a high operating speed with minimal use of the resources of the main processor. The DMA channel can be located anywhere in a 24 bit address space, so the board is suitable for use in extended address systems.

Instead of the more usual dedicated floppy disk controller chip the AED board uses a Z80 microprocessor. The board can be used with a wide variety of disk formats, with the controller automatically determining the length of sectors to be read and whether the disk to be read is single or double density and single or double-sided.

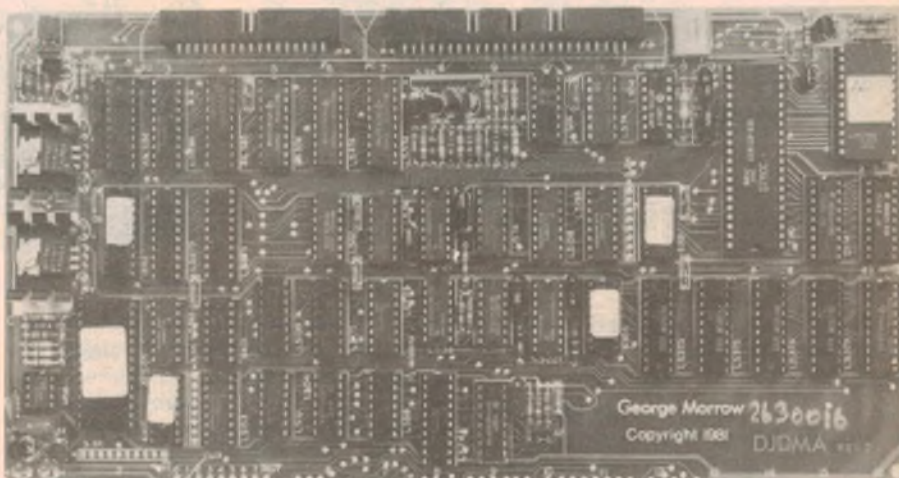

In addition it is possible to change the controller's parameters either by reprogramming the on-board EPROM or down-loading a special purpose controller routine into RAM on the board. Unlike many other boards the AED

board can control both 20cm and 14cm disk drives concurrently.

For more information on the new disk controller contact AED Microcomputer Products, 130 Military Rd, Guildford, NSW. (02) 681 4966.

Apple takes action against imitators

In an effort to stop manufacture and distribution of imitation Apple II computers, Apple Computer Inc has filed a number of lawsuits in Taiwan, Hong Kong and New Zealand. Investigations are said to be continuing into the situation in Australia, Japan and Singapore.

In July, Apple brought a civil action against the Taiwanese manufacturer of

the "Apollo II" computer, claiming that it was a copy of the Apple II. As a first step in the action Apple seized evidence in a surprise raid on the Apollo II factory in Taipei, as permitted under Taiwanese law. A similar action against another manufacturer is planned, and the government of Taiwan will help to prevent the export of Apple copies according to the company.

In Hong Kong, Apple filed a civil action under local patent laws against a small

manufacturer selling alleged Apple copies. A number of the machines of the company were seized as evidence in a raid similar to the one in Taiwan. Apple expects to halt all manufacturing and selling of Apple copies under Hong Kong patent and copyright law.

Apple has also obtained an injunction against a New Zealand company alleged to be selling "Orange" computers from a Taiwanese manufacturer in breach of Apple licensing rights.

VIC 20s ★ ACCESSORIES ★ SOFTWARE ★ BOOKS

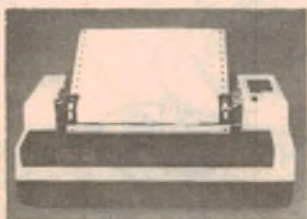
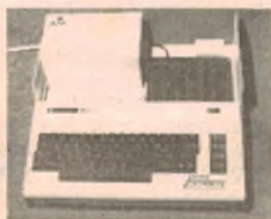

Vic 20 \$399! Arfon module \$250! Printer \$479! Disk drive \$699! Cartridges from \$39.95!

We have a wide range of accessories, peripherals, and software for the Vic — including Commodore, Vicsoft, Acme, etc.

EDIBLE ELECTRONICS

50 PARK ST, ABBOTSFORD 3067. (03) 41 5708

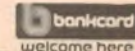

SPHERE COMPUTERS



Box 380 Darlinghurst NSW 2010

AN ADVANCED SYSTEM BASED ON THE 6809 MICROPROCESSOR

- * EFFICIENT
- * VERSATILE
- * EXCELLENT SUPPORT
- * SUPERB SOFTWARE
- * MK2 MULTI USER AND MULTI TASKING



PERIPHERALS

Additional VDUS, Dot Matrix Printers, Daisy Wheel Printers, 8" and 5" Floppy Disk Systems, and a hard disk drive of up to 40MB may be connected to the system. Interface boards and software are available to support all these devices in a singular or multi-user environment.

INPUT/OUTPUT

8 I/O Boards slots are provided, each of which may be fitted with a dual serial or dual parallel interface board using DB-25 "D-TYPE" Connectors. Many other types of interface Boards are also available.

CABINET

The Cabinet is made of heavy gauge (approx 1/8") Aluminium Anodised in Delightful blue.

SIZE

Approx. 16" wide by 20" deep by 7.5" high

WEIGHT

Approx. 10KG. (including supply, CPU, 64K RAM, and I/O board)
A/C POWER INPUT 115-240 VOLTS A/C
+/- 10%, 50-60Hz

MK 1 and MK 2 SPECIFICATIONS

PROCESSOR

The heart of the system is the Motorola 6809 CPU and considered to be the most powerful 8 bit Microprocessor available today. The CPU board is fitted with Memory Management hardware which allows it to directly address up to 1 Megabyte of memory using a 20 Bit address bus. The system is provided with a 2716 compatible 2k Monitor ROM or EPROM.

MEMORY
A 64K Ram board is provided as standard. However the system may be provided with as little as 8k if desired and more added later.

POWER SUPPLY

Provides 8.5V, +12V, -12V unregulated supply to the buss. All components are P.C board mounted and fuses readily accessible.

PERIPHERALS

Additional VDUS, Dot Matrix Printers, Daisy Wheel Printers, 8" and 5" Floppy Disk Systems, and a hard disk drive of up to 40MB may be connected to the system. Interface boards and software are available to support all these devices in a singular or multi-user environment.

SOFTWARE SPECIALIST FOR THE 68XX SERIES

MICROWARE SYSTEM CORP

OS-9 Level 1 Operating System	\$195.00
OS-9 Level 2 Operating System	\$495.00
Basic 09 Programming Language	\$195.00
Pascal OS-9	\$440.00
Macro Text Editor	\$ 95.00
Assembler	\$ 95.00
Debugger	\$ 35.00
Stylograph Word Processor	\$175.00
Cobol Programming Language	\$995.00
C Programming Language	\$440.00

TECHNICAL SYSTEMS CONSULTANTS

UNIFlex Operating System	\$550.00
UNIFlex Basic	\$200.00
UNIFlex Pascal	\$250.00
UNIFlex Fortran 77	\$350.00
UNIFlex Relocating	
Assembler & Language Editor	\$175.00
General Purpose Flex 6809	\$165.00
General Purpose Flex 6800	\$165.00
Exorcisor Flex 6809	\$165.00
SWTPC Flex 6809	\$ 45.00
GIMIX Flex 6809	\$ 99.00
TRS80C Colour Flex	\$ POA
Extended Basic	\$110.00
Utilities	\$ 82.50
Pascal for Flex	\$220.00
68000 Cross Assembler for Flex	\$275.00

Sort Merge Package	\$ 82.50
Text Editor	\$ 55.00
Assembler	\$ 55.00
Debug Package	\$ 82.00
Diagnostics	\$ 82.50
Text Processor	\$ 82.50

FRANK HOGG LABORATORY, INC

XForth	\$165.00
Basic Programmer Tool Kit	\$ 77.00
Extended Use Utilities Pack	\$ 77.00
Password Protection Pack	\$ 99.00
Dynasoft Pascal Flex	\$ 99.00
Bill Payer System	\$185.00
Spell Test	\$220.00
Super Sleuth	\$110.00
Stylograph 2:0	\$325.00
Dynastar Full Screen	
Editor OS-9, Flex	\$ 99.00
CRASMB Cross Assembler, Flex,	
6809, 6800, Z80, 8080, 6502	\$149.00
Dataman + DBM	\$220.00
Plot	\$ 49.00
Tabula Rasa	\$110.00
Job Control Program	\$ 99.00

WASHINGTON COMPUTER SERVICES

6809RMS DBM for Flex	\$220.00
6809 RMS DBM for UNIFlex	\$330.00
6809 RMS DBM for OS-9	\$275.00

UNIVERSAL DATA RESEARCH INC

DBM 2 Flex	\$450.00
DBM 2 UNIFlex	\$550.00
Payroll	\$495.00
Accts Receivable	\$495.00
Accts Payable	\$495.00
General Ledger	\$495.00
Inventory	\$495.00

TALBOT MICROSYSTEMS

tForth	\$ 99.00
tForth+	\$275.00

COMPUTER SYSTEM CENTRE

DYNAMITE Dissassembler	\$ 66.00
DYNACALC	POA

DUGGERS GROWING SYSTEMS

6809 C Compiler ver 2.0	\$130.00
-------------------------	----------

OMEGASOFT PRODUCTS

PCS2 Pascal Compiler Flex,	
OS-9, MDOS	\$490.00
Rall1 Relocatable Assembler &	
Linking Loader	\$150.00

SWTPC

EDIT Word Processing Editor Flex	\$110.00
C Compiler for UNIFlex	\$ POA
* Prices subject to alteration without notice, \$5 handling and packaging plus postage.	

All prices plus Sales Tax if applicable

AVAILABLE FROM

Office and showroom:

Shop 1 165 Bunnerong Rd Kingsford NSW 2032.

Postal address:

PO Box 380 Darlinghurst NSW 2010.

Tel (02) 344 9111

Telex AA22579

J. H. MAGRATH & CO

208 Little Lonsdale Street,
MELBOURNE, VIC 3000

TEL: (03) 663 3731

Microcomputer News

32K RAM expansion for Sinclair ZX81

Vendale Pty Ltd now has available a 32K RAM expansion unit for the Sinclair ZX81. The ZX81 normally works with up to 16K of RAM, and when switched on with the Vendale RP32 unit in place will come up as a 16K machine.

A single POKE instruction activates the second bank of 16K, which is then available for storage of data variables and Basic programs. The unit uses dynamic RAM chips with refresh and bias voltage generation taken care of on the board. According to Vendale no extra power supply is required.

The RP32 costs \$165 including postage and is available from Vendale Pty Ltd, PO Box 456, Glen Waverley, Vic 3150.

Modular business software from IMS

A new concept in software marketing was unveiled recently by leading Australian software house IMS Computer Systems Pty Ltd. "Ascent" is a new series of modular business software packages which allow users to start with a minimal package and add modules to suit as their business expands.

As Managing Director of IMS, Mr Bryan Gardiner, explained: Ascent will "fit small machines, such as the Osborne, while providing access, through modules, to the most highly powered micro-based

New store for Paris Radio Electronics



Paris Electronics' new store at 165 Bunnerong Rd, Kingsford, NSW, is worth a visit for anyone interested in SS-50 bus systems, such as the SWTPC, Gimix and Sphere computers.

A wide range of software for 6800 6809 and 68000 systems is also available, including the Flex disk operating system for the TRS-80 Color Computer.

Peripherals, including Epson and Anacom printers, SWTPC terminals and Paris Electronics' own disk drive units can be provided, in addition to a

range of expansion boards for SS-50 systems.

Latest new products are the "Speech Systems" speech synthesiser and music boards for the SS-30 bus. Two versions are available, one using the National Semiconductor Digtalker chip set and the other the Votrax SC-01 chip. Both units include an on-board amplifier and 8-bit D/A converter for sound effects.

Paris Electronics offer a mail order service. The address is PO Box 380, Darlinghurst, NSW 2010. Telephone (02) 344 9111.

accounting software available in the world".

Ascent provides a powerful basic package to cover Accounts Receivable, Accounts Payable, General Ledger and Stock Control, with the option of adding any of a further 18 modules.

For more information contact IMS Computer Systems Pty Ltd, 582 St Kilda Road, Melbourne 3004. (03) 51 9156.

Disk upgrade kit — more power to Sorcerer

PJB Systems now has available a disk upgrade kit for the Exidy Sorcerer computer. A pre-programmed EPROM is supplied to replace one of the Sorcerer Monitor ROMs, and adds the following features to the Sorcerer:

- Automatic boot of disk — as soon as the Sorcerer is switched on the new ROM automatically loads the disk operating system. Pressing the two Reset keys has the same effect.
- Easy Monitor entry — entry to the Sorcerer Monitor can be made from disk mode or from RomPac Basic by pressing Control-C and Reset together.
- Easy entry to RomPac Basic — from disk mode or the Sorcerer Monitor, entering Basic is a matter of pressing the ESC key and Reset together, causing a cold start of Basic.

The upgrade kit will work with both Micropolis (Mod 1 and Mod 2) and Exidy FDS disk drives. With no disk attached the Sorcerer behaves normally, with the added advantage of being able to use features 2 and 3 listed above.

For owners of Micropolis drives the PJB kit provides an added advantage. By rewiring the Basic RomPac they can have a full 48K of RAM and still use RomPac Basic.

For more information contact PJB Systems, PO Box 252, Forestville, NSW, 2087.

32K BYTES FOR THE ZX81

This board uses Dynamic RAM chips for lower cost and lower power consumption.

Simply plugs into the ZX81 expansion port offering 32K bytes for Basic programs and data handling. No extra PSU required. AMAZING!!!

Extra memory to help you build up your ZX81 into a powerful microprocessor system at an affordable price. Compare the price with other RAM PACKS available on the market!!!

SPECIAL RAM PACK FOR THE ZX81

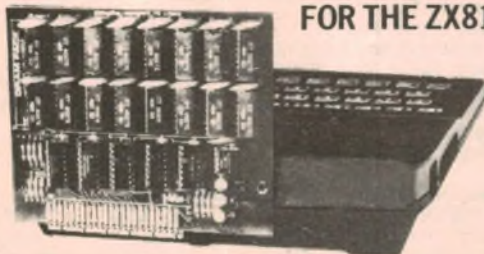

PRICE FOR 32K RAM PACK (RP 32) ONLY: \$165 Incl. p & p (Australia)

SEND ORDER TO:
VENDALE PTY. LTD., Dept A7, P.O. Box 456,
Glen Waverley, VICTORIA 3150.
36 Plymouth St., Glen Waverley (03) 232 0444.

VENDALE

VEN 0357

ANACOM

SERIES 160

DOT MATRIX PRINTERS

ANACOM'S MODEL 160 SERIES:

- Pays for itself by saving forms
- Print at the tear line
- True demand document delivery
- Forms handling/data processing
- Virtually ends wasted forms

Standard features include:

- True 100% duty cycle rating
- Logic seeking, bidirectional printing
- Ribbon cartridge
- Underlining with true descenders
- 150 characters per second
- Serial or Parallel interfacing
- 110 to 9600 baud
- Original plus 4 copies



ANACOM

Distributed in Australia by
PARIS RADIO ELECTRONICS

Office and showroom:
Shop 1 165 Bunnerong Rd Kingsford NSW 2032.

Postal address:
PO Box 380 Darlinghurst NSW 2018.
Tel (02) 344 9111

Telex AA22579

MICROPROCESSOR

Typical crystal oscillators

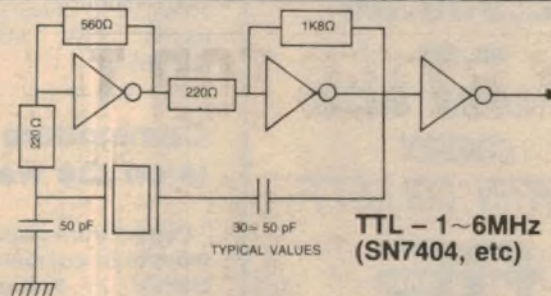
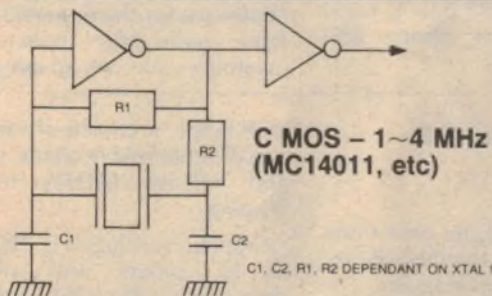

STANDARD MICROPROCESSOR FREQUENCIES

XTAL f	Holder	XTAL f	Holder	XTAL f	Holder
1.0000 MHz	HC6μ/W	2.09715 MHz	HC6μ/W	4.1943 MHz	HC6μ/W, HC18μ
1.2288 MHz	HC6μ/W	2.4575 MHz	HC6μ/W	4.43361 MHz	HC6μ/W, HC18μ
1.6384 MHz	HC6μ/W	3.2768 MHz	HC6μ/W	5.0688 MHz	HC6μ/W, HC18μ
1.8432 MHz	HC6μ/W	3.57954 MHz	HC6μ/W, HC 18μ	5.1850 MHz	HC6μ/W, HC18μ
2.0000 MHz	HC6μ/W	4.0000 MHz	HC6μ/W, HC 18μ	5.7143 MHz	HC6μ/W, HC18μ

The crystals listed are a small selection of our low cost range, suitable for microprocessor and timing devices.

Rakon also manufacture crystals to MIL-SPEC. and individual requirements. Inquiries concerning price and delivery are invited and should be forwarded to:

New Zealand manufactured crystals are competitively priced and duty-free in Australia.



RAKON INDUSTRIES

9 George Street, Mt. Eden, P.O. Box 9308, Newmarket, Auckland.
Cables: "RAKON". Telex: 21682. Phone (64-9) 605-010, 605-270.
Civil Aviation Department Approval No. AWB556.

BCA 7096

Tandon

HARD DISK DRIVE ADD-ONS

For
APPLE
TRS80
S100
MULTIBUS
S.T.D.

Your Computer

FOR AROUND
\$2,950.00

inc. tax

*For further details
contact
MARTIN COLLETT*

AE
**ADAPTIVE
ELECTRONICS P/L**

**418 St. Kilda Road,
Melbourne, 3004
(03) 267 6800**

*O.E.M. Enquiries
Welcome*

Microcomputer News

Radio University microprocessor course

Following on from his popular Radio University courses in Microprocessor Fundamentals, Dr David Mee of the University of NSW School of Electrical Engineering will broadcast a new course on "Microprocessor Applications" over the University's radio station starting in early October.

The course will cover applications of microprocessors in a variety of common situations, with projects including a complete single chip analog data acquisition, display and control system for water heating, EPROM programming for a single chip microcomputer, a raster scan terminal and subsystems for communications and magnetic data storage.

Eight lectures will be broadcast by University Radio VL2UV at 7pm on Tuesdays, repeated at 8pm Thursdays. Transistor radios adjusted to pick up VL2UV can be purchased from Radio University for \$10 post paid. One lecture will be transmitted over VITU, the University's television station, and there will be two attended seminars held at the University.

The course fee of \$27.50 includes a comprehensive set of notes in addition to lectures and seminars, and the course will be available on tape following the broadcasts, for \$8 per lecture.

For more information on this course and others offered by Radio University contact the University, PO Box 1, Kensington, NSW, 2033 or phone (02) 622 2691.

Commodore VIC-64 is on the way

Commodore displayed the new Commodore 64 computer at the Data '82 exhibition in Sydney in August. The machine is physically identical to the VIC-20, although in beige plastic, but offers an expanded range of features.

The basis of the new machine is a new microprocessor developed by Commodore subsidiary MOS Technology. The 6510 processor uses the same instruction set as the 6502 but has additional input and output lines. Commodore are calling it a "significant advance in technology".

Features of the new computer include 64K RAM as standard, although only 39K are available to the user from Basic. A high quality music synthesiser is built in, with three voices, each with a nine oc-

Club news:

The Microcomputer Enthusiasts Group meets at St Andrews Presbyterian Church Hall, 31 Anderson St, Chatswood, on the 3rd Monday of each month, from 7.00pm. All are welcome to attend.

Apple-Q, the Brisbane Apple User Group meets every third Sunday of the month (except December) at the Hooper Education Centre, Kuran St, Wavell Heights. The Centre is open from 8.30am to 4.30pm, and barbecue facilities are available for members staying the day.

Subscription fees for the club are \$18 per year. Further information is available from the secretary, Apple-Q, PO Box 721, South Brisbane, Qld, 4101.

The Christchurch 80 users' group has been operating for about 18 months, and boasts a regular attendance of 50 at meetings. Main interests are the TRS-80 and System-80 computers and the group publishes a monthly newsletter.

Meetings are held at 7.30pm on the last Wednesday of each month at St John's Church Hall, Latimer Square, Christchurch. For further information write to the club at PO Box 4118, Christchurch, NZ.

Atari Computer Enthusiasts (NSW) meets on the first Monday of each month at the offices of I. P. Sharp Associates, 8th Floor, Carlton Centre, 55 Elizabeth St, Sydney. The group publishes a very well presented newsletter containing programs and Atari computer information and tips.

Postal address is 78 Ayres Rd, St Ives, NSW, 2075.

"Software for the Super-80 Computer" is now available from "Electronics Australia". See our advert p107.

tave range, a choice of four waveforms and programmable attack, decay, sustain and release (ADSR) for envelope shaping.

Graphics resolution is 320 x 200 pixels, in 16 colours, and with eight independently movable "sprites" available for animation and games.

Basic for the Commodore 64 is the same as PET Basic and PET style graphics characters are available from the keyboard. The text display is 25 lines of 40 characters each, in any of the 16 colours available. Programmable graphics characters allow the user to replace the character set with a customised set.

Release date and price of the Commodore 64 are unspecified as yet but Commodore in NSW expects the machine to go on sale either late this year or early next year. Price is quoted as "under \$1000".

THINKING APPLE MICROCOMPUTERS

THINK COMPUTER COUNTRY

We are one of Australia's oldest Apple Dealers
and the oldest in Victoria!

We carry probably one of the largest ranges of
Apple Products in Australia!

GREAT PRICES!
GREAT SERVICE!
WHY GO ELSEWHERE!

Come to the
Computer Country Group
for all Your Apple needs



**COME TO
COMPUTER COUNTRY (VIC) PTY LTD**

338 Queen Street Melbourne Vic 3000 (03) 329 7533

 **apple computer**
Authorized Dealer



INFORMATION CENTRE

6-DIGIT CLOCK: I built the 6-digit crystal clock described in the March 1979 issue. It all worked at switch-on but it runs much too fast, gaining 12 seconds per minute. Is this due to an incorrect timebase? I believe there are two versions of the MM5369 and I may have the wrong one. (P.Q., Redfern, NSW).

- The crystal timebase for this clock used the National Semiconductor MM5369 oscillator/divider chip to derive a 60Hz signal from the American colour TV sub-carrier crystal at 3.579545MHz. Recently, a different version of this chip has become available which has a 50Hz output. This device is coded MM5369-EYRN. However, it seems likely that you have the former version as specified and the problem really is that a track on the PC board, connecting the 50/60Hz select, pin 11, of the MM5314 clock chip to the 0V rail, is open circuit. We suggest you check this track very carefully for cracks.

GRAPHIC EQUALISER: My EA graphic equaliser recently went off song and on checking was found to have eight defective op amps. Only two ICs were completely functional. After replacing the duds, this time in sockets, and finding everything else normal, I searched for a

cause. Possibly the use of single tantalum capacitors at the inputs was to blame, for while they are okay unpolarised for small signals, around 1 volt p-p, large reverse signals such as DC offsets at switch on will be passed on. I have noted that in some Japanese amplifiers they are used as back-to-back pairs.

So I drilled holes, cut tracks and installed paired capacitors at the inputs and outputs.

While the equaliser was on the bench, I looked for the source of the hiss which was apparent when the equaliser was switched into circuit. About one millivolt was visible on the CRO, all apparently coming from the 100kΩ buffer amp input resistors. Reducing these to 27kΩ reduced the hash to invisibility and on test it is now virtually inaudible. Finally while I was at it, I incorporated the relay idea of one of your recent contributors. The switch-on plop, the switch-off chirp and the hiss are now history and I'm back in business. But I still don't really know what blew the op amps! (W.A.J., Nambucca Heads, NSW).

- We doubt whether the tantalum capacitors were to blame for the failure of ICs. After all, you did not find any defective capacitors. Nor will back-to-

back capacitors prevent the coupling of large switch-on transients. The more likely reason for the practice of using back-to-back tantalum capacitors is to reduce harmonic distortion at low frequencies where the capacitor's reactance becomes large with respect to the circuit impedance.

The most likely reason for the IC failure was a voltage surge on the mains. This would have been fed to the ICs because the supply rails of the Graphic Equaliser are unregulated. The best way to avoid this problem is to install zener diodes or three-terminal regulators in the power supply. However this will require a complete redesign of the power supply if you still require ±15V rails.

It is true that changing the input and feedback resistors for the input op amp to 27kΩ will improve the signal-to-noise ratio. This will also reduce the input impedance but in most circumstances this will not be important.

RLC BRIDGE: I am seeking your assistance or advice regarding your RLC Bridge in the March 1978 issue of EA. In trying to calibrate the instrument I struck an error of 10 times the correct reading, as under:

1000pF capacitor measures 100pF
 .1μF capacitor measures .01μF
 .01μF capacitor measures .001μF
 10kΩ resistor measures 100kΩ
 1kΩ resistor measures 10kΩ
 100Ω resistor measures 1kΩ
 10Ω resistor measures 100Ω

Your reply in "Information Centre" would be greatly appreciated.

(C.R., McMasters Beach, NSW)

- In a relatively simple instrument such as this, we can think of only two possible causes for the above fault. Either the switch wiring is hopelessly confused, which we tend to discount, or the scale potentiometer is non linear, possibly logarithmic. We specified a wirewound linear pot.

LONG BATTERY LIFE: I have a battery in my car which was installed just over six years ago and still appears to be going strong. Is this unusual and can I expect much more life out of it? Apart from keeping the electrolyte levels above the plates and occasionally checking the voltage regulator, I have done nothing

Designing loudspeaker crossover coils

CROSSOVER COILS: In several of your speaker systems over the years you have advised constructors that they can wind their own crossover coils by using a certain number of turns of 18 B&S (or 19 SWG) wire on a non-metallic former, 25mm in diameter, 20mm long, with 50mm diameter cheeks at both ends. I would be grateful if you could supply me with some sort of formula that I can use to work out the number of turns needed for such an inductor, given the inductance in millihenries. (D.H., Charnwood, ACT).

- The relevant factor to remember in any calculation of inductance of a coil is that the inductance is directly proportional to the square of the number of turns. This means that, for a given coil former, you can use this direct relationship to come up with an inductor of desired value. Hence, if you have access to one of our previous articles which specified so many turns on a specified

former for a given inductance, you are "home and hosed".

We delved into this subject fairly deeply in an article entitled "Hifi Crossover Networks" back in July 1959. This article featured a number of useful charts. On the other hand, you can find a number of general formulas for coils of differing shape factors, by referring to the relevant sections of "Radiotron Designer's Handbook" edited by F. Langford-Smith. This trusty book should be on the shelves of most technical libraries.

For a coil with depth smaller than its diameter, the inductance is calculated by the formula:

$$L = \frac{a^2 N^2}{9a + 10b + 8.4c + 3.2cb/a}$$

where as L is in microhenries, a is the average radius of the winding, b is the depth, and c is thickness (difference between the two winding radii). Dimensions are in inches.

special to extend the battery life. In fact I must admit to using tap water more often than not, instead of rain water. The battery originally had a two-year warranty, by the way. (D.S., Collaroy, NSW).

● Many buyers of car batteries do not expect to receive much more than the guaranteed life and, of course, since the battery manufacturers have done their sums correctly, that is what most buyers get. However, when battery manufacturers compile their statistics on expected battery life and hence calculate their guarantee periods, the assumption is that they are dealing with an "average" motorist.

Buying a battery with a three-year warranty instead of a two-year warranty does not necessarily mean that you have a better battery. In most cases, you are buying exactly the same battery but paying an "insurance" premium in case the battery expires before the end of the pro-rata guarantee. Manufacturers calculate that premium on the cost of honouring the guarantee.

It also stands to reason that if the majority of batteries last for the guarantee period (otherwise the manufacturer would go broke), then a small minority of batteries must last considerably longer than this period. You have one of those. It also stands to reason, that if battery guarantees are calculated on the care and maintenance given by the average motorist (which is almost nil) then the care given by you is almost fanatical by comparison and you should naturally expect long battery life.

Filling the battery with tap water, incidentally, is far more preferable than not filling with distilled or rain water. Having said all that, you have had a good run.

LCD TACHO/DWELL METER: I recently built the LCD Tacho/Dwell meter as featured in EA May, 1982. Unfortunately

Problems with the 500MHz DFM

500MHz FREQUENCY COUNTER: It is with regret that I must ask for your assistance with this project. The problem I have is with the display and the ICM7216A chip. The display will not vary with a signal injected although the "0"s in the display light as they should (as mentioned in your construction article), and vary with switching from 4 to 1 (or vice versa) zero digits.

I have conducted all checks that your February 1982 article suggests and "all" seem OK. I confirm all the voltages are (and always have been) correct and that all components are inserted correctly. The crystal is also

functioning. The suppliers of the kit can offer me no clues as to the problem, hence my reluctant request to you.

As a footnote I advise that the leads of the two transistors (2N4258) have to be bent specially to suit the PCB. (D.H., Springwood, NSW).

● It appears likely that the problem does not lie with the 7216 chip but with the ECL front-end section involving the MC10116. The fact that you had to bend the leads of the 2N4258 ECL-to-TTL level translator transistors is significant and suggests that the fault may lie in this section.

it does not work and I am writing to request help!

Instead of installing it in a car, I built it as a portable instrument, which resulted in some changes to the layout. I also added an additional switch to cover 4, 6 and 8-cylinder cars. The changes did not alter the actual circuitry (I hope) and were as follows:

1. The circuit board and DPM200 were not soldered, but joined by wires.

2. The switch used to select 4, 6 and 8 cylinders was a 4-pole 3-position type and broke the connections between one end of the 10kΩ and 100kΩ trimpots and the 220kΩ resistors as well as the connections from the wipers to the dwell/tacho switch. The other ends of the trimpots were joined together and to pins 3, 4, 5 and 12 on DPM200.

The circuit board was made from your pattern by a photographic technique but the trimpots were mounted elsewhere.

The display shows the first "1" only when switched to "Tacho" and the

decimal point is also displayed when switched to "Dwell". Adjustment of the trimpots does not alter the display of "1" nor does shorting the points lead to earth. There is no voltage between pin 4 and pin 1 but all other voltages appear correct.

I have replaced the 4001, which was fitted with a socket, and the DPM200, as I have two. Is there any way to check out the DPM200 as a separate item? The circuit appears to be correct (checked 20 times) and components are of correct value.

On the DPM200 there are additional tracks, especially between pins 3 and 4. These would have been soldered if the PCB and the DPM200 had been joined. Is this important?

Can you help? (B.W.T., Frenchs Forest, NSW).

● The fact that there is no voltage between pins 1 and 4 on the DPM-200 module indicates that there is a short circuit somewhere in your layout which is dragging the potential of the common

TRUSCOTT ELECTRONICS

- ALL SEMICONDUCTOR COMPONENTS
- CAR HI-FI
- CB RADIO

IN FACT ALL YOUR ELECTRONIC NEEDS

SUPPLYING THE EASTERN SUBURBS WITH COMPETITIVE CITY PRICES AND SERVICE



TRUSCOTT ELECTRONICS

Cnr Eastfield and Bayswater Roads,
South Croydon 3136, Vic.
Phone (03) 723 3860.

wherever
you drive, work, live...



Electrophone UHF

TWO-WAY RADIO KEEPS YOU IN TOUCH

for further details and a Brochure on this new low cost system
see your local two-way communication dealer or post this coupon.

TO Electrophone TX470
PO Box 174, Leichhardt NSW 2040

NAME

ADDRESS

PHONE

**Rest in Peace
Old Gell
sealed lead
batteries.**

**Your number is up.
Because here comes EXIDE's new...**

LIVE TWICE

(for the same money)

RE* SYSTEMS BATTERY

(*Recombination Electrolyte... a space-age breed
built nothing like all you oldtimers.)

Poor Gell Oldtimers,
Flatten you to zero volts and you stay dead. I take charge and
come up near full potential. Now that's living twice.
You only live 3 years at best. I live 5-6 years. That too is
living twice.
I fit anywhere you can (1-65 A.h). I standby on continuous
charge. Or I take cycling duty. Living twice again.
Folk who want to persevere with outmoded batteries, why
that's their business. You OEMs and users who do your sums
know a battery that LIVES TWICE for the SAME MONEY
is twice the value.
The RE Systems Battery... from Chloride. Call for details NOW.
Sydney 646 2244, Melbourne 288 6244, Brisbane 44 1751,
Adelaide 277 7255, Perth 271 7377, Hobart 34 4022

L. E. CHAPMAN

122 PITT ROAD, NTH CURL CURL.
MAIL ORDERS: BOX 156, DEE WHY, NSW. 2099.
TELEPHONE 93-1848.

SUPER SPECIAL

GRAMOPHONE motor and pickup 3 speed
stereo balanced arm.
240 volt \$9.75

PP NSW \$1 50
Interstate \$2 75
WA \$4



SPECIAL MAGNAVOX SPEAKERS

10 INCH WOOFER
10 INCH MID-RANGE
8 OHM SYSTEM, 20 WATTS RMS



P&P NSW \$3 50 — INT \$4 50 — WA \$5 50
NT \$6 50

SUPER SPECIALS FM STEREO TUNER KITS

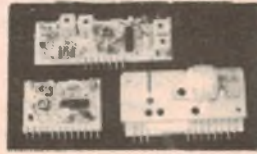

Sets of 3 modules include FM tuner decoder
and IF detector. Circuit diagram supplied. Can
be used with amp modules.

ONLY \$22
P&P \$1 40

SPECIAL

SPEAKER CROSSOVER NETWORKS 2WAY
FREQ 4KHZ 30W 80HM

\$2



BSR DELUX RECORD PLAYER

11 INCH TURNTABLE CING
DEVICE SHIELDED MOTOR,
MAGNETIC CARTRIDGE \$50 BASE
TO SUIT \$8 EXTRA

P&P NSW — \$4.50; INT — \$5.50
WA — \$6.50
NT — \$6.50



SPEAKERS 2 1/2 INCH 2 FOR \$1

Power Transformers 240V 2/6 3 Windings
0 15 AMP (suit clock modules) \$3 00
Power Transformers 240V 1/130V x 12V 60
Mil \$6 00

MAGNAVOX SPEAKERS

8 INCH DUAL CONE 16 OHM 10 WATT

\$6



PP NSW \$1 80
INTERSTATE \$2 75
WA, TAS, NT, \$4.

VALVES

6CJ8	\$3	12AV6	\$2	6AN7	\$3
6DS8	\$2	12AC6	\$2	EAF42	\$3
6AB8	\$2	12J8	\$2	EL84	\$3
15A6	\$2	E281	\$2	6D38	\$3
6AM5	\$3	6EAB	\$3	UY41	\$3
9UB	\$2	6BD7	\$3	6B4	\$4
7AW7	\$2	6V9	\$3	DL98	\$4
6S2	\$2	6BH6	\$2	6BK8	\$2
PCL81	\$2	12AO5	\$3	1954	\$3
EC92	\$3	6BS8	\$2	6AJ8	\$3
PL84	\$2	6BL8	\$2	12AN7	\$3
6DC8	\$2	6CB6	\$2	6BH6	\$2
12AX4	\$3	6EH7	\$2	12AO5	\$2
EF89	\$3	2E26	\$6	6BH5	\$3
EBF89	\$3	6DA4	\$2	9A8	\$3
12AN7	\$3	6X2	\$2	6AX4	\$4
6DC8	\$2	6AM8	\$2	6SN7	\$3
EY51	\$2	6BK7	\$2	7C5	\$4
6AB4	\$3	6DR8	\$2	7C7	\$4
6201	\$2	21A6	\$3	6CH6	\$3
6AQ4	\$2	6AU5	\$2	ECL80	\$2
UCC85	\$2	6AH4	\$3	6AWEA	\$2
6FC7	\$2	EY88	\$3	6AM8	\$2
EC89	\$2	PCL83	\$2	15A5	\$1
6BF6	\$2	6CK5	\$2	16A8	\$3
6BW8	\$3	6C5	\$2	21HB5	\$3
PCF80	\$2	1AH5	\$2	21A6	\$2
30AE3	\$2	6G6	\$2	1723	\$2
DM70	\$3	6CH6	\$2	PCCB4	\$2
19Y3	\$3	6BCC	\$2	6Z01	\$3
50EH5	\$3	886A	\$5	16B8	\$2
GES6	\$2	6BB	\$3	7AN7	\$2
15CW5	\$3	6DQ6	3 50	6DA4	\$3
6JN8	\$3	6BR5	3 50	PCL81	\$3
19Y3	\$3	1U4	\$1	15CW5	\$3
PCL83	\$2	1R5	\$3	6S2	\$2
6BJ5	\$2	6BW7	\$2	17AR11	\$3
6ES6	\$2	6AR7	\$3	UY85	\$2
9AK8	\$2	12K5	\$3	1AH5	\$2
6BJ6	\$2	6N7	3 50	9AK8	\$2
EF91	\$2	7V7	\$2	PCL84	\$2
UF41	\$2	155	\$1	PCL85	\$2
CAJ8	\$3	6SC7	\$2	6CB8	\$2
EZ81	\$2	1U4	\$1	6J8	\$2
6CJ8	\$3	6AX4	\$3	PCL81	\$2
6DB8	\$3	6BV7	\$3	6A08	\$2
6ET8	\$2	6GV8	\$3	15A6	\$2
17BF11	\$3	EM84	\$3	EL42	\$2
GW6GT	\$2 50	DM70	\$2	16A8	\$2
1723	2 50	6AT6	\$1	16Y9	\$3
6DB5	\$2	6DX8	\$3	50EH5	\$4
EF97	\$3	UCL82	\$2	6SH7	\$2
6BJ8	\$3	6EM5	\$2	6AH6	\$2
6AW8	\$3	6CS6	\$2	9AK8	\$3
6AM8	\$3	6BU8	\$3	6BW8	\$3
12AT6	\$2	6BA6	\$2	6BN8	\$3
6AM6	\$2	6HG8	\$2	21A6	\$3
6B07	\$4	6DX8	\$2	6DR8	\$2
EY86	\$2	6AL3	\$3	30AE8	\$3
6BK7	\$3	1S2	\$2	11AR11	\$3
6DA6	\$3	12BE6	\$2	17BFH	\$3
6BN4	\$3	ECL82	\$3	6ME10	\$3
6CJ8	\$3	6BM8	\$3	EC67	\$2
PC885	\$2	5Y3	\$3	UBC41	\$2
EFE	\$3	5AS4	\$2	UCC85	\$2
6BX7	\$3	6N3	\$2	15CW5	\$2
6AV6	\$2	6EAB	\$3	35W4	\$2
6DA4	\$2	12AV6	\$2	6DJ8	\$2
PC884	\$2	ECL82	\$3	6DB5	\$2
21H5A	\$3	16A8	\$3	16A5	\$2
6BC8	\$2	6U9	\$3	ECL80	\$2
6AH6	\$3	12AU7	\$3	6CH6	\$3
EY86	\$2	6B26	\$3	6AWBA	\$3
6AU4	\$3	12AU8	\$3	6BE6	\$2
EY86	\$2	6AN7	\$3	EY51	\$3
6BM8	\$3	12AT6	\$2	6BW7	\$3
EF86	\$2	6BH5	\$3	3M-P23	\$3
6CA7	\$4	1U4	\$2	3AQ4	\$2
6F6	\$3	6AU8	\$2	DL98	\$4
6V6	3 50	6AN8	\$3	8AT6	\$2
9AB	\$2	6BV7	\$3	SC95A	\$4
6K5	\$3	PCL83	\$3		

SPEAKER SYSTEMS

\$29.50 PAIR

Two 6" Dual Cone Magnavox
Speakers in each cabinet.
10 watts RMS

P&P NSW \$4 50 INT \$5 50 WA \$6 50
— NT \$6 50

rail down to earth. Fortunately, this will not damage the module. The display reading shown by the DPM-200 is the overrange display and in these circumstances is indicative of the fault described above. Upon removal of the short circuit, the voltage at pin 4 should rise to approximately +4.7V.

The thin tracks running between various pins on the DPM-200 (eg between pins 3 and 4) are guard tracks at earth potential. These should not be soldered to the pins, as this will short the pins to earth. From what you have said in your letter, it is likely that you will find that a short circuit between pin 4 and an adjacent guard track on the DPM-200 module is your problem.

ION GENERATOR: Is there a simple way of telling if an Ion Generator is working okay? (R.L., Merimbula, NSW).

● Yes. Sniff it. If it smells of ozone then it is probably working. Whether it is working okay is quite another matter. We do not believe that they are effective, although they may precipitate dust particles from the air.

HEADPHONE SENSITIVITY: I have a pair of compact headphones which were given to me as a birthday present. The problem with them is a disappointing inability to deliver any exciting amount of volume. I have enclosed the specifications with my letter. As stated, they are 32Ω. Is the lack of volume due to the mismatch when plugged into my 8Ω stereo socket. Can anything be done about this such as a matching transformer or equivalent circuit? When plugged into an 8Ω source, the volume control on the particular amplifier has to be turned up to twice or three times the setting which I use for the amplifier's speakers, for the same comfortable listening level.

A friend has a similar pair of phones, different brand but 20Ω impedance. These produce a much more acceptable listening level. I previously possessed a 15Ω pair of Sony headphones which delivered enormous volume. Can you offer any advice on the subject? (P.S., Chatswood, NSW.)

● First of all, let us talk about the typical 8Ω headphone socket and the likelihood of mismatch. In fact, the typical headphone feed circuit on a stereo amplifier or receiver is simply a resistor of about 330Ω, in series with the output of each channel. So the true output impedance is of the order of half this figure, or around 150Ω. This order of resistance performs a number of functions.

First, it prevents the output of the power amplifiers from being shorted when the headphone jack is being plugged into the socket. Second, it limits the drive voltage to low impedance phones to a safe level, by dint of the voltage

Electronics Australia Reader Service

"Electronics Australia" provides the following services:

PHOTOSTAT COPIES: \$3 per project, or \$6 where a project spreads over multiple issues (price includes postage). Requests can be handled more speedily if projects are positively identified, and if not accompanied by technical queries. We reserve the right to supply complete back issues instead of photostats, where these are available.

CHASSIS DIAGRAMS: For the few projects which require a custom metal chassis (as distinct from standard cases) dyeline plans showing dimensions are normally available. \$3 including postage.

PC BOARD PATTERNS: High contrast, actual size transparencies: \$3, including postage. Please specify positive or negative.

PROJECT QUERIES: Members of our technical staff are not normally available to discuss individual projects, either in person at our office, or by telephone.

REPLIES BY POST: Limited to advice concerning projects published within the last three years.

Charge \$3. We cannot provide lengthy answers, undertake special research, or discuss design changes. Nor can we provide any information on commercial equipment.

OTHER QUERIES: Technical queries outside the scope of "Replies by Post" or submitted without fee may be answered in the "Information Centre" pages, at the discretion of the Editor.

COMPONENTS: We do not sell electronic components. Prices and specifications should be sought from advertisers or agents.

BACK ISSUES: Available only until our stocks are exhausted. Within six months of publication, face value plus 90c for post and packing for each issue. Seven months and older: \$3 (includes post and packing and storage fee).

REMITTANCES: Must be negotiable in Australia and made payable to "Electronics Australia". Where the exact charge may be in doubt, we recommend submitting an open cheque endorsed with a suitable limitation.

ADDRESS: All requests to the Assistant Editor, "Electronics Australia", Box 163, Chippendale, 2008.

divider action. Third, it can effectively improve the signal-to-noise ratio of the amplifier. As far as headphone listening is concerned, if you were to connect a typical pair of phones directly across the loudspeaker outputs of the amplifier, you would become instantly aware of a relatively high level hum and hiss which is not normally audible from your speakers. So as far as a mismatch is concerned there is really no problem since every headphone circuit constitutes a severe mismatch in absolute terms.

Given that the headphone circuit on a stereo amplifier is a current source, ie, resistive feed, you will be better off with a headphone that has a low impedance, for a given headphone efficiency. Now considering the specifications of your particular headphones, it does appear that they are fairly normal. Sensitivity is quoted at 96dB/mW which is a fairly typical figure. Rated power is quoted at 50mW which would give a sound pressure level of 113dB which is pretty loud. And the power handling capacity is quoted at 0.5W which would give a maximum sound pressure level of 123dB which is about the level which most run-of-the-mill phones are capable of. In other words, they should give a very loud sound level.

But your experience suggests that they

are well below par in sensitivity. We can only assume that you have been given a pair which just do not meet the spec. We can also say that there is quite a wide disparity in sensitivity between brands and models of these newer supra-aural headphones (which were originally designed to suit the new personal portables). The most sensitive types use the new samarium-cobalt magnets which are very powerful but add only a few dollars more to the headphone price.

In any case, the motto "try before you buy" really does apply when you buy headphones. If you just buy a "bubble pack" from a large retail display you could just be buying a pair of ear muffs.

Notes & Errata

SOUND LEVEL METER (May 1981, File 7/M/59): The errata on page 133 of the August 1982 issue neglected to show the 1kΩ resistor connected from pin 2 of IC5 to the zero volt rail. This is best achieved by soldering the resistor beneath the PCB directly from pin 2 of IC5 to the negative side of the 100μF capacitor which also connects to the common earth point of switch S1.

Wizzard video game . . . ctd from p131

the Commodore VIC-20 or the Tandy Color Computer.

Where it is likely to suffer by comparison with these two machines is in the pressure sensitive keyboard which is not as easy to use as a regular typewriter keyboard. And whether there will be a large range of software to suit the Wizzard Basic remains to be seen.

In the meantime, the Wizzard provides a good selection of games cartridges which is likely to expand. The Wizzard console together with one game cartridge sells for \$295 and additional game cartridges are available for \$39.50 each. The Basic cartridge will sell for \$69.50 which will include the companion Basic manual. (L.D.S.)

MARKETPLACE

FOR SALE

COMPONENTS at bargain prices BC547/8/9 — \$7 per 100, BC557/8/9 — \$8 per 100, 2N3055 — \$8 per 10, Z80 cpu \$9, Z80 CTC — \$7. Mail order to "South West Electronics", PO Box 53, Belmont, Vic 3216. Add 50c p&p.

EA CAR COMPUTER EPROMS (July 82 issue). \$NZ15 EPROM custom-program service for 2708 2516 2716 2532. Write for free info to: Technman Electronics Ltd, PO Box 56238, Auckland 3, New Zealand.

TAPE TRANSPORT (only) 16 trk 1, 1/2 and 1/4 inch, suitable digital \$375. Tapes, 14" reels, 1 and 1/2 inch \$5 each. Valves (new) MSPENT, 5 pin 4 volt Rt, LS7, LS9A (bulbous), 3A 110 A direct equ. B406, all at \$5 each. S. Dekker, Box 437, Gawler 5118.

SUPER-80 GAME CASSETTES: 3 programs \$20 the lot or \$3 for detailed descriptions. Send cheque or money order to K. Khalil, 4/76 Harlington St, Clayton, Vic 3168.

SUPER 80 OWNERS Software now available. Super Invaders: Destroy the aliens before they destroy you! Sea Wars: You are attacked by planes, sub, missiles and mines. Both games in machine code, animated graphics. 16K and character generator required \$29.50 each + p&p \$1.50. Send cheque or money order to: Megasoft, 151 Denton Ave, St Albans 3021.

AUSTRALIAN STC RADIO in wooden cabinet, excellent condition. Ring J. Reid (047) 87-1212 7pm to 9pm.

OSCILLOSCOPE Tektronix 545A 30MHz. Delayed sweep, two plug-ins — dual trace and differential. Probes and camera attachment \$1200 ono. (03) 347 0399 BH.

SUPERBRAIN 64K COMPUTER, CP/M with 170K disk storage built-in. 737 centronics dot-matrix printer with connecting cable and payroll, stock control, debtors, creditors and general ledger software included, worth over \$6000. Still has 6 months full warranty. \$4500. Phone (042) 96 7906 (Wollongong, NSW) after 6pm.

HEWLETT-PACKARD 1741A 100MHz Storage Oscilloscope. Current model. New price over \$7000, asking \$4000. In excellent condition with 2 x 10:1 and 1 x 1:1 probes, all accessories and handbook. This is the super CRO Auto Store, Variable Persistence, delay and 3 Trace (Trigger) viewing capability. Ring (07) 391 2796.

PROJECTION TV SYSTEMS, large screen units, kit form reviewed as the best available (Science review 81 USA) now available at \$499 coloured brochures upon request. Xenon World Imports, 8 Sutton Ave, Seacombe Gardens, SA 5047.

CB RADIOS \$67, walkie-talkies, shortwave radios, military, outback, business, amateur, marine, repairs, aeriels, 40CH conversions, new rigs weekly, Bridge Disposals, 12 Old Town Plaza, Bankstown Rail Station. Ring 5am 7pm — 9pm only (02) 407 1066.

DISK UPGRADE KIT

ENHANCE YOUR SORCERER!

- ★ Auto Boot ★ Monitor Entry
 - ★ 48K + Basic ★ Easy to fit
- Micropolis \$44.95 Exidy FDS \$39.95
P.J.B. Box 252 Forestville 2087

VIDEO TAPES, top brands from Japan VHS and Beta at the best prices in Australia for bulk buyers, Xenon World Imports, 8 Sutton Ave, Seacombe Gardens, SA 5047.

QUALITY NICAD BATTERIES. Cheap. AA: Sub C; C and D size to 4 amp. Fast charge. Suit most gear including flashguns, toys and Big Jim torches etc. Last for years. Info 557 Merrylands Rd, Merrylands 2160. (02) 636 1592 (anytime).

WOOFERS AWA (MSP) 12" 8 ohm 30Wrms, 30-7K, \$15 ea plus p&p. P. Davies, P/O Sherbrooke, 3789. (03) 755 2114.

CURTIS SYNTH IC's — 3340 (VCO) \$20, 3320 (VCF) \$16, 3310 (ADSR) \$16. User notes \$1.50 ea. NRG Electronics, 135 Rae St, Nth Fitzroy 3068.

ZX81 USERS, are you sick of those odd sized gaps between string arrays or tired of assigning one specific length to all. ZX80 users, do you feel your hands tied with only 26 strings. This program solves all this by creating provisions for hybrid arrays that are "read" like data. After one run the entire program can be deleted leaving "Let A\$=A\$" acting as a read statement, send \$5 for listing, instructions and tape or \$3 without tape, to Read Arrays, Box 112, Fairfield, Vic 3078.

AMIDON FERROMAGNETIC CORES — Large range for all receiver and transmitter applications. For data and price list send 105 x 220 SASE to: R. J. & U. S. Imports, PO Box 157, Mortdale, NSW 2223.

ELECTRONIC PROJECTS: low cost books containing circuits of projects for experimenters, constructors and students. Written in simple language expressly for beginners. Send stamped addressed envelope for catalogue and price list to Hobby Electronic Books, PO Box 92, East Gosford, NSW 2250.

SUPER 80 SOFTWARE AND HARDWARE Assembler editor. To run on a 16K Super 80 complete with 21 page instruction manual \$35 45 Joysticks kit: Fully proportional dual joysticks with four pushbuttons for real time games. With assembly manual and interface program \$39.95. Monitor VI 2 Source Listing. Original source listing of Super 80 monitor program (commented), \$11 95. Write to Pelatronics, 9 Eldon St, Indooroopilly, Qld 4068.

S100 DYNAMIC MEMORY BOARDS 16K-64K, S100 disk controller boards, 2650 single board computer systems can be expanded to S100. Ass or kit. Software available for tape or disk system. C.A.E. Electronics, 1/27 Forge St, Blacktown, 2148 (02) 621 4242.

DREAM EPROM PROGRAMMER. Requires only standard Dream and min K RAM. Read, write, verify, copy and 2708/2716 Eprom. Send \$10 and tape (tape will be returned) for s/ware & inst to build or SAE for info to WKM, 47 Pendle St, Box Hill, Vic 3128 (03) 88 2199.

FOR HIRE

MAN WITH HP4193A RF vector impedance meter, measures Z±jX from 400KHz to 120MHz. Please ring Mr Pride on: (09) 450 4379 for further details.

RETAILERS WANTED IN ALL STATES

We make superb quality durable mobile antennas for CB, Ham and Commercial users. These are luxury items at reasonable prices and outperform and outlast all others tested. We also make bases and roller inductors. Excellent profits assured. If your shop has a possible place for us then please write for further details to:

**ANTENNA SCIENCE & ENGINEERING,
P.O. BOX 238, NEDLANDS, WA**

DISPLAY ADVERTS IN MARKETPLACE are available in sizes from a minimum of 2cm x 1 col rated at \$15 for a col cm.

CLASSIFIED RATES \$3.60 for 40 letters or part thereof an insertion payable in advance. Minimum 80 letters.

Please use coupon below.

CLOSING DATE is six weeks prior to the on-sale date. Issues are on sale the first Wednesday of each month.

REMOTE ANTENNA SITE 40 miles from Perth. Electrically quiet — ideal for large HF installations. We will erect and maintain to your specifications. Write to Antenna Science & Engineering, PO Box 238, Nedlands, WA 6009 or ring (09) 386 2010 for details.

MICROCOMPUTERS for weekly rental \$25 per week Commodore PET systems, with manuals and software tapes. Cassettes include games and self-teaching tutorials in BASIC and 6502 Machine Language. David Bates & Associates, ph (02) 630 8652.

READER SERVICE

HAVING TROUBLE INTERFACING to your microcomputer? We will design and manufacture an interface to suit your individual requirements and supply the software to drive it. Also available EPROM programming service. C.A.E. Electronics, 1/27 Forge St, Blacktown 2148. (02) 621 4242.

COMPUTER CLINIC repairs and services Sorcerer, Pet, Apple, System 80, Super 80, Tandy and all hobby and small business computers. (07) 269 8573, PO Box 68, Aspley, Qld.

REPAIRS to all home, hobby and small business microcomputer systems and peripherals, also all EA and ETI projects. C.A.E. Electronics, 1/27 Forge St, Blacktown 2148. (02) 621 4242.

BUSINESS FOR SALE

RETAIL ELECTRONICS Business and Repair Section. Accountants figures available. For more details phone BH (066) 52 5684 or AH (066) 53 1272.

CLUBS

THE BRISBANE SUPER 80 USERS GROUP who have approx. 80 financial members and produce a regular monthly newsletter will be holding an Open Day and Annual General Meeting at the Western Districts Aust Rules Club, located at Oxley Rd (corner Queenscroft St), Chelmer starting at 10am and finishing off at 4pm. Software, hardware, programs and ideas. The snack and drinking bars will be open for normal business. Garry Gatfield is the convenor and also the person to contact regarding this special day. His home phone number is (07) 355-3173 — All Welcome.

TEKTRONIX

Oscilloscope 465B as new \$3,500 O.N.O.
2-RK05J Drives and Controller 2.4 Mb disks
B.R.P.E. Tape Punch Tally Tape Reader
Best offers Phone (03) 699 8255

RCS Radio Pty Ltd

Tel. (02) 587 3491

IS THE ONLY COMPANY
WHICH MANUFACTURES AND
SELLS EVERY PCB & FRONT PANEL
published in EA and ETI
**651 Forest Road Bexley 2207
AUSTRALIA**

RING FOR INSTANT PRICES
24 HOUR TURNAROUND SERVICE

ELECTRONICS CENTRE

BARGAIN PRICES • PERSONAL ATTENTION • SLICK MAIL ORDER SERVICE • SATISFACTION

KRIESLER

240 VAC
50Hz

BRAND NEW
GUARANTEED

\$66

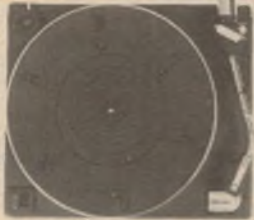

BELT DRIVE STEREO PLAYER

- MAGNETIC CARTRIDGE AND DIAMOND STYLUS •

P-P NSW \$4.50
Q. V. T. SA \$5.50
WA, NT \$6.50

Features — big aluminium turntable • 2 speeds 33-45rpm • Cue lever • Calibrated adjustable counterweight • Calibrated anti-skate • Auto return-stop • Switch click suppressor • Power cable, RCA connectors • **OUR BEST PRICE EVER. BE QUICK.**

PYE BELT-DRIVE STEREO PLAYER

PRO MODEL
TA-10

\$89.95

P-P NSW \$5.50
Q. V. T. SA \$6.50
WA, NT \$7.50



Detachable Headshell
Magnetic Cartridge
Diamond Stylus

Features — Manual Start • Auto Return • Eject Lever • Cue Lever • Full Size, 30cm Heavyweight Aluminium Platter with Anti-static Mat • 2-speed 33-45 rpm • Fully Calibrated Adjustable Counterweight • Anti-Skate • 240 VAC 50Hz 4 Pole, Fully Shielded Motor • Switch Click Suppressor • 3 Core Power Cable, Audio Cable with RCA Plugs • Base Size 40 x 30 5cm • Cut Out Template Included.

VALVES — AT GIVE AWAY PRICES

Some types are rare • so order early • should your preference be out of stock, please indicate a substitute.

1H6	5U4	6AL5	6B07	6CZ5	6F6	6U7	12AD6	1303	508M8	A2223
1M5	5MK9	6AB8	6BY7	6CB6	6FY5	6X5	12AC6	148R11	50EHS	25055
1A5	5Z4	6AMBA	6BW7	6CC8	6F5	6X4	12AB5	15CW5	58	2303C
1N5	5V4	6AC5	6BK7	6CV7	6FC7	6U4	12AE6	150B11	61SV	2M1237
1R5	5AS4	6AJ8	6BJ5	6CW7	6CS7	6W6	12AU6	15A6	75B1	GR211
1S5	6A06	6AV6	6BG6	6CM7	6CK5	6W2	12AX5	1500B	76	DK24
1A4	6AM5	6AW8	6BW4	6CJ6	6CV8	6X2	12AH8	16A5	90AV	AZ41
1G3GT	6AM6	6BA7	6BD5	6CU8	6CW8	7C5	12AX4	1723	95A1	DM160
1S4	6AC5	6B26	6BH5	6CB5	6CJ7	7R7	12AN7	21A6	108C1	N37
1T4	6AN6	6BM8	6BC8	6CF6	6JN8	7V7	12AF6	21H85	11723	OS150/45
1U5	6A08	6BJ6	6BD6	6DR8	6J7G	7N7	12BV7	2526	884	DRP90
2A3	6AK8	6BN4	6BW6	6DS8	6J6	7AM7	12B27	25L6	922	RYP30
2X2	6AU6	6BA8	6BX7	6DT6	6K7G	7G57	12B7	32A8	954	EB8CC
2A6	6AK6	6BF5	6C4	6DC8	6K6	7FC7	12B06	31AV3	217C	5964
2E30	6AC7	6BF6	6C5	6EH7	6S07	7D18	12BE6	35C5	717A	5879
2C51	6AB7	6BX6	6CA4	6EM7	6SA7	9A8	12CU5	33GT7	5696	5823A
2A3	6AS6	6BA6	6CS6	6EM5	6SN7	9UB	12J8	35A5	5965	41
3B25	6A07	6BR7	6C06	6ET6	6SS7	9AK8	12K5	35L6	006	77
1A4	6AS8	6BR5	6CM6	6FL2	6SK7	9BJ11	12X4	35W4	DC3	80
3C4	6AM4	6BH8	6CU5	6FY7	6SA4	9A08	12SA7	45A5	2021	
305	6AH4		6S2	6T2	6U2	11LY11	12SK7			
4GK5										

10 MIXED TYPES \$15.95

(MAXIMUM IS TWO OF EACH TYPE PER LOT)

P-P NSW \$2.50

INTERSTATE \$3.50



PROTECT YOUR HOME AND FAMILY WITH THE



ULTRASONIC BURGLAR ALARM

\$29.00

• P-P NSW \$1.50
INTERSTATE \$3.50

• UNWANTED INTRUDERS, BURGLARS, MOLESTERS — BEWARE. NO WIRES • EASY TO SET UP • COMPACT 175 x 100 x 80mm • 9 VOLT (BATT LASTS 12 MTHS) • WHEN ACTIVATED SOUNDS FOR 5 MINUTES, THEN AUTO-RESET • SELECT YOUR OWN PUSH BUTTON SWITCH OFF CODE • INSTANT DELAY ON • COMPREHENSIVE INSTRUCTION BOOK.

• EX AWA — TOP QUALITY — LOW PRICE •
SPEAKER KIT BARGAIN



LAST OFFER

20 WATTS RMS • 8 OHMS • FREQUENCY 45-18,000HZ • THE KIT INCLUDES — ONE 20cm BASS DRIVER AND TWO 10cm HIGH FREQUENCY SPEAKERS • PLUS — CROSS-OVER COMPONENTS • GRILLE CLOTH • ACOUSTIC PACKING • CABLE • SCREWS • SOLDER • CABINET PLANS

\$22.95 ea OR 2 KITS \$44

P-P NSW \$3.50
Interstate \$5.50

GOLD PLATED SUPER QUALITY AUDIO LEADS

ALL METAL PLUGS. 5 PIN DIN TO 4 RCA. 1.2M. HALF PRICE

\$5.50

P-P 90c

• AWA CARPHONE • TRANSCEIVER



76MHz 3 CHANNEL • LOW BAND • FM • 6 12 VDC SOLID STATE POWER SUPPLY • (INBUILT). 22 MINI TUBES, 7 AND 9 PIN PLUS TYPE 6146 IN FINAL • N.B. CRYSTALS ARE NOT SUPPLIED, NOR ARE THE SETS AIR TESTED • INTERCONNECTING CABLE AND CABINET IS SUPPLIED • CONVERSION TO 6 METRE BAND IS EASY • DATA AVAILABLE • WE GUARANTEE THE SETS TO BE COMPLETE AND IN EXCELLENT CONDITION •

EX AMBULANCE \$35

P-P NSW \$4.50
V. Q. SA, T. \$7.50
WA, NT. \$11.50.



GENUINE FACTORY PRICES ETONE 12" SPEAKER SPECIALS

GUARANTEED TOP QUALITY BRAND NEW BARGAINS
Rugged diecast frame. 8 and 15 ohms available
12" Woofer. 30 watts RMS Reson 65Hz freq 50-8000Hz

\$28.50 each OR 2 for **\$49.95**. P-P for 1. NSW \$3 Interstate \$4.50

12" Twin Cone 30WRMS Reson 65Hz Freq 50-15,000Hz

\$29.50 each OR 2 for **\$52**. P-P for 2 NSW \$4.50 Interstate \$6.50

EXTRA SPECIAL — 12" HI-FI WOOFER

60 WATT RMS. 8 OHM FREQ 30-4000Hz Reson 30Hz HEAVY DUTY DIECAST FRAME FOAM SURROUND

\$34.95 EACH OR 2 FOR **\$64**. P-POST AS ABOVE

EX-COMPUTER MAINS FILTER 250 VAC 3 AMP

Also ideal for audio gear, receivers, etc. NO MORE INTERFERENCE
Chokes, caps in fully sealed metal container, 55 x 55 x 30mm

ONLY \$9.50 P-P 90c

HIGH GRADE POTTER AND BRUMFIELD RELAY



KU series • 240 VAC 50Hz operation • 3 sets of 240V 10 amp change over contacts • perspex cover and mounting base included • size 50mm x 37mm x 35mm • ex-computer • as new condition. At less than 1/2 of the normal price.

\$3.50 P-P 95c

1" DOME TWEETER (SIMILAR DESIGN TO PHILIPS AD0161)

8 OHMS. 100 WATTS.



2000 —
20000Hz

X-OVER AT
5000Hz

CAP X-OVER ONLY. USE 4 7µF 50V OR 36MH CHOKO AND 3.3µF CAP. 12dB/OCTAVE.

\$8.50 P-P NSW, \$1.50
INTERSTATE, \$2.50

RED ROTATING DISTRESS BEACON

12 VOLT

\$9.95 P-P 75c

4700 UF 35V Axial
Electrolytics.
4 for \$5.90

P-P \$1.25

HEAVY DUTY POWER TRANSFORMER SALE

Modern types. Brand new. Primary 230V 50Hz

PF2050 0-285V 250MA. 2 x 35V. 1A. 6.3V 4 5A. 6.3V. 1A
Type 216 325V-0 325V. 300MA. 6.3V. 12A 5V. 3A
Type PVD 109. SEC HT 126. 136. 146VAC. For voltage doubling to — 330. 355. 380V DC 180MA SEC
LT. 6 3VCT 3A 6 3V 4A
Type H1 285VCT. 180MA. 6 3VCT. 6A. 5V. 3A
Type H2. 300VCT 250 MA. 6 3VCT. 4A. 6 3V 8A

• ALL THE ONE PRICE •

\$18.50 ea

P-P NSW \$4.50; V. Q. SA, T. \$5.50;
WA, NT, \$7.50.

EA Magazine Holders



The binders and magazine holders are available over the counter from Electronics Australia, 57 Regent Street, Sydney, NSW — Price: \$5.10 binders, \$4.50 holders

Mail orders should be sent to Electronics Australia, PO Box 163, Chippendale, NSW 2008

Prices including postage are:

Holders: \$5.50 NSW; \$5.60 other states; or six for \$29.00 NSW; \$31.50 other states, \$A33.00 NZ

Binders: \$7.00 NSW; \$8.50 other states; or six for \$33.00 NSW; \$36.00 other states, \$A37.00 NZ

ADVERTISING INDEX

ADVERTISER	PAGE
A & R Soanar	IBC
AMS Systems	40
AWA Ltd	9, 39, 116
Ace Radio	143
Adaptive Electronics	136
Altronic Distributors Pty Ltd	30, 31, 56, 57
Amtex Electronics	77
Antenna Science Engineering	142
Audax Loudspeakers	23
Audio Engineers Pty Ltd	46
Australia School of Electronics, The	93
BASF	79
Billco Electronics	117
Bright Star Crystals	63
C.K. Corporation Pty Ltd	68
Chapman, L. E.	140
Check-Point Computers	131
Chloride Batteries Aust Pty Ltd	140
Computer Country Pty Ltd	22, 137
Cunningham, R. H.	118, 121
Daneva Controls	125
Daro Office Systems Pty Ltd	84
David Reid Electronics Ltd	114
Defence Force, Recruiting	33
Dick Smith Electronic Group	4, 5, 19, 34, 55, 64, 65, 74, 80, 81, 98, 102, 113, 120, 129, 130
Edible Electronics	132
Electrocraft Pty Ltd	41
Electronic Agencies	20
Ellistronics	110
Elmeasco Instruments Pty Ltd	59
Ferguson Transformers Pty Ltd	60
Jaycar Pty Ltd	10, 11, 29, 42, 43, 62, 70, 71, 95, 115
K-Nar Computer Cards	101
Kalextronics	35
Looky Video	124
Marantz (Aust) Pty Ltd	OBC
Melbourne Machinery Co	119
PJB Systems	142
Paris Radio Electronics	133, 135
Philips	2
RCS Radio Pty Ltd	142
RIFA Pty Ltd	89
Racon Industries	135
Radio Despatch Service	118
Rod Irving Electronics	24, 25, 52, 92, 96, 97, 106, 126
STC Canon	17
Sanyo (Aust) Pty Ltd	in centre magazine
Scientific Electronics	78
Silvertone News	127
Software Source	127
Sony (Aust) Pty Ltd	IFC
Standard Components Pty Ltd	140
Stotts Technical Correspondence College	105
Technical Book & Magazine Co	103
Trade Television & Video Service	87
Truscott Electronics	139
Vendale Nominees Ltd	134
Wireless Institute of Australia	105

EA PC BOARDS AND FRONT PANELS

Some readers have problems obtaining PC boards and front panels for projects. Many of our advertisers sell these items and their advertisements should be checked in the first instance. Failing that, below is a list of firms which produce or sell PC boards and front panels.

NSW
Dick Smith Electronics,
 125 York Street,
 Sydney, 2000.
 Telephone 290 3377.
 DSE also has branches and resellers throughout Australia.

Electronic Agencies,
 115-117 Parramatta Road,
 Concord, 2137.
 Telephone 745 3077.

117 York Street,
 Sydney 2000.
 Telephone 29 2098.

Jaycar Pty Ltd,
 125 York Street,
 Sydney 2000.
 Telephone 264 6688.

Radio Despatch Service,
 869 George Street,
 Sydney 2000.
 Telephone 211 0816.

RCS Radio Pty Ltd,
 651 Forest Road,
 Bexley, NSW 2207.
 Telephone: 587 3491

VIC.
Rod Irving Electronics,
 425 High Street,
 Northcote, 3070.
 Telephone 489 8131.

Kalextronics,
 101 Burgundy Street,
 Heidelberg 3084.
 Telephone 743 1011.

Shop 11,
 Regional Shopping Centre,
 Melton 3338.
 Telephone 743 1011.

Sunbury Printed Circuits,
 Lot 14, Factory 3,
 MacDougal Road,
 Sunbury 3429.
 Telephone 744 2714

WA
Altronics,
 105 Stirling Street,
 Perth 6000.
 Telephone 328 1599.

Jemal Products,
 8/120 Briggs Street,
 Welshpool, 6106.

N.Z.
Marday Services,
 PO Box 19 189,
 Avondale, Auckland.

Mini Tech Manufacturing Co Ltd,
 PO Box 9194,
 Newmarket.

Printed Circuits Limited,
 PO Box 4248,
 Christchurch.

SUBSCRIPTION SERVICE



**ELECTRONICS
 Australia**

Subscription Rates
 \$28.00 per year
 within Australia
 \$A29.50 per year
 elsewhere

Make sure you receive every copy of the magazine by ordering it from your newsagent or the publisher. For publisher subscriptions post this coupon, with your remittance to Electronics Australia Subscription Dept. John Fairfax & Sons Ltd, GPO Box 506, Sydney 2001. Subscription will start with first available issue.

Name

Address

Postcode Enclosed is for years

STANLEY SUPER BRIGHT LED SEVEN SEGMENT DISPLAYS



ALSO

- WORLD'S BRIGHTEST LEDS.
- NEW COLOURED LCD ALPHANUMERIC AND GRAPHIC DISPLAYS.

FURTHER INFORMATION AVAILABLE FROM AUSTRALIAN DISTRIBUTOR

SOANAR

SOANAR ELECTRONICS PTY. LTD.

30-32 Lexton Road, Box Hill,
Vic., 3128, Australia. Telex: 32286.

VICTORIA: 840 1222 QUEENSLAND: 52 1131
N.S.W.: 789 6733 WEST AUST: 381 9522
Sth. AUST: 42 8918 TASMANIA: 31 6533



Marantz Gold. Life couldn't sound more beautiful. —

A day is made perfect by its ending.
Sunset, anticipation for the evening
to come.

Soothing, sounds of your favourite
music. The day's problems disappear.

The moment is Marantz. Unmatched in
its eloquence, unmatched for its purity of
sound reproduction.

Elegant, indulgent.

The Marantz Gold Renaissance 1000.
Top-of-the-line in a range of superbly crafted
hi-fi systems from Marantz.

Six separate components of unsurpassed
technical excellence. Highly sophisticated
Pre-amplifier and Power Amplifier, 14-station

preset AM/FM Stereo Tuner, Cassette Deck,
Equalizer and fully automatic Turntable —
subtly burnished gold tone.

And finally, the magnificent system
speakers — matched in quality and luxury of
design to rosewood finish furniture pieces.

Marantz Gold Renaissance Series.

Life couldn't
sound better.

Marantz Gold.
The New Audio Standard.

marantz.
Now you're listening.

Distributed by: MARANTZ (Australia) Pty. Limited, 19 Chard Road, Brookvale, NSW, 2100
Telephone (02) 939 1900 Telex AA24121 Melbourne (03) 544 2011 Brisbane (07) 44 6477
Adelaide (08) 223 2699 Perth (09) 276 3706 Townsville (077) 72 2011

Design and specifications subject to change without notice