

AUSTRALIA'S NUMBER ONE ELECTRONICS MAGAZINE

ELECTRONICS

AUSTRALIA

VIDEO, HI-FI & COMPUTERS

NOVEMBER, 1982

AUST \$2.00 * NZ \$2.50

Registered by Australia Post — publication No. NBP0240.

**DEPTH
SOUNDER
FOR BOATS**

**DATUM 6800
COMPUTER
TO BUILD**

**SOLAR
POWERED
FOUNTAIN**



Power you can taste.



Sony's new TA-AX5 amplifier with memory is a high fidelity feast.

Its multiple memory lets you create your own acoustic "flavours." Bass and treble tone settings, turnover frequencies, high and low filter are all programmable.

At a touch you can instantly recall the recipe for bittersweet country, hot 'n' spicy rock, or a well-seasoned Stravinsky. And electronic displays graphically show you everything the amp is cooking up.

Sony's Audio Signal Processor means that every function is touch controlled. This knifes through the usual maze of audio circuitry for a streamlined design of the future. Pure and simple, it sounds delicious.

The ideal companion for this tasty new amplifier is Sony's ST-JX4 synthesizer tuner. Why not make a reservation for two?



TA-AX5

ST-JX4

SONY
THE ONE AND ONLY

SON 0118

ELECTRONICS

AUSTRALIA

Volume 44, No. 11
November, 1982

AUSTRALIA'S LARGEST SELLING ELECTRONICS MAGAZINE

Depth sounder for small boats



Build this depth sounder for your boat and forget about those pricey commercial units. Our unit has a range of approximately 100 metres and features a digital display and a depth alarm (see page 44).



Interested in learning about microcomputers? DATUM is a completely self-contained microcomputer system with everything needed to get you started. Details page 86.

COMING NEXT MONTH! — Find out what's coming by turning to page 128.

On the cover

Small fountains and rock pools have become very popular with Australian householders. Now you can add even more charm and interest to the garden by running the fountain from a solar cell array, as our article on page 58 explains. Cover design by Andrew Powell.

FEATURES

FREQUENCY MODULATION <i>The basic concepts</i>	12
HOW TO INSTALL MULTIPLE TV OUTLETS <i>For video enthusiasts</i>	24
50 AND 25 YEARS AGO <i>Interesting items from past issues</i>	129

HIFI, VIDEO AND REVIEWS

STEREO SOUND FOR TELEVISION <i>On air tests in Australia</i>	32
HIFI REVIEW <i>Miller & Kreisel Volkwoofer & Satellite-1A loudspeakers</i>	40

PROJECTS AND CIRCUITS

DIGITAL DEPTH SOUNDER FOR SMALL BOATS <i>Reads to 100 metres</i>	44
SOLAR-POWERED FOUNTAIN <i>Plugs into the Sun</i>	58
POWER UP SWITCH CONTROLLER <i>Ends the multiswitch fiddle</i>	66
CIRCUIT & DESIGN IDEAS <i>Model train signal controller etc</i>	78
BUILD THE SUPER SIREN <i>An ear-splitting alarm</i>	82

PERSONAL COMPUTERS

MODEMS: COMPUTING BY TELEPHONE <i>What they are & how they work</i>	15
DATUM MICROPROCESSOR TRAINER <i>Build it yourself & learn</i>	86
A VOTRAX VOCABULARY <i>Useful word list for the Compuvoice</i>	96
MICROCOMPUTER NEWS <i>Tandy Electronics: new products, new policies</i>	130

COLUMNS

FORUM <i>Tracking, thorn needles & assorted topics</i>	28
THE SERVICEMAN <i>Handyman repairs can prove expensive</i>	74
SHORTWAVE SCENE <i>Voice of America to challenge Radio Moscow</i>	121
RECORD REVIEWS <i>Classical, popular & special interest</i>	124

DEPARTMENTS

EDITORIAL 3 — NEWS HIGHLIGHTS 6 — LETTERS TO THE EDITOR 102 —
BOOKS AND LITERATURE 110 — NEW PRODUCTS 112 — INFORMATION
CENTRE 138 — MARKETPLACE 142 — NOTES AND ERRATA 141.

Videlec[®] LCDs when size is important

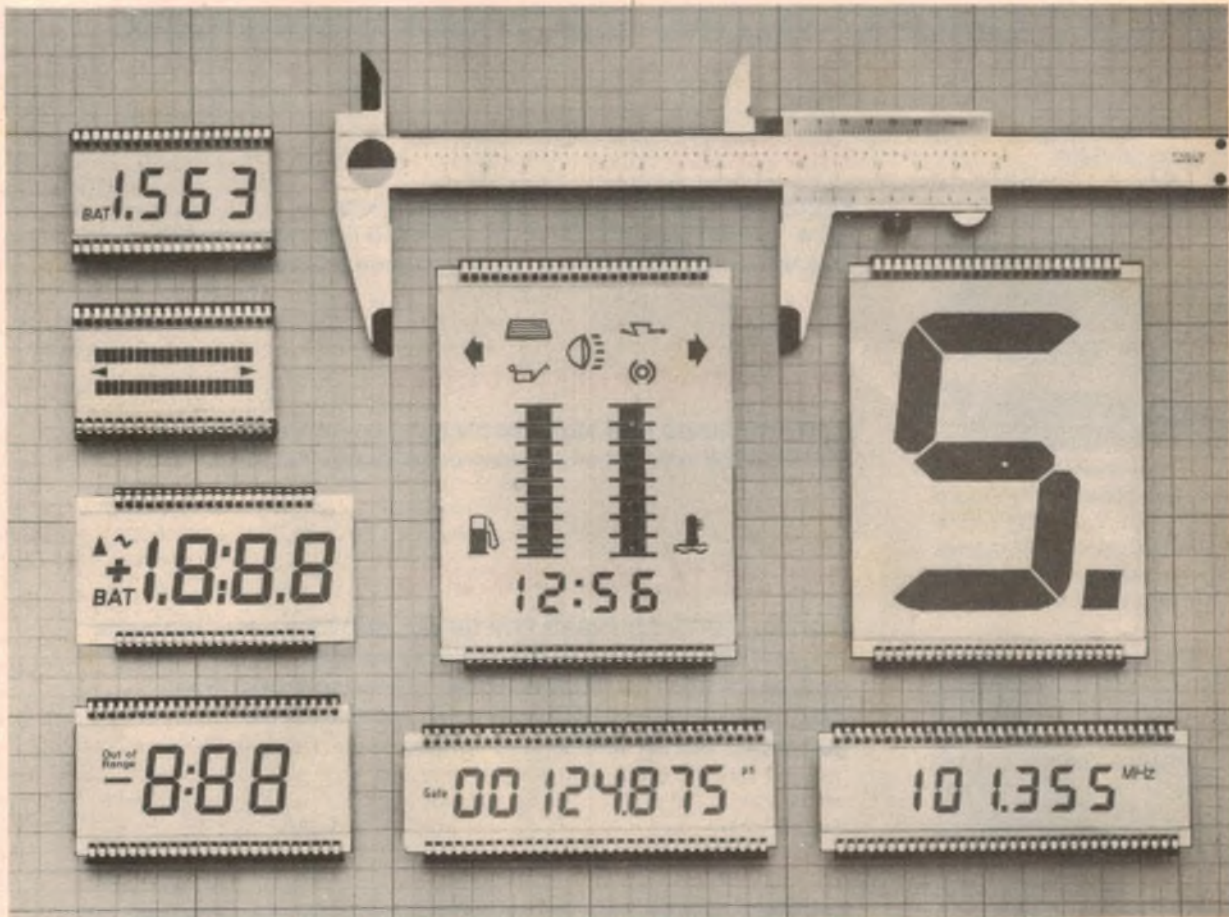

Now high quality, high contrast LCD's are available from Philips in an easy to read range up to 7.6cm tall . . . that even makes them suitable for time clocks.

Speaking of time, Videlec LCD's have a service life greater than 50,000 hours and are constructed to withstand a wide temperature range for harsh environments and industrial applications.

We think you'll see what we mean by our extensive range when you look over our Videlec LCD literature available at any of the offices listed below. It's as simple as LCD, call Philips Components.

**Sydney 427 0888, Melbourne 542 3333,
Adelaide 243 0155, Perth 277 4199,
Brisbane 44 0191.**

Videlec . . . another Philips Component.



**Electronic
Components
and Materials**

PHILIPS



Editorial Viewpoint

There is no need to be modest . . .

EDITOR-IN-CHIEF
Neville Williams
S.M.'R.E.E. (Aust.) (VK2XV)

EDITOR
Leo Simpson
B. Bus. (NSWIT)

ASSISTANT EDITOR
Greg Swain, B.Sc. (Hons. Sydney)

TECHNICAL PROJECTS
John Clarke, B.E. (Elect. NSWIT)
Peter Vernon, B.A. L.L.B. (NSW)
Jeff Skeen
Colin Dawson

PRODUCTION
Danny Hooper

GRAPHICS
Robert Flynn

SECRETARIAL
Pam Hilliar

ADVERTISING MANAGER
Selwyn Sayers

CIRCULATION MANAGER
Alan Parker

As we approach the end of 1982 there must be many readers who regard the state of Australian manufacturing, particularly the electronics industry, as being at a low ebb. It is certainly true that over the last decade many thousands of jobs have been lost from the electronics industry but the situation is far from being as black as many people seem to believe.

Just consider the following propositions which could be drawn from the present Australian electronics scene: (1) Even though Australia has great potential for solar power, solar cells are not manufactured in this country; (2) Current model dishwashing machines are noisy, wasteful of power and water and are all imported into this country; (3) Even though Richard Small and Neville Thiele are regarded as being in the vanguard of loudspeaker design, there are no local manufacturers of loudspeaker systems or drivers who implement the principles developed by these two men; and (4) All television manufacture in this country has now ceased.

If you agree with any of the above propositions you are quite wrong. None of the above is correct but you can be forgiven for being uninformed because the companies concerned have done little to make their activities known.

This is a great shame because there is a host of Australian companies that produce a vast range of well-designed and manufactured products. A great many of them have stories which should be told. How many potential customers are there who do not know about these products and services? Much of the local electronics industry is paralleled in this regard by the electronics importers, as instanced by a letter featured in the Information Centre pages this month.

Many Australian companies do little or no advertising, either in this magazine or elsewhere. Nor can many be bothered with furnishing information about themselves to potential customers or the technical press. And of those that do, some produce incredibly amateurish and obscure press releases, without photographs!

The point of this editorial is that any company which experiences a downturn in business cannot complain if its products are not well-known in the marketplace. To put it more strongly, many companies who find themselves unduly affected by a recession in 1983 will do so because they have resigned themselves to it. In spite of having good products they will be "snatching defeat from the jaws of victory".

It is time that company managers stopped looking to the Government for help and roused themselves to action. They can start by making their companies visible in the marketplace.

Leo Simpson

Editorial and Advertising Office

57 Regent St, Chippendale 2008.
Phone (02) 699 3622 Telex 25027.
Postal Address: PO Box 163, Chippendale, 2008.
Advertising Sales Manager: Sel Sayers.

Melbourne — 392 Little Collins St, Melbourne 3000. Phone (03) 602 3033
Representative: Mark Christian.

Adelaide — Charles F. Brown & Associates Ltd, 278 Halifax St, Adelaide, 5000.
Representative: Sandy Shaw (08) 267 4433.

Perth — 454 Murray Street, Perth 6000.
Representative: Ashley Croft (09) 321 8217.

Circulation Office

21 Morley Ave, Rosebery, Sydney 2018.
Phone (02) 663 3911.

Subscriptions

Subscription Dept, John Fairfax & Sons Ltd,
GPO Box 506, Sydney 2001.
Enquiries: Phone (02) 20944. ext 2589.

Distribution

Distributed in NSW by Magazine Promotions, 57 Regent St, Chippendale; in Victoria by Magazine Promotions, 392 Little Collins Street, Melbourne; in South Australia by Magazine Promotions, 101-105 Waymouth St, Adelaide; in Western Australia by Magazine Promotions, 454 Murray Street, Perth; in Queensland by Gordon and Gotch (A'asia) Ltd; in Tasmania by Ingle Distributors, 93 Macquarie St, Hobart; in New Zealand by Gordon and Gotch (NZ) Ltd, Adelaide Rd, Wellington.

Registered by Australia Post — publication No. NBP0240.

Copyright. All rights reserved.

Devices or arrangements shown in this magazine may embody patents. Information is furnished without responsibility for its ultimate use, or for failure of equipment to operate as expected, or for any damage, loss or injury which may be sustained. Material intended for publication is submitted at the sender's risk and, while care will be taken, responsibility for any possible loss will not be accepted by "Electronics Australia".

Printed by Magazine Printers Pty Ltd, of Regent Street, Chippendale and Masterprint Pty Ltd of Dubbo NSW for Magazine Promotions, of Regent St, Chippendale.

ISSN 0313-0150

* Recommended and maximum price only.

new store now open
CARLINGFORD 872 4422

BOTTOM-OF-THE-HARBOR

WE'VE DREDGED MORE GREAT BARGAINS!!

S 100 Socket Sensation *

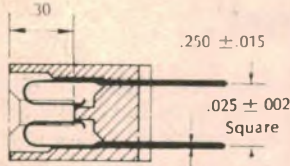

ONLY \$4.95 each
10+ \$4.45 each

A socket of this quality is normally around \$12. Not this bottom of the harbor special! We dealt these from the mighty Yarra!

We have secured a bulk-buy of HIGH QUALITY S-100 card edge connectors. Remember! the S-100 Standard is a "queer" 0.125" pitch. Each connector features gold plated bifurcated contacts with wire wrap pins in a Diallyl Phthalate moulded body. If you want to solder into a PCB this is O.K., simply cut the pins down to suit.



Quantities strictly limited.

final runout of GE Consumer Products

WE HAVE SOLD OVER 1000 OF EACH OF THESE ITEMS. ONLY A FEW ARE LEFT NOW. WHY NOT BUY ONE FOR YOUR MUM?

Smoke Detector Burglar Alarm

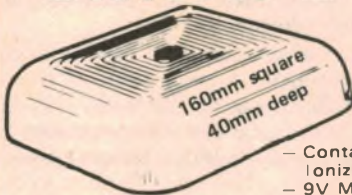

FROM \$12.50

- Contains Americium 241 Ionization Chamber
- 9V Mallory Duracell included
- Contains very loud solid state buzzer
- 12 month factory warranty.

One of the greatest consumer flops of the last decade was the Ionization Chamber Smoke Detector. Even though it is a brilliant product (reliable compact, easy installation, fail-safe etc) it just did not sell. Human nature being what it is finds safety-oriented products just not worth the investment. We all know that accidents and fires never happen to US!! As smoke is the greatest killer in a fire, the market research gurus thought that such a product would have a wide appeal. When they were \$49.50 no-one wanted them. The price fell to a very reasonable \$29.50 and still they stayed on the shelf. We have now been instructed to clear them for less than 1/2 of \$29.50.

GENERAL ELECTRIC

BURGLAR ALARM SLASHED!!!
HUGE SCOOP PURCHASE -
ONCE SOLD FOR OVER \$100

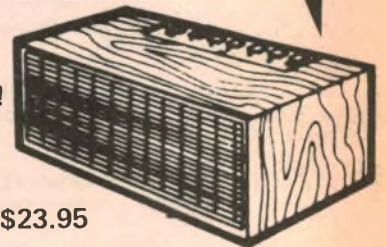

FROM \$23.95

Amazingly low price for a full feature ultrasonic proximity/burglar alarm. + Completely self contained + 12 month manufacturer guarantee + Instant or delayed alarm + Handsome imitation woodgrain + Cabinet measures 180(w)x85(h)x100(d)mm + Programmable multi-code disable switch + Single 9V Alkaline battery* lasts one year + unit beeps when battery gets low + Contains receiver element designed for greater sensitivity without false triggering + Uses state-of-the-art LSI circuitry + Worth the money in parts alone + Comprehensive 24 page manual included + Comes complete with 4 window deterrent stickers + Absolutely no installation needed * Battery extra.

QUANTITY PRICES ★ ★ ★ ★ 1-\$29.50: 2-5 \$25ea: 6-10 \$24.50ea: 10up \$23.95ea
1-\$14.50: 2-5 \$13.50ea: 6-10 \$13.00ea: 10 up \$12.50ea Buy one for Mum for Christmas...

MainsWidget

Nifty little 2 x 0.1uF 250V ceramic which schematically looks like this:

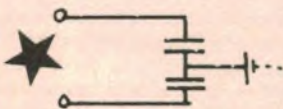

PACK OF 4
\$1.00

Ideal to mount across the mains chocolate block with the centre terminal going to earth. Helps prevent mains interference. Found floating in the sea off Bondi!!

rotary mains switch 99¢

- A 20 year throwback. These days all we do is flick our toggles. In the past a quick twist of the knob turned things on. You can relive this experience with our DPST mains switch. Convenient bushing mount with 1/2" shaft. Ideal replacements. Genuine 240V AC 3 amp rated.

micro headphones

AS REVIEWED SEPT EA Page 45
FEATURES:
MODEL MT310
Samarium Cobalt magnets
102dB/mW
Weight 15 grams
Response: 50Hz-20kHz
Impedance: 32 ohms



Unit fits into the cusp of your ear. Can be worn under motorcycle helmets. Unbelievably clear sound.

ONLY \$19.50

-1 Edgeconnectors * *

1-9 \$3.50 ea

10+ \$2.95 ea

Collectors special. Made by UECL of England. Sold in quantity for over \$10 each. Each Diallyl Phthalate moulded connector contains 170 heavily gold plated bifurcated contacts. (2x 85 way). Each contact is solder eyelet terminated. The connector is 217mm long but you can cut it down to any length you wish. Outstanding quality and they did not get wet after laying at the bottom of the Swan river.

Narrow band-pass type - ideal for communications equipment. High quality multi-stage unit suitable for precision I.F. work. Incredible value: Manufacturers distress stock. YOU SAVE. ONLY \$5.00 each (1-9) worth 4 times this amount. Oscillator crystals to suit; 10.240MHz or 10.695MHz ONLY \$2.50 each 10 up on both - less 25%



BARGAINS

BIG MAL IS CALLING A ROYAL COMMISSION!!

new store
now open
CARLINGFORD 872 4422

fibreglass matrix board

Not flimsy Bakelite junk. You will be able to use this board over and over again without deterioration. Measuring a massive 115 x 164mm and contains 2816 x 1.0mm diameter holes. Worth over \$8 but our special for November only \$2.95 each.
Source: Brisbane River.



\$2.95

NOVEMBER ONLY

JUMBO SPEAKER CABLE

Now you can have super-quality cable without breaking the bank! Each conductor contains a MASSIVE 259 strands of 0.12mm wire!! It could carry 30 amps! Great for Hi Fi or high power amps.

Only \$2.50/m
100m \$2.00/m



Walkie Talkies Sensational price for X'tal controlled units



Sensational price for CRYSTAL CONTROLLED UNITS!! Not your super-regen rubbish!! Don't be fooled! These units actually do work - well in fact. Will transmit voice or morse over fairly respectable distance (over a mile in ideal conditions). Fitted with proper transmit/receive crystal controlled superhet circuitry. DO NOT COMPARE with far inferior units that may only be a dollar or so cheaper anyway and almost always are a disappointment. At only \$12.50 each, how could you go wrong? Place of origin: Botany Bay

only **\$12.50**

Factory Seconds ~ YOU COME FIRST. . .

We have secured a smallish quantity of 5 pin DIN to 4 RCA audio leads that are on the wrong side of the Q.C. inspection. Shame though. Because the DIN plug is ALL METAL and GOLD plated. So are the RCA plugs. Problem is that the gold plating is bubbling on the gold DIN plug. (As far as we can see the 4 gold RCA's are PERFECT.)

An ordinary NICKEL PLATED lead set like this costs around \$4.75. The gold versions normally are around \$9.95. You can have one of these for \$3.95 and that's better than Nickel any day! Worth it for the 4 x RCA's alone!

value **\$3.95**

NUMERIC KEYPAD ELASTOMERIC

Get in quick!! Only 35 available. High quality 12 button keypad. 0-9 with 2 extra push-buttons. As seen on U.S. style telephones.

Measures 76x57x10mm approximately. **\$4.95**



Motorola Piezo Horns ~ back in stock

Model KSN 1005A
50 WATT P.A.
ONLY \$17.00 EACH
Model KSN 1025A
100 WATT P.A.
ONLY \$26.00 EACH

buy now

top value

Model KSN 1038A
50 WATT HI-FI/P.A.
ONLY \$17.00 EACH
Model KSN 1039A
50 WATT HI-FI
ONLY \$13.00 EACH



Electric Eels??

No. One metre long 7.5A appliance cords. Each (black) cord has a moulded 3 pin approved mains plug on the end. Why so cheap? Well they ARE only a metre long. But consider this:
- Any benchtop piece of equipment only needs a short mains cord. A long mains cord gets in the way and is positively dangerous!!
- Ideal for power supplies or any bench or rack mounted audio or test equipment.

We have HEAPS. But we have said that before.

Buy in bulk and save. We doubt whether you will ever see mains cords this cheap again.

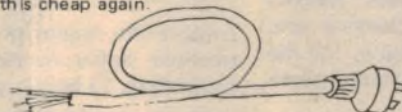

1-9pcs 69 cents each
10-24pcs 50 cents each
25-99pcs 45 cents each
100 up 39 cents each

GENUINE APPROVED cords from the Parramatta River

Proximity Switch



1/2 price

\$14.75

Shown this time the right way around. In August we advertised this product and the picture showed the 'bum' end facing you. It was sort of like having a sumptuous view of a Ferrari - you didn't see the nice part.

They didn't sell in any case and we're not sure whether it was the photo or not.

So this month we've HALVED the price and showing it to you the right way round.

FEATURES: 12V powered unit. When metal object passes near to target face, output swings low. Ideal for Roller shutter doors, Burglar alarms or counting metal objects passing by.

Were \$29.50 in August - NOW \$14.75 and they have not suffered from their dunking in the Derwent!!

Jaycar

125 YORK St. "NEVILLES CORNER" Cnr CARLINGFORD & SYDNEY 2000
Phone: 264 6688
Telex: 72293
Mail Orders To: BOX K-39 HAYMARKET SYDNEY 2000

MINIMUM MAIL ORDER \$5.00



POST AND PACKING CHARGES
\$5-\$9.99 (\$1.20) \$10-\$24.99 (\$2.40)
\$25-\$49.99 (\$3.50) \$50-\$99.99 (\$4.60)
\$100 up (\$6.20)

NEW SHOP HOURS
Mon-Fri 8.30 to 5.30pm
Sat 8.30 to 12.00pm
Thurs night to 8.30pm



News Highlights

Go-ahead for Starlab space telescope

The Federal Government has approved the second phase of the joint Australian/Canadian/US Starlab project to put a one-metre telescope into orbit from the Space Shuttle in 1989. (See "Electronics Australia" August 1982.)

The Minister for Science and Technology, Mr David Thomson, announced that Starlab would receive \$3.337m in the next two years. The funds are being made available under the public-interest project provision of the Industrial Research and Development Incentives Act.

The Mount Stromlo and Siding Springs Observatories (MSSSO) of the Australian National University developed the first phase of the project in conjunction with leading Australian companies. MSSSO and the Department of Science and Technology will be responsible for the second phase, and 80% of Starlab work will go to Australian industry.

Starlab has major scientific and technological implications. It will be able to see objects in 100 times more detail than the largest ground-based telescopes. It will allow astronomers to

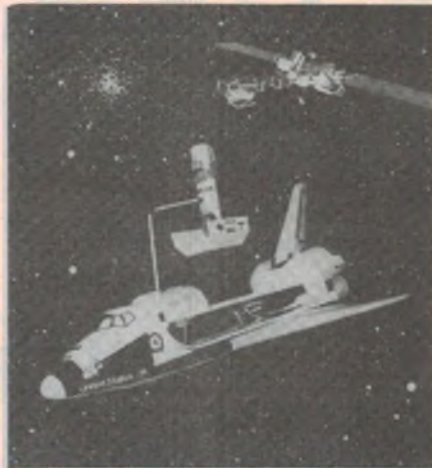

One plan calls for Starlab to be placed on an orbiting Space Platform by the Shuttle.

explore the origins of the universe, and observe stellar events which occurred more than 10 billion years ago.

As a co-operative academic/industry/government project, Starlab will open up opportunities to develop Australian space-age high technology. It will serve as a "seed project" from which an Australian space industry can develop

the capability to design and build the next generation of satellites. The Government will make a decision in 1989 on the go-ahead for the final phase three of the Starlab project.

The Government has also agreed to provide \$30 million over the next six years for the completion of the very large radio telescope array, to be known as the Australia Telescope.

The Australia Telescope will consist of three main elements; one a linear array of five 22 metre dishes at Culgoora, near Narrabri in NSW, a 22 metre dish at Siding Spring, Coonabarabran and an existing 64 metre dish at Parkes. Linking the three elements together by land line will form a radio telescope array equivalent to a single dish 300 kilometres in diameter.

The completed array could also be linked by satellite to radio telescopes in Hobart, Alice Springs and Carnarvon, WA, to span the entire 3000km of the Australian continent. The enlarged array would be the most sensitive high resolution radio telescope in the world, able to recognise features 1000 times smaller than those detectable by the most powerful single dish telescopes.

Japan looks to high-definition TV

Japan's television industry is pressing ahead with a high definition television system which it hopes, eventually, will be adopted worldwide.

Sony, Matsushita and Ikegami have already developed some of the equipment; Toshiba and the Japan Victor Company (JVC) are likely to announce products before the end of the year.

This new system will provide better picture quality than that available with today's technology and will allow the use of much larger television screens.

In the proposed system, each television picture is made up of 1,125 lines compared with 625 and 525 used in existing world broadcasting systems. This means that each television channel must have a frequency bandwidth of at least 30MHz, compared with about 6MHz for conventional television.

For high definition to be a success, however, it requires several other

technologies to become well-established – direct broadcast television by satellite and cable systems. These have the extra bandwidth necessary to transmit high definition TV.

Japan's public broadcasting corporation, Nippon Hoso Kyokai (NHK) has developed the necessary hardware – transmission equipment, TV cameras, and television sets – in co-operation with the Japanese equipment manufacturers.

It began its research 12 years ago; now the pace of development has increased because of the possibilities opening up with satellites and optical fibre cables.

High definition television is not new. France was one of the first countries to introduce – and eventually drop – a high definition system where each picture frame was made up of 819 lines instead of the 625 and 525 line systems used in other countries.

New work on electric vehicles

US company General Electric has been awarded a US\$3.1 million contract by the Ford Motor Co to investigate power train components for electric vehicles.

The work will form part of an overall power-train project that Ford is conducting under a \$6.8m research contract from NASA (which manages propulsion research for the US Department of Energy). Systems to be developed by Ford/GE will use an induction motor with an automatic gearbox and transmission unit in a common housing on the front wheel axle.

General Electric will design and build the AC motor, the power inverter needed to produce AC from batteries, and electronic drive control equipment. Ford will oversee the design of the power train as a whole and also the microprocessor based control system.

Videotext and teletext doomed says US report

Videotext and teletext are doomed in the US, say analysts at the Boston-based Yankee group who have undertaken long-term studies of the potential for such information services there. They believe that information services must be radically improved – by the addition of high resolution video pictures and perhaps even sound – before they will find a ready audience.

Despite such predictions, several major corporations continue to show interest. A T & T is involved in providing equipment for several trials of teletext and videotext in the US and has placed its support firmly behind the American standard.

Major publishers including Time Inc and Knight Ridder have made significant investments in teletext and videotext in trials in the US.

CBS and A T & T, working together, will soon begin a seven-month teletext trial in Los Angeles. Following the test and completion of FCC rule-making on teletext regulation, CBS plans to announce its regular teletext service. The broadcasting company remains convinced that there are profits to be made in the US in teletext and videotext as home information services.

Times-Mirror, a large Los Angeles based newspaper and cable TV group, is about to begin a trial videotext service in



Los Angeles. Subscribers will be offered a "gateway" to established information services as well as the standard information retrieval and transaction services.

Also among the US companies investigating the potential of videotext are major banks who see the electronic services as potential cost savers.

Can they all be wrong? Yes, says Yankee group analyst Robert Wells who follows the information services in-

dustry. Looking to the UK experience, he declares that: "Prestel is a stunning failure."

As a consumer service, Prestel has failed, even in the UK, he maintains. Only 11 per cent of the UK subscribers use the service in their homes, and of those many are believed to be businessmen working at home.

(Financial Times, London.)

US gears for home satellite TV

Over 15 million rooftop home earth stations for reception of direct broadcast satellite transmissions will be installed in the United States by 1990, according to a report from US market research firm International Research Development Inc.

The report predicts that the rooftop terminals, designed for Ku band frequencies, will almost totally replace the present "backyard" terminals, which operate on C band frequencies.

After 1985, the report states, the rooftop terminal market will be boosted by the launch of high power direct broadcast satellites.

The high power broadcasting satellites will allow rooftop antenna dishes to be reduced in size to .75-1.25 metres. Combined with price reductions (to \$350-\$500 by 1990, says IRD), these developments will significantly expand the market for home satellite TV systems in the United States.

Launch date doubt for compact disc system

Despite the undoubted technical advantages of digital audio recording, its use so far has been confined largely to master production and copying in recording studios, with the end result a conventional – though better quality – analog disc.

The advent of domestic digital players and the discs to go with them seems to be a lot further off than the industry initially planned. The so-called "compact disc system" was originally to be introduced in the United States late this year, or early 1983, but reports from Japan and the US indicate that this is not now likely before 1984.

There are a number of reasons for the slow acceptance of the domestic digital system in the United States. Research organisation, Venture Development Corporation (VDC) conducted a market survey – "Professional and Consumer Digital Audio Equipment: A strategic Analysis" – and, while cautiously op-

timistic about the ultimate success of the product, point to a number of problems to be overcome.

The major one appears to be the traditional chicken-and-egg situation involving a shortage of software, ie, records. Recording studios are reluctant to embark on a costly program of installing digital recording equipment, unless there are sufficient digital players in use to guarantee a market.

On the other hand, consumers are reluctant to buy players until they have a reasonable range of records from which to choose and an assurance of continuing supply.

The survey went on to state that, while some 95 per cent of recording studios had used digital recording equipment to some extent, most work had been on an experimental basis using rented equipment. And many of these studios complained of reliability problems, editing difficulties and incompatibility.

Multi-colour LCDs: new auto instrument panels

A quiet revolution in display technology is underway, with Japanese companies poised to release a range of multi-colour LCD panels. Alps Electric Company, Stanley Electric Company and Epson Corporation have all shown prototypes of LCDs using up to six colours and work is progressing on mass production techniques.

Applications being investigated include car dashboard displays, clocks and watches, consumer audio equipment and flat-screen computer displays.

Automotive displays are seen by many Japanese manufacturers as the chief application of colour LCDs. Conventional speedometers, fuel meters and indicators may soon be replaced by a single LCD panel that displays both digital read-outs and analog bar-graphs in a variety of colours.



Multi-colour LCD instrument panel from Epson Corporation, Japan. Five different colours are featured: blue, green, yellow, red and black.

Some problems remain to be solved, however. Many LCDs lack visibility in high ambient light because of inherently low contrast, and operating temperature ranges are still restricted.

Some Japanese manufacturers, too, are

concerned at the automobile industry's failure to come up with standard formats for dash displays. Standardisation would allow successful mass marketing of a small range of colour liquid crystal displays.

BIG FUTURE FOR SOLAR POWER

By the end of the century, European manufacturers of solar photovoltaic cells will be making enough cells each year to generate 1000 megawatts of electricity, according to a recent study by the EEC Commission.

The results of the study were announced at a European Economic Community conference on solar electricity held recently in Italy. Mike Starr, a British engineering consultant who worked on the study, predicted that by the year 2000 solar cells would be producing 200,000 megawatts of electricity, around 10% of Europe's predicted consumption.

Starr warned however that the EEC's projections were made on the basis of continued government support for

the photovoltaic industry. So far governments and private companies around the world have spent about one billion dollars on solar electricity research and development.

Starr made the point that Italy, host country for the conference, was a prime candidate for solar electricity production. In addition to sunny conditions, there are about 70,000 households in remote areas which are not connected to electricity grids.

Electricity presently used in these areas is generated by small diesel generators, at costs of up to 50 cents per kilowatt hour – more expensive than electricity from some present day photovoltaic generators.

Battlefield system for Australian Army

The Australian Army is to develop a computer-based battlefield information system. The Minister for Defence, Mr Ian Sinclair, announced recently that tenders would be called for the first phase of a project to computerise battlefield command and control.

The first phase of the Australian Army Tactical Command and Control System – Project AUSTACCS – will require Australian industry to establish a test-bed computer facility at Headquarters, 1st Division, Enoggera, Queensland. It will also require industry to develop, with the Army, two representative sub-systems of AUSTACCS.

Subsequent phases, over a 10 year period, call for the development of three more sub-systems, and the acquisition of the final system.

The existing tactical command and control system relies on the manual handling of information. AUSTACCS will eliminate the slowness and potential inaccuracy of a manual system.

Development of the project will require close co-ordination with two other major projects – Raven, a single channel field communications system; and Parakeet a field trunk communications system.

The Parakeet system will be designed specifically to operate in the hot and dusty Australian environment and will include operation in the high frequency (HF) bands, which are not currently available in overseas systems.

Japanese plan "fifth generation" computer

The Japanese plan for a "fifth generation" computer that can think like a human being is attracting the attention of the British computer industry.

The project is still at the planning stage, and nobody has any clear idea of what kind of computer will result from the project. Funds amounting to around \$1000 million have already been allocated or promised to the project in Japan by the Ministry of International Trade and Industry (MITI).

The fifth generation computer will be a general purpose "problem solving and

inference machine", with users communicating in speech, graphics images or a "natural" language that simplifies ordinary speech just enough for a computer to understand.

The goal is to provide an entire computer system that reasons and solves problems in much the same way as a human being.

Where current computers can perform one to 10 million instructions per second, the goal for the 1990s is a network of parallel processors capable of performing around 100 to 1000 million instructions per second.

MAGRATH'S NOVEMBER MONEY SAVERS SEMICONDUCTORS

See 6 pack Specials for super prices, on asterisked products.

4011B	19c	*74LS04	20c	LM340T 5	51c
*4016B	30c	*74LS14	40c	LM340T 15	60c
4023B	19c	74LS47	72c	LM386N	60c
4028B	55c	*74LS90	42c	LM555	25c
*4066B	44c	74LS161	53c	LM741N DIP	23c
*4511B	69c	81LS95	87c	LM741 DIP	36c
4520B	74c	81LS98	88c	*74C02	20c
7406	20c	LM301A DIP	35c	74C89	\$1.50
7414	33c	LM308 DIP	49c	*74C107	30c
74164	48c	*LM324	42c	*UA317UC REG.	\$1.20
74365	37c	LM339 DIP	42c	*KBPC602 6A 200V BR	\$1.00
*74LS00	20c	*LM340KC 12	\$1.20	*S6006L 6A 600V SCR	80c

ELECTRICAL INTERFERENCE UPSETTING YOUR CIRCUITS?

The Bulgin mains filter protects personal micro's and any other TTL, CMOS or memory circuits.

- Incorporates 3 pin mains inlet connector
 - Fully screened
 - Conforms to British & European specifications.
- 3 Amp & 6 Amp \$14.00**
10 Amp \$17.00



Engraving made easy with "Gravilo"



Easy to hold
Easy to use

\$29.00

FROM NOVEMBER 1st.

MAGRATH'S NEW ADDRESS

55 A'BECKETT St.
MELBOURNE 3000
TELEPHONE (03) 347 1122

Close to RMIT, Good parking, Public Transport

5% OFF

all cash sales over
\$20 for month of
November 1982

QUALITY VIDEO MONITOR only \$136.00

Special offer for November 1982 only

- Input signals: Composite video signal Negative SYNC 1.0 P.P., 75 ohm.
- CRT size: 31 cm diagonal
- Green Phosphor — P31
- Video Amp Bandwidth 15MHz
- Display Format: 1920 characters max. (80 char. X 24 lines)

µP SPECIALS

- 6821 PIA **\$2.50 ea.**
- 6800 MPU **\$5.00 ea.**
- 6802 MPU **\$7.12 ea.** with clock and RAM

MAGRATH'S 6-PACK SPECIALS

6 for the price of 5

DIGITAL & LINEAR

6x4016B	\$1.50
6x4066B	\$2.40
6x4511B	\$3.45
6x74LS00	\$1.00
6x74LS04	\$1.00
6x74LS14	\$2.00
6x74LS90	\$2.10
6xLM324	\$2.10
6xLM340KC-12	\$6.00
6xLM340T-5	\$2.55
6xUA317UC Regulator	\$6.00
6xUA348PC Op Amp	\$4.25
6x74C00	\$1.00
6x74C107	\$1.50
6x74C04	\$1.00
6x74C02	\$1.00

LEDs

6xMV5053S	35c
-----------	-----

BRIDGES

6xKBPC602 6A 200V	\$5.00
-------------------	--------

SCRs

6x6006L 6A 600V	\$4.00
-----------------	--------

DIODES

IN4002 100 per pack	\$4.50
IN4148 100 per pack	\$3.50

TRANSISTORS

6xPN2222A	25c
-----------	-----

CAPACITORS

	Normal Price Each	Special Price Per Pack of 6
STETTNER 3.12 pf	50c	\$2.50
CERAMIC TRIMCAPS		
ELECTROLYTICS		
2.2Mfd 25V RB s	16c	80c
10Mfd 16V RB s	16c	80c
10Mfd 25V RB s	16c	80c
25Mfd 25V RB s	17c	85c
47Mfd 16V	20c	\$1.00
47Mfd 25V RB s	22c	\$1.10
100Mfd 10V RB s	20c	\$1.00
100Mfd 25V RB s	26c	\$1.30
220Mfd 25V RB s	36c	\$1.80
POLYESTERS		
001Mfd 100V Greencaps	8c	40c
0047Mfd 100V Greencaps	8c	40c
01Mfd 100V Greencaps	14c	70c
012Mfd 100V Greencaps	14c	70c
022Mfd 100V Greencaps	14c	70c
033Mfd 100V Greencaps	14c	70c
039Mfd 100V Greencaps	14c	70c
056Mfd 100V Greencaps	14c	70c
068Mfd 100V Greencaps	14c	70c
1Mfd 100V Greencaps	14c	70c

HARDWARE

RCA Plugs	20c	\$1.00
RCA Chassis sockets	35c	\$1.75
3.5mm Plugs mono	20c	\$1.00
3.5mm Chassis sockets	35c	\$1.75
MS 102 Push to make switch	35c	\$1.75
Philips Carbon Resistors		
1/4W 50 per pack	\$1.00	
1/2W 50 per pack	\$1.00	

BULGIN MAINS CONNECTORS

For computer equipment, consumer appliances, any 240V application.



10A 240V AC Hot condition
Keyway prevents cross mating
SEMKO & VDE approved.

SUPER VALUE

Amphenol BNC Panel Jacks for RF applications

Panel Jack \$1.25
Cable Jack \$3.00

CONNECTOR SPECIAL

Flat Cable 50 way, standard disc drive interface connector
225F-A50-3
\$4.50

24 Pin Socket

Zero Insertion Force
Only \$7.50

Add Sales Tax if applicable

Prices valid until stock sold
Prices subject to alteration



EA-6

NOW AVAILABLE

DICK SMITH'S AUSTRALIAN RADIO FREQUENCY HANDBOOK

Now available... for the first time in Australia, up-to-date and thorough listing of virtually all the VHF/UHF radio users we've been able to find. Yes — find out who is where — and where to listen for all the excitement! Plus much more information besides — air band marine band, how to use a scanner, amateur radio and CB, etc. It's a MUST for anyone interested in radio or electronics. Where else can you get this sort of information? Cat. B 9500

VALUE AT ONLY \$12⁹⁵

DICK SMITH'S AUSTRALIAN RADIO FREQUENCY HANDBOOK
Get into the exciting world of 'Secret' radio with a SCANNER

WOTTA BARGAIN! ULTRA THIN CAR STEREO SPEAKERS

We've made a huge scoop purchase of these incredibly thin car speakers. Flush mount with modern mesh grille front & they rate at 20 WATTS RMS PER CHANNEL. 4 ohms. Why pay more elsewhere? Cat. A-7050

ONLY \$24⁹⁵

POPULAR TRANSFORMERS - LOW LOW PRICES

Top quality transformers you'd expect to pay more for! Excellent specifications and they're so economical!

Model M-2840
Primary: 240V AC
Secondary voltage: 9 volts CT
Secondary current: 150mA
Termination: Flying leads
Cat. M-2840 **\$3⁹⁵**

Model M-2155
Primary: 240V AC
Tapped Secondary: 6.3, 7.5, 8.5, 9.5
Voltage: 12.8, 15 volts
Secondary current: 1 amp
Termination: Solder lugs
Cat. M-2155 **\$5⁹⁰**

Model M-2851
Primary: 240V AC
Secondary Voltage: 12.6 volts CT
Secondary current: 150mA
Termination: Flying leads
Cat. M-2851 **\$2⁹⁰**

DICK'S ZIPPY'S ARE THE ORIGINAL - AND BEST!

Our Zippy boxes are genuine — not somebody else's clone! Insist on Dick Smith Zippy boxes — the one with the ribbed sides!

SMALL UB-5 (28 x 54 x 83mm) Cat. H-2755 **\$1⁸⁰**
MEDIUM UB-3 (41 x 66 x 130mm) Cat. H-2753 **\$2²⁵**
LARGE UB-1 (50 x 90 x 150mm) Cat. H-2751 **\$2⁸⁰**
GIANT UB-2 (60 x 113 x 196mm) Cat. H-2752 **\$3⁹⁹**

"For projects that need to be done in a jiffy you can always rely on a Dick Smith Zippy!"

NEW SCAN X ANTENNA

Just the thing for your new PRO 40 Scanner! Rugged design with plated finish — it will last for years on end! Cat. D-4430

No special mounting needed — will stand alone for use on roof or patio.

Wide operating frequency range: 65MHz - 520MHz

Will mount on vertical mast up to 38mm dia.

easy to assemble can be pulled apart in seconds.

Comes complete with 52 ohm cable & connector.

Fantastic value only \$49⁹⁵

Our most popular PRO 40 SCANNER

from DICK SMITH **\$399**

Compare with similar performance elsewhere at nearly twice the price! You get the latest state-of-the-art technology.

- ★ Completely solid state computer-controlled circuitry.
- ★ Specially prepared AUSTRALIAN instruction manual — not some foreign lingot!
- ★ Touch-type splash proof keypad.
- ★ Ideal as base or mobile scanner (operates from 12V).
- ★ Complete with plug in telescopic antenna (provision for any other external antenna).

● 88.8MHz, 136-174MHz, 360-512MHz ● Scanning steps 5, 10, 12.5 & 25kHz ● 40 channels ● Scan rate 18 sec

Great for listening to 'secret' broadcasts as well as emergencies, ambulance, marine, taxis, amateur operators, private conversations & MUCH MORE!!! Cat. D-2805

LAST CHANCE TO SAVE! FAMOUS AMPEX TAPES

Huge scoop purchase at BELOW MANUFACTURERS COST!!!

WAS NOW

- 3082 C-90 ELN \$3.15 \$2.49
- 10 up price only \$2.24
- 3088 C-90 EDR \$4.15 \$2.99
- 10 up price only \$2.69

HIGH IMPEDANCE FET METER

DC VOLTS: 250mV, 2.5V, 10V, 100V (10M)
AC VOLTS: 2.5V, 10V, 50V, 250V, 1000V (1M)
DC CURRENT: 25uA, 2.5mA, 25mA, 250mA
DECIBELS: -20 to +62dB
RESISTANCE: x1, x10, x100, x1k, x100k (5k, 50k, 500k, 5M & 500M)

\$78⁰⁰ 25 RANGES plus reversal 10M input impedance

DISKETTE SPECIAL OFFER

YES! When you buy a box of 10 soft sector diskettes (ideal for TRS-80 & System 80 etc) you receive FREE of charge a superb library case to protect your disks from dust, scratches etc. 5.4in type diskette. Cat. X-3512

Worth \$5.95 — yours for FREE!

VALUE! \$49⁸⁰

BUY 10 — GET A LIBRARY FREE!

SOUVENIR DICK SMITH HELICOPTER HAT

Don't be a turkey! Wear one of these great caps commemorating Dick's epic flight across the world in a helicopter. Now your friends will think you flew with Dick Smith!

Cat. Y-1000 **\$3⁵⁰**

HI FI LOW SIZE!!!

AND A LOW PRICE TOO! Great for any hi-fi system as extra speakers or for extension speakers at parties etc. They handle 15 watts each which is plenty for the outdoor. Barby! Cat. A-2460

\$49⁵⁰ each!

VERIFIED COMP. CASSETTE (C10)

Famous Microcette computer verified cassette tape. Five minutes per side gives over 40K capacity per side! Top quality — no glitches!!! (no scratches) Cat. X-3502

only \$1⁹⁹

SINGLE DISKS TOO!

Hard Sector: Suits Microcette-type drives for Sanyo etc. Cat. X-3505

Soft Sector: Suits System 80, TRS-80 & Sorcerer floppy disk sub-system. Cat. X-3510

EACH ONE \$8⁸⁵ 10 OR MORE — SEE ABOVE

BEAUT STAND

Complement your system to make it look a million dollars! Assembles in minutes. Simulated (not real) walnut vinyl veneer & black vinyl vinyl. Will HOLD ALL THE YEAR GOODIES BELOW & MORE!!!

BARGAIN! Cat. A-0105 only \$74⁵⁰

WANT BETTER FM?

why pay more? ONLY \$16²⁰

Cat. L-4064

Throw away that messy ribbon indoor antenna. The latest reception is out there — on your roof! Pulls in all the stations so you can enjoy top quality FM sound — & it's so easy to erect!

COOL IT!

For anything that needs cooling! Standard mounting hole position & sizes. 110mm dia fan can be used in sucking or blowing position. 740V AC, # 0.125A

OURS IS ONLY \$19⁹⁵

WHY PAY OVER \$30?

SEE WITH THIS CLOSED CIRCUIT TV CAMERA

Top quality 86W CCTV is ideal for the home (watching the pool from the living room) or for security purposes or for anything requiring surveillance! Outstanding value for money. Cat. Y-1195

only \$299

USE WITH STANDARD TV OR MONITOR BELOW

MONITOR TO SUIT: for all monitoring applications. Cat. X-1198 **\$149⁵⁰**

TEAC TIME - TOP NAME HI FI AND YOU SAVE!!!

BX-330B AMPLIFIER only \$249
Cat. A-1301

- 35W RMS/channel
- Frequency 10Hz - 100kHz
- MM or MC Pre-amp
- Dual Speaker outputs
- THD of only 0.006%

TX-550B TUNER only \$199
Cat. A-1501

- Harmonic Distortion 0.008%
- Sensitivity of 1.9uV
- Signal/Noise Ratio 80dB (mono)
- Frequency ±1dB 30Hz - 15kHz
- Selectivity 65dB

V-30 CASSETTE DECK only \$172⁸⁰
Cat. A-3505

- Brilliance switch for 2-3dB boost
- Bias & Equalisation switching
- Dolby NR plus Metal facility
- LED Level display for accuracy
- Separate recording knobs

DON'T FORGET... IT'S ONLY 7 WEEKS TO CHRISTMAS!



GREAT GIFT IDEAS!

FUN WAY VALUE PACKS

Fun Way Vol. 1 Value Pack
An easy to follow system of learning basic electronics. 20 exciting projects for you to build, ranging from a beer powered radio to an electronic siren. Completely safe, no need to solder, suitable for all ages. Cat. K-2615 **\$17.95**

Fun Way Vol. 2 Gift Pack with Soldering Iron
Fantastic Savings! Over \$25 value! Everything you need to build an actual working project, including a hobbyist soldering iron, a pack of solder, a 9 volt battery, a copy of Fun Way Vol. 2 and a wireless microphone kit. **\$19.95** Cat. K-2620

THOUSANDS SOLD! OUR MOST POPULAR IRON
A general purpose mains operated iron that will give 25 watts of heat very quickly! Stainless steel barrel complete with copper tip. You even get a FREE length of solder!!! **WHY PAY MORE????????????????** Cat. T-1300 **\$9.75**
Spare tips available

SAVE \$\$\$ AUTO RANGING DMM
Great for all applications at home, work, service etc. Look at these professional features:
● Full auto ranging ● Overload protection ● Low battery voltage ● Rec. only 2 x AA batteries
Cat. D-1446 **\$49.50**

BE A SPY!
For all you aspiring James Bonds or Smarts out there! Secret size fits snugly in your pocket or gun holster. Great for kids of all ages. Ideal! Cat. D-1101 **\$9.95**

THE DICK SMITH WIZZARD
The ultimate TV game with a computer built in. See page 189 for details

WATCH OUT!
Don't get caught with a 'cheapie' watch this Christmas. You know what they say about 'two bob watches!' Dick Smith digital watches are fully guaranteed by Dick Smith. Try this one - a 'World Time' watch showing different time zones, with times great for travellers, hams, etc. **SAVE 15% OFF \$15.95** Cat. Y-1051 **\$13.49**

COMPUTERS FOR KIDS
Dick Smith's great introduction to computers for kids (of all ages). Takes them through the difficult part - coming to terms with the computer. Widely acclaimed by parents and educational authorities. Cat. B-6190 **\$4.95**

STOP! DON'T BUILD A MODEM!
Why build one, when you can buy a fully built up, fully tested and fully Telecom Permitted one for less than you'll pay for the kit/power supply/case? Dick's Direct Coupled Modem is the one you want - and its only \$169.00 - complete!!! Cat. X-3272 **\$169**

BUILD A KIT THIS KITMAS

FLUORO STARTER
Replace your old faulty starter NOW! Fits into the carcass of your old starter. Our smallest kit ever - even the instruction manual is small! And at our price it's a steal!!! Cat. K-3082 **\$4.50**
MAKES TUBES LAST MUCH LONGER!!

SAVE \$\$\$ OVER A BUILT UP FREQUENCY COUNTER
You'll freakout when you see our new frequency counter! Low component count makes it very easy to build & very reliable. It rivals the performance of commercial units costing much more. You get 50MHz (up to 500MHz optional Pre-scaler) plus much more. (Case is optional extra). VALUE! Cat. K-3439 **\$102.95**

Let your computer say G'day to you!!! SPEECH SYNTHESIZER
A fraction of the cost of others! You get:
● an unlimited vocabulary
● variable pitch control
● easy to program
● works with any computer fitted with a Centronics-type parallel printer port such as the System 80 Super 80 TRS-80 etc. Fantastic value!!! Cat. K-3530 **\$97.50**

12V FLUORO INVERTER KIT
Power strike problems? This beauty can drive 2 x 20 watts fluorescent tubes from your 12V car battery for hours! Cat. K-3275 **\$49.50**

PANEL METER MODULE KIT
Versatile & accurate. LCD readout for low power consumption. Flexible mounting. Capacity makes it ideal for amateur & professional use in projects or updating analogue equipment. Cat. K-3450 **\$29.50**

WARNING! Hurry - prices must rise soon!
The Australian Dollar is devaluating!
Yea! The Australian dollar has dropped by a huge amount over the last 12 months. That means any imported product costs a lot more - up to 25% - to import. And sales tax has also been savagely increased - by up to 50%. Not to mention double digit inflation, etc. etc. Because we import direct, our costs have risen dramatically. But our prices haven't - we've absorbed a large proportion of these cost increases and only put prices up as a last resort. But this cannot last indefinitely.

FOIL THE CHRISTMAS CROOKS
Looks so good! When the felon peers through the window, he'll probably think it's just a small speaker - BUT DON'T JUDGE A BOOK BY ITS COVER!!! It's a fully self-contained ear piercing alarm.
● AC/DC operation (req. optional mains adaptor) ● Built in test LED to ensure it works before you leave ● Built in remote switch terminals makes it handy for elderly, disabled, nervous people etc. ● Wide range of accessories available for this unit.
Your owe it to yourself & family **ONLY \$59.50** Cat. L-5102

BIG BEAUT!
200mm Air Suspension with Aluminium Voice coil - 30W power handling! Dual impedance - 4 & 8 ohms - makes it an ideal replacement or for new designs. And look at our low price! Cat. C-2100 **\$22.95**

LITTLE BEAUT
57mm dia 8 ohms - hundreds of uses!!! Cat. C-2222 **\$1.99**

VANTASTIC! SUPERB NEW DISCRETE AUTO HI FI
You know your big hi-fi - the one in the living room. Imagine the sound quality and versatility of a big system in your car! Now it's a reality with this hi power mini component system from Dick! Ultra compact - designed for today's car, it delivers a huge 30 WATTS RMS PER CHANNEL!

Here is what you get:
● 5 Band Graphic equaliser
● AM/FM Push button tuner
● Auto reverse cassette player with Dolby Nr & Metal
● Fader control for front & rear speakers
● Dual 5 position LED displays
● 6 MUCH MORE!!!
Suit our 50W 3-way's (Cat. A-7083 @ \$99.50pr) **\$299**
H: (120mm) W: (55mm) D: (160mm)

FLASHING LEDS DON'T PAY 45¢ OR EVEN 35¢ - OUR PRICE IS 25¢
WOW! All you do is apply voltage!!! Tiny circuit inside causes it to flash. Heaps of applications. (not intended for those with large raincoats) Cat. Z-4000

12 VOLT DIGITAL CAR CLOCK
Here is the ideal clock for your car, boat, plane, etc. All controls are mounted on the front face for time setting, alarm and lock. Quartz controlled for accuracy. Requires 12 DC for operation. Complete in case with bracket and power leads. Cat. Y-1047 **\$24.50**

GOLD IS ON THE WAY UP AGAIN! FIND YOUR SHARE WITH THESE BEAUTIES!!
Techna T/R A true discriminator
A great unit for beginners! Ideal to throw in the car when you go away for a weekend or on holiday. Provides endless hours of fun and the whole family can join in as well. Lightweight and very easy to use. Cat. Y-1066 **\$99** **SAVE \$50!** **WAS \$149**

and the 'Bolls Royce' **D-TEX DETECTOR**
If you want the ultimate in metal detection, then this is the one for you. But you must be prepared to put plenty of effort into it. The unit has full discrimination between trash and treasure and has two waterproof search coils. Cat. Y-1076 **\$399** **WAS \$685**

PUSH BUTTON PHONE DIALS
Converts rotary dial phones to push button type. Ideal for hobby or private phone systems. Memory re-dial allows a previously engaged number to be re-called at the press of one button. Up to 16 digits can be retained in the memory. Easy to install, with instructions supplied. Cat. Y-1175 **1,000'S SOLD!** **SAVE \$10** **WAS \$49.50** **\$39.50**

AND A 10 MEMORY DIAL
We've sold thousands of the popular phone diallers (above) and now we're proud to present this little beauty! Not one memory but TEN - yes 10 phone numbers can be stored in this unit. Please Note: Cat. Y-1183 **Not Telecom Permitted** **ONLY \$59.95**
STOCKS DUE MID NOVEMBER

DON'T MISS YOUR COPY OF OUR GIANT LIQUIDATION MAILER with 1000's of bargains for you FREE in this issue of EA & ET!!!!

DICK SMITH ELECTRONICS
See page 98 for store & re-seller addresses

Frequency modulation the basic concepts

Following on from last month's article on the fundamentals of amplitude modulation, this article explains frequency modulation, as used in commercial broadcasting, two-way communications and television sound transmissions. What is frequency modulation, and what advantages does it offer?

One of the greatest disadvantages in using amplitude modulation for the transmission of information is that the modulated signal has to compete with background electrical noise. Quite often, it is difficult to distinguish between the desired information signal and the undesired background electrical noise. The noise signal generally shows itself as an additional amplitude variation of the original signal as shown in Fig. 1.

Both the desired information signal and the undesired noise appear as amplitude variations, and any attempt to reduce or eliminate the noise will affect the information signal as well.

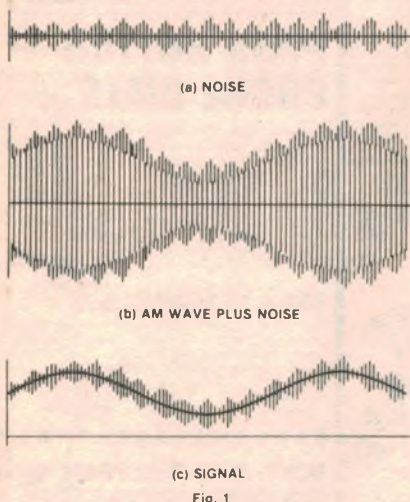
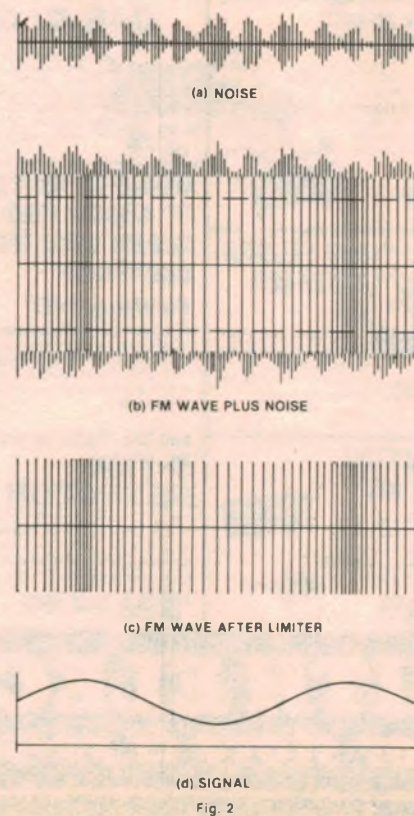

Fig. 1, above, illustrates the effect of noise on an amplitude modulated signal. The noise appears as an additional variation in the amplitude of the signal and is reproduced by the receiver.

Fig. 2, at right, illustrates the effect of noise on a frequency modulated signal. Since the noise effects only the amplitude of the signal it can be eliminated.

The problem was studied by E. H. Armstrong in the 1930's and a reasonable solution was put forward. Instead of varying the amplitude of the carrier as is done in amplitude modulation, he placed the information on the carrier by varying the carrier frequency. That is, the frequency of the carrier is varied in keeping with the instantaneous amplitude of the modulation signal.

Fig. 2 shows the components of an FM signal and the effects of noise on it. Notice how at certain points the frequency has increased while at others it has decreased. The noise is shown at the top and bottom edge of Fig. 2b. The FM



signal can now be put through a limiter in the receiving equipment which slices off the noise signal and leaves the FM signal as shown in Fig. 2c. We are able to do this in the case of FM, because it is the frequency variations we are interested in and not the amplitude variations as in AM. Figure 2d shows the modulation or information signal after it has been separated from the carrier.

Mathematical representation

Let us begin as we did in the case of amplitude modulation with a carrier wave, which we shall represent as follows.

$$V_c = A \sin 2\pi f_c t$$

It is now required to vary the frequency f_c in keeping with the modulating signal, which is represented as follows.

$$V_m = B \sin 2\pi f_m t$$

Using these two equations, it can be shown that the FM signal can be represented by an equation of the form

$$V_{FM} = [A \sin 2\pi (f_c + \Delta f \sin 2\pi f_m t) t]$$

In this equation, f_c , which represents the frequency of the unmodulated carrier, is called the rest frequency. Δf is the maximum frequency change the car-

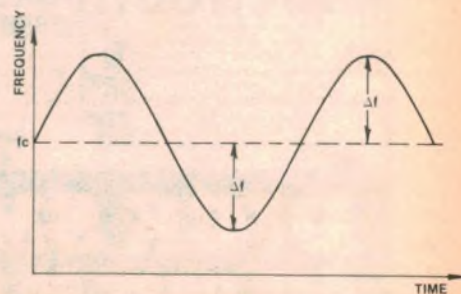

Fig. 3

Variation of carrier from rest frequency

by ELMO V. JANSZ VK7CJ

rier undergoes. The total frequency deviation from the lowest to the highest value is called the carrier swing. Fig. 3 shows the variation of carrier frequency from the rest frequency.

Modulation index

The frequency modulated wave is sometimes represented by an equation of the form

$$V_{FM} = A \sin \left(2\pi f_c t + \frac{\Delta f}{f_m} \cos 2\pi f_m t \right)$$

In this equation the quantity $\frac{\Delta f}{f_m}$ is called

the modulation index and is normally designated by m_f . In order that we do not lose the picture of the FM waveform in a lot of mathematical representation, Fig. 4 shows a carrier, frequency modulated by a sine wave.

Fig. 4a shows the unmodulated carrier. This is the rest frequency because no frequency modulation has taken place. Fig. 4b shows the modulating signal and Fig. 4c shows the resulting FM waveform. Notice that in Fig. 4c the frequency of the carrier increases in proportion to the amplitude of the modulating signal. That is, when the amplitude of the modulating signal reaches its maximum value so does the frequency of the carrier, and when the amplitude of the modulating signal reaches its minimum value the frequency of the carrier is at its minimum. This is what FM is all about.

Illustrative example

Let us illustrate the above ideas by working through a little problem. Suppose a 100MHz carrier signal is frequency modulated by a 4kHz audio tone, causing a frequency deviation of 25kHz. What are the highest and lowest frequencies that the modulated wave at-

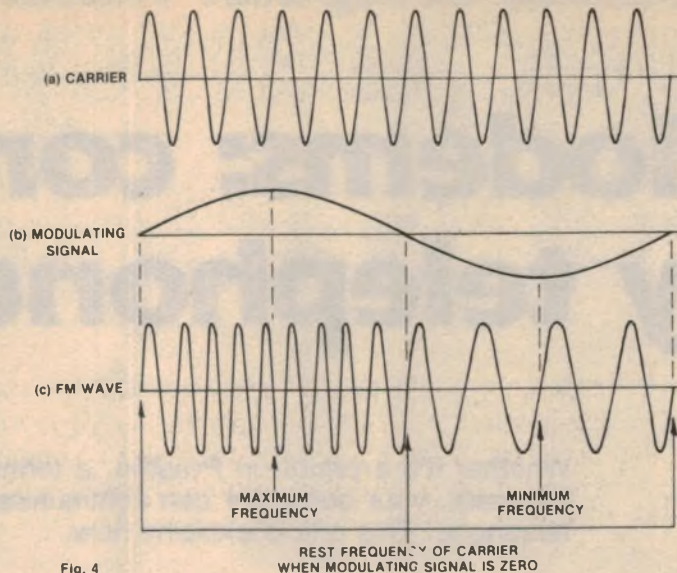

Fig. 4

A carrier frequency (a) modulated by signal (b) results in a frequency modulated waveform as shown in (c).

A frequency modulated waveform consists of an infinite number of side-bands, although not all of them have enough power to be significant.

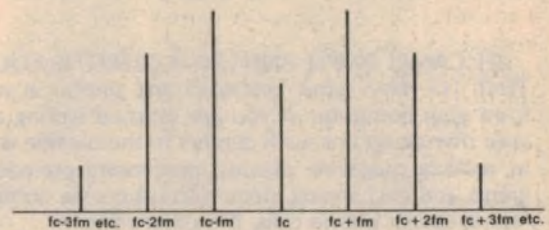

Fig. 5

tains? Also find the carrier swing and the modulation index for this FM wave.

$$\text{Frequency Deviation } \Delta f = 25\text{kHz}$$

$$\begin{aligned} \text{Highest Frequency attained} &= f_c + \Delta f_c \\ &= 100\text{MHz} + 25\text{kHz} = 100.025\text{MHz} \end{aligned}$$

$$\begin{aligned} \text{Lowest Frequency attained} &= f_c - \Delta f_c \\ &= 100\text{MHz} - 25\text{kHz} = 99.975\text{MHz} \end{aligned}$$

$$\begin{aligned} \text{Carrier Swing} &= 2 \times \text{Frequency Deviation} \\ &= 2 \times 25\text{kHz} = 50\text{kHz} \end{aligned}$$

$$\begin{aligned} \text{Modulation Index } m_f &= \frac{\Delta f}{f_m} = \frac{25\text{kHz}}{4\text{kHz}} \\ &= 6.25 \end{aligned}$$

Frequency spectrum

Unlike an AM wave which consists of a carrier and an upper and lower side band, the FM wave consists of an infinite number of side bands as shown in Fig. 5.

Not all these side bands, however, have enough power to be significant. The amplitude distribution is clearly shown in Fig. 5.

Noise and modulation index

The modulation index of an FM system has a direct bearing on its ability to suppress noise. When the modulation index

increases, the signal to noise ratio with respect to an AM system increases, for the same signal input to the AM receiver. The improvement in signal to noise voltage ratio is given by the formula

$$\begin{aligned} \text{Improvement in dB} &= \\ &= 4.75 + 20 \log_{10} (\text{Modulation Index}) \end{aligned}$$

As an example, suppose the maximum frequency deviation of a transmission is $\pm 50\text{kHz}$ and the modulating frequency is 15kHz .

$$m_f = \frac{\Delta f}{f_m} = \frac{50\text{kHz}}{15\text{kHz}} = 3.3$$

Therefore, the signal to noise voltage ratio improvement with respect to an AM system

$$\begin{aligned} &= 4.75 + 20 \log_{10} (3.3) \\ &= 15.2\text{dB} \end{aligned}$$

Using higher values of modulation index would increase the signal to noise ratio, but this would require an increase in bandwidth for the transmission of the FM signal. A compromise value of modulation index is normally used so that a significant improvement in signal to noise ratio takes place, without unduly increasing the bandwidth.

Modems: computing by telephone

Whether it's a printer in Preston, a terminal in Tempe or a data base in Denmark, your computer can communicate with it using a modem and a telephone. This article explains how.

by SCOTT PARKER

LIFE CAN BE SIMPLE AND UNCLUTTERED IF YOU ARE CONTENT TO HAVE your keyboard and printer at arm's length from your computer. If you are satisfied writing and running your own programs, with contact to the outside world limited to reading magazine articles, purchasing pre-packaged programs and exchanging ideas with others via computer clubs, letters and/or phone calls, then that's fine.

But should you decide to expand your world, and tie your personal computer to a time-sharing system — or write your output to a distant printer or terminal — you suddenly are involved with data transmission and the need for a modem (Modulator-Demodulator). Your computer can send its data stream to a remote terminal over telephone lines with a modem at each end. The modem at your end converts the digital bits to a more convenient form to transmit over the phone lines, and another modem at the distant location restores the original stream of data bits.

Similarly, if you wish to make use of time-shared computer networks, such as the Source or "The Australian Beginning" a modem must be inserted between your terminal (or computer) and the telephone line.

Why are modems necessary? Why not simply route computer signals along the telephone wires to a peripheral device such as a printer or remote terminal?

Telephone lines were designed to carry audio signals in the 300Hz to 3500Hz range. Frequencies below 300Hz are

attenuated and thus a stream of data pulses routed along such a line would suffer waveform distortion as shown in Fig. 1. Here a logic-pulse train of three 0's is followed by five 1's as shown in Fig. 1-a. If this pulse train were to be transmitted over the telephone lines, then attenuation would result as shown in Fig. 1-b. Many of the logic 1's transmitted over the telephone line would be recognised as 0's at the remote peripheral, with resultant errors.

Since the telephone line is optimised to handle the 300Hz to 3500Hz frequency range, it is practical to convert the data bits to sine waves or sinusoidal tones that can be transmitted without distortion. Computer data is in the form of pulses — a pulse represents a logic-1 level, the absence of a pulse represents a logic-0 level, as shown in Fig. 2. Thus, a pulse or digital signal has two distinct states with nothing in between.

An analog signal, or sinusoidal signal, is a continuously-varying voltage, as shown in Fig. 3; its frequency and amplitude remain constant as long as nothing is done to alter or modulate it. In that form, the sinusoidal voltage is termed a carrier and, since it is at a fixed frequency and amplitude, it conveys no information. However, if its amplitude were deliberately changed — such as reduced to zero for a few seconds — and then allowed to return to its original condition, it would convey information that some input had caused the change in the carrier.

As an example, the light beam in a photosensitive burglar

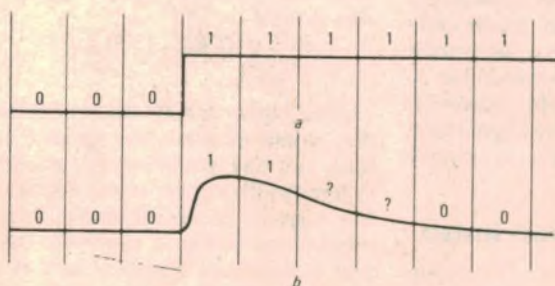

Fig. 1: a stream of data pulses (a) sent over a telephone line would be distorted by the line's limited bandwidth (b).

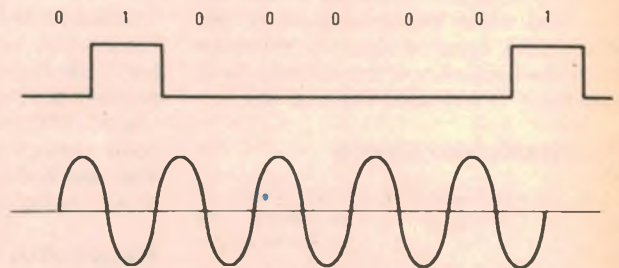

Fig. 2 (top): For digital data a pulse represents a "1" and the absence of a pulse a "0", while the frequency and amplitude of a sinusoidal signal remains constant unless modulated as shown in Fig. 3 (above).

alarm system sends a steady beam of light from a lamp, across a doorway, to a detector. The beam is a carrier that conveys no information until someone passes through the doorway, interrupting the light beam; the short duration during the absence of light at the detector conveys information that something has changed the carrier. Changing or altering the carrier is termed modulation.

AM, FSK, and PSK

The three common techniques used to modulate or alter a fixed-frequency signal (carrier) are: amplitude modulation (AM), frequency modulation (FM), or phase modulation (PM).

With amplitude modulation, Fig. 4, the level or intensity of a constant-frequency sinewave is varied. For example, an increase in amplitude could signify a logic-1 level while a decrease in amplitude would signify a logic-0 level.

In frequency-modulation, shown in Fig. 5, the amplitude of the sinewave is kept constant but the frequency of the carrier is changed. For example, a logic-1 level could be represented by a carrier frequency of 1650Hz; a 1850Hz tone could be generated if the logic state changes to a 0. The term FSK (frequency-shift keying) is often used to indicate that the carrier's frequency is shifted between two distinct frequencies to designate logic 1's or 0's.

Phase modulation, shown in Fig. 6, involves instantaneous changes in the phase of the carrier relative to a fixed reference phase angle. A standard sine wave starts at zero amplitude and zero phase angle, rises to a peak positive amplitude at 90° , and drops to zero at 180° before returning to zero at 360° (see Fig. 3). It is possible to represent a logic-1 level as a signal with a particular phase angle and a logic-0 level as the same amplitude, same frequency carrier but displaced in phase by 180° (see Fig. 6). A phase-detector circuit can be used to detect the phase of the carrier and thus determine whether a logic 1 or logic 0 is present. That technique is called PSK or Phase-Shift Keying.

It is possible to combine amplitude modulation (AM) that has two states (high or low) with phase modulation, which can be extended to four phase shifts, to provide eight signal-state conditions; that technique is termed quadrature phase modulation. Using that technique, data rates as high as 9600 bits-per-second are achieved.

Frequency modulation or FSK is most commonly used for modems operating at 300 bits-per-second or less.

Parallel-to-serial interface

Letters or characters generated by a computer are generally coded in an 8-bit ASCII (American Standard Code for Information Interchange) set. ASCII is a 7-bit code with 128 combinations for letters, numerals, and control functions. During serial transmission, the ASCII code is sent as an 8-bit word, with the additional bit used for parity or error checking. Those bytes of information, containing eight bits or pulses, cannot be sent over the conventional two-wire telephone line; the parallel or simultaneous transmission of bits must first be converted to a serial transmission, with bits moving along the phone line one at a time. The necessary parallel-to-serial conversion is performed by an RS-232 serial interface.

Assume that the computer is transmitting the letter "r", represented by 01010010 in the ASCII code: The serial interface would accept the simultaneous group of bits and output them one bit at a time, as shown in Fig. 7. The string of bits are represented by voltage levels of 0 and +5 for a logic 0 and a logic 1, respectively. Those pulses are then fed to the modem that converts them into audio tones. Those audio tones are transmitted along the phone lines to the distant computer or terminal, where a receive modem converts or demodulates the audio tones to their binary equivalents.

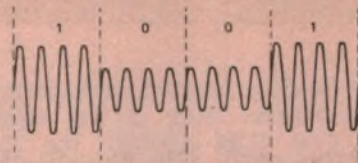

Fig. 4: In amplitude modulation (AM) data is represented by a change in the amplitude of the waveform.

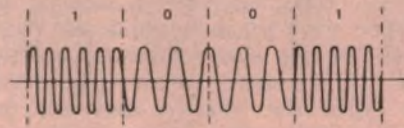

Fig. 5: In frequency modulation (FM), the frequency of the carrier is varied to represent data and the amplitude is constant.

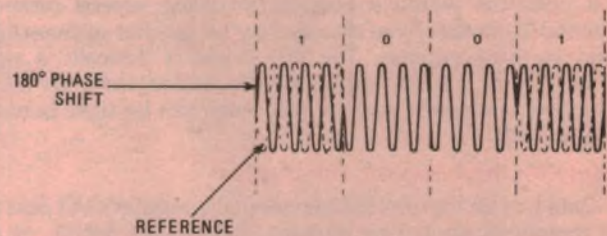

Fig. 6: Phase modulation (PM) represents a "1" by a signal with a particular phase and a "0" by a phase shift of 180° .

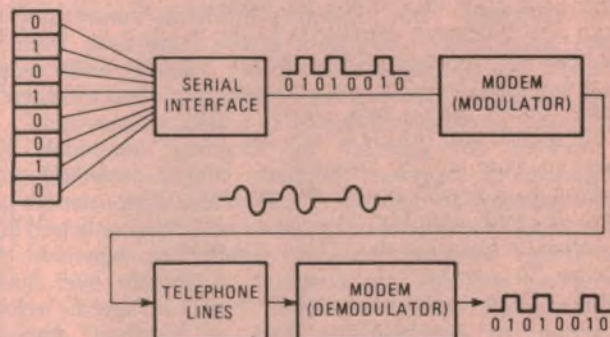

Fig. 7: The components required for serial communications are shown in this generalised block diagram.



Acoustic coupler made by Electro-Medical Engineering Pty Ltd.

Modems: computing by telephone

The RS-232 interface standard, adopted by the Electronic Industries Association (EIA), is the equivalent of the international CCIT TV24 standard. The 25-pin connector arrangement used for modems involved with serial data transmission is shown in Fig. 8. Table 1 lists the pin functions for modems that are used for synchronous and asynchronous transmission.

Although EIA does not define how data is to be transmitted, it does define the control functions and their use. It also standardises the pin connections on a 25-pin interface connector; the computer or terminal holds the male connector while the modem uses the female 25-pin connector. Terminals can be connected to a computer if cable length is less than 20m; for lengths extending more than this distance errors due to lost bits or extraneous noise-pickup may compromise the system.

If distances within a building involving several terminals exceed 20 metres, line drivers may be used at each terminal and at the computer. The line driver is basically a signal converter to amplify digital signals routed from an RS-232 interface connector; twisted-pair wires can be used between line drivers.

Simplex, half-duplex, full-duplex

Data can be transmitted between a computer's I/O port and a peripheral device by simplex, half-duplex (HDX), or full-duplex (FDX) modems. Simplex modems allow transmission in one direction only and thus are not often used. In a half-duplex system, data may be sent in either direction but not simultaneously. With full-duplex modems, transmission can take place in both directions at the same time. With full-duplex, two telephone channels are required, while simplex and half-duplex modems require only one. Most modems are designed for either half-duplex or full-duplex operation.

Modems are available for long-haul (extremely long distances) or short-haul (relatively limited distances). Long-haul modems are capable of satisfactory performances over thousands of kilometres of standard telephone or leased lines. Short-haul modems, generally slightly less expensive than long-haul versions, are designed to operate over limited distances with short, leased lines. There is no specific industry standard or definition for short- or long-haul distances. Modems may be classified by the speed of operation with these definitions. Low-speed: up to 600 bits-per-second; medium-speed: up to 2400 bits-per-second; high-speed: up to 9600 bits-per-second; and wideband: above 9600 bits-per-second. It is common to refer to data-transmission speed as baud or bits-per-second; however, this is strictly true if the transmission system only involves two signal states (on or off), as is the case with a computer.

Peripherals, such as a slow-speed printer, must operate at the same baud rate as the modem. Thus modems with multiple transmission rates may include a switch (or wiring connections) to match the data-transfer rate of the modem to the printer. For most installations, modems are hooked up to a dial-up line in a standard telephone network or perhaps a Telecom leased line; for short distances, one or several twisted pairs of wires may be used. (When modems are used with the telephone network, signals are limited to a specified level to avoid line overload and interference). Modems carrying Telecom approval can be connected directly to the phone lines; otherwise, users must include a Telecom approved interface between the modem and telephone circuit.

Here's a simple example of how a modem would transmit and receive data in a full-duplex system (see Fig. 9).

The ASCII output from the computer, converted to serial form, is routed to the send modem that converts the logic state of 0 to a frequency of 1180Hz and a logic 1 to 980Hz.

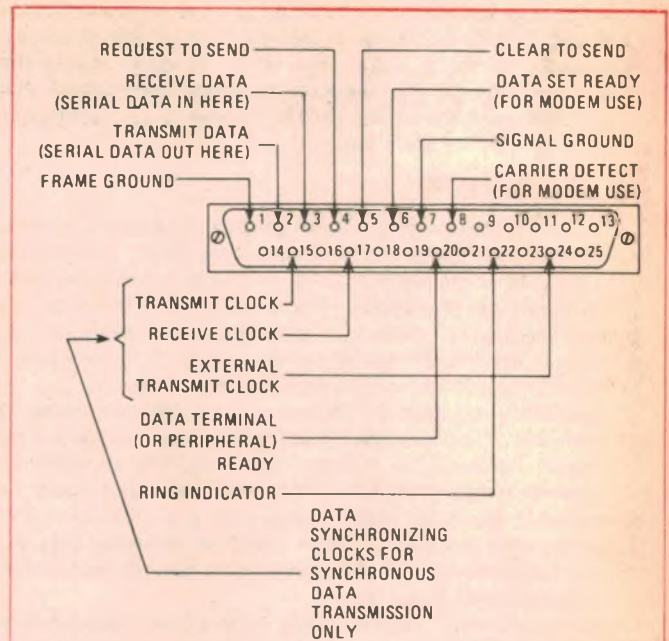

Fig. 8: Pin connections for the standard RS-232 interface. The 12V inputs shown in Table 1 have been omitted here.

TABLE 1—MODEM INTERFACE FUNCTION

PIN NUMBER	SYNCHRONOUS	ASYNCHRONOUS
1	Frame ground	Frame ground
2	Transmit data	Transmit data
3	Receive data	Receive data
4	Request to send	Request to send
5	Clear to send	Clear to send
6	Data set ready	Data set ready
7	Signal ground	Signal ground
8	Carrier detect	Carrier detect
9	---	+ 12V
10	---	- 12V
15	Transmit clock	
17	Receive clock	
20	Data terminal ready	Data terminal ready
22	Ring indicator	Ring indicator
24	External transmit clock	

Table 1 shows RS-232 connections for both synchronous and asynchronous data interfaces.



This 300 baud direct connect modem from Dick Smith Electronics represents something of a revolution in low speed data communications. Apart from offering the advantages of direct connection, the "Dataphone" is actually less expensive than equivalent acoustic couplers.

The change to excellence in sound...



needn't cost you a fortune.

Denon, the name associated worldwide with professional audio equipment has available in Australia their range of advanced magnetic tapes. The result of 30 years of research and technology offers the listener true excellence in sound.

Six dynamic tapes - the LX, DX1, DX3, DX5, DX7 and DXM provide a range to suit any requirement in high grade recording and reproduction.

See the exciting range of tapes at your Denon dealer now, you'll find their prices rather exciting as well.

DENON

Professional Audio Brand.



AMALGAMATED WIRELESS (AUSTRALASIA) LIMITED
554 Parramatta Road, Ashfield, NSW 2131 Phone 797 5757

Canberra 80 5200	Melbourne 560 4533	Launceston 44 5155	Adelaide 272 2366	Brisbane 44 1631	Townsville 79 6155	Perth 271 0888
---------------------	-----------------------	-----------------------	----------------------	---------------------	-----------------------	-------------------

YOUR BUDGET PROBABLY WON'T STRETCH TO AFFORD OUR PROFESSIONAL SERIES ALL ALUMINIUM RACK CABINETS

NOW YOUR PREAMPS, AMPS, CONTROL MODULES MONITOR PANELS ETC. CAN LOOK EVERY BIT AS GOOD AS TECHNICS, NAKAMICHI AND OTHER TOP MANUFACTURERS



Cat No.	Finish	A	B	C	PRICE	5 or More
H 0401	Natural	44	34	38	\$39.50	\$38.00
H 0402	Natural	88	57	82	45.00	42.50
H 0403	Natural	132	89	126	49.50	45.00
H 0411	Black	44	34	38	39.50	38.00
H 0412	Black	88	57	82	45.00	42.50
H 0413	Black	132	89	126	49.50	45.00

Beware of other rack boxes that do not conform to international rack sizing.

THE BRILLIANT MARC NR 82 FI

FEATURING: Digital frequency Display, SSB/CW, FM/AM reception, B.F.O., Double Conversion, Double Super-het, crystal controlled (VHF) Local Oscillator, 4 inbuilt antennas and good looks, you will spend hours just learning how to drive it!

FREE DELIVERY ANYWHERE IN AUSTRALIA



See Review in Electronics Australia August 1982

- 3 Way Power
- * Digital Tuning
- * HI FI SOUND
- * 4 Inbuilt Antennae

only \$349

SPECIFICATIONS:
 Semi-conductors: 1-LSI, 4-IC's, 7-FET, 34-Transistors, 42-Diodes
 Frequency range:
 LW 145-360 KHz SW3 9-22 MHz VHF3 88-108 MHz
 MW 525-1600 KHz SW4 22-30 MHz VHF4 108-136 MHz
 SW1 1.6-3.8 MHz VHF1 30-50 MHz VHF5 144-176 MHz
 SW2 3.8-9 MHz VHF2 68-86 MHz UHF 430-470 MHz
Power supply: AC 240V 50Hz. DC 12V (8 x "D" cells). Ext. DC 12V Car/Boat.
Speaker: 12.5cm Permanent Dynamic Speaker (3.2 ohm)
Antenna: Ferrite Bar Antenna for LW, MW and SW1
 3 x Telescopic Antenna for SW, VHF and UHF
Controls: Power ON-OFF switch - Digital display ON-OFF switch - Tape-Radio switch, Wide-Narrow band selector switch, AM band selector (LW/MW/SW1/SW2/SW3/SW4), VHF band selector (VHF1/VHF2/VHF3/VHF4/VHF5/UHF), Ant. Selector (Telescopic ANT./EXT. ANT.), Tuning control (direct gear drive), volume control, Bass control, Treble control, Squelch control, BFO pitch control, RF gain control, Antenna adjustor control, Mode switch (USB-NOR-LSB/CW)
Terminals: Ext. Speaker/Headphone Jack, Tape IN-OUT jack, VHF/UHF ANT. connector (coaxial), SW EXT. ANT. terminal (Screw), Ext. battery jack
Meter: Tuning Meter
Digital Frequency Counter Section:
Display: LW/MW/SW-1 KHz SW2-4/VHF1-5 MHz
Control: SW Calibrator Dimensions: 452mm (W) x 288mm (H) x 130mm (D)

ALTRONICS RESELLERS

Please note that resellers may not have all the items advertised in stock, and as resellers have to bear the cost of freight, prices may be slightly higher than advertised. ALTRONICS reseller prices should however represent a considerable saving over our competitors' prices.

SOUTH AUSTRALIA	QUEENSLAND
CITY ADN Electronics 212 5505 Protronics 212 3111	CITY Delsound P/L 279 6155
SUBURBAN PROSPECT Jensen Electronics 769 4744	SUBURBAN SALISBURY Colourview Wholesale 275 3188 FORTITUDE VALLEY St. Lucia Electronics 52 3547
ELIZABETH GROVE A.E. Cooling 255 2249	BIRKDALE Wholesale Sound Accessories 707 2502
CHRISTIES BEACH Force Electronics 382 3366	COUNTRY CAIRNS Thompson Instrument Services 51 2404
KESWICK Freeway Electric Wholesalers 297 2033	TOWNSVILLE Solia 72 2015
VICTORIA CITY All Electronic Components 662 3506 Eliatronics 602 3499	ROCKHAMPTON Purley Electronics 21058 GLADSTONE Purley Electronics 72 4321
SUBURBAN FOOTSCRAY Acorn Electronics 680 1911	GYMPIE TV and Appliance Services 82 1671
CHELTENHAM Talking Electronics 550 2386	IPSWICH P & S Electronics 281 8001
HUNTINGDALE Sewart Electronics 543 3733	TOWOOMBA Hunt's Electronics 32 9677 Down's Radio and TV 32 1044
SOUTH CROYDON Truscott Electronics 723 3860	NAMBOUR Nambour Electronics 41 1604
COUNTRY SHEPPARTON G.V. Electronics 21 8866	NT DARWIN Radio Danon 81 8508 Kent Electronics 81 4749 Ventronics 81 3491
MILDURA Electronic and Digital Services 23 3380	ALICE SPRINGS Farmer Electronics 52 2967 Aicom Electronics 52 1715
NEW SOUTH WALES CITY Radio Dispatch 211 0191 Electronic Agencies 29 2098 Jaycar 264 6688	TASMANIA HOBART Beta Electronics 34 8232
SUBURBAN LEWISHAM Radio Electronics 569 9770	KINGSTON Kingston Electronics 29 6802
CONCORD Electronic Agencies 745 3077	AVOCA Freeview TV 84 2166
DEE WHY David Ryall Electronics 982 7500	WEST AUSTRALIA ALBANY BF Electronics 41 2881
WAITARA Applied Technology 487 2711	GERALDTON Generation TV and Radio 21 2777
MATRAVILLE Creative Electronics 666 4000	WYALKATCHEM D & J Photo 81 1132
COUNTRY BROKEN HILL Crystal TV 4803	MANDURAH D & J Photo 35 3227
COFFS HARBOUR Coffs Harbour Electronics 52 5684	KALGOORLIE Today's Electronics 215 212
PENRITH Acorn Electronics 21 2409	ACT S & S Electronics 54 8334 Electronic Components 80 4654
NEWCASTLE D.G.E. Systems 69 1625	
WINDANG Marlene Electronics 36 5066	
GOSFORD Tomorrow's Electronics 24 7246	
KURRI KURRI Kurr Electronics 37 2181	

RESELLERS WANTED IN ALL AREAS (including WA)

Phone: STEVE WROBLEWSKI (09) 381 7233 for details

LABORATORY MULTIMETER 100K OHMS/VOLT CHECKS TRANSISTORS AND MEASURES CAPACITANCE

From Tokyo Laboratories, Japan

Remember the days when high grade precision laboratory multimeters were available only from UK and then they cost a King's Ransom?! - Well, that's history - The new Q 1040 is everything a high quality meter should be PLUS it checks transistor HFE and ICO and measures capacitors from 50 pf-50 UF.
 * 100K OHMS/Volt DC ranges * 8.5 uA movement * Fuse and diode movement protected * Inbuilt oscillator for capacitance measurement.
RANGES: DCV 250MV, 2.5V, 10V, 50V, 250V, 1000V. ACV 5V, 10V, 50V, 250V, 1000V (10K/V) DCA 10UA, 2.5MA, 25MA, 500MA, 10A ACA 10A Resistance x1, x10, x1K, x10K Transistors NPN/PNP HFE 0-1000 ICO 0-50UA Capacitors 50PF-3UF, .01UF-50UF.

Q 1040 Multimeter \$72.50

Q 1041 Carry Case \$14.50



VALUE & PERFORMANCE INSTRUMENTS FOR THE SERIOUS USER



Time proven under Australian conditions TRIO oscilloscopes represent the best value available. Performance and reliability to please you—and prices to keep you happy!

CS-1560 All 15 MHz Dual-trace, Triggered Sweep \$525



The most popular in the range!

- Sensitivity 10mV/Div. (Triggers at 0.5 Div. Typ.)
- CH1, CH2, DUAL, ADD, and SUB
- Risetime 23nS
- XY Mode
- Triggered Sweep and Auto
- Sweep Time 0.5µS/Div - 0.5S/Div and XY
- Price does not include probes.

NEW!

CS-2070 4 Channels, 8 Traces *\$1,595 70 MHz Only \$1,995



TREMENDOUS VALUE NEW RELEASE

A 70 MHz Scope for less than the price of many 50 MHz Scopes

Features include

- 4 Channel, 8 Trace display making use of alternating delayed sweep
- Dual sweep with completely independent A and B sweeps
- 1mV/Div sensitivity all the way to 70 MHz
- Sweep time to 5nS/Div for easy-viewing of fast signals
- Delayed sweep intensity control
- Bright, Clear CRT
- Price includes 2 probes.

B&K 820 Portable Capacitance Meter \$175



Simple to use and economical
Measures all the way up to 999.9 millifarads

- Resolves to 0.1pF
- 4 Digit easy-to-read LED display
- Special lead insertion jacks or banana jacks
- Fuse protected against charged capacitors
- Uses either rechargeable or disposable batteries
- Overrange indication

Model 88100 Greenpar Probes \$30



Precision built professional probes at a hobbyist price!

- Switched attenuation (10 1, 1 1)
- Bandwidth 100MHz (10 1), 10 MHz (1 1)
- Working Voltage 600V
- Standard BNC connector
- Complete earth lead and standard accessories

AG-202A Audio Oscillator from Trio \$149



Rugged, dependable audio oscillator for professional or hobbyist use — Outstanding Value!

- Frequency Range 20Hz to 200kHz
- Sine/Square Wave
- Output Voltage to 10V RMS
- Deviation within ±1dB
- Distortion Less Than 0.5%
- Compact and lightweight

Thurlby *\$349 1503 D.M.M. ~~\$395~~



* While Stocks Last

Better Performance at a Better Price.

- 4½ digits (±32,768 counts)
- 10µV, 10MΩ, 1nA resolution
- 0.05% basic DCV accuracy
- LCD display
- Fully field portable
- 7 functions including frequency
- 10MΩ / 1000MΩ input impedance
- Unique diode test facility

B & K LA1025 Logic Analyser \$2,680



Best of both worlds, both a logic and signature analyser

- DC to 20MHz
- 16 Channels (logic analysis) displayable on almost any scope
- 16 bit x 250 word memory
- 18 qualifiers
- 12 digit LED display
- TTL, MOS or CMOS operation
- Programmable trigger, clock and event delays
- Word recognition triggering of external equipment
- Integral display of four data formats.

All prices plus Sales Tax if applicable



PERFECTION IN MEASUREMENT

Sydney: 439 3288
Melbourne: 580 7444.

Available at a Leading Stockist near you

Modems: computing by telephone

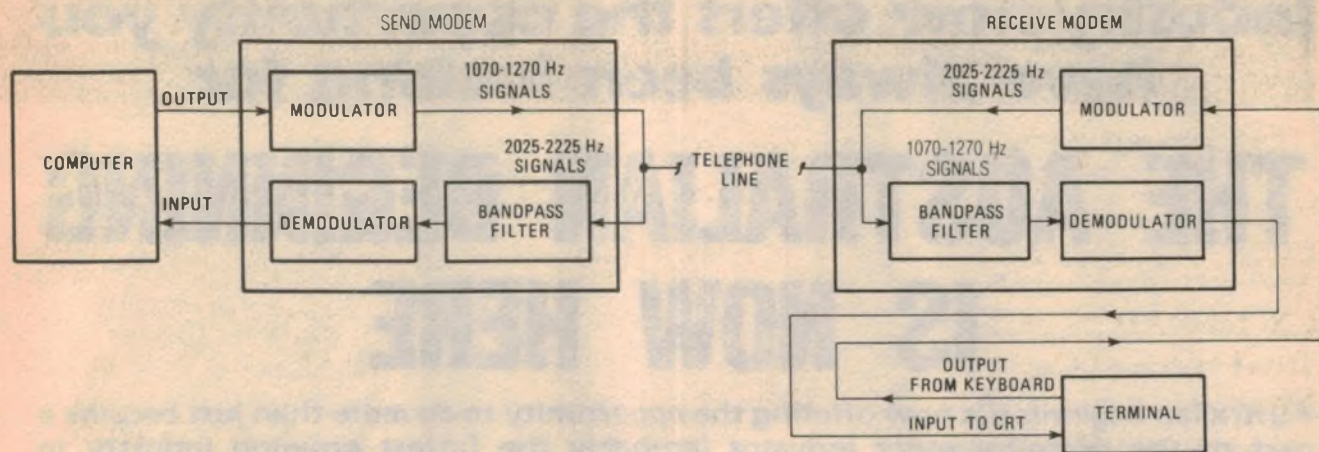

Fig. 9: A block diagram shows how a modem is used for bidirectional transmission in a full duplex system.

The frequency-shifted (or FSK) signals are then sent along the telephone lines to a distant location where a receive modem accepts the signals from the telephone line via a bandpass filter that passes signals in the range of 950-1200Hz and rejects all other frequencies. The 1180Hz tones are converted back to logic 0's and the 980Hz audio signals to logic 1's, restoring the original string of ASCII-coded pulses.

Now, the operator at the distant location may wish to send data or instructions back to the main computer to answer or respond. The keyboard output, in the form of ASCII-coded pulses, is fed to the modulator at the receiver modem where a logic 0 state generates a 1850Hz audio tone and a logic 1 develops a 1650Hz tone. Those audio signals are sent back, along the same telephone wires, to the main computer. At the main computer, a bandpass filter accepts the 1650Hz and 1850Hz signals and rejects other tones before they reach the demodulator. At the demodulator, the 1850Hz and 1650Hz tones are converted back to their logic 0's and logic 1's. Since two different sets of frequencies 980/1180Hz and 1650/1850Hz are used together, specially-designed bandpass filters are required to make the full-duplex system feasible using only one set of telephone lines.

Some modems on the market are available as originate only or answer only; although those units are less expensive than modems that include both originate and answer, they are obviously limited in performance.

An originate-only modem converts the logic 1's and 0's to the 980-1180Hz tones that are sent over the telephone lines. It cannot, however, receive tones in that frequency range. It can only receive the 1650-1850Hz tones. Therefore, two originate-only modems cannot talk to each other. Until recently this type of modem is the kind that you will probably use with your home computer to access dial-up data bases.

An answer-only modem converts logic 1's and 0's to the 1650/1850Hz tones, but it cannot receive these tones. It can only receive 980/1180Hz tones. Some answer-only modems have the capability to answer the telephone and connect the computer to the telephone line. A modem with answer and originate capabilities can both send and receive data on both tone pairs. That kind of modem can therefore, carry on a conversation with either an originate-only or an answer-only modem.

Synchronous vs asynchronous transmission

Data is in the form of a stream of logic 1's and 0's, representing letters, numbers, and symbols. As they are transmitted over the telephone lines, some method of

synchronisation – either synchronous or asynchronous – at the sending and receiving ends is required to maintain the bit code.

Asynchronous transmission involves defining the beginning and end of each individual character or 8-bit byte sent over the lines. The word asynchronous can be misleading since it implies no synchronisation. Actually, a begin and end (or start and stop) bit is inserted between each 8-bit word to synchronise the transmitter and receiver; a parity bit is included to detect errors.

Synchronous transmission does not involve individual timing signals for each character; instead, timing signals are provided for long, lengthy stretches or blocks of data flow. Thus, there are no start and stop bits between characters.

Binary data transmission may be expressed as one of two conditions, mark for a binary 1 and space as binary 0, shown in Fig. 10. In asynchronous transmission, the transmitter rises to a mark condition at the end of each byte and remains at that level until the next byte is heralded by a space; thus, the mark at the end of the byte is the stop bit and the space at the beginning of the byte is the start bit. Those two synchronisation bits permit the receiver at the end of the line to lock in or sync with the transmitter. However, an 8-bit byte requires an additional two bits to signal when a byte is arriving and is completed; those bits do not convey data and thus the system is relatively inefficient. The clock or timing signals at the transmitter and receiver are synchronised or locked each time a byte arrives; there may be lengthy periods (in the fast nanosecond world of computers) when bytes are not transmitted. However, as a new byte appears, synchronisation will again take place. Asynchronous transmission of the letter "R" with start, parity, and stop bits included, is shown in Fig. 10. If data bits could be sent in a continuous stream, efficiency would be increased. For high-speed data,

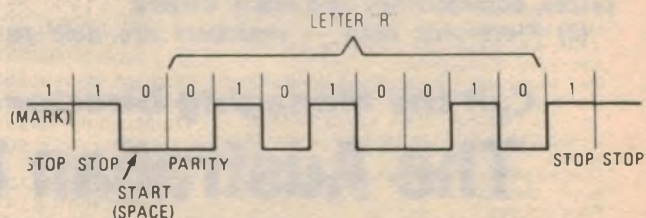

Fig. 10: Asynchronous transmission of the letter "R" in ASCII code with start, stop and parity bits.

Mr Businessman . . . the Micro-Computer industry now offers the opportunity you have always been looking for

THE AUSTRALIAN BEGINNING IS NOW HERE

Australian Beginning is now offering the opportunity to do more than just become a part of the micro-computer industry (probably the fastest growing industry in Australia). Australian Beginning now offers you the opportunity to become involved with micro-computer networking, which is considered by many to be the wave of the future in this industry.

The Australian Beginning is looking for an individual or groups of individuals in any of the following areas (WA, SA, QLD, NT, TAS, ACT) to work and develop the market for our revolutionary service in their respective areas.

The Australian Beginning is a computer network service which offers a wide range of services to its members.

Australian Beginning members can now have access to the computer services, data banks and large storage space previously only available to large computer installations. The era of the personal computer is now here, as now through The Australian Beginning any businessman or individual can now have on his desk for an extremely small cost, a system that has the level of storage power, computer services and data banks for which only a few years ago government departments and large private companies were paying millions of dollars for.

Australian Beginning can be accessed by virtually any micro-computer, word processor, or terminal over standard telephone lines. The services The Australian Beginning offers are:

(1) Information Services, members have access to a number of information services which include news, sports, weather, stock-exchange prices, commodities and many others.

(2) Electronic Mail — members are able to

communicate nationwide with other members through our systems.

(3) Software Bank — members have access to a myriad of computer programs that will include entertainment, education aids, programming and diagnostic tools, and financial applications.

(4) Large Computer Power — members have the capability to make use of the large computer's huge storage capacity by using any of our large programs on our system.

(5) Electronic Shopping — members can take advantage of our shopping by computer system to get the best prices of a number of popular business and consumer items.

(6) Telex — another interesting feature is that members can send telex messages through our system to any telex user and at the same time receive messages from other telex users.

The Australian Beginning service is both inexpensive and extremely easy to use. It represents what microcomputer revolution is all about; now that it is making computers both affordable and understandable.

The Australian beginning group has a very interesting proposal for local businessmen who would like to get in on the ground floor of the fastest growing industry in Australia. If you would like to team up with a group that many people feel represents one of the most aggressive and inventive marketing groups in Australia.

Call the Managing Director now before your area is taken

The Australian Beginning Pty Ltd

364 La Trobe Street, Melbourne, Victoria 3000

Phone (03) 329 7533

Modems: computing by telephone

synchronous transmission is used whereby the transmitter clock triggers the receiver clock and is allowed to run for a lengthy sequence of bytes or blocks of data. Bytes are transmitted in a rapid, steady stream; in the event that gaps occur in the data flow, the transmitter must inject idle-bytes to maintain synchronisation. The synchronous transmission system is initiated by a predetermined bit pattern or code sent by the transmitter.

Direct connect modems vs acoustic couplers

Modems are available either as direct connect or acoustic coupled types. The hard-wired units are connected to the telephone lines directly by means of a plug fitted into the telephone's wall jack. An acoustic coupler, shown in Fig. 11, is designed to accept the telephone handset physically; the analog/digital signals entering and leaving the telephone lines are fed to the modem through tight-fitting, soundproof rubber cups to reduce external noise that might enter and upset transmission. ASCII input (in serial form) from the computer is fed to the modulator which converts logic-0's and 1's to either of two tones. FSK audio signals are converted to logic-1's and 0's by the demodulator to reproduce the ASCII coded information.

In use, the rubber cups are tightly pressed against the mouthpiece and receiver of the telephone handset; the audio tones are then transmitted along the phone lines. Assuming that a full-duplex system is used, incoming audio tones reach the earpiece of the handset, which is closely coupled to a microphone. The two-tone FSK audio signals are converted to logic 1's and 0's by the demodulator to produce the ASCII coded information sent by the distant computer or terminal.

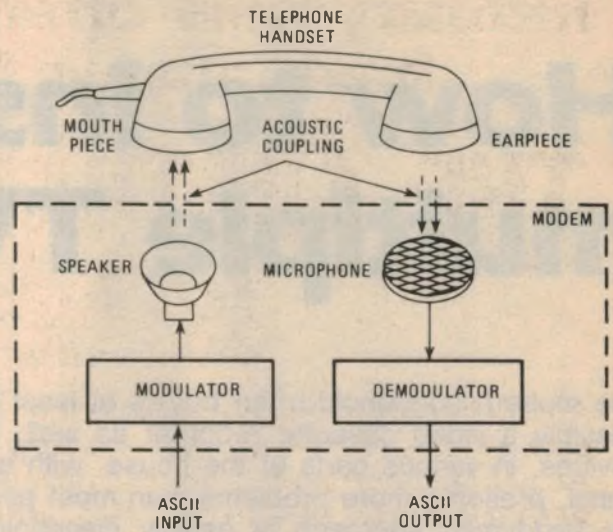

Fig. 11: An acoustic coupler accepts the telephone handset in rubber cups. They can be used with any telephone, but are susceptible to noise from external sources.

Until recently, direct connection modems were generally more expensive than acoustic coupled types; however the Dick Smith Electronics direct connect modem has reversed this relationship.

Reprinted by permission from *Radio Electronics*, October 1981. Copyright © Gernsback Publications Inc. 1981.

Listen. You need a 'Sendata' 700 Series Acoustic Coupler!

An easy solution to the complex problem of information gathering in the '80s...and there's one to suit your needs in bridging your communications gap.

SENDATA



Manufactured by
ELECTRO-MED
Electro-Medical Engineering Pty. Ltd.
Melbourne, Australia.
(03) 509 5844 (02) 439 5488

How to install multiple TV outlets

The modern household often boasts at least two TV sets, and possibly a video cassette recorder as well. Feeding all these devices, in various parts of the house, with a clean, strong TV signal, presents more problems than most people imagine, and the handyman approach is usually disappointing. This article discusses the problems and the practical solutions to them.

by JIM LAWLER *

When TV was introduced about 25 years ago few people had more than one TV set, and that usually lived permanently in the lounge room. Not until smaller, more portable sets became available did the need for two or more antenna outlets arise.

All sorts of signal dividers were in use, from simple parallel junctions to well designed signal splitters. With monochrome signals in ghost free locations almost anything worked, and most viewers were satisfied.

With the advent of colour TV, well designed and installed signal handling systems became essential. Systems that had passed monochrome signals without trouble still passed monochrome but not colour. Many people installed new antennas in the hope that this would cure their troubles. Most were disappointed. The faults lay in the connecting cables and had to be corrected before the system would work properly.

Recently, the introduction of video cassette recorders has led to a demand

for even more complex signal distribution systems. The purpose of this article is to uncover some of the mystery surrounding the handling of VHF TV signals.

If you have only one TV set, your system can be represented as in Fig. 1. The three elements are the antenna, feeder cable and the TV set. If these are well designed and carefully installed, the system must work wherever there is sufficient signal. When you add a VCR to this system, no changes are needed. The antenna feeds the VCR which in turn feeds the TV set, as in Fig. 2.

If you already have two sets working off the one antenna, as in Fig. 3, the addition of a VCR is simple enough while you are content to watch the VCR replay on only one of the TV sets. The antenna signal is split two ways in the two-way splitter and one of the splits goes to the VCR as in Fig. 4. The difficulty with this arrangement comes about when you wish to play the VCR through either TV set. One idea is to feed the VCR output back into the antenna socket, as shown by the dotted line in Fig. 4. This is a "brute force" method and relies on the VCR being able to overcome the cumulative losses in the splitter.

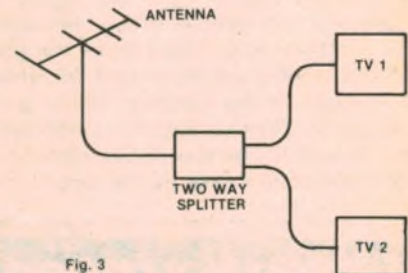

Fig. 3

A two way splitter is necessary to run two TV sets from a single antenna.

Better approach

A much better arrangement, although a more complicated one, is shown in Fig. 5. Here the VCR output is brought back to the antenna end of the system and mixed with the broadcast signals in a "combiner". The output of the combiner now contains all the available TV channels plus the VCR output and can be distributed as in the earlier examples.

Once the system reaches this degree of complexity a nasty gremlin called "loss" begins to make his presence felt. Each combiner and splitter takes a little energy out of the system and these losses accumulate. The result can be a weak, snowy picture. If time and energy are of no consequence, you can install the system and see if it works, but it's much easier to calculate the signal strength needed and to arrange an antenna capable of meeting the requirements.

Antenna signals are measured in microvolts (μV) and for a good, snow free picture most sets need about $1000\mu\text{V}$ at the antenna socket. To make the calculations easier, it's an advantage to convert the various voltages to

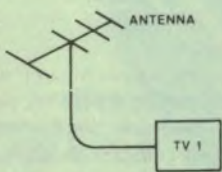

Fig. 1

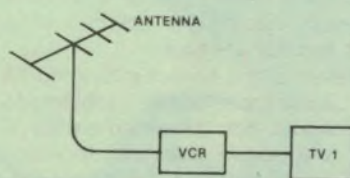

Fig. 2

Fig. 2 shows how a VCR is added to a system with a single outlet.

*Professional TV serviceman, Geilston Bay, Tasmania, 7015.

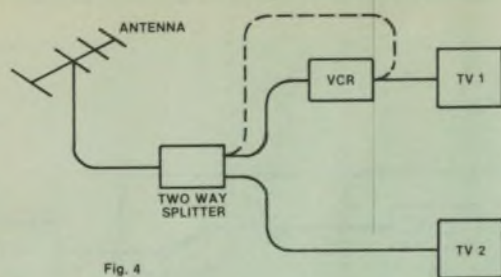

Fig. 4

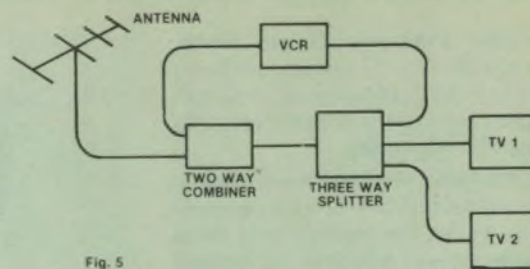

Fig. 5

How a VCR output can be made available to two TV sets. Fig. 5 is the preferred approach.

decibels (dB) above $1\mu\text{V}$. Losses are then simply subtracted from the antenna signal to arrive at the level delivered to the set. $1000\mu\text{V}$ represents 60dB so the antenna must deliver this level plus all the losses in the system.

Using Fig. 5 as an example of the calculations, it will be seen that the TV sets follow a three-way splitter. A typical three-way splitter has one leg of minus 3.5 dB and two legs of minus 7dB. The set connected to the minus 7dB leg still requires 60dB so the level into the splitter must be 67dB. The combiner is actually a splitter working back to front and its losses are the same in either direction. The average two-way splitter or combiner has a loss of 3.5dB on each leg so, if it is to deliver 67dB to the following splitter, its input from the antenna must be 70.5dB. If the antenna delivers more signal you have no worries. If less, you will need an antenna with higher gain.

The only way to ensure that the antenna is delivering enough signal is to measure the level with a signal strength meter. If you can't borrow one, it is a wise economy to pay an installer to measure your signals. Once you know the level available the rest of the system can be designed with confidence.

One point that must be mentioned here is the balance of signals. That is, all channels available to the antenna must deliver approximately the same signal level. A difference of 10dB is acceptable provided that no signal gives less than 60dB at the TV set.

Intermodulation

In locations where a distant station is available but at a low level, some amplification must be provided before the signals are combined and split. Fig. 6 shows how this can be done. With this system a serious problem can arise. In spite of the fact that the high gain antenna may be pointing well away from the direction of the local channels, there will still be considerable pickup of local signals on this antenna. This will be amplified by the masthead amplifier and will cause intermodulation of the various

signals in the system.

Intermodulation causes two distorted pictures to appear at the same time, often with a vertical black bar moving across the screen. It's a nasty problem and can only be prevented by keeping the high level local signals out of the amplifier. This is done by using a masthead amplifier designed for the channel of interest only, with heavy attenuation of all other frequencies. These are available to order and cost only a few dollars more than a conventional broadband amplifier.

At this point a few words about how a VCR handles TV signals is in order. Fig. 7 shows the internal arrangement of a typical VCR. The signal enters from the antenna and is passed through a broadband amplifier. This is provided to make up for the losses in the next stage, a two-way splitter. One split goes direct to the changeover switch on the VCR's RF outlet. The other goes through the VCR's signal processing circuits, then to the VHF or UHF modulator and onto the

external trap will be required to reduce the offending signal.

Fortunately, the offending signal is usually Channel 2 and ready made traps are available to cut this back to manageable levels. If one of the other channels is causing the problem, it will be necessary to have a trap specially made. The signal level measurements mentioned earlier will be a big help in specifying the attenuation, in dB, needed to bring the offending level back to balance with the other channels.

Getting complicated

Finally, there is the system shown in Fig. 8. This is about the biggest domestic installation imaginable and combines two separate systems at my home and backyard workshop. The input accepts local TV, VCR, and pattern generator signals. A three-way splitter after the combiner feeds two dual outlets on the service bench and a long trunk up to the house. There, a two-way splitter and a dual outlet feeds two TV sets and the

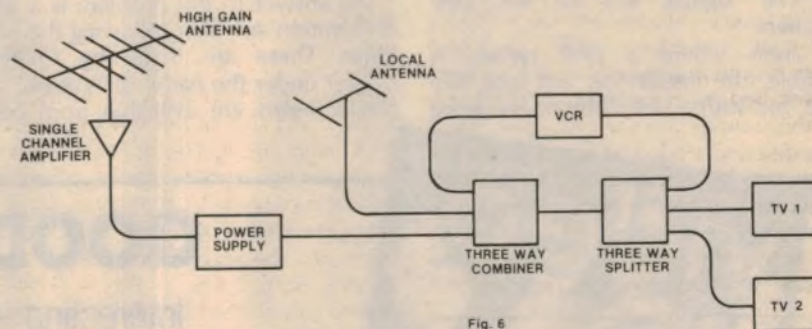

Fig. 6

This arrangement accommodates two antennas, a VCR and two TV sets.

changeover switch. This arrangement allows you to watch one channel while the VCR records another.

The presence of a broadband amplifier in the VCR can cause similar problems to the intermodulation discussed earlier. If one of the local channels is much stronger than the others it can cause intermodulation in the VCR. This is rather harder to deal with than the antenna problem. It isn't possible to modify the VCR's internal amplifier, so some sort of

VCR. To complete the system, the VCR feeds a trunk line back to the combiner in the workshop.

Needless to say, a system such as this is very lossy and needs a healthy signal into the head end to make everything work. It also introduces another source of losses that hasn't been mentioned yet. Coaxial cable has a built in loss of about seven to 12dB per 100 metres at 200MHz. Thus my 25 metre trunk lines adds a 3dB loss to those introduced by

the combiner and splitters. In any design, a cable run of up to 10 metres can be ignored, but if the system has to feed sets at opposite ends of the house then cable losses can be important.

Up to this point we have been discussing systems for the VHF service on channels 0 to 11. At the present time there are UHF services in Adelaide, Melbourne and Sydney only, and a few other translators in some difficult locations. Also, there are some VCRs that output a signal on the UHF band. There are no UHF services in my location, so I have no direct experience of handling these signals. Nevertheless, good VHF practice will apply directly to UHF provided certain precautions are taken.

Firstly, all terminations must be perfect. A loose screw might pass VHF but not UHF. Splitters and combiners should be screwed up firmly then finished with a touch of solder. And they must be suitable for UHF. Most brands on the market now are designed for both bands and should work well, but older units designed in the days of monochrome TV are probably quite unsuited to UHF. Another cause of serious losses is in the cable itself. Coax losses increase as the frequency goes up, and UHF is up a long way. Cable runs should be kept as short as possible and if a long run is necessary, an amplifier will be required.

If a system is working well on VHF, the introduction of an amplifier to lift the UHF signals may cause intermodulation of the lower bands. Remember what has been said about balancing the available signals. Success will depend on keeping the VHF signals out of the UHF amplifiers.

In areas where a UHF service is available, the installation will look like Fig. 6, but with a UHF antenna replacing

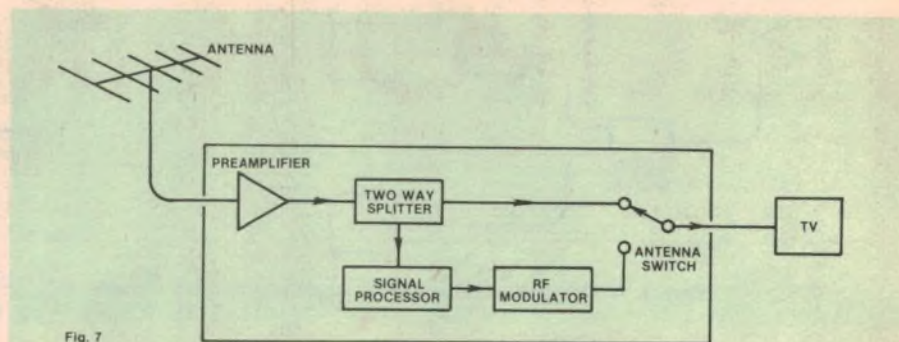

Fig. 7

Fig. 7: internal arrangement of a typical VCR.

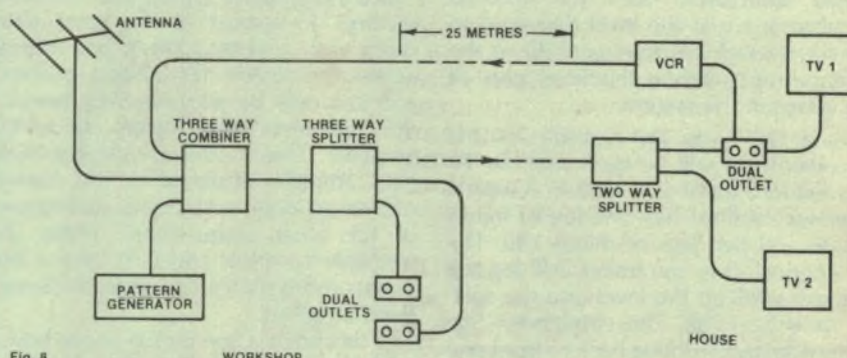

Fig. 8

Fig. 8: this system provides multiple TV outlets for the home and workshop.

the high gain antenna and single channel amplifier. If you also get a distant channel the front end can become very busy. A four-way combiner will be needed to mix all the signals and these items are very lossy.

The answer to this problem is a small distribution amplifier following the combiner. These are made by Channel-Master under the name of "Vutron" and similar items are available from other

manufacturers. The Vutron has a gain of about 12dB and this is just enough to overcome the losses in the combiner and splitter.

Having got all this gear installed and working, here is a word of warning. Don't play your R-rated cassettes when your mother-in-law is staying with you. The VCR output appears at every TV set, and Ma-in-law might not appreciate R-rated movies in her bedroom.

GOOD READING

Interesting — relaxing — informative
Brought to you by the same team that
produces "Electronics Australia"

IN THIS ISSUE

- Henry Fonda — a legendary film career.
- Pam Ayres on video cassette.
- High definition television.
- Review National's NV300 VCR.
- Medical cassette listing.
- Review current video cassettes — and much more.

ON SALE AT YOUR NEWSAGENT NOW



BILL EDGE'S

ELECTRONIC AGENCIES

115-117 Parramatta Rd. Concord 2137
(Corner Parramatta Rd & Lloyd George Ave)
Telephone (02) 745 3077 (two lines)
117 York St. Sydney Phone 29 2098

Mail Orders:
PO Box 185
Concord
2137

NSW & ACT ONLY	VIC SA QLD TAS WA NT
\$1 - \$ 9.99 \$150	\$1 - \$ 9.99 \$250
\$10 - \$24.99 \$250	\$10 - \$24.99 \$400
\$25 - \$49.99 \$350	\$25 - \$49.99 \$500
\$50 - \$99.99 \$450	\$50 - \$99.99 \$600
\$100 or more \$550	\$100 or more \$750



TRADING HOURS
BOTH STORES
Mon-Fri 9 am-5:30 pm
Thursday 9 am-8 pm
Saturday 9 am-12 pm

★ **What else do we carry? HI-FI ★ KITS ★ TEST EQUIPMENT ★ SEMICONDUCTORS ★ COMPONENTS ★**

All prices correct and goods in stock at time of going to press. Please phone to check current availability.



POWER UP.

Switch all your HiFi equipment on with the flick of one switch. Just unplug your power leads from your Tuner, Amplifier, Equalizer, Cassette Deck, etc and plug them into the Power Up and Whammo, by switching off your Amplifier, you switch the power off on everything else.

KE1940 Complet Kit

See EA Nov 82. **\$39.50.**

NEW

1/2 PRICE DOME MIDRANGE. PHILIPS ADO210/SQ8

BUY TWO FOR THE PRICE OF ONE. CE2082 WAS \$32.00

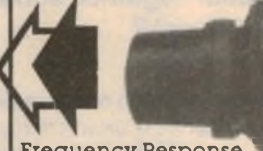

Frequency Response 550-5 KHz
Resonant Frequency 350 Hz
SPL 89 db lw/lmt
50mm dome
60 watt RMS handling
Very low distortion

NOW ONLY \$16.00.

ET15000 1/3 OCTAVE GRAPHIC EQUALIZER KIT

NEW



Absolutely complete kit which includes pre punched chassis, all IC sockets, metal film resistors, and all the quality components you would expect from an Electronic Agencies kit.

See ETI Nov 82.
KE5060 **\$199.00**
or two for **\$389.00**

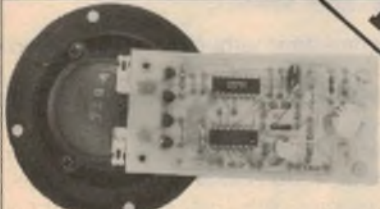

SUPER SIREN.

Ultra loud (over 100db) alarm beeper device built around a Motorola Piezo tweeter.

Complete kit including piezo tweeter KE1055

See EA Nov 82. **\$22.00.**

NEW



PHILIPS ETI4000/1

Speakers and crossovers only **\$449.00** pair

CE2430 **Save \$50**

Comet freight \$12

Speakers, Crossovers and Cabinets together only **\$679**

Save \$100.00

Comet freight \$25.

Cabinets are pre built with real wood veneer.

FREE for the asking this month only Bill Edges Kit Constructors manual. Pick one up free from our stores, or ask us to put one in your mail order. Please add 40c postage if you only require a manual.

This manual is ideal for beginners in electronics or as a handy guide for the more experienced.



PIONEER GUITAR SPEAKER

Far more watts for your dollar.



40oz Ferrite Magnet
Nominal Impedance 8 OHM
Voice Coil Dia 1 1/2 (inch)
Power Rating 100 WATT (RMS)
Nominal Resonant Freq (fo) 80 Hz
Nominal Sensitivity 100 (dB/W)
Response Range 10 - 6,000 Hz
Total Flux 108,000 MAXWELL
Flux Density 11,000 GAUSS
Net Weight 3.520 (124.2) gr (oz)

CE2380 **\$49.50 ea.**

LIMITED QUANTITY.

PLESSEY 12" WOOFER.

This price can never be repeated.

90 watt handling, about 50w RMS

Foam rubber surround beautiful white cone

Freq response 10-3500 hz

SPL 92 db lw/lmt

CE2140 Res. freq 25 hz

ONLY \$25.00 each



SUPER TWEETER

Available again for a limited period. Plessey HO16N17 Horn Power 50 watts RMS Freq resp 5K-40 KHZ SPL 96 db lw/lmt



CE2016 STILL ONLY **\$18.00 ea**

PHILIPS CONE TWEETER.

LESS THAN 1/2 PRICE AD2273/T8

CE2005

\$2.99 each

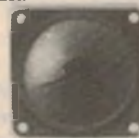

MAGNAVOX 8MV Mk 2

(Updated 8.30)

40 watts

RMS handling

CE2113 **\$34.50.**



ALL PRINTED CIRCUIT BOARDS FOR ELECTRONICS AUSTRALIA AND ELECTRONICS TODAY KEPT IN STOCK IN BOTH STORES BACK TO 1975.



FORUM

Conducted by Neville Williams

Tracking, thorn needles and assorted topics

Getting caught up in major themes, in these columns, has one inevitable result: smaller items tend to get passed over. So, in this issue, and perhaps the next, I plan to gather together some of the "loose ends". For starters, what about a limerick?

"Why a limerick?" you may ask.

For no other reason than, while sorting through the files, I came across a couple of pages from the January 1972 issue of "Hi-Fi News and Record Review", carrying the results of a limerick competition.

Some of the entries were "R-rated", or at least NRC but, having in mind past discussion about the dynamic range of recordings, trackability, etc, this one from a certain R. Mackenzie, seemed appropriate:

*A stylus was told by a platter
To follow the groove and not chatter.
Came back the reply:
"I really would try,
"If only the platter were flatter!"*

While we did have a fair bit to say about groove tracking, as recently as in the last issue, we have tended to "cool" prolonged debate on the two closely allied subjects — extended dynamic range and digital recording.

If not suitably inhibited, discussion of these topics can proceed at great length and with almost evangelical fervour — becoming tedious in the process.

WHY ALL THE FUSS?

By contrast, some choose to push aside all the ifs and buts, proceeding to a conclusion which may be as simplistic as it is summary. Take, for example, the following letter:

Re Forum articles on digital recording (Nov '81 and Jan '82). I agree that some of Douglas Sax's claims seem to be outlandish and to lack justification.

But aren't we getting away from the important issue, the end product of all this technical, theoretical debate — the record?

I challenge anyone to find a better recording, regardless of price, in either

digital or analog format in terms of depth of detail, clarity, lack of surface noise, imaging, than the Sheffield Lab Analog series.

Surely this indicates that both conventional analog and digital records have room for improvement!

R. D. (Christies Beach, SA)

Simplistic? Summary?

The points which R. D. seems to be making might be summarised as follows:

- Argument about analog v digital is a waste of time. The Sheffield Lab series shows what can be achieved with conventional technology, given sufficient dedication.

- If other companies want to improve their product, what they need to do is to emulate Sheffield Labs.

The observations seemingly ignore the fact that the Sheffield Lab series is a relatively limited, hand-picked issue.

The criteria which are responsible for their claimed excellence may simply not be applicable over the broad spectrum of the artists, the venues, the occasions and the performances which have to be captured on record. All these can — and do — impose their own constraints, compromises and methods.

I'd prefer to express it this way:

The most meritorious recordings are not distinguished by one particular label or one particular combination of technology.

They are recordings in which there has occurred a coincidence of a top-line performance, a sympathetic acoustic environment, an excellent (even fortuitous microphone) placement, compatible levels and dynamic range, and so on right through to the final over-the-counter pressing.

The recordings that so qualify may hap-

pen to have a predominance of certain labels and certain technological approaches, but there will be plenty of exceptions. What's more, a label/engineer/technology that excels in one area of recording may be quite ordinary in another.

I agree with R.D. that one cannot logically argue the merit of recordings on the basis of analog v digital.

But I would contest any possible inference (I did not say implication) that Sheffield has a monopoly of recording wisdom.

Perhaps we could round this off with another limerick:

*Some treat sampled sound with great
caution,
Lest waveshapes get out of proportion.
And some tend to sneer
At what they can't hear
And at non-existent distortion!*

GOLDRING MEMORIES

At the risk of getting stuck on the groove, I would like to include a couple of other "loose ends" to do with the subject of phono pickups. The first is by way of an interview with Gerry Sharp, the present Managing Director of Goldring (UK) published in a recent issue of "Gramophone" magazine.

He reminisces about his grandfather and great-uncle (the family name was then Scharf) who moved from their native Czechoslovakia to Berlin and entered the gramophone industry in 1906.

In 1933, Gerry Sharp's father and his uncle Fred Scharf moved to Britain and carried on the business from there. (It was Fred Scharf who later set up home in Australia and established a local branch of the British company).

During the interview, Gerry Sharp mentioned some of the matters to which I referred in last month's Audio-Video pages.

He quotes the tracking weight of one particular Goldring acoustic soundbox as four ounces or 113 grams — 75 to 100 times the tracking weight of a modern cartridge!

And he states that production of Goldring acoustic soundboxes continued right up to 1955. As we observed, last month: "... the shadow of the acoustic phonograph remained on the disc record industry right through until after World War II."

On the subject of phono cartridges, Gerry Sharp recalls the company's efforts with the magnetic principle (Oct issue, p37) and says of the first 700-series stereo cartridge: "... not a great success". It certainly wasn't and remains in my memory as the one cartridge which had a negative stereo separation characteristic. Towards the high frequency end, the left/right outputs actually crossed over!

Fortunately, Goldring have learned a great deal since then and their latest top-line cartridge not only has excellent performance figures but is so light that weight needs to be added to the headshell to allow it to be used in some arms.

THORN NEEDLES

The other item to do with phono cartridges also turns back the clock by 40 years or more, to the era when audiophiles used to argue the merits or otherwise of playing their beloved records with needles contrived from natural thorns. The following letter carries its own message, for which we thank the writer:

Dear Sir,

I wrote to you some months ago, asking if the Editor-in-Chief could remember the type of cactus plant which was used to make the "thorn" needles which we once used to play the old 78rpm phonograph records.

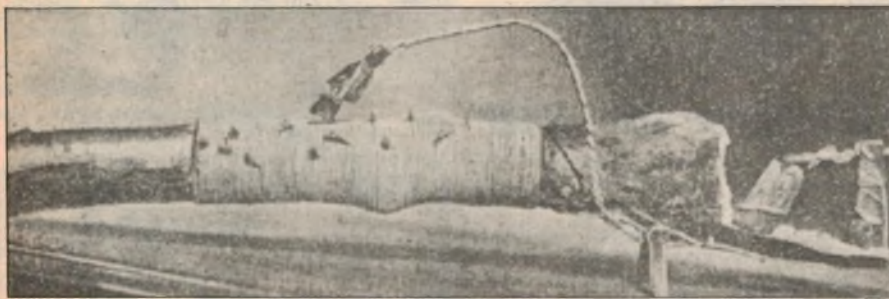

In 1929, Mr C. Snelling built a crystal set on a piece of a plum branch. In 1982, they're accommodating receiver circuits on a single chip!

You may be interested to know that I now have the information that I was seeking. I paid a visit to a cactus nursery at Galston, Sydney, and found the lady there both interested and helpful. She had heard of thorn needles but had not associated them with cactus thorns.

After examining a few original thorn needles which I still had, she named two species which she thought would be the most likely to bear suitable spikes: one was the AGAVE, the other a MYRTILLOCACTUS.

The Myrtillocactus proved to be the more suitable of the two, as its thorns were the correct diameter for needles and had only to be cut to length and sharpened. It is possible to get three needles from one long thorn.

I remember hearing once that the needles (or thorns) were oiled as part of their manufacturing process. This may have been done to relieve the thorn of any brittleness and tendency to fracture. It could possibly provide some lubrication, as well, and reduce record noise still further. A vegetable oil seemed to be the logical choice and, having some linseed oil on hand, I tried that.

After a week or so of experimenting, I was satisfied that the needles I had made were entirely satisfactory and sounded quite the equal of my old remaining bought ones.

So, I returned to the nursery and bought a mature Myrtillocactus (about eight years old and one metre tall) which could be expected to have suitably hard spikes. So I am now the owner of my own private thorn needle manufacturing plant!

You may care to publish this letter, as it may interest those readers who, like myself, have a few old records that they might like to play on suitable occasions. The thorns are quieter than steel needles and can be resharpened. As such, they're a better proposition than spoiling the tip of a "permanent" stylus on a faulty disc. Save your permanent stylus for playing discs with a good surface.

R. O'D (Epping, NSW)

That letter stirs memories of the period when thorn needles were an everyday option for playing records. At that time, I, too, had my own cactus and a

miniature grinding-wheel sharpener made out of sheet brass and Meccano gears.

Growing happily in one corner of the back lawn, my cactus plant was the centre of considerable interest and comment. But then, as it grew from a spiny sprig to around three metres, sprouting arms on the way, it became quite a hazard to frolicking children!

If you're ever looking for an interesting odd job, try cutting down, sawing up and disposing of an oversize cactus, com-

JIL SX-200, A BETTER SCANNING MONITOR RECEIVER.

Covers 26-88 MHz & 108-180 MHz
& 380-514 MHz



Monitors over 33,000 frequencies from 26 to 88 MHz, 108 to 180 MHz and 380 to 514 MHz. Bands included within this range are HF and UHF CB, 27 and 155 MHz MARINE, Australian LOW BAND, AIRCRAFT band, VHF SATELLITE band, 10 Mx, 6 Mx, 2 Mx and 70CMx AMATEUR BANDS, VHF High BAND as well as UHF two-way band.

Mechanically rugged the SX-200 uses high quality double-side Epoxy-Glass printed circuit boards throughout. Some of its other outstanding features include 3 MODE SQUELCH circuitry which allows the lockout of spurious and carrier only signals, extremely low spurious count, AM and FM detection on all bands, FINE TUNING control for off channel stations, 240 VAC on 12 Volt DC operation, Accurate QUARTZ CLOCK, Squelch operated OUTPUT for switching a tape recorder etc, 16 Memory channels, MEMORY BACKUP which lasts up to two years, high SENSITIVITY and SIGNAL-TO-NOISE ratio on all bands, CRYSTAL FILTER for excellent SELECTIVITY and easy serviceability due to component layout as well as a 90 day warranty.

Its high quality and performance is testified by the fact that it is in use by a large number of State government and Federal bodies including most state and federal police departments.

Contact GFS, the Australian Distributors, or our interstate outlets for full technical specifications.

We also market a range of pocket scanning receivers and transceivers. Contact us for full details.

PRICE \$512 INCL S.T. + \$8 P&P
SERVICE MANUAL \$10 + \$1 P&P
SCAN-X BASE ANTENNA \$48 + \$8 P&P

Interstate Dealers:
WA: (09) 387 4966
NSW: (02) 211 0531
QLD: (07) 397 0808
SA: (08) 269 4744

GFS Electronic Imports

15 McKeon Road
Mitcham, 3132 Vic
TLX 38053 GFS
(03) 873 3939

**YOU'D BE
CRAZY TO BUY
JUST A TV
GAME!**



**OUR MOST
POPULAR VIDEO
GAME**

**before you see
the amazing
DICK SMITH**

WIZZARD

**the
Home
Entertainment
Computer
that's years ahead!**

Yes — an absolutely up-to-date design. Most of the TV game consoles around were designed at least 2 years ago. And in electronics, that's an eternity!

Compare the quality

Amazing picture quality with over 49,000 dots — over twice as good as the largest selling TV game. You'll be amazed at the clarity, the detail — just like the screens NASA use in the space shuttle!



Space age Controllers



**GREAT FEATURES —
GREAT PRICE!**

Not just simple sticks: full space-age guiding devices with 48 keys as well. You get incredible control capability — far more than possible with other games. And slide-in overlays for controllers: you can see exactly what to do! When the controllers are placed in the console, they form a standard typewriter-style 'QWERTY' keyboard — that's versatility!

Fantastic game Cartridges

21st century games — like you've never played before. And every cartridge has many games — up to 32 in each! You'll never be satisfied with anything less after playing the WIZZARD.

Every cartridge has a built-in demonstration program to show you how to play the game. And plays music, too — it's that advanced!



Compare the price

The best part of all: the Dick Smith WIZZARD is around \$200 cheaper than the closest comparable computer! Yes, you not only save a fortune by buying the Dick Smith WIZZARD — you get much greater flexibility and enjoyment!



FREE
GAME CARTRIDGE
WORTH
\$39.95

**SUPPLIED
WITH
WIZZARD**

7 Day Trial Offer

if you're not completely happy, you can return the WIZZARD within 7 days in original condition and packing for a full refund. You owe nothing — not even an explanation. So why not try the WIZZARD, today!

★★★★★★★★★★★★★★★★★★★★

The one with the inbuilt personal computer

★★★★★★★★★★★★★★★★★★★★

The Dick Smith WIZZARD has an inbuilt personal computer facility! Just plug in the optional 'BASIC' cartridge and the WIZZARD becomes a powerful personal computer, complete with 17K of memory (that's more than you get with many personal computers! Learn how to run your own programs. Finance, homework, anything! —



'BASIC' CARTRIDGE
Cat. Y-1605 **\$69.50** Available soon — watch our ads for details!

DICK SMITH WIZZARD
\$6.85 weekly over 12 mths to approved customers
Cat. Y-1600 **ONLY \$295**

Great range of cartridges!

- Tank Attack (Cat. Y-1610)
- Wimbledon Tennis (Cat. Y-1620)
- Auto Chase (Cat. Y-1630)
- Plant Defender (Cat. Y-1650)
- Air/Sea Attack (Cat. Y-1660)
- Skiing cartridge available soon (Cat. Y-1670)

All \$39.95 each

DICK SMITH Electronics

See page 98 for address details



Mail Order Centre: PO Box 321, North Ryde 2113
Phone: (02) 888 3200

pletely covered by 3-4cm, needle-sharp spines.

Mr R. O'D of Epping may have a job ahead of him, in a few years time!

Still with a sense of history, but right away from phono records, a couple of reader's letters reach back into the '20s and '30s.

Prompted by an article in our April issue, G. Snelling of Granville, NSW, searched through his family relics and penned the following letter:

Recently you published information about crystal sets.

I have enclosed a "photocopy" of the Daily Telegraph Pictorial, dated May 2, 1929, showing the front page depicting "Freak Radio Sets at the Town Hall Exhibition."

My father, who was 18 at the time, won 2nd Prize with a crystal set made from a branch of an old plum tree.

He won 2nd Prize for the "Most Novel Crystal Set", and 1st Prize for the Best Crystal Set.

At that time, he was a member of the Granville and District Radio Club.

I still have the "Plum tree branch" crystal set and also a copy of the Newspaper's front page, which is a bit yellowed with age.

Trusting the above information may be of interest to you.

G. Snelling (Granville, NSW)

The occasion was identified by the Daily Telegraph Pictorial as the 1920 Radio and Electrical Exhibition. Apparently, the best that the industry had to offer was on show but the freak crystal sets took the

photographer's eye, sufficient to win front-page display.

Pictured were crystal sets built into an upright telephone (1st prize, T. Cleverley); on to a plum tree branch (C. Snelling); into a dolls' house (A. Keough); and into an old boot (W. Hawkins).

Quite a feat, that last one!

Another reader, from Kingsford, NSW, is also keen to document the activities of his father, this time in connection with amateur band television in the '30s. His letter is accompanied by a copy of a QSL card, as pictured below, itself an interesting item:

I would like to relate the experiences of my late father, Richard Ernest Smith, with radio and television from 1920 to 1940.

In March, 1933 we received television pictures from experimental television station VK2KI — A. V. Pickering, Blair St, North Bondi. The pictures were received in black and white using the scanning disc driven by 1000rpm home-made synchronous motor. The light waves were transmitted through a neon lamp, then white frosted glass, and magnified with a 4-inch diameter lens.

The pictures were transmitted from Blair St, North Bondi to 289 Darley Rd, Randwick. My father was a member of the Waverley Radio Club, along with Gordon Wells and A. V. Pickering. He also gave lectures at the club. One I can bring to mind was electric accumulators using Vegemite jars as cell containers.

The Technological Museum in Harris St, Ultimo has the motor and other parts of the television set used on this occasion.

P. E. Smith (Kingsford, NSW)

Beeforth On Oscilloscopes



If you have anything to do with electronics then I bet you can think of many jobs where an oscilloscope isn't useful. I guess it all comes about from the old adage 'a picture is worth a thousand words'. Now, in less than a thousand words, I'll put you in the picture regarding TRIO's CS-1560All oscilloscope.

The 1560All is a dual trace, 15MHz, honest-to-goodness value for dollar instrument. It is well suited to industrial applications, TV servicing, production line testing, educational or hobby work. It is rugged, reliable, easy to use and very portable. Vertical sensitivity is good without sacrificing large signal input capability. Sweep rates are from a high 0.5µS to 0.5S per division and a high persistence P7 Phosphor is now available as an option to make full use of the slowest ranges.

Triggering can be normal or via a video sync separator and has to be the best in any low-cost oscilloscope ever made. How often have you used a big name, high performance oscilloscope for routine work and been driven mad by the constant fiddling needed to maintain a stable triggered display particularly when the input is variable. With one wave of a CS-1560All the problem vanishes. Up to its rated 3db point of 15MHz it will produce a locked display with only 0.2 of a division deflection amplitude. At 20MHz it requires only 0.3 of a division to lock and at 25MHz, 0.7 of a division. That is real triggering!

Along with the rest of TRIO's range, this instrument is slanted toward useability, the kind of convenience and practicability that makes you reach past the 'Gee wizz technoscope' to grab the little TRIO with the sharp, stable, bright blue trace that shows the whole picture quicker than I can tell it.

The best way to see why I'm so keen on the CS-1560All is to check it out for yourself at any Parameters location or stockist right throughout Australia.

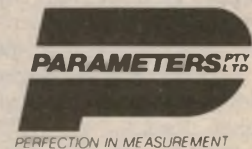

Trade Enquiries Sydney (02) 439 3288
Melbourne (03) 580 7444

Adelaide	PROTRONICS TRIO ELECTRIX K D FISHER & CO	(08) 212 3111 (08) 51 6718 (08) 277 3288
Brisbane	ST LUCIA ELECTRONICS	(07) 52 3547
Canberra	GEORGE BROWN & CO ORTEX	(062) 80 4355 (062) 82 4995
Hobart	IMBROS GEORGE HARVEY ELECTRIC	(002) 34 9899 (002) 34 2233
Launceston	GEORGE HARVEY ELECTRIC	(003) 31 6533 (03) 329 7888
Melbourne	RADIO PARTS GROUP GEORGE BROWN & CO ELLISTRONICS	(03) 419 3355 (03) 602 3282
Newcastle	D G E SYSTEMS GEORGE BROWN (NEWCASTLE)	(049) 69 6399 (049) 325 5277 (09) 362 1044
Perth	W J MONCREIFF CO PROTRONICS	(09) 2 1058 (02) 519 5855
Rockhampton	PURELY ELECTRONICS	(02) 29 6601
Sydney	GEORGE BROWN & CO DAVID REID ELECTRONICS RADIO DESPATCH SERVICE	(02) 211 0191 (077) 79 8600 (042) 29 1455
Townsville	NORTEK	(077) 79 8600
Wollongong	MACELEC	(042) 29 1455

LISTEN FOR MY SIGS ON 136.36 M.SKED

Experimental Television Station
Q.R.A. A. V. PICKERING "OCEAN VIEW" BLAIR STREET
NTH BONDJ SYDNEY, N.S.W. AUSTRALIA.

XMITTER
STGE C C LOW PWR MOD
QRH TELEVISION 136.36M
QRH FONE
ANT. *Antenna*
PWR. *25-50W*

V K 2 K I

TO RADIO
QSA.....R.....
A.M.
P.M. SMT
22 March 1933

QSB.....QRN.....QRM.....

RECEIVER
REMARKS *Thanks for tests
Hope to send more pictures soon*

P.S.L. Q.S.L. O.M. 73 *W. Pickering* O.P. OWNER

I LISTEN ON 80M AT ALL TIMES FOR Q.S.O.s

While John Logie Baird in England was doing a lot of pioneering work on television, Radio amateurs in Australia were following hard on his heels. This card, verifying reception of experimental TV transmissions, is dated March 22, 1933.

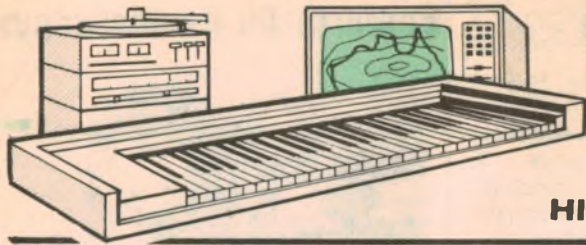

Audio-video Electronics

HIFI • HOME VIDEO • PROFESSIONAL AUDIO

TV Stereo Sound: on-air tests in Australia

Stereo sound for TV is very much in the news these days, particularly in Japan, the USA, and Europe. There are no less than four different systems currently in operation, more or less experimentally, in these countries. Australia has not made any official moves in this direction yet, but one TV channel is showing an interest.

by PHILIP WATSON

One of the systems, developed in Germany, and the subject of this article, is currently being investigated in Australia. Sydney's TV station channel 9 (TCN) has been conducting experimental transmissions, under special licence, since July of this year.

In the United States the FCC has had three of the proposed systems under review for some time, with a view to nominating a US standard. One is Japanese and two are American. The Japanese system, sometimes known as the EIAJ system, uses a 31.47kHz FM sub-carrier superimposed on the normal TV sound carrier. The normal sound channel carries an L+R signal, and the sub-carrier an L-R signal.

One American system, the Telesonics system, uses a double sideband suppressed carrier AM sub-carrier, which carries the L-R signal. The other American system, the Zenith system, is similar in most respects, the main difference being in the choice of pilot signal frequency, which both systems need to restore the suppressed carrier at the receiving end.

The German system appears to have a number of advantages over these systems and a brief description of how it operates should interest readers.

Rather strangely, perhaps, the stimulus for the development of TV stereo systems was as much the language problems encountered in many countries, particularly Japan and Europe, as the straightout stereo requirement.

Films made in other languages, and intended for showing in these countries, have new dialogue dubbed in to suit the country of destination. However, where the population is mix-

ed, many viewers can understand, and would prefer to hear, the original dialogue.

So, if two channels are available, one can carry the dubbed dialogue and the other the original sound track, or even a second dubbed track where this may be appropriate.

The German system is a relative latecomer. It was introduced at the International Radio Exhibition, in Berlin, in September 1981. Prior to that, one German TV network had been transmitting stereo sound, on an experimental basis, using the Japanese system.

The new system was developed, in

The channel spacing used in continental Europe is identical with that used in Australia, making this system particularly attractive for this country. The original sound channel is spaced 5.5MHz from the vision carrier, producing a 5.5MHz IF sound signal in the receiver. The new sound carrier is 5.742MHz from the vision carrier, producing a 5.742MHz IF in the receiver.

The separation between these two sound channels, 242.1875kHz, is an odd multiple of half the horizontal line frequency, to minimise interference to the vision signal.

The original sound carrier normally runs some 13dB lower than the vision carrier, and the new carrier is lower again by a further 7dB. This is to minimise any risk of adjacent channel interference. In spite of this reduction the second channel performance is still satisfactory in fringe area reception conditions.

Apart from the reduced power, both channels are given identical

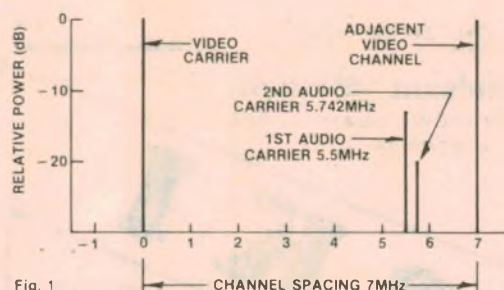

Fig. 1

In Germany, video carriers in adjacent TV channels are separated by 7MHz — the same figure as in Australia. The new German system for stereo TV sound adds an additional sound carrier as shown, involving double intercarrier sound reception.

collaboration with the German television industry, by the Institut für Rundfunktechnik, and was put to air via a second German TV network, ZFD, coincident with the opening of the Exhibition. By that time suitable receivers were on sale in Germany.

The German system is quite different from the other proposed systems, all of which employ multiplexing techniques with a sub-carrier superimposed on the existing sound carrier. The German system simply adds a second sound carrier adjacent to the original sound carrier. (See Fig 1).

characteristics, the same deviation (50kHz in Australia), the same pre-emphasis (50μs), and the same bandwidth (40-15000Hz).

The original audio channel (channel 1) carries a left-plus-right sum signal in which the left and right signals, individually, are set at half their normal level so that, when combined, they will not exceed the deviation limitations of the system. Also, when combined as a mono signal in a conventional receiver, they will produce the same recovered audio as would a normal mono signal.

The new carrier (channel 2) carries a

IF YOU'RE SWITCHED ON, THIS IS PARADISE.

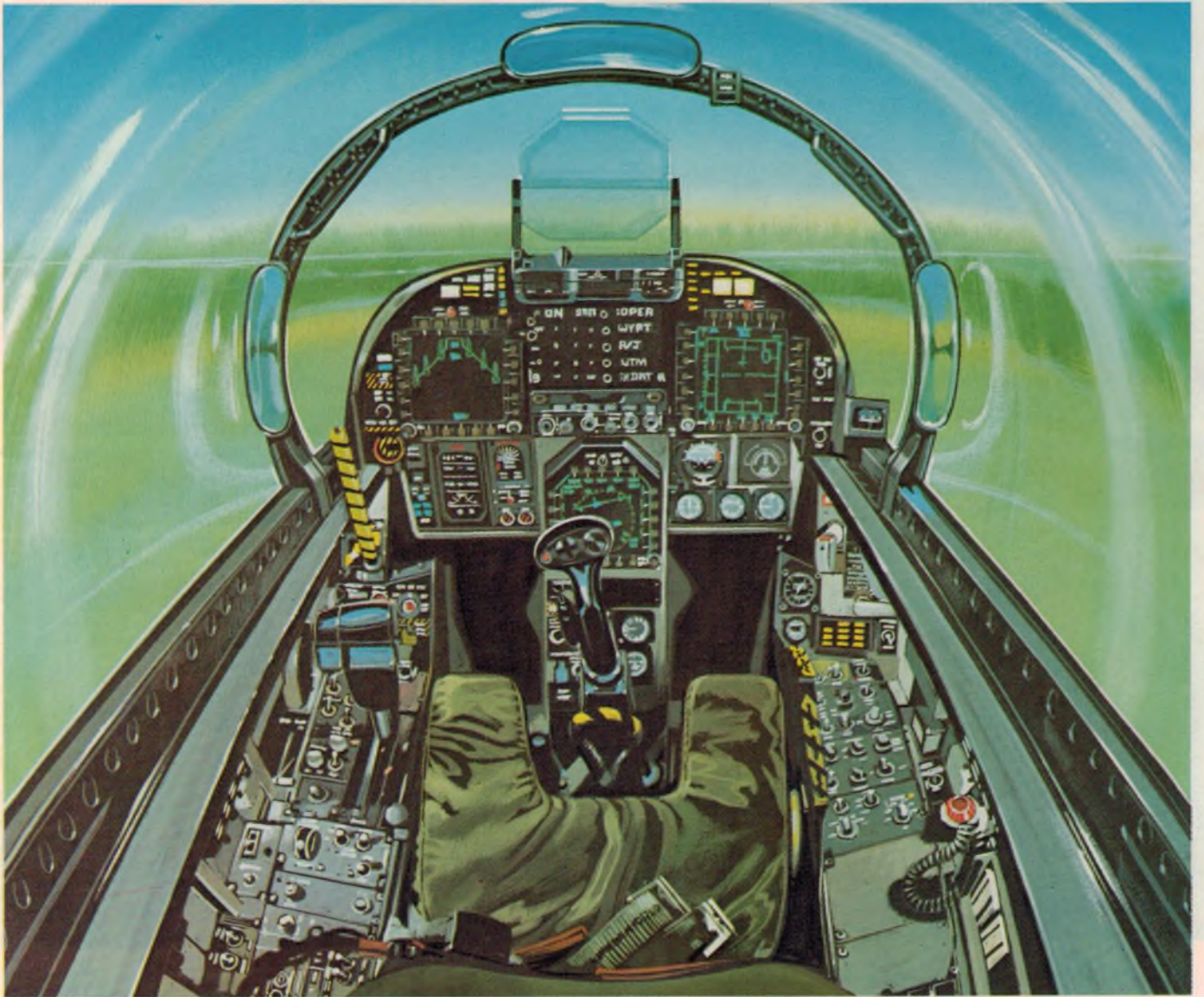

Australia's Hornet. The cockpit contains the latest in the world. Enough electronics to keep any switched on enthusiast happy for years. The Hornet will form the backbone of Australia's Air Force. You can form the backbone of the people who will keep it in the air. Simply phone your Air Force Careers Adviser on Sydney 212 1011, Newcastle 25476, Wollongong 286492, Parramatta 635 1511, Canberra 822333, Melbourne 613731, Geelong 21 1588, Brisbane 2262626, Townsville 724566, Adelaide 212 1455, Perth 3256222, Hobart 347077, Launceston 31 1005.



JOIN AUSTRALIA'S AIR FORCE.



It's at home

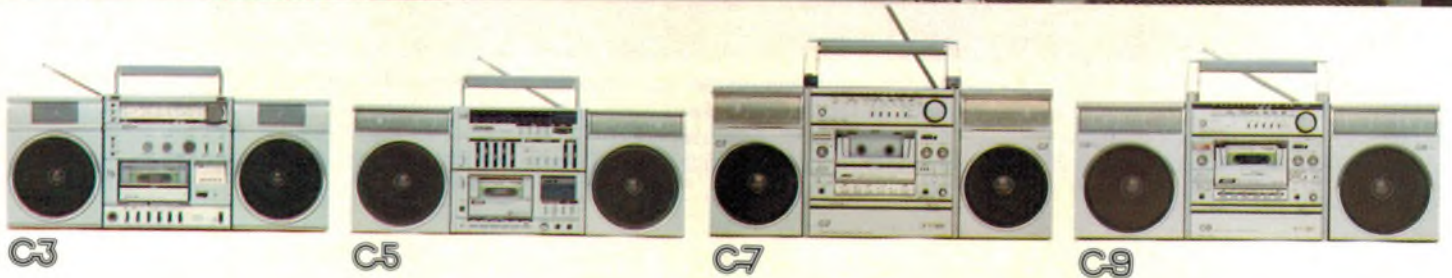

Up till now, about the only place you could hear great sound outdoors was at a rock concert.

 **SANYO**
That's Life!

But now Sanyo has answered that problem beautifully, with a new range of portable Stereo Radio/Cassette Recorders, with detachable speakers. The quality of sound is, in a word, amazing.

So now, enjoying great sounds in the great outdoors, or anywhere else for that matter, is as easy as picking up one of these new Sanyos.

anywhere.



PH420K



PH460K



PH480K



PH492K

In addition, Sanyo are now distributors in Australia for Fisher Equipment, and we are pleased to announce their new range of portable Stereo Radio/Cassette Recorders, with detachable speakers.

Obviously, there's not enough room here to go into details, so we'd like to suggest you see your nearest Fisher retailer.

As they say, hearing is believing.
But, that's life.



FISHER

Distributed by Sanyo Australia Pty Ltd

TDK'S NEW CASSETTES. HEARING IS BELIEVING.



The lab data supporting the just-released line-up of new TDK cassettes is impressive, and detailed objectively on other pages. But to fully appreciate the dramatic difference between these new tapes and any others you are using, ours included, you should hear for yourself. Choose from new MA-R and MA for metal position, new SA-X and SA for high position and new AD-X, AD and D for normal position. Also, we would be delighted to send you our free 26-page Guide to Better Recording. Just write to:

TDK (Australia) Pty. Ltd., Unit 5, Level B South, 100 Harris Street, Pyrmont, NSW 2009.

 **TDK**
Now TDK does even more
amazing things to your system.



Note: Any person practising tape-recording should observe the provisions of the Copyright Act 1968.

John Bevins TDK/09

right-only signal, plus a pilot carrier on 54.7kHz. The pilot carrier is modulated with audio tones according to whether the transmission is stereo, mono, or twin channel (bi-lingual). The pilot tone frequency and its audio tones, are also related to the line frequency to minimise interference to the vision signal.

Because channel 2 carries only one audio signal, this can be allowed to drive the carrier to full deviation. This means that the recovered audio from the R signal in channel 2 will be 6dB higher than the R signal in channel 1, but this presents no serious problem.

RECOVERY PROCESS

To recover the separate L and R signals the R signal from channel 2 is simply attenuated by 6dB and then mixed with the L+R signal from channel 1 in opposite phase so as to cancel the R content of channel 1. Thus, channel 1 is left with an L-only signal and channel 2 with an R-only signal.

(Alternatively, the L+R signal from channel 1 can be amplified by 6dB before mixing, if this is more convenient in terms of the receiver design.)

There are, in fact, a number of ways in which the TV receiver can be designed to handle the new signal, but the block diagram in Fig. 2 shows one possible approach. (Existing receivers would simply ignore the extra carrier and deliver an apparently normal mono signal.)

In this arrangement the signal path remains much the same as for a conventional set, up to the video detector, and beyond to the video amplifier. But whereas a normal set takes a 5.5MHz sound IF carrier from the detector, for subsequent IF amplification, the new set would take off two such signals, one at 5.5MHz and one at 5.742MHz, and feed them to separate IF amplifiers.

After IF amplification the signals would be detected, producing an L+R audio signal out of the 5.5MHz IF and an R-only audio signal out of the 5.742MHz IF. These would then be passed on to the matrixing circuit to

In block schematic form, the matrixing and decoding system which switches the receiver automatically for mono, stereo or bi-lingual sound. In the last case, manual switching selects the required language.

A DOUBLE INTERCARRIER TV RECEIVER

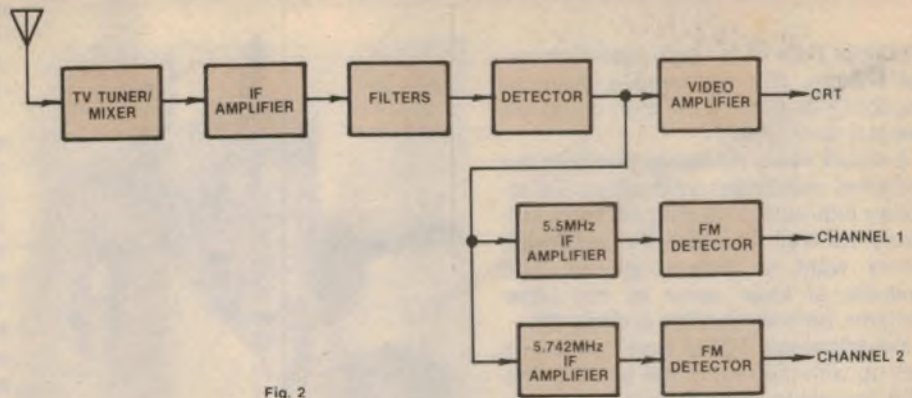

Fig. 2

The most basic type of stereo sound TV receiver would have an extra intercarrier sound channel following the video detector. More elaborate systems could be expected in higher technology designs.

separate the L and R signals. (See Fig 3.)

Fig. 3 also shows the pilot tone decoder and, in order to understand how this works, it is necessary to go back to our mention of the pilot tone and expand the modulation details.

If the transmission is stereo the pilot carrier is modulated at 117Hz, but if it is bi-lingual the modulating tone is 274Hz. For mono transmissions the pilot carrier remains, but is unmodulated. These codes are used to switch the audio channels in the receiver to appropriate configurations.

Thus, if a 117Hz tone is detected the L and R signals are switched, separately, to the left and right audio amplifiers, giving full stereo reproduction. If a 274Hz signal is detected the inputs to the two amplifiers are combined and one of the two audio signals fed to it, as selected by the viewer via a manual switch. If there is no modulating tone the two amplifier inputs are combined to give mono operation.

And what are the advantages of the German system? The main ones are lower noise and, most important, far better separation between channels. The multiplexed sub-carrier systems, when used in a TV system, suffer from

increased noise, with more noise on one channel than the other. In the German system the noise is equal in both channels and some 8dB lower.

The improved separation is important because of the bi-lingual application. The other systems — and most FM radio stereo systems — achieve a separation of no more than about 40dB, and as low as 30dB in some cases. This is quite adequate for the stereo application and is actually better than that achieved by most pickup cartridges.

BI-LINGUAL SEPARATION

But the bi-lingual application is much more demanding. When one particular language is selected there must be no noticeable background of the other language. The German system can provide at least 56dB of separation, and this is more than adequate to meet this requirement. At the same time, the better separation does no harm to the normal stereo function.

As far as Australia is concerned it is far too early to get excited about the prospect of TV stereo sound in your lounge room. The current tests at TCN channel 9 are just that; tests to evaluate the good and bad points of the system

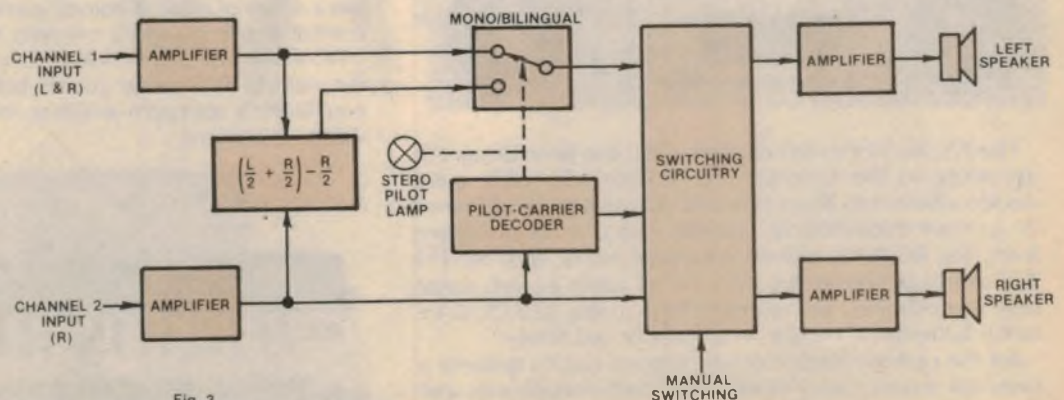

Fig. 3

AUDIO-VIDEO ELECTRONICS — continued

and how they fit in with Australia's requirements. (Do we need a bi-lingual capability in this country or could we use it if we had it?)

It would seem inevitable that both the licensing authorities and other TV industry interests, including set manufacturers as well as other TV networks, would want a chance to test and evaluate at least some of the other systems before reaching a decision.

Nevertheless, TCN's work has put us well up with the rest of the world — the USA has yet to make its decision — and should ensure that we do not lag behind. In the meantime, a little patience will enable us to benefit from overseas experience and make a wise choice.

In brief . . .

SANYO AUST PTY LTD have a suggestion for anyone who might be wondering what to buy as a Christmas present for that rather special person. What about their new M-G12 mini

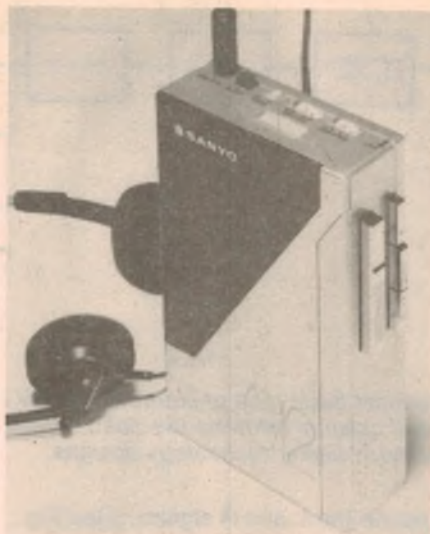

stereo cassette player? It weighs only 400 gms and measures only 136 x 85 x 34mm, but is nevertheless capable of excellent stereo performance. It has locking controls for fast wind or rewind plus auto stop, LED battery indicator, tone control and anti-rolling mechanism

to minimise motion-wow effects. A belt grip is provided for hands-free operation. RRP is \$79. For details: W. Fabiszewski, Sanyo Aust Pty Ltd, 225 Miller St, North Sydney 2060. Phone (02) 436 1122.

WHARFEDALE, one of the oldest and best known of the British loudspeaker manufacturers, has won a new lease of life. Founded some 50 years ago by the late Gilbert Briggs, the company was sold to the Rank organisation in 1958. For a while, it pursued its original hifi ideals but they did not always align with hard-headed commercialism. Finally, the organisation fell victim of the malaise which has affected much of Britain's electronic industry and, on July 23 last, Rank announced that the factory would be closed — almost a personal bereavement to generations of hifi enthusiasts. Now comes the news that an independent company, Tradewest Ltd, has bought the factory, plant, R&D facilities and, most importantly, the tradename. They plan to re-start the operation, with the same models and re-employing many of the original key personnel. Who can possibly fail to wish them well?

MAJOR PROMOTION BY JVC

Under the guidance of Group Managing Director, Hans Went, Hagemeyer (Australasia) BV have embarked upon a major sales promotion for JVC products. Much of the promotion is to be centred around the visit of the English cricket team for the 1982/3 Centenary Cricket Season. Hans Went (left) is pictured with Doug Thompson, Australian Sales Manager of Major Media Promotions.

To give point to the promotion, Hagemeyer have assembled an impressive array of JVC equipment ranging from consumer audio/radio, through hifi audiophile components, to domestic and commercial video equipment. All has about it a certain "state-of-the-art" distinction.

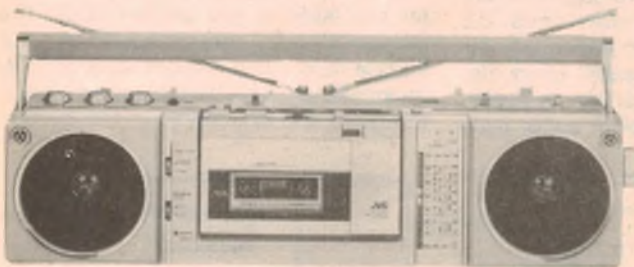

The JVC RC-S55 stereo cassette-radio has been designed, according to the brochure, for people who can't quite decide whether to buy a personal player with headphones or a more conventional cassette radio! In its complete form, the RC-S55 is indeed a cassette radio, with AM-FM and shortwave coverage, 3W+3W of audio power, metal tape compatibility, and operable from mains, 12V DC or internal batteries. It comes in a silver or red finish.

But the cassette section can be slipped out, to become a personal stereo player for use with hifi headphones and



operating from its own batteries.

Another intriguing item is the JVC Keyboard KB-500. Suitable for use with a stereo hifi system or headphones, it has a range of musical voices, auto chord, auto percussion, ensemble effects, and a memory system.

Those are just two novelty items which catch the eye but the current JVC range covers tuners, amplifiers, graphic equalisers, a spectrum analyser and an extensive range of video equipment.



Great Products - ★ LOW Prices! ★

low cost I.C. inserters/extractors

Up until now these have cost a fortune!!

Features:

- CMOS SAFE conductive plastic
- Exclusive bent pin alignment guides in handle . 8 to 40 pins.
- Ground strap can be connected.
- One hand operation.

INSERTERS

CIT820	8-20 pin	ONLY \$5.95
CIT2428	24-28 pin	ONLY \$6.95
CIT3640	36-40 pin	ONLY \$8.95



EXTRACTOR

Deceptively simple looking device. One piece metal construction. 8-40 pins ET-840 ONLY \$2.95 **IMPORTANT!!** Don't be conned into buying a non conductive inserter/extractor. The possible static damage to your MOS I.C.'s could cost you a fortune!!

REED SWITCH/MAGNET ASSEMBLY

Grab some of these before the Canberra boys grab the shirt off your back!!

A bulk buy of these has enabled us to pass on great savings!! Quality dry reed insert in tough plastic housing with screw terminations. Matching Magnet assembly closes SPST reed contacts when near reed.

- 10 million operations
 - Comes with instructions
 - Double sided foam tape inc.
 - Screw mount as well!
- Staggering value. Jaycar has a complete range of Burglar alarm components - call in!!



★ 1-9 \$1.50 ea
★ 10-99 \$1.40 ea
★ 100+ \$1.25 ea



spring reverb

We have purchased a small quantity of high quality US-made spring reverb units. This 3-spring model is the one used in such amps as 'PEAVEY' etc. Grab a spare now or build a complete reverb system with free circuit supplied.

A FEW LEFT \$34.50

AM/FM STEREO CAR CASSETTE

Unbelievably low price! (Pre Budget tax) That's right! An AM/FM Stereo Radio and Cassette!

- Features:
- * 2 x 7 watts * One lever operation (fast forward and eject) * Tape run indicator
 - * FM Stereo indicator * Auto stop * Adjustable pitch controls * Mounting hardware included.



★ STAGGERING VALUE ONLY \$69.50

TELEPHONE DIGITAL DIALLER

Much easier than wearing the top of your finger off. Remembers last number called for 12 hours. SAVE \$10 - \$29.50

CRADLE RELAYS SLASHED!!!

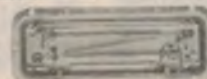

SAVE A FORTUNE!!

Top quality relays. Gold flashed contacts, 1 AMP rating. As used in Telecom equipment. Professional quality.

COIL VOLTS	IMPEDANCE	SWITCH CONFIG	PRICE
6	-	4 C.O.	\$4.50
12	250	2 C.O.	\$4.50
24	1100	2 C.O.	\$4.50
48	2100	2 C.O.	\$4.50

Relay socket: 2 C.O. 75 cents 4 C.O. 75 cents
UP TO 50% OFF NORMAL PRICES!!

EXPERIMENTER BREAD-BOARDS

WBDN 100 holes	\$2.50
WBTDN 640 holes	\$8.95
WB2N 840 holes	\$12.95
WB4N 1680 holes	\$24.50
WB6N 2420 holes	\$39.50

Ample stocks of these boards plus the range has been extended.

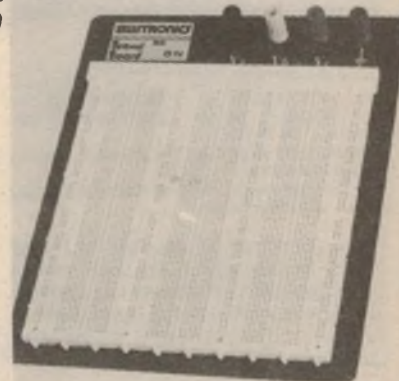

"Useless" Adaptors

A FEW PACKS LEFT

We have double female. We also have the opposite! And some weird combinations in between. Each adaptor is solid metal and high quality and we can't see the reason why some were over made and we're sick of looking at 'em.

You get 12 in a bag and if you only use ONE once they will owe you nothing. Once sold for \$3 each, but we won't insult you by claiming \$36.00 'value'. A bag will cost you \$3.95.

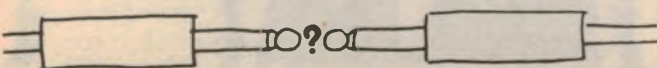

Jaycar

125 YORK St. "NEVILLES CORNER" Cnr CARLINGFORD & SYDNEY 2000
Phone: 264 6688
Telex: 72293
Mail Orders To: BOX K-39 HAYMARKET SYDNEY 2000

MINIMUM MAIL ORDER \$5.00



POST AND PACKING CHARGES
\$5-\$9.99 (\$1.20) \$10-\$14.99 (\$2.40)
\$15-\$49.99 (\$3.50) \$50-\$99.99 (\$4.50)
\$100 up (\$6.00)

NEW SHOP HOURS
Mon-Fri 9:30 to 5:00pm
Sat 9:30 to 12:00pm
Thurs 10 to 8:30pm

"HEY"

When you're in the market for a car you head for "Auto Alley"—

For you, the electronic enthusiast, tradesmen, hobbyist or just an electronic Nut, we've created "Silicon Alley" - better known as York Street. So no matter what you need in electronics, drop your soldering iron and come on in. (OOP'S switch it OFF first)

sinclair ZX81

HOME COMPUTER

Price
Reduction
November



SUDDENLY,
HOME COMPUTING
IS WITHIN THE
REACH OF
EVERYONE

**ONLY
\$179.00**

Save \$20.00 on R. Retail of \$199.00.

How about these for Hot Prices on Memory chips.

4116 200 N - SEC: 1 to 24 @ **\$2.50 ea.** 25 up @ **\$2.00ea.**

6116 C/MOS: 1 - 9 @ **\$9.95 ea.**

10 up @ **\$8.50 ea.**

BE QUICK LIMITED STOCK ONLY!

LOOKING -TO- BUY a multimeter. We recommend KAISE Digital Model 6221 @ **\$79.00.**

We also stock other models:

SK6330 Auto range - hold - Trade Tax incl.
Buzz - 10A AC/DC **\$121.50 \$138.51.**

SK6440 Auto range - 24 Ranges - 10A AC/DC **\$ 85.00 \$ 96.90.**

SK6400 Auto range - 20 Ranges - 0.8% Acc. **\$ 75.50 \$ 86.07.**

SK6221 Auto range - hold - Buzz - 10A AC/DC Econ. **\$ 69.95 \$ 79.00.**

Plus of course all models of Fluke Hand held's including their latest 6060B at **\$398.00 + Tax.** Other instruments include Standard Escort, Anigawa, Trio, Hitachi, Aaron and Goodwill.

These are just a few of the many 100's of up - to - date Electronic items on display at:-



DAVID REID ELECTRONICS LIMITED
127 York Street, Sydney, 2000.
or Telephone (02) 29.6601

AUDIO-VIDEO ELECTRONICS — continued

MR ACOUSTICS announce three new products, imported from QED Audio Products, UK. One is the Protech SP150T loudspeaker protection unit which, they claim, can protect expensive loudspeaker systems from accidentally applied DC, excessive HF content and transients. C38 is the type number of the second product — a loudspeaker cable having extremely low losses. The third product is a conductive record sleeve which is intended to combat the build-up of static charges on frequently used demonstration records. At about \$1.50 each, the sleeves may be too expensive for general collections but MR Acoustics see ready application for them in hifi demonstration rooms. For details contact Col Robertson, MR Acoustics, PO Box 165 Annerley, Qld 4103. Phone (07) 48 7598 or 284 6764.

Pioneer's SC-5 "Sound Creator"

Pioneer Electronics has released an unusual new stereo system that, they say, "can turn an ordinary suburban living room into a sophisticated recording studio."

"It opens up a whole new world of do-it-yourself music for the budding musician, composer or recording engineer."

The "Sound Creator" is made up of an SA-05 Sound Mixer/Amplifier, SG-05 Graphic Equalizer, CT-05 Double Cassette Deck, TX-05 Tuner, PL-05 front loading automatic turntable, a DT-32 digital tuner and a CS-05 three-way speaker system.

The heart of the system is the SA-05

Sound Mixer/Integrated Amplifier, which can be transformed at the touch of a button from a powerful 70 watts per channel amplifier into a versatile home studio mixer.

It has multiple input jacks for microphones, keyboard instruments, electric guitars, &c, faders, panpots and reverberation. Budding vocalists can have live accompaniments or sing along with pre-recorded music.

The SG-05 graphic equaliser has seven bands per channel each providing 10dB of boost or cut. It can be used to compensate for listening room defects, to achieve special vocal emphasis, optimise tapes for in-car listening, minimise tape hiss, &c.

Not surprisingly, the cassette deck provided is a double-function double-Dolby unit with a play and a record/play section. When used in conjunction with the mixer, it can provide mixing, sound-on-sound, dubbing and copy-plus-edit.

Other items included in the SC-5 Sound Creator system include a TX05L digital synthesiser tuner with presets for eight AM and eight FM stations. The turntable is a front-loading fully automatic unit with automatic sensing of record size. A DT-32 timer can turn equipment on and off from one minute to 24 hours in advance.

All this equipment is housed in a moveable rack, as illustrated, which also provides a jack system for external inputs and storage space.

For further information, contact Ron Ward, Audio/Video Products, Pioneer Electronics Aust Pty Ltd, 178-184 Boundary Rd, Braeside, Vic 3195. Phone (03) 580 9911.



From Audio Telex Communications



Telex Communications Inc have announced this new high-speed audio tape duplicating system, model 6120. They say that it is an entirely new generation of equipment, operating at speeds that reach the practical production-line limits for in-cassette duplication. The model 6120 represents the culmination of 20 years experience in the tape duplicating business. It is based on modules for both open-reel and cassette duplication, which can be ordered initially or acquired later, as necessary, simply plugging into a common control centre.

Either two or four channel configurations are available, while the hubs accept either 178 or 267mm reels, to operate at either 152 or 305cm/sec. The cassette modules operate at 76cm/sec or a 16:1 speed relationship. On this basis, both sides of a C-30 cassette can be duplicated in less than one minute. With a full complement of 11 cassette slaves, it adds up to a production rate of 350 C-30 duplicates per hour.

For details of this and other tape duplication systems, contact Audio Telex Communications Pty Ltd at 1 Little St, Parramatta, NSW 2150. Phone (02) 633 4344. (Branches in Melbourne and Brisbane).

LUCAS AUDIO IN AUSTRALIA

Lucas Industries Australia Ltd has introduced a range of car audio products to meet the needs of the Australian audio market. Whilst the UK parent company has been successfully marketing Lucas audio for many years, every unit in the range introduced for Australia has undergone a series of stringent tests to ensure that quality and performance meet Australian conditions.

Lucas has upgraded the often neglected AM section of all tuners to ensure fade-free reception, even in country areas, and quality componentry and robust construction to ensure durability.

The range includes AM radios, AM/FM-stereo radios, AM/FM cassette units, graphic equaliser, combination units, speaker systems and enclosures and a range of aerials from basic lockdown to fully automatic types. All aerials incorporate low-loss cables to ensure that the maximum signal reaches the radio.

Also in the range are three personal



headphone units: a stereo cassette player, a stereo cassette player with built-in FM-stereo radio, and an AM/FM radio. All have dual headphone outlets.

Lucas are represented Australia-wide but their National Headquarters are at 300 Lower Dandenong Rd, Mordialloc, Vic 3195. Phone (03) 586 8209.

AUDITEC AUDIO MODULES

THE HIGH QUALITY ALTERNATIVE

- Australian made
- Professional designs
- Carefully tested
- Rugged and reliable
- 12 month warranty



THE NEW 054 HIGH-POWERED MURRAY AMPLIFIER

— 250 watts of very high quality power.



For illustrated literature on our wide range of modules and amplifiers, write to

AUDITEC

Australia Pty. Ltd.

10 Waitara Avenue,
Waitara N.S.W. 2077

Or Phone: NSW: AUDITEC (02) 48 4116; OLD. DELSOUND
(07) 229 6155. VIC: ZEPHYR (03) 553 3266. SA:
NEIL MULLER (08) 272 8011.

CLAMP METER

MODEL YF-700

Top of the range model AC Voltage 150V 300V 600V AC Current 6A 15A 60A 150A 300A Resistance 5kΩ (Midscale 200Ω)

was \$49.99

NOW ONLY

\$43.55

DISCOUNT

DISC DRIVES COMPUTERS

PRINTERS	
ITOH 1500 PARALLEL (DAISYWHEEL)	\$1515 + TAX
ITOH 1500 SERIAL (DAISYWHEEL)	\$1555 + TAX
ITOH 8510 PARALLEL	\$910 + TAX
ITOH 8510 SERIAL (GRAPHIC ETC)	\$1015 + TAX

RITRON COMPUTER GRADE P/S
+5V reg 10a 16V unreg @ 1A
KIT \$79.95 inc
Built and tested \$99.50

ETI636 MOTHERBOARD
7 Slot Motherboard \$90.00
Built and Tested \$120.00
ACTIVELY TERMINATED

INTERSI LCD \$38.50 3 1/2 DIGIT PANEL METER KITS

Build a working DPM in 1/2 hour with these complete evaluation kits. Test these new parts for yourself with inter-sil's low cost prototyping kits complete with A/D converter and LCD display (for the 7106) or LED display (for the 7107). Kits provide all materials including PC board, for a functioning panel meter ICL7106EV (LCD).

P.C. EDGE CONNECTORS



S100 gold plated wire wrap	\$8.50
S100 solder tail	\$7.90
D2 Motorola bus	
43/86 solder tail	\$8.50
43/86 gold plated wire wrap	\$11.50

10 TURN POTENTIOMETERS

Stock resistance values

50R 100R 200R
500R 1K 2K 5K
10K 20K 50K
100k

Spectral model 534 1/4" shaft
Price 1-9 \$9.90
10+ values may be mixed \$9.50

DIP PLUGS

Ideal for use with flat ribbon cable or to mount components on



14 pin \$1.50 24 pin \$2.90
16 pin \$1.90 40 pins \$5

POWER TRANSFORMERS

SPECIALLY DESIGNED FOR MICROCOMPUTERS

- Good regulation electrostatic shield
- RI 810 8V @ 10A x 15V @ 1A \$31.00
- RI 820 8V @ 20A 15V @ 1A 15V @ 3A \$37.50

20 TURN CERMET TRIM POT



SPECTROL 43P ACTUAL SIZE

STOCK RESISTANCE VALUES
10R 20R 50R 100R 200R 500R 1K 2K 5K 10K 20K 50K 100K 200K 500K 1M 2M
1-9 \$1.80
10-99 \$1.60
100 \$1.30
Values may be mixed

Hexadecimal Keypad \$32.50



19-key pad includes 1-10 keys ABCDEF and 2 optional keys and a shift key
Ideal for dream project

MULTIDIALS



Dials to suit 10 T Pots
Model 21 1.8" dia \$16.50
Model 16 9" dia \$12.50
Model 18 1" x 1.75" dia \$21.50

RS232 & "D" TYPE CONNECTORS

PART NO	DESCRIPTION	1-9	10-25	25+
DE 9P	9 PIN MALE	\$3.50	\$3.50	\$3.10
DE 9S	9 PIN F/MALE	4.50	4.20	3.90
DE 9C	9 PIN COVER	2.20	2.10	1.90
DA 15P	15 PIN MALE	4.50	4.20	3.90
DA 15S	15 PIN F/MALE	5.10	4.90	4.70
DA 15C	15 PIN COVER	2.30	2.10	2.00
DB 25P	25 PIN MALE	5.90	5.60	5.10
DB 25S	25 PIN F/MALE	6.90	6.60	6.10
DB 25C	1 pc Grey Hood	2.40	2.20	2.00
DB 25C2B	2 pc Black Hood	2.80	2.70	2.50
DB 25C2G	2 pc Grey Hood	2.70	2.50	2.40
DC-37P	37 PIN MALE	7.90	7.50	7.10
DC 37S	37 PIN F/MALE	10.90	9.90	9.10
DC 37C	37 PIN COVER	4.90	4.50	4.10
DH-S	Hardware set (2 Pairs)	2.10	1.90	1.80

cermet single TURN TRIM POT



Spectral model 63P ACTUAL SIZE

STOCK VALUES
10R 20R 50R 100R 200R 500R 1K 2K 5K 10K 20K 50K 200K 500K 1M 2M
1-9 \$1.20
10-99 \$1.00
100 \$0.90
Values may be mixed

DIP SWITCHES SPST

P/N	No of Switches	Price
SD3	3	\$1.60
SD4	4	1.70
SD5	5	1.90
SD6	6	2.30
SD7	7	2.40
SD8	8	2.50
SD9	9	2.70
SD10	10	3.00

DIP SWITCHES SPST

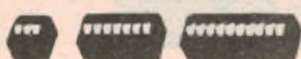

TEXT TOOL

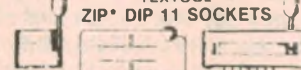

16 Pin Zip* Dip 11 \$11.50
24 Pin Zip* Dip 11 12.50
40 Pin Zip* Dip 11 17.50
*Zero Insertion Pressure

INCREDIBLE MEMORY AND DISC DRIVE PRICES

	1-9	10-25	25+
2708	4.90	4.00	3.90
2716	4.90	4.20	3.90
2732	8.00	7.50	7.00
4116 (200nS)	1.95	1.80	1.75
4164 64K Dynamic	11.00	10.00	9.50
M58725P (2K x 8)	10.00	9.00	8.50

Static
(As used in new 64K Static S100 PCB)
ALL PRICES INCLUDE SALES TAX

DISK DRIVES

MPI 51 \$275.00 + 17.5% ST.
MPI 52 \$385.00 + 17.5% ST.
MPI 91 \$415.00 + 17.5% ST.
MPI 92 \$515.00 + 17.5% ST.

Mitsubishi 8" \$625 including tax.

Microline 80 \$499 inc tax

BUILD YOUR OWN SPEAKERS WITH PHILLIPS

PART No	PRICE
AD0140T8	\$11.86
AD01610T8	\$16.95
AD01605-TB	\$16.54
AD0162-T15	\$18.78
AD0162-T15	\$13.03
AD0162-TB	\$13.77
AD0210-SQ8	\$42.00
AD02180-SQ8	\$45.00
AD02161-SQ8	\$33.46
AD10100-W8	\$52.72
AD12100-HP8	\$85.10
AD12100-M15	\$79.11
AD12100-M8	\$79.11
AD12100-W8	\$53.99
AD12200-W8	\$73.12
AD12250-W8	\$83.00
AD12650-W8	\$59.00
AD2273-T8	\$5.03
AD4060-W8	\$19.06
AD5060-SQ4	\$22.05
AD5060-SQ8	\$22.05
AD5060-W8	\$17.59
AD5061-MB	\$17.08
AD70601-W8	\$22.00
AD70620-M8	\$21.54
AD7063-M8	\$20.78
AD70630-M8	\$20.78
AD70650-W8	\$26.96
AD7066-W8	\$26.96
AD80601-W8	\$20.24
AD8061-W8	\$20.24
AD80652-W8	\$26.20
AD8066-W4	\$27.66
AD8081-M8	\$9.81
AD9710-MB*	\$41.11
ADF1600-8	\$19.44
ADF500-4500-8	\$19.44

DIODES

	10-99	100+
IN4001	6c	5c
IN4002	6c	5c
IN4004	7c	6c
IN4148	5c	4c
IN5404	30c	25c
IN5408	35c	30c
IN4007	12c	11c

HEATSINKS

High Thermal Capacity Black Anodised

	1-4	5-9	10-49	50-99	100-499	500 plus
	\$	\$	\$	\$	\$	\$
HS1 - 38mm	1.85	1.75	1.50	1.35	1.00	0.90
HS2 - 75mm	3.00	2.90	2.50	2.00	2.00	1.50
HS3 - 150mm	5.80	5.40	4.90	3.80	2.90	2.70
HS4 - 225mm	8.10	7.60	7.10	5.90	4.50	4.30
HS5 - 300mm	8.90	8.40	7.90	6.50	4.90	4.60
Unanodised						
HS11 - 38mm	1.40	1.20	1.00	0.90	0.80	0.70
HS12 - 75mm	2.50	2.20	1.90	1.60	1.25	1.20
HS13 - 150mm	4.90	4.50	4.00	3.20	2.45	2.40

BLANK CASSETTES T. D. K.

TDK ADC60	1 for \$3.60	10 for \$26.00
TDK DC60	1 for \$2.10	10 for \$18.00
TDK ODC60	1 for \$3.50	10 for \$31.00
TDK SAC60	1 for \$3.50	10 for \$31.00
TDK SAXC60	1 for \$5.70	10 for \$46.00
TDK DC90	1 for \$2.40	10 for \$21.00
TDK ADC 90	1 for \$3.50	10 for \$30.00
TDK SAC 90	1 for \$4.20	10 for \$39.00
TDK ODC90	1 for \$4.70	10 for \$45.00
TDK SAXC90	1 for \$5.50	10 for \$49.00
TDK DC120	1 for \$4.50	10 for \$37.00
TDK ADC120	1 for \$5.40	10 for \$46.50

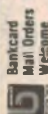

Please debit my Bankcard.
Bankcard No.
Expiry Date
Name
Signature

Post & Pack \$2.50 small kits, heavier kits add extra postage.

Prices subject to change without notice. Send 60c and SAE for free price list and inclusion on all future mailing lists.

MAIL ORDERS: PO Box 235, Northcote, Vic 3070. Min P & P \$1.00.

Ph: (03) 489 8131.

ROD IRVING ELECTRONICS

425 HIGH STREET, NORTHCOTE 3070, MELBOURNE, VICTORIA. Ph (03) 489 8131. Telex No. 38897

DIGITAL ENG. ANALYSER
\$48.50



EA August 80

DIGITAL CAPACITANCE METER
\$45.00



Here is an inexpensive Digital Capacitance Meter which measures from 1pF to 99.99uF in just three ranges. It's simple to use and features a big bright four-digit display with automatic updating and decimal points. EA March 80

ELECTRONIC DUMMY LOAD
\$99.00



With this unit you can test power supplies at currents up to 15 Amps and Voltages up to 60 Volts. It can 'sink' up to 200 Watts on a static test and you can modulate the load to perform dynamic tests. ETI 147 October 80

SELECTALOTT
\$22.00

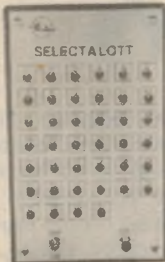

"Who wants to be a millionaire...?" I do. "Selectalott" could help. It will select random numbers without superstition or bias. It could be you. EA December 80

PHOTON TORPEDO GAME



EA September 81

\$24.50

7-SLOT \$100 MOTHER BOARD



ETI May 80

\$85.00

FUZZBOX
\$19.90



Simple Fuzz Box for electric guitars. The no fuss, no nonsense Fuzz Box Confused — So are we. Seriously though if you want a sound with a difference, build this project and you can distort the waveform. It produces a sound which is buzzy (like politicians at election time). EA February 81

150W MOSFET POWER AMP
\$79.00



Plus Transformer \$43.50
Plus Heatsink Drilled, Tapped and Black Anodised \$42.50

A general purpose 150W Mosfet Power Amp Module. Here's a high power, general purpose Power Amplifier Module for guitar and PA applications employing rugged, reliable Mosfets in the output. ETI 499 March 82

CYLON VOICE EA December 80
\$19.95



Sound like Darth Vader

ANALOGUE AND DIGITAL STORAGE CRO KIT
\$189.00

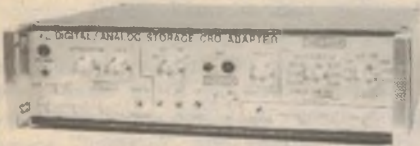

Store and record non-repetitive Analogue Signals. EA March 81

TV CRO ADAPTOR
\$38.50

Includes Plug Pack. EA August 80



VOICE CANCELLER

\$22.50

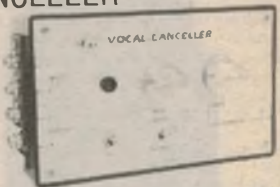

Ever wondered how your voice substituted for your favourite vocalists would sound, well now its possible! You can cancel out the lead vocal on almost any stereo record and substitute your own voice or musical instrument. EA April 82

ETI 471 PREAMP KIT ETI June 79 **\$49.50** Extremely versatile pre-amp kit



LOUD SPEAKER PROTECTOR

ETI 155 March 80



\$32.50

CAR ALARM
\$29.00

This Car Alarm uses the battery earth strap as a sensor to detect when a "courtesy" light or other electrical load occurs when a thief enters a vehicle. The circuitry is simple and immune from false triggering problems. ETI July 81



10-15V EXPANDED SCALE V-METER

ETI 159 December 81

\$26.50



CORE BALANCE RELAY ETI 567



\$44.50

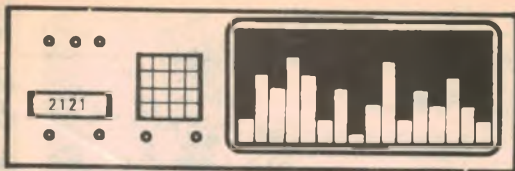

HIFI REVIEW

Miller & Kreisel Volkwoofer and Satellite-1A loudspeakers

Unusual features such as an internal 60 watts amplifier and 14 possible midrange-treble equalisations combine with high power handling and a response to 18Hz in this subwoofer-satellite speaker system from Miller and Kreisel.

Despite the Germanic sounding name, the Volkwoofer and Satellite-1A loudspeaker system has American origins. It is manufactured by the Miller and Kreisel (M&K) Sound Corporation in

California. The speakers we reviewed were finished in genuine woodgrain veneer and had been assembled in New Zealand.

The appearance of the Volkwoofer-Satellite loudspeaker system is a little unusual at first sight. Instead of the usual two speaker boxes there are three. A cubic woofer box measuring 458 x 421 x 458mm (HxWxD) and two smaller midrange-treble boxes measuring 546 x 196 x 190mm (HxWxD).

The woofer box contains a single 250mm driver and each satellite contains a pair of 125mm cone midrange drivers and a pair of 25mm soft dome treble drivers.

Frequency response of the Volkwoofer-Satellite system is claimed by M&K to be within ± 3 dB over the range 18Hz to 22kHz.

Connecting the loudspeakers to the amplifier is a little different to normal practice and no attempt should be made to do so until the instruction books have been thoroughly read and understood. Two instruction books are provided, one for the Volkwoofer and one for the Satellite-1A's. To connect the loudspeakers four heavy gauge figure-eight speaker leads are provided.

Connections are made by running the output of both channels of your normal amplifier into two pairs of input terminations located on a metal panel on the back of the Volkwoofer. Midrange-treble signals are then taken from two pairs of output terminations on the back of the Volkwoofer, and fed to the satellites, one pair of terminations being used for each satellite.

The woofer, or more accurately the subwoofer, has its own 60 watt amplifier and power supply built into the enclosure. Crossovers attached to the amplifier filter the incoming signals from your regular stereo amplifier, and bass signals below 100Hz are fed to the 60

watt amplifier. Frequencies higher than 100Hz are passed onto the satellite speakers via the output terminations on the Volkwoofer rear panel.

Also on the rear panel is a LED power indicator, a fuse, a level control and a three-position room variation switch. The level control is used to match the output of the Volkwoofer to the output of the Satellites. The room variation switch changes the response of the Volkwoofer to suit certain rooms or music. Additionally the metal rear panel is used as a heatsink for the 60 watt amplifier.

Nominal input impedances are 200 Ω for the Volkwoofer and 4 Ω for the Satellites. Power handling for the Satellites is 200 watts rms with unclipped peaks up to 400 watts.

Each Satellite box has four input terminals instead of the usual two. Various combinations of these input terminals together with a small kit of resistors allow the user to alter the midrange-treble balance and produce 14 different "sounds". Three of these have been given names by Miller and Kreisel, the "English" sound, the "German" sound and the "American" sound.

These sounds supposedly typify the type of sound produced by the majority of loudspeakers manufactured in the respective countries.

The backplate of each satellite speaker contains connection details for producing six sounds, however recourse to the instruction booklet is necessary for details of the additional variations provided by the resistors.

The Volkwoofer is mounted in what seems to be a small box for a speaker with a response to 18Hz (-3 dB). This response appears to be achieved by a combination of a very heavy speaker cone (with a low resonance), filling the enclosure with damping material to make it acoustically larger and using feedback from a second voice coil on the woofer to control the cone excursion.

The use of feedback also reduces woofer distortion by placing the cone excursion under direct control of the amplifier. This arrangement is much bet-

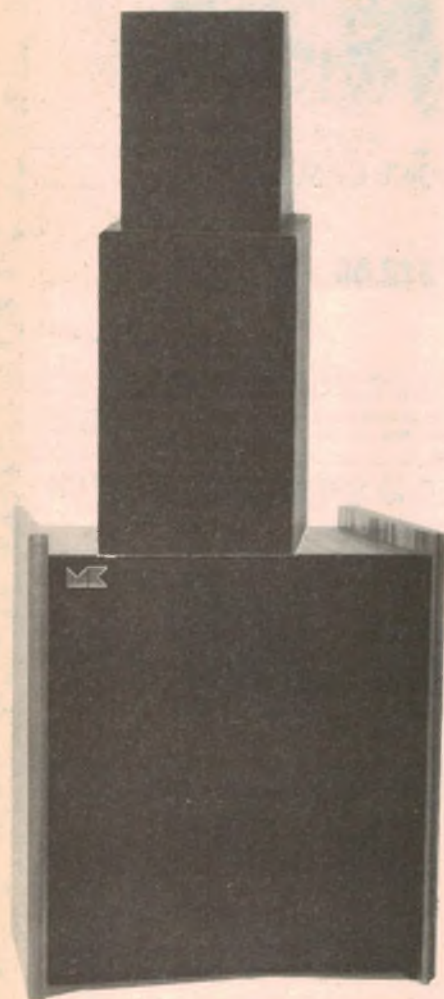

The unusual shape of the loudspeakers can be seen here. Pictured is the Volkwoofer and one Satellite -1A.

Volkwoofer & Satellite-1A loudspeakers

ter than simply relying on the damping factor of the amplifier to control the speaker.

Under sinewave testing a small amount of frequency doubling became evident below 25Hz but it was of such a low level it was almost unnoticeable. The bass response was certainly good. It went down lower than what our test instruments could measure. M&K's claims of a response to 18Hz appear to be well justified. The room variation switch on the back panel of the Volkwoofer switches in filters which roll off the response of the Volkwoofer below 30Hz.

At the same time a slight emphasis is applied to frequencies around 60-70Hz. This gives the effect of a more "punchy" bass, a sound preferred by some people when listening to rock or disco music.

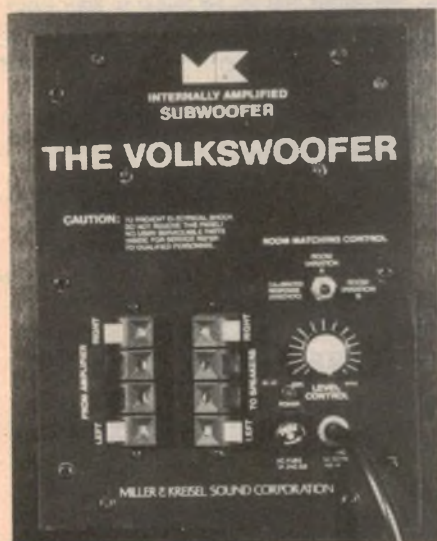

The metal rear panel of the Volkwoofer showing the comprehensive facilities.

Listening tests were done with the satellites connected in the configuration referred to by M&K as the "high efficiency low tweeter level subdued 'German Dome' sound". A new Telarc digital recording of Beethoven's Appassionata Sonata and Sonata Number III was used as one of the principal program sources to test the loudspeakers.

In this configuration piano came through as being slightly muffled or veiled. There also appeared to be a dip in the response around 100Hz possibly caused by phase cancellations between the output signals of the Volkwoofer and the Satellites.

The high pass and low pass crossover filters employed to cross between the Volkwoofer and the Satellites have different slopes, resulting in a phase difference between the speaker outputs at the crossover frequency, 100Hz. This

might be corrected by careful positioning of the Volkwoofer and may not be a problem in a normal household situation.

Bear in mind though that the range of Volkwoofer positions will be limited by the lengths of the connecting speaker leads and the power cord.

We also tried listening to the speakers in other configurations in order to see if we could obtain an improvement in the piano reproduction. To our ears we could not seem to get an even balance between the midrange and treble portions of the spectrum. In one configuration the mid-range would be too bright, in another too subdued. Maybe we need an Aussie sound variation!

The Volkwoofer has a solidly built enclosure and no discernible colourations from vibrating panels were evident in the listening tests. The enclosure dimensions are too small to support standing waves at frequencies handled by the woofer so enclosure resonances caused by standing waves do not occur.

A problem in reviewing these speakers is that there are so many possible combinations of sounds (42 in fact) it is difficult to compare each possibility against all the others. A good deal of time spent listening and comparing between preferred sounds is essential if the best is to be obtained from this system.

In summary, we are reluctant to come to a conclusion about the Volkwoofer and its Satellites. The large number of possible variations would seem to cast doubt on the veracity of the system. After all, could not the designers themselves discover what was the "right" sound and settle on that. We certainly had problems in this regard.

The Satellite-1A's and the Volkwoofer are also available separately so anyone wishing to upgrade the bass response of their speakers could investigate this possibility.

The Volkwoofer-Satellite loudspeaker



A view of the loudspeakers with grilles removed. Paired midrange and treble drivers boost the efficiency of the Satellite-1A's.

system we reviewed was supplied to us by HiFi City. At the time of review, retail prices were \$600 for a pair of Satellite-1A's including stands and \$630 for the Volkwoofer. Further details about the speakers can be obtained from any HiFi City store. (J.S.)

AN INTRODUCTION TO DIGITAL ELECTRONICS

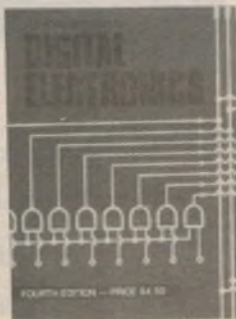

Electronics is going digital. This book can help YOU go right along with it.

Electronic equipment now plays an important role in almost every field of human endeavour. And every day, more and more electronic equipment is "going digital". Even professional engineers and technicians find it hard to keep pace. In order to understand new developments, you need a good grounding in basic digital concepts, and *An Introduction to Digital Electronics* can give you that grounding. Tens of thousands of people — engineers, technicians, students and hobbyists — have used the previous editions of this book to find out what the digital revolution is all about. The fourth edition has been updated and expanded, to make it of even greater value.

Available from "Electronics Australia", 57 Regent St, Chippendale 2008. PRICE \$4.50 OR by mail order from "Electronics Australia", PO Box 163, Chippendale 2008. PRICE \$5.40.

SERIES COMPONENT

OCTAVE GRAPHIC EQUALISER — BRILLIANT!!



8 CHANNEL MIXER KIT

FROM \$495

The Jaycar 8002 Mixer was originally conceived to be the successor to the very popular ET1414 Master Mixer. The 414 was basically configured as a 'stage' mixer and suffered from a number of severe technical limitations — notably poor signal-to-noise figures. Enormous advances in Audio IC's have occurred since the 414 was designed. Jaycar engineers have taken advantage of this. The incredibly low noise and distortion figures of the 8002 are a testimony to the sound basic design of the mixer coupled with the performance capability of these IC's. Whilst the 8002 is the ideal 8 channel compact stage mixer, other applications have been kept in mind AS A "STUDIO" MIXER. The prime requirement of a studio mixer is that it must be quiet — i.e. have good S/N. Due to the fact that the "miracle" 5534 IC's are used in the 8002 studio applications are entirely feasible. In addition to this, metal film resistors are used in critical signal areas AS A DISCO MIXER. The balanced input feature of the 8002 is not really necessary for disco use. This track can easily be bypassed with either a moving magnet (Dynamic Cartridge) preamp, or a moving coil preamp. The sensible format of the 8002 and tremendous equalization facilities should make this mixer popular for disco use.

- Balanced (600 Ohm) Mic. Inputs/Line Inputs.
- Cannon Connectors included in the price.
- Bass, Mid & Treble Equalization on each Input.
- "Effects" (i.e. Echo etc.) capability.
- Foldback and Stereo Pan on ALL 8 Inputs.
- 60mm Slide Faders used throughout.
- 19" Rack Mount capability (or Console Mount).
- Professional Black Front Panel with Format borders & multi-coloured knobs to assist function identification.
- VU Metering.

Send SAE for full details + details on use as stage mixer

WIRELESS GUITAR LINK

— low cost breakthrough!



NOT A KIT COMPLETELY BUILT AND TESTED

\$149.50

SPECIFICATIONS

EFFECTIVE RADIATED POWER OF TRANSMITTER 30mW
 RELIABLE RANGE Over 50 metres
 INPUT SENSITIVITY Variable down to 15mV (RMS)
 SIGNAL TO NOISE 60dB with typical
 TUNABLE FREQUENCY 88-100 MHz or less (tunable part of FM band)
 FREQUENCY RESPONSE 10MHz to 16kHz (Flatter than most tuners)
 FREQUENCY STABILITY Similar to the frequency stability of high quality FM tuners as you can tune many link units without 1MHz hand without interference to each other
 DIMENSIONS A COMPACT 40 x 40 120mm
 BATTERY LIFE 25 hours continuous (alkaline)
 FACILITIES Nicad charging socket, low battery indicator, LED monitoring chip

Now you can roam almost anywhere without the hassle of a trailing cord back to the mixer or amp. The Musolink simply clips to either your belt or guitar strap and transmits back to any FM tuner. IT works on the largely unused section of the Australian FM band. The FM tuner then connects to the PA direct or thru a mixer. The results are spectacular and reliable. The transmitter is very stable. The massive price reduction is due to the fact that you don't need a special crystal controlled receiver, just your FM tuner.

EA KITS

Le Gong - Electronic Doorbell Ref. EA3/81	\$14.95
PC Birdies - Duetting Canary Sound Ref. EA5/81	\$16.50
Gudupp Cricket - Circuit drives you crazy Ref. EA2/82	\$12.50
Vocal Controller - Insert your voice onto records Ref. EA4/82	\$19.50
VOX Relay - Open doors with a handclap Ref. EA4/82	\$14.50
Mitronome - Stick to the beat when learning Ref. EA2/82	\$16.95
Fuzzbox - Punky guitar sound Ref. EA1/81	\$19.50
EPROM Programmer - Cheap EPROM programming Ref. EA1/82	\$53.00
Guitar Booster - Play your guitar on the Hi-Fi Ref. EA6/82	\$14.99
Onscreen Graphic Analyser - A must for the audiophile EA9/81	\$105.00
Cassette Deck Audio Test Unit Ref. EA10/81	\$45.00
Multicolour IV - Coloured lighting for your Hi-Fi	\$85.00
Photon Torpedo - Alien invaders game Ref. EA9/81	\$29.50

ETI KITS

445 - General Purpose Preamp	\$8.50
449 - Balanced Microphone Preamp	\$9.50
581 - 15W Hi 200mA Power Supply Tranny included	\$17.50
492 - Sound Bender - Dalek!!	\$29.50
330 - Car Alarm - works well!	\$24.50
492 - Sound Bender - Dalek!!	\$12.00
446 - Audio Limiter	\$9.95
478 - Bridge Adaptor ET13/82	\$79.50
499 - 15W MOSFET P.A. Amplifier ET13/82	\$39.50
498 - Preamp for above	\$23.00
480/50 - 50W Economy amplifier - quality version	\$27.00
480/100 - 100W Economy amplifier - quality version	\$26.50
158 - Low Ohm Meter ET11/81	\$25.95
729 - UHF Matched Amplifier	\$37.50
735 - UHF Converter	\$59.00
477 - 5000 Series MOSFET Module - Quality	\$29.50
478MC - 5000 Series Moving Coil Pre-amp	\$19.50
478MM - 5000 Series Moving Magnet Pre-amp	\$29.50
458 - 5000 Series Peak Reading Level Meter	\$29.50

KITS from EA ETI

Ref: EA 11/82

NEW 'Power UP' ONLY \$39.50

What will they think of next????! Sensational project that detects the current drawn by one appliance to switch on up to 4 others -- AUTOMATICALLY!
 Great for computers, component Hi-Fi etc. when you have to normally switch on several items in a system. Will switch total load of 240V 10A.
 Complete kit including outlets, box, mains relay etc. ONLY \$39.50

Jaycar

125 YORK St. "NEVILLES CORNER" Cnr CARLINGFORD & SYDNEY 2000 PENNANT HILLS Rd. CARLINGFORD
 Phone: 264 6688 Phone: 872 4422
 Telex: 72293
 Mail Orders To: BOX K 39 HAYMARKET SYDNEY 2000

MINIMUM MAIL ORDER \$5.00



PLEASE ORDER FROM THE FOLLOWING: **SYDNEY** 125 YORK ST. (02) 264 6688 **PENNANT HILLS** 125 YORK RD. (02) 872 4422 **HAYMARKET** BOX K 39 (02) 264 6688

'super siren'

Incredible CMOS circuit drives a Motorola piezo horn (KSN 1038A) to achieve extremely high sound pressure levels. Makes a great alarm and only draws — would you believe — 5mA average?
 Runs for ages on a 9V battery. You can get the electronics including the PCB for only \$5.00. KSN1038A only \$17 extra.

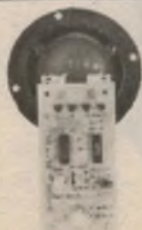

Ref: EA 11/82 FROM \$5.00

Gives echo soundings to 100 metres

Digital depth sounder for small boats

Pleasure craft of all types are fitted with depth sounders these days and these are an invaluable safety aid. This easy-to-build unit features a digital display, an alarm depth function, and has a range of approximately 100 metres.

by COLIN DAWSON

Depth sounders on pleasure craft are primarily used for simply measuring water depth although some more elaborate (and expensive) models can locate fish or even produce a scan of the sea bottom so that reefs and other sunken objects can be located. The unit described here falls into the former category and, as such, is designed to be easy to construct and to operate.

After all, what could be easier than reading a few numbers off a digital display?

Actually, "Electronics Australia" cannot claim any credit for the design of this project. Instead, the circuit was developed by Sydney engineer Neville Harleck whose company, Monitor Instruments, will be supplying complete kits for the project. Our role simply involved assembling the unit depicted here, and presenting the constructional details.

Once assembled, the kit certainly looks the part. Two printed circuit boards – a display board and a main board – accommodate virtually all the electronics, and these are housed in a white moulded plastic case. Overall case dimensions are a compact 125 × 140 × 58mm (W × D × H).

While the case is not water tight, it is reasonably weatherproof and should stand up well to the rigours of the marine environment. Its compact size also means that you should have no difficulty in finding a suitable mounting position for the device, regardless of the type of boat you own.

Other features include a bright 3-digit LED display, a sensitivity control, an alarm depth set control, and a feet/metres switch mounted on the rear panel. Naturally, we assume that readers will set the display to read in metres now that there are no such thing as feet (at

least not in a measurement sense)! A U-shaped mounting bracket allows the case to be tilted to provide a convenient viewing angle.

The audible alarm function is a particularly useful feature. When selected, it sounds whenever the water depth decreases below a preset level, thus eliminating the need for continuous visual monitoring. The danger of running aground is never greater than when the fish are biting, or you are otherwise preoccupied!

Basic principle

The principle on which a depth sounder operates is quite straightforward. An ultrasonic sound pulse is directed into the water and the time taken for the signal to be reflected from the bottom is measured. Since the speed of sound in water is reasonably constant, the distance the sound pulse has travelled, and hence the water depth, can be easily calculated.

Fig. 1 shows the essential elements of a depth sounder system.

First, the transmitter generates a short pulse of 200kHz energy and, at the same time, starts the clock. The receiver subsequently detects the reflected signal and produces a pulse that stops the clock. If the clock is counting at the correct rate, then the display will indicate the water depth directly in the appropriate units (metres or feet).

Most of the important functions of the transmitter and receiver circuits are incorporated into a single IC made by National Semiconductor. This IC, designated the LM1812, has been around for some years now and greatly simplifies the design task for a practical depth sounder. Fig. 2 shows the block diagram of the complete unit, and should be studied in conjunction with

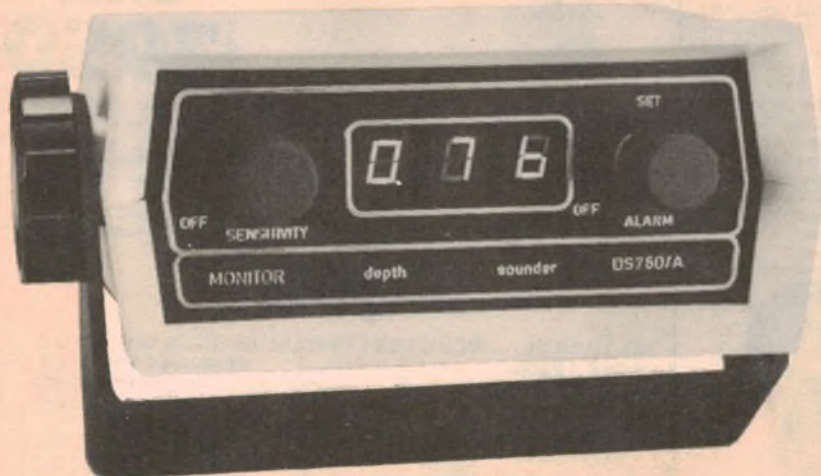

The depth sounder is housed in a weatherproof plastic case.

the circuit diagram in order to understand how the instrument operates.

Circuit description

Our circuit description starts with IC1a, which functions as the timebase clock. This generates a 1ms pulse approximately every 800ms and this pulse activates the transmitter and resets the display and alarm functions.

IC1a, part of an MC3401 quad op amp, is wired as an astable multivibrator which functions as follows: at switch-on, both the non-inverting input (pin 2) and the output (pin 4) are high. The 1μF timing capacitor now charges via diode D4 and its series 3.3kΩ resistor and, when the voltage across the capacitor (and hence on pin 3 of IC1a) reaches a critical level, the output of IC1a goes low.

Since diode D4 is now reverse biased, the timing capacitor discharges via the 1.2MΩ resistor into pin 3 of IC1a. When the voltage on pin 3 goes low enough, pin 4 switches high again and the whole cycle is repeated. The 10MΩ resistor between pins 2 and 4 provides positive feedback to speed up the switching transitions.

The output of IC1a thus consists of a train of short positive going pulses. These pulses are coupled to ultrasonic transceiver IC3, counter IC4 and to the non inverting input of IC2a which controls the alarm function.

IC3 is the LM1812 transceiver chip referred to earlier. Both the transmitter and receiver sections share a common tuned circuit, consisting of L1 and the .001μF capacitor, which makes for easy tuning. Readers are referred to the National Semiconductor Linear Databook for a detailed description of this IC, as only a general description of its operation will be given here.

The timebase pulse from IC1a is applied to pin 8 of IC3 via a 10kΩ resistor. This causes the transmitter to "fire" at a

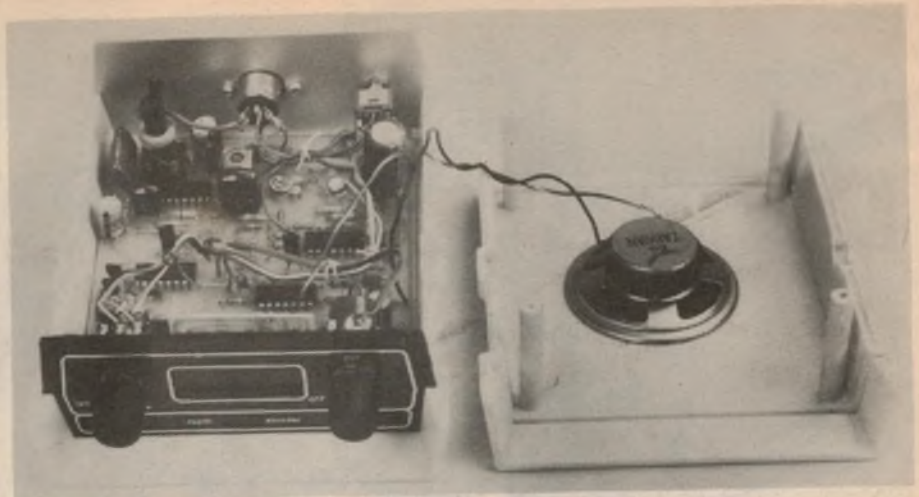

Virtually all the circuitry is accommodated on two printed circuit boards. Unit provides alarm settings to depths of 30 metres (approx).

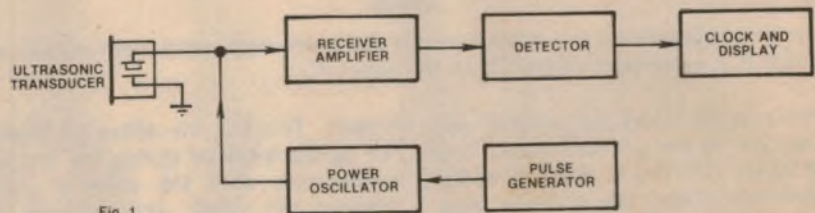

Fig. 1

Basic scheme for an ultrasonic depth sounder circuit.

frequency determined by the tuned circuit, the output signal appearing at pin 6. This is coupled to the transducer via L2, a parallel 3300pF capacitor, and a .01μF blocking capacitor. The signal appearing across the transducer thus consists of a 1ms burst of 200kHz energy of about 150-200V peak-to-peak.

At the end of the 1ms clock pulse, IC3 reverts to the receive mode.

Signals picked up by the transducer are coupled into the first receiver stage at pin 4 via a 100pF capacitor. Following amplification, the signal appears at pin 3

and is coupled into the next amplifier stage via VR1, the sensitivity control. It is this stage that is tuned by the LC network on pin 1.

As far as the user is concerned, the signal is not seen again until it appears at pin 14, and by this time it has been amplified, detected, shaped, clamped and clipped so that we get a nice clean negative-going pulse from the supply voltage to ground.

The functions of a few other pins on IC3 should also be considered before moving on to the next section. It will be

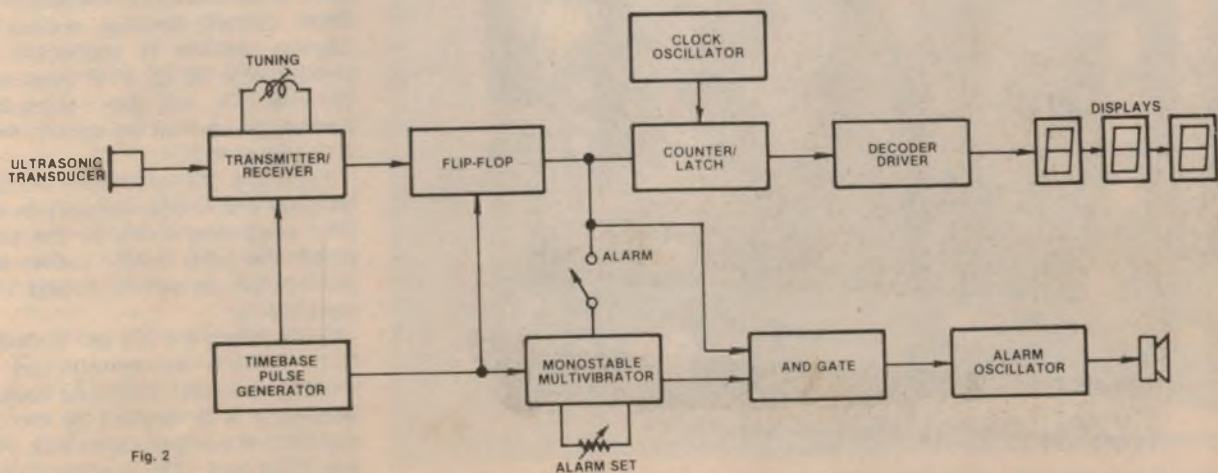
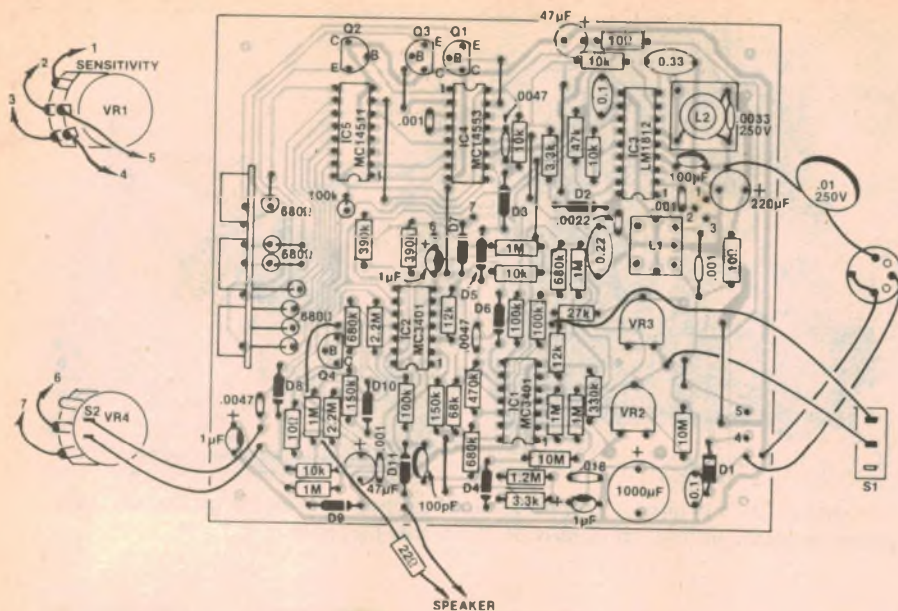

Fig. 2

Block diagram of the complete depth sounder circuit. The transmitter/receiver is based on a single IC.



Parts overlay diagram for the depth sounder. Take care with component polarity and note that IC4 is oriented differently to the other ICs.

noticed that the timebase pulse is also fed into pin 18 via a $3.3\text{k}\Omega$ resistor and series diode D2. This is done to inhibit the detector during the transmit time, and thus prevent a false output signal appearing at pin 14. The $47\text{k}\Omega$ resistor and $0.22\mu\text{F}$ capacitor connected to pin 17 provide a measure of impulse noise rejection.

The $0.33\mu\text{F}$ capacitor on pin 9 is charged during the transmit period, and serves to inhibit the second stage of the receiver. As the voltage across the capacitor falls (at the end of the transmit period), the gain of the second stage in-

creases. This has the effect of filtering out signals received during the first few milliseconds after the transmit pulse. Without this effect, echoes from the boat's keel or rudder could falsely trigger the display circuitry and cause an incorrect reading.

The output signal appearing at pin 14 is coupled to IC1c which functions simply as an inverter. The inverted signal is then fed to IC1d which is connected as a monostable and functions as follows.

Pins 9 and 4 of IC1 are normally low and, because of its $470\text{k}\Omega$ feedback resistor, IC1d will be latched either high

or low. When a timebase pulse occurs, pins 12 and 10 are forced high, and the feedback resistor latches the device in this state. When an echo is subsequently received, it produces a positive pulse at pin 9 which is coupled to the inverting input of IC1d and hence forces pin 10 to go low.

Thus the time that pin 10 stays high is the time from transmit pulse to received echo. Note that pin 10 stays low until the next transmit pulse, which means that any echoes occurring after the first have no further effect on IC1d. Multiple echoes are thus ignored.

The signal at pin 10 of IC1d is differentiated and the negative going pulse coupled via diode D5 to the latch enable input (pin 10) of counter IC4.

IC4 is an MC14553 3-digit BCD counter with multiplexed outputs. The counter is reset to zero by the timebase pulse on pin 13 and the trailing edge of this pulse is used to enable the latches in the chip (thus displaying 000); ie, the timebase pulse is differentiated by a $.0047\mu\text{F}$ capacitor and a $10\text{k}\Omega$ resistor, and the resultant negative going pulse coupled to the latch enable input of IC4 via D3.

As soon as the reset pulse has finished, the counter starts counting clock pulses from IC1b. When an echo is received, a negative going pulse is coupled through to pin 10 via diode D5 as above, and the counter data is transferred to the latches for decoding and display. The next transmit pulse again resets the counter and displays to zero and the cycle is repeated.

Note that if no echo is received, the displays will remain on zero. This is because a latch enable pulse must occur before data can be transferred to the latches.

IC5 is a BCD to 7-segment decoder/driver chip which decodes the binary data from IC4 to drive common cathode 7-segment LED displays. Since the displays are multiplexed, the corresponding anodes are wired in parallel and connected to the outputs of IC5 via 680Ω current limiting resistors. Each display cathode is connected to the emitter of a BC327 PNP transistor (Q1, Q2 and Q3), and these transistors are turned on and off by signals from the multiplexer in IC4.

If you like, you can regard the counter, decoder and display circuitry as a "black box" controlled solely by the timebase pulse, the latch enable pulses and the clock pulses on pins 13, 10 and 12 of IC4 respectively.

Clock pulses for IC4 are derived from IC1b which is connected as a multivibrator and runs continuously. Its frequency is controlled by the $.018\mu\text{F}$ capacitor in company with VR2, VR3 and the $27\text{k}\Omega$ and $12\text{k}\Omega$ feedback resistors. Switch S1 shorts out VR3 and the $27\text{k}\Omega$ resistor, thus changing the oscillator fre-

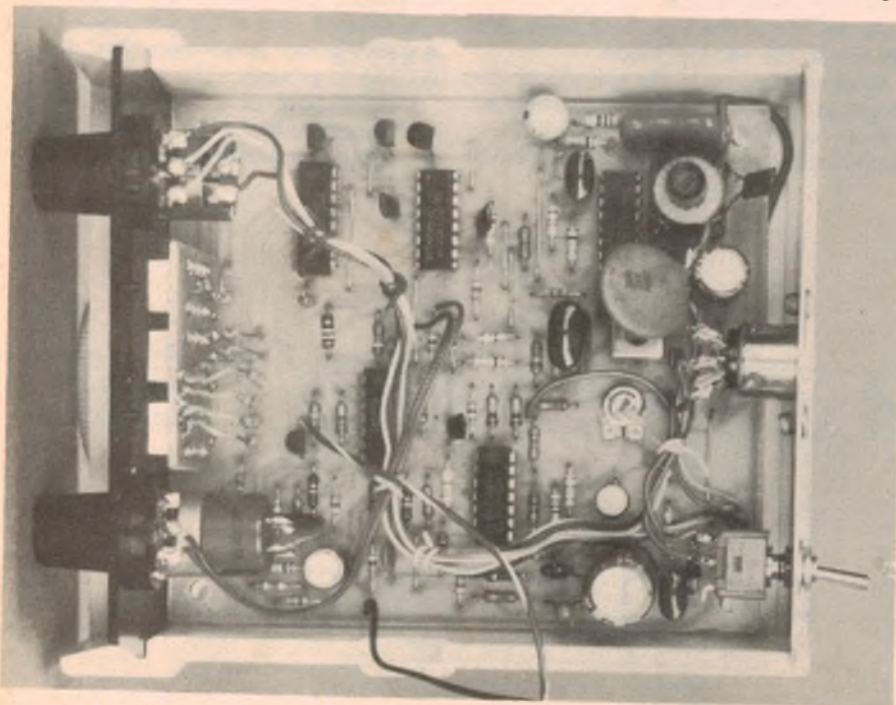

Close-up view of the completed PCB assembly. Note that the seven 680Ω resistors adjacent to the display board are mounted end on.

DEPTH SOUNDER

* SEE TEXT

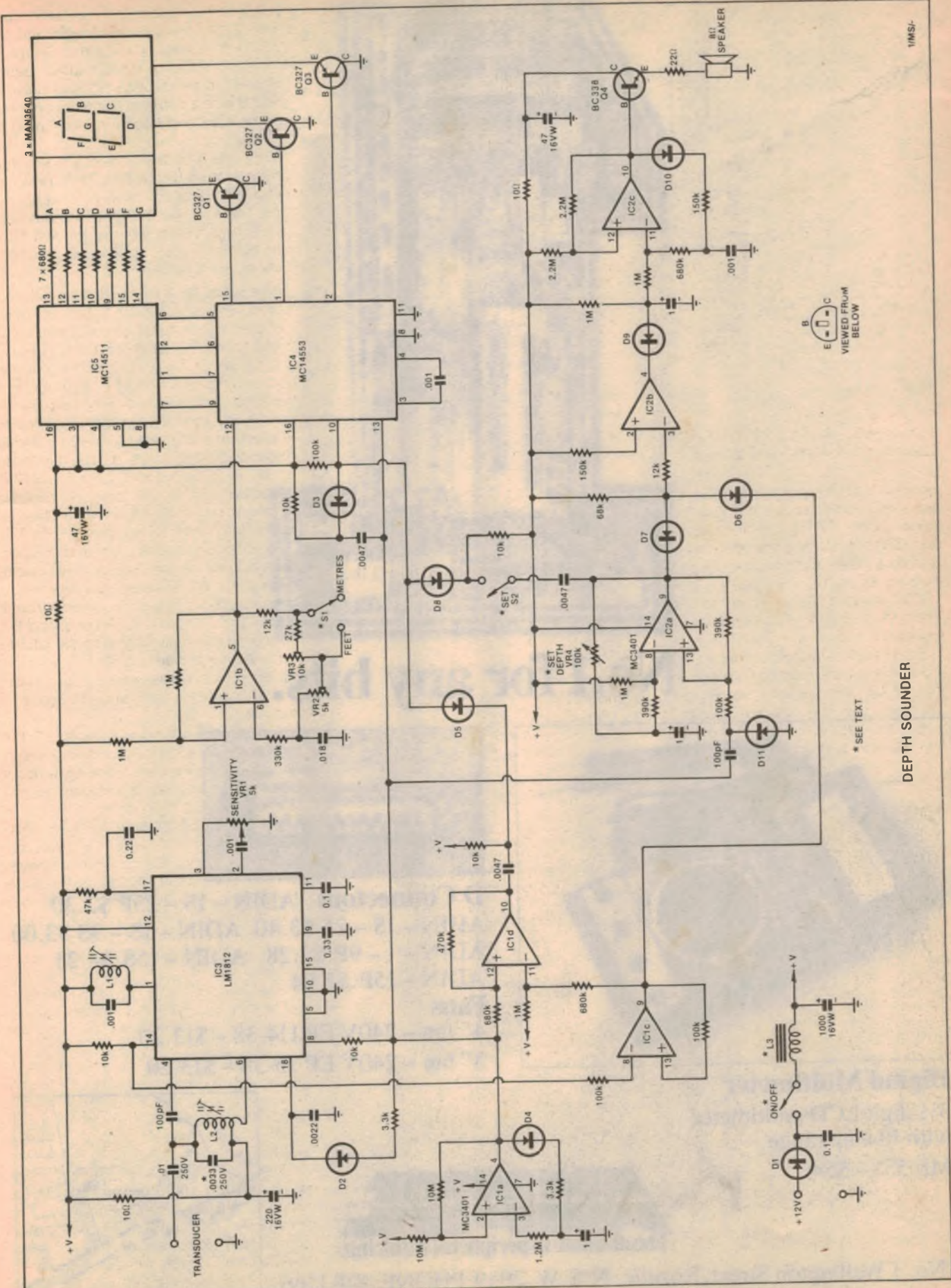
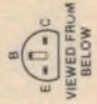

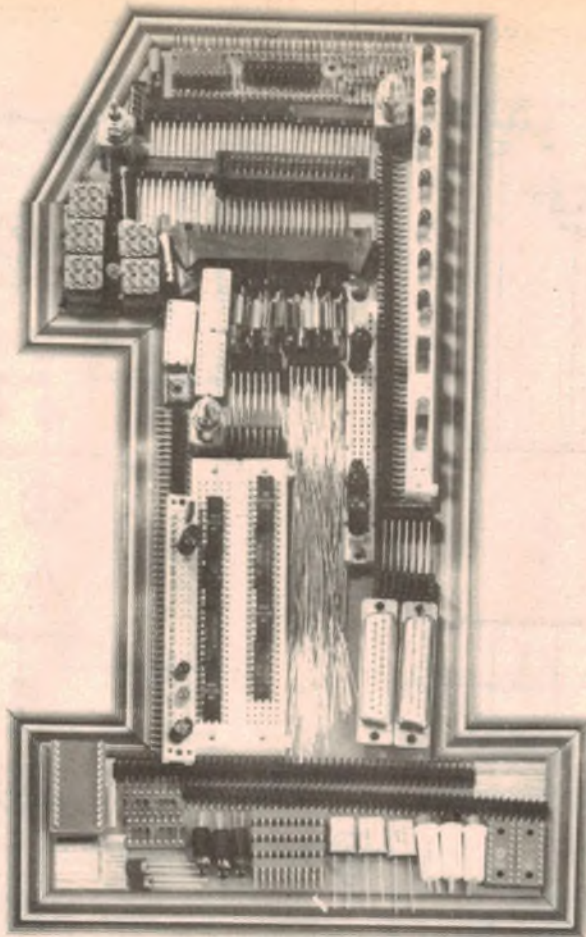

No.1 for any bits.

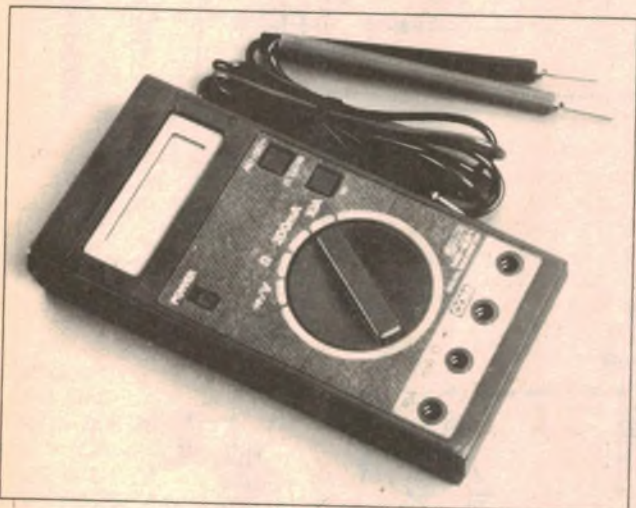

Digital Multimeter

3 1/2 digit LCD multimeter
with 10 amp range.

ME 531 - \$54

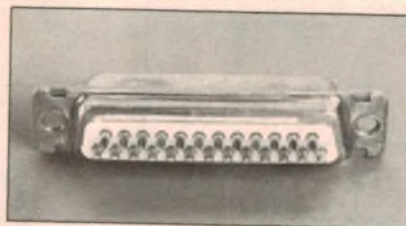

D Connectors ADIN - 1S - 25P \$2.30
 ADIN - 1S - 25 \$3.40 ADIN - 1S - 9S \$3.00
 ADIN - 1 - 9P \$2.28 ADIN - 15S \$4.23
 ADIN - 15P \$3.04

Fans

4" fan - 240V EP 114-38 - \$13.20

3" fan - 240V EP 75-38 - \$13.20



ANPEL
 The absolute in peripheral thinking.

No. 1 Wellington Street, Rozelle, N.S.W. 2039 PHONE: 818 1166

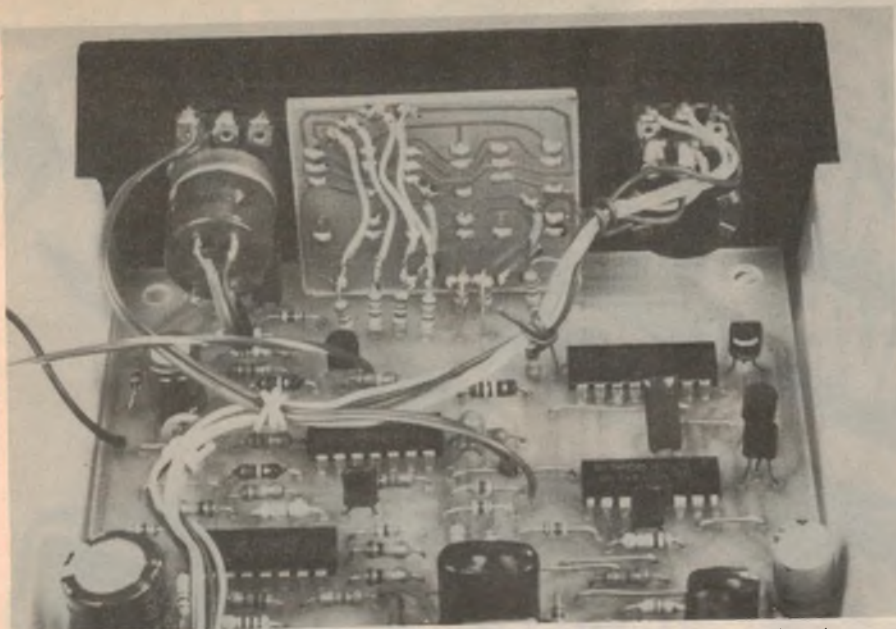

Front panel and display PCB details. Note that the spare switch pole on the alarm set control can be used to automatically disable the echo pulse (see text).

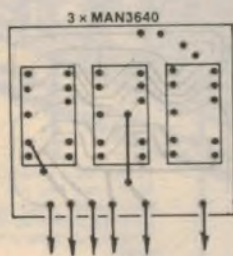

Parts overlay diagram for the display PCB. Insert the two wire links first.

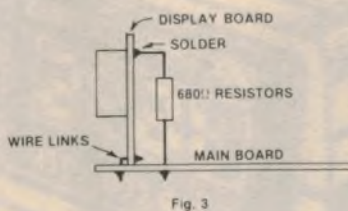

This diagram shows how four of the 680Ω resistors are mounted.

quency so that the display can read directly in either feet or metres.

The clock frequencies for IC1b are derived as follows: the speed of sound in water is approximately 1500m/s and is fairly constant over quite a wide range of temperature and salinity. It will therefore take 1s to receive an echo in 750m of water, since the sound pulse has to go down and up. Thus, if the clock is set to 750 pulses per second, the counter will count up to 750 and the water depth will be displayed directly in metres.

If we want the display to read in feet, then the oscillator frequency can be found simply by multiplying 750 by 3.28 (the conversion factor from metres to feet) which gives 2460Hz. Thus the clock must run at 2460Hz for feet and 750Hz for metres. A fathoms display could be achieved with a clock of $2460/6 = 410\text{Hz}$.

Finally, we come to the alarm function. The depth at which the alarm sounds is set using front panel "alarm set" control VR4. First, the "alarm set" control is pulled out to display the alarm setting. The control is then rotated until the display reads the required alarm depth and then pushed in again. The display immediately reverts to the water depth and, if this

is less than the alarm setting, an audible warning is produced.

All alarm functions are controlled by IC2, an MC3401 quad op amp. IC2a functions as a monostable multivibrator, the period of which is determined by VR4 and the $1\mu\text{F}$ timing capacitor. The monostable is triggered by the timebase pulse which is coupled in via a 100pF capacitor and causes pin 9 to go high, thus reverse biasing diode D7.

If an echo is received while the monostable output is high, then both D6 and D7 will be reverse biased for the duration of the echo pulse (ie for as long as pin 9 of IC1c remains high). This causes pin 3 of IC2b to go high and the pin 4 output to go low. Since it is now forward biased, the anode of diode D9 also goes low, enabling oscillator IC2c to start up.

IC2c is a voltage controlled oscillator whose frequency depends on the voltage at the anode of D9; ie the charge on the $1\mu\text{F}$ capacitor. Initially, the $1\mu\text{F}$ capacitor is discharged and the oscillator starts at a high frequency. When the echo pulse ends, D9 is reverse biased again and the $1\mu\text{F}$ capacitor charges towards the positive supply rail via a $1\text{M}\Omega$ resistor. As the voltage across this

PARTS LIST

- 1 printed circuit board, 111 × 100mm
- 1 printed circuit board, 41 × 35mm
- 1 SPST toggle switch
- 1 5-pin DIN socket and plug
- 1 plastic case, 125 × 140 × 58mm
- 1 front panel to suit
- 1 8Ω loudspeaker
- 2 knobs
- 1 U-shaped mounting bracket
- 2 mounting knobs for bracket
- 1 ultrasonic transducer kit
- 2 slug-tuned coils, L1 & L2 (available from Monitor Instruments)

SEMICONDUCTORS

- 2 LM3900, MC3401 quad op amps
- 1 LM1812 ultrasonic transceiver
- 1 MC14553 3-digit BCD counter
- 1 MC14511 BCD to 7-segment decoder
- 3 BC327 PNP transistors
- 1 BC338 NPN transistor
- 11 1N4001 silicon diodes
- 3 MAN3640 7-segment LED displays

CAPACITORS

- 1 1000μF/16VW PC electrolytic
- 1 220μF/16VW PC electrolytic
- 2 47μF/16VW PC electrolytic
- 3 1μF/16VW tantalum
- 1 0.33μF metallised polyester (greencap)
- 1 0.22μF greencap
- 2 0.1μF greencap
- 1 .018μF greencap
- 1 .01μF/250V disc ceramic
- 3 .0047μF greencap
- 1 .0033μF/250V disc ceramic
- 1 .0022μF greencap
- 4 .001μF greencap
- 2 100pF disc ceramic

POTENTIOMETERS

- 1 100kΩ linear potentiometer with DPST pull-on switch
- 1 10kΩ mini-trimpot, horizontal mounting
- 1 5kΩ mini-trimpot, horizontal mounting
- 1 5kΩ linear potentiometer with SPST rotary switch

RESISTORS (¼W, 5% unless specified)

- 2 × 10MΩ, 2 × 2.2MΩ, 1 × 1.2MΩ, 6 × 1MΩ, 3 × 680kΩ, 1 × 470kΩ, 2 × 390kΩ, 1 × 330kΩ, 2 × 150kΩ, 4 × 100kΩ, 1 × 68kΩ, 1 × 47kΩ, 1 × 27kΩ, 2 × 12kΩ, 5 × 10kΩ, 2 × 3.3kΩ, 7 × 680Ω, 1 × 22Ω, 3 × 10Ω

MISCELLANEOUS

- Rainbow cable, tinned copper wire, solder, styrene adhesive, epoxy resin.

capacitor rises, the discharge current from the .001μF capacitor slows and the output frequency drops lower and lower until eventually the oscillator stops.

NPN transistor Q4 simply functions as a

AT LAST! THE E.A. CAR COMPUTER— YOU CAN SAVE A FORTUNE! NOW IN STOCK!



Easy installation in your car's electrical system. PCB pins supplied for instant and reliable connection.

Professional quality silk-screened front panel (not just a Scotchcal panel as on some other kits). Ensures ultra long life and is virtually immune from scratch marks.

Our kit comes complete with specially designed case INCLUDED IN THE PRICE (don't pay \$30 extra!) Also included at no extra charge is a special mounting bracket to mount the computer either on or under the dashboard.

Large brightness matched LED readouts for top readability in most light conditions.

Specially imported multi-colour push button switches (as specified in the EA article) to make selection very easy while you're driving.

YES! The kit you've been waiting for is now a reality. Electronics Australia's new Car Computer is the ideal way to find out how your car is performing — and how much it is costing you to run it!

Now you'll be able to check fuel consumption — instantly — and find out exactly how much damage a lead foot does to your pocket.

All those questions you ask yourself as you're driving along can be answered — electronically — in a fraction of a second ...

- How much fuel is left?
- Can I make it to the next town?
- How far have I travelled?
- How long has it taken?
- How long have I got to go this trip?
- How far have I got to go?
- How much fuel have I used/am I using/will I use?
- What's my exact speed (much more accurate than the speedo)?

Inside: Two computer-grade double sided fibreglass printed circuit boards with plated-through holes for minimum soldering. Don't be caught with a PCB without plated-through holes: you'll regret it when you start construction!

Amazing technology: how is it done?

A few years ago a device such as this would have been virtually impossible to build — especially build yourself.

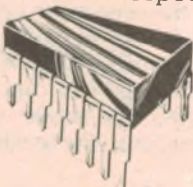

Dick Smith searched the world for the most important components — the fuel and speed sensors — and the brilliant design engineers at Electronics Australia did the rest! The result: a magnificent kit which really can save you a lot of money! Simply because it can show you how to drive really economically.

Cat K-3400

OUR KIT ONLY \$93⁵⁰
sensors extra

Special Computer Quality PC Board

Yes: we've not only made our board with plated through holes (as recommended by EA) we've also had a solder mask and component position overlay printed. You'll find it difficult to make an error!

Low Noise IC

We've arranged a special purchase of low-noise Schmitt trigger IC's (as used in the front end). Your Dick Smith car computer will be less prone to noise problems than other kits!

It will give you 12 different readings:

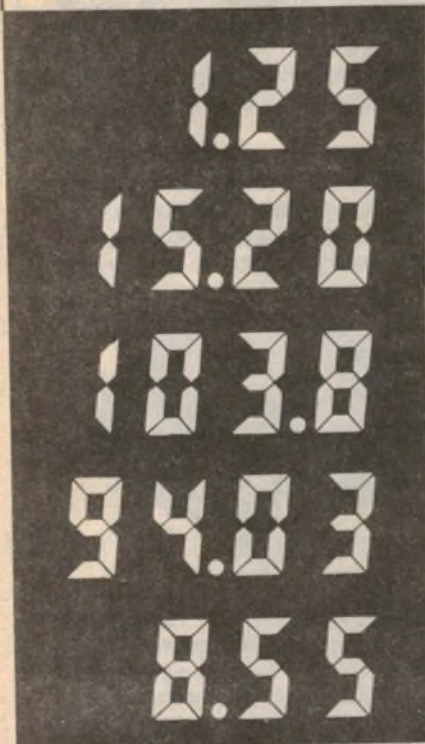

TIME

Either the time elapsed since the start of the journey (accurate to one minute) or the time remaining to complete the journey at your average speed since commencement (updated every minute or kilometre travelled).

FUEL

It will show you the amount of fuel you have used — or the amount of fuel you have left — or even how much fuel your tank can take at the moment!

DISTANCE

Your choice of distance travelled, or the distance remaining on this journey — or the distance possible with the amount of fuel you have left.

SPEED

Your exact present speed (much more accurately than your speedo can show!) or your average speed since the start of the journey.

CONSUMPTION

Either your present (instantaneous) consumption (lead footers: be prepared to be shocked!) or your average consumption since the start of your journey.

AND EVEN MORE REASONS WHY YOU SHOULD BUY YOUR KIT FROM DICK SMITH ELECTRONICS!

Exclusive!

Our unique 'Sorry Dick, it doesn't work' repair service. In the unlikely event that you can't get your kit working successfully, our Service Department will, for a fixed fee, repair, adjust your kit* as necessary to get it working properly. This fee includes all parts necessary.

*'Sorry Dick, it doesn't work' service available on specifically nominated kits, and we reserve the right to return your kit, with your service fee, should it be so badly wired or damaged as to make repair uneconomic.

Exclusive!

Our unique construction manual. We have a technical writer prepare a special step-by-step construction manual for most of our kits — so you don't have any problems. Everything is clearly and logically presented, with all construction information from the magazine — plus any other 'traps for young players' we discover along the way. We discover any problems before they affect you!

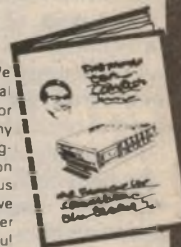

7 Day Trial Offer

if you're not completely happy, you can return the CAR COMPUTER within 7 days in original condition and packing for a full refund! You owe nothing — not even an explanation. So why not try the CAR COMPUTER today!

SOLE AUTHORISED AUSTRALIAN AGENTS FOR THE FAMOUS

MORAY FUEL FLOW SENSOR

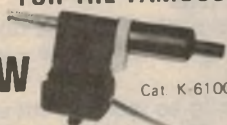

Cat. K-6100

(The one recommended by Electronics Australia) Don't be fooled — the ONLY fuel flow sensor to give optimum results with the car computer is the fully imported 'Moray' unit. And Dick Smith Electronics are the sole authorised Australian agents for this magnificent device. It delivers an incredible 1500 pulses per 0.1 litres (other kits may be supplied with inferior sensors delivering only 130 pulses/0.1 litres). So with the 'Moray' sensor you get incredibly increased accuracy.

\$69⁵⁰

DRIVELINE SPEED SENSOR



More accuracy — Easier installation

Knowing how incredibly difficult it can be to cut successfully a speedometer cable without risk of damage, we've decided to use the alternative (and, we think, much better) driveline sensor. A lot easier to install, it is not subject to the problems of speedo cables. And a further BIG advantage: when your speedo cable breaks (as they ALL do eventually) you'll still have a very accurate speedometer. (Not possible if you use the other sensor)

Cat. K-6102

\$8²⁵

SPECIAL OFFER: Buy both sensors and get the speed sensor for \$3.00! YES: The exclusive Moray Fuel Flow Sensor plus the Driveline Sensor at the bargain price of just \$72.50! This makes the complete Dick Smith Car Computer only \$166.00 — with nothing else to buy!

DICK'S PRICE
\$166

DOES NOT OPERATE ON DIESEL ENGINES

REMOTE DISPLAY OPTION

A number of customers have told us they'd love to own a car computer but that the project was simply too big to put on their dashboard. So we've solved that little problem.

This is the exclusive Dick Smith Electronics car computer remote display option. It simply connects in parallel to the existing displays in the main computer (these can be disabled if you like) and also with five of the push buttons (you select the readings you want the most). And all it measures is a tiny 110 x 70 x 50mm — complete with its own mounting bracket. Included are the four LED displays, five push buttons and the PCB's, plus enough rainbow cable to connect it all together. If you really want to have all functions displayed, there's plenty of room on the front panel to add at least another four small push buttons. Complete with full instructions — and remember, it's not available anywhere else!

NOTE: This important option is only available from Dick Smith Electronics



Cat. K-3405

\$21⁵⁰

DICK SMITH Electronics

SEE PAGE 98 FOR ADDRESS DETAILS

DSE/A312M/JW



buffer and drives a small loudspeaker in its emitter circuit via a 22Ω resistor. The result is a siren-like note pulsed at the timebase frequency.

The alarm can sound only if an echo pulse is received while the output of monostable IC2a is high. Thus, it is the monostable pulse width that determines the alarm depth and this is displayed by using the trailing edge of the pulse to trigger the latch enable (pin 10) of counter IC4.

First, however, the echo pulse must be disabled and this is done by setting the sensitivity control (VR1) to minimum. The output of monostable IC2a is differentiated by the .0047μF capacitor, and the negative going pulse produced at the trailing edge coupled via switch S2 (on the back of VR4) and diode D8 to the latch enable of IC4. Since the timebase simultaneously resets IC4 and enables IC2a, the display will now show the alarm depth in the appropriate units.

Power for the circuit is derived from a 12V battery (normally fitted to the boat). Diode D1 provides protection against reversed supply polarity, while 0.1μF and 1000μF capacitors provide supply decoupling and filtering. Choke L3 is not supplied as part of the kit, and is not fitted unless problems are encountered with ignition interference (see construction).

Construction

Construction can begin with the assembly of the main PCB according to the overlay diagram. Insert the wire links first, followed by the resistors, capacitors, coils, diodes and transistors. Take care to ensure that all polarised components are mounted the right way round.

The ICs should be inserted last. Note that IC4 and IC5 are CMOS devices and should be treated accordingly. When soldering these devices, earth the barrel of your soldering iron to the earth track on the PCB (use a small clip lead) and solder the supply pins (8 and 16) last.

The display PCB should be assembled next. Watch the orientation of the displays and note that the links must go in first. The display board is mounted on the main board using six tinned copper wire links along the bottom edge. In addition, four of the 680Ω current limiting resistors are mounted between the main PCB and the display PCB and, if these are bent as shown in Fig. 3, will provide additional support.

The front panel controls can now be mounted in position and the red perspex window cemented in place using epoxy adhesive. This done, wire the controls to the main PCB, and fit the DIN socket and feet/metres switch to the rear panel. Complete the wiring according to the main wiring diagram and Fig. 3.

TRANSDUCER ASSEMBLY

Begin the transducer assembly by glueing together the two plastic pieces forming the element housing. These are moulded in ABS so use a suitable styrene adhesive. Apply adhesive sparingly to the top edges of the "fried-egg" shaped piece and then press the two parts together, ensuring that the mounting holes are correctly aligned. Allow sufficient time for the adhesive to dry.

The barium titanate element must be prepared next. Carefully tin a small spot close to the edge of the element on each side and solder a short length of hook-up wire to each spot. Be very careful with this operation, as too much heat will burn the silver off the surface of the element. Wrap the circumference of the element in plastic tape, using the tape to hold one of the wires against the edge.

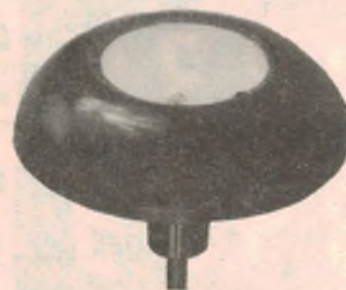
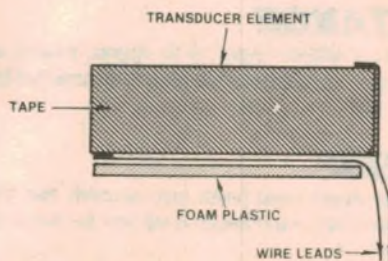

The surface where the two wires emerge is now the rear face of the transducer. Now lay the wire from the rear surface against the transducer and place the plastic foam disc in position. Use more tape to secure it in place. The two wires should now emerge from one side as shown in the accompanying diagram, and should be reasonably well supported by the tape. Leave about 25mm of wire free and strip and tin 3mm at the end of each wire.

Force one end of the coaxial cable through the hole in the stem of the housing and strip and tin the ends of the braid and the centre conductor. Carefully solder the coax to the wires coming out of the transducer assembly and insulate the joints with more plastic tape.

The transducer assembly must now be pushed into the housing, carefully pulling the coax down to avoid building up a loop of cable behind the transducer.

Push the transducer down in the housing so that its front surface is about 3mm below the lip of the housing cavity. Check the cable, at the other end, for shorts and if all is well put your meter on a low AC voltage range and tap the transducer with a screwdriver handle. You should see the meter give a kick, indicating that the transducer is functioning correctly. If not, check your connections carefully.

Support the transducer assembly face up, where it can be left overnight, and you are ready for the epoxy resin encapsulation. Do not use 5-minute epoxy. You must obtain some epoxy resin with a 6-12 hour setting time and carefully mix up sufficient to fill the transducer housing. After mixing, allow it to stand for about 20 minutes to allow the air bubbles to escape, then pour it into the transducer housing.

Fill the housing right to the top so that the transducer element is completely immersed and keep an eye on it for an hour or so, topping it as it runs down behind the element. Use a pin to prick any air bubbles that emerge. Take care here, as any air bubbles can drastically degrade transducer performance.

On no account should you use polyester resin — you must use epoxy. Epiglass 40 resin is quite satisfactory.

Finally, fit the DIN plug to the end of the cable, and fit the red and black supply leads.

Although not part of the original design, the circuit can be easily modified so that the echo signal is automatically disabled whenever S2 is closed. As supplied, there is a spare switch pole on the back of VR4, and this may be used to disable the echo signal by connecting it

between pin 2 of IC3 and ground. With this simple modification, you won't have to fiddle with the sensitivity control each time you wish to display the alarm depth.

The loudspeaker is fitted to the top half of the case (over the slots) by glueing it

JUST ARRIVED

Check the Incredible Low Prices!



THE GREATEST PRESENT A KID EVER GOT

Useful range up to 1/4 mile.

Cat D 1005 . . . \$12.50 ea . . . \$25 pr

These brilliant new KT5 "Walkie Talkies" are miles better than any comparable units we've seen (and that includes the super popular pocketcom which we sold over 10,000 sets a year or so ago). Crystal Locked Transmitter, 27.455 MHz operation, Quality Japanese manufacture, Morse Code Key, uses standard 9 volt transistor batter (Cat S 5009 . 50c extra) Clear crisp sound output — easy to operate. Grab a pair for your favourite son, daughter, nephew, grandson or the kid next door.

Cat D 1005 . . . \$12.50 ea
Batteries S 5009 (9V) . . . 50c ea.



AM/FM STEREO ROVER

Just the Shot for the Beach this Summer

Clear powerful stereo sound. Outstanding sensitive receiver supplied complete with headphones, carry case and batteries. Fits on the belt or use with the carry strap supplied. Fantastic Value at this price.

Cat A 0808 . . . \$39.50

HOW ABOUT THIS! NEW GALAXY 3883 STEREO RECEIVER WITH POWER BOOSTED SPEAKERS



Now you can have the best of both worlds — a personal stereo radio to carry around, plug in the booster speakers and presto you've got a great little home stereo.

The booster speakers each have an inbuilt amplifier which delivers quite amazing volume and clarity.

Battery Requirement (Not included)
Receiver 3 x AA (S 5003 . . . 25c ea)
Ea Speaker 2 x "C" cells (S 5002 . . . 35c ea)
Cat A 8820 (complete set) . . . \$89.50

REMEMBER! WE DELIVER NEXT DAY WITH JETSERVICE

CUSTOMER WARRANTY

We realise that a lot of these great bargains may be given as Christmas presents — so we have extended our Warranty on these to 31/3/83.

PUSH BUTTON PHONE

Was ~~\$59.50~~

Now Only \$39.50



Comes fitted with STD Telephone Plug

This nifty little phone has all the features of units selling near twice the price!

- * Last number redial memory & Mute Key
- * Rings on/off switch & Dialing Indicator

Attractive brown colour blends in beautifully with desktop and home furniture.
Cat A 0490 . . . \$39.50

"WALKMAN" TYPE PERSONAL STEREO



This has got to be the best value in Australia. Quality Japanese manufacture. Superb stereo sound.

Features: Fast forward/play/stop button. Sturdy all metal case, carry case and shoulder strap inc. Runs on 2 x AA Batteries.

Cat S 5003 . . . 25c ea extra
Cat A 8801 . . . \$49.95

"BRILLIANT UNISEF F-1 "WALKMAN" TYPE CASSETTE STEREO WITH AM/FM RADIO



The ultimate in Personal Stereo — The Unisef F1 has the works!

Sensitive AM/FM stereo receiver, quality Cassette player and powerful IC audio stage. Features stereo led indicator, separate channel volume controls, fast forward, cue, rewind controls, carry case and shoulder strap. Sturdy capstan drive cassette mechanism. Japanese reliability. Requires 4 x AA batteries.

(S 5003 . . . 25c ea extra). Quality headphones, carry case and shoulder strap supplied. Superb sound reproduction.
A8805 . . . \$99.50

AT LAST! HEAD CLEANERS THAT REALLY DO A 100% JOB



Our exciting new range of Kyowa (wet type) head cleaners are the best we've seen, and most importantly they are gentle on your heads!

Why risk damaging your video or audio cassette player with inferior units.

A 9200 Audio Cassette type . . . \$5.95
A 9300 Beta Video type . . . \$17.50
A 9310 VHS Video type . . . \$17.50

Great Xmas Gift Idea.

ALTRONICS

For Address, Phone No. and Despatch details see our Double Page Advertisement pages 64-65.



SHERIDAN'S

makes a clean sweep of the opposition prices!!

WOT ABOUT THIS!! LITRONIX DISPLAYS

1st time offer - Litronix Red Single Digit Light Pipe Dip "Displays"
Type: DL-750 common cathode display
Character height: 630"
7 segment D.P. left light output (MCD)
Typ 5.0 Min 2.0 = 20ma
Fwd. volt Typ 3.4 Max 4.00



ONLY \$9.00 for 10!!

2716 EPROMS

A fantastic scoop purchase of prime spec 2716 EPROMS by National. This is a once in a lifetime offer. Be quick and grab them now!!

\$3.99

10 for \$37



HUGE SAVINGS ON PHILIPS HEATSINKS

Type 45D3CB

13cm wide 7½cm tall 6cm tall undrilled, black anodised ready to use on amps, powersupply etc Limited stocks going out the door at

only \$6.50

Type 55D6CB

Huge cooling fins for the biggest job. Now at this crazy low price. 19cm wide 15cm tall 6cm deep Get in early at

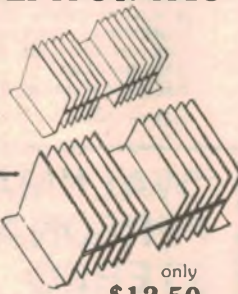

only **\$12.50**

IC CLEAROUT

Huge shipment of ICs at under wholesale prices must be cleared soon. Prices are slashed to an all time low!!

4001AE Quad two input nor gate

10 for \$1.20

100 for \$10.00

1000 for \$90.00

4020 14 stage ripple/carry binary counter divider.

10 for \$3.00

100 for \$25.00

1000 for \$220.00

All these are brand new prime spec devices from SGS-ATES



\$100 SOCKETS SLASHED

Solder type **\$4.00 each** or **10 for \$36.00**. Wire Wrap type **\$6.00 each** or **10 for \$55.00**

PLUG BARGAINS

3.5mm miniature phono plugs.

10 for \$1.80

100 for \$12.00

75 ohm plastic body coax plug

10 for \$1.50

100 for \$10.00



FANTASTIC DEALS ON MINIATURE SWITCHES

These switches are selling at less than half the normal retail price. All are top quality with 2A/250VAC contacts. Under wholesale price. Only available in lots of 10 at these prices

SPDT 10 for \$6.00

DPDT 10 for \$7.00

2SP centre off (Lock/lock)

10 for \$9.00

SP centre off (Lock/spring return)

10 for \$9.00

DP centre off (Lock/lock)

10 for \$10.00

DP centre off (Lock/spring return)

10 for \$10.00

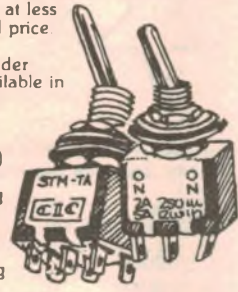

TRANSISTOR BARGAINS

BD537 50W/8A/80V TO220 power transistor

10 for \$2.00

TIP29B 10 for \$2.00

NPN Power Transistor

BC547. BC557 \$6.00 per 100

2N3565 NPN 30V 200mV small signal

10 for \$1.00



MOSFET POWER AT GIVEAWAY PRICES!

2SK134 and 2SJ49 Back in stock at unbeatable prices again **\$5.50 each** or **\$5.00 each 10 up**. (Note the ten up price is for 10 of one type, not for a mixture of types)



PUSHBUTTON DIALER

Back again at a clean sweep price. This quality fully guaranteed dialler connects in seconds with the easy to understand instructions. No soldering or technical knowledge required. Has last call memory. Speedy dialling doesn't cost a fortune.



only \$24.95

Not Telecom approved.

RELAY BARGAINS

New shipment of superb miniature PC mount relays. Both types have SPDT contacts. Rated at 1A/125V and 2A/30V 5V-75ohm coil and 12V-400ohm coil only **\$1.75 each \$1.50 each ten up**.



BRILLIANT NEW LCD GAME/CLOCKS

These superb new Japanese game clocks are simply the best we have seen. And of course we are offering them at a fantastic introductory price. These games are a real challenge to play (Harder than Game and Watch). Both include a clock with alarm function.



CUPID'S ARROW

Shoot a heart. The devils prevent the heart going up **\$19.95**.

Both games have 2 levels and a clock/alarm function. Others are charging over \$30.00 but look at our tiny price!!

What a steal!!!

FIGHTING CLIMBER

Find a way out to the top roof by avoiding many falling obstacles and get out by helicopter. But beware of King Kong!!! **only \$19.95**

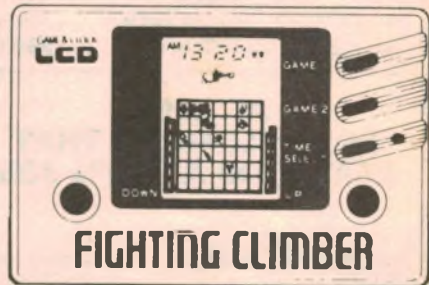

BUY THE PAIR FOR ONLY \$36.00

SHERIDAN ELECTRONICS

164-166 Redfern St., Redfern NSW 2016. Phone (02)699 6912, (02)699 5922
Mail Orders to Dept EA, PO Box 229 Redfern NSW 2016

Trading Hours:-
Mon-Fri 9am-5:30pm
Thursday 9am-7pm
Saturday 9am-12noon

Mail Charges:-
\$5.00-\$9.99 \$2.50
\$10.00-\$24.99 \$3.00
\$25.00-\$49.99 \$5.00
\$50.00-\$99.99 \$6.00
\$100.00 or more \$7.00

Heavy or bulky items sent freight forward by 'Overnighters'



in place with contact adhesive. A piece of cloth is provided to cover the slots. Connect up the speaker, fit the transducer DIN plug with a couple of flying leads for the power connections, and you are ready for the smoke test!

Apply power (12V) and switch on. All being well you should be greeted by a chirp from the speaker and the display should read 000 or 001. Make sure that the alarm set control is pushed in and fully anticlockwise (ie alarm off).

Now set the sensitivity control to minimum (to disable the echo pulse) and pull out the alarm set control. Slowly rotate the alarm set control clockwise and check that the display shows progressively higher numbers. If this check is OK, operate the feet/metres switch and check that the display changes by a 3:1 ratio. With the alarm set control fully clockwise, the display should read a maximum of approximately 30 metres (VR2 and VR3 roughly midrange).

Now turn the alarm off and the display should go back to zero. Turn the sensitivity control fully clockwise and lightly tap the face of the transducer with a screwdriver handle. The display should flicker and momentarily read some random numbers. If the alarm is now set to maximum depth it may be possible to trigger it by tapping the transducer face as above. (It will only trigger if you "hit" upon an echo reading of less than the alarm setting.)

Calibration

If all the above tests work, your depth sounder is functioning and will give readings if taken out in a boat. However, it has to be tuned and calibrated if we are to obtain maximum sensitivity and if the readings are to be accurate. If you have access to the appropriate test gear this can be easily done on the bench; if you don't have test gear, the only way is to take the instrument out on the water.

Assuming that you don't have test gear, the procedure is as follows:

- Tuning: advance the sensitivity control until an echo is obtained then back it off until the echo is just lost. Now tune L1 carefully until the echo reappears (display reading). Reduce the sensitivity again and continue the process until the optimum setting is found for L1. L2 can be tuned in the same way, but as this has a low Q, its setting is not so critical. Most units will tune with the slug of L2 about flush with the top of the former.

- Calibration: once the tuning is done, the calibration can be set if you have a chart. The problem is to find a known depth of water and set VR2 and VR3 to the known depth. Do not forget to allow for the fact that the transducer may not be at the surface if it is mounted on the

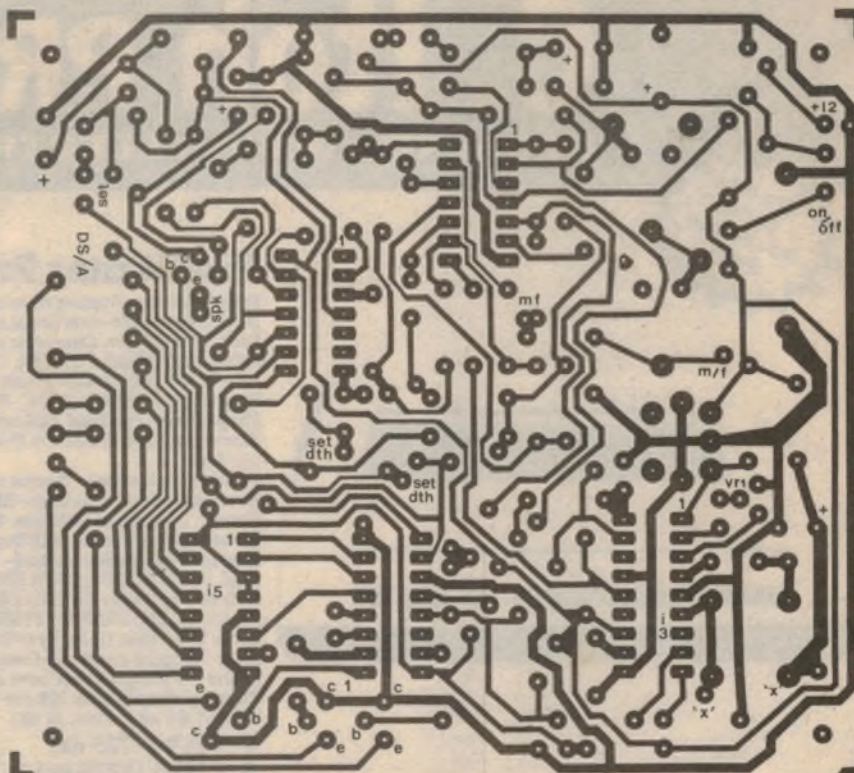

This actual size PCB artwork is reproduced for readers who like to make their own boards. Finished boards are available from Monitor Instruments.

bottom of the boat; ie the instrument reads depth beneath the transducer.

It may even be possible to resort to the good old lead line to get an accurate depth measurement.

First, set switch S1 to the "feet" position and adjust trimpot VR2 until the display shows the correct depth. This done, set S1 to "metres" and adjust trimpot VR3. Note that VR2 must be set first as it affects the setting of VR3.

If you have access to an oscilloscope, a signal generator and a frequency meter, the procedure is somewhat different:

- Tuning: connect the oscilloscope probe to pin 1 of IC3 and couple in a

200kHz signal to L2 via the .01μF capacitor. Now adjust L1 and L2 for maximum signal strength.

If no signal generator is available, then it is possible to get a signal echo in air. Clamp the transducer to the underside of the workbench and check that the unit is over a hard floor (carpet will not reflect ultrasound). Once an echo is being received, simply tune L1 and L2 for maximum signal strength. (Note: because of the much lower velocity of sound in air than in water, the display will read about four and a half times the actual distance.)

- Calibration: a frequency meter con-



Basic Electronics

For the beginner, or for the hobbyist as a reference book and almost certainly the most widely used manual on basic electronics in Australia.

It is used by radio clubs, in secondary schools and colleges, and in WIA youth radio clubs.

Begins with the electron, introduces and explains components and circuit concepts, details the construction of simple receivers. Separate chapters on test instruments, servicing amateur radio, audio techniques, stereo sound reproduction.

Available from "Electronics Australia", 57 Regent St, Chippendale 2008. PRICE \$3.50 OR by mail order from "Electronics Australia", PO Box 163, Chippendale 2008. PRICE \$4.40



C. Itoh PRINTERS

FROM ROD IRVING ELECTRONICS

SPECIAL OFFER NOVEMBER ONLY

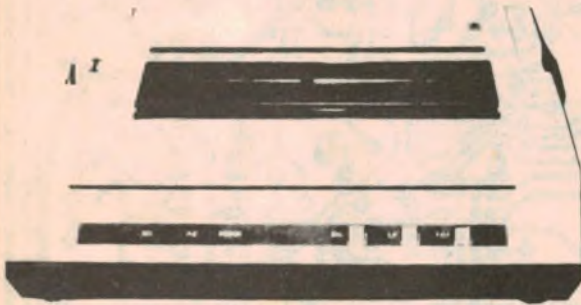

Pro/Writer Printer 8510

Print Features: Number of columns—136 col. max. Print Speed—120 CPS. Print Direction—Single-directional and Bidirectional, Switch Selectable. Throughput Speed—From 44 to 152 lpm. Character spacing (max. number of columns per line)—Pica 10 CPI (80), Double Width 5 CPI (40), Compressed Font 17 CPI (136), Double Width 8.5 CPI (68), Elite 12 CPI (96), Double Width 6 CPI (48), Proportional Double Width Proportional. Line Spacing—Variable to 1/144". Print Width—203 mm (8") max.

Forms Type: Fan Fold Roll or Cut Sheet: Width—113 mm to 254 mm (4.5" to 10.0"). Total Thickness—0.05 to 0.28 mm (0.002" to 0.011"). Number of Copies—Original + 3 copies nominal.

Form Feed: Method—Tractor or Friction. Form Loading—Either rear or top.

Interface—Serial: Method—EIA RS232-C and 20mA (40 & 60mA switchable option)

Current Loop Serial Interface. Baud Rate (BPS)—110, 300, 600, 1200, 2400, 4800, 9600.

Transmitting Method—Half Duplex. Synchronization—Asynchronous.

Interface—Parallel: Method—TTL compatible, 7-bit, parallel interface. Control Signals—ACK, BUSY, SELECT, DATA STB, INPUT PRIME FAULT, INPUT BUSY, PAPER EMPTY. Instruction Codes—(ASCII): CR, LF, VT, FF, CAN, SO, SI, DEL, DC1, DC2, DC3, DC4, GS, RS, US, FS, EM; GRAPHIC SYMBOLS: BIT GRAPHICS.

Error Detection: (1) Parity (VRC)—Odd, Even, No-parity. Switch selectable. (2) Framing Error—Stop bit check. (3) Overrun Error—Error is detected when data are received before the previous data have been processed.

Physical dimensions: 398 mm W x 120 mm H x 285 mm D (15.7" W x 4.7" H x 11.2" D).

Weight: 8.5 kg (18 lbs., 12 oz.)

P* \$759 (\$725 ex)

S \$845 (\$775 ex)**

Model 1550

The Model 1550 is a compact desk-top dot matrix serial impact printer used for data communication terminals, hardcopy of CRT displays, peripheral terminals for minicomputers and microcomputers, and small-sized business systems.

The character format is a dot matrix of 7(H) x 9(V), or 8(H) x 8(V).

Print speed is 120 characters/second. Up to 136 characters can be printed per line at 10 CPI.

Its main features are: • Compact desk-top dot matrix printer • 136-column print • Lightweight • Low power-consumption • High-quality print • Bit image graphics • Graphic Symbols • Prints in six different languages • High reliability • Low cost.

P* \$1225 (\$1050 ex)

S \$1275 (\$1195 ex)**

F-10 Printmaster Daisy Wheel Printer

Print Speed: 40 CPS. **Print Method:** Static Print Impact. **Number of Printable Columns:** 136, 163, Variable. **Character Spacing:** 1/120 Inch (minimum). **Line Spacing:** 1/48.

Return Time: 900 msec. **Line Feed Time:** 40 msec. **Paper Width:** 406 mm (maximum).

Print Characters: 96. **Printwheel:** Industry Standard 96 Character Wheel. **Interface:**

Industry Standard 8-bit Parallel, RS232-C Compatible, X-ON, X-OFF, 12-bit Qume and Diablo Compatible. **Dimensions:** 574 mm W x 405 mm d x 153.5 mm H (22.5" W x 15.9" D x 6" H). **Weight:** 14 kg (30.8 lbs.) with cover and power supply. **Noise:** Less than 65 Db (1M from Platen, A Scale).

P* \$1600 (\$1450 ex)

S \$1750 (\$1510 ex)**

* Parallel Interface ** Serial Interface

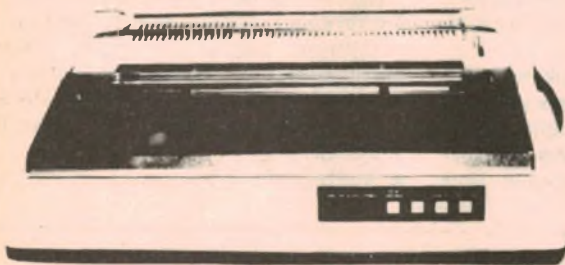
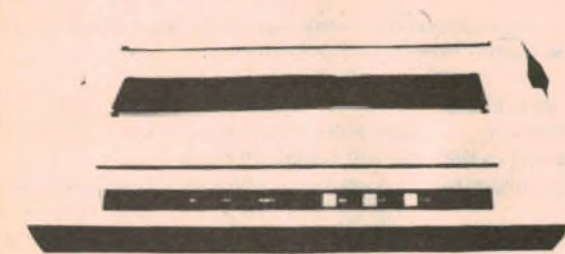

Extra Special Microline 80
\$499 incl. tax \$435 tax exempt

RITRONICS WHOLESAL

425 HIGH STREET, NORTHCOTE 3070. MELBOURNE. (03) 489-8131.

TO ORDER: Heavy items sent Comet Freight on Mail Order Phone 481-1436. Wholesale Customers Phone: 489-7099. Mail Orders to RITRONICS WHOLESAL, P.O. Box 235, Northcote 3070. Minimum P&P \$2. Add extra for heavy items, registration and certified mail. Prices and specifications subject to change without notice.

Turn to Page for our Big Board Specials

Bankcard mail orders welcome
ORDER FORM
Please Debit my Bankcard ETI 10/82/6
No.
Expiry Date
Name
Signature



nected to pin 5 of IC1b will allow precise setting of VR2 and VR3 to 2460Hz and 750Hz respectively. Alternatively, you can use a CRO or a frequency meter to set the periods to 406µs and 1.333ms respectively.

Once the unit is tuned and calibrated it may be mounted in the case. To do this, lay the top half of the case (the half with the speaker in it) upside down on the bench and sit the circuit board on the four mounting pillars. Fit the front and back panels into the slots provided and fit the large brass nuts into the cavities in the sides. Ensure that the board holes line up with the mounting pillar holes and fit the bottom half of the case.

The two halves will fit together closely and the four 12mm x No 4 self tapping screws may be fitted through the bottom holes and screwed into the mounting pillars. The U-shaped mounting bracket may now be attached with the large plastic knob-headed screws. Fit the front panel control knobs and your instrument is ready for use.

Operation

The transducer is the key to satisfactory operation of any depth sounder and a few tips on mounting may not go astray. Many people have mounted transducers inside the hull in a "waterbox" and it is possible to get satisfactory results with this method. However some sound attenuation will occur and this will reduce the range of the instrument. In the worst case it may not work at all.

The best mounting method is on the outside of the hull, roughly in the middle third of the boat and as close to the centre line as possible. It must be clear of any fittings and in an area of clear water flow. Turbulence and bubbles under the

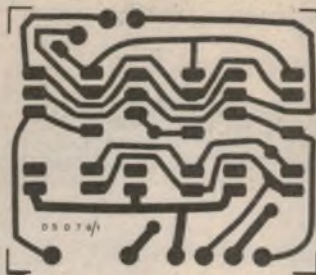

Above is the actual size artwork for the display PCB.

transducer will reduce its performance. In yachts, hull heeling under sail will cause the transducer to fire its sound beam out at an angle and this will reduce sensitivity — if the boat heels far enough the echo may be lost altogether. Mind you when this happens the crew is usually too busy to be looking at echo sounders!

Installation of the unit should be straightforward, but keep the transducer and all leads as far away from the engine as possible to avoid ignition interference. If ignition interference does prove a problem (ie the display reading fluctuates randomly), choke L3 will have to be fitted in place of the appropriate link on the PCB. This should be a power supply choke of around 10mH in value.

Because this choke is not available from Monitor Instruments, it will have to be purchased separately if required.

The maximum depth range attainable with this instrument will vary considerably and depends on a number of factors including: tuning accuracy, transducer mounting, water turbulence and bottom reflectivity. Bottom reflectivity will be high with a flat sandy bot-

tom and may be nil with heavy weed growing over soft mud.

A typical unit should give a depth range of from 80-120 metres without any difficulty and possibly more with careful tuning and installation.

Note that apparently strange readings can occur with this type of instrument because the display is triggered by the first echo received. For example, echoes may be received from cold layers in the water, undersea currents, propeller wash from other boats and even fish. The usual effect of this is a steady bottom reading of 30 metres say, with occasional readings of much less; eg a fish at 20 metres or a salinity or cold water layer at 15 metres etc.

Where to buy the kit

A complete kit of parts for this depth sounder is available from Monitor Instruments, PO Box 116, Rosebery 2018. Cost is \$143 for the kit or, if you prefer, \$203 for a fully-assembled and tested unit. These prices include postage and packing.

If you are unable to get the kit working, Monitor Instruments offer a repair service for a standard \$25 fee (includes postage and packing), but reserves the right to return any kit which is badly wired so as to make repair uneconomic. The repair charge will be \$60 in the event that the fault lies in the transducer.

Note that because the PCB is a proprietary design, it will not be available from other kit suppliers. Similarly, the transducer is not sold as a separate item, although it may be possible to purchase an equivalent unit from a ship's chandler. All other components, including the PCB, are available on a one-off basis from Monitor Instruments.

BILCO ELECTRONICS

ELISTRONICS

Breadboard system

IZUMIYA IC INC.

Printed Circuit Aids

ARLEC

Transformers and accessories



OK MACHINE & TOOL CORPORATION

Wire wrap tools & equipment



TOYO

Mini lathes and drills

PRODUCTS AT COMPETITIVE PRICES INCLUDE:

- ★ Complete range of transistors, resistors and capacitors
- ★ Meters and instruments ★ LED and LCD Displays ★ Plugs, sockets, cables
- ★ Boxes and printed circuit boards ★ Tools and hardware ★ Books and magazines.

Shop 2, 31 Pultney Street,
Dandenong, Victoria, 3175.

Telephone: (03) 791 8655

Bill Street & Co's new shop at Dandenong is the answer to every electronic enthusiast's needs.

You are invited to inspect the self service display of components and equipment ranging from a variety of kits for the amateur, to Hi Power Rating S.C.R.'s and Diodes, etc for industry.

HOURS OF TRADING:

Mon. — Thurs.	8.30am — 5.30pm
Friday	8.30am — 9.00pm
Saturday	8.30am — 12 noon

Harness the sun for tranquillity with a

Solar-powered Fountain

Over the last few years small ornamental fountains and garden pools have become very popular with Australian householders. And with good reason. Bright sunshine and trickling water go together to add sparkle and charm to any garden. But there is a way to add more charm and interest and that is to run the fountain from solar power.

by LEO SIMPSON

When the sun shines the fountain runs. That is the concept used here in applying silicon solar cells to run a fountain pump.

In a way, the concept of using solar power to run a fountain is a return to the original method used by the early Greeks and Romans. They used water from mountain streams and springs and brought it long distances in aqueducts to supply their needs for fresh water and incidentally, to provide the cooling and soothing effects of fountains. That was an early use of stored solar energy.

Up till now, if you had a yen for a cascading garden pool or fountain, it had to be mains-powered. This meant the need for a full mains installation or a power supply for a low voltage installation. As well as that, you would have to remember to turn the pump on and off or use a mains timer. For many people this probably amounts to too much trouble and after a while the fountain is likely to fall into disuse.

When the sun shines your fountain runs, the process is completely automatic. You don't have to remember to turn on anything and there is no cost, (apart from the initial investment). And there is a further benefit. The amount of water going through the fountain is proportional to the amount of sunlight actually present from moment to moment. If a cloud partially obscures the sun, the

flow will drop to a trickle and then stop altogether if the sun is totally covered. Then it will burst into life as the sun comes out again.

In designing this project, "Electronics Australia" has arranged with Amtex Electronics for the supply of a suitable pump and the principal parts for a solar array consisting of 14 75mm diameter solar cells and Lexan or similar polycarbonate glazing sheets.

The pump which is to be supplied for this project is designed as a bilge pump. Called the "Bilge Mate", it is a submersible impeller pump with a sealed permanent-magnet motor. It is rated at 1400 litres/per hour for an input of 12 volts DC at 3.2 amps. A particular advantage of this pump is that the motor itself is not cooled by the water being pumped and is thus less likely to be clogged by vegetable matter in the water.

When used at 12 volts the Bilge Mate pumps far more water than is likely to be desired for a small garden fountain or pool. Operating the pump at a lower voltage reduces the volume of flow as can be expected but it also reduces the current drain appreciably. At below six volts the current drain is less than one

amp which is within the capacity of the supplied solar cells.

While solar cells normally have a nominal open circuit voltage (when fully illuminated) of 0.6 volts, this normally drops to around 0.4 volts under load. With fourteen cells, the total supply voltage varies between 5.5 and 6.4 volts, depending on the available sunlight. This is sufficient to give an adequate flow of water for most small fountains and circulating garden pools. We estimate the volume to be around 300-500 litres per hour.

This assumes that the pump is working against a head of about 30cm or so. If working against zero head the pump is less efficient. Maximum head is about 1.2 metres. At around 6 volts, the pump is considerably derated so it should have a long life.

Construction of the Array

A number of problems must be taken care of in making an array of the 14 solar cells. First, they must be held securely and protected from any flexing which would crack them. No strain must be placed on the grid (negative) connections otherwise they may be damaged.



The principles of solar cells

Silicon solar cells are photovoltaic. They generate a voltage in response to light falling upon them. The cell is a pn junction as shown in Fig. 1. Light falling on the cell generates hole-electron pairs which are swept away to the two electrodes to produce a voltage between them.

The amount of energy needed to release electrons is called the band gap of the material and this is ex-

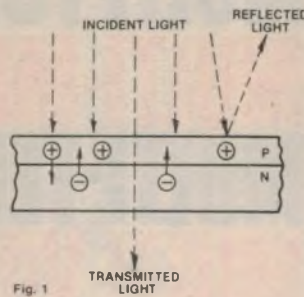

pressed in electron-volts. Silicon has a band gap of 1.12eV and this gives a cell with a maximum open circuit voltage of 0.6V.

The characteristics of a silicon solar cell are shown in Fig. 3. When not illuminated, the cell behaves like an ordinary diode with heavy currents flowing for forward voltages in excess of 0.6 volts. For reverse voltages relatively small currents flow. This is shown on the dark characteristic curve.

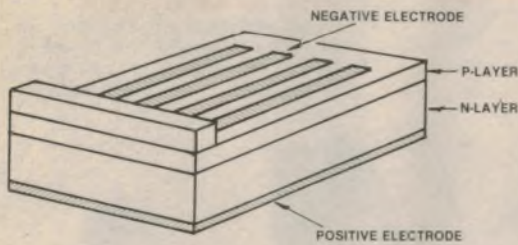

When light falls upon the cell it

generates an open-circuit voltage V_o , or delivers a short-circuit current I_s which is also the reverse current without any voltage applied. The

or cadmium sulphide or gallium phosphide. This has a grid pattern for the negative electrode connection.

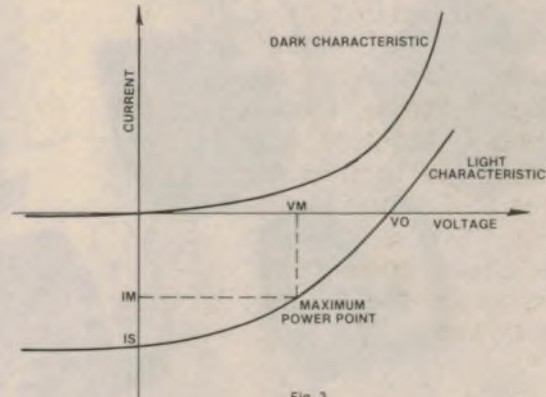

The cells must also be protected from the weather while being exposed to as much solar radiation as possible. This latter factor means that they cannot be housed under ordinary glass as its iron content will unduly attenuate ultraviolet radiation. The preferred glazing material for this application is Lexan (made by General Electric) or an equivalent transparent polycarbonate material.

Two sheets of this polycarbonate material will be supplied with the cells and the pump. Both sheets will measure 600x180mm, one 3mm thick and one 2mm thick. The thin sheet is the top cover while the thick sheet becomes the base.

A series of holes is drilled in the base sheet so that the connecting leads to the cells can be passed through it and interconnected. In practice this means that an 8mm (5/16-inch) hole should be drilled under each cell to make the positive connection while a small hole (about 2mm) adjacent to each cell allows the negative lead connection to pass through. Two holes are also drilled at one end of the array to take a pair of binding post terminals (one red, one black)

The "Bilge-Mate" pump must be fully immersed in the pool and should work against a head of at least 30cm for best results.



**EVERYTHING YOU'VE EVER
WANTED IN AN AUDIBLE ALARM!**

AudioLarm



**MULTI-FORM
MULTI-MODE
MULTI-TERM
MULTI-VOLT**

WHAT FORM!

8 models with mounting styles and body depths to suit your application. They're small, rugged, durable and tamper proof. No moving parts and economy priced. Even work under water.

WHAT SOUND!

Take your pick. Tweeter, Siren, Warble, Beep or Continuous Tone. High sound output. Low current consumption. Up to 90db output. More alarming and fail-safe too!

TERMINALS GALORE!

P.C. pin, quick connect, direct solder, colour coded wire lead and more. Easy to fit. Even quicker to connect. Labour saving simplicity.

O.E.M. DESIGN ENGINEERS

know AudioLarm for its versatility. Take the voltage ranges, 5-15 VDC through to 140-270 VAC. A choice of seven operating voltage ranges. AudioLarm has it all!



C & K Electronics (Aust.) Pty Limited

15 Cowper Street, Parramatta, NSW 2150
PO Box 229 Parramatta NSW 2150
Telephone (02) 635 0799 Telex AA23404

Agents Melb 598 2333 Adel 277 3288 Bris 36 1277
Perth 458 7111 Hobart 34 2233/Launceston 31 6533

RADIO DESPATCH SERVICE

869 George St., Sydney,
NSW 2000 (Near Harris Street)
Phone 211 0816 • 211 0191

Open: Mon-Fri 8am to 5.30pm
Thursday night late shopping
till 8.30pm Sat 8am to 11.45am

**MAIL
ORDER
CUSTOMERS**

P&P CHARGES:

Local (NSW) \$3.50
Interstate \$4.50



DIGITAL MULTIMETERS



HANDHELD MODELS

	Tx Ex \$	Tx Paid \$
8020B	210.00	238.48
8021B	165.00	187.38
8022B	155.00	176.02
8024B	265.00	300.94
Case	15.00	17.03

(All handheld models)

BENCH MODELS

	Tx Ex \$	Tx Paid \$
8010A	290.00	329.33
8012A	375.00	425.86
8050A	415.00	471.28
Case	40.00	45.43
(8010A & 8012A only)		
Case	55.00	62.46

Note:

Handheld DMM's include battery, test leads, instruction manual, pocket-size operator's card and certificate of calibration.

Benchtop DMM's include line cord, test leads, instruction manual, and certificate of calibration.

COME AND SEE US NOW!



MAIL ORDERS TO: RADIO DESPATCH SERVICE

869 George St., Sydney 2000

Phones: (02) 211 0191 • 211 0816

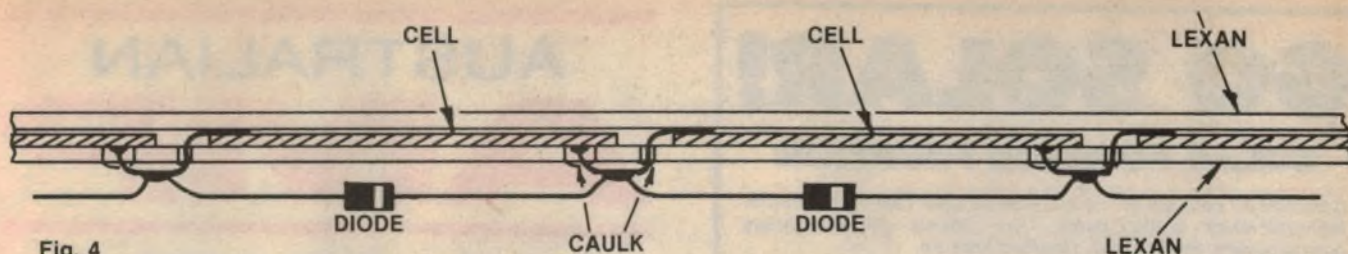

Fig. 4

This diagram shows the sandwich construction of the array with the cells held between two sheets of Lexan.

for the output connections to the pump.

The method of construction is as follows. The Lexan sheets are supplied with protective paper covering on both sides. This allows you to mark the positions of holes to be drilled with a soft pencil. Keep all holes in two straight lines so that the resulting wiring is neat and tidy. Do not remove the paper backing until all holes have been drilled and deburred. Do not use too high a drilling speed for this job otherwise the material will tend to melt.

Having drilled all the holes, remove the paper backing and place a dab of Dow-Corning silicone caulking compound in the centre of each cell mounting position on the sheet. Then place all cells in their respective positions and line them up so that their grids are oriented in the same direction. Be very gentle in handling the

the cell connections. (We used a ribbon of tin foil for connections on our prototype but this is not available).

It is essential that you use a low-powered soldering iron with a small tip. Preferably, it should be a temperature controlled iron. Be very careful when making the solder connections to apply the very minimum of heat to the cell tab connections as they can easily lift from the cell surface.

Having made a connection to the top tab of each cell, pass each connecting wire through the Lexan sheet. Place the top Lexan sheet over the cells and then turn the entire sandwich assembly upside down so that the solder connections can be made to the underside of each cell, via the 8mm access holes.

Proceed until all the cells are connected in series. Then temporarily

the pump should start immediately and pump at a reasonably high rate. With no outlet pipe attached to the pump it will place maximum loading on the array which should deliver 5.5 volts or more in bright sunlight. Under these conditions each cell should deliver about 0.4 volts.

If the pump does not run it is probably because you have a bad connection to one of the cells or one of them has become partially open circuit. The voltage checks above should reveal any defect of this sort.

If one of the cells is defective, try bridging it out with a jumper lead. The pump should now run. However, if you have been reasonably careful in assembling the array you should not have any problems.

With these checks complete, we suggest the addition of a diode across each

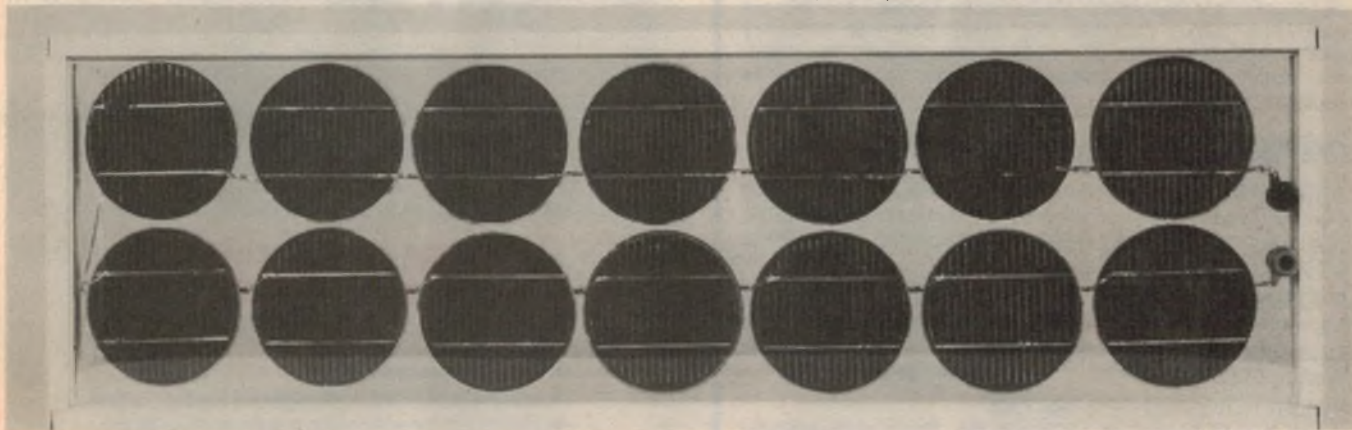

The prototype solar array with extruded aluminium frame. Note the two binding posts. The cells to be supplied will have a different grid pattern.

cells as they are very fragile. Squeeze the cells down on the sheet (very gently) so that they are held reasonably firmly by the surface tension of the caulking compound. (In time, the compound will cure.)

It is important that the top surface of the cells does not become contaminated by any foreign substance. Do not handle the top surface, and take care to ensure that the cells are not splashed with water or other liquids. Also, when soldering, avoid depositing flux sediment on the cell top surface.

Now solder a short length of stripped and tinned multi-strand insulated wire to the grid connection of each cell. Do not use single-strand insulated wire as it is too rigid and inclined to break or stress

mount the binding post terminals and connect them. The red (positive) terminal should connect to the underside of the last cell in the series string while the black terminal should connect to the grid connection of the cell at the other end.

Now you are ready to test the array before it is sealed.

Take the array outdoors, and expose it to sunlight and measure the voltage across the output terminals. It should be close to 8.4 volts in bright sunlight. If not, check that you have 0.6 volts across each cell and that the series connections have been correctly made so that individual cell voltages all add.

Now immerse the pump and connect it to the solar array. With bright sunlight

cell, connected so that it is normally reverse-biased. We recommend a diode type with a rating in excess of one amp. In practice, this means that most people will use the 1N5404 (14 required) which has a three-amp rating and is readily available.

The diodes are a protective measure. First, if one cell does become defective over the life of the array, the parallel diode will automatically shunt it out of circuit and only a small loss of performance will result, rather than complete failure. Secondly, if a leaf or other object lodges over one of the cells it will not be reverse-biased and possibly burn out.

Deep shadows falling over part of the array will also be protected against. This is important if the array cannot be posi-

GO SOLAR!

SOLAR POWERED FOUNTAIN

Complete kit consists of: 14 x 75mm dia solar cells, submersible, high-efficiency water pump, two sheets of solar-grade polycarbonate. Price \$150. Certified post \$5.

SOLAR LIGHTING KIT

If you are not connected to mains electricity, think how convenient it is to just push a button to get light! In most locations, this kit will provide four hours of light from three 13 Watt fluorescent lamps. Alternatively, the power could be used to run other 12V DC appliances like a TV set, ham rig, water pumping, remote data logging — just to name a few.

On average this kit will supply 75 AHrs/week at 12V DC. The actual performance depends on the season, exact location and weather condition at the time.

SEE ARTICLE ON PAGE 58



Kit consists of: One ARCO 35Watt solar module, one 90 Ahr deep-cycle battery (supplied dry), three 13W high efficiency fluorescent lamps, 10M cable, diode, battery clamps. Price \$700. Rail freight to nearest station \$15. Road transport can be arranged, freight collect.

OTHER SOLAR PRODUCTS

ARCO ASI-16-2000 solar module 15.5V 2.26A 35W
Tempered solar glass cover with extruded aluminium frame all around. 1220 x 300 x 38mm. Lightweight 4.9kg. Price \$600. Rail freight to nearest station \$7.

PHOTOWATT MU3410 solar module 14.1V 1.2A 17W
Tempered solar glass on an extruded aluminium heatsink. Hexagonal cells allow compact size of 725 x 300 x 25mm. Weight 6kg. Price \$370. Certified post \$6.

SOLAR POWERED CEILING FAN

Three timber blades of 1000mm dia. Runs automatically when the sun shines, and costs nothing to run!

Complete with its own solar module \$250
Fan only (runs off 6 to 24V DC) \$150
Certified post \$6.



AMTEX
ELECTRONICS

PO Box 285
11 Spring Street,
Chatswood 2067.
Telephone (02) 411 1323.

Please send me \$

Freight cost \$

Cheque enclosed

Name:

Address:

Nearest railway station (if ordering by rail):

AUSTRALIAN AMP

LOW-PROFILE DIP SOCKETS

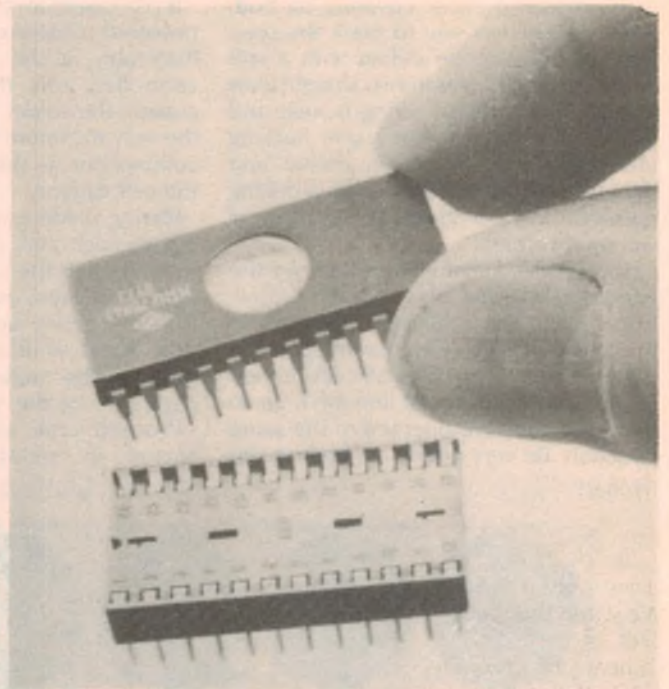

DIPLOMATE

Features

- Low Profile
- Dual wiping contacts
- Large target area, with tapered lead-in ramps
- Designed for automatic machine insertion—
- Tin or gold plated phosphor bronze or beryllium copper contacts
- Closed bottom
- Visual polarization
- Designed to meet EIA RS-415
- Stackable end-to-end and side-to-side for high board density.

Technical information available on request.

SOANAR

Soanar Electronics Pty Ltd

30-32 Lexton Road, Box Hill, Vic., 3128, Australia.

VICTORIA: 840 1222

QUEENSLAND: 52 1131

N.S.W. 789 6733

WEST. AUST. 381 9522

STH. AUST: 42 8918

TASMANIA: 31 6533

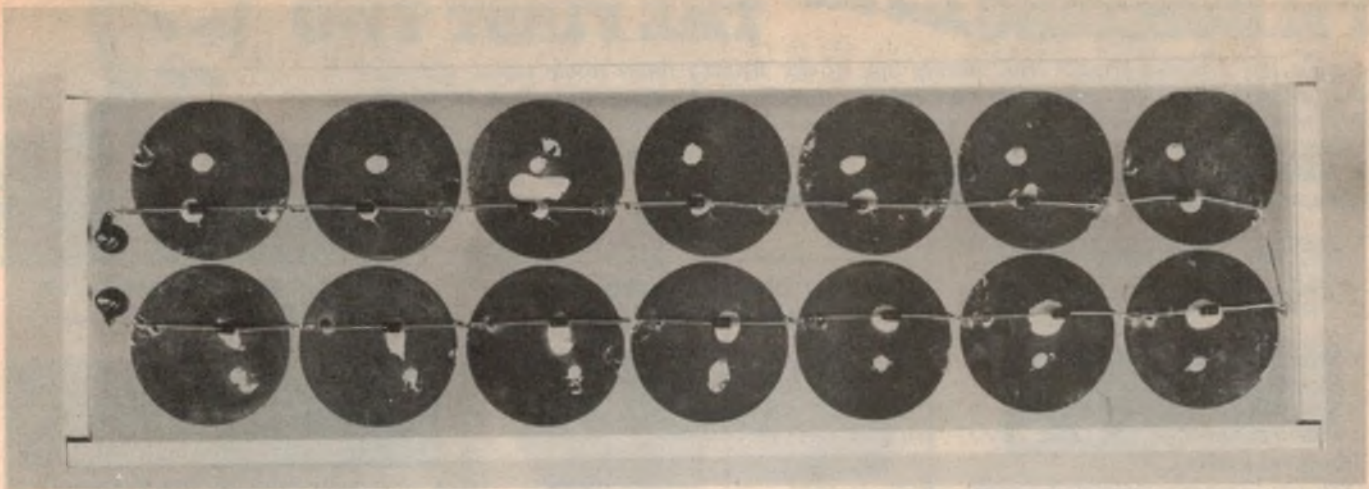

The rear of the cell array showing the dabs of caulking compound on each cell and the protective diodes wired in place.

Optimum inclination for solar arrays

Darwin	17°
Cairns, Broome	22°
Rockhampton, Alice Springs	28°
Brisbane, Geraldton, Broken Hill, Perth	37°
Sydney	39°
Canberra, Adelaide	40°
Melbourne	43°
Hobart	48°

tioned high enough to avoid shadows falling over it at some time of the day. We wired the diodes directly across the back of each cell, as shown in the accompanying photographs.

With the wiring complete, there still remains the task of making a suitable frame for the Lexan sheeting so that the array is a rigid assembly. We made our prototype from white-enamelled aluminium extrusion which is normally intended for making flyscreens. This extrusion is made by Alcan and has two channels, one of which will hold the two sheets tightly together. A similar rolled and folded aluminium strip, also intended for flyscreen use, is available from most hardware stores and can be used for this purpose.

Individual constructors can make their own decision as to whether the aluminium frame should be mitred, lapped or butted. We used lap joints. Before slipping the frame work over the Lexan sheets, run a bead of silicone caulking compound into the channels to provide a good weather seal.

Wipe off any excess caulking compound after the frame has been assembled. Now set up the array in the sun and leave it to run the pump for several hours. This will make it quite hot and any moisture lodged between the sheets should be exhausted via the wiring holes in the bottom sheet of Lexan. Finally,

This posed picture shows the solar array with a set of three small cascading pools at Ferguson's Garden Centre, Narrabeen, NSW.



seal each of these holes with a dab of caulking compound. The assembly should be completely sealed against any ingress of moisture.

Constructors may also wish to provide a protective panel over the rear of the array, to avoid any possibility of damage to the wiring of the diodes. We did not do this.

When finally installing the array, it should be firmly mounted and positioned as high as possible so that it will be unaffected by trees, shadows, mischievous children and other hazards. Ideally, it should face due north and be inclined as shown in the accompanying table, to obtain maximum solar input, all year round. In this application, this is probably not really important.

Wiring from the solar array to the pump can be ordinary figure-8 mains cable but the overall resistance should be less than 0.3 ohms to avoid undue

voltage losses. The wiring can be buried so that it is out of sight.

Where to buy the bits

Amtex Electronics, of PO Box 285 Chatswood, NSW 2067 will supply the pump, 14 cells and two sheets of Lexan or equivalent polycarbonate glazing cut to size. The price for the package is \$150. See details in the advertisement elsewhere in these pages. Aluminium flyscreen framing can be obtained from hardware stores or Alcan aluminium centres. Selley Dow-Corning silicone caulking compound is available from hardware stores in tubes or cartridges. The cartridges cost about \$6.60. 1N5404 diodes can be obtained from almost any electronic parts retailer, as can figure-8 cable. Fountains and recirculating pools can be obtained from landscapers, nurseries or home handyman centres. Have a nice day! Good gardening!

I'M BUILDING *have built* THE FIRST TWO

— what am I raving about? Well, having one of the World's finest home stereo systems (the brilliant ETI 5000 series amp and preamp together with my beloved B & W DM II loudspeakers of course!), I couldn't resist building ETI's 5000 series 1/3 octave Graphic Equalizers. I have been pestering ETI for well over a year — and at last the many 1000's of 5000 series owners have the opportunity to complete their system with another classic, no compromise DAVID TILBROOK DESIGN. Details are on the other page of this ad. Cheers. *Jack O'Donnell*



DIGITAL FREQUENCY METER

See Electronics Aust. Mag. Dec. 81-Feb. '82
500 MHZ, 7 DIGIT RESOLUTION PLUS
PERIOD MEASUREMENT FEATURE



IMPORTANT NOTES:
(1) This project is well within the scope of the "not so experienced" as virtually all components are contained on a single PCB.
(2) ALTRONICS USE ONLY THE SPECIFIED INTERSICL LSI — BEWARE OF INFERIOR KITS THAT DO NOT CONFORM TO THE ORIGINAL DESIGN.

- * Screened front panel
- * Bright high efficiency 7 segment display
- * Frequency ranges 0-10 MHz, 0-50 MHz, 10-50 MHz (with optional pre-scaler)
- * 4 gating times — 0.1, 1, 10, 100 seconds
- * 4 period measuring ranges 1, 10, 100 and 1000 input cycles give 0.1 μs resolution
- * High input sensitivity — 10 mV to 30 MHz, 100 mV at 50 MHz @ 1 M input impedance, 200 mV at 500 MHz @ 75 ohms input impedance
- * High accuracy — typically better than .005% count uncalibrated.

Costs a fraction of commercial counters.

EXCLUSIVE ALTRONICS KIT FEATURES:

- * IC sockets provided throughout.
- * Low aging 10,000 MHZ XTAL.
- * Thermalloy heatsink for 5V regulator.
- * Quality Pactec Instrument Case

K 2500 (50 MHZ version) \$119.50

K 2501 Pre-scaler (add for 500 MHZ version) \$ 26.00

FUNCTION GENERATOR WITH DIGITAL DISPLAY



EA's new Function Generator covers the frequency range from 15Hz to 170kHz in three ranges with coarse and fine frequency controls. An economical 4-digit display has been incorporated to eliminate dial calibration. Sine wave distortion can be trimmed to around 0.5%. See EA April, 1982

K 2505 \$85.00

ALTRONICS POWER SUPPLY

BASED ON EA LM 317K PROJECT
Every workshop, school and hobbyist should get one now!



- * Overload and short circuit protected.
- * Full voltage and current metering.
- * 3-32 volt output at 1 AMP.
- * Uses LM 317K variable regulator.
- * Full instructions and every last part included.

VALUE PLUS!

K 3200 \$39.95



DIGITAL CAPACITANCE METER
Electronics Australia Project. Measures 1PF — 99.99 UF, 240V Mains Powered, Bright LED Display. Easy to build. Complete kit of parts and full instructions.

*** EXCLUSIVE TO ALTRONICS ***
Each kit now includes precision measured capacitors for accurate calibration of each range.

K 2520 \$45.00

DUAL TRACKING POWER SUPPLY



+ 1.3 to + 22V = 2 AMPS + 5V = 0.9 AMPS

Unit is fully protected against short circuits, overloads and thermal runaway. Pos and Neg supplies track within 1mV, voltage adjustable to within 10mV.

- * Uses .25% linearity 10 turn pot.
 - * High sensitivity meter.
- Essential for every school, workshop and lab. Easy to build!

K 2507 \$86.00
See Electronics Australia March 1982

GREAT NEW MOSFET PA AMPLIFIER KIT FROM ETI

150 watts power output.
See June '82



UNCONDITIONALLY STABLE - SOUND STUDIO SPECIFICATIONS

OUTPUT IMPEDANCE Selectable to low Z voice coil or 100V or 70V line out.
INPUTS 2 mic inputs HI or low Z with speech filter.
1 Aux. input.

- * Low noise 5534 op amps used.
- * Noble W/wound power resistors used in output stage for guaranteed stability.

*** ALTRONICS EXCLUSIVE ***

All due respects to ETI, but we felt the original case was lousie — So we've brought out ours utilising our snazzy H 0400 Black Rack Cabinet.

It looks terrific! And for this month only, it's the same price as the original version.

K 5035 ONLY \$239.00

GO ANYWHERE 240V PWR. KITS

See EA May and June 82. These great new inverter kits enable you to power 240V appliances for your car, caravan or boat. (From Standard 12V car battery.)

40 WATT

Suits small appliances, i.e. turntable, tape deck, shaver etc. Variable frequency adjustment enables accurate speed control of turntable motors.



IC Sockets Provided

K6700 \$55.00

300 WATT

Fully regulated and overload protected
XTAL locked frequency.

NOW USING HIGH EFFICIENCY C-CORE TRANSFORMER

Use to power hi-fi, TV sets and for emergency lighting.



- * Gold plating on both PCB edge and edge connector.
- * Low age rate parallel resonant XTAL used.
- * Sockets for all IC's.

K6750 \$199.50

\$10 DELIVERY ANYWHERE IN AUSTRALIA!

ALTRONICS GUARANTEE

Nominate Jetservice Delivery with your order and we guarantee to deliver quicker than any other Australian supplier — it doesn't matter where you live — from Townsville in the North to Hobart — ALTRONICS delivers faster!

* THE EVER POPULAR * MUSICOLOUR IV EA PROJECT

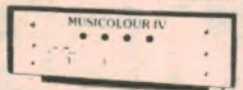

Combination Colour Organ and Light Chaser. Four channel colour organ. Internal microphone or connect to speakers for colour organ operation. (The lights connected to each channel pulse in beat to the music proportional to portion of frequency spectrum concerned.) Four chaser modes forward and reverse. Output lamp load capacity a massive 2400 watts — that's 100 party globes. Full instructions and every last nut and bolt included. Great for parties, shop signs, display windows etc.
K 1004 \$79.50

TRANSISTOR ASSISTED IGNITION WITH DWELL EXTENSION



Petrol \$2.00 a gallon — Good Grief!

Yes, it's bad enough paying \$2.00 a gallon for petrol without waisting a fortune on an out of tune engine. Fit this transistor assisted ignition kit in minutes and start saving money from the very next petrol stop. Easy to build!

K 1010 \$35.00

**At last a graphic worthy of the 5000 NAMETAG
SERIES 5000 1/3 OCTAVE GRAPHIC EQUALIZER**

Another brilliant DAVID TILBROOK no compromise design



Free
Jetservice
over-night
delivery on
this Kit —
Nov. & Dec.

SPECIFICATIONS:
Noise — at zero gain and 20 KHZ Bandwidth — 102 db. Distortion 1 KHZ — typically .007%. Bandwidth — 12HZ — 105 KHZ + 0 — 1 db. Boost/Cut — + and — 14 db.

ALTRONICS EXCLUSIVES:
* All IC sockets provided * Quality series Racking Case supplied * Genuine Philips Synetics Low Noise 5534 IC op amps supplied * Specially imported high accuracy linear slide potentiometers employed for precision control adjustment. (NOTE: Not compromise "Null Centre" types that some suppliers offer.)

K 5025 See ETI Magazine November 1982 **\$199.50**

**STUDIO FORMAT
ETI 5000 STEREO CONTROL PREAMPLIFIER**

There have been countless accolades exclaiming this brilliant design by Australia's top audio design engineer David Tilbrook — and with good reason!



As a demonstration of our faith in this classic designed preamp we proudly release the **STUDIO FORMAT 5000 PREAMP** which includes some very worthwhile refinements as detailed here:—

* Gold plated RCA Jacks on all phono inputs * 1 x pair gold plated RCA Line Plugs, supplied * Military spec. National Semiconductor LM 394's employed * Low capacitance screened cable, supplied; IC sockets provided throughout; Multicoloured led display * Metal film 1% resistors used throughout all audio circuitry * Pretinned PCB's * Satin Black brush finished, aluminium control knobs

DELUXE STUDIO FORMAT 5000 PREAMP KIT Complete kit includes all ETI specified parts plus the Studio Format Package. Full instruction booklet included. SEE ETI MAG. JULY '81—OCT. '81 FOR FULL DETAILS.

K 5001 **\$275.00**

ETI 5000 STEREO MOSFET AMPLIFIER

See ETI magazine Jan. '81—April '81. New generation mosfet power semis facilitate David Tilbrook's classic power amplifier. Listening tests prove it surpasses even the best in conventional amplifiers in low fatigue, high definition audio. Completely uncoloured crisp sound purity.



EVEN BETTER: This beautifully engineered amp design is based principally on two identical printed circuit boards with a minimum of other wiring, thus enabling even a relative "beginner" to accomplish by step instructions are followed.

building this project as long as the step by step instructions are followed. The **ALTRONICS KIT** includes the **DELUXE FINISH FRONT PANEL HEATSINK** * Original specified chassis bar design case * All metal work finished satin black * Flux shorting strap transformers used to minimise hum * Low leakage power supply electrolytics

SPECIFICATIONS: Power Output: 100 watts into 8 ohms x 2. Frequency Response: 8 HZ - 20 KHZ + 0 db — .4 db. Noise: 116 db below full output. Input sensitivity: 1V RMS for 100 W output. Distortion: Less than .001% at 1 KHZ and full output. Stability: Unconditional stable.

COMPLETE MOSFET AMP KIT K 5005 \$289.00

ETI SERIES 5000 LOUDSPEAKER PROTECTION KIT

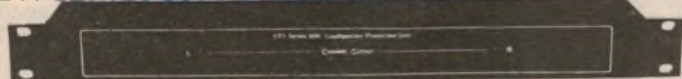

Protect your valuable loudspeaker system with this easy to build, professional appearance kit. This easy to construct kit, based on the latest ETI design (Oct. '82), provides both DC and overpower protection for your valuable Hi-Fi speakers. Self-powered unit disconnects the speakers within 1/10th of a second of a fault occurring yet in no way effects the sound quality.

The **ALTRONICS Kit** comes in a superb 1 unit rack box including quality silk screened front panel.

EXCLUSIVES: * LED Monitoring of channel cutout * Fujitsu 10 amp relays * **ALTRONICS Kit**, stereo unit complete to last nut bolt and washer * Input/Output speaker cable terminals supplied.

Install it in minutes — no AC or DC connections required — simply connects into the left and right channel speaker lines.

K 5050 Stereo Rack Version **\$79.50**

SINGLE CHANNEL SPEAKER PROTECTOR KIT

For the economy conscious the same electronics employed with the K 5050 are available in single channel format. Jiffy box, printed front panel and all terminals supplied.

K 5051 **\$22.50**



**ETI'S BRILLIANT NEW
DIRECT-CONNECT COMPUTER MODEM**



Employs unique 'Commutated Filter' design overcoming virtually all the problems involved with conventional modems.

Super flexible unit facilitates communications between computers over cables, the telephone network and radio links.

Unit connects to a standard RS 232 interface and is capable of both 1200/75 Baud and 300/300 Baud transmission and reception * Line switching; answer and dialing facilities on board.

EXCLUSIVES: * Plated through, double sided PCB * Complete set of IC sockets * Kit requires 85 1N914 Diodes for programming these are included * Ceralock resonator and matching balanced load capacitor used for long life and high accuracy * Telecom approved Isolating transformer and Reed relays included.

K 9644 (See ETI Oct 82) **\$169.50**

MODEM MONITOR AND CASE OPTION I

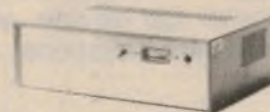

Having built the modems for our own computer use **ALTRONICS** strongly recommend (as do ETI) the inclusion of Audio and Visual Monitoring (signal strength). Our K 9645 includes all the components listed on Page 23 October ETI, custom **ALTRONICS** PCB, speaker, panel meter, front panel and case to house these options plus the full modem.

K 9645 Modem Option I **ONLY \$30.00**

NEW UNIVERSAL DC-DC INVERTER

SEE ETI MAG. SEPT. 1982

Rated at 200 watts this versatile inverter can be simply configured for virtually any desired input/output voltage required by the winding format of T2.

Typical input voltages: 12/24/32 V. Typical output voltages available: + 50, + 15, + 40, 1400 V.

Now you can use high power hi-fi and PA amps for your boat, caravan etc.

K 6509 includes metal case **\$39.50**



**40W FLUORESCENT LIGHT INVERTER
FOR 12V BATTERY OPERATION**

Self-oscillating, push-pull inverter operates above the available frequency range and is capable of driving two 20 watt or one 40 watt fluorescent tube to 150% of normal (240 volt operation) efficiency.

Great for camping, working on the car, and of course, during power blackouts!

Complete boxed kit, including all winding wire.

K 6505 Includes Meter Case **\$37.50**

\$2 DELIVERY AUSTRALIA WIDE We process your order the day received and despatch via Australia Post. Allow approx. 7 days from day you post order to when your receive goods. Weight limited 10kgs.

\$4 DELIVERY AUSTRALIA WIDE We process your order day received and despatch via Jetservice for delivery next day.

BANKCARD HOLDERS CAN PHONE ORDER UP TO 8PM (EST) FOR NEXT DAY DELIVERY — SOUNDS INCREDIBLE DOESN'T IT? Alright you cynics just try us! Weight limit 3.3kgs. Jetservice cannot deliver to P.O. box numbers (Australia Post would have a fit).

\$10.00 HEAVY HEAVY SERVICE — AUSTRALIA-WIDE All orders over 10kgs must travel on the heavy service, that is — road express. Delivery time 7 days average.

ALTRONICS
105 STIRLING ST., PERTH
FOR INSTANT SERVICE
(09) 328 1599

All Mail Orders: Box 8280 Stirling St, Perth, W.A. 6000

Build this for your hifi system

Power Up: ends the multiswitch fiddle

How would you like to turn your entire hi-fi system on or off using just the one switch on the amplifier — and get rid of that ugly mess of piggy-backed power plugs at the same time? It's easy with our Power Up device, which should also prove useful in many other similar situations.

by JEFF SKEEN

The Power Up is basically a current operated switch which senses whether a controlling appliance, eg an amplifier, is drawing current, and turns on all the other components in the system if it is.

This should have applications for any combination of appliances, such as a computer or audio system, where mains power has to be applied to many devices at once. Rather than turn on and off maybe three or four switches, the Power Up allows you to control the system with just one switch.

A further benefit is that no warranty voiding modifications have to be made to any system component. The Power Up is a completely self contained unit, designed to be placed out of sight behind the system. It plugs into the wall socket and provides four outlets into which the devices to be controlled can be plugged. A fifth socket, mounted on the end face of the unit, powers the controlling appliance.

Another application for the Power Up is in providing an auto turn-off facility at the end of a record. This presupposes that you have an automatic or semi-automatic turntable.

In this case, power supplied to the turntable is used to control power to the rest of the system. When the start switch of the turntable is pressed, the system is automatically turned on. After the record is finished, the turntable automatically turns itself off, thus turning off the rest of the system.

This can be a useful feature if you listen to records in bed at night, or if, like the author, you forget to turn off the rest of the system after the record has finished. In this case the amplifier usually sits for several hours doing nothing but wasting power.

A cassette player with automatic shut-

off may also be used in the same manner as the turntable.

As the Power Up is permanently connected to the mains, it should consume as little power as possible. With this in mind we have designed the circuit so that standby consumption is under 0.75 watt. This increases to around 3.75 watts when the relay is activated, mainly due to dissipation in the 10 watt resistor and the relay coil.

How it works

To best understand the circuit it is necessary to split the operation into

several parts. To begin with, assume that the unit has just been plugged into a wall socket and there are no appliances connected to any sockets.

When the voltage on the active lead goes positive, current flows through the two 82k Ω resistors in parallel, through the 1N4007 diode, and charges the 47 μ F capacitor to the zener value, approximately 33V. When the active lead goes below the capacitor voltage the 1N4007 diode is reverse biased and prevents the capacitor discharging. The capacitor takes several seconds to charge.

If an appliance is now plugged into the controlling socket, and the appliance turned on, a voltage will appear across the 1N5404 diodes. This voltage is used to turn on the relay in the following manner. When the voltage on the active lead goes positive, current through the controlling device and through the diodes, makes the base of transistor Q2 about 1.2V positive with respect to its emitter.

This turns Q2 on, which discharges the 47 μ F capacitor through the relay coil. The current supplied by the capacitor pulls in the relay, closing its contact. This switches in the 10k Ω resistor, placing it in parallel with the two 82k Ω resistors already connected to the active lead.

The effective value of these resistors is 8k Ω , low enough to supply the current required to hold the relay on. When the voltage on the active lead drops to zero Q2 is cut off and no current flows through the relay. This condition is very brief, and the relay, which has a release time of 3ms, will not have time to let go.

As the active lead goes negative, current flows through the 1N5404 diodes but in the opposite direction. This biases on Q1, which completes the circuit from the 47 μ F capacitor through the relay, thus holding the relay on. The capacitor

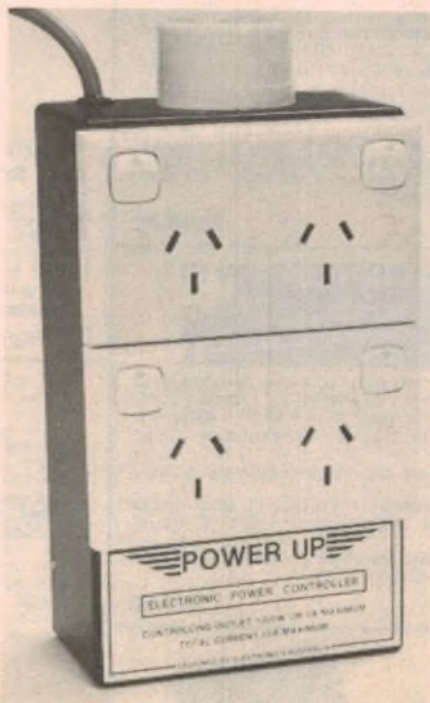

Power Up automatically controls up to four separate mains appliances.

PARTS LIST

- 1 PCB coded 82pc10, 106 × 56.5mm
- 1 Zippy Box, 196 × 112 × 60mm
- 1 Scotchcal front panel, 106 × 48mm
- 1 240V surface mounting socket
- 2 240V double wall sockets
- 1 mains cord and plug
- 1 2-way insulated mains terminal block
- 4 earth lugs
- 1 grommet to suit mains cord
- 1 cable clamp to suit mains cord
- 1 metre brown 240V AC rated mains wire (active)
- 1 metre blue 240V AC rated mains wire (neutral)
- ½ metre green/yellow 240V AC rated wire (earth)
- 1 24V relay, code VF24HN (see text)
- 4 adhesive rubber feet

SEMICONDUCTORS

- 1 1N4007 or A14P diode
- 4 1N5404 diodes
- 1 1N4001 diode
- 1 33V 1 watt zener diode
- 2 BC547 transistors

- ### RESISTORS (10% tolerance)
- 2 × 82kΩ 1W, 1 × 10kΩ 10W,
 - 2 × 1kΩ ¼W, 1 × 220Ω ¼W

CAPACITORS

- 1 47μF/63VW PC electrolytic
- 1 .01μF/250V AC rated mains suppression capacitor (see text)

MISCELLANEOUS

- Nuts, bolts, washers and lockwashers for mounting hardware.

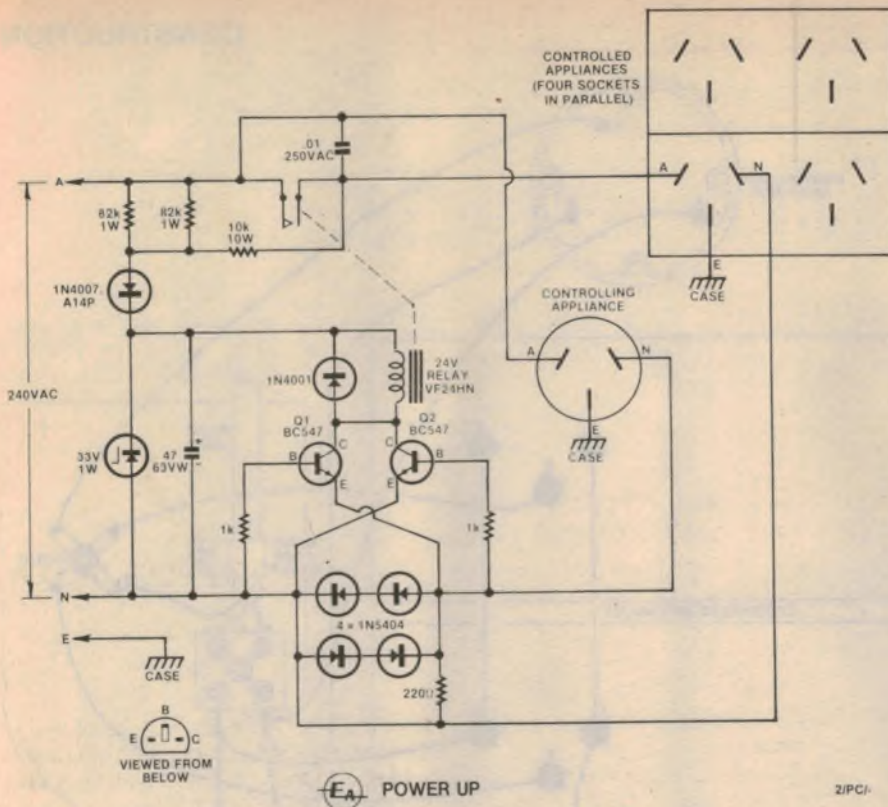

Transistors Q1 and Q2 form the heart of the circuit and activate the relay whenever current flows in the controlling appliance.

discharges to its lowest point during this period (about 4.2V).

In the next half cycle Q2 turns on as before, and the relay is held on by current via the two 82kΩ and the 10kΩ resistors in parallel. At the same time the 47μF capacitor is partially recharged (to around 7.2V) via the above resistors.

This cycle of events continues while ever the controlling appliance is turned on. If an appliance is plugged into one of the switched outlets and the controlling appliance is turned on, power will be supplied to the switched appliance when the relay contact closes.

As the energy to pull in the relay comes from the 47μF capacitor, it is essential that this capacitor be given time to charge before the relay is asked to operate. As already mentioned, this charging cycle takes several seconds, and at least three seconds should be allowed between switching on the power point and switching on the appliance. This same time should be allowed between off-on cycles of the controlling appliance.

No damage will result if the above period is not maintained; the relay simply will not operate and the switched outlets will remain off. To correct this situation, switch the controlling appliance off, wait three seconds, then switch on again. The switched outlets should now be energised.

The function of the 220Ω resistor in parallel with the 1N5404 diodes is to pre-

vent current under 2.5mA from turning on Q1 and Q2. This is necessary as the suppression capacitors placed across the mains switches of most electronic equipment will pass enough current to partially turn on Q1 and Q2.

If this happens, Q1 and Q2 will prevent the 47μF capacitor from fully charging and there is a good chance there will not be enough voltage to pull in the relay. This problem only occurs when a suppression capacitor is fitted to the controlling appliance. The 1N5404 diodes do not pass current from the switched appliances and so capacitor currents from these appliances will not trouble the circuit.

The final components to discuss are the diode across the relay coil, and the capacitor across the relay contacts. Both these components act as suppressors by limiting voltage spikes.

When Q1 and Q2 turn off, the current in the relay coil drops to zero in a very short time. This induces a large voltage spike across the relay coil which could damage Q1 and Q2. The diode prevents the build up of such a voltage by appearing as a short circuit across the relay whenever the spike exceeds 0.6V.

The .01μF capacitor suppresses the arc that would appear between the relay contacts when they open while carrying current. The capacitor appears as a short circuit at the instant the contacts open and the current flows through the capacitor. By the time the capacitor is

charged the contacts are too far apart for an arc to form. This is a precaution against thumps in any speakers in the system.

This suppression capacitor must be rated for 250VAC operation. This means that it must either be a metallised paper or dual dielectric (paper plus polyethylene terephthalate) type rated at 250VAC, a metallised polypropylene type with a rating of 250VAC or 1kV or 1600VDC or a ceramic disc capacitor rated at 2kV or higher.

Do not use polyester or polypropylene capacitors rated at 630VDC or 220VAC. They could be a potential fire hazard.

Construction

Our prototype was assembled into a commonly available Zippy Box measuring 196 x 112 x 60mm. These boxes have multiple internal slots for mounting printed circuit boards (PCBs) or other hardware. The PCB for this project is designed to fit into these slots.

The PCB is coded 82pc10 and measures 106 × 56.5mm. Before mounting components on it, trim it so that it fits exactly into the last set of slots in one end of the box. The metal lid should be able to fit flush with the box without the PCB fouling it.

Mount the components on the board, beginning with the smallest, such as the resistors, diodes and transistors. Take particular care with the orientation of the diodes as mistakes could be spectacular. Now mount the larger components, the 47µF capacitor, the 10 watt resistor and the relay. Solder the suppression capacitor directly across the relay contact terminals.

The VF24HN relay used was supplied by Associated Controls Pty Ltd. It has a 24V coil and contacts designed to switch up to 25A and 240V. The relay may be purchased directly from Associated Controls, 55 Fairford Rd, Padstow, NSW 2211 for \$3.85 plus sales tax.

We would not suggest substituting any other type of relay unless it has specifica-

We estimate that the current cost of components for this project is

\$33

This includes sales tax.

tions equal to or better than the above relay.

Next, mount the 240V outlets on the box. The positions we use for the prototype can be seen from the photo. Holes for the double sockets can be made quite easily in the soft plastic with the aid of a drill and small saw. The single surface socket mounts on the end of the case opposite the PCB. Use the socket itself as a template for locating the mounting holes and cable holes.

In the same end of the case, drill a hole large enough to take the mains cord grommet. Locate this hole in one corner near the lid (as in the prototype), to allow the mains cord to be terminated easily. Use a 2-way piece of insulated terminal block for the termination, and secure the mains cord to the lid with a cable clamp.

The earth lug from the mains cable is attached to a central earth point on the lid with a separate nut and bolt.

All wiring within the Power Up should be done with 240V-rated mains cable. Follow the wiring diagram carefully, crossing off wires on the diagram as they are run on the project. For maximum protection, run separate earth wires to each socket. Do not simply link the

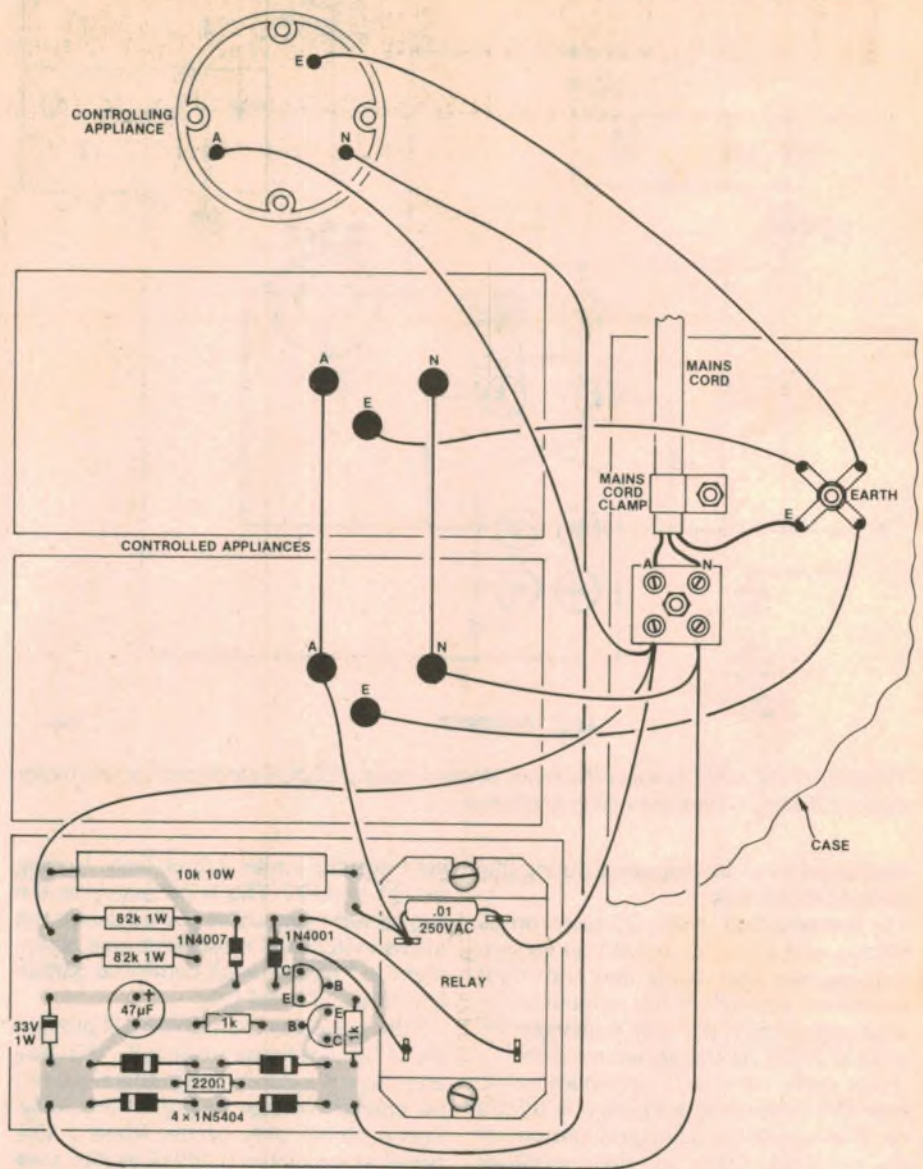

Follow this wiring diagram carefully when building the Power Up and make sure that you keep all mains wiring neat and tidy.

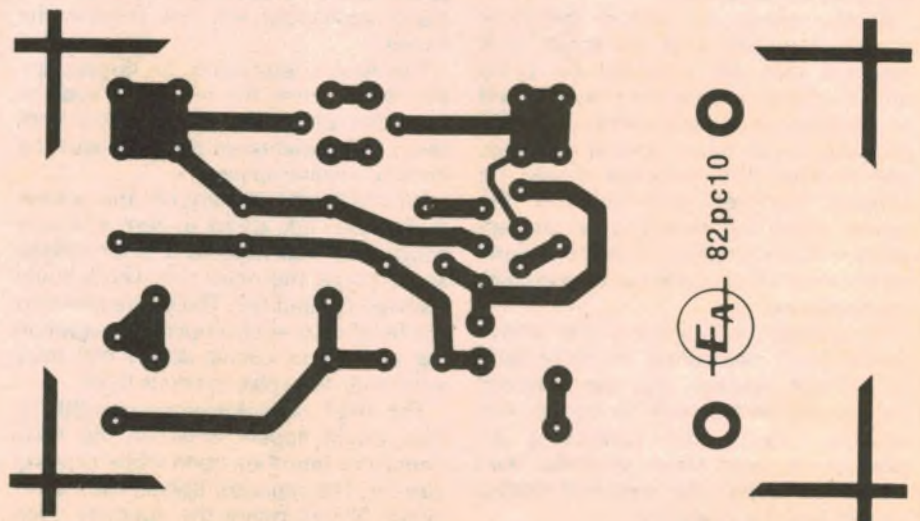

Above is an actual size reproduction of the printed circuit board.

DICK SMITH



NEW ZEALAND

LOOK AT THESE FOR VALUE!

24 RANGES HANDYMAN'S MULTIMETER

If you're into electronics as a hobby or as a business, and want a reliable, economical multimeter, this has got to be the one! Robust, high sensitivity, very easy to use. Comes complete with batteries, test leads and instructions. **NZ**

ONLY \$35



Cat. Q-1024



INCLUDES FREE VHF LISTENING GUIDE

OVER 6000 SOLD!
THE DICK SMITH COMMUNICATOR VHF RADIO

There's a whole different world of radio you probably haven't even discovered yet! This superb portable VHF Communicator Radio will introduce you to the world of VHF - without missing out on the radio stations you also want to listen to. It's six bands cover the AM & FM broadcast stations, through the full 40 channel CB band up to the VHF bands from 107 to 147 MHz. Cat. D-2833

ONLY \$149 NZ

A WATCH IN A PEN

A superbly styled pen with an LCD digital watch. Great for those who don't like to wear watches. Uses standard Parker refill. Cat. Y-1030

\$19.50 NZ

IDEAL GIFT



COMPARE OUR VALUE

SEMI AUTOMATIC BELTDRIVE TURNTABLE

Here's top value: a semi automatic belt-drive turntable, with all the 'mod cons' such as variable speed, strobes, damped tone arm with cueing lever, anti skate auto return, etc. etc. all mounted in a deluxe damped plinth with perspex hinged lid - at the unbelievable price of just \$295!!!

AND NOW \$295 NZ



Cat. A-3080

SAVE ON TUNEUPS

With The DICK SMITH ENGINE ANALYSER

Be your own serviceman and Save \$\$\$ on car tuneups! Checks ● Dwell ● Amps ● Volts ● Points ● RPM Easy to use and ideal for all 4, 6, and 8 cyl. cars. Cat. A-8514

ONLY \$31.95 NZ



Transistor Checker/M. Meter

A Great Buy! This multimeter is one of our most popular and almost a test bench in itself. If you don't need to measure capacitors (for instance you have an AC bridge), you can save heaps!!

Cat. Q-1136

NZ \$67.50

AIR BAND (VHF) RADIO

AM Band too!

Listen to what Pilots and control towers talk about. You might even catch Dick as he takes off!!! Also features AM so you can listen to your favourite radio station! Incredible Value! Cat. D-2836

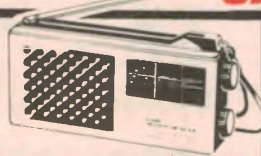

\$69 NZ

XENON TIMING GUN

Cut down on fuel and maintenance costs. Why waste money on tuneups when you can do it yourself. Cat. A-8508



\$29.95 NZ

TAKE ANYWHERE STEREO!



MYLAR

ULTRA LIGHT PHONES

Comes complete with lead and stereo jack. Cat. C-4106

\$19.95 NZ

SAVE ON BATTERIES

MICRO CASSETTE RECORDER

Pocket size, easy to carry recorder with carry strap. Includes inbuilt microphone and weighs only 285g. Cat. A-4040



Micro cassette to suit \$4.95@
Cat. C-3360
10 up \$4.50

ONLY \$89.50 NZ

BATTERY TESTER
Don't throw 'em out test them!
You could be throwing money out the window! Cat. Q-1525

Get into Electronics the Fun Way!

Funway Vol. 1
4th printing of this amazing book. 72 pages packed with exciting projects all safe as they are battery operated AND all projects are illustrated so mistakes are virtually impossible. Cat. B-2600

Funway Vol. 2
After mastering Funway Vol. 1, why not go further. Learn about PCB's and soldering. 130 pages, packed with more projects. Cat. B-2605



\$5.95

\$7.95

This AM/FM radio with light weight headphones means you can take your favourite radio programs wherever you go. Just think, whatever you're doing, at work or play, listen to whatever you want! Powered by 4 pen light batteries (supplied) Cat. A-4330

VALUE AT \$99.50 NZ

THE DUAL MELODY ALARM CHRON. WATCH

A superb LCD watch with quartz accuracy and melody alarm! Features include: dual time, stop watch with lap time and light. Comes complete with attractive bracelet. Cat. Y-1044



AMAZING VALUE! \$39.50 NZ

IDEAL FOR BOAT CAR OR PLANE 12V DIGITAL CLOCK



Large, bright display & sturdy construction - will compliment any dash. Even has alarm! Cat. Y-1047

ONLY \$32.50 NZ

DICK SMITH Electronics

98 Carlton Gore Rd. Newmarket, Auckland 1. Ph: 504 409

POST & PACKAGE CHARGES

ORDER VALUE	CHARGES
\$5 - \$9.99	\$1.00
\$10 - \$24.99	\$2.00
\$25 - \$49.99	\$3.00
\$50 - \$99.99	\$4.00
\$100 or more	\$5.00

Mail Orders: P O Box 9452 Newmarket



Shop by phone
Use your Bankcard
Or Visa card

DSE/A382/JW

earths together as the loss of just one link may remove the entire earth protection.

To give the finished unit a professional appearance we have prepared a label to fit on the front panel below the two power outlet blocks. The artwork is reproduced herewith, and copies of it have been distributed to various component suppliers, who normally provide Scotchcal versions. They should be available by the time this article appears.

If necessary, trim the Scotchcal label using scissors or a sharp knife. Stick it into place on the top of the box then screw the lid of the box into position. If you are using adhesive rubber feet, peel off the backing tape and stick the feet to the metal lid. Construction is now complete and after a final error check power can be applied.

If everything is OK, switch off and plug an appliance into the controlling outlet, and another into one of the switched outlets. Turn on the switched outlet, and the appliance plugged into it. Switch on the power point, wait three seconds, and switch on the controlling appliance. There should be a click from the relay and the other appliance should come on.

If, for any reason, the Power Up fails to perform as expected, turn it off immediately and double check the circuit for errors. Do not reapply power until the fault has been found and corrected.

During operation the front panel of the Power Up will get warm. This is quite normal, and is due to the 10 watt resistor mounted underneath the front panel. ☺

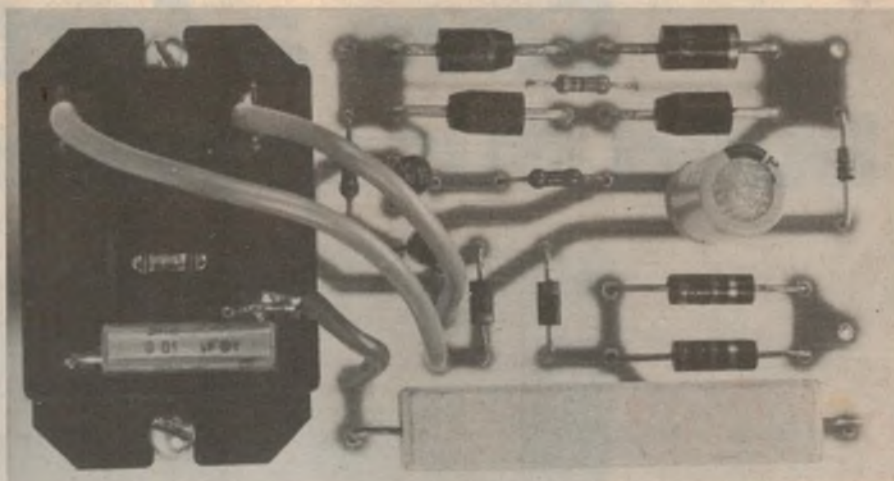

Above is a view of the assembled PCB. We recommend that you use the VF24HN relay from Associated Controls Pty Ltd (see text).

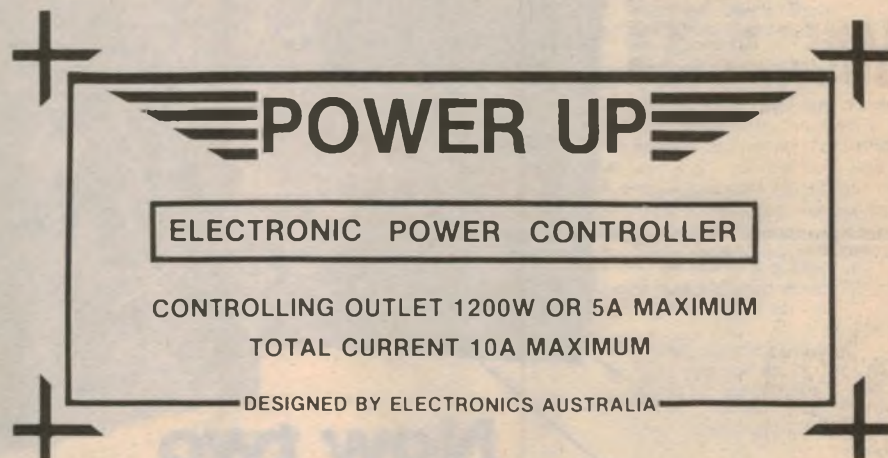

Here is an actual size artwork for the front panel.

ELECTRONICS AUSTRALIA HANDBOOKS

Fundamentals of SOLID STATE

AN INTRODUCTION TO SEMICONDUCTORS AND THEIR APPLICATIONS

JANUARY 1988



AN ELECTRONICS AUSTRALIA PUBLICATION

FUNDAMENTALS OF SOLID STATE provides a wealth of information on semiconductor theory and operation, delving much deeper than very elementary works, but without the maths and abstract theory which make many of the more specialised texts very heavy going. It's for anyone who wants to know just a little bit more about the operation of semiconductor devices.

BASIC ELECTRONICS

PRICE \$3.50



BASIC ELECTRONICS is almost certainly the most widely used manual on electronic fundamentals in Australia. It is used by radio clubs, in secondary schools and colleges, and in WIA youth radio clubs. Begins with the electron, introduces and explains components and circuit concepts, and progresses through radio, audio techniques, servicing, test instruments, etc. If you've always wanted to become involved in electronics, but have been scared off by the mysteries involved, let Basic Electronics explain them to you.

Available from "Electronics Australia", 57 Regent St, Chippendale, NSW. **PRICE \$3.50 each** OR by mail order from "Electronics Australia", PO Box 163, Chippendale, 2008. **PRICE 4.40 each.**

Save a fortune - build this speaker system!



Special self-adhesive 'Playmaster' logo to complete your system, stylish, elegant - and professional!

Fully imported contour grilles that simply press into place on the special grille clips provided. You won't have to worry about grille rattle or movement.

Inside, a fully assembled wiring loom with colour coded push-on connectors. No soldering required, everything is pre-made, ready for you to simply connect together.

Wire-grip cable sockets supplied at no extra cost, for easy connection to any stereo amplifier (speakers are rated at 8 ohms - so will perfectly match your stereo amplifier).

Acoustically transparent silk-like grille cloth already heat-welded to support the frame. All the hard work is done for you!

Matching plinth to raise speaker system above floor level - resulting in minimum bass colouration, more pure, natural sound.

Fully imported quality tweeters, especially selected for minimum sound colouration and distortion.

Separate high range & mid range fader controls - you can tailor the sound to the way YOU want it!

Sealed mid-range driver - you'll thrill to the clean, pure sound this superb speaker delivers.

Precision manufactured wrap-around enclosure, finished in the latest spillproof vinyl woodgrain surface. No polishing necessary!

Airtight front and rear baffle boards slot into grooves to ensure no air leakage. We even supply special speaker sealant to ensure absolute air tightness is maintained.

Huge 300mm bass driver (woofer) with the latest ribbed cone construction. This magnificent speaker handles a massive 55 watts RMS!

Now two new magnificent

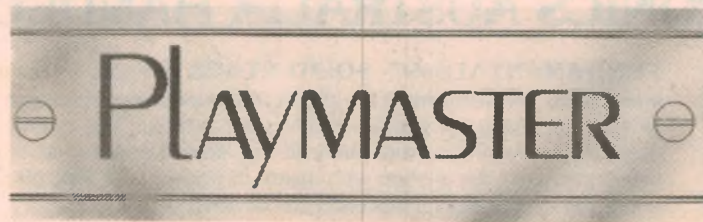

build-it-yourself hi fi speaker systems

Dick Smith brings you these superbly styled speaker systems to suit your room, your decor ... and your pocket!

Acoustically designed by Neville Williams, MIREE (Aust.), Editor-In-Chief of Electronics Australia magazine, they feature a **completely new format and style**, starting with the strikingly **handsome new grilles** with the **new 'Playmaster' logo** - and ending with a **performance you'd be amazed at!**

You'll **save a fortune** over comparable commercial speakers - because you build them yourself. And all it takes is a couple of hours construction time, a tube of glue and a screwdriver.

They look so good, and sound so great, your friends will never believe you built them!

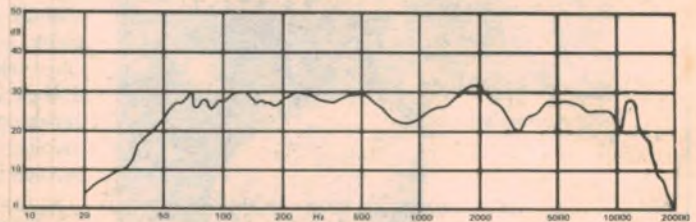

Measured response of Playmaster 300mm speaker system. Compare this performance with speaker systems you'd pay 3 or 4 times as much for.

Measurements performed by Dick Smith Electronics Technical staff



The boxes simply fold together - no wood-working knowledge needed. All panels are pre-cut, pre-rebated and pre-drilled. We've even heard of schoolchildren building their own Playmasters: they're that simple!



What the experts say:

"... the end result represents outstanding value for money. Whether you buy it in kit form or fully assembled, we are sure you will be pleased with sound quality."

"... the new Playmaster 3-70L has generous power handling capacity so that it can give a good account of itself on virtually any type of music."

*Neville Williams & Leo Simpson
(EA, March 1982)*

All you need is a tube of glue and a screwdriver - everything else is supplied for you. The wiring loom for the speakers is pre-assembled — the connectors just push on. And the speakers drop into position in the holes provided. If you can read simple instructions, you can build your own commercial quality speakers.



Look at these new features:

- ★ All new design in simulated woodgrain finish to complement decor
 - ★ Separate level control for high and mid ranges* - tailor the sound to suit your listening environment
 - ★ Special speaker sealant material supplied to ensure absolute air tightness
 - ★ New design ribbed woofer with massive 30cm cone for accurate bass reproduction
 - ★ Built-in plinth to raise speaker off floor level for minimum audio colouration
 - ★ Manufactured to the exacting standards of the original design published in Electronics Australia magazine
 - ★ Acoustically transparent silk-like grille cloth heat welded to support frame.
- *300mm system only

And now you're finished. Settle back with a drink, play your favourite record or tape. The sound quality will make you more than happy and your friends will never believe you built them!

300mm SYSTEM	250mm SYSTEM ⁴
Speaker kit, crossovers & faders This kit includes 300mm woofers, high and mid range faders, and 3 way crossover with high power handling capacity. Cat C-2042 \$179.00	Speaker kit, and crossovers This kit includes 250mm woofers and 3 way crossover with medium power handling capacity. Cat C-2044 \$155.00
Enclosure kits A pair of large 70 litre cabinets for the ultimate in sound reproduction. Cat C-2632 \$165.10	Enclosure kits A pair of large 53 litre cabinets to give great sound reproduction. Cat C-2634 \$148.10
Deluxe speaker grilles Handsome new design featuring the new 'Playmaster' logo. Cat C-2612 \$39.90	Deluxe speaker grilles Handsome new design to fit 53 litre cabinets, featuring the new 'Playmaster' logo. Cat C-2610 \$35.90
<small>Note: All prices are per pair.</small>	
TOTAL SYSTEM ONLY	TOTAL SYSTEM ONLY
\$384 per pair	\$339 per pair



DICK SMITH Electronics



SEE PAGE 98 FOR ADDRESS DETAILS

DSE/A285M/JW

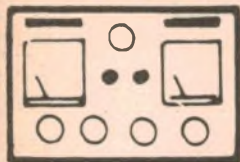

The Serviceman

Handyman repairs can prove expensive!

Where should the handyman leave off and the professional take over? Unfortunately, there can be no precise answer: How handy is the handyman? How urgent the need? How far away is professional help? And what are the risks if he fails? Will he simply be back to square one, or can he do more damage in the process? My first story highlights the risks in this latter regard.

In fact, the story is somewhat unusual on a couple of counts. One is that there is nothing particularly significant about it from a technical point of view, the interest being almost entirely in the reason why the set had to be serviced. And the other point is that the set came from well outside my normal area; from some 300 odd kilometres up the coast to be more exact.

I became involved with the set through one of my regular local customers, who was a friend of the owner. The location was a small coastal village, with no resident serviceman. And, while he doubtless could have found a competent service organisation a lot closer than the city, it was fairly natural for him to ask the advice of my customer when he encountered trouble. Added to that, he was in the happy position to organise transport at minimal cost.

FAULTY LOUDSPEAKER

The set in question was a HMV C211 colour set; a 63cm chassis in a large double ended cabinet featuring twin speakers, one on each side of the picture tube. And it was these speakers, or rather one of them, that caused all the bother.

I'm not absolutely certain about all the details, or the sequence of events but, as nearly as I have been able to piece the story together, it went something like this. One of the speakers began to misbehave, the voice coil apparently having gone out of alignment.

The resultant distortion was more than the owner could stand and, being relatively isolated as he was, he decided to have a go at fixing it himself. His approach, if not completely new, was at least unusual; he wedged pieces of

plastic foam between the speaker frame and the cone, and these were still in place when I received the set.

I'm not sure whether his aim was to force the voice coil back into alignment — assuming he knew enough about loudspeaker mechanics to reason thus — or whether it was more of a brute force approach aimed simply at silencing the speaker, or at least those of its sounds which were objectionable. I suspect the latter.

Anyway, the cure was apparently successful for a while, but the trouble gradually became worse, necessitating several more plastic foam "treatments". And each time he did this it was necessary to move the chassis out of the way. The chassis on the C211 hinges near the top of the cabinet and can be swung out and up, and locked in position either horizontally or vertically 180° from its normal position.

The next thing that happened was that the speaker failed altogether, due to an open voice coil. I imagine that this may have happened because, in spite of the foam plastic, the voice coil was still rubbing and eventually wore its way through the wire.

At this stage the owner would have been well advised to call it quits, at least

until he could get professional help. After all, the speaker's complete failure meant that there was no longer a distortion problem and he should have been able to rough it on one speaker for a few weeks.

But no; apparently something of a perfectionist, he insisted on having one more go at the problem. And this was when tragedy struck. He swung the chassis out and up as before, locking it in place, and turned his attention to the speaker.

The trouble was, he hadn't locked the chassis properly, or perhaps the lock was faulty. Anyway, it came crashing down and, in the process, clipped the neck of the picture tube. And that was that; one picture tube down the drain.

NEW PICTURE TUBE

So my job was basically to supply and fit a new picture tube and a new speaker. I ordered a new speaker from the makers, and a rebuilt picture tube from an independent organisation. This resulted in a worthwhile saving, though not as much as it normally would. The old picture tube was no longer under vacuum and therefore of no value as "glass allowance", a fact which added about \$80 to the price.

The new items eventually arrived and were duly fitted. The set worked immediately and, after a de-gauss, purity adjustment, convergence, and grey scale adjustment, turned in a first class performance. And, in theory at least, that was all that I needed to do.

In practice, experience has taught me that there are a number of potentially troublesome components in this set, mainly in the power supply, which can be changed with advantage on a routine basis. This approach was particularly appropriate in this case, in view of the owner's isolation and the high cost which was involved anyway.

The suspect components are several electrolytic capacitors; a 10 μ F, C101; and two 47 μ F, C102 and C104. These were replaced as a matter of course and I also checked C112, the 330 μ F main



smoothing capacitor, and C105, a 1 μ F electrolytic.

The 330 μ F is not the most reliable, and needs to be changed if there is any suspicion of hum trouble. There were no such symptoms in this case, so I left it in place. The 1 μ F, C105, should be a tantalum electrolytic but, in some production chassis, an aluminium electrolytic was fitted, and this can give trouble in that the switch mode power supply will not start. This one was, in fact, the right type and did not need to be changed.

This left only one more suspect; another 10 μ F electrolytic in the frame circuit, C318. Failure here can cause the picture to creep down from the top of the frame or, in some cases, to jitter at the top. This was replaced as a matter of course.

And that was more or less that. I let the set play in the workshop for the next couple of days while the owner arranged transport, and it never missed a beat. That was several weeks ago and a message just to hand via my local customer advised that the set had travelled well and performed perfectly at switch-on and ever since.

So there it is; a relatively simple fault which should not have cost more than a few dollars turned out to be a very expensive one due, in part, to the owner's inexperience and in part to bad luck. The truth is, I'm not quite sure why the chassis clipped the picture tube when it collapsed; it should have followed the same path down as it did up. I can only assume that its bearings were sloppy.

NO REMOTE CONTROL

My next story concerns one of the early model Kriesler TV sets with remote control; a model 59-3 to be exact. This uses a quite comprehensive remote control system, featuring channel selection, volume, brightness, colour saturation, tone control, sound mute, etc. And it was this section of the set which had failed, there being no remote control function at all.

In any remote control failure the first thing to establish is whether it is the transmitter in the remote unit which has failed, or whether it is the receiver section within the set. To this end I always like to take a spare remote unit with me when answering such calls. There is little point in lugging the whole TV set back to the workshop, and depriving the owner of its use, if it is only the remote transmitter which is faulty.

Unfortunately, on this occasion, I had no such spare available, and so I just had to play it by ear. Fortunately, the lady of the house was able to give me the history of the failure — "I had an accident with the thing and sent it flying along the floor" — which seemed to leave little doubt that it would be the transmitter at fault.

In fact, from the lady's description of the accident, I fully expected a broken printed circuit board, or some equally drastic damage, when I opened the unit. I even went so far as to warn the customer that the repair could be expensive or, if the damage was too great, that it would be cheaper to buy a new one. This didn't seem to deter the lady, who simply insisted that whatever was necessary should be done.

Back at the workshop I opened the unit, fully expecting the worst, only to find that there appeared to be no physical damage at all; certainly none of the dreadful things I had envisaged. But why wouldn't it work?

A more subtle form of damage to the board? A hairline fracture? I pulled the board out and examined it in detail under the bench magnifier, but could find nothing wrong with it. The battery? Could one of the cells have been on its last legs anyway, and failed coincidentally with the accident? Once again I drew a blank; the cells were obviously new and in perfect condition.

So, with these preliminaries over, I had to really get down to some serious testing. This remote control system uses an ultrasonic link to the set proper, so the first thing I had to do was establish that an ultrasonic signal was being generated and applied to the transducer and then, if this was so, confirm that the transducer itself had not been damaged.

The first step was relatively simple: I hooked the CRO across the transducer terminals, set the timebase to an appropriate speed, and pressed one of the buttons on the unit. Sure enough, up came a near sine wave pattern at around 40kHz, suggesting that most of the circuit was functioning correctly.

Checking the transducer was a little more complicated. I fished out a small microphone insert which had been used for something quite different originally, and connected it to a general purpose amplifier which I keep on the bench for audio signal tracing. I connected the output of the amplifier to the CRO and set the microphone hard up against the transducer.

I was aware of several serious limitations in this set-up. The weakest link was the microphone, which was certainly never designed to respond to these frequencies, and to a lesser extent the amplifier. While it is not unusual to find that modern amplifiers work well beyond the audible spectrum, this is often as much a matter of good luck as of design. And I had no idea how good this amplifier was in that region.

All of which added up to a test which might well prove inconclusive; if no signal could be detected it could be due to either failure of the transducer, or simply because the test set-up wasn't

COLOUR TV CHANGE OVER MODULES

THORN 4KA	
P/supply, Scan excluding tripler	\$57
Vertical	\$33
Chroma	\$39
Signals Complete	\$63
THORN 3500	
Convergence	\$53
Vert-Audio	\$33
Horizontal	\$57
Power Supply	\$42
Video	\$33
Chroma	\$45
HMV — EMI C211	
Power Supply	\$38
Horizontal	\$45
Vertical	\$22
HMV — EMI C221	
Power Supply	\$32
Horizontal	\$42
Vertical	\$24
PYE T29-T30-34	
Signals	\$53
Scan	\$53
Varicap Tuner ENV77405	\$48
PHILIPS K9-K11-K12-K2	
Power Supply	\$53
U190 Power supply	\$18
U240 Sound	\$15
U260 CHR-LUM	\$10
U270 Ref Comb	\$15
U280 Demod	\$12
U330 Line	\$18
U335 Frame	\$18
K12 Sync	\$24
K12 I.F.	\$20
K12 Matrix	\$27
KREISLER 59-1-2-3	
Power Supply	\$53
Power Supply control	\$18
Chroma Demod	\$27
Frame	\$30
Line	\$30
Ref Comb	\$27
CHR Lum	\$27
Remote	\$30
RANK 2201-2601	
Deflection Boards	\$48
PWC 296	\$21
PWC 411	\$22
PWC 367	\$15
LUXOR	
Power Supplies	\$30
SHARP	
Horizontal	\$24
Vertical	\$12
Chroma I	\$23
Chroma II	\$24
<i>Other modules available for most makes and models. Complete changeover chassis for Sharp, Luxor, Blaupunkt and others.</i>	

PARTS ON SPECIAL

Thorn Thick Films			
TF 302	\$7	TF 401	\$9
TF 303	\$6	TF 402	\$9
TF 501	\$8	TF 502	\$8

LARGE RANGE OF TV SPARES IN STOCK — NEW AND SECOND-HAND

Phone for availability:

TRADE TELEVISION AND VIDEO SERVICES

159 Queens Parade,
Clifton Hill, 3068.
Ph: (03) 489 1168

THE SERVICEMAN — Continued

good enough. Only a positive reaction would be of any benefit.

Strangely enough, it did work; much to my surprise. Granted, it only just worked. Only when the microphone was held hard against the transducer could I get any response; move it four or five centimetres away and there was nothing. That still left a niggling doubt; was this result due solely to the limitations of the test set-up, or was the transducer sick? I decided to assume that it was my set-up that was weak, at least for the present.

But now, having apparently cleared the transducer, I was rapidly running out of simple ideas to explain the unit's failure. In fact, I could think of only one other explanation; that the frequencies being generated were out of tolerance, though how the accident could have caused this I couldn't imagine. Still, it had to be checked out.

This meant delving into the instruction manual and re-acquainting myself with the finer points of the unit's behaviour. It actually generates three frequencies; 37kHz, 39kHz, and 41kHz, all of which have been chosen because they fall between the second and third harmonics of the line frequency and thus prevent false triggering by the line output stage.

As a further precaution against false triggering, a command always involves two frequencies, either 37 or 39kHz in a suitable code, followed by 41kHz to confirm that the command be executed. (Some early ultrasonic systems would change channels, etc. when a viewer sneezed or rattled a bunch of keys!)

As an example of the system, the manual reads as follows: "When any one of the eight channel selection buttons on the transmitter is pressed, a signal is transmitted consisting of a pulse of given duration at 37kHz, followed directly by a continuous signal at 41kHz. The duration of the 37kHz pulse determines which of the eight channels is to be selected, and then the 41kHz signal indicates that the command may be executed. The 41kHz signal remains for as long as the button is depressed."

This makes it relatively easy to generate a 41kHz signal for test and measurement purposes; simply hold the button down for as long as is necessary. But measuring the frequency with the accuracy required is another matter. It might be possible to do this with the CRO, assuming a suitable timebase reference frequency was available, but it is likely to be a rather messy approach.

The job really calls for a frequency counter and, fortunately, I had treated myself to one of these instruments not so long ago. In fact, this was the first serious service application I had found for it. The procedure, as set down in the

manual, starts with adjustment of the 41kHz signal. This is produced by holding down the channel selector button as already described, then adjusting transformer T1 to give exactly 41kHz.

In fact, this frequency turned out to be noticeably off; it was closer to 43kHz than 41kHz. I put this back on frequency, then tackled the other two adjustments. This involved shorting out first one transistor (TR5) and then another (TR7) while adjusting first one variable capacitor (C5) to produce a 37kHz signal and then another (C9) to produce 39kHz. Finally, a second transformer (T2), in the output stage, is adjusted for maximum output.

(Incidentally, my copy of the circuit has a minor error in it; there are two C5s and no C9. Fortunately, the correct designations are fairly obvious.)

In fact, both the other frequencies were a little off, though not by as much as the first one. However, it appears that transformer T1 is common to all three oscillator circuits, so that these two frequencies could have been badly off also, before I adjusted the core.

After that there was little more that I could do until I took the unit back and tested it on the set. When I did, it was with some relief that I found it was working perfectly. Naturally the lady was delighted, particularly when she realised that the repair had not cost as much as I had feared it might.

That was a couple of months ago, and I have seen both the lady and her husband several times since and they report that the unit hasn't missed a beat.

But why had it gone off frequency in the first place or, more specifically, how could the accident have caused such a fault? Frankly, I haven't a clue. The adjustable core, while not locked tight, was firm enough, and I find it hard to believe that the accident could have caused it to move as far as I had to turn it to put it back on frequency.

Another possibility I considered was that the fall had damaged the core, causing a small piece to break away and thus increase the frequency. The only snag is that I could find no evidence to support this theory.

The only theory I can advance is that the system was well off frequency to start with, and only just managing to work. When it was bashed, the core did move marginally and this was enough to move the frequency outside the working tolerance. I know it's a tenuous theory, but it is the best that I can offer.

As the Bard said, "There are more things in heaven, earth, and TV servicing Horatio . . ."

Well, something like that!

HOW TO GET MICROBEE ORDERING DETAILS

Fully built MicroBee 16K including	
manuals and 16K ROM BASIC	\$399.00
MicroBee 32K	\$499.00
MicroBee 64K	\$649.00
New Moulded case	\$25.00
Black and White Monitor	\$139.50
Green Screen Monitor	\$299.00
Cassette Recorder	\$35.00
MicroBee Editor/Assembler	\$49.50
Cassette Software	each \$7.95
Space Invaders program	\$14.75
Conversion 16K to 32K	\$100.00
Conversion 32K to 64K	\$155.00
\$100 Expansion Interlace	\$299.00
Disk Drive with CP/M and disk controller	\$799.00
Add on disk drive	\$549.00

AVAILABLE FROM

Sydney Showrooms:

1A Pattison Ave. Waitara NSW 2077 Hours 9-5 Monday to Saturday Phone (02)487 2711 (order queries), (02)487 3798 (mail orders)

Ararmon: 35, Dickson Ave. Ararmon NSW 2064 Phone (02)439 2322

Gosford Showroom: 1, Debenham Rd. West Gosford NSW 2250 Phone (043) 24 1022
Canberra: Applied Technology (ACT) Pty Ltd 27 Colbee Court, Philip ACT Phone (062)82 4611

Mail Orders to:

PO Box 311 Hornsby NSW 2077
Telex APPTTEC AA72767

Beeline

If you have technical questions on MicroBee, just phone on our new Beeline number (043)24 1022



Goods expected in stock and goods available at time of going to press



microbee
APPLIED TECHNOLOGY

Distrib. & Assoc. AT-33



MicroBee isn't the only computer you can buy for \$399, but it's the only one that includes these powerful features — options on most computers and just not available on others. Features that give you real computing power — at a realistic price.

1. **16K User RAM** The basic MicroBee has a full 16K of RAM available for programs or data. The screen RAM is a separate 4K. The memory can be expanded to 32K or 64K — without expensive "expansion boxes."
2. **Continuous Memory** Using the latest technology CMOS RAM chips, the MicroBee never forgets. Unplug MicroBee and your programs and data are there when you plug it back in. (Note: Battery and clips not included.)
3. **16K ROM BASIC** Advanced error reporting and editing features include global search and replace (which makes it a snack to modify programs written on another BASIC) and automatic line numbering.
4. **RS232 Serial Port** Lets MicroBee communicate with printers, modems, etc. Optional on most other computers.
5. **Sound** Bring your programs to life with MicroBee's programmable sound generator and inbuilt speaker.
6. **High/Low resolution programmable graphics** Under full BASIC control. High resolution display of 512x256 — compare that!
7. **Upper & Lower case 64x16 display standard**
8. **Two speed cassette interface** Uses just about any low-cost cassette recorder to save your programs.
9. **Self Test** MicroBee can perform a complete test of all its circuitry with a simple command from the keyboard.

Before you buy any computer compare it with MicroBee. No other computer gives you all this for \$399.

\$399.00
16K



microbee

APPLIED TECHNOLOGY

9 FEATURES
OTHERS CALL OPTIONS.
ON MICROBEE
THEY'RE STANDARD!

Circuit & Design Ideas

Interesting circuit ideas from readers and technical literature. While this material has been checked as far as possible for feasibility, the circuits have not been built and tested by us. As a consequence, we cannot accept responsibility, enter into correspondence or provide constructional details.

Signal controller for model train layouts

Using a single light beam, this circuit will switch three miniature 12V lamps, as used in model trackside signals.

The signals are placed about 40cm or more past the light beam. As the train passes between the LDR and lamp, the signals change from red to green. After a delay of several seconds, the signals turn amber, then back to red again. In the prototype, the green lamp remained on for about eight seconds and the amber lamp for approximately four seconds. While this may not seem realistic (the train never has to stop for a red light), it is better than a static display.

The circuit is based on a pair of 555 timers, wired as monostable multivibrators. When light falling on the LDR is interrupted, the voltage on pin 2 drops below one-third of the supply potential. The timing capacitor then charges up towards 9V at a rate determined by the charging resistors (1MΩ trimpots and associated resistors). The time taken for the capacitor to charge to two-thirds of the supply voltage regulates the length of the output pulse.

IC1 generates a pulse which governs the length of time in which a train can "legally" pass through the signals. IC2 provides a shorter pulse, used to divide this time between the green and amber lamps.

The lamp for the light beam could be an ordinary torch bulb; the type with the built in lens would be ideal. In my version, the bulb was a small 14V type with

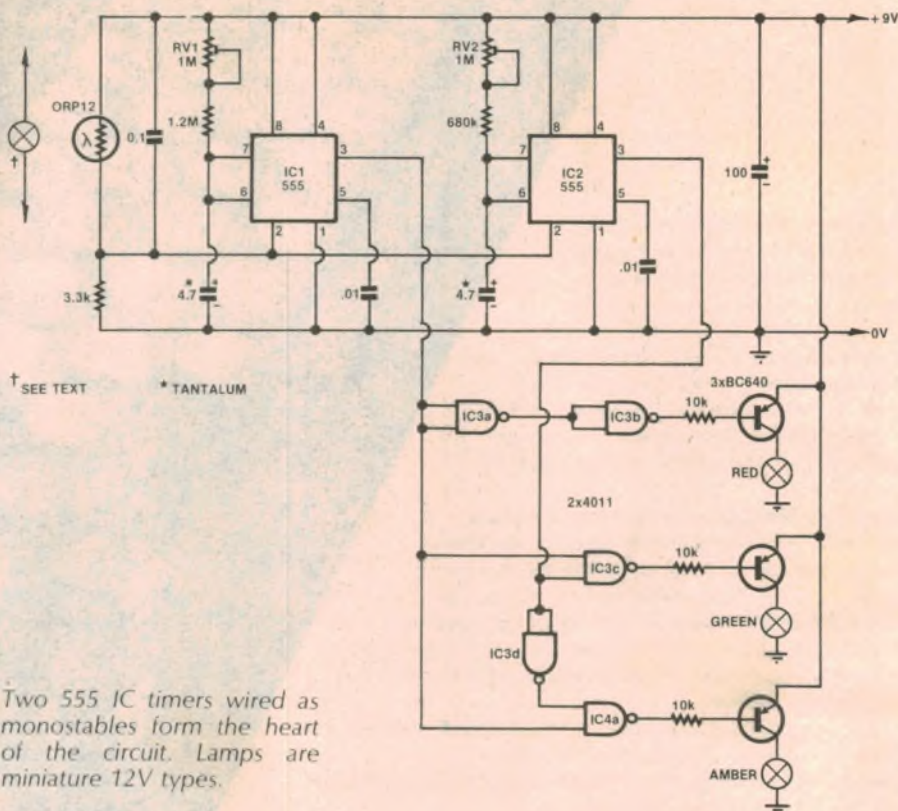

Two 555 IC timers wired as monostables form the heart of the circuit. Lamps are miniature 12V types.

an aluminium foil reflector wrapped around it, and run off the main train transformer.

When setting up the controller, RV2 should be set for minimum resistance, then RV1 adjusted to give the required

length of the entire timing cycle (green AND amber times). After this, RV2 can be set to obtain the desired green:amber timing ratio.

D. Houlter,
Charnwood, ACT.

Cudlipp's sister a ladybug

Those who were intrigued with Cudlipp (EA, February 1982) and Cudlipp's Brother (EA, June 1982, p84) will want to know about Cudlipp's sister. Now Cudlipp's sister does not like light, she loathes it. While ever you leave the light on to read she complains. You could have fun by building the whole Cudlipp family and hiding them in some poor soul's room.

When the light is on, Cudlipp's sister complains. When the light is off, Cudlipp's brother starts up and if the victim starts swearing, Cudlipp himself chimes in. Pity the poor victim — he can't read, can't sleep and can't swear.

The circuit is basically a NOR-gate oscillator which has its pitch controlled by the photo-transistor Q1. Changing R1 to a higher value will give a lower-pitched wail and vice versa.

K. Mueller,
Greensborough, Vic.

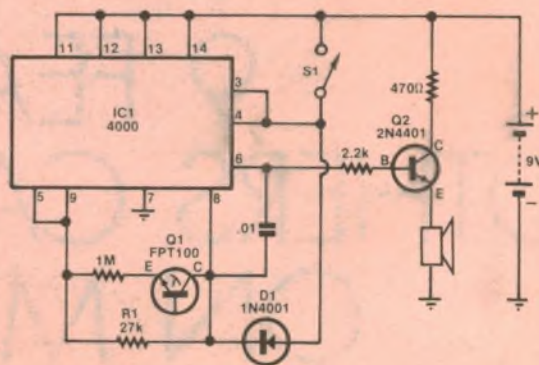

Cudlipp's sister consists of a NOR-gate oscillator driving a loudspeaker via transistor Q2.

Look who else has hooked up to Epson

When Rank Xerox launched their 820 Micro Computer they knew they had a winner. And now, to complete the winning package, the Xerox 820 comes with the world's best selling desktop printer . . . EPSON.

The EPSON MX80 111 F/T and the EPSON MX 100 111 F/T, each with Buffered Serial Interface, offer high quality, cost effective output at a speed of 80 and 100 characters per second respectively.

Standard features of the EPSON systems include bi-directional printing with logic seeking (text mode), full 96 ASCII with descenders, multiple fonts with superscript-Subscript and underlining, electronic sensors and a self test facility. Two paper feed options—friction and tractor feed are available.

When Rank Xerox hooked up with Epson, they hooked up with the best. No other printer has made such an impression. When you have a look at the Epson range . . . we know you'll be impressed.



EPSON
RANK XEROX*

For further information contact your nearest Warburton Franki office

WARBURTON FRANKI

• ADELAIDE (08) 356-7333 • BRISBANE (07) 52-7255 • SYDNEY (02) 648-1711 • MELBOURNE (03) 699-4999 • PERTH (09) 277-7000

*Xerox and Rank Xerox are registered trade marks of Rank Xerox.



PRO. KITS FOR PRO.

JAYCAR KITS ARE MADE FOR YOU – THE "WEEKEND PROFESSIONAL". YOU HAVE THE CALIBRE THING IS, YOU PAY NO MORE FOR QUALITY JAYCAR KITS ANYWAY!!

NEW

STEREO Synthesiser



ONLY **\$49.50**

COMPLETE

Creates a very realistic stereo sound from mono sources i.e. AM tuners, TV or video units Very easy to build and comes complete.

500MHz Digital Frequency Period Meter

REF: EA Dec '81 – Feb '82
500MHz option only \$26 extra
50MHz Version \$119



Tilting Bail to suit ONLY \$4.95

Other people may appear to be selling this kit for less. But you GET less!!! Exclusive Jaycar features:
* Heavy gauge front panel. Pre-punched, and silkscreened. (NOT Scotchcal). * Low aging rate 10,000 MHz crystal * Quality IC sockets provided (A MUST) * All metal film resistors used (1% 50ppm) * Thermal alloy heatsink for +5V regulator
Beware of advertised units that do not conform to the original design. They may have inferior performance.

ONLY \$119
EXCLUSIVE!!!
Gold Plated BNC Input Connectors

Digital EA282 Thermometer *



Ref: EA Feb 1982
Read the temperature in your room (or outside) from 0 degrees C to 100 degrees C in fact to within 0.1 degree C. Fantastic resolution on a bright easy-to-read display.
INC CASE

\$69

DIGITAL CAPACITANCE METER *

Ref: EA March 1982



This kit once again uses the amazing DPM 200 LCD /driver module. Capable of measuring capacitance from 1pF to 19.99uF. It is a must in every workshop or lab.

\$69

Function Generator Ref: EA April 1982

"Pigeon Pair" companion to the new 500MHz DFM. Low distortion generator of sine, square and triangular waveforms. From below 20Hz to over 160kHz. Inbuilt 4 digit frequency counter in de-luxe Pac-Tec case. Only \$85

JAYCAR EXCLUSIVE – 1% 50ppm metal film resistors used for stability and it's still only \$85!!!



Only **\$85**

Unit pictured with EA Panel

HEART RATE MONITOR

WAS \$79
SAVE \$10

NOW \$69

Ref: EA 7/82

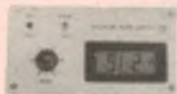

This unit enables you to measure your own pulse instantly and accurately. It is light enough even for joggers to carry. A must for people who may have heart problems.
Complete kit including LCD Display

NEW!!! LCD TACHO KIT ref: EA May 1982



\$49.50

- USES NEW DPM-05 DISPLAY
- FITS INTO YOUR DASHBOARD
- RPM, DWELL DISPLAY

NEW * ETI 644 * direct connect modem



+ Capable of a range of Answer/Originate operating modes + Selectable Baud rate + Software controlled + Uses new patented technique + More reliable and faster than most acoustic modems.

The Jaycar kit contains all basic PCB components inc: Full compliment of IC sockets, Arlec line tranny, all Fujitsu relays, Ceralock resonator, ETI 644 PCB etc. Outperforms units selling for over \$1,000!!!
A suitable 12V plugpack is available for only \$9.95

only \$169

syntom

As used by Warren Cann of 'Ultravox' *

Original design from the UK magazine 'Electronics and Music Maker' April 1981. Self contained unit produces a variety of fixed and falling pitch effects. Trigger by tapping the unit itself or by striking a drum to which the unit is attached. The Jaycar SYNTOM comes complete with high quality pre-drilled moulded all ABS box 152 x 80 x 47mm with professional silk-screened front panel.

FEATURES: Decay from less than 0.1 second to several seconds, pitch control, sweep control and volume on/off



ONLY \$36.50

PEOPLE - YOU!

AND DEMAND THE BEST. BUT THE FUNNY

EA CAR COMPUTER KIT new low price!

BUY THE WHOLE KIT
(INC. FUEL & SPEED SENSORS!)
FOR ONLY
\$165!!

WE too have the genuine
Moray fuel sensor. We buy it from the
same factory as Dick Smith!!
We also have an EA APPROVED Speedo
Cable sensor. The speedo cable sensor
gives better results at very low speed.

TAILSHAFT SPEED SENSOR

This unit also has the EA stamp
of approval. The sensor kit in-
cludes two powerful magnets, two
long Nylon locking straps to secure
the magnets to the tailshaft (we
recommend that you AVOID the
magnets as well!) and a plated
mounting stud with nut and
shakeproof washer.

ONLY \$14.50

T PIECE JAYCAR EXCLUSIVE

Only necessary if your car has a
fuel by-pass system (Many Euro-
pean and Japanese cars). Enables
by-pass system to operate with-
out affecting the accuracy of the
flow sensor. Has special restric-
tion in T-section.

ONLY \$3.95

SPEEDO CABLE SENSOR

This device has been tested and
endorsed by EA. It works on cars
that don't have tailshafts!! We
won't treat you like an imbecile
and say not to buy it in case your
speedo cable breaks - how often
does THAT happen? At \$29.50
you may as well leave it in the car
when you sell it, as it is cheaper
than most speedo cables anyway.

ONLY \$29.50

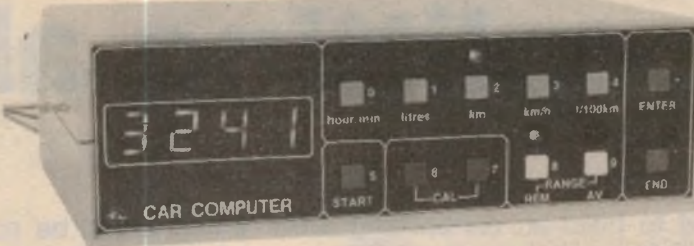

FUEL FLOW SENSOR - NEW MODEL

This is the LATEST VERSION of
the Moray fuel sensor. The early
models had a turbine impeller
moulded in ordinary Nylon.
Apparently this component ab-
sorbed moisture & expanded. The
expanded impeller then gave
slightly inaccurate results. The
Jaycar/Moray LATEST MODEL
impeller is now moulded in
DELRYN. This does not absorb
moisture & the flow sensor re-
mains accurate over the life of the
car. If you do not buy a Jaycar
Car Computer Kit make sure that
you are getting the LATEST
MODEL fuel flow sensor.

ONLY \$59.50

PRICING INFORMATION

ALL ELECTRONICS including both
PCB's plated through, programmed EP-
ROM, 1% metal film resistors, and other
high spec. components. You also get a
CHOICE of either tailshaft or speedo
cable type speed sensor (PLEASE
SPECIFY) ONLY \$99.50

Pre-punched genuine AMERICAN PAC-
TEC case (as used by EA) and NOT a
Hong Kong copy, with special silk-
screened front panel and multi-way
connector ONLY \$39.50

Genuine MORAY high resolution fuel
sensor - LATEST VERSION
ONLY \$59.50

Lyrebird Piano Kit **NEW LOW PRICE**

REF: EA 11/81-1/82

7 1/2 OCTAVE
(88 NOTE)
VERSION
\$589

6 OCTAVE
\$475



GREAT NEW FEATURES!!

- FREE! A stand (like the one illustrated but not exactly the same). Worth over \$50 but yours at no extra charge with each 73 or 88 note kit.
- FREE! A soldering iron (worth around \$19). Yours to keep to give years of faithful service after you have completed your Lyrebird. (88 note only)
- FREE! A 200g roll of solder. You will need some to build the Lyrebird but there will be plenty left over for other projects. (73 & 88 note versions).
- FREE! Quality IC sockets provided in both kits.

NEW LOW PRICE!! Because we are shipping keyboards and other expensive components in bulk due to high demand, we can pass savings on to YOU.

You can now have a magnificent "Lyrebird" 6 octave touch sensitive piano now for only \$475!! That's a staggering \$50 off the old price. **REMEMBER!! THE LYREBIRD OUTPERFORMS READY BUILT PIANOS COSTING UP TO THOUSANDS OF DOLLARS MORE. WHY PAY MORE WHEN YOUR CONSTRUCTION KNOWLEDGE CAN SAVE YOU A FORTUNE?**

HOBBY ELECTRONICS KITS - GIANT SELLOUT

KITS FROM UNDER \$3.00

If you buy these popular kits for the month of November you will get a whopping 25% off!! But only in November and ONLY while stocks last!

	Normally	This Month
HE102 Guitar Phaser	\$26.50	\$19.88
HE103 Transistor Tester	\$9.50	\$7.13
HE104 Simple AM Tuner	\$7.50	\$5.63
HE105 Basic Amplifier	\$9.75	\$7.31
HE106 Wireless Microphone (BUG)	\$6.50	\$4.88
HE107 Electronic Dice	\$5.95	\$4.46
HE110 Unmistakabell	\$6.95	\$5.21
HE111 Ohmmeter	\$19.95	\$14.95
HE112 Micromixer	\$12.00	\$9.00
HE113 Water Alarm	\$9.50	\$7.13
HE114 Digital Counter/Display	\$13.95	\$10.46
HE115 Reaction Timer	\$6.95	\$5.21
HE116 OP Amp Tester	\$3.95	\$2.96
HE117 House and Car Alarm	\$16.95	\$12.71
HE121 Scratch and Hiss Filter	\$9.50	\$7.13
HE123 Alien Invaders	\$13.95	\$10.46
HE126 NiCad Charger	\$9.95	\$7.46
(Plug Pack to suit above only \$9.95)		
HE127 Siren	\$3.95	\$2.96
HE128 Fog Horn	\$6.70	\$5.95
HE129 Simple Timer	\$6.95	\$5.21

In addition, we will give you FREE two copies of Hobby Electronics magazines (worth up to \$2.50) with each order!!!

Jaycar

125 YORK St. "NEVILLES CORNER" Cnr CARLINGFORD &
SYDNEY 2000 PENNANT HILLS Rd.
Phone: 264 6688 CARLINGFORD
Telex: 72293 Phone: 872 4422
Mail Orders To: BOX K-39 HAYMARKET SYDNEY 2000

MINIMUM
MAIL ORDER
\$5.00



POST AND PACKING CHARGES: NEW SOUTH WALES
\$1.99 (1-20), \$3.24 (21-40), \$4.49 (41-60), \$5.74 (61-80), \$7.00 (81-100), \$8.25 (101-120), \$9.50 (121-140), \$10.75 (141-160), \$12.00 (161-180), \$13.25 (181-200)
MUSIC: 8.30 to 5.30pm
SUN: 8.30 to 12.00pm
THURS: 11.00 to 8.30pm

Super Siren: an ear-splitting alarm

Ever wanted to build an ear-splitting alarm which would be compact and not draw much current? This is just the circuit for you. It uses a piezoelectric tweeter in a pulsed mode to form an arresting and very efficient alarm.

design by COLIN DAWSON

Piezoelectric tweeters have been around for a long time but they have never really caught as a medium for high fidelity sound reproduction, probably because they are difficult to manufacture to the requisite smoothness of frequency response.

Be that as it may, piezo tweeters have a number of characteristics which make them highly suitable for use in alarms. In this respect, they are identical in principle to the small, highly efficient alarms used in many computers and digital watches.

The equivalent circuit of a typical piezo tweeter is a capacitor of about $0.1\mu\text{F}$. Because of this, a piezo tweeter connected across an AC signal source draws very little current. This is important for our application because we wanted to operate the alarm from a small 9V battery. At this voltage the circuit draws less

than 10mA when it is sounding.

The sound output of this alarm is a series of four short pips in a one-second period, followed by a half-second break, then another burst of pips and so on. The resulting sound effectively conveys a sense of urgency and is more likely to be acted upon than one of the more common transistor powered alarm circuits which sound like a half-strangled cat!

We will leave it to the reader to think of applications for this alarm. We are sure that there will be many. It could be used as an equipment malfunction alarm, intruder alarm or car alarm (separately powered and not dependent on the car battery).

Fig. 1 gives a picture of what the sound output of the alarm looks like on an oscilloscope. Each pip is actually a burst of 5kHz signal lasting for about 60 milliseconds and there are four pips in

each 400ms burst. The frequency of 5kHz was settled upon as being the most earsplitting. At frequencies below 5kHz, piezo tweeters do not have much output.

The waveform of Fig. 1 could easily have been produced by conventional logic circuitry using counters and gates plus an oscillator to drive it all. But we elected to take a different approach and ended up with a circuit that uses no counters at all. The circuit uses just two CMOS ICs plus four transistors to buffer the piezo tweeter.

The two ICs are a 74C14 hex Schmitt trigger and a 4011 quad 2-input NAND gate.

How it works

IC1a is the free-running oscillator in the circuit with its 5kHz frequency determined by the $390\text{k}\Omega$ resistor and 470pF capacitor. This is one of the simplest oscillators possible and makes use of the hysteresis characteristic of a Schmitt trigger inverter. It works as follows:

Consider that power is applied and the 470pF capacitor is discharged. This means that pin 5 of IC1a is low and (because it is an inverter) pin 6 will be high. The capacitor is then charged from pin 6 via the $390\text{k}\Omega$ resistor until the voltage across it rises to the upper threshold of the Schmitt trigger. At this point the voltage at pin 6 abruptly goes low and so the capacitor begins to discharge via the $390\text{k}\Omega$ resistor.

It continues to discharge until it reaches the lower threshold of IC1a whereupon the voltage at pin 6 abruptly goes high again. This sequence continues while ever the power is applied. Thus the output waveform at pin 6 is a square wave of 50% duty cycle while the waveform at pin 5 is a sawtooth.

So IC1a provides the basic 5kHz tone which then needs to be frequency divided to derive the "pip" waveform. IC1b in conjunction with D1 and D2 form the first frequency divider. If you ignore the diodes for the moment the configuration of IC1b is similar to IC1a just described

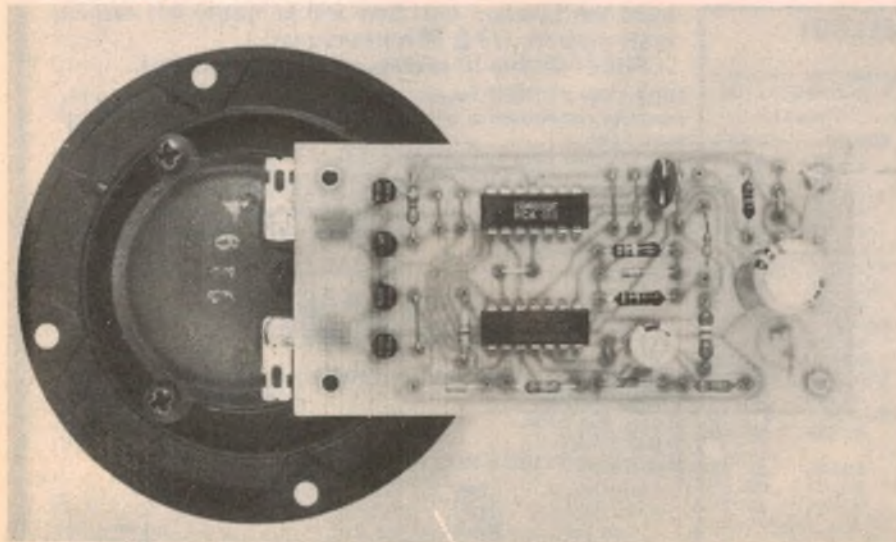

The Super Siren PCB is soldered directly to the terminals of the tweeter.

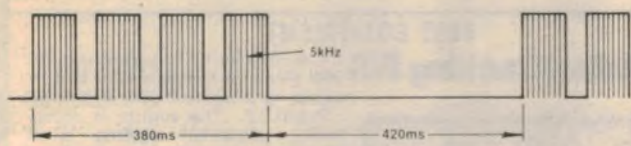
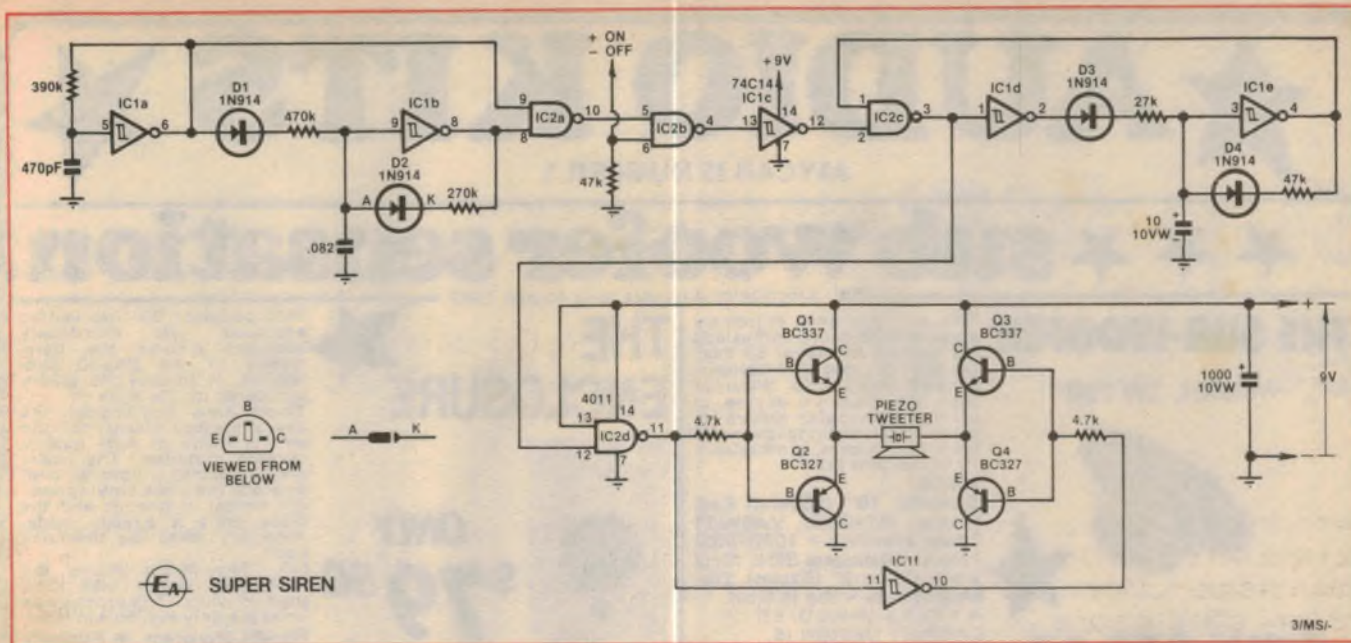
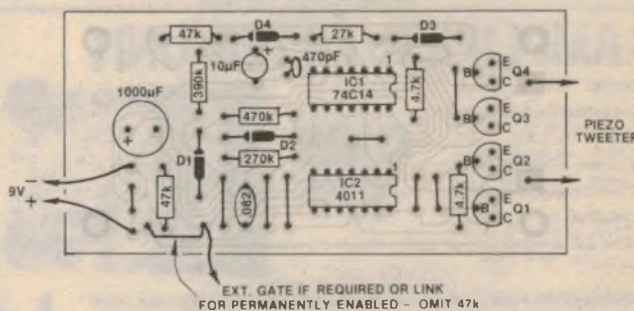

Fig. 1

This diagram shows the waveform across the tweeter.

At right is the parts overlay diagram. The 47kΩ resistor on pin 6 of IC2 can be omitted if the alarm is to be permanently enabled.



and that will give a clue to its operation.

Now consider that the .082μF capacitor associated with IC1b is discharged and, as a consequence, pin 8 is high. This reverse-biases D2 and effectively removes it and the 270kΩ series resistor from the circuit, for the moment. Each time pin 6 of IC1a goes high, D1 is forward biased and feeds a small amount of charge into the .082μF capacitor via the series 470kΩ resistor.

This continues until the voltage across the .082μF capacitor rises to the upper threshold of IC1b whereupon the voltage at pin 8 goes low. This then discharges the .082μF capacitor via D2 and the 270kΩ resistor until the voltage at pin 9 drops to the lower threshold of IC1b. The voltage at pin 8 then goes high again, reverse-biasing D2 and allowing the capacitor to charge via D1.

The result of this charge and discharge cycle is a square wave at the output of IC1b which is high for approximately 65 milliseconds and low for 30 milliseconds. This is then used to gate the 5kHz waveform on and off, using NAND gate IC2a.

IC2b is used to provide an enable control for the whole siren circuit. If pin 6 of IC2b is held high, the signal from IC2a will be gated through and the cir-

cuit will operate. If pin 6 is low, IC2b is disabled. The gated signal from IC2b is inverted by IC1c to provide the correct pulse polarity, to enable the following frequency divider, comprised of IC2c, 1d and 1e, to work.

IC2b allows the circuit to be switched on in a "standby" mode without the siren actually sounding. When the external gate is taken high, the siren is instantly enabled. This avoids the inevitable distortion of the siren tone which occurs briefly while the supply bypass capacitor charges. Also, because the circuit uses such a small amount of power, the siren is audible for a number of cycles after power is switched off. If either of these characteristics is considered a disadvantage, then the external enable is the solution. Where not required, it is simply tied high by an optional link on the board.

IC1e plus diodes D3 and D4 function in exactly the same way as IC1b, with the 10μF capacitor charging via D3 and discharging via D4. The difference with this circuit is that while the capacitor is being discharged by D4 the signal to D3 via IC1d is disabled by means of NAND gate IC2c. IC2c, and thus IC2d, is gated on when the output of IC1e (pin 4) is high. IC2d functions merely as an inverting buffer for the output of IC2c.

By using IC2c and IC1d (to invert the signal), the duty cycle of the output waveform from IC1e can be controlled over a wide range by suitable selection of the associated 27kΩ and 47kΩ resistors.

To sum up the circuit description thus far: We have a free-running oscillator at 5kHz, IC1a; a frequency divider with an output at about 10Hz (IC1b) which gates the 5kHz signal on and off via IC2a; and a further frequency divider, IC1e and associated components, with an output at about 1.25Hz which also gates on and off the pulse-modulated 5kHz signal from IC2a, using gate IC2c.

Two variables will affect the oscillator frequency and the timing of the pips. The first variable is the supply voltage and the second is the hysteresis of each Schmitt trigger in IC1, ie, the difference

We estimate that the current cost of components for this project is approximately

\$21

This includes sales tax, but not the cost of a battery.

★ AUDIO KITS ★

JAYCAR IS NUMBER 1

★ ★ ★ sub woofer sensation

Ref: Electronics Australia June-August 1982

THE SUB-WOOFER

MODEL SW 250



ONLY \$79.50

This unit has been extremely popular with audio enthusiasts right across Australia! EA have designed a special crossover/booster amp just for this unit. Now you have no excuse to build a subwoofer system to enjoy those thrilling low notes from pipe organs, synthesisers, 1812 cannons etc!!

SPECS:

Diameter 10" (250mm) Cast Frame. QT=0.39. VAS=631
Power Handling = 100WRMS.
Free-air Resonance 32Hz ±1Hz
Voice Coil = 2" (51mm). Dia.
Magnet Assy = 3kg (6.6lbs).
A FREE SUB-WOOFER CABINET DESIGN IS PROVIDED WITH EACH UNIT!!

THE ENCLOSURE



ONLY \$79.50

This compact 63 litre vented enclosure was specifically designed around the parameters of the SW250 Sub-Woofers. It follows the theory pioneered by the work of Thiele, Small and Snyder. The Jaycar enclosure is easy to build and is made of high quality durable materials. The heavy walled cabinet is covered with an attractive black vinyl veneer. All timber is pre-cut and the black grille is already made. Assembly takes less than one hour.

N.B. The photo shows the prototype which was finished in white. The production units are only available in black. Freight anywhere in Australia only \$10.00.

AMPLIFIER/FILTER UNIT

AMPLIFIER/FILTER UNIT
Amplifier Module \$79
Transformer to suit \$39.50
Metal case specially made to suit including front panel, hardware etc (not a twin 25 case). Only \$29.50 \$148.00

ONLY \$79

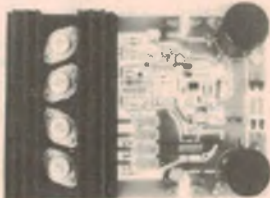

Buy the lot for only \$125.00 if you purchase the enclosure and woofer at the same time

REF. EA JULY 1982

State-of-the-art power Mosfet technology combined with an active low pass filter results in a sub-woofer amp without equal anywhere!!

FEATURES: Around 100WRMS Drive capability.
Low pass (sub-woofer) filters on board.
Can hook-up to pre-amp out or power-amp out.

Power supply on board.

(Transformer needed. ONLY \$39.50)

TEST EQUIPMENT

EA dual tracking P/S



Extremely versatile power supply: Will give plus & minus 1.3V to 22V at up to 2 amps PLUS A FIXED +5V@0.9A. The supply is completely protected against short circuits, overloads and thermal runaway. A large meter with voltage calibration is supplied as well as IC sockets. A quality kit.

\$84.50

Ref: EA March 82

Digital Storage CRO Adaptor \$110

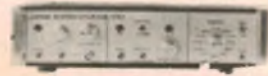

Not only can you avoid buying an expensive CRO but you can have the features of the REALLY expensive ones!! *Can display very slow waveforms * One shot triggering * Inbuilt graticule shows on TV screen * Crystal locked timebase * DC-100kHz bandwidth * Capable of storage operations.

Ref: Feb 1982 EA

MARC NR82 MULTIBAND RECEIVER

AS REVIEWED IN ELECTRONICS AUSTRALIA AUGUST 1982
Virtually continuous coverage from 145kHz to 470MHz in all modes. AM, FM, SSB, CW. Built-in VFO, Squelch, RF Gain, Antenna trim and dozens more features!!
Measures a huge 484(H)x355(W)x165(D)mm and weighs 5 kilos (plus batteries!!) Fantastic performance from one radio.

\$10 freight anywhere in Australia.



12 * band

GREAT VALUE

only \$349

GOOD-BYE 3002



~~\$489~~ \$399

This 2x300WRMS P.A. Head is a classic road amp. Ruggedly constructed, 19" rack mount makes an ideal main P.A. or foldback unit. Great for Disco use as well.

We are discontinuing this amp because it is becoming too expensive to make. The metalwork costs alone now account for well over 50% of the unit. Because of this we have reluctantly decided to discontinue the unit. You can grab one now while they last for only \$399

Send SAE for full spec. sheet.

magazine binder

LOW IMPORT PRICE

ONLY \$4.95 4 up \$4.50



Keep your precious (and expensive) magazines in order for easy reference. Smart blue colour with gold lettering. Heavy gauge and richly chromed metal fittings.

JAYCAR

125 YORK ST. SYDNEY 2000
Ph. 264 6688 Telex: 72293
Mail Orders To:
Box K-39 Haymarket 2000

"NEVILLES CORNER"
Cnr. CARLINGFORD & PENNANT HILLS RD.
CARLINGFORD Ph: 872 4422

between the upper and lower voltage thresholds.

Because of the effect of these variables it may prove desirable, in some cases, to alter some resistor values to obtain a preferred sound from the circuit. The important point to note is that, if alterations are made to the first frequency divider, IC1b, the 270kΩ resistor cannot be increased appreciably, with respect to the 470kΩ resistor, otherwise the circuit will cease to divide.

The pulse-modulated signal from IC2d cannot be used to drive the piezo tweeter directly because of the relatively high output impedance of CMOS devices. One side of the tweeter is driven by Q1 and Q2 which function as complementary emitter-followers and thus as a buffer stage for IC2d.

PARTS LIST

- 1 Printed circuit board, code 82a111, 49 x 101mm
- 1 9V battery (Eveready 216 or equivalent)
- 1 Battery clip to suit
- 1 Piezo tweeter

SEMICONDUCTORS

- 4 1N914, 1N4148 diodes
- 2 BC337 NPN transistors
- 2 BC327 PNP transistors
- 1 4011 quad NAND gate
- 1 74C14 hex Schmitt trigger

CAPACITORS

- 1 1000μF/10VW electrolytic
- 1 10μF/10VW electrolytic
- 1 .082μF metallised polyester (greencap)
- 1 470pF ceramic

RESISTORS (¼W, 5%)

- 1 x 470kΩ, 1 x 390kΩ, 1 x 270kΩ, 2 x 47kΩ, 1 27kΩ, 2 x 4.7kΩ

If Q1 and Q2 were used alone to drive the tweeter, it would have a square wave of about 9 volts peak impressed across it. This is equivalent to a voltage of 4.5V RMS. By adding Q3 and Q4 to drive the other side of the tweeter with an antiphase signal from inverter IC1f, we double the drive voltage to 9V RMS and thus quadruple the power level.

The 1000μF electrolytic capacitor across the 9V battery allows the transistors to deliver the necessary high spike currents to the tweeter. These spike currents occur because we are essentially feeding a capacitor (the tweeter) with a square wave.

While the spike currents may be quite high, the average current when the

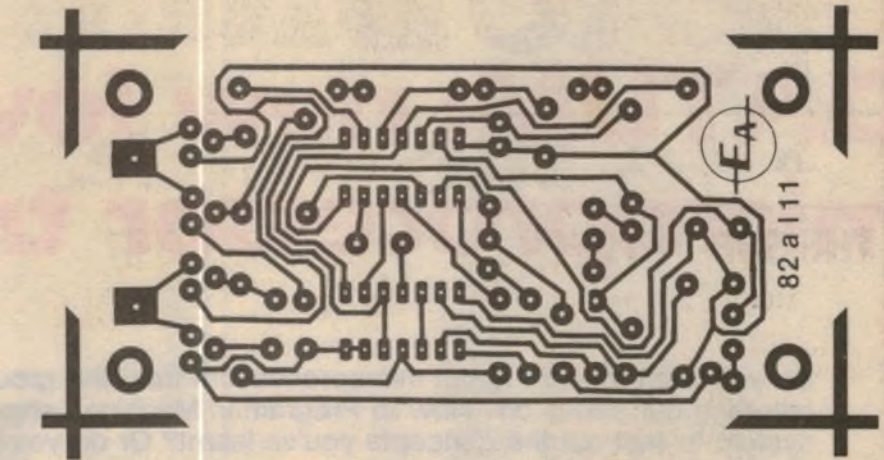

Above is an actual size reproduction of the PC board.

alarm is sounding is low and typically of the order of only 10mA during actual sound pulses, or about 5mA overall. When the alarm is disabled, using pin 6 of IC2b, the standing current is about 0.4mA.

The circuit will work effectively, with some change in frequency and rate as mentioned before, over the range of supply voltages from 6 to 15 volts. For supply voltages above 10V, the rating on the two electrolytic capacitors in the circuit should be increased to 16VW.

Construction

Almost any piezoelectric tweeter may be used with the circuit. We used one made by Motorola and supplied by Jaycar. The printed circuit board, measuring 101 x 49mm and coded 82a111, was designed to mate with the solder lugs on the Motorola tweeter.

Mount the links first on the PC board and then the resistors and diodes. Take particular care to ensure that diode polarity is correct. The diodes we used had clear glass packages with a coating of grey paint over the cathode end.

Next, mount the capacitors, starting

with the 470pF ceramic. The transistors can then be installed and, finally, the two CMOS ICs. With these you should solder the supply pins, 7 and 14, first and then solder the others but first connect the barrel of the soldering iron to the negative rail of the copper pattern using a jumper lead.

The piezo tweeter may be soldered directly to the PC board if its lugs are compatible with the spacing of the output pads. Alternatively, it may be wired into circuit.

When it comes to testing the siren, place the piezo tweeter face down on the bench and wear ear muffs. Do not direct the tweeter at yourself or anyone else as the sound level is painful at close quarters. It could do permanent damage, so do not play about!

If you are using the external enable option do not forget to tie it high for the test.

When finally installing the alarm, be aware that the piezo tweeter is fairly directional and should be aimed to cover the "target" area. Do not place it where someone may be blasted by it at close range.

EA Magazine Holders

The magazine holders are available over the counter from Electronics Australia, 57 Regent Street, Chippendale, NSW — Price: \$4.50.

Mail orders should be sent to Electronics Australia, PO Box 163, Chippendale, NSW 2008.

Prices including postage are:

\$5.50 NSW; \$5.60 other states; or six for \$29.00 NSW; \$31.50 other states. \$A33.00 NZ.



Getting started with microprocessors

DATUM: new low-cost microprocessor trainer

Do you want to learn about microprocessors from the ground up? Have you been following our series on "How to Program in Machine Language" but have no system to test out the concepts you've learnt? Or do you know a bit and are looking for a low-cost dedicated microprocessor system for experiments or for use in a control application? If your answer to any of these questions is "yes" then this is the project for you. Designed initially for teaching microprocessor concepts to students of Electronic Engineering, DATUM is a complete self-contained microprocessor system with everything needed to get you started.

This project got its start when staff at the School of Electronic Engineering at the South Australian Institute of Technology noticed that students with their own microprocessor system at home performed much better than those who had to rely on the limited number of evaluation kits used in the laboratories.

It was obvious that to give every student the same opportunity a low cost microprocessor trainer was required, so the staff set to work. The result was DATUM (Digital Aid for Teaching yoU Microprocessors), an inexpensive, easy to use microprocessor kit based on the Motorola MC6802 processor.

The design and development of DATUM was a co-operative effort, with many of the staff of the School of Elec-

tronic Engineering contributing, and a South Australian company, Gammatron, undertaking the production of the printed circuit board and kits for the project. Software for the Monitor program was written by Mr P. D. O'Neill of the Institute.

One of the most important design decisions for the DATUM project was that it had to be a completely self-contained system. A simple keypad on the board provides the means of inputting instructions and data, while output is displayed on seven segment LED displays.

Those readers who have followed our series on "Machine Language Programming for the 6800" will be in their element here, for the only way to program DATUM is by machine language and the "instruction set" of the 6802 is iden-

tical to that of the 6800. Both processors are relatively simple but very versatile, and quite powerful enough for many advanced applications.

There are only two differences between the 6800 and 6802 processors. The 6802 has an on-chip clock generator, needing only an external crystal. More importantly, the MC6802 has 128 bytes of Random Access Memory on the chip, 32 bytes of which can be placed in a low power "stand-by" mode to preserve important data when the rest of the system is off. This is one reason why we chose the 6802 for use in our Car Computer project.

In fact the Car Computer is a good illustration of what is possible with a small system such as this. Besides its use as a learning aid, DATUM can be put to use

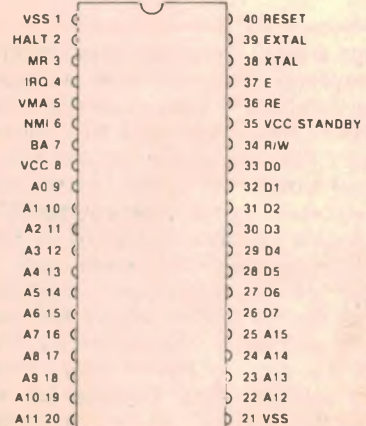
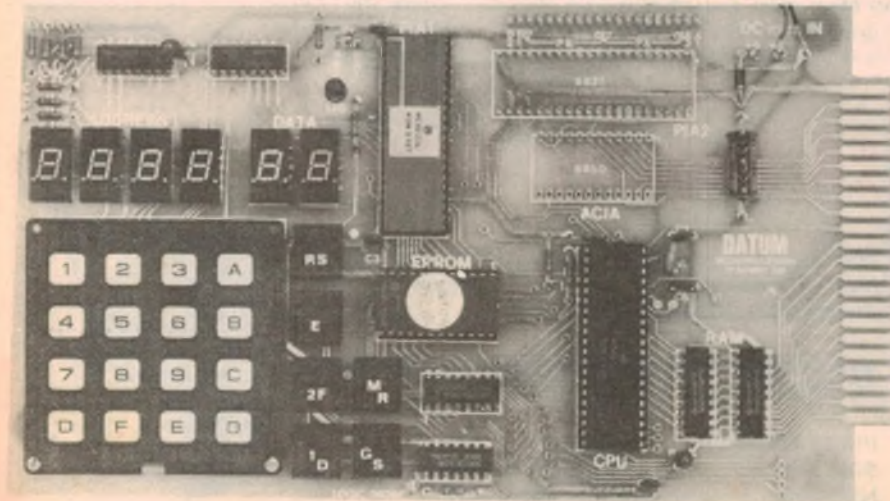

Fig. 1

Fig. 1: Pin-outs of the MC6802.

DATUM is a low-cost trainer for learning about microprocessors.

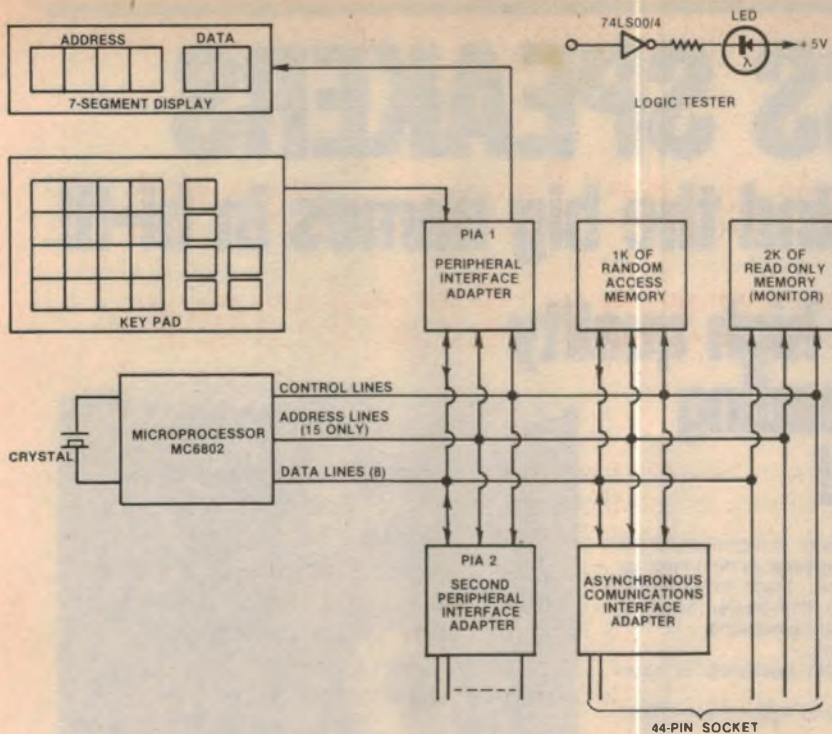

Fig. 2: Block diagram of the fully expanded DATUM system.

as a controller around the home (or the factory), or expanded into a larger computer system. Bus signals are brought out to a 44-way edge connector on one end of the board for this purpose and there is provision on the board for additional Input/Output, with a PIA for parallel I/O and an ACIA (Asynchronous Communications Interface Adapter) for serial communication.

The double-sided DATUM printed circuit board measures 228mm x 127mm and is silk-screened with component locations (although not component values). The manual we received had the component values hand-written after the parts list, although it is hoped that this will be corrected in final versions.

The design of a minimum microprocessor system

The heart (or is that the brain?) of any microprocessor system is of course the processor chip itself. Pin connections for the MC6802 are shown in Fig. 1. The processor has 16 address lines, and is

thus capable of addressing 2^{16} or 65,536 separate memory locations.

64K of memory is far more than we need, so the first decision made in the design of DATUM was to decode blocks of memory, rather than individual locations. This simplifies the circuitry required and reduces costs, at a negligible penalty — maximum memory expansion. This is 12K bytes in 4K increments.

A minimal system will require both Read Only Memory for permanent storage of an operating program, and RAM (Random Access Memory) for user programs. Static RAM is used since it avoids the complications of refreshing dynamic RAM (see our articles on the Super-80 for details of a dynamic RAM system).

Because we will be entering programs by hand it is unlikely that they will exceed about a hundred instructions. Around 200 bytes of RAM would be sufficient, but the most readily available and cost effective memory for our purposes is the 2114 static RAM chip.

HARDWARE SPECIFICATIONS

Processor: Motorola MC6802.

Clock: 1MHz.

RAM: 1K x 8 on board, expandable to 12K externally, plus 128 bytes on chip.

ROM: 2K (Monitor program occupies 1K).

Display: Seven segment LED readouts (6).

Input: Hexadecimal keypad and six function select buttons.

Output: Two PIA lines, optional extra PIA, ACIA

Power requirements: Regulated +5V or 6V battery at 400mA.

Programming: Hexadecimal machine code.

This chip is organised as 1K locations, each of four bits, so just two packages will give us 1024 8-bit memory locations.

The ROM package of DATUM holds the Monitor program — a collection of routines which assist the user in communicating with the microprocessor system. Software is provided which scans the keypad, drives the LED displays and accepts input from the user. Depending on this input other routines are activated which allow the contents of memory to be inspected and changed, the internal registers of the 6802 to be displayed and the user's programs carried out.

The Monitor program of DATUM is 1K bytes long, and a complete listing of the source code is included in with the instruction manual supplied with the kit. Since the 2716 EPROM is a 2K device other programs which the user wishes to store permanently can be programmed into the unoccupied addresses. An EPROM programmer suitable for this purpose was described in our January 1982 issue.

Since DATUM is programmed in assembly language, hexadecimal output was decided on. Each 16-bit address location and 8-bit data byte are considered as combinations of four bits, with each combination represented by one of 16 hexadecimal characters, the numbers from 0 to 9 and letters from A to F. A complete description of the hexadecimal numbering system is given in Part One of "How to Program in Machine Language Language", EA March, 1982.

In hexadecimal, 16-bits are considered as four groups of four, and 8-bit data consists of two groups of four. Six displays are therefore required, four to display the address and two to display the data stored at that address.



A commercially available keypad provides hexadecimal inputs while six individual pushbuttons are used for control functions. Six switches provide the best balance between flexibility and cost. Key functions provided are:

PEERLESS SPEAKERS

The name behind the big names in hi-fi!

Chosen for their high quality by the world's leading speaker makers!



Peerless is a world authority on loudspeaker design. In fact, many of the world's top hi-fi manufacturers select Peerless speaker components for inclusion in their own Brand Speaker Systems. Made in Denmark, Peerless speakers are incomparable for their high-power handling, smooth frequency response, low distortion and colouration. Peerless speakers can be purchased three ways:—

1. Fully-assembled in timber cabinets — from bookshelf to floor-standing models.
 2. Speaker Kits — build-it-yourself and save up to 40% on assembled speaker prices.
 3. Individual speaker components to suit your exact hi-fi needs.
- Peerless makes speakers to suit amplifiers from 20-100 watts. For true-to-life sound, Peerless is the name behind the biggest names in hi-fi. Hear Peerless speakers at one of the authorised dealers below — or contact the sole importer for full technical details.

Sole Australian Importer: G.R.D. GROUP PTY LTD
698 Burke Road, Camberwell, Vic. 3124. Trade Enquiries welcome



N.S.W.

Bondi Junction
Danish Hi-Fi Aust Pty Ltd Ph (02) 387 5878
Concord
Electronic Agencies Ph (02) 745 3077
Crows Nest
Deeva Hi-Fi Ph (02) 439 3999
Dee Why
David Ryall Electronics Ph (02) 982 7500
Wagga Wagga
Car Radio & Hi-Fi Centre Ph (069) 21 46 18

VIC.

Ballarat
Turner Audio Ph (053) 32 2042
Camberwell
Danish Hi-Fi (Aust) Pty Ltd Ph (03) 82 7348
Cheltenham
Beland Electronics Ph (03) 550 2279
Geelong
Steve Bennett Audio Ph (052) 21 6011
Hawthorn
Tivoli Hi-Fi Ph (03) 818 8637
Warrnambool
Bruce Henderson Audio World Ph (055) 62 5147

S.A.

Adelaide
Hi-Fi Acoustic Ph (08) 223 6774
Adelaide
Danish Hi-Fi Aust Pty Ltd Ph (08) 51 2124
Goodwood
The Acoustic Foundry Ph (08) 271 0276
Hawthorn
Sound Craftsmen Ph (08) 272 0341
St. Peters
Miltronix Ph (08) 42 3781

W.A.

Nedlands
Danish Hi-Fi Aust Pty Ltd Ph (09) 386 8564
Kalamunda
Kalamunda Hi-Fi Ph (09) 293 4333
QLD.
Brisbane
Brisbane Agencies Audio Centre Ph (07) 221 9944
Barunda
G Mills Stereo Ph (07) 391 5606
Redcliff
Hi-Fi Sales Ph (07) 284 2495

★ BRIGHT STAR CRYSTALS

Specifications, Dimensions and data sheets available on request

BULK ORDERS: In addition to our normal range we can supply quantity orders (100 up) at very competitive prices. All we ask is 50% of cost with order balance 30 days.

DELIVERY: 5-6 weeks from receipt of Order. Ring for quote: (03) 546 5076. Telex: AA 36004.

NEW NSW AGENT: APP Master Communications, Sydney (02) 682 5044

BRIGHT STAR CRYSTALS

35 EILEEN RD, CLAYTON, VIC
ALL MAIL TO: PO BOX 42, SPRINGVALE 3171



WATCH CRYSTALS

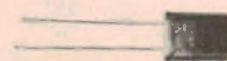

CRYSTAL UNITS FOR QUARTZ CRYSTAL CLOCK

CRYSTAL OVENS AND OVEN OSCILLATOR UNITS

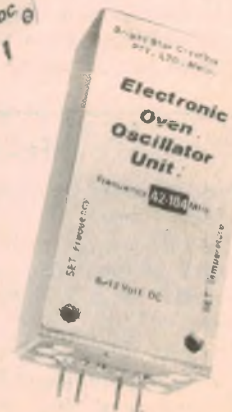

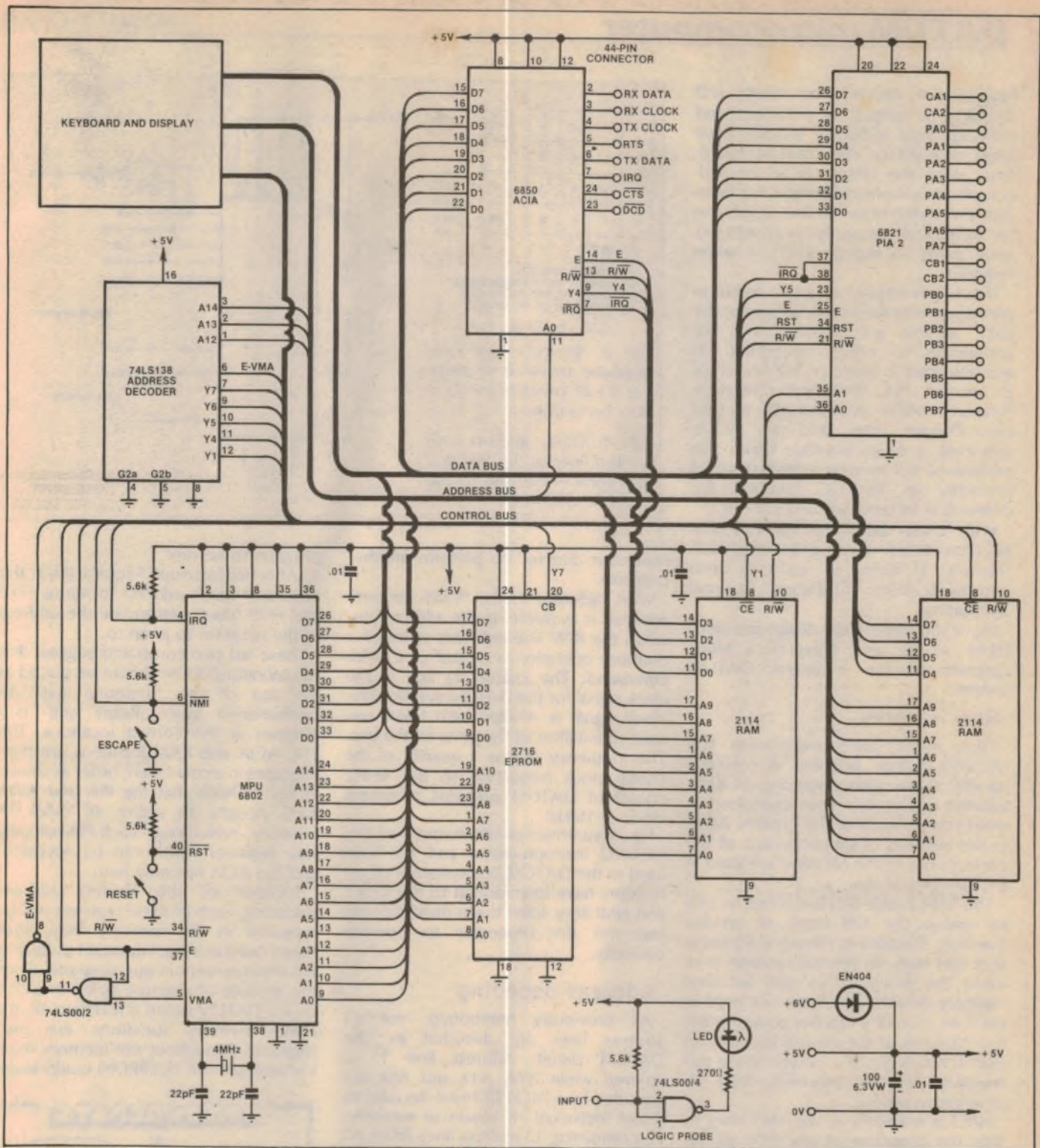

Circuit diagram of the full DATUM system, less the keyboard and display section shown in Fig. 6.

1. RESET (RS). Initialises all devices and causes the system to jump to the beginning of the Monitor control program.
2. ESCAPE (E). Lets us exit one control function ready for the next control sequence.
3. MEMORY (M). Allows memory contents to be displayed and modified.
4. GO (G). Provides a "start" instruction so programs can be run.

5. REGISTERS (S). Lets us display the contents of the internal registers of the 6802 microprocessor.
 6. SINGLE STEP (R). Assists in "debugging" programs by allowing us to step through a program one instruction at a time.
 7. INCREMENT/DECREMENT. Lets us inspect memory contents, stepping the address in either direction.
- While all these functions were considered essential, some will be used

less frequently than others. It is thus possible to share some switches, with functions which are used less often requiring two key presses, the first being the "second function" (2F) key. Other keys such as Reset and Escape must operate directly and cannot be shared. Fig. 3 shows how the seven functions can be accommodated on six switches.

So far we have described a minimum microprocessor system, with a

hexadecimal keypad for input, LED displays for output, a processor and memory. Two additional features have been included on the DATUM board. First, since the system is to be self-contained a simple logic probe has been included on the board so that signals can be monitored. Secondly, provision has been made to expand DATUM when required.

The 44-pin edge connector, visible in photographs of the board, brings out the data, address and control lines for connection to other equipment. In addition there is space on the board for a second PIA (Peripheral Interface Adapter) which provides 20 parallel Input/Output lines and an ACIA, providing a serial interface. With the addition of 12V level translators this chip provides an RS-232C channel for connection to terminals and printers.

With these additions DATUM can become more than a learning aid, finding a host of control and communications functions in real applications.

Fig. 2 summarises the design decisions taken so far and presents a block diagram of the minimum DATUM system.

How it works

Like most microprocessors the MC6802 is "bus" oriented. A common parallel signal path consisting of data, address and control lines connects the main components of the system. Again in the interests of simplicity, not all the control lines of the MC6802 are used in the DATUM design.

The RAM Enable (RE) line is tied to +5V to enable the 128 bytes of on-chip memory. The Memory Ready (MR) line is also tied high. Its normal function is to allow the processor to wait for slow memory devices which are not used in DATUM. "Standby" applies power to the first 32 bytes of the internal memory so that in the event of a power failure this memory can be powered from an emergency supply.

HALT is not used, as we don't want to stop the processor at any time so this line is also tied to +5V. Since HALT is not used, the Bus Available (BA) line which indicates that the processor has halted is not used and can be left open. The remaining control lines are used as follows:

RESET resets the MC6802. A pull-up resistor holds this line high until the Reset pushbutton is operated. NMI, the Non-Maskable Interrupt, is also pulled high and connected to a pushbutton, in this case the "Escape" function. IRQ is the interrupt request line, allowing processing to be suspended and the

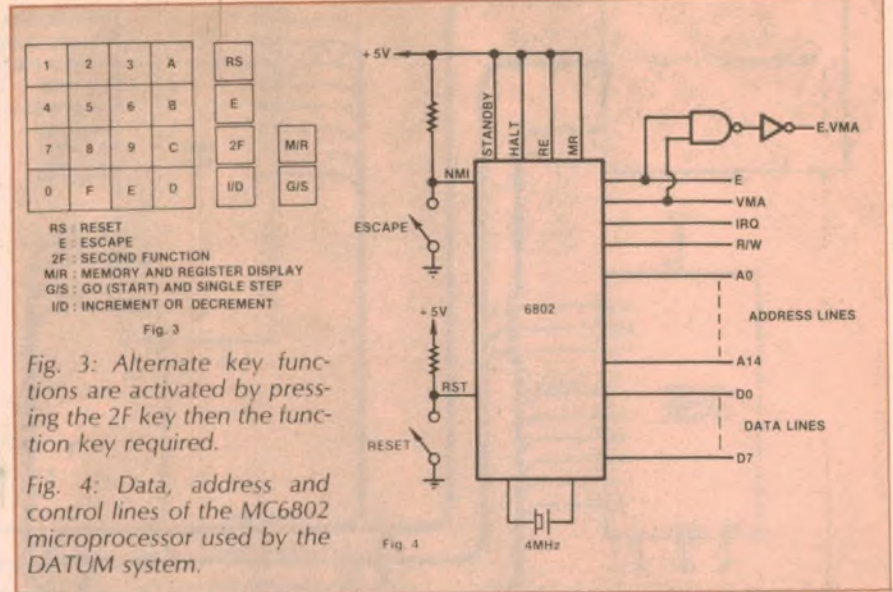

processor directed to perform another program.

VMA indicates that a "Valid memory address" is available on the address bus, while the R/W line indicates whether a memory operation is a read or a write command. The Enable (E) line is the clock signal for the DATUM system. This clock signal is ANDed with VMA and used to initialise all the units on the bus. The frequency of E is a quarter of the crystal clock frequency, so the 4MHz crystal of DATUM provides a system clock of 1MHz.

Fig. 4 summarises the outputs of the MC6802 microprocessor and the lines used in the DATUM bus system. Pull up resistors have been added to the RESET and NMI lines since these must be held high for the processor to operate correctly.

Address decoding

As previously mentioned, not all address lines are decoded by the DATUM circuit. Address line 15 is ignored while A14, A13 and A12 are decoded by a 74LS138 1-of-8 decoder to select individual 4K blocks of memory. The remaining 12 address lines (from A0 to A11) provide a 4K (4096 bytes) addressing capacity. Memory in DATUM is thus divided into eight blocks, each of 4K, for a total addressing capacity of 32K bytes.

The next question is how to allocate the available memory locations. Three constraints are set by the internal organisation of the MC6802 chip:

1. The internal 128 bytes of RAM must be the first 128 memory locations.
2. After a Reset the last processor reads the last two locations in memory (FFFE and FFFF hex) to find the address of the

program to be run.

3. After an Interrupt Request (IRQ) the processor reads address locations FFF8 and FFF9 hex to determine the address of the program to jump to.

These last two constraints suggest that the Monitor EPROM should be placed at the top of the "memory map" to permanently store Reset and IRQ pointers at the correct locations. The PIA, ACIA and RAM locations are then allocated in a convenient order as shown in Fig. 5. Note that the PIA and ACIA each occupy an entire 4K block of memory, even though each PIA has only four registers which can be accessed, and the ACIA has only two.

Because of the limited address decoding, each of these registers will be repeated in the memory map 1024 times, but this is not important as long as we are consistent in our programs. Since the amount of memory (RAM or ROM) on the DATUM board is less than 4K, the same memory locations are also repeated throughout the memory map. For example the 2K EPROM is addressed



**MASSIVE
BREAKTHROUGH!**

CAR COMPUTER BELOW \$200

SEE REVIEW
OCTOBER EA
PAGES: 26,27,28.



COMPLETELY BUILT
AND TESTED —
NOT A KIT!!

MADE
IN ENGLAND!
— QUALITY!!



**only
\$199
complete**

CONTAINS EQUIVALENT OF
THOUSANDS OF TRANSISTORS
— USES MASSIVE CUSTOM
LSI CHIP TO ACHIEVE
LOW PRICE

Never before has such a comprehensive car performance computer been offered at such a low price!! Once again miracle microprocessor technology has enabled us to pass enormous savings on to you!! But don't let the low cost fool you. The "Voyager" car computer IS THE MOST COMPREHENSIVE PRODUCT THAT WE HAVE SEEN. No other car computer matches this one AT EVEN TWICE THE PRICE! You could buy a \$20,000 Holden and not get a better car computer!! Just check the features. We are sure that you will calculate that the "Voyager" represents outstanding value!

FEATURES

- INSTANT FUEL CONSUMPTION IN LITRES/100KM AND MPG!! (MOST OTHERS HAVE ONLY ONE OF THE ABOVE) JUST SWITCH FROM ONE TO THE OTHER AS YOU DRIVE ALONG.
- INSTANT SPEED, TIME AND OTHER FUEL DATA.
- VISUAL AND AUDIBLE EXCESS SPEED ALARM.

INSTALLATION

The "Voyager" comes complete with an unbelievable array of mounting configurations, on dash, under dash or stalk mount. ALL installation hardware is supplied (even a roll of insulation tape!) as well, of course, as the speed and fuel sensors. A lavishly illustrated installation manual is provided as well as a comprehensive operators manual. If you do not want to install the unit yourself we can do this for you for a guaranteed \$39.50*. (A few exotic cars excluded!). A typically competent EA/ETI reader would do the job in 3-4 hours.

* Sydney metropolitan area only.

VOYAGER OPERATING FEATURES



JAYCAR

125 YORK ST SYDNEY 2000
Ph. 2646688 Telex: 72293
Mail Orders To:
Box K-39 Haymarket 2000

POST AND PACKING CHARGES
\$5.95 up to \$200 \$10.95 up to \$400
\$15.95 up to \$800 \$20.95 up to \$1400
\$25.00 up to \$2000

NEW SATURDAY HOURS
Mon-Fri 9:30 to 5:30pm
Sat 9:30 to 12:00pm
Thurs night to 8:30pm

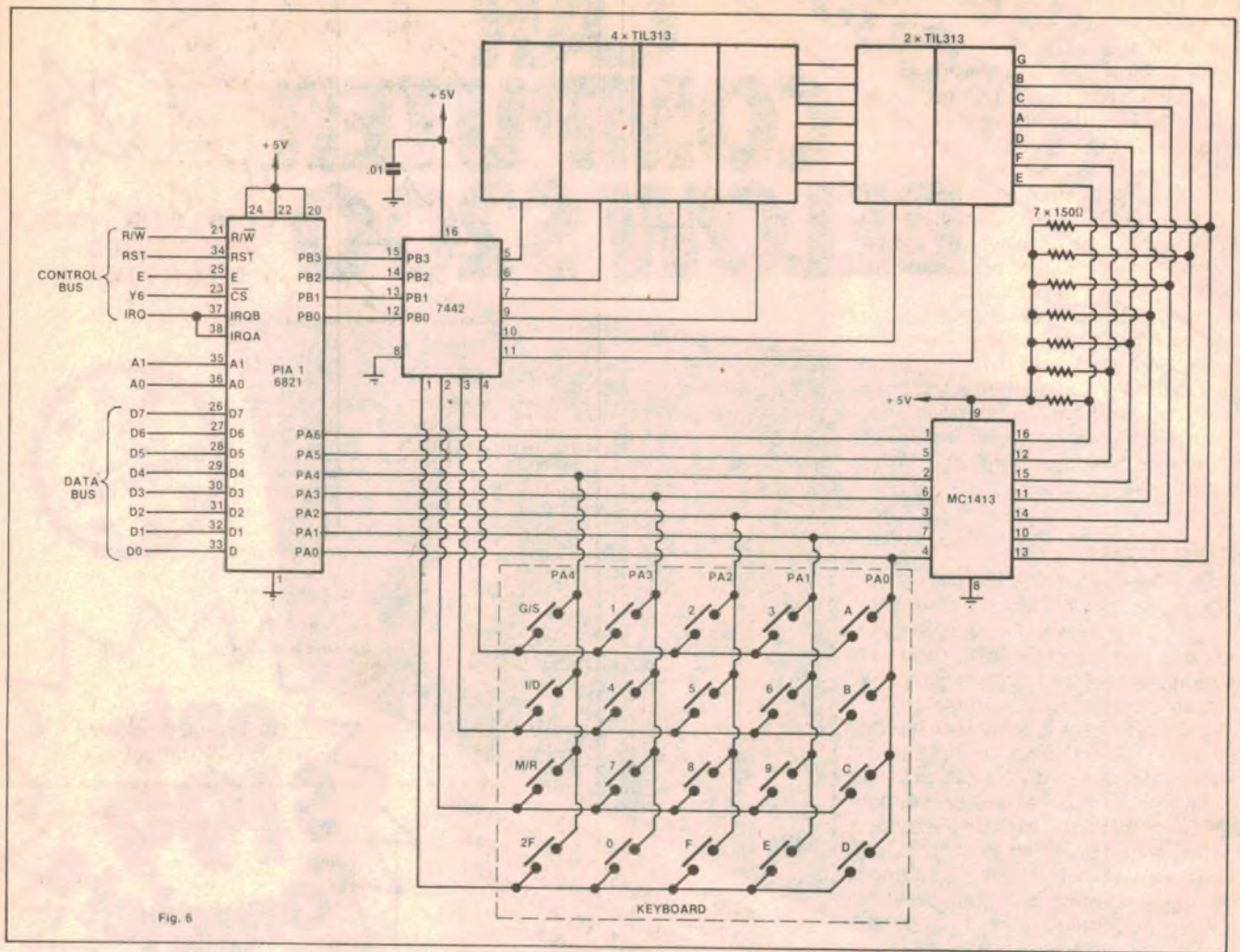

Fig. 6

Fig. 6: Circuit diagram of the keyboard and display section of DATUM.

from 7000 (hex) to 77FF and is then duplicated from 7800 to 7FFF hex. Similarly the 1K of RAM is repeated four times, beginning at address location 1000 hex.

This repetition does not matter and any of the appropriate redundant addresses can be used, although a lot of trouble and confusion will be avoided by consistently using the same address locations.

Note that if we ignore the 16th bit of the address bus, 7FFF in hex is the same as FFFF, so the two constraints on EPROM addressing are satisfied even though DATUM has only a 32K addressing capability.

Keyboard and display

Fig. 6 shows the method of interfacing the keypad and the six displays to the microprocessor. Port B of PIA1 is programmed for output, and four lines, DB0 to DB3, drive a 7442 1-of-10 decoder. Six of the outputs of the 7442 sequentially ground the cathode of each seven segment display while the

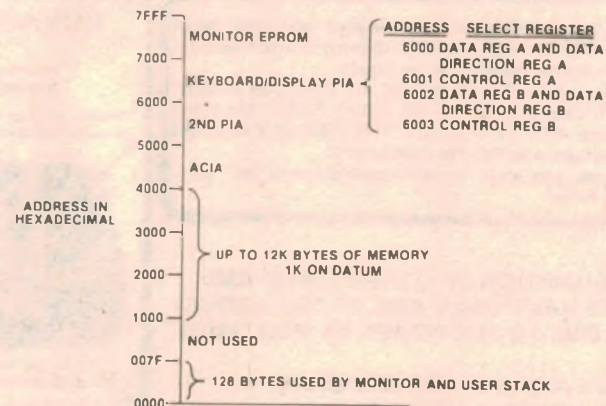

Fig. 5: DATUM memory map shows allocation of ROM, RAM and peripheral adapters.

remaining four lines are input to the rows of the keypad.

A closed key is detected by programming Port A of PIA1 for input and scanning the columns of the keypad through PA0 to PA4. With the four rows of the keypad each driven low in turn a closed key will cause one of the five column lines to go low. The particular key pressed will be at the intersection

of the row which is currently low and the column line which is read as low.

For driving the display Port A of PIA1 is programmed for output and seven of the lines (PA0 to PA6) are fed to an inverting buffer to select one of the segments of each seven segment display. All the identical segments of the six displays are connected in parallel and the display illuminated is determined by which

cathode is selected by the outputs of the 7442. The segment driving lines of Port A go low to select a segment, causing the output of the MC1413 inverter to go high and allow the 150Ω resistor to +5V to supply current to the LED segment.

Fig. 7 shows the organisation of the keypad and display circuitry and the way in which each output line is decoded. With this information it is possible to program DATUM to illuminate any segments of the display for a quasi-alphanumeric messages or to monitor a particular key of the keypad.

Note that pins DA7 and DB7 of the PIA1 are not used for the keypad or display and are brought out to pins on the board for experimental purposes. More details of the Peripheral Interface Adapter chip can be found in "How to Program in Machine Language", in EA, August 1982.

Logic probe

One element of the 74LS00 NAND package on the DATUM board drives a LED which serves as a power-on indicator and a simple logic probe for checking wiring and the operation of programs using the PIA outputs.

A pull-up resistor ensures that the LED will be on when there is no input to the probe, indicating that power is available to the circuit. This has the unfortunate side effect that if the logic probe input is applied to a pin which is in fact open circuit the LED will be lit, indicating a high state. Despite this drawback the probe is still useful. If for instance, the input of the probe is connected to pin 37 of the microprocessor (the clock output) the LED will be lit if the oscillator is functioning but its intensity will be less than when the probe input is connected to +5V.

The final system

Page 89 shows the circuit diagram for the complete DATUM system, excluding the keyboard and display sections shown in Fig. 6. Fig. 8 shows the connections for the 44-pin edge connector while the printed circuit board overlay is shown at right.

Power to DATUM can be provided either via the edge connector or via pins on the PCB (labelled DC volts in). Power can be supplied from a regulated 5V source or by a 6V lantern battery. Current consumption is around 400mA.

If a battery is used power can only be connected to the pins on the circuit board labelled 0 and +6V which is connected via a series diode. The diode prevents the power being applied with the reverse polarity and drops the 6V to approximately 5.4V. Under no circumstances should 6V and 5V supplies be used at the same time as the diode will be destroyed.

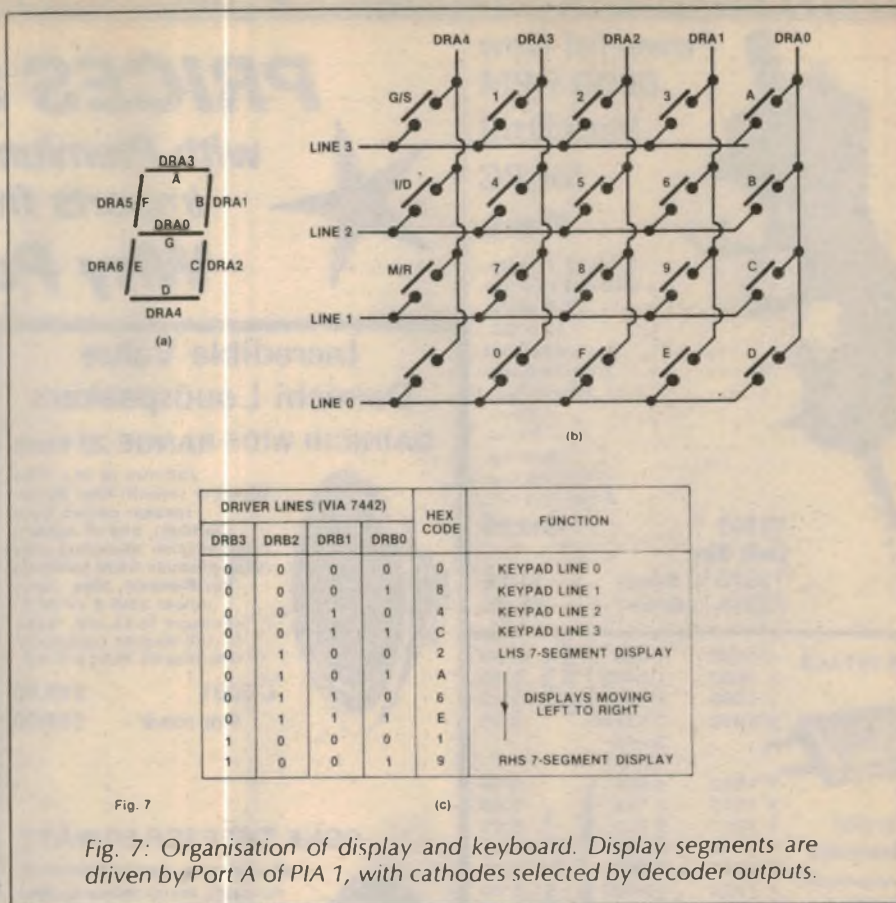
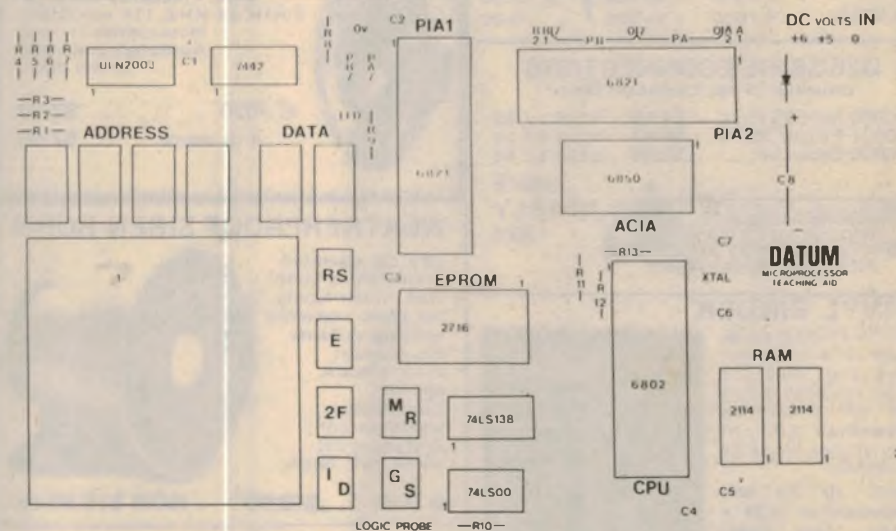

Fig. 7

Fig. 7: Organisation of display and keyboard. Display segments are driven by Port A of PIA 1, with cathodes selected by decoder outputs.



Component overlay of the DATUM board. PIA2 and ACIA are optional additions.

Assembling the DATUM kit

Start construction with the keypad. The kit provides a nut and bolt to fix the keypad to the board. When soldering the connecting pins of the keypad be wary of applying excessive heat, or else internal solder joints could melt and create an open circuit. Mount the six pushbutton switches then the resistors and capacitors.

Make sure that the electrolytic capacitors are correctly oriented as shown on the PCB overlay.

Mount the diode, LED and the seven-

segment displays, again observing the polarity of each part. The 4MHz quartz crystal and the socket for the EPROM should be installed next. We also installed sockets for the microprocessor and the PIA1, although these are not provided in the kit.

Install the ICs, starting with the smaller packages, and making sure that pin 1 of each chip aligns with the 1 printed on the board. Before mounting the ICs, apply power to the circuit and check for the presence of 5V on the appropriate supply pins.



**Powerful New
6000 RPM
Mini Drill
for PC
Work**

Tons of Torque.
Just the shot for
PCB work.
12V DC
operated
from external
Power Pack
1.2mm
chuck
capacity.
Supplied c/w
1mm drill bit.

- T2302 \$12.95
Drill Bits:
 T2320 (0.8mm) ... \$1.25
 T2325 (1.0mm) ... \$1.25

CRYSTALS	Y 1000	1 000	11.50
	Y 1003	1 8432	9.50
	Y 1006	2 000	7.50
	Y 1010	3-57945	3.00
		Solder Type	
	Y 1012	4 000	5.00
	Y 1015	4 194	5.00
Parallel Resonant	Y 1017	5 000	5.00
	Y 1018	6 000	5.00
	Y 1019	8 000	5.00
Frequencies Quoted in MHZ	Y 1020	10 000	5.00
	Y 1025	12 000	5.00
	Y 1030	16 000	5.00



12.3mm Pinout
5mm Pinout

D25 SERIES CONNECTORS
Universal 25 Pin Computer Series

- P 0900 Male 25 Pin \$5.50 NOW \$3.95
 P 0901 Female 25 Pin \$5.50 NOW \$4.50
 P 0905 Backcover \$3.50 NOW \$2.50



SAVE
NEARLY
30%

VINYL BINDER

Holds 12 magazines, each on a spring out wire rod. Just the shot for each year's set of Electronics Australia, ETI or any of your favourite magazine.

Suits all A4 size publications (275 x 210). Very smart Royal Blue colour with beautiful gold embossing.

- B 9999 \$5.50

THIS MONTH

\$5.00 each

4 or more \$4.50 each



ALTRONICS JIFFY BOXES

Incredible savings

Black plastic body with 22 g. aluminium lid and 4 st. screws supplied. These utility boxes are used in dozens of E.T.I. and E.A. projects.

Box	Dimensions	Were	Now	10up
H 0101	150x 90x50	\$2.75	\$2.45	\$1.90
H 0102	195x113x60	\$3.75	\$3.40	\$2.90
H 0103	130x 68x41	\$2.20	\$1.85	\$1.60
H 0105	83x 54x28	\$1.50	\$1.25	\$1.00

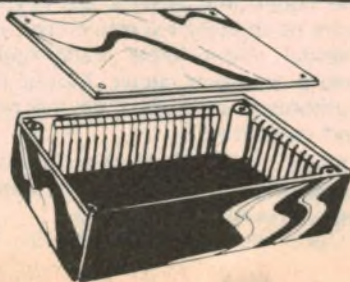

PRICES SLASHED

with Premium Grade Quality Imports from Altronics

Why Pay More?



**Incredible Value
Dainichi Loudspeakers**

DAINICHI WIDE RANGE 25 Watt



200 mm (8 in.). This superbly smooth high power speaker comes from Dainichi, one of Japan's finest speaker manufacturers (they produce OEM Speakers for Pioneer). Max. input power 25W 8 OHM Z. Resonant to 60 HZ. Huge 10 OZ Magnet frequency response 40 HZ-18 KHZ.

- C 2001 \$19.50
 4 or more \$17.00

CONE TWEETER 50 WATT



50 watt max. power 8 OHM Z. Amazing performance budget price. Frequency response 2 KHZ-18 KHZ. 110 mm Diam. Hole centres 79 mm. Australia's best value at this price.

- C 3020 \$7.50
 4 or more \$7.00

WEATHERPROOF SIREN HORN

12V DC operated — Deafening Siren Wail. Super handy for audio signalling, security systems etc. Current drain 500MA approx. Completely weatherproof. Attractive off-white PVC finish.



- S 5058 \$19.50 NOW \$15.00 ea.

PIEZO ALARM

Similar to "Sonalert" type. Absolutely ear piercing sound. Recommended voltage 5-15V DC. Ideal for almost all audio signalling applications. i.e. fire, water and gas signalling, computer alarms, etc.



- S 5066 \$4.95 NOW \$4.50 each

**New 10mm Digit LCD
Clock Module**

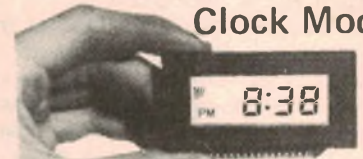

Uses the new NEC UPD833G LSI and quality EPSON LCD display. Size 60 x 38 x 10mm, operates from 1.5V DC. Display selectable to 12 or 24 hour format. AM/PM Display.

Inbuilt control timer selectable to 15, 30, 60 and 120 minute intervals. Stop watch facility to 24 mins duration. Alarm timer, Snooze timer, Sleep timer. An incredible diversity of applications. i.e. clock radio, travellers watch, stop watch, digital alarm clock, sleep timer, snooze timer, appliance timer, sequential controller, dual time clock.

And the best news is the low price!

- Y 1020 \$16.50

MINI TOGGLE SWITCHES

OEM QUALITY 250V 2 AMP RATED



		PRICE	10 UP
S 1010	SPDT	\$1.20	\$1.00
S 1025	SPDT Centre off	1.40	1.20
S 1020	DPDT	1.40	1.20
S 1030	DPDT Centre off	1.95	1.75

DIL Switch Bargains

GOLD PLATE SELF WIPING CONTACTS

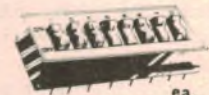

- S 3050 4 way \$1.25
 S 3060 8 way \$1.75

KEY OPERATED SWITCH



19.5mm mounting hole required. Supplied with two keys. Hundreds of applications for security type applications.

- S 2500 \$6.95
NOW ONLY \$5 EACH

ALTRONICS

For Address, Phone No. and Despatch details see our Double Page Advertisement pages 64-65.

Install EPROM, PIA1 and micro-processor. Finally stick the rubber pads on the underside of the board to keep it clear of the bench.

The manual that comes with the DATUM kit provides a fairly complete description of the circuitry from a technical point of view and step-by-step assembly instructions. A simple troubleshooting guide is also provided which proved unnecessary in our case. The only problem we had was with the placement of capacitor C6, which is parallel to and directly opposite C7. An inviting pair of holes to the left are through-the-board connections, not for component installation.

We also found that it was necessary to cut the plastic supports off the bottom of the pushbutton switches supplied so that they would mount flush on the board. This makes it slightly difficult to mount the switches neatly and some care is required.

The PCB is not solder masked, and some of the tracks are closely spaced. A soldering iron with a small tip is essential here.

The manual provides an example of test procedures, including reading the contents of the EPROM and a simple program to test the RAM. If everything checks out OK you're on your way. Our next article will provide some software for the system and article number three will provide suggestions for applications.

Assembled or kit form DATUMs are available from Gammatron, Weens Road, Pooraka, 5095. Printed circuit boards, key pads and monitors are also available separately. Next month we shall look at software aspects, including the monitor routines.

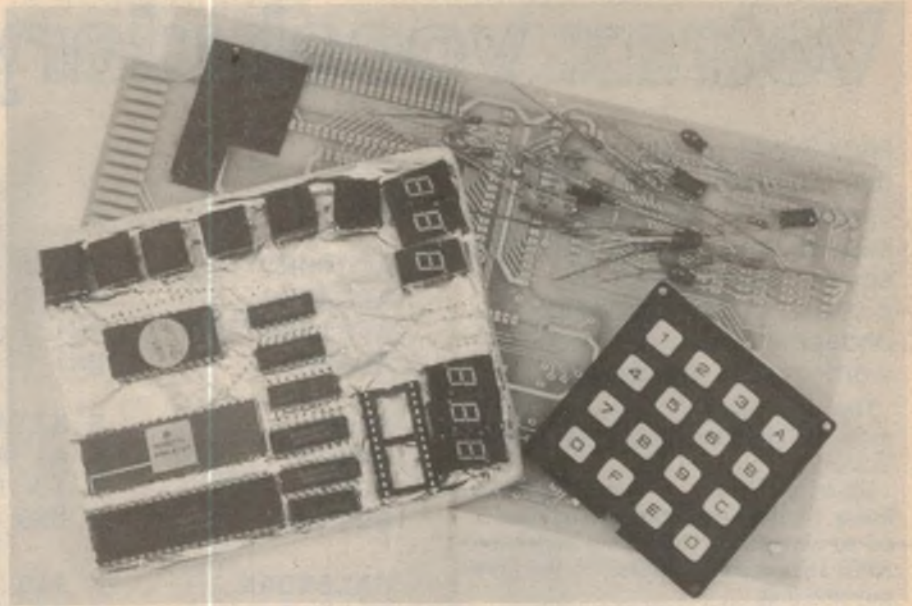

DATUM kit provides PCB and all components for a minimal system. Full instructions are included.

UPPER (IC) SIDE OF PCB	PIN NUMBER COMMENCING FROM TOP	UNDER SIDE OF PCB	
+5V	1	0V AND COMMON	
ACIA LINES (NOT USED)	RX DATA	2	
	RX CLOCK	3	
	TX CLOCK	4	
	RTS	5	
	TX DATA	6	
	DCD	7	
	CTS	8	
	IR0	9	E
	RESET	10	ADDRESS BLOCK 3000
	A0	11	ADDRESS BLOCK 2000
A1	12	ADDRESS BLOCK 1000	
A2	13	} 4K BYTES	
A3	14		
A4	15	R/W	
A5	16	VMA	
A6	17	D0	
A7	18	D1	
A8	19	D2	
A9	20	D3	
A10	21	D4	
A11	22	D5	
		D6	
		D7	

Fig. 8: Connections for 44-pin expansion interface of DATUM. The third article in this series will cover applications.

HOMELEC ELECTRONIC GLUE GUN

It glues simply everything

The Homelec Gluefix 2000 outdates tube adhesives. Its hot melt glue replaces most tube adhesives and gives you a professional job in seconds. No need for clamps. Tiles, wood, leather, metals, plastics, rubbers and most other materials can be glued better. And the hot melt glue fills cracks and porous surfaces better than conventional glues. Gluefix's advanced solid state element means fast (5 minutes) warmup. And there is no conventional thermostat and heating element to burn out or go wrong. Gluefix can be left on all day without damage to glue or gun. Gluefix is fully approved by the electricity authorities. So throw away your messy tube adhesives. No more mixing or wastage. For just \$19.95 you can have the most advanced glueing technology at your fingertips!

To order your Gluefix 2000 send cheque or money order to: **Homelec Products, PO Box 185, West Ryde 2114 or phone order on your Bankcard on (02)85 2922**
Gluefix 2000 with 8 gluesticks \$19.95 plus \$2.00 P & P. Gluefix with 4 gluesticks \$19.25 plus \$2.00 P & P.
Replacement gluesticks available.

Available from: Homelec Products Pty Ltd 1073, Victoria Road, West Ryde and Nataan Pty Ltd 36, Lilydale Grove, Hawthorn Victoria 3123 Phone (03) 62 4582



Repair indoor and outdoor furniture



Tiles can be glued very quickly.



No clamps needed.



A useful word list for the Compuvoice

Votrax vocabulary

Held over from last month, this vocabulary list is just a sample of some of the capabilities of our Compuvoice speech synthesiser. By combining the appropriate phoneme codes any required word can be produced.

The vocabulary is presented in the form of "phoneme codes" as used by Votrax.

Either the table or the program in listing 1 published last month, can be used to convert the phoneme codes into ASCII characters to be sent to the Compuvoice unit.

The short sample program given here illustrates how the resulting ASCII codes can be used to construct words and sentences.

Note that to produce the "CH" sound, as in "charge", the "CH" code must be preceded by a "T" code. To produce the "J" sound of "judge", the "J" code must be preceded by a "D" phoneme code. Normally both "CH" and "J" are silent, having no sound of their own but affecting the sound of following codes.

By following the examples given here and in last month's article an unlimited vocabulary can be created for your computer.

A talking program

```
00100 FOR W=1 TO 7
00110 READ A1$
00120 LPRINT A1$;
00130 LPRINT "?";
00140 NEXT W
00150 REM
00160 REM
01000 DATA "\V^UI!"
01010 DATA "CC"
01020 DATA "8KIR?"
01030 DATA "IIR?"
01040 DATA ")44+"
01050 DATA "Y3L%)67*:"
01060 DATA "R%<YET"
```

Due to an oversight, last month's article did not include interfacing details for the System-80 computer. To use the Compuvoice with the System-80 it is necessary to ground pins 23 and 25 of the Centronics edge connector. Otherwise the Centronics driver program will receive a "paper out" signal from pin 23 and suspend processing.

ACCOUNT	UH1 K AH1 O1 U1 N T
ADDRESS	UH1 D R EH1 S
AFFIRMATIVE	UH1 F ER M EH2 T I1 V
ALARM	UH1 L AH1 AH1 R M
BASE	B A1 AY S
BASIC	B A1 AY S I3 K
BUSY	B I3 I2 Z Y
BUTTON	B UH1 UH3 T EH3 N
CALENDAR	K AE1 UH3 L I3 N D ER
CASSETTE	K A2 AY S EH1 EH2 T
CENTIGRADE	S EH1 N T I3 G R A1 Y D
CHECK	T CH EH1 EH3 K
CONTINUE	K UH1 N T I1 I3 N Y1 IU U1
DAMAGE	D AE1 EH3 M I1 D J
DATA	D AE DT UH1
DECIMAL	D EH1 S M UH3 L
DESTROY	D Y S T R O1 UH3 I3 AY
DIVIDE	D I1 V AH1 EH3 Y D
EASY	E1 AY Z Y
END	EH1 EH3 N D
EQUAL	Y K W UH3 L
ERROR	EH3 EH3 EH3 R ER
FALSE	F AW L S
FARAD	F EH3 EH3 ER AE1 EH3 D
FINAL	F AH1 Y N UH3 L
FIRST	F ER R S T
FUEL	F Y1 IU U1 UH3 L
GAUGE	G A1 AY Y D J
GO	G O01 O1 U1
GRAM	G R AE1 EH3 M
GUESS	G EH1 EH3 S
HAPPY	H AE1 EH3 P Y
HEAR	H AY I1 R
HELP	H EH1 EH3 L P
HERTZ	H R R T S
HEX	H EH1 EH3 K PAO S
IMMEDIATE	I1 I3 M E1 D Y EH3 T
IMPORTANT	I1 I3 M P O2 O2 R T EH3 N T
INCOME	I1 I3 N K UH1 UH3 M
INDEX	I1 I3 N D EH1 EH3 K PAO S
ITEM	AH2 UH3 Y D UH3 M

A Votrax vocabulary

JOB	D J AH1 UH3 B
JOIN	D J O1 UH3 I3 AY N
JOLT	D J O2 O2 L T
JUMP	D J IU U1 U1 N
KEEP	K E1 Y P
KEYBOARD	K AY Y B O1 O2 R D
KILL	K I1 I3 L
KILO	K E1 AY L UH3 O2 U1
LARGE	L AH1 R D J
LENGTH	L EH1 EH3 NG TH
LIST	L I1 I3 S T
LOAD	L UH3 O1 U1 D
LOW	L O1 U1
MAXIMUM	M AE1 EH3 K PAO S EH3 M UH2 M
MEASURE	M EH3 EH1 ZH ER
METRE	M E1 Y T ER
MILLI	M I1 I3 L UH3
MINUS	M AH1 Y N UH3 S
MULTIPLY	M UH1 L T I3 P L AH1 Y
NEAR	N AY I1 R
NEGATIVE	N EH1 G EH3 T I1 V
NEXT	N EH1 EH3 K PAO S T
NO	N O01 O1 U1
NUMBER	N UH1 UH2 M B ER
OBJECT	AH1 UH3 B D J EH2 EH2 K T
ODD	AH1 UH3 D
OFF	AW F
OHM	O2 O2 U1 M
OPERATE	AH1 UH3 P ER A1 Y T
PAPER	P A1 Y P ER
PEEK	P E1 AY K
PERCENT	P ER S EH1 EH3 N T
PLEASE	P L E1 Y Z
PLUS	P L UH1 UH2 S
POSITIVE	P AH1 UH3 Z I1 T I1 V
QUANTITY	K W AH1 N T I3 T Y
QUARTER	K W O1 R T ER
QUIET	K W AH1 EH3 AY I2 T
QUOTE	K W O1 U1 T
RANGE	R A1 AY Y N D J
RATIO	R A1 Y SH Y O1 U1
READY	R EH1 EH3 D Y
RECORD	R E1 K O2 O2 R D
RETURN	R E1 T ER R N
SAVE	S A1 AY Y V
SAY	S A1 I3 Y

Desolder in seconds!

WITH

Soderwick

DESOLDERING BRAID

Select from standard or
NEW
FINEBRAID

1. Hold Soderwick on termination with hot soldering tip. Wicking action soaks up solder.



2. Remove tip and braid. Termination is left clean and solder-free.

- Fast, safe and easy.
- Soaks up molten solder like a sponge.
- Acts as a heat sink to protect circuits and components.
- Six braid widths available.

Buy from your
electronic parts supplier
DISTRIBUTED BY
ROYSTON ELECTRONICS

NSW (02) 709 5293 QLD. (07) 277 4311
VIC. (03) 543 5122 S.A. (08) 42 6655
TAS. (002) 34 2233 W.A. (09) 381 5500

F582

AN INTRODUCTION TO

DIGITAL ELECTRONICS

FOURTH EDITION

Electronic equipment now plays an important role in almost every field of human endeavour. And every day, more and more electronic equipment is "going digital". Even professional engineers and technicians find it hard to keep pace. In order to understand new developments, you need a good grounding in basic digital concepts, and An Introduction to Digital Electronics can give you that grounding. Tens of thousands of people — engineers, technicians, students and hobbyists — have used the previous editions of this book to find out what the digital revolutions is all about. The fourth edition has been updated and expanded, to make it of even greater value.

Available from "Electronics Australia",
57 Regent St. Chippendale, N.S.W.
PRICE \$4.50 OR by mail order from
"Electronics Australia", PO Box 163,
Chippendale. **PRICE \$5.40.**

4 convenient ways to shop

- You can go into your nearest Dick Smith Electronics centre or authorised re-seller and get the personal service our customers have come to expect. And with 31 stores Australia wide, there's one near you!
- Or you can use our reliable mail order service — 14 years and over a quarter of a million satisfied customers proves we're no fly-by-nighters!
- In a hurry? Use our handy phone-in order service. We'll charge the goods to your Bankcard and have them on the way the same day.
- And, of course, there's our unique computer ordering system; the first in Australia. Your computer orders direct from our computer — in an instant! Want to know more? Ask for a copy of our free brochure!



Terms available to approved applicants through...



NEW STORES
Parramatta Store
 We've moved to the Cnr Smith & George Sts
 Ph: 689 2188
New Liverpool Store
OPENING SOON!

STORE LOCATIONS

NSW	145 Parramatta Rd T55 Terrace Level 613 Princes Hwy 552 Oxford St 818 George St 531 Pittwater Rd 147 Hume Hwy 162 Pacific Hwy 396 Lane Cove Rd 30 Grose St 6 Bridge St 125 York St 173 Maitland Rd 263 Keira St Tamworth Acde & Kable Ave.	AUBURN BANKSTOWN SQ. BLAKEHURST BONDI JUNCTION BROADWAY BROOKVALE CHULLORA GORE HILL NORTH RYDE PARRAMATTA SYDNEY SYDNEY TIGHE'S HILL WOLLONGONG TAMWORTH FYSHWICK MELBOURNE COBURG RICHMOND SPRINGVALE GEELONG FRANKSTON BRISBANE BURANDA CHERMSIDE ADELAIDE ENFIELD DARLINGTON PERTH CANNINGTON HOBART	648 0558 707 4888 546 7744 387 1444 211 3777 93 0441 642 8922 439 5311 888 3200 683 1133 27 5051 290 3377 61 1896 28 3800 66 1961 80 4944 67 9834 383 4455 428 1614 547 0522 78 6766 783 9144 229 9377 391 6233 59 6255 212 1962 260 6088 298 8977 328 6944 451 8666 31 0800
ACT	96 Gladstone St		
VIC	399 Lonsdale St 260 Sydney Rd 656 Bridge Rd Springvale & Dandenong Rds 205 Melbourne Rd Ross Smith Ave & Nepean Hwy		
QLD	293 Adelaide St 166 Logan Rd 842 Gympie Rd		
SA	60 Wright St 435 Main North Rd Main South & Flagstaff Rds		
WA	414 William St Wharf St & Albany Hwy		
TAS	25 Barrack St		

STORE HOURS

All Dick Smith stores are open from 9am to 5:30pm (Saturday 9am to 12 noon) except Queensland stores which open and close half hour earlier. Many stores are open for late night trading. Phone your nearest store for details

Dear Customers,

Quite often the products we advertise are so popular they run out within a few days. Or unforeseen circumstances might hold up shipments so that advertised lines are not in the stores by the time the advert appears. And very occasionally, an error might slip through our checks and appear in the advert (after all, we're human too!). Please don't blame the store manager or staff, they cannot solve a dock strike on the other side of the world, or fix an error that's appeared in print. If you're about to drive across town to pick up an advertised line, why not play it safe and give the store a call first — just in case. Thanks



Dick Smith and Staff

DICK SMITH Electronics

MAIL ORDER CENTRE
PO BOX 321, NORTH RYDE NSW 2113
Telephone orders: (02) 888 3200

POST & PACKING CHARGES

ORDER VALUE	CHARGE	ORDER VALUE	CHARGE
\$5.00-\$9.99	\$1.40	\$50.00-\$99.00	\$4.60
\$10.00-\$24.99	\$2.40	\$100.00 or more	\$6.20
\$25.00-\$49.99	\$3.50		

Charges are for goods sent by post in Australia only — not airmail, overseas or road freight

SPEEDY PHONE/BANKCARD ORDER SERVICE

Just phone through your order and Bankcard details — it's so simple!
(02) 888 3200



MAJOR RESELLERS

These are our major resellers. However, we cannot guarantee they will have advertised items in stock or at the prices advertised.

Atherton QLD: Joe Sue's Radio Service 55 Main St 91 1208 ● Bendigo VIC: Sumner Electronics 7 Edward St 43 1977 ● Ballina NSW: A. Cummings & Co 91-93 River St 86 2285 ● Broken Hill NSW: Crystal TV Rentals 166 Argyle St 6897 ● Cairns QLD: Thompson Instrument Services 79-81 McLeod St 51 2404 ● Coffs Harbour NSW: Coffs Harbour Electronics 3 Coffs Plaza Park Ave 52 5684 ● Darwin NT: Kent Electronics 42 Stuart Hwy 81 4749 ● Darwin NT: Venronics 24-26 Kavanagh St ● East Maitland NSW: East Maitland Electronics Cnr Laws & High Sts 33 7327 ● Geraldton WA: KB Electronics & Marine 361 Main Terrace 21 2176 ● Gladstone QLD: Purely Electronics, Shop 2 Cnr Herbert & Auckland Sts 72 4321 ● Gosford NSW: Tomorrow's Electronics & Hi Fi 68 William St 24 7246 ● Kingston TAS: Kingston Electronics Channel Court 29 6802 ● Launceston TAS: Advanced Electronics 5a The Quadrant 31 7075 ● Lismore NSW: Decro Electric 3A/6-18 Carrington St 21 4137 ● Mackay QLD: Stevens Electronics 42 Victoria St 51 1723 ● Maryborough QLD: Keller Electronics 218 Adelaide St 21 4559 ● Mt Gambier SA: Hutchison's Comm 5 Elizabeth St 25 6404 ● Mildura VIC: McWilliam Electronics 40 Lemon Ave 23 6410 ● Morwell VIC: Morwell Electronics 128 George St ● Nambour QLD: Nambour Electronics Shop 4 Lowan House Ann St 41 1604 ● Orange NSW: M & W Electronics 173 Summer St 62 6491 ● Penrith NSW: Acorn Electronics Shop 12 541 High St 36 1466 ● Port Macquarie NSW: Hall of Electronics 113 Horton St 837 440 ● Rockhampton QLD: Purely Electronics 15 East St 21 058 ● Southport QLD: Amateurs Paradise 121 Nerang St 32 2644 ● Toowoomba QLD: Hunts Electronics 18 Neil St 32 9677 ● Townsville QLD: Tropical TV 49 Fulham Rd, Vincent Village 79 1421 ● Traralgon VIC: Power in Sound 147 Argyle St 74 3638 ● Wagga NSW: Wagga Wholesale Electronics 82 Forsyth St ● Wadonga VIC: A & M Electronics 78a High St 24 4588 ● Whyalla SA: Mellor Enterprises Shop 2 Forsyth St 45 47 64

A Votrax vocabulary

SCORE	S K O2 O2 R
SPEECH	S P E1 Y T CH
SYNTAX	S I1 N T AE1 EH3 K PAO S
TEMPERATURE	T EH1 EH3 M P ER UH1 T CH ER
TIME	T AH1 EH3 Y M
TOTAL	T O1 U1 T UH3 L
TURN	T ER R N
UNDER	UH2 UH2 N D ER
UP	UH1 UH2 P
URGENT	R R D J I3 N T
USE	Y1 IU U1 U1 Z
VALID	V AE1 UH3 L I1 D
VERIFY	V EH1 R I3 F AH1 EH3 Y
VOICE	V O1 UH3 I3 AY S
VOLT	V O2 O2 L T
WAIT	W AH1 UH3 N T
WEAPON	W EH2 EH2 P UH1 N
WHO	H IU U1 U1
WRONG	R AW NG
X-RAY	EH1 EH2 K PAØ S R A1 I3 Y
YEAR	Y1 AY I3 R
YES	Y1 EH3 EH1 S
YOUR	Y O2 O2 R
ZAP	Z AE1 EH3 P
ZERO	Z AY I1 R O1 U1
ZONE	Z O1 U1 N

SUPER-80 USERS . . .

The following are the Graphics Kits to suit the Super-80 computer.

Kit 1 — 64 "special" symbols, lines, card suits, stick figures etc.

Kit 2 — Full range of 64 "chunky" characters similar to that used on the TRS-80 and System-80 computers.

Kit 3 — Contains the characters of both Kit 1 and Kit 2. Can be software switched to either Kit 1 or Kit 2.

Kit 3 Upgrade — For those who have purchased Kit 1 or Kit 2 this will convert either Kit 1 or Kit 2 to Kit 3 for little extra cost.

Prices: Kit 1 . . . \$39.50 plus \$2.00 p/p

Kit 2 . . . \$39.50 plus \$2.00 p/p

Kit 3 . . . \$49.50 plus \$2.00 p/p

Kit 3 Upgrade . . . \$15.00 plus \$1.00 p/p

Each new character has its own unique ASCII code and can be printed or poked as desired.

All graphics kits come complete with constructional and installation instructions with sample programs included.

NOTE: None of these kits have lower case characters and they are not directly compatible with Dick's lower case kit!

Also available is an S-100 adapter card to extend the S-100 bus connector to a mother board or whatever else you wish. This is a short double-sided S-100 card with two standard 50-way edge connectors opposite and connected to the S-100 edge connector. It also has solder pads on every contact for easy internal access to signals. This was designed for the Super-80 but will obviously suit any S-100 system.

Price . . . \$8.50 plus \$1.00 p/p per card

For further information on El Graphix Products send large SAE to:

EL GRAPHIX

PO Box 278 Croydon 3136, Victoria, Australia.
Or phone (03) 725 9842 (after 7pm please).

ITOH 8510A!

**THE MOST REMARKABLE
DOT-MATRIX PRINTER
FOR UNDER \$1000!**

FULL CHARACTER SET WITH MATHS SYMBOLS, GRAPHICS AND LOWER CASE DESCENDERS.

120 CHARS PER SECOND BI-DIRECTIONAL LOGIC-SEEK PRINT.

FULL PRECISION PROPORTIONAL PRINTING FOR LETTER-QUALITY WORD PROCESSING.

UP TO 136 COLUMNS ON 9 1/2 INCH PAPER. (15-INCH MODEL AVAILABLE).

NEGATIVE LINEFEED CAPABILITY.

TRACTOR & FRICTION FEED BUILT IN.

AVAILABLE FROM:

*Software
Source Pty Ltd.*

89 Oxford Street,
Bondi Junction. 389 6388
P.O. Box 364, Edgecliff 2027.
DEALER ENQUIRIES INVITED

SILVERTONE NEWS

*Newsletter of Silvertone Electronics
Specialists in Radio Control*

ROBOTS

**DISPLAY AND
ENTERTAINMENT TYPE**

A completely new approach to small (up to 1.5 metres) ROBOTIC PUPPETS

- Up to 24 simultaneous functions
- Full Proportional Movement
- Programmable Memory
- Radio Controlled
- Mobile
- Realistic
- Voice Synchronous Mouth
- Transmitted Voice

MAY BE BUILT TO YOUR
REQUIREMENTS
HOLLYWOOD TECHNOLOGY

SILVERTONE ELECTRONICS

6/2 SCHOFIELD ST,
RIVERWOOD, NSW, 2210
Phone (02) 533 3517

6/2 Schofield Street, Riverwood, NSW, 2210
Telephone: 533 3517

Electronics Australia/ DICK SMITH SUPER 80 Computer Kit



Production costs have now been absorbed due to fantastic response — YOU REAP THE BENEFIT!!

Yes, this makes the full 16K computer with 9K BASIC on tape, transformer, construction manual, and IC socket only.

NEW SUPER LOW PRICES

\$275

was \$289.50
NOW
\$239.50
save \$50

Photo shows the basic board with the following options: S-100 expansion, IC sockets and a full 48K of memory.

- SHORT FORM KIT:** Designed for computer applications where 'BASIC' programming is not required. Kit supplied with EPROM monitor and 16K RAM. (Cat. K-3600)
 WAS \$289.50 — SAVE \$50.00 **\$239.50**
 Transformer to suit (Cat. M-2325) **\$23.00**
 IC Socket Set (Cat. K-3603) **\$12.50**
 BASIC program (interpreter) on cassette (Cat. K-3602)
 WAS \$24.50 — SAVE \$12.00 .. **BONUS** **\$12.50**
OTHER OPTIONS:
 Case to suit (Cat. H-3200) **\$44.95**
 BASIC program in EPROM (Set of 3 IC's) (Cat. K-3604)
 WAS \$89.50 — SAVE \$40.00 **\$49.50**
 S-100 Expansion (Cat. K-3606) **\$19.50**
 Character Generator (upper/lower case) (Cat. K-3607)
 WAS \$69.00 — SAVE \$20.00 **\$49.00**
 Detailed construction manual (Cat. B-3600)
 WAS \$12.50 — SAVE \$3.00 ... **BONUS** **\$9.50**
 BASIC manual (Cat. B-3602)
 WAS \$14.50 — SAVE \$5.00 ... **BONUS** **\$9.50**
 RAM expansion to 48K (2 sets 16K RAM IC's)
 (Cat. X-1186 x 2)..... **\$59.90**

EX-STOCK Available NOW! OVER 23000 SOLD!

The SUPER 80 is the proven computer kit with over 2000 sold and it is available ex-stock! Why wait for others — check out our prices with the competition and whilst you are doing that, check out the features too! Dick Smith Electronics have reduced the price of the SUPER 80 as the enormous design costs have now been absorbed by the superb sales of this superlative kit computer — read on . . .

Very Advanced design — but works with any TV set!

The 'Super 80' offers a specification that we believe just cannot be bettered at the price. It uses the popular Z80 Microprocessor IC, a professional keyboard and has direct RF output so that you can use the computer with any TV set (you don't need to purchase a special video monitor).

Easy to build

Even though we would not recommend this kit to the raw beginner, it is very easy to build. Any person who can use a small soldering iron and can solder neatly should have no difficulty in construction. This is because of the unique double-sided board design which means there is virtually no other wiring. The board is covered with professional 'solder mask'; this makes soldering much easier without the problems of bridges, etc. Once the components are soldered onto the board in their marked positions over 98% of the construction is completed. Even if you cannot get the completed kit to work, we have a special "Sorry Dick it doesn't work" repair service to assist you.

NEW lower price, higher specification - how is it done?

Most computers sold in Australia are manufactured in the U.S.A. where extremely high labour rates prevail - and you pay dearly for this on built up units. With this computer kit, you provide the labour and therefore save a fortune. And remember, this computer does not have a small toy-like calculator keyboard but a full size professional typewriter keyboard.

Advanced programming capability

The Super 80 Computer gives you a huge 9K of BASIC — comparable in fact, with the BASIC on our very popular Sorcerer computer (over 2000 sold) — and this machine sells for over \$1,000. Many other computers currently available do not offer as much BASIC programming capability as the SUPER 80 — it is obvious that by building it yourself you are saving real money!

Imagine how much you will learn!

Most computer enthusiasts can program a computer but would have absolutely no idea of how to build one. By building this kit you will learn both the technical side of construction, how it works and then how to program. What a fantastic background for the future.

Sectional construction

We have designed this kit not only for the serious computer user but also for first time users like the student or hobbyist. This is why we have a short form kit which may be added to as you build (and as you have the money!). For example, you may build the computer originally and operate it with 'BASIC on tape' and then add 'BASIC in ROM', add the S-100 and provide other parts at a later stage.

Check the Super 80 against all others

	SUPER 80	OTHER
* IS IT S-100 EXPANDABLE	<input checked="" type="checkbox"/>	<input type="checkbox"/>
* DOES IT EXPAND TO 48K ON BOARD	<input checked="" type="checkbox"/>	<input type="checkbox"/>
* DOES IT HAVE RF OUTPUT FOR TV CONNECTION	<input checked="" type="checkbox"/>	<input type="checkbox"/>
* WAS IT FEATURED IN ELECTRONICS AUSTRALIA — AUSTRALIA'S LEADING ELECTRONICS MAGAZINE	<input checked="" type="checkbox"/>	<input type="checkbox"/>
* IS IT AVAILABLE EX-STOCK	<input checked="" type="checkbox"/>	<input type="checkbox"/>
* HAS IT SOLD OVER 2000 AND BEEN PROVEN AGAINST TEETHING TROUBLES	<input checked="" type="checkbox"/>	<input type="checkbox"/>

CHECK OUT THESE FEATURES: * Relay operates cassette unit automatically * 2K Monitor program supplied * Character generator giving full 64 characters, 32 characters x 14 line screen * Spare IC positions for prototyping and user customising * RF modulator inbuilt, connects to your TV set * Optional S-100 provision * Keyboard can be remotely mounted if required * 12MHz quartz crystal * Optional 9K SUPER BASIC in ROM plug in facility * Full size professional 60 key keyboard * Inbuilt power supply * 16K RAM on board plus provision for on board expansion to 48K * Inbuilt cassette interface

7 Day Satisfaction Guarantee

Another exclusive Dick Smith offer: purchase this kit and inspect it for up to 7 days. If, for some reason, you do not wish to go ahead and construct the kit, simply return it to us in original condition and packing (ie. before construction has commenced) and with all instructions, cards, etc. and we will refund your money in full. What have you got to lose?

Designed in conjunction with Electronics Australia Magazine.



This is what Reg Hesper, Technical Officer of Gladesville had to say about 'Super 80' "I enjoyed building the Super 80 project and felt it worthwhile, of immense educational value and quite easy to construct. It worked as soon as I turned it on and has provided many hours of enjoyment".

DICK SMITH ELECTRONICS

THIS MONTH ONLY

SPECIAL OFFER - \$31.50 EXTRAS FREE!

We're celebrating the enormous success of the Super 80 — by far Australia's most popular kit computer — and for this month only, we're giving away \$31.50 worth of extras with each Super 80 kit purchased! Hurry in for this special offer now . . .

Here's what you get: Super 80 BASIC manual (was \$9.50) . . . Super 80 construction manual (was \$9.50) . . . And the BASIC interpreter program on cassette (was \$12.50) Total value \$31.50 . . . yours FREE with your Super 80 kit computer from Dick Smith Electronics.

★ ORDER BY PHONE ★ QUOTE YOUR BANKCARD NUMBER ★ WE DELIVER ★

DSE/A193M/JW



More on that Gordon River editorial

For the first time in my life I am moved to support an editor of a magazine or newspaper. For a period well in excess of two years I have put up with "emotional garbage", as Mr Coulson so elegantly puts it in your September issue.

Judging by the "incensed" response of Mr Coulson and many of the "unbiased non-greenies" to your editorial, but more importantly to the whole of the Franklin/Gordon power scheme and (dare I drag a ghost from the past) the Lake Pedder and current Pieman schemes, the issue can not be less than emotional.

My reasons for saying this are as follows. In selecting and implementing each of the aforementioned power developments the people of Tasmania have been repeatedly subjected to a barrage of facts, fantasy distortions and half truths. As recently as the Tasmanian State Election our now Premier (then opposition leader) stated quite clearly — "the Franklin/Gordon power scheme is a NON issue" when asked on the bearing this scheme would have on his (Liberal) party's chances in the election.

Just a few weeks ago Mr Gray then stated "my party has a clear mandate to get on with the job". I question how one sets a mandate about such a non-issue. How else can the average Australian evaluate the issue at hand except on an emotional level?

It is true that the HEC is one of the State's largest employers — on capital works. However their permanent post-construction employment numbers are incredibly small for the enormous amount of money invested. Fifty per cent of its budget goes towards interest payments (1979 figures).

Whilst 17% of eligible voters in the Tasmanian Referendum wrote "no dams", which was classified as informal, the total informal vote was a staggering 34%. One can only speculate, albeit at an emotionally biased level, what a true No Dams option vote would have meant for Tasmanians.

The Tasmanian State election was clouded by a politically and an economically unstable climate and to lay the election result at the bottom of yet another Hydro-Electric power scheme is

Letters to the editor

clearly irresponsible if not letting one's "emotions" blind one from the other issues that are involved in looking after our State.

One final and very emotional point I would like to make about the "selfish minority". A dictionary would broadly define the act of being selfish as looking after one's own interest in preference to another's needs. I have been most fortunate to have rafted the Franklin River on two occasions. I may never do so again. If, by being selfish, I may preserve this — our heritage — for my children and YOURS then so be it.

D. Tasker.
Westbury, Tas.

In reply to comments by Dr Guidici in "Electronics Australia", August, 1982. I fail to see that approximately one billion dollars to finance 180MW of elec-

Power factor error

I would like to comment on a recent article in "Electronics Australia", namely, the Power Monitor featured in the July 1982 issue.

While the idea of using a moving iron ammeter to indicate power consumption is fine for a resistive or near unity power factor load, for many applications it can be in error by a factor of two or more!

What I really want to take issue with is the statement that average household loads such as refrigerators and washing machines have a power factor near unity.

This is just not so. The average $\frac{1}{4}$ or $\frac{1}{3}$ HP split-phase motor has a PF of about 0.6 on full load as does the average hermetic refrigerator unit. A few (very few) may have PSC motors (permanent split capacitor) but even then PF is about 0.8 maximum. Small shaded-pole motors such as used in fans etc can have PF's as low as 0.2 to 0.3.

A few figures will illustrate the point. Take an average $\frac{1}{4}$ hp motor which on 240V draws about 2 amps; $\frac{1}{4}$ hp is 746/4 which equals 186.5W; efficiency is about 65% so input is $186.5/.65 = 287$ watts; but $240V \times 2 \text{ amps} = 480VA$ so $PF = 287/480 = 0.59$.

tricity (and this to be done by the taxpayers in the whole of Australia) is in any way, shape or form, a "bargain" and considering the generators still to come for the Strathgordon scheme and after that the Pieman scheme, flooding the Franklin or Gordon rivers further is completely unnecessary.

The HEC seems to be only interested in building dams to generate electricity. Has full research been carried out into the use of wind power, also a costless fuel, as an alternative? (Tasmania certainly has the ideal geographic location for this) and if not, why do we lag so far behind many other countries in the search for more "passive" forms of energy?

Creating a lake is one thing: flooding a whole river system, with its absolutely unique scenery and vegetation, archaeological sites etc is a different thing completely and is tantamount to ravaging the area.

Our environment is being destroyed at a rapid enough rate already and great problems have been generated by large scale damming and irrigation systems and destruction of forest so it would seem to be a logical step to find ways to save and not destroy our land.

The same 60,000 people have also looked at the rest of Tasmania and probably a lot of the mainland as well and I

(Continued on page 104)

For power consumption purposes the figure of 287W (in this case) is the one to use. If you take the 2 amp reading on your meter this equates to 500W which you'll agree is a long way out.

The only satisfactory way to measure power consumption in an AC circuit is to use a standard (preferably dynamometer) type wattmeter or one of the newer solid state transducers which can have a DC voltage or current output linear with the power consumed. Watts/kW can then be read on a standard moving coil instrument or digital meter. Agreed, these are costly (\$500-600) for the average home experimenter to buy, however, what about a project to build a solid state version which may cost, say, \$150-200? An article in the American magazine "EDN" for February 4, 1981, describes such a device.

I am currently using a commercial version very successfully, which cost \$NZ465. Perhaps I should point out at this stage that I have been in the home appliance design and development field for over 30 years so have some experience in this area. Apart from this one brickbat I have nothing but bouquets for your magazine.

I. N. Ricketts,
Auckland, NZ.



OUR LOWEST PRICES EVER ON SEMI-CONDUCTORS AND IC's

	1-24	25-99	100plus
2708	4.90		3.10B
2716 5V	4.50	4.00	3.50B
2732 5V	5.50	5.00	4.50B
2114 300NS	2.10	1.90	1.80B
4116 200NS	1.40	1.30	1.20B
8164 64x1K DYN. RAM	38.00	32.00	29.00B
Z80 CPU 2MEG	6.00	5.00	4.00B
Z80ACPU 4MEG	7.00	6.00	4.20B
Z80P10	5.00	4.50	4.00B
Z80API0	6.00	5.00	4.20B
Z80CTC	6.90	5.10	4.80B
Z80ACTC	8.40	6.00	5.70B
Z80S10/0	15.00	14.00	10.00B
Z80AS10/0	16.00	15.00	11.00B
8212	3.00	2.50	2.10B
8214	6.00	5.50	4.90B
8224	4.90	4.50	4.20B
8251	4.90	4.50	4.20B
8255	5.50	4.30	4.00B
6800	5.50	5.00	4.50B
6802	8.00	7.00	6.20B
6821	2.50	2.20	2.00B
6850	2.50	2.20	2.00B
FD1771	15.00		
FD1791	24.00	23.00	21.00B
FD1795	27.00	25.00	23.00B
8080A	5.00	4.50	4.20B
8085	6.00	5.00	5.00B
7400	.18	.17	.16B
7410	.18	.17	.16B
7421	.15	.12	.11B
74LS00	.16	.17	.13B
74LS10	.18	.17	.13B
74LS32	.18	.17	.13B
74LS74	.45	.41	.30B
74LS240	.80	.70	.60B
74LS241	.80	.70	.60B
74LS242	.80	.70	.60B
74LS244	.80	.70	.60B
74LS245	1.00	.90	.90BN
81LS95	1.70	1.50	1.40B
81LS96	1.70	1.50	1.40B
81LS98	1.70	1.50	1.40B
8131	2.10	1.90	1.70B
BC547-8-9	.10	.09	.07B
BC557-8-9	.10	.08	.07V
RED LEDS 5mm	.10	.08	.07B
IN4001	.04	.035	.032B

	1-24	25-99	100plus
IN4002	.05	.04	.035B
IN4003	.05	.04	.035B
IN4004	.06	.04	.039B
IN4007	.11	.09	.07B
IN4148	.04	.03	.025B
INS404	.20	.018	.017B
INS408	.25	.023	.021B
BU126	1.70	1.50	1.30A
BUX80	2.50	2.20	2.10A
TIP50	.99	.89	.81A
BD139	.40	.30	.22A
BD140	.40	.30	.22A

LINEARS

LM308	.60	.45	.40A
LM555	.29	.26	.25B
LM741	.29	.26	.25A
LM317K	2.90	2.50	2.40B
LM350K	6.50	5.50	4.90B
LM380-14	1.10	1.00	.90A
LM324	.80	.65	.55A
CA3130T	1.50	1.40	1.30A
CA3140T	1.50	1.40	1.30A
RO-3-2513	11.00	10.90	9.50B
7805	.50	.40	.38B
7812	.50	.40	.38B
7815	.50	.40	.38B
7905	.60	.50	.45B
7912	.60	.50	.45B
7915	.60	.50	.45B
MDA3501	2.80	2.70	2.60B
MDA3502	2.90	2.80	2.70B
MDA3504	3.00	2.90	2.80B
FND357	1.00	.95	.72B
FND500	.95	.90	.72B
FND507	1.00	.95	.72B
78H05	6.50	5.90	5.00B
78HGKC	6.90	6.50	5.90B
78PO5	9.90	9.50	8.90B
4001	.19	.18	.16B
4002	.19	.18	.16B
4007	.19	.18	.16B
4011	.19	.18	.16B
4077	.19	.18	.16B
4081	.19	.18	.16B
4093	.60	.55	.50B
4082	.19	.18	.16B
4017	.70	.60	.50B
2SK134	4.90	4.75	4.30A
2SK49	4.90	4.75	4.30A
MJ802	4.50	4.00	3.50A

LESS 5% THIS MONTH ONLY

DISC DRIVES

MPI 51.....	\$275.00 + 20% S.T.
MPI 52.....	\$385.00 + 20% S.T.
MPI 91.....	\$415.00 + 20% S.T.
MPI 92.....	\$515.00 + 20% S.T.

	100+	1000+	100+	1000+	
DB25C	1.00	.90	4116	1.30	1.10
DB25P	1.90	1.70	2716	3.50	2.95
DB25S	2.90	2.75	2764	9.00	8.50

ALL SEMI-CONDUCTORS ARE PLUS TAX

TAX A = 32½% TAX B = 20%

RITRONICS WHOLESale

425 HIGH STREET, NORTHCOTE 3070. MELBOURNE. (03) 489-8131.

TO ORDER: Heavy items sent Comet Freight on Mail Order Phone 481-1436. Wholesale Customers Phone: 489-7099. Mail Orders to RITRONICS WHOLESale, P.O. Box 235, Northcote 3070. Telex No. AA38897. Minimum P&P \$2. Add extra for heavy items, registration and certified mail. Prices and specifications subject to change without notice.

Bankcard mail orders welcome
ORDER FORM
 Please Debit my Bankcard
 No.
 Expiry Date
 Name
 Signature

ETI 10/82/1
 ETI 10/82/9

would go as far as to suggest that a significant proportion of these tourists would also favour no further destruction of this beautiful area.

I also find it hard to reconcile the fact that men with such a high standard of education seem to have so little feeling or interest in preserving what surely is a God's gift.

B. Rixon.
Strathfieldsaye, Vic.

Belligerent letters criticised

I must say I am not surprised at the replies invoked by the editorial regarding the Gordon River dam (EA, June 1982). Editorials are meant to be provocative, and this one certainly provoked some discussion, both rational and irrational. What does surprise me is the lack of reader support for the editorial and the obvious bias of those who have written.

Mr Felmingham of Tarraleah (an HEC power station plus employee residences) says (EA, September 1982) "It appears to Tasmanians that the most vocal people against the flooding of the Franklin River are those on the mainland". Perhaps Mr Felmingham only monitors the mainland news-media because from my perspective the most vocal opponents of the scheme are members of the Tasmanian Wilderness Society. I hope your readers do not gain the impression from correspondence so far that all Tasmanians are so parochial. We are, after all, Australians, and the Franklin River is a part of Australia's heritage.

The HEC cannot build the scheme without a federal loan, so let all Australians who wish to, have a say.

Leo Simpson's query regarding continued employment for the construction crew might be extended to cover the highly paid bureaucracy and engineers who would have to seek employment elsewhere should the scheme be negated. I might add that Mr Holgate, during his short colourful term as Premier, outlined a further half a dozen schemes to follow the lower Gordon scheme. Mr Gray (current Premier and treasurer) announced in his budget the allocation for \$11 million to the HEC to get on with the lower Gordon scheme. Is he trying to get well under way before the Federal proposal for World Heritage listing of the area is formalised?

Perhaps Messrs Coulson, Felmingham and Roberts have been under the realm of the HEC for so long they no longer question the validity of HEC motives and actions. Why do they prefer to believe

all the misleading and false propaganda comes from opponents of the scheme? Why does the HEC need to spend thousands of dollars to advertise itself. After all, where else can we obtain power in Tasmania?

With the mining companies on Tasmania's West Coast closing down as they are what happens to power consumption predictions? TEMCO (BHP) at Bell Bay recently had to shut down a furnace owing to lack of product demand and this single act released over 12 megawatts for other uses. A pointer for the future?

I am heartened to see that some engineers are concerned about the effects of technology on the environment. Through lack of this concern in the USA, overdamming of the Colorado River has ensured that it no longer reaches the sea and Mexico gains minimal benefit from the little that reaches its soil. In Tasmania the largest single cause for the disappearance of forest is the HEC and its dams.

I commend "Electronics Australia" for printing these often belligerent and insulting letters. This demonstrates their willingness to listen to other opinions, even though they may disagree.

Still on power consumption, but a separate issue, regarding the September editorial. As an adjunct to microprocessor power meters, a 24-hour clock based on a crystal oscillator could be used as an off-peak system controller. If a NiCad battery and charging circuitry were incorporated, power failures would become superfluous as would the need for resetting following blackouts.

D. R. Waters,
Scottsdale Tas.

I applauded your editorial regarding the Gordon River dam and in view of the comments you have received I would like to make a few points of my own.

Firstly, the referendum that is constantly referred to never was a chose bet-

Sensational headline?

As one who has worked in the occupational health field for 27 years after several years in the electronics industry, I should like to protest at your use of a sensational headline for the well-balanced article on VDUs by Dr Colin Mackay. That there are some unsatisfactory areas in the use of this equipment is not doubted - I find myself suggesting methods for their correction almost weekly - but your headlines will give rise to unnecessary apprehension.

ween dams or no dams; it consisted of a choice of two **dam projects** and approximately 38% of the people cast an informal vote, most by writing no dams on the ballot paper. There are still a number of schemes being completed and according to press reports when the Pieman is completed (about 1986) there will be 200 megawatts more power available than there is at the moment. The greatest worry is that with the closure of mines and a general down turn in business, the HEC projection of power requirements for the future is going to be grossly exaggerated. If that is so and the power is not sold, who is going to pay off the colossal debt involved in building the Gordon scheme.

I do not knock the HEC as I feel they have done all that is required in the past, but I do think that when a vital decision, such as the Gordon River scheme is at stake, an unbiased independent authority (completely divorced from the State and its politics) should be engaged to give the government the true facts. The present drought highlights the weakness of hydro power, and a decision for a thermal plant would not have only saved a worthwhile asset, but would give back up when water is scarce. Of course the whole question is do we need that quantity of power for the future? One must remember that if, for example, the aluminium works closed down there would be almost a third of the total power developed in the State not needed.

D. C. Logan.
Lenah Valley, Tas.

Car Computer comments

As importers of the Zemco range of trip computers and cruise controls, we have naturally followed your recent series on the car computer with interest. After three years of experience with these devices we thought that it may be

(Continued on page 107)

More appropriate headlines for the article would be along the following lines:

"VDUs can be used safely!"

Whilst there are no intrinsic health hazards associated with video display units their inappropriate use may cause unacceptable disability to some people. This article will help to allay some unnecessary fears."

I should be pleased if you could find space in your journal to publish this letter.

G. Major,
Lecturer in Occupational Hygiene,
University of Sydney.

BOOKS! BOOKS! JAYCAR

NOW WE'RE YOUR No.1 SOURCE OF ELECTRONIC BOOKS TOO!!!



LEARN TO PLAY THE ETI 4600 AND 3600 SYNTHESISERS

\$12.50

Written in England by Mike Beecher - probably the most experienced ETI Synthesiser Player. This book imported by us from Maplin UK is an invaluable asset to the keyboard Synthesiser builder or player. If you have ever thought of building one of these legendary Synthesisers you must buy this book first.

Setting up and testing - Controllers - Keyboard control - Reverberation - Interfacing - How it works - The patch panel - Oscillators - Helpful hints - plus dozens of patch layouts. Over 76 pages (softcover) 300x210mm

3600 AND 4600 SYNTHESISER CONSTRUCTION BOOK

The Australian edition of this very popular project book has been out of print for over 12 months. We now have the English edition of this popular book. If you missed out on the Australian edition then this is for you. (It contains the latest improvements such as the digitally scanned keyboard circuitry). Complete construction details on both synthesisers provided. BOOK ONLY \$17.50



great value
\$17.50

46 pages;
Size 20cms x 29½cms

LINEAR DATA - 1982 EDITION NATIONAL SEMICONDUCTOR

Our thickest book - 170w x 230h x 65d THE book for linear data from the world leaders. Titles include: Voltage regulators, OP amps/buffers, Instrumentation amps, Comparators, Analogue switches, A/D, D/A, TV circuits, Transistor and diode arrays, Digital speech synthesiser and physical details of devices.



FOR THE PROFESSIONAL OR SERIOUS AMATEUR A MUST...

\$17.95



MODERN RECORDING TECHNIQUES

368 pages, 5½x8½, softbound Provides the information necessary to prepare pop music recordings. Explains the equipment, controls, and techniques found in the modern recording studio and how to use them not only properly but creatively to produce a desired result. Numerous photographs, diagrams, and charts.

TOP VALUE BOOK \$8.95

288 pages, 5½x8½, hardbound Provides nonstop source of information needed by engineers, technicians, students, hobbyists, and experimenters. The handbook presents the basic formulas and laws of electronics as well as the hard to remember constants. Covers standards, symbols, codes, and design data for electronic application. Also includes methods and tables, formulas, and a section of miscellaneous data such as a table of the elements, temperature scale and metric facts.

\$16.95

ELECTRONIC TABLES AND FORMULAS

TV ANTENNAS AND SIGNAL DISTRIBUTION SYSTEMS

As reviewed in Sept. EA page 107

256 pages, 5½x8½, softbound An invaluable guide to selecting and installing TV antennas and signal distribution systems, this book is packed with easy-to-understand information on using these systems to produce high quality TV reception. Many of the antennas described have been personally tested by the author.

WAS \$14.75
NOW ONLY \$12.50

★ SPECIAL NOTE ★

- (1) We have over 20 new titles arriving towards the end of November. If you want a complete list with descriptions send SAE
- (2) Some of the titles shown sell out very quickly. We endeavour to keep all titles in stock at all times but we may have to back order for you. A card will be sent advising the delay.
- (3) Where the number of pages is not shown we try to give you the approximate THICKNESS of the book. This will give you some idea. (In most cases the pages are very thin and there is about 4.5mm per 100 pages!)



50 PROJECTS USING RELAYS SCR'S & TRIACS

110w x 180h x 7mm Over 100 pages Fascinating and low cost book. We have just received another shipment after having been out of stock for over 6 months. Book gives theory of operation of relays, EMF suppression, Testing etc. Circuits include: Timers, Motor Reversing, Train control, Light control and many more. SCR section is very comprehensive. Outlines theory and then goes on to give over 25 SCR circuits including: Sound operated switch, Zener triggered oscillator, Audio oscillator, SCR flasher, Train model control, Audio light modulator, Automatic battery charger etc. TRIAC section gives several circuits viz: Drill or motor controller, 3-position control, Low voltage AC motor control and Temperature warning.

★ ONLY \$7.95

ESSENTIAL THEORY FOR THE ELECTRONIC HOBBYIST



110w x 180h x 10d mm Over 115 pages We find that many readers tackle projects in electronic magazines with only a smattering of theory. This is fine if the project works straight off - but if it doesn't, as often as not, it is discarded. The project is a complete waste of money. With some theoretical background knowledge you can get those projects going and enjoy your hobby more anyway. We won't say much about this book except to say that it is one of the best we have seen for the price - 10 chapters in all and well written for the novice. A bargain and an investment in the future.

ONLY \$4.95

CMOS DATA - 1982 EDITION NATIONAL SEMICONDUCTOR

Completed data on National 4000 and 74C series CMOS as well as the CMOS LSI devices produced by N.S. 170w x 230h x 60d

ALL YOU NEED TO KNOW ON CMOS IN ONE BOOK...

\$8.95

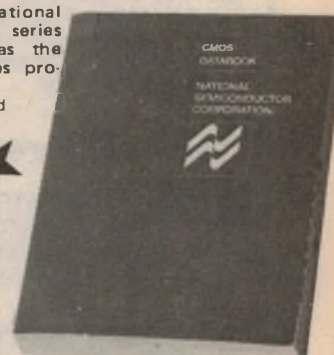

OTHER BOOKS

- BP94 Electronic Projects for Cars and Boats - ONLY \$5.85
- BP76 Power Supply Projects - \$6.40
- BP43 How to Make Walkie Talkies - \$5.50
- BP37 50 Projects using Relays, SCR's and TRIACS - ONLY \$6.49
- 213 Electronic Circuits for Model Railway - ONLY \$6.60
- TEXAS BOOKS
- MOS Memory Data 185 pages \$8.50
- V Reg Handbook \$7.50
- Linear Control Circuits Data Book \$8.50
- Power Semiconductor Data 40mm \$39.50
- Transistor & Diode Data 50mm \$19.50
- 9900 Family System design 45mm \$29.50
- MOTOROLA BOOKS
- SCR Manual 17mm \$8.50
- Schottky TTL Data Book 20mm \$8.50
- RF Data Manual 40mm \$12.50
- CMOS 35mm \$14.50
- Optoelectronic Device Data 17mm \$9.50

WE STOCK OTHER BOOKS PLUS A RANGE OF MAGAZINES CALL IN AND BROWSE...

BOOKS!
BOOKS!
JAYCAR

Jaycar

125 YORK St. "NEVILLES CORNER" Cnr CARLINGFORD & SYDNEY 2000
Phone: 264 6688
Telex: 72293
Mail Orders To: BOX K-39 HAYMARKET SYDNEY 2000

MINIMUM MAIL ORDER \$5.00



POST AND PACKING CHARGES
\$5.99 (\$1.20) \$10.24 (\$9.32 40)
\$7.54 (\$9.92 \$3.50) \$10.99 (\$9.14 60)
\$10.00 (\$6.20)

NEW SHOP HOURS
Mon-Fri 8.30 to 5.30pm
Sat 8.30 to 12.00pm
Thurs night to 8.30pm

MICROPROCESSORS AND PERSONAL COMPUTERS



Microprocessors and personal computers, little more than a dream a few years ago, are now changing the face of electronics. This book introduces the basic concepts, describes a selection of microprocessor and personal computer systems, and details a build-it-yourself computer designed especially for beginners.

HERE ARE THE CONTENTS:

PERSONAL COMPUTERS: TANDY ELECTRONICS TRS-80 PERSONAL COMPUTER, EXIDY SORCERER PERSONAL COMPUTER SYSTEM, HEATH H8 HOME COMPUTER SYSTEM, HEATH H11 16 BIT MINICOMPUTER KIT, COMPUCOLOR II PERSONAL COMPUTER SYSTEM

MISCELLANEOUS EQUIPMENT: E & M ELECTRONICS CASSETTE INTERFACE KIT, PARATRONICS MODEL 100A LOGIC ANALYSER, PARATRONICS MODEL 10 TRIGGER EXPANDER, LEAR SIEGLER ADM-3 VIDEO TERMINAL KIT, TAPE READER KIT FOR HOBBY COMPUTERS, SIGNETICS INSTRUCTOR 50 TRAINING SYSTEM

DREAM 6800 COMPUTER: INTRODUCTION TO THE DREAM 6800, BUILDING THE DREAM 6800 COMPUTER, INTERESTING PROGRAMS FOR THE DREAM 6800, CHIP-8 PROGRAMMING FOR THE DREAM 6800, DREAM 6800 POWER SUPPLY.

GENERAL: THE PERSONAL COMPUTER REVOLUTION, MICROPROCESSORS: THE BASIC CONCEPTS, PLOT BIORHYTHMS WITH YOUR TRS-80, UNDERSTANDING BASIC PT 1, UNDERSTANDING BASIC PT 2, GIVE YOUR COMPUTER AN RS 232C INTERFACE.

MICROPROCESSORS: INTEL 8080A & SDK 80 EVALUATION KIT, INTEL 8085 & SDK 85 SYSTEM DESIGN KIT, MOTOROLA 6800 & MEK6800D2 EVALUATION KIT, MOTOROLA 6802D3 EVALUATION KIT, NATIONAL SEMICONDUCTOR SCMP CHIP & EVALUATION KIT, SIGNETICS 2650 CHIP & EVALUATION SYSTEMS, FAIRCHILD F8 & F8 DESIGN EVALUATION KIT, MOSTEK F8 & MOSTEK EVALUATION KIT, SIGNETICS 8X300 & EVALUATION KIT, NATIONAL SEMICONDUCTOR PACE & DEVELOPMENT SYSTEM, TEXAS INSTRUMENTS TM990/189 TRAINING SYSTEM

Available from "Electronics Australia", 57 Regent St, Chippendale, NSW. **PRICE \$5.00** OR by mail order from "Electronics Australia", PO Box 163, Chippendale, 2008. **PRICE \$5.90.**

LIKE TO GET AN AMATEUR RADIO CERTIFICATE? IT'S MUCH EASIER WITH PROFESSIONAL HELP.



If something's worth doing, it's worth doing well. So don't waste your valuable spare time finding your own way through the Amateur Radio maze. Ask Stott's instead. We have top professional instructors, who'll make sure your time is well spent on your way to an operator's certificate. You'll have individual attention, working at your own speed, in the comfort of your own home. Any queries will be answered personally, and promptly.

So don't delay. Mail the coupon for full details.
Over and out.

Stotts 
TECHNICAL CORRESPONDENCE COLLEGE

The name to trust in correspondence education.

Please send me free, and without obligation,
full details of the following courses:

(PLEASE PRINT)

MR MRS MISS _____ AGE _____

ADDRESS _____

POSTCODE _____

Stott's undertake that no sales counsellor will visit you

Melbourne, 159 Flinders Lane, 3000 Tel: 63 6212
Sydney, 383 George Street, 2000 Tel: 29 2445
Brisbane, Suite 3/65 Mary Street, 4000 Tel: 221 3972
Adelaide, 85 Pirie Street, 5000 Tel: 223 3700
W. Perth, 25 Richardson Street, 6005 Tel: 322 5481
Hobart, 1st Fl, 29 Argyle Street, 7000 Tel: 34 2399

The Stott's range of courses
in Amateur Radio is:

Novice Amateur Operator's
Certificate of Proficiency.
Amateur Operator's Certificate
of Proficiency.
Amateur Operator's Limited
Certificate of Proficiency.
Radio for Amateurs.

ALA/ST3595/EA1182

beneficial to your readers if we were to make some observations based on this experience.

Firstly, after fitting the flow sensor to the fuel line, run the engine and inspect all connections for fuel leaks. Even if there are no leaks ensure that each clamp is tight. Should a fire result from a loose connection or faulty hose, the insurance company may refuse to cover the damages.

While it has been said that the flow sensor will not operate on fuel injected petrol engines and diesel engines, this could well be possible. Zemco have an adaptor available for electronic fuel injected vehicles which reads the electronic pulse to the injector solenoid, and this should marry in with the EA computer. If the system is mechanical, eg Volvo, there is an adaptor but this is suitable for the four cylinder only. With the increased fuel flow of the six cylinder there are problems with fuel vapourisation. The Saab has a similar system but as the fuel pump is within the fuel tank it creates difficulties.

On diesel engines it should be possible to place the flow sensor in the fuel line, but it must be fitted to the suction (low pressure) side of the pump (the same applies to petrol injection). Pressure on the delivery side is excessive and there is the possibility of hoses bursting. One problem to be overcome is the injector spill return. On some vehicles this spill is fed back to the pump or filter, and so it is a simple matter to carry out the installation. However, on many vehicles the spill is returned to the tank, which means re-routing the line back into the suction side of the pump with a T-piece, and locating the sensor between the T-piece and the fuel tank. This system will work providing there is no vapour in the spill. If there is this may cause vapourisation problems. It is our belief that there is little or no vapour in diesel systems, but this is not the case with petrol-injected engines.

In relation to the speed sensor magnets, the fore and aft movement of the drive shaft as the rear axle moves up and down is only slight, and it is not necessary to mount two magnets side by side. If at all possible we recommend that the sensor bracket be attached to a bolt on the back of the gearbox, and (if there is sufficient space) the magnets be secured to the gearbox output coupling (but not on the larger diameter universal joint flange). If the bracket is attached to the floor pan, there could be sufficient flexibility in the rear engine mountings to allow the drive shaft to move sideways when a large pot hole is encountered. If the magnets strike the sensor damage could occur.

As mentioned in the text, whenever possible connect the power supply to the fusebox. If other sources are tapped, eg the horn wire, the voltage drop occurring when the horn is used can be sufficient to lose the memories.

The motor vehicle is a rather unfriendly environment for anything electronic, and one problem sometimes encountered is interference from an electrical source within the vehicle. While this is rare, when it does happen it can take some time to track down. Possible sources of EMI are: primary and secondary ignition wiring (solid core spark plug leads in particular); ignition components (coil, distributor, spark plugs); electronic ignition; alternator; tachometer and digital clock wiring; radio, and two-way radio wiring; compressors for air horns or pneumatic shock absorbers. Similar problems can also be caused by EMI sources outside the vehicle, such as radio frequency interference (RFI) and high voltage power lines. There may be a possibility of memory loss if a booster battery is used to start the vehicle or if high voltage tune up equipment is attached to the vehicle.

While problems may be caused by faulty connections do not overlook the possibility of a suspect sensor if there are no distance or fuel readings.

One last observation. When the computer is installed in the vehicle, do not devote too much time to pushing buttons or reading the display. Years ago the vacuum gauge was referred to as the "panel beater's friend" due to the fact that the driver paid too much attention to the gauge and too little to the road. The car computer can be a similar hazard during the first few days of operation, so take care!

Brian Willis,
Antelope Automotive Pty Ltd,
Neutal Bay, NSW.

Standards for computer shielding

I was interested to see an article in the August 1982 issue on the shielding of a System-80 personal computer to prevent interference to local TV reception.

The problem described is a very real one and one which the Association's committee on electromagnetic interference takes seriously enough to prepare an Australian standard which will be circulated for comment shortly. The approach taken by your reader and described in this article is alright as far as it goes but is not guaranteed to fix the problem in all cases.

He has certainly identified the simplest remedy for the simplest equipment but the approach is strictly limited, dealing only with one type of interference from the basic computer unit. The method he has used, the application of metallic shielding will be reasonably effective in limiting radiated interference even though the continuity of the shielding is suspect. The electrical safety of the procedure described is not something the experts like to think about either. Contact adhesive in a heated atmosphere is not noted for its ability to retain its bond-strength so the foil is likely to come adrift with possibly disastrous consequences to computer or operator even where the adhesive is compatible with the plastic enclosures.

The interference problem has been only partly dealt with. It has been found that the greatest source of radiated interference from a computer system is the cables used to connect the various devices which are interconnected. Shielding only the computer unit is therefore just a start. Of course, conducted interference is also a problem. Individual devices meeting the requirements of the various regulations already in force overseas have been found to radiate at high levels due to interference **reaching** them through the cables.

Shielding is something which can give some protection where radiated interference is the problem but it does nothing for conducted interference. To be sure of a good result the shielding must be continuous, well bonded to earth and isolated from the mains or other cables by suitable filters.

Apart from shielding the various devices and their connecting cables there are other simple options available such as only operating the computer at a distance from the TV receiver or shielding the room in which the computer is operated with aluminium insulation or fly-wire, in the direction between the computer and the TV receiver.

The problem can really only be contained, however, if attention is paid at the design stage of the computer, to limiting the generation of RF radiation and spurious signal voltages at the terminals. Shielding, filtering and isolation can then be regarded as additional treatment which may be necessary for various combinations of equipment not envisaged by the designer or not available at the time of testing. It is problems such as these that make the application of a standard on the subject rather difficult. Regulations on the subject would seem to be essential.

R. K. Profitt,
Standards Association of Australia.

ROD IRVING ELECTRONICS FANTASTIC NOVEMBER KIT SELLOUT

Post & Pack \$2.50 small kits, heavier kits add extra postage — Prices subject to change without notice. Send 60c and SAE for pricelists. Phone (03) 489 8131. — MAIL ORDERS: PO Box 235, Northcote, Vic 3070.

ON SCREEN GRAPHIC ANALYSER \$109.00

The On Screen Graphic Analyser links your hi-fi to your TV set
Features:
Six colour bar graph display (Standard PAL receiver)
Ten vertical bars in the display corresponding to the 10 octave bands.
Gives you the best sound quality your system can deliver.

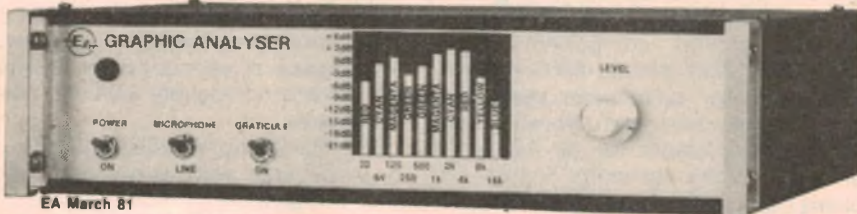

CUDLIPP

\$12.00

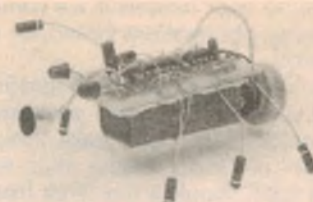

A fascinating Electronic Cricket with just two ICs. The Cudlipp can be used to bug your Home, Office or Board Room. Great fun. EA February 82

FM WIRELESS MICROPHONE \$8.50

HOBBY ELECTRONICS May 81



CAR BATTERY MONITOR \$9.50

Fiat Battery! Don't get left out in the rain. Install a voltage monitor which monitors the state of your battery at a glance. EA, October 80.

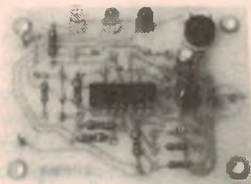

UNIVERSAL RELAY BOARD \$13.50

Operating a relay to switch heavy current or mains voltages is a common requirement in electronic control applications. This project permits a relay to be switched in a variety of ways and from a variety of inputs. ETI May 81



LOW FUEL INDICATOR \$16.50

EA March 81

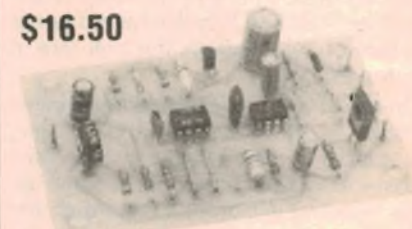

AM TUNER \$99.00

ETI 475 September 80

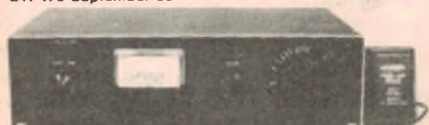

Includes plug pack and punch metal work

\$9.50

MINI DRILL SPEED CONTROLLER

Here's an easy to assemble project for a simple speed regulator for miniature DC electric drills. ETI July 81



ELECTROMYOGRAM \$89.00

ETI Top Projects Vol 6



SLOT CAR POWER SUPPLY \$19.50

ETI December 81



SERIES 4000 SPEAKER KITS

Speakers and crossovers	\$450
Speaker boxes	\$240
Crossover kits	\$189
Complete kit	\$679

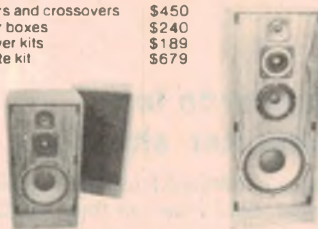

EPROM PROGRAMMER \$77.50

EA July 80

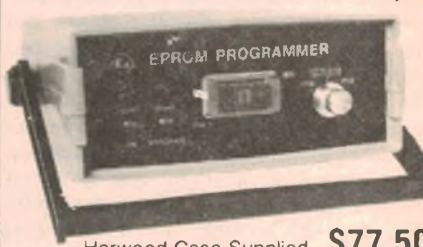

Horwood Case Supplied

HUMIDITY METER. \$19.50

ETI 256



BRIDGING ADAPTER

ETI March 82

\$10.95



SLIDE CROSS FADER \$85.00

EA November 80



ROD IRVING ELECTRONICS

425 HIGH STREET, NORTHCOTE 3070, MELBOURNE, VICTORIA. Ph (03) 489 8131. Telex No. 38897

Electric fence **\$17.50**



Check our prices

SEPTEMBER EA 1982

Ultrasonic Rule



\$49.00

AUGUST EA 1982

Car Computer



\$109

AUGUST EA 1982

Tacho/dwell meter with digital display

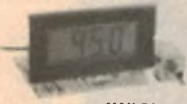

\$62

MAY EA 1982

12/240 volt Inverter



\$55

MAY EA 1982

\$35

Universal preamplifier for MM/MC cartridges

MAY EA 1982

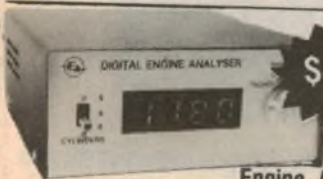

\$48.50

Engine Analyser Kit



Eprom Programmer

\$55.00

JANUARY EA 1982



\$189.00

Analogue and Digital Storage CRO Kit

\$79.50 Function Generator



APRIL EA 1982



\$55.00

SEPTEMBER EA 1982

Dual Tracking Power Supply



\$83.50

Power Monitor

JULY EA 1982



\$18

Portable 3 1/2 Digit Heart Rate Monitor

JULY EA 1982



\$79.00

100w Sub-Woofer Amplifier



\$85.00

JULY EA 1982



EA POWER UP

\$33

EA SUPER SIREN



\$21

(Battery extra)

300W AMP MODULE



\$63.00

JUNE EA 80

EA DIGITAL READOUT FOR SW RECIEVERS

P.O.A.

OCTOBER EA 1982



EA EASY-TO-BUILD FREEZER ALARM

\$21

OCTOBER EA 1982

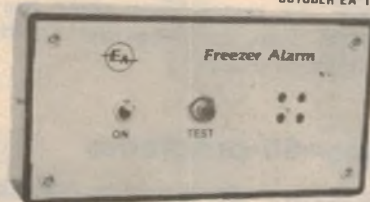

EA ELECTRONIC STARTER FOR FLUORESCENT LAMPS



\$5

OCTOBER EA 1982

EA GUITAR BOOSTER

\$17.50



JUNE EA 1982

EA THEREMIN **\$34.50**



JUNE EA 1982

OVER 200 NOW SOLD EA INVERTER INCLUDING TRANSFORMER **\$189**



P & P \$10.00

JUNE EA 1982

Minimum P & P \$3.00 for kits

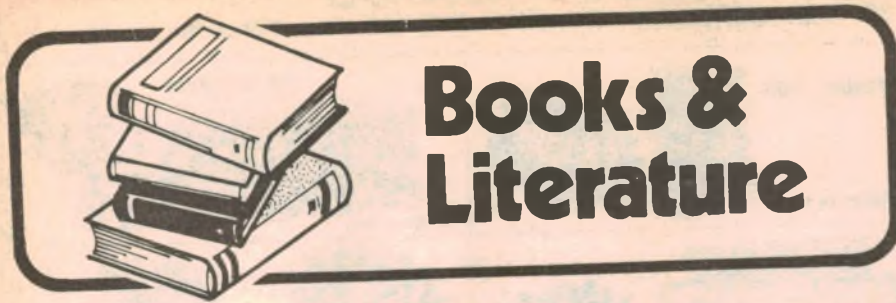

Books & Literature

Electronic design with ICs

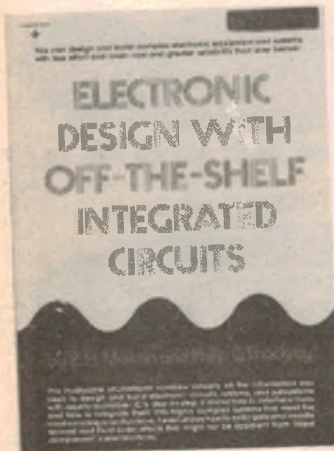

ELECTRONICS DESIGN WITH OFF-THE-SHELF INTEGRATED CIRCUITS by Z. H. Meiksin & P. C. Thackray. Published 1980 by Parker Publishing Company, New York. Soft covers, 383 pages, 246 x 175mm. Illustrated with many circuit diagrams. ISBN 0 13 250274 7. Price \$10.75.

This is primarily a practical text which gives the broad principles of operation of a large number of circuit configurations without resorting to heavy mathematics or electronic circuit theory. It is ideal for the hobbyist, being very easy to read and well laid out. As such it will also be useful to many engineers who find their grasp of theory has become rusty.

Chapter one is devoted to op amps and covers all the major parameters such as common-mode rejection, gain-bandwidth product, slew rate, phase compensation and supply rejection ratio. Transconductance amplifiers are also covered as are the basic voltage amplifier configurations.

Chapter two covers passive components and features selection of resistors, capacitors, inductors and the various types of transformer for power supply, audio coupling, IF and RF and pulse applications. Chapter three discusses low noise design and talks in fair detail about the two main sources of noise, passive, ie, resistors and active, ie, op amp input devices.

Chapter four is devoted to oscillators:

free-running multivibrators, sine wave oscillators (Wien bridge), triangle wave generators, quartz crystals and free-running oscillators using TTL, ECL and CMOS devices.

Chapter five has the broad heading of linear applications and covers integrators, differentiators, bridge amplifiers, voltage followers and four quadrant multipliers. Chapter six covers precision rectifiers, peak detectors, sample-and-hold circuits and comparators.

Chapter seven covers filter design up to fourth order plus high-Q bandpass filters. Chapter eight is devoted to basic logic circuitry and discusses the various types of gates, latches and flipflops. It also distinguishes between the three broad logic technologies: TTL, ECL and CMOS.

Chapter nine is entitled Digital Building Blocks and discusses adders, comparators, parity generators and checkers, shift registers and counters. Chapter ten covers analog-to-digital conversion and discusses successive approximation and parallel conversion. Chapter 11 is headed Grounding and Shielding and covers the subject of ground loops, stray fields, unwanted signal coupling and so on. Finally, chapter 12 is headed System Design.

At the price of \$10.75 it really is a bargain. Our review copy came from Technical Book and Magazine Co Pty Ltd, Melbourne. (L.D.S.)

Super-80 programs

DICK SMITH'S FIRST BOOK OF SUPER-80 PROGRAMS. Compiled by L. Ramsay. Published 1982 by Dick Smith Electronics, Sydney. Soft covers, 207 x 293mm, 34 pages. ISBN 0 949772 08 9. Price \$4.95.

This book is a compilation of 16 Basic programs written or modified by owners of Super-80 computers. The listings are copies of printouts from various printers, from dot matrix to spinwriters, so the legibility is variable. The book represents a useful addition to the growing software base for the Super-80.



HOW TO PROGRAM AND INTERFACE THE 6800: Andrew C. Staugaard, Jr. Soft Covers, 414 pages, 137 x 216mm. Published by Howard W. Sams and Co Inc, ISBN 0 672 21684 1. \$21.50

Many books have been written about the Motorola 6800 Microprocessor, however, this book is one of the few which encourages "hands on" experience with either the Heath ET3400 or Motorola MEK6800 D2 Evaluation Kits.

There are nine chapters in all and four appendices. The first chapters discuss the fundamental microprocessor concepts, the evaluation kits and then begins with programming. The author leads the reader through the various types of addressing modes and all the instruction types available with the 6800. In each chapter the objectives are listed, experiments carried out with the evaluation kits and questions.

Apart from the programming considerations, hardware interfacing using the 6821 Peripheral Interface Adapter is discussed. Not only is the operation of the PIA dealt with in great detail, but examples of using the PIA to control a switch matrix and LED display are shown. A complete chapter is devoted to memory system for the processor.

The entire instruction set of the 6800 is given in the Appendix. This is the complete version and not abbreviated. Revision on logic gates and number systems is provided in further appendices. The final appendix gives a complete copy of data for the 6800, 6821 and some memories. Data is also given for some D-A and A-D converters.

The book can be used as a complete teaching aid for the beginner, when learning microprocessor systems and will also be useful as a reference for the experienced user of 6800 microprocessors.

Our review copy came from McGills Authorised Newsagency, 187 Elizabeth Street, Melbourne, Vic 3000. (JC).

TWICE THE FUN!

WITH
DICK SMITH

FUN WAY INTO ELECTRONICS

Vol 1 For the absolute beginner, this book is a must. 20 exciting projects - all built without the need to solder. The unique "breadboard" method of construction enables you to follow the circuit via the wires, and because every project is battery powered, they are perfectly safe! Learn electronics the FUN WAY! Cat. B-2600

Vol 2 We now have this superb book in stock again! Packed with 20 exciting projects to build (see Kit list below) this book provides fun AND education! From printed circuit boards to using a multimeter, it's all there - and it's fun. Cat. B-2605

\$4⁹⁵

\$6⁹⁵

POST AND PACKAGE
\$1 PER BOOK

TWICE THE VALUE!

BOOKS & KIT PACKS

FUN WAY VOL. 1 VALUE PACK

An easy to follow system of learning basic electronics. 20 exciting projects for you to build ranging from a beer powered radio to an electronic siren. Completely safe, no need to solder, suitable for all ages. Hours of fun building educational projects. Find out what electronics is all about - the easy way! Cat. K-2615

ONLY
\$17⁹⁵

FUN WAY VOL. 2 GIFT PACK WITH SOLDERING IRON

Fantastic savings! Over \$25 value! Everything you need to build an actual working project, including a hobbyist soldering iron and pack of solder, a 9 volt battery, a copy of Fun Way Vol. 2 and a Wireless Microphone Kit. The Fun Way Vol. 2 Gift Pack makes electronics fun, easy, and now, economical! Cat. K-2620

ALL FOR
\$19⁹⁵

FUN WAY TWO KITS: EASY, SAFE & ECONOMICAL!

MULTI-PURPOSE LED FLASHER \$2.95

A really simple kit that can be used as a warning device, electronic jewellery, etc. Cat. K-2621

DING DONG DOORBELL \$4.50

Welcome visitors to your home with this integrated circuit doorbell! Cat. K-2622

MORSE CODE TRAINER \$4.50

This simple oscillator circuit lets you learn Morse code the easy way! Cat. K-2623

UNIVERSAL TIMER \$5.50

Use it as an egg timer, a dark-room timer, etc. in fact, it's got a lot of applications! Cat. K-2624

ELECTRONIC DICE \$4.95

Throwing a dice is old hat, do it electronically! Simple circuit has other uses too. Cat. K-2625

MONOPHONIC ORGAN \$7.95

Easy to build, and easy to play! And it even has vibrato - just like the big ones! Cat. K-2626

POCKET TRANSISTOR RADIO \$7.95

Simple to build, and it's nice and small. Listening is so much more fun! Cat. K-2627

TOUCH SWITCH \$5.50

One touch on, next touch off - or 'on while touched'. Dozens of uses in the home. Cat. K-2628

MOSQUITO REPELLER \$4.95

Don't get eaten by mozzies, scare them away electronically. Take it anywhere. Cat. K-2629

SIMPLE AMPLIFIER \$6.50

A useful little amplifier for all those projects needing audio amplification. Cat. K-2630

WIRELESS MIC. \$6.50

A tiny transmitter that can be received on any FM receiver. A great little kit! Cat. K-2631

LIGHT ACTIVATED SWITCH \$5.50

Highly useful for alarms, night light switches, etc. Sensitive and reliable. Cat. K-2632

METAL/PIPE LOCATOR \$6.50

A simple BFO circuit you can use to find metals, pipes, wiring, etc. - maybe gold! Cat. K-2633

SOUND ACTIVATED SWITCH \$6.95

Picks up sound waves and mps a relay. Use as a telephone bell extender, too! Cat. K-2634

HOME/CAR BURGLAR ALARM \$6.50

Learn how burglar alarms work when you install your own! For home or car. Cat. K-2635

ELECTRONIC SIREN \$4.95

Great for alarm use - or where any warning is required. Good for kids toys, too! Cat. K-2636

LED LEVEL DISPLAY \$8.95

This fascinating project shows you the audio level of any amplifier. Cat. K-2637

INTERCOM UNIT \$8.95

Communicate! Build this intercom and talk between rooms, etc. Cat. K-2638

LED COUNTER MODULE \$7.95

Learn how digital circuits work by building a counter. Count slot car laps, etc. Cat. K-2639

SHORTWAVE RECEIVER \$6.95

Listen in to the exciting world of shortwave radio, amateurs, foreign countries! Cat. K-2640

SCHOOLS, RE-SELLERS, ETC.:
We'll negotiate a special price for bulk quantities on either books or kits, or both!

DICK SMITH ELECTRONICS



SEE PAGE 98 FOR ADDRESS DETAILS

DSE/A170M/JW

Discrete components — comprehensive text



DISCRETE ELECTRONIC COMPONENTS, BY F. F. Mazda. Cambridge University Press 1981. Hard covers, 262 x 182mm, 177 pages, illustrated with many diagrams. ISBN 0 521 23470 0. Price UK £18.

In these times of galloping progress in LSI technology, a book on discrete components is rare indeed and most useful. This text covers the whole gamut of discrete components from active semiconductor devices such as transistors and thyristors, optoelectronic devices, passive linear components such as resistors and capacitors, magnetic components and even batteries.

In a slim text of only 177 pages one cannot expect detailed coverage of all the components featured but the author is to be commended in the succinct coverage given. In each component type covered, the principles of operation and range of parameters is given but few details of manufacture are described.

Chapter headings are as follows: Discrete Semiconductors, Optoelectronic components, Resistors, Capacitors, Magnetic Components (includes relays and Hall effect devices), Peripheral components (switches and keyboard, fuses, heatsinks and connectors), Quartz, Ceramic, Glass & Selenium, Power Sources (includes fuel cells and solar cells).

In short, a good reference for any engineer's bookshelf. Our review copy came direct from the publisher. (L.D.S.)

New Zealand callsigns

NZART CALL BOOK '82. Published 1982 by the New Zealand Association of Radio Transmitters, Inc. Soft covers, 184 pages, 185 x 245mm.

As well as New Zealand amateur radio callsigns, this book includes information on marine radio services, radio and TV services and a 76-page catalog insert from Tricity House, Christchurch. Our copy came direct from the NZART.

Data manuals on Japanese semiconductors

Data Manuals with information on Japanese semiconductor devices have never been readily available. However, a range of manuals is now available from Imark Pty Ltd, 167 Roden Street, West Melbourne, 3003. Brief details of the various 1982 manuals are as follows:

"The Transistor Manual" lists all 2SA, 2SB, 2SC and 2SD devices including maximum characteristics, typical characteristics, typical uses, package configuration, and complementary device if applicable. (319 pages)

"The Transistor Substitution Manual" lists equivalent Japanese transistors by Makers for 2SA, 2SB, 2SC and 2SD transistors. Whether the transistor is discontinued, principally for renewal purposes only, available only by custom order, or if the manufacture is suspended is explained. (238 pages)

"The Diode Manual" provides specifications and package details for Japanese diodes. (439 pages)

"The FET Manual" details specifications and package details for Japanese FETs (2SK, 3SK and others). Performance charts and typical circuit configurations are often provided. (302 pages)

"The OP Amp Manual" (Parts 1 and 2) provides detailed specifications and package information for (Part 1) Analog Devices, Ancom, Burr Brown, Intech, Function Modules, Teledyne Philbrick, Zeltex, Hitachi, Matsushita, Mitsubishi, NEC, JRC, CR Box, Toshiba; (Part 2) Advanced Micro Devices, Analog Systems, Fairchild, Harris Semiconductor, Intersil, Motorola, National Semiconductor, Philips, Precision Monolithics, Raytheon, RCS, SGS Ates, Siemens, Signetics,

Siliconix and Texas Instrument devices. (Part 1 — 303 pages, Part 2 — 399 pages)

"The Linear IC Manual" provides technical specifications, and package details of Japanese manufactured Linear Integrated Circuits. Typical or suggested circuit designs are usually included with the details for each particular IC (359 pages).

"The TTL IC Manual" provides technical specifications, package details, and lists world-wide manufacturers of the particular device. The manual includes details for 7400 series/74SL series/74S series. (332 pages).

"The C-Mos IC Manual" provides technical specifications, package details, world-wide manufacturers for 4000B series, 4500 series, TC5000BP series, TC5000P series, MSM500 series, and TC40H000P series devices. Truth and timing tables are often included. (367 pages)

"The Memory IC Manual" provides technical and package details, has tables of similar devices with their particular specifications and lists most major world-wide manufacturers devices including Japanese devices. Devices covered include Static RAMs, Clocked RAMs, Dynamic RAMs, UV-EPRoMs, and EARoMs. (405 pages)

While each individual manual would provide a wealth of information for technicians, engineers, etc the complete set would provide an almost complete library of information on Japanese Semiconductor devices.

Each manual is priced at \$9.95 (plus \$1.50 post/pack) and the complete set of 10 manuals is \$89.50 (plus \$5.00 post/pack).

Teach yourself microcomputer programming

PASCAL PROGRAMMING FOR THE APPLE by T. G. Lewis. Published 1981 by Reston Publishing Co, Virginia, USA. Soft covers, 234 pages, 152 x 228mm. Illustrated with programming examples. ISBN 0 8359 5454 4. Price \$13.50.

Our copy came from McGills Newsagency, Melbourne.

TRS-80 COLOR BASIC by Bob Albrecht. Published 1982 by John Wiley & Sons, Inc, New York. Soft covers, 378 pages, 172 x 253mm. Illustrated with program exercises. ISBN 0 471 09644 X. Price \$13.95.

This book is written in the same light-hearted vein as the TRS-80 Color Computer manuals. It is easy to read and should be useful to TRS-80 owners. Our copy came from McGills Authorised Newsagency.

ASSEMBLY LANGUAGE PROGRAMMING FOR THE APPLE II by Robert Mottola. Published 1982 by Osborne/McGraw-Hill California, USA. Soft covers, 143 pages, 165 x 235mm. ISBN 0 931988 51 9 Price \$18.15.

This book assumes that the reader has access to one of the assemblers sold for the Apple II, and a 48K Apple II with a disk drive and a printer, Applesoft in ROM or the Language Card.

Starting with a brief introduction to hexadecimal, the book covers the entry and editing of code, use of an assembler and elementary 6502 programming. Relocatable code and addressing modes are covered briefly, and there are separate chapters on debugging and use of the stack.

Our review copy came from McGills Authorised Newsagency, 187-193 Elizabeth St, Melbourne.

DID EARLY AUSTRALIAN MAN COME FROM CHINA?

New evidence links ancient Australia with China – it's a mystery story that raises many controversial questions.

READ ABOUT IT IN



OMEGA

On sale at your newsagent.

Tomorrow's magazine today



THE BEST KIND OF JOB I

Job satisfaction means fitting the right man to the right job. It's obvious really. If you like doing it, you're likely to do it better.

If you'd enjoy working with electrical equipment, or radio equipment, jet or marine engines and you meet the entry requirements, it's very likely there's a good job waiting for you in the Navy.

The Navy has a long history of discovering great talent in young people. So if you know you've got a lot to offer, but you're not quite sure what it is, a good chat with a Navy Careers Counsellor is just what you need. You may both uncover a great new talent, and that would be something to be proud of. Pick up a phone now, or send the coupon.





IT'S THE JOB YOU DO BEST.

N.S.W.: Sydney 212 1011, Parramatta 635 1511, Newcastle 2 5476, Wollongong 28 6492.
 VIC: Melbourne 613731, Geelong 21 1588. QLD: Brisbane 226 2626, Townsville
 724566. S.A.: Adelaide 212 1455. W.A.: Perth 325 6222. TAS: Hobart 34 7077,
 Launceston 31 1055. A.C.T.: Canberra 82 2333.

To: Navy Careers Counsellor, G.P.O. Box XYZ...(your Capital City and Postcode)
 Please send me more information about joining the Navy.

Name _____ Date of Birth _____

Address _____ P/Code _____

General Entry (17-26) on entry. Junior Recruits (15³/₄-16¹/₂) on entry.

Apprentices (15-17¹/₂) on entry. Tick the information box that interests you.

NAVY

THE PRIDE OF THE FLEET IS YOU.

AC or dc voltage displayed in dBm referenced to 600 ohms, or relative dB.

Measures frequencies from 12Hz to 200kHz, fully auto-ranging, with 1-second response time and 0.01 Hz resolution to 200Hz.

Selectable visual (⇄) and audible ())) indicators for high-speed continuity checking. 50µS response time.

Relative reference (offset) feature works with all functions — including frequency and dB—to indicate ± deviations from stored inputs.

NEW FLUKE HANDHELD DMM COMBINES 0.04% ACCURACY, 10µV RESOLUTION, TRUE RMS AC, DIRECT dB and FREQUENCY

CHECK THE COMPLETE FLUKE 8020B SERIES OF DMMS

8060A

This remarkable state of the art DMM combines the accuracy and resolution of larger, more expensive instruments with the convenience of a hand-held instrument. Flukes own LSI/microcomputer design provides:

- Wideband true RMS AC measurements to 100kHz
- Frequency measurement to 200kHz
- dBm and relative dB
- 10µV sensitivity
- Direct resistance measurement to 300Meg
- Relative reference on any range or function
- Microcomputer-based self diagnostics

8062A

Provides continuity and relative reference functions as 8060A also true rms to 30kHz.

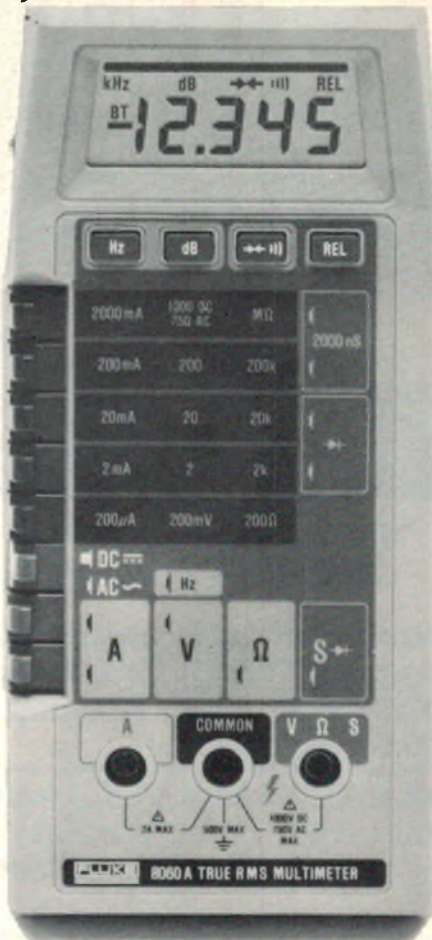

8020B

- 0.1% basic accuracy. 3½ digit
- Improved version of the most popular DMM ever made!
- Eight functions including conductance and diode test
- Now with high speed beeper

8021B & 8022B

- 0.25% Accuracy. 3½ digits
- Extensive overload protection
- AC and DC Voltage and Current. Resistance and Diode Test
- High Speed audible continuity beeper (8021B Only)
- 8022B is Fluke's lowest price DMM

8024B

- 11 functions including temperature with K-type thermocouples
- Peak hold on voltage and current ranges
- Logic detection and continuity
- Audible and visible indicators
- 0.1% basic accuracy. 3½ digit

Selection Guide

	DC Voltage	AC Voltage	DC Current	AC Current	Resistance	Diode Test	Conductance	Continuity	Logic Level	Temperature	Peak Hold	DC Accuracy	
8022B	•	•	•	•	•	•	•	•	•	•	•	0.25%	\$173
8021B	•	•	•	•	•	•	•	•	•	•	•	0.25%	\$185
8020B	•	•	•	•	•	•	•	•	•	•	•	0.1%	\$234
8024B	•	•	•	•	•	•	•	•	•	•	•	0.1%	\$296



All prices are plus sales tax if applicable and subject to change without notice

MAIL COUPON FOR FREE GUIDE

Please send me details of Fluke DMMs
 8060/62 & 8050 8020B Series

NAME

ADDRESS

..... P'CODE

TELEPHONE

	4½-Digit Resolution	Wideband True RMS AC	Continuity (Audible & Visual)	dBm, Relative dB	Frequency	Relative Reference (Offset)	Autorangeing Microohms	Conductance	Self-Diagnostics	Basic DC Accuracy		
8060A	•	•	•	•	•	•	•	•	•	•	0.04%	\$432
8062A	•	•	•	•	•	•	•	•	•	•	0.05%	\$346

8050A

A bench portable providing 4½ digits with a basic accuracy of 0.03%. True rms measurements to 50kHz. 108dB range and 16 selectable reference impedances from 8 to 1200ohm.

\$457



ELMEASCO

Instruments Pty. Ltd.

P.O. Box 30, Concord
 N.S.W. 2137
 13-15 McDonald Street,
 Mortlake, N.S.W.
 Telephone (02) 736 2888
 Telex 25887

P.O. Box 107, Mt. Waverley
 Victoria 3149
 21-23 Anthony Drive,
 Mt. Waverley, Victoria
 Telephone (03) 233 4044
 Telex 36206

Adelaide: (08) 271 1839
 Brisbane: (07) 369 8688
 Perth: (09) 398 3362

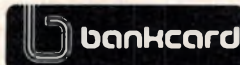

N.S.W. George Brown 519 5855 • DGE Systems (049) 69 1625 • Radio Despatch 211 0191 • Vimcom (042) 28 4400
 VICTORIA Radio Parts 329 7888 • Browntronics 419 3986 • G.B. Telespars 328 4301 • Elanco 428 4345 • Ellitronics
 602 3282 QUEENSLAND L.E. Boughen 36 1277 • Colourview Wholesale 275 3188 • Audiotronics 44 7566 • Electronic
 Shop (075) 32 3632 • Nortek (077) 79 8600 • W.G. Watson (079) 27 1099 S.A. Protronics 212 3111 • Trio Electrix 51 6718
 W.A. Atkins Carlyle 321 0101 • Hincro Eng 381 4477 • Brookeades 276 8888 • Protronics 362 1044 A.C.T. Actec
 (062) 80 6576 N.T. Thew & McCann (089) 84 4999 T.A.S. G.H.E. Electronics 31 6533 & 34 2233

New Products...

Product reviews, releases & services

Quiet printer connects to telephone lines

Teleprinters are not widely used for communication, although the basic design has not changed for many years. They can be slow, noisy and difficult to use. 3M Australia, however, has recently introduced a new design which overcomes these problems.



3M Australia has introduced a desktop teleprinter which will "revolutionise office communications and encourage executives to use a keyboard and a computer", according to the company.

3M's "Whisperwriter" teleprinter has a 4000 character memory and can communicate at 300 baud with computers, word processors, and other teleprinter units over the public telephone lines. It uses a quiet thermal printer with a built-in modem, coupled to a keyboard unit which can store and forward send messages.

According to Mr David Judge, 3M National Sales and Marketing Manager for Business Communications, the "Whisperwriter" will accelerate the trend to a paperless office, and overcome the reluctance of executives to use a computer.

"About 70% of middle/upper management are aged 40 years or more and have never used a typewriter and fear the computer. Because the 'Whisperwriter' has a full editing facility, a message can be prepared and corrected

before sending. Executives themselves will become used to working with computers instead of leaving the task of obtaining information to the computer operators."

The Whisperwriter is available in a receive-only version, without keyboard, or as a transmit/receive unit. An external acoustic coupler is also available for use where direct connection to the telephone lines is not feasible.

For further information contact 3M Australia, PO Box 99, Pymble, NSW, 2073. Phone (02) 498 0033.

Dual concentric attenuators

Vicom International, Australian representatives of JFW Industries of the United States have announced the release of two models of dual concentric attenuators, the 50DR-003 and 75DR-003.

Available with either 50 or 75 ohm impedance, the attenuators cover a frequency range of DC-1000MHz and an attenuation range of 0-50dB in 1dB steps. Accuracy is said to be better than 0.5dB up to 500MHz and power rating is 1W average or up to 1000W peak. Units are available with BNC, TNC, N, SMA and F type connectors.

For detailed information contact Vicom Australia International Pty Ltd PO Box 366, South Melbourne, Vic 3205, or branches in NSW Phone (02) 436 2766 and New Zealand 697 625.

Measuring and control by Elmeasco

Elmeasco Instruments now has available a new 4½-digit panel meter display, the Datel Intersil DM4104, that accepts either parallel or multiplexed BCD data. The data are displayed on 7.6mm high LED seven segment displays.

The BCD (Binary Coded Decimal) data is latched on board the panel meter, and inputs can be taken directly from four, eight, 12 and 16 bit parallel data buses. A display blanking pin is also provided so that the display can be made to flash, to indicate an alarm condition, for example.

Also from Elmeasco is a new multi-function analog-to-digital and digital-to-analog convertor board for the Motorola Exorciser bus systems and Rockwell's System 65.

The SineTrac ST-6832 board interfaces both analog input and output signals to the computer system, and plugs into any slot in Exorciser bus systems. The board accepts up to 32 single-ended analog input channels or 16 differential inputs. Particular analog inputs are selected and digitised under program control. Two D/A channels can also be provided.

Analog input ranges can be selected by installing wire links on the board. Ranges available are 0 to +5V, 0 to +10V, ±5V and ±10V, and the board can also use 4-20mA current loop signals. A/D conversion time is eight microseconds.

A new Basic software package for the Fluke 1720A instrument controller is also available from Elmeasco Instruments. The new software updates existing controllers, providing features such as increased floppy disk storage capacity (up

New Products

from 175K to 200K bytes), a Help file, and lower case command inputs.

The Basic also provides easier setting up of RS-232C and IEEE-488 interface ports and enhanced interrupt handling. Several new software packages are in Fortran are also available. Users of the 1720A instrument controllers should contact their nearest Elmeasco office for details.

For further information on any of these products contact the Elmeasco Instruments office in your state, or the head office, PO Box 30 Concord, NSW 2137. Phone (02) 736 2888.

New range of Motorola optocouplers

Motorola has introduced a range of slotted optocoupler/interrupter devices that are drop-in replacements for the popular GEH21 and H22 series. These devices consist of a gallium arsenide infrared emitting diode facing a silicon NPN phototransistor, encapsulated in a moulded plastic housing. A slot in the housing between the emitter and the detector provides a means of interrupting the optically coupled signal by means of an externally introduced opaque material such as a card, tape, or disk.

The slotted optocouplers are widely used in video games, copy machines, keyboards, card readers, garage door openers, tape drives and floppy and hard disk drives. Other applications include position and motion indicators, digital pressure sensors, scales, industrial machine controls, limit switches, etc.

While the standard slotted optocoupler package being introduced is equivalent to the GE package, Motorola's custom moulding capability allows encapsulation of the various optocoupler components in a wide variety of customer configurations.

The newly-introduced slotted couplers are the first of a large projected family of standard units, and use the new MLED71 IRED and MRD701 phototransistor detector. The family will include devices using PIN diodes, Darlington and resistor-Darlington detectors, to be followed by more complex output functions.

The MLED71 infrared-emitting diode is manufactured with gallium arsenide. It provides a continuous power output of 2.5mW, at a forward current of 50mA. The pair of devices provides a transistor output of approximately 10mA for a diode current of 50mA, with a separation of 4.0mm.

Accessories for HP calculators



Hewlett-Packard has added three new peripheral products to its range of Hewlett-Packard Interface Loop (HP-IL) systems, used with HP calculators, computers and test instruments.

Included in the new release is the 82905B printer, an 80 character-per second dot matrix unit which can produce high quality text and dot graphics. The printer can be used with HP scientific calculators such as the HP-41 and the Series 80 personal computers equipped with interface loop capabilities.

Also available is the 82163B Video Interface which plugs into a television set or video monitor and adds video display capability to HP-IL systems.

Display format is 16 lines of 32 characters each. The video display interface can be used with the HP-41 calculator, for class-room demonstrations and business presentations.

The HP 82165A general purpose input/output interface (GPIO) links devices with parallel ports to the HP-IL system. The GPIO is said to be particularly suited for connecting low-cost portable systems to mainframe computers that have parallel ports. A HP-41 can be used, for example, as a portable data entry terminal, linked to a large computer.

Further information on these and other new HP products is available from Hewlett-Packard Australia Ltd, 31-41 Joseph St, Blackburn, Vic 3130. Phone (03) 89 6351.

Antenna designs and equipment

A new series of active high frequency multicouplers (antenna combiners) has been released by Antenna Engineering Australia Pty Ltd. The RMC series can be supplied in a variety of configurations offering either one antenna input with up to 16 outputs or two antenna inputs each with up to eight outlets, allowing several receivers to use the same antenna.

An in-built broadband amplifier covers from 0.3MHz to 30MHz and an optional highpass filter is available to give 30dB attenuation below 1.6MHz of nearby medium frequency broadcasting stations.

Also from Antenna Engineering is the Model 4131 "Sloping Triangle" antenna, a broadband directional antenna design-

ed for long range transmission or reception. The antenna is made up of two sloping wires 80 metres long in a "V" shape with the apex supported by a 15 metre mast and the wires resistively terminated at the centre of the base of the triangle, near ground level.

The antenna is fed via a balun transformer at the mast head.

Frequency range of the antenna is 5-30MHz without adjustment. The signal is horizontally polarised, and power gain varies from 0 at 4MHz to 10dBi (dB isotropic) at 22MHz.

For more information on the RMC antenna coupler or the new antenna design contact Antenna Engineering Australia Pty Ltd, PO Box 191, Croydon, Vic 3136.

**DICK'S DIRECT
IMPORT PRICES**

SAVE ON 40CH



40Ch AM STALKER VIII

Don't take chances in buying CB radio buy your CB from Dick Smith, Australia's CB expert! The superb Stalker VIII CB features the new legal 40 channels, complete with microphone and mounting bracket. Large LED channel readout, easy to use and has maximum legal output.

FANTASTIC VALUE!

DOC Approval No
249A001

Cat. D-1447

~~\$149.00~~

**NOW
ONLY
\$109**

Cat. D-1710

40Ch AM/SSB UNDER \$250! That's the DICK SMITH HORNET II

This unit is the latest in 40 channel CB technology. With the massive 12 watts p e p output on SSB, this set meets the high DOC standard RB249A. Frequency range is 26.965MHz to 27.405MHz and accessories include DC power cable with built-in fuse and microphone clip.

\$239⁵⁰

DOC Approval No
249A006

TOP VALUE HAND HELD

Cat. D-1102

For the weekend boatmen who don't want the more expensive full power transceivers, but who still need that reassurance of having a safety transceiver on board. Three channels available, one fitted with 27.620MHz, the others left blank for your own choices. Crystals are reasonably priced and easy to fit. This set takes 8 'AA' pencil batteries.

GREAT VALUE!

ONLY \$55⁰⁰



**FULL
RANGE OF
ACCESSORIES
AT LOW
DICK SMITH
PRICES!**

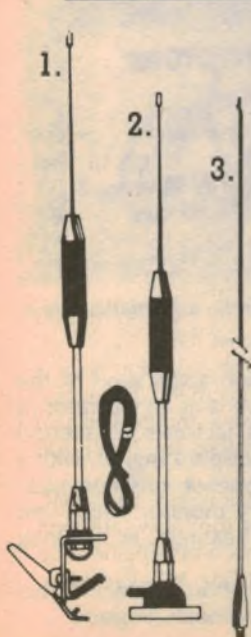

1. **27MHz Gutter Grip**
Simply clips onto the rain gutter of any vehicle. Features no hole installation and can be installed or removed without tools. Antenna has centre loading coil and ample coax is supplied.
Cat. D-4411 **\$25⁰⁰**
2. **27MHz Magnet Base**
Centre loaded stainless steel construction with heavy magnetic base. 16 feet of coax supplied, complete with PL259 plug. Ideal for 'instant' mobile use.
Cat. D-4412 **\$25⁰⁰**
3. **1/4 Wave Whips**
Your choice of stainless steel or fibreglass. Each is approx. 2.75m long, ideal for marine or CB use.
Cat. D-4415 **\$17⁹⁵**
Cat. D-4416 **\$22⁵⁰**
4. **'Rubber Duck'**
Indestructible and very flexible, perfect for handheld sets. Only 300mm long, great replacement antenna!
Cat. D-4629 **\$9⁹⁵**

DICK SMITH Electronics

See our Address Page
for address details

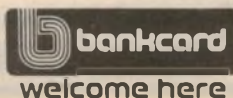

Terms available to
approved applicants
through...



DSE/A234M/JW

New Products

Equipment for electronic assembly

The CM-1 "Cable Master", from The Eraser Company Inc, strips insulation from solid or stranded conductors with outside diameters from 10mm to 32mm. It uses a rotating blade driven by a chain from an electric motor, and can be adjusted according to thickness of the insulation.

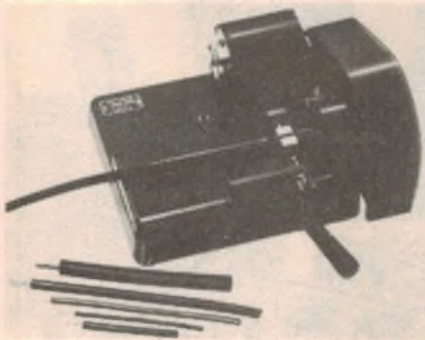

Wireguides are used to accommodate different cable sizes, and each unit is provided with one set of wireguide bushings, made to customer specifications.

The unit measures 56cm x 56cm x 23cm, and is available for use with 110VAC or 220VAC supplies.

The Eraser Company has also published a new 24-page catalogue covering their range of wire preparation and printed circuit board assembly equipment and tools. The catalogue includes

details of tools and machines for cleaning component leads, pre-forming of components for automated assembly, IC insertion and PCB assembly.

For further information or a free copy of the catalogue contact The Eraser Company, PO Box 4961, Oliva Drive, Syracuse, New York, 13221.

New range of sealed trimpots

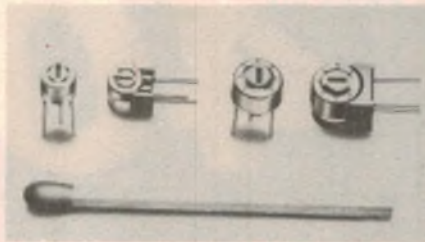

Copal Electronics Co Ltd has announced a new range of single turn sealed cermet trimpots, the RJ series. Features of the new range include small mounting space (60% of that of conventional trimmers), a wide resistance range from 10Ω to 2MΩ, setting stability of 1% against a shock of 100G, and half watt power rating.

Copal products are distributed in Australia by Mayer Krieg & Co, who also distribute a wide range of quality electrical and electronic components from manufacturers such as OKW, Preh and Hirschmann, to mention a few.

Head office is in Adelaide and the postal address is GPO Box 1803, Adelaide, SA, (08) 223 6766. In Melbourne ring (03) 579 5722 and in Sydney (02) 684 1900.

Computer program for amateur radio logs

Dick Smith Electronics has released a computer program designed for maintaining amateur radio log books. Written for the System-80 and TRS-80 Model I, Level II computers, the disk-based program provides for up to 500 individual log book entries.

Search facilities allow for entries to be retrieved by their stored sequence number or by the call sign entered. A series of reports can be produced on a printer attached to the system including detailed log listings by sequence numbers, call sign or call area.

The program diskette is supplied with a users manual, and is available from all Dick Smith stores and dealers, at \$39.50.

From England; an automatic noise alarm

A British company, Cirrus Research Ltd, has announced an automatic noise alarm, the CRI 3.01. The self-contained noise alarm is a conventional illuminated sign with a built-in precision sound level meter, a comparator, and an electric switch.

When the sound level exceeds a preset limit the comparator will trigger the switch and illuminate the high noise level warning legend.

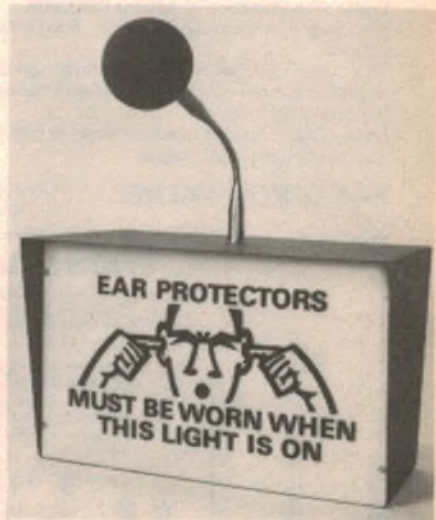

The Cirrus Research automatic noise alarm.

The most common application of the noise warning alarm is as an indicator of excessive noise in factories. A second use is in product noise testing, or, with a sensitive microphone or vibration pickup, as a machinery monitor which can warn of failing bearings in rotating equipment.

For more information contact Cirrus Research Ltd, Scarborough, England.

Create clean, fresh, Country Air with the **LIVING AIR** Negative Ion Generator

A "Living Air" ion generator restores balance to the very gases that we breathe, by putting back into the air negative ions that have been polluted away by dense city living.

SIZE: 130mm x 125mm x 38mm

\$71.50 Generator
\$16.50 Base

EA 1647

Please send me . . . Living Air Generators at \$71.50ea . . . Optional base \$16.50ea. These prices are inclusive of all charges. **CLIFT ELECTRONICS PTY. LTD.** P.O. Box 33, 11 Morinda Street, Ringwood East, Victoria 3135. Phone 870 0684

Mr/Mrs/Miss
Address
Postcode or, I prefer to pay by bankcard the sum of \$
Signature 496

EXPERIMENTER KIT

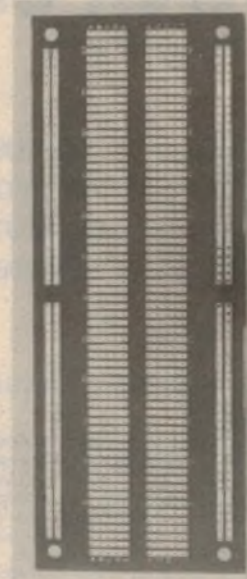
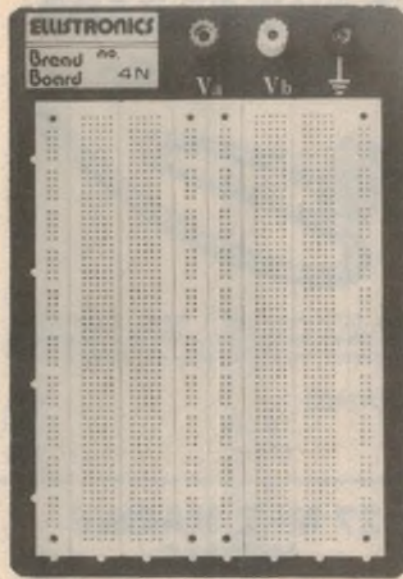
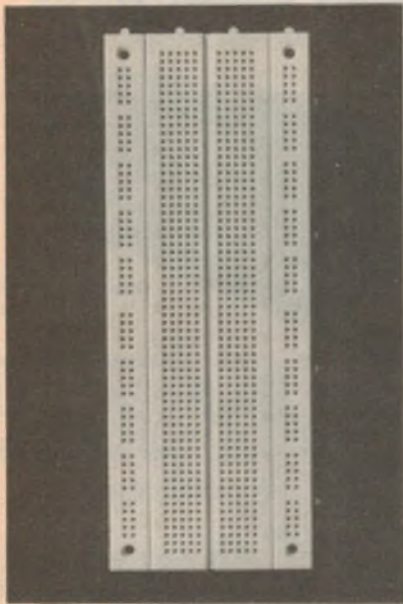

SPECIAL PRICE IN CONJUNCTION WITH ELECTRONICS AUSTRALIA
COMPETITION — \$11.75

ELLISTRONICS

SOLDERLESS BREADBOARD

Designed around two interlocking modular units, the WBDN is a distribution strip for power etc. and contains 100 contacts grouped in clusters of five. The WBTN is the terminal strip containing 640 contacts in two separate rows of five intercon-

nected contacts each separated by a .300" median. Contacts are made from non-corrosive nickel silver alloy and are reliable for more than 10,000 insertions. The boards accept all DIP size including RTL, TTL, DTL, CMOS and most passive

devices and interconnect with 20 to 29 awg solid wire. All boards are interlocking and elements are mounted on ground plane. Ideal for H.F., High Speed, Low Noise application

		RETAIL PRICE
WBDN	Distribution Strip	\$1.80
WBTN	Terminal Strip	6.80
WB2N1	1 Distribution + 1 Terminal Strip	8.35
WB2N	2 Distribution + 1 Terminal Strip	10.30
WB2NB*	2 Distribution + 1 Terminal Strip	14.50
WB4N3*	1 Distribution + 2 Terminal Strips	17.00
WB4N1*	3 Distribution + 2 Terminal Strips	20.50
WB4N*	4 Distribution + 2 Terminal Strips	23.00
WB6N*	5 Distribution + 3 Terminal Strips	31.50
WB8N*	7 Distribution + 4 Terminal Strips	44.50
WB16N*	10 Distribution + 8 Terminal Strips	83.50
WB24N*	20 Distribution + 12 Terminal Strips	126.50
Experimenter Board	A drilled and etched circuit board to match WB2N	1.60

*WB2NB thru to WB24N are mounted on an aluminium base plate complete with non scratch rubber feet and appropriate binding posts.

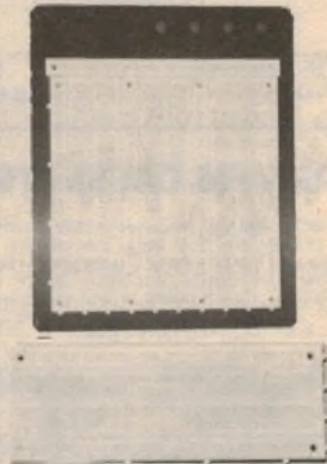

Available from: **VICTORIA:** Rod Irving (03) 489 7099 Kalex (03) 458 2976 Truscott Electronics (03) 723 3860 Billco (Project Electronics) (03) 791 8655 Ballarat Electronic Services (053) 359 584 **SOUTH AUSTRALIA:** Electronic Equipment (08) 212 5999 **WESTERN AUSTRALIA:** Altronics (09) 328 1599 Atkins Carlye (09) 277 0511 **NEW SOUTH WALES:** Electronic Developments (02) 438 2500 Jaycar (02) 264 6688 Bill Edge (02) 745 3077

ALL PRICES PLUS 20% SALES TAX

New Products

Hands free pocket-size transceiver

Imark Pty Ltd has released a pocket-size FM transceiver for the 55MHz band. The transceiver is designed for "hands free" operation, with an integrated headset containing the microphone and antenna, and a voice operated transmit switch.

The transceiver switches to the transmit mode when the operator speaks into the microphone and automatically reverts to receive when the operator stops speaking.

Called the "Talkmate", the transceiver incorporates a switched volume control, an automatic squelch control, and an antenna filter. A vinyl carry case is provided while nicad batteries and a 240V adapter are optionally available.

Further details are available from the importers, Imark Pty Ltd, 167 Roden St, West Melbourne, 3003. Phone (03) 329 5433.

Dispenser pack for desoldering braid

A new dispenser pack for desoldering braid which helps to avoid burnt fingertips and lets surplus braid be rewound easily has been released by Scope Laboratories of Melbourne, under the name "Scope Solder Blotter". In addition to these advantages the new dispenser is said to hold 30% more braid than conventional packages.

The metal tipped dispenser avoids the need to hold the flexible braid close to the working area and hot soldering iron. Both 3mm and 2mm widths of braid are available, in two metre lengths.

For further information contact Scope Laboratories, 3 Walton St, Airport West, Vic 3042.



Obviously, an idea whose time has come - not only does this pack hold more desoldering braid; it also dispenses it conveniently.

Low cost thermostat switches

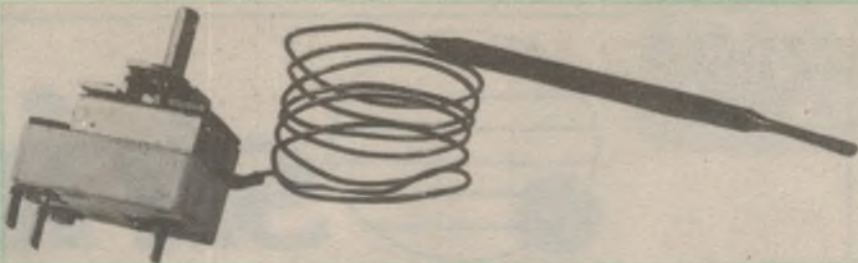

Homelec Products Pty Ltd now has available a range of low-cost thermostats from Italian company CAEM. Four varieties are available, with adjustable set points in the ranges of 4-40°C, 30-110°C, 90-220°C and 50-300°C.

The units consist of a sealed sensor unit connected by copper tubing to the switch unit. Gas inside the sensor expands when heated, operating the thermostat switch at a pre-set level.

We tested a sample of the Homelec stock and found the thermostats to be quite accurate and positive in action.

Homelec thermostats are suitable for heating and air conditioning applications, cooking and laundry equipment, either installed in new appliances or as a replacement for existing controls.

Hobbyists will be interested to know that there is no minimum order quantity from Homelec. Recommended retail price is \$8.66 including sales tax, with a knob and chrome bezel and extra \$1.50.

For more information contact Homelec Products Pty Ltd, PO Box 1073 Victoria Rd, West Ryde, NSW 2114. Phone (02) 85 2922.

Solid-state audible alarms from C&K

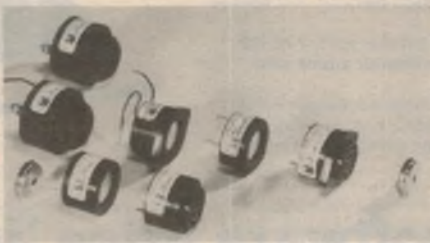

C&K of Australia can supply a comprehensive range of audible alarms and indicators manufactured by Floyd Bell Associates of the United States. The devices are available in a number of mounting styles, with audio outputs ranging from continuous tones, beeps and warbles to the special-purpose high volume "Screamer".

Sound output is said to be typically 95dB (A), or 106dB (A) for the "Screamer". Operating voltages range from 5V to 35V with 110VAC and 250VAC types also available. Current consumption is from 6mA to 13mA depending on the model and operating voltage.

The audible alarms are entirely solid-state and are claimed to be completely unaffected by extremes of humidity and vibration or salt spray.

In addition to panel mounting types two varieties of piezoelectric sound transducers adapted for printed circuit board mounting are also available.

For further information contact C&K Electronics (Australia) Pty Ltd, PO Box 229, Parramatta, NSW 2150. Phone (02) 635 0799.

IRH Components has ceramic resonators

IRH Components now has available a selected range of Murata ceramic resonators, designed as a replacement of crystals in microprocessor circuits, television and radio receivers, tone diallers, and remote control circuits. Stability is between that of crystals and RC tank circuits.

Ceramic resonators can offer advantages of size and cost saving over equivalent crystal circuits.

For information on the availability of Murata ceramic resonators contact IRH Components, PO Box 265, Kingsgrove, NSW 2208.

Arlec transformer for door chimes

Arlec Pty Ltd has introduced a multi-voltage transformer specifically designed to supply power to door bells and chimes from 240V mains.

The Arlec Bell and Chime transformer, type 60999 has a current rating of 1A and a choice of 5, 8, 12 or 16V outputs.

The transformer is totally enclosed in a flame retardant case with mains inputs protected from inadvertent contact. An in-built thermal cut-out switch protects the transformer from being damaged if a fault develops in the door chime wiring, etc.

For more information contact Arlec Pty Ltd, PO Box 170, Box Hill, Vic. 3128. Phone (03) 840 1222.

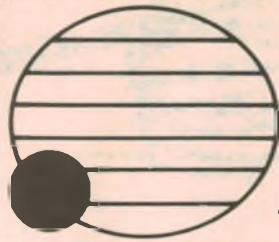

Sirius 1

A third generation computer, from the designer of the 6502 Processor.

\$4950 + TAX



TECHNICAL SPECIFICATIONS:

- CPU:** 8088, 5 MHz
- Memory:** 128k (64k dynamic RAM chips) internally expandable to 512 kbytes; external module to expand to 1 Mbyte
- Keyboard:** 95 keys inc. 7 prog. function keys, numeric pad, cursor control, editing, screen & loudspeaker control, all software re-definable.
- Screen:** 80 char x 25 lines; hi-res graphics, 800 x 400 bit-mapped, user-definable character sets.
- Disk drives:** 2 x 5 1/4in single-sided, high density, 600 kbytes per unit.
- Ports:** 1 Centronics/IEEE-488 printer port, 1 RS232 printer port, 1 RS232 communications port.
- System Software Languages:** CP/M-86 and MSDOS
Basic 86; Graphics & character set packages. Assembler, Fortran, Cobol, Pascal, PL-1, Extended business basic compiler, various applications software.

software price list

The Sirius comes complete with CP/MI-86, MS-DOS & M Basic

CBASIC (Digital Research)	\$440	SELECT (Select)	\$550
Report Manager (Image)	\$330	SuperCalc (Sorcim)	\$330
Time Manager (Image) (a)	\$225	Pascal/M (Sorcim)	\$550
Personnel Manager (Image) (a)	\$225	Basic Interpreter (Microsoft)	\$440
Project Manager (Image) (a)	\$225	Basic Compiler Diskette	\$550
Level II COBOL with Forms 2 (Microfocus)	\$1125	COBOL (Microsoft)	\$880
WordStar (MicroPro)	\$550	Multiplan (Microsoft)	\$330
WordStar with MailMerge (MicroPro)	\$775	Pascal (Microsoft)	\$660
WordStar with SpellStar (MicroPro)	\$880	Fortran (Microsoft)	\$550
WordStar with MailMerge and SpellStar (MicroPro)	\$1125	Real Estate Package (Sample printout available)	\$1500
SuperSort (MicroPro)	\$280	Medical Package (Sample printout available)	\$1500
WordMaster (MicroPro)	\$175	Debtors & Creditors	\$1500
		Stock Control Package	\$2000

RITRONICS WHOLESALE

425 HIGH STREET, NORTHCOTE 3070. MELBOURNE. (03) 489-8131.

TO ORDER: Heavy items sent Comet Freight on Mail Order Phone 481-1436. Wholesale Customers Phone: 489-7099. Mail Orders to RITRONICS WHOLESALE, P.O. Box 235, Northcote 3070. Minimum P&P \$2. Add extra for heavy items, registration and certified mail. Prices and specifications subject to change without notice.

Turn to Page 56 for some great new Printers



Shortwave Scene

by Arthur Cushen, MBE



Voice of America to challenge Radio Moscow

A recent announcement by the United States Government indicates that President Reagan has plans to upgrade the Voice of America to meet Radio Moscow influence world wide, and will spend up to \$US300 million on new sites and refurbishing present transmitters.

Approval is currently awaited for the establishment of a completely new relay base near Puttalam, Sri Lanka. Plans include the installation of four 500kW transmitters to increase coverage of the USSR and China and antenna systems to enable the area from East Africa to the Philippines to be covered. Work is continuing on the installation of two additional 250kW transmitters at the Tinang relay station in the Philippines, and four more 250kW transmitters were installed for the VOA by the BBC at its Woofferton station in Britain. Plans are under way for four shortwave transmitters in Botswana to increase the output from the present medium-wave transmitter.

The Voice of America is also requesting \$11 million to build medium-wave relay stations on Grand Cayman, Grand Turk and a permanent station in Antigua, for coverage of the Caribbean. Further expansion includes 10 500kW and three 250kW transmitters for the relay base at Tangier, Morocco while the Munich relay base in West Germany would get a further eight 500kW transmitters. President Reagan has also recently authorised the Voice of America to operate on some out of band frequencies in order to overcome interference with the broadcasts.

The Voice of America operates 24 hours each day in English with the service to the South Pacific at 2200-2400UTC on 17740 and 26000kHz, and from 1100UTC onwards on 9565, 15160 and 15425kHz.

NEW FREQUENCIES

INDIA: A new transmitting station has been heard on 5050kHz with the opening of AIR Aizawal which operates from 1130-1630UTC, according to "Down Under DX Survey".

The new transmitter site is near the

Burmese border and all broadcasts are in the dialects of that region.

INDONESIA: 5055kHz is a new frequency for RRI Nabire which uses 1kW, broadcasting from 0915-1400. The old 500W transmitter is now on 6126kHz and should be heard in their last transmission at 0700-0915UTC according to David Foster of Burwood, Victoria.

RRI Surakarta is now on 4900kHz at 1100-1700UTC and this frequency replaces 4932, but not on a regular basis. Our reception has been at 1300UTC when news is relayed from Jakarta.

NORWAY: Oslo has been observed on the new channel of 17710kHz at 1100-1230UTC but suffering considerable interference from Radio Moscow World Service. For this transmission Radio Norway is scheduled to use 6015, 21730, 25730 and 25615kHz and English is broadcast on Sunday 1200-1230UTC.

SWEDEN: Radio Sweden is using 21615kHz at 1100-1130UTC for the English Service to Australia. This frequency replaced 17825kHz which was used for the period July-September. Radio Sweden also has English at 0230-0300UTC on 9695 and 11705kHz.

USSR: Radio Moscow has re-introduced Russian language lessons into the World Service. The frequency of 9600kHz has been heard with the World Service at 0400UTC, but suffers severe interference from BBC World Service on the same channel.

BBC WAVEGUIDE

Since the BBC World Service ended World Radio Club some months ago, the 15 minute program has been replaced by a five minute feature called "Waveguide". This has covered reception of BBC broadcasts and has also given replies to questions about listening to London. This program has now been

extended to 10 minutes and is broadcast on Monday 0915UTC, Tuesday 0100, Wednesday 0430 and 1735UTC. Listeners in Australia should find the Monday transmission at 0915 on 11750, 15070, 21550 and 25650kHz giving the best reception. As well as giving the latest frequency information concerning BBC broadcasts the program is able to look at various aspects of world-wide broadcasting.

Another BBC program which covers the subject of reception to some degree is "Letterbox", compered by Margaret Howard. Often questions from listeners to this session are of interest to the short-wave listener. The program is broadcast on Sundays at 0515 and 2015 for reception in this area.

BROADCASTS FROM ATHENS

Listeners to Greek Radio either in Greek or English will have noted some frequency changes in the three daily transmissions to this area. The broadcast 0900-0950UTC which includes English at 0940UTC has moved to 9865 and 15050kHz, while the transmissions for our morning reception 2100-2150UTC is on 9865, 11645 and 15050kHz, and 2200-2250UTC on 15050kHz. The power of all the transmitters is 100kW except for that on 11645kHz.

Relays of the Greek Home Program are also carried on shortwave over a 35kW transmitter at 0600-0830UTC on 9815 and 9855kHz on Sunday only, 1000-1730UTC on the same frequencies each day, and 1800-2215UTC on 15020 and 15035kHz. All these transmissions are in Greek. These times are for broadcasts from October to March, which during the remainder of the year are heard one hour earlier.

LATIN AMERICAN NEWS

COSTA RICA: Radio Reloj has returned to 6006kHz with the other shortwave outlet on 4832kHz. The stations operate around the clock and have frequent time announcements indicated by the slogan Radio Reloj. A verification card from the station lists the frequencies as well as 700kHz medium-wave, also heard here

DICK SMITH PRESENTS

THE NEW YAESU FT102



SP102 Speaker/ Audio Filter

The SP102 features a large (120mm) Hi-Fi speaker with selectable low & hi-cut audio filters allowing twelve possible response curves. Cat. D-2883

\$72.50

Cat. D-2880

FT102 HF TRANSCEIVER

The new super high performance HF Transceiver is now here! It's got all the amateur bands PLUS the new WARC bands. Special Hi voltage JFET RF Amplifier provides exceptional dynamic range - well beyond 100dB. New adjustable noise blanker even works on the woodpecker.

SPECIFICATIONS: ● TRANSMITTER POWER INPUT: SSB & CW 240W DC AM* 80W DC FM* 160W DC ● CARRIER SUPPRESSION: better than -40dB ● SIDE BAND SUPPRESSION: better than -60dB ● SPURIOUS RADIATION: better than -40dB ● IF REJECTION: better than 70dB ● AF OUTPUT: 1.5W minimum (8 ohms) ● AF IMPEDANCE: 4-16 ohms ● SELECTIVITY: SSB, CW, AM 2.7kHz - 6dB, 4.8kHz - 60dB ● WIDTH ADJUSTMENTS CONTINUOUSLY FROM 2.7kHz to 500Hz (-6dB) ● IF NOTCH DEPTH: better than 40dB ● SENSITIVITY: (RF Amp on) - SSB better than 25uV - CW better than 18uV ● AM better than 1uV - FM* better than .4uV - CW (APF ON) better than .05uV - SSB (Option Filter) better than .2uV - CW (option filter) better than .12uV

FC102 ANTENNA TUNER

This is the big one - All newly designed Antenna Tuner for the FT102. Band switched L-C PI - network will match a wide variety of antennas including a single wire. It features an inline watt meter with 3 ranges, a 'peak hold' system, SWR metering and best of all will handle 1.2KW, that means you can use it with the FL 2100Z. Cat. D-2881

ONLY \$319

**CHECK
NEAREST
STORE FOR
AVAILABILITY**

AM/FM PCB
Allows your 102 to operate AM and FM mode - great for 10 meter FM, Oscar or transverter to 6, 2 or 70cm Cat. D-2882

\$72.50

ALL THIS FOR ONLY \$1225

CHECK THESE ACCESSORIES FOR THE FT 290R

ALINCO ELH230 LINEAR AMP

High efficiency Linear Amplifier for 2 meters. 30 watts output - 13.8V supply make it perfect for mobile use. Cat. D-2546

\$89.50

2 METRE 1/4 WHIP

Super strong Mobile Antenna. 1.3 m long fibreglass for mobile use. Cat. D-4205

\$15.50

YAESU CSC1A CARRYING CASE

Protect your FT 290R with this smart black case. Cat. D-2910

NEW \$7.50

YAESU MMB-11 MOBILE MOUNTING BRACKET

Mount your FT 290 in your car. Cat. D-2911

NEW \$39.50

YAESU YHA15 FLEXI ANTENNA

Replace your rigid FT 290 antenna with the Flexi Helical Antenna. Cat. D-2912

NEW \$9.50

**NO PRICE
INCREASE!**

FT 290R \$349

**Our most
Popular 2 Metre**

The brilliant Yaesu FT-290R. For the person who can't quite make up their minds whether they want a portable or a mobile set. This one is both! And what's more, it's fully microprocessor controlled, offering up to 10 memory channels, scanning, LCD display, high or low power operation, and all modes. All this in a transceiver which can be operated both portable (from internal batteries & whip antenna) or mobile (ext. antenna & power sockets fitted) Cat. D-2885



**DICK SMITH ELECTRONICS
INC IN NSW**

SEE PAGE 98 FOR ADDRESS DETAILS



DSE/A381/JW

in southern New Zealand. The transmissions on shortwave are received around 0800UTC and according to the verification card the address is PO Box 341, San Jose, Costa Rica 1000.

NO LIBERTY CONFIRMATION

During April and the Falkland Islands crisis Radio Liberty was widely reported by listeners in Australia and New Zealand with its broadcasts to the forces in the South Atlantic. This Argentine-based station used Miss Liberty to try and persuade the British forces to return home in a propaganda broadcast similar to Tokyo Rose of Japan during World War II.

In a handwritten letter from Radio Argentine Exterior a station official said that they were not Radio Liberty and had nothing to do with it. They advised details of the present schedule of RAE including a booklet on Argentina, a cassette of Argentine folk music and the latest schedule. Broadcasts in English are at 1100-1130, 1930-2000, 2230-2300, 0100-0130 and 0430-0500UTC. Frequencies are given as 6060, 6180, 9690 and 11710kHz.

The frequency of 15345kHz is also listed in operation from 1530-1800UTC. The station verifies with a card showing a map of the Malvinas Islands and has the address Radio Argentine Exterior, CC 555 Correo Central, 1000 Buenos Aires, REPUBLIC ARGENTINA.

FURTHER BRAZILIAN EXPANSION

A further expansion in the External programs of Radio Nacional Brazil has led to the inclusion of additional services in Portuguese. The station already broadcasts three transmissions in English with the broadcast at 0200-0300UTC heard on 15290 and 17830kHz.

Notes from readers should be sent to Arthur Cushen, 212 Earn Street, Invercargill NZ. All times are UTC (GMT). Add eight hours for WAST, 10 hours for EAST and 12 hours for NZT. In areas observing daylight time, add a further hour.

DO YOU WANT TO BE A RADIO AMATEUR?

The Wireless Institute of Australia, established in 1910 to further the interests of Amateur Radio, conducts a Correspondence Course for the A.O.C.P. and L.A.O.C.P. Examinations conducted by Telecom Throughout the Course, your papers are checked and commented upon to lead you to a successful conclusion.

For further information, write to

**THE COURSE SUPERVISOR
W.I.A. (N.S.W. DIVISION)**

P.O. BOX 1066
PARRAMATTA, N.S.W. 2150.

32K BYTES FOR THE ZX81

SPECIAL RAM PACK FOR THE ZX81

This board uses dynamic RAM chips for lower cost and lower power consumption. Simply plugs into the ZX81 expansion port offering 32K BYTES for basic programmes and data handling. No extra PSU required.

Extra memory to help you build your ZX81 into a powerful microprocessor system at an affordable price. Compare the price with other RAM PACKS available on the market!



Price for 32K Ram Pack (RP 32) only: \$165.00 incl. P & P (Aust.)

JUST RELEASED!

ZX 80/81 PROGRAMMABLE CHARACTER GENERATOR

Using simple BASIC programs you can create your own unique character sets and graphic symbols for games. High Res graphs and charts and interesting patterns.

Program symbols normally available only on more expensive microprocessors and you are not limited to preprogrammed graphic sets.

Fully assembled price \$95.00 incl. P & P (Australia).

Uses the 8K ROM from Sinclair (not incl.)

UPGRADE YOUR ZX80 GRAPHICS

Now you can upgrade your ZX80 to the full animated graphics of the ZX81. Your ZX80 will now run in SLOW mode.

Fully assembled price only \$38.50 incl. P & P (Australia).

Works only in conjunction with 8K ROM from Sinclair (not incl.)

Please send order or S A E for further information to:
VENDALE PTY. LTD., Dept A7, Box 456,
Glen Waverley, Victoria 3150.
36 Plymouth St., Glen Waverley,
(03) 232 0444.

VENDALE

VEN 0261

Software for the Super-80 Computer

\$5.00*

An "Electronics Australia" publication

"Software for the Super-80" was compiled from submissions to the Super-80 Software Competition judged earlier this year. The book has 48 pages, of the same size as this magazine, featuring 17 Basic programs in printed listing form. They represent a useful range of exercises which will be of use to all Super-80 owners.

Available from "Electronics Australia", 57 Regent St, Chippendale. PRICE \$5.00 OR by mail order from "Electronics Australia", PO Box 163, Chippendale, 2008. PRICE \$5.00 plus \$1.00 for packaging and posting anywhere in Australia.

Here Are The Program Headings:

- 1 Poker machine simulation
- 2 Printing demonstration
- 3 Calendar calculator
- 4 Othello game
- 5 Investment analysis
- 6 Guessing game
- 7 List and sort
- 8 "Fred the shrink"
- 9 Simple maths drill
- 10 Lotto number selector
- 11 Triangle solutions
- 12 Mortar attack game
- 13 Caves & Monsters
- 14 Amateur radio Q-code tutorial
- 15 Caravan park directory
- 16 Super Pokey game
- 17 Tattsлото selector



REVIEWS OF RECENT

Records & Tapes

CLASSICAL • POPULAR • SPECIAL INTEREST

MAHLER-ABBADO: "... phrased to perfection"

MAHLER — *Symphony No. 4 in G Major*. Vienna Philharmonic Orchestra conducted by Claudio Abbado with Frederica von Stade (soprano). DGG Analog Stereo 2530966.

Mahler's Fourth is his "lightest" symphony, mercifully free from the tiresome German metaphysics he so often associated with his others. The nearest he got to that outlook in the Fourth was to call it a *Symphony of Heavenly Life*.

For many years my favourite recording of this work has been Szell's with the Cleveland. It is a typical Szell "no nonsense" reading, kept simple without over-expression and almost always obedient to the composer's interpretative instructions. And, added to this, is the Cleveland's unique precision under its martinet conductor.

Abbado's reading of the symphony is almost directly opposite to Szell's. Abbado is often wilfully disobedient to many of Mahler's specific instructions, especially in the matter of tempos. Yet it must indubitably be accepted as a fine reading.

Let me explain this apparently paradoxical statement. First, in place of the Cleveland's unmatched precision, you have the Vienna Philharmonic at its sensuous best. They play for Abbado with elegance and a matchless bloom on their tone, always doing full justice to the composer's marvellous scoring. In this, they are aided by the analog disc's quite adequately wide dynamic range and meticulous clarity of detail.

Those who find the VPO's ability to sustain so successfully Abbado's extremely slow tempo in the long slow movement should bear in mind that this great orchestra is often called upon to deal with one of Bruckner's huge peristaltic themes in the same way. Throughout the movement's 23-minute, mostly pianissimo progress, Abbado never once loses his concentration. Every bar is phrased to perfection.

Frederica von Stade, who sings the Wunderhorn song in the Finale has been

Gustav Mahler

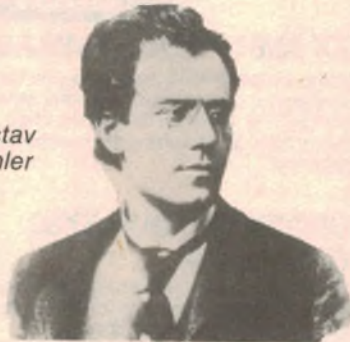

criticised for introducing affectation into her reading. In my opinion, her interpretation adds childish charm to this innocent little piece. Moreover, her beautiful, light, fresh voice is quite capable of finding a true mezzo quality to the low B flats.

To me, after her very slightly breathless start, she is a joy to listen to. Also, for that matter, is the whole disc. (J.R.)

Italian vocal music

LUCIANO PAVAROTTI — *First recording of rare Verdi arias*. With the La Scala Orchestra conducted by Claudio Abbado. CBS Stereo Analog Disc SBR236060.

PLACIDO DOMINGO — *Recital of arias from mostly popular Italian and French operas*.

To readers interested in recitals of Italian vocal music I can recommend



these two discs. The Pavarotti has the added attraction of novelty in its introduction to the public of the first recording of rare Verdi arias never used by the composer for one reason or another. The accompaniments are by the La Scala Orchestra under Abbado.

The full title of the second is "A Portrait of Placido Domingo". It comprises popular arias from frequently performed Italian and French operas. Strangely, the name of the accompanying orchestra or orchestras is omitted, which tempts one to speculate that the program was derived from many sources. (J.R.)

Chilly and warm!

FAURE — *Sonata for Violin and Piano in A Major. Berceuse*.

DEBUSSY — *Sonata for Violin and Piano in G Minor*. Pinchas Zukerman (violin) and Marc Neikrug (piano). CBS Masterworks Analog Disc 76813.

There was a wide disparity in the ages of the composers when they wrote these works. In 1876 Faure was in his early 30s, of youthful spirits and still unknown. Forty odd years later, Debussy, who had long since won fame, was dying of a revolting form of cancer with the Germans working towards the gates of his beloved Paris. The Violin Sonata was his last work.

Faure could not find a publisher in France for his now popular sonata and ironically it was published eventually by a German company — Breitkopf — on savagely mean terms. It is a lovely work still gaining more and more popularity and one of the finest examples of French chamber music.

Faure's was a gentle art as this work — and don't forget his Requiem — shows. Yet it is a warm and intensely personal exercise, which calls for the most delicately responsive performance from both players.

Zukerman's reading, however, which could never be justly described as dead pan, has about it a seriousness which I feel was never intended by Faure. Its essential Frenchness is delivered with the

Reviews in this section are by Julian Russell (J.R.), Paul Frolich (P.F.), Neville Williams (W.N.W.), Leo Simpson (L.D.S.), Norman Marks (N.J.M.), Greg Swain (G.S.), and Danny Hooper (D.H.).

slightest of foreign accents. It lacks what the French call "volupte". Neikrug's excellent piano part must perform follow the mood of the violinist.

Curiously, on the other hand, Zukerman adds welcome warmth to the otherwise slightly chilly score of the Debussy. I described the circumstances of its composition above. There was every excuse for Debussy's occasional aridity but this is, to some extent, alleviated by the warmth of Zukerman's sympathy.

It is almost as if an Israeli of a younger generation were trying to console a member of an older on the grounds of having himself suffered similar patriotic agonies. A moving thought although perhaps not acceptable to some. Marc Neikrug adds a valuable contribution to both works.

The fill, Faure's Berceuse, is just a very pleasing little salon piece very nicely played. The analog sound is fine. (J.R.)

☆ ☆ ☆

STRAVINSKY — Petrouchka (complete). Scherzo a la Russe. Philharmonia Orchestra conducted by Michael Tilson Thomas. CBS Digital Disc D37271.

I found this first digital recording of Petrouchka to come my way a bit disappointing. This was chiefly because of a tendency to the lackadaisical in Thomas' reading.

In the first scene, there is very little sense of the hassle of a Russian carnival, although the digital process works well here on a score so full of important detail. (The version, by the way, is Stravinsky's own 1947 revision.)

Lack of vitality in the playing is the main offender although, at the end, the Puppet's Dance is nicely rhythmical.

In the second scene, in Petrouchka's black-walled room, I have never heard the music played so mournfully. This Petrouchka is a sad little fellow indeed. Later, where the piano has the solo part, it even seems to slow down until it reaches Petrouchka's attempt to battle his way out of the room.

Thomson, by the way, keeps the drum-roll going between scenes, something rarely done in concert performances but preserved when the work is presented in ballet form.

The third (Moor's) scene is more successful. Thomas' lackadaisical attitude matches well the Moor's idle playing with the big ball. And, of course, everything brightens up when the seductive little ballerina joins him. I have, however, heard her little trumpet tune sound much crisper.

The final scene gains in vitality, I think largely because the increased crowd and activity on the stage is responsible for more complex orchestral scoring, and that incident follows incident at great

BOSTON PIPE ORGAN

... a matter of opinion!

ENCORES A LA FRANCAIS. Michael Murray playing the organ at the Symphony Hall, Boston. Digital stereo, Telarc DG-10069. [From P. C. Stereo, Pty Ltd, PO Box 272, Mt Gravatt, Qld 4122. Phone (07) 343 1612]

As depicted on the jacket, the Symphony Hall, Boston, is a large rectangular auditorium, with double galleries along both sides and a proscenium occupying almost the entire front wall.

Beyond the proscenium is a tapered sound stage area, backed by the pipes and chambers of the Aeolian-Skinner concert organ, installed in 1949-50. In effect, the organ speaks into the auditorium from the smaller end of a huge acoustic short horn — large and small pipes alike.

But apparently Bostonians like it that way because, according to the jacket notes, the organ has been carefully maintained in original condition and is one of the few substantially "romantic" organs in the USA which have not been re-voiced for a totally baroque sound.

Perhaps it's because of all this that the organ sounds as it does — at least as judged on this recording. The sound can be loud but scarcely spacious; soft but not really delicate.

The bass can be very loud, and I use the words deliberately with a degree of puzzlement. At a quite modest setting of the volume control, and with the power output LEDs on the amplifier hardly stirring, the loudspeakers were rumbling and the room reverberating in an impressive fashion. Perhaps the subjective loudness had to do with the harmonic structure of the sound.

Buried somewhere in the bass were the smaller pipes and I found myself wishing that Telarc engineers hadn't been so professedly meticulous in mic placement and balance to capture the sound as heard in the auditorium.

speed on the stage. Spirits get higher and higher until Petrouchka's macabre death — and resurrection.

The fill is a little Scherzo a la Russe, commissioned in the early 1940s by Paul Whiteman, who was apparently expecting something like Gershwin's vastly popular Rhapsody in Blue.

He finally rejected it but Stravinsky, as careful with themes as Scots are with bawbees, reorchestrated it into its present form, which can surely mean nothing but another fair scene. Stravinsky loved country fairs!

As mentioned above, the digital sound is good, but the Philharmonia Orchestra



I finished up playing the record minus a bit of bass and plus a bit of treble. Fortunately, the recording itself is basically very clean and it can be re-balanced thus, without significant penalty in respect to noise and distortion.

One other point should be mentioned: the organ has an enormous dynamic range which Michael Murray exploits in the Widor Toccata, perhaps to the delight of Telarc engineers. It's dramatic, abrupt but not very musical — and also frustrating unless your listening room is dead quiet!

Michael Murray is a very experienced musician who has been performing solo and with orchestras, throughout Europe, Canada and USA for more than 10 years. The items in this performance are a collection of the encores which he may offer at the end of formal recitals:

Chacone in G Minor (Louis Couperin); Carillon, Op 27 (Marcel Dupre); Scherzo (Eugene Gigout); Piece Heroique (Cesar Franck); Toccata, Symphony V (Charles-Marie Vidor); Sinfonia, Cantata 29 (J. S. Bach); Final, Symphony I (Louis Vierne); Musette, Op 51 (Marcel Dupre); Fanfare (Nicolas Jacques Lemmens).

As might be expected, Michael Murray plays them capably but, overall, "Encores a la Francais" didn't emerge as one of my favourite organ records.

I make that last remark with a frown on my gradually expanding forehead because, in the October issue of "Audio" magazine, reviewer John M. Eargle said of this same disc: "This stunning recording is a must for all lovers of organ music!" (W.N.W.)

plays as if it weren't very interested. I think you might be advised to wait until an alternative performance is on offer. (J.R.)

☆ ☆ ☆

RAVEL — Piano Trio in A Minor. SAINT-SAENS — Piano Trio in F Major. Played by the Tortellier family. World Record Club Stereo Analog Disc R09432.

Ravel's Piano Trio, unlike his String Quartet has never won the affection of a large public. This is a pity, because the Trio is an exemplary example and its per-

formance by the Tortellier family (Maria de la Pau, piano; Yan Pascal Tortellier, violin; and Paul Tortellier, cello) is in every way admirable.

From the very first bar, there is no mistaking the Trio's origin in Ravel's own very personal harmony and melody. There is a delicious air of chastity about its perfect construction. Ravel has done more than most composers to reconcile the different timbres of a percussive piano, with bowed strings.

The Passacaglia treats this venerable form with great respect, while the players put refined passion into its tall dignity. The whole work is a supreme example of French elegance at its best. An important French tendency it carefully avoids is "La Gloire". Even the curiously accented Finale goes splendidly.

The Saint-Saens has its own style of elegance, simpler than Ravel's. And, as to the composer, it is hard to believe that that old curmudgeon was once a happy young man and during his life exercised a very strong influence on his younger contemporaries. I am referring here, of course, to his later years when

he developed into a crusty old Chauvinist.

Yet at his worst during World War I, he retained in his music typical French clarity and taste. If it sometimes sounds slim alongside most of the German school of the period, it is nearly always brilliant and always immaculately turned out.

His influence, however, seldom reached beyond France although his Piano Concertos and his opera, *Samson and Delilah* had a good innings elsewhere, especially in England. The Concertos often get an airing today, played by pianists of all nationalities.

I have deliberately omitted the name of his great predecessor, Hector Berlioz, because I cannot think of his influencing anyone except, perhaps, Charles de Gaulle. The Saint-Saens Trio was composed during a stay in one of the least attractive parts of France — the Auvergne.

Yet the whole work is exuberant in form and content, the Scherzo especially a delight to mind as well as ear. Needless to add that, in the hands of the Tortellier family, its performance is immaculate; their attention to detail faultless. The analog sound is excellent. (J.R.)

FROM THE MOVIES

GONE WITH THE WIND. Composed and authorised by Max Steiner. Played by the London Sinfonia, conducted by Muir Mathieson. Super stereo, Stanyan Records POW-4023. Distributed by RCA.

In his jacket notes, Richard Oliver points out that "Gone With The Wind" not only made its mark as an epic film and one that set box office records, it also contributed enormously to the acceptance of dedicated music scores and to the reputation of that most notable exponent of film music, Max Steiner.

Curiously, on the same weekend that I wrote this review, I also reviewed the very old film "Bill of Divorcement" and watched "Johnny Belinda", both with music direction credited to Max Steiner.

His score for "Gone With The Wind" has something of what Richard Oliver refers to as "symphonic proportions" and it forms the basis of this new performance by the London Sinfonia.

There are 16 theme titles on the two sides but there are no separate tracks; those who do not know the themes may have some difficulty in identifying them from the unbroken flow of music. But the jacket notes should help.

As an idea, here are the theme titles from Side 1: Tara's Theme — Invitation To The Dance — Melanie's Theme —



Ashley — The Prayer — Bonnie Blue Flag — Scarlett O'Hara — Scarlett's Agony — War. There are seven more themes on side Two.

I am not sure what is meant by the endorsement "Super Stereo"; the sound certainly has a wide frequency range although, I felt, it to be a trifle "zizzy" in the string department. But, even if you prefer it with a bit of top-cut, it can be a pleasant reminder of a film that many readers may possibly have seen several times. (W.N.W.)

☆ ☆ ☆

MUSIC FROM GREAT AUSTRALIAN FILMS. The Neon Philharmonic Orchestra. ABC Records ABCL 8202. (Manufactured and distributed by CBS Records Australia Ltd.)

In recent times, the ABC has been doing the Australian viewing and listening public quite a service by releasing so



many discs and cassettes inspired by the Australian entertainment scene.

This particular album, made in the ABC studios, uses the Neon Philharmonic Orchestra, conducted by William Motzig. The name Neon Philharmonic means nothing to this reviewer but it does feature such musicians as Bob Barnard, Errol Buddle, Tony Ansell and Mark Isaacs.

Featured on the discs are themes from 12 Australian movies. One dates back to 1937 ("Tall Timbers") but the remainder are of much more recent origin: Newsfront — Gallipoli — My Brilliant Career — Cathy's Child — Eliza Fraser — Breaker Morant — The Chant of Jimmy Blacksmith — The Picture Show Man — Picnic At Hanging Rock — The Mango Tree — Dimboola — Caddie.

The album comes in a handsome double-fold jacket, carrying a brief resume of each of the movies and the actors who featured in them. On the rear of the jacket is further interesting comment by the ABC's film critic, John Hinde.

The sound quality on the album is excellent but I felt that the orchestra could have been a little more adventurous in the matter of dynamic range. Even so, it should prove a popular release. (N.J.M.)

Devotional

DANA — Totally Yours. Stereo, Word WSB-8850. From Word Records Aus, 18-26 Canterbury Rd, Heathmont, Vic 3135. Phone (03) 729 3777.

Dana (pronounced Donna) is pictured on the jacket as a striking dark-haired beauty who, not so long ago won Europe's most coveted secular music award. Born and raised in Ulster, she has become a devout Christian and has recorded this album in London and Dublin for ultimate release through Word Records in Waco, Texas.

The basic theme of the album is probably caught best by "Sing For Me" on side 1 — an expression of her personal challenge — and "Totus Tuus" on side 2 or "Totally Yours", a hymn of personal dedication.

Other titles are: Praise The Lord — Mary's Song — Oh, So Wonderful — The Soft Rain — Home Where I Belong — Little Baby — He Careth For You — A Simple



Song Of Love.

Some of the words are by Dana herself but all of the songs have a personal, pensive quality, reflecting a deeply spiritual approach to everyday living. Diction is good and the lyrics are given in full on the inner sleeve, so it matters little if the titles are unfamiliar. And the melodies, too, are rhythmic and easy on the ear.

Technically, the quality is normal and, all told, it adds up to a pleasant album from a very pleasant lass. (W.N.W.)

Popular & rock

MURDERED BY THE MUSIC, Yuki Takahashi. Regular 2, REG L200. RCA Release.

According to the artist biography included in the sleeve, Takahashi is one of the leaders of the computerised, synthesised music rage in Japan at the moment. Apart from being the producer and arranger for this record, he is the electro-percussionist (how's that for a new career?) for the Yellow Magic Orchestra, runs a trendy boutique and produces stage clothing as well as records. I wonder what he does in his spare time?

The music is very bright and pop orientated, with all sorts of synthesised gimmicky sounds.

The titles are: School Of Thought – Murdered By The Music – Kid Nap The Dreamer – Radioactivist – The Core Of Eden – Bijin-Kyoshi At The Swimming Pool – Blue Colour Worker – Stop. In The Name Of Love – Mirrormaniac – Numbers From A Calculated Conversation. The sound quality is clear; try a track to see if you like the sound! (NJM)

☆ ☆ ☆

DEPECHE MODE, Speak & Spell. Mute records POW 6012 RCA Release.

Unless you are heavily into electro-pop, this record from one of the leading British bands using only synthesisers and voices, will not do much for you. Despite the synthesiser's ability to make almost any sound you wish, there is a limit to what the ordinary person will accept as musical; as a result, commercial electronic releases tend to become rather predictable.

The eleven tracks are: New Life – Puppets – Dreaming Of Me – Boys Say Go – Nodisco – What's Your Name – Photographic – Tora Tora Tora – Big Muff – Any Second Now – Just Can't Get Enough. In this last track, by the way, the title is the lyric!

Technically, the record is of a high quality. (NJM)

☆ ☆ ☆

INDIVIDUALS. Sunnyboys. Mushroom Records, L 37835, Festival release.

The Sunnyboys are a new Australian band and a lot of work has gone into the making of their album, which was recorded at Mandrill Studios, Auckland, New Zealand and mixed at Pasha Studios, Los Angeles, USA.

The band already has a following in Australia and the first single lifted from this album "You Need A Friend" has received considerable airplay.

The members of the band are: Jeremy Oxley, guitar and vocals; Richard Burgman, guitar; Peter Oxley, bass and vocals; Bill Bilson, drums; Steve Harris, keyboards.

The other tracks on the album are: This Is Real – Individuals – It's A Sunny Day – Leaf On A Tree – No Love Around – I'm Not Satisfied – Days Are Gone – You Don't Need Me and Colour Of Love.

Peter Oxley wrote "You Don't Need Me" while Jeremy Oxley wrote the other nine tracks.

This is a refreshing album from an exciting new Australian band. (D. H.)

"Electronic" singles

ONLY YOU. POW-0063 Powderworks Records.

Already an extremely successful single and receiving considerable airplay throughout Australia, this recording by the group Yazoo demonstrates the appeal of the "new romantic" sound that originated in the United Kingdom.

CALL THE UH-OH SQUAD. 104011 RCA Records.

An up-tempo record with a catchy tune and chorus. On Side B is a live version performed at the Paradise Theatre, Boston, USA by Robert Ellis Orrall.

URUQUAY. POW-0089 Powderworks Records.

An English single performed by The RB's that incorporates a considerable number of brass instruments; it has a good beat and should emerge as a good dance record.

PAPA'S GOT A BRAND NEW PIGBAG. POW-0077 Powderworks Records.

The Australian group Pigbag perform (to me) a rather disjointed instrumental single, and was not appealing to this reviewer. (D.H.)

COMPACT 200 SPEAKER SYSTEM



LOUDSPEAKER DRIVERS . . .

Read the comprehensive article in September 1982 Electronics Australia. A speaker kit which compared favourably with Electronics Australia's own large reference three-way system. Using quality European Audax drivers and a specially tailored crossover this exceptional compact speaker system is available in kit form for just \$199.00 rrp. Speakers, Electronics Kit and if required, the fully assembled Cabinet Kit, is available for an additional \$99.50 rrp.

Call us now for the name and address of your nearest dealer.



Used by leading speaker manufacturers the world over, a small range of these famous drivers has been made available for the home constructor. The range includes high, medium and bass drivers of quite exceptional quality. Naturally Audax back up the sale of drivers with excellent technical specifications and advice. Before constructing your next loudspeaker project remember AUDAX, a world leader in loudspeaker technology. Call or write for more information.

AUDAX LOUDSPEAKERS, Head Office — 32 Wilson St, Oakleigh Vic 3166.
Phone: (03) 543 5266 (AH) 579 5196. Sydney — PO Box 181, Granville 2142. Phone: (02) 682 4133.

Coming Next Month***

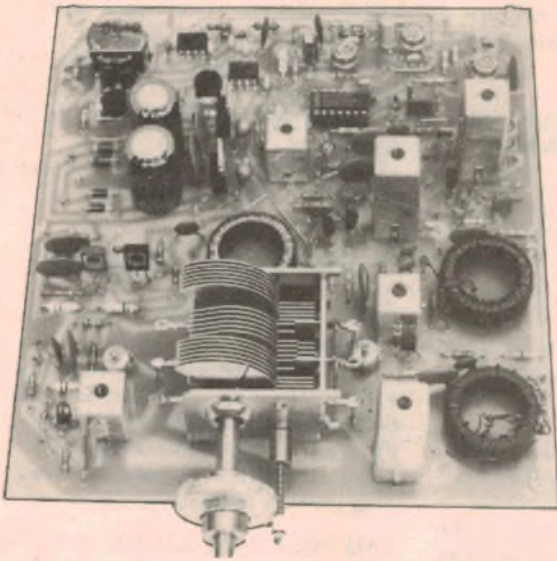

Wideband AM tuner

Want to build a really high-quality wideband AM tuner? This completely new design features wide audio frequency response, low harmonic distortion and excellent signal-to-noise ratio. In fact, apart from stereo reproduction, this new tuner compares very favourably with typical FM tuners. Other features include digital readout with 1kHz resolution, a 9kHz whistle filter and LED signal strength indication. (Picture at left shows the tuner PCB in early prototype form.)

Digital pH Meter

Based on the DPM-05 3½-digit LCD module, our new pH Meter can be used to check swimming pools, photographic solutions, fish tanks, or chemicals in the laboratory.

ON SALE:
Wednesday, December 1st

* Our planning for this issue is well advanced but circumstances may change the final content. However, we will make every attempt to include the articles mentioned here.

Our square 'floppy' is impervious to dirt, head crashes and power failure.

The loss of data and software from static RAM or from disk can be extremely annoying and costly - whatever the cause.

Our new CRA-128K CMOS RAM card with on-board battery back-up, can give you permanent protection from data loss.

It is totally impervious to the environment no matter how hostile, and is totally unmoved by power surges or brownouts. It runs on outside power, but its on-board battery will protect your data from accidental disconnects or power failure for 130 hours without external power.

All the memory you need can be stored in perfect safety on one card, or a series of cards up to 500K bytes.

And a big bonus of direct access is its Very High Speed Operation, eliminating the usual wait time required while the processor scans a disk.

The CRC 128 is plug compatible with SME's SBC-800 microprocessor which contains the CP/M program in PROM.

Software write/protect prevents accidental overwrites, and the board can be loaded externally. The battery also permits the card to be shipped already loaded and the data kept alive for over 130 hours.

Call us today for further details

SME SYSTEMS

22 Queen Street,
Mitcham, Vic. 3132

Tel: (03) 874 3666.

Telex: SMELEC AA37213

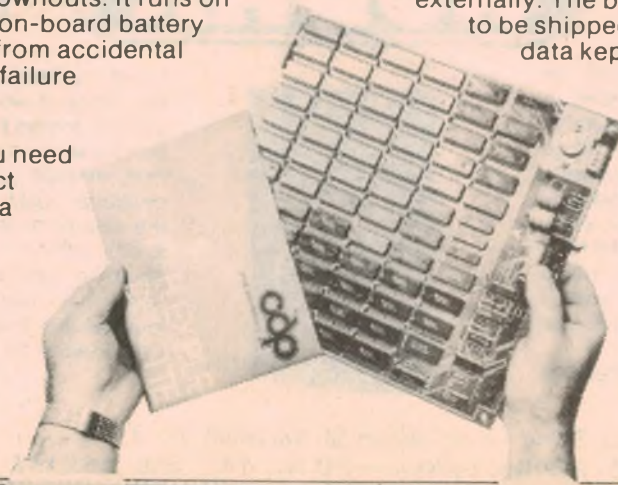

PEN/292

50 & 25 YEARS AGO

"Electronics Australia" is one of the longest running technical publications in the world. We started as "Wireless Weekly" in August 1922 and became "Radio and Hobbies in Australia" in April 1939. The title was changed to "Radio, Television and Hobbies" in February 1955 and finally, to "Electronics Australia" in April 1965. Below we feature some items from past issues.



November 1932

The Radio Season: In the past it has been general practice to consider that radio is divided into seasons, that radio sets can only be sold and used in the winter time, and that a radio set is useless in summer time. What a ridiculous idea.

Today the local stations have such a powerful output that the great majority of listeners can have programs perfectly free from static except when there is a violent thunderstorm in the immediate neighbourhood. Radio has now definitely left the ranks of the novelties.

☆ ☆ ☆

Follow The Test: "OWZAT?" — Oldfield echoes Ironmonger's appeal for LBW . . . The batsman pauses. The umpire is looking at him intently . . . He shakes his head . . . Not out! . . . Listen to the crowd.

December 2, 1932, the first Test Match! In your easy chair with your Audiola Junior on the table, you can follow the match ball by ball — run by run. The announcer's voice is as clear as if you sat beside him. (From a Warburton Franki advert.)

☆ ☆ ☆

Radio for motorcycles: Some idea of the many applications of radio can be gauged from the fact that in America even the police motor cycles are fully equipped with radio sets, so that the patrolmen on their machines can pick up messages from headquarters whilst riding along.

A special form of loudspeaker has been developed for the job, and this is mounted between the handlebars with the mouth turning upwards. By slightly leaning forward the rider of the machine gets the full benefit of output from the speaker.



November 1957

Next stop Mars: Experts are now planning space ships which can make the round trip to Mars in a few weeks.

Scientists visualise a stream of electrified vapour thrusting from the rear of the space ships like a violent electric wind.

They claim that ships up to 600 tons could be propelled through space once they are clear of earth's atmosphere.

British, US and Russian scientists are working on the "electric" space ships.

The new method of driving space ships is described as "fantastic".

Called the Ionic Drive, the new method amounts to the thrust of a huge machine through space by a beam of electrified particles instead of a jet of flame.

☆ ☆ ☆

Transistor radio advert: Now you can own a truly portable radio incorporating transistors, the tiny electronic marvels which obviate valves and cumbersome B batteries. These smartly styled "Sony" receivers give excellent reception with high sensitivity using only standard torch batteries costing, in all, only approximately four shillings. The "Sony" Model TR72 is equal in tonal quality to the best electric models and costs £45.

☆ ☆ ☆

Animals aloft: Reports from Moscow Radio say that scientists are sending animals more than 125 miles into space to study the effects of cosmic radiation on living organisms.

The broadcast quoted a scientist who spoke on research in the higher layers of the atmosphere.

In 1951 animals were taken up to a height of more than 60 miles, he said.



UNIVERSITY OF
CAPE TOWN

Senior Lecturer in Electrical Engineering

Applications are invited for the above post for appointment as soon as possible. Specialisation in Digital Systems, including digital electronics, microprocessors and realtime computer applications is required. The incumbent will be required to teach undergraduate and postgraduate students in the above topics, supervise and conduct research, and assist with the planning and running of laboratories for these purposes. This latter duty encompasses both hardware and software aspects of various mini and microcomputer systems.

Appointment, depending on qualifications and experience, will be made on the salary scale R16 557 x 936 R24 045. In addition, a service bonus of nearly one month's salary is payable annually.

Staff benefits include a 75% remission of tuition fees for dependants at UCT, generous study leave privileges, a housing subsidy scheme subject to government regulations, pension fund, medical aid and group life assurance.

Applicants should submit a curriculum vitae stating present salary, research interests and publications, the date duty could be assumed and the names and addresses of three referees.

Further information should be obtained from the Registrar (attention: Appointments Office), University of Cape Town, Private Bag, Rondebosch, 7700, South Africa, by whom applications (quoting ref no BJ/281) must be received not later than November 12, 1982.

The University's policy is not to discriminate on the grounds of sex, race or religion. Further information on the implementation of this policy is obtainable on request.



MAIL ORDER DEPARTMENT: PO Box 254,
Heidelberg, 3084.
Phone: (03) 435 3004, Monday — Saturday
1.00pm to 6.00pm

NEW PRICES:

OHIO SOFTWARE & HARDWARE

OHIO SOFTWARE:

K1 Hardware Catalogue (incl new boards) \$1 98
K2 Software Catalogue (over 200 pieces) \$2 98

OHIO HARDWARE:

C4P, VIDEO BOARD (converts C1P Series 7) \$130 00

COLOUR BOARD — C1P — Series 2

H13A Short Kit, including documentation \$35 00

H13B = H13A and tracks for 5v to 12v DC \$39 00

H13A Colour and RF out. Assembled and Tested \$85 00

H13B = H13A Assembled and Tested includes 5v to 12v tracks \$89 00

OPTIONS:

SOUND — Parts Kit \$2 50

incl assembled and tested \$18 00

VIDEO — Parts Kit \$2 50

incl assembled and tested \$15 00

5v to 12v DC — No Kit available (Specialised) — incl assembled and tested \$24 00

COMBINATIONS:

Sound and 12v assembled and tested \$36 00

Video and 12v assembled and tested \$35 00

All 3 mods (H13B) assembled and tested \$45 00

"H13B — Deluxe" — All mods assembled and tested (\$89 and \$45) \$129 00

Note: All prices include sales tax.

COMPUTER EARS — SPEECH PROCESSOR

for PET, OHIO, VK101, TANDY, APPLE

NASCOM — Specify \$49 00

Write for **SALE PRICE LIST — FREE.**



Tandy Electronics — new products and policies

Tandy Electronics recently added 12 new products to their line-up in Australia. Announcing the releases, Tandy also gave details of marketing strategies for the business and educational markets, and made some scathing criticisms on the lack of direction from Education departments on the controversial subject of computers in the classroom.

Tandy claims that their new Model 16 "puts minicomputer performance into a complete, compact desktop system". The Model 16 is Tandy's venture into the 16-bit market, combining the software base of the Z80A Model II and the power of the MC68000 16-bit microprocessor.

The Z80A handles input and output and other "housekeeping", and also allows the machine to run all TRS-80 Model II programs. The MC68000 running at 6MHz, provides advanced capabilities and allows the machine to use up to 512K bytes of programmable memory. (The Model 16 comes with 128K of RAM as standard, and can be expanded internally to 512K).

Features of the Model 16 include an 80 x 24 line green phosphor display, a detachable keyboard with numeric keypad, and one or two built-in 20cm disk drives, each providing 1.25MB of storage. Optionally, Tandy's hard disk

controller unit can be added, providing 8.4MB of storage and the capacity to add three "secondary" hard disk drives, giving a total of 33MB.

One or two terminals can be attached to the Model 16, so the system be used by three users simultaneously, each running a different program. This "multi-user" capability allows users to add computing power as their requirements grow, without the need for additional software or hardware (apart from the terminals).

Software for the Model 16 consists of Tandy's own 16-bit operating system, which includes an editor, assembler, linking loader and debug program. Model 16 Cobol is also available for users who want to develop their own business programs. Software written in ANSI-74 standard Cobol can be transferred to the Model 16 "with little or no modification" according to Tandy.

Tandy also released the TRS-80 DT-1 data terminal, a stand-alone video terminal which can be used with the Model 16 or mainframe computers. The DT-1 can be configured under software control to emulate four standard terminal protocols; Televideo 910, Lear Siegler ADM-5, ADDS 25 or Hazeltine 1410. A back-up battery retains the terminal parameters when the machine is turned off.

Also announced is a new version of the Tandy Pocket Computer, the TRS-80 PC-2. This machine is slightly larger than the original PC-1 (195mm x 86mm x 25mm) and is said to be up to ten times faster. A 16K Basic in ROM offers features equivalent to the TRS-80 Model III, and 4K and 8K plug-in modules are available to expand the 1.8K of RAM provided internally.

The new PC-2 can be coupled with a four colour printer/plotter unit, which also contains two cassette interfaces. The tiny printer/plotter uses four pens, moved by solenoids in conjunction with forward and reverse movement of the printer platen to produce print-outs and plots in nine different character sizes in red, blue, green and black.

Tandy also announced details of a new range of printers, starting with the CGP-115 Color Graphics Printer, which uses the same printing mechanism as the PC-2 printer/plotter. Three new dot matrix printers have also been announced and a new lower priced daisywheel printer, intended for low volume professional printing applications.

It was Tandy's announcement of policies for the educational market which aroused the most interest.

Tandy has been active in computer education since 1978 and are one of the few microcomputer suppliers who maintain a specialist Education Division, offering workshops, seminars, in-service training and consultation.

There is at least one Tandy Computer training centre in each capital city (except Hobart). Each facility typically offers a number of computers for "hands-on" training and are used to conduct familiarisation sessions for teachers, school principals and educational ad-



continued on p133

SPHERE COMPUTERS

Box 380 Darlinghurst NSW 2010



AN ADVANCED SYSTEM BASED ON THE 6809 MICROPROCESSOR

- * EFFICIENT
- * VERSATILE
- * EXCELLENT SUPPORT
- * SUPERB SOFTWARE
- * MK2 MULTI USER AND MULTI TASKING



PERIPHERALS
Additional VDUS, Dot Matrix Printers, Daisy Wheel Printers, 8" and 5" Floppy Disk Systems, and a hard disk drive of up to 40MB may be connected to the system. Interface boards and software are available to support all these devices in a singular or multi-user environment.

INPUT/OUTPUT
8 I/O Boards slots are provided, each of which may be fitted with a dual serial or dual parallel interface board using DB-25 "D-TYPE" Connectors. Many other types of interface Boards are also available.

CABINET
The Cabinet is made of heavy gauge (approx 1/8") Aluminium Anodised in Delightful blue.

SIZE
Approx: 16" wide by 20" deep by 7.5" high.

WEIGHT
Approx. 10KG. (including supply, CPU, 64K RAM, and I/O board).
A/C POWER INPUT 115-240 VOLTS A/C +/- 10%, 50-60Hz

MK 1 and MK 2 SPECIFICATIONS

PROCESSOR
The heart of the system is the Motorola 6809 CPU and considered to be the most powerful 8 bit Microprocessor available today. The CPU board is fitted with Memory Management hardware which allows it to directly address up to 1 Megabyte of memory using a 20 Bit address bus. The system is provided with a 2716 compatible 2k Monitor ROM or EPROM.

MEMORY
A 64K Ram board is provided as standard. However the system may be provided with as little as 8k if desired and more added later.

POWER SUPPLY
Provides 8.5V, +12V, -12V unregulated supply to the buss. All components are P.C board mounted and fuses readily accessible.

SOFTWARE SPECIALIST FOR THE 68XX SERIES

MICROWARE SYSTEM CORP

OS-9 Level 1 Operating System	\$195.00
OS-9 Level 2 Operating System	\$495.00
Basic 09 Programming Language	\$195.00
Pascal OS-9	\$440.00
Macro Text Editor	\$ 95.00
Assembler	\$ 95.00
Debugger	\$ 35.00
Stylograph Word Processor	\$175.00
Cobol Programming Language	\$995.00
C Programming Language	\$440.00

TECHNICAL SYSTEMS CONSULTANTS

UNIFlex Operating System	\$550.00
UNIFlex Basic	\$200.00
UNIFlex Pascal	\$250.00
UNIFlex Fortran 77	\$350.00
UNIFlex Relocating Assembler & Language Editor	\$175.00
General Purpose Flex 6809	\$165.00
General Purpose Flex 6800	\$165.00
Exorcisor Flex 6809	\$165.00
SWTPC Flex 6809	\$ 45.00
GIMIX Flex 6809	\$ 99.00
TRS80C Colour Flex	\$ POA
Extended Basic	\$110.00
Utilities	\$ 82.50
Pascal for Flex	\$220.00
68000 Cross Assembler for Flex	\$275.00

Sort Merge Package	\$ 82.50
Text Editor	\$ 55.00
Assembler	\$ 55.00
Debug Package	\$ 82.00
Diagnostics	\$ 82.50
Text Processor	\$ 82.50

FRANK HOGG LABORATORY, INC

XForth	\$165.00
Basic Programmer Tool Kit	\$ 77.00
Extended Use Utilities Pack	\$ 77.00
Password Protection Pack	\$ 99.00
Dynasoft Pascal Flex	\$ 99.00
Bill Payer System	\$185.00
Spell Test	\$220.00
Super Sleuth	\$110.00
Stylograph 2:0	\$325.00
Dynastar Full Screen Editor OS-9, Flex	\$ 99.00
CRASMB Cross Assembler, Flex, 6809, 6800, Z80, 8080, 6502	\$149.00
Dataman + DBM	\$220.00
Plot	\$ 49.00
Tabula Rasa	\$110.00
Job Control Program	\$ 99.00

WASHINGTON COMPUTER SERVICES

6809RMS DBM for Flex	\$220.00
6809 RMS DBM for UNIFlex	\$330.00
6809 RMS DBM for OS-9	\$275.00

All prices plus Sales Tax if applicable

UNIVERSAL DATA RESEARCH INC

DBM 2 Flex	\$450.00
DBM 2 UNIFlex	\$550.00
Payroll	\$495.00
Accts Receivable	\$495.00
Accts Payable	\$495.00
General Ledger	\$495.00
Inventory	\$495.00

TALBOT MICROSYSTEMS

tForth	\$ 99.00
tForth+	\$275.00

COMPUTER SYSTEM CENTRE

DYNAMITE Disassembler	\$ 66.00
DYNACALC	POA

DUGGERS GROWING SYSTEMS

6809 C Compiler ver 2:0	\$130.00
-------------------------	----------

OMEGASOFT PRODUCTS

PCS2 Pascal Compiler Flex, OS-9, MDOS	\$490.00
Rall1 Relocatable Assembler & Linking Loader	\$150.00

SWTPC

EDIT Word Processing Editor Flex	\$110.00
C Compiler for UNIFlex	\$ POA

* Prices subject to alteration without notice, \$5 handling and packaging plus postage.

AVAILABLE FROM

Office and showroom:
Shop 1 165 Bunnerong Rd Kingsford NSW 2032.

Postal address:
PO Box 380 Darlinghurst NSW 2010.
Tel (02) 344 9111 Telex AA22579

J.H. MAGRATH & CO
55 A-Beckett St,
MELBOURNE, VIC 3000
TEL: (03) 347 1122

“Why buy just a video game when you can get a full colour computer for this price.”

A computer like this would have been science fiction a few years ago. Now it's a reality. It's the Commodore VIC-20, a full-fledged, expandable colour computer that costs little more than video games.

Everybody loves video games and the VIC-20 has some of the best. But the Commodore VIC-20 can also help the kids with their homework and mum with her budgeting. Dad can even take the light, portable VIC-20 to the office for financial and business applications.

And Commodore has many more applications on the way.

With Full Capability For:

- Education programs
- Recreational programs
- Personal computing
- Includes Microsoft, PET BASIC
- Full-size typewriter-style keyboard
- Easy to follow instruction manual
- Memory expansion to 32K RAM
- Connects to any TV set
- 66 graphic characters
- 25K total memory
- 4 sound generators
- 16 colours



VIC-20

The computer for everyone.

The VIC-20 is the friendliest way we know to learn computing. It has a full computer keyboard even a small child can operate.

It plays music, has exciting graphics and lets you create pictures. It even tells you when you've made a mistake and how to correct it. The VIC-20 can take your children from pre-school through post-graduate studies.

Why get just another game that could end up in the closet? Get an honest-to-goodness computer for just \$399. Get the Commodore VIC-20.

Learn more about Commodore, the micro-computer you can depend on. Call or write for the name and location of your Commodore dealer nearest you.

The Commodore Information Centre,
3 Campbell St., Artarmon NSW 2064. Phone: 437 6296.

 **commodore**
COMPUTER

Microcomputer News

ministrators. The computer centres are freely available to schools and individual teachers who wish to bring in classes.

In South Australia Tandy has donated equipment worth \$35,000 to the South Australian Education Department. The donation is intended to demonstrate Tandy's concept of the "computer classroom" with off-the-shelf equipment and software.

The biggest sale to date has been the purchase of \$933,000 worth of TRS-80 Model III computers by the Queensland Colleges of Technical and Further Education. The computers will be used in Queensland technical colleges to meet the demand for training in word processing, data processing and in "Computer Awareness in Society" and business courses.

According to Tandy, the adoption of computer technology in Australian schools has been anything but smooth. Mike Lehman, Tandy's Educational Marketing Manager, says the process has been "characterised by mystery, an aura of complexity, and pre-conceived ideas". Australian schools, with a few notable exceptions, have failed to take advantage of the equipment and consultation services available.

Most of the blame, says Tandy, rests with bureaucrats in both state and federal Education Departments. In many cases, decisions on the type of equipment to be used in schools has been left to a handful of people, "a band of amateur programmers-cum-teachers, or professional programmers with no knowledge of teaching, trying to re-invent the wheel", according to Tandy.

Most administrators, including Education Ministers, directors-general and heads of resources allocation committees, have admitted to a total incapacity to question the decisions made by this

small group of people, to Tandy's evident frustration.

As an example of the "inappropriate" decisions being made, Tandy cites the ruling by the NSW Education Department that colour displays are an important feature of computers for use in the classroom. Tandy quotes figures to show that out of 272 computers with colour capability currently used in NSW schools only 31 are used with colour video monitors. Presumably many schools do not see the need for colour.

Tandy were particularly critical of the NSW Education Department. It seems that the officer appointed to co-ordinate the use of computers in State Schools has upset Tandy by not visiting their computer centres to see what is on offer. Worse still, says Tandy, the NSW Computer Education Office has not formally advised regional committees of the availability of the Tandy computer centres.

Mr Richard Wiktorowitz, of the NSW Computer Education Office, when contacted by this writer, replied that the in-service training courses are organised by regional committees, and says that Tandy were advised to approach each regional authority directly.

Some regions do take advantage of the availability of the computer centres. Schools in the western metropolitan region of Sydney, for example, have obtained permission and funding for in-service computer courses at Tandy's Rydalmere computer centre training rooms.

Tenders for the supply of computers to NSW schools are called each year, to ensure that the Education Department sees the latest in technology. At the time tenders were called for approval of computers for purchase in 1982 many of the products which Tandy cites as significant advances in education were not available. No doubt Tandy will have their chance to present current equipment when tenders are called for 1983.

Tandy expects that by 1985, educational applications will account for 20% of their computer sales. They already of-

fer an extensive range of educational software (or "courseware", as they call it), and new titles and subjects are constantly being introduced. Scheduled for introduction next year is the Tandy authoring system and hardware to allow a Model II computer to control video tape and video disc players.

Tandy make no secret of the fact that their efforts to introduce TRS-80 computers into schools is self-serving. The company freely admits that it is hoping that school sales will flow on to the domestic and business markets as more and more people become familiar with computers.

"Psychotec" — program for the Microbee

Melbourne software supplier "Dreamcards" has turned its hand to programs for the Microbee, with the first offering, called "Psychotec", said to turn your computer into "a tame psychiatrist". The program allows a dialogue between operator and computer in the style of a psychiatric interview, and is based on the controversial "Doctor" programs developed some years ago in the United States.

The language processing logic which is the heart of any "conversational" program has been completely re-designed to adapt the program to the Microbee.

The program is supplied as a printed booklet containing a full program listing, a complete description of the program logic, and instructions for use. Instructions for conversion to other Basics are also provided. Users of the Super-80 should note that the program is particularly easy to convert because of the common string handling capabilities of both machines.

The program listing and instructions cost \$20, with a cassette copy in Microbee format an extra \$5. For further information send a stamped, self-addressed envelope to Dreamcards, 8 Highland Court, North Eltham, Vic 3095.

VIC 20s ★ ACCESSORIES ★ SOFTWARE ★ PERIPHERALS

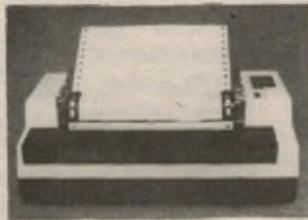

Vic 20 \$399! Arfon module \$250! Printer \$479! Disk drive \$699! Cartridges from \$39.95!

We have a wide range of accessories, peripherals, and software for the Vic — including Commodore, Vicsoft, Acme, etc.

EDIBLE ELECTRONICS 50 PARK ST, ABBOTSFORD 3067. (03) 41 5708

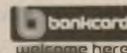

Programs by shortwave and a universal Basic

In 1981 Radio Netherlands began a unique experiment, broadcasting programs for popular microcomputers over its worldwide short-wave network using standard cassette data formats. The experiments were successful, with many listeners reporting that they were able to record the programs off-air and run them on their computer.

Programs were broadcast using the cassette data formats of the Apple II, TRS-80 and Commodore PET systems. To cope with the demands of owners of other systems to be included in the experiment, Radio Netherlands also began work on a "universal" version of Basic, and a universal cassette interface to suit many popular microcomputers.

A recent letter from Radio Netherlands advises us that this work is completed. The universal language, called "NOS BASICODE" allows programs to be written for the Acorn Atom, TRS-80 and System-80 computers, the Apple II, Exidy Sorcerer, OSI and SWTPC computers. In some cases minor hardware modifications are required to the cassette interface, and of course, machine language subroutines cannot be incorporated in programs.

David Webster wins CHIPS award



Mr David Webster, Managing Director of D. D. Webster Electronics Pty Ltd was awarded the Australian Computer Industry's major 1982 CHIPS Award for services to the Australian Computer Industry. The Award was presented in conjunction with the Data '82 Computer Ex-

hibition in Sydney in August. Future tests on Radio Netherlands' short-wave program "Media Network" will use a 300 baud translation program, while 1200 baud version of the system is in weekly use on Dutch domestic radio. Computer users in West Germany report being able to record programs off medium-wave radio.

Radio Netherlands broadcasts to Australia via a relay station in Madagascar, and early results in this country were disappointing. The best chance of receiving a usable program requires a direct connection between the receiver and a cassette recorder (no microphone), levels of recording as high as possible without distortion, and maximum treble boost.

The protocol for NOS BASIC, details of hardware modifications, and a cassette input translation program for 10 different machines is available in a booklet from Radio Nederland, together with a cassette of sample programs. Computers covered are the Acorn Atom, Philips P200 (popular in Europe), the DAI, Sorcerer, Apple II, PET/CBM, TRS-80 and Videogenie (the European version of the System-80), the Cosmac VIP, the OSI IP and SWTPC 6800 systems.

Cost of the booklet and cassette is 35 Dutch Guilders, including airmail postage. At the time of writing the exchange rate is f2.61 to \$A1.00, so the book and cassette will set you back \$13.40. Payment must be made in Dutch Guilders however, via international money order payable to "Nos Algemeen Secretariat". The address is PO Box 222, 1200 JG Hilversum.

hibition in Sydney in August.

D. D. Webster Electronics manufacture the Spectrum-11 range of minicomputers, based on the DEC LSI-11 processor with Webster's own slave processor and peripheral boards. Since 1977, 400 Spectrum-11 minicomputers have been installed, with exports to the United States and South-East Asia.

The judges remarked that Mr Webster "has demonstrated that given determination and innovative ability, an Australian company can start in the humblest possible way and grow to compete successfully in one of the world's most competitive computer markets".

Other CHIPS awards included "the most innovative computer application of the year", which went to Tom Zajovic, managing director of Tel Professional Consulting Services, for his work on automating coal loaders, and "the best computer advertising of the year", awarded to the Tandy Corporation for "Computerama", a highly successful series of computer exhibitions held in Sydney, Melbourne, Adelaide, Brisbane and Perth during early 1982, and seen by an estimated 90,000 people.

SME 48K memory board with battery back-up

SME Systems has introduced a 48K CMOS memory board with battery backup, intended to store operating system software and retain data even when the computer system is switched off. The CRC-48 board is designed for use in systems with clock rates of up to 8MHz, and is fully compatible with the S-100 bus.

A major feature of the CRC-48 board is its low power consumption. With a full complement of 6116 2K x 8 bit memory chips, the on-board 30mA/hr battery can ensure data storage for around 250 hours. The 6116 RAM chip is pin-compatible with single supply EPROM chips, which can be substituted in any combination for the RAM devices.

Bank protect logic and write protection are also provided.

For more information contact SME Systems, at 22 Queen St, Mitcham, Vic 3132. Phone (03) 874 3666.

New from the Clubs

- A computer interest group has been formed for the northern suburbs of Brisbane. Called "Computer Owners' Group" (COG), the club publishes a monthly newsletter called "COG 'n' Spiel" and encourages membership by owners of a variety of machines so that all members gain wider knowledge of computers. Emphasis is on computer use and programming rather than hardware.

The club meets on the second Wednesday of each month. Contact the secretary, Mrs Betty Adcock, PO Box 115, Aspley, Qld, 4034. Phone (07) 263 4268.

- The Hasting Computer Group meets on the first Tuesday of each month at the Port Macquarie High School. Contact Secretary Neville Joyce, 8 Morton St, Wauchope, NSW 2446, for more information.

- The South Australian branch of the Commodore/VIC Computer Users Association meets each month. Further information is available from the Secretary, 13 Miranda Rd, Paralowie, SA 5108.

- The Northern and Western Suburbs Computer Users Group (Queensland) meets every second Thursday at the Maribyrnong Primary School, Warrs Road, Maribyrnong. For more information contact Mr David Coupe, 370 9590.

- The Blue Mountains Computer Club has changed its meeting schedule to the second and last Friday of each month, at the Springwood Civic Centre, 7.30pm. Contact Mr T. McIndoe, c/o Faulconbridge Post Office, NSW 2776.

LET THE

AUSTRALIAN BEGINNING

BRING MAINFRAME POWER INTO YOUR HOME OR OFFICE



THE AUSTRALIAN BEGINNING PTY LTD

The Australian Beginning Pty Ltd is an Australian company, with Australian based computer facilities, using the Australian Telecommunications network to offer Australian clients Australian information services and software.

WE ARE PROUD TO ANNOUNCE THE LAUNCHING OF AUSTRALIA'S FIRST MICROCOMPUTER INFORMATION UTILITY

The AUSTRALIAN BEGINNING is Australia's first microcomputer information utility, aimed at giving the average microcomputer user access to the computer data banks and also massive storage space previously only available to large Mainframe installations. The era of home computers has now officially begun in Australia, now that the AUSTRALIAN BEGINNING is here: as now, any small businessman or student can have on his desk for an extremely small cost, a system that has the level of storage power and access to data banks for which only a few years ago, government departments and large private users were paying millions of dollars.

The AUSTRALIAN BEGINNING can be accessed through a number of 'approved' personal computers, and terminals, by use of an acoustic coupler or modem.

Users will receive a number of benefits which will include:

INFORMATION SERVICES

Members will have access to a number of information sources which will include the latest news, sports results, financial reports, and farm information.

NATIONWIDE COMMUNICATION

Members will be able, also, to communicate nationwide with other AUSTRALIAN BEGINNING members through our system.

THE AUSTRALIAN BEGINNING RECOMMENDS 3M DISKETTES

SOFTWARE BANK

Users will have access to a myriad of computer programs that will include entertainment, educational aids, programming and diagnostic tools, and financial applications.

MAINFRAME POWER

Users will have the capability to make use of the Mainframe's huge storage capacity by using any of our large programs, or storing your large programs on our system.

SHOP AT HOME

You can take advantage of our 'shopping by computer' system to get the best prices on a number of popular consumer items.

EXTREMELY EASY TO USE

You do not have to be a computer programmer to make use of the AUSTRALIAN BEGINNING. All of the instructions are in everyday English, so that even the younger members of your family will be able to operate the system.

LOW COST

While services like these used to cost tens of thousands of dollars to the government departments and large corporations who used them, they are now available to you for less than the cost of a packet of cigarettes a day for the 'average' user.

You can join the AUSTRALIAN BEGINNING by paying a one-time joining fee of \$100, and a small hourly user charge of \$10 an hour 8 a.m. - 6 p.m. and \$4.50 an hour 6 p.m. - 8 a.m.

TELEX

Through the AUSTRALIAN BEGINNING'S unique telex feature — you can send messages to any telex users and receive messages back from anywhere in the world. All without having to pay an installation or rental fee for a telex machine.

TO JOIN THE AUSTRALIAN BEGINNING FAMILY, AND TAKE ADVANTAGE OF THE EXCITING SERVICES WE WILL BE OFFERING, PLEASE COMPLETE THE COUPON BELOW:

MEMBERSHIP REQUEST

Yes, I think the idea of the AUSTRALIAN BEGINNING is great! I enclose \$100 so please send me my user manual and password

I have a computer, Brand.....

Model.....

Please send me information on low cost equipment packages I can use to take advantage of the AUSTRALIAN BEGINNING'S services.

NAME:

ADDRESS:

CITY:

STATE: POSTCODE:

PHONE:

THE AUSTRALIAN BEGINNING (SALES) PTY LTD.

364 LaTrobe Street, Melbourne, Victoria, 3000. Tel: (03)329 7998

I am interested, but I need more information.

DEALER INQUIRIES INVITED

Quotation from Electronics

“the best for a Computer”

That's the brilliant Dick Smith SYSTEM 80 Blue Label

Try it for yourself . . . and see why Electronics Australia liked it so much! The new 'Blue Label' System 80 computer has even more features than before – and the best news of all, it actually costs less! Cat. X-4005

Features:

- ★ 16K Memory (expandable to 48K with X-4020 Expansion Unit)
 - ★ Full upper and lower case video display capacity
 - ★ Built-in speaker
 - ★ Built-in cassette deck with level control
 - ★ Works with any standard TV set or monitor
 - ★ Flashing Cursor
 - ★ Huge range of software programmes
- AND SO MANY MORE FEATURES!!!

“Overall we are very impressed with the Blue Label System 80 . On a dollar per function basis it probably represents the best value around for a readybuilt computer. Other systems can be bought for less, but ultimately they are not as readily expandable as the System 80. There is also the matter of software, and here the System 80 really scores, with hundreds of compatible programs available for the TRS-80 as well as those specially written for the System 80.”

Reprinted with the kind permission from.
ELECTRONICS AUSTRALIA June 1982

*Huge range of software
Compatible to most Tandy TRS 80 I programmes.*

~~WAS
\$750~~

**NOW
\$699**

HCF
\$21.88
per week

SORCERER DEMO

We are replacing our display stock and the Demo models must go! The famous Exidy Sorcerer computer comes with the industry standard Microsoft 8K BASIC, Z80 CPU based, 32K RAM, and many other features. It is the most powerful flexible and business like machine in its class.”

- ★ Latest Model, not superseded.
- ★ Full new computer warranty.
- ★ Demo & Store Models.
– Some with imperceptible case marks.

★ ACT QUICKLY AND YOU'LL REAP THE BENEFIT!

SALE



HCF
\$16.24
per week

BE QUICK –
ONLY A FEW AT THIS PRICE!

Cat. X-3002

Australia, June 1982

value around ready built



OVER 10,000 SOLD!



FINANCE AVAILABLE ON SELECTED ITEMS TO APPROVED CUSTOMERS. ALL PRICES QUOTED ARE TAKEN PER WEEK OVER A 12 MONTH PERIOD.

COLOUR COMPUTER UNDER \$400!

VIC-20

Colour Graphics, Sound and more for under \$400! This remarkable breakthrough in computer technology represents outstanding value for money. And you don't have to know anything about electronics or computer programming to enjoy the advantages of the Vic 20 Colour Computer. Anyone can operate it with ease and confidence. It's ready to use as soon as you turn it on. Cat. X-2000



HFC \$9.19 per week

- Look at these Features**
- Colour Graphics in up to 8 colours
 - Memory expandable up to 32K with plug-in modules
 - Typewriter style keyboard & programmable function keys
 - An inbuilt tone generator for music and sound effects

ONLY \$399

7 DAY TRIAL OFFER
 If you're not completely happy, you can return your computer within 7 days in original condition and packing for a full refund. You owe nothing - not even an explanation!

DATSUN STANZA DRAWN THIS MONTH!

Hurry! It could be your last chance to win a great Datsun Stanza. All you have to do is purchase a System 80, Sorcerer or VIC 20 and fill in the entry coupon supplied. It's that simple! Good luck!

Definitely Closes this Month!



DICK SMITH Electronics

SEE PAGE 98 FOR ADDRESS DETAILS

INC IN NSW
DSE/A379/JW

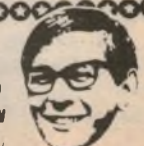



INFORMATION CENTRE

WIND DIRECTION INDICATOR: The January 1982 issue contained an article by John Clark called the Low Cost Wind Direction Indicator. The introduction referred the reader to the original project of an anemometer published in the August 1981 issue with further information regarding rewiring of the switch S1 in the October issue.

I have obtained both these issues and unless I am going blind in my old age I did not find any reference to the new or original project between the covers of both the entire magazines. What gives John? I wish to embark on said project but am not psychic! (L.P., Armadale, WA).

● The Wind Speed Indicator was published in the October 1981 issue, on pages 50 to 56. The person responsible for this error still bears the terrible scars of his punishment.

THE ALL-WAVE THREE: I am writing to you in the hope of obtaining some information concerning a certain project of yours that I have almost completed. The project in question is called the "All-Wave Three", dated April 1980. I have completed this project with the exception of the four Neosid toroid formers of type 4329R/2/FS. I know the frequency range of these toroids but unfortunately I do not know their initial permeability, and hence I cannot buy any equivalent types to substitute for the hard to get type mentioned above.

I would appreciate it if you could tell me either the initial permeability of this type (as once I know this I can buy the equivalent from Amidon Associates of America), or tell me from where the type used in this project was obtained. (D.B., Whitton, NSW).

● Neosid toroids are distributed in Australia by Watkin Wynne Pty Ltd, 32 Falcon St, Crows Nest, NSW. They are available in Sydney from Radio Despatch Service, 869 George Street, Sydney. Phone (02) 211 0190. Incidentally, the correct type number for these toroids is 4329R/2/F25.

SELECTALOTT: I seek your help in completing a project which has yielded a limited success in operation.

The project referred to is the Selectalott Pools/Lotto game. Upon completion I had no problems with operation of the circuit; all worked as per the written

word. However the problem encountered is one of making the unit select numbers over the full capability of numbers. The lowest that I have been able to select is 10.

I believe that a modification has been given to alter this, however I have not been able to find this. Could you please advise the necessary steps to correct this minor problem. (G.F., Para Hills, SA).

● We have not published any Errata on this project and as far as we know, the article did not contain errors. It seems likely that you have a malfunction in the circuit. When you say you cannot select numbers below ten, are you saying that every selection gives a number above ten? Or do you draw blanks quite frequently? If the latter case is true then it is likely that you have an open circuit in the connections to pins 1 and 2 of IC1, as these outputs drive the first two rows of LEDs, the numbers one to 12.

DMM REPAIR: Although the following may not be an item of major importance, I feel that it is interesting enough to write to you about, and may save money. Recently, after working on a high voltage power supply (3kV), it was discovered that my digital multimeter was showing a constant offset of 70 on all ranges. This DMM is a 3½ digit LCD instrument and contains display driver circuitry, an AC converter, an Intersil ITS80062 chip, batteries and switchgear.

The ITS80062 was the item which had gone faulty, doubtless due to a high voltage transient. The cheap solution was to buy a new chip. A ring to the Intersil dealer brought forth "sorry no such number", moment of silence, "but it could be a special factory number". This could be expensive, I thought, if the instrument had to be sent to the dealer's service section for a new chip, but we persevered.

It was decided that the chip would probably be a standard Intersil line. Working from this I told the gentleman on the phone what type of DMM it was, ie 3½ digit LCD etc. Comparing the circuit diagram with his description we came up with the Intersil ICL7106CPL, which was exactly the same as the ITS80062 except that the pins were reversed, ie pin one was pin 40, pin two was pin 39, etc. It was then that I realised why I had been unable to find a pin one identification dimple on the IC. A screwdriver was

grabbed, the chip removed and there was the dimple, on the underside of the IC.

So it was concluded that the DMM makers when buying ICL7106's for their instruments have Intersil, during manufacture, flip over the ICs bend the legs in the opposite direction and stamp a different identification number on the device. This means that you, the owner, would have to send the instrument to the dealer's servicing section.

The solution now is simple: purchase a standard Intersil ICL7106CPL (approximately \$17) and working on an anti-static surface carefully bend the legs through 180° and insert the chip into the socket (checking the orientation), power up and the instrument is fully operational again. It would also be wise to write a brief note and staple it to the circuit diagram. (M.A., Clayton, Vic.)

● We agree that your solution may have been quick and simple but we wonder whether the DMM distributor may have had the correct item readily available and possibly cheaper. And were some parameters of the chip specially selected for the particular application? Before using a non-standard part (which may be perfectly acceptable) we would always be inclined to first approach the manufacturer or distributor to inquire about price and availability. That way, you know the device will work.

A typical case where this latter approach is usually the only practical way concerns FETs used in CRO circuits. While these usually have familiar type numbers they are often specially selected types for the particular application. Try as you might, an off-the-shelf FET from your friendly local parts grocer will usually be a dismal failure.

SPEED SENTRY: I have recently completed construction of your Speed Sentry circuit (May 1981) for the purpose of using it as an audible over-rev alarm as fitted to some exotic high performance cars. Unfortunately the circuit appears to work well at relatively low revs (up to 3000 rpm) but will not function reliably at higher engine speeds. Can you suggest any simple modifications which could overcome this problem? If the circuit cannot easily be adapted for high engine speeds (up to 7000 rpm) perhaps you would consider publishing a suitable

Self-excited wind generators not much chuff!

THOUGHTS ON WIND GENERATORS:

Having read both John Andrew's article on the rewinding of a 12 volt car alternator (EA July 1978) and G. J. Bowden's letter in the July 1981 issue, I would like to offer a few belated comments.

The problem with any self-excited generator lies in the fact that below a certain critical speed it fails to build up its field, and only produces a very small voltage from the residual field. One can reduce the critical build-up speed by rewinding the field coils with a heavier gauge of wire, so producing a higher magnetomotive force for any given applied voltage. The MMF for any given voltage depends only upon the gauge of wire; naturally one puts on the maximum number of turns which can be got into the available winding space to keep the field current and therefore the energy loss as low as possible.

The other method, the one adopted by Mr Andrews, is to leave the field winding as it is and rewind the stator with more turns of a smaller gauge of wire. This produces the same effect.

The real point about any wind driven generator is that it must be capable of putting something into the battery at low speeds, ie, in light winds, which are the normal condition in most parts of the world for most of the time. The quoted output from the modified machine was 13 watts at 417rpm. Firstly, 417rpm isn't really low speed (it's nearly 7 revs per second). Secondly, 13 watts at 12 volts means about one

amp of useful charging current, but to obtain this it was necessary to put two amps into the field. Disregarding other losses, the efficiency was only 33%. The wind rotor would therefore have been producing at least 40 watts, most of which wasn't available. Mr Bowden's test results clearly put the kiss of death on self-excited generators driven directly from the wind rotor.

I have held the opinion for many years that any viable small wind power system must have a permanent magnet generator. This ensures that the maximum field is present all the time, and eliminates the problem of critical build-up speed. It also eliminates the field winding loss which as we have just seen is a major factor under the wind conditions which prevail for most of the time.

If we wish to fulfil the condition of having a useful output at low wind speeds using a single generator we will have to accept the problem of a speed increaser, otherwise the machine will have to be wound with such a small gauge of wire to get the necessary number of turns that its maximum output will be unduly restricted. This doesn't however have to be a gearbox. Why not a toothed belt as used for the timing drive in many modern cars? They have a high mechanical efficiency, require only a weather shield, and the drive would relieve the generator of end thrust.

Permanent magnet machines are more or less self regulating through armature reaction, but in any case the

output could be kept within the thermal limit by electronic regulation in the load circuit. Alternatively, the speed could be regulated by automatic (centrifugal) feathering of the rotor blades. This is desirable in any case, and would be within the capabilities of many hobbyists.

Direct driving combined with a significant output at very low speeds would seem to require two generators (both permanent magnet) in tandem on the same shaft. The first machine, for light wind conditions, would probably require a greater number of turns per phase than Mr Andrews' modification, and should be designed to reach 12 volts and start charging at about 150rpm. It would be electronically controlled to cut out when the wind speed brought it up to its thermal limit, at which point the second machine should be designed to cut in and take over.

I agree with Mr Bowden that the wind rotor end thrust should not be imposed on the generators. The rotor should be on a stub shaft with a pin type coupling which cannot transmit end thrust. Car alternators have 12 pole rotating field magnets with imbricated pole pieces and a single magnetising coil. It wouldn't be very difficult to reconstruct one with a cylindrical permanent magnet in place of the coil. Speaker magnets would probably be suitable. (A.B., Nundah, Qld.)

● Thank you for your thoughtful comments on windpower. We will have another article on this subject in a subsequent issue.

design in a future issue. (J.R., Alderley, Q).

● To adapt the circuit for higher engine speeds we suggest you reduce the value of the 47k Ω resistor connected to pin 3 of the 741 op amp.

CLOCK INTERFERENCE: Greetings from the Sovereign State of Queensland where the fishing is extra fine. Though our weather has been cold, rumour hath it that our beloved leader intends before next winter to build along the border a high wall to keep out the blast of cold air from the Nether Regions thereby making the Sovereign State more like Paradise.

In this epistle I have not been game to make any remarks about Daft Time, as twice in the last two months I have had an unexplained Happening. I own a Goldair AM/FM Electronic Clock Radio which normally keeps within ± 30 secs of correct time. However one Sunday night recently I found the clock over one hour fast. Rejecting the theory that some

of Nifty's Heavies had been tampering with it while I'd been working downstairs, I reset things to correct. All went well for another three weeks when again on a Sunday night I found the clock about 12 minutes fast. Again I reset it and no further anomalies have occurred.

Seriously, the only cause I can think of is mains interference. On the first Sunday we'd been working extensively with an electric drill for a large part of the day; on the second Sunday I'd used the old Sunbeam electric fry-pan to cook tea for the first time in ages. What think you? (H.S., Bulimba, Qld.)

● Perhaps you are right. Why not try additional filtering across the low voltage supply rail to the clock circuitry. In addition, a 0.1 μ F metallised polyester capacitor connected directly across the transformer low voltage winding may be of assistance.

MUSICOLOUR Mk III: I purchased a Musicolour Mk III from Dick Smith electronics and assembled it. Since I assembled it, I have had to replace the components twice, at considerable expense and time. I found the fault to be a damaged flood light which was shorting and blowing the output Triacs.

My kit is now operational again, but I have had hesitations in using it for fear of another short circuit. I would be grateful if you could advise me on some sort of protection device (ie, fuses) that I could build into my Musicolour to prevent further damage to it through possible short circuits in my lighting system. Thank you. (R.S., Floreat Park, WA).

● In the article on the Musicolour III published in September 1976, we did warn against using lamps with a rating in excess of 150W. The problem with high power lamps is that if an arc occurs in the stem of the lamp the resulting cur-

Shorten the Circuit.

Your Complete Computer System
for Printed Circuit Board Design Automation.

COMPLETE DESIGNS IN HOURS, NOT WEEKS
FULL DOCUMENTATION
CAMERA READY ARTWORK

For a demonstration and information on
our Design Automation seminars, phone
Daro Office Systems Pty. Ltd.
Sydney Mike Avey (02) 699 3877.
Melbourne Ian Allen (03) 690 6600.

- Single or multi-user
- Indepth training
- Complete systems
from \$16,200.

DARO
AUTOMATION SYSTEMS.

Rest in Peace
Old Gell
sealed lead
batteries.

Your number is up.
Because here comes EXIDE's new...

LIVE TWICE

(for the same money)

RE* SYSTEMS BATTERY
(*Recombination Electrolyte... a space-age breed
built nothing like all you oldtimers.)

Poor Gell Oldtimers,
Flatten you to zero volts and you stay dead. I take charge and
come up near full potential. Now that's living twice.
You only live 3 years at best. I live 5-6 years. That too is
living twice.
I fit anywhere you can (1-65 A.h). I standby on continuous
charge. Or I take cycling duty. Living twice again.
Folk who want to persevere with outmoded batteries, why
that's their business. You OEMs and users who do your sums
know a battery that LIVES TWICE for the SAME MONEY
is twice the value.

The RE Systems Battery... from Chloride. Call for details NOW:
Sydney 646 2244, Melbourne 288 6244, Brisbane 44 1751,
Adelaide 277 7255, Perth 271 7377, Hobart 34 4022

L. E. CHAPMAN

122 PITT ROAD, NTH CURL CURL.
MAIL ORDERS: BOX 156, DEE WHY, NSW. 2099.
TELEPHONE 93-1848.

SUPER SPECIAL

GRAMOPHONE motor and pickup 3 speed
stereo balanced arm.

240 volt \$9.75
PP NSW \$1.50
Interstate \$2.75
WA \$4



SUPER SPECIALS FM STEREO TUNER KITS

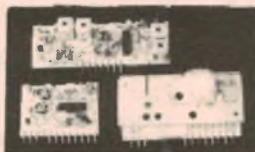

Sets of 3 modules include FM tuner, decoder
and IF detector. Circuit diagram supplied. Can
be used with amp modules.

ONLY \$22
P&P \$1.40

SUPER SPECIAL

FAMOUS M.S.P. H.I. FLUX SPEAKERS

7 x 5, 15 Ohm. Strap a pair together for
8/Ohm 14/Watt R.M.S. — \$7.00 a pair
P&P NSW \$1.80; Interstate \$3.50; WA,
TAS, NT \$4.00



BSR DELUX RECORD PLAYER

11 INCH TURNTABLE CUING DEVICE
SHIELDED MOTOR MAGNETIC CARTRIDGE

\$50. BASE & PERSPEX TOP \$22 EXTRA
P&P NSW — \$4.50; INT — \$5.50
WA — \$6.50
NT — \$6.50



SPEAKERS 2 1/2" INCH

2 FOR \$1

MAGNAVOX SPEAKERS

8 INCH DUAL CONE 16 OHM 10 WATT

\$6



PP NSW \$1.80
INTERSTATE \$2.75
WA, TAS, NT, \$4.

DUAL VU METER \$3



Touch micro switches 4 for \$1
100 mixed capacitors fresh stock
handy values \$2
Crystals for a colour TV \$1.50
100 mixed resistors handy values \$2
200 mixed screws, bolts, nuts,
self tappers, etc \$1

SLIDE POTS

1/2 meg dual 50 cents
1 meg dual 50 cents
2 meg dual 50 cents
25K dual 50 cents
250K dual 50 cents
1K dual 50 cents
50K single 30 cents
250K single 30 cents
10K single 30 cents

VU & BALANCE METERS



12K Ω 100 μ A \$2.00
STEREO VU \$3.00

SPEAKER SYSTEMS

\$29.50 PAIR

Two 6" Dual Cone Magnavox
Speakers in each cabinet!
10 watts RMS
P&P NSW \$4.50 INT \$5.50 WA \$6.50
— NT \$6.50

POTS ROTARY

1/2 Meg 30c
1 Meg 30c
100K 30c
100K Switch 50c
50K Double Pole Switch 50c
7.500 30c
10K Switch 50c
250K 30c
50K 30c
20K 30c
10K Min Pots 25c
50/ohm 50c
1/2 or 1 Meg Switch 50c
1/2 1 meg dual Concentric tapped at 100K \$1
2 meg ganged double pole switch \$1
1.5 meg dual ganged 50c
2 meg ganged log \$1
1 meg dual ganged \$1
1/2 meg dual ganged LIN 75c
25K 50K dual ganged Concentric
double switch \$1
200K single line 30c
20K wire wound 75c
Dual log 10K 75c
100K dual ganged linear pots 75c
10K sub min log pots 50c
250K ganged pots 75c
25K lin ganged pots 75c

SPECIAL MAGNAVOX SPEAKERS

10 INCH WOOFER \$20 PAIR
10 INCH MID RANGE
8 OHM SYSTEM, 20 WATTS RMS



P&P NSW \$3.50 — INT \$4.50 — WA \$5.50
NT \$6.50

SPECIAL

SPEAKER CROSSOVER NETWORKS 2WAY
FREQ 4KHZ 30W 80HM

\$2



rent may well blow the Triac before it blows the fuse in the stem. Additional fuses in the Musicolour will not help. In any case, these economy plastic-pack Triacs are not really expensive, at around \$3, and any protective circuit is likely to cost more than this. For the best display, use lamps with ratings of no more than 100W.

FM RECEIVER: I found a diagram for an FM receiver in a book called "Understanding Electronics" by R. H. Warring. Unfortunately it gave no component values. As I have only scratched the surface of electronic theory I can't work out the values. Please will you do this for me. The schematic diagram is enclosed. Please also can you tell me where I can purchase the transformers and the cost. Thanks for any help in answering this letter and a great magazine. (D.M., Esperance, WA).

● We do not think the author of your reference understood much about his subject. Otherwise he would not have shown a receiver for FM using only two transistors and two diodes. Some idea of the circuitry needed for an FM receiver can be gained by looking at the circuit for the tuner module used in our Playmaster AM/FM tuner. The circuit of the module was published in November 1978.

OPTO-ELECTRONIC IGNITION: I found one small mechanical problem when using the opto-electronic ignition unit (June 1981), which I feel I should pass on to other readers.

In many distributors, including mine (Australian Lucas), there is quite a lot of play in the centrifugal advance mechanism. Normally this is no problem because the drag of the points in the cam and rotor always "follow" the distributor drive shaft. However, with the points removed, the lack of drag means that the rotor, cam and chopper disc can sometimes "lead" the drive shaft, and sometimes "follow", producing a random variation in timing (of 4° in my case).

The solution is simple. Leave the points in, but not electrically connected, and mount the phototransistor and LED opposite them, with the rest of the electronics outside (my distributor was too small to fit the PCB anyway). Reliable timing results, as the points still cause sufficient drag on the cam.

With this modification, the unit seems excellent. Driving is noticeably smoother. Also, cutting the dwell angle on the chopper disc as shown in the article, produces a larger dwell angle in operation, because the chopper switches the circuitry on at a different point on the phototransistor to where it switches it off. In my case a cut gap of 36° produced a 42° measured dwell. This, of course, does not hurt. (S.R., Lane Cove, NSW).

Electronics Australia Reader Service

"Electronics Australia" provides the following services:

PHOTOSTAT COPIES: \$3 per project, or \$6 where a project spreads over multiple issues (price includes postage). Requests can be handled more speedily if projects are positively identified, and if not accompanied by technical queries. We reserve the right to supply complete back issues instead of photostats, where these are available.

CHASSIS DIAGRAMS: For the few projects which require a custom metal chassis (as distinct from standard cases) dyeline plans showing dimensions are normally available. \$3 including postage.

PC BOARD PATTERNS: High contrast, actual size transparencies: \$3, including postage. Please specify positive or negative.

PROJECT QUERIES: Members of our technical staff are not normally available to discuss individual projects, either in person at our office, or by telephone.

REPLIES BY POST: Limited to advice concerning projects published within the last three years.

Charge \$3. We cannot provide lengthy answers, undertake special research, or discuss design changes. Nor can we provide any information on commercial equipment.

OTHER QUERIES: Technical queries outside the scope of "Replies by Post" or submitted without fee may be answered in the "Information Centre" pages, at the discretion of the Editor.

COMPONENTS: We do not sell electronic components. Prices and specifications should be sought from advertisers or agents.

BACK ISSUES: Available only until our stocks are exhausted. Within six months of publication, face value plus 90c for post and packing for each issue. Seven months and older, \$3 (includes post and packing and storage fee).

REMITTANCES: Must be negotiable in Australia and made payable to "Electronics Australia". Where the exact charge may be in doubt, we recommend submitting an open cheque endorsed with a suitable limitation.

ADDRESS: All requests to the Assistant Editor, "Electronics Australia", Box 163, Chippendale, 2008.

● Thanks for the useful feedback, S.R. We wonder if the same problems occur with conversions using toothed magnet rings and Hall effect devices. Anybody know?

FOREIGN COMPONENTS: I wonder if you would be able to answer a couple of questions to which I have been unable to find answers. During WWII I was in radar so I know about magnetrons, but I trained as a biologist and have just gone back to electronics as a hobby. I have read all the texts, and built many of your circuits, mainly instrumentation. The whole field is fascinating; on a breadboard I can design and build circuits ten times more complex than circuits in the forties. But there are two snags.

How on earth can one get data on the European and US photodiodes, ICs and so on? For example, the TIL 100, it is not in my (expensive) T.I. photoelectronics data book. And what about the endless European semis? I look at a European circuit (I am mainly interested in optoelectronics) with diodes, ICs and so on, to which I can find NO reference whatsoever in the catalogues I can buy in Melbourne. Every new circuit I look at has a new photodiode! eg, the TIL 100, how do you find out it's dark current?

Secondly, where do you buy the things? I want an AD545L, nobody has heard of it. Do you write to the US?

These questions must be common, but I have not seen them discussed in "Radio & Hobbies" as I still think of your magazine. My reference book is Horowitz & Hill "The Art of Electronics". I suppose one can buy 5% of the op-amps described briefly and used in circuits in that book!

I have been designing and building high gain amps for modulated IR receivers. There are literally dozens of semis which would be useful, but none of the dealers

have heard of them, eg, the SL 480.

There must be hundreds of people in my position, who want to design their own circuits but who do not have the library of a big engineering firm. Maybe there is an article here. (N. H., Canterbury, Vic).

● We commiserate with you. We suspect that the TIL 100 is now an obsolete device. The AD545L, a precision FFT-input op amp, made by Analog Devices, Inc is distributed in Australia by Parameters Pty Ltd, 41 Herbert St, Artarmon, NSW. The SL480 is made by Plessey but we have no knowledge of it. It is distributed in Australia by Plessey Components, 4 Christina Road, Villawood, NSW.

In fact, virtually every semiconductor manufacturer in the world is represented at some level in Australia. But, with relatively few exceptions, they are all asleep. None seem to be interested in promoting or advertising their wares, either in this magazine or in the small controlled circulation magazines. One wonders whether they are interested in doing more business. We often have great difficulty in obtaining data or samples of new devices.

We suppose that some semiconductor distributors may have all the business they can handle but there must be many who are doing little to exploit their potential market in Australia.

Notes & Errata

INFORMATION CENTRE (October 1982): The answer concerning headphone sensitivity on page 141 has two errors. For the example quoted, the output impedance is 330Ω and maximum loudness will occur when the headphone impedance matches the source impedance.

MARKETPLACE

FOR SALE

SUPER 80 OWNERS. Software now available. **SUPER INVADERS:** Destroy the aliens before they destroy you! **SEA WARS:** you are attacked by planes, subs, missiles and mines. **CHESS CHASERS:** (Similar to Pacman), both games in machine code, animated graphics. 16k and character requires. \$25.50 Each + P&P \$1.50. Send cheque or money order to MEAGASOFT, 151 Denton Ave, St Albans 3021.

ORGAN, expanded version of Playmaster 760, pedals, 2K BOS (F-F), in well made console. Builder lacks expertise to solve audio problems. Has lost interest. Ideal to build upon. Photographs and sundries available. R.H., 88 Bayview St, Williamstown 3016.

SUPER 80 JOYSTICKS. Fully proportional dual joysticks with four pushbuttons for use in real time games. Comes complete with assembly manual and interface program. Kit \$39.95. Assembler/Editor, to run on a 16k (or more) Super 80, complete with 21-page instruction manual. \$34.45. Source listing of Monitor V1.2. Original source listing of the Super 80 monitor program with comments. Great for learning machine code! \$11.95. Write to PELATRONICS, PO Box 807, Toowong, Qld 4066.

ZX 81 FUN GAMES: Golf, Darts, Shove-halfpenny, Deadly Dungeons, Ancient Sumeria, Chess, Blackjack and others. Send for catalogue. Adelaide Software Supplies, Box 153, St Marys 5042, SA.

AMIDON FERROMAGNETIC CORES. Large range for all receiver and transmitter applications. For data and price list send 105 x 220 SASE to RJ & US Imports, PO Box 157, Mortdale, NSW 2223.

QUALITY NICAD BATTERIES. Cheap. AA; sub C; C and D size to 4 amp. Fast charge. Suit most gear incl. flashguns, toys and Big Jim torches, etc. Last for years. Info 557 Merrylands Rd, Merrylands 2160. (02) 636 1592 any time.

CB RADIOS, \$67, walkie-talkies, shortwave radios, military, outback, business, amateur, marine, repairs, aerials, 40 Ch conversions, new rigs weekly. Bridge Disposals, 12 Old Town Plaza, Bankstown Rail Station. Ring Sam 7pm-9pm only (02) 407 1066.

ICOM IC25a 25 Watt Synth: 2 metre mobile radio, with scanning, program offset, 5 memories. 2 VFO's As new. still in box \$300. Wahroonga. Ph (02) 483 688

CURTIS SYNTH IC's — 3340 (vco) \$20, 3320 (vcf) \$16, 3310 (ADSR) \$16. User notes \$1.50 ea. NRC ELECTRONICS, 135 Rae St, Nth Fitzroy 3068

S100 dynamic memory boards 16k-64k, S100 disc controller boards, 2650 single board computer systems, can be expanded to S100. Ass or kit. Software available for tape or disc system. CAE Electronics, 1/27 Forge St, Blacktown 2148 (02) 621 4242.

DISK UPGRADE KIT

ENHANCE YOUR SORCERER!

- ★ Auto Boot ★ Monitor Entry
 - ★ 48K + Basic ★ Easy to fit
- Micropolis \$44.95 Exidy FDS \$39.95
P.J.B. Box 252 Forestville 2087

MUSICAL WARE. Valves 6 L. 6 GE at \$4 ea, minimum quantity 10. Ph (03) 480 5988 9am to 5.30pm Mon-Fri.

READER SERVICE

HAVING TROUBLE interfacing to your microcomputer? We will design and manufacture an interface to suit your individual requirements and supply the software to drive it. Also available EPROM programming service. CAE Electronics, 1/27 Forge St, Blacktown 2148 (02) 621 4242.

COMPUTER CLINIC, repairs and services Sorcerer, Pet, Apple, Super 80, System 80, Tandy and others. (07) 269 8573, PO Box 68, Aspley, Qld.

REPAIRS to all home, hobby and small business microcomputer systems and peripherals, also all EA and ETI projects. CAE Electronics, 1/27 Forge St, Blacktown 2148 (02) 621 4242.

COMPUTER REPAIRS. All makes. EPROMS programmed. Mach lang routines written. Ph (09) 401 2733.

REPAIRS to Personal Computers at low rates for Apple, Pet, Sorcerer. System 80, IBM, Peach, Actari, and many others. Phone Len Harman (02) 632 5656 any time.

DISPLAY ADVERTS IN MARKETPLACE are available in sizes from a minimum of 2cm x 1 col rated at \$15 for a col cm.

CLASSIFIED RATES \$3.60 for 40 letters or part thereof an insertion payable in advance. Minimum 80 letters.

Please use coupon below.

CLOSING DATE is six weeks prior to the on-sale date. Issues are on sale the first Wednesday of each month.

FOR HIRE

MICROCOMPUTERS FOR WEEKLY RENTAL — \$25 per week. Commodore PET systems, with manuals and software tapes. Cassettes include games and self-teaching tutorials in BASIC and 6502 machine language. David Bates & Associates, ph (02) 630 8652.

REMOTE ANTENNA SITE, 40 miles from Perth. Electrically quiet — ideal for large HF installations. We will erect and maintain to your specifications. Write to Antenna Science & Engineering, PO Box 238, Nedlands, WA 6009. or ring (09) 386 2010 for details.

MICRO RENTAL. Microcomputer systems of various models and configurations with peripherals, are available for hire from DORF MICROCOMPUTER. Start-up and reference manuals included. Sydney 922 1644 or 960 1808 (AH).

Electronics is going digital. This book can help YOU go right along with it: Here are the chapter headings:

1. Signals, circuits and logic
 2. Basic logic elements
 3. Logic circuit "families"
 4. Logic convention and laws
 5. Logic design: theory
 6. Logic design: practice
 7. Numbers, data & codes
 8. The flipflop family
 9. Flipflops in registers
 10. Flipflops in counters
 11. Encoding and decoding
 12. Basic readout devices
 13. Multiplexing
 14. Binary arithmetic
 15. Arithmetic circuits
 16. Timing & Control
 17. Memory: RAMs
 18. ROMs & PROMs
 19. CCD's & magnetic bubbles
 20. D-to-A converters
 21. A-to-D converters
- Glossary of terms

Available from "Electronics Australia", 57 Regent St, Chippendale. **PRICE \$4.50 OR** by mail order from "Electronics Australia", PO Box 163, Chippendale, 2008. **PRICE \$5.40.**

RCS Radio Pty Ltd

Tel. (02) 587 3491

IS THE ONLY COMPANY
WHICH MANUFACTURES AND
SELLS EVERY PCB & FRONT PANEL
published in EA and ETI
**651 Forest Road Bexley 2207
AUSTRALIA**

RING FOR INSTANT PRICES
24 HOUR TURNAROUND SERVICE

RETAILERS WANTED IN ALL STATES

We make superb quality durable mobile antennas for CB, Ham and Commercial users. These are luxury items at reasonable prices and outperform and outlast all others tested. We also make bases and roller inductors. Excellent profits assured. If your shop has a possible place for us then please write for further details to:

**ANTENNA SCIENCE & ENGINEERING,
P.O. BOX 238, NEDLANDS, WA**

ELECTRONICS CENTRE

BARGAIN PRICES • PERSONAL ATTENTION • SLICK MAIL ORDER SERVICE • SATISFACTION

WAREHOUSE SELLOUT SCOOP

ALL BRAND NEW STOCK WITH WARRANTY

PUSH BUTTON TELEPHONE DIALER WITH MEMORY
\$25.95
P-P 90c



Last phone number memory re-call. Busy number redialled by touch of one button. Instant cut-off by touch of one button. Converts your old fashioned mechanical system into a modern, reliable, speedy phone dialer. Easy to install.

WALKIE TALKIE with MORSE CODE KEY
\$19.95
P-P \$2



Better quality, made in Japan 27MHz. Solid state transceiver. Power 50MV 1/4 mile range. Morse code chart printed on case. Vol control with switch. Telescopic antenna. Type 216, 9V battery.

AM-FM PUSH BUTTON CAR RADIO
8 WATTS



4-8 ohms 12 volt neg gr Good reception. Sounds great O A. size 180W 110D 45Dmm

\$35.95 P-P \$2

MULTI-BAND INCL X AND K RADAR DETECTOR
\$95
PP \$2



ULTRA SENSITIVE FAMOUS U.S.A. BRAND

12 volt. Covers all six bands used by police radar, plus experimental bands. Detects moving radar. Auto-rejects non radar signals. Audio warning — short beeps. Visual warning — bright light. Comprehensive book. Installs in seconds.

PYE BELT-DRIVE STEREO PLAYER

PRO MODEL TA-10
\$89.95

P-P NSW \$5.50
Q, V, T, SA \$6.50
WA, NT \$7.50



Detachable Headshell
Magnetic Cartridge
Diamond Stylus

Features — Manual Start • Auto Return • Eject Lever • Cue Lever • Full Size, 30cm Heavyweight Aluminium Platter with Anti-static Mat • 2-speed 33-45 rpm • Fully Calibrated Adjustable Counterweight • Anti-Skate • 240 VAC 50Hz 4 Pole, Fully Shielded Motor • Switch Click Suppressor • 3 Core Power Cable, Audio Cable with RCA Plugs • Base Size 40 x 30.5cm •

IN4004 DIODES
400 PIV 1AMP
\$7.50 PER 100. P-P 90c.

BSR STEREO RECORD PLAYER MANUAL OPERATION

240V 50HZ

LATEST DESIGN MODEL P-207 • S SHAPE TONE ARM WITH COUNTERWEIGHT • CERAMIC CARTRIDGE — DIAMOND STYLUS • AUTO RETURN AND STOP • 33-45 RPM • PLAYS 7", 10", 12" RECORDS • CUT-OUT TEMPLATE, INSTRUCTIONS •

\$39.95 P-P NSW \$4.50, WA, NT \$6.50 Q, V, T, SA \$5.50



FM WIRELESS MICROPHONES

No cable to trip over operate with FM receiver, 88-108MHz
PRO MODELS

Unidirectional model (illustrated) **\$34.75 P-P \$2.50**
Omnidirectional model **\$26.75 P-P \$2.50.**
Tie tack model with separate pocket size transmitter **\$43 P-P \$2.50**

Pro quality FM receivers available
Send stamps for tech. data.

TECNICO VARICAP VHF front end tuner
2 BANDS • 46.25 — 107MHz
• IF 33.4 MHz • 138.25-221.75 MHz • IF 38.9 MHz • 3.28V OPERATION • CIRCUIT SUPPLIED

\$10.95 P-P \$1.50

FLAT 5-CORE EX-PMG PHONE CABLE

5 std colours 7mm wide
White PVC covered.

75c metre or 10 metres for **\$5.**
P-P \$1.70

TECNICO STEREO FM FRONT END TUNER

BRAND NEW SUPERIOR GEAR • FULLY CONSTRUCTED ON PCB • UP TO 10.7 MHz • IF STAGE • IN FULLY SHIELDED METAL BOX 74 x 70 x 42MM • INCLUDES 5 GANG TUNING CAP • 2 RF STAGES • FREQ 87.5 — 108.5 MHz • SUPPLY 12V 10MA • CIRCUIT SUPPLIED •

P-P \$1.50 **\$10.95**

SILVER PLATED VARIABLE CAPACITOR



150pf air spaced 1" x 1/4" dia shaft
Ceramic insulation

\$4.50 P-P 90c

NEW GRAMMO MOTOR
Has 101 uses 240VAC 50Hz
Double ended 4mm shaft Length 25mm and 14mm
\$5.50 P-P \$2.50

VARIABLE SPEED CONTROLLER
Solid state. 240 VAC 50 HZ 2 BA
Ideal for electric drills, motors, etc.
\$6.50 P-P 90c.

SUB MINIATURE ROTARY SWITCH BY DAVEN U.S.A.



1 pole 15 positions 3 bank Gold plated contacts Fully sealed dust proof. O A dia 20mm. Body dia 16mm Body length 32mm Shaft 10 x 3mm dia

\$3.50 P-P 90c

2.5MM CHROME PLATED BRASS NUTS/BOLTS

Round philips head bolts
12mm x 2.5mm dia \$2 per 100
2.5mm hex nuts \$2 per 100
P-P 75c

HIGH GRADE POTTER AND BRUMFIELD RELAY



KU series • 240 VAC 50Hz operation • 3 sets of 240V 10 amp change over contacts • perspex cover and mounting base included • size 50mm x 37mm x 35mm • ex-computer • as new condition. At less than 1/3 of the normal price
\$3.50 P-P 95c

!KEEP IT COOL!

EX-COMPUTER FAN MOTOR
GUARANTEED PERFECT WORKING ORDER.
220-230VAC. 50Hz INPUT

STURDY DIECAST FRAME • 10 BLADE STEEL ROTOR •

113 x 113 x 50MM.
IDEAL FOR — AMPS • POWER SUPPLIES • TRANSCEIVERS • ETC •
P-P NSW \$1.50 **\$12.50**
INTERSTATE \$2.50

AUDIO SWITCH DPDT



10 for \$2.95
P-P \$1.

GENUINE FACTORY PRICES ETONE 12" SPEAKER SPECIALS



GUARANTEED TOP QUALITY BRAND NEW BARGAINS
Rugged diecast frame 8 and 15 ohms available
12" Woofer, 30 watts RMS. Reson 65Hz Freq 50-8000Hz
\$28.50 each OR 2 for **\$49.95.** P-P for 1, NSW \$3, Interstate \$4.50
12" Twin Cone 30WRMS Reson 65Hz Freq 50-15,000Hz
\$29.50 each OR 2 for **\$52.** P-P for 2, NSW \$4.50 Interstate \$6.50
EXTRA SPECIAL — 12" HI-FI WOOFER
60 WATT RMS. 8 OHM FREQ 30-4000Hz Reson 30Hz. HEAVY DUTY DIECAST FRAME FOAM SURROUND
\$34.95 EACH OR 2 FOR **\$64.** P-POST AS ABOVE

EA Magazine Holders



The binders and magazine holders are available over the counter from Electronics Australia, 57 Regent Street, Sydney, NSW — Price: \$5.10 binders, \$4.50 holders

Mail orders should be sent to Electronics Australia, PO Box 163, Chippendale, NSW 2008.

Prices including postage are:

Holders: \$5.50 NSW, \$5.60 other states or six for \$29.00 NSW; \$31.50 other states, \$A33.00 NZ.

Binders: \$7.00 NSW; \$8.50 other states or six for \$33.00 NSW; \$36.00 other states, \$A37.00 NZ.

ADVERTISING INDEX

ADVERTISER	PAGE
A & R Soanar	62
AWA Ltd	17
Ace Radio	143
Altronic Distributors Pty Ltd	18, 19, 53, 64, 65, 94, 118
Ampec Engineering	48
Amtex Electronics	62
Antenna Science Engineering	142
Applied Technology	76, 77
Audax Loudspeakers	127
Auditec Aust	37
Billco Electronics	57
Bright Star Crystals	88
C. K. Corporation Pty Limited	60
Chapman L. E.	140
Chloride Batteries Aust Pty Ltd	140
Clift Electronics	116
Commodore	132
Computer Country Pty Ltd	22, 135
Danish Hi Fi	88
Daro Office Systems Pty Ltd	140
David Reid Electronics Ltd	36
Defence Force, Recruiting	
IN CENTRE SECTION	
Dick Smith Electronic Group	10, 11, 30, 50, 51, 70, 72, 73, 98, 100, 101, 111, 115, 122, 136, 137
Edible Electronics	133
Electronic Agencies	27
El Graphics	99
Electro Medical Engineering	23
Ellistronics	117
Elmeasco Instruments Pty Ltd	
IN CENTRE SECTION	
GFS Electronic Imports	29
Homelec Products	95
Jaycar Pty Ltd	4, 5, 35, 42, 43, 80, 81, 84, 91, 105
Loctite Aust	OBC
Looky Video	129
McGraths	9
Marantz (Aust) Pty Ltd	IBC
Parameters	20, 31
PJB Systems	142
Paris Radio Electronics	131
Philips	2
RCS Radio Pty Limited	142
Radio Despatch Service	60
Rod Irving Electronics	38, 39, 56, 69, 103, 108, 109, 120
Royston Electronics	97
Sanyo (Aust) Pty Ltd	
IN CENTRE SECTION	
Sheridan Electronics	54
Silvertone News	99
SME Systems	128
Software Source	99
Sony (Aust) Pty Ltd	IFC
Stotts Technical Correspondence College	106
IN CENTRE SECTION	
TDK	
Trade Television & Video Service	75
University of Cape Town	129
Vendale Nominees Ltd	123
Warburton Franki	79
Wireless Institute of Australia	123

EA PC BOARDS AND FRONT PANELS

Some readers have problems obtaining PC boards and front panels for projects. Many of our advertisers sell these items and their advertisements should be checked in the first instance. Failing that, below is a list of firms which produce or sell PC boards and front panels.

NSW

Dick Smith Electronics,
125 York Street,
Sydney, 2000.
Telephone 290 3377.
DSE also has branches and resellers throughout Australia.

Electronic Agencies,
115-117 Parramatta Road,
Concord, 2137.
Telephone 745 3077.

117 York Street,
Sydney 2000.
Telephone 29 2098.

Jaycar Pty Ltd,
125 York Street,
Sydney 2000.
Telephone 264 6688.

Radio Despatch Service,
869 George Street,
Sydney 2000.
Telephone 211 0816.

RCS Radio Pty Ltd,
651 Forest Road,
Bexley, NSW 2207.
Telephone: 587 3491

VIC.
Rod Irving Electronics,
425 High Street,
Northcote, 3070.
Telephone 489 8131.

Kalextronics,
101 Burgundy Street,
Heidelberg 3084.
Telephone 743 1011.

Shop 11,
Regional Shopping Centre,
Melton 3338.
Telephone 743 1011.

Sunbury Printed Circuits,
Lot 14, Factory 3,
MacDougal Road,
Sunbury 3429.
Telephone 744 2714

WA

Altronics,
105 Stirling Street,
Perth 6000.
Telephone 328 1599.

Jemal Products,
8/120 Briggs Street,
Welshpool, 6106.

N.Z.
Marday Services,
PO Box 19 189,
Avondale, Auckland.

Mini Tech Manufacturing Co Ltd,
PO Box 9194,
Newmarket.

Printed Circuits Limited,
PO Box 4248,
Christchurch.

SUBSCRIPTION SERVICE



ELECTRONICS Australia

Subscription Rates

\$28.00 per year within Australia
\$A29.50 per year elsewhere

Make sure you receive every copy of the magazine by ordering it from your newsagent or the publisher. For publisher subscriptions post this coupon, with your remittance to Electronics Australia Subscription Dept. John Fairfax & Sons Ltd, GPO Box 506, Sydney 2001. Subscription will start with first available issue.

Name

Address

Postcode Enclosed is for years

Exclusive to Marantz. Very sophisticated. Very superior. Very expensive.



Very high fi indeed.

These Marantz Gold components represent the world's most advanced, most inspired, most stringently tested and sophisticatedly engineered audio equipment.

For the wealthy—exclusive toys.

For the connoisseur—the finest hi-fi money can buy.

The Marantz TT1000 (around \$2500), with its precision-made high density glass and golden aluminium sandwich structure, is justifiably described as one of the most beautiful turntables ever.

'Playing a series of direct-recorded discs, warped discs, discs with nasty low frequency content and discs requiring unusual trackability performance, showed clearly that this system borders on the superlative in areas where even most good turntables only provide good to above average performance.'

'...the resonance characteristics of the TT1000 are the lowest we have yet seen from any turntable irrespective of its selling price.'

'This is top-of-the-line equipment for people who rate hi-fi as their greatest pleasure in life'.
— Louis Challis, *Electronics Today International*, April 1981.

Similarly, the Marantz SM1000 Stereo Amplifier (around \$5000) is designed to be the ultimate in luxury and performance.

When it was benchmarked by ETI Magazine in an exhaustive lab study, Louis Challis stated 'The Marantz SM1000 Amplifier has the capability to provide superlative performance at home, in a laboratory, in a studio, or in a rock band with the ease and panache of a professional.'

'The power output claims are modest for the unit is readily capable of producing 625 watts into an 8 ohm load with both channels driven...'

And when the Marantz ST8 FM/AM Tuner (around \$700) was

put through its paces so technically surprising was its performance that a second series of tests was devised to check the first results.

'As a result... the Marantz ST8... far ahead of any tuner we have ever measured and better than any tuner we have ever seen reviewed in any other



The TT1000's adjustable, high-absorption air suspension audio insulator feet.

magazine, either local or overseas.' — Paul de Noskowski, *Electronics Australia*, April 1981.

Marantz Gold. The New Audio Standard.



ST8

Detailed specifications of these exclusive Marantz Gold components are available on request by writing to:

Marantz (Australia) Pty. Limited,
19 Chard Road, Brookvale, NSW 2100
Phone (02) 939 1900 Telex AA24121
Melbourne (03) 544 2011
Brisbane (07) 44 6477
Adelaide (08) 223 2699
Perth (09) 276 3706
Townsville (077) 72 2011

marantz



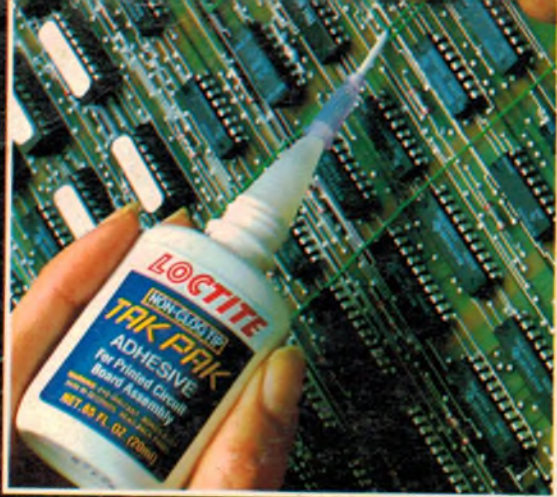

LOCTITE[®] TAK PAK[™] ADHESIVE SYSTEM For Printed Circuit Board Assembly



Tak Pak is the fastest adhesive system in the world

Printed circuit assembly? It'll be right with quicker, cleaner Tak Pak, specially formulated by Loctite for the Electronics Industry. Tak Pak's instant action saves material and labour and because components can be handled in 15 seconds or less, it is the most effective component tie down available!

BE RIGHT WITH LOCTITE TECHNOLOGY.

For full details, post the coupon now or call:
Loctite Australia Pty. Ltd. Telephone (02) 525 8366

LOC 992

To: Loctite Australia Pty. Ltd.
58 Alexander Avenue, Taren Point, N.S.W. 2229.

Please send me full details on your Tak Pak adhesive system.

Name

Title

Company Name

Address

..... Postcode