

AUSTRALIA'S NUMBER ONE ELECTRONICS MAGAZINE

# ELECTRONICS

## AUSTRALIA

OCTOBER 1983  
AUST \$2.10 NZ \$2.60

32-PAGE  
ROD IRVING  
CATALOG



### BUILD THIS VIDEO ENHANCER

**SUPERWEAPON  
SOFTWARE PROBLEMS  
SPEED SENTRY FOR CARS**

**YAMAHA R100  
RECEIVER REVIEWED**

**NEW CONCEPT DIGITAL MULTIMETER! ▲**





CDP-101

COMPACT  
disc  
DIGITAL AUDIO

# Hear digital perfection.

## Introducing the Sony Compact Disc Player.

When we used our long experience in digital technology to create the CDP-101 Compact Disc Player, we wanted to give you something more than the world's clearest sound.

**WIRELESS REMOTE CONTROL** Full-function remote control.

**3-WAY MUSIC SEARCH**  Instant direct access to any selection with the 10-key pad on remote control unit.  AMS (Automatic Music Sensor) allows access to the beginning of next or previous selection.  2-speed bi-directional search to find any desired music passage.

**REPEAT FUNCTION** Program to repeat the entire disc, one selection, or a specific portion of music.

**3-FUNCTION DIGITAL READOUT DISPLAY**  Selection number.  Time lapse of selection being displayed.  Remaining time on the disc.

**LINEAR SKATE DISC LOADING** Just press the button, platter control and cueing are automatic.

Get even more perfect sound with the Sony Digital Audio Component System, "Precise Series".



It's a Sony

**SONY**

AUD 0391

AUSTRALIA'S LARGEST SELLING ELECTRONICS MAGAZINE

# ELECTRONICS AUSTRALIA

Volume 45, No 10, October, 1983

## On the cover

Our covers features the video enhancer which is described on page 52. It won't cure ghosts, snow, or RF interference, but it can sharpen the edges of a clean picture and make it just that much better. And it won't cost a fortune!

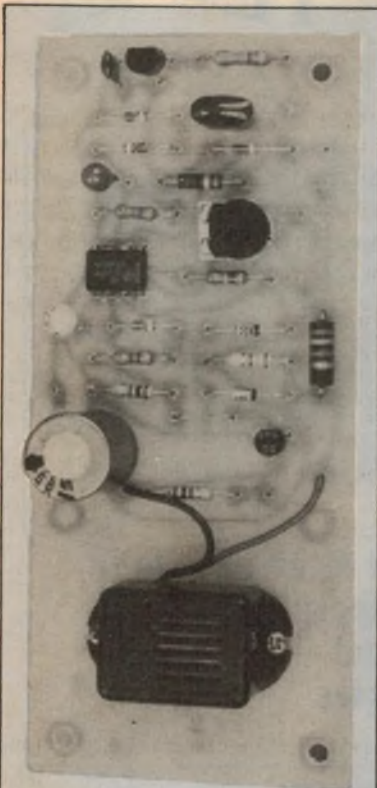

Save petrol, save wear, and don't get fined. Keep your speed down and drive within the law with our Speed Sentry. Details on page 60.



One of the Fluke series 70 multimeters described in the equipment review on page 16. They feature both digital and analog read-outs.

## Features

- 12 SUPERWEAPON SOFTWARE WOES *DOD computer headaches*
- 16 NEW CONCEPT DIGITAL MULTIMETER *Fluke 70 series*
- 22 THE INVENTIVE GENIUS OF NIKOLA TESLA *Part 2 of a three part series*
- 88 HOW TO OBTAIN BETTER TV RECEPTION PT. 4 *Log periodic antennas*
- 104 NEW CONCEPT IN ENERGY MANAGEMENT *Remote control for appliances*
- 125 50 & 25 YEARS AGO *TV in three years, the "smellies" etc*
- 130 EA CROSSWORD *And the solution for last month*

## Hifi, Video and Reviews

- 33 AUDIO-TECHNICA "SOUND BURGER" *Personal stereogram*
- 44 HIFI REVIEW *Yamaha R-100 AM/FM stereo receiver*

## Projects and Circuits

- 52 VIDEO ENHANCER *Touch up your TV pictures*
- 60 SPEED SENTRY FOR CARS *Drive within the law*
- 79 40 CHANNEL UHF AMATEUR TRANSCEIVER *Constructional details*
- 84 NAIL FINDER *The electrician's mate*
- 69 CIRCUIT AND DESIGN IDEAS *Model glow plug driver etc*

## Personal Computers

- 94 SIGMA DATA OKI i1800 COMPUTER *High resolution colour graphics*
- 126 PERSONAL COMPUTERS *New products*

## Columns

- 30 FORUM *Ageing ears — as sluggish as they say?*
- 66 SERVICEMAN *Fires in TV sets — one certain cause*
- 111 SHORTWAVE SCENE *Shortwave representative at WARC 84*
- 116 RECORD REVIEWS *Classical, popular, and special interest*

## Departments

- 3 EDITORIAL
- 6 NEWS HIGHLIGHTS
- 40 LETTERS TO THE EDITOR
- 105 BOOKS AND LITERATURE
- 108 NEW PRODUCTS
- 132 INFORMATION CENTRE
- 134 MARKETPLACE
- 133 NOTES AND ERRATA

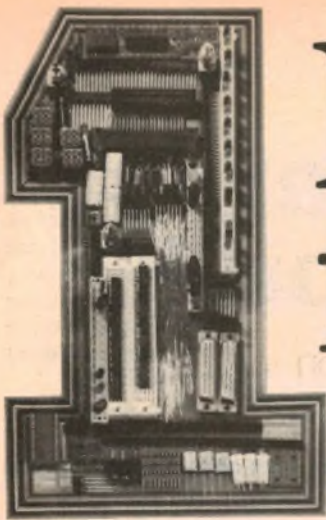

# No.1 for any bits.



**SOME AT COST!  
SOME BELOW COST!**

*While  
stocks  
last*

**High Quality  
S100 Bus**  
Fully gold-plated  
edge connector



**REDUCED  
TO COST**

P/N CR 12100DS  
**\$3.13**  
EACH



*Ideal  
for toys  
& hobbies*

P/N EP 610T16

**6 Volt Rechargeable  
1 Ampere Hour lead  
acid gel  
batteries** **\$9.11**  
EACH

**10 way bit  
Switches**  
AT COST

*While  
stocks  
last*

**\$1.19**  
EACH

P/N 1010692

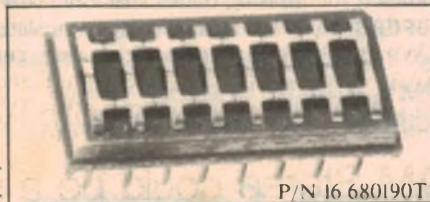

P/N 16 680190T

**16 Pin Programmable  
header**

**50** cents  
each

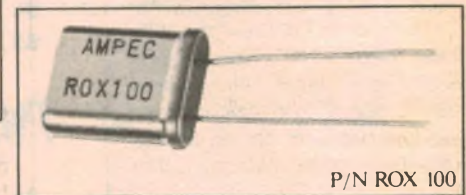

P/N ROX 100

**10 MHZ Crystals**  
BELOW  
COST **\$1.80**  
EACH



*Mail order welcome.  
Add 10% for postage.*

*Sales tax not included*

## The Ampec Trade Shop

No. 1 Wellington Street,  
Rozelle, N.S.W. 2039  
PHONE: 818 1166

**AMPEC**  
The absolute in peripheral thinking.



ATS 007



## Editorial Viewpoint

### EDITOR

Leo Simpson  
B. Bus. (NSWIT)

### ASSISTANT EDITOR

Greg Swain, B.Sc. (Hons. Sydney)

### EDITORIAL CONSULTANT

Neville Williams  
F.I.R.E.E. (Aust.) (VK2XV)

### TECHNICAL PROJECTS

John Clarke, B.E. (Elect. NSWIT)  
Peter Vernon, B.A. L.L.B. (NSW)  
Jeff Skeen  
Colin Dawson

### PRODUCTION

Danny Hooper

### GRAPHICS

Robert Flynn

### SECRETARIAL

Christine Cleary

### ADVERTISING MANAGER

Selwyn Sayers

### CIRCULATION MANAGER

Alan Parker

#### Editorial and Advertising Office

57 Regent St, Chippendale 2008.

Phone (02) 699 3622 Telex 25027.

Postal Address: PO Box 163, Chippendale, 2008.

Advertising Sales Manager: Sel Sayers.

Melbourne — 392 Little Collins St, Melbourne  
3000. Phone (03) 602 3033.

Representative: Mark Christian.

Adelaide — Charles F. Brown & Associates  
Ltd, 178 Fullarton Rd, Dulwich 5065

Representative: Sandy Shaw (08) 332 7711.

Perth — 454 Murray Street, Perth 6000.

Representative: Ashley Croft (09) 321 8217.

#### Circulation Office

Unit 3B, Sydneygate, Waterloo, 2018.

Phone (02) 699 2388.

#### Subscriptions

Subscription Dept, John Fairfax & Sons Ltd,

GPO Box 506, Sydney 2001.

Enquiries: Phone (02) 699 2388.

Registered by Australia Post —

publication No. NBPO2040.

ISSN 0313-0150

\*Recommended and maximum price only.

Printed by Magazine Printers Pty Ltd, Regent Street, Chippendale and Masterprint Pty Ltd, Dubbo, NSW for Magazine Promotions, Regent St, Chippendale.

Copyright. All rights reserved.

Information is furnished in this magazine without responsibility for its ultimate use or for any failure of equipment to operate as expected, or for any damage, loss or injury which may be sustained. Patents may apply to devices or arrangements depicted in this magazine. Material intended for publication is submitted at the sender's risk and while care will be taken, responsibility for any possible loss will not be accepted by "Electronics Australia".

**Distribution:** Distributed in NSW by Magazine Promotions, 57 Regent St, Chippendale, in Victoria by Magazine Promotions, 392 Little Collins Street, Melbourne; in South Australia by Magazine Promotions, 101-105 Waymouth St, Adelaide; in Western Australia by Magazine Promotions, 454 Murray Street, Perth; in Queensland by Gordon and Gotch (A'asia) Ltd; in Tasmania by Ingle Distributors, 93 Macquarie St, Hobart; in New Zealand by Gordon and Gotch (NZ) Ltd, Adelaide Rd, Wellington.

## Channel 0 to cease transmission in 1984

Amateur radio operators will be delighted. The Minister for Communications, Mr Duffy, has decided that the temporary arrangement whereby SBS Multicultural Television began transmissions on VHF channel 0 and UHF channel 28 will indeed be temporary and will cease at the end of 1984. And a good thing too. From the end of 1984 multicultural television will be available only via UHF channels 28 or 54.

Channel 0 never was a good allocation for television, for a number of reasons. For a start, it is slap up against the six metre amateur band from 52 to 54MHz and so is subject to mutual interference with amateur transmitters. Second, since it is the lowest television channel it is the most prone to interference from CB on 27MHz and to electromagnetic interference from high voltage mains transmission lines.

Another major source of interference is the brushes and commutator of the ubiquitous universal motor used in countless consumer appliances such as food mixers and electric drills. These all do their bit lessening in viewer enjoyment when watching channel 0.

Add to that the antenna problem. Sydney viewers did not have antennas cut for channel 0 but it was not until transmissions began that the problems arising from this began to be recognised. Any TV antenna cut to suit Sydney conditions, where Channel 2 used to be the lowest channel, can be expected to be "down the gurgler" as far as channel 0 is concerned. For most viewers this simply meant that they received a snowy and unwatchable picture. But in strong signal areas the falling low frequency response of the antenna could result in "picture pulling" because the sync amplitude of the recovered video signal was reduced.

But now that channel 0 is to cease operation not everyone in Sydney will be consoled by the fact there is a much improved channel 28 signal now being radiated from the top of the channel 2 tower at Gore Hill. The fact is that the temporary introduction of SBS on channel 0 in 1980 was a backward move and has probably delayed the phasing out of VHF-only sets on the Australian market. And that in turn has delayed the wider use of UHF translators in difficult metropolitan reception areas.

Whatever happens, one thing seems certain. Multicultural television is doomed to have a small portion of the viewer audience while ever it is condemned to go it alone on UHF. The answer is to move other TV channels into the UHF bands. Perhaps we could clear TV from the FM bands too.

## AM Stereo could be a schemozzle

No doubt many readers are aware that AM stereo transmissions are already being carried out experimentally by quite a few stations and the final go ahead from the Department of Communications is expected late this year or early next year. But what system will we have?

Apparently, the AM stations expect that we will inherit the same botch-up as in the USA whereby four different systems of AM stereo encoding are allowed or, to be more correct, no one system is preferred by the FCC. Wouldn't it be good if the Dept of Communications decided on one system and one system alone? This would greatly simplify the design of a decoder and may even make local manufacture of receivers a possibility.

**Leo Simpson**

# YOUR DOLLAR BUYS MORE AT JAYCAR! ELECTRONIC AGENCIES

## FANTASTIC Multimeter

ONLY \$17<sup>95</sup>



### 115V COMPUTER FANS



GREAT VALUE!

\$14<sup>95</sup>

We have made a scoop purchase of computer grade Box Fans. They measure a standard 80 x 80 x 40mm. But there's a catch! They are only available in 115V! Great if you are making equipment for export to the USA - or use 2 in series! No problem! Cat. YX-2508

STAGGERING VALUE

ONLY \$14.95

- FUSE/DIODE PROTECTED!
  - 4mm BANANA SOCKET PROBES!
  - BIFURCATED SELECTOR SWITCH CONTACTS!
  - ABS IMPACT - RESISTANT CASE!
  - LARGE! MEASURES 90(w) x 135(h) x 45(d)mm
- SPECIFICATIONS**
- |    |          |    |                     |
|----|----------|----|---------------------|
| DC | 0 - 0.25 | AC | 0 - 10              |
|    | 0 - 10   |    | 0 - 50              |
|    | 0 - 50   |    | 0 - 250             |
|    | 0 - 250  |    | 0 - 1000            |
|    | 0 - 1000 |    | AT 9,000 ohms/volt  |
|    |          |    | AT 20,000 ohms/volt |

- RESISTANCE**
- 0 - 5K
  - 0 - 50K
  - 0 - 500K
- DC CURRENT**
- 0 - 0.05
  - 0 - 25
  - 0 - 250mA

dB: 20 to +22dB  
 BATTERY CHECK FACILITY: AA, C & D CELLS  
 ACCURACY: DC +/-3% F.S. AC +/-4% F.S.  
 OHMS +/-3%

**BANANA PLUG PROBES AND BATTERY INCLUDED**  
 This is an unbelievable meter bargain. Normally this unit would sell for around \$25. Japanese made quality.  
 Cat. QM-1005 \$17.95

### MICROCHARTS BACK! NEW LOWER PRICES! NEW CHARTS!

**ALGORITHMS - Cat. BM-8504** ONLY \$9.95  
 This 215 x 280 (A4) virtually indestructible plastic card contains a set of algorithms expressed in the BASIC language. Most are easy to implement even with assembly language for small machines. You will be surprised at the amount of information this card contains.

**7400 SERIES TTL REFERENCE CARD** ONLY \$9.95  
**Cat. BM-8503**  
 This card gives complete pin out and description details on 54/74 series devices from 7400 (74LS00) thru 7496! OVER 350 devices in all!

**OTHER POPULAR MICROCHARTS**  
**280 CPU MICROCHART**  
 ALL the info on the 280 series CPU  
**Cat. BM-8500** ONLY \$9.95

**280 MICROCHART** ONLY \$9.95  
**Cat. BM-8501**  
 ALL the info on ORIGINAL micros and their newer cousins

**6502/65XX MICROCHART** \$9.95  
**Cat. BM-8502**  
 As above, for the 6502 etc.



## Incredible TOGGLE SWITCH

Check the schematic! Ideal for Headlight/Parking switch. Dependable 10 AMP contacts conservatively rated. A special shorting strap on the rear of the switch enables you to customise your own configuration!  
 Cat. SE-0658 \$1.50

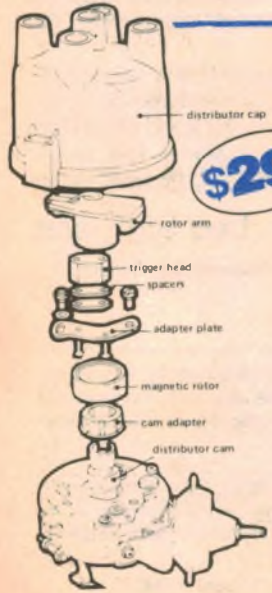
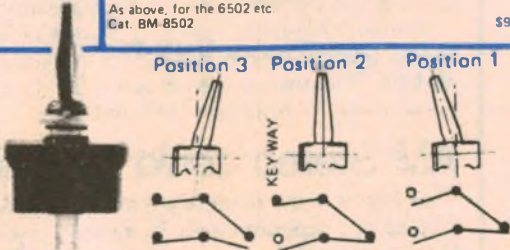

\$29<sup>95</sup>

**PLEASE NOTE**  
 this system must be used in conjunction with an electronic ignition. The Hall Effect device will not switch enough current to replace the contact breaker points on their own!

A professionally engineered electronic ("breakerless") contact breaker system. Yes, only Jaycar has a complete Hall effect triggerhead assembly designed to adapt to an extensive number of cars. Each kit contains the following:

- HALL EFFECT TRIGGER HEAD
- MAGNETIC ROTORS FOR BOTH 4 & 6 CYLINDER CARS
- OVER 6 CAM LOBE ADAPTORS
- OVER A DOZEN DIFFERENT ADAPTOR PLATES FOR YOUR PARTICULAR DISTRIBUTOR
- OTHER HARDWARE (i.e. SCREWS etc.)

YOU CAN REMOVE THIS SYSTEM AND RE-EQUIP YOUR CAR WITH THE ORIGINAL BREAKER POINTS WHEN YOU SELL THE CAR! AS EASY TO INSTALL AS A SET OF POINTS!

**INSTRUCTIONS (SIMPLE TO FOLLOW) INCLUDED!**

This set is designed to fit most European and Japanese cars. In fact it will also fit many Australian cars fitted with Lucas, Bosch, Motorcraft, AC Delco or Autolite electrics. If you wish to check first, please send SAE for car distributor list.

Because we have no way of knowing you get the fitting set for ALL of the distributors available. Basically you end up with a jar full of parts that you don't need to use! (Perhaps for your next car?) Quite frankly, we are amazed that we can supply such a comprehensive kit for this price. To produce a kit that will adapt to the (dozens of different) distributors around is amazing!

Remember, once you have installed a breakerless system it will never wear out and that part of your system will remain in tune FOR EVER.

We expect this kit to sell well! To ensure that you receive one, check with us early!  
 Cat. KJ6655

## IT HAD TO HAPPEN



## FERGUSON TRANSFORMERS

MF-1000	PL9/5VA	PCB	\$7.90
MF-1002	PL12/5VA	PCB	\$7.90
MF-1004	PL15/5VA	PCB	\$7.90
MF-1006	PL18/5VA	PCB	\$7.90
MF-1009	PL24/5VA	PCB	\$7.90
MF-1012	PL30/5VA	PCB	\$7.90
MF-1015	PL40/5VA	PCB	\$7.90
MF-1018	PL18/12VA	PCB	\$8.95
MF-1021	PL24/12VA	PCB	\$8.95
MF-1024	PL30/12VA	PCB	\$8.95
MF-1027	PL1.5-18/20VA	LP	\$17.95
MF-1030	PL12/20VA	LP	\$14.50
MF-1033	PL15/20VA	LP	\$14.50
MF-1036	PL18/20VA	LP	\$14.50
MF-1039	PL24/20VA	LP	\$14.50
MF-1042	PL30/20VA	LP	\$14.50
MF-1045	PL40/20VA	LP	\$14.50
MF-1048	PL12/40VA	LP	\$17.95
MF-1051	PL15/40VA	LP	\$17.95
MF-1054	PL18/40VA	LP	\$17.95
MF-1057	PL24/40VA	LP	\$17.95
MF-1060	PL30/40VA	LP	\$17.95
MF-1063	PL40/40VA	LP	\$17.95
MF-1066	PL30-9/60VA	LP	\$20.95
MF-1069	PL12/60VA	LP	\$20.95
MF-1072	PL15/60VA	LP	\$20.95
MF-1075	PL18/60VA	LP	\$20.95
MF-1078	PL24/60VA	LP	\$20.95
MF-1081	PL30/60VA	LP	\$20.05
MF-1082	PL40/60VA	LP	\$20.95
MF-1087	PP88/1000 Bell transformer		\$13.95
MF-1092	TS115/125B 115V STEPDOWN		\$79.50
MF-1095	PF3577/JT144 56VCT 2 amp		\$34.50
MF-1098	OP590 Line output transformer		\$45.00
MM-2015	PF4361		\$39.50
MM-2016	PF4362		\$49.50
MM-2017	PF4363		\$49.50

**VIDEO SENSATION  
AT LAST**  
A Video Enhancer/  
Distribution Amplifier  
designed  
**EXCLUSIVELY  
for AUSTRALIA**



**VALUE  
\$49<sup>50</sup>**

Jaycar has had designed a high quality, high performance Video Enhancer which is specifically for the Australian 625 line 50 frame PAL D system  
As far as we know it is the ONLY Australian designed, Australian built unit available!!  
But, guess what? The Jaycar AV6501 Enhancer is CHEAPER than its inferior imported Asian counterparts!!  
This unit is professionally designed and University tested!! It works and it works well.

**SPECIFICATIONS**

- #1 Maximum enhancement, not less than +8.3dB @ 2MHz
- #2 Enhance disabled (Bypass) response, DC to 6MHz, -0.5+1.0dB
- #3 Colour Subcarrier DdB notch frequency, tunable to 4.43 MHz, +/- 0.0dB, all settings
- #4 Amplifier group delay, less than 0.078µS
- #5 Signal handling capability not less than 1.35 volts p.p. (iSync. is clipped first)
- #6 Power 12V AC @ 100mA
- #7 Controls, ON/OFF, ENHANCE, ENHANCE/BYPASS SWITCH, CORE/GAMMA CONTROL
- #8 Input connector, RCA socket
- #9 Output connector, RCA socket x 3

**DESIGN FEATURES**

- #1 A unity gain notch at the colour subcarrier frequency, whose purpose is to prevent chrominance to luminance errors at high enhance levels.
- #2 A closed loop configuration with lead lag compensation to achieve stable, well defined gain
- #3 DC coupling eliminating large capacitors in series with the video signal and achieving DC response for applications requiring it
- #4 Low output impedance prior to termination resistors, enabling up to three outputs to exist and be used or left unterminated
- #5 A level dependant closed loop response or Gamma control ('Core')
- #6 Clip on negative going signals at -87 volts into 75 ohms to prevent sync errors owing to overshoot

Cat. AV6501

**NOT A KIT  
BUILT, TESTED  
AND GUARANTEED  
KIT VERSION  
ONLY \$39.50**

12 Volt AC  
Adaptor only  
\$12.95

**IEC Cable  
Connectors**

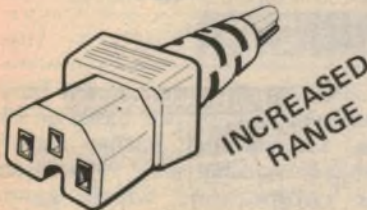

Most imported equipment these days now uses IEC-320 style AC power inlet connectors. Indeed, the electronics mags will soon be specifying these connectors on many of their mains powered projects to simplify (and therefore make safer) mains wiring. Jaycar now stocks a range of ELECTRICITY AUTHORITY APPROVED mains line cords. We have them in straight entry, left and right entry with and without standard 240V mains moulded plug. Each cord is a generous 2 metres long and is rated at 7.5 amp continuous.

Cat No	Description	Price
PS4302	LINE CORD STRAIGHT ENTRY 2M	\$3.95
PS4304	LINE CORD R/HAND ENTRY 2M	\$3.95
PS4305	LINE CORD L/HAND 2M	\$3.95
PS4306	LINE CORD STRAIGHT ENTRY WITH 240V PLUG - 2M	\$4.95
PP2302	IEC 320 CHASSIS PLUG	\$2.95
WM4530	2 PIN 240V PLUG MOULDED TO 2M FIG 8 7.5 AMP CORD - BLACK IN COLOUR (Note the first 5 items are grey in colour)	\$2.95

**TWIN SCREENED AUDIO  
CABLE**

Twin screened round audio cable. (Two screened conductors - NOT fig. '8')

This cable normally sells for \$0.48/metre or \$42.00/roll.

Cat. WB-1504

\$20.00/roll



**SAVE PER ROLL  
OVER 50%... \$20<sup>00</sup>**

**OCTOBER ONLY**

HORWOOD CASES		
HE 1452	84/6V	\$18.50
HE 1454	84/8V	\$20.00
HE 1457	84/10V	\$21.50
HE 1458	84/12V	\$23.00
HE 1459	84/17V	\$28.00
HE 1461	93/6V	\$16.50
HE 1462	93/8V	\$18.00
HE 1463	93/10V	\$19.50
HE 1467	93/12V	\$22.00
HE 1469	93/17V	\$25.50

**Quartz  
Crystal  
Clock  
movement**

Cat. XC6000



Very compact and reliable  
Self starting one second stepping motor has strong torque  
Powered by 1.5V AA battery that lasts for a year  
Supplied with two sets of hands, one short and one long  
± 15 second/month accuracy  
56mm square, 15mm deep  
complete with data sheet, instructions and wall hanger bracket

**UV GLOBES**

The ideal globe for parties. Works in standard light socket (240V AC). This UV light will not erase EPROMs  
Cat. SL 2680 100watt \$3.95

**TRANSISTOR BARGAIN**

3 amp high speed TO-5 power transistor type 2SC 799. Normally \$1.95 ea. Now 75 cents each OR \$5 for 10!! Has exclusive slide-on flange to convert to chassis mount for greater power dissipation!  
Cat. Z T-2600



**FABULOUS  
TAPE  
SENSATION**

1/4" TAPE



2500' - 1.5 mil  
Cat. AL-1560

Jaycar has done it again - for all of the HiFi buffs who have professional NAB centre reel-to-reel tape recorders - a superb METAL spool complete with 2500' of quality tape. The tape is 1.5 mil thick and comes on a NAB centre 10 1/2" spool.

**\$19<sup>95</sup> \$17<sup>95</sup>**

**CASSETTE HEADS SPECIAL**

REPLACEMENT HEADS FOR YOUR CASSETTE DECK

Cat. AC-1950	C21RPS18 Mono record/playback	\$14.95
Cat. AC-1952	B24 02 Stereo record/playback	\$17.95
Cat. AC-1954	B24 07 Stereo record/playback for use with Dolby ONLY \$24.95	
Cat. AC-1956	C42RPH04 Stereo record/playback glass ferrite faced ONLY \$36.50	
Cat. AC-1958	C21ES18 Mono or stereo erase	\$7.95



As used in Playmaster 50+30 Maxel Amp

**PLAYMASTER  
40/40  
OWNERS  
LOOK!!!**

**SAVE \$3**

We still have stocks of the original tapped 50K dual gang volume pot for this project. This pot is not a standard stock item. It may be a good idea to have a spare (the volume control will be the first to wear out).

GRAB ONE NOW FOR ONLY \$2.95  
NORMALLY \$5.95

Cat. RE-1263

**Jaycar**

Incorporating  
**ELECTRONIC AGENCIES**

**SYDNEY**

SHOWROOMS

125 & 117 YORK STREET PHONE (02) 264 6688 and (02) 267 1614  
TELEX 72293

**CARLINGFORD**

Cnr. CARLINGFORD & PENNANT HILLS ROAD - PHONE (02) 872 4444

**CONCORD**

115 - 117 PARRAMATTA ROAD - PHONE (02) 745 3077

**HURSTVILLE** 121 FOREST ROAD - PHONE (02) 570 7000

**NUMBER 1 FOR KITS**

POST AND PACKING CHARGES	
\$5 - \$9.99 (\$1.50)	\$10 - \$24.99 (\$3.20)
\$25 - \$49.99 (\$4.50)	\$50 - \$99.99 (\$6.50)
\$100 - \$198 (\$8.00)	Over \$199 (\$10)

\*Free INSURANCE for Road & Registered Post over \$200\*\*  
All heavy or bulky items (over 20kg.) sent Comet Road Freight \$12.00 anywhere

in Australia  
SHOP HOURS CARLINGFORD, CONCORD & HURSTVILLE  
Mon - Fri 9am - 5.30pm Sat - 9am - 12pm Thurs night 8.30pm

SHOP HOURS SYDNEY  
Mon - Fri 8.30am - 5.30pm Sat - 8.30am - 12pm Thurs night 8.30pm

MAIL ORDERS AND CORRESPONDENCE BOX K 39 HAYMARKET SYDNEY 2000



Mail Order  
By

**BANKCARD**

Via Your Phone

# News Highlights



## Neville Williams' Retirement Dinner

Pictured above is Neville Williams and his wife, together with Peter Gaunt, Magazine Promotions general manager, and publisher Jules Zanetti, at the

retirement dinner held for Neville on July 27, 1983. Around 140 people were present, with many having come from interstate.



## MIDAS begets MINERVA

OTC has introduced a new business communication service, based on Midas, the international packet switching network available since 1979. Intended for corporations which generate substantial overseas intra-company confidential correspondence, the new service – Minerva – can be operated via any computer terminal and modem anywhere there is a telephone and mains power.

The service is operated by the executive typing the message, in plain language, into his desk-top terminal. The message is then transmitted into the Minerva high security centralised computer system in Washington, DC.

## New UHF systems

The State Electricity Commission of Victoria is about to replace several existing VHF mobile radio systems with new UHF systems costing some \$1.2 million. Main sites for the new systems will be the Commission's open cut mines at Morwell, Loy Yang, and Yallourn in the La Trobe Valley.

The system will comprise 600 mobile units and 15 base/repeater stations, to be supplied by Plessey Australia Pty Ltd. The mobile units will be the Plessey MTR 8000 frequency synthesised sets. The new system will be linked to the Commission's private automatic branch telephone exchange, giving personnel direct telephone access to Commission vehicles. Vehicles will be called via a selective calling system.

Plessey will supply some of the equipment from its Meadowbank, NSW, factory, but the major portion will be manufactured in Victoria.

## Pollution Alert

It seems that high technology industries are not necessarily environmentally benign, judging from reports of recent pollution alerts in California's "Silicon Valley".

Solvents, detergents and acids used for etching and cleaning chips have leaked from the underground storage tanks maintained by many companies and have permeated the area's ground water. Several communities in and around the 200 square kilometre "high-tech" area depend on wells for their water and are seriously threatened by the toxic chemicals.

Ten wells have already been closed in south San Jose after they were found to be contaminated with trichloroethane, a degreasing solvent which can damage the central nervous system, liver and heart. Fairchild Camera and Instrument Corporation, with premises in San Jose,







The message is then available only to the addressee, who may be anywhere in the world, and who can interrogate the Washington computer, at any convenient time, by using a special security code.

Any modem and terminal may be used, whether it is a word processor, personal computer or specialised communications terminal. In the near future, Minerva will be able to connect with Telex services.

There is no registration fee or minimum monthly bill for the Minerva service. Users may buy or lease a terminal if they don't already have one within their organisation and then pay only for the hourly use they make of the service.

Further information may be obtained from the Overseas Telecommunications Commission.

has already spent \$US14 million trying to alleviate the problem and now faces a multi-million dollar law suit brought by 266 residents of the area.

Since the Fairchild incident, local authorities have asked other companies to check for leaks from storage tanks. So far 67 firms have reported leaking tanks involving similar solvents.

## EIA name-change

The former Electronic Importers Association has adopted a new name, the Consumer Electronics Suppliers Association (CESA). The association was formed under the original name in 1973 to prepare a submission to the government on policy matters affecting the import of consumer electronic goods.

Since 1973 the association has expanded considerably and now includes Australian manufacturers as well as importers. The new name more accurately reflects the current position.

## The ultimate photocopier?

Special equipment has been developed by the British Library to copy valuable and aged documents without damaging the paper or the spine of books.

The "digital copier" cradles the selected page at a convenient angle and raises it towards a scanning head that contains a 2056-element high resolution camera and a high intensity lamp designed to keep ultraviolet and infrared emissions to a minimum.

Heat and UV radiation are two major enemies of paper, and many historic documents cannot be copied by conventional means because of the possibility that the light sources used may hasten deterioration of the manuscript.

The camera of the image digitiser scans across a page and converts the image to a stream of digital information. The data can be transmitted to a printer for reproduction of copies or to a computer memory for storage. An interface is also under development which will allow the digitised image of the page to be



transmitted to a receiver anywhere in the world.

Production of the first 10 image digitisers is planned for this year and the demand from libraries, universities and historical institutions is expected to create a market for up to 100 machines a year in the near future.

## Telcom buys local optical fibres

The optical fibre industry in Australia has received a major boost following the awarding of a contract to Amalgamated Wireless (Australasia) Limited.

AWA will supply 160km of optical fibre to Austral Standard Cables Pty Ltd, who will make it up into a cable for a Telecom connection between the Sydney suburb of Waverley and the main city telephone exchange seven kilometres away.

This is the first wholly Australian-manufactured fibre cable to be used by Telecom, which is the only Australian organisation or company so far to use optical fibres in quantity. Until now, fibre cable used by Telecom has been made in Japan, or has contained Japanese fibre.

AWA believes that the contract is an important step forward in the local optical fibre industry. After 11 years of research, AWA claims its product equals anything produced overseas.

Fibre cables have many important advantages over wire cables. They are interference-free and may be installed without special precautions in electrically noisy environments. Optical fibres are also smaller, lighter, easier to install, and have a greater information carrying capacity.

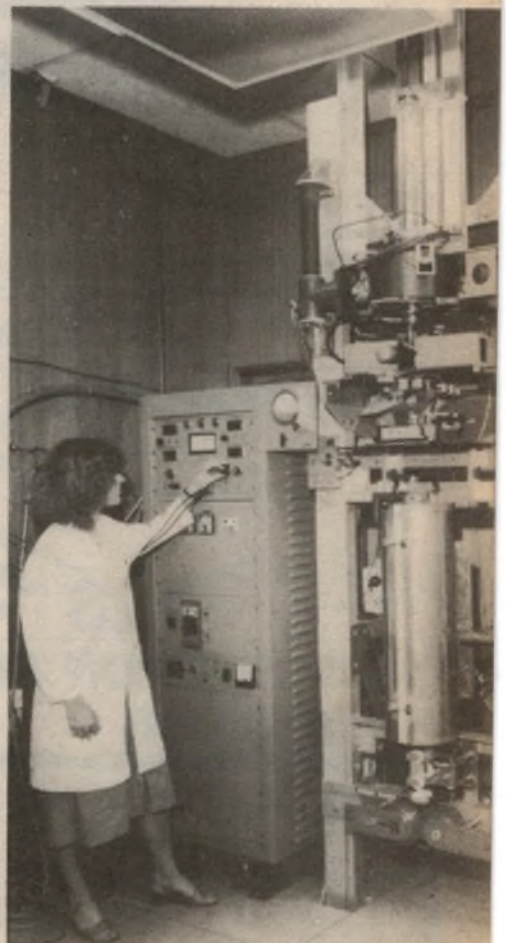

# FOR PERFORMANCE & VALUE AARON HAS TO BE YOUR FIRST SCOPE CHOICE

All these scopes are dual trace and incorporate the latest features such as high brightness rectangular CRTs.



- 7.7nS risetime
- Single sweep
- Trigger delay
- TV sync
- X-Y, dual, chop, add, subtract etc.

45MHz/1mV  
BS625 \$1095



- 21 range timebase
- 100mS-1  $\mu$ S trigger delay
- Front panel trace rotate
- X-Y, dual, chop, add, subtract etc

35MHz/1mV  
BS635 \$875



- Check components on screen
- 19 range timebase
- Triggerable to over 30MHz
- 17nS risetime

20MHz/5mV  
BS601 \$535

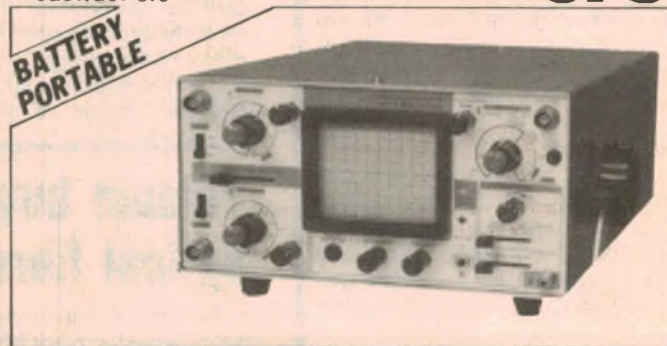

- 2 hour operation from built-in NiCad battery
- Automatic recharging
- Auto trigger free run
- TV sync

15MHz/2mV  
BS310 \$795

## COLINE SP100 PROBE

Professional 100MHz probe offering x1, ref, x10 positions. 1.5m lead with BNC connector and selection of tips. Complete in heavy duty plastic pouch. \$28



## QUICK SPEC CHECK

MODEL	B WIDTH	SENS	SIG DEL	TRIG DEL	SCREEN	T BASE
625	45MHz	1mV	Y	Y	150mm	0.2 $\mu$ S 0.5S div
635	35MHz	1mV	N	Y	150mm	0.1 $\mu$ S 0.5S div
601	20MHz	5mV	N	N	150mm	0.5 $\mu$ S 0.5S div
310	15MHz	2mV	N	N	95mm	0.5 $\mu$ S 0.5S div

All prices are plus sales tax if applicable and subject to change without notice



# ELMEASCO

## Instruments Pty. Ltd.

## MAIL COUPON FOR FREE GUIDE

Please send me a copy of your shortform oscilloscope guide.

NAME \_\_\_\_\_

ADDRESS \_\_\_\_\_

P CODE \_\_\_\_\_

TELEPHONE \_\_\_\_\_

P.O. Box 30, Concord  
N.S.W. 2137  
13-15 McDonald Street,  
Mortlake, N.S.W.  
Telephone (02) 736 2888  
Telex 25887

P.O. Box 107, Mt. Waverley  
Victoria 3149  
21-23 Anthony Drive,  
Mt. Waverley, Victoria  
Telephone (03) 233 4044  
Telex 36206

Adelaide: (08) 271 1839  
Brisbane: (07) 369 8688  
Perth: (09) 398 3362



N.S.W. Ames Agency 699 4524 • George Brown 519 5855 (049) 69 6399 • Davred 29 6601 • DGE Systems (049) 69 1625 • Macelec (042) 29 1455  
• Radio Despatch 211 0191 • Sheridan Electronics 699 6912 • T. Thew & McCann (089) 84 4999 • A.C.T. George Brown (062) 80 4355  
V.I.C. G.B. Telespares 328 4301 • Q.L.D. Colourview Wholesale 275 3188 • St Lucia Electronics 527 466 • Electronic Shop (075) 32 3632 • W.G. Watson  
(079) 27 1099 • Nortek (077) 79 8600 • Integrated Technical Services (070) 51 8400 • S.A. Trio Electrix 51 6718 • Protronics 212 3111  
W.A. Atkins Carlyle 321 0101 • T.A.S. GHE Electronics (002) 34 2233 & (003) 31 6533

## News Highlights

### First test of European Torus

The Joint European Torus (JET) was operated for the first time at Culham, Oxfordshire, England during the weekend of June 25-26, 1983. This marks the culmination of a five year construction program, costing some £175 million (\$A300 million) at current prices, which has been carried out by a team from the 11 European countries participating in the project.

The completion of the constructional work has enabled a program of experiments to commence, scheduled to last for seven years. These experiments will help to determine the feasibility of using nuclear fusion reactions to produce a long term source of energy. However, several further steps will be required beyond the JET work before a commercial nuclear fusion power station could be built in the next century, perhaps around the period 2020 to 2030.

In the initial experiments a current of 60,000 amps was passed through hydrogen gas at a low density for  $\frac{1}{10}$  second to convert the gas into a hot ionised plasma. It is planned to increase this current progressively up to a maxi-

mum of about five million amps. In the later years of the experimental work it is intended to use additional heating systems providing some 25 megawatts to try to raise the temperature of the plasma to about 50 million °C for a period of about 10 seconds. It is then hoped to replace the hydrogen gas with a mixture of the hydrogen isotopes deuterium and tritium and to produce thermonuclear reactions which will raise the temperature still further to about the desired 100 million °C required for a satisfactory thermonuclear reaction rate.

At such temperatures bursts of high energy neutrons are released which will provide the heat required for the generation of electricity. Neither JET nor the American TFTR experiment has been designed to utilise the energy of the neutrons.

JET employs a toroidal-shaped gas vessel in which specially shaped magnetic fields are used to hold the high temperature plasma away from the walls of the vessel. The so-called "tokamak" magnetic field configuration is employed. JET is the largest and the most ambitious tokamak in the world and has been constructed mainly with funds from the European Communities as part of the Euratom fusion program.

JET was set up in 1978 as a joint undertaking for a seven year period with the object of studying plasmas under conditions approaching those required for a commercial fusion reactor. It is hoped temperatures greater than those at the centre of the sun will be reached.

### New appointment



### Jim Rowe new Marketing Director at DSE

Dick Smith Electronics has appointed Jamieson (Jim) Rowe to the position of marketing director. Jim has spent the last four years as technical director of Dick Smith electronics. Besides developing the first small computer for home construction in Australia, Jim is the author of several well respected electronic books.

Previously Jim was with "Electronics Australia" for 20 years, the last nine as editor.

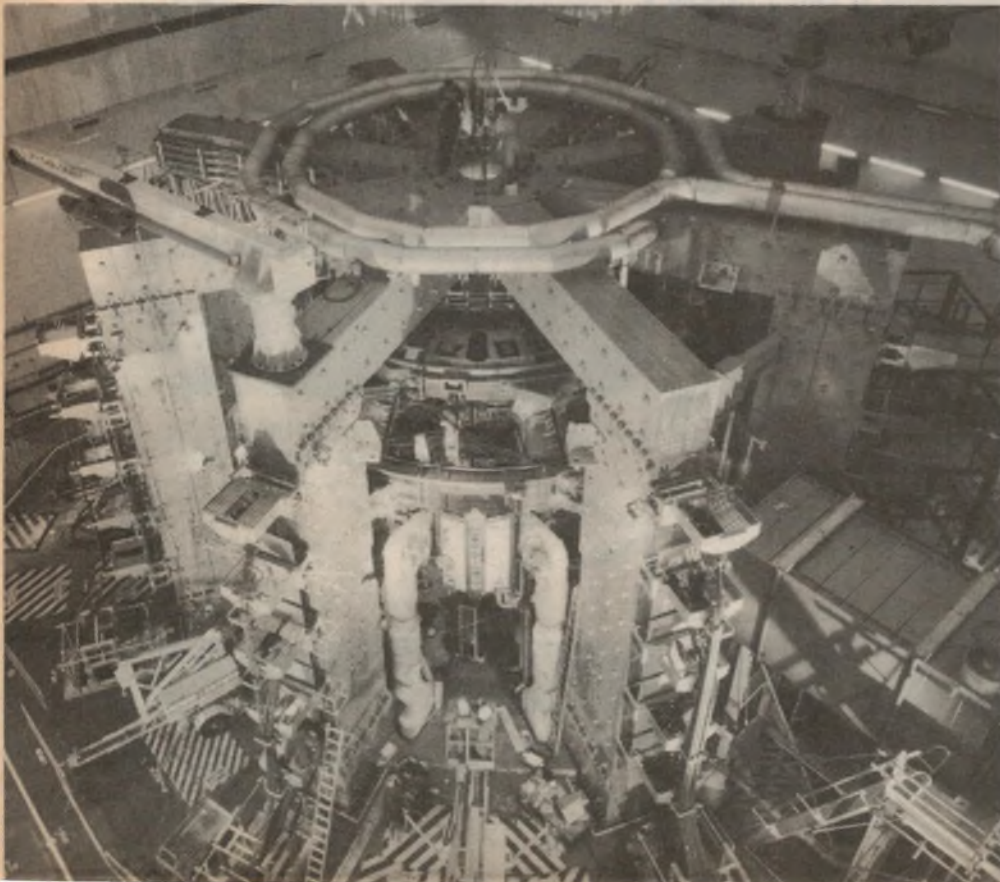

### Electronic Agencies purchased by Jaycar Pty Ltd

On September 1 Jaycar Electronics Pty Ltd, purchased the operations of Electronics Agencies Pty Ltd.

Trading will continue at the previous Electronics Agencies outlets at Concord and York St, City, with both Jaycar and Electronics Agencies products on sale.

The previous Jaycar store in York St, City will close at the end of October and operations transferred to the old Electronics Agencies store at 117 York St.

All outlets will be known as: "Jaycar Electronics incorporating Electronic Agencies".



# DICK'S 15th BIRTHDAY

Make Circuit Design easy!

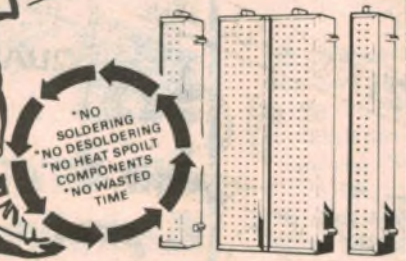

## PROTOBOARD

Now circuit designing is as easy as putting a lead into a hole with this superb Protoboard. Designed to accept transistors, ICs, LSI packages, resistors, capacitors, LEDs, trimmers, relays etc. Base board has 290 holes and pack includes two clip-on extensions each of 50 holes. 390 holes in all and you can add on as many more as you require.

Cat P-4614  
**ONLY \$9.20**

YOU'D BE POTTY TO BUY ELSEWHERE

## TEN TURN TRIMPOTS



\$2.60 ea.

A multi-turn pot as used in a large variety of test gear, precision equipment etc. Very well made 10 turns from end to end.  
Cat R-1900 - 1k  
Cat R-1901 - 10k  
Cat R-1902 - 20k  
Cat R-1903 - 50k

## URGENT PRODUCT SAFETY NOTICE

Re: 3½ Digit Digital Multimeter Cat Q-1455

It has been found that a small number of these multimeters may be capable of developing an internal short circuit when used to measure high voltages. In some circumstances this could result in danger to the user.  
If you have purchased one of these meters, please return it to the point of purchase, where it will be sent to our Service Department for a free modification to ensure its safety.

STOCK DUE SOON

## Reverse safely with a BACK UP SENSOR

\$59

Blind spots in your rear vision? Reverse park by the touch method? Fit a back-up sensor & forget the dings! Very simple to fit.  
Cat A-8520

## 4 sector control module

Protect your home and valuables with this alarm control unit. Virtually identical in op and circuitry to one of the advanced alarm control units you pay \$553 more for.  
Cat L-5056

**\$69.50**

## NEW FROM KAMBROOK!

## 4 WAY POWER BOARD



Get rid of that ugly piggy-back double adaptor with this superb new-look powerboard. 4 outlets.  
Cat P-5612

**ONLY \$12.99**

## TOP VALUE ON 240V

## 3 PIN PLUG



The standard Australian 3-pin AC plug - it has locking collar to hold cable tight and push fit cover to main body.  
Cat P-5400

**ONLY \$1.30**

## DOUBLE POWER POINT

Replace your old single outlets with a double! Attractive modern styling and very convenient!  
Cat P-5560

**\$6.60**

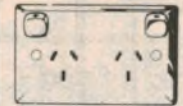

## ARCHITRAVE SWITCH



Update your old, worn out units with this smart, modern architrave switch. Positive action switching.  
Cat P-5570

**ONLY \$3.50**



**NEW!!**

## HITACHI 20 MHz DUAL TRACE CRO

DICK SMITH PRICE!

If you want a good CRO, do not buy this one. It is definitely not good, it's great! Quality Hitachi brand offering huge 20 MHz bandwidth, dual traces, extra high sensitivity... it's got the lot! Just look at some of the specs and you'll agree. And look at our low, low price!  
It's even lower for tax free purchasers!

Some of the features include:  
● Extra high bandwidth ● Extra high sensitivity  
● TV Sync-separator circuit allows stable TV signal observation ● 5 display modes ● One touch waveform shifting and more.  
Cat Q-1243

Specifications:  
Vertical Sensitivity 5mV/div, to 5V/div ● Bandwidth DC to 20 MHz  
● Input R & C: Approx 1 M in parallel with 25pF ● Sweep time: 0.2µs to 0.2S/div in 19 calibrated steps.

WHY RISK BUYING AN UNKNOWN BRAND?

**\$699**

## 240V Cannon Plug & Socket

Mains rated! Don't take chances with mains! If you haven't got room for normal 3 pin plugs/sockets, these genuine Cannon brand fittings are the only safe way to go!



Line Plug Cat P-1627 **\$6.95**  
Panel socket Cat P-1630 **\$5.95**

You reap the benefit!

## FIVE YEAR Guarantee!



Yes - we offer an exclusive 5 year guarantee on all transistors with a DS prefix (eg DS548). We're so confident of the quality of these components we make this guarantee. We will replace any DS brand transistor free of charge if it fails in 5 years from the date of purchase while being used in normal service.

Look at the amazing prices of these Silicon semi's!

Type	Description	Cat No	1 - 9	10 up
DS547	NPN	Z-1300	14c	12c
DS548	NPN	Z-130B	14c	12c
DS549	NPN	Z-1319	14c	12c
BC549C	NPN lownoise	Z-1329	34c	30c

## HORN SPEAKER

Ideal for all PA or outside work! Rugged, weatherproof horn has an impedance of 8 ohms and a power rating of 5 watts.  
Cat C-2705



**ONLY \$10.25**

AMAZING VALUE!

## ON DICK SMITH QUALITY LEDS

Need some LED's for your projects? Don't go past these for value!

Type	Cat No	1-9	10 up
Flashing	Z-4000	45c	35c
Red	Z-4030	20c	18c
Green	Z-4032	30c	25c
Hi Lite	Z-4075	95c	90c

# DICK SMITH

See Page 98 for



**NEW!!**



**NOW A FULLY BUILT UNIT WITH ALL SENSORS... READY TO INSTALL!**

# DICK SMITH CAR COMPUTER

**YOU CAN MONITOR...**

- ★ Immediate (instantaneous) fuel consumption
- ★ Average consumption
- ★ Total consumption
- ★ Average speed
- ★ Speed limit
- ★ Elapsed driving time
- ★ Current time
- ★ Road ice

What a bargain! Not a kit - it's ready built and ready to go. And it actually costs less than most kit car computers! All you have to do is install it and the sensors (full easy instructions supplied) - and you're ready to start saving money by analysing your car's performance and your driving habits.

**FEATURES**

- Fully self-contained and pre-assembled computer ready for mounting in any petrol carburetted vehicle
- All sensors required included
- All mounting hardware for computer and sensors included
- Comprehensive 50 page installation and instruction manual.

Just like the new model 'luxury' cars, you can have a comprehensive car computer in your car. And it won't cost you an arm and a leg. Just think - it could pay for itself in just a few thousand kilometres. You'll be amazed at what the computer can tell you about your driving!



**DICK'S TOP SELLING PRO-QUALITY METER**

The Dick Smith Q-1140

SAVE \$7 **\$69<sup>50</sup>**

100K/VOLT!  
A test bench in one small package! Yes, you get an ultra sensitive multimeter featuring fuse and diode protection; an inbuilt transistor oscillator to allow you to measure capacitance in TWO ranges; a transistor checker for measuring gain and leakage on both NPN & PNP types as well as checking diodes. What more could you ask for? **WAS \$76.50**  
Cat Q-1140

**WHY PAY MORE?**

**LOOK AT DICK'S PRICES FOR QUALITY METERS**

VU  
-20 - +3 VU  
(1000 ohms) (0dB)  
1mW into 600 ohms  
Full scale accuracy  
of better than 2%  
Cat Q-2050



**ONLY \$9<sup>95</sup>**

**Moving Iron**  
0 - 20V (AC & DC)  
Rugged and accurate AC/DC meters, ideal for power supplies etc. Oval style meter.  
Cat Q-2080

**ONLY \$8<sup>15</sup>**

**Level Meters**

Ideal for use with audio/tuner projects. Elegant styling.  
**Signal Strength**  
Cat Q-2100  
**Centre Zero (Tuning)**  
Cat Q-2095

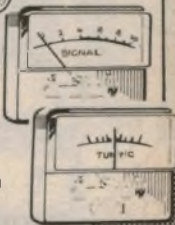

**\$5<sup>55</sup> ea**

**AMAZING VALUE!**

**\$169**

**STOCK UP NOW!**

**TOP VALUE CERAMIC PACK**  
Over 60 popular sized ceramics in one bag. Save \$\$\$  
**\$4.75**  
Cat R-7050

**TOP VALUE RESISTOR PACK**  
300 1/4 watt types worth \$12.00. 6 values. Cat R-7010  
**\$5.90**

**TOP VALUE ELECTROLYTIC PACK**  
55 top quality single ended electrolytics. Save around \$7.00!  
Cat R-7030  
**\$6.75**

**NEW PIEZO TRANSDUCER**

Great for miniature audio alarms. Can be driven by Transistor, C-MOS or TTL giving a piercing note around 80dB @ 30cm. Very low power needed - operates from around 3V to 30V peak to peak.  
Cat L-7022

**and only 99¢**

Have you got your copy yet?

**DICK SMITH AUSTRALIAN SEMICONDUCTOR H'BOOK**



For the first time in Australia, all the information you need to know about semiconductors is gathered together between two covers. Which component to use - what are its ratings - what are pin connectors - and more.  
Cat B-4200

A must for the weekend professional!

**\$7<sup>95</sup>**

## Hand Held Computer

Casio quality - Dick Smith price!

**AS ADV. ON TV.**



A brand new hand-held computer from one of the world's leading manufacturers. The Casio PB100 - learn as you go computer with VLSI CPU - equivalent to 150,000 transistors! With 544 program steps and 94 data memories (expandable), 5 x 7 LCD dot matrix 12 digit display and a standard ASCII keyboard, the PB100 offers you unbelievable computing power - wherever you go! Cat X-5110. Includes beginner's manual at no extra charge!

**NEW MODEL ONLY \$79<sup>95</sup>**

**1K RAM PACK** Expands the PB100's memory to 1K programming to 1,568 steps. A must for the serious user. Cat X-5112

**\$40**

**NEW!**

DSE/A597/PAI

**Electronics**

address details



# Superweapon

Weeding the errors out of US Defence Department computer programs that operate everything from missiles to tanks is a frustrating business, but the process is essential.

There were only two little mistakes in the computer program that guided a new missile through its firing test last December. But the mistakes were serious enough to cause the computer-controlled missile to drift from its plotted trajectory, and a human controller had to save the missile from crashing. The result was an expensive delay in a major US Department of Defence project.

Donald R. Greenlee, a specialist in the Defence Test and Evaluation office, uses the incident to illustrate that "in the digital world, it only takes one bit to bring on catastrophe." One of the errors was simply a reversal in sign, a negative where a positive should have been.

To Greenlee, the incident is also a success story. "The test was conducted, and it did what was intended — to reveal a problem," Greenlee says. Laboratory simulations allowed design engineers to duplicate the failure noted in the flight test. This narrowed down the search, and a line-by-line check of the relevant parts of the computer program eventually isolated the mistakes. The computer program was fixed, and subsequent firing tests were successful.

Software errors, mistakes in computer programs, occur frequently. According to Edward Miller of Software Research Associates in San Francisco, during software development every 1000 lines of computer program typically contains 10 to 80 "defects", all of which must be caught somehow. Some programs are millions of lines long.

This problem is a special concern at the Defence Department because almost every system in the current and planned military inventory relies on computers and microprocessors extensively. For example, computers control the targeting and flight of missiles, coordinate and control sophisticated systems installed in high-performance aircraft, and integrate the complex activities of battlefield command. "Consequently, software has become the dominant factor in military systems," says Edith W. Martin, deputy undersecretary of defence for advanced technology. One reason for DOD's increasing reliance on software is that soft-

ware changes are easier and less costly to make than altering the comparable function built into electronic circuits, she says. New threats can be met by making appropriate changes in computer programs.

Software must be reliable, particularly in life-threatening situations, and that means weeding out any errors. However, testing and evaluating computer programs efficiently and effectively is very difficult. Many senior program managers at DOD feel much more comfortable with hardware, such as jet engines or artillery shells, than with computer software. "We know very well how to test an artillery shell. We've been doing it for centuries," says Greenlee. "We know how to condition the thing environmentally — heat it up and freeze it, drop it, and then test fire it. But computer software? You can't even see it, let alone beat it with a hammer or attempt to destroy it. It requires a different intellectual approach."

DOD's concerns were reflected in a recent software test and evaluation conference held in Washington, DC. Sponsored by the National Security Industrial Association, a collection of defence-related companies, the meeting brought together representatives of government, industry and universities to review and discuss experiences and advances in locating software errors. Rear Admiral Isham Linder, Defence Test and Evaluation director, in his keynote address pinpointed two key questions: "How much testing is enough, and how should it be conducted?"

The most obvious method for testing a computer program is to track exhaustively every possible logical branch in the program or to try every possible calculation, but in large programs this method is impractical. Even a simple program with just 10 two-choice branches provides more than 1000 different paths. Anything more complicated could require months of computer time and might generate thousands of pages of output. Who's going to read all the results? Who knows the results are correct? In general, an exhaustive test that

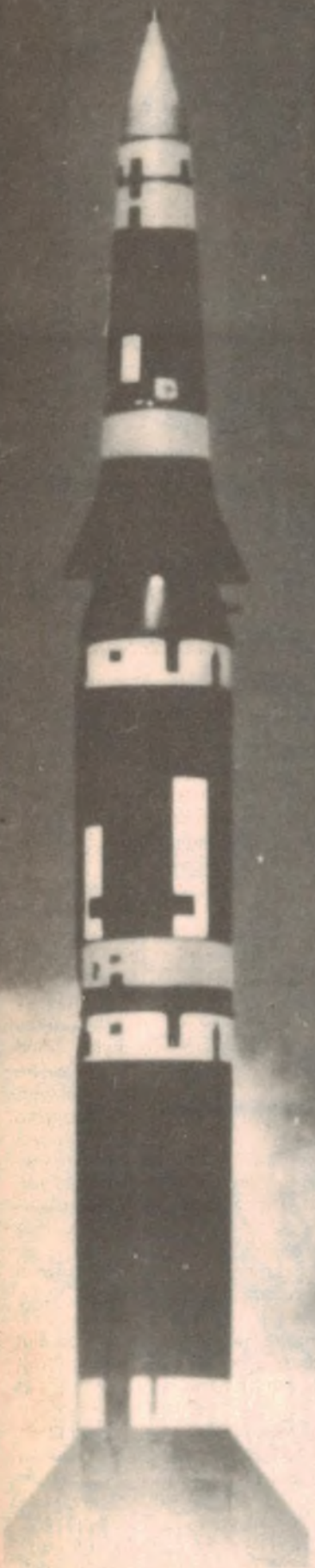

# Software Woes

by IVARS PETERSON

covers all the possibilities is impossible.

One way to get around this difficulty is to randomly sample a small portion of the possible paths in a computer program. If enough tests are performed, and all errors found are corrected, then the probability of any remaining errors should be very low. Some software developers even deliberately seed their large programs with a known number of errors. If an independent testing group finds all the deliberately introduced errors and others besides, then the probability is high that practically all the errors in the program have been found.

"That's a far cry from dropping an artillery shell off the back of a truck," says Greenlee.

Another approach is to construct test cases that pinpoint specific types of errors known to occur during the course of software development. However, developing a comprehensive set of suitable test cases can take as much effort as writing the computer program itself. More theoretical methods, like mathematical "proofs of correctness", have turned out to be too complicated to apply in real situations or restricted to a few special cases.

Part of the problem is that computers are usually brought in when the mental task is too hard for the human user to do in sufficient time. "Therefore, you're trying to test something which, by definition, is mentally challenging," says Greenlee. "You don't sit down and check out a complicated piece of software on the back of an envelope."

***"You don't sit down and check out complicated software on the back of an envelope"***

"Testing is hard work," Miller told the conference participants, and no one disagreed. Victor R. Basili of the University of Maryland concluded his presentation, "It is almost frightening how many open questions there are in a field where we have been working so long."

Within DOD, software development "ranges from a reasonably effective, disciplined approach in a few systems to near chaos in others," says Martin. A US Navy study, for example, reveals 13 different mathematical systems in use for steering an airplane from one place to another. In the US Air Force, as much as 90% of computer program lines are coded in a primitive, difficult-to-decipher computer language. In many situations,

programmers find it easier to start over rather than try to modify existing software. The US Army, in a 1978 survey of about 100 battlefield systems, found 34 different versions of essentially the same computer, each operated by a different computer language.

This diversity creates headaches for those responsible for testing and upgrading the systems, and produces problems on the battlefield when one computer has to communicate with another.

Any standardisation program to improve "interoperability" and make testing easier faces immense obstacles. For instance, Captain David Boslaugh of the Naval Material Command pointed out that the Navy has about 450 different systems and subsystems with "embedded computers". The number of computers in use is doubling every two years. About 50 million unique lines of software, in a variety of computer languages, are currently operating active systems. To redo these lines would take years, considerable expertise and at least \$85 billion, said Boslaugh.

Nevertheless, because of DOD's growing reliance on computers, efforts to rationalise the software development process are continuing. Many in DOD, especially in the Army, are counting on a new committee-built computer language, Ada, which is the result of a seven-year DOD-sponsored design effort. Ada promises to help computer programmers work more quickly, with fewer errors, and to allow the development of portable computer programs capable of running on almost any computer instead of just a few models.

The Pentagon has mandated that software for most military systems be written in Ada, and the language will probably be in routine use by 1985. However, Ada's prospects for becoming a standard language outside of DOD and military applications are limited because of doubts about its ability to handle complicated scientific calculations.

Some critics also see Ada as a big, complex language that eats up costly computer memory space. The language offers so many options that, despite the emphasis on programming in "packages" and the use of English-like sentences for computer instructions, Ada would be difficult to learn, they contend.

The Ada approach is part of an effort to bring more discipline to software development. At one time, computer



programmers were akin to magicians, cleverly stringing together chains of logical statements, using whatever tricks they could invent, that somehow got a computer to do what it was supposed to do. Such undisciplined efforts, imbued with programmers' idiosyncracies, proved difficult to test and modify when they sprang unexpected errors.

Many conference participants argued that programs had to be written with testing in mind, and that this approach had to be emphasised in the training of programmers. Basili said that a recent experiment he conducted at the University of Maryland showed that students altered their programming styles when they knew their programs were to be tested by an independent reviewer. Several students were apologetic because they had avoided trying anything "funny" and instead concentrated on meeting the specifications and making their programs as clear as possible to the reviewer. To Basili, this shift in attitude was encouraging.

Carolyn Gannon of General Research Corporation in Santa Barbara, Calif, argued that one way of helping both programmers and testers was to compile and study the kinds of errors made during software development. This record would indicate where to look for mistakes, which tests to use to find them and how to handle them. When enough data are collected, these error analyses could be used for developing new tests and for estimating the probability of hidden errors still left in complicated computer programs. Although such data

# "HEY"

When you're in the market for a car you head for "Auto Alley" —

For you, the electronic enthusiast, tradesmen, hobbyist or just an electronic Nut, we've created "Silicon Alley" — better known as York Street. So no matter what you need in electronics, drop your soldering iron and come on in. (OOP'S switch it OFF first)



**HY-500 — \$44.60**

or better still

**MODEL HY-10MX \$152.80**

**UNIVERSAL STEREO MIXER**

with cue control, or getting the best results from your video.

Try using

**VIDEO DETAIL ENHANCER**



**MODEL VP-5030, \$84.60**

or

if your picture is unsteady use our  
**VIDEO IMAGE STABILIZER**



**MODEL VP-5010 \$75.00**

LOOKING TO BUY a multimeter We recommend KAISE Digital Model 6221 @ **\$79.00.**

We also stock other models:

	Trade	Tax incl
SK6330 Auto range - hold -		
Buzz - 10A AC/DC	\$121.50	\$138.51
SK6440 Auto range - 24 Ranges - 10A AC/DC	\$ 85.00	\$ 96.90
SK6400 Auto range - 20 Ranges - 0.8% Acc	\$ 75.50	\$ 88.07
SK6221 Auto range - hold -	\$ 69.95	\$ 79.00
Buzz - 10A AC/DC Econ		

Plus of course all models of Fluke Hand held's including their latest 8060B at **\$484.00** + Tax Other instruments include Standard Escort, Anigawa, Trio, Hitachi, Aaron and Goodwill.

These are just a few of the many 100's of up-to-date Electronic items on display at:



**DAVID REID ELECTRONICS LIMITED**

127 York Street, Sydney, 2000  
or Telephone (02) 267 1385

## Superweapon Software Woes

would be valuable, one problem is that programmers are reluctant to admit they make mistakes, and companies don't want the public to know how many errors are made, even if the errors are corrected, Gannon said.

Testing and evaluation already take up as much as half of the budget for software development, so contractors are naturally reluctant to spend extra money on compiling error histories. At DOD, when program budget cuts are necessary, the test program itself (as the "bringer of bad news") often is an early victim. The frequent result, however, is the discovery of surprise problems late in a program or perhaps even on the battlefield. Greenlee says, "The earlier the developer finds deficiencies, the quicker, easier and cheaper it will be to fix them."

Last year at an Electronics Industries Association meeting, Brig Gen Robert D Morgan described "Airland Battle 2000", the Army's evolving doctrine for fighting on future battlefields. "The new doctrine requires continuous action by many elements," he said. "There is no forward edge of the battle area or line of scrimmage. Many battles are conducted over wide areas by units which appear to act independently but, in fact, know their role and strive for a common goal." Computers and satellite communication systems tie together the array of electronic systems that will have to operate in a "chemical, nuclear and electronic warfare environment". In such complicated "systems of systems", finding software errors early becomes even more important.

Colonel Edward Akerlund of the Air Force Systems Command said these coming complex networks introduce whole new areas of problems. Programmers are just beginning to learn how to put together these large systems, and the development of testing procedures lags far behind. He said that tests are needed, for example, to ensure that when part of a system fails, the rest of the system does not go down.

Concerns like this led DOD to initiate the Software Test and Evaluation Project, an effort to develop guidelines for the test and evaluation of defence systems software and to identify useful testing tools that showed promise and were worthy of further research. One of the key issues raised during the early stages of the project involved the amount of testing required. Because it is difficult (expensive and time-consuming, too) to find every error that may exist in a computer

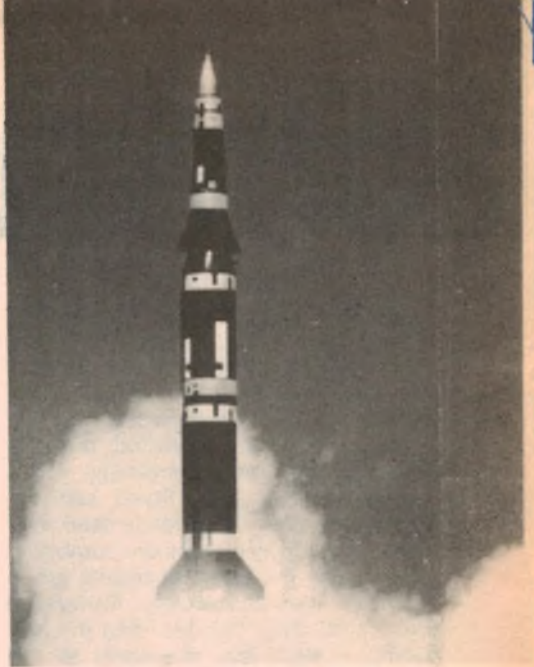

program, one need is for a formal risk assessment procedure that balances the risks of not doing a test against the number and nature of errors likely to still reside in the program. One preliminary recommendation was that testing should be done in proportion to the risks involved if a failure were to occur. Linder noted that a quantitative measure of this risk would be very helpful for high-level decision makers who have to decide whether a certain project should proceed.

This spring, DOD plans to launch another program, a \$250 million, 10-year "software initiative". One aim of the STARS (software technology for adaptable, reliable systems) program is to create a software engineering institute where DOD, in cooperation with industry and universities, can evaluate and demonstrate the usefulness of new programming techniques and integrate these ideas into military systems more quickly. The institute would also train DOD personnel. As several conference participants pointed out plenty of programming and testing tools exist, but the information is hidden in obscure journals, locked in company testing centres or scattered in bits and pieces and applicable only to particular computers and computer languages. Some collecting and sifting of this material would be valuable, they agreed.

Spending time and effort on learning how to catch mistakes reflects a recognition that no human-designed system is perfect. Software errors are as likely to come up in a business program that generates invoices as in a program that is supposed to co-ordinate five space shuttle computers. However, software errors in DOD computer systems, whether in missiles, satellites or at command headquarters, can have drastic consequences. Even one little mistake could be one too many.





# It's just common sense . . .

Mitsubishi are well known throughout the world as the manufacturers of top quality electronic apparatus, from disk drives to t.v.'s, from home hi-fi to industrial robots.

But Mitsubishi also manufacture the semi-conductors that make possible the efficient operation of all these, and many more, products.

So it makes sense that Mitsubishi have a very deep understanding of the requirements of semi-conductor users.

Mitsubishi manufacture a wide range of semi-conductors for almost every electronic application. Second to none, the range covers memories; micro-processor related LSI's; LS TTL's;

discrete semi-conductors; C MOS and the M54000 series. For the very special application, GaAs FET's, R.F. power transistors and "Jumbo" high power transistors 625 (W); all manufactured with the quality you've come to expect from one of Japan's leading electronics manufacturers.

Mitsubishi semi-conductors, disk

drives and video monitors are distributed in Australia by Nexus in Sydney, and Sycom in Melbourne; two companies dedicated to the pursuit of excellence. This philosophy ensures that adequate stocks of all Mitsubishi products are held at all times; and their technical support, particularly in areas of application, is second to none.

If you would like more information on any of our products, simply circle and return the Readers' Service card, and we'll get full information, including technical specs. to you straight away. It's all just part of the service, because at Nexus and Sycom, we do things just that much better!



Mitsubishi disk drives

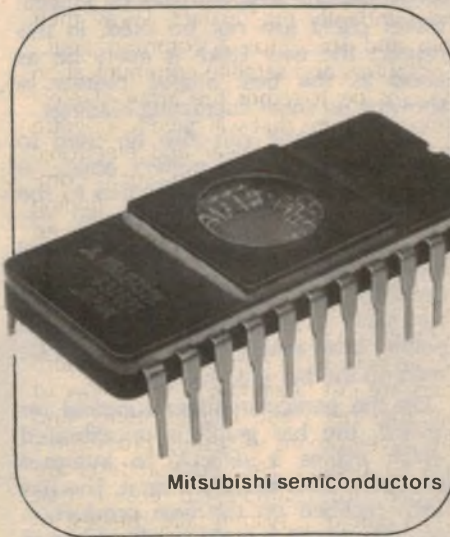

Mitsubishi semiconductors



Mitsubishi display monitors

## Just that much better

Available throughout Australia. For your nearest distributor contact:

### NEXUS

**ELECTRONICS PTY LTD.** (Inc. in NSW)  
339 Pacific Highway,  
Crows Nest, NSW Australia, 2065.  
Telephone: (02) 922 1722

### SYCOM

Systems and Components Division of  
**SYSTEMS RELIABILITY (AUST) PTY LTD.**  
49-53 Tope Street,  
South Melbourne, 3205. Telephone: (03) 699 8433

*Fluke re-establishes its leadership in the DVM market*

# New concept Digital Multimeter

by COLIN DAWSON

Since 1977, Fluke has been a leader in the handheld digital multimeter market. Now, with its entirely new 70 series meters, Fluke is positioned to grab a major share of the market for digital and analog meters.

Digital or analog? The debate still continues years after the introduction of digital multimeters to the "popular" market. The accuracy and instant readability of digitals have won them a wide following, but they still can't give a useful display with a fluctuating input. Or can they? With the new Fluke 70 Series Multimeters, the answer is a definite "Yes".

Combining the best of both digital and analog multimeters, the Fluke 70 Series are a new type of test instrument certain to attract the attention of the electronics industry. With a unique digital/analog display, they are priced to appeal to hobbyists but have features which will suit professionals.

Besides the display, other attractive features are autoranging, full scale readings of 3200 instead of 2000 and, on the top of the line 77 model, a sample and hold function. All in all, very desirable pieces of test equipment.

At first glance, the new Fluke meters look much the same as any other handheld digital — the same rotary function switch, inputs sockets and a liquid crystal display. It's not until you turn one on that you realise things are going to be different. The meters immediately perform a self-test, activating all the segments and annunciators of the display. They have all the expected symbols — V, A and  $\Omega$ , and of course a low battery indicator. But, running across the full width of the display is a 32-segment bar graph. This is the feature which sets the Fluke apart from anything you've used before.

The bar graph normally indicates a value which is in proportion to the digital display. Set the rotary switch to DC volts to check your car battery. The meter automatically selects the 32V range and the bar graph gives a reading of just over

one third full scale. But for the real test, apply the probes to a changing voltage — a fluctuating power supply or subsonic oscillator. Here's where the bar graph really comes into its own. The segments flicker across the display as quickly as the needle of the fastest analog meter while the digital display is indicating more or less meaningless random values. In fact, the bar graph updates 25 times per second, 10 times faster than the digital display itself. So the bar graph can be used for peaking and nulling measurements where previously a digital meter could just not be used. In this respect the new Fluke is every bit as good as the best analog meters in showing up small fluctuating readings.

The bar graph can also be used to duplicate the analog meter's ability to check capacitors when switched to the "ohms" range. We must qualify this however and say that the typical analog meter is still superior in this respect for capacitor values under  $0.1\mu\text{F}$ . For these very small values, the small kick from the pointer of an analog meter would not be seen on the bar graph display.

On the particular meter supplied for review, the bar graph is uncalibrated which makes it difficult to interpret absolute values directly from it. This has been rectified on the final production versions where a scale is silk screened onto the display window.

Because the full scale reading of the 70 Series meters on all ranges (except diode test) is 3200, they will in many cases have an extra digit of resolution over a typical DMM. For example, measuring a 240V line most meters will over-range at 200V and have to switch to their 1000V range. This results in a resolution of  $\pm 1\text{V}$ . By comparison, 70 Series meters will remain in the 320V range, giving a resolution of  $\pm 0.1\text{V}$ . A similar situation

would occur when measuring a 24V power supply.

Actually, there are three different multimeters in the 70 Series — the 73, 75 and 77. All three have the new analog/digital display, autoranging and seven input modes. Selecting between the input modes is achieved with the rotary switch on the front panel — each position is clearly indicated with standard electrical symbols. On the 75 and 77 models, the autoranging can be overridden manually by means of a small blue button in the centre of the range selector knob. Whenever this is pressed,

*When first turned on the new Fluke 70-series meters go into a self-test routine as shown below.*



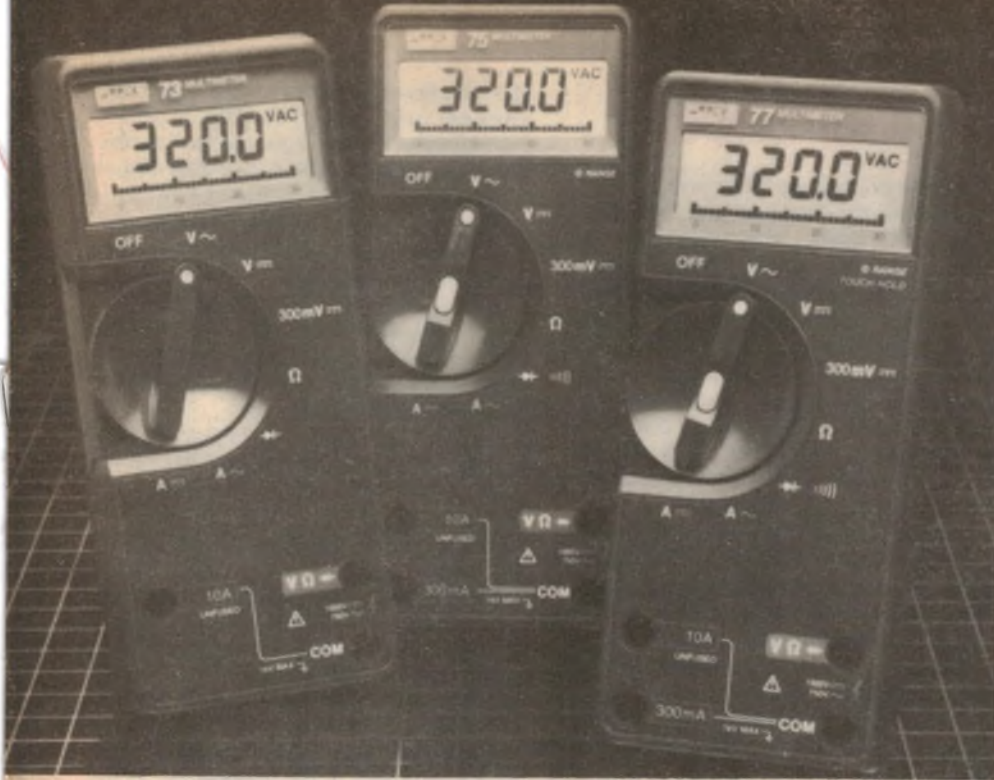

and 0.7V, it registers as a good diode and a half-second beep is emitted. Forward voltage drops of up to 2V are displayed so that LEDs can also be tested.

A beep emitted after the power-on self test signals that all systems are OK. Impressed? There's more to come!

On the 77 model meter, Fluke have a function called "Touch-hold", for which there is a patent pending. Arm the meter, set it to any range and it locks onto the first steady reading. This is perfect for those awkward situations where you really should be watching the probes rather than the display. To let you know that it has locked onto a reading, the ubiquitous beeper sounds for half a second.

To enter the touch-hold mode, the button in the selector knob is depressed before switching the meter on and must be held until the self-test is complete, ie, about two seconds. Once a reading has been taken, it is held until the button is depressed again. This clears the reading and re-arms the meter. The meter can be changed from one function to another without leaving the touch hold mode. In fact, it is only possible to exit this mode by switching the meter off.

There is a wide range of accessories available for the 70 Series meters which will adapt them for use in many specialised applications. Undoubtedly, the most universal accessory is the plastic holster. This is made of flexible, shock absorbing plastic and greatly enhances the versatility of the meter – set it upright on the bench, hang it from

Shown above are three multimeters in the new Fluke 70-series.

a brief "beep" is emitted from the meter and a special annunciator appears in the display. Repeatedly pressing the button causes the decimal point to shift (with another beep at each shift). If the button is held for one second, the meter reverts to autoranging (with two beeps) and the annunciator disappears.

The beeps are provided by means of a small piezoelectric buzzer (not fitted to the 73 model). As you may have guessed, it is used quite frequently. In

fact, some sort of audible indication is given whenever the rotary switch is operated or the button is depressed, and for a lot of other operations as well!

The most obvious use for the buzzer is in the role of continuity tester. This is realised in the diode test position where a resistance of less than 100Ω in the test circuit corresponds to a short circuit. This causes the buzzer to sound continuously. If the test component has a forward voltage drop of between 0.1

These Fluke meters are supplied with a plastic holster which can be used in a number of attitudes.

A number of accessories are available for Fluke multimeters such as these current and temperature probes.



# New concept Digital Multimeter

your belt, use it to hold or stow the test probes. It even comes with a nylon belt which stows in the back of the holster when not required.

Other accessories include a temperature sensing probe (-50 to 150°C), an RF probe for measuring signals up to 500MHz, a high-voltage probe for voltages up to 40kV and a current transformer probe. Full specifications of these accessories are provided in the 70 Series Multimeter brochures.

First glance inside the multimeter revealed mostly conventional components such as fuses (two), battery and function switch. The only unusual item was an encapsulated resistor array which looked like a strip of white cardboard mounted edge-on to the printed circuit board. It is interesting to note that there was no wiring at all in the multimeter. Everything — even the battery connectors — mounted directly

on to the printed circuit board.

Removing the larger of the two fuses (600V, 3A) reveals the printed circuit board retaining screw. Once this is removed, the board slips easily out and, yes — there they are — two special ICs. Each of the packages is 13mm square and has 60 pins — 15 along each side. Spacing of the pins is microscopic, at about 0.75mm. In fact these ICs were developed by Fluke specifically for the 70 Series multimeters and they provide most of the high tech facilities.

The printed circuit board is double sided and solder masked. Combine this with the multitude of fine tracks on the underside of the board and you have something which looks more suitable for a computer than a multimeter! In fact, there is good reason why the board should look like computer equipment — one of the ICs is a microprocessor with inbuilt ROM!

We were interested to discover that

the display interfaces to the board by means of compressible rubber connectors. When the plastic display shell is screwed to the board, the rubber is compressed, bringing minute metallised conductors into contact with the board. Something unusual at every turn with this device!

On reassembly, we noticed that the buzzer element is mounted on the back panel and also has rubber connectors. A spare fuse (250V, 630mA) is mounted inside the front cover.

Basic DC accuracy is  $\pm 0.7\%$  for the 73 meter,  $\pm 0.5\%$  for the 75 and  $\pm 0.3\%$  for the 77. The 9V battery (Eveready 216 type) has an expected life of 2000 hours in all models. Combine this with the automatic power-down facility, which puts the meter into "standby" mode after one hour of non-use, and battery changes should be few and far between.

So that's the Fluke 70 Series multimeters, from the technical point of view at least. But what are they like to use? We can state without hesitation that the bar graph type display is a big improvement over conventional DMMs. Its ability to track quickly changing signals makes it a useful test instrument in conditions that would leave others floundering.

The only area of performance which we had any cause to complain about was the diode test. The current at less than 1mA is too low. This gives only moderate immunity to parallel resistance when measuring a diode or transistor in circuit. Also, this current is insufficient to illuminate a green LED.

Some staff members felt that the beeper was too intrusive, but this is really a matter of personal preference. It is certainly useful in indicating continuity

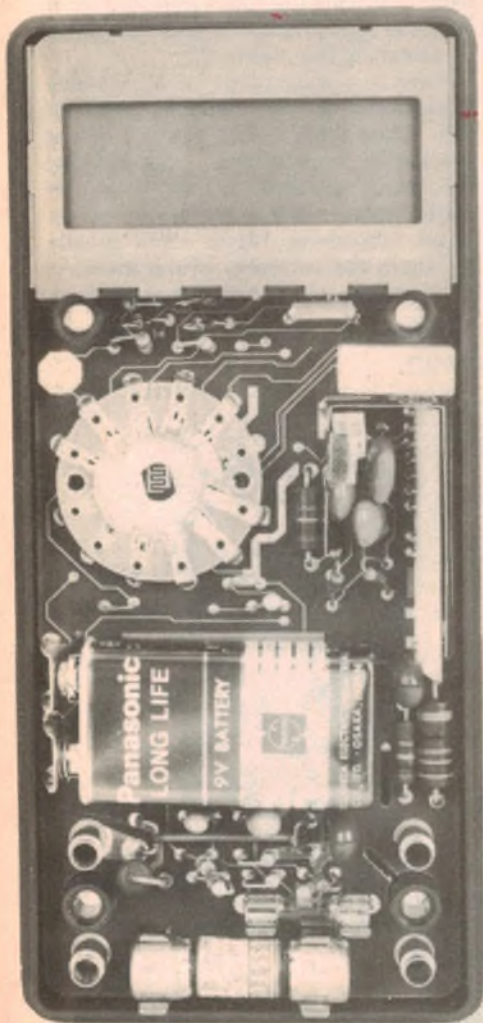

The front of the multimeter can be removed to reveal this internal view.

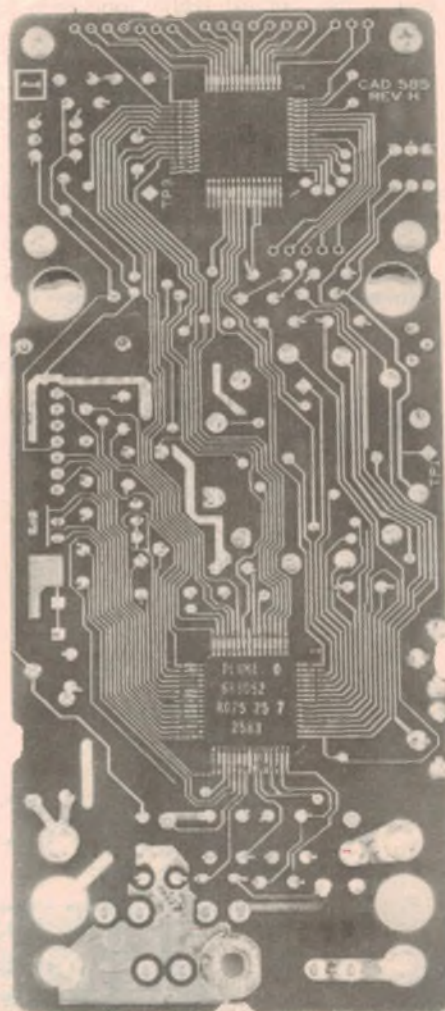

Two LSI chips with very close lead spacing provide all the features of the 70-series. One is a microprocessor with inbuilt ROM.

## The two outstanding features

Two features stand out from the rest as far as the new Fluke 70 Series are concerned: the Touch-hold facility and the bar graph analog display. The Touch-hold facility is similar to the sample-and-hold facility found on some electronic voltmeters of the past but the fact that the measurement is stored as a digital value in the microcomputer's memory makes the process far more elegant.

And the bar graph's fast response certainly will break down reservations that many users have previously had to DVMs. Note that the response of the bar graph is just as quick as a typical analog meter so it would be possible to use the Fluke for very quick "ball-park" measurements while ignoring the digital values completely.

and capture for the touch hold, but is not really necessary in the other roles. This, of course, is not a consideration with the 73 model which does not have the beeper fitted.

Similarly, some staff members thought that the self test function should be initiated manually — not every time you switch the meter on. However, this only lasts for two seconds and is not likely to prevent the industrious worker from getting on with the job.

A great deal of thought has obviously gone into the touch hold facility of the 77 Model — it works very well. Whether or not you need such a feature depends on the type of repair/troubleshooting you're likely to be doing. For those working in cramped or hazardous

conditions, it would be worth serious consideration.

We also liked the rugged engineering approach in the design of the 70-series — it should take a lot of punishment.

To sum up: a very sophisticated and yet easy to use test instrument. Definitely good value for money if you spend a lot of time measuring electric/electronic circuits.

Recommended retail prices of the Fluke 70 Series Analog/Digital Multimeters: 73 Model \$126.60, 75 model \$148.40, 77 Model \$189.80. Prices include sales tax. Further information is available from Elmeasco Instruments Pty Ltd, Box 30 Concord, NSW 2137. Also offices in Mt Waverley, Adelaide, Brisbane and Perth.

## About the Fluke company

Beginning in the basement of John Fluke's Connecticut home in 1948, the John Fluke Manufacturing Co has grown into an international operation with annual revenue of over \$160 million and 2700 employees. The headquarters, occupying a 136Ha estate in Everett (Washington) encompasses a microelectronics laboratory and production facility, and is the administration centre for operations in four continents.

The first product released by Fluke was a power meter. This was sold, in 1949, to General Electric and ever since the Fluke name has been associated with quality test equipment. Traditionally, this equipment has been "upmarket", but it is interesting to follow the progress of Fluke leading to their present assault on the popular market.

In 1952, the company, with a small but growing catalogue of test equipment, moved from Connecticut to Seattle. Three years later, Fluke introduced differential voltmeters, providing laboratory accuracy in portable equipment.

During the period 1958 to 1963, Fluke Manufacturing became a public company and undertook an expansion program, acquiring two companies in related industries. International operations were initiated in 1966, with a move into the European market.

An important new product release in 1969 was the digital voltmeter. These technically innovative meters set the stage for a decade of unparalleled growth.

Electronic test equipment was revolutionised in 1977 with the introduction of the Fluke hand held digital multimeter. Although manufactured by a major semiconductor company, the microelectronics for this meter were actually developed by Fluke, enabling them to produce compact test equipment which outperformed much larger and more expensive models. The ICs used in this meter subsequently became available commercially, with the result that numerous competitors appeared in the hand held DMM market.

Many of the competing models, originating in Japan, Korea and other Asian countries were lower quality instruments, offering reduced accuracy and input protection but at a much lower price.

Fluke continued to improve multimeter technology, releasing the 4½ digit 8060A in 1982. This was aimed at the communications and business machine service markets. However, competitors achieved an increasing share of the lower end of the market and Fluke formulated a new strategy. This culminates in the release of the 70 Series meters this month, bringing Fluke into the popular market with a vengeance.

The 70 Series meters will be manufactured entirely by Fluke. Rather than sub-contract the manufacture of ICs to semiconductor companies, the process will be completed within the Fluke Electronics Park. In this way, Fluke hopes to achieve a significant headstart over its competitors. In anticipation of volume sales, an assembly line has been prepared which has a capacity of 1000 units per shift. This gives a manufacturing potential of up to 400,000 units per year!

## NEW RELEASE



### REWINDER FOR BETAMAX & VHS VIDEOCASSETTES

- Auto Rewind, Stop and Eject Betamax & VHS video cassettes



- Double durability precious video cassette recorder and valuable video cassette.

Prolong mechanism of your VCR

ATTENTION:

#### DUPLICATION HOUSES VIDEO RENTAL STORES

Rewinds your tapes faster.  
Releases your VCR for rental quicker.

### VIDEO DETAIL ENHANCER



Video detail enhancer particularly designed to rectify loss in detail derived from VCR tapes and picture impairment. Ideal for off-air recording — dubbing, etc.

Also available

VIDEO ACCESSORIES, CABLES,  
HEAD CLEANERS ETC.

## VIDEO BAR

343 Illawarra Rd, Marrickville  
N.S.W.

**OPEN 7 DAYS A WEEK**

Phone: (02) 559 5492  
ADELAIDE (08) 47 7334

Agents for other states required.

**BANKCARD HOLDERS —  
PHONE YOUR ORDERS  
TOLL FREE!**

**NEXT DAY DELIVERY**

**AUSTWIDE**

**ALTRONICS**

**008-999-007**

**VIA  
JETSERVICE**

(CAPITAL CITY & SUBURBAN AREAS)



**GO ANYWHERE 12-240V POWER**

**MASSIVE  
300 WATTS**



These great Inverter kits enable you to power 240V appliances from a 12V DC power source. Tremendous for camping, fishing etc. Install Into your Car, Boat or Caravan.

A fully regulated and overload protected design, featuring XTAL locked frequency. Use to power hi-fi, TV sets, even electric drills for short time periods.  
**MANY OF THESE KITS ARE NOW IN USE FOR EMERGENCY LIGHTING PURPOSES.**  
ALTRONICS' KIT features → Gold plated edge connector and PCB huss → Low age rate XTAL → Sockets for all IC's → High Efficiency Transformer.

K6750..... (EA JUNE '82) ... **\$199.50**

(\$10 DELIVERY AUSTRALIA WIDE)

**TWO GREAT 40 WATT MODELS**



**GENERAL PURPOSE**

Suits small appliances, i.e. Turntables, Tape Decks, Shavers etc. Variable frequency adjustment enables speed control of turntables. Works as a trickle charger when mains power is available.  
EASY CONSTRUCTION → VALUE PLUS

K6700..... **\$55.00**

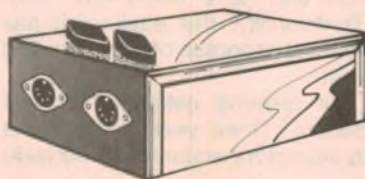

**FLUORESCENT LIGHTING**

Operates above the audible frequency range and is capable of driving one 40 watt or two 20 watt fluorescent tubes to 150% of their normal 240V efficiency. Install permanently into caravans. **COMPLETE BOXED KIT, INCLUDING ALL WINDING WIRE.**

K6505..... **\$37.50**

**ALCOHOL  
BREATH TESTER**



**K1583  
ONLY  
\$29.95**  
(SEE EA  
MAY 1983)

This Great new Kit from EA will be a smash hit with all the smashed people at your next party. Fun to build. Fun to calibrate and Fun to use. More seriously, this unit could save lives.

**MICROWAVE OVEN  
LEAK DETECTOR**



**ETI PROJECT**

Completely passive project receives microwaves via an antenna which develops a voltage across a detector diode driving the meter.  
Monitor your microwave oven with this easy to build kit. All components mount on single PCB, including the meter.  
Genuine Hewlett Packard Hot Carrier Diode supplied.

K1724..... (still only) **\$14.50**

**TRANSISTOR ASSISTED IGNITION  
WITH DWELL EXTENSION**



The Altronics Kit includes all components for the modifications, detailed by Electronics Australia Feb. 1983.

Yes, it's bad enough paying \$2.00 a gallon for petrol without wasting a fortune on an out of tune engine. Fit this transistor assisted ignition kit in minutes and start saving money from the very next petrol stop. Easy to build!

K4010..... **\$35.00**

**POWER DOWN  
MAINS APPLIANCE TIMER**

(ETI JULY '82)



Clever new design from ETI, mains appliance is turned on at the press of a button and automatically turned off some preset time later.  
Use for electric blankets, bathroom heaters, patio light. If your inclined to fall asleep while watching TV late at night — this is the kit for you.  
SEC Approved Transformer Screened Front-Panel Complete Kit as per ETI article, includes every last part

K6265..... only **\$32.50**

See EA November, 1982

**POWER**

**UP**

**A MUST  
FOR YOUR  
COMPUTER  
SYSTEM**



This great new Project from EA is the answer to a Maidens Prayer.  
What Does it Do?

A single 240v mains plug and lead feeds one unswitched master 240v outlet plus 4 switched 240v outlets. With say a hi-fi system, plug your main equipment item (e.g. Amp) into the master outlet and whenever you "switch on" your amp — presto — mains power is applied to the other 4 outlets i.e. simply "turning on" your amp turns on your tape cassette, tuner, turntable, graphic equaliser without mains spikes, plops etc.

Just the shot for your Computer System. The Altronics Kit includes case and all outlets

K6000..... **\$39.50**

ALTRONICS • BANKCARD JETSERVICE DELIVERY NEXT DAY • ALTRONICS

ALTRONICS • BANKCARD JETSERVICE DELIVERY NEXT DAY • ALTRONICS

**VIDEO RF MODULATOR**  
(SEE ETI OCT 1981)



If you cannot afford a Video Monitor for your computer this is the kit for you. Super stable oscillator design and very low modulation distortion ★ Works with both B & W and Colour TV sets ★ Suitable for computers, TV games, TV pattern generators or what have you. Deluxe kit featuring heavy duty diecast box for RF shielding ★ Input and output sockets  
K9760 \$17.50

**0-40 VOLT / 5 AMP LAB SUPPLY**

(SEE ETI MAY & JUNE 1983)

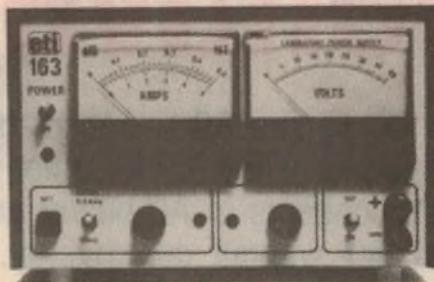

FEATURING: VARIABLE CURRENT LIMIT- DUAL METERING

A Laboratory Supply requires specifications second to none. **This Supply has them!**

- Output voltage ..... 0-40 V variable
- Output current ..... 0-0.5 A variable limiting  
..... 0-5 A variable limiting
- Output regulation ..... <50 mV at up to 2.5 A  
..... <100 mV up to 5 A
- Maximum output power ..... 200 watts
- Metering Voltage ..... 0-40 V in 1 V divisions
- Current ..... 0-0.5 A in 20 mA divisions  
..... 0-5 A in 200 mA divisions

Series regulator design enables design and development of sensitive high gain audio and RF circuitry free from hum and noise sometimes associated with other techniques.

K3325 ..... \$175.00

★ **KIT SUPPORT FOR THE MICROBEE** ★

**EPROM PROGRAMMER**  
(ETI JAN '83)



K9668 ..... \$55.00

Versatile, low cost and easy to build. Plugs straight into the microbee I/O port. Suitable for 2716, 2732, 2532, 2732A and 2764 Eproms. Burn your games programmes and eliminate cassette loading time.  
**KIT FEATURES** ★ Sockets for all other IC's ★ 1 x 2716 supplied — get started straight away ★ Front Panel and Mains (SEC approved) transformer ★ 28 pin and 16 pin wire wrap sockets to flush mount personality plugs (2 included) and ZIF socket (included) ★ DB15 Plug ★ Complete to last nut and bolt.  
(See Review ETI AUGUST 1983)

**RADIOTELETYPE DECODER**  
(ETI APRIL '83)



K9733 ..... \$19.50

Display RTTY encoded messages on your Video Monitor. Receive up to date weather information, International News before the Papers, all sorts of coded military info. Simple circuit uses PLL techniques ★ Single PCB Construction ★ KIT includes DB15 Plug and backshell for connection to microbee ★ Shielded pretinned PCB

**MICROBEE LIGHT PEN**  
(ETI AUGUST '83)



PROVIDES DIRECT PERSONAL CONTACT WITH YOUR BEE!

K9649 ..... \$19.95

AT LAST — a light pen for the Bee. This pen works in the low-resolution graphics mode and connects directly to the I/O port ★ Complete kit including DB15 and backshell, 2m CORD ★ Fully documented with software examples.

★ **BUILD YOUR OWN PROFESSIONAL TEST GEAR** ★

**7 DIGIT FREQUENCY COUNTER**

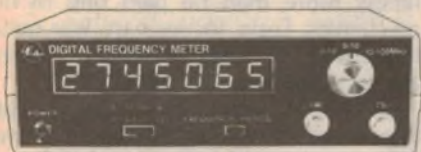

**UNBELIEVABLE 0.005% ACCURACY**

★ Frequency and Period measurement to 500 MHz (with optional prescaler) ★ High input sensitivity. Professional unit at a fraction of the cost of built up units.

★ IC sockets provided throughout ★ Low age rate 10,000 MHz XTAL ★ Quality ABS plastic case with deluxe front panel ★ Specified LSI

K2500 ..... \$119.50

**PRESCALER**  
K2501 ..... \$26.00

**DECIMAL POINT**  
K2502 ..... \$7.50

**FUNCTION GENERATOR**

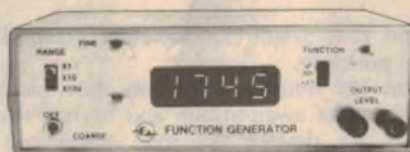

The most essential piece of test gear (second only to a good multimeter) on any hobbyist's bench is some kind of audio signal generator. This design utilizes the latest circuit techniques to produce stable, low distortion waveforms.  
A truly versatile unit at a bargain price.

★ 4 digit frequency readout (eliminates tiresome dial calibration) — typical accuracy ± 2% ★ 3 overlapping ranges x1, x10, x100 ★ 600 OHM Nominal Output — continuously variable 3MV — 2.5V P-P ★ Distortion — sine wave: less than 0.7% @ 1KHz ★ Linearity — triangle wave: better than 1% @ 1KHz ★ Square wave rise time — 6V/μs maximum output ★ Amplitude stability — better than 0.1dB on all ranges

With the exception of the display all components mount on a single PCB making this kit suitable for all constructors.

K2505 ..... \$85.00

**DIGITAL CAPACITANCE METER**

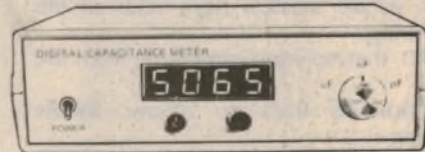

with Deluxe Instrument Case

**NEW DELUXE FINISH**

We are pleased to announce the release of the Digital Capacitance Kit housed in our Deluxe H0480 ABS Instrument Case.

This superb Test Instrument Kit now compliments our top selling Digital Frequency Counter and Function Generator Project Kit. Electronics Australia Project Measures capacitance of both polarized and non-polarized capacitors from 1 picofarad to 99.99 microfarads in 3 ranges. Check values of unmarked capacitors, especially those little trimmers that are never coded. Select precise values for filters and timing networks within ease.

EXCLUSIVE TO ALTRONICS

Each kit includes precision measured capacitors for accurate calibration of each range

K2521 ..... \$55.00

# The inventive genius

“The battle of the currents” — DC versus AC — raged throughout the 1880s. On one side was Edison, already famous, while on the other was an unknown newcomer, Nikola Tesla. Tesla’s concepts of AC power generation and distribution eventually carried the day, but not without controversy.

While Tesla worked at the Hungarian Telegraph office thoughts of alternating current never left his mind. Every spare moment was used in creating his unique mental constructs. Eventually, the toll became too much and Tesla had a breakdown. Doctors professed themselves mystified by his weird symptoms.

Tesla wrote: “I could hear the ticking of a watch with three rooms between myself and the timepiece. A fly alighting on a table in the room would cause a dull thud in my ear . . . the roaring noises from near and far often produced the effect of spoken words which would have frightened me had I not been able to resolve them into their accidental components.

“In the dark I had the sense of a bat and could detect the presence of an object 12 feet away by a creepy sensation on my forehead. My pulse varied from a few to 260 beats.”

The physicians’ cures did nothing for him, but slowly the malady ebbed. Tesla was pleased that his memory had not been affected, for his ability to quote from the classics remained as sure as ever.

One afternoon in February, 1882, whilst walking in a park with his assistant, Szigeti, he spoke some lines from Goethe:

The glow retreats, done is the day of toil;

It yonder hastes, new fields of life exploring;

Ah, that no wing can lift me from the soil;

Upon its track to follow, follow soaring . . .

Suddenly he fell silent. There, before him, was the device he had thought about so long.

“Watch me reverse it,” he told Szigeti. His assistant, naturally seeing nothing, feared that Tesla had had a relapse.

Impatiently, Tesla described the concept that had flashed into his mind when he quoted those lines of poetry: a two-phase circuit — two magnetic fields — that would create a rotating force to pull a rotor by induction. Quickly, he picked up a stick and sketched the circuit in the dust of the path. His exposition was so

Photo courtesy Westinghouse Electric Corp.

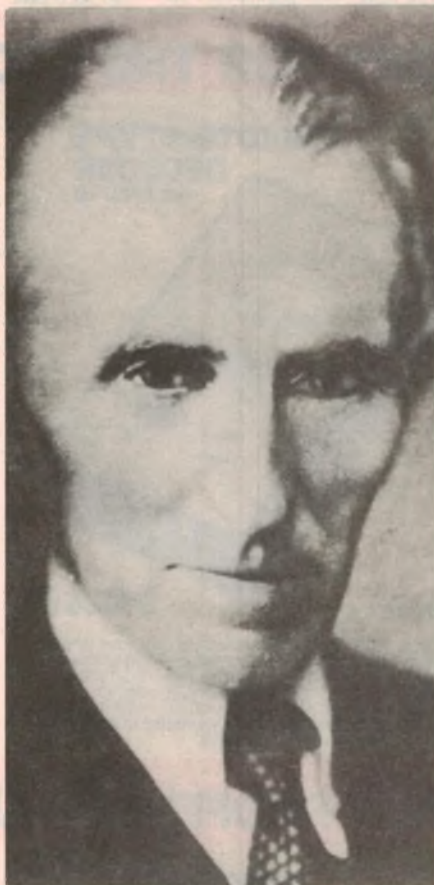

One of the few photographs of Tesla, taken late in life.

lucid that Szigeti immediately grasped the principle.

On his return to his job, however, other tasks awaited him and he had no time to devote to this marvellous discovery. It did not worry him, for he could build his mental constructs and set them running, to be examined at some future date. Soon, the telephone central office was completed.

In the spring of 1882, Tesla travelled to Paris, securing employment with the Continental Edison Co. After some design work, a power plant assignment took him to Strassburg. A physical example of the rotary field AC motor was constructed there in the summer of 1883. When not wasting time with the Germanic bureaucracy, he tried to raise in-

terest and capital for his AC discovery but had no luck.

Returning to Paris early in 1884, he found the same situation. What is more, the large bonus he had been promised for earlier design work and his efforts as trouble-shooter in Strassburg never materialised. At that point, he determined to go to “The Land of Golden Promise” — America.

Armed with a letter from Charles Batchellor, a company director, and a personal friend of Thomas Edison, Tesla prepared to depart Europe, perhaps for good. On his way to the docks, someone picked his pocket. He convinced ship’s personnel that he had booked a passage by quoting the ticket number. He arrived in the United States with a book of his poems, a couple of technical articles, some notes on a mathematical problem, a design for a flying machine — and four cents in his pocket.

Nikola Tesla presented himself to Edison straight away. The famous Yankee inventor looked suspiciously at this dapper foreigner before him, but read the letter of recommendation from Batchellor:

“I know two famous men and you are one of them,” it said. “The other is this young man.”

On the strength of that, Edison offered the excellently educated and well-experienced engineer \$18 a week — hardly more than he paid one of his mechanics. Tesla, for his part, was quite impressed by Thomas Alva Edison, almost a legend in his own lifetime.

He was to write: “The meeting with Edison was a memorable event in my life. I was amazed at this wonderful man who, without early advantages and scientific training, had accomplished so much. I had studied a dozen languages, dived in literature and art . . . and felt that most of my life had been squandered.”

At first, Tesla was given very junior tasks but soon he had won Edison’s confidence. On one occasion, Tesla was despatched to the steamship *Oregon*, which had missed its sailing date, due to a problem with Edison generating equipment on board. At five o’clock the next



# of Nikola Tesla *Part 2*

by J. L. ELKHORNE

morning, Tesla, with the assistance of the crew, had effected major repairs and was returning to the shop, when he met Edison and Batchellor, recently returned from Europe.

"Here is our Parisian running around at night," Edison commented. Tesla informed him that the repairs on the *Oregon* had just been completed. As he left, he heard Edison tell Batchellor: "This is a damn good man."

The good relationship would soon deteriorate, however. As soon as Tesla mentioned his ideas about alternating current, Edison silenced him. Then, in one of those little incidents that grow all out of proportion, Nikola Tesla would misunderstand a casual statement.

He had suggested some significant improvements to the Edison equipment. The American inventor remarked: "There's \$50,000 in it for you, if it works."

Soon, Tesla had completed his calculations and tests. His improvements were put into practice. Time passed, and the reward he envisaged did not occur.

***"The American inventor remarked: "There's \$50,000 in it for you, if it works"***

Finally, he questioned Edison about it, and learned that it was "a practical joke". Tesla could not laugh, however. He had designed 24 different types of machines, in a workday which went from 10.30 in the morning to 5am the next morning — without a day's exception — for nearly a year.

Tesla resigned.

His initial impression of Edison had been tempered by observation of the great man at work: "If Edison had a needle to find in a haystack, he would proceed at once with the diligence of the bee to examine straw after straw until he found the object of his search. I was a sorry witness of such doings, knowing that a little theory and calculation would have saved him 90% of his labour."

Edison relied on his "intuition" and trial-and-error methods. After 10,000 trials for a new type of storage battery had proved fruitless, Edison bragged that he had not failed. "I now know 10,000 ways that won't work," he said.

Unfortunately, Edison had the reputation — and the money to follow his own path. Tesla, only a year in America, had no money, no contacts, and no pro-

Photo courtesy Westinghouse Electric Corp.



*This tower was built on Long Island in 1904 while Tesla was experimenting with power distribution by wireless.*

spects. Still, a group of entrepreneurs approached him with an idea to start yet another street lighting company, still a money-maker in the big cities. Tesla worked for some time, designing new types of arc lights and regulators, and eventually found himself the possessor of a stock certificate of doubtful value.

Edison, bitter over their differences, told anyone who would listen that the foreigner was not to be trusted. Tesla went through such hardship during the next year that he seldom spoke of it afterwards. He did occasional electrical repair jobs and during the bitter winter of '86-7, worked as a common labourer. His foreman, a stockbroker who had lost

everything in the market, maintained contacts in the business world. After listening to Nikola Tesla at length, he approached an executive, A. K. Brown, of the Western Union Telegraph Co.

Brown and an associate were favourably impressed by Tesla and financed a laboratory for the inventor, not far from the Edison works. The concepts Tesla had developed five years earlier were on file — in his head. His original motor lay forgotten in Europe; the later work had all been intellectual. By October of 1887, Tesla built his engine models. He filed for patent on an alternating current system, of which the motor was only a part.

# The inventive genius of Nikola Tesla

Just as Edison had foreseen that the electric light without a distribution system was of little import, so Tesla regarded his discovery of the rotating magnetic field. To him, the motor provided only a piece of a unified system. The US Patent Office, however, reacted with horror at his sweeping approach. They broke the original application down into seven sections, and by the end of the year, had issued 30 basic patents.

As his work began to receive publicity, he was hailed as the scientific genius of the age. On invitation, he delivered a lecture before the American Institute of Electrical Engineers on May 16, 1888. The theory and practice he presented are the basis of the system we still use today. Improvements have been made, to be sure, but offer no radical departures to his central concept. In one stroke, he accomplished an engineering breakthrough of such magnitude that no comparable development has been presented since — especially by a single individual.

The group of patents included single and multi-phase motors, polyphase distribution and transformers, alternating current generators, AC to DC conversion, condensers, insulators and meters.

Five years before, Edison had electrified New York City, a remarkable achievement — with remarkable limitations. Even with his feeder-and-main distribution system, there was about a 30 volt drop overall. The nominal 110 volt adopted by Edison was compensated for by generating at 120 or even 130 volts. Those closest to the central station had brighter light — and quicker burnouts; those people at the far end had light that left much to be desired. The Edison system was predicted on an arrangement of a power house every mile or so. Although men had actually made DC generators that emitted as much as 6kV, outside the laboratory such machines were not practical, nor was long-distance transmission feasible with them. Line loss remained a significant factor of DC operation.

With Tesla's polyphase system, however, power could be generated anywhere, transformed, sent down a transmission line, and then stepped down at the point of use, all with a very high efficiency.

Fortunately for Tesla — and for mankind — a man of commerce who could bring this scientific feat out of the laboratory and to the world of everyday engineering practice made his approach.

George Westinghouse, inventor and head of his own company, had succeeded after the American Civil War in marketing a portable device for getting derailed cars back on the tracks.

His invention of the railroad air brake though, established him as one of the giants of American business. He went on to become a pioneer of the gas-distribution and lighting industry. When Edison's electric distribution system began making itself felt, Westinghouse knew he needed to get involved in electricity to remain competitive. He swiftly mastered the state-of-the-art and bought the patent rights of various inventions. He designed a transformer, after study of the recent Gaulard-Gibbs unit, in three weeks. Having invented one of the first steam turbines in the world, he was

***"I will give you a million dollars for the use of your AC patents."***

quick to realise that a practical AC motor would be the key to a new and profitable system.

When he heard of the Tesla patents in the latter part of 1887, he had already organised the Westinghouse Electric Company. He saw the importance of the rotating magnetic field concept. He approached Tesla in 1888 with an offer that could not be refused: "I will give you a million dollars for the use of your AC patents," he told the gaunt inventor, 10 years his junior. Tesla later admitted that such an astounding figure shocked him speechless. After a long pause, he replied, "Accepted — if you will also offer a royalty on manufacture."

At this point legend appears to take over from known fact. A popular story has it that Tesla and Westinghouse agreed on certain sum per horsepower of equipment sold; a sum which varies — apparently depending on the re-teller of the story — from one dollar to two dollars fifty. And, according to the story, it was a handshake agreement.

Whether this was ever ratified by a formal contract is not known, and no such contract has ever been found. But the story goes on to tell how the Westinghouse board, who had provided most of the money, refused to honour the agreement and threatened to withdraw their support on the basis that it would bankrupt the company.

At this stage Tesla reputedly tore up the contract rather than see the company, and his work fail.

By all accounts, including that of Westinghouse historian Charles A. Ruch, this legend is just that; a legend arising out of a royalty discussion which was documented but which never went beyond that stage.

At any rate, the initial payment for patent rights (which one writer states was only \$200,000) was split with Tesla's backers. With a small fortune at his fingertips, Tesla found himself eager to pursue remarkable new areas on the frontier of science. Westinghouse, however, convinced him that immediate practical work on the problem at hand was necessary.

Edison, extremely worried over his two million dollar investment in the New York City generating system, launched a vitriolic attack on the new system. With his usual publicity machine in action, he raised the horrors of imminent electrocution of the general public exposed to the AC system.

He wrote: "Just as certain as death Westinghouse will kill a customer within six months after he puts in a system of any size. He has got a new thing and it will require a great deal of experimenting to get it working practically. It will never be free from danger."

Edison men distributed pamphlets, warning the populace that it would be a matter of taking one's life in his hands to merely walk the streets, constantly at the mercy of the lethal high-tension wires. The fact that a lineman a month on the Edison system was killed was ignored. Convinced by their boss's propaganda the DC was inherently safe, they failed to take adequate safety precautions.

Half a mile from his estate at West Orange, New Jersey, Edison had built a large laboratory, replacing the facilities at Menlo Park. As part of his propaganda campaign, he and his associates regularly electrocuted "stray" cats and dogs in public demonstrations.

Animals were purchased at 25 cents a head from local schoolboys. Immediately after their acquisition, they were thrown onto a contrivance powered by a 1kV alternator, possibly manufactured by the Westinghouse Electric Company. The pet population of the New Jersey community was nearly wiped out.

Charles Batchelor, who had unleashed Tesla on Edison and America, suffered an unfortunate experience while helping his boss in these enlightenments. One large dog, having deduced no good was about to be done him, wriggled out of Batchelor's grasp, knocking the man

***In one stroke, he accomplished an engineering breakthrough of such***

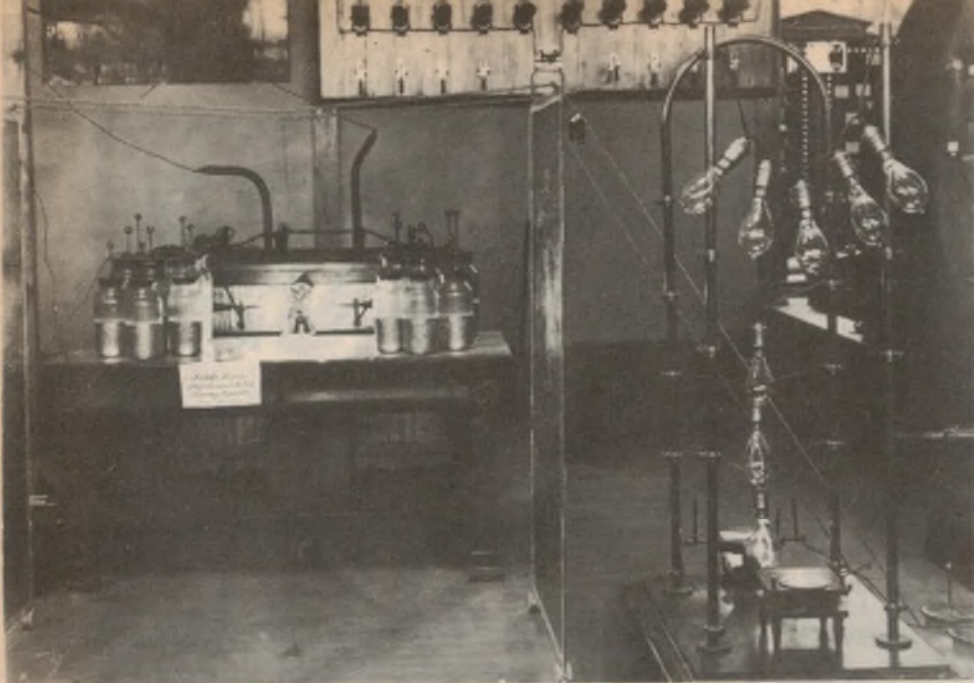

Photo courtesy Westinghouse Electric Corp.

A high voltage, high frequency set-up at Tesla's Westinghouse Laboratory.

himself onto the electrocution platform. Although he was not killed, he described the sensation: "(as) the sensation of an immense rough file thrust through the quivering fibres of the body."

Edison published an article defending his cruelty to animals, saying: "I have taken life — not human life — in the belief that the end justifies the means."

H. P. Brown, who had been a laboratory assistant at West Orange, himself began public execution of cats and dogs. He claimed to be demonstrating that such a death was "instantaneous, painless and humane." He became a lobbyist and independent consultant to the New York State legislature, helping to usher in a bill allowing capital punishment by electrocution. As soon as the statute became law, he made a well-publicised purchase of Westinghouse equipment, which was installed at Sing Sing Prison.

Westinghouse appealed to common sense, issuing a public statement that no deaths by electrocution had previously been caused by his company's equipment. He managed to counter a suggestion that the term "to Westinghouse" be used to refer to electrocution of condemned criminals.

Over strenuous objections by Westinghouse and his associates, the authorities finally decided to give the new statute — and equipment — a test. On the night of August 6, 1890, convicted wife murderer, William Kemmler, was led from his cell. Moments later, he found himself vibrating to a jolt of Westinghouse alternating current. To the chagrin of the prison officials, the shock did not kill him — the voltage was too low. He was unstrapped from the chair, marched back to his cell, and the

electric chair examined. A wiring fault was found. (The electrician was probably another Edison man — fearful of his proximity to such a devilish machine.)

Hasty modifications were effected — and William Kemmler brought once again to face his punishment. This time, death was instantaneous, but called by one observer "an awful spectacle, far worse than hanging." Apparently, the optimum high-tension had been far exceeded . . .

Tesla found himself fighting Westinghouse engineers in Pittsburgh during the year 1889. He had selected 60 Hertz as the best compromise frequency for commercial power applications. Westinghouse engineers (or company accountants) had decided that 133 cycles a second would be the standard —

**"He built an alternator with 384 poles which generated 10,000 Hertz."**

it would decrease the cost of core materials. Even though George Westinghouse offered Tesla a \$24,000 per annum salary to stay, the younger man argued he wasted his time in minor design work, disagreements, and was not free for creative work.

"At the close of 1889, my services in Pittsburgh being no longer essential, I returned to New York and resumed experimental work in a laboratory on Grand St." Tesla later wrote.

Back in New York City, he began spending lavishly. He embarked on a program of research into a number of areas simultaneously. Familiar with the work of James Clark Maxwell and Heinrich Hertz,

he proceeded to research apparatus working on higher and higher frequencies. He built an alternator with 384 poles which generated 10,000 Hertz. Although he finally achieved a stable rotary machine working at 30,000 Hertz, he abandoned such equipment for new apparatus capable of far higher frequencies. At the same time, he delved into the areas of mechanics, pneumatics, hydraulics and resonance phenomena.

His first high-frequency experiments culminated in a lecture at Columbia College on May 20, 1891. In it, he demonstrated the high-frequency alternator, as a power source for induction coils of his own design. He showed many curious electrostatic effects, so-called bush discharges, unique forms of incandescent lamps, and the first demonstration of wireless lighting. He achieved the phenomenon of stationary waves in a large copper bar, lighting various types of lamps at the maximum potential nodes of what seemed in conventional terms to be a short-circuit.

From the mundane world of low-frequency alternations, he had leaped into a strange, new frontier where each discovery was more unbelievable than the last — except for the fact that he was able to show experimental proofs to an astounded audience.

These investigations were the predecessor to the development of the Tesla coil. At this time, he was working with closely-coupled coils, sometimes cored, and immersed in oil or insulated with paraffin to prevent arc-over.

One of the more curious effects he demonstrated was the illumination of a carbon filament lamp, in which the globe itself was incandescent, whilst the filament remained dark! He also developed a lamp with a single button of ruby which emitted light.

His unique research so fired the imagination of scientific men that he was invited to England. In February, 1892, he gave a more advanced lecture before the Institution of Electrical Engineers, London, titled "Experiments with Alternate Currents of High Potential and High Frequency." Work he had done the previous year had been added to considerably. He had worked with Crookes tubes, precursors of the cathode ray tube. As the electron was not yet known to scientists, a great many puzzles manifested themselves in this research. Tesla was still working with relatively small, oil-insulated coils, but had made considerable advances in the types of sparkgaps employed. Dozens of fantastic luminescent effects were displayed: A group of incandescent lamps that had solid buttons of various materials instead

*Continued on page 134*

***magnitude that no comparable development has been presented since —***

# ELECTRONICS

PROPRIETARY LIMITED

797 SPRINGVALE RD. MULGRAVE 3170. PHONE: (03) 561 5844 TELEX AA37758 LSTRON  
289 Latrobe Street, Melbourne 3000. Phone: (03) 602 3499 Telex AA37758 Lstron



LINEAR  
**\$12<sup>50</sup>**  
BOOK

## REGULATORS

### UA78P05SC

- 10 A OUTPUT
- INTERNAL THERMAL OVERLOAD PROTECTION
- INTERNAL SHORT CIRCUIT CURRENT LIMIT
- LOW DROPOUT VOLTAGE (TYPICALLY 2.3V @ 10 A)
- 70 W POWER DISSIPATION
- PIN-FOR-PIN COMPATIBLE WITH THE UA78HO5/A and SH323
- STEEL TO-3 PACKAGE



**\$10<sup>95</sup>**



**\$7<sup>95</sup>**

### UA78S40

- STEP-UP, STEP-DOWN OR INVERTING SWITCHING REGULATORS
- OUTPUT ADJUSTABLE FROM 1.3 to 40V
- PEAK CURRENTS TO 1.5A WITHOUT EXTERNAL TRANSISTORS
- OPERATION FROM 2.5 to 40V INPUT
- LOW STANDBY CURRENT DRAIN
- 80 dB LINE AND LOAD REGULATION
- HIGH GAIN, HIGH CURRENT, INDEPENDENT OP AMP
- PULSE WIDTH MODULATION WITH NO DOUBLE PULSING

### UA78HGA

- 5.0 A OUTPUT CURRENT
- INTERNAL CURRENT AND THERMAL LIMITING
- INTERNAL SHORT CIRCUIT CURRENT LIMIT



**\$6<sup>50</sup>**

- LOW DROPOUT VOLTAGE (TYPICALLY 2.3 V @ 5.0 A)
- 50 W POWER DISSIPATION
- ELECTRICALLY NEUTRAL CASE
- STEEL TO-3 PACKAGE
- ALL PIN-FOR-PIN COMPATIBLE WITH UA78HG

# ELECTRONICS

PROPRIETARY LIMITED

797 SPRINGVALE RD. MULGRAVE 3170. PHONE: (03) 561 5844 TELEX AA37758 LSTRON  
 289 Latrobe Street, Melbourne 3000. Phone: (03) 502 3499 Telex AA37758 Lstron

## REGULATORS



### HYBRID REGULATORS

DEVICE	PRICE
SH1605	9.70
SH323SC	3.45
UA78H05ASC	4.95
UA78H05SC	4.85
UA78H12ASC	6.15
UA78H12SC	6.10
UA78HGASC	6.60
UA78HGSC	6.50
UA78P05SC	10.95
UA79HGSC	11.00



PRODUCTS MANUFACTURED BY

## FAIRCHILD

A Schlumberger Company

ONE OF THE WORLDS LEADING  
 SEMICONDUCTOR MANUFACTURERS

UA7812UC	.45
UA7815KC	1.25
UA7815UC	.45
UA7818KC	1.25
UA7818UC	.45
UA7824KC	1.25
UA7824UC	.45
UA7885UC	.98
UA78GKC	2.15
UA78GUIC	.95
UA78L05AWC	.29
UA78L09AWC	.29
UA78L12AWC	.29
UA78L15AWC	.29
UA78L62AWC	.29
UA78L82AWC	.29
UA78M05HC	1.25
UA78M05UC	.45
UA78M06HC	1.25
UA78M06UC	.45
UA78M08HC	1.25
UA78M08UC	.45
UA78M12HC	1.25
UA78M12UC	.45
UA78M15HC	1.25
UA78M15UC	.45
UA78M24UC	.45
UA78MGUIC	.80
UA78S40DC	2.05
UA78S40PC	1.95
UA7905KC	1.25
UA7905UC	.55
UA7908KC	1.25
UA7908UC	.55
UA7912KC	1.25
UA7912UC	.55
UA7915KC	1.25
UA7915UC	.55

### LINEAR REGULATORS

DEVICE	PRICE
UA305AHC	.95
UA305HC	.75
UA309KC	1.25
UA317KC	2.05
UA317UC	.65
UA376TC	.37
UA431AWC	.45
UA494DC	2.53
UA494DC	2.10
UA723DC	.65
UA723HC	.71
UA723PC	.38
UA7805KC	1.25
UA7805UC	.45
UA7806UC	.50
UA7808KC	1.25
UA7808UC	.45
UA7812KC	1.25

ALL PRICES PLUS 20% TAX IF APPLICABLE.

# ELECTRONICS

PROPRIETARY LIMITED

797 SPRINGVALE RD. MULGRAVE 3170. PHONE: (03) 561 5844 TELEX AA37758 LSTRON  
 289 Latrobe Street, Melbourne 3000. Phone: (03) 602 3499 Telex AA37758 Lstron

## NEW VIDEO MONITOR

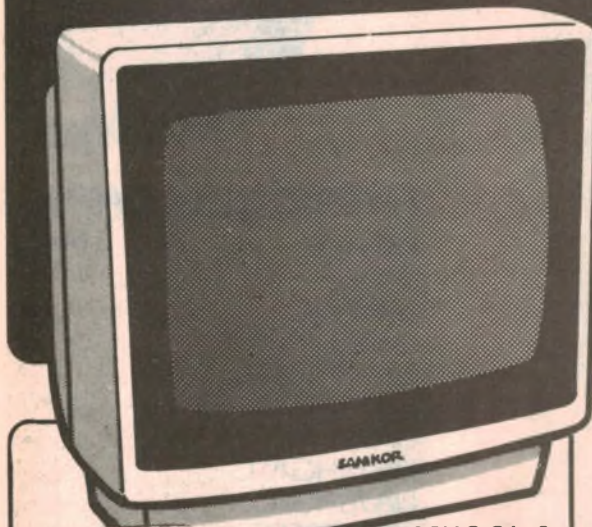

**MCG-12G** SCHOOL &  
(12") CLUB BULK BUYERS  
PLEASE RING FOR PRICING.

### OUTSTANDING FEATURES:

- LOW COST, HIGH QUALITY - SMART, RELIABLE
- COMPACT DESIGN & LIGHT WEIGHT
- LOW POWER CONSUMPTION
- NON-GLARE, GREEN/AMBER OPTION
- WIDE VIDEO BANDWIDTH (20MHz) FOR CLEAR & SHARP PICTURE
- INTERFACES WITH ALL POPULAR PERSONAL COMPUTERS LIKE IBM PC, APPLE
- FCC, UL APPROVED - 1000 LINES RESOLUTION

**GREEN PHOSPHOR ...\$154**  
**ORANGE PHOSPHOR ...\$175**

**RESELLER PRICES  
ON APPLICATION.**

ALL PRICES PLUS 20% TAX IF APPLICABLE.

## AMAZING NEW CP-80 PRINTER

QUALITY PRODUCT  
MADE IN JAPAN



## HITACHI V152F



## TRIO CS-1560 AII

• Simplified circuitry - improved performance and dependability have been successfully realized with the use of ICs throughout  
 • A vertical amplifier provides as wide a bandwidth as DC to 15 MHz, as high a sensitivity as 10 mV/div and a low input capacitance  
 • A sweep rate extends from 0.5  $\mu$ sec/div to 0.5 sec/div in 19 ranges. Further, TV vertical and horizontal syncs are available for measuring video signals and, its x5 magnified sweep, its range of application is extremely wide  
 • Very easy X-Y operation of high input sensitivity for Lissajous measurements  
 • Dimensions: 260(W) x 190(H) x 385(D) mm. Weight: 8.4kg

### • Features

- TV sync-separator circuit
- High-sensitivity 1 mV/div (15MHz)
- X-Y operation
- Sweep-time magnifier (10 times)
- Trace rotation
- Z-axis input (Intensity modulation)

**PROBES 10 to 1  
SWITCHING  
ONLY \$22 ea.**



130mm DUAL-TRACE TRIGGERED  
SWEEP OSCILLOSCOPE

# ELLISTRONICS

PROPRIETARY LIMITED

797 SPRINGVALE RD. MULGRAVE 3170. PHONE: (03) 561 5844 TELEX AA37758 LSTRON  
289 Latrobe Street, Melbourne 3000. Phone: (03) 602 3499 Telex AA37758 Lstron



**NOW  
IN STOCK**

**FOR A FULL LINE LISTING  
REFER TO THE SGS DATA BOOKS  
NOW ON SALE**

**NEW HS-C<sup>2</sup> MOS  
PRICE & AVAILABILITY ON APPLICATION**

## SGS Z80 SERIES

Z8001BI	16 BIT C.P.U. 4 MHZ	25.00
Z8002BI	NON SEG C.P.U. 4 MHZ	19.20
Z8010ABI	ZMMU 6 MHZ	27.00
Z8030ABI	Z-SCC 4 MHZ	32.50
Z8036BI	ZC10 4 MHZ	25.00
Z8036ABI	BC10 6MHZ	31.00
Z8038ABI	ZF10 INTERFACE UNIT 6 MHZ	32.00
Z8400BBI	Z80 8 BIT C.P.U. 6 MHZ	5.40
Z8400ABI	Z80 8 BIT C.P.U. 4 MHZ	2.95
Z8410ABI	Z80 DMA 2 PORT PLASTIC 4 MHZ	9.50
Z8420ABI	P10 2 PORT PLASTIC 4 MHZ	2.95
Z8420BI	P10 2 PORT PLASTIC 2.5 MHZ	2.90
Z8430ABI	Z80 CTC 4 CHAN CTR/TIMER 4 MHZ	2.95
Z8430BBI	Z80 CTC 4 CHAN CTR/TIMER 6 MHZ	6.00
Z8430BI	Z80 CTC 4 CHAN CTR/TIMER 2.5 MHZ	2.90
Z8440ABI	Z80 SIO 2 CHAN IO 4 MHZ	7.80
Z8440BI	Z80 SIO 2 CHAN IO 2.5 MHZ	7.20
Z8441ABI	Z80 SIO/1 2 CHAN IO 4 MHZ	7.80
Z8442ABI	Z80 SIO 2 CHAN IO 4 MHZ	7.20
Z8442BI	Z80 SIO 2 CHAN IO 2.5 MHZ	6.95
Z8470ABI	Z80 DART 4 MHZ	6.30
Z8470BI	Z80 DART 2.5 MHZ	5.90
Z8530BI	Z80 SCC 2.5 MHZ	29.50
Z8536BI	Z80 C10 4 MHZ	28.50

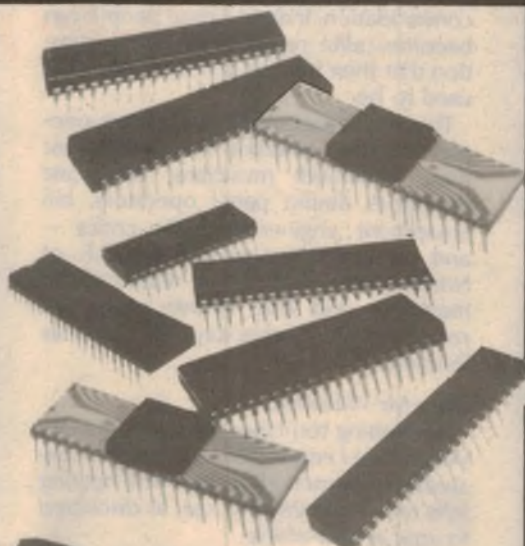

PLUS SALES TAX 20%  
TRANSISTORS SALES TAX 32 1/2%

## SGS TRANSISTORS

BC107	16	MJE350	36
BC108	16	MJE800	32
BC109	16	TIP120	34
BC547	05	TIP2955	65
BC548	05	TIP3055	55
BC549	05	TIP31C	28
BC327	05	TIP32C	29
BD139	18	TIP41C	39
BD140	18	TIP42C	39
BDV648	98	2N2222A	18
BDV658	98	2N2905A	23
BU326A	1.05	2N2907A	19
BUX80	1.65	2N3053	22
MJE340	.30	2N3055	49

## SGS MEMORY

M2114	M27128	22.00
M2716	M3870	3.75
M2532		
M2764		

## SGS DATA BOOKS

Z80 FAMILY TECH	\$7
Z80 PROGRAM	\$7
Z80 FAMILY	\$3
Z80 TRAINING BOOK	\$18
Z8000 FAMILY	\$7.50
Z8000 CPU PROG	\$9
Z8000 CPU	\$3
Z8 MCU	\$2.50
Z8 MCU PROG	\$5
Z8 MCU TECH	\$4
SIGNAL TRANSISTORS	\$10
POWER TRANSISTORS	\$12
MOS & SPECIAL MOS	\$5
CMOS BOOK	\$10.50
TTL BOOK	\$12
M3870 FAMILY	\$2.50
M3870 TECH	\$2.50
M3870 PROG	\$3.00



Type	Description	PACKAGE
<b>MAND GATES</b>		
M74HC001	QUAD 2 INPUT NAND GATE	DIP14
M74HC101	TRIPLE 3 INPUT NAND GATE	DIP14
M74HC201	DUAL 4 INPUT NAND GATE	DIP14
M74HC501	8 INPUT NAND GATE	DIP14
<b>NOR GATES</b>		
M74HC021	QUAD 2 INPUT NOR GATE	DIP14
M74HC271	TRIPLE 3 INPUT NOR GATE	DIP14
M74HC4001	DUAL 4 INPUT NOR GATE	DIP14
M74HC4071	8 INPUT NOR GATE	DIP14
<b>AND GATES</b>		
M74HC081	QUAD 2 INPUT AND GATE	DIP14
M74HC111	TRIPLE 3 INPUT AND GATE	DIP14
<b>OR GATES</b>		
M74HC321	QUAD 2 INPUT OR GATE	DIP14
M74HC4075	TRIPLE 3 INPUT OR GATE	DIP14
<b>INVERTERS</b>		
M74HC041	HEX INVERTER	DIP14
<b>HEX BUFFERS</b>		
M74HC049	HEX BUFFER INV.	DIP16
M74HC4050	HEX BUFFER	DIP16
<b>BUS BUFFERS</b>		
M74HC240	OCTAL BUS BUFFER INV.	DIP20
M74HC241	OCTAL BUS BUFFER	DIP20
M74HC244	OCTAL BUS BUFFER	DIP20
M74HC365	HEX BUS BUFFER	DIP16
M74HC364	HEX BUS BUFFER INV.	DIP16
M74HC367	HEX BUS BUFFER	DIP16
M74HC368	HEX BUS BUFFER INV.	DIP16
<b>QUAD BI-DIRECTIONAL BUS BUFFERS</b>		
M74HC243	QUAD BI-DIRECTIONAL BUS BUFFER INV.	DIP14
M74HC245	OCTAL BI-DIRECTIONAL BUS BUFFER	DIP20
M74HC4001	OCTAL BI-DIRECTIONAL BUS BUFFER	DIP20
M74HC643	OCTAL BI-DIRECTIONAL BUS BUFFER	DIP20
<b>TTL RECEIVERS</b>		
M74HC240	OCTAL BUFFER INV. TTL RECEIVER	DIP20
M74HC241	OCTAL BUFFER TTL RECEIVER	DIP20
M74HC157	OCTAL D-F-F INV. TTL RECEIVER	DIP20
M74HC157	OCTAL D-F-F INV. TTL RECEIVER	DIP20
M74HC157	OCTAL D-F-F INV. TTL RECEIVER	DIP20
M74HC157	OCTAL D-F-F INV. TTL RECEIVER	DIP20
<b>J-K FLIP-FLOP</b>		
M74HC761	DUAL J-K FLIP-FLOP	DIP16
M74HC107	DUAL J-K FLIP-FLOP	DIP14
M74HC112	DUAL J-K FLIP-FLOP	DIP16
<b>D FLIP-FLOP</b>		
M74HC74	DUAL D-TYPE FLIP-FLOP	DIP14
M74HC74	Hex D-TYPE FLIP-FLOP	DIP16
M74HC175	QUAD D-TYPE FLIP-FLOP	DIP16
M74HC273	OCTAL D-TYPE FLIP-FLOP	DIP20
M74HC74	OCTAL D-TYPE FLIP-FLOP	DIP16
M74HC541	OCTAL D-TYPE FLIP-FLOP INV.	DIP20
M74HC541	OCTAL D-TYPE FLIP-FLOP INV.	DIP20
M74HC541	OCTAL D-TYPE FLIP-FLOP INV.	DIP20
M74HC541	OCTAL D-TYPE FLIP-FLOP INV.	DIP20
<b>LATCHES</b>		
M74HC259	8-BIT ADDRESSABLE LATCH	DIP16
M74HC175	OCTAL D-TYPE LATCH	DIP16
M74HC175	QUAD D-TYPE LATCH	DIP16
M74HC538	OCTAL D-TYPE LATCH INV.	DIP20
M74HC538	OCTAL D-TYPE LATCH INV.	DIP20
M74HC538	OCTAL D-TYPE LATCH INV.	DIP20
M74HC538	OCTAL D-TYPE LATCH INV.	DIP20
<b>MULTIVIBRATORS</b>		
M74HC221	DUAL MONOSTABLE MULTIVIBRATOR	DIP16
M74HC4538	DUAL MONOSTABLE MULTIVIBRATOR	DIP16
<b>DECODERS</b>		
M74HC471	BCD TO DECIMAL DECODER	DIP16
M74HC138	3 TO 8 LINE DECODER	DIP16
M74HC138	DUAL 7 TO 4 LINE DECODER	DIP16
M74HC151	BCD TO 10 LINE DECODER	DIP16
M74HC4543	BCD TO 7 SEGMENT L-D (LED)	DIP16
M74HC4543	BCD TO 7 SEGMENT L-D (LED)	DIP16
<b>ENCODERS</b>		
M74HC147	10 TO 4 LINE PRIORITY ENCODER	DIP16
M74HC148	8 TO 3 LINE PRIORITY ENCODER	DIP16
<b>REGISTERS</b>		
M74HC70	4 WORD X 4 BIT REGISTER FILE	DIP16
M74HC164	8 BIT SHIFT REGISTER	DIP16
M74HC164	8 BIT SHIFT REGISTER	DIP16
M74HC173	QUAD 2 INPUT REGISTER (3 STATE)	DIP16
M74HC164	8 BIT PIP0 SWIFT REGISTER	DIP16
M74HC158	4 BIT PIP0 SWIFT REGISTER	DIP16
<b>BINARY COUNTERS</b>		
M74HC161	SYNC BINARY COUNTER	DIP16
M74HC161	SYNC BINARY COUNTER	DIP16
M74HC161	SYNC UP-DOWN BINARY COUNTER	DIP16
M74HC161	DUAL BINARY COUNTER	DIP16
M74HC4020	16 STAGE BINARY COUNTER	DIP16
M74HC4020	OCTAL COUNTER DIVIDER	DIP16
M74HC4020	7 STAGE BINARY COUNTER	DIP14
M74HC4040	12 STAGE BINARY COUNTER	DIP16
M74HC4060	14 STAGE BINARY COUNTER-OSC	DIP16
<b>DECADE COUNTERS</b>		
M74HC160	SYNC DECADE COUNTER	DIP16
M74HC160	SYNC DECADE COUNTER	DIP16
M74HC160	SYNC UP-DOWN DECADE COUNTER	DIP16
M74HC160	DUAL DECADE COUNTER	DIP16
M74HC4017	DECADE COUNTER-DIVIDER	DIP16
<b>ANALOG MULTIPLEXERS</b>		
M74HC4051	4 CHANNEL ANALOG MULTIPLEXER	DIP16
M74HC4051	DUAL 4 CHANNEL ANALOG MULTIPLEXER	DIP16
M74HC4051	TRIPLE 2 CHANNEL ANALOG MULTIPLEXER	DIP16
M74HC4068	QUAD 2 LINE 1 SWITCH	DIP14
<b>DIGITAL MULTIPLEXERS</b>		
M74HC153	8 TO 1 LINE MULTIPLEXER	DIP16
M74HC153	DUAL 4 TO 1 LINE MULTIPLEXER	DIP16
M74HC153	QUAD 2 TO 1 LINE MULTIPLEXER	DIP16
M74HC153	QUAD 2 TO 1 LINE MULTIPLEXER INV.	DIP16
M74HC154	8 INPUT MULTIPLEXER	DIP16
M74HC151	7 TO 1 LINE MULTIPLEXER (3 STATE)	DIP16
M74HC253	DUAL 4 TO 1 LINE MULTIPLEXER (3 STATE)	DIP16
M74HC157	QUAD 2 TO 1 LINE MULTIPLEXER (3 STATE)	DIP16
M74HC157	QUAD 2 TO 1 LINE MULTIPLEXER (3 STATE) INV.	DIP20
M74HC156	8 INPUT MULTIPLEXER	DIP20
<b>COMPARATORS</b>		
M74HC451	4 BIT MAGNITUDE COMPARATOR	DIP16
M74HC681	8 BIT EQUALITY COMPARATOR	DIP20
<b>SCHMITT TRIGGER</b>		
M74HC14	HEX SCHMITT INVERTER	DIP14
M74HC14	QUAD 2 INPUT SCHMITT NAND	DIP14
<b>MULTIFUNCTIONAL</b>		
M74HC51	DUAL 2N/2 AND/OR INVERTER GATE	DIP14
M74HC68	QUAD EXCLUSIVE OR GATE	DIP14
M74HC68	QUAD EXCLUSIVE OR GATE	DIP14



Please debit my Bankcard  
Bankcard No. ....  
Expiry Date ....  
Name .....  
Signature .....

Prices subject to change without notice. Phone or write for quantity discounts.  
MAIL ORDERS: To ELLISTRONICS, 797 SPRINGVALE RD MULGRAVE 3170  
Minimum pack and post \$2.00. Phone (03) 561 5844

# Are ageing ears really as sluggish

An article in the June issue — "Hifi Sound But Lofi Ears" — seemed to create considerable interest, being taken up, I understand, by groups catering for the hard of hearing. But it also raised again the old question: are ageing ears really as limited as the literature says?

In so phrasing the above introduction, I may appear to be drawing a distinction between theory and practice — an old source of contention referred to again in the last instalment of "Forum". But I'm not being inconsistent; some of the theory to do with aural perception is rather tentative, while a lot more remains to be done on the practical side as well.

But let's not get sidetracked.

On page 45 of the June issue, we published a table suggesting that, with "clinically normal" ears, the upper limit of hearing diminishes from about 18,000Hz at age 10, to about 4000Hz at age 80 — a loss of about 2000Hz for each additional 10 years in age.

On page 46, we showed a set of curves indicating the progressive loss in aural acuity for frequencies below the upper limit. It was apparent from the curves that the gradual loss in treble response is roughly equivalent to turning the treble control progressively back to full cut — a situation reached by people in the 50-60 year age group.

## HISS LESS NOTICEABLE

A further set of curves on the same page showed how progressive high frequency hearing loss can diminish awareness of tape hiss, particularly for people in the over-50 age bracket.

While such curves must be regarded as an approximation only, they are at least "in the ballpark" and they are in accordance with everyday observations:

Adults do show a measurable, progressive loss in aural acuity, especially at the higher frequencies. Top-cut filters and tone controls do seem to be less drastic in their effect than once they were. Octogonarians do complain that people no longer speak distinctly — because they can no longer hear the sibilants and the explosive sounds.

With the passing years, tape hiss does seem to be less of a problem than once it was, with noise reduction systems appearing to be more of a fad than necessity!

For most people, the loss of aural acuity is very gradual, being rendered the

more so by a degree of unconscious accommodation. Indeed, some people can become quite resentful of any suggestion that their hearing is not as keen as it used to be.

Those who take it the hardest are people who have relied on their hearing for their livelihood: musicians, broadcast operators, studio panel operators, hifi equipment engineers, music critics — and hifi journalists; people like B.F. of North Sydney, a long-time reader of the magazine and one whose name we remember from other days. He writes as follows:

Dear Mr Williams,

*It is getting too close for comfort to 40 years since I entered broadcasting. In my studies, I learned about the way hearing falls off with increasing age, as discussed in your recent article.*

*But, somehow, the old technicians seemed to have an ability to hear things, despite what the textbooks said. I have often wondered if people's hearing did not deteriorate as much as the books said — provided they had really been using the faculty of hearing high frequencies.*

*Faculties not used do tend to waste away and, in the pre-hifi days, why would people in western society need high frequency hearing? To those people who rubbish the advance in technology,*

*Referenced to clinically normal hearing of 20-year-old females (0dB), these curves give some idea of the gradual loss of aural acuity with increasing age. The dotted curve shows the response of a typical hifi amplifier system with the treble tone control set for maximum cut.*



## FORUM

Conducted by Neville Williams

*the very availability of hifi equipment of a standard undreamed of when I began broadcasting, may have the effect of sustaining high frequency hearing.*

*Unfortunately, researching this would not be the sort of exercise that an academic could get into and out of quickly, with a research paper under his arm to help him in his upward climb. It would be a very long project to measure the hearing of broadcast technicians, when they first entered a station, then monitoring their hearing for the next 45 years, until retirement.*

*In my own case, one ear is markedly inferior to the other but, while it is 20 years since I left broadcasting and while I am getting too close to 60 for my liking, I still think my good ear has retained better high frequency hearing than I could have expected from the figures you gave.*

*Roll on FM and high frequency sound! B.F. (North Sydney, NSW).*

My first reaction to the letter was to say: "I know how you feel, B.F."

There is a certain frustration for a hifi enthusiast to feel well in other respects but to know that one's high frequency perception is sliding inexorably "down the drain".

The frustration is heightened by the thought that there is really not much one can do about it. The curves might suggest the possibility of compensating the

## FREQUENCY RESPONSE V. AGE

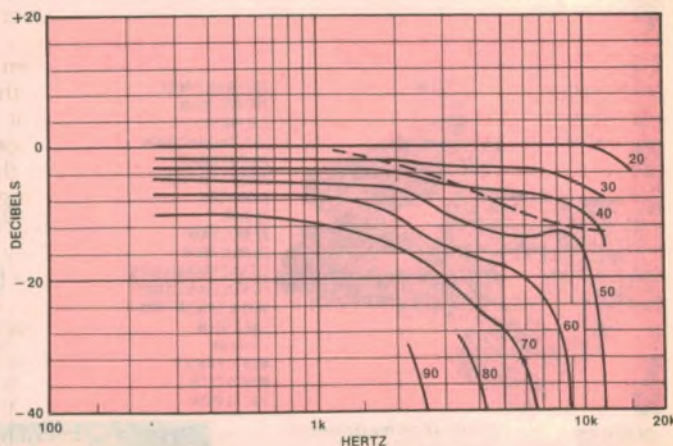



# as the books say?

droop by advancing the treble control — but only providing the amplifier and tweeters can handle the higher output and the family can put up with the sssibilant sssound!

And even then, no practical amount of treble boost can compensate for the usual "brick wall" roll off at the top end. If the hearing rolls off at six or eight or 10kHz, then that's it, treble boost or no treble boost!

Nor do I know of anything to support B.F.'s fond hope that high frequency acuity has been — or will be — preserved by "exercise", as provided by wide-range hifi equipment. After all, there are plenty of age-old natural sounds which have an aurally delicious high frequency content, but they haven't kept us aurally fit.

## VOICES FROM THE PAST

In acknowledging B.F.'s letter privately, I could only concede that: "technicians may develop a certain skill in using the aural faculty that remains, but not of actually hearing what, to them, is inaudible". Reading it again, I must admit that it sounds like a fairly lame statement.

There the matter might have remained had I not, quite by accident, come across an item in the October 1951 issue, while looking up references for last month's: "Let's Buy An Argument — Where It All Started". It was a letter written by "Diallist" of "Wireless World" fame, which we reprinted under the heading "To Hear Or Not To Hear". . .

It seems that Sir Ernest Fisk, at that time Chairman of EMI Britain, had just announced to the Royal Society of Arts that his Company had been successful in recording frequencies on wax disc of up to 20,000 c/s. (Hz came much later). Diallist's first reaction was to suggest that "aged dodderers" like himself, who normally have a cut-off in the neighbourhood of 10,000-12,000 c/s, might well retort: "So what?".

Somewhat abbreviated, his letter continues:

*But when Sir Malcolm Sargent and others maintain that even higher frequencies may have to be recorded in order to obtain complete realism in reproduction, you begin to do some thinking.*

*At first blast, the idea seems utter nonsense. How can we be affected by the presence or absence of frequencies that we can't hear? And then something at the back of your mind whispers:  $f_1 - f_2 = f_3$  in other words: two supersonic frequencies may produce an audible beat frequency.*

*It seems possible that, when an or-*

*chestra is in action, the supersonic harmonics of certain instruments do produce such beats. If they are absent from an electro-mechanical reproduction, it doesn't sound quite real.*

*If the original supersonic harmonics are, say, 19,000 and 21,000 c/s, the beat will be at the audible frequency of 2000 c/s. Assuming that there is such a beat and that I record and reproduce up to, perhaps, 6000 c/s, why should not the beat frequency of 2000 c/s be adequately brought out, even though the generating frequencies are removed by the cut-off at 6000 c/s?*

*The answer is that non-linearity is required somewhere in the system to produce the beats. If the recording system is totally free from non-linear distortion, the beats will not be generated as such in the record, nor will they be present in the reproducing equipment if it is similarly distortion-free.*

*Not until the original supersonic frequencies reach that non-linear device known as the human ear will the audible beat frequency emerge.*

*So, if you want to cut off at 16 kc/s in recording, you must do your mixing before that and introduce some non-linearity before or in the cutter head, if you want to generate and record those beats. Which poses the question: if one records only audible frequencies, how much non-linear distortion should be introduced for realistic reproduction? ("Diallist").*

## MUSICAL BEATS . . .

Perhaps I should explain that, a couple of months prior to the publication of Diallist's letter, there had been spirited debate in the "Let's Buy an Argument" columns on the subject of musical beats — the effect that musicians make use of to help tune musical instruments. There seemed to be fairly common agreement, at the time, that our awareness of beats was a by-product of basic non-linearity in the human ear.

The letter from "Diallist" added a new dimension to this discussion. On the assumption that the ear could indeed behave as a non-linear mixer, he was suggesting that the intermodulation products would range far beyond the slow, pulsating beats observed by instrument tuners; that they would cover a whole range of audible frequencies and be produced even by the intermodulation of overtones in the supersonic range.

(For this argument to hold good, frequencies outside a person's audible range would still have to be processed by some part of their hearing mechanism

# KALEX

## UV MATERIALS

- Riston™ PCB
- 3M Scotchcal
- 3M INT

## UV PROCESSING EQUIPMENT

### KALEX LIGHT BOX

- Autoreset Timber
- 2 Level Exposure
- Timing Light
- Instant Light Up
- Safety Micro Switch
- Exposure to 22in x 11in

**\$395.00** + ST  
DELIVERED

### KALEX "PORTU-VEE"

- UV Light Box
- Fully Portable
- Exposure to 10in x 6in

**\$175.00** + ST  
DELIVERED

### KALEX ETCH TANK

- Two Compartment
- Heater
- Recirculation (by Magnetic Pump)
- Two Level Rack
- Lid

**\$595.00** + ST  
DELIVERED

### KALEX "PORTETCH"

- Two Compartment
- PCB Rack
- 16in x 8in x 4in

**\$29.95** ST  
DELIVERED

- With 200mg Aerosol can Positive 20 Photo resist

**\$39.95** ST  
DELIVERED



# KALEX

101 Burgundy St.  
Heidelberg 3084  
(03) 458 2976  
Telex AA 37678  
MELTON  
(03) 743 1011

ELECTRONIC COMPONENTS & ACCESSORIES  
● SPECIALIST SCHOOL SUPPLIERS

## FORUM — continued

— eg the outer and middle ear — to produce the beats which could penetrate the otherwise unresponsive inner ear. Whether or not it could happen this way, I leave to others to decide).

The argument advanced by Diallist was clear enough, however: when listening to a live musical performance, the subjective listening experience is not confined to frequencies which are generated and heard directly, but include a whole spectrum of intermodulation products.

How the brain might interpret these modulation products is a fertile area for speculation:

- Optimistically, the brain might learn to perform a kind of "instant Fourier analysis" and add further overtones to the frequencies which the ears are processing directly.

- Pessimistically, and especially in the presence of high aural non-linearity, the brain may not be able to cope with the modulation products and may register a strong dislike of complex musical sound. There are any number of people who do react in this manner and it could be for this very reason.

### BACK TO B.F.'s LETTER

Curiously, this kind of thinking, extrapolated from what Diallist penned in 1951, brings us back to the letter from B.F., mentioned earlier. B.F. is searching for a reason why older broadcast station operators (allegedly) seem to be able to sense more about sound quality than would seem likely from their aural response, as measured with a single, variable tone audiometer.

Superficially, I can advance no reason why broadcast operators and their ilk should have any more extended hearing than the statistics suggest. Indeed, they might even end up below average if they have been indiscreet in the matter of listening levels! But could it be — just could it be — that they have learned to make better than average use of the intermodulation products which are still within their range of hearing?

Diallist — in 1951 anyway — seemed to support that possibility.

It's a very tenuous proposition, B.F., and I'm not suggesting that it could be a substitute for the athletic hearing of youth, but it may just be a small compensation; a reason why a musically educated brain may develop what I suggested earlier: "a certain skill in using the aural faculty that remains."

Of one thing you can be certain B.F. There are plenty of people who would share your fervent hopes that there is more to hearing than a straight-out single-tone audiometer test; people who would welcome even a temporary "stay

of execution" in the auditory sense!

But let's think again about Diallist's letter:

When he wrote as he did in 1951, he was speculating both about intermodulation effects in human hearing and the role of non-linearity distortion in sound recording and reproduction systems. If it was not possible to cope with the entire energy spectrum of music, he wondered, might it not be wise to design a specific amount of non-linearity into the system to create and retain intermodulation products of the magnitude that the listener's brain expects?

When I re-read this letter, a couple of weeks ago, it reminded me of a test record issued some time back by Ortofon; in fact two similar test records: a direct-cut version 0001 and a tape-mastered version 0002.

One group of tracks on the first side carries pairs of high frequencies, spaced 1kHz apart, which are intended primarily to provide a measure of the intermodulation distortion percentage in a disc replay system.

The first such track contains frequencies of 20kHz and 19kHz. Both are well above the range of normal hearing but, when the track is played, a 1kHz difference tone can be heard, not loudly but quite distinctly. Following tracks provide frequency pairs at 18/17kHz, 16/15kHz, 14/13kHz, etc, some of which will also lie beyond the hearing range of many mature adults.

For the purpose of identification, the high frequency signal pairs are coded into repetitive long and short dashes, forming the Morse code letter "N". A pure 1kHz reference tone occupies the intervening spaces, thereby forming the Morse code letter "A". If the difference tone (letter N) is less loud than the reference tone (letter A) it is an indication that the intermodulation distortion through the entire system, as heard, is less than 2%.

### First Aussie valve?

"Wireless Weekly" for Sept. 29, 1933 carried a picture of a rather modern looking "80" type rectifier with a caption to the effect that it was the first valve to be manufactured in Australia. It may have been the first valve from the then newly constituted Amalgamated Wireless Valve Company but, in his book "70 Years of Radio Tubes and Valves", New Zealand Author John Stokes states that valve manufacture had been undertaken in Australia by AWA "as early as 1920", an early example being the AWA "Expanse B" valve.

In the relevant explanatory notes, Ortofon observes that, if the reference tone "A" is the louder, the system is All right. If the difference tone "N" is the louder, then that is Not good!

In my own system, the test indicated that the intermodulation distortion was a lot less than 2% — ostensibly a desirable result. But, even so, the difference product from the two test tones was clearly audible suggesting that, even with a direct cut analog disc and good quality everything else, spurious intermodulation products are present.

How much worse they must have been in 1951!

I took the opportunity to repeat the tests with the treble control and filter both set for minimum response, thereby virtually eliminating the high frequency source tones from the power amplifier and loudspeakers. It made virtually no difference to the N/A ratio, indicating that the 1kHz difference tone had already been generated in the record/replay system and prior to the tone control stage; the contribution from the output system and from my ears seemed to be negligibly small.

Perhaps, if Diallist had been able to make similar observations in 1951, he might have reached a different conclusion.

### NON-LINEARITY . . . NO!

Having just been through the exercise, however, I cannot escape the conviction that non-linearity distortion is a liability at any level, and I doubt very much its ability to compensate for frequencies which fall outside the passband of either equipment or ears.

Sorry Diallist and sorry B.F. for having dangled a carrot, earlier in the article, only to whip it away at the end!

In offering the foregoing opinion, I had better be right because, if I'm wrong, the world audio industry will share the egg on my face.

In recent years, the entire hifi industry has embraced sampling and digital techniques, ranging from FM-stereo multiplex to digital tapes and discs. All of these systems involve a sharp roll-off filter operating just above the audible frequency range — by implication rejecting the musical significance of possible supersonic overtones.

Not only that, but systems like the compact disc and VCR-based digital tape recording have further transgressed Diallist's proposition by virtually eliminating distortion and the consequent generation within the system of spurious difference tones.

Nothing personal . . . but one can only hope that Diallist was wrong on this particular occasion.

# The Digital vs. Analog battle is over.

From **\$110** buys you the new champion. **The new Fluke 70 Series.**

They combine digital and analog displays for an unbeatable two-punch combination.

Now, digital users get the extra resolution of a 3200-count LCD display.

While analog users get an analog bar graph for quick visual checks of continuity, peaking, nulling and trends.

Plus unparalleled operating ease, instant autoranging, 2,000+ hour battery life and a 3-year warranty.

All in one meter.

Choose from three new models. The Fluke 73, the ultimate in simplicity. The feature-packed Fluke 75. Or the deluxe Fluke 77, with its own multipurpose protective holster and unique "Touch Hold" function (patent pending) that captures and holds readings, then beeps to alert you.

Each is Fluke-tough to take a beating. American-made, to boot. And priced to be, quite simply, a knockout.

So call or write for more information.

## Fluke 73

**\$110\***

Analog/digital display  
Volts, ohms, 10A, diode test  
Autorange  
0.7% basic dc accuracy  
2000+ hour battery life  
3-year warranty

## Fluke 75

**\$129\***

Analog/digital display  
Volts, ohms, 10A, mA, diode test  
Audible continuity  
Autorange/range hold  
0.5% basic dc accuracy  
2000+ hour battery life  
3-year warranty

## Fluke 77

**\$165\***

Analog/digital display  
Volts, ohms, 10A, mA, diode test  
Audible continuity  
"Touch Hold" function  
Autorange/range hold  
0.3% basic dc accuracy  
2000+ hour battery life  
3-year warranty  
Multipurpose holster



SOLD & SERVICED IN AUSTRALIA BY

**ELMEASCO**

**Instruments Pty. Ltd.**

P.O. Box 30, Concord  
N.S.W. 2137  
15-15 McDonald Street,  
Mortlake, N.S.W.  
Telephone (02) 736 2888  
Telex 25887

P.O. Box 107, Mt. Waverley  
Victoria 3149  
21-23 Anthony Drive,  
Mt. Waverley, Victoria  
Telephone (03) 233 4044  
Telex 36206

Adelaide: (08) 271 1839  
Brisbane: (07) 369 8688  
Perth: (09) 398 3362



N.S.W. Ames Agency 699 4524 • George Brown 519 5855 (049) 69 6399 • Bryan Call 522 4923 • DGE Systems (049) 69 1625 • Davred 267 1385  
• Macelec (042) 29 1455 • Radio Despatch 211 0191 • Sheridan Electronics 699 6912 • Standard Components 896 1755 N.T. Thew & McCann  
(089) 84 4999 A.C.T. George Brown (062) 80 4355 VIC. Radio Parts 329 7888 • Browntronic 419 3986 • G B Telespares 328 4301 • Elanco 428 4345  
• Ellistronics 561 5844 • Stewart Electronic Comps 543 3733 • Nilsen-Rowe 347 91 66 QLD L.E. Boughen 36 1277 • Colourview Wholesale 275 3188  
• ECO Electronics 376 5677 • Electronic Shop (075) 32 3632 • W.G. Watson (079) 27 1099 • GEC Electrical Wholesale (079) 51 3155 • Nortek  
(077) 79 8600 • Solex (077) 72 2015 • Integrated Technical Services (070) 51 8400 S.A. Tno Electrix 51 6718 • Protronics 212 3111 • Lab Service  
278 7488 W.A. Atkins Carlyle 321 0101 • Protronics 362 1044 • Brookeades 276 8888 • Cairns Instrument Services 325 3144 T.A.S. GHE Electronics  
(02) 34 2233 & (003) 31 6533

\* All prices are plus Sales Tax if applicable and subject to change without notice.

# TI LOGO

Giving your children  
the Educational Edge.

A lesson in  
Educational Software  
from Texas  
Instruments.

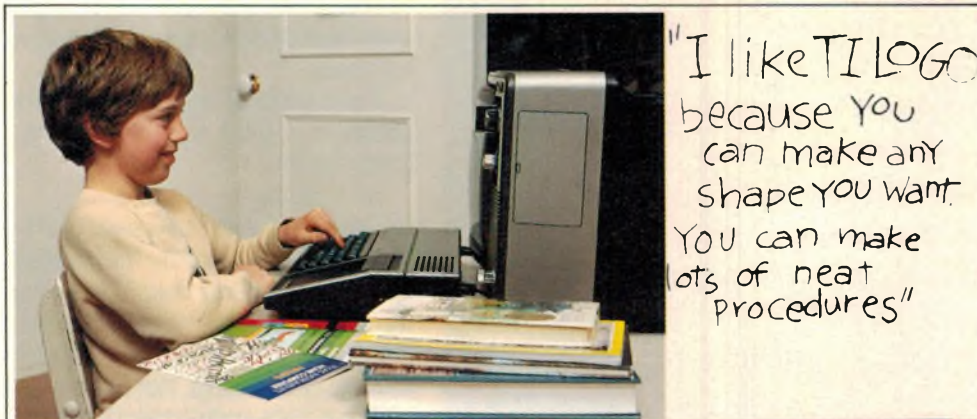

"I like TI LOGO  
because you  
can make any  
shape you want.  
You can make  
lots of neat  
procedures"



"I wish I could  
do the computer  
every day"



"I WISH EVERY  
SCHOOL HAD  
TI LOGO"

"about 6 weeks  
ago I made a  
procedure  
called 'LIKE.'  
IT lists all  
the names of  
the people I like  
over and over  
that's why I like  
TI LOGO"

The natural way to  
learn

TI LOGO is the  
innovative approach to  
education that not only  
develops computer  
awareness, but enriches  
a child's math, logic and  
communication skills in a  
natural step-by-step  
way.

WHAT THE EXPERTS SAY  
ABOUT  
TI LOGO

Step-  
by-step  
learning

TI LOGO is a child-  
appropriate computer  
language. This means  
students of all levels of  
ability can communicate  
with the computer using  
an easy-to-understand  
language. To accomplish  
a specific task the  
student must "teach" the  
computer what to do.  
This puts the student in  
control of the computer

and so can set his or her level of achievement. Learning is therefore fun and rewarding.

**Exploring increasingly complex learning**  
TI LOGO can teach

students on a personal level helping them to discover the importance of skills like spelling, communication and sequential thinking. With the help of "Turtle Graphics" students can

learn a computational style of geometry by "acting out" the role of the turtle, from simple to advanced stages. The procedure can be saved on a diskette, or cassette and re-used as required. Animated "Sprites" can also be used to create designs already known to the computer, or any shape the student designs.

In the home or classroom, a Texas Instruments Home Computer with TI LOGO programme plays a special role in today's teaching and learning. That's the educational edge.



For further information on  
TI LOGO or TI HOME COMPUTER  
send this coupon to Texas Instruments P/L,  
8-10 Talavera Road, North Ryde 2113

NAME: \_\_\_\_\_

ADDRESS: \_\_\_\_\_

POSTCODE: \_\_\_\_\_

Creating useful products  
and services for you.



**TEXAS INSTRUMENTS**

TEX10086A

# Audio-video Electronics

HIFI • HOME VIDEO • PROFESSIONAL AUDIO

## 25yr old "Wondergram" becomes the new "Sound Burger"

Twenty-five years ago, a two-speed personal portable record player was announced for pending world release by a British company. It failed to make its mark but, just recently, Audio-Technica of Japan have released an essentially similar unit, styled for the headphone-stereo generation.

The original "Wondergram" was announced and pictured in our September 1958 issue. It was to be manufactured by Camp Bird Industries of London, under the chairmanship of Major C. Collaro — at that time a very well known name in the British audio industry. The company was reported to have set up two fully automated production lines and to be aiming for volume sales in the USA at about \$20 per unit.

Seeking to match the impressive economies that had become possible with solid-state amplifiers, Major Collaro and his team had produced a small six-volt governor-controlled motor and a two-speed disc drive system that involved very few moving parts. It could be powered from the same battery as the amplifier, with the output fed to a small loudspeaker in the lid section of the case.

When folded for carrying, the Wondergram measured



The "Sound Burger" close up and, below, in a New Zealand setting

about 8 x 4 x 1 inch (200 x 100 x 25mm). While it could play discs up to 300mm in diameter, it had no provision for a turntable, as such. In use, the unit was placed flat on a table; raising the hinged lid section exposed a rubber coated spindle and drive fingers, over which the disc was placed. When the lid was closed again, a free-wheeling nipple on the underside locked the disc against the drive, keeping it mechanically stable.

The tone arm, which at first glance looked like part of the lid, could then be swung out and placed on the playing surface.

Reportedly, the company had a mains powered unit under development which was intended primarily for connection to an existing radio receiver or amplifier. It was hoped at the time that the actual factory cost of the mains unit could be kept down to little more than £1 (\$2) per unit. Presumably, however, neither the mains nor the battery unit lived up to market expectations.

The new model AT727 "Sound Burger" from Audio-Technica (pictured) is very similar, at first glance, to the original "Wondergram". It is the same general shape and size, weighs about 1.2kg and also comes with a shoulder strap for ease of carrying. It opens up in the same way to receive the disc, and the pickup arm pulls out from the side of the lid. But there the similarity ends, with the Sound Burger having the benefit of new technology and new consumer expectations.

It has been designed, primarily, to take advantage of the comparatively recent swing to personal stereo listening, using miniature hifi-stereo headphones. The Sound Burger has no in-built mini-speaker to limit quality and chew up battery power; it comes with mini hifi headphones, which fold up, for carrying, like a pair of spectacles. It provides a more modern disc drive system and a good quality magnetic stereo cartridge to take full advantage of the quality of modern discs.

Audio-Technica admit that the Sound Burger cannot be played on the move, like a personal cassette player but, against this, it gives direct access to the wealth of sound currently available on disc. It is cushioned to minimise

vibration from the surface on which it may be placed while the tonearm is dynamically balanced to obviate problems with non-level surfaces. Output connections are provided for two sets of stereo headphones and for connection to an external audio system for dubbing or loudspeakers listening.

The Sound Burger is intended for world release and, according to a New Zealand reader, Mr Dolf de Roos, has been announced for release in that country at \$NZ289. As yet, we are not aware of release arrangements for Australia.

## Australian venture . . . UHQR "UP MARKET" AUDIO CASSETTES

Like David, but taking on a whole array of Goliaths, a small Australian company is seeking to break into the market for prestige quality audio cassettes, using the somewhat familiar initials UHQR.

A division of Mofid Records Pty Ltd, the new company has registered the name "UHQR Sound Laboratories" in Australia and is operating from the same address: 421 Forest Rd, Bexley, NSW 2207. Phone (02) 59 4727.



Mofid Records Pty Ltd is already well established in the specialist audiophile market handling, among other products, discs and cassettes issued by Mobile Fidelity Sound Laboratories in the USA, some of which carry the endorsement UHQR; hence the familiar initials.

Some time ago, facing the uncertainty of being created by the emergence of compact disc, Mofid Records proprietor/manager Bob Hessing, decided to diversify into the local manufacture of compact cassettes. However, being so deeply involved in audiophile products, he seems to have little choice but to set his sights on the quality market rather than the budget end.

As a starting point, he decided to concentrate on the cassette shell, on the reasoning that, no matter how good the tape and formulation may be, its desirable qualities can all too easily be negated by lack of precision in the mechanics or by heat warp, both of which can produce tape wander, azimuth error and unpredictable contact between coating and head gaps.



## POLAROID VIDEO CASSETTES

Diversifying from their essentially photographic image, Polaroid have recently announced their entry into the home video market, with a line of "Supercolour" blank video cassettes in the VHS and Beta formats. In each case, Polaroid claim performance standards equal to, or better than, system specifications.

In announcing the new marketing venture, Polaroid's General Manager for Australia, Peter Terry, pointed out that his Company was no stranger to electronics. Many of the electronic features in the Polaroid instant cameras were invented within the Company as, for example, transistorised shutters, sonar focussing and light mixing. They had made vital contributions, too, in general science, medicine, industry and business, and in hard copy imaging systems. A move into video tape was a natural extension of such activities . . . as it were, into instant photography of a different kind!

According to Peter Terry, Polaroid Video cassettes are manufactured to specifications laid down by Polaroid, using a high density coating of cobalt-doped ferric oxide particles. They are available in two grades – standard and super-quality – and in two popular lengths for the respective formats:

VHS E120 (120 min, 173m) STD and SHG.

VHS E180 (180 min, 258m) STD and SHG.

Beta L500 (130 min, 150m) STD and HG.

Beta L750 (195 min, 222m) STD and HG.

In a specification sheet accompanying the product release announcement, Polaroid quote the thickness of the VHS tape as  $20\mu\text{m}$  and the width at  $12.65\text{mm}$  with a fluctuation not exceeding  $5\mu\text{m}$ . Video characteristics of the STD tape are said to be in exact accordance with the system reference standard, with a notably low dropout count. For the SHG tape, a still lower dropout count is claimed, with the RF output at 4MHz up by 3dB, a marginal increase in chroma output and video and colour S/N ratio up by more than 3.5dB. Polaroid also claim an ability for the tape to withstand still frame playback for more than 60 minutes. For both grades, the coating colour is black.

In the case of the Beta cassettes, the L500 uses tape  $20\mu\text{m}$  thick, with a black coating, while the L750 is thinner, at  $15\mu\text{m}$ , with a dark grey coating. The STD tape conforms closely with system standards but, again, the HG offers 2.1dB extra output at 4MHz, slightly higher chroma output, and S/N ratio improved by 2.1dB and 3.2dB respectively for video and colour. The dropout figures are the same as for VHS, as also is the still frame rating.

Polaroid say that their Supercolour video cassettes should be available by the time you read this, through selected outlets, including photographic retailers and video specialty stores.

**SAVE  
ON A GREAT SOUND**

Replace your existing speakers or "ADD ON" to enjoy superb stereo sound in other rooms in your home.

## The Dick Smith SERIES 200

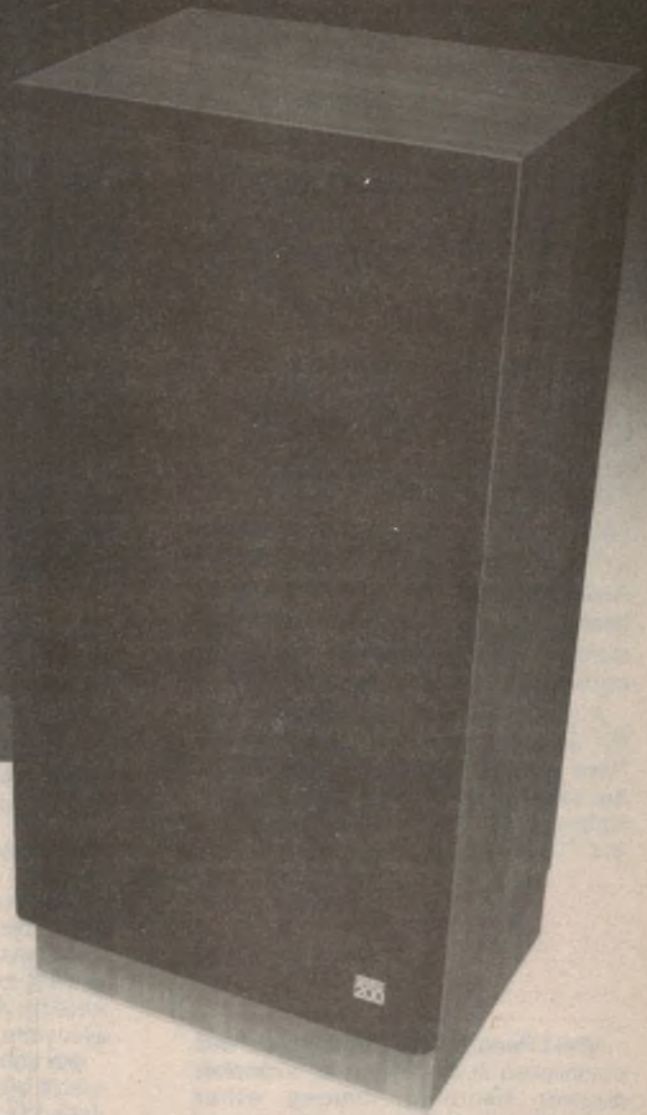

## build yourself at a large saving on comparable speakers

Designed in Australia by our own technical staff, the Series 200 speakers can actually be built by you in just a few hours. The result is a superbly handsome pair of speakers which sound like you spent a fortune.

Dick's worldwide buying power, coupled with new sound technology and the fact that you build these speakers yourself enables you to enjoy the sound quality of big home speakers at a fraction of the cost!

### Compare the quality features and specifications:

- Fine Woodgrain Finish
- Fully Imported Contoured Grilles
- Top Quality Speakers

Peak power handling - 40W, Impedance - 8ohms, Freq. response - 45Hz to 20kHz, Speakers - 200mm woofer, 125mm mid-range & 64mm tweeter, Crossover - 3 way, at 1.5kHz & 5kHz, Dimensions: (cm) 64x38x29.6 (26 litres)

As featured in September ETI.

**EXCLUSIVELY FROM**  
**DICK SMITH**  
**Electronics**

See our other ads this issue for full address details

### Included in the Series 200 kit are:

Speaker Grilles (Cat C-2608)	\$31.50
Enclosure Kit (Cat C-2636)	\$128.50
Speaker Kit (Cat C-2046)	\$89.50

Complete Series 200 Kit **\$249<sup>50</sup>**  
per pair

Haven't time to build them yourself? The Dick Smith Series 200 Speakers are also available in built-up form for only:

**AMAZING  
VALUE**

**\$299<sup>00</sup>**

Cat A-2370

Per Pair



## Audio-Video Electronics — continued

Reminiscent of the Japanese love for initials, UHQR (Ultra High Quality Recording) Laboratories have come up with what they describe as the ULM (Ultra Laboratory Mechanism) cassette shell that is manufactured in Australia to very fine tolerances. It is moulded from a polycarbonate material with an intrinsic "memory" that ensures its return to original shape, even if subjected to otherwise unacceptable heat stresses.

Other features listed in the brochure include: a single-sided silicon slip sheet, with carbon stripes to control friction and dispel static charges; precision, polished brass guide rollers; precision designed, larger-than-normal pressure pad.

The first of the new cassettes being offered by UHQR Laboratories is branded C-100 and provides 50 + 50 minutes of playing time, giving a 10-minute bonus over the usual C-90 cassette. This is achieved without any sacrifice in tape thickness.

The tape itself, according to Bob Hessing, is an imported premium quality cobalt-doped product, intended to operate in the CrO<sub>2</sub> setting of cassette decks. Ratings show an MOL of +5.6dB at 333Hz, an output uniformity at 8kHz of  $\pm 0.2$ dB, a print-through factor of 60dB, and an output at 10kHz that is 1dB above the IEC-II reference tape.

UHQR C-100 compact cassettes are being distributed through specialist hifi stores but, if not available in your area, enquiries may be directed to UHQR Sound Laboratories at the address (or phone number) given earlier.

By way of a special introductory offer, UHQR have a gold-stamped velvet-covered "UHQR Cassette Library" case, which is available free with a six-pack of UHQR cassettes.

## SUPER QUALITY VIDEO CASSETTES FROM BASF

What is claimed to be a state-of-the-art video cassette has just been released by BASF. Building on long experience with chromium dioxide technology, the company claims to have produced particles which are even smaller and more uniform than previously, resulting in a smooth, even coating with outstanding high frequency resolution. For the viewer, this means the very best detail, contrast and colour, of which his/her VCR is capable. The initial release of BASF Chromdioxid Super HG cassette will be VHS E-180, Beta L-500 and VHS-C 30-minute. [BASF Australia Ltd, 55 Flemington Rd, North Melbourne 3051; phone (03) 320 6555].



Above: the SKM4031 FM mic/transmitter and below: the MVF30 microphone system.



## NEW MICROPHONES FROM SENNHEISER

At the recent Trade Music Show in Sydney, R. H. Cunningham Pty Ltd engaged well known Melbourne vocalist, Nadine Wells, to demonstrate a new Sennheiser range of VHF and UHF wireless microphone systems.

Nadine Wells is pictured, left, with the new SKM4031 integrated transmitter/microphone, a unit — according to an R. H. Cunningham news release — "modelled on the now famous Profi Power Microphone". The SKM 4031 has a very high modulation range, with built-in Hi-Dyn noise suppression system and "insensitive to pop and handling noises." Sennheiser claim that the new model "compares favourably" with cabled microphones and is a notable advance in a technology which has, to date, been reserved mainly for speech amplification.

In technical terms, the SK4031 is described as an "electrostatic pressure gradient receiver", with a supercardioid response pattern and a frequency range of 70Hz-20kHz. It has an RF output of 50mW at a selected frequency between 200 and 900MHz and offers a S/N ratio of 78dB. It uses 3x1.5V alkaline-manganese AAA batteries, giving an operating time of 5 hours. All-up weight is 260gm.

Speaking at the release function, Managing Director, James Cunningham said: "a special feature of this microphone is the high sound pressure levels it will handle . . . up to 150dB without distortion".

A new miniature pocket transmitter, model SK2012, has also been released by Sennheiser, featuring very light construction, a high modulation range and the Hi-Dyn noise suppression system. The SK2012 is particularly well suited for film and TV production, especially when used in conjunction with the new sub-miniature microphone MKE2.

The pocket transmitter measures 92 x 52 x 17mm and weighs 180gm, with batteries, making it easy to conceal in the performer's clothing.

To complement the new wireless microphone systems, two new wireless microphone receivers have been introduced by Sennheiser. Where portability is a paramount consideration, the single-channel EM10019 receiver is recommended, combining compactness with a performance level which is equal to the demands of high quality



## The NEW KEF Constructor Series

A new generation of drive units from KEF is now available to the home constructor. KEF's drive units have been improved in terms of reducing audible colouration as a result of the detailed analysis of speaker vibrational characteristics, using computer aided techniques.

Now the improved units and complete technical data on them are available to you to build a system to your own design or to use in any prescribed combinations to complete a system designed by KEF.

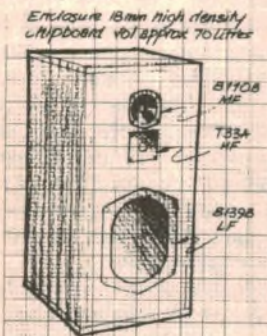

### Model CS7

A new three way design incorporating the B139, which was the world's first flat diaphragm loudspeaker. The system offers an extended bass response and excellent power handling capability, with the three drive units being combined through a computer designed crossover network to give a very smooth frequency response characteristic with finely detailed reproduction of critical mid-range information.

# KEF

Making it together  
Drive Units

Certified mail delivery throughout Australia & New Zealand.

Bankcard, American Express and Diners Club Cards welcome.

For full information, write to: AUDIOKITS,  
PO BOX 361,  
BROOKVALE, NSW 2100.

Please send me details of KEF Systems Designs.

Name: .....

Address: .....

..... Postcode: .....

## Audio-video Electronics — cont.

microphones. It has its own telescopic antenna, features Hi-Dyn noise suppression and has provision for headphone monitoring.

The alternative EM1036 is a multi-channel Mikroport receiver, designed to meet the highest demands of professional audio production. It can be used either for individual channel operation or diversity reception, with suitable antenna units. Each channel is equipped for Hi-Dyn noise suppression.

As distinct from the wireless microphones, Sennheiser have also released a new packaged microphone system, intended primarily to meet the needs of professional and semi-professional video producers.

Called the MVF30, the basic system comes in a neat shoulder-type carrybag, which contains the powering

grip (or base) K30AV, a mini gun microphone head ME80, a windscreen for outdoor use MZW415, camera and mounting bracket MZQ30, and cable for direct connection to the camera MZK802.

Provision is made for possible expansion of the kit to include cardioid, omnidirectional and lapel microphone heads. Fully optioned, the system can provide in one package the optimum microphone for all likely on-location situations, along with a high quality signal. The standard kit has a professional-consumer price of \$295 plus tax.

Details of Sennheiser products are available from R. H. Cunningham Pty Ltd, 146 Roden St, West Melbourne. 3003; phone (03) 329 9633. In Sydney: 4-8 Waters Rd, Neutral Bay, 2089; phone (02) 909 2388.

### In brief . . .

**AKG ACOUSTICS**, makers of AKG microphones, have turned the clock back in terms of technology although, as some would see it, not in terms of sound quality. They have produced what they call the "AKG Tube", a pressure gradient microphone with double diaphragm and — wait for it — an in-built vacuum tube preamplifier!

While the valve amplifier approach cannot rival a solid state preamplifier in terms of economy or convenience, AKG have obviously reacted to the opinion of some producers and performers that valve technology confers a "personal" quality that is not possessed by transistors.

Certainly, AKG have spared no pains in the design of the new AKG Tube. The type 6072 preamplifier valve is shock mounted inside the body of the microphone, while an elastic suspension system mounts the microphone to the stand. The microphone, suspension unit, foam windscreen and power/control unit are all contained for transport in a special flight case, along with a 10m connecting cable.

The power/control unit provides an on-off switch, plus a two-position bass roll-off control and remote control of the polar pattern: omni, cardioid, figure-of-8 and 6 intermediate patterns, adding up to 9 in all.

Details of the new microphone can be obtained through AWA.



### Mordaunt Short loudspeakers

A well known product on the British hifi scene, Mordaunt Short loudspeakers are handled in Australia by Concept Audio Pty Ltd of 17/89 Old Pittwater Rd, Brookvale, NSW. The new "Carnival", "Festival" and "Pageant" Series 3 range from \$525 to \$948, while other models retail for \$398 and \$1998.

## NEW HIFI COMPONENTS FROM UK.

Nicknamed "The Rock", this Elite-Cranfield player is the latest hifi product from Elite Townshend, of Enterprise House, 44-46 Terrace Rd, Walton-on-Thames, Surry, KT12 2SD, England. The product of a 7-year research program at the Cranfield Institute of Technology, under Senior Lecturer Jack Dinsdale, it uses a plinth and turntable of synthetic granite, claimed to be as inflexible as cast iron but 10 times less susceptible to vibration.



Released in early 1982, after 3 years of research, the Celestion SL6 loudspeaker system (left) carried off Japan's Stereo Grand Prix Award. Although a very compact design, the SL6 has a 100-watt rating. Each unit is tested in an anechoic chamber under microcomputer control, its performance being displayed on a CRO and printed out for a permanent record. (Celestion International, Ditton Works, Foxhall Rd, Ipswich, Suffolk IP3 8JP, England).

**TANDBERG** have announced a new TCCR 530 computer-controlled audio recorder cassette, based on their 500-series professional cassette recorder. It has a similar long-life 4-motor drive system with dual capstans, but the control system has been redesigned to simplify control from an external computer — be it a

single-chip microcontroller or a main-frame system. It is equally suitable for audio information or data or digital data and has obvious application to public announcement systems, automated broadcasting and computer assisted teaching.

Inquiries to Rank Electronics Pty Ltd, of 16 Suakin St. Pymble, NSW 2073.

# NEW: WIDE RANGE INPUT

## BOSCHERT 3 TERMINAL SWITCHING REGULATOR



The wide-range input three-terminal 25kHz switching regulators are flexible, inexpensive, efficient design modules providing a single adjustable output from a raw positive DC source.

The 3T modules are complete, functional blocks whose input and output flexibility easily and quickly solve unique power system requirements. Seventy-five per cent typical efficiency is an added advantage of the switcher which helps reduce transformer and heatsink requirements over an equivalent linear regulator. Also, efficiency is essentially independent of input voltage; hence output current need not be derated with increasing input voltage.

Model	Input	Output
3T12AP-6130	+10V to +60V	+4.5V to +30V 12A
3T20AP-6115	+10V to +60V	+4.5V to +15V 20A
3T5AN-6130	+10V to +60V	-4.5V to -30V 5A

# AMTEX

ELECTRONICS

A DIVISION OF **TELCON**  
AUSTRALIA PTY LIMITED

11 Spring Street,  
Chatswood 2067

Phone: (02) 411 1323

# LISTEN TO THE



## ON TOP NAME 150 BEARCAT

### FEATURES INCLUDE:

- Up to 490MHz coverage
- Battery memory back-up
- High 0.5uV sensitivity

ONLY **\$285**

**GREAT VALUE**

What a beauty! The superb Bearcat 150FB is THE BEST value scanner available in Australia today. With splash-proof touch-type controls it's great where other scanners might get knocked around. And it operates from mains power - just plug it in! What convenience! A full-function scanner for under \$400 is unbelievable. Less than \$300 is staggering! Cat D-2800

Want to know more about your exciting hobby?

## DICK SMITH'S Australian Radio Frequency Handbook



**2nd Edition**

The how, when, where, why, what, which and whee of this exciting hobby. Tells you who's where and what's what. A MUST for the scanner enthusiast.

**NEW REVISED EDITION**

Cat B-9600

**GREAT VALUE!**

only **\$12<sup>95</sup>**

## Excitement - that's the heart of the city!

All the things that you never get to hear about because they don't necessarily make the news . . .

You can catch all the action in your area with a scanner from Dick Smith.

Fire crews racing to a skyscraper. Cars and trucks speeding along city streets. A taxi calling for help. Emergency services assisting with an accident. It's all there - and so much more - on the airwaves.

Waiting for you on your scanner.

# HEART OF THE CITY!

**THE ECONOMY  
SCANNER  
WITH  
DELUXE  
FEATURES!**

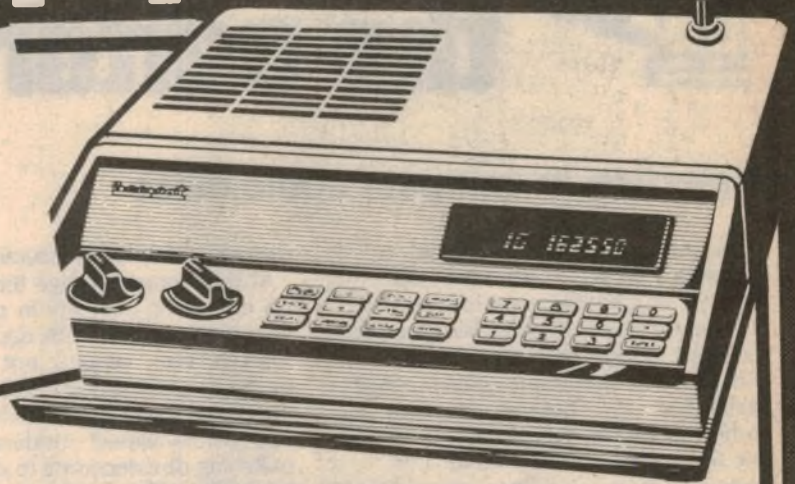

## That's the **BEARCAT 200**

Microprocessor controlled to give a 16 channel memory with thousands of frequencies available: automatic and manual search facilities over the full 66 - 88 MHz and 138 - 174 MHz VHF bands, plus the 406 - 512 UHF bands; automatic and manual memory scanning; operates from 12V so it can be used mobile as well as at home with the optional 240V adaptor. The features of this remarkable scanner just keep on rolling!

Want some more?

**How about:**

- Direct channel access - you don't have to step through other channels to reach the one you want
- Automatic channel lockout
- Priority channel function
- Patented selective scan delay - adds two second delay so you don't miss the reply on a two-way conversation.

**AND THE  
PRICE OF  
THIS  
LITTLE  
BEAUTY?**

Cat D-2801

**ONLY  
\$369**

WANT TO KNOW MORE?

CALL IN TO ONE OF OUR STORES AND HEAR IT DEMONSTRATED

**Ideal for  
Scanners!**

**3-6-9-12V DC  
@ 1 amp  
Power Supply**



**ONLY  
\$17<sup>50</sup>**

Cat M-9530

Most scanners are designed to operate mobile from a car battery. If you want to use them at home, here's the answer: a 240 volt power pack with high 1 amp output at 12V - more than enough for scanners. Simple screw connection.

## Get the most from your scanner with the **SCAN X ANTENNA**

You'll wonder where all those extra stations came from! Scanner experts agree to get the most from your scanner, an outside antenna is virtually a MUST. Until now, the choice has been pretty limited. But here's the new SCAN-X to solve that problem. Ultra-wide bandwidth (65 to 520 MHz), and it comes complete with mast clamps & 5 metres of cable ready to assemble and put up. It will also stand alone on a patio, roof, etc, if you don't wish to mount it on a mast.

Cat D-4430

**FANTASTIC VALUE AT \$59<sup>95</sup>**

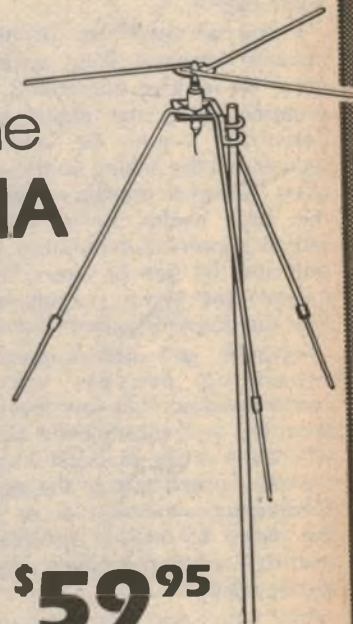

**DICK SMITH  
ELECTRONICS**



See Page 98 for  
full address  
details

03E/A257M/PA



# Letters to the editor

## Distortion in compact audio discs

Currently there is evidence of a concerted drive to promote sales of compact disc equipment which operates on what appears to be a flawed design principle. If one operates at levels of about 1.5% of maximum signal level (not unrealistic for quieter passage of orchestral music) the errors due to bit size limitations will be around 0.1%.

Also the deviations will be sharp edged with significant high frequency components and, except for tones which are submultiples of the sampling frequency, will be associated with non-harmonic distortion. The resulting effect will (must) be as bad as and probably more severe than cross-over distortion in its audible effect. It seems inevitable that acute listening fatigue will result in the long term, although initially the listener may be seduced by the absence of background noise.

The end result can only be disillusionment for the purchaser. Similar effects are discernible already in many digitally mastered analog discs even though masked by background noise to some extent.

If one accepts that 16 bits is the ultimate practical limit, what can be done to retrieve something from the situation? First, the digital to analog converter could be designed to reconstruct the analog synthesised signal using isosceles triangle shaped pulses, the base width being exactly two sampling intervals in duration. While not reducing the size of errors, this would remove the sharp discontinuities and thus the higher frequency content.

Secondly, and more importantly, the recording process should be compressed so that low level music is recorded at a substantially higher level where the errors of digital encoding are a smaller proportion of the signal level. Subsequent expansion at or following the digital to analog converter would lead to a restoration of the range of the analog signal.

Prior dbx encoding and post dbx decoding of the analog signals would appear to be suitable. The absence of background noise should avoid any obvious pumping effects. For high fidelity reproduction, the encoding and

decoding should be accurately matched.

At the recording stage there would be no economic difficulty in precision dbx encoding. Accurate dbx decoding during reproduction would not present a problem especially if incorporated into the digital to analog decoder. However, one would expect moderate errors in matching dbx decoding to dbx encoding would be audibly more tolerable than the fatiguing effects of errors due to finite bit size in the digital process.

I believe it is important that such steps be taken quickly while yet there is only limited software available. Failure to come to grips with the problem will lead to disillusionment and many unhappy customers.

H. W. Holdaway, MIREE,  
Coogee, NSW.

## Beware that old B/W monitor

After convincing my wife that my need for a microcomputer was more than I could bear, she reluctantly sanctioned the purchase on the understanding that no extra expense would be incurred for a monitor, and that I would modify an

old B/W TV for visual display.

There are obviously lots of micro beginners like me out there who cannot afford the extra expense of a monitor "off the shelf". This is supported by EA, hence the article in the August issue on a "you beaut" video amplifier for correct level and wave insertion.

However, there is one pit that the unwary could fall into. I did, so you can benefit from my belated wisdom.

Old TV sets accumulate a lot of dust and fluff over the years and in my haste to see the results of late nights rigging my old TV up for video insertion, I forgot to clean out the dust from the EHT cage and check for high voltage tracks around the leads and tube.

There I was one rainy night merrily filling the Microbee with program when to my chagrin the TV set went "zap, zap". The humid air had broken down what resistance had remained, and the resultant high voltage transients in close proximity to the Microbee nearly popped its cork.

The Microbee was still thinking, thank goodness, as it came up with "option not fitted" (heaven only knows what the zap asked for). I do have a problem, however, as intermittently on typing "new" the Microbee comes up with "illegal line error".

The moral of the story is that you have a relatively unshielded delicate CMOS device in your micro, so take care to prepare your TV for the marriage to your microcomputer. Failure to do this could make a brand new monitor a cheap alternative to having your micro suffering from a bad case of amnesia.

W. Glasson,  
Condolbolin, NSW.

## Monitoring Telecom circuits illegal

As you may be aware there has been sold a large quantity of radiocommunications equipment, including scanners, capable of being used to intercept radio communications.

While the court ruled in the *Golds V Comerford* case that the operation of a receiver for interception purposes without a licence is not an offence under the Wireless Telegraphy Act, I understand that its use to monitor communications carried on Telecom's public automatic mobile radio telephone system (AMTS) would constitute an offence against Section 7 of the Telecommunications (Interception) Act 1979. Furthermore if a person prints or publishes any writing which incites, urges, aids or encourages any person to commit the above offence, it may constitute a breach of Section 7A of the Crimes

Act 1914. That Section creates the offence of incitement to break Commonwealth or Territory laws.

I feel it is my duty to draw the above matters to your attention, and also to point out the need for care in publishing technical articles and advertisements for radio communications equipment in your magazine to ensure that you do not encourage the unlawful use of receivers. In particular, references in advertising material to the ability of certain receivers to intercept radiocommunications carried on Telecom's public automatic mobile radio telephone system should be carefully considered.

M. R. Ramsay,  
First Assistant Secretary,  
Radio Frequency Management  
Division,  
Department of Communications.

# Software for the Super-80

## Software for the Super-80 Computer

\$5.00

An "Electronics Australia" publication

The programs are:

### POKER MACHINE SIMULATION:

This simulated poker machine keeps a record of your winnings and unlike the real ones, you can set a limit on your losses.

### CALENDAR CALCULATOR:

This program displays or prints out a calendar for any year of the 20th century — and keeps track of paydays!

### OTHELLO GAME:

The game of Othello, or Reversi, is played on an 8 X 8 grid with counters of two colours. This one has a "help" option.

### INVESTMENT ANALYSIS:

How much money can you make investing for a fixed term of years at current interest rates? Find out with this program

### GUESSING GAME:

Is it animal, vegetable or mineral, a place, name or a car? Play against your friends, trying to guess the object.

### LIST AND SORT:

This program lets you compile lists of up to 500 items, arrange them in alphabetical order and save them on cassette tape.

### FRED THE SHRINK:

Got a problem? Perhaps Fred can help. Talk things over with your computer — it may give you a new perspective on life!

### SIMPLE MATHS DRILL:

A great one for the kids — or to test your own arithmetic skills. It tells you the right answer, with comments if you goof.

### LOTTO NUMBER SELECTOR:

We don't guarantee you'll win your fortune, but this program makes picking Lotto numbers easy. It's fun to use, too.

### TRIANGLE SOLUTIONS:

Computerised trigonometry at your service. If you think you know all the angles, try this program for size.

### MORTAR ATTACK GAME:

Match wits with the computer! See how long you can hold out in this challenging game of mortar bombardment.

### CAVES & MONSTERS:

Go adventuring in the maze. You must fight monsters and find the treasure, but be careful — the monsters get tougher as you go.

### AMATEUR Q CODE TUTORIAL:

If you're thinking of going for your amateur radio licence, or just want to find out what all those "Q" codes mean, try this.

### DIRECTORY FOR CARAVAN PARKS:

Owners of caravan parks can keep track of who's where with this program. It can be adapted to other applications too.

### SUPER-POKEY GAME:

Another poker machine game, but this one has graphics. For the budget conscious, you can set an upper limit on your stake.

### TATTSLOTTO NUMBERS:

For those south of the border we present a program to select numbers for Tattsлото entries. Good luck.

**Note:** this book is exclusive to, and available only from, Electronics Australia, 57 Regent Street, Chippendale, NSW, 2008. PRICE \$4.00 or by mail order from Electronics Australia, PO Box 163 Chippendale, NSW, 2008. PRICE \$5.00.

## The new JBL L15. Its sound will take your breath away. Its price won't.

JBL

If you think high performance audio has to be expensive or large, we've got a great surprise for you — the new JBL L15 compact loudspeaker. While only 375 mm (14¾") high, this astonishing 2-way system combines clean, clear, accurate sound with incredible power capacity, high efficiency and ultra-low distortion — all requirements for the digital age. Designed with the aid of computer models and laser interferometry, the JBL L15 does not need a huge amplifier to provide good volume levels; however you can use an amplifier up to 100 watts/channel. At any volume, the JBL L15 creates a lifelike, three dimensional sound quality.

Finished in oiled American black walnut veneer, the L15 is hand-rubbed to bring out the natural grain structure of the wood. For a detailed brochure or the location of your nearest JBL High Fidelity Dealer, contact:  
Harman Australia, LMB 12, PO Nth Ryde  
NSW, 2113. (02) 887 3233

**\$538** pair.

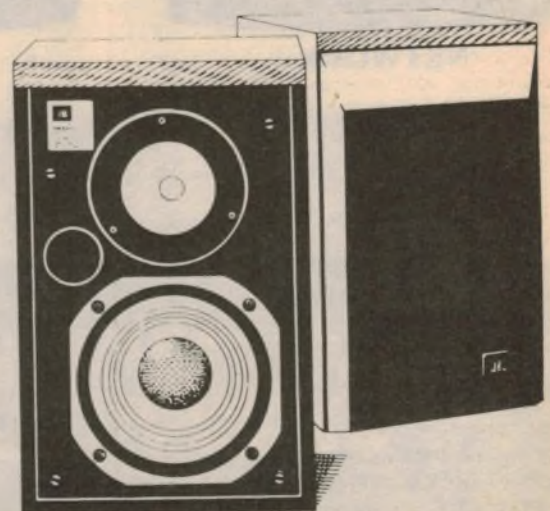



Now! Australia's leading  
ahead with totally  
operation.

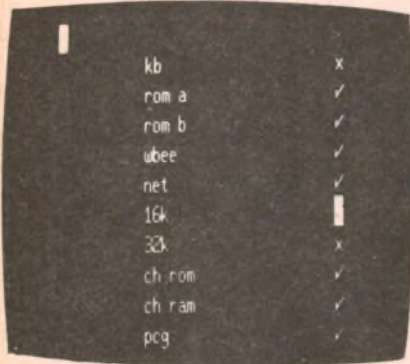

SELF TEST.

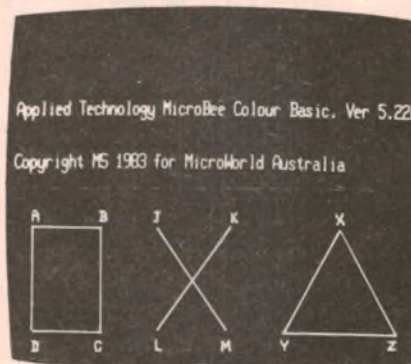

BASIC WITH GRAPHICS

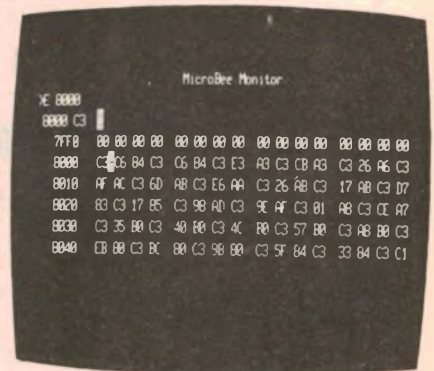

MONITOR

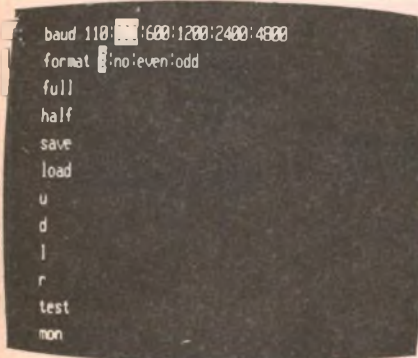

NETWORK

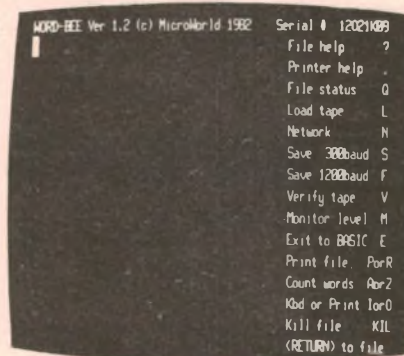

WORDBEE

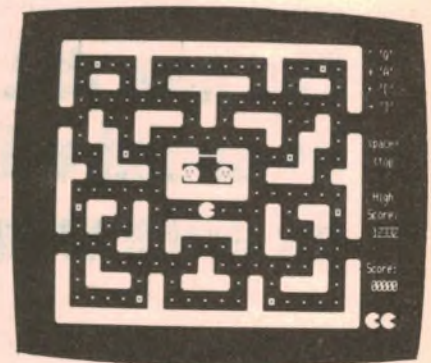

ARCADE GAMES



Microbee features:

- 16K and 32K.
- Non-Volatile CMOS RAM.
- Programmable RS232 Serial Port.
- Programmable 8 Bit I/O Port.
- Display 64 x 16 and 80 x 24 screen format.
- 6545 Programmable VDU Driver.
- Cassette Interface, 300 and 1200 baud.



# personal Computer moves further integrated software and faster

## microbee®

First in the world with all these software features integrated  
into one computer —

**MICROWORLD COLOUR BASIC 5.22e**  
**WORDBEE WORD PROCESSOR**  
**NETWORKING**  
**TERMINAL COMMUNICATIONS**  
**MACHINE CODE MONITOR**  
**SELF TESTING**

Here's why microbee has become Australia's biggest selling personal/educational computer. Over 3000 microbees are already helping teaching in Australian schools, T.A.F.E.'s and Universities.

New enhanced MICROWORLD BASIC 5.22e allows easy programming of colour into educational software and games with high resolution graphics. 16 Background and 26 Foreground colours. Wordbee in ROM means you can connect your microbee to a printer and have a complete word processor in your home for letters, school and Uni assignments and accounts.

Add a low cost modem or acoustic coupler and you can exchange BASIC and WORDBEE files with other microbees OR you can talk to the popular bulletin boards and sources around the world. Select the Terminal Mode to give you standard ADM3A or Televideo 912C terminal emulation in 80 x 24 format. Your microbee becomes a personal terminal to communicate with mainframe computers — your window to the world! Select the machine code monitor and you can program the Z80 microprocessor directly.

Your microbee IC even has a built in self test facility so you can be sure its not the machine but possibly your program that has the bug!



**microbee 16K IC — \$499.**  
**microbee 32K IC — \$599.**

Recommended Retail Price Only. Prices may vary beyond Sydney.



PHONE ORDERS  
**(02) 487 2711**



## microbee®

CEAT05R1

### Available from your microbee computer shops:

1 Pattison Ave, Waitara, Sydney.  
Phone (02) 487 2711

729 Glenferrie Rd, Hawthorn,  
Melbourne. Phone 818 2244

141 Stirling Highway, Nedlands,  
Perth. Phone 386 8250

Coolman Court, Weston. Phone  
88 6384

### Microbee dealers:

NSW: Electronic Agencies,  
117 York Street, Sydney.  
115 Parramatta Road, Concord.  
Compu-K, 7 Casino Street, South Lismore.  
Comput'Ed, 8 Park Arcade, Park Avenue,  
Coffs Harbour.

ACT: Computech, Belconnen Churches  
Centre, Benjamin Way, Belconnen.

VIC: Computerland South Melbourne,  
37 Albert Road, Melbourne.

S.A.: Key Computers, 1061 South Road,  
Edwardstown. 77 Grenfell Street, Adelaide.

W.A.: Altronics, 105 Stirling Street, Perth.

QLD: Software 80, 200 Moggill Road,  
Taringa. Electrographic Office Systems,  
25 Grafton Street, Cairns.

Town and Country Computers,  
CTL Centre, Anne Street,  
Aitkenvale, Townsville.

TAS: Central Data, 14A Goodwin Street,  
Launceston.

### PHONE ORDERS

## (02) 487-2711

Applied Technology Retail Pty Ltd

# Hifi Review

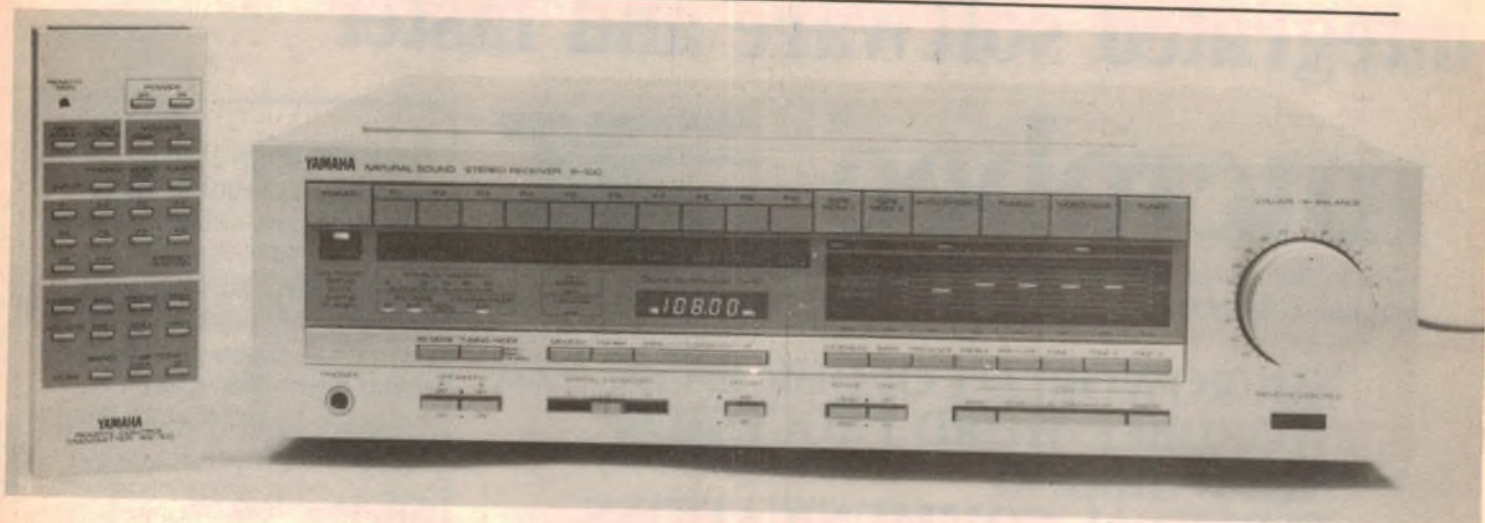

## YAMAHA R100 Stereo Receiver

The Yamaha R-100 receiver this month is one of the most interesting pieces of equipment we have seen in a long time. Containing virtually "everything that opens and shuts" it uses a microprocessor to control most of the receiver functions.

In line with the trend toward increased consumer equipment complexity, Yamaha have released a new 100 watt, top-of-the-line receiver, the R-100, which contains probably the most features we have ever seen packed into one receiver.

Chief among these features would be the microprocessor system which automatically controls many of the receiver's functions.

Other features included in the tuner section are: a digital readout of the band and frequency, a LED tuning meter, automatic station search, local and distant tuning modes with automatic switching between the two, a ten-station tuner memory and a blend facility which helps reduce high frequency hiss in weak FM signals.

The amplifier section of the receiver also contains a host of features and these include switching for two sets of

speakers, a spatial expander, a dynamic noise canceller, a switchable moving coil or moving magnet phono preamplifier, an auto phono function, tape dubbing facilities and a five band equaliser called the CCSS or Computer Controlled Sound System.

Perhaps the best feature of the R-100 is the infrared remote control unit, the RS-100. This is included in the basic price of the R-100 and allows virtually full control over the R-100 from the comfort of your armchair.

With the RS-100, the user may turn the R-100 on or off, adjust the volume up or down, select between the tuner, phono, video/aux or tape monitor inputs, recall any of the equaliser settings or change one to suit the listening position, or select any one of the ten preset tuner frequencies.

Operation of the R-100 is quite simple but it does take a little time to become

proficient with all the facilities it provides.

Manual tuning is achieved by first pressing the AM/FM button to select the band and then pressing the tuning mode button to place the tuner in the manual mode. Sustained pressure on one side of the tuning button (right side for up, left side for down) will cause the tuner to shift frequency in the desired direction. Short touches on the button step the tuner in increments of 50kHz on FM and 9kHz on AM.

Automatic tuning is also provided on the R-100. To operate, the AM/FM button is pressed first to select the desired band, then the auto mode is selected via the tuning mode button. A touch on one end of the tuning button (right for up, left for down) will cause the tuner to scan through the selected frequency band until a station is located.

If no station is located by the end of the band, the tuner will jump to the other end of the band and begin scanning from there.

To enter a station into the tuner memory, the receiver is first tuned to the desired station then the memory button is pressed followed by one of the station preset buttons. The tuner will now remember both the station frequency and the band.

Up to 10 station frequencies can be stored in any order with no limits on the mixture of AM and FM stations. To recall a station from memory just press the appropriate station preset button on either the receiver or the remote control and the receiver will jump to the preset frequency.

Muting is applied to the receiver output during tuning and is not removed until the tuner frequency has remained

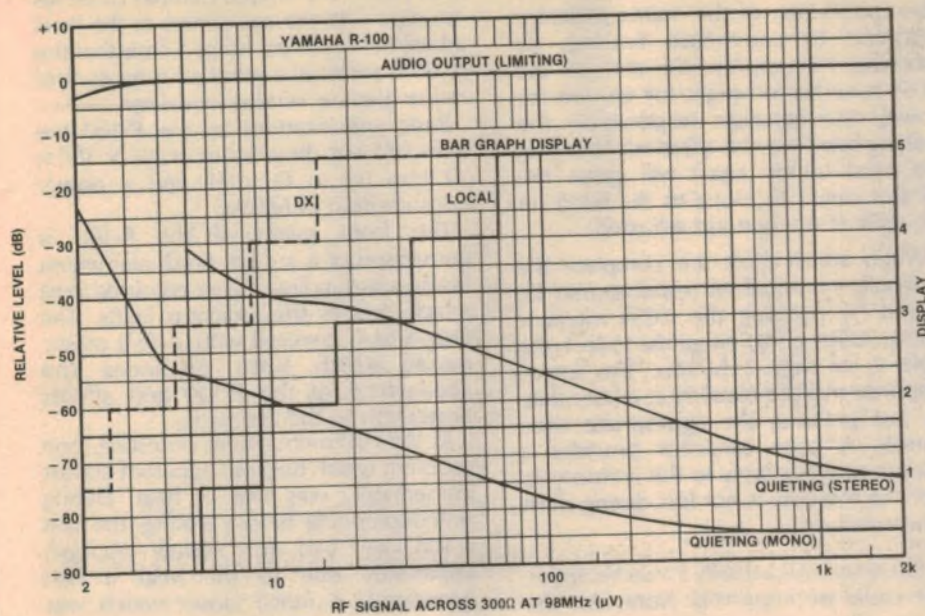

The signal strength bar graph has two levels of sensitivity, for DX and local reception.

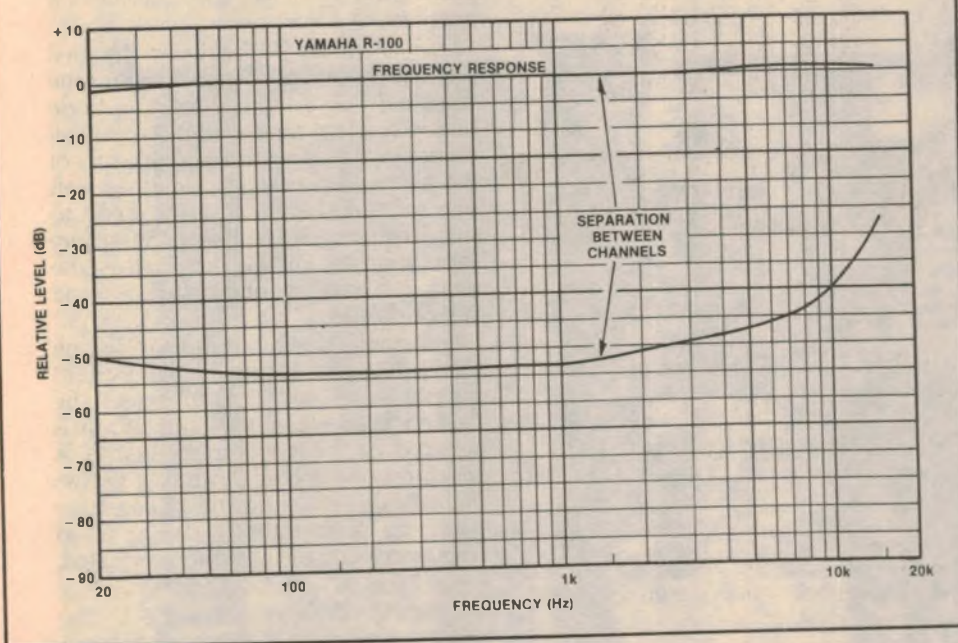

steady for approximately two seconds. This is of little consequence during automatic tuning but makes single stepping in the manual mode quite tedious since each time you increment the frequency it takes about two seconds before the tuner output is heard.

A disadvantage with tuning the receiver manually is that whenever the tuner is placed in the manual mode, the receiver output is in mono. To receive programs in stereo, the tuner must be returned to the automatic mode after the desired station has been tuned in. This is not a serious limitation, however it is annoying and we cannot see any reason as to why the tuner should be restricted in this way.

The receiver has two modes of FM reception, local and distant. The local mode is used when the station being received has a good strong signal. If the station has a weak signal then the DX mode is used. The receiver may be held in either the local or the DX mode, however for the best reception under all conditions the RX mode switch should be set to the "auto" position.

When this is done, the microprocessor inside the R-100 continually monitors the FM signal and switches the receiver into the mode best suited to the strength of the incoming signal.

A publicity handout on the R-100 makes mention of the fact that it contains two different types of tuning

systems. These are, to quote Yamaha, "a high-precision PLL tuning mode" and a "high-performance FM servo tuning mode" which are automatically selected by the microprocessor to provide the best reception under all conditions.

Unfortunately no further information is provided on these tuning modes so we can only conjecture that the PLL tuning mode is used in the DX position for weak and noisy signals and the servo tuning mode is used for strong local signals where high quality is important.

A high-frequency blend circuit is also provided in the receiver and this works to reduce the hiss present in a weak stereo signal. The blend circuit cannot be controlled manually and is brought into play on weak signals automatically by the microprocessor whenever the "RX mode" switch is in the auto position.

A light emitting diode (LED) signal strength meter is also fitted to the R-100 and this serves to indicate the relative strength of the incoming signal. Although there are 10 LED segments, the segments are actually paired so that in reality there are only five signal strength segments. The segment thresholds are changed depending on whether the receiver is in the local or DX mode and both sets of thresholds are shown on the tuner performance graph.

Another feature of the R-100 which we have little information about is the spatial expander. While it does change the signal, whether it enhances the separation or not is open to personal opinion.

The dynamic noise canceller mentioned earlier in the review is actually a sliding low pass filter which follows the upper frequency limit of the program material and removes any higher frequency noise present. This type of noise filter will not work with signals which contain high level, high frequency signals.

The phono preamplifier fitted to the R-100 receiver is a dual purpose device which can handle both conventional moving magnet cartridges and the more exotic low output moving coil cartridges. Only one set of phono inputs is provided on the R-100, with a front panel switch being used to change the phono input from moving coil to moving magnet and back again when required.

The Auto Phono function is a convenience feature which, when selected, automatically switches the receiver's input to the phono mode whenever the turntable tonearm is lowered onto the record at the start of play. The previous input mode is cancelled and record replay starts immediately.

As mentioned earlier, a five band

Continued on page 46

# YAMAHA R100 Stereo Receiver

*Continued from page 45*

equaliser called the CCSS has been fitted to the R-100. Using what appears to be a fluorescent display, a five element by seven element matrix display located in the centre right of the front panel gives a visual indication of the equaliser settings.

Immediately below the display matrix are a row of eight pushbuttons. Five of these buttons recall factory preset equaliser curves with rather descriptive names such as loudness, bass, treble, presence and high filter. The other three buttons are used to store and recall user programmed equaliser curves from the CCSS memory.

*The heatsink for the IC power amplifiers in the R100 receiver is actually a true heatpipe. It works well but ventilation through the case could be improved. Note also the motor-driven volume control.*

The equaliser may be manually controlled by the CCSS band button. This causes one of the matrix indicator segments to commence flashing. By touching the appropriate end of the CCSS tone button (right for up, left for down), the equaliser response in the flashing band may be adjusted. Touching the band button again will cause the control circuit to move to the band on the right of the one just adjusted.

When adjustments are complete the manually set equaliser response may be stored by pressing the CCSS memory button followed by either the tone 1, the tone 2, or tone 3 button. The stored response may be recalled at a later date by just pressing the appropriate tone button. A large capacitor provides a backup power supply to the memory so that the memory is not lost during short power failures.

Although the CCSS display looks impressive, the limited number of bands coupled with the coarseness of the level adjustment (4dB per step) means that the CCSS is more of a glorified tone control rather than a serious equaliser.

Basic specifications of the R-100 are mass of 11kg, dimensions of 435 x 386 x 122mm (W x D x H) and a power consumption of 680W.

The front panel of the R-100 is composed of a scratch finish aluminium facing surrounding a grey coloured area which houses the indicator lights. The grey area is covered with a clear plastic panel which both enhances the appearance of the R-100 and affords protection to the indicators.

At the commencement of testing, one problem which became apparent almost immediately was that of heat. During preconditioning before testing, the first R-100 we had for review expired, apparently due to the heat it had generated. A much closer watch was

*Continued on page 49*

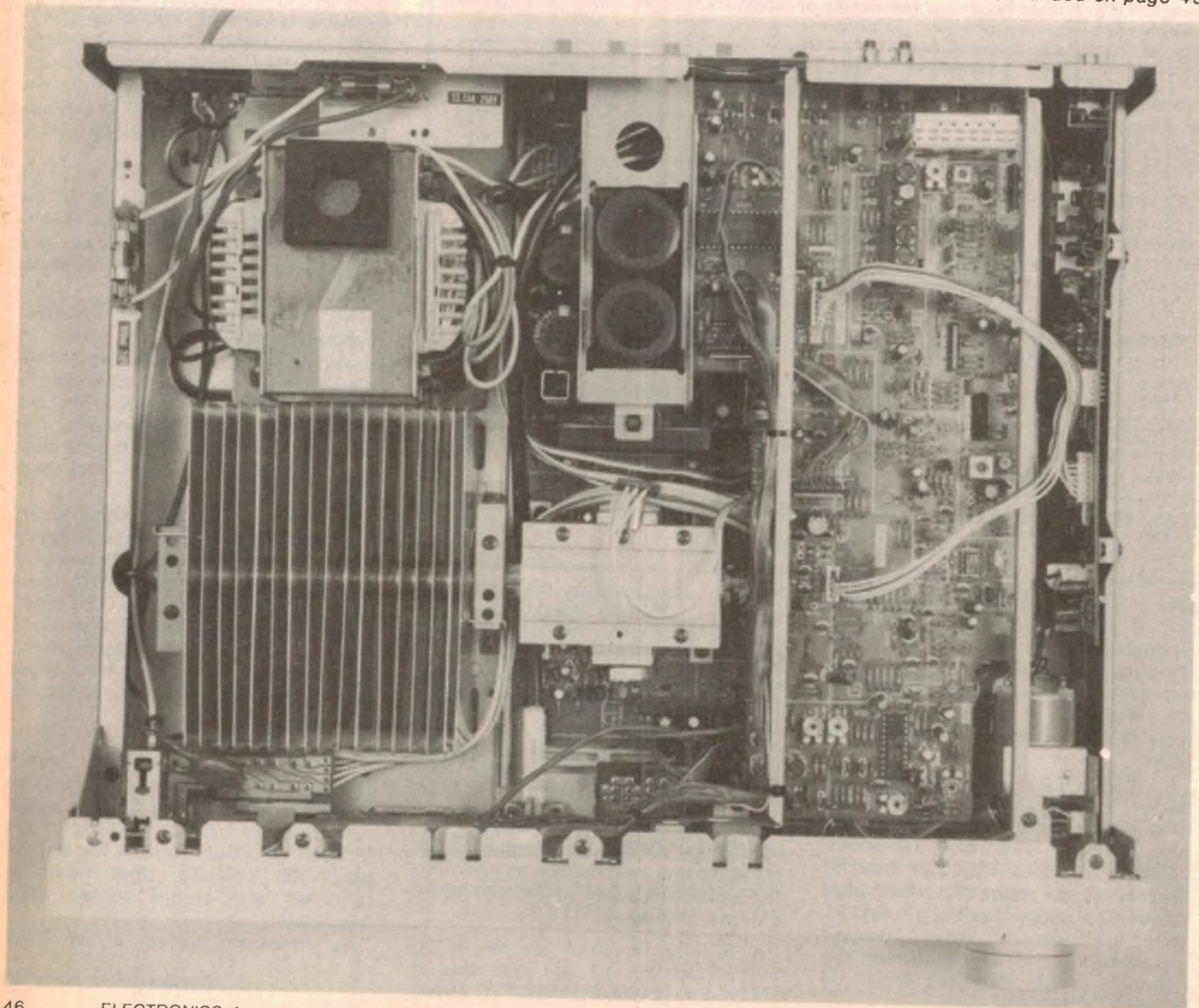

# BUY THE BEST FROM THE



Why are more and more people buying their hi-fi equipment at AUDIO ONE? Simple. We have a better range of better products. And we know how to get the best performance from them. So whether you're looking for the ultimate system for utmost enjoyment of recorded music, or simply want a replacement stylus, we can help you. Better.

## ACTIVE SPEAKERS — BIGGEST RANGE

We have, for example, Sydney's biggest range of active speakers. And because we've stocked more of them, for longer, we know a lot about them. Not only can we demonstrate their unique advantages, we can also make sure you get the very best from them. We can demonstrate how the MERIDIAN INTER-ACTIVE speakers give a performance that would be impossible from conventional speakers and amplifiers of equivalent size and price. And we can show you how easy it is to progress from an advanced, high-performance passive system to the accomplishment and majesty of a fully-fledged active system using ARC speakers and dedicated NYTECH AUDIO electronic components without making your existing system obsolete and without wasting your money.

## THE BETTER RECORD PLAYER

You can hear for yourself how using a better turntable like the MICHELL GYRODEC — quite simply the finest example of precision, high-performance turntable engineering we have ever encountered — will give you even more pleasure and enjoyment from your record collection. And we can provide you with a choice of meticulously engineered tonearms including the famous SYRINX PU3 and the daringly innovative ALPHASON HR100S to give you more excitement and involvement with your records than you ever thought possible.

## BETTER BUDGET BUYING

Equally important, we seek out the very finest products in lower price ranges. Compare, for example, the famous REGA PLANAR 3 with the unusual yet highly effective WALKER CJ55 turntable — both exceptional performers, both designed along different but equally valid concepts. We ensure you make the right choice, because we ensure you hear the differences — one or the other will be clearly preferable. And to complete these excellent products we can offer tonearms like the sensational SYRINX LE1, the low-cost pickup that makes most of the expensive "super-arms" sound like a bad joke.

## ARE AMPS REALLY DIFFERENT?

In amplifiers we can help you choose between the superb HAFLER and award-winning MERIDIAN systems on one hand, or at lower cost, between NYTECH's brilliant new CA202 and CA252 models, ROTEL's incredible RA820 and RA840 and, of course, the latest excellent designs from MARANTZ. Each model has distinctive attributes in terms of sound and facilities; at AUDIO ONE we make it easy to choose the one that's best for you. We can guide you in your choice of speakers — from the superbly finished and already acclaimed MONITOR AUDIO "R" series, through the highly specialised BOSE range to the precise, crisp sound of ROGERS whose famous BBC LS/35A Miniature Monitor continues to set the standard by which all small (and very many larger) speakers are judged. We have the pick of the best of British speakers, including CELESTION and the advanced, definitive ARC range.

## AUDIO ONE — THE EXPERTS

Buying your equipment from AUDIO ONE makes more sense because we have the experience and background knowledge to get more performance out of systems and components. We're aware, for example, of the effects of interconnecting cables, speaker stands, turntable mats, record clamps and a host of other details which despite your care in choosing and assembling your system, can make or break its ability to give you continued enjoyment. That's why we always take care that systems and components we supply and install are absolutely complete in the details — often the humblest system is transformed by use of a more suitable turntable mat, which gives improved record support — or even through having a thoroughly cleaned stylus by use of an effective and efficient brush.

## NATIONWIDE SERVICE

Take advantage of our comprehensive installation service anywhere in the Sydney Metropolitan Area, or elsewhere use our high-speed mail order service. We'd also like to welcome you to attend our regular FREE demonstration evenings in which we present in-depth profiles on the latest, most interesting (and not necessarily the most expensive!) equipment and various topical subjects which crop up from time to time. Details are available by contacting us and, if you'd like to receive our special AUDIO ONE CLUB NEWSLETTER which contains advance details of special offers and bargains, all the latest information (factual) and gossip (no smoke without fire!) just mail the coupon below and we'll add your name to our privileged mailing list. Or simply call and bring yourself up to date with what's happening in the world of AUDIO ONE HI-FI.

# AUDIO ONE

71 MILITARY ROAD  
NEUTRAL BAY 2089.  
TEL: 90-6001

To: AUDIO ONE, 71 MILITARY ROAD, NEUTRAL BAY, NSW 2089  
Please send me your latest Newsletter and information  
Mr/Mrs/Ms/Miss  
Address  
Postcode  
Ref Aud One Ad 001

# Jaycar

Incorporating  
ELECTRONIC AGENCIES

**SYDNEY** SHOWROOMS  
125 & 117 YORK STREET - PHONE: (02) 264 6688 and (02) 267 1614  
TELEX: 72293

**CARLINGFORD**  
Cnr CARLINGFORD & PENNANT HILLS ROAD - PHONE: (02) 872 4444

**CONCORD**  
115 - 117 PARRAMATTA ROAD - PHONE: (02) 745 3077

**HURSTVILLE** 121 FOREST ROAD - PHONE: (02) 570 7000

## NUMBER 1 FOR KITS

POST AND PACKING CHARGES  
\$5 - \$9.99 (\$1.50) \$10 - \$24.99 (\$3.20)  
\$25 - \$49.99 (\$4.50) \$50 - \$99.99 (\$6.50)  
\$100 - \$199 (\$8.00) Over \$199 (\$10)  
\*Free INSURANCE for Road & Registered Post over \$200\*  
All heavy or bulky items (over 20kg.) sent Comart Road Freight \$12.00 anywhere in Australia.  
SHOP HOURS CARLINGFORD, CONCORD & HURSTVILLE  
Mon - Fri 9am - 5:30pm Sat - 9am - 12pm Thurs night 8:30pm  
SHOP HOURS SYDNEY  
Mon - Fri 8:30am - 5:30pm Sat - 8:30am - 12pm Thurs night 8:30pm  
MAIL ORDERS AND CORRESPONDENCE: BOX K 39 HAYMARKET, SYDNEY 2000



BANKCARD  
Via Your Phone

### VIDEO ENHANCER KIT

KF7016 \$35.00  
See FA Oct. 83



### PARALLEL INTERFACE KIT FOR MICROBEE

15 Pin D Plug supplied.  
Add \$15.00 if Centronics plug required.  
See FT1 Oct. 83, KF7017  
\$15.00



### MONSTER CABLE

You will be amazed like we were! when you hear the difference this cable makes. Who would have imagined that replacing your ordinary speaker cable with Monster cable will make as much difference to the sound as changing to a moving coil cartridge. This is a must for serious audiophiles. You don't buy it like normal wire. Measure how much you need for each speaker and when you purchase it we fit on the connectors for the ends. You can use either gold banana plugs, gold spade connectors or gold pins. The spade connectors are used if you have screw terminals on your amp and speakers, the pins if you have the push type terminals and the banana plugs for banana skins. Sample order for Mail Order customers: 1 length 4 metres, 2 gold pins to 2 gold spades - left speaker, 1 length 6 metres, 2 gold pins to 2 gold spades - right speakers, Cable - \$4.50 per metre, Gold Pins - \$2.75 pair, Gold Spades - \$4.40 pair, Gold Bananas - \$17.00 pair

### HEARING IS BELIEVING!

### LATEST PCB'S FROM RCS

83EG5	\$11.60	83VAR	\$4.40
83BT5	\$4.50	83PL8	\$3.80
ET1323	\$4.80	83SC8	\$5.40
		8317SR	\$6.60
ET1164	\$3.80	ET11520	\$7.00
ET1163	\$10.40	ET1464	\$4.80
83GA6	\$6.60	ET1265	\$5.80
83PP5	\$4.80	ET1336	\$5.40
ET11516	\$3.80	ET1166B	\$8.40
ET1153	\$3.80	ET1166C	\$4.80
ET1686B	\$6.40	ET11660	\$5.60
83AL6	\$3.60	ET1649AB	\$7.40
83SC7	\$5.40		
83RS7	\$3.60		

### NEW MICROBEE SOFTWARE

XE6900	Keplers Laws - Physics	\$14.95
XE6905	Graphic Life - Experiment	\$14.95
XE6910	Millikans Experiment - Physics	\$14.95
XE6915	Dissassembler - Dreamcards	\$15.00
XE6920	Cheapie - Hangman & Battleship	\$15.00
XE6925	Cannibals & Missionaries - Game	\$14.95
XE6930	Composer Bee - Music	\$22.50
XE6935	Word Adventure - English	\$14.95
XE6940	Pontoon - Gambling Card Game	\$14.95
XE6945	Data Bee - Data Base	\$19.95
XE6950	Space Patrol - Game	\$16.95
XE6955	Penetrator - Game	\$19.95
XE6960	Mine Drop - Game	\$14.95
XE6965	Forth - Language	\$45.00
XE6970	Screen Dump - Utility	\$14.95
XE5000	Microbee 16K +	\$469.00
XE5050	Microbee 16K IC	\$399.00
XE5100	Microbee 32K +	\$559.00
XE5150	Microbee 32K IC	\$599.00
XE5200	Microbee 64K +	\$699.00
XE1250	Micron Super 80 Printer	\$499.00
XE1260	Paper to suit 2000 sheets	\$39.50
XE1186	Micron Green Monitor	\$199.50
XE1190	Kaga Green Monitor	\$259.00
XE1205	Printer Cable Interface	\$49.95
XE5400	Microbee Data Cassette	\$49.50
KF7014	Light Pen Kit for Microbee	\$18.50

### PEERLESS 12" WOOFER

This price can never be repeated  
80 watt handling  
about 40W RMS,  
European Quality - Made in Denmark  
Freq. Response 35-4000 Hz  
Res. Freq. 35 Hz  
CE2130



ONLY  
\$29.75  
each

LIMITED QUANTITY

**PIONEER WIDERANGE 4" NEW**  
Handling 10W RMS  
Res. Freq. 115-120 Hz  
Sensitivity 91 db lmt/lw  
Freq. Resp. CE2290  
fo - 18,000 Hz  
\$9.95



### PEERLESS QUALITY CROSSOVERS

Two way crossover  
50W RMS handling  
Freq. 2,500 Hz  
CE2612

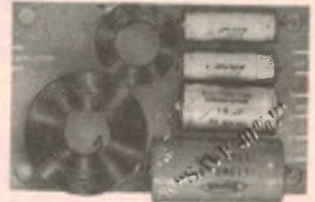

\$9.50  
each



Three way crossover  
50W RMS handling  
Freq. 750 Hz, 5000 Hz  
CE2622

\$22.50  
each

### NEW COMPUTER BOOKS

BF8150	Computer for Everybody	\$ 9.95
BF8152	Microcomputer Dictionary	\$ 7.50
BF8155	Introduction to Word Processing	\$23.95
BF8157	CPM Handbook	\$27.95
BF8160	Microcomputers in Plain English	\$ 7.95
BF8162	Your First Computer	\$16.95

### ETI 660 COLOUR COMPUTER KIT

Mother board	\$99.00
Push button Switches	\$32.00
Colour Option	\$16.50
TOTAL	\$147.50

SPECIAL - THE LOT  
ONLY \$99.00

SAVE \$48.50

SLASHED

RUN OUT  
LIMITED STOCK

### LATEST KITS

KF7015	5 Watt Amplifier Module	\$7.50
KF7014	Light Pen for Microbee S/Form	\$18.50
KF7013	12 volt Addon for EA 5A Power Supply	\$14.95
KF7012	Breath Test Kit	\$28.50
KF7011	5 AMP Power Supply	\$19.00
KF7010	Temperature Probe for Digital M/Meter	\$19.50
KF7009	ETI House Alarm Kit	\$59.95
KF7008	Stereo Simulator Kit	\$19.95
KF7007	Touch Light Dimmer Kit	\$19.95
KF7006	Motor Speed Controller	\$19.95
KF7005	Auto Tester	\$14.75
KF7004	Red Light Flasher	\$20.95
KF7003	E-prom Burner for Microbee	\$46.50
KF7002	Nicad Charger	\$7.95

### PARALLEL INTERFACE KIT FOR

Includes 15 Pin D Plug  
Add \$15.00 if Centronics  
plug req'd. KF7017 \$15.00

microbee

**PROFESSIONAL COMPUTERISED CAR ALARM WITH FLASHING LIGHT**

This alarm has all the features of those expensive types. These include:-

- Flashing light for visible protection
- Automatically switches on when ignition key is in off position and switched off with same key - no switches
- Exit and entry delay, and unit chirps when exit delay begins
- Sounds for one minute, then resets
- Pulsating or steady alarm tone
- Can be used with optional N.O. Motion selectable
- Can be used with optional N.O. Motion sensor
- Bonnet, boot, car stereo and C.R. protected
- All hardware, wire and two warning decals supplied.
- LF8600 \$69.95

# YAMAHA R100 Stereo Receiver

Continued from page 46

kept on a second R-100 during preconditioning and this was found to get too hot to touch after just 20 minutes (preconditioning lasts one hour according to IHF procedure).

The fault does not appear to be a lack of heatsinking in the R-100 but rather a lack of adequate ventilation for the heatsink which is mounted inside the case.

Admittedly our tests are rather more demanding than a typical home environment, however even playing music at moderate volumes caused the R-100 to become quite warm to touch. Because of this heat buildup, the manufacturer's warning about not placing things over the ventilation holes should be adhered to strictly.

Most of the test results on the tuner section of the R-100 have been summarised into two graphs which allows a quick and easy comparison to be made with other receivers and tuners we have tested.

Looking at the graph of the quieting characteristic it can be seen that 50dB of quieting was achieved in mono mode with an input of  $3.8\mu\text{V}$ . The sudden decrease in the quieting at signal strengths below  $4\mu\text{V}$  is related to the loss of audio limiting below this signal strength.

Ultimate quieting was 85 dB in mono and 79 dB in stereo, an excellent result. The 19kHz stereo sub-carrier had a measured residual of -50dB while the 38kHz switching frequency could not be measured at all, its amplitude being below the noise.

Total harmonic distortion with a 100% modulated (75kHz deviation) input signal was: in mono mode, 0.058% at 100Hz, 0.037% at 1kHz, and 0.05% at 6kHz. In stereo mode the figures were: 0.067% at 100Hz, 0.047% at 1kHz, and 0.057% at 6kHz. These are very good results and are comfortably inside the manufacturer's specifications.

Audio output limiting was achieved with an RF input of  $4\mu\text{V}$ . Frequency response was +1dB at 10kHz and -1dB at 20Hz with respect to 1kHz. Response above 15kHz is not shown since this is affected by the 19kHz filter.

Channel separation was better than 50dB over the range 20Hz to 2.5kHz, deteriorating to 40dB at 10kHz and 27.5dB at 15kHz. This deterioration at higher frequencies is quite normal with FM tuners and is to be expected.

Yamaha specify a power output for the R-100 of 100 watts per channel into an  $8\Omega$  load. We measured the maximum power output at the onset of clipping as 120 watts with both channels driven and 160 watts with a single channel driven. Both these figures were into  $8\Omega$  loads.

At 100 watts into  $8\Omega$  distortion was measured as below 0.006% from 20Hz to 1kHz, rising to 0.024% at 10kHz and 0.045% at 20kHz.

We did not measure performance into  $4\Omega$  loads because of the heat problem mentioned previously and the fact that for A+B speaker operation, Yamaha caution against using speakers of less than  $16\Omega$  impedance.

Power bandwidth of the R-100 extended from 11.5Hz to 20kHz (-3dB points), while the damping factor was measured as 35 with an  $8\Omega$  load at 1kHz. Separation between channels was 79.5dB at 100Hz, 76.5dB at 1kHz and 71.5dB at 10kHz.

Unweighted signal-to-noise ratio on the Aux input measured 92dB with respect

to 100 watts into  $8\Omega$ . The corresponding signal to noise ratio for the moving magnet (MM) phono input was 74dB with respect to an input level of 5mV at 1kHz. This is a good result.

Phono input overload occurred with a 125mV input on the moving magnet position and with an 8.1mV input on the moving coil position. Ultimate sensitivity (to produce 100 watts into  $8\Omega$ ) was measured as 2.6mV for the moving magnet phono input and 110mV for the high level inputs.

The harmonic distortion of the moving magnet phono input for a 1VRMS output from the Rec Out socket was just 0.008%, an excellent result.

The performance of the AM section was not actually measured in the review, however we have no reason to doubt the manufacturer's specifications. These are: Usable sensitivity -  $250\mu\text{V/m}$ , selectivity - 25dB, harmonic distortion (400Hz) - 0.3%, signal to noise ratio - 52dB. There was no specification for AM bandwidth.

Our overall impression of the R-100 receiver is a little mixed. Although it performed quite well overall, the fact that it runs very warm has us concerned and could lead to problems in the long run.

Some features such as the spatial expander and the computer controlled sound system are little more than gimmicks in their present form and should either be improved or abandoned as they do little but add to the cost.

The Yamaha R-100 receiver carries a recommended retail price of \$1199 and should be available through any Yamaha hifi retailer. For further details on the R-100 and a list of dealers, phone Rose Music Pty Ltd on Sydney 750 8999 or Melbourne 699 2388.(JS)

**IAN J. TRUSCOTT'S**

CORNER BAYSWATER AND EASTFIELD ROADS,  
CROYDON, VICTORIA, 3136.

**(03) 723 3860**

## ELECTRONIC WORLD

SPECIALISING IN SALES AND SERVICE TO —

**CAR RADIOS**



**C.B.**



**AND MARINE**

CONTACT US FOR ALL YOUR 27MHZ AND 477MHZ REQUIREMENTS

OUR VAST RANGE OF COMPONENTS TO SUIT THE ELECTRONIC ENTHUSIAST INCLUDES: RESISTORS — CAPACITORS — IC's — POTENTIOMETERS — HEAT SINKS — CABINETS — PLUGS AND SOCKETS OF MOST KINDS.

WE ALSO STOCK A RANGE OF TEST AND ASSEMBLY GEAR  
TO HELP THE HOBBY TYPE ELECTRONIC BUFF

WE ARE SPECIALISTS IN TV, STEREO AND MOST ELECTRICAL REPAIRS.

# JAYCAR & ELECTRONIC AG

## Digital Delay Line

The Digital Delay Line is designed to produce a huge variety of electronic effects. It works very well but the amazing thing is the low low price! The effects depend on the time delay selected and some of those included are: Phasing, Flanging, Chorus, ADT (Automatic Double Tracking), Echo, and Vibrato. The delay time can be varied from 0.32ms to 1.6 seconds! Because the signal is stored in digital form there is, unlike analog systems, no degeneration of the signal with time and unlimited repetition is provided by use of the freeze control.

All the controls mount directly upon PCB's to eliminate wiring and to further simplify construction the main board is 'plated through' i.e. there are no wire links or link through pins. The whole of the memory whether for the basic 400ms machine or the fully expanded 1.6 second model all fits on the main board. The cabinet which is free standing but also suitable for 19" rack mounting, is fully finished to a very high standard. The panel is deep blue whilst the cover is sprayed with a durable black enamel. The kit is available for only \$449 - compare that with inferior units that can cost over \$2,000!!

Cat. KJ 6621

\$449.00

400ms VERSION ONLY

**\$449**  
COMPLETE  
KIT



## 0-30V 1amp power supply

ETI 162  
Cat. KE4570

- Fully protected
  - Output variable from 0-30V DC
  - Selectable current limit
  - Both voltage and current metering
  - After a multimeter & soldering iron an absolute must for the enthusiast.
- You will never own a more useful piece of gear.

Ref: ET1  
December 1982

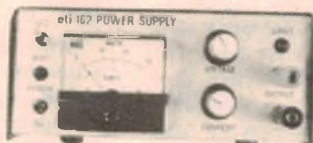

**\$49.50**

## LOW COST DIGITAL MULTIMETER KIT

Ref: EA March 1983 (This month)  
Almost everybody who asks for a multimeter kit, has used more or less thought that it was just not worth it, considering the low cost built-up units available. The DP2010 changed all that.

This kit, fully inspired from the UK uses the famous DPM-05 custom LCD/Vmeter to achieve unparalleled accuracy at very modest cost!

All parts are included to complete the meter including an attractive and colourful front panel. (A 9V battery is required)

Set of test probes to suit \$2.95  
Probe to suit Cat. WTS312 ONLY \$2.50  
Eveready 216 (red) 9V Battery Cat. SB2370 ONLY \$1.40



ONLY \$45

"LEARN ELECTRONICS AND END UP WITH A USEFUL PIECE OF TEST GEAR IN THE END"

AC VOLTAGE AND CURRENT RANGES when '3A' select a.c. functions the output from either the voltage attenuator or current shunt is fed through C1 to remove any d.c. component

DP2010 kit Cat. KJ7010 ONLY \$45

Function (d.c.)	f.s.d.	Resolution	Accuracy	Protection
Volts	20V	1mV	1% -1 digit	500V for
	200V	10mV	1% -1 digit	one minute
	500V	100mV	1% -1 digit	
	1000V	1V	1% -1 digit	
Current (d.c.)	2mA	100µA	1% -1 digit	1A/250V
	20mA	10µA	1% -1 digit	
	200mA	100µA	3% -1 digit	
	2000mA	1mA	5% -1 digit	
Volts (a.c.)	2V	1mV	2% -5 digit	500V for
	20V	10mV	2% -5 digit	one minute

Function (a.c.)	f.s.d.	Resolution	Accuracy	Protection
Current	200V	100mV	2% -5 digit	
	500V	1V	2% -5 digit	
	2mA	10µA	2% -5 digit	1A/250V
	20mA	100µA	2% -5 digit	
Resistance	2000mA	1mA	7% -5 digit	
	20K	1	1% -1 digit	260V
	200K	10	1% -1 digit	r.m.s.
	2000K	1K	1% -1 digit	
Diode Test	2V	1mV	1% -1 digit	260V r.m.s.

## Video Amplifier/Buffer

Ref: EA Aug 1983



Jiffy Box to suit HB-6003 \$2.20

The answer to a maddening prayer! This device can be made to fit inside a TV set (or in a separate box if necessary). It basically enables you to connect straight into the video drive of your TV, turning it into a colour monitor. This means that the video signal from your computer, VCR, TV game etc. does not need to be converted to RF and go through the TV IF strip. You will be amazed by the clearer, sharper signal that has less interference! Notes on how to fit to various TV sets are included. Cat. KA 1527 \$14.95

## minitune

Function	F.S.D.	Resolution	Accuracy
Voltage (d.c.)	20V	10mV	0.5% -1 digit
	200V	100mV	0.5% -1 digit
Resistance	200K	100mΩ	0.5% -1 digit
	20kΩ	10Ω	0.5% -1 digit
R.P.M.	20,000 r.p.m.	10 r.p.m.	1% -3 digits
Dwell	90°	0.1°	2% -3 digits

FAR CHEAPER THAN DPM SEPARATELY

**\$42.95**

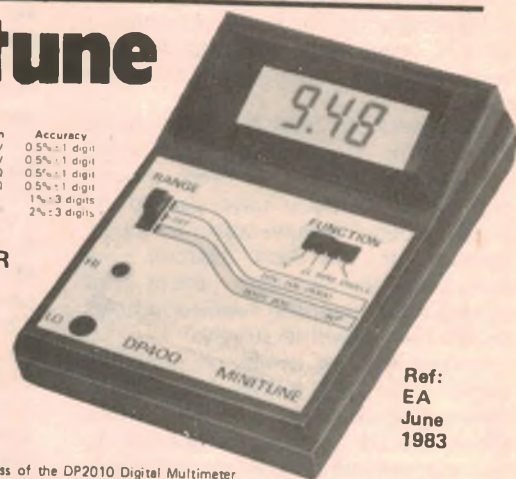

Ref: EA June 1983

Following the spectacular success of the DP2010 Digital Multimeter kit, we now have an ENGINE ANALYSER KIT! But the spectacular thing is the price! It is ACTUALLY CHEAPER than the DPM-05 Display and Case! The Minitune will measure voltage, resistance (down to a very low range), RPM and Dwell Angle.

Cat. KJ-7012

TEST LEADS TO SUIT ONLY \$2.95

\$42.85

## Touch Lamp Timer

Ref: EA Aug 1983

This project is very similar to the EA touch dimmer which has been very popular. Recently, you touch the wallplate and the light stays on for a predetermined amount of time. The same wallplate is used as the dimmer. The usual Jaycar kit contains quality components as originally specified including a quality RPM wallplate.

Cat. KA 1525

\$21.00



## BBD EFFECTS BOX

Fantastic low cost instrument using the versatile MN3001 Bucket Brigade Delay Line to achieve brilliant sonic effects. Now you can emulate the commercial rock groups with Phasing, Flanging, Reverb and Echo. The Jaycar kit includes all components INCLUDING IC sockets and the TU-04 box. (Not cut down but this is easily done). Jaycar has a specially built cabinet for this kit with all holes pre-punched etc., at only \$10 extra but only if you buy the original kit from us. Available as a separate item for \$29.50. WHEN THE KIT IS PURCHASED WITH THE DE-LUXE CASE THE TU-04 CASE WILL NOT BE SUPPLIED.

Special cabinet to suit \$10.00  
Cat. HB6445

COMPLETE KIT

Cat. KE1522 \$79.00



## TRANSISTOR ASSISTED IGNITION

Ref: EA Jan '83. Latest version of this popular kit. The Jaycar kit has a genuine die cast box as used in the EA prototype. Beware of others that use flimsy sheet metal.

Cat. KA1506 \$35



## "Fluoro Starter"

Ref: EA Oct 1982  
One of our most popular kits. Enables you to replace the electromechanical starter with an electronic one! The Fluoro starts up instantly without a flicker!

All electronic components supplied including high quality mains cap. (Fluoro starter case required)

**\$5**

Cat. KA-1480

## MICRON 30 WATT SOLDERING IRON

Cat. TS-1450

LIGHT WEIGHT FULLY S.E.C. TESTED & APPROVED



\$9.95

**SAVE A FORTUNE!**



# ENGINES - NO.1 FOR KITS

## EA Wideband AM Tuner

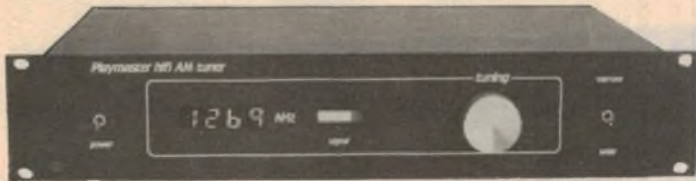

Australia is one of the few countries in the world where wideband AM is transmitted in fact a good quality AM signal can be much better than its FM counterpart!! Anyone who has suffered from FM multipath distortion will know what we mean. The Playmaster AM tuner is a true broadbandwidth superhet design. See the frequency response graph in November EA 1982. Once again, the Jaycar kit is a high quality approach. Jaycar supplies an exclusive front panel design that differs from the original EA design. The Jaycar kit provides all components to complete the project INCLUDING a completely pre-purchased cabinet.

K A-1498

FANTASTIC VALUE  
AT ONLY

**\$249**

Ref: EA Dec-Jan 82-83

**OUTSTANDING  
VALUE**

**FREE**  
ALIGNMENT KIT AND  
STEREO SIMULATOR  
WORTH ALMOST  
\$20

## "Blueprint" 5000 preamp



- FUNCTIONS**
- MOVING COIL INPUT
  - MOVING MAGNET (DYNAMIC CART)
  - INPUTS (2 OFF)
  - TUNER INPUT
  - AUX INPUTS (2 OFF)
  - TAPE INPUTS (2 OFF)
  - INPUT LEVEL CONTROL
  - TAPE OUTPUTS (2 OFF)
  - 400Hz CALIBRATION OSCILLATOR
  - LED AVERAGE (VU) & PEAK
  - LEVEL METERS -48dB to +9dB
- MODE SWITCH: STEREO BALANCE CONTROL LINE OUT MONITOR OUT MONITOR VOLUME CONTROL**

**\$299**

- FEATURES**
- EXTREMELY CLOSE TRACKING TO RIAA PHONO EQ
  - GOLD PLATED CONNECTORS ON ALL INPUTS
  - ENGLISH 'LORLIN' LOW NOISE SELECTOR SWITCHES
  - LOW NOISE 1% 500ppm METAL FILM RESISTORS USED
  - TINNED FIBREGLASS PCB
  - LOW CAPACITANCE SCREENED CABLE USED THROUGHOUT
  - QUALITY I.C. SOCKETS
  - SPECIAL REAR PANEL
  - MULTICOLOURED RECTANGULAR LED USED

## 5000 POWER AMPLIFIER



**BLACK MONOLITH**  
unbeatable  
value  
ONLY \$319

## 5000 SERIES GRAPHIC EQUALISERS



**\$199  
each**

**ECIFICATIONS:**  
Signal-to-Noise - 100dB with respect to 1 Volt  
Frequency Response - 12Hz - 20kHz to -1dB Band/Cut 1400 (20dB)  
Distortion: 100Hz - 0.05% 1kHz - 0.007% 10kHz - 0.008% (essentially irrespective of cut or boost)  
Current consumption (DC) - 100mA at 2.5V (Requires 30V AC CT) Output short-circuit proof.

**AUSTRALIAN (NOT HONG KONG) MADE - SPECIAL BUILT RACK CABINET - QUALITY**

## FULL ROAD QUALITY 1/3 OCTAVE EQUALISER



**OUR PRICE \$199**

**SPECIAL LOW PRICE FOR OCTOBER**  
We have decided to discontinue the 2801 Mk111 that has RCA sockets fitted on the back. The 2801 has ETI 5000 Electronics standard 150 1/3rd octave frequency centres & a 240V power supply. (After October the 2801 Mk111 will only be available with professional Canon connectors). You can save money in October by purchasing the unit and fitting Canons yourself. There is no other difference.  
Cat. KJ6530 Normally \$225.00  
October ONLY \$199 - SAVE \$26!!

## Syntom



KJ-6502

**\$36.50**

Original design from the UK magazine "Electronics and Music Maker" April 1981. Self-contained unit produces a variety of fixed and falling pitch effects. Trigger by tapping the unit itself or by striking a drum to which the unit is attached. The Jaycar "SYNTOM" comes complete with high quality predrilled moulded all ABS box 152 x 80 x 47mm with professional silk-screened front panel.  
**FEATURES:** Decay from less than 0.1 second to several seconds, pitch control, sweep control and volume on/off.

### Polyphonic Organ

Ref: ETI Jan 1983  
Here at last! This very popular kit is now in stock.  
\* "Touch Sensitive" P.C.B. keyboard \* Fully Polyphonic \* Two voices \* 25 notes, 2 octaves \* Can operate from battery or pluckup. (Case not included) ONLY \$49.50  
**KE-4652**

### ETI 330 Car Alarm

Ref: ETI July 1981  
This unique design detects the voltage drop that occurs across the strap that connects the engine block to the chassis. It does not use wiring inside the car where false triggering can take place. Kit comes complete with all components and metal work (die cast box) **KE-4105 \$29.50**

## EA dual tracking P/S

Ref: EA March 1982  
One of our most popular kits!! Can provide dual voltages (+) from 1.3V to 22V at up to 2 AMPS. In addition the supply features a fixed +5V @ 0.9A. The output is protected against short circuits, overloads and thermal runaway  
ONLY \$89 COMPLETE **KA-1410**



## 500MHz Digital Frequency Period Meter

ONLY \$119



Ref: EA Dec '81 - Feb '82  
Jaycar has by far the best kit version of this project in Australia. We now supply 2 x GOLD plated BNC input connectors at no extra cost!  
Cat. KA1390 \$119 (50MHz Version)  
Cat. KA1392 \$26 (500MHz option)

### ETI 581 POWER SUPPLY

ONE OF OUR MOST POPULAR KITS  
This inexpensive kit gives you a regulated +/-15V at 500mA.  
All components including power transformer mount on the component PCB.  
Cat. KE-4405 \$17.50



## Jaycar Incorporating ELECTRONIC AGENCIES

**SYDNEY SHOWROOMS**  
125 & 117 YORK STREET - PHONE (02) 264 6688 and (02) 267 1614  
TELEX: 72293

**CARLINGFORD**  
Cnr. CARLINGFORD & PENNANT HILLS ROAD - PHONE: (02) 872 4444

**CONCORD**  
115 - 117 PARRAMATTA ROAD - PHONE (02) 745 3077

**HURSTVILLE** 121 FOREST ROAD - PHONE (02) 570 7000

### NUMBER 1 FOR KITS

POST AND PACKING CHARGES  
\$5 - \$9.99 (\$1.50) \$10 - \$24.99 (\$3.20)  
\$25 - \$49.99 (\$4.50) \$50 - \$99.99 (\$6.50)  
\$100 - \$198 (\$8.00) Over \$199 (\$10)

\*Free INSURANCE for Road & Registered Post over \$200!  
All heavy or bulky items (over 20kg) sent Comat Road Freight \$12.00 anywhere in Australia.  
SHOP HOURS CARLINGFORD, CONCORD & HURSTVILLE  
Mon - Fri 9am - 5.30pm Sat - 9am - 12pm Thurs night 8.30pm  
SHOP HOURS SYDNEY  
Mon - Fri 8.30am - 5.30pm Sat - 8.30am - 12pm Thurs night 8.30pm  
MAIL ORDERS AND CORRESPONDENCE: BOX K 39 HAYMARKET, SYDNEY 2000



Mail Order



BANKCARD

Via Your Phone

# Video Enhancer

by JEFF SKEEN & NEVILLE WILLIAMS

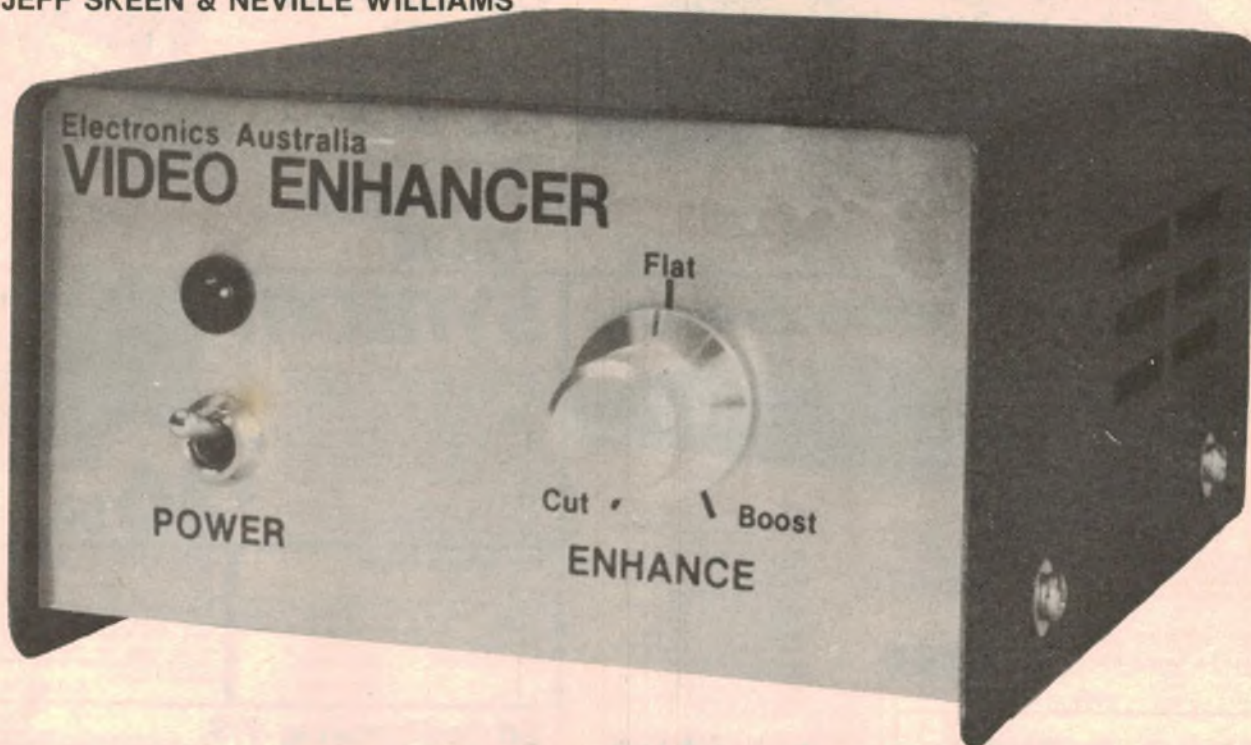

Here's an opportunity for video enthusiasts to acquire a simple but effective build-it-yourself video enhancer for a fraction of what a commercial model might cost. But first: what are enhancers supposed to do and how do they work? Well, read on:

At the outset, we should put to rest the fiction that video enhancers are some kind of magic cure-all for a whole range of picture problems. They aren't! Like the tone controls in a hifi amplifier, they are meant simply to "touch up" the signal after things elsewhere in the system have been put right.

If the off-air pictures on your TV screen are consistently "noisy" or "grainy", or spoiled by "ghosting", you either live in a very poor area for TV reception, or you need a better antenna system. To install an enhancer, while ignoring the antenna, is very definitely putting the cart before the horse!

Again, if the pictures from your VCR frequently roll, or bend, or wobble, the chances are that your receiver needs to be modified internally to allow it to lock more effectively to the synchronising signals from a VCR. Either that, or the VCR may need attention for dirty or worn heads. Get those matters checked first.

The basic role of an enhancer is —

where possible — to effect a further (and usually modest) improvement in the visual appeal of the on-screen picture. Most commonly, this means making the image more "crisp" by sharpening the outlines and, perhaps, slightly increasing contrast and colour content. Occasionally, it may mean "softening" the picture with the idea of reducing the "grain" or "noise".

In principle, enhancers achieve the foregoing effects by modifying the frequency content of the video signals passing through them.

Selectively boosting frequencies within

the range from about 1 to 4MHz tends to emphasise picture contrast and outline, usually with an attendant increase in noise content. Attenuating the same range of frequencies has the reverse effect. In between, it is usual to provide for a flat-response, unity-gain condition, where the enhancer is virtually passive, and where the picture can be seen "au naturel" for the sake of comparison.

In practice, the amount of high frequency boost which can be applied to a video signal is usually quite limited, especially where the signal has already been "peaked up" before transmission or

## SPECIFICATIONS

Signal to noise ratio	—50dB ref 1Vp-p
Frequency response (flat setting)	1 Hz to 6.5MHz —3dB
Boost and cut range	see graph
Gain	0dB
Input impedance	82Ω
Output impedance	68Ω

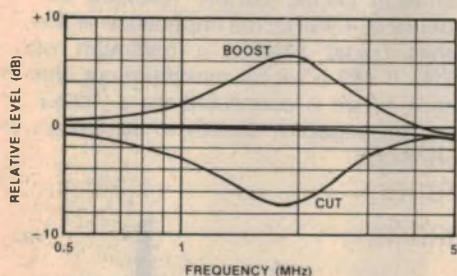
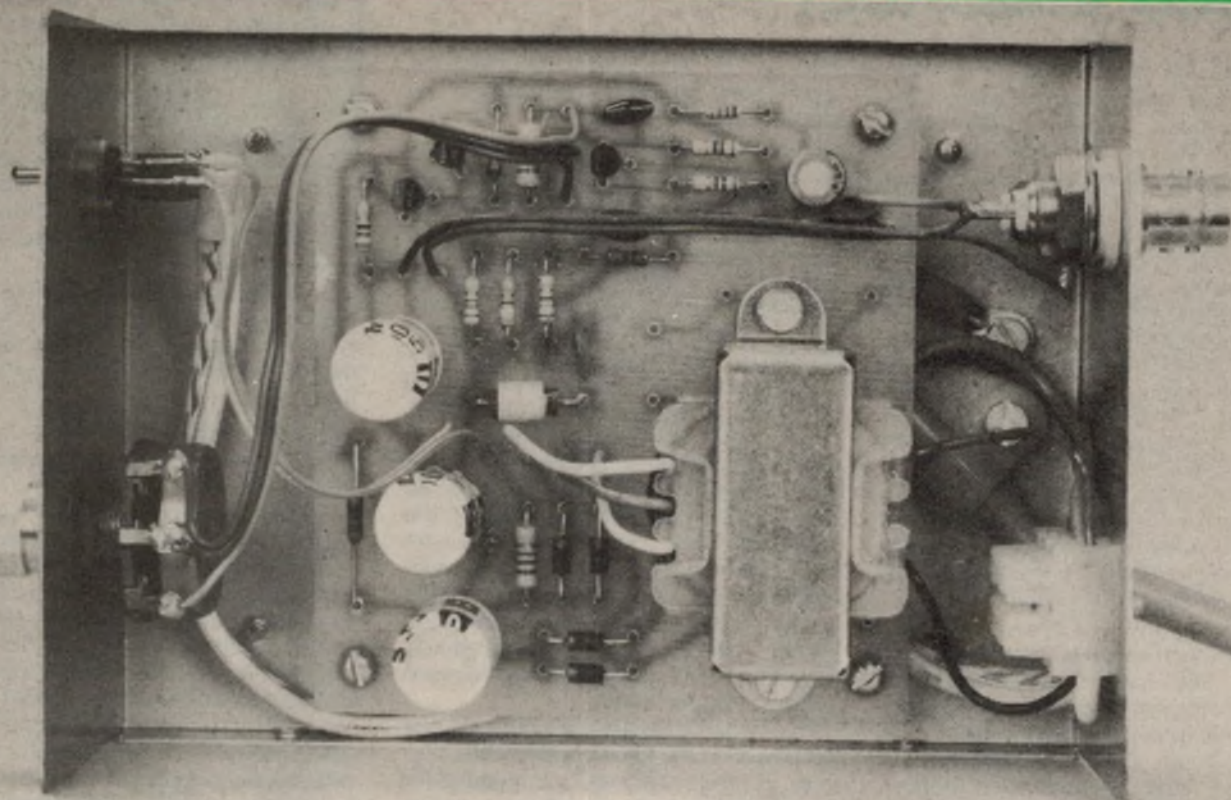

This graph shows the amount of boost and cut available with the enhancer.

before recording on tape. More than about 4 to 5dB of boost is likely to produce an unacceptable increase in noise, or to produce halo effects, with white edges around dark objects, and vice versa. In more technical terms, this would be described as video "overshoot" or "ringing".

Amongst video enthusiasts, enhancers are most commonly used in the following situations:

- Between a home video camera and a VCR. For this purpose, an enhancer needs to be easy to use, as light and compact as possible, and fitted with a socket and plug which allows it to be inserted straight into the camera cable link. Physically and electrically, this is a special case.
- In the video link between two domestic VCRs for purposes of editing or copying from an existing video cassette – legally or otherwise!
- Between a VCR and a TV receiver or

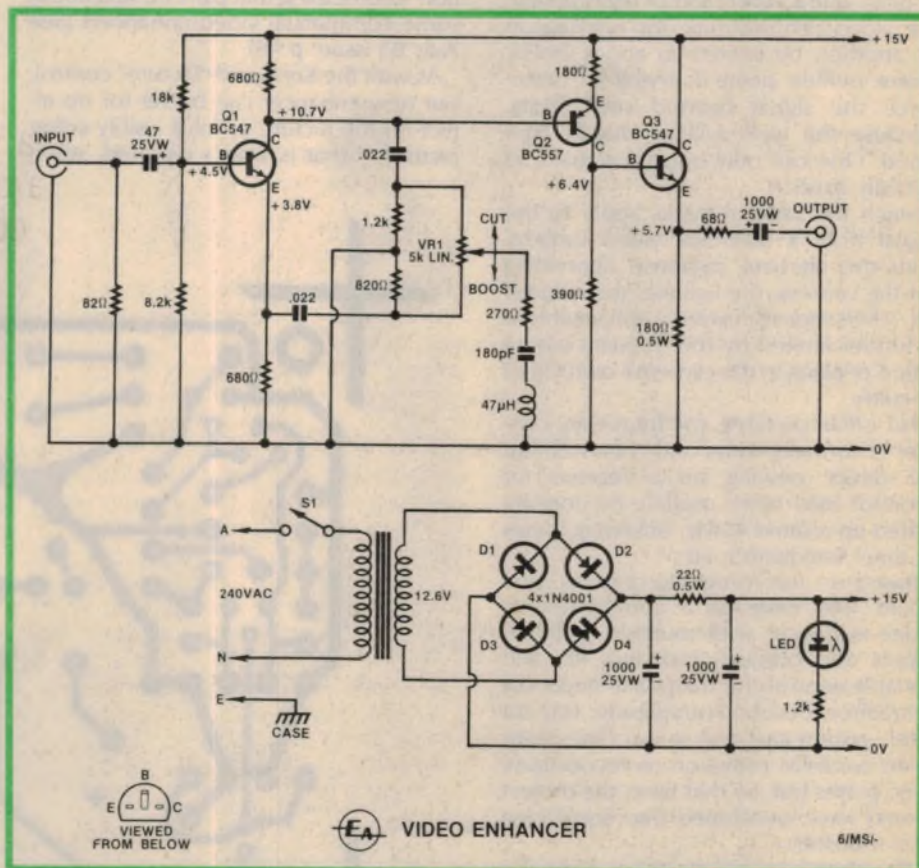

monitor, with the idea of obtaining the sharpest looking pictures from video cassettes.

- Between a TV tuner, or a VCR used as

a tuner, and a jumbo screen receiver or monitor, to sharpen all images, whether from cassette or off-air.

If domestic TV receivers had all been

# Video Enhancer

provided with sockets for direct video signal input, the design of enhancers would have been considerably simplified. They could simply have been provided with video input and output sockets (BNC or RCA) and coupled directly into any of the above situations, without further ado.

In fact, most TV receivers to date have had provision only for "RF" input via the antenna terminal. They therefore cannot be fed directly from an enhancer unless it incorporates — or is used in conjunction with — an RF modulator which will provide a composite video/audio signal in an unused TV channel.

Without such a modulator, a video enhancer can be used only between a VCR and monitor, between two VCRs, or between a camera and VCR (if it can be accommodated conveniently).

A further consideration is that video response of an enhancer needs to be optimised, not just in relation to the amount of boost or cut, but the frequency around which it is concentrated.

For example, the video signal from a domestic VCR is unlikely to contain much information beyond about 3MHz at best; with a visibly soft or fuzzy image, the video content may, for one reason or another, be limited to about 2MHz. There is little point in trying to brute-force the signal beyond such limits, because the yield will be mainly tape noise. One can only boost a signal that actually exists!

Much the same remarks apply to the signal from a domestic video camera, with the ultimate response depending on the camera, the lighting, the subject, etc. The scope for external enhancement is further limited by the frequent use of video peaking in the camera's own video circuitry.

For off-air pictures, the frequency content is normally wider and enhancement for direct viewing on a receiver or monitor may more usefully be concentrated up around 4MHz, offsetting losses in tuner bandwidth, etc.

Based on the foregoing remarks, one could well envisage a comprehensive video enhancer with multiple switched inputs and outputs, including RF, and variable controls for things like boost/cut frequency, boost/cut amplitude, top cut filter, system gain and so on. One might even consider provision to reconstitute sync pulses but, by that time, the project would have developed into something of a monster.

This time around, we have kept the design right down to basics, with no RF modulator and a single video and output circuit. The gain is unity when fed from and into 70-ohm circuits, and the

response is substantially flat over the whole band when the control is in the physical centre position.

In practice, there are few modulator designs which do not cause a significant loss in video information at frequencies of 2MHz or more. So in a sense, feeding signals through an enhancer and then via a modulator is an exercise in frustration. Significantly those enhancers we have seen which did have an internal modulator were not very effective.

We envisage that the enhancer will be used mainly between two VCRs or between a VCR and a monitor and that its main task will be to sharpen-up images from cassettes which can obviously do with such treatment. That being the case, we have arranged the resonant boost/cut network to have its maximum effect around 2MHz, where there should always be some signal to work with. Above 2MHz, the response gradually reverts to normal, minimising the need for an additional filter.

The basic philosophy is similar to that employed in the Kenwood KVA-502 "Picture" control, which we commended for its straightforward, unambiguous operation — something that can't be said about some commercial video enhancers (See Aug '83 issue, p 46).

As with the Kenwood "Picture" control, our new enhancer can be set for no effect on the picture or for a visibly softer picture, if that is what's required. Alter-

We estimate that the current cost of parts for this project is approximately

**\$35.00**

This includes sales tax

natively, turning the control clockwise beyond centre position allows the outlines to be sharpened to just short of video over-shoot.

If you want to experiment, it is possible to shift the frequency of the resonant circuit by changing one component, as mentioned later. But let's now look at the project in detail:

## How the circuit works

Refer now to the circuit diagram. Q1 is connected as a common-emitter amplifier with a nominal gain of one set by the ratio of the collector impedance to the emitter impedance. The network associated with VR1 varies this collector-to-emitter impedance ratio and produces either boost or cut of the higher frequencies in the video waveform, depending on the setting of VR1.

A series resonant circuit composed of a 270Ω resistor, 180pF capacitor and a 47μH coil connected to the wiper of VR1 forms the heart of the boost-cut (or enhance) circuit. At the resonant frequency of 1.9MHz, the impedance of the series circuit reaches a minimum of 270Ω. If VR1 is set for maximum cut, the series circuit is connected via a .022μF coupling capacitor directly to the collector of Q1.

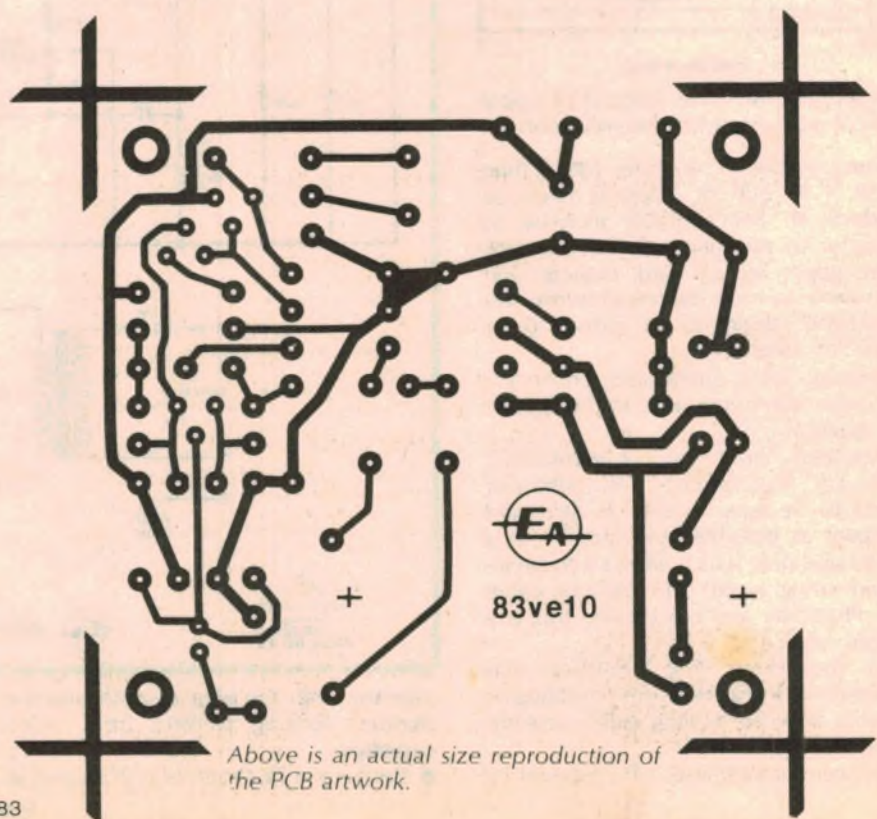

Above is an actual size reproduction of the PCB artwork.

# TRIO – Still the Best Scopes for Value and Performance

## 100MHz, 4 Channels, 8 Traces. 1mV Sensitivity!

For applications requiring the highest degree of measurement sophistication, TRIO offers the new 100MHz CS-2100A. A second generation design with a new level of performance and reliability. It brings ultra-high performance standards and a vast array of features into one efficient package. This new scope represents the state-of-the-art and features a rugged industrial construction. As a result, the CS-2100A is efficient, light-weight and highly reliable.

- 100MHz response and 3.5ns rise time
- 120MHz response at -6dB
- 500µV/Division cascade sensitivity
- 2ns/division sweep rate with 10x magnifier
- Four-input operation provides trigger views or four separate inputs
- Selectable 1MΩ or 50Ω inputs
- Alternate timebase operation
- 20MHz bandwidth limiter for best view of low frequency signals
- Lighted function pushbuttons
- Voltage and current probe calibrators
- 8 x 10cm internal graticule CRT
- Video sync separator standard
- Dual intensity controls

CS 2100A

**\$2,495\***

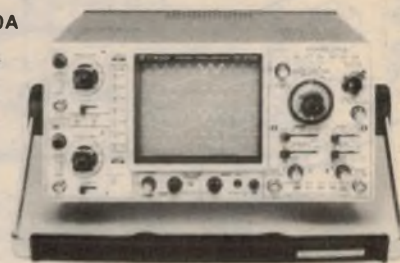

## 70MHz 4 Channel, 8 Trace, 1mV Sensitivity Scope at a 60MHz Price!

The new TRIO Model CS-2070 is a cost-effective full-feature portable lab scope. Having many of the important capabilities of the CS-2100A, the CS-2070 comes more feature-packed than most other scopes in its bandwidth class — and it offers higher performance.

- 1mV/division sensitivity to 70MHz
- 500µV/division cascade sensitivity
- Four-input operation provides trigger view on four separate inputs
- Alternate time base operation
- 20MHz bandwidth limiter
- Lighted function pushbuttons

CS 2070

**\$1,795\***



## An Ideal Scope for Video and Computer Companies! 60 or 40 MHz and mV Sensitivity

The CS-1060 or 1040 should be your choice for microprocessor system development and troubleshooting. Broadcast studio applications. Monitoring RF waveforms. Monitoring digital data transmission. Logic and digital design work. Measuring propagation delays and phase shifts. Troubleshooting and maintaining video systems. Comparing amplifier input-output waveforms and displaying algebraic difference as a distortion curve.

- 60MHz 3 channel, 40MHz 3 channel
- 1mV/cm input sensitivity
- 150mm rectangular CRT with 16KV accelerator (12KV for 1040)
- Three channel six-trace capability
- High-speed signals are easily seen on 5ns/div sweep rate
- Automatic synchronising of video signals using a special video signal clamping function
- Unique delay sweep function provides simultaneous starting of both A and B sweeps, besides the normal continuous sweep and trigger delay functions

CS 1060

**\$1,495\***



## Our Most Popular Model — and Still the Best Value Available!

Used extensively by educational institutions, hobbyists and by industry, the TRIO CS-1560AII has gained an enviable record for dependability. A record unsurpassed by any other scope in its class. Truly your first choice for a workhorse oscilloscope. A reliable scope that will stand by you in even the toughest conditions.

- Sensitivity 10mV Div. (Triggers at 0.5 Div. Typ.)
- CH1, CH2, DUAL, ADD and SUB
- Risetime 23ns
- XY Mode
- Triggered Sweep and Auto
- Sweep time 0.5µs Div. - 0.5S Div. and XY

CS 1560AII

**\$545\***



Over 2,000 Sold

## For Those Who Require the Extra Capability of a 20MHz Scope at a Reasonable Price

The CS-1022 has that extra punch needed for engineering design work. Its 20MHz bandwidth and 1mV/div sensitivity make it ideal for microprocessor, digital data, broadcast, RF and IF system design work. All performance features are geared for maximum flexibility and convenience.

- Illuminated inner-face graticule 150 mm rectangular CRT (6KV)
- Maximum sensitivity 1mV/div (DC-10MHz)
- Maximum sweep speed 20ns/div (X10MAG)
- Maximum accuracy ±3% (voltage and time axis 0-40°C) guaranteed
- New video sync circuit requires no troublesome trigger setup
- 8-division dynamic range
- Vertical signal output (CH1 output)

CS 1022

**\$649\***



## Capture Those Unpredictable One-Time Events!

The MS-1650B captures one-time or otherwise unpredictable events, stores them in a digital memory, and instantaneously reproduces them as analog waveforms on a CRT display screen. In combination with the MU-1651 memory unit, represents a powerful and versatile waveform recording and analysis tool.

- Simple storage and display of transients
- 1024 byte memory
- 1µs write time
- Conventional 10MHz oscilloscope mode
- Immediate display of stored waveform
- Can capture waveform prior to trigger signal
- Digital data output capability

**\$3,195\***

“DIGITAL STORAGE”

MS 1650B

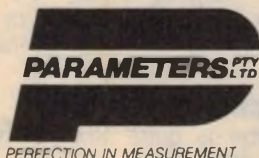

Sydney: (02) 439 3288. Melbourne: (03) 580 7444  
 Adelaide: PROTRONICS (08) 212 3111. TRIO ELECTRIX (08) 51 6718. K. D. FISHER (08) 277 3288. Brisbane: ST LUCIA ELECTRONICS (07) 52 3547. L. E. BOUGHEN (07) 369 1277. Cairns: THOMPSON INSTRUMENT SERVICES (070) 51 2404. Canberra: GEORGE BROWN (062) 80 4355. ORTEX (062) 80 5283. Hobart: IMBROS (002) 34 9899. GEORGE HARVEY (002) 34 2233. Launceston: GEORGE HARVEY (003) 31 6533. Melbourne: RADIO PARTS (03) 329 7888. BROWNTRONICS (03) 419 3355. ELLISTRONICS (03) 602 3282. Newcastle: D. G. E. SYSTEMS (049) 69 1625. GEORGE BROWN (049) 69 6399. Perth: W. J. MONCREIFF (09) 325 5277. PROTRONICS (09) 362 1044. Rockhampton: PURELY ELECTRONICS (079) 2 1058. Sydney: GEORGE BROWN & CO (02) 519 5855. DAVID REID ELECTRONICS (02) 267 1385. Townsville: NORTEK (077) 79 8600. Wollongong: MACELEC (042) 29 1455.

\* All prices plus sales tax if applicable. Prices do not include probes.

Inc. in Victoria

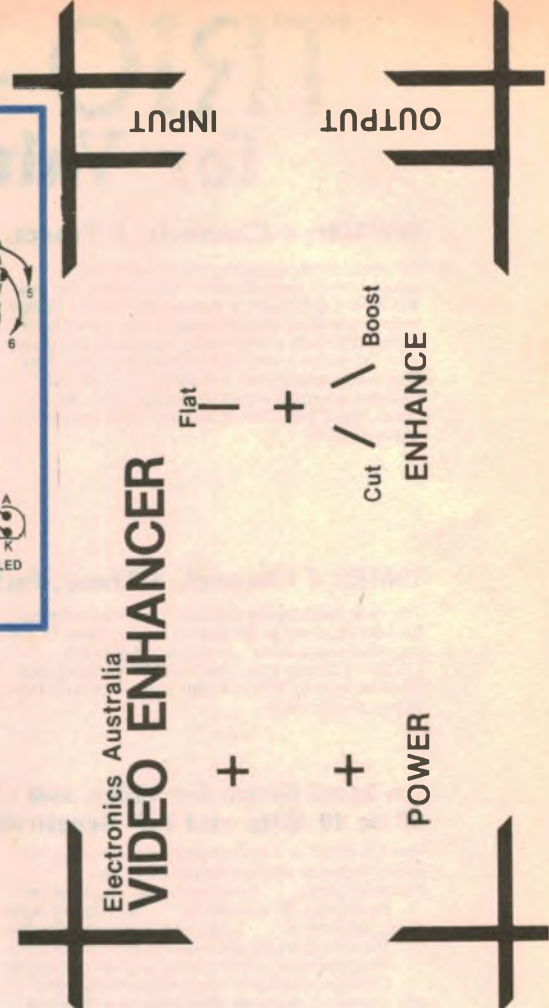
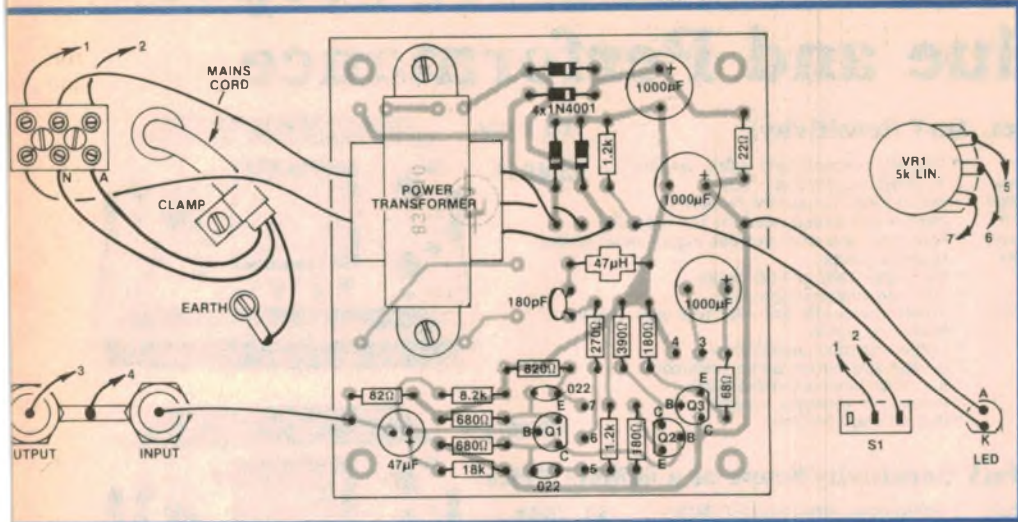

# Video Enhancer

The AC load seen by the collector of Q1 is now reduced because of the low shunting impedance of the resonant circuit. Neglecting secondary effects, the impedance seen at Q1's collector is  $270 \parallel 680 \parallel 1200 = 166\Omega$ . The impedance at Q1's emitter is  $680 \parallel 820 = 166\Omega$ . The ratio of these to impedances sets the gain of the stage at  $166/372 = 0.446$ . This gives a maximum cut of  $-7\text{dB}$ .

When VR1 is set to maximum boost, the series resonant circuit is connected via a  $.022\mu\text{F}$  capacitor to the emitter of Q1. This sets the impedance seen by the emitter of Q1 at  $680 \parallel 820 \parallel 270 = 156\Omega$ . The corresponding impedance seen at the collector of Q1 is  $680 \parallel 1200 = 434\Omega$ . This sets the gain of the stage to  $434/156 = 2.78$  and gives a maximum boost of  $8.9\text{dB}$ .

Any amount of boost or cut between the above limits may be selected by an appropriate setting of VR1. Due to secondary effects such as collector capacitance, the load seen by Q1's collector is in practice lower than we have calculated. This reduces the maximum boost by about 2dB and increases the maximum cut by about 0.6dB.

The non-uniform loading on the collector and emitter of Q1 from secondary effects shifts the "flat" setting of VR1 away from the centre position of the potentiometer. The  $1.2\text{k}\Omega$  and  $820\Omega$  resistors connected between the ends of VR1 and ground compensate for the uneven

loading and shift the "flat" position of VR1 back to the centre of the potentiometer.

Since the impedance of the series resonant circuit rises as the signal frequency moves away from resonance, the amount of boost or cut will be decreased at frequencies away from resonance. The circuit response therefore shows a peak (or dip) which decays away slowly back to the 0dB level.

Following Q1 is a second common emitter amplifier consisting of Q2 and the  $180\Omega$  and  $390\Omega$  resistors. This stage provides an additional fixed gain of around two which is required for the following stage, as we shall see shortly.

The output of the second stage is directly coupled into the third stage which is an emitter follower based around Q3. This stage acts as a buffer between the high impedance amplifying stages and the low impedance input of a VCR or television monitor.

The signal from the emitter follower is coupled via a  $68\Omega$  resistor and  $1000\mu\text{F}$  capacitor to the output of the video enhancer. The capacitor AC-couples the signal so that DC bias conditions in the third stage will not be changed by the connection of a load impedance.

The  $68\Omega$  resistor in series with the output serves two purposes. First, it provides rough matching for the  $75\text{-ohm}$  input impedance of most VCRs. Second, it protects the output stage against short-circuits.

As with any such matching arrangement, there is a signal loss of 50%. To compensate for this loss, Q2 provides a gain of two, as mentioned previously.

Note also that the input to the enhancer circuit is loaded with an  $82\Omega$  resistor and this gives rough matching to the output signal from a VCR or video

Actual size front and rear panel artwork.

camera. Power for the video enhancer is provided by a 12V centre-tapped transformer. The transformer output voltage is full wave rectified by diodes D1 to D4 and the resulting DC filtered by the first  $1000\mu\text{F}$  capacitor. An RC filter network consisting of the  $22\Omega$   $\frac{1}{2}\text{W}$  resistor and the second  $1000\mu\text{F}$  capacitor provides further supply filtering and results in a supply of 15VDC with about 15mV of ripple.

Power on-off indication is provided by the red light emitting diode (LED) connected to the enhancer power supply.

The frequency at which we have centred our boost and cut circuit gives the best result for enhancement of typical VCR playback signals. In some cases where the signal is of a higher quality (ie, greater bandwidth) the optimum frequency for enhancement will be higher. Table 1 shows the value of capacitance required in the series resonant circuit to achieve a particular centre frequency for boost and cut.

Note that changing the capacitance in the series resonant circuit will not change the amount of boost or cut available, only the frequency at which it occurs.

## Construction

Construction is quite straightforward with most parts being mounted on a

**Table 1. Peak frequency versus series resonant capacitor**

Capacitor	Frequency
180pF	1.9MHz
100pF	2.2MHz
82pF	2.5MHz
56pF	2.9MHz

small printed circuit board (PCB) coded 83ve10 and measuring 90 x 85mm. Follow the layout diagram when mounting parts on the PCB and take particular care with polarised components. These include the transistors, diodes and electrolytic capacitors.

The PCB is mounted in a small metal instrument case measuring 150 x 103 x 61mm (L x W x H). Four 9mm tapped brass spacers are used to support the PCB and hold it clear of the case.

Holes for the BNC sockets, the terminal block and the mains cable entry point are now marked out and drilled in the back panel. Remember to fit the insulating washers to the BNC sockets and a grommet to the mains cable entry hole.

The mains cable is now inserted through the grommet and suitable locations marked out for the cable clamp and earth lug mounting holes. These holes should be drilled and then the Scotchcal label stuck to the front panel of the case. The Scotchcal label may now be used as a guide for locations of the front panel mounting holes.

Install the components on the front panel and then complete the wiring according to the wiring diagram. Note that 240VAC rated cable must be used for the wiring between the mains switch and the terminal block. If a PCB mounting

transformer is used, 240VAC rated cable is also required between the terminal block and the transformer primary input on the PCB.

With construction completed, go over the unit and check for possible wiring errors. In particular, check that the mains wiring is correct and that the job is done in a workmanlike manner. The switch terminals should be sleeved with plastic

tubing to prevent the possibility of electric shock.

Finally, some people may wish to run two VCRs or maybe one VCR and one television monitor from the output of the video enhancer. To do this just substitute a 39Ω resistor for the 68Ω output resistor and add a second BNC socket in parallel with the existing output socket.

## PARTS LIST

- 1 Instrument case, 150 x 103 x 61mm (L x W x H)
- 1 PCB, code 83ve10, 90 x 85mm
- 1 Scotchcal front panel, 111 x 55mm
- 1 12V centre tapped transformer, AL7VA/12, PL/2/5VA or PF2851
- 1 SPST 240VAC rated toggle switch
- 1 mounting bezel to suit light emitting diode
- 2 insulated BNC panel mounting sockets
- 1 3-way mains terminal block
- 1 mains lead and plug
- 1 grommet to suit mains lead
- 1 cable clamp to suit mains lead
- 1 solder lug
- 4 9mm tapped PCB standoffs
- ½ metre 240VAC rated mains hookup wire
- ½ metre 3-way ribbon cable
- 1 front panel knob

10 sets of nuts and bolts for mounting hardware

1 47μH RF choke

### SEMICONDUCTORS

4 1N4001 diodes

2 BC547 NPN transistors

1 BC557 PNP transistor

1 red light-emitting diode

### CAPACITORS

3 1000μF 25VW PC mount electrolytics

1 47μF 25VW PC mount electrolytic

2 .022μF greencaps

1 180pF ceramic

### RESISTORS (¼W, 5% unless stated)

1 x 18kΩ, 1 x 8.2kΩ, 2 x 1.2kΩ, 1 x 820Ω, 2 x 680Ω, 1 x 390Ω, 1 x 270Ω, 1 x 180Ω, 1 x 180Ω ½W, 1 x 82Ω, 1 x 68Ω, 1 x 22Ω ½W, 1 5kΩ linear potentiometer.

# PULSAR

ELECTRONICS PTY. LTD.



#### Hardware includes:

- Z80A (4MHz)
- 64K RAM
- Floppy disk controller for up to 4 x 8 or 5 25 inch disk drives (2.6 Mb)
- 2 x RS232C I/O ports
- Battery backed real time clock and calendar
- 2K monitor eprom
- STD BUS
- CP/M Distribution disk includes:
  - Source listing of Bios, loader and bootstrap and utilities

#### Users Manual provides:

- Detailed description of LBB operations.
- Circuit diagrams of LBB
- Setup procedure for various disk drives.
- Functions of Monitor Eprom
- Block diagram of LBB operations.

#### Available from:

- Avtex Electronics (02) 267 8777
- Sheridan Electronics (02) 699 5922
- Promark Electronics (02) 439 6477
- Ellitronics (03) 561 5844
- Macgraths (03) 347 1122
- Ritronics Wholesale (03) 489 8131
- Stewart Electronics (03) 543 3733
- Baltec Systems (07) 369 5900
- Rover Engineering (071) 43 5918
- Steve's Communications (062) 80 4339

Assembled & Tested

**\$750**

Kit No. 1 with:

- PCB
- Users Manual
- Monitor Eprom
- Setup Sheet

**\$134**

Kit No. 2 with:

- Kit No. 1 and
- all components

**\$440**

CP/M 2.2

**\$150**

PLUS SALES TAX

Designed and Manufactured by:

## PULSAR ELECTRONICS

Lot 2 Melrose Drive  
Tullamarine  
Victoria, 3043  
Australia

(03) 330 2555





ALTRONICS • BANKCARD JETSERVICE DELIVERY NEXT DAY • ALTRONICS • ALTRONICS

**DELUXE ABS INSTRUMENT CASE**

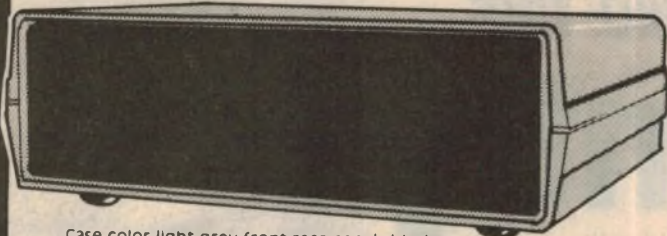

Case color light grey front-rear panels black

Our superb new instrument case will give your projects the professional appearance they deserve.

- \* Internal mounting posts enable a wide combination of PCB's, Transformers, etc. to be accommodated (screws supplied).
- \* PCB guide rails provided internally allow vertical PCB positioning to several locations.
- \* Removable front and rear panels. Attractive textured finish one side and plain the reverse side. (Enables direct engraving, silk screen printing etc. to plain side.)
- \* Great for test instruments and other high grade projects.

Overall Size: 200W x 160D x 70mmH

HO480 ..... only **\$13.50** ..... 10 UP **\$11.50**

**OEM'S — Manufacturers — Bulk Users:** Your product will look like it's straight out of "Hewlett Packard's" factory with this brilliant low cost case. Contact our Wholesale Department for Bulk Prices.

**ALARM CONTROL MODULE**

**EASY TO INSTALL ★ BUILT IN SIREN DRIVER — DIRECTLY DRIVES LOW COST 8 OHM HORN SPEAKERS, SIREN HORNS AND MECHANICAL BELLS ★ LOW POWER 12V DC OPERATION.**

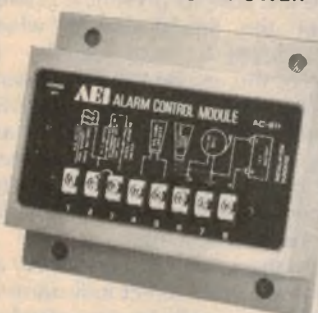

The AC-811 is a low cost professional burglary protection system which detects the presence of an intruder who breaks into your home, office or business. The system also allows connection of emergency panic buttons, wall vibration switches, smoke and heat sensors, as well as freezing or flooding detectors to form a complete protection system.

**EXIT / ENTRY DELAY BOTH N/C AND N/O CONTACTS**  
**Ideal for homes, offices, factories, shops, caravans, any area requiring protection.**

S5042. Only **\$39.50**

**LOW COST WEATHERPROOF HORN SPEAKER**

**5 WATT 8 OHM**  
 Fully weatherproof. New unique voice coil construction ensures high dependability on full drive. Suitable for PA intercom and security systems etc.



C2010 ..... **\$9.50**  
 10 Up ..... **\$8.90**

**FULLY ENCAPSULATED REED SWITCH & MAGNET SETS**

Powerful Magnet Self Adhesive or Screen Mount.

N/C Reed & Magnet  
 S5055 ..... **\$2.50**  
 10 up ..... **\$2.10**

N/O Reed & Magnet  
 S5056 ..... **\$2.95**  
 10 up ..... **\$2.75**

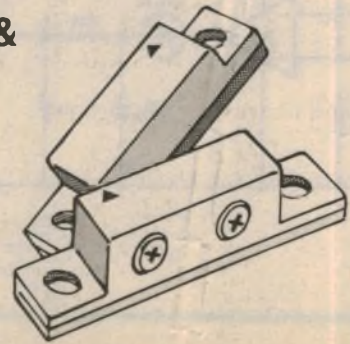

**ALTRONICS RESELLERS**

Please note that resellers may not have all the items advertised in stock, and as resellers have to bear the cost of freight, prices may be slightly higher than advertised. ALTRONICS reseller prices should however represent a considerable saving over our competitors' prices.

<b>VICTORIA</b>	<b>NEW SOUTH WALES</b>	<b>QUEENSLAND</b>
<b>CITY</b>	<b>CITY</b>	<b>CITY</b>
All Electronic Components 662 3506	Avtek Electronics 267 8777	Delsound PIL 229 6155
Ellitronics 602 3499	David Reid Electronics 267 1385	<b>SUBURBAN</b>
MacGrath's Electronics 347 1122	Electronic Agencies 29 2098	<b>BIRKDALE</b>
<b>SUBURBAN</b>	Jaycar 264 6688	Wholesale Sound Accessories 207 2502
<b>BENTLEIGH</b>	Radio Despatch 211 0191	<b>FORTITUDE VALLEY</b>
Absolute Electronics 557 3971	<b>SUBURBAN CONCORD</b>	St Lucia Electronics 52 3547
<b>BOX HILL SOUTH</b>	Electronic Agencies 745 3077	<b>PADDINGTON</b>
Eastern Communications 288 3107	<b>DEE WHY</b>	ECO Technics 369 1474
<b>CHELTENHAM</b>	David Ryall Electronics 982 7500	<b>SALISBURY</b>
Talking Electronics 550 2386	<b>LEWISHAM</b>	Colourview Wholesale 275 3188
<b>DANDENONG</b>	PrePak Electronics 569 9770	<b>SLACKS CREEK</b>
Bilico Electronics 791 8655	<b>MATTRAVILLE</b>	David Hall Electronics 208 8808
<b>FOOTSCRAY</b>	Creative Electronics 666 4000	<b>COUNTRY</b>
Acron Electronics 689 1911	<b>COUNTRY ALBURY</b>	<b>CAIRNS</b>
<b>SOUTH CROYDEN</b>	Webb's Electronics 25 4066	Thompson Instrument Services 51 2404
Truscott Electronics 723 3860	<b>BATHURST</b>	<b>GLADSTONE</b>
<b>COUNTRY</b>	Sound of Music 31 4421	Purley Electronics 72 4321
<b>BENDIGO</b>	<b>BROKEN HILL</b>	<b>IPSWICH</b>
Lindrea & Johnson 41 1411	Crystal TV 4803	P & P Electronics 281 8001
<b>MILDURA</b>	<b>COFFS HARBOUR</b>	<b>NAMBOUR</b>
Electronic and Digital Services 23 3380	Coffs Harbour Electronics 52 5684	Nambour Electronics 41 1604
<b>SHEPPARTON</b>	<b>GOSFORD</b>	<b>PALM BEACH</b>
GV Electronics 21 8866	Tomorrows Electronics 24 7246	The Electronics Centre 34 1248
<b>ACT</b>	<b>KURRI KURRI</b>	<b>ROCKHAMPTON</b>
<b>CITY</b>	Kurri Electronics 37 2141	Purley Electronics 2 1058
Electronic Components 80 4654	<b>NEWCASTLE</b>	<b>TOOWOOMBA</b>
Scientronics 54 8334	D G E Systems 69 1625	Hunts Electronics 32 9677
<b>WESTERN AUSTRALIA</b>	<b>NOWRA</b>	<b>TOWNSVILLE</b>
<b>COUNTRY</b>	Vimcom Electronics 21 4011	Solex 72 2015
<b>ALBANY</b>	<b>PENRITH</b>	<b>SOUTH AUSTRALIA</b>
BP Electronics 41 2681	Acron Electronics 21 2409	<b>CITY</b>
<b>ESPERANCE</b>	<b>PORT MACQUARIE</b>	ADN Electronics 212 5505
Esperance Communications 71 3344	Hall of Electronics 83 7440	Protronics 212 3111
<b>GERALDTON</b>	<b>RICHMOND</b>	<b>SUBURBAN</b>
Geraldton TV and Radio 21 2777	Vector Electronics 78 4277	<b>CHRISTIES BEACH</b>
<b>KALGOORLIE</b>	<b>TOUKLEY</b>	Force Electronics 382 3366
Today's Electronics 21 5212	TES Electronics 96 4144	<b>ELIZABETH GROVE</b>
<b>MANDURAH</b>	<b>WINDANG</b>	A E Cooling 255 2249
Kentronics 35 3227	Madjenk Electronics 96 5066	<b>KESWICK</b>
<b>WYALKATCHEM</b>	<b>NT</b>	Freeway Electric Wholesalers 297 2033
D & J Pease 81 1132	<b>DARWIN</b>	<b>PROSPECT</b>
<b>TASMANIA</b>	Radio Part: Darwin 81 8508	Jensen Electronics 269 4744
<b>CITY</b>	Ventronics 81 3491	<b>COUNTRY</b>
D & I Agencies 23 2842	<b>ALICE SPRINGS</b>	<b>PORT PIRIE</b>
	Ascum Electronics 52 1713	G F & J A Pointon 32 5141
	Farmer Electronics 52 2967	

**RESELLERS WANTED IN ALL AREAS (Including WA).**

Phone: STEVE WROBLEWSKI (09) 381 7233 for details.

Phone toll free 6am - 8pm (EST) for personal service, or take advantage of our 24 hour 7 day p / week Bankcard phone order service. Give your name address with postcode, phone number, bankcard number and expiry date then your order — and presto your order will be processed and back to you in a flash. — Please nominate Jetservice if you want overnight delivery.

**\$2.50 DELIVERY AUSTRALIA WIDE** We process your order the day received and despatch via Australia Post. Allow approx. 7 days from day you post order to when you receive goods. Weight limited 10kgs.

**\$4.50 DELIVERY AUSTRALIA WIDE** We process your order day received and despatch via Jetservice for delivery next day.

**BANKCARD HOLDERS CAN PHONE ORDERS UP TO 8PM (EST) FOR NEXT DAY DELIVERY — SOUNDS INCREDIBLE DOESN'T IT?** Alright you cynics just try us! Weight limit 3.3kgs. Jetservice cannot deliver to P O box numbers (Australia Post would have a fit).

**\$10.00 HEAVY HEAVY SERVICE — AUSTRALIA WIDE** All orders over 10kgs must travel on the heavy service, that is — road express. Delivery time 7 days average.

**ALTRONICS**  
**105 STIRLING ST, PERTH**  
**FOR INSTANT SERVICE**

**008 999 007 TOLL FREE**

**(09) 328 1599** PERTH METRO AREA & AFTER HOURS RECORDED SERVICE

All Mail Orders: Box 8280, Stirling St, Perth WA 6000.

Avoid speeding fines. Build this...

# Speed Sentry for cars

by COLIN DAWSON



Paying speeding fines can be a painful business. Build this speed sentry and avoid further pains in the wallet due to this cause.

It's a situation familiar to every driver: a long stretch of good road leads you to imperceptibly increase speed. After a while you can be exceeding the speed limit by a wide margin which means that you're a goner if you stumble upon a roadside radar trap. It could well be a case of the book, the bag and a large extraction from the wallet.

Similarly, driving into a built-up area after a long stretch of highway can make the 60km/h restriction seem like an agonising crawl. Constant vigilance is required to keep the speed under the limit, but clearly, the driver's attention should be directed outside the car – not at the dashboard. In such cases, the warning buzzer of the Speed Sentry will greatly assist in re-orientating the driver to the lower speed limit.

The Speed Sentry actually has two alarm speeds. One of these is set at installation and would normally be calibrated to trigger at about 60km/h.

The other can be adjusted on the move by means of a remote potentiometer mounted in any position convenient to the driver. Selection between the two alarm speeds can be made by a switch mounted near the potentiometer.

When the driver does not need the Sentry, it is simply switched to the adjustable mode and the trigger speed set to maximum.

The original version of the Speed Sentry, presented in May 1981, interfaced to the car's ignition system. In fact it was monitoring engine speed rather than road speed, but provided the car is in top gear this is a valid technique. By calibrating the circuit to trigger at a given engine RPM, it is also being calibrated to trigger at a given speed. Unfortunately, this type of monitor will also trigger at this same RPM in the lower gears even though the speed is well below the preset value. And it was not really valid for cars with automatic transmission.

We estimate that the current cost of components for this project is approximately

**\$11**

This includes sales tax but not the cost of the sensor.

Now we are able to present a revised version of the Speed Sentry which responds directly to road speed – irrespective of the engine RPM. Following the introduction of our car computer project last year, several retailers are supplying the distance transducers specified for that project. As it happens, these transducers are equally suitable for use with the Speed Sentry.

Although these transducers have an output which gives a direct indication of distance, this can easily be processed so that it represents speed. For vehicles already fitted with the car computer, no

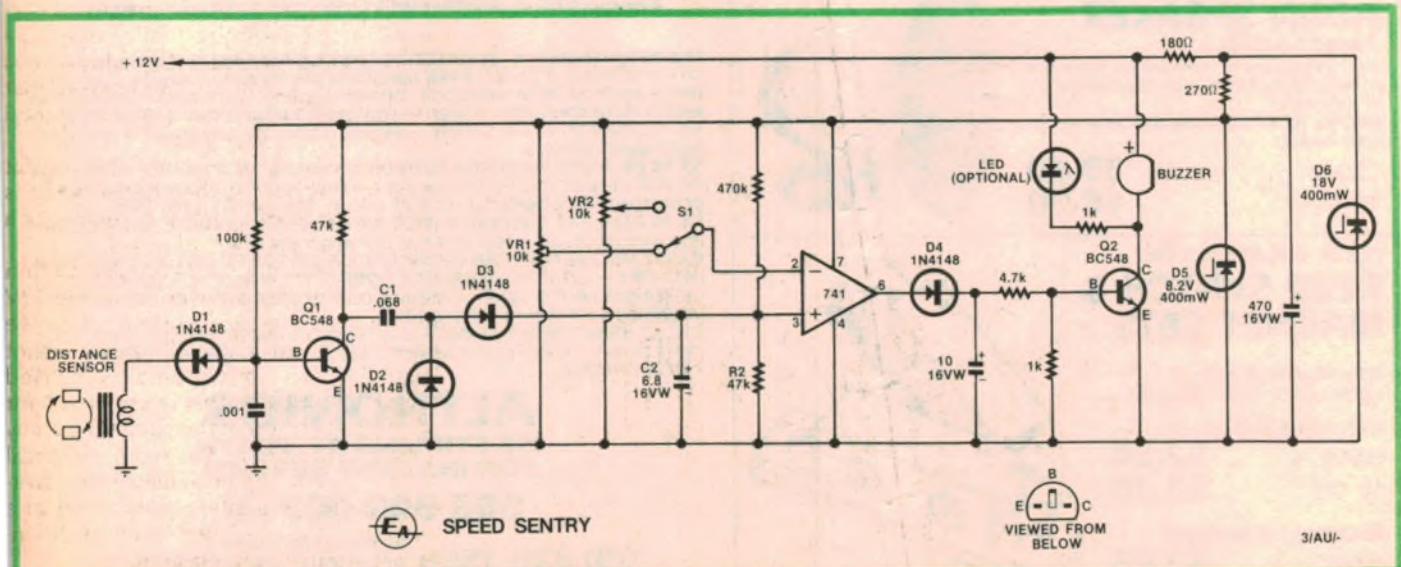

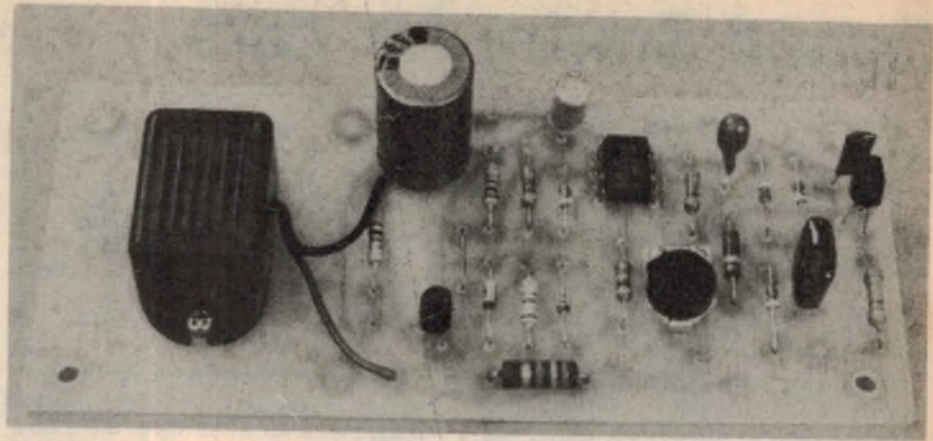

The components are all mounted on a small printed circuit board.

modification to the sensor circuit will be necessary. The Speed Sentry will simply require a "tap" from the output line of the sensor. This could be taken from any convenient point between the sensor and the computer.

There are two different types of distance sensors available, both of which can be used with this project: (1) a magnetic pick-up using a coil and rotating magnets, or (2) a speedometer cable sensor. Generally, the magnetic pick up system will suit most rear-wheel drive cars with a front mounted engine as the tailshaft is an ideal position for the magnets. It may also be possible to find a suitable position on some front-wheel drive cars.

The cost of the speedometer cable sensor is about \$20, but the driveshaft sensor is cheaper at about \$12. Actually, it is quite practical to manufacture your own driveshaft sensor. All you need is a coil and two reasonably strong magnets. We are aware of one reader who used

an old washing machine solenoid for the coil. Large relay coils could prove equally suitable for the purpose and the magnets are available commercially.

With either type of sensor the output is a series of pulses, for which the frequency is dependent on the speed of the vehicle. From this, it is apparent that the Speed Sentry is actually a frequency sensing circuit. In fact it utilises a diode charge pump to produce a DC level which is proportional to the frequency of input pulses. When this DC level exceeds a preset reference (as determined by an op amp comparator) an alarm condition exists and the warning buzzer sounds. An optional LED can also be used to signal the warning.

The output of the magnetic sensor cannot be used to drive the charge pump directly, since the amplitude of the pulses tends to vary with RPM. Instead, the sensor is coupled to Q1 via a diode, D1. By virtue of the diode, the base of Q1 is held at 0.6V.

With no signal supplied from the coil, Q1 is on the verge of being forward biased, hence only a very small signal from

the coil is needed to bias it into conduction. As soon as Q1 is forward biased, its collector goes low. Since the coil is rotating rapidly we can expect that Q1 will be on only briefly with its collector then being pulled high by the 47kΩ resistor. Each one of these positive transitions counts as an input pulse.

The speedometer cable sensor has an integral buffer transistor which serves the same purpose as Q1. This means "squared up" pulses can be taken directly from the sensor, eliminating Q1 and its associated circuitry from the Sentry. The disadvantage with this sensor — besides more difficult mechanical installation — is that it must have a power supply connection to the Sentry circuit.

Although Q1 provides pulses of constant amplitude, the pulse width is still determined by vehicle speed. With faster driving the pulses become shorter and shorter. To provide a pulse of constant duration for the charge pump, the signal from Q1 is differentiated by C1. This converts each pulse into a short spike, the duration of which is independent of vehicle speed.

The signal spikes are transmitted via diode D1 to C2, which consequently acquires a certain amount of charge. The 47kΩ resistor across C2 allows this charge to bleed off at a fixed rate so that the voltage across C2 can be determined by the rate of input pulses.

Reference to the complete circuit diagram shows that the charge pump is followed by a comparator consisting of a 741 op amp and two trimpots.

The op amp (IC1, a 741) is fed from a regulated supply, derived from the 12V of the car's electrical system. Here we have used an 8.2 volt zener shunt regulator to provide a stabilised operating voltage. This is important for reliable operation of the circuit since any voltage changes in the main electrical system (due to the headlights being switched on for example) would result in a change in the reference levels at the inverting input of the op amp.

Right: parts layout and wiring diagram for the speed sentry. Take care with polarised components

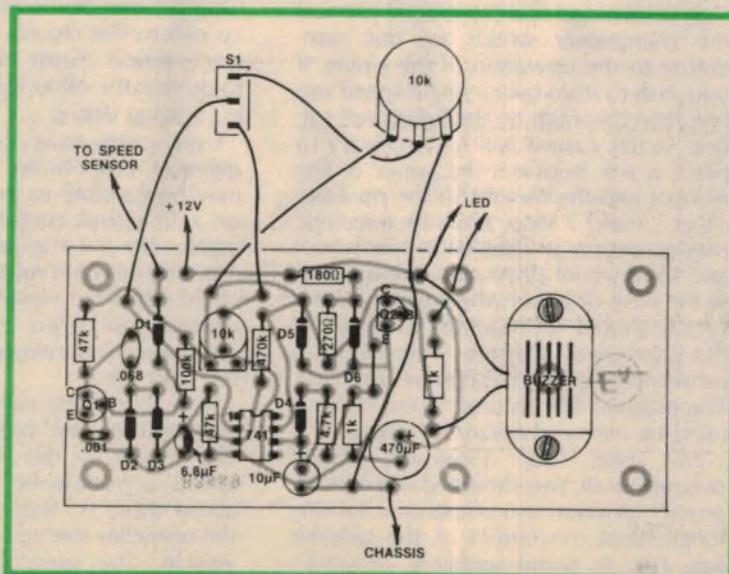

The circuit (left) consists of a diode charge pump, an op amp comparator and a transistor output stage.

# Speed Sentry for cars

The voltage developed across C2 is applied to the non-inverting input (pin 3) of IC1, while an adjustable reference voltage is applied to the inverting input (pin 2). If the voltage on pin 3 is lower than the voltage on pin 2, the output (pin 6) will be close to 0 volts. As soon as the voltage on pin 3 rises above that of pin 2, the output will rise to almost 8.2V (the zener regulated voltage).

The output of the op amp is fed to a second diode/capacitor combination which is used to smooth any pulses appearing there. Where the voltage across the capacitor in the charge pump circuit is just at the threshold level of the comparator, pulses will appear at the output, due to the ripple at the input. This ripple is due to the charging and discharging of the capacitor with the input pulses.

This smoothed voltage at the output of the op amp is used to drive transistor Q2 which is a saturating switch for an oscillator-driven buzzer or a piezo alarm device.

The purpose of the 18V zener diode across the power supply of the Sentry is to clip any high voltage spikes that may occur on the car's electrical system. This protects the IC from the spikes which are quite common.

Power for the circuit should be taken from a part of the car's wiring which is active when the ignition is switched on.

Fig. 1. Magnetic pick-up sensor system for rear-wheel drive cars. Note the twin magnet arrangement.

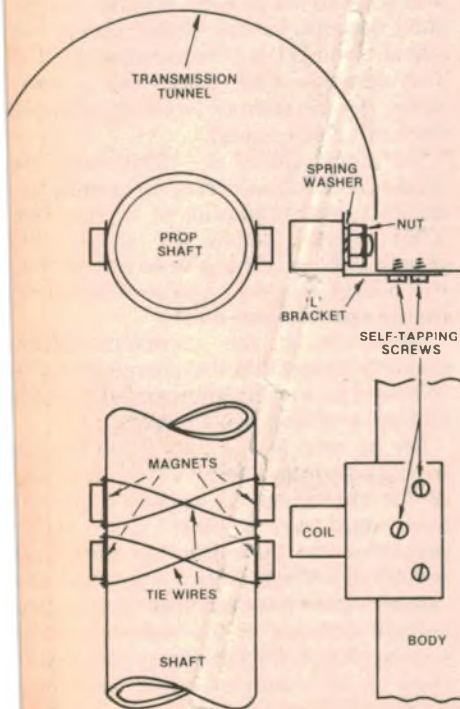

Fig. 1

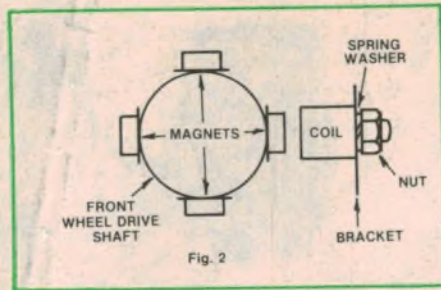

Fig. 2. Suggested coil and magnet arrangement for front-wheel drive cars.

We have designed a printed circuit board which accommodates all the components except the sensor, the second potentiometer and the changeover switch. The board measures 117 x 52mm and is coded 83ss9. Construction is simple and should not take more than half an hour or so. The components should be mounted in the usual order; starting with resistors and diodes, then capacitors, transistors and lastly the IC. The wire link on the board should be soldered in at the same time as the resistors.

We have made provision on the board for an additional 1k $\Omega$  resistor which allows a series LED to be connected in place of the buzzer, or if desired, in parallel.

If using the speedometer cable sensor, omit D1, Q1 the associated 100k $\Omega$  and 47k $\Omega$  resistors and the 0.001 $\mu$ F green-cap. What was the collector of Q1 now becomes the input.

The external connections to the board are the input, power supply, the switch and the external potentiometer. This is shown in the wiring diagram.

The remote pot and the changeover switch can be mounted on the dash, or, if your car has it, in the centre console. It should be noted that the second pot and the changeover switch are not mandatory to the operation of the circuit. If you wish to have only a single speed setting then the input on the board will suffice. In this case it will be necessary to place a link between the wiper of the trimpot and the trimpot to the op amp.

Figs. 1 and 2 show how the magnetic pick-up sensor is installed in rear-wheel and front-wheel drive cars respectively. In the case of a rear-wheel drive car the sensor should be mounted as close to the gearbox as possible, where vertical movements of the tailshaft are minimal. The magnets are secured to the tailshaft using tie wire and epoxy adhesive.

We used four 15mm-dia round magnets in all, two mounted side-by-side at each position to compensate for any longitudinal movement of the tailshaft (see Fig. 1). Some suppliers, however,

## Parts List

- 1 printed circuit board 117 x 52mm, code 83ss9
- 1 switch, single pole double throw (SPDT)
- 1 buzzer
- 1 knob to suit potentiometer

### SEMICONDUCTORS

- 1 741 op amps
- 2 BC548 NPN transistors
- 4 1N4148 diodes
- 1 18V/400mW zener diode
- 1 8.2V/400mW zener diode
- 1 LED (See text)

### CAPACITORS

- 1 470 $\mu$ F/16V electrolytic
- 1 10 $\mu$ F/16V electrolytic
- 1 6.8 $\mu$ F/16V electrolytic
- 1 .068 $\mu$ F metallized polyester (greencap)
- 1 .001 $\mu$ F greencap

### RESISTORS (1/4W, 10%)

- 1 x 470k $\Omega$ , 1 x 100k $\Omega$ , 2 x 47k $\Omega$ , 1 x 4.7k $\Omega$ , 2 x 1k $\Omega$ , 1 x 270 $\Omega$ , 1 x 180 $\Omega$ , 1/2W, 1 x 10k $\Omega$  linear potentiometer, 1 x 10k $\Omega$  trimpot small horizontal.

will provide 25mm-long bar magnets, in which case only one magnet will be required at each position.

The coil was mounted on an L-shaped bracket made from aluminium and secured to the underside of the car using self tapping screws. This bracket should be positioned so that there is a 10mm gap between the end of the coil and the magnets when they are directly opposite each other.

Wiring to the coil can be run along the underside of the car, with the leads secured at various points as convenient. Connect one of the leads from the pick up coil to the chassis at the coil mounting position. Plastic tubing can be used to protect the other lead against damage from flying debris.

Front-wheel drive cars are a somewhat different proposition. In some cars, it may be possible to mount the magnets on a drive-shaft coupling flange where it bolts onto the transaxle (provided it is not covered by a rubber boot). The coil could then be mounted on a suitable bracket secured to the nearest convenient mounting point. Fig. 2 shows the basic idea.

Note that in this case the magnets are mounted at four positions, 90 $^\circ$  apart. The reason for this is that, for a given speed, a front-wheel driveshaft rotates about three to four times slower than the propeller shaft on a rear-wheel drive vehicle. The extra magnets are thus

necessary in order to get a similar number of pulses for a given distance.

Do not mount the magnets directly on to one or other of the driveshafts. They move about too much when the vehicle is in motion to allow for reliable coupling between coil and magnets.

The alternative speedometer cable sensor can be used with both front and rear-wheel drive cars, but is mainly applicable to front-wheel drive cars where the driveshaft flanges are not accessible. In order to fit it, the outer sheath must be removed from the speedometer cable and cut at a suitable point. The inner cable is then pushed through the sensor and the speedometer cable reassembled.

Generally speaking, the best position for the speedometer sensor is close to the firewall in the engine compartment.

The installation procedure is as follows:

- Mark the appropriate position with white chalk, then remove the speedometer cable from the vehicle;

- Remove the retaining circlip and withdraw the inner cable;

- Using a hacksaw, cut out and discard a 15mm section of the outer sheath at the marked position;

- Push the inner cable through the sensor and refit the two sheath sections by clamping the ends in the slotted end tubes. Note that the inner cable should

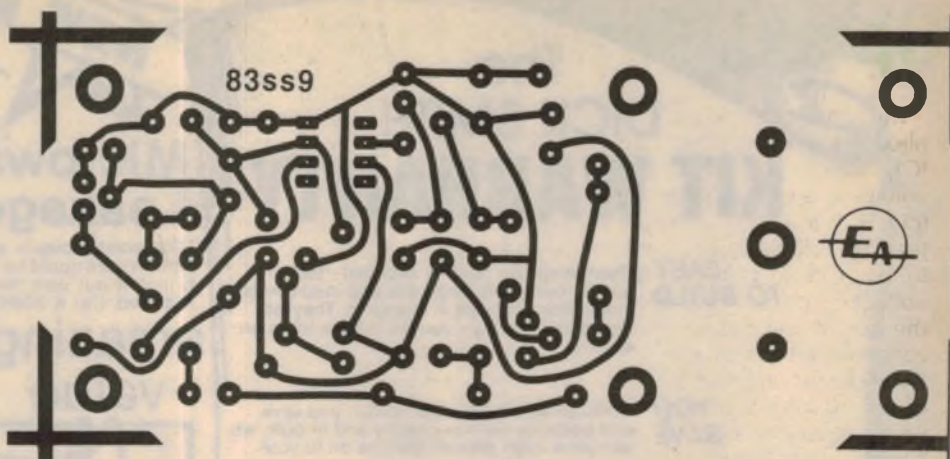

be a force fit into the sensor, otherwise the slotted disc inside the sensor will not rotate;

- Check that the inner cable is free to rotate, then re-install the speedometer cable in the vehicle.

When wiring the speedometer cable sensor, the colour coding for the wires is: Brown +8.2V; Green/Yellow signal; Blue ground.

The PCB itself is best installed under the dashboard of the car. Alternatively, the PCB may be mounted in a plastic case and installed towards the top of one of the front kick panels.

Once construction has been completed and the unit has been fitted to the car, you should enlist the help of a friend, either as driver or passenger, to set the trimpot.

Get the car moving at a constant speed of say 60km/hr (or any other that may be required) and then set the trimpot so that the buzzer just begins to sound. Now drop the speed back a little and make sure that the buzzer stops. Accelerating up to or just over the preset speed should cause the alarm to sound.

The same procedure is used to set the second pot, although here the driver can do it while driving along.

# EVERYTHING IN BREADBOARDS

**B-29T Terminal strip**  
58 groups of 5 tie points  
**\$5 + S.T.**



**B-512 390 tie points**  
**\$6.50 + S.T.**



**B-124 1680 tie points**  
**\$23 + S.T.**



- All modules will accept all DIP sizes
- B-111 & B-112 with aluminium back plate
- Will accept all components with leads and solid wire AWG No. 22-30
- B-123 to B-212 with aluminium back plate, binding posts and rubber feet.

**As supplied under Government contract**  
B-212 840 tie points  
**\$16 + S.T.**



**B-135 2420 tie points**  
**\$33 + S.T.**



**B-147 3260 tie points**  
**\$44.50 + S.T.**



**B-112 840 tie points \$10 + S.T.**



**Plus**

**B-64T Terminal Strip**, 128 groups of 5 tie points  
**\$6.95 + S.T.**

**B-64T Distribution strip**, 4 bus of 25 tie points  
**\$1.65 + S.T.**

**B-111 740 tie points** . . . **\$8.35 + S.T.**

**B-123 1580 tie points** . . . **\$22.00 + S.T.**

**Analogue & Digital Circuit Designer**

**AT-101 ANALOG LAB**  
**\$384 + S.T.**

**AT-102 DIGITAL LAB**  
**\$494 + S.T.**



**Features**

- 1680 solderless, plug-in tie points with B-124 bread boards
- Breadboard elements are mounted on ground planes
- DC power supply with short circuit protection
- Sine, Square and Triangle waveform generator (1Hz - 100 KHz) Operates on 240 V AC
- Plus a host of individual features on each model.



**Wire Cutter & Stripper**

For wire from 0.5 to 8 mm<sup>2</sup>. An essential tool for breadboarding **\$6.50 + S.T.**

**Breadboard Jumper Wire**

Four reels of 5m each. Colours: red, black, green, white.

**\$4.50 + S.T.**



Use A-Tek<sup>®</sup> Circuit Designers for faster and easier prototyping of all types of electronic circuits

**EMONA ENTERPRISES P/L** Suite 204/661 George St, Sydney 2000 Ph (02) 212 4815 Telex AA 74500  
Distributors in all States. See our range of Instruments on IREE Stand No. 28

# The DICK SMITH KIT WARRANTY

## EASY TO BUILD

Everything you need is supplied - parts, solder, even nuts and bolts and step-by-step instruction manuals in most kits. They go together so easily - you don't have to be an expert.

## YOU SAVE

Because you supply the labour, you save, and because we buy directly and in bulk, we can pass even greater savings on to you!

## EXCLUSIVE 'SORRY DICK' IT DOESN'T WORK GUARANTEE

On our major kits, we even include a repair service: if for some reason your kit fails to work, we will diagnose the faults and repair them for a lower than normal fixed service fee.

This includes any parts you may have damaged during assembly. So you cannot fail with a Dick Smith Kit!

## DICK SMITH MONEY BACK OFFER

We're confident you'll be delighted with our kits. But if you're not (for absolutely any reason at all) - you can return any kit to us in original condition and packaging (ie. before construction has commenced) and we'll refund your purchase price in full. What could be fairer than that?

## YOU REAP THE BENEFIT!

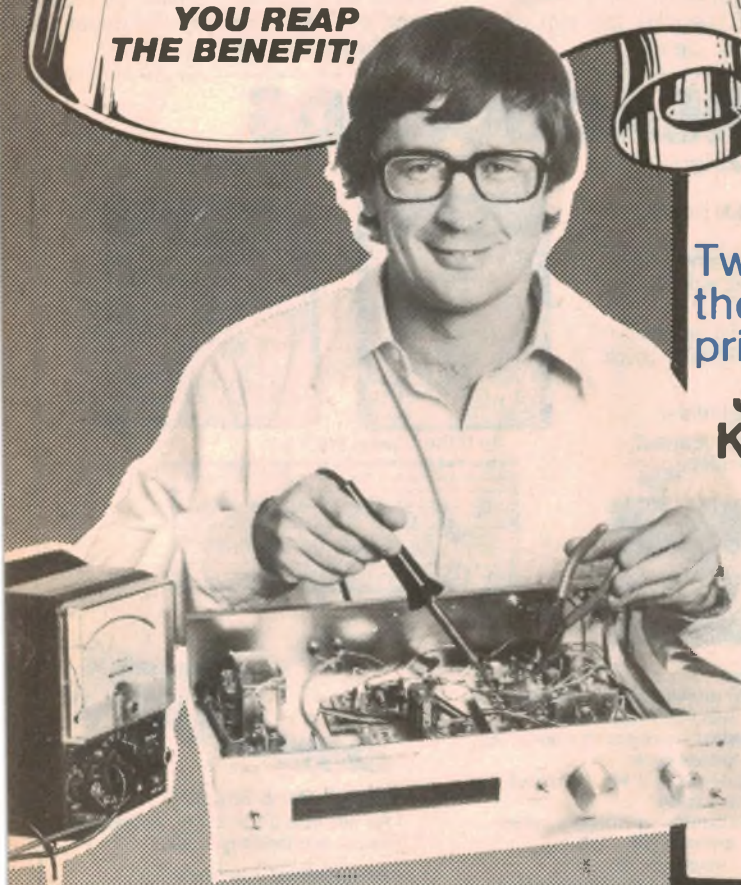

**NEW**

## Microwave Leakage Detector

Microwave ovens are fantastic - but are they safe? Yours could be leaking dangerous radiation! Check it out with this handy meter. No batteries required. Cat K-3095

amazing value **\$13<sup>95</sup>**

## Build your own Alien Invaders

Wow! You could save the earth from those pesky aliens..... and on a kit you built yourself! Multi-level LED display, easy to build and battery operated. Fantastic for Christmas gifts for technically inclined kids. Cat K-3393

VALUE AT ONLY **\$15<sup>95</sup>**

**SAVE**

Two for the one low price!

## Joystick Interface Kit & the Quickshot Joystick

Calling all System 80 owners - isn't it a pain in the neck using the arrow keys to play games? Wouldn't you rather use a Joystick control? Here's your chance! This kit allows you to add a joystick to your System 80 via the printer port - and here's the good news. Now we're INCLUDING THE "QUICKSHOT JOYSTICK" with the interface Kit for the one low price! This fantastic joystick features contour grip and rubber suction cups to hold it down. It's just like the real one in a helicopter. Suits System 80 Cat K-3455

Kit & Joystick for only

**\$49<sup>50</sup>**

**NEW**

## Courtesy Light Extender

You know what it's like, into the car in the dark shut the door - and then have to find that infernal keyhole! Aha - problem solved. The light will stay on automatically for a few seconds with this easy build, easy fit kit. Suits most cars. Cat K-3242

ONLY **\$4<sup>95</sup>**

Give your Tube a Longer life!!!

## Fluoro Starter

Alleviates fluorescent light flickering when you switch it on. Outlasts conventional starters & prolongs tube life. Cat K-3082

ONLY **\$4<sup>50</sup>**

**UNBEATABLE QUALITY & VALUE DICK SMITH IMPORT PRICES!**

**DICK SMITH**  
See page 98 for

**13.8 Volt Supply**  
Ideal for smaller amateur transceivers and 2 metre rigs

A big 5 amps continuous rating and 6 amp peak (depending on the heatsinks used) from this supply. Comes with all components, PCB, etc. or make your own case to suit. Ideal for the slightly larger amateur transceivers; (FT7's 2 metre rigs etc). Cat K-3449

**GREAT VALUE! \$35<sup>50</sup>**

**EXCLUSIVE**

**STEP BY STEP**

**EXCLUSIVE**

Identifying parts

Why spend 100's of \$\$\$ on a good receiver if you're only using a piece of string for an antenna??

Get the DICK SMITH

**SHORTWAVE ANTENNA KIT**

- Get the best reception from your receiver with this high quality short wave antenna:
- Designed especially for Dick Smith by a short wave expert
  - Complete and ready to assemble.
  - Needs no soldering

**ONLY \$10<sup>75</sup>**

Cat K-3490

**EXCLUSIVE**

How to solder

**DICK SMITH FUN WAY**

THOUSANDS SOLD

get into electronics for **\$4<sup>95</sup>**

**DICK SMITH'S FUN WAY INTO ELECTRONICS VOL1**

Designed for the beginner, this 72 page book is packed with projects which will introduce the newcomer to the exciting world of modern electronics. 20 projects you can build without soldering. And they are all battery powered for absolute safety, Cat B-2600

**\$4<sup>95</sup>**

**DICK SMITH'S FUN WAY INTO ELECTRONICS VOL2**

When you have mastered Fun Way Vol 1, move on to Vol 2. Learn how to work on PCB's and how to use the latest digital IC's and other semiconductor devices. The projects are described in superb detail. Cat B-2605

**\$6<sup>95</sup>**

**Vol. 1 Kit Projects 1-10 only**

All the parts you need to build the first 10 projects from Funway Vol 1. Even the baseboard is included. Top Value **\$7<sup>25</sup>**

**Vol. 1 Kit Projects 11-20** \*Requires Vol 1 1-10 Kit as well.

Contains the more specialized components so you can complete the full 20 projects in the book. Cat K-2610 **only \$7<sup>90</sup>**

**Vol 2 Kits**

All the kits for building the projects in Fun Way Volume 2 starting from a low \$2.99 are available separately, as you learn. **from \$2<sup>95</sup>**

**NEW NEW NEW NEW NEW NEW**

**LOUD HAILER**

A great new kit for the kids - their own loudhailer! exclusive detachable horn for minimising feedback, battery holder/ handle, amplifier and mic module, it's so easy to build and it really works well! (Horn can be remotely connected too) Cat K-3507

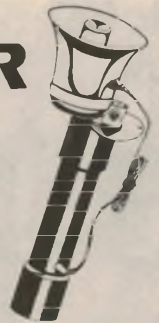

See August ETI  
Top value at only

**\$29<sup>95</sup>**

and now...  
**20MHz Hand-Held Frequency Counter**  
take anywhere!

What a beaut little kit for the amateur, hobbyists, serviceman... measure up to 20MHz anywhere. Fully battery operated with LCD display for low power consumption. Also doubles as a period counter. Includes the magnificent imported meter case at no extra charge. Cat K-3521

VALUE AT ONLY

**\$69<sup>95</sup>**

**Watts a Wattmeter? Watt...**

It measures watt watts a watten watt-using wattsamijig uses. Saves turning the appliance around to look at the rating plate on the back. Seriously, these days you need to know just how much power your appliances are consuming Great for fighting the electricity authority when they send you those monstrous bills. Measures up to 3kW in two scales, all cable, plugs & sockets supplied. Cat K-3453

**ONLY \$69<sup>95</sup>**



Check out the savings in Dick's **15th Birthday Mailer**

**Electronics**  
store addresses

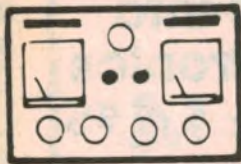

# The Serviceman

## Fires in TV sets — one certain cause

The subject of spontaneous fires in TV sets has cropped up again but, happily, in a more positive way. There is now very convincing evidence pinpointing at least one almost certain cause of such outbreaks, and which may lead to similar causes being revealed.

The evidence concerning the fire problem comes from one of my regular contributors, Mr J.L. of Tasmania. His story is really a follow-up of one concerning a mystery fire, which he sent to "EA" some months ago and which was featured in "Forum". I am making it the main story this month because I felt that as many people as possible should be alerted to the problem. This is how J.L. tells it:

In the September 1982 edition of Electronics Australia, Forum ran my story describing a TV fire, or at least its aftermath. Now I can describe the "foremath" of a TV fire and clear up a lot of mystery surrounding these events. I have saved the evidence and forward it herewith.

(The "evidence" is illustrated in the accompanying photographs. Serviceman.)

I was called to service a Blaupunkt colour TV set which was showing a green picture. It seemed that the fault normally appeared about half an hour after the set was switched on, so the customer had switched it on sometime before I was due. The picture was well and truly green when I arrived, so I lost no time in getting the back off to measure the collector voltage on the green output transistor. The voltage was sky high and the transistor obviously shorted.

### FAINT BLUE GLOW

I reached around the front of the set to turn it off and, as the switch clicked over, I saw a faint blue glow appear on the body of the switch. I switched on again and the glow disappeared; switch off and the glow was back.

Closer examination showed that the glow was coming from an arc across one set of terminals on the power switch body. The arc was about 3mm long and appeared to be right inside the switch body material. I let it run for a couple of minutes and there was no change in its appearance.

At this point I should mention that the set appeared to be switched off; there was no sound and no picture. Presumably the standby current for the picture tube heater was enough to maintain the arc. The arc made only the faintest hiss and would have been quite undetectable outside the cabinet. As far as anyone would have been aware the set was off and totally inactive.

It would have been interesting to let the fireworks continue, and see how long it would take the set to catch fire. But by now the owner was quite concerned and felt that something should be done to stop the display.

Before pulling the plug — now the only course open to me — I reached into the cabinet and moved the wires leading to the back of the control panel. There was a bright blue "flame" as the AC wires parted from the switch — and the owner and I collided as we dived for the power point.

Up to this point I had not studied the switch very closely but once I had removed it from the set I realised that it was the same brand and type as fitted to the Kriesler set described in the September 1982 Forum article. It is also fitted to the Philips K9 and K11 series, and now I had found it in a Blaupunkt. How many more brands will it show up in?

Getting a replacement switch presented a problem. My source of Blaupunkt spares is in Melbourne, several days away, and the customer wanted his set that night. A possible solution was an old Blaupunkt set in the shop, the switch from which might be suitable. However, when I examined it I found that it was well on the way to the same fate. All I could do was order a new switch; the customer would have to wait.

Careful study of the second switch showed two of the contacts quite loose in the phenolic body of the switch. Presumably the reduced contact pressure and higher contact resistance resulting from this had heated the contacts to the point where the solder attaching the leads to the switch had

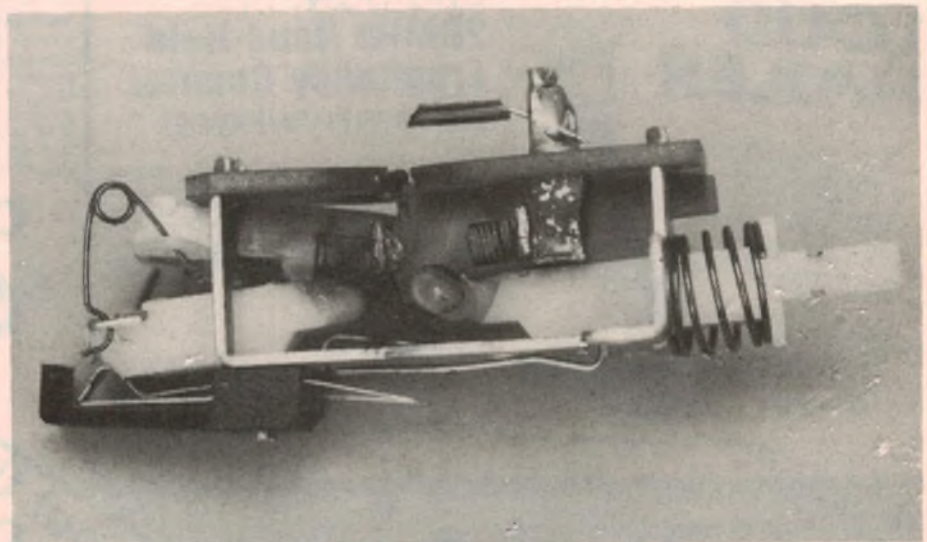

Potential fire hazard! — the plastic activating lever of the switch had melted in half while the rest of the switch shows severe damage due to arcing.



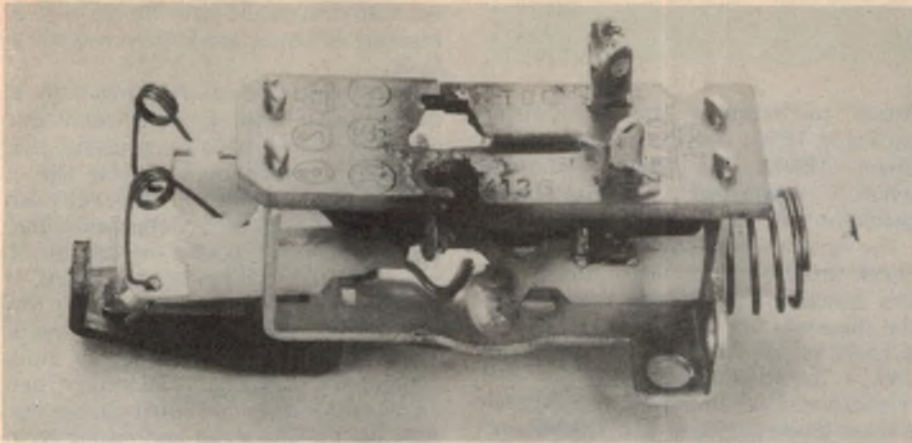

Note the damage to the phenolic switch body around the two missing contacts.

melted. All four joints were "dry".

As I write I have another Blaupunkt on the bench and it, too, has a loose contact in its power switch, with the first signs of dry joints on the leads. Significantly, it is the joints to the thin wires leading to the power supply that fail first. They cannot sink as much heat as the thicker multi-strand wire from the power plug.

Referring to the September 1982 Forum article, I would now make a significant change to the scenario I described then. I then blamed stray wires, dust, moisture, and loose contacts. I would now exonerate the first three items. The blame appears to lie entirely with the design of the switch and the loose contacts which develop as a result of the design.

If the TV subject of this article had not shorted its green output transistor, the owner would never have known of the faulty switch — until his house burned down. I was lucky to be able to witness the start of the conflagration and to stop it before much damage was done.

Well, that's J.L.'s story, and I feel that we should all take it very seriously. At the very least, all the sets mentioned should be checked for potentially faulty switches, as a matter of routine, whenever they are serviced for any other fault. And, naturally, if you recognise this switch as being used in any other brands or models, these should be treated similarly.

At the time of writing I have passed this story on to various colleagues, but I have not had time or opportunity to investigate other likely brands. However, the comments from some of these colleagues suggest that this particular type of switch may not have been fitted to all batches of the models which J.L. quotes. So, if you encounter this apparent contradiction, don't write off that particular brand or model. Keep checking.

Another point to note is that the problem appears to be aggravated in those sets, like the Blaupunkt, which feature a



This view clearly shows the damage to the switch contacts.

partially energised picture tube heater for "instant switch-on". I suggest that any set with this feature be given a routine power switch check whenever encountered.

In previous stories about fires in TV sets, particularly those in the newspapers, various authorities, such as firemen, have been quoted as advising people not to rely on the set's own power switch, because this "allows power to build up inside the set." They go on to advise switching the set off at the power point for maximum safety.

Somewhat ironically, this appears to be a case of giving the right advice for the wrong reason; switching off at the power point is always a wise precaution, even if the "power build-up" theory has little credence at a technical level.

## FROM MY OWN BENCH

The main story from my own bench this month concerns a Rank Arena 2603; a set I have not had a great deal to do with until now. In most respects, it is very similar to the 2601 and, in fact, uses many of the same boards. However, there are differences and one of these set me back somewhat in trying to track down the trouble.

The set, as I encountered it in the customer's home, was completely dead; no sound, no picture. I pulled the back off and made a few preliminary checks,

# Software for the Super-80 Computer

The programs are:

### POKER MACHINE SIMULATION:

This simulated poker machine keeps a record of your winnings and unlike the real ones, you can set a limit on your losses.

### CALENDAR CALCULATOR:

This program displays or prints out a calendar for any year of the 20th century — and keeps track of paydays!

### OTHELLO GAME:

The game of Othello, or Reversi, is played on an 8 X 8 grid with counters of two colours. This one has a "help" option.

### INVESTMENT ANALYSIS:

How much money can you make investing for a fixed term of years at current interest rates? Find out with this program

### GUESSING GAME:

Is it animal, vegetable or mineral a place, name or a car? Play against your friends, trying to guess the object

### LIST AND SORT:

This program lets you compile lists of up to 500 items, arrange them in alphabetical order and save them on cassette tape.

### FRED THE SHRINK:

Got a problem? Perhaps Fred can help. Talk things over with your computer — it may give you a new perspective on life!

### SIMPLE MATHS DRILL:

A great one for the kids — or to test your own arithmetic skills. It tells you the right answer, with comments if you goof.

### LOTTO NUMBER SELECTOR:

We don't guarantee you'll win your fortune, but this program makes picking Lotto numbers easy. It's fun to use, too.

### TRIANGLE SOLUTIONS:

Computerised trigonometry at your service. If you think you know all the angles, try this program for size.

### MORTAR ATTACK GAME:

Match wits with the computer! See how long you can hold out in this challenging game of mortar bombardment.

### CAVES & MONSTERS:

Go adventuring in the maze. You must fight monsters and find the treasure, but be careful — the monsters get tougher as you go.

### AMATEUR Q CODE TUTORIAL:

If you're thinking of going for your amateur radio licence, or just want to find out what all those "Q" codes mean, try this.

### DIRECTORY FOR CARAVAN PARKS:

Owners of caravan parks can keep track of who's where with this program. It can be adapted to other applications too.

### SUPER-POKEY GAME:

Another poker machine game, but this one has graphics. For the budget conscious, you can set an upper limit on your stake.

### TATTSLOTTO NUMBERS:

For those south of the border we present a program to select numbers for Tattsлото entries. Good luck.

Note: this book is exclusive to, and available only from, Electronics Australia, 57 Regent St, Chippendale 2008, PRICE: \$4 or by mail order from Electronics Australia, PO Box 163, Chippendale, NSW 2008. PRICE: \$5.

## THE SERVICEMAN — Continued

from which the main point that emerged was that the main HT rail, which I expected to be around 120V, was up to 145V.

At this point I decided that the job would be better done on my own bench. Not only was I less familiar with the set than others in this brand, but I was worried that the fault, whatever it was, might be potentially damaging if the set was run for any length of time. I wanted to know a little more about it before letting it run continuously while I prodded and probed. Also, it so happened that the customer had another set and wasn't worried if I took some time over the job.

As I fished out the circuit one difference immediately caught my eye, although it did not have a great deal to do with this story. It concerned the all-important 19V rail, which I noted was once again regulated. The original 2201, from which the 2601 was derived, featured a regulated 19V rail, but the 2601 did not. Later, it seemed the designers had second thoughts and decided that the 26in version deserved a better deal and fitted a regulator. Just how important it all is in practice I'm not sure.

### AUXILIARY BOARD

A more important addition, as far as this story goes, is a small auxiliary board, PWC 256, designated "HV Protector". This consists of a couple of transistors, TR2001 and 2002, a couple of zener diodes, a normal diode, and resistors and electrolytic capacitors. It is mounted at the front of the chassis, under the picture tube, and connects to the "Deflection Out" board, PWC 433, via a plug and socket arrangement.

With the set on the bench I switched it on again and made a few more tests, the most important one being to determine if the line output stage was working. It wasn't and, having established this, I felt a good deal happier about letting the set run. I also realised that most of the set would be shut down in these circumstances; the aforementioned 19V rail, which powers several sections, is derived from the line output transformer.

My next check was the regulator transistor in the main power supply, TR691, (2SC1114). These have been known to go short circuit, which can send the supply rail up, as in this case, and this might conceivably trigger the HV Protector circuit and shut the rest of the set down. In fact, it proved to be quite OK, so that squashed that theory.

Next, I stoked up the CRO and made for the deflection board, PWC 367, and

more particularly the horizontal oscillator, TR501, and the horizontal pre-driver, TR502. The scope confirmed what I suspected; the horizontal oscillator was not working.

The obvious next step was a voltage check around the oscillator stage and this revealed a very good reason why the stage was dead. This stage runs from a 13.5V rail derived from the 120V rail and a 3.3k $\Omega$  resistor (R551) on the "Deflection Out" board (PWC 433) and a zener diode (D505) on the "Deflection" board (OWC 367), but the best it could manage was about 2V.

Thus began the job of tracing out the circuit, via the numerous plugs, sockets, copper patterns, etc in an effort to determine just where the missing voltage was going astray. At first I suspected that some kind of breakdown on the deflection board might be loading the 13.5V rail, but a few measurements with the interconnecting plugs removed seemed to squash this idea.

Tracing the circuit back towards the 120V rail on the deflection out board, I suddenly realised that the extra HV Protector board, which I mentioned previously, was now interposed in this circuit, though I wouldn't attempt to even guess how this board is supposed to function.

But a few measurements made me suspect that all might not be well on this board so, not without some difficulty, I managed to get it out from under the picture tube, disconnect it from its cable, and get it on the bench for a closer look. There were no obvious signs of anything wrong, and a few preliminary measurements of resistors, diodes, etc also revealed nothing.

But what about the transistors? On an impulse I pulled out TR2001 (2SA539) and tested it. And for once I had picked it first time; it was a dead short from collector to emitter. I also checked the second one, TR2002 (2SC945), but it was intact. I replaced the faulty transistor, reconnected the board, and prepared to switch on.

But I hesitated at the last minute. I was still worried about the excessive voltage I had observed on the 120V rail. Was this what had taken out the transistor on the protector board? And had this board been trying to shut the set down to prevent further damage? More importantly, was I risking further damage if the short circuited transistor was only a symptom of a more serious fault?

With these thoughts in mind I decided to play safe. I fished out the Variac, and wound it down to do what I calculated would bring the 120V volt rail down from 145V to its correct value. I reason-

ed that this should provide at least a measure of protection if there was still a fault.

Finally I switched on. And was there a fault! I don't know to what extent my precautions may have been useful, but the tripler turned on a display like a thunderstorm; sparks and flashes all over the place. I switched off hurriedly, but not soon enough to save the transistor I had just fitted to the protector board.

But that was only a minor problem. My real concern was for the tripler. Triplers are expensive and, sometimes, in short supply. As it happened I had a spare, but I did wonder whether I could salvage the old one. I pulled it out and examined it carefully, finding a number of fine cracks in the case, but without being able to determine what form the breakdown had taken.

I decided it was worth a try to save the tripler, so I cleaned out and around the cracks and then filled then with a silicone sealant which has proved successful in other, more clear cut, cases. I left it to cure and, in the meantime, fitted another transistor on the protector board. Finally, when the curing time had expired, I tried again, with the Variac wound down even further.

Unfortunately, it didn't work. Granted the sparking was much less intense, and the transistor on the protector board survived, but it was clear that the tripler had had it. So I fitted the new tripler and, with the Variac still in circuit, tried a third time. Not surprisingly, everything held this time and, as I wound the Variac up to the full mains voltage, the 120V rail settled at 119.65V — according to my new digital meter.

I let it run on the bench for a day or so, carried out the usual routine adjustment procedure, then returned it to the customer. I don't anticipate any further problems, although I'd like to know more about that protector board in case I encounter more serious faults in the future.

### MORE ON FUSES

And, to finish off, here is a letter just to hand from a professional serviceman, Mr D.R. of The Entrance, NSW. He offers a possible explanation for the fuse and de-gauss problems which I related in the August issue. He writes:

Dear Fellow Sufferer: Re the August article on fuses in the National set. The symbol "T" always indicates time delay on Japanese chassis. Standard fuses would be marked "2A", not "2AT"

We run into this type of problem a lot, with customers buying wrong fuses.

I always enjoy the column. Best regards.

Well, that appears to be a piece of very vital information which I confess escaped me. Thank you, D.R., and I hope your comment will help other readers. ☺

# Circuit & Design Ideas

Interesting circuit ideas from readers and technical literature. While this material has been checked as far as possible for feasibility, the circuits have not been built and tested by us. As a consequence, we cannot accept responsibility, enter into correspondence or provide constructional details.

## Frequency doubler uses one comparator

Based on a single comparator IC, this simple circuit produces rectangular pulses at twice the input signal frequency. It does this by producing a positive output pulse of duration  $T$  on both the rising and falling edges of a square wave input signal.

Here's how it works: On the rising edge of the waveform, D1 is forward biased and D2 is reverse biased. Consequently, the non-inverting input will be at  $V_{cc}$  while the inverting input will be at  $0.5V_{cc} + 0.6V$ . The output of the comparator thus switches high, and remains in that state until C2 charges to the level where the voltage on the non-inverting terminal falls below the voltage on the inverting terminal. The output of the comparator then switches low again.

Similarly, on the falling edge of the input waveform, the inverting input of IC1 is grounded (D1 reverse biased) while the non-inverting input is set to  $0.5V_{cc} - 0.6V$  (D2 forward biased). The output of the comparator thus switches high again and remains in this state until C1 charges.

The duration of the output pulse ( $T$ ) is adjustable for both the rising and falling edges of the input waveform. It is given by  $K(R1 + R3)C1$  for the falling edge and  $K(R2 + R4)C2$  for the rising edge, where  $K$  is a constant that is dependent on  $V_{cc}$  and the input voltage. In the example shown, both sections of the circuit are identical and the period  $T$  is about 0.31ms.

From "Electronics", May, 1983.

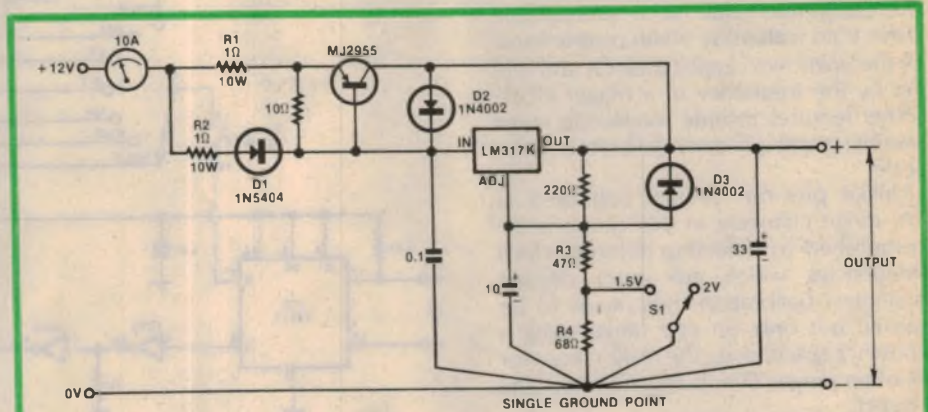
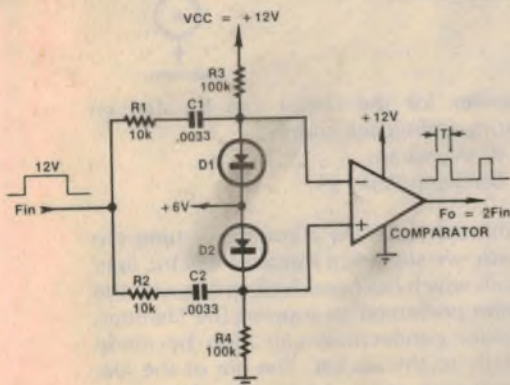

## Glow plug driver for model aeroplanes

This glow plug driver circuit was developed as a result of dissatisfaction with existing circuits or devices. It has a regulated output voltage switchable between 1.5 and 2V, is short-circuit protected, thermal overload protected, and output current limited.

Diode D1 is used to keep the voltage across resistors R1 and R2 approximately equal. The maximum current through R2 is approximately equal to the maximum current through the LM317K. This is approximately 2.5A but varies between brands; some will pass only 1.5A. In the above design the current through R1 and R2 is approximately equal so the maximum output current is about twice the maximum current of the LM317K.

The LM317K and the MJ2955 are mounted on a common heatsink (Dick Smith cat No. H-6704) as close together as possible. This allows

excessive heat in the MJ2955 to activate the thermal overload circuitry in the LM317K. Both devices must be mounted with thermal grease, insulating washers, and plastic insulator caps.

To check the maximum output current short the output briefly and read the meter. Between five and six amps is sufficient to drive a glow plug. If the reading is less than 5A the value of R1 must be reduced by connecting resistors in parallel with it.

The resistive divider in the output circuit gives 2V with switch S1 open and 1.5V with it closed. Heavy flexible cable is needed to connect to the glow plug to minimise losses. Twin 4mm auto cable, about 1.2m long is adequate. The input should use similar wire.

An alternative, and more economical, regulator is the LM317T. This could be bolted to the heatsink underneath the MJ2955. Resistor R1 would be 0.47Ω and R2 1.5Ω.

I.R.B. Lovi,  
Moranbah, Q.

## IC sockets and double sided boards

A problem with IC sockets — as distinct from ICs themselves — is that they are not designed for soldering to double sided boards. The following solution to this problem is both simple and effective.

First, when preparing the board, drill the IC pin holes slightly oversize. Then thread a fine gauge wire, such as tinned fuse wire, through each hole, bend one end over, and secure

it to the copper pattern with a dab of solder.

Cut the wire on the other side of board and secure that end similarly, taking care that the solder does not flow over the hole. Do this for each hole, then insert the socket all pins securely.

If carefully done the result is as effective as plated-through holes, but does not require any special equipment.

H. Nacinovich,  
Gulgong, NSW.

## Circuit & Design Ideas

continued from page 69

### Wide range capacitance meter

Need a low-cost capacitance meter that covers the range 4pF to 100 $\mu$ F with high accuracy? This unit functions by averaging the value of a monostable pulse train with pulse width proportional to the unknown capacitance  $C_X$  and rate set by the frequency of a trigger clock. Other features include six-decade range switching and a linearly calibrated meter scale.

Unlike previous circuits published in EA, range changing in this circuit is accomplished by selecting different clock frequencies which are exact decade multiples. Calibration thus needs to be carried out only on one range using a known capacitance, the calibration for all other ranges then being automatically correct.

Gates, IC1a and IC1b form a 1MHz oscillator whose output is buffered by IC1c. From there, the signal is fed to three CD4518 CMOS dual decade dividers (IC2, 3&4) while range switch S1 selects one of the seven available clock frequencies from 1MHz to 1Hz. The selected clock signal is then buffered by IC1d and fed to the trigger input of IC5.

IC5 is a TTL SN74121 monostable whose pulse width is set by the unknown capacitor  $C_X$  connected to pins 10 and 11. The monostable output pulse

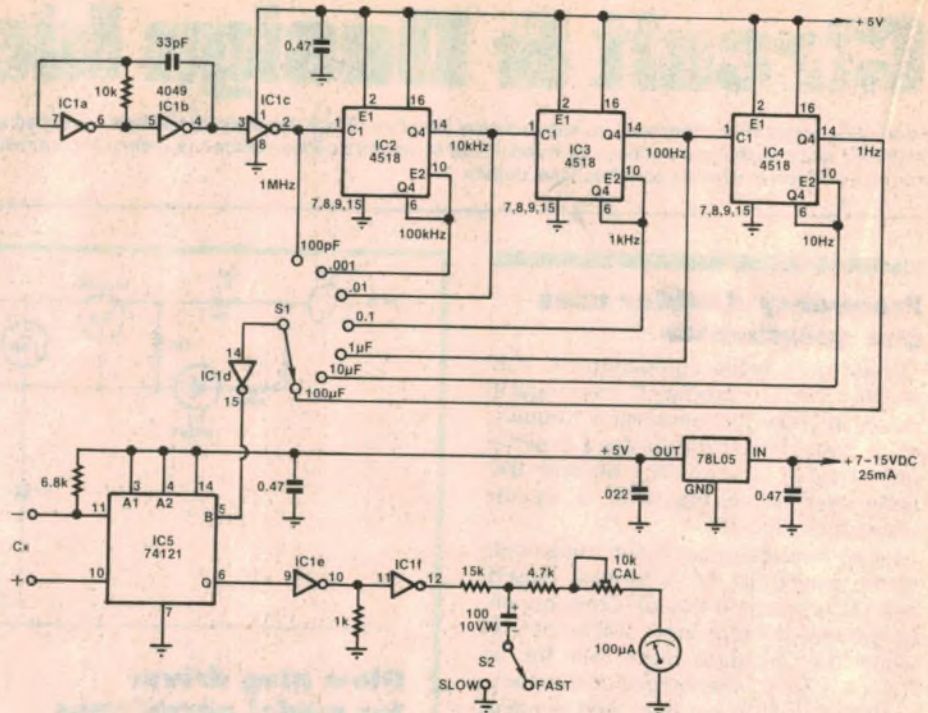

train is taken from pin 6 and buffered by IC1e and IC1f to produce defined output logic levels of 0V and 5V. Finally, the signal is fed to an averaging network and then applied to a 100 $\mu$ A FSD meter via a 10k $\Omega$  calibration trimpot.

The meter inertia provides sufficient smoothing on most ranges to provide stable readings, but additional filtering on the 10 $\mu$ F and 100 $\mu$ F ranges is

necessary. This function is performed by the 100 $\mu$ F capacitor. Switch S2 switches out the capacitor on the lower ranges to avoid a slow response time or problems due to leakage current.

Construction is straightforward but take care to minimise stray capacitance to IC1e and IC1f.

G. Watt,  
Como, NSW.

### Flame detector circuit controls booster fans

Most gas space heaters are equipped with booster fans that operate continuously. The problem is that the booster fan in some designs can be quite noisy or can become noisy with age. This flame detection circuit alleviates the problem by turning the fan on only when it is required — ie, when the main heater flame is on.

Here's how it works. IC1 is a 555 timer IC used here as a comparator. When the main flame is on, pin 2 of IC1 is pulled low and thus its pin 3 output is high. This, in turn, triggers the SC141D Triac via a MOC3021 optocoupler and so the fan motor runs for as long as the flame is present.

IC2 is a 555 monostable delay circuit that keeps the fan running for 132 seconds after the main flame has gone out. When the heater thermostat cuts off the flame, pin 3 of IC1 goes low and triggers IC2 via a 0.1 $\mu$ F capacitor. Pin 3 of IC2 is high during the monostable period and thus the fan will continue to run during this time.

After about 132 seconds, the 10 $\mu$ F tim-

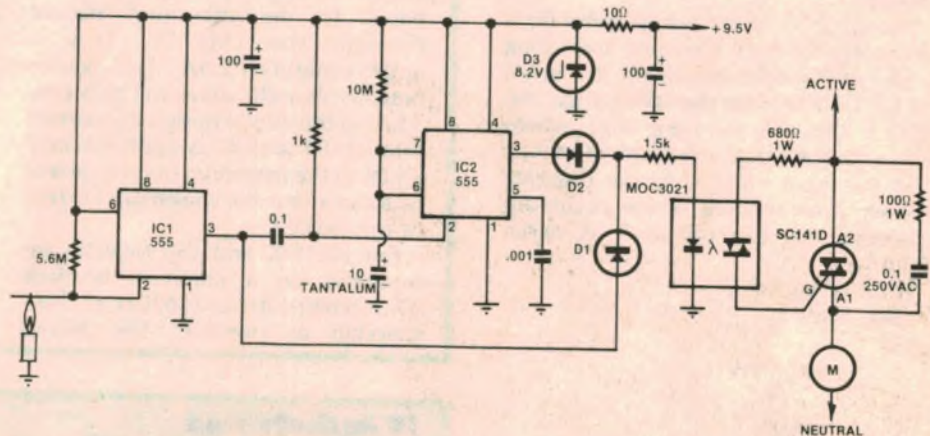

ing capacitor of IC2 reaches 2/3Vcc and the pin 3 output goes low. The fan motor now turns off and remains off until the heater thermostat turns on the heater flame once again. Diodes D1 and D2 form a simple OR gate to isolate the outputs of the two 555 timers from each other.

Construction of the circuit is straightforward, but take care with the mains wiring to the Triac and the fan motor. A piece of tungsten wire should be used for the flame detector, while

power for the circuit can be derived from a plugpack supply.

R. Wundram,  
Ferryden Park, SA.

Editorial Note: As a source of tungsten wire, we suggest a standard electric light bulb which has been broken but with the stem preserved to support the filament. Solder connections can then be made easily to the socket. The life of the filament may not be long under these conditions because it is exposed to air.

# MULTIRAIL SWITCHING POWER SUPPLIES

More choice, more performance, more efficiency, more back up and support — at a truly competitive price.

- Single, three, four & five rail outputs
- 240V/120V AC input
- 3.5kV isolation
- 50KHz switching
- Standard models
- Custom design available

- Output o
- Australia
- 5 year g
- Short ci
- Full loca
- DCLO s
- Conve
- High e
- Fan ou
- Comp

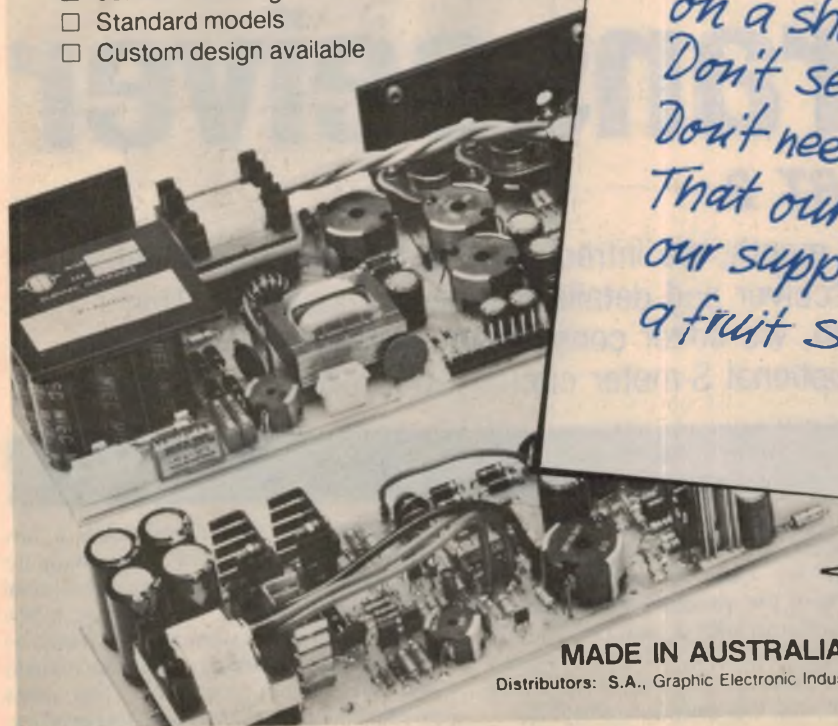

*Peter,*

*How do we tell the industry that our supplies —*

- Don't blow up at 280VAC or on a short circuit*
- Don't self-destruct*
- Don't need a fan over 25°C.*
- That our specs are real and our supplies don't look like a fruit salad.*

*Kevin*



**Scientific Electronics**

6 Holloway Drive, Bayswater,  
Victoria, 3153  
Tel. (03) 762 5777 Telex AA 36308

**MADE IN AUSTRALIA**

Distributors: S.A., Graphic Electronic Industries 42 6655 W.A., W.J. Moncrieff Pty. Ltd. 325 5722



Despite its relative circuit complexity, construction of the new UHF transceiver is quite straightforward. Most of the components are mounted on a printed circuit board (PCB) measuring 162 x 199mm and coded with the Dick Smith type number ZA1510. Two further PCBs, which form the front and rear panels, are soldered at right angles to this main board and the whole assembly fitted into a rugged ABS plastic case.

Both the front and rear panels are supplied with silk-screen lettering featuring white lines on a black background (see last month's front cover). Combine these with an attractive set of matching knobs and a backlit S-meter, and the result is a really professional looking unit that gives little away to expensive commercial equipment.

In designing the new UHF transceiver, Dick Smith Electronics were determined that the job of construction should be made as easy as possible. To this end, all purchasers of the kit receive a detailed instruction manual which describes construction on a step-by-step basis. The parts layout diagram comes complete with a grid pattern and you simply insert each part in turn at the grid location indicated and cross it off the parts list.

In fact, it is almost impossible to make a mistake during construction if the manual is carefully followed. In addition to the usual parts layout and wiring diagrams, the manual includes numerous photographs and diagrams showing every conceivable aspect of construction. It even gives the colour code for each resistor!

As a further aid to constructors, the top of the main PCB is screen-printed with the parts overlay while the underside has a blue solder mask to help prevent

## **BUILD THIS:**

by GREG SWAIN

# **40-channel UHF amateur transceiver**

## **PART 2**

Last month, we introduced the Explorer 1 UHF amateur transceiver and detailed its circuit operation. This month, we cover construction. Alignment details and the optional S-meter circuitry will follow in November.

inadvertent solder bridges. Even so, many of the copper lands are quite close together so care is required when soldering in the various components. A fine-tipped iron with a rating of 15-30W is essential for the job, although a slightly larger iron may be required for soldering the front and rear panels to the PCB.

Constructors should note that a few minor corrections have been made to the parts layout diagram since the initial PCB production run. In particular, a few component labels were missing from the original parts overlay, a situation which has since been corrected. The parts overlay diagram shown with this article is

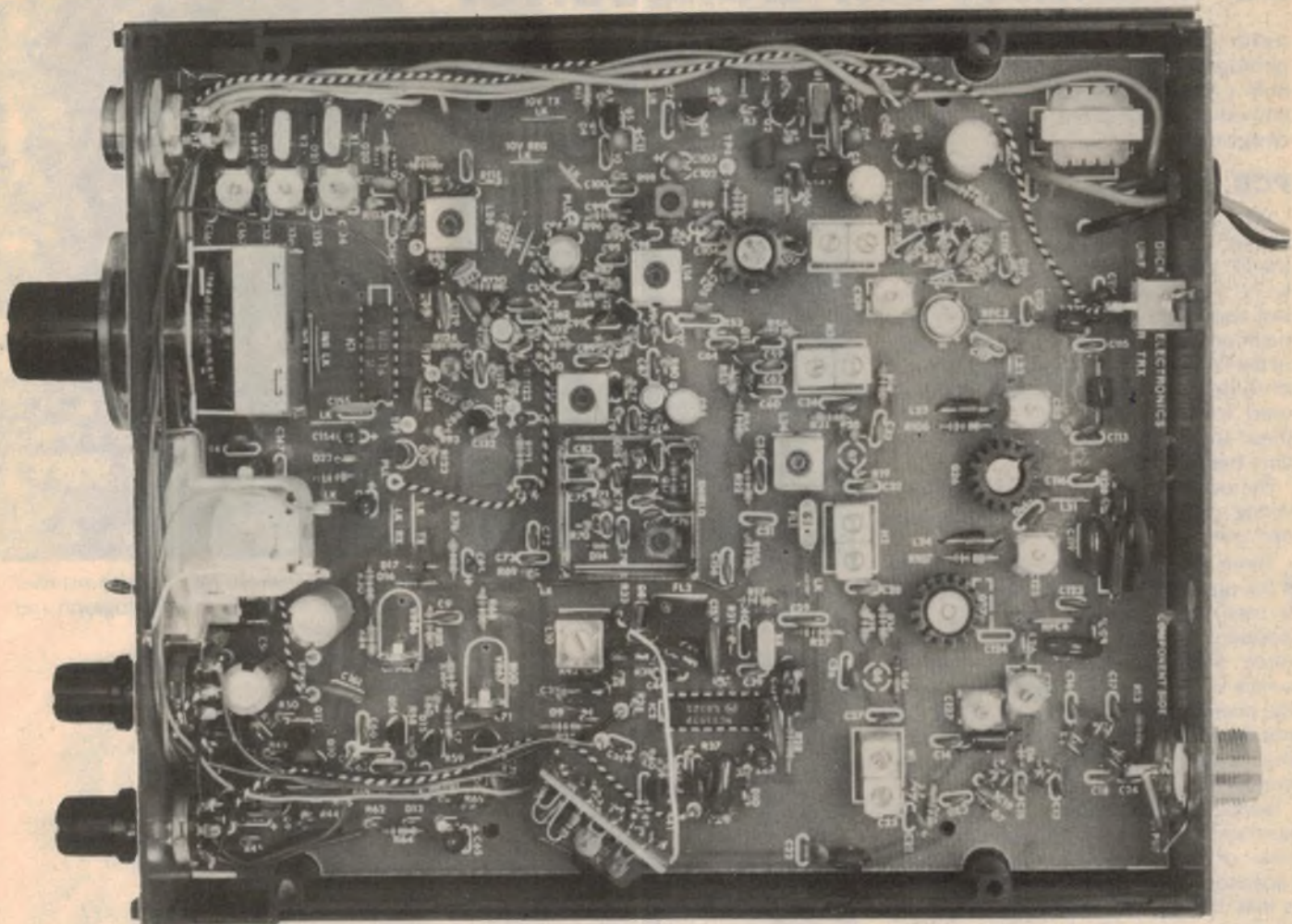

### SPECIAL NOTE

Readers should note that it is illegal to operate transmitting equipment on the amateur bands without an amateur radio licence.

correct and should be referred to if there is any doubt.

### Board preparation

Before actually mounting any of the components, a certain amount of work on the PCB is necessary. The first job is to remove a 3mm strip of solder mask from the earth pattern at either end of the PCB. This is best done by masking off each 3mm strip with masking tape and then removing the solder mask using a cotton bud dipped in nail polish remover.

Alternatively, the solder mask can be scraped off using a sharp utility knife.

A fault that is common to all PCBs in the initial production run is that the solder mask runs right up to the edge of one of the mounting holes for capacitor C34 (adjacent to helical resonator H3). Constructors should therefore scrape

CHANNEL FREQUENCIES			
Switch position	Frequency	Switch position	Frequency
1	438.025	21	438.525
2	438.050	22	438.550
3	438.075	23	438.575
4	438.100	24	438.600
5	438.125	25	438.625
6	438.150	26	438.650
7	438.175	27	438.675
8	438.200	28	438.700
9	438.225	29	438.725
10	438.250	30	438.750
11	438.275	31	438.775
12	438.300	32	438.800
13	438.325	33	438.825
14	438.350	34	438.850
15	438.375	35	438.875
16	438.400	36	438.900
17	438.425	37	438.925
18	438.450	38	438.950
19	438.475	39	438.975
20	438.500	40	439.000

away the solder mask from around the hole to provide a suitable solder land.

It is also necessary to enlarge the mounting hole for transistor Q27 to

1/8-inch. This transistor is actually mounted on the underside of the PCB and secured by a 1/8-inch screw which screws into a brass stud on the compo-

# 40-channel UHF transceiver

nent side of the board (see photographs). The relevant mounting hole is located in the middle of the circle immediately adjacent to the Q27 designation.

## PCB assembly

We are now ready to commence assembly of the PCB. Begin by installing the PC stakes and the wire links. Basically, PC stakes are required at each of the test points TP1-TP4, at the unmarked test point adjacent to L28, and at both ends of the PCB where you removed the strips of solder mask. Four PC stakes are also used to support the VCO shield but these should be left off the PCB for the time being.

The use of PCB stakes for the external wiring connections can be considered optional.

There are 17 wire links on the PCB (16 if the optional 10.7MHz crystal filter FL1a is used) and these are installed at the positions marked "LK". Note that the three links adjacent to the channel switch should all be insulated to prevent the possibility of short circuits. If you are not using the optional crystal filter (FL1a), then install a wire link in this position between the two outside holes.

Having installed all the wire links, the next step is to begin the rather tedious task of installing the resistors and capacitors. The main point to note here is that, because we are dealing with RF, all component leads should be as short as possible. Install the resistors end on only when there is insufficient space to mount them flat against the PCB.

Resistor R111 acts as a coil former for L27, so this coil must be wound before the resistor is inserted. Layer-wind 24 turns of 33 B&S enamelled copper wire onto the resistor body, clean the enamel from the ends of the winding, and solder the ends to the resistor leads immediately adjacent to the resistor body. The resistor can then be inserted end-on in the normal fashion.

Little comment is called for with regard to mounting the capacitors except to point out that you must use the capacitor type designated. Do not interchange greencaps for ceramics or tantalums for normal electrolytics. When mounting the trimmer capacitors, make sure that the red dot on the side of the trimmer is mounted away from the earth pattern. The exception here is trimmer C126 which should be mounted with its red dot towards diode D6.

Do not install capacitors C105 or C124 at this stage. These two capacitors are mounted on the copper side of the PCB and their installation will be covered later. Capacitor C36 (shown dotted on



This photo shows how transistor Q27 is installed. Note also Q6 and C124.



Capacitor C105 (100pF) must be installed exactly as shown in this photograph and in Fig. 4 below.

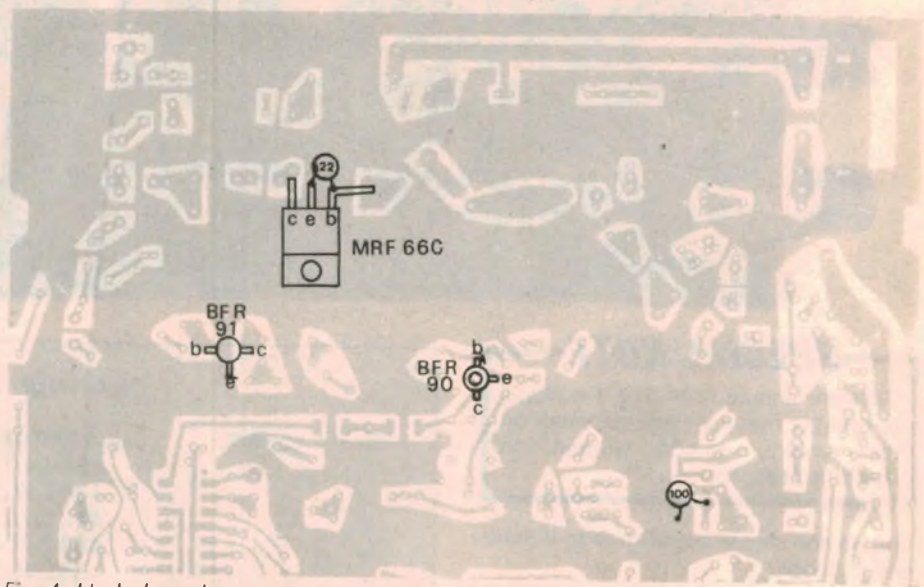

Fig. 4: Underboard component mounting details (Q6, Q7, Q27, C105, and C124).

the parts layout diagram) should be installed only if FL1a is also installed.

By now, the PCB will be beginning to take shape. Once you've got all the resistors and capacitors installed, most of the hard "yakka" is over. The rest is straightforward.

## Semiconductors

The semiconductor complement consists of no less than 23 diodes, 30 transistors and two integrated circuits. Mount the diodes first, again keeping all component leads as short as possible. Diodes D2, D4, D9, D10, D11, D13, and D19 are mounted end on, while the remainder are mounted flat against the PCB in the conventional manner.

Pay particular attention when installing

diodes D6 and D7 (both BA244 types). The cathode end of these diodes is indicated by the red band, not by the two yellow bands which simply indicate the type number. (Red, yellow, yellow = 244. Get it!)

Care is also required when mounting the transistors to ensure correct lead orientation. Double check each transistor against the circuit diagram before soldering it into circuit. Transistors Q1, Q18, Q19 and the small signal plastic pack types should all be mounted so that the transistor bodies are 3-4mm above the surface of the PCB. In practice, this simply involves pushing the transistors down onto the PCB as far as they will comfortably go without placing undue strain on the leads.



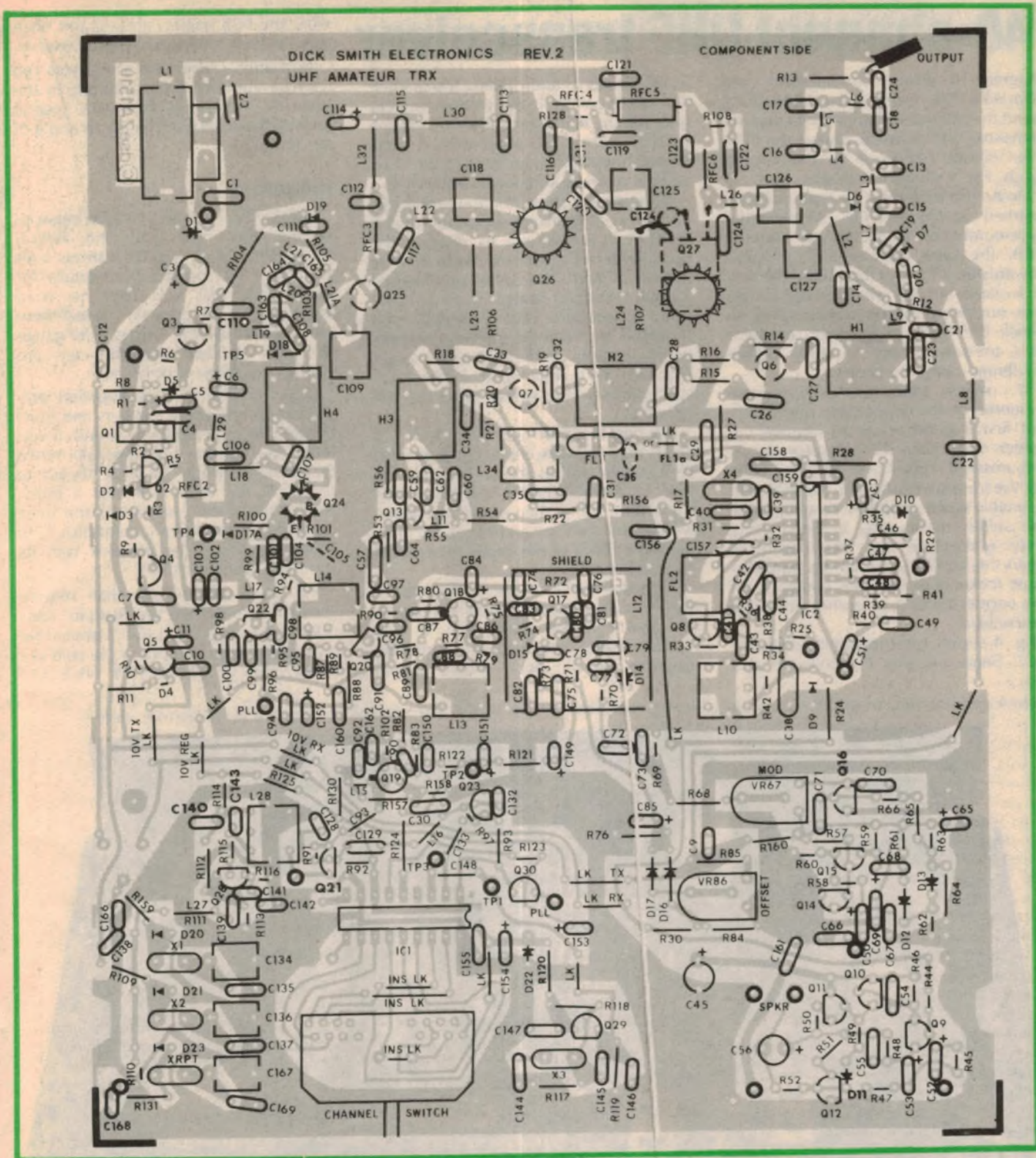

Fig. 3: parts location diagram for the main PCB. Mount the parts in the order indicated in the parts list

The TO-39 package transistors – Q24, Q25 and Q26 – are all mounted flat against the PCB. Note that four holes are drilled at the Q24 location, although only three are used in practice. This was originally done so that an alternative transistor (with a different lead configuration) could be substituted for the 2N3948, but Dick Smith Electronics ad-

vised that they will now only be supplying the latter. The three holes to be used at Q24 are designated e,b,c on the parts overlay, so there should be no confusion as to lead orientation.

The metal cases of Q25 and Q26 must be earthed and to this end you will find a hole in the earth pattern adjacent to each transistor. The earth connections

are made by means of short lengths of tinned copper wire inserted through the holes and soldered directly to the transistor cases. Note that small clip-on heat-sinks are required for Q24 and Q26, but not for Q25.

RF transistors Q6 and Q7 are mounted on the copper side of the PCB and require careful reference to the circuit

# 40-channel UHF transceiver

diagram to ensure correct lead configuration. To install these transistors, bend the leads down and out so that the transistor bodies sit flat against the PCB, then solder the leads to the copper lands. Fig. 4 shows the details.

Do not be misled by the type numbers marked on Q6 and Q7. Whereas the type number for Q6 faces away from the PCB, the type number for Q7 faces towards the PCB — at least that's the way it worked out on the prototype. This may not always be the case however, so check the lead configuration of these two transistors very carefully before soldering them into circuit.

RF power transistor Q27 is also mounted on the copper side of the PCB, but first it is necessary to remove the solder mask from the transistor mounting position. This is best done by marking the transistor outline on the PCB with a suitable scribe, and then scraping away the solder mask using a sharp utility knife. Make sure that you thoroughly clean the contact area, as the transistor must make good thermal contact with the copper pattern to ensure adequate heatsinking.

Fig. 4 shows the mounting details for Q27. Bend and trim the collector and

emitter leads as appropriate, smear heat-sink compound on the mating surfaces and bolt the transistor to the PCB using a machine screw and brass stud. A small clip-on heatsink is then fitted to the brass stud to provide additional heatsinking.

Although not shown on the prototype, additional heatsinking should be added to Q27 if you intend to operate the transceiver in the transmit mode for long periods of time. This can be provided by a small U-shaped heatsink bent up from scrap aluminium (not provided) and mounted between the transistor and the copper pattern on the PCB. Don't forget to smear all mating surfaces with heat-sink compound to ensure good thermal contact.

The base lead of Q27 forms coil L25 and is bent to make contact with an adjacent solder land as shown in Fig. 4 and the accompanying photograph. Capacitor C124 is then connected directly between the base and emitter of Q27. Keep the leads of this capacitor as short as possible.

Capacitor C105 can also be installed at this stage, and must be mounted exactly as shown in the photograph. In particular, make sure that you earth the capacitor at the point shown (ignore

what the PCB overlay shows) and once again keep the leads as short as possible.

Installation of the semiconductors can now be completed by soldering in the two ICs. Note that there are several unused holes adjacent to pins 8 and 9 of IC1 (PLL02A).

## Inductors

At this point, you are ready to begin installing the coils and the helical resonators. Fig. 5 lists the various coils and gives the construction details for those coils that you have to wind yourself. The main points to watch here are that you use the correct wire gauge for each coil and that the coils are wound exactly to specification.

Coils L12 and L17 are supplied pre-wound on red plastic formers and must be mounted the right way round. If you look closely at the coils, you will notice that one side of the coil body has a long rib while the other side has a much shorter rib. In the case of L12, the short rib should be adjacent to capacitor C79, while L17 should be installed with its short rib adjacent to R94.

The only other coils that require special comment are the "hairpin" coils L19-L21, L22 and L26. L19-L21 should be mounted so that the tops of the coils are about 7mm above the PCB, while L22

Below: general view inside the transceiver looking towards the rear panel. The S-meter board is visible at bottom, right.

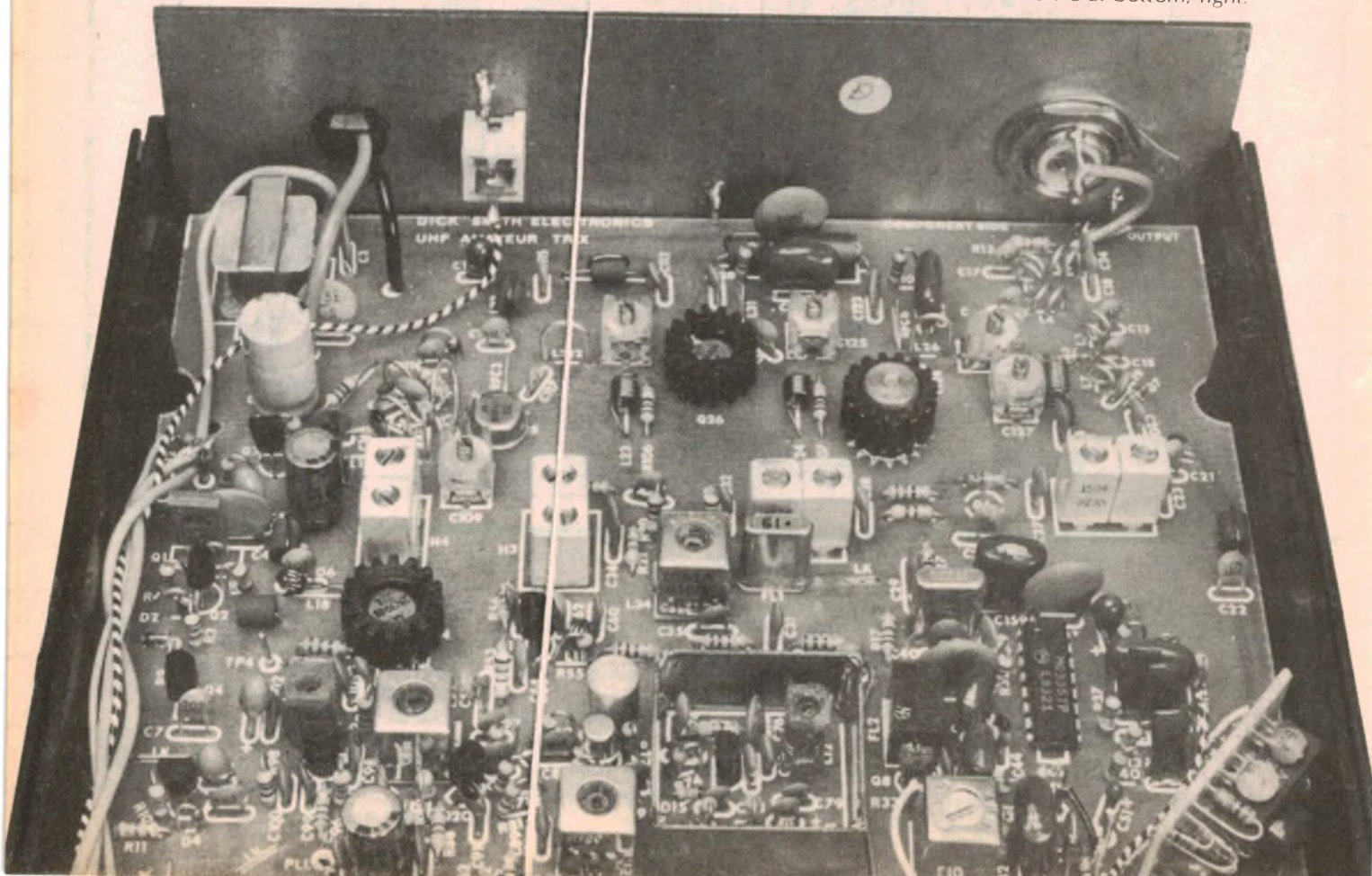

**AMATEURS:  
CAN YOU MEET  
THE CHALLENGE!**

**'HOME BREW' -  
the very latest  
technology...  
build yourself a  
UHF Transceiver**

Remember the 'good old days' of amateur radio? When an amateur built his own gear - and was **so** proud of it! Sadly, those days passed! With incredible advances in technology, it became economically and technically impossible to compete with commercially built equipment. Now home brewing is here again!

And what's more, with the all-new Dick Smith UHF Explorer, you'll end up with a transceiver less than the cost of a commercial unit - and not just as good, **it's better!**

YES! A completely up-to-the-minute design featuring phase-locked-loop frequency synthesis.

It's ready to go simplex as soon as you've finished it - or with the addition of our low-cost upgrade kit, you're able to use repeaters too! Designed in Australia - for Australian conditions, using readily available components - so you'll never have any worries about spares!

And just in case you have any problems building it, we'll even help you out with our 'Sorry Dick, it doesn't work' repair service.

You can't lose!

**SPECIAL INTRODUCTORY OFFER**

For radio clubs, etc - order five or more sets and get a \$30 discount on each! That's right - until October 31 five or more sets will cost just \$169.00 (you can pass the saving on to your members or keep it for the club coffers - a great way to raise money for your club!)

*SPECIAL OFFER MUST END OCTOBER 31 - if stock runs out all orders received before that date will qualify.*

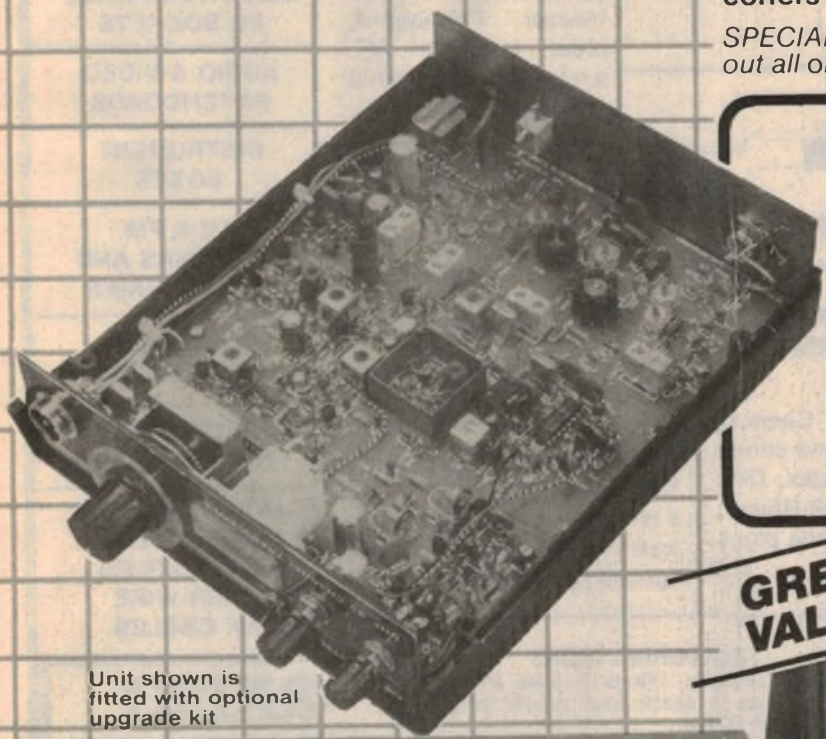

Unit shown is fitted with optional upgrade kit

**SPECIFICATIONS**

Frequency Coverage	438.025-439.000MHz in 25kHz steps
No. of Channels	40
Mode of Operation	FM
Supply	13.8v DC. Receiver 340mA with full audio output and all options. Transmitter 2A more (5 watt output)
<b>Receiver</b>	Dual Conversion Superhet
Sensitivity	0.4uV for 20dB quieting
Selectivity	+/-7.5kHz - 6dB, +/-15kHz - 60dB Better than 80dB
Adj. Chan. Reject	
<b>Transmitter</b>	
Power Output	5W (typical)
Deviation	+/-5kHz
Spurious Emissions	Better than -60dB

**GREAT VALUE!**

**DICK SMITH EXPLORER UHF TRANSCEIVER**

Cat K-6300 **\$169\***  
from only

\*for five or more until October 31

Single price \$199

- OPTIONS AVAILABLE:**
- Upgrade Kit (Cat K-6302)** (Repeater kit, S meter & kit, additional xtal filter & new front panel) ..... **ONLY \$24.50**
  - Antenna Kit (Cat D-4014)** 1/4 wave stainless steel whip, co-axial fed UHF antenna base, PL-259 plug, 3.5m low loss UHF co-ax, gutter grip mount and cutting instructions ..... **ONLY \$24.50**



**DICK SMITH Electronics**

See Page 98 for address details



DSE A571M/PAI

# RADIO DESPATCH SERVICE FOR ELECTRONIC COMPONENTS

## SEMICONDUCTORS

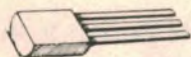

From Texas, NS,  
Motorola, etc.  
4000B Series  
7400 Series  
74C00 Series  
74LS00 Series  
LM300 Series  
LF300 Series  
TLOxx Series

## TEST EQUIPMENT



Fluke, Aaron, GW,  
Hitachi University,  
CRO's, multimeters,  
digital multimeters,  
sew panel meters.

## FERGUSON TRANSFORMERS

Low profile, printed circuit board and conventional types in various voltages and current ratings up to 350VA. Also 110v step down transformers from 30 to 2000VA and special purpose types.



## TOOLS

Side cutters, screwdrivers, wire strippers, wire wrap tools, etc.



FET's, SCR's,  
TRIAC's, UJT's,  
PUT's diodes zeners  
OPTO's displays

## CAPACITORS

Polyester, ceramic,  
monolithic, electro,  
tantalum.



## SWITCHES:

Toggle  
Rotary  
Push button  
Wafer

## RESISTORS

1/4W 1/2W  
1W 5W  
10W  
Also 1% and 2% types.

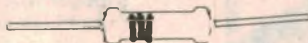

## OCTOBER SPECIAL

E-180 VHS video  
cassettes TDK quality.  
\$15.50 each or  
\$145.00 box of 10.

## WE ARE EVEREADY BATTERY STOCKISTS

## VARTA NI-CAD BATTERIES

## TEXTOL ZERO INSERTION FORCE I/C SOCKETS

## AUDIO & VIDEO PATCHCORDS

## INSTRUMENT BOXES

## TV & FM ANTENNAS AND ACCESSORIES

## ELECTRICAL ACCESSORIES

## RIBBON CABLES From 9 to 50 way

## 2 CORE CABLES 3 CORE CABLES 6 CORE CABLES SPEAKER WIRE CO-AX CABLES

## ILLUSTRATED ANSLEY 609-25s

## LARGE STOCKS OF CONNECTORS

From Ansley, Amphenol, Acme, Belling & Lee, Cannon, etc. Including solder, board mount, ribbon tails and crimp. In series 57, 57F, D, XLP, XLR, AXR, LNE, coax, DIN, BNC, VHF, N, RCA and phone (2.5mm, 3.5mm, 6.35mm) mono and stereo. Also screw terminals and banana plugs and sockets. (Panel and cable mounting).

## MASTER ELECTRONICS LOGIC PROBE MLB-1

TTL/DTL/CMOS 50ns 10MHz  
\$32.40 tax paid.

## POTENTIOMETERS

Trim pots, 1 to 25 t, 1/4" pots  
1 or 10 turns 1/4" carbon pots,  
wire wound pots, slider pots,  
special purpose pots.

## CALCULATORS

Texas, Hewlett Packard and Casio — Scientific, financial and metric programmable and non-programmable from simple four function to "State of the Art" Hewlett Packard HP-41cv.

## SOLDERING IRONS

Weller, Adcola, micro various models and types in stock also Weller solder station WTCPN.

**QUALITY I/C SOCKETS** by Texas and Amphenol, tin or gold in solder or wire wrap types.

# RADIO DESPATCH SERVICE

869 George St., Sydney  
NSW 2000 (Near Harris St.)

Tel. 211 0816  
211 0191

Open: Mon-Fri 8.15am to 5.30pm  
Thursday night late shopping  
till 8.30pm Sat 8am to 11.45am



"QUALITY COMES FIRST" has been our trading principle for over 40 years. This enables us to give you the best in service and the best in products — ensuring durability in what you buy and guaranteed satisfaction.

**MAIL ORDERS TO RADIO DESPATCH SERVICE**  
869 George St Sydney 2000 Tel. (02) 211 0191 • 211 0816

# 40-channel UHF transceiver

and L26 should be the same height as the screwdriver slots on the adjacent trimmer capacitors C118 and C126. Note

also the special shape of L21A (see photograph and Fig. 5).

Assembly of the main PCB can now be

completed by installing the filters and crystals and, finally, the channel switch. As mentioned previously, FL1a and the repeater crystal XRPT are part of the optional upgrade pack. Do not forget to install C36 if you do elect to install FL1a.

The channel switch mounting is a little tricky and requires care to ensure that all the leads pass through the PCB. Screw a lock nut onto the threaded switch shaft, then push the switch down onto the PCB as far as it will go and solder the end connectors first. The switch mounting can now be checked and adjusted as necessary before soldering the remaining pin connectors.

Finally, it is necessary to shield the VCO to prevent spurious radiation into adjacent circuitry. Supplied with each kit is a strip of 1mm-thick double-sided PCB material and this should be cut into four 28mm lengths using a sharp pair of scissors. The four PCB strips are then soldered to PC stakes at the corners of the VCO circuit (see photographs).

The best way to go about this job is to

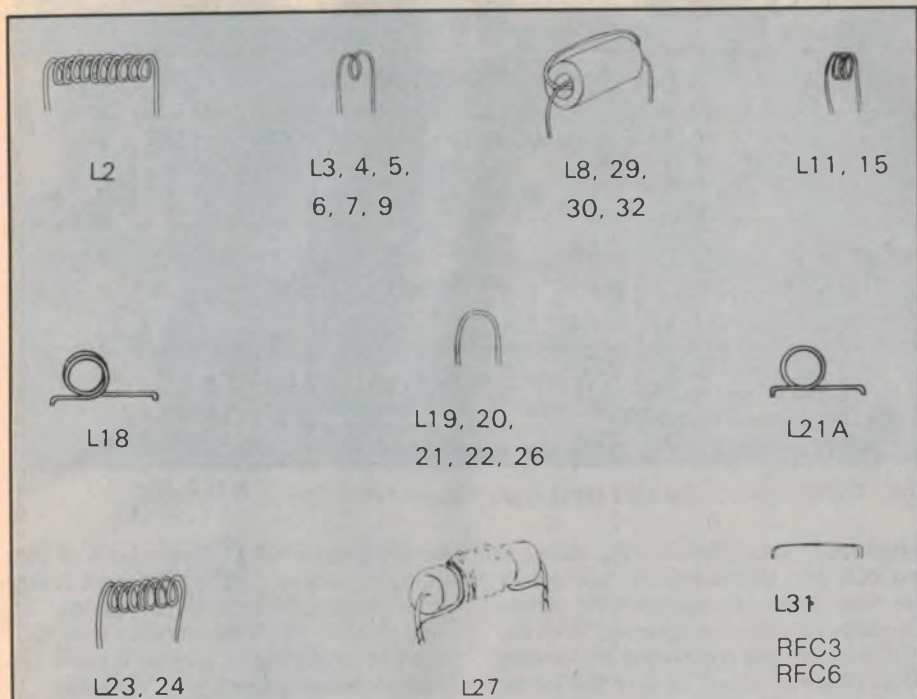

L1	DC choke	L21	hairpin 20 B&S on 3/16-inch mandrel
L2	11T 25 B&S close wound on 1/8-inch mandrel	L21A	1T 20 B&S on 3/16-inch mandrel (see Fig. 5)
L3	2T 20 B&S on 1/8-inch mandrel	L22	hairpin 20 B&S on 3/16-inch mandrel
L4	2T 20 B&S on 1/8-inch mandrel	L23	8T 25 B&S close wound on 1/8-inch mandrel
L5	2T 20 B&S on 1/8-inch mandrel	L24	8T 25 B&S close wound on 1/8-inch mandrel
L6	2T 20 B&S on 1/8-inch mandrel	L25	base lead on transistor Q27 (see text)
L7	2T 20 B&S on 1/8-inch mandrel	L26	hairpin 20 B&S on 3/16-inch mandrel
L8	1T 25 B&S on ferrite bead	L27	24T 33 B&S wound on R111
L9	2T 20 B&S on 1/8-inch mandrel	L28	150MHz coil 004
L10	455kHz coil	L29	1T 25 B&S on ferrite bead
L11	4T 25 B&S close wound on 1/8-inch mandrel	L30	1T 25 B&S on ferrite bead
L12	red coil (VCO)	L31	20 B&S wire link
L13	150MHz coil 004	L32	1T 25 B&S on ferrite bead
L14	150MHz coil 004	L34	10.7MHz transformer
L15	4T 25 B&S close wound on 1/8-inch mandrel	H1	1506 helical resonator
L16	10uH	H2	1506 helical resonator
L17	red coil	H3	1506 helical resonator
L18	2T 25 B&S on 1/8-inch mandrel	H4	1506 helical resonator
L19	hairpin 20 B&S on 3/16-inch mandrel	RFC2	link 22SWG through ferrite bead
L20	hairpin 20 B&S on 3/16-inch mandrel	RFC3	20 B&S wire link
		RFC4	1T 25 B&S on ferrite bead
		RFC5	6-hole ferrite choke, 23 B&S
		RFC6	20 B&S wire link

Fig. 5: Coil details. Note that there is no L33 in the above list. Windings specifying 25 B&S and 33 B&S use enamelled copper wire. All other windings MUST use tinned copper wire, not enamelled wire.

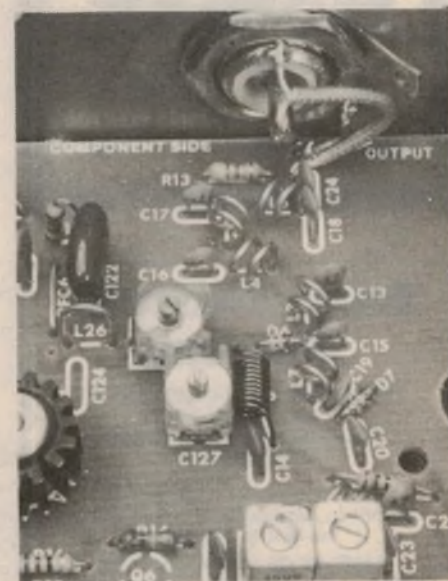

Close-up view of the antenna filter coils. See text re diodes D6 and D7.

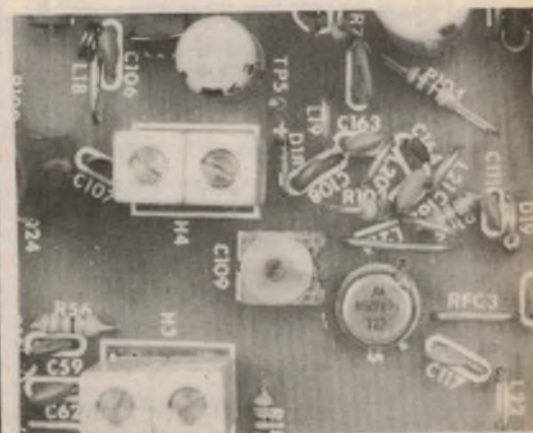

Detail shot showing how L18 on the PCB is mounted.

# Super 80 Users

WE ARE NOW  
OFFERING THE MOST  
COMPETITIVELY PRICED  
RANGE OF PROGRAMMES  
ON TAPE INCLUDING:

- GAMES
- UTILITIES
- WORD PROCESSORS
- FREE SUPER 80  
OVERHAUL INFORMATION

FOR FULL INFORMATION CONTACT

**Bemak**

PTY LTD

PO BOX 218

BELCONNEN ACT 2616

PHONE: 58 6862 OR 51 1558

## Dandy Electronic Discounts

508 Bridge Rd, Richmond 3121  
Phone (03) 428 6887  
(The Little Shop with the BIG  
DISCOUNTS)

Call in and see our huge range of  
Electrolytics, Capacitors, Slider Pots etc, incl  
the hard to find article

### SAMPLES OF STOCK ON HAND

"Philips" Can Electrolytic Board Mount  
220 $\mu$ F-385Va \$4.50 ea. (\$3.00 ea. per 100)  
"Philips" 4.43 Crystal @ \$2.50 ea. (\$1.00 ea  
per 100)  
Triangular Red LEDs 5mm 30c ea. (25c ea per  
100)  
"Siemens" 7 Segment Display LEDs, 10mm  
Yellow, Green, Red @ \$1.00 ea.  
"Philips" Stepper Motors 4-Phase Unipolar No.  
9904-112-05101 @ \$30.00 ea. (\$25.00 ea  
per 10)  
Slider Pots 1c per mm plus 10c for double. eg.  
double 45mm = 55c.  
Philips Plastic 1K, 10K, 11K, 220K @ \$1.00 ea  
"ITT" Industrial H-D Relays SL Series 110V,  
220V, 240V. All @ \$5 ea. (\$4.00 ea per 100)  
"Alps" DPDT Isostat Switches Bank of eight @  
\$3.00 ea. (\$2.00 ea per 100)  
"Ralmar" SDT5 Tweeters 10cm, Bohm 50W @  
\$10.00 ea  
"ICs" 4001 @ 25c (20c ea per 100) 7492 @  
30c ea (25c ea per 100) 74LS192 @ 40c ea  
(30c ea per 100). "Harris" 6508 1K x RAM @  
\$3.50 ea (\$3.00 ea per 100)  
Diode 25amp Press Mount 810181 \$1.00 ea  
(80c per 100)

MINIMUM P & P \$2.00. ADD EXTRA FOR  
HEAVY ITEMS, REGISTERED AND  
CERTIFIED MAIL

# 40-channel UHF transceiver

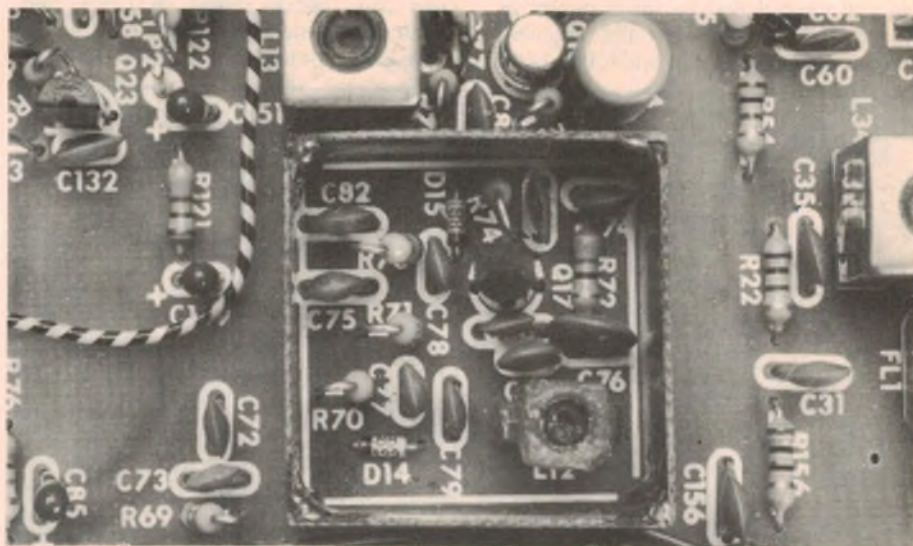

The VCO circuitry is shielded using four strips of 1mm-thick PCB material.

temporarily insert the four PC stakes in the PCB and then carefully tack solder the four strips in position. The whole assembly can then be removed from the PCB and the job completed by running fillets of solder along each of the joints. Finally, the shield can be re-installed and the PC stakes soldered to the PCB to secure the assembly.

### Final assembly

With assembly of the main PCB now completed, attention can be turned to front and rear panels. Mount the various items of hardware on the two panels according to the wiring diagram (Fig. 6), but leave the S-meter to one side for the time being. The channel indicator LED should be secured using epoxy adhesive (eg. "Araldite") and its cathode lead soldered directly to the copper surface of the front panel.

This done, slide the front and rear panels into their respective mounting slots in the case and mount the main PCB using the four self-tapping screws supplied. The PC stakes at the front and rear of the main PCB are now soldered to the two end panels and the case fully assembled to ensure that everything fits together correctly.

Adjust the PCB assembly as necessary, then remove it from the case and run a series of solder connections between the earth track of the main PCB and the end panels. A second lock nut can now be added to the channel switch shaft and the two lock nuts tightened against the front panel to provide additional support for the switch.

Fig. 6 shows the internal wiring details and should be followed carefully. Medium duty 10 x 0.2mm hook-up wire should be used for all power supply con-

nections to switch S1 on the back of the volume control, while the remaining front panel connections can be run in light duty 10 x 0.12mm flexible wire. Do not use single-strand wire as it tends to fracture when subjected to vibration.

The power supply leads are clamped to the rear panel using an in-line cord clamp and the leads terminated directly to the PCB (red for positive, black for negative). Don't forget to fit the 2A fuse to the in-line fuse holder. The antenna connection is run using good quality 50 coax and must be kept as short as possible. Solder the earth braid of the coax directly to metal earth of the antenna socket as shown in the photograph (do not use the solder tag).

The front panel knobs are push-on types designed to fit the splined shafts of the various controls. Fit the knobs to the controls as appropriate and don't worry about the orientation of the channel switch knob at this stage. This will be determined later during the alignment procedure.

Finally, the optional S-meter may be fitted to the front panel (assuming that you bought the upgrade kit). This can be secured using two stout pieces of tinned copper wire or you can use epoxy resin.

Details of the S-meter circuitry and repeater switch wiring will be published next month, along with the alignment procedure.

### Footnote

The following corrections should be noted on the circuit diagram published last month: capacitor C108 should be 5.6pF (not 3.3pF); capacitor C124 should be 22pF (not 15pF); C168 should be designated C169; and C169 should be designated C168.

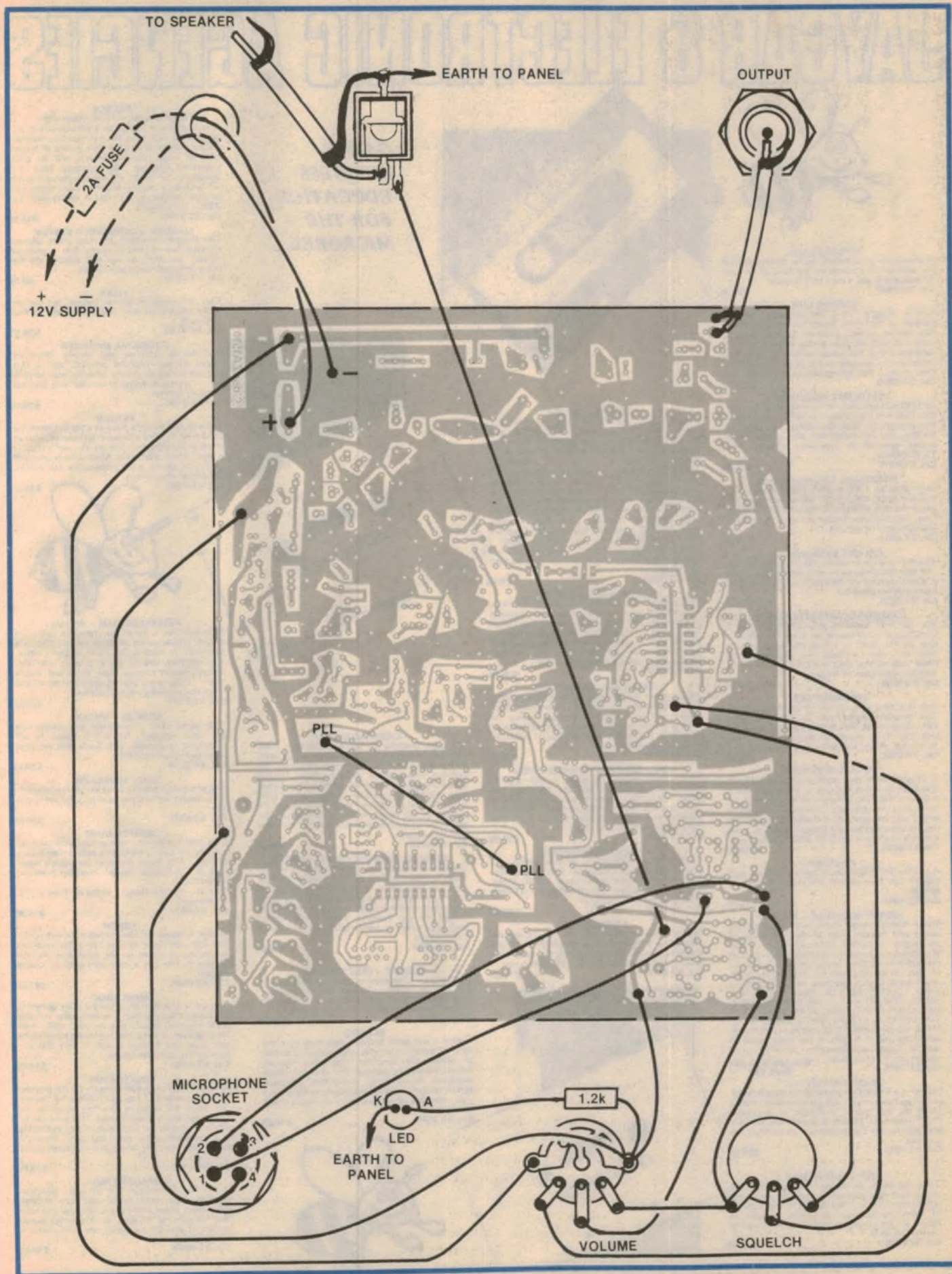

# JAYCAR & ELECTRONIC AGENCIES



## GAMES BUSINESS EDUCATION FOR THE MICROBEE

**KEPLER'S LAWS**  
A simulation of planetary orbits, producing data for analysis by students of the laws of Periods, Ellipses and Areas. Year 11/12 Physics.  
Cat. XE-6900 \$14.95

**GRAPHIC LIFE**  
Life is "played" on a two dimensional grid of squares, so that every square has eight neighbouring squares or cells. Each cell is either alive or dead and each cell lives or dies depending on its neighbour cells. A dead cell with three live neighbours will be brought to life in the next generation. A very intriguing experimenters tool kit.  
Cat. XE-6905 \$14.95

**MILLIKAN'S EXPERIMENT**  
In 1910 Millikan deduced the charge of an electron. Side A is a simulation in HIREC graphics of the experiment. Side B contains a tutorial on Millikan and his experiment and students must answer questions as they work through Year 11/12 Physics.  
Cat. XE-6910 \$14.95

**DISASSEMBLER** By Dreamcards  
Some may say "Not another Disassembler!" But this one has a difference. It allows you to set out where the data fields are so the computer is saving time, not trying to disassemble data. A program you shouldn't be without.  
Cat. XE-6915 \$15.00

**CHEAPIE** By Dreamcards  
Two top quality programs for the price of one. The best Hangman we've seen yet on side A and a superb version of Battleship on side B. Both have excellent graphics.  
Cat. XE-6920 \$15.00

**CANNIBALS AND MISSIONARIES**  
The old logic problem game of transferring 3 Cannibals and 3 Missionaries from one side of a river to the other in a boat that holds two. If there are more Cannibals than Missionaries on either side at any time the Cannibals revert to their favourite form of feeding.  
Cat. XE-6925 \$14.95

**COMPOSER BEE**  
This is a very well written program for music. This program allows you to compose, play, edit, transpose as well as being able to load and save your music. A program that has been a long time in the writing and well worth buying.  
Cat. XE-6930 \$22.50

**WORD ADVENTURE**  
A program with very good graphics using little characters to entice the user to think what word is either a synonym, antonym or homonym of the word they are showing. Everytime you get it wrong you are given more clues. After the clues run out you must face the Dragon when you must spell the word he is holding correctly before you.  
Cat. XE-6935 \$14.95

**PONTOON**  
A quality fast moving card game where up to 6 players can play against the computer who is banker.  
Cat. XE-6940 \$14.95

**WORD PROCESSOR - MYTEK**  
Mytek Wordprocessor comes with a quality ring binder and features most of the commands of the highly acclaimed SPELLBINDER. Mytek Wordprocessor is screen orientated and re-formats the screen to 32 lines, allowing twice the amount of text to be displayed at once. Commands, which are all single keystrokes, included APPEND, BACK, CLOSE, DELETE, EDIT, FORWARD, HOLD, INSERT, KILL, LINE LENGTH, MEMORY, OPEN, PRINT, READ, SEARCH/REPLACE, TOP, UNHOLD, VERIFY, WRITE and EXIT. Mytek Wordprocessor is not a plaything. Although simple to use, it is one of the most powerful cassette based wordprocessors currently available on any microcomputer. Was \$80, now \$35. Save \$45!  
Cat. XE-7015

**MUSIC - B - MYTELK**  
MusicB is a music Composer/Editor that lets you create and save music and sound effects with a flexibility that makes chopsticks of the Basic PLAY command. MusicB is a great way to learn and play music! Comprehensive instructions are included.  
Cat. XE-7010 \$20.00

**STOCK SUPERVISOR**  
This program is the means of creating a stock or product data base which provides an on-line information system. This system is then capable of being continuously and easily updated to reflect all the inventory and accounting aspects of stock on hand.  
Cat. XE-6865 \$15.95

**TRS-BEE - MYTEK**  
TRS-BEE is a package of three programs that loads TRS-80 Model 1 and 3 program tapes into the MicroBee without any additional hardware. Although some program editing will still be required prior to their running the majority of program typing time is saved by TRS-BEE. The first program loads TRS-80 BASIC programs into MicroWorld BASIC. Most programs may then be edited and run. The second program in the package loads any TRS-80 machine code file into MicroBee memory. The third program loads TRS-80 assembler files into the MicroBee EDITOR/ASSEMBLER. Any TRS-80 Model 1 or 3 tape may be loaded. TRS-BEE opens up a whole new world of possible software on your MicroBee!  
Cat. XE-7005 \$30.00

**HOUSEHOLD REGISTER**  
This program will simplify the task of determining the value of your home's contents for insurance purposes, as well as providing descriptions of all listed items in the event of their loss or destruction. Effects are catalogued by name, description and value. Nine separate rooms are provided, and up to 28 items may be listed in each.  
Cat. XE-7000 \$15.95

**STAT PACK - STATISTICS**  
This program is a general purpose graph plotting, linear regression, line of best fit and correlation program. It features a t-test of significance for the correlation coefficient and, if no evidence of correlation is found, a determination of minimum sample size is performed.  
Cat. XE-6999 \$14.95

**LOG - GENERAL PURPOSE INDEX**  
This program is designed to suit a wide range of records where indexing (and later searching) can be on one or two words, or on a string of up to 15 characters. Each record consists of its index heading, plus up to 12 lines of text. Each line can contain up to 41 characters.  
Cat. XE-6890 \$15.95

**PROGRAMMING HINTS**  
Consists of a collection of modules which you may use to improve your own BASIC programs. They are all linked together under a menu driven display which allows you to RUN or LIST each module to see how they work.  
Cat. XE-6895 \$14.95

**PROSPECTOR**  
Arcade game in which you are the prospector attempting to get gold and diamonds which are scattered around the field, and at the same time avoid two drunken bandits who are chasing you.  
Cat. XE-6885 \$14.95

**BUDGET - SPREADSHEET**  
This program is designed to speed up and simplify the task of framing a usable financial budget. Applications range from personal or household to small business finances. A quality program.  
Cat. XE-6850 \$15.95

**SEADOG**  
Seadog a war game between two ships from the days of Nelson. You may play against a friend, or against the computer. The game features limited resolution graphics for the war battle sequences. As well as the enemy fleet, you must survive hazards such as hurricanes, diseases, and your own gun aimers who do not always shoot straight!  
Cat. XE-6845 \$14.95



**DECODE**  
Basic decoder and listing formatter. This programme will be an invaluable aid to any one taking first steps in understanding machine code or wants to expand their library of proven machine code routines. Decode will (a) print imbedded machine code routines fully and accurately (b) print all unprintable characters (c) provide a clearer, easier to read listing and send all output to a printer if so required. ED ASM is not required.  
Cat. XE-6765 \$15.95

**CARDEX - CARD INDEX SYSTEM**  
This program simulates the card index systems of yesteryear in that it neatly files a series of records, and the user can leaf through the file inspecting each record one by one.  
Cat. XE-6755 \$9.95

**FILEX**  
Filex is a larger version of Cardex, but handles larger amounts of data, and also is easier to find "the cards".  
Cat. XE-6760 \$14.95

**FINANCIAL MANAGER**  
Provides an accurate and clearly formatted record of any financial account, and a cost analysis stated in money amounts and percentages - Personal Account Monitor and Business Account Analyst.  
Cat. XE-6750 \$15.95

**TEXTED**  
This program helps to produce a neatly formatted document of word processor appearance, with an absolute minimum of fuss on the user's part. It is the logical alternative when a high powered (and high priced) word processor is not warranted and/or not justified.  
Cat. XE-6745 \$14.95

**ASTEROIDS PLUS - MYTEK**  
Asteroids Plus is one of the finest high resolution graphic arcade games available for the MicroBee computer. It features 3D point by point resolution graphics, shields, sound effects, intelligent objects, guided missiles, black holes and a score board. If you enjoy playing computer games, you will be captivated by Asteroids Plus.  
Cat. XE-6297 \$22.50

**BEEZ 80 - MYTEK**  
This secret code disassembler will disassemble any code sequence. Nothing is illegal, it will allow you to program with codes that no other disassembler can decipher!  
Cat. XE-6298 \$20.00

**SPACE INVADERS**  
One of the most popular programmes ever released. This version was written especially for the MicroBee.  
Cat. XE-6030 \$14.95

**SCREEN DUMP**  
This tape comes with two programmes and can be used on both parallel and serial printers such as Star, FX80, Epson and other compatible types. Side A - Horizontal Dump - executed from net command. Side B - Vertical Dump - executed from CTRL P command.  
Cat. XE-6970 \$14.95

**FORTH**  
A new language for the MicroBee. Comes complete with interpreter on one side of the tape and supporting programs on the other side. As well as this it includes a very well written, bound manual.  
Cat. XE-6965 \$45.00

**MINE DROP**  
You are a tank running around a maze gathering all the supplies you can. It sounds easy, but you have a guided missile hot on your trail. Your only defence is a remote controlled mine which you drop and explode at will. A very fast joystick or key controlled game.  
Cat. XE-6960 \$14.95

**PENETRATOR**  
A low resolution graphic version of the popular game "Scrambler". You must defeat the rockets and bomb the radars in an effort to get to the next stage which is even harder. This game can be either controlled by a joystick or by keys. Being in Lores graphics it is a very fast game. If you are bored with the same land pattern you can devise your own.  
Cat. XE-6955 \$19.95

**SPACE PATROL**  
A lot like Penetrator but in high resolution graphics. You must battle your way through the various stages where at the last stage you have four chances of blowing up a neutron bomb shelter. If you are successful, the next round is a lot harder.  
Cat. XE-6950 \$16.95





# NO.1 FOR MICROBEE SOFTWARE!

## DATAFILE

This program is a well written data base management system that utilizes the MicroBee to its fullest to provide a Data Management System similar to those found on larger and more expensive systems. This comes complete with large bound manual. **Cat. XE 6945 \$10.95**

## TEACHERS MASTER TAPE

This tape allows the user to enter 20 words for a spelling list. These words are then at a later stage displayed back on the screen in clear graphics with four options of speed and display time. It makes a very useful program. **Cat. XE 6985 \$21.50**

## FRACTIONS AND DECIMALS

Side one of the tape goes through a graphic tutorial of what fractions are and what they look like. Side two explains what equivalent fractions are and also introduces decimals to two decimal places. A well written tape which uses graphics to its fullest to teach the principles. **Cat. XE 6980 \$16.95**

## NUMBER HANGMAN

A graphic game which helps improve times in solving mathematical questions. You must answer the question before the hangman has time to hang himself. Optional times and difficulty are available making it suitable for everyone. **Cat. XE 6990 \$12.50**

## MEASUREMENT

This tape starts from scratch and defines the unit of measurement and what its other equivalents are. It gives exercises converting, measures small and large to the standard metre. It continues on to show perimeters, length and area and giving various exercises on the way. Another program that uses graphics to prove a point. **Cat. XE 6998 \$12.50**

## MULTIPLICATION TABLES

This program is directed more at operation rather than age or grade. It uses graphics to enhance the display and optional time limits and difficulty to bring anyones multiplication tables up to scratch. **Cat. XE 6975 \$10.95**

## ALGEBRA 1

This program introduces the uses of pronumerals as theoretical numbers with simple problems. Simple algebraic equations are treated showing collection of like terms, etc. It then gives exercises to try to further push the principles of algebra. **Cat. XE 6995 \$12.50**

## METEOR RESCUE - MYTEK

Your mission is to rescue stranded astronauts. You are the commander of the Landing Module docked in space with the mother ship. It is your responsibility to guide the landing module through a meteor field, down to the surface of the planet, to land safely on a landing pad. An astronaut will then run to your landing module and you will blast off. You must use your lasers if necessary and dock with the mother ship again. A total of six astronauts must be shuffled to the mother ship. **Cat. XE 7020 \$17.50**

## STARVILLE CASTLE

Starville Castle is an adventure which will take you to a far away place of mystic castles, fierce monsters and evil warlocks. You must enter the warlocks castle and find some dark secret which will help you to destroy the warlock. But remember, you only have until dusk. **Cat. XE 6285 \$16.95**

## CARAGE

A fast exciting graphic game for the MicroBee. You must weave your way through a field of cars and oil slicks to produce the highest score. If you're too good at one speed then try the next (10 speeds to choose from!). **Cat. XE 6700 \$11.95**

## EYE OF MIN (32K)

An adventure game with a difference in that it gives you a picture of where you are. Once you enter the castle you are given a floor plan making it easier than moving in the dark. A very thrilling adventure game. **Cat. XE 7025 \$14.95**

## MORSE CODE TUTOR

Perfect for all you budding young amateurs. Quality program which covers the full alphabet random letters, and allows you to enter a sentence in English and plays it back in morse, plus more. **Cat. XE 6880 \$14.95**

## PSYCHOTEC By Dreamworks

Psychotec provides a striking example of artificial intelligence, allowing a dialogue in English between computer and operator, the computer playing the role of psychiatrist and the operator being a "patient" on the couch. Leaves other "similar" types for dead. **Cat. XE 6875 \$15.95**

## MERLIN By Dreamworks

Merlin is a 32K adventure set in England during the dark ages. Your task is to search through the dark forest inhabited by robbers, outlaws and creatures with awesome magic powers to find a legendary sword. An excellent adventure. **Cat. XE 6870 \$25.95**

## TAUNTZE

The famous old addictive dice game. Try to beat your own best score. Up to 3 players. **Cat. XE 6866 \$14.95**

## UNDERWORLD OF KYN

Underworld of Kyn is an advanced adventure, average playing time to complete the game is about 10 to 12 hours for this reason it is recommended for experienced adventurers. **Cat. XE 6840 \$14.95**

## BACKUP

A program to assist you in making backup copies. Allows you to load in a file loaded at 300 baud and save it again at 200 baud or 1200 baud. **Cat. XE 6780 \$11.95**

## OTHER MICROBEE THINGS

### RE MODULATOR FOR MICROBEE

Allows you to connect your MicroBee to your TV. **Cat. XE 8052 \$17.50**

### REPLACEMENT CASE

**Cat. XE 6300 \$29.50**

### EDITOR ASSEMBLER IN ROM

**Cat. XE 6505 \$59.50**

### WORDBEE IN ROM

**Cat. XE 6505 \$59.50**

### 5 1/4" MEMOREX DISKETTE

Double sided, double density, soft sector. **Cat. XE 3510 \$6.95**

### MICROBEE PLUGPACK

**Cat. XE 5410 \$17.50**

### MICROBEE MONITOR LEAD

**Cat. XE 5420 \$9.50**

### QUALITY BLANK COMPUTER CASSETTES

**XE 3530 C10 \$1.10 \$0.99 \$0.90**

**XE 3540 C20 \$1.20 \$1.08 \$0.99**

**XE 3545 C30 \$1.40 \$1.26 \$1.15**

**1-9 10-19 20 or more**

The quality tapes are supplied to us in boxes of 20, so make it easier and buy at our special 20 or more price and save money!

FREE "Survivor" program with every Joystick \$15 value!

## Replacement Battery for Backup Circuit

**Cat. XE 8030 \$5.50**



## MICROBEE JOYSTICK

New for the MicroBee is the Quickshot Joystick. Connects straight into the MicroBee's I/O port and provides real time action in games. This unit can be mounted on a table with its suction cups giving one handed operation. With its contour design and very fast response this unit will give you the edge in winning computer games. **Cat. XE 7030 \$49.95**

Comes with special MicroBee plug and circuitry to interface directly with your MicroBee. Do not confuse with units that will not work with the MicroBee!!!

**\$49<sup>95</sup>**



**An introduction to microbee personal computers and programming.**  
Your First 100 programs.

**WILDCARDS**  
Volume One  
A potpourri of application notes and tips for the MicroBee Personal Computer

## INTRODUCTION TO MICROBEE YOUR FIRST 100 PROGRAMS

This book is specially prepared for people who have never had their hands on a computer before. **Cat. XE 8010 \$14.95**

## MICROBEE BASIC MANUAL

The very manual that is supplied with the MicroBee is available separately. **Cat. XE 8005 \$14.95**

## EDITOR ASSEMBLER TECHNICAL INSTRUCTION MANUAL

**Cat. XE 8000 \$11.50**

## WORDBEE TECHNICAL INSTRUCTION MANUAL

**Cat. XE 8001 \$15.95**

## WILDCARDS VOL 1

A potpourri of application notes and tips for the MicroBee. Excellent book. **Cat. XE 8015 \$15.00**

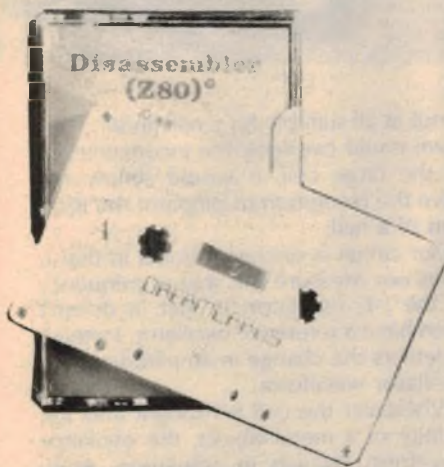

**Jaycar**

Incorporating  
**ELECTRONIC AGENCIES**

## SYDNEY

125 & 117 YORK STREET - PHONE: (02) 264 6688 and (02) 267 1614

## CARLINGFORD

Cnr. CARLINGFORD & PENNANT HILLS ROAD - PHONE: (02) 872 4444

## CONCORD

115 - 117 PARRAMATTA ROAD - PHONE: (02) 745 3077

## HURSTVILLE

121 FOREST ROAD - PHONE: (02) 570 7000

## NUMBER 1 FOR KITS

POST AND PACKING CHARGES  
\$5 - \$9.99 (\$1.50) \$10 - \$24.99 (\$3.20)  
\$25 - \$49.99 (\$4.50) \$50 - \$99.99 (\$6.50)  
\$100 - \$199 (\$8.00) Over \$199 (\$10)

\*Free INSURANCE for Road & Registered Post over \$200\*  
All heavy or bulky items (over 20kg) sent Comet Road Freight \$12.00 anywhere in Australia

SHOP HOURS CARLINGFORD, CONCORD & HURSTVILLE

Mon - Fri 9am - 5:30pm Sat - 9am - 12pm Thurs night 8:30pm

SHOP HOURS SYDNEY

Mon - Fri 8:30am - 5:30pm Sat - 8:30am - 12pm Thurs night 8:30pm

MAIL ORDERS AND CORRESPONDENCE: BOX K 39 HAYMARKET, SYDNEY 2000



Mail Order

By



**BANKCARD**

Via Your Phone

# Nail Finder: the electrician's mate

Basic  
Electronics



by  
COLIN DAWSON

The nail finder is an essential tool for any home handyman. It will help locate timber studs behind Gyprock or plasterboard wall surfaces and also locate pipes buried in walls.

Actually this article arose as the result of a home renovation project carried out by one of our staff members. The said staff member had to put new skirting boards in a large room with Gyprock surfaced (plasterboard) walls. He had great difficulty in locating the timber studs so that the skirting boards could be nailed to them.

Where a tradesman has to do this sort of job he would normally locate the wall studs by banging along the wall with his "calibrated" fist or knuckles. Unfortunately, our said staff member did not have such a calibrated fist and so quite a

few nails were banged through the skirting boards and then into thin air rather than into solid timber studs. Naughty words were said. But out of this frustration grew this neat little device which really works well.

Just move it along a wall and it will flash its LED whenever it passes over a hidden nail. Voila! No more bashing nails into the void between studs. And if you have to drill into masonry walls, use the Nail Finder at the spot you intend to drill and it will tell if a water pipe is buried just under the cement render (although not if it is buried very deep).

Having decided to produce this Nail Finder project we tried a number of circuits with varying success. The circuit we have finally settled on is based on a commercial device but we believe our unit is superior, as well as using readily available bits and pieces.

In fact, this is an ideal junk box project. If you use all new parts the cost will probably be around \$15 or so but if you can raid your junk box you may end up paying only \$5 or even less. The prime resource in this case is an old pocket transistor radio. If you have an old one of these you already have the most costly parts: the case and the small antenna rod. But more of this later. Let's talk about the circuit.

## How it works

Metal locators always employ at least one L-C (inductance-capacitance) type oscillator. The inductor (or "search coil") undergoes a change of inductance whenever a piece of metal is placed in its magnetic field. This causes the oscillator frequency to shift and by measuring this shift with respect to a stable reference frequency, we can detect the presence of a metal.

With expensive treasure hunter type metal locators the search coil is quite large — up to 40cm for some models. Although this improves the sensitivity, it

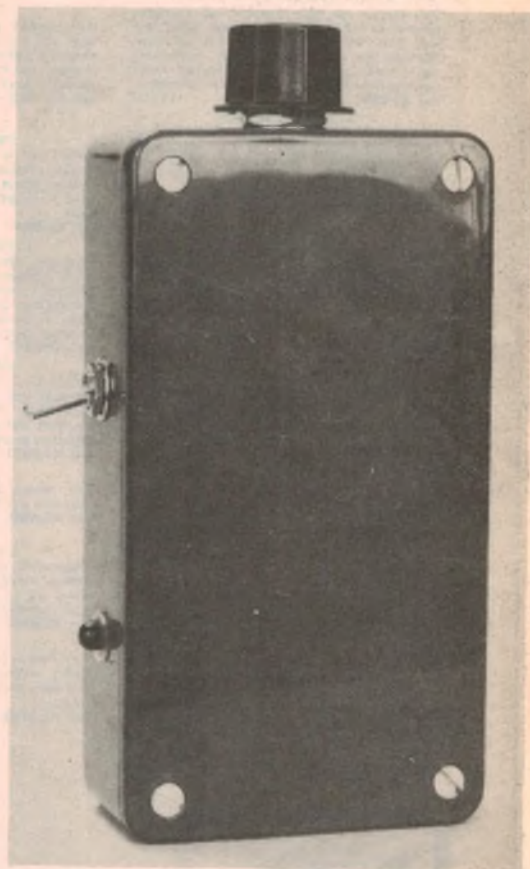

is not at all suitable for a nail finder. Even if we could overlook the inconvenience of the large coil, it would simply not have the resolution to pinpoint the location of a nail.

Our circuit is unconventional in that it does not measure the shift in frequency of the L-C oscillator. In fact, it doesn't even have a reference oscillator. Instead, it detects the change in amplitude in the oscillator waveform.

Whenever the coil is brought into the vicinity of a metal object, the oscillator waveform reduces in amplitude. Additional circuitry detects the reduced signal and drives an LED indicator.

If you now have a look at the circuit you will see that it uses just four transistors and very little else. Q1 is the oscillator while Q2, Q3 and Q4 monitor the oscillator amplitude and turn on the LED.

## PARTS LIST

- 1 printed circuit board, 55 x 27mm, code 83m9
- 1 ferrite antenna rod (approx 55mm long)
- 1 plastic box 113 x 63 x 29mm
- 1 miniature SPST switch
- 1 9V battery, Eveready 216 or equivalent
- 1 Battery snap to suit
- 1 Knob to suit potentiometer
- 4 metres of 0.2mm enamelled copper wire

### SEMICONDUCTORS

- 2 BC549C NPN transistors
- 2 BC547 NPN transistors
- 1 1N4148 diode
- 1 5.6V 400mW zener diode
- 1 red light-emitting diode and bezel

### CAPACITORS

- 1 10 $\mu$ F/10V electrolytic
- 1 .01 $\mu$ F metallized polyester (greencap)
- 1 .0033 $\mu$ F greencap

### RESISTORS (1/4W, 5%)

- 1 x 390k $\Omega$ , 1 x 68 $\Omega$ , 1 x 10k $\Omega$ , 1 x 1k $\Omega$ , 1 x 330 $\Omega$ , 1 x 20k $\Omega$  vertical trimpot, 1 x 500 $\Omega$  potentiometer

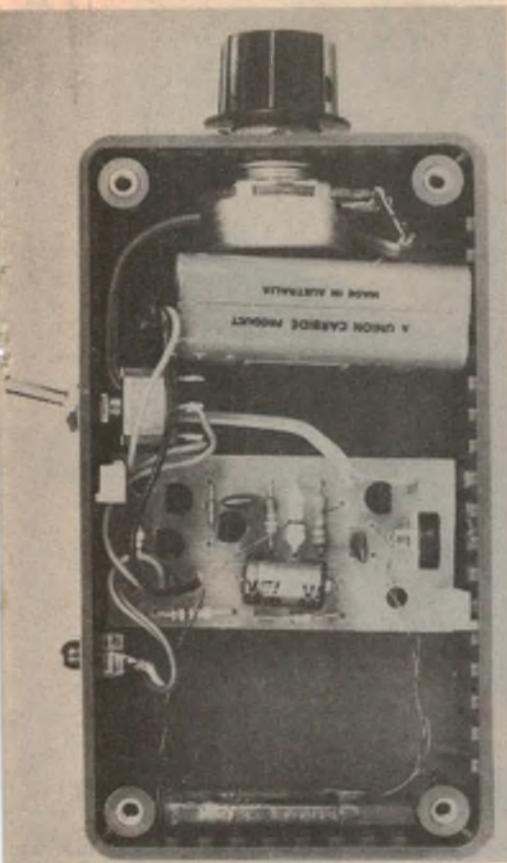

Left: The finished nail finder and, right interior view showing the general layout.

We estimate that the current cost of components for this project is approximately

**\$10**

This includes sales tax, but not the cost of a box or battery.

Q1 has a tuned collector load and maintains oscillation by virtue of positive feedback via coupling from the collector coil winding to the winding in series with the base. (Both windings are on the same ferrite rod.) The amplitude of the oscillation can be adjusted precisely by trimpots in the emitter circuit of Q1.

Introducing a metallic object such as a nail into the magnetic field between the two windings actually causes losses and so the oscillator amplitude is reduced. By contrast, placing a piece of ferrite in the vicinity of the two windings will increase the oscillator amplitude.

The 0.003 $\mu$ F capacitor in parallel with the collector winding of Q1 simply determines the frequency of oscillation, which is around 170kHz.

Q2 monitors the oscillator amplitude in the following way. Its base is held at a nominal 0.8V by the 68k $\Omega$  and 10k $\Omega$  resistors which also provide the DC bias

for Q1. At the same time there is a silicon diode in the emitter circuit for Q2 so that the 0.8V bias is insufficient to turn it on, when Q1 is not oscillating.

Q2 controls a Darlington pair consisting of Q3 and Q4 which drive the LED indicator. With Q2 switched off, the base of Q3 is pulled high by the 390k $\Omega$  resistor. This causes the Darlington pair to switch on and drive the LED indicator (via a 330 $\Omega$  current limiting resistor).

So far, we have assumed that Q2 is subject to DC conditions only, with its base held at about 0.8V. In fact, whenever Q1 is oscillating an AC signal will be superimposed on the 0.8V base bias of Q2. When the oscillations are of sufficient amplitude, the positive peak of each cycle will take the base of Q2 above its switch-on threshold.

In other words, the higher the oscillation amplitude the more Q2 will conduct and so reduce the voltage at its collector which is smoothed by a .01 $\mu$ F capacitor. Under normal conditions Q1 is oscillating and the trimpots in its emitter circuit are adjusted so that the level of oscillation is just sufficient to maintain

Q3 and Q4 barely in conduction so the LED is just a glimmer. At this point a slight decrease in oscillation, due to a metallic object in close proximity to the coil, will cause the LED to light fully.

The 20k $\Omega$  trimpot is used to set the detector as near as possible to its trigger point and the 500 $\Omega$  potentiometer – the sensitivity control – is used for the “fine tuning”. Once the trimpot has been set for a given environment, it will normally only be necessary to use the sensitivity control.

The supply rail to the oscillator and detector circuit is regulated by a 5.6V zener diode. This prevents the supply rail from varying widely due to the LED be-

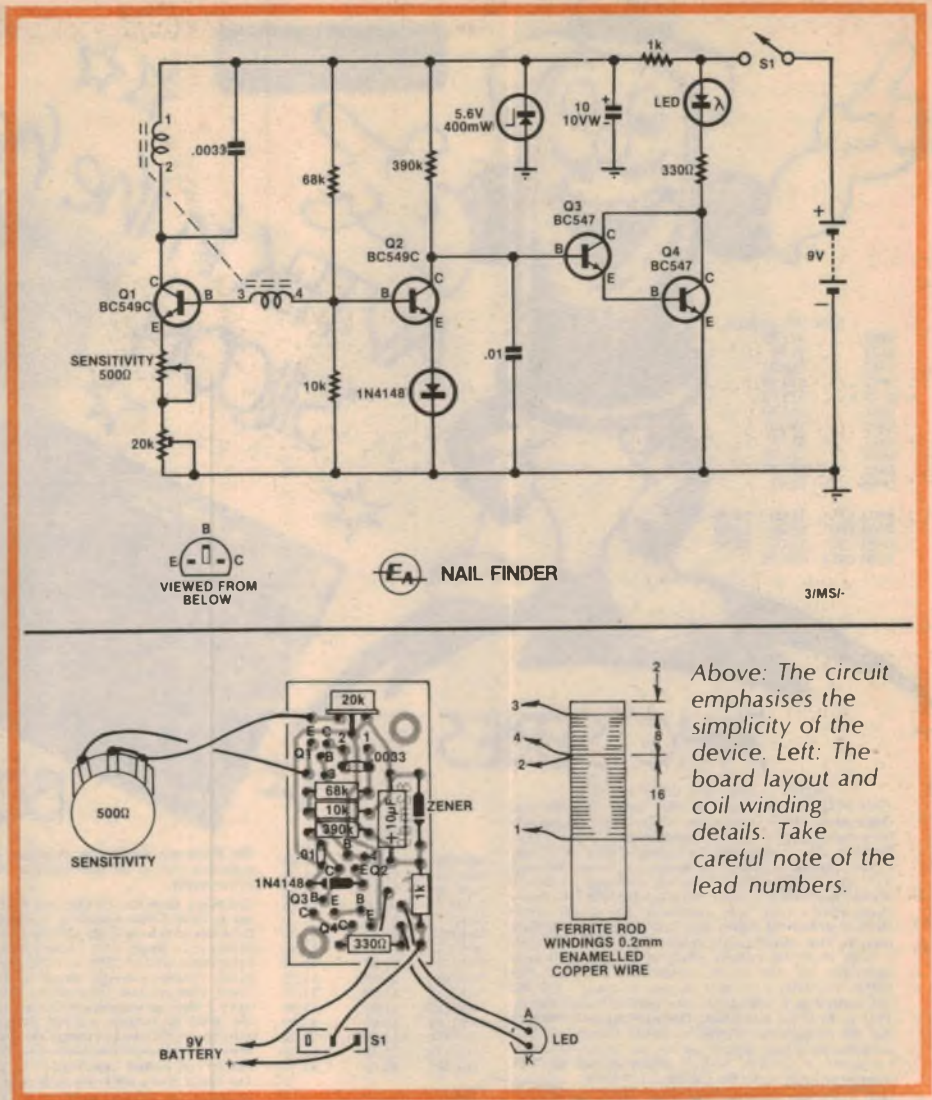

Above: The circuit emphasises the simplicity of the device. Left: The board layout and coil winding details. Take careful note of the lead numbers.

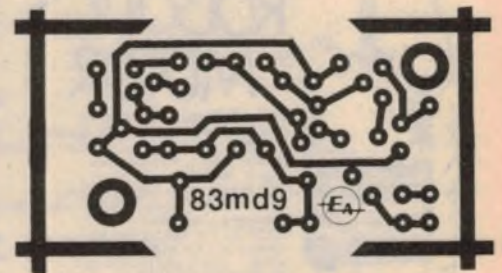

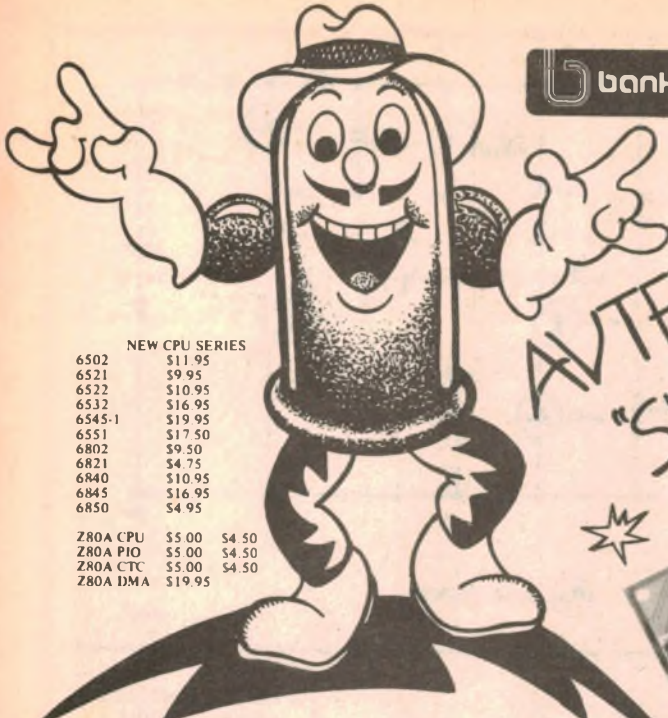

AVTEK in the heart of "ALLEY" SILICON

**NEW CPU SERIES**

6502	\$11.95
6521	\$9.95
6522	\$10.95
6532	\$16.95
6545-1	\$19.95
6551	\$17.50
6802	\$9.50
6821	\$4.75
6840	\$10.95
6845	\$16.95
6850	\$4.95

280A CPU	\$5.00	\$4.50
280A PIO	\$5.00	\$4.50
280A CTC	\$5.00	\$4.50
280A DMA	\$19.95	

## 74HC SERIES

**WHAT IS THE 74HC CMOS SERIES?**  
 74HC CMOS is a family of High Speed SSI MSI logic components. High speed logic circuits have historically been the domain of bipolar circuits, namely TTL and ECL. However due to improved processing, CMOS technology is now capable of speeds similar to low power Schottky TTL logic, whilst still retaining the advantages of the CD 4000B and MM74C series circuits. The MM74C family characteristics have been standardized to ensure compatibility within the family and ease designing with these devices. The overall family concept has been to provide a series of CMOS circuits which retain the input noise immunity and low power consumption of metal gate CMOS, but offer a ten fold increase in speed. The MM 74C series logic is intended to be a "self sufficient" family. That is, an entire set of logic functions are provided such that the designer can develop his family entirely of "HC" components. These devices are pin out and functionally compatible to LS-TTL circuits, which enables the TTL designer to easily make the transition to CMOS.

**74HC SERIES**

	1-9	10+
74HC00	\$1.25	\$1.15
74HC08	\$1.25	\$1.15
74HC10	\$1.25	\$1.15
74HC11	\$1.60	\$1.45
74HC27	\$1.30	\$1.20
74HC30	\$1.30	\$1.20
74HC73	\$1.60	\$1.45
74HC74	\$1.60	\$1.45
74HC86	\$1.70	\$1.55
74HC112	\$1.60	\$1.45
74HC139	\$1.95	\$1.85
74HC164	\$2.99	\$2.80
74HC174	\$2.50	\$2.30
74HC175	\$2.50	\$2.30
74HC367	\$4.99	\$4.50

The Multiprom board is an extension of the Microbees memory in ROM. It simply plugs into the fifty way bus expansion port on the core board. It fits either neatly inside the Microbee or behind it, using the Microbee's own power supply.

The board takes the EDASM and NET eeprom normally residing inside the Microbee, but allows several different sets to fit in: Editor-Assembler, Wordbee Logo, MiniPascal, Networkrom, Bemon or your own program. It has room for 4 sets of eeproms in the EDASM location and 3 sets of eeproms in the NET location, a total of 44K of eeprom. The board can be simply daisy chained with up to 6 slave boards (using an outside power supply in this case), allowing a maximum total of 308K in ROM. The EDASM locations accept either type 2532 or 2764 eeproms and they can be mixed. Another powerful feature of the board is the input/output system. 11 outputs, open collector transistor driven. Each can turn ON or OFF a relay under program control. 8 inputs, buffered and protected can read 8 switch status - ideal for computer controlling of model trains, alarm systems, tape recorders, machinery etc. The Avtek kit includes a plated through board plus all components to make this exciting project. There is also provision on the board to change the address of the ports used for eeprom selection and input/output.

A NEW KIT  
**MICROBEE**  
**MULTIPROM**  
**INTERFACE**  
**BOARD ONLY \$99**

**SEE ETI OCTOBER 1983 FOR FULL DETAILS**  
 The Pulsar Series 6000 microcomputer card has been designed to provide a cost-effective general purpose central processor that will find application in a wide range of systems, from stand-alone and dedicated control processors to multi-processing and network configurations. While the 6000 Series is fully compatible with the industry standard STD Bus, attention was given to partitioning the circuit so that a complete disc-based computer system could be constructed using just one card. Included on the board is: Z80A processor operating at a full 4MHz, 64Kbytes dynamic RAM, single double density floppy disc controller, two RS232C serial I/O ports, 2Kbytes EPROM boot-strap monitor and battery-backed real-time clock and calendar.

Interfacing to the STD bus allows systems to include modules from a range of over 1800 cards available from some 80 manufacturers.  
 Card Includes:  
 - Power-on automatic bootstrap to CP/M system in on-board EPROM  
 - Real time clock chip with battery backed supply  
 Bus Interface  
 - All signals meet STD Bus electrical specs.  
 External Connections  
 - 50 way edge connector provided for 8" floppy disc connections  
 - 1 16 pin RS232C for terminal connection  
 - 1 16 pin RS232C for printer connection  
**FULL KIT - PHONE FOR FINAL PRICE**  
 PCB - MANUAL & ROM ONLY \$149.00



**ROBOTICS MOTOR**

\$9.99

24 Volt but runs perfectly on 12 volts DC. Output speed @ 12V approx 40 RPM. Current drain @ 12V No load approx 100mA. Stalled current approx 200mA.  
 Size: Overall 55mm long by 35 mm wide. Shaft length 20mm and diameter approx 4mm.  
 MADE BY CANON OF JAPAN  
 ABOUT 30% OF NORMAL PRICE  
 SAVE - BUY 4 UNITS FOR \$35 OR ONLY \$9.99 EACH

**LITTLE BIG BOARD FROM \$149**

"Reach the World" FOR AROUND \$200



**NEW MODEM**

THIS IS THE PRE-RELEASE INFORMATION ON A BRAND NEW MODEM KIT THAT IS DUE FOR RELEASE IN NOVEMBER - THIS KIT WILL 'KILL' ALL OTHER KITS AVAILABLE IN ITS TOTAL COMMUNICATION WITH THE WORLD - READ ON  
 Modulation - Frequency shift keying. Digital interface - RS-232C. Auto answer and disconnect. Data communication to basic Bell or CCITT specifications giving a world data communications capability. Operates with your normal phone. 300BPS or 1200 BPS with backward channel 75 BPS. Indicators and test switch. Auto answer or manual connect. Backward channel standard on 1200 BPS mode. Direct connection, inbuilt line isolation unit. Operates in the following modes - Bell 103 originate 300 BPS. Bell 103 answer 300 BPS. Bell 202 equalised 1200 BPS. Bell 202 1200 BPS. CCITT V23 mode 2 equalised 1200 BPS. CCITT V23 mode 2 1200 BPS. CCITT V21 originate 300 BPS and CCITT V21 answer 300 BPS.  
 AND IT'S COMING SOON!  
 THE PRICE? AROUND \$200 - THAT'S HUNDREDS LESS THAN THE NEAREST EQUIVALENT!

**AVTEK**  
 (ELECTRONICS) Pty. Ltd.

TWO GREAT LOCATIONS  
 119 YORK STREET, SYDNEY 2000  
 PHONE: (02) 267 8777  
 (Above Charlie Browns Place)  
 172 LIVERPOOL ROAD (HUME HIGHWAY), ENFIELD  
 PHONE: (02) 745 2122  
 All Correspondence to  
 P.O. BOX Q302, QUEEN VICTORIA BUILDING, SYDNEY 2000

POST AND PACKING  
 Divide the value of your order by 20 (5%) to get post and packing value and then add \$2.00 - it's that simple!  
 All Bankcard orders can only be sent to a normal address (NOT a P.O. Box). All Bankcard orders will be sent by registered mail (add \$3 to P&P charges).  
**ENFIELD OPEN ON SUNDAY**



## Nail Finder: the electricians mate

ing turned on and off. The 5.6V zener is a 400mW type. 1W types should not be used as they require more current to regulate properly.

An old pocket transistor radio with an all-plastic clip-together case would be ideal for this job. If you can salvage the ferrite rod as well, so much the better.

If selecting a commercial box for the project, choose one which will allow the ferrite rod to be mounted at least a few centimetres from both the battery and the 500Ω potentiometer. To achieve this with our box, it was necessary to shorten the ferrite by about 1cm so that it would fit between the screw mounting posts. This is really quite easy — just score a groove around the ferrite using a file and it will snap cleanly along the groove without too much effort.

### Trim the board

The printed circuit board (PCB) used is coded 83md9 and has nominal measurements of 55 x 27mm. Actually, up to 5 of the 55mm can be trimmed from the board if you are really pressed for space. The extra is to allow the board to clip neatly into the special PCB stand offs supplied with the plastic utility box.

When mounting components on the PCB, particularly watch the polarity of the two diodes and the electrolytic capacitor. Also, wire the LED and the coils exactly as per the wiring diagram.

Four holes must be drilled in the box — one for the LED, one for the switch, one for the sensitivity control and one for the trimpot. This last hole is not actually to mount the trimpot, but rather to allow screwdriver access to it.

When winding the coils, use 0.2mm enamelled copper wire. Although the number of turns is not critical, try to make the windings as near as possible to 8mm and 16mm long, respectively. Leave about 60mm of wire free on each of the ends and scrape the enamel off for about the last 5mm. These leads must be connected to the PCB exactly as per the wiring diagram, otherwise the oscillator will not work.

For the finishing touches, dab some glue onto the ferrite and fix it in position and then select a knob for the sensitivity control. When performing the initial test, don't use the sensitivity control to set the LED — use the trimpot on the PCB. This is a much coarser control and should be used to set the LED on the threshold of conduction. The sensitivity control is then adjusted so that the LED is just beginning to illuminate before any metal is detected.

## LIKE TO GET AN AMATEUR RADIO CERTIFICATE? IT'S MUCH EASIER WITH PROFESSIONAL HELP.



If something's worth doing, it's worth doing well. So don't waste your valuable spare time finding your own way through the Amateur Radio maze. Ask Stott's instead. We have top professional instructors, who'll make sure your time is well spent on your way to an operator's certificate. You'll have individual attention, working at your own speed, in the comfort of your own home. Any queries will be answered personally, and promptly.

So don't delay. Mail the coupon for full details.  
Over and out.

# Stotts



CORRESPONDENCE COLLEGE

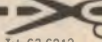

**Melbourne**, 159 Flinders Lane, 3000 Tel: 63 6212  
**Sydney**, 383 George Street, 2000 Tel: 29 2445  
**Brisbane**, Suite 3, 65 Mary Street, 4000 Tel: 221 3972  
**Adelaide**, 85 Pirie Street, 5000 Tel: 223 3700  
**Perth**, 25 Richardson Street, 6005 Tel: 322 5481  
**Hobart**, 150 Collins Street, 7000 Tel: 34 2399  
**New Zealand**, box No 30/990 Lower Hutt Tel: 676 592

**The name to trust in correspondence education.**  
Please send me free, and without obligation,  
full details of the following courses:

\_\_\_\_\_ (PLEASE PRINT)

MR. MRS. MISS \_\_\_\_\_ AGE \_\_\_\_\_

ADDRESS \_\_\_\_\_

\_\_\_\_\_ POSTCODE \_\_\_\_\_

Stott's undertake that no sales counsellor will visit you.

**The Stott's range of courses in Amateur Radio is:**

- Novice Amateur Operator's Certificate of Proficiency.
- Amateur Operator's Certificate of Proficiency.
- Amateur Operator's Limited Certificate of Proficiency.
- Radio for Amateurs.

ALA/ST4467/EA1083

# The principle of the log-periodic antenna

## How to obtain better TV reception Pt. 4

While there appear to be a large number of different TV antenna designs they tend to fall into two broad categories: Yagi and log-periodic. Both use dipole elements but the log periodic design has advantages in a design which is intended to cover all channels from 0 to 11.

by LEO SIMPSON

As noted in the last article in this series, in the August issue, the Yagi antenna is essentially a narrow bandwidth design by virtue of the resonant character of its elements. In fact, it is quite difficult to design a Yagi to cover more than one-third of an octave (ie, a frequency range of 1.3:1) and such an antenna would have a lot of directors and not a great deal of gain.

To overcome this problem, designers usually combine two Yagis on the one boom and couple them together. A popular example of this is the Austenna A10-80 model which covers channels 0,

2, 7, 9 and 10. See facing page. The three long elements (reflector, folded dipole and angled director) provide coverage of channel 0 and 2 while the shorter elements cover the other channels.

While such multi-band Yagis do give sterling service they cannot give optimum performance for every channel. For example, you may be able to resolve finer picture detail on one channel than on others and this will be because the Yagi covers the particular channel's 7MHz bandwidth better than others. Alternatively, one channel may give noisier reception than others

because the antenna's gain is less than for the other channels.

The solution to this problem of designing an antenna which gives equally good performance for all VHF channels (from 0 to 11) was just about insoluble until the late fifties when a new antenna design was developed which was referred to as the log-periodic dipole array or LPDA. These days people normally refer to them simply as "log-periodics".

Fig. 1 shows the general arrangement of dipole elements in a log periodic antenna. The length of the elements increases gradually from the front to the back as does the spacing between each pair of elements. As might be gathered from the "log periodic" designation, the overall taper from the front to back and the spacing between the elements increases in a logarithmic relationship or, more simply, as a geometric progression.

In fact, the ratio between the spacings of adjacent pairs of elements and the ratio of the lengths of adjacent elements is the same and it remains constant throughout the array. The ratio is known as the Tau factor and it is this factor plus the included angle of the array taper, alpha, which defines the overall gain of the antenna.

The overall frequency range of the antenna is defined in the same way as for a Yagi array. The longest dipole sets the low frequency end and the shortest dipole the high frequency end. This means that a log-periodic antenna can cover the whole VHF TV band with relatively few elements tapering from very long to quite short in as few as four steps, say, or at the other extreme, it may be very large indeed, with a multitude of elements for the same frequency range.

For a high gain array, the included angle is made small so that a relatively large number of elements is required to cover a given bandwidth. It follows that to obtain a reasonable gain from a log-periodic and also to cover the whole VHF TV range from 45 to 222MHz the resulting antenna will have to be very large.

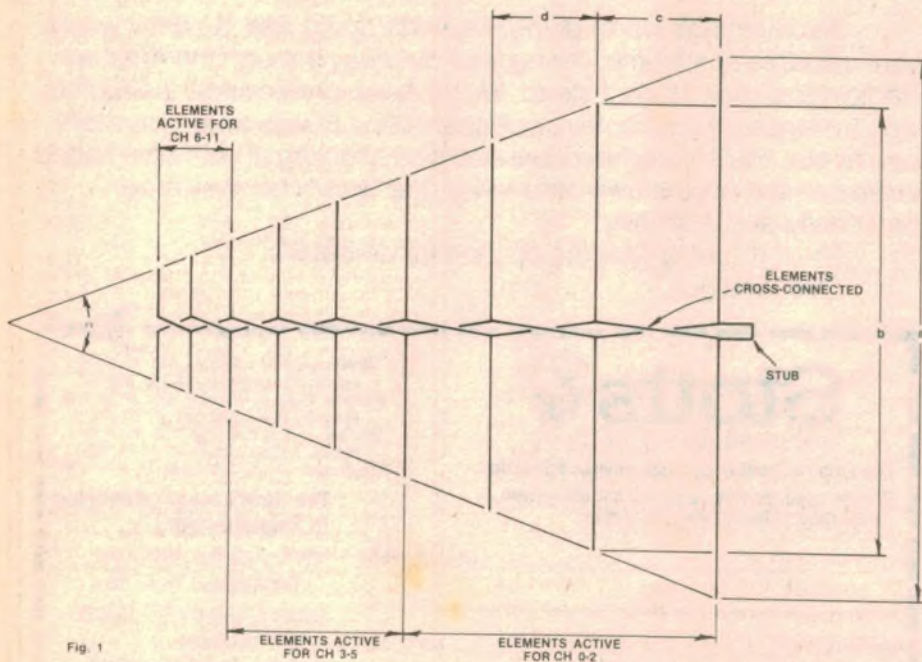
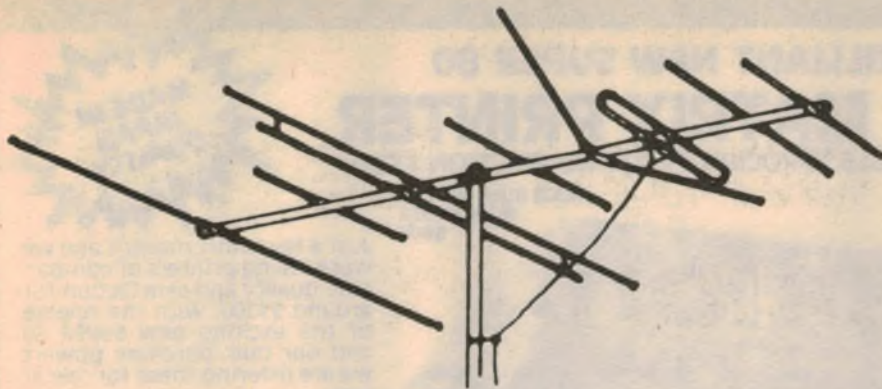

Fig. 1

This is the typical configuration for a log-periodic dipole array. The ratios  $b/a$  and  $d/c$  are identical for all adjacent pairs of elements. In any frequency band three or four sets of elements are active. The stub is dimensioned to give matching to the feeder line and is not present in many commercial designs.



In order to overcome the problem of making a Yagi antenna cover all VHF channels designers have combined two Yagis on the one boom such as the Austenna A10-80. (Diagram by courtesy of Austenna Systems Pty Ltd, Rydalmere NSW.)

In practice, typical commercial log periodic antennas intended for TV reception are a compromise between gain and overall size of the array. The largest commercially available array has a boom length of about 3.2 metres which is still pretty large.

Apart from the characteristic tapering of the array, log periodics have another feature which gives them an unusual appearance. Each pair of dipole

This is the Hills HD4, a large log periodic with additional parasitic elements to increase the high frequency gain. It is made of stainless steel to resist corrosion. (Photo courtesy of Hills Industries Ltd.)

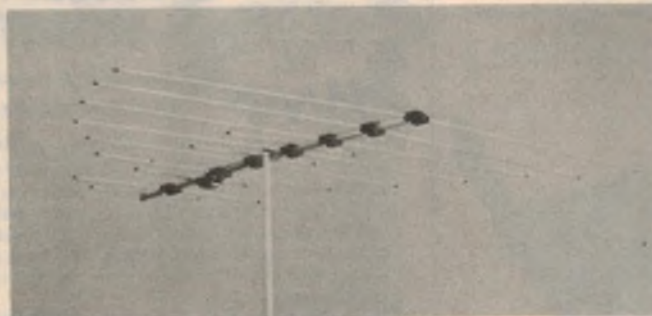

elements is reversed in phase compared to the adjacent pairs. When combined with the length of the feeder connecting each adjacent set of dipoles this has the effect of giving a strong directional effect to the antenna.

Putting it another way, for a given pair of dipole elements, the shorter elements in front act as a director while the longer elements at the rear act as a reflector.

Two methods are used to reverse the connections to each set of dipoles. The first and most common way is to mount all the elements on a single boom but insulated from it. Then heavy gauge wire or metal strips are used to make the respective crossover connections. The Austenna CC9FA log periodic antenna illustrated on page 91 of this article is a typical example of this method of construction.

The other method of construction uses two booms, one below the other and electrically isolated from each other. In this way, alternate elements are directly

mounted on each boom (not insulated) and the antenna output connection is made to the front end of the booms. An example of this method of construction is the Hills EFC3 and EFC4 antennas which are illustrated on page 93 of this article.

These two Hills antennas are unusual in a number of respects, as will be discussed in a moment.

As a glance at the photos included with

this article will show, Fig. 1 is a notional antenna only and typical commercial antennas, while broadly conforming to the same pattern, do show a number of divergences. For a start, the stub shown on the rear of the antenna in Fig. 1 is usually not present in commercial TV antennas.

The stub is merely a length of short-circuited feeder or a wire loop of a particular length and would normally be included to provide matching of the antenna to the load. However, since such matching is usually not important for a receiving antenna, the manufacturers are presumably able to dispense with it.

By contrast, log periodics intended for use on the amateur bands are used with transmitters and matching is important. So for amateur use the matching stub is a crucial part of the antenna design.

Another difference with commercial versions of the log periodic antenna is that they usually have additional short



## ELECTROCRAFT

THINKING OF TV AERIAL INSTALLATIONS? We can help you with the largest stocks of Antenna's and all associated equipment in NSW, from six manufacturers. Austenna — Channel-Master — Ecraft — Hills — Kingray — Matchmaster. Plus all the Technical information of 40 year experience in the aerial business.

<b>HILLS ANTENNA'S</b>	\$
Gutter GM5 Kit 5EL	31.96
3-5/0 8EL 0-10 High Gain	48.02
EFC3/03S 12E1 0-10 Top of Line	117.68
EFC3/03S 3EL add on kit = 15EL	33.15
TL3/0 Log Periodic 10EL Ch0-11	74.03
TL4/0 Log Periodic 12EL Ch0-11	85.54
215 8EL Ch7s2-10 300Ω	43.73
CA16 Phased array	77.06
2010 Ch's 2-10 (Airways) 300Ω	109.49
PF7 Anti ghost 7EL 300Ω-75Ω	58.13
Y4 Ch's 6-11 4EL Yagi	21.31
Y6 Ch's 6-11 6EL Yagi	24.76
Y10 Ch's 6-11 10EL Yagi	38.86
Y14 Ch's 6-11 14EL Yagi	59.71
<b>CHANNEL MASTER BROAD BAND 0-10</b>	
3110A Coloray 300Ω-75Ω	51.00
3112 Super Coloray 7EL 75-300Ω	65.00
CX7 7EL Crossfire 300Ω	44.00
CX13 13EL Crossfire 300Ω	70.66
CX17 17EL Crossfire 300Ω	111.00
CX21 21EL Crossfire 300Ω	176.00
CX 28EL Crossfire 300Ω	210.00
428 Airmaster Anti ghost 300Ω	106.00
1113 Quantum Anti ghost 300Ω	109.00
<b>FM ANTENNA'S</b>	
Hills D.I.Y. FM Kit 75Ω	54.60
Hills Y3/FM 3EL 300Ω	27.40
Channelmaster FM700 7EL 300Ω	32.00
Matchmaster FMG/2 5EL 300Ω	38.98
Matchmaster FMG/6 10EL 300Ω	73.83
<b>HILLS UHF ANTENNA'S</b>	
TC10/B5 10EL 75Ω 11dB/G Kings X	37.42
TC18/B5 18EL 75Ω 13.5dB/G Kings X	54.15
TC10/B4 10EL 75Ω 11.7dB/G Gore Hill	42.25
TC18/B4 18EL 75Ω 15.5dB/G Gore Hill	60.50
<b>CHANNEL MASTER UHF ANTENNA'S</b>	
M2 13EL Wide Band B4 5 10dB/G	53.13
M3 22EL Wide Band B4 5 11.5dB/G	61.93
M4 27EL Wide Band B4 5 13dB/G	37.57
4225 Bowtie Wide Band B4 5 13dB/G	52.85
4194 Corner reflector B4 5 9dB/G	43.51
4193 Corner reflector B4 5 11dB/G	62.58
<b>Austenna AUV14 VHF-UHF (special price)</b>	35.00
<b>INDOOR &amp; CARAVAN ANTENNA'S</b>	
Austenna AL1/10 1EL 2 Dipoles	19.93
Standard spiral (Indoor)	6.93
Hills Tenna Trakka (Indoor)	15.59
Hills CV1 Caravan aerial	54.42
Matchmaster GGR Caravan	26.66
<b>MAST HEAD AMPLIFIERS</b>	
MH22 Ecraft 22dB/G 75Ω VHF	89.94
MH26 Ecraft 26dB/G 75Ω VHF-UHF	96.61
Hills MH4 25dB/G 300-75Ω VHF	92.22
Hills MH6 36dB/G 300-75Ω VHF	107.28
Kingray MH20 20dB/G 300-75Ω VHF	91.10
Kingray MH20WN 20dB/G Selective filter attenuates CH's 3 to 5A	96.89
Car Radio amplifier 12V AM-FM SW-MV-LW-FM 240V	9.00
<b>50 types of amplifiers in stock</b>	
<b>Down converters UHF-VHF</b>	
Kingray UV1/V for VCR'S	83.64
Hills VHF-UHF Converter tuneable	98.96
<b>REGARDLESS</b> of how much you spend on your TV/FM receiver or Video cassette, your equipment will only perform as well as the Antennae system will allow, a good installation will rectify these problems and let your equipment prove how good it can perform.	
Phone for technical information. Hours 8am to 5pm Monday to Friday. All prices plus freight or postage	
<b>ELECTROCRAFT MFG PTY LTD</b> 68 Whiting St (P.O. Box 398), ARTARMON 2064 (Off Street Parking). TELEPHONE 438 4308, 438 3266.	





## How to obtain better TV reception

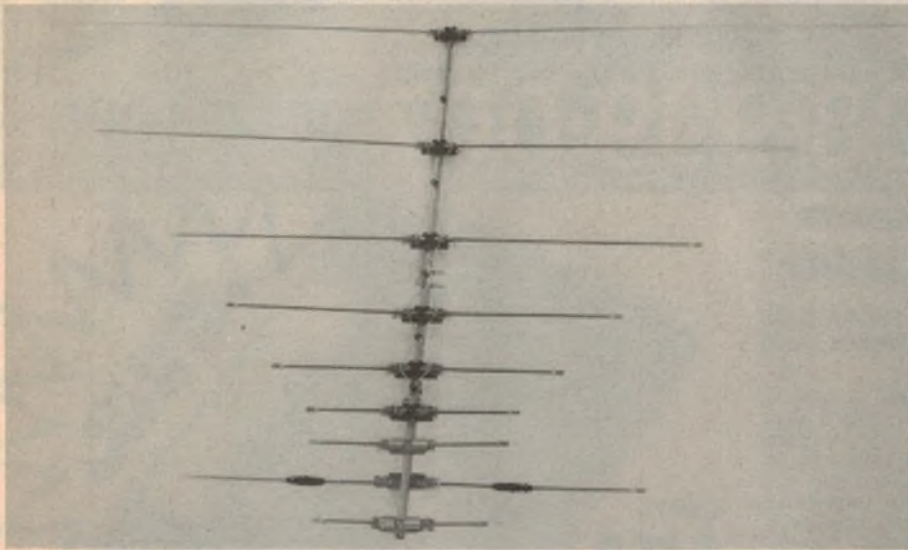

This is the Austenna CC9FA log periodic antenna which is constructed on a single boom and has additional parasitic elements for improved high frequency gain.

elements which may be in front of the main log periodic section or they may be distributed all the way along the boom. An example of the former case is the Austenna CC9FA previously referred to, on page 91 of this article.

This antenna has six pairs of elements in the log periodic array but has three additional short elements on the front end of the boom. Note that these elements are mounted directly on the boom but are not connected in any way to the dipoles. These elements are acting as additional directors for the shortest dipoles in the array.

One of these directors has an additional extension at each end. This presumably allows it to operate as a director for some of the longer dipoles in the array.

The reason for adding these directors is to improve the gain and the directional properties of the basic log-periodic configuration in the upper region of its frequency range. This is usually found to be necessary because as pointed out before, the upper and lower limits of the frequency range of a log-periodic array are defined by the shortest and longest dipole elements, respectively.

This means that, whereas intermediate dipoles have the benefit of shorter dipoles acting as directors and longer dipoles acting as reflectors, the shortest dipole element does not have any directors. Hence they are added to give a worthwhile increase in gain.

At the other extreme, it is not usual to add a reflector element for the longest dipole to improve the low frequency gain. This is not necessary because these very long elements pick up a very strong signal in any case. Remember that the

received signal is directly proportional to the product of the signal strength (in mV/m) and the dipole length.

The Hills EFC3 and EFC4 also add parasitic elements to the front of the log periodic array to increase high frequency gain. These elements are said to be collinear in that because of the insulator which breaks them into three equal parts, they can operate in the high frequency and mid-frequency portions of the antenna range.

Antennas which use a combination of log periodic array and additional directors are often termed a "hybrid log periodic" or a "log-Yagi".

Besides having an essentially flat gain characteristic over the whole of its design passband, the log periodic also has a very smooth polar response characteristic, as illustrated on page 93 of this article. This has a fairly broad frontal response lobe and a smaller lobe to the rear, giving quite a good front-to-back ratio.

This is not the whole story though. Note that we have shown two such polar response curves, one being typical of a high band response and one being typical of the low band. Note that the low band response has just one small rear lobe, as would be expected from a log-periodic design.

With the accompanying high band response there are two small rear lobes. The two rear lobes are typical where additional directors have been added to improve the gain. They sharpen up the frontal lobe, as well as providing the extra rear lobes. In this latter respect the performance is becoming similar to that of a three or four-element Yagi which has several rear lobes.

So what have we so far, as far as polar response is concerned? We have a very smooth response which is free of the many small rear lobes and deep nulls "off the back and side" of the antenna which is usually typical of multi-element Yagi designs. But while the log-periodic may have a better front-to-back ratio on paper, the existence of those deep nulls in the polar response of a typical Yagi may be better for eliminating ghosts. Note also that because the log-periodic does not have the benefit of a reflector

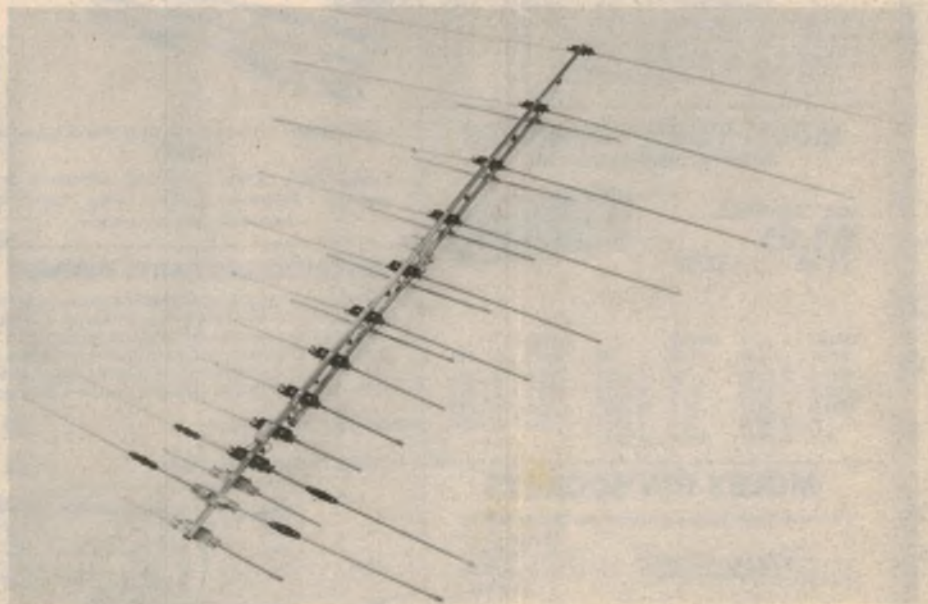

One of the largest log periodics available, this Austenna CC19FA uses crossover wires to connect the dipole elements and a second boom to mount five additional parasitic elements.

**BANKCARD HOLDERS —  
PHONE YOUR ORDERS  
TOLL FREE!**

**AUSTWIDE**

**NEXT DAY DELIVERY**

**ALTRONICS 008-999-007**

**VIA  
JETSERVICE**  
(CAPITAL CITY & SUBURBAN AREAS)

**A SINGLE BOARD CP / M COMPUTER**

**"THE LITTLE BIG BOARD"**

64K on board RAM, Z80A based running at 4MHz (Top speed) Floppy disk controller, Real time clock.

That's right! A fully configured Z80 computer running at maximum capacity, on a single PCB. On board disk controller drives up to four double sided, double density drives either 8" or 5". 2 by RS232 I/O Ports, both may be software configured, use one for a terminal the other for a printer or modem etc. Battery backed real time clock software accessible for automatic dating of documents, timing during games. Fully STD buss compatible — choose from thousands of ready available play in card options. Bootstrap Monitor on board — boots to CP/M. Choose from the world's largest range of software.

**ALTRONIC KIT FEATURES**

Two versions of the bootstrap monitor supplied. One set for 1200 baud operation enables connection to MICROBEE 16 & 32K IC's utilizing their terminal emulation facilities. The other set for 9600 baud operation. Complete set of IC sockets. Double sided plated through PCB — solder masked and pretinned. 56 Pin STD connector. 2 x DB25P's and ribbon cable for peripheral connections. Quality components used throughout including solder and full documentation.

K9690  
**\$499**

**CP / M  
Diskettes**

- 8" 9600 Baud K9691 ..... \$150
- 5" 9600 Baud K9693 ..... \$150
- 8" 1200 Baud K9692 ..... \$150
- 5" 1200 Baud K9694 ..... \$150

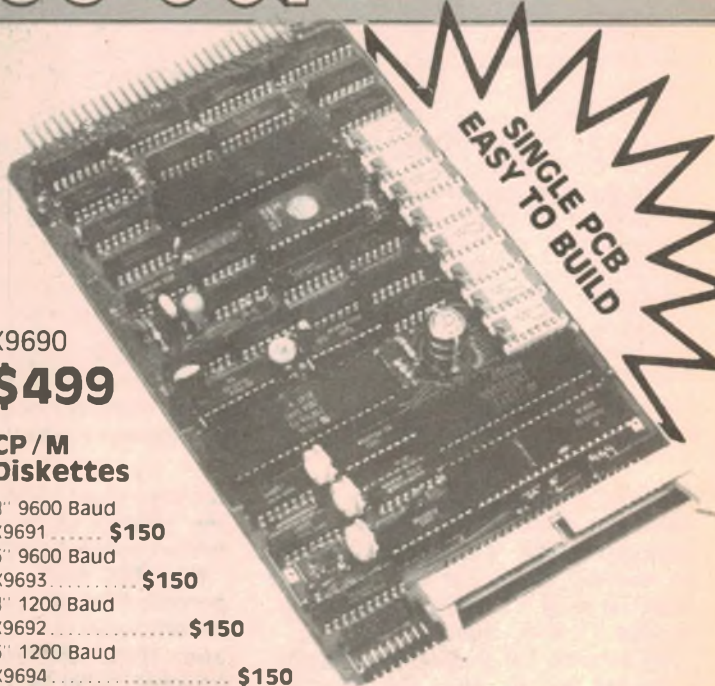

ALTRONICS • BANKCARD JETSERVICE DELIVERY NEXT DAY • ALTRONICS

ALTRONICS • BANKCARD JETSERVICE DELIVERY NEXT DAY • ALTRONICS

**LEDS**

Z 0140	Led 3mm Red	14	10
Z 0141	Led 3mm Green	20	18
Z 0143	Led 3mm Yellow	22	20
Z 0150	Led 5mm Red	14	10
Z 0151	Led 5mm Green	20	18
Z 0152	Led 5mm Yellow	22	20
Z 0154	Led 5mm Orange	25	22
Z 0159	Led 5mm Flashing FRL4403	49	45
Z 0160	Led Rectangular Red	22	19
Z 0162	Led Rectangular Green	25	22
Z 0164	Led Rectangular Yellow	25	22
Z 1072	Led Infra Red CQY89A	55	52

**TECHNICIAN'S UTILITY PARTS CASE**



H 0449  
NOW  
**\$6.50**

Lightweight and durable this Parts Case is a MUST!

Featuring:— Clear lid (tell contents at a glance); Positive action snap lock; 30 partition combinations

**KEY OPERATED SWITCH**



19.5mm mounting hole required. Supplied with two keys. Hundreds of applications for security type applications.

S 2500 **\$6.95**

NOW ONLY **\$5 EACH**

**MULTI-TURN TRIMMERS  
INDUSTRY PREFERRED TYPE**

ALL ONE PRICE  
**\$1.95**  
10 up ..... \$1.80



Resistance	Cat	Resistance	Cat	Resistance	Cat
100 R	R 2410	5K	R 2423	200 K	R 2433
200 R	R 2415	10 K	R 2425	500 K	R 2435
500 R	R 2417	20 K	R 2427	1 M	R 2437
1 K	R 2419	50 K	R 2429	2 M	R 2439
2 K	R 2421	100 K	R 2431		

**INTERLOCKING PARTS DRAWER**

Unique side and top/bottom keying system allows you to use just a few or build a whole wall of drawers as your parts expansion dictates. Quality designed drawer slides will not "stick" or seize. Slide handle also takes ident. cards. Single or double drawers available.

H 0435 Single Way ..... \$2.20

H 0436 Double Drawers ..... \$2.20



**FUSE HOLDER  
3AG**

32 x 6.3mm Fuse

S 6000 ..... 95

NOW **60c**



**SATURDAY  
ARVO KITS**

(SEE ETI AUGUST 1983)

- RADIO MIC K1106 ..... \$6.50
  - ALIEN INVADERS K1123 ..... \$13.95
  - SOUND BENDER K1492 ..... \$29.50
  - COURTESY LIGHT EXTENDER K4232 ..... \$3.95
  - SOUND EFFECTS PACK K1607 ..... \$17.50
- (CONTAINS PARTS FOR ALL 5 PROJECTS)



**MOLEX PIN SOCKETS**

For use with single pins up to .5mm diam. Make your own sockets for IC's, displays, LSI's etc.

P0700 Pack of 100 ..... \$ 2.00  
P0701 Pack of 1000 ..... \$16.50

Supplied on 'Break off' header pre-spaced 1 inch.

GET A TRADE PACK FOR YOUR WORKSHOP NOW.

# How to obtain better TV reception

at the low frequency end of the band, the polar response usually suffers with the result that it is not as good as the mid-band polar response.

Surprisingly, Australian TV antenna manufacturers have appeared to adopt a very low profile and do not generally publicise performance figures for their products. So even for the reasonably informed user making judgements on likely performance of different brands is bound to be difficult.

About the best that can be said is that the size of a log periodic is the guide to its overall gain; the bigger the better. Even so, the gain of even large log periodic antennas is quite modest. And since, for a given frequency band, only three or four of the dipole elements are active, the gain is comparable with that of a three or four element Yagi.

So as far as gain and polar response is concerned the log periodic design is good without being outstanding. It is as close as the antenna manufacturer will ever get to being the "good all round performer" for the whole VHF range.

For that reason it has become very popular with Australian manufacturers and has been installed in very large numbers in recent years. But for fringe areas where the signal level is quite low or in areas where pronounced ghosting occurs it is not the best answer. Nor is it necessarily the best practice to install a log periodic and then make up the gain by adding a masthead preamplifier.

In all this talk of gain, frequency response and polar response we have not been entirely realistic. One of the reasons why Australian manufacturers are reluctant to make a big deal about the performance of their antennas is that so much depends upon the actual installation. Relatively few are ideal.

Most TV antennas are simply installed on a bargeboard using a short J-bracket which puts the antenna only about one metre above the metal guttering and in most cases, not even clear of the line of the roof. The presence of a large metal structure in the near vicinity to an antenna inevitably degrades the polar response. It never improves; it always worsens.

So while you may start out with an antenna which is designed to have excellent directional characteristics, this typical sort of installation may easily degrade it to the point where it is more or less omnidirectional with little or no front-back ratio. Thus the ability of the antenna to cancel out ghosts is lost.

Worse still, that ubiquitous length of metal guttering may very well resonate on the frequencies of one particular channel. It can then re-radiate its

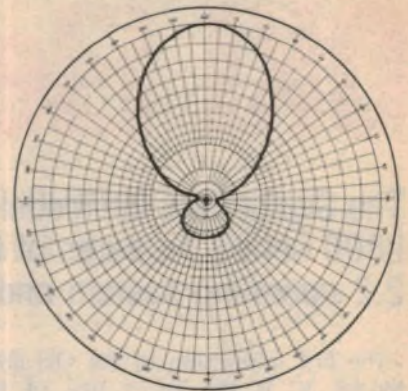
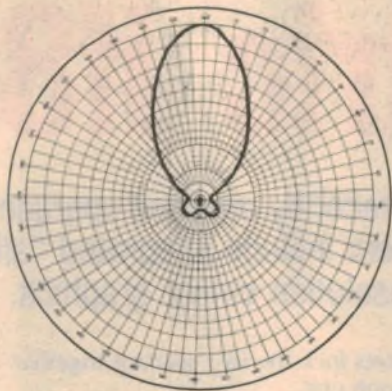

These are polar response diagrams for a typical log periodic antenna. At left, the high band response and at right, the low band response.

received signal into the antenna and cause signal cancellation. This could result in poor reception on one channel.

Installing a TV antenna within the roof is often just as bad. Not only will the antenna be surrounded by roof guttering and mains wiring but it may also have to "look past" a hot water system or water pipes. And in rainy weather the wet roof tiles will weaken the signal. About the

the surrounding structures or terrain. For an antenna receiving channel 0, the height above the roof, or at least above the guttering, is about 3.2 metres.

As well as reducing the degrading effect on the polar response, raising the height of an antenna almost always gives an improvement in received signal. The amount of increase will depend on just how far you are from the transmitter and

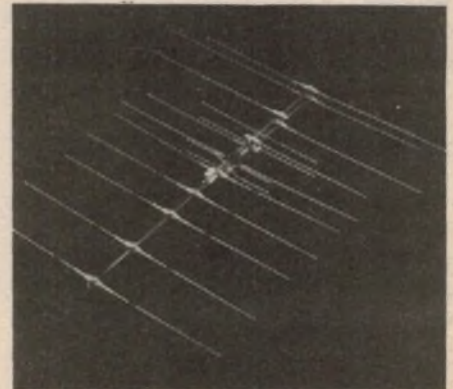
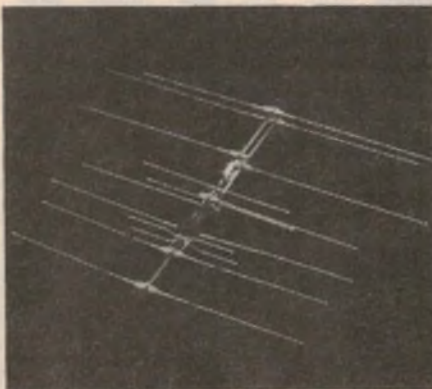

Two hybrid log periodics made by Hills: The EFC3 (left) and EFC4 (right). (Photos by courtesy of Hills Industries Ltd, Edwardstown, SA).

best that can be said for such an in-roof installation is that it may be reasonably satisfactory in strong signal areas and it will prevent the antenna being damaged by the weight of perching birds.

Unfortunately, the only way to obtain the claimed directional characteristics of any antenna is to install it well above any surrounding structures, metal or otherwise. Ideally, it should be at least three or four wavelengths above any structure. For an antenna receiving channel 0 or channel 2 this means a height above the roof of 25 metres.

A more practical approach which will still allow most highly directional antennas to give a good quota of their claimed performance is to mount it so that it is at least one half wavelength, at the lowest operating frequency, above

on the intervening terrain. If you live in a hilly area a relatively small increase in elevation may give a very worthwhile increase in signal level.

There is another advantage of mounting the antenna as high as possible which is not generally realised and this is that it can make the reception less prone to ghosts caused by aircraft. The reason for this is that ground reflection effects tend to mean that the greatest signal pickup is not in the plane of the antenna but from an angle above the horizon.

In other words, mounting the antenna close to the ground or not far above surrounding structures has the effect of tilting the polar response of the antenna upwards, just the ideal situation for picking up reflected signals from aircraft! (Continued next month.)

Electronics Australia reviews the . . .

# OKI Electric if800 'all-in

The Sigma Data Oki Model 30 is a recently released upgrade of the Oki Electric Company's if800 series. Features of the system include integrated "all-in-one" packaging, the CP/M 2.2 operating system and high resolution colour graphics.

The first impression of the Oki if800 Model 30 is the sheer size of the machine.

Dimensions of the complete system are 55 x 71.5 x 51cm (W x D x H) and mass is a hefty 53kg. Sigma Data, who distribute the machine in Australia, claim that the space occupied by the if800 is comparable with other computer systems once the space saved by the built-in printer is taken into account, but the impression of bulk remains.

While big, the system is complete. The keyboard, colour video monitor, dual 20cm disk drives and full-size dot matrix printer are all combined in one large package.

As delivered the if800 is in two parts, one containing the keyboard and printer and the other holding the power supply and processor board, with a 30cm colour monitor mounted on pillars above the rearmost unit. Next to the CRT screen are dual 20cm disk drives.

To install the Oki, first clear your desk. The two units are connected with three multi-way cables and the keyboard section fitted into the open front of the rear part. Two screws through small metal

brackets lock the two sections together into one unit.

The integrated configuration has one immediately obvious advantage — there is only one power cord and a single power switch for the system, conveniently located on the left side of the console.

Forward of the power switch and also on the side are two small pushbuttons, one labelled "IPL" and the other NMI. Preparing the if800 for use is a matter of loading a disk into drive A and pressing IPL. Within seconds the disk will load (indicated by colour cycling of the screen border and various clunks and whirring noises from the disk drive). Brief messages on the screen report the status of program initialisation before the screen clears and the CP/M operating system is activated.

## Specifications

The Oki if800 Model 30 is based on a Z80B microprocessor running at a clock rate of 4.9152MHz. Programmable memory is provided in the form of 64K x 1-bit dynamic RAM chips, with 128K bytes provided with the standard

machine and an additional 128K provided by an optional memory expansion board.

Two configurations of the system are available. One, the IF80150 (reviewed here) has a colour display while the IF80160 has a monochrome display. In the colour version video memory consists of three 64K planes (one each for red, green and blue) for a total of 192K bytes.

The standard machine includes an on-board clock/calendar with internal Nicad battery backup so that the time and date are maintained whether or not the machine is switched on. A sound generator is also provided, generating 64 tones over a range of 65Hz to 1976Hz through an internal speaker.

An RS232C serial port is built into the standard machine and a Centronics parallel port is available as an option. With a full-size 80cps dot matrix printer built in to the keyboard console, the lack of a Centronics port on the standard unit is probably not important. If correspondence quality printing is required any of the available daisywheel printers can be connected to the serial port.

The built-in printer is a fast impact printer, able to produce multiple copies on either single-sheet or tractor feed paper. Lines of 80 or 132 characters can be specified and graphics, including a printed copy of the screen display, are also available. Individual characters are formed on a 5 x 13 dot grid in a 16 x 16 dot matrix, allowing full descenders on lower case letters and the production of user-defined graphics symbols. Double-size, enhanced and boldface type can also be produced, and in fact the version of WordStar available for the if800 supports all the features of the printer.

The if800 is well-equipped with peripheral interfaces and expansion slots. Built into the standard machine are interfaces for a light pen, communications port, and a ROM cartridge. Five expansion slots are provided in the processor unit, with two already occupied by controller boards for the colour graphics display and the disk drives. The three vacant slots can be used with

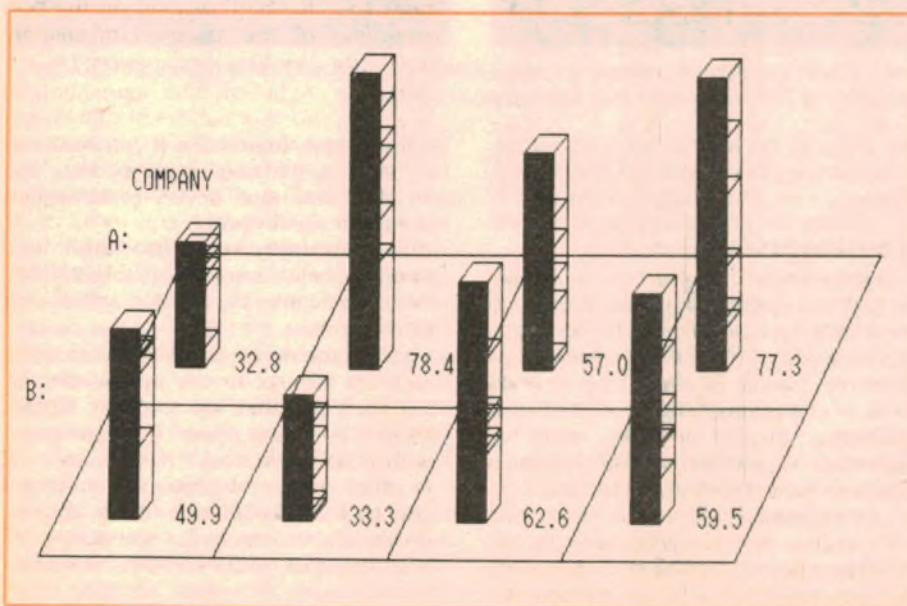

This 3D bargraph was dumped from the screen to the in-built printer.

# -one' computer



The if800 comes complete with printer, colour monitor and dual disk drives.

parallel and serial add-on boards, D/A and A/D converter boards or an IEEE 488 communications bus adaptor board.

Currently available optional extras also include a light pen which is connected by a socket on the right side of the machine. In conjunction with a Basic program the pen can be used to indicate a specific  $40 \times 200$  pixel area on the screen or to select items from a menu by touching a point adjacent to the written description of the menu entry.

The ROM slot on the left side of the console can be used for cartridges which contain programs or data, although as yet no program cartridges have been released. The information stored in a ROM cartridge does not appear in the memory space of the if800 but can be copied into RAM for use. Up to 20K bytes of information can be stored and accessed in this way.

A "Kanji" cartridge is available for use as an add-on character generator. This ROM pack contains patterns for 2965 Japanese kanji characters, alphanumeric characters, and Greek and other special symbols.

## The keyboard

The keyboard of the if800 is extensive. In addition to the standard alphanumeric keys in a typewriter-style layout and a numeric pad, the 104 keys include cursor control, special function keys for the screen and printer and a set of 10 user definable keys. All keys have an automatic repeat feature and an internal speaker provides audible feedback for every keystroke.

Of course not everyone likes audible feedback from a keyboard. Unfortunately, with the if800 it is not an option — there is no way to disable the feature (or

if there is we couldn't find it in any of the system manuals). With a noisy cooling fan, noise from the disk drives and compulsory audio from the keyboard the if800 is obtrusive — a point which must be considered in an office or home environment.

Other features of the keyboard include completely redefinable keys, a Japanese character mode, access to special graphics characters and single key entry of common Basic statements.

The user-definable keys above the alphanumeric keyboard can each be assigned a string of up to 15 characters. Pressing the function key then has the same effect as typing this string.

As initialised, the keys perform various functions under CP/M and a different set of operations under Basic. Under Basic, for example, pressing F1 will print the statement LOAD on the screen, ready for the user to type in a program name to be fetched from disk.

Under CP/M, pressing F1 will print "dir", the instruction to list the directory of a disk drive on the screen. Pressing F6 will call up DDT, the "Designers' Debugging Tool" of CP/M, while F10 will load Basic.

From Basic the statements KEY, ON KEY () GOSUB . . . and KEY LIST will respectively assign functions to the programmable keys, call subroutines according to the key pressed and list the current definitions of the keys.

A row of touch switches directly below the video monitor duplicates the operation of the function keys. It would be possible to write software which required no use of the standard keyboard at all, by presenting a series of menu-driven operations with options called up by the function keys. A list of key definitions can also be displayed on the bottom line of the screen conveniently above the key that the label refers to.

To the right of the alphanumeric keyboard are two clusters of four cursor control keys (marked with arrows) and the editing function keys INS, DEL, CLS and HOME. The 20-key numeric keypad is further to the right and includes its own separate keys for arithmetic operators and a separate RETURN key for easy entry of numeric data and calculations.

Above the numerical keypad are three keys for control of the in-built printer. From left to right they are "Hard Copy", "Form Feed" and "Print" (a latching key with a LED indicator). "Hard Copy" will produce a printed copy of the current contents of the screen, using double-width characters and reproducing all graphics (but not colour). Shift-Hard

Continued on page 96

# OKI Electric if800 'all-in-one' computer

Continued from page 95

Copy will provide a reduced copy of the screen image.

The "Print" key, when locked down, will send all text information to the printer as well as to the screen, using normal size characters. It does not reproduce graphics, but is handy for generating program listings and permanent copies of program output in conjunction with the LIST statement of Basic. LLIST from Basic will also activate the printer, and the LFILES statement will produce a printed list of the contents of a disk directory.

Horizontal tab and tab setting keys complete the complement of special functions in the upper area of the keyboard.

At both sides of the space bar are other special function keys which are more of a nuisance than an asset in English-speaking countries. The first, labelled CHR MODE, is a locking key with a LED indicator. It operates to replace all characters with boxes on the screen, and is presumably designed to work with a Japanese character generator which is

not installed in the standard machine.

Accidentally pressing this key makes it appear that the if800 has developed a strange fault, but there is no information in the manuals on this aspect of the system.

To the right of the space bar are three unmarked keys, one of which is locking and sports a LED indicator. Locking this key down causes the standard keys to be displayed as further Japanese characters, a function of dubious value if you can't read Japanese.

Single key entry of Basic statements is supported by the if800. Pressing the COMD key (on the left side of the keyboard) in conjunction with an alphabetic key will print the Basic keyword associated with that key. COMD-G, for instance, prints GOTO, COMD-E prints ELSE and COMD-F prints FOR and so on.

A GRAPH key to the left of the spacebar allows various graphics characters to be displayed on the screen from the keyboard. Each key alphanumeric key has a pre-defined graphics symbol associated with it, but the Basic statement DEF CHR\$ allows the



Colours on the video monitor are reproduced black by the printer.

programmer to redefine these symbols to create customised characters on an 8 × 16 dot matrix grid. The standard graphics set includes line segments, boxes, card suites and some specialised symbols for cross-hatching and area fill.

While the keyboard of the if800 has many features, user comfort is not one of them. Apart from the compulsory audible feedback, the lowest part of the keyboard is around 8cm from the desktop and there is no room for a "wrist rest" as found on some of the more popular low-profile keyboards. Using the if800 for prolonged periods could be very fatiguing for this reason.

## Screen display and graphics

High resolution colour graphics is the best feature of the if800. The colour version of the Model 30 comes with a high bandwidth RGB monitor, capable of displaying up to 25 lines of 80 characters each and graphics in eight colours with a resolution of 640 (horizontal) × 400 (vertical) pixels.

This exceptionally high resolution means that further colours can be created on the screen. Using a technique which Oki call "dithering", shades of various colours can be built up by juxtaposing the available colours. For example, a line made up of alternate red and green points will be perceived as a solid line of some shade between red and green because of the fine detail of the display. Using red for 70% of the pixels and green for the remainder will produce yet another shade. According to the distributors up to 120 distinct shades of colour can be created in this way.

Four options are available for text displays, allowing either 20 or 25 lines of either 40 or 80 characters each. Both graphics and text displays are clear and sharp, and the colours are fully saturated, not the more common "washed out" tones more usually seen.

The display capabilities of the if800 are fully supported by the Basic interpreter

Continued on page 99



Eleven keys below the screen are paralleled to keys F1-F10 on the keyboard.

## Rheostats 150ohm/25W

Massive savings on these ceramic body 1/4" shaft rheostats. Normally \$12.00

Knobs to suit 20¢

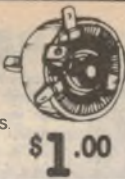

\$1.00

# THE sine

## Fantastic 240VAC

Motors were \$18.00

Scoop purchase of these fantastically versatile open frame motors.

\$2.00



each

# YORK ST CRASH!

Sheridans bring the opposition to their knees with earth trembling prices!!

## Electro Price Massacre

Selling at around 1/4 their normal price. We had a huge response to our half price electro sale. There are a few left and the have to be moved out, so the prices have been reduced to crazy levels. If you need top quality Philips or Sprague electros, get in for your chop - they'll never be cheaper!! They even include the mounting brackets!!

- 14,000/25V were \$5.50, now \$4.50
- 47,000/25V were \$17.00 now \$12.00
- 10,000/40V were \$6.50 now \$5.00
- 14,000/40V were \$9.00 now \$7.00
- 39,000/30V were \$13.00 now \$10.00
- 500/250V were \$5.00 now \$3.00
- 22,000/75V were \$19.00 now \$15.00
- 120,000/15V were \$18.00 now \$12.00

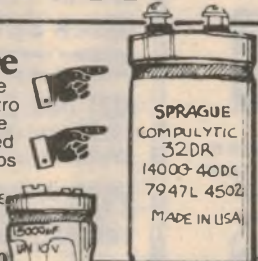

SPRAGUE  
ELECTROLYTIC  
32DR  
14000-40DC  
7947L 4502  
MADE IN USA

A quiet day at Sheridans!!



CMOS Databook. Includes the 54C/74C, CD40XXB and CD45XXB series, special function, LSI, A/D converters and Memory devices. Applications notes are provided. Price only 12.00



## New National Semiconductor Databooks

Fresh off the presses. These are essential reference for the enthusiast or designer.

1982 Linear Databook Volume 1 and 2. The most comprehensive available. Together they provide approximately 2,000 pages of specifications, applications, descriptions and diagrams. Includes voltage regulators, Op amps, Voltage comparators, Industrial and Audio Blocks. The databooks also includes advanced telecommunications devices, speech synthesis

Volume 1 \$13.00  
Volume 2 \$13.00

Linear Applications Handbook. A fully indexed and cross-referenced collection of linear IC applications of both monolithic and hybrid. A vital source of ideas and reference for the hobbyist and engineers.

Price \$18.00

Voltage Regulator Handbook Provides full information on selection heat sinking, power transformer and filter specification when using three terminal and dual tracking regulators.

Includes information on higher current booster circuits. 212 pages Price only \$7.50

Logic Databook. Includes data on 54/74, 54S/74S, 54LS/74LS, 54H/74H and 54L/74L families. Includes full device specifications, connections, test waveforms and physical data.

Price \$10.50

## Telecom Approved Cordless Phone.

- Last number redial ● Pause button.
- Remote dialling with confirmation key-tone.
- Full duplex operation ● Built in Ni-Cads in handset and charger cradle in Base Unit.
- Operating range up to 700ft in suburban area. ● Paging from base to handset.
- Security from base to handset.

\$199<sup>00</sup>



Normally \$259.00

## Fantastic Digiphone

Fully Telecom approved, it provides the following features:

- One memory redial ● Pushbutton Keys ● Mute Key for private conversation. ● Desk or wall mounting possible. Normally selling for \$35.00. Our introductory price is only

\$26<sup>95</sup>

# SHERIDAN ELECTRONICS

164-166 Redfern St., Redfern NSW 2016. Phone (02)699 6912, (02)699 5922  
Mail Orders to Dept EA, PO Box 229 Redfern NSW 2016

Trading Hours:-		Mail Charges:	
Mon-Fri	9am-5:30pm	\$5.00-\$9.99	\$3.50
Thursday	9am-7pm	\$10.00-\$24.99	\$4.00
Saturday	9am-12noon	\$25.00-\$49.99	\$6.00
		\$50.00-\$99.99	\$7.00
		\$100.00 or over	\$8.00

Note: We regret we cannot give quantity discounts on credit card purchases.  
Credit Cards: We accept both BankCard and American Express  
MINIMUM ORDER \$6.00



## 12-Digit LED Display

Sheridan does it again with a fantastic deal on these common cathode LED numeric arrays. Each digit is a 7 segment readout with a right hand decimal point. Eight inputs are provided for selection of segments and 12 inputs for digits (cathodes). The anodes are internally connected for multiplexing. Easy to interface with TTL, DTL or CMOS operation.

only \$1.50

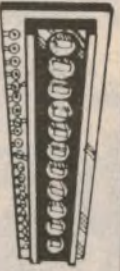

## New 2114AP2 Memory ICs

These fantastic low power memory ICs from Hitachi are going for a song!! High Speed (200nS) and low power consumption design.

Only \$1.50 each

10 up \$1.30

## MOSTEK Z80 P10 and CTC

Both 2.5MHz going for a fraction of their normal cost. Normally \$6.75 but look at our crazy price:

Only \$3.00

## STORE LOCATIONS

<b>NSW</b>	Parramatta Rd & Melton St	<b>AUBURN</b>	648 0558
	T55 Terrace Level	<b>BANKSTOWN SQ</b>	707 4888
	613 Princess Hwy	<b>BLAKEHURST</b>	546 7744
	Oxford and Adelaide Sts	<b>BONDI JCT.</b>	387 1444
	531 Pittwater Rd	<b>BROOKVALE</b>	93 0441
	147 Hume Hwy	<b>CHULLORA</b>	642 8922
	162 Pacific Hwy	<b>GORE HILL</b>	439 5311
	315 Mann St	<b>GOSFORD</b>	25 0235
	4 Florence St	<b>HORNSBY</b>	477 6633
	Elizabeth Dr & Bathurst St	<b>LIVERPOOL</b>	600 9888
	Lane Cove & Waterloo Rds	<b>NORTH RYDE</b>	88 3855
	George & Smith Sts	<b>PARRAMATTA</b>	689 2188
	The Gateway, High & Henry Sts	<b>PENRITH</b>	32 3400
	818 George St	<b>RAILWAY SQ.</b>	211 3777
	6 Bridge St	<b>SYDNEY</b>	27 5051
	125 York St	<b>SYDNEY</b>	267 9111
	Tamworth Arc & Kable Ave	<b>TAMWORTH</b>	66 1961
	173 Maitland Rd	<b>TIGHE HILL</b>	61 1896
	263 Kiera St	<b>WOLLONGONG</b>	28 3800
<b>ACT</b>	96 Gladstone St	<b>FYSHWICK</b>	80 4944
<b>VIC</b>	260 Sydney Rd.	<b>COBURG</b>	383 4455
	Nepean Hwy & Ross Smith Ave	<b>FRANKSTON</b>	783 9144
	205 Melbourne Rd	<b>GEELONG</b>	78 6766
	399 Lonsdale St	<b>MELBOURNE</b>	67 9834
	Bridge Rd & The Boulevarde	<b>RICHMOND</b>	428 1614
	Springvale & Dandenong Rds.	<b>SPRINGVALE</b>	547 0522
<b>QLD</b>	293 Adelaide St	<b>BRISBANE</b>	229 9377
	166 Logan Rd	<b>BURANDA</b>	391 6233
	Gympie & Hamilton Rds	<b>CHERMESIDE</b>	359 6255
	Bowen & Ruthven Sts	<b>TOOWOOMBA</b>	38 4300
	Ingham Rd & Cowley St West End	<b>TOWNSVILLE</b>	72 5722
<b>SA</b>	Wright & Market Sts	<b>ADELAIDE</b>	212 1962
	Main South & Flagstaff Rds	<b>DARLINGTON</b>	298 8977
	Main North Rd & Darlington St	<b>ENFIELD</b>	260 6088
<b>WA</b>	Wharf St & Albany Hwy	<b>CANNINGTON</b>	451 8666
	William St & Robinson Ave	<b>PERTH</b>	328 6944
	Centreway Arc, Hay St	<b>PERTH</b>	321 4357
<b>TAS</b>	25 Barrack St	<b>HOBART</b>	31 0800



## STORE HOURS

All Dick Smith Stores are open for trading during the normal trading hours for their particular area (either 9-5.30 or 8.30-5). Many stores are also open for late night trading. Please ring the store concerned for their particular hours.



Terms available to approved applicants through...



## MAJOR RESELLERS

● **Atherton QLD:** Maavien's Music Centre, 55 Main St. 91 1208 ● **Ballina NSW:** A. Cummings & Co. 91-93 River St. 86 2285 ● **Broken Hill NSW:** Hobbes & Electronics, 37 Onda St. 88 4038 ● **Cairma QLD:** Electronic World, Shop 27 K-Mari Westcourt Plaza, Mulgrave Rd. 51 8555 ● **Cairma QLD:** Thompson Instrument Services, 79-81 McLeod St. 51 2404 ● **Campbelltown NSW:** Fishers 'Chp' Shop, Shop 3, 274-276 Queen St. 27 1475 ● **Colts Harbour NSW:** Colts Harbour Electronics, 3 Colts Plaza, Park Ave. 52 5684 ● **Darwin N.T.:** Ventronics, 24-26 Cavanagh St. 81 3491 ● **Demilequin NSW:** Dem Electronics, 220 Crossy St. 81 3672 ● **East Maitland NSW:** East Maitland Electronics, Cnr 99 High St. 33 7327 ● **Echuca VIC:** Webster Electronics, 220 Packerham St. ● **Geraldton WA:** KB Electronics & Marine, 361 Mam Terrace, 21 2176 ● **Gladstone QLD:** Purely Electronics, Shop 2, Cnr Herbert & Auckland Sts. 72 4321 ● **Goastland NSW:** Tomorrow's Electronics & Hi-Fi, 68 William St. 24 7246 ● **Kingston TAS:** Kingston Electronics, Channel Court, 29 6802 ● **Launceston TAS:** Advanced Electronics, 5a The Quadrant, 31 7075 ● **Lismore NSW:** Decro Electronics, 3a-6-18 Carrington St. 21 4137 ● **Mackay QLD:** Stevens Electronics, 42 Victoria St. 51 1723 ● **Maryborough QLD:** Keller Electronics, 218 Adelaide St. 21 4559 ● **Mt Gambier SA:** Hutchesson's Comm, 5 Elizabeth St. 25 6404 ● **Mildura VIC:** McWilliam's Electronics, 40 Lamon Ave. 23 6410 ● **Morwell VIC:** Merwell Electronics, 128 George St. 34 6133 ● **Nambour QLD:** Nambour Electronics, Shop 4, Lowan House, Ann St. 41 1604 ● **Orange NSW:** M&W Electronics, 173 Sumner St. 62 6491 ● **Penrith NSW:** Acorn Electronics, Shop 12, 541 High St. 21 2409 ● **Port Macquarie NSW:** Hall of Electronics, 73 Horton St. 83 7440 ● **Rockhampton QLD:** Purely Electronics, 15 East St. 21 058 ● **Shepparton VIC:** G.V. Electronics Centre, 189b Coxo St. 21 8866 ● **Southport QLD:** Amateusz Paradise, 121 Nerang St. 32 2644 ● **Toowoomba QLD:** Hunt's Electronics, 18 Neil St. 32 9677 ● **Townsville QLD:** Tropical TV, 49 Fulham Rd, Vincent Village, 79 1421 ● **Wagga NSW:** Wagga Wholesale Electronics, 82 Forsyth St. ● **Wodonga VIC:** A&M Electronics, 78a High St. 24 4588 ● **Whyalla SA:** Mellor Enterprises, Shop 2 Forsythe St. 45 4764

## SPEEDY PHONE/BANKCARD ORDER SERVICE

Just phone your order and Bankcard details - it's so simple!

**(02) 888 2105**  
ORDER ONLY ON THIS NUMBER  
ENQUIRIES: (02) 888 3200

**HEAD OFFICE AND MAIL ORDER CENTER:**  
P.O. Box 321, NORTH RYDE, NSW 2113.  
TEL. (02) 888 3200

### POST & PACKING CHARGES

ORDER VALUE	CHARGE	ORDER VALUE	CHARGE
\$5.00-\$9.99	\$2.00	\$50.00-\$99.99	\$5.00
\$10.00-\$24.99	\$3.00	\$100.00 or more	\$6.50
\$25.00-\$49.99	\$4.00		

Charges are for goods sent by post in Australia only - not airmail, overseas or road freight

### Dear Customers,

Quite often, the products we advertise are so popular they run out within a few days. Or unforeseen circumstances might hold up shipments so that advertised lines are not in the stores by the time the advert appears. And very occasionally, an error might slip through our checks and appear in the advert after all (we're human too!). Please don't blame the store manager or staff; they cannot solve a dock strike on the other side of the world, or fix an error that's appeared in print! If you're about to drive across town to pick up an advertised line, why not play it safe and give the store a call first - just in case.

Thanks

Dick Smith and Staff

## OR SHOP FROM THE COMFORT OF YOUR ARMCHAIR

with our lightning fast  
fully computerised  
new mail order  
system.

Yes! Our mail order service has 'gone computer' offering you even faster, more efficient service than ever before - and (we believe!) much better than anyone else can offer.

Whether you choose to shop by mail, by our phone-in Bankcard order line (see above) or even by telex (no. 20036) you'll find it receives the personal attention that only our friendly, expert staff can give - plus the incredible speed and accuracy of our computer.

When you place your next order you'll find a special note enclosed telling you all about our amazing new system. We think you'll agree... it's pretty special!



OPENING  
THIS MONTH

**NEW  
STORE IN  
ALBURY**



Come to the corner of  
**SWIFT AND YOUNG ST.**  
(060) 218 399  
You'll find highly trained  
electronics enthusiasts,  
ready & able to help you!

**Dick Smith Electronics**





# OKI Electric if800 'all-in-one' computer

Continued from page 96

provided with the system. Size of the text display format is selected with the WIDTH command while the CONSOLE command allows other display attributes to be modified, including the scrolling area of the screen, the function key label display and the scrolling speed of the display.

Rather than scrolling over the full height of the screen the if800 can be instructed to scroll only part of the screen by specifying the top line of the scroll window and the number of lines to be included in the window. Lines are numbered from 0 to 24 in the 25 line mode and from 0 to 19 in the 20 line mode.

The fourth parameter of CONSOLE controls the speed of scrolling. When "0", scrolling will be performed on a line by line basis, called "jump scroll" by Oki because of the jerkiness of the resulting movement. Specifying a value from 1 to 255 will select smooth scrolling (pixel by pixel movement). The lower the number the faster the scrolling speed.

Further basic statements allow cursor positioning on the screen and the display of text in any position and in a variety of sizes and orientations. The SYMBOL statement of Basic, for instance, displays a specified character string at a specified position on the screen, and allows the selection of a variety of type sizes. Character strings can also be rotated in increments of 90 degrees for labelling graphs etc.

The display screen of colour versions of the if800 is "bit-mapped" in three planes, one each for the red, green and blue components of a screen image. Each bit plane can be displayed and erased separately, allowing a multitude of special effects. Different colours can be selected for the characters displayed, the screen background and the border of the screen with the Basic COLOR statement (the English spelling "COLOUR" will generate a syntax error).

Further Basic statements support graphics, with statements to set and reset individual pixels to any colour, draw lines using either relative or absolute co-ordinates and fill areas of the screen with colour until a boundary of a specified colour is encountered. A "graphics sub-language" accessed by the DRAW statement allows specification of connected lines, angles of rotation and various scaling factors using strings of parameters, and the statements GET and

PUT will respectively store a graphics image in a data array and re-display it.

There is also the CIRCLE statement, which will give draw circles, as the name implies. Given various parameters the statement will also draw arcs and ellipses and optionally fill the shape with any of the available colours.

To make best use of graphics displays usually requires some adjustment of the screen for the best picture, and the if800 has a conveniently placed brightness control tucked into a recess beneath the left side of the screen. Controls for contrast and vertical and horizontal adjustments are at the rear of the monitor and would require use of a screwdriver. No adjustments were necessary on the review machine.

A knurled knob on the leftmost supporting pillar of the display allows the tilt angle of the screen to be adjusted, but of course the design of the if800 does not allow the screen to be swivelled. The RGB monitor is always directly in front of the user, at a distance of perhaps 45cm, since the keyboard is not detachable. Tilting the display screen should eliminate most problems with glare, but attention would have to be given to lighting of the environment, since the physical configuration of the if800 is not as flexible as that of modular systems.

## Disk storage and software

Next to the CRT screen are two vertically mounted 20cm disk drives, each providing 968K bytes of useable storage for programs and data. Several other disk formats are supported, including the IBM 3740 single density single-sided standard. Using this format disk, capacity is reduced to 239K bytes but disks are compatible with the standard CP/M 20cm disk format, allowing the if800

user to take immediate advantage of the thousands of programs available in this format under CP/M 2.2.

Supplied with the review system was a disk containing the CP/M 2.2. disk operating system and "OBasic", Oki's extended version of Microsoft Basic80. Features of this interpreter include variable names up to 40 characters long, the CHAIN and COMMON statements which allow one program to call up another while preserving a common set of data between the two, and extensive support for the graphics, sound, I/O and extended memory facilities of the if800.

Statements and functions of OBasic are listed in Table 2, but some of the more unusual features may require explanation.

AUTO, as might be guessed, enables the automatic generation of line numbers, a great convenience for programmers. Parameters to the command allow the specification of the starting line number and the increment between lines. The RENUM command is also available to change line numbers of a program or part of a program.

BEEP will sound a tone from the internal speaker, while the PLAY statement provides control of the five-octave sound generator by use of a parameter string specifying the octaves, notes and rests to be played.

The statement BLOAD will load a machine language program from disk to a specified area of memory, and the CALL statement is available to activate the routine. The USR statement is also supported, but unlike CALL it does not allow parameters to be passed to the machine language program.

While the EDIT command allows editing of lines using the cursor control keys and INS and DEL, "full screen" editing is also available. In this mode the user moves the cursor over the characters to be changed and inserts,

*Continued on page 101*



The if800 has a comprehensive keyboard with dedicated function keys and LED indicators on the locking keys.

# at the leading edge

## **CMOS CTCSS ENCODER/DECODER MEETS EIA SPECS**

(UK) Sub audio tone squelch systems will get a boost from CML's FX315, FX325 crystal-locked chips. The FX325 boasts 38 Field programmable tones, on-chip filtering to attenuate incoming CTCSS signals, audio switch and a choice of either DIL or Flat-Pack housing.

## **SHARP SCORES WITH 20mm DIAMETER "JUMBO" LEDS**

(JAPAN) Coloured red, green or yellow, these outsized domed devices are an ideal replacement for filament lamps in electrical or control panels. Indoor scoreboards will also benefit from their wide viewing angle and high brightness.

## **WHISTLE, BEEP, HONK, CHEEP, CHIME, TICK, RING, CLICK ... ZOUNDS — WHAT SOUNDS!**

(USA) General Instrument's Sound Synthesizer, IC AY-3-8910, will add new dimensions to your computer's audio repertoire. For less than \$9.00 you could have your computer express itself in sounds, symphonic or even naughty.

## **INDUSTRIAL ACTION EXPECTED FROM SINGLE CHIP PROGRAMMABLE CONTROLLER**

(USA) LSI Computer Systems LS7270 Programmable Logic Controller (PLC) could grab a large chunk of the timer, sequencer and relay combinational logic action. At around \$28.00 this 40-pin part has features which rival top-drawer packaged PLCs costing hundreds of dollars. Summarizing: 12 latched outputs, 20 debounced inputs including 12 discretes, 4 downcounters, 4 priority interrupts, on-chip clock generator and up to 2048 instructions from an external ROM or PROM. This device is geared to individual bit processing, Boolean processing, turn-on turn-off functions, counting and timing operations, not numeric computation — so don't confuse the LS7270 with your common or garden variety micro.

### **daneva australia Pty Ltd**

66 Bay Rd Sandringham Vic 3191  
P.O. Box 114 Sandringham Vic 3191  
Telephone 598-5622 Telex AA34439

Sydney: (02) E & M Electronics 51-5880  
Adelaide: (08) DC Electronics 223-6946  
Perth: (09) Micro Controls 445-2544  
Brisbane: (07) Ballec 369-5900



# OKI Electric if800 'all-in-one' computer

Continued from page 99

deletes or types over existing text to make the changes. On pressing RETURN these alterations will be incorporated into the program on display. When line numbers are changed in this way the result is a new line, while the existing line also remains in memory with the previous line number.

The SELECT statement allows the programmer to specify one of a number of

banks of memory, each of 32K. When a memory expansion board is installed in the if800 up to four such banks are available and can be used as the Basic program area, or for storage of "extended arrays" (indicated by the use of the DIM@ statement). The extended array declared by this statement is stored in the memory bank specified by the number used with SELECT.

CHAIN@ also uses the extended

memory capabilities of the if800. A number of programs may be loaded from disk at the start of a session and called up by the CHAIN@ statement. Since the programs are already in memory access is much faster than if a program is loaded from disk each time it is required.

The real-time clock of the if800 is supported with the statements TIME, TIME\$, DATE and DATE\$. PRINT TIME will display the current count of the clock while PRINT TIME\$ will display the time (to the second) in 24-hour format PRINT DATE\$ will display the date, month and year. When using Basic, pressing Function key six will have the same effect as PRINT DATE\$, TIME\$.

Extensive support is also provided for the communications functions of the if800. Peripheral devices can interrupt the execution of a Basic program when enabled by the COM ON statement. Once enabled, subsequent use of ON COM GOSUB xxxx lets the program incorporate routines which will only be entered on receipt of data through the RS232C communications port.

The ON PEN and ON KEY statements function in the same way to allow light pen or function key inputs to be handled from within a Basic program.

For additional versatility there is the OBasic TERM command which allows the if800 to operate as a terminal using the RS232C interface. Either full or half duplex communication formats can be used and an extensive range of control codes and ESC sequences allows control of screen formats, communications protocol and the internal printer. Most Basic statements can be executed in a "remote" mode, which carries out the operation specified and outputs the result to either the terminal or the host computer.

## OKI if800 Model 30 Specifications

Processor:	Z80B at 4.9152MHZ
RAM:	128K bytes, expandable to 256K
ROM:	2K bytes for Initial Program Loader
Keyboard:	104 typewriter style keys, numeric pad, definable keys and special functions keys
Display:	RGB monitor, 80 characters X 25 lines, 640 X 400 pixel graphics in eight colours (see text)
Interfaces:	RS232C serial port (110-9600 baud) light pen socket. Three expansion slots for optional devices.
Disk drives:	Two 20cm double-sided double density each providing 968K storage.
Peripherals:	Built-in 80cps full-size dot matrix printer.
Documentation:	Separate manuals on hardware, Basic and CP/M. Manuals well organised but lack detail.

## OKI if800 Basic statements

ABS, ASC, ATN, ATTR\$(disk), AUTO, BEEP, BLOAD, CALL, CDBL, CHAIN, CHR\$, CINT, CIRCLE, CLEAR, CLOSE, CLS, COLOR, COM OFF, COM ON, COM STOP, COMMON, CONSOLE, CONT, COPY, COS, CSNG, CSRLIN, CVI, CVS, CVD, DATA, DATE, DATE\$, DAY, DAY\$, DEF CHR\$, DEF FN, DEF USR, DEFINT/SNG/DBL/STR, DELETE, DIM, DIM@, DRAW, DUMP, EDIT, END, EOF(disk), ERASE, ERL, ERR, ERROR, EXP, FIELD(disk), GET@, GOSUB . . . RETURN, GOTO, HEX\$, IF . . . THEN . . . ELSE, INKEY\$, INP, INPUT, INPUT (disk), INST, INT, KEY, KEY LIST, KEY OFF, KEY ON, KEY STOP, KILL(disk), LEFT\$, LEN, LET, LFILES(disk), LINE, LINE INPUT, LINE INPUT (disk), LIST, LLIST, LOAD(disk), LOC(disk), LOCATE, LOF(disk), LOG, LPOS, LPRINT, LPRINT USING, LSET(disk), MDI\$(disk) MERGE(disk), MID\$, MKD\$(disk), MKS\$(disk), NAME(disk), NEW, OCT\$, ON . . . COM GOSUB, ON ERROR GOTO, ON KEY GOSUB, ON PEN GOSUB, ON . . . GOSUB, ON . . . GOTO, OPEN(disk), OPEN(port), OPTION BASE, OUT, PAINT, PAUSE, PEEK, PEN(n), PEN OFF, PEN ON, PEN STOP, PLAY, POINT, POKE, POS, PRINT, PRINT USING, PRINT (disk), PRINT USING(disk), PSET, PRESET, PUT(disk), PUT@, RANDOMIZE, READ, REM, RENUM, RESET, RESTORE, RESUME, RIGHT!, RND, RSET(disk), RUN, SAVE(disk), SCALE, SCREEN, SELECT, SET, SET(disk), SGN, SIN, SPACE\$, SPC, SQR, STOP, STR\$, STRING\$, SWAP, SYMBOL, SYSTEM, TAB, TAN, TERM, TIME, TIME\$, TRON/TROFF, USR, VAL, VAPRTR, WAIT, WHILE/WEND, WIDTH, WIDTH LPRINT, WRITE.

## Enhanced CP/M

CP/M (Control Program for Microcomputers) is an operating system written by Digital Research to run on the 8080 microprocessor. It is organised in such a way that only a small section of the program (the BIOS, or Basic Input/Output System) is dependent on the configuration of any one machine. All other functions are implemented with calls to this system, allowing CP/M programs to be used by a large number of machines.

Many thousands of applications programs are available from commercial and private suppliers which will, in theory, run on any system using CP/M.

In practice a major obstacle to the interchange of CP/M programs between different computers is the variation in disk formats used to store data on disks. Although a standard format exists for 20cm disks (the IBM 3740 format), each manufacturer of systems using 13cm disk

# OKI Electric if800 'all-in-one' computer

Continued from page 101

drives tends to use a different data storage format, so that disks written on one system cannot be read by a system with a different brand name.

The if800's 20cm disk drives can be configured to be fully compatible with the 3740 format, so that these problems do not arise.

Oki supplies an extended version of CP/M with the if800 Model 30. While compatible with CP/M 2.2 this version of the operating system incorporates other functions to take advantage of the special features of the if800 system. What this means is that standard CP/M programs will run on the if800, but programs written using the special features of Oki's CP/M cannot be run on systems which lack these features.

The extended features of IF-CP/M allow the programmer to access graphics, the in-built printer, screen format routines, RS232C port and optional Centronics port, ROM cartridge and light pen directly from CP/M or any other program running under CP/M. Function keys and the extended "bank select" memory arrangement of the if800 can also be fully utilised and a number of disk utility programs provide further capabilities.

Access to the graphics features of the if800 is an exceptional feature of IF-CP/M. Many other systems provide graphics capabilities which can only be accessed through Basic, making them unusable by other programming languages and applications programs.

Two methods are available to allow the user to add graphics to programs running under CP/M on the if800. The first method uses Escape key sequences to indicate that graphics commands and parameters follow. To draw a circle under CP/M, for example, the command is ESC G C, Colour, Centre X, Centre Y, Radius, where the four parameters are expressed as decimal numbers. Ellipses, arcs, line and boxes can be drawn and coloured with variations on this technique.

The second method of accessing graphics is faster but less general-purpose. Direct calls to the BIOS routines of Oki's extended CP/M are permitted, allowing graphics to be added to any program. This method requires some experience of assembly language programming but allows fast, versatile access to all graphics functions.

A number of utility functions of the on the Oki system disk further expand the usefulness of the if800. IFCONFIG allows the selection of parameters for the RS232C port and an external printer which may be connected to either the



This view shows the if800 with an on-screen self-portrait.

serial port or via the optional Centronics interface. Another utility, 20T030, allows programs stored on the 13cm disks used with the Oki Model 20 to be transferred to the 20cm disks of the Model 30.

A utility called MDDUTY can be used to create a "memory disk" using the colour graphics memory or the extended memory provided by a memory expansion board. Using this utility a section of memory of up to 192K bytes can be configured so that it appears to the system as a very fast disk drive.

The advantage of this approach is that programs which require frequent disk accesses can operate on the "memory disk", considerably increasing the speed of execution. Compilers, database programs and word processing programs in particular can make good use of this feature. While most other S100 CP/M systems can be fitted with a "memory disk" it is usually a costly optional feature.

## Applications

Given the standard CP/M format of the if800 disk drives, applications programs for the system should be readily available, although some customisation would be required to take full advantage of the if800 features. WordStar and Spellbinder word processing programs are available, as is the spreadsheet calculator SuperCalc and a host of other programs from dealers and organisations such as the CP/M Users Group.

We ran Spellbinder, a full-featured easy-to-use word processor. Using this program shows up a possible disadvantage of the if800. The bit-mapped colour display and long persistence phosphor means that screen updates take an appreciable amount of time. Since

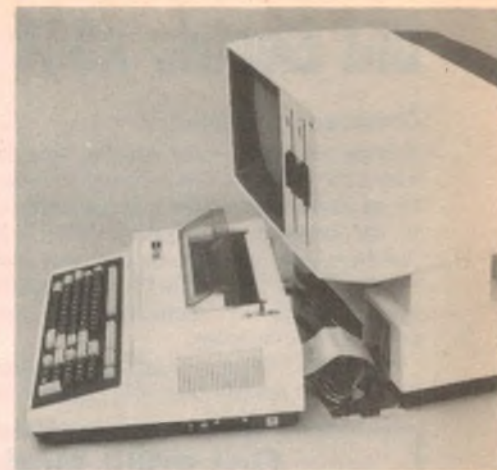

The two parts are joined by three cable connectors and bolted together.

Spellbinder (and to a lesser extent, WordStar) reformat the screen as new characters are entered or inserted, for a great deal of the time what's on the screen has no relationship to what is being typed — an annoying peculiarity.

To some extent the problem is inherent in the design of the if800, in that colour graphics and text processing make different demands on a system. While the colour version of the if800 is excellent for graphics it is not ideal for processing large amounts of text. Those considering such applications would perhaps be better advised to look at the monochrome version of the if800.

## Conclusions

We have some reservations about the if800. With its expanded memory and fast Z80B microprocessor, plus colour graphics, the machine is an excellent implementation of a CP/M system. In these days of 16-bit microprocessors however, CP/M, while maintaining a large and loyal following, can hardly be described as "state of the art".

Other reservations arise from the "all in one" configuration. Perhaps the if800 does take up no more space than an equivalent modular system with separate printer and disk drives, and the lack of cabling is a definite advantage, however the if800 presents itself as a big, bulky and noisy system. The height of the keyboard and the fixed position of the display are also incompatible with current thinking on ergonomic design standards.

Cost of the system reviewed here is \$5650 plus sales tax. Included in the price is the CP/M operating system, OBasic interpreter, WordStar word processing program, SpellStar, Mailmerge and the CalcStar electronic spreadsheet program.

For further information contact Sigma Data Corporation Pty Ltd, 157 Walker St, North Sydney, NSW, 2060, phone (02) 436 3777.

# THE ULTIMATE TRANSCEIVER! **BUY BEFORE PRICE INCREASE!**



Cat. D-2852

## look at these features

- ALL mode (even FM\*) so you can go anywhere — on its own, or teamed up with a transverter. It's brilliant!
- ALL band — it receives from 150kHz to 30 MHz continuous, with resolution down to 10 Hz! And the transmitter includes all the new WARC bands!
- ALL microprocessor controlled — which makes operation nice and easy for you (including keeping track of the FT-ONE's 10 VFO's!)
- ALL area operation: run it from 100—120 or 200—240V AC in the shack, or 13.5V DC when mobile!
- ALL solid state (of course!) with a massive complement of 659 semiconductor devices, including over 70 IC's!
- ALL performance — with better than 0.3uV sensitivity and more than 100W PE output (SSB).

## be quick— stocks limited at this price

"On 28th June a new 30 per cent Customs Tariff was imposed on ALL imported transceivers... means the end-user retailer price will escalate to approximately 40-50 per cent above current retail prices..." — Amateur Radio, August 1983.

Hurry, beat the massive price rise! The next shipment of FT-ONES MUST rise in price to almost \$3000. There are only limited stocks left at the old price.

You won't do any better than buying your Yaesu from Dick Smith Electronics: Australia's leading factory-approved Yaesu agent...after all, we're the ones who give you a full 12 month guarantee!

FOR ONLY **\$1995** \*FM board optional at extra cost

# DICK SMITH ELECTRONICS

See page 98 for full address details

A606/TH

# *New concept in energy management*

# Remote control for lights and appliances

by PETER VERNON

Remote control of lighting and other appliances from a central point offers convenience, security and energy savings for the office manager or factory supervisor. Until recently however such a system was difficult to install, requiring extensive re-cabling of buildings. A new product on the Australian market, "Ripul" mains carrier switching, offers all these advantages and more, using simple controllers that plug into any mains electricity outlet.

Ripul is the trade name for a method of superimposing a carrier signal on the mains electricity supply to remotely control lights and other appliances. Using the existing mains wiring and Ripul control units, appliances can be switched on and off or lights dimmed under the control of a handheld infrared transmitter or a programmable timer, over wiring distances of up to 2000 metres.

Applications for the system include energy management, security, household control and aid for the physically handicapped.

The Ripul system uses a pulsed 140kHz carrier signal which is switched on and off to convey information in a binary code. The first pulse indicates that an "address" or channel number follows and the four subsequent bits of the code select one of 16 possible receivers. Appliances connected to the receiver can either be switched on and off or controlled proportionally, depending on the type of receiver in use.

Expansion of the coding system is possible to allow a maximum of 600 channels on each phase of the mains supply — a total of 1800 independently controlled switching functions.

Some of the components of the system are shown in the accompanying photographs. From the user's point of view the most visible piece of equipment is the handheld infrared remote controller. The compact control unit transmits an infrared signal to "senders" plugged into the mains. Available units include 16-channel, four channel and single channel versions, all completely self-contained and battery powered. Power is only consumed when the controller is actually sending a signal, so the life of the calculator-type battery of the

unit is a claimed two years.

In addition to handheld controllers, Ripul equipment can be coupled to a programmable timer or computer to allow switching of appliances according to a preset schedule. The standard timer offers four control channels and timing up to seven days in advance, with one minute accuracy. A 14 channel model is also available which will time events up to a year in advance.

Several different types of "sender" are available. These receive the signal from the infrared controller and produce the appropriate sequence of 140kHz pulses to activate the selected receiver. Probably the most commonly used sender is the plug-in version, a small rectangular device with a lens for the infrared detector and a one metre mains cord. Installation is simply a matter of plugging the unit into a convenient mains socket.

An outdoor model is also available in a tough weatherproof polycarbonate case. Installation requires connections to the active and neutral lines of the mains supply. Using this sender, signals from an infrared controller outside a building can be used to control internal or external lights and appliances. With one of these units and suitable receivers installed in the home a driver could turn into the driveway, open the garage door, switch on the interior and exterior lights, turn up the heat and perhaps get dinner under way before even stepping from his car!

There are several different types of Ripul control receivers. The portable 16-channel switch is perhaps the most commonly used. This version has a 16 position rotary switch which selects which address the receiver will respond to and two pushbuttons for manual con-

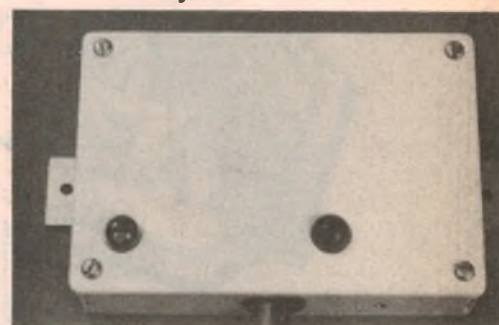

trol of the switch function. It is supplied with two integral power cords, one of which plugs into a mains socket for reception of control signals and the other containing an "in-line" socket to accept the plug of the appliance to be controlled.

The most straightforward receiver simply provides on/off control for loads of up to 1500W, but specialised types are also available for heavier loads and for dimming lights. When used for the dimmer mode, a touch of a button on the handheld controller causes the light to dim until the button is released. Lights can also be turned off or on at a preset brightness level.

The standard light dimmer receiver has a rating of 1A at 240V, but heavy duty versions are available for controlling incandescent lighting of up to 3kW or fluorescent arrays of up to 1.5kW. A 66kW (25kW for fluorescent fittings) version of the dimmer switch is also available.

For use with such a dimmer, fluorescent lights must be fitted with a "dim-mable" ballast and a heater to ensure that the tube "strikes" at low settings of the dimmer.

Receivers for lighting control can also be fitted with a photocell which detects the amount of ambient illumination in an area and switches off the light when natural illumination exceeds a preset level. When coupled with central control from a programmable timer, local control via an infrared transmitter and an over-riding touch switch this system

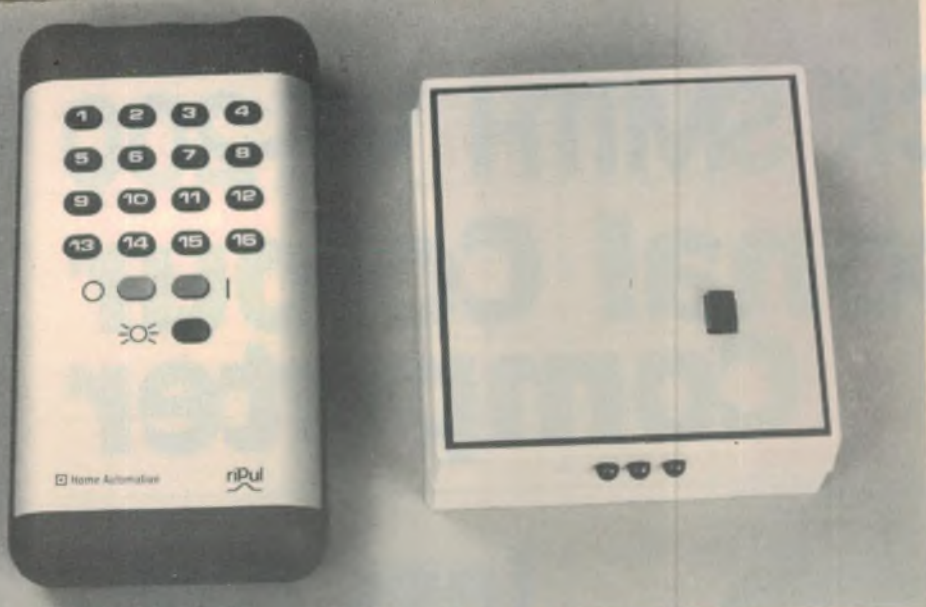

ABOVE:  
16-channel  
hand-held  
remote control  
unit (left) and  
touch-sensitive  
wall mounting  
unit (right).

LEFT: this ceiling  
mount unit  
combines  
infrared control  
with an ambient  
light sensor.

RIGHT: single  
channel IR  
receiver/sender  
(left) and  
16-channel IR  
receiver/sender.

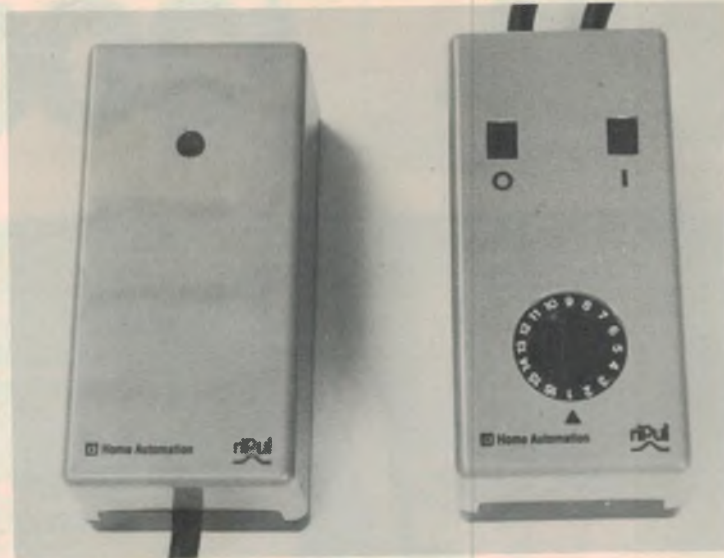

forms a flexible, responsive lighting control system which can offer considerable savings in power bills.

## Energy conservation

Conserving energy is a matter of using power only when and where it is needed. According to authorities, lighting in commercial buildings should be switched on only when each individual needs more light than is available at the time, rather than the more common "blanket" approach. As individuals move around or alter their schedule the lighting pattern should immediately respond to the changed circumstances.

This degree of energy management requires a highly flexible control system which is responsive to need but also convenient to work with. The answer, according to Ripul is not a large and laboriously pre-programmed computer, but a combination of local manual control with time switching and ambient light sensing.

A local receiver added to each light fitting or group of lights controls illumination in response to signals from a central timer and also from a hand-held or wall

mounted local controller available to each individual. Ambient light sensing is also incorporated. Power bill savings arise from four aspects of the system; lights are switched on only when actually needed and switched off when ambient light rises above a preset level. Lights can also be turned off after the expiry of a time lag so that unoccupied offices are not illuminated, and a central control timer ensures that lights are not left on overnight.

With only minor alterations the same system can be applied to the control of heating and air-conditioning equipment, allowing further energy savings.

Trials of such installations both here and in the UK have demonstrated energy savings of from 15 to 35%, which means that the required Ripul equipment pays for itself in around two years, according to the manufacturers.

Apart from energy conservation a major application of the Ripul controllers is in the security field. A central sender can allow a security guard to remotely control the lighting in any part of a building. Usually this approach is combined with closed circuit television monitoring for a

cost-effective surveillance system which does not require constant illumination.

Other applications of the equipment involve sending messages to either audible or visual indicators. Lloyds of London, for example, has installed Ripul systems in the offices of senior staff to activate an "engage" light outside each office door as well as control office lighting. A number of hotels have also installed the system to allow guests to signal for room service. The advantage here is that no additional wiring is required — the existing mains wiring carries the service request signals as well as power.

Easy, low-cost installation is one of the most frequently cited advantages of Ripul systems. Since the units simply plug in to existing mains wiring there is no need for expensive special cabling and the consequent re-decorating required by control systems which use separate wires. Architects working on the restoration of historic buildings in particular have specified Ripul control to avoid the need for disturbance created by new cable runs and conduits.

Some customers in fact claim that the ease of installation of Ripul systems has meant that they can add energy management and control functions for the same price as a less comprehensive system which requires special cable runs.

## Domestic use

Lighting Energy Systems, the distributors of Ripul products in Australia, has concentrated mainly on industrial and commercial installations. Price is one factor, but more importantly the Ripul system can in fact be too far-reaching.

While the 2000 metre carrying range of the senders is an advantage in a large building it could cause problems if a number of systems are installed in dwellings. Switching lights on and off in your own house may also switch Ripul controlled appliances in your neighbour's house — a situation guaranteed to cause some domestic friction!

Fortunately there is a way out, in the form of a filter which is installed in the household junction box, eliminating the possibility of interference between adjacent Ripul installations.

Ripul switching in private houses is not common, however. Far more interest has been shown by major industrial and commercial organisations and a number of successful installations are currently operating in Sydney, with many more planned.

Ripul equipment is manufactured in England, and imported in bare board form by Sydney company, Lighting Energy Systems, who assemble and install the systems. For further information contact the company at 1 Leighton Place, Hornsby, NSW 2077. Phone (02) 476 1199.

# DICK SMITH VZ-200 Personal Colour Computer



less than  
**\$200**

Here it is at last - the breakthrough you've been waiting for! A personal computer with all the right features: colour graphics, sound, standard Microsoft BASIC for easy programming, a whopping 8K bytes of RAM memory, the ability to work with a standard TV set, and much more. Yet thanks to modern electronics and our buying power, the Dick Smith VZ-200 will cost you only \$199 - far less than any comparable computer! There'll never be a better time to invest in your family's future . . . .



Don't take our word for it; read what the experts at Australia's leading computer magazine had to say . . .

*"Overall, this is a great little computer, and one that is likely to change the face of Australian personal computing."*

And from the editor: *"I'm certainly going to buy one!"*

(May 1988 issue, Australian Personal Computer)

**Now every family can afford their own personal computer!**

Yes, for just \$199, the Dick Smith VZ-200 gives you amazing computing power - far more than many machines two, three or even four times the price. Now you can find out what computers are all about. The kids can use it with their school work. It can keep track of your home budget. It can even help you in your business!

Still not convinced? *Try our exclusive 7 day money back satisfaction guarantee:*

Buy the Dick Smith VZ-200 Colour Computer and try it in your own home for up to 7 days. If you're not absolutely delighted, you can return it in original condition and packaging for a full refund.

*You'll owe nothing - not even an explanation!*

**AMAZING \$199<sup>00</sup>  
VALUE**

Cat No. X 7200

**And that's for a complete, ready-to-go computer that plugs into your TV set! If required, these options are available:**

**16K Memory Expansion Module:** **VALUE \$79.00**

Cat No. X 7205

**Colour Monitor:** **VALUE \$389.00**

Cat No. X 1195

**Printer Interface Module:** **ONLY \$49.50**

Cat No. X 7210

**EXCLUSIVE TO:**

## DICK SMITH Electronics

DSEA491/JCP

- Sydney 888 3200 ● Newcastle 61 1896 ● Wollongong 28 3800
  - Tamworth 66 1961 ● Gosford 25 0235 ● Canberra 80 4944
  - Melbourne 67 9834 ● Brisbane 229 9377 ● Adelaide 212 1962
  - Perth 328 6944 ● Hobart 31 0800 ● Townsville 72 5722 ● Toowoomba 38 4300
- Head Office & Mail Order Centre: PO Box 321, North Ryde NSW 2113. Ph (02) 888 3200



**ORDER BY PHONE!**

Just phone us on (02) 888 2105 and quote your Bankcard No. Your VZ-200 will be on its way the same day!!!



**& look at these exciting ways to expand your system**



**Technological Breakthrough!**

**Colour Printer/Plotter at an amazingly low price!**

Don't buy just a printer - here's a fantastic NEW 4 colour printer that is an X-Y plotter as well! Use it to produce graphs, pie charts, printing in many different sizes and lots more - all in four colours. Thanks to its built-in microprocessor, all of this can be done easily using simple commands in your BASIC programs.

Look at some of the features:  
 ★ 4 colours! (black, green, red, blue [uses ball pen inserts]) ★ A PLOTTER as well as a printer ★ Standard Centronics-type parallel interface ★ 10 chars. per sec. printing speed ★ Software switching between printing and plotting ★ 40/80 columns per line ★ Resolution 0.2mm ★ Step size 0.2mm min. ★ Full 96 char. ASCII set (caps and lower case) ★ Inbuilt microprocessor provides 'intelligence' - plots lines, etc. in response to simple commands ★ Plotting speed 52 mm/sec max vertical and horizontal, 70 mm/sec for 45 plotting.  
 ★ & the best feature of all is THE PRICE!  
 Cat X-7208

**NEW!**

Write & store your own programs/data!

**VZ Datasette**

Get the most from your VZ-200 - store your programs on this deluxe recorder. Made just for the VZ-200 so it's better than any normal cassette unit.  
 Cat X-7207

**ONLY \$69<sup>50</sup>**

**WANT MORE MEMORY? SIMPLY PLUG IT IN!**

**16K MEMORY MODULE**

Want to write your own programs but find the memory of your computer unable to handle it? This happens with almost every computer, no matter how large its memory! But with the VZ200 the answer is simple - just plug in the memory expansion module and now your VZ200 has a whopping 24K of total RAM! Cat X-7205

**\$79**



**A great range of games software**

**POKER**

Straight draw poker - just you and the computer. You can bet, raise, call, bluff and fold, just like the real thing.  
 Cat X-7232

**MATCHBOX**

A great memory tester! Behind the letters on the grid are pairs of symbols, but you can only see one at a time. Which letters have which pairs behind them? Good colour graphics and sound effects.  
 Cat X-7231

**BLACKJACK**

Ever wanted to visit Las Vegas? This is the next best thing - OR a good way to practice if you're planning a trip there. Blackjack or 21 is the game and the screen shows all the cards.  
 Cat X-7235

**HANGMAN**

If you can't guess the mystery word (8 letters) the figure on the screen is hanged - you lose! Based on the popular children's game, this program helps kids with spelling and vocabulary.  
 Cat X-7233

**EXCITING NEW GAMES AVAILABLE**

- SLOT MACHINE/KNOCK OFF/ RUSSIAN ROULETTE Cat X-7234
- CIRCUS Cat X-7238
- BIORHYTHM/PAIR MATCHING/ CALENDAR Cat X-7237
- HORSE RACING Cat X-7238
- INVADERS Cat X-7239
- DYNASTY DERBY Cat X-7240
- GHOST HUNT Cat X-7242
- HOPPY Cat X-7243

Use any Centronics type printer with this **Printer Interface**

Now get a printed 'hard copy' of both your programs and your data with this low cost Printer Interface. This superb compact module simply plugs into the back of your VZ200 alongside the memory expansion module, and lets you connect it to any standard Centronics-type printer, (like the X-7208 above). Includes printer cable.  
 Cat X-7210

**ONLY \$49<sup>50</sup>**

**AVAILABLE THIS MONTH ONLY \$299**

**WE'VE GOT NEW BOOKS TOO!**

**VZ-200 Technical Manual**

Want to get the most from your VZ-200? This technical manual explains all the ins and outs, ups and downs. For the real computer enthusiast or the beginner who wants to know more!  
 Cat B-7204

**\$9<sup>50</sup>**

**Introduction to Computing**

Are you a 'babe in the woods' when it comes to computing? Try this one out: written just for YOU! In a language you can understand, it will have you a VZ-200 expert in just a few days!  
 Cat B-7200

**\$9<sup>50</sup>**

**First Book Of Programs**

Tried, trusted and true programs for your VZ-200. There's something for everyone - and remember, they're all written in BASIC so you can save these on cassette so you only have to key them in once!  
 Cat B-7202

**\$6<sup>95</sup>**

**Plus these great financial & educational programs**

**STATISTICS 1**

A great introduction to the basic principles of statistical analysis. Explains about the Mean, Variance Standard Deviation, different types of Distribution etc. Gives you the opportunity to test your knowledge by working out examples.  
 Cat X-7251

**STATISTICS 2**

Following on from Stat. 1, this program deals with more advanced concepts. Tests of statistical significances. Students T-test, the Chi-Square test and so on.  
 Cat X-7252

**MATRIX**

Working out mathematical matrices can be a real chore. This program gives you more skill in handling them by practice.  
 Cat X-7253

**TENNIS LESSON/GOLF LESSON**

Challenge your computer to a game of tennis or golf. It plays by the rules so even if don't twin

you can learn a quite a lot about the game.  
 Cat X-7254

**PORTFOLIO MANAGEMENT**

Like to invest in the share market? This program will help you to analyse and manage your portfolio for max. profit and min. risk. It gives you a working model of your portfolio, so you can see the likely effects of any changes.  
 Cat X-7261

**DISCOUNTED CASH FLOW ANALYSIS**

An ideal working tool for executives, accountants etc. providing a model for market capital budgeting decisions and minimising an investment without prejudicing a project's liquidity.  
 Cat X-7262

**FINANCIAL RATIO ANALYSIS**

A program for the professional accountant, investment advisor, or small business owner who doesn't want to stay small!  
 Cat X-7263

**ALL ONE PRICE! \$12.50 ea.**

**ONE LOW PRICE \$12.50 ea**

**NOTE: Some programs may require 16K memory module.**

# Books & Literature



## Semiconductor Data and Applications



**DICK SMITH'S AUSTRALIAN SEMICONDUCTOR DATA AND APPLICATIONS BOOK.** Published by Dick Smith Management Pty Ltd, 1983. Soft covers, 127 pages, 210 x 140mm. Illustrated with many circuit diagrams and device connections. ISBN 0 949772 07 0. Price \$7.95.

This book, one of the Dick Smith range of publications, is designed as a reference book for hobbyists. It provides pinout and circuit diagrams for many common semiconductor devices as well as background theory and information essential for understanding how many of today's devices and circuits work.

Several types of diodes are covered in the book, these being small signal diodes, rectifier diodes, zener diodes, light emitting diodes and photosensitive diodes. Included in the light emitting diodes (LEDs) are sections on seven segment displays and infrared LEDs.

Transistors are covered in several sections with specifications being given for some of the most commonly used devices in bipolar, unijunction and field effect transistors.

Sections are also included on silicon controlled rectifiers (SCR's) and Triacs with specifications and circuits shown for the more common devices.

Operational amplifiers (op amps) which are covered include the 741 and 301, the CA3130 and CA3140 (FET input) and the 3080 (transconductance amplifier). A surprising omission from the operational amplifier sections is data for the TL071-TL074 series of op amps which are used quite extensively these days.

Both data and circuits are provided for the well known 555 timer IC and a section has also been provided for the 7555, the CMOS version of the 555.

Data is also provided on voltage regulator ICs and includes the adjustable 723 as well as the very common 78XX and 79XX series fixed voltage regulators.

The last third of the book is given over to digital ICs, more specifically the 74 series TTL and the 74C and 4000 series CMOS. Included are sections on suitable power supplies, interfacing between the two logic types, and static protection of the 4000 series CMOS. A very brief look at the 74C series CMOS is given and comparison made between this and the 4000 series CMOS.

Overall, as a first data book, this book will be of considerable use to most hobbyists. Obviously it cannot replace a full set of manufacturer's data books, but then it does not cost several hundred dollars.

Our review copy came from Dick Smith Pty Ltd and is available from any of the Australian Dick Smith stores. (JS)

## 301 Circuits by "Elektor"

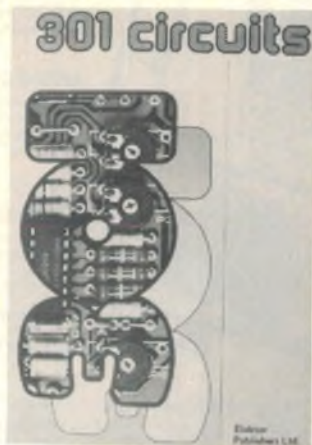

**301 CIRCUITS.** Published 1983 by Elektor Publishers Ltd, Canterbury. Printed in the Netherlands. Soft covers, 140 x 210mm, 342 pages, illustrated with many circuit diagrams. ISBN 0 905705 12 2. \$12.75.

As can be gathered from the title, this is a collection of 301 circuits which have been published previously in "Elektor" magazine. Most of the circuits can be characterised as having no more than

two or three IC's and just a few other parts. Some of the circuits use only one IC or transistor. And most of the circuits appear to have been produced by contributors to the magazine rather than by magazine's staff.

Some 35 of the circuits are published with actual size artwork for a printed circuit board. This artwork is to the usual high "Elektor" standard, ie neat and geometrical and closely packed. This may pose problems if some of the components are unavailable in Australia although all the semiconductor devices featured should be obtainable here.

Most of the circuits are intended for battery operation and a quick perusal of the books indicates that they all should be viable. Our copy came from Technical Book & Magazine Company Ltd, 295 Swanston Street, Melbourne. (L.D.S.)

## Information Technology



**BRAVE NEW WORLD: Living with Information Technology.** Published by McDonald & Co, London, 1982. Soft covers, 147 x 211mm, 174 pages ISBN 0 356 09178 3. Price \$12.95.

This book is a collection of essays on the impact of information technology, or IT as the British say. Eleven eminent journalists, businessmen and educators have each contributed a chapter on the applications and effects of automated information handling in their fields. Kenneth Baker, the British Minister for Information Technology (the Minister for IT?) wrote the brief preface.

The individual essays cover a wide range of subjects in four broad areas. Peter Large, of the London Guardian, and Alan Cane of the Financial Times provide overviews of the effects and potential of information technology and a number of industrialists contribute chapters on the applications of technology in engineering design, manufacturing, retailing, finance and office administration.

Part Three of the book covers wider

topics; mass communications, social and economic implications and the prospects for education. David Fairbairn, the director of the UK National Computing Centre Ltd provides the final section, bringing the reader back down to earth with a "practical guide" to computer equipment currently available.

The problem with all books of this kind is that in covering such a wide area as information technology they can necessarily only touch briefly on each particular subject. While providing an overview they can be short on detail or just plain wrong (as in the glossary entry in this book which defines APL as "A program language which needs little or no previous computing knowledge". That may be true if you already have a degree in mathematics, but can only mislead those unfamiliar with the language).

Fortunately slips such as that are rare in this book. The general approach is balanced and the material is written by contributors who obviously know the fields of which they write. The material is both understandable and thought provoking, and altogether a most readable introduction to the perils and potential of information technology. Our review copy was supplied by MacDonal Futura Australia, 19a Boundary St, Rushcutters Bay, NSW 2011 (PV).

## 1983 Radio and Television Handbook

**1983 WORLD RADIO & TELEVISION HANDBOOK** published by the World Radio & Television Handbook Company, Copenhagen, Denmark, 37th Edition 608 pages, soft cover, 146 x 228mm.

The World Radio & Television Handbook has been published from Copenhagen for 37 years. It was first conceived by O. Lund Johansen who published the Handbook in 1946 when it covered less than 100 pages. Today the World Radio & Television Handbook, covering more than 600 pages gives complete details of all the world's radio and television stations. They are listed in countries by continental groupings and then medium and shortwave stations are listed by frequency. The Australian, New Zealand and South Pacific section had been completely updated and rewritten thanks to collaboration by readers in Australia and New Zealand who have gone through the last World Radio & Television Handbook thoroughly to ensure that this section is as accurate as possible.

The Handbook has continued to expand its information and many new countries appear in the 1983 edition for the first time. In the section "Listen to the World", Lawrence Magne reviews many of the popular portable communication

# PLACE

## ELECTRONICS

**\$750\***

**ND 2200**  
165 CPS DRAFT  
80 CPS NLQ  
80 col  
Condensed print  
Expanded print  
Epson compatible  
Pin addressable graphics

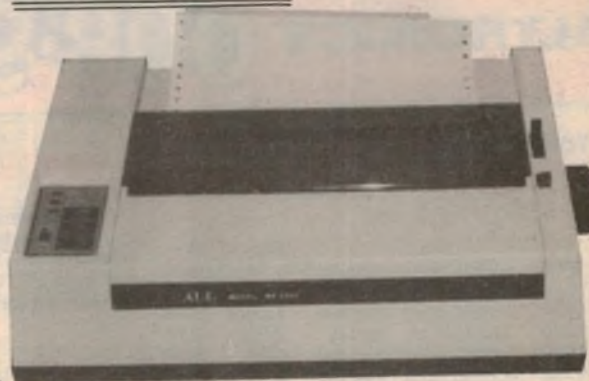

**\$445\***

**CP 80  
COMPUTE MATE**  
80 CPS  
80 col  
Condensed print  
Expanded print  
Epson compatible  
Pin addressable graphics



**\$650\***

**DAISY WHEEL  
PRINTER**  
160 WPM PLUS

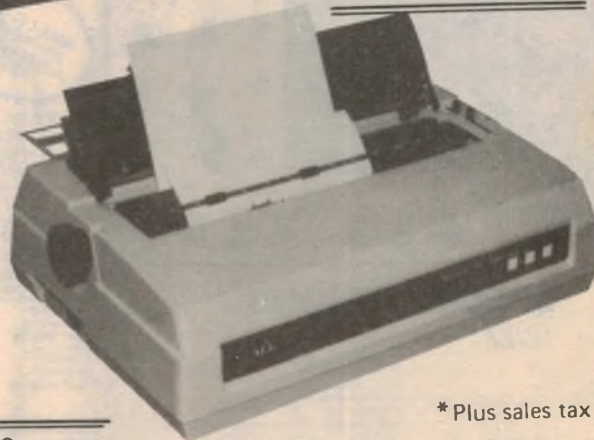

\* Plus sales tax

PLACE ELECTRONICS

5/24 HELEN STREET . LANE COVE . NSW . 2066 . PHONE 412 3386

receivers which have taken the listening world by storm in recent months. These include the ICOM IC-R70, Sony ICF-6800W, Trio-Kenwood R-600, National Panasonic DR-31 and many more receivers from leading world manufacturers. The section gives background information needed when one is considering purchasing a new receiver. Other features sections include Yachting and Shortwave Radio, the High Fidelity Future of Shortwave and Mediumwave AM Radio. The Red Cross Broadcasting Service, Radio in Nicaragua etc - altogether 43 pages of interesting reading.

The World Radio & Television Handbook had long been regarded as

the only directory of international broadcasting sold throughout the world. The United States Information Agency has put copies into its libraries in 71 countries so that those in third-world countries who cannot afford the book will have access to its information. The Editor J. M. Frost, and Assistant Editor A. G. Sennitt, are to be congratulated on the painstaking work involved in compiling another excellent edition of the Handbook. Readers in Australia and New Zealand should find copies at their bookseller this month, or they can write to the sole New Zealand agent, Arthur Cushen, 212 Earn Street, Invercargill, New Zealand for further information. (A.T.C.)

**BANKCARD HOLDERS —  
PHONE YOUR ORDERS  
TOLL FREE!**

**NEXT DAY DELIVERY**



**ALTRONICS**

**VIA  
JETSERVICE**  
(CAPITAL CITY & SUBURBAN AREAS)

**TOP QUALITY  
XTALS**

			ea.	10 +
Y 1000	1.0000 mHz	Parallel	\$11.50	\$10.25
Y 1003	1.8432 mHz	Parallel	9.50	8.75
Y 1006	2.0000 mHz	Parallel	7.50	6.75
Y 1010	3.5875 mHz	Series	3.00	2.75
Y 1012	4.0000 mHz	Parallel	5.00	4.50
Y 1015	4.1940 mHz	Parallel	5.00	4.50
Y 1017	5.0000 mHz	Parallel	5.00	4.50
Y 1018	6.0000 mHz	Series	5.00	4.50
Y 1019	8.0000 mHz	Series	5.00	4.50
Y 1020	10.0000 mHz	Series	5.00	4.50
Y 1025	12.0000 mHz	Series	5.00	4.50
Y 1030	16.0000 mHz	Series	5.00	4.50

**HEATSINK COMPOUND**

Heat conducting paste facilitates heat transfer from semi to heatsink. One tube good for up to 30 TO3 package semiconductors.

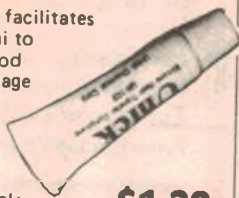

H 1600...7.5g Pack..... **\$1.20**  
New trade pack  
H 1610...150g Pack..... **\$7.50**  
SAVE UP TO 33%

**VELOSTAT**



Non-static sheeting for storing CMOS IC's, LSI's etc. 1000 times better than aluminium foil. Will store up to 150 IC's on one 225 x 150mm sheet.

H 0500.... **\$3.50 per sheet**

**DIL SWITCHES**

GOLD PLATE SELF WIPING CONTACTS



S 3050 EA 10UP  
4 Way **\$1.50 \$1.35**  
S 3060  
8 Way **\$2.00 \$1.75**

**NEW HITACHI F SERIES  
SQUARE SCREEN DUAL BEAM CRO**

SUPERB NEW MODEL V152F DC TO 15 mHz 1Mv/DIV DUAL TRACE



CAT 00152  
PRICE ONLY  
**\$579 TAX EXEMPT**  
**\$649 TAX PAID**

Features \* X-Y Operation \* Vertical sensitivity 1mV/div. \* 10 x Sweeptime magnification with 1-touch operation \* Convenient Ch1 signal DVM output \* Z-axis input provided — possible to use as CRT display \* 0.2us to 0.2s — wide sweep range setting \* Five modes of vertical operation \* Panel layout with colour coding of respective functions

**SPECIFICATIONS**

**Vertical deflection**  
Sensitivity 5mV/div to 5V/div - 5%  
10 calibrated steps  
1mV/div to 1V/div - 6%  
When using 5amp. filter  
Uncalibrated continuous control between steps 1 - 2.5  
Provided with click positioning function.

**Bandwidth** DC to 15MHz - 3dB at 4div  
DC to 7MHz - 3dB at 4div  
When using 5amp. filter  
24% for 5.70mV/div

**Rise time** 24ns for 5.70mV/div

**Signal delay time** 24ns for 5.70mV/div

**Max. input voltage** 600Vp-p or 300V DC - AC peak at 1kHz

**Input Coupling** AC, GND, DC

**Input impedance** Direct 1V ohm approx 70pF

**Operating modes** CH1 X axis CH2 Y axis

**X-Y operation** 5mV/div to 5V/div when using 5amp. filter 1mV/div

**Sensitivity** CH1 X axis CH2 Y axis

**Phase difference** DC to 10kHz within 3

**X bandwidth** DC to 50kHz - 3dB

**Dynamic range** 4div or more

**CH1 output** 20mV/div or more

**Output voltage** Term. rated into 50Ω

**Band width** 50Hz to 5MHz - 3dB

**Output impedance** Approx 50Ω

Frequency	Internal	External
20Hz to 2MHz	0.5div	200mV
2 to 15MHz	1.5div	800mV

**AUTO low bandwidth**  
Trigger stage  
External trigger input

**Sweep time**  
30Hz  
Input impedance approx 1M ohm, 30pF or less  
Max. input voltage 100V DC - AC peak at 1kHz  
0.2us/div to 0.2s/div - 5%  
19 calibrated steps  
Uncalibrated continuous control between steps 1 - 2.5  
Provided with click positioning function.

**Sweep time magnifier**  
Max. sweep time  
10 times - 7%  
100ms/div, 20ms/div and 50ms/div, not calibrated.

**Amplitude calibrator**  
Waveform: Approx 1kHz - 10% (typ.) square wave  
Voltage: 0.5V - 5%

**Power requirements**  
100/120/220/240V - 10%  
50 to 60Hz, approx 40W

**Dimensions**  
Approx 275(W) x 190(H) x 400(D)mm

**Weight**  
Approx 8.5kg

**Powerful New  
6000 RPM  
Mini Drill  
for PC  
Work**



Tons of Torque. Just the shot for PCB work. 12V DC operated from external Power Pack 1.2mm chuck capacity. Supplied c/w 1mm drill bit.

T2302 ..... **\$12.95**  
Drill Bits:  
T2320 (0.8mm) ... **\$1.25**  
T2325 (1.0mm) ... **\$1.25**

**ALTRONICS JIFFY BOXES**

**Incredible offer!**

Black plastic body with 22 g. aluminium lid and 4 st. screws supplied. Unique horizontal PC "Snap In" mounts as well as vertical card guides. Order your PC Boards presized and dispense with costly stand offs, screws etc. These utility boxes are used in dozens of E.T.I. and E.A. projects.

Box	Dimensions	Vertical	Horizontal	Price this month
H 0101	150 x 90 x 50	90	87	<b>\$1.90</b>
H 0102	195 x 113 x 60	106	103	<b>\$2.90</b>
H 0103	130 x 68 x 41	62	60	<b>\$1.80</b>
H 0105	83 x 54 x 28	50	47	<b>\$1.20</b>

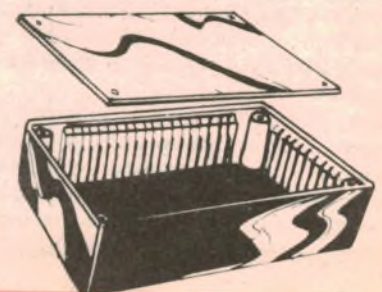

ALTRONICS BANKCARD JETSERVICE DELIVERY NEXT DAY

ALTRONICS BANKCARD JETSERVICE DELIVERY NEXT DAY



# New Products...

## Product reviews, releases & services

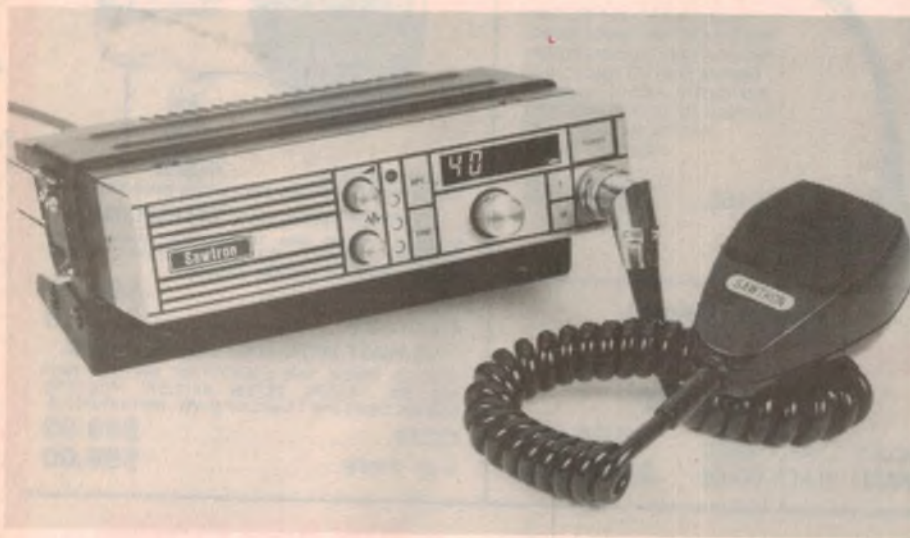

## 40 channel UHF transceiver

Imark Pty Ltd has released a new UHF transceiver, the Sawtron 990, to replace the popular Sawtron 880 UHF CB. The Sawtron 990 is compact and will fit in the smallest DIN size radio apertures in vehicle dashboards. The control head can be mounted separately from the transceiver section. This makes the Sawtron 990 ideal for compact vehicles.

The receiver uses the double conversion superheterodyne method, two monolithic crystal filters, and two ceramic filters to ensure excellent sensitivity, selectivity, and immunity to signals on the image and adjacent channel frequencies. The transmitter

uses an RF power amplifier IC which will withstand extreme SWR conditions.

An optional three-tone Selecall system is available and features operator selection of the last two tones (ie, "tens" and "units") as well as an automatic answer-back acknowledgement. Thus, a system can incorporate a total of 81 transceivers, each with their own set of call tones, which can be individually called by any other transceiver within the system and which automatically acknowledges receipt of the call.

Further information from Imark Pty Ltd, 167 Roden Street, West Melbourne, 3003. Phone (03) 329 5433.



## FM transmitter module

Transmitting on the 88-108MHz band, this FM transmitter module is suitable for applications requiring a high quality wireless link. Constructed on a small printed circuit board the unit is partially potted into a 25mm diameter plastic tube. One end is left protruding so that the power, antenna and audio inputs can be connected. Overall length is 90mm.

The transmitting frequency can be adjusted and the usable transmitter range is up to 50 metres. Frequency response is claimed to be from 20Hz to 15kHz and the input sensitivity is adjustable to a maximum of 30mV. The noise output is very low at -60dB. Pre-emphasis is set at 50us. The unit is claimed to have good frequency stability however no specifications are given for this. Power requirements are a DC voltage of between 6 and 9 volts at 20mA.

This unit is available from Jaycar, and price is \$49.95.

Full instructions are supplied with the unit, providing information on the input connections and adjustments for transmission frequency and input sensitivity.

## A new frequency counter

A new frequency counter offering high performance, ease of operation and measurement flexibility from 5Hz to 650MHz has also been introduced by Global Specialities.

The new Model 6000 incorporates an easy-to-read eight digit LED display and simple push button controls with LED indicators for selecting the input, gate time, and low-pass filter.

Two front-panel BNC inputs are provided: one covering the rate 5Hz to 100MHz with a 1M $\Omega$  input impedance and the other for signals between 40MHz and 650MHz with a

50 $\Omega$  impedance. Gate times of 0.1, 1.0 and 10 seconds are available, and a switchable low-pass filter provides 3dB/octave rolloff at 60kHz for audio and ultrasonic measurements.

The standard Model 6000 incorporates a 3.579545MHz temperature-compensated crystal oscillator with an accuracy of  $\pm 1$  part in  $10^6$ . An alternative high-stability version, the Model 6500, features a crystal oven oscillator with an accuracy of  $\pm 1$  part in  $10^7$ .

The instrument is compact (76 x 254 x 178mm) and lightweight (1.6kg), and features a flip-up leg for benchtop use.

Global Specialities products are distributed in Australia by Vicom International Pty Ltd.

## Mini bar code reader

Nortronic Instruments has released a new compact bar code reader. The Databar Model 402 Reader is provided with dual RS232 communications to allow easy and flexible connection to most asynchronous serial terminals. All commonly used bar codes are supported, including Code 39, Interleaved 2 of 5, Codabar and APN.

When used with a video terminal, the reader is totally transparent to both the computer hardware and software, so that no programming changes are needed when a bar code reader is installed. A choice of hand held wands is available, optimised for high density code, medium density, or colour printed code.

Databar bar code readers are designed and manufactured in Australia and are used in libraries, hospitals, retail stores, and manufacturing plants where speed and accuracy of data entry is essential.

Further information from Nortronic Instruments, GPO Box 995, Sydney, 2000. Telephone (02) 290 2844.



## Wind and Solar energy recorders

Measuring and Control Equipment Pty Ltd has recently released two new recorders for use in wind and solar energy research. The MACE DFR78-WND wind recorder and the MACE DFR78-SOL solar recorder are a further extension of the DFR77 and DFR78 range of meteorological and hydrological recorders which employ EPROM as the data recording medium. These recorders are capable of operating for several months without attention and are especially designed to operate in remote areas under harsh environmental conditions.

The DFR78-WND records from an anemometer and wind vane to log information on wind run and direction or

wind velocity. It is ideal for wind prospecting applications and airfield design studies in which long term measurement of wind distribution is of prime importance.

The DFR78-SOL operates from a Kipp & Zonen Pyranometer Solarimeter to record global solar radiation. The solarimeter output is directly connected to the recorder which has a very low drift DC instrumentation amplifier (typical temperature drift 0.02mV/°C) feeding a precision voltage to a frequency converter. The frequency output is counted in a register to obtain an integrated incident radiation reading which is logged by the recorder at predetermined time intervals.

Further details from Measuring & Control Equipment Co Pty Ltd, 2A Chester St, Epping, NSW, 2121. Phone (02) 86 4060.

# SWITCH TO THE HOUSE OF THE FUTURE.

The totally programmable house is here! Now, for modest cost, you can control anything electrical in your home by remote control. From one chair, from your car, or even your bed you can switch anything and everything.

Switch on the TV downstairs, dim the light upstairs, open the garage door, start the oven, light up the pool, turn on the heat - without leaving your bed. Almost anything's possible with the new RIPUL Electronic Switching System. And it's easy to install.

The RIPUL System includes a remote control, a sender which plugs into the existing mains wiring at any ordinary power point, and as many receivers as you need. You press a button on the remote control, an infra-red signal is transmitted to the sender, which passes that signal through the mains wiring to the appropriate appliance. You can add a programmer for automatic control of everything in the house at set times - great for security. Find out how easily you can turn your home into the house of the future. Call RIPUL today.



**RIPUL**  
ELECTRONIC SWITCHING SYSTEM

1 Leighton Place  
HORNSBY NSW 2077  
(02) 476 1199

## New Products...

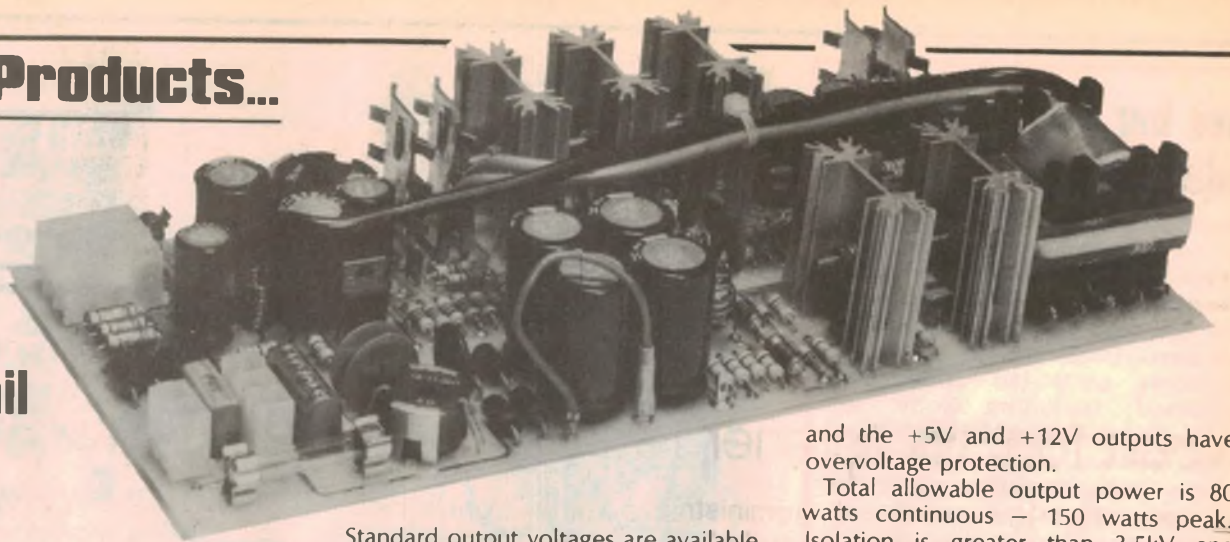

### Five rail power supply

Scientific Electronics have just released details of their newest power supply – the SM80AE1. Designed and manufactured by Scientific Electronics to meet Telecom specification 1302, this new five rail switchmode supply offers 80W total output and high reliability in a small package at a competitive price.

Standard output voltages are available as well as output rails to customer specifications. The five rails on the standard model are: +5V at 8A continuous; +12V at 2.5A continuous, 4A peak for 30s; +24V at 0.2A continuous, 2A peak for 30s; -5V at 0.5A continuous; and -12V at 1.0A continuous.

All outputs are short-circuit protected

and the +5V and +12V outputs have overvoltage protection.

Total allowable output power is 80 watts continuous – 150 watts peak. Isolation is greater than 3.5kV and efficiency greater than 60% full load.

The SM80AE1 measures 108 x 240 x 45mm and, as with all other power supplies from Scientific Electronics, is fully supported by a five year warranty and complete local technical back up.

Further information from Scientific Electronics, 6 Holloway Drive, Bayswater, Victoria. (03) 762 5777.

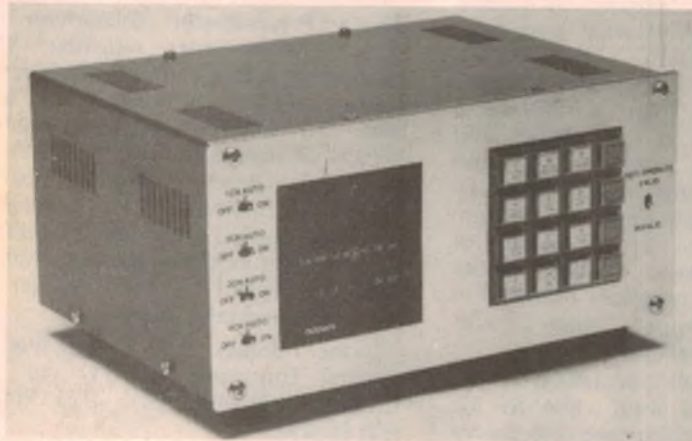

### Seven-day timer

A new one week programmable timer has been released by Audio Telex. Manufactured in Japan, the CT series timers are ideally suited for switching bells, sirens, background music, sprinkler systems and the other multitude of applications where pre-programmed, seven-day, time switching is required.

Some of the features of the CT series timers include: storage capacity of up to 70 programs; inbuilt rechargeable battery operation if mains fail; four separate control circuits; optional built in electronic chime; and affordable cost.

Further details from Audio Telex Communications Pty Ltd, 1 Little St, Parramatta, PO Box 421, NSW 2150. Phone (02) 633 4344.

# BILCO ELECTRONICS

SHOP 2, 31 PULTNEY ST, DANDENONG 3175  
PHONE: (03) 791 8655

★ ★ ★

Our range of printed circuit boards for all current E.A. & E.T.I. circuits and large stock of Components, Instrument cases, "Izumiya" P.C. Artwork, Single and D.S. Copper Board, Ristron Coated Board, Breadboard Systems, OK Wire Wrap Equipment, backed up by friendly helpful staff makes us the best one-stop electronic shop.



# Shortwave Scene

by Arthur Cushen, MBE



## Need for SW listener representative at WARC 84

In January, 1984 the World Administrative Radio Conference reconvenes in Geneva and will study the international shortwave bands, and their future. These decisions will be of major concern to all shortwave listeners.

The 1979 WARC meeting was significant as it affected all medium wave listeners throughout the world, except in the Americas, as all countries adopted a 9kHz spacing on medium wave which has now been implemented. The shortwave bands were also expanded with the creation of a new band and this is gradually being used.

It is of concern that the decisions made in January 1984 will affect the world wide shortwave audience and the consumer will have little input into the decision. The major fields of discussion will centre around the use of a single program on several frequencies in the one band, the extension of out-of-band broadcasting, the greater use of the tropical bands (60, 90 and 120m), and the increasing problem of jamming and deliberate interference.

During our monitoring of various bands, on a regular basis, we find that between 0200-0430UTC the 9MHz band is used by 106 stations sharing 55 frequencies. Sixteen are completely blocked by jamming, and 14 suffer severe side splatter, making 60% of this band unusable. Similar observations apply to the 6MHz band — 96 different signals were heard on 48 channels: 15 frequencies were jammed, and 10 suffered from sideband interference, making 50% of the band unusable.

The present broadcasting plan is based on theory when, four times each year, international stations make frequency adjustment due to seasonal changes. This plan for frequency sharing and co-operation is devised in Geneva but when the plan goes into effect the listener with years of listening experience is called on to sort out the co-channel interference. Poor frequency allocation means the listener has to try to get some resemblance of order so that he can enjoy clear reception.

No matter how high powered the transmitter, or the millions of dollars spent on equipment, studios, aerials, and top class programs, if the audience cannot hear an entertaining program they will abandon shortwave listening. The audience is the consumer in the field of international broadcasting and, at the World Administrative Radio Conference next year, it is hoped that some representation from the shortwave audience will be present to put forward their views to the international broadcasters. After all, the listener has a practical knowledge of frequency usage and the interference problem.

### KNLS ALASKA

After months of preparation the first Alaskan shortwave station, KNLS, has commenced operation with gospel programming. The station has been heard on two frequencies — in Russian on 11820 up to 1200UTC, and from 1200 in Chinese-Mandarin on 9690kHz. The station closes in English at 1200UTC on 11820kHz.

The tests were first noted in July and the full tentative schedule of KNLS is 0900-1200 11820kHz in Russian; 1200-1330 9690 in Chinese-Mandarin; and 1330-1630 11820kHz in Russian.

### HIGH FREQUENCY CUT

The BBC World Service is no longer using 25650kHz to Australia at 0900UTC as the falling sunspot count has meant that this high frequency is no longer providing a reliable service. During our summer months the frequency could be reinstated on a trial basis, as other European broadcasters are still using this band to serve the South Pacific during our summer listening period.

At the other end of the band the BBC World Service is now using 6010kHz at 0400UTC replacing 5975kHz. At 0600UTC, when the transmission is

beamed to Australia, 7150, 9640, 11955 and 15070kHz give the best reception. After 0900, 11750, 15070 and 17705 are used, while the transmission at 2000UTC, for morning reception in this area, is heard on 9410, 11750 and 15070kHz to past 2200UTC. The BBC Waveguide program which updates frequency information on BBC broadcast is heard on Monday at 0915UTC.

### KILOHERTZ OR MEGAHERTZ

Most international broadcasting stations make their announcements and print their schedules using kilohertz as the frequency reference. Some stations, including the BBC, continue to use megahertz, but it seems that a change is inevitable because of two major reasons. When stations use both medium and shortwave, the use of kilohertz means a continuation of the same frequency reference, while there is also a saving in space when the decimal point is removed so that 11955kHz takes less space than 11.955MHz. It is felt that if the BBC adopt the kilohertz reference, the other international broadcasters, who are now very much in the minority, will also make this change.

Notes from readers should be sent to Arthur Cushen, 212 Earn Street, Invercargill NZ. All times are UTC (GMT). Add eight hours for WAST, 10 hours for EAST and 12 hours for NZT.

### DO YOU WANT TO BE A RADIO AMATEUR?

The Wireless Institute of Australia, established in 1910 to further the interests of Amateur Radio, conducts a Correspondence Course for the A.O.C.P. and L.A.O.C.P. Examinations conducted by the Department of Communications. Throughout the Course, your papers are checked and commented upon to lead you to a successful conclusion.

For further information, write to

### THE COURSE SUPERVISOR W.I.A. (N.S.W. DIVISION)

P.O. BOX 1066  
PARRAMATTA, N.S.W. 2150.



# microbee

**Australia's leading  
personal  
Computer  
Now with  
Jaycar  
Dealer  
Support**

# SUPER DEALS

**JAYCAR ELECTRONICS &  
No. 1 FOR COMPUTERS,**

### Microbee features:

- 16K and 32K.
- Non-Volatile CMOS RAM.
- Programmable RS232 Serial Port.
- Programmable 8 Bit I/O Port.
- Display 64 x 16 and 80 x 24 screen format.
- 6545 Programmable VDU Driver.
- Cassette Interface, 300 and 1200 baud.



### New Model video monitor



Cat. YM2000

Screen - 12"  
Display area - 80 char-  
acters by 24 lines  
Input - RCA  
Bandwidth - 10Hz-  
20MHz  
Input sig. 0.5 to 2.0  
pp compo/s, sinc neg.  
240V AC & 12V DC  
Weight 8.6 kg

**\$199**

### green screen



data  
cassette

Micron adjustable azimuth -  
data compatible cassettes

**\$4950**

### green screen video monitor KAGA DENSHI



18MHz Bandwidth makes  
this the best quality  
monitor on the market.  
Due to bulk buying we've  
been able to slash \$66  
off the price!

Cat. XE-1190

WAS \$325  
SAVE \$66

**\$259**

### pricing information

Cat. XE-5000	MicroBee 16K Plus	\$469.00
Cat. XE-5050	MicroBee 16K IC	\$499.00
Cat. XE-5100	MicroBee 32K Plus	\$559.00
Cat. XE-5150	MicroBee 32K IC	\$599.00
Cat. XE-5200	MicroBee 64K Plus	\$699.00
Cat. XE-5250	Single Disc System	\$1099.00
Cat. XE-5255	Add-on Disc	\$559.00
Cat. XE-5260	Dual Disc Drives	\$1599.00
Cat. XE-1205	Printer Cable Interface	\$49.95

## MICROBEE

KITS KITS KITS KITS KITS

ETI 733 RTTY Converter. Ref: ETI April 1983. This simple project allows you to hook up your MicroBee to a HF receiver and print radio teletype messages on a monitor screen. Listen to world news for FREE!!  
Cat. KE 4654

ONLY \$17.95

ETI 649 MicroBee Light Pen. Ref: ETI August 1983. This simple, low cost device plugs into the Bee's 8 bit port. The 'pen' gives you an entry into the world of light pens and interactive software.  
Cat. KE 4656

SHORT FORM \$19.50  
SPECIAL PROBE CASE TO SUIT (as specified in ETI article) Cat. HB-6400 \$18.95

ETI 668 MicroBee EPROM Programmer. Ref: ETI February 1983. This simple, low cost EPROM programmer just plugs into the Bee's I/O port and enables you to save programs in any of the 5 different common EPROMs available (2716, 2532, 2732, 2732A, 2764). Kit comes complete with 'Personality' plug and all IC sockets.  
Cat. KE 4850

\$46.50

Parallel Interface Kit for the MicroBee. Includes 15 pin 'D' plug - add \$15.00 if Centronics plug required.  
Cat. KE 7017

\$15.00

# FOR COMPUTERS!

**ELECTRONIC AGENCIES  
SOFTWARE & PERIPHERALS**

## 80CPS Matrix Printer

Magnificent 80 Character/Second Matrix Printer! — WITH GRAPHICS CAPABILITY  
INCREDIBLE PRICE BREAKTHROUGH!!  
We DARE you to compare with other units selling for well over \$900!!  
WHERE ELSE will you buy an 80 column (142 compressed mode) printer for under \$700? Check the specs below and you must agree!!

### FUNCTIONAL SPECIFICATIONS

Printing method: Serial impact dot matrix  
Printing format: Alpha numeric — 7 x 8 in 8 x 9 dot matrix field  
Semi-graphic (character graphic) — 7 x 8 dot matrix  
Bit image graphic — Vertical 8 dots parallel, horizontal 640 dots serial/line  
2.1mm (0.083") W x 2.4mm (0.09") H/7 x 8 dot matrix  
Character size: 228 ASCII characters, Normal and italic alpha numeric fonts, symbols and semi-graphics  
Character set: 80 CPS, 640 dots/line per second  
Line feed time: Approximately 200msec at 4.23mm (1/16") line feed  
Printing direction: Normal — Bidirectional, logic seeking  
Superscript and bit image graphics — Unidirectional, left to right  
Dot graphics density: Normal — 640 dots/190.5mm (7.5") line horizontal,  
Compressed characters — 1,280 dots/190mm (7.5") line horizontal  
Line spacing: Normal — 4.23mm (1/16")  
Programmable in increments of 0.35mm (1/72") and 0.118mm (1/216")  
Columns/line: Normal size — 80 columns  
Double width — 40 columns  
Compressed print — 142 columns  
Compressed/double width — 71 columns  
The above can be mixed in a line  
Adjustable sprocket feed and friction feed  
Paper feed: Fanfold Single sheet Paper width — 101.6mm (4") to 254mm (10")  
Paper type: Original plus 3 copies by normal thickness paper

### MECHANICAL SPECIFICATIONS

Ribbon: Cartridge ribbon (exclusive use), black  
MTBF: 5 million lines (excluding print head life)  
Print head life: Approximately 30 million characters (replaceable)  
INTERFACE SPECIFICATIONS  
Interface: Standard Centronics parallel  
Data transfer rate: 4,000 CPS max  
Synchronization: By external supplied STROBE pulses  
Handshaking: By ACKNLG or BUSY signals  
Logic level: Input data and all interface control signals are TTL level  
SUPPLIED WITH 48 PAGE MANUAL

AND 13 DIFFERENT PRINTING MODES

e.g. normal, condensed, enlarged, emphasised, underlined, italic, etc. And remember — GRAPHICS as well!

Cat YM2400

CALL IN NOW FOR A DEMO!

## BRILLIANT!

**DIRECT CONNECT MODEM**

LOW COST, HIGH SPEED, HIGH FUNCTION COMMUNICATIONS MODEM! — DIRECT CONNECT FUNCTION The UDM-1200 allows you to connect your micro-computer or VDU to other micros, VDUs, mainframes or public data bases such as The Australian Beginning, INFONET, I.P. Sharp, through your home telephone line. SIMPLICITY The UDM-1200 is extremely simple to use. Just plug it in and communicate. No need to keep attaching each time. Lets your micro communicate when you're not there. SPEEDS Selectable between 300/600/1200 bits per second under manual or computer control. The UDM-1200 handles all the common public network speeds. High speed 1200 bps communications will cut out the tedium and give massive savings on STD and connect time charges. Speeds can be set manually or by your computer. Thus on a dirty line you can automatically switch to a lower speed. INDUSTRY STANDARDS Supported are the CCITT V21 and V23 using the RS232C interface. These are the standards used in Australia and Europe, so you can interface with 99% of all VDUs, micros, mins, data bases offered in Australia. The Bell 103/113, 108 and 202 standards are also supported to ensure you can dial direct to the U.S.A. AUTO DIAL Under your computer's control. This will save you time and eliminate mistakes when making connections. It allows unattended operation by monitoring or security systems. AUTO ANSWER Lets you access your computer remotely. You can easily set up your own private or public data base. PHONE The modem only ties up your phone when you are actually communicating. It can be used normally at other times. TELECOM APPROVED Approval No. C83/37/1020. This means you are allowed to connect to the telephone network. SELF CHECK A loop back facility offers you the ability to test the modem by a flick of a switch. This is a simple way to identify problem areas. INSTRUCTIONS The UDM-1200 comes with a simple User Manual, which not only shows you how to set up and use the modem, but also provides a guide to application uses, public data bases, and communication gateways open to you. WARRANTY A 12 month warranty is offered with each modem.

### KEY FEATURES

- \* DIRECT ATTACH AUTO ANSWER MODEM
- \* 300 BPS FULL DUPLEX (CCITT V21)
- \* 1200 BPS HALF DUPLEX (CCITT V23)
- \* 75 BPS BACK CHANNEL (FULL V23)
- \* AUTO DIAL
- \* BELL FREQUENCIES INCLUDED
- \* TELECOM APPROVED
- \* 1 YEAR WARRANTY
- \* NO ADJUSTABLE CIRCUITRY
- \* DESIGNED IN AUSTRALIA
- \* MADE IN AUSTRALIA
- \* THIS IS NOT A "TOY"

**\$399**

Jaycar has made a bulk purchase to bring them to you at the incredibly low price of \$399. Amazing value for a FULL DUPLEX unit.

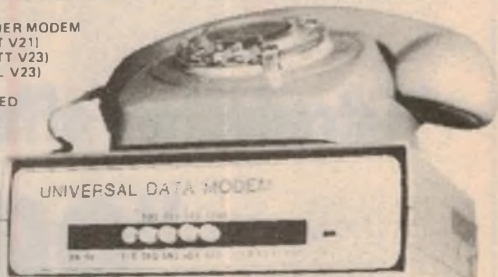

UNIVERSAL DATA MODEM

**Jaycar** Incorporating  
**ELECTRONIC AGENCIES**

**SYDNEY** SHOWROOMS  
125 & 117 YORK STREET — PHONE: (02) and  
TELEX: 72293

**CARLINGFORD**  
Chr. CARLINGFORD & PENNANT HILLS ROAD — PHONE:

**CONCORD**  
115 — 117 PARRAMATTA ROAD — PHONE:

**HURSTVILLE** 121 FOREST ROAD — PHONE:

### NUMBER 1 FOR KITS

POST AND PACKING CHARGES  
\$5 — \$9.99 (\$1.50) \$10 — \$24.99 (\$3.20)  
\$25 — \$49.99 (\$4.50) \$50 — \$99.99 (\$6.50)  
\$100 — \$199 (\$8.00) Over \$199 (\$10)

\*Free INSURANCE for Road & Registered Post over \$200\*

All heavy or bulky items (over 20kg.) sent Comet Road Freight \$12.00 anywhere in Australia.

SHOP HOURS CARLINGFORD, CONCORD & HURSTVILLE

Mon — Fri 9am — 5:30pm Sat 9am — 12pm Thurs night 8:30pm

SHOP HOURS SYDNEY

Mon — Fri 8:30am — 5:30pm Sat 8:30am — 12pm Thurs night 8:30pm

MAIL ORDERS AND CORRESPONDENCE: BOX K 39 HAYMARKET SYDNEY 2000



Mail Order

By



BANKCARD

Via Your Phone

**SAVE**



FAX-80

**\$499**

## COMPUTER SENSATION!

Only

**\$399**

**SPECIFICATIONS**  
CPU: R6502  
ROM: 16K bytes  
RAM: 64K bytes  
BASIC: Interpreter  
More than 80 instructions stronger than those for Apple II  
Memory mapped into system RAM  
Fast, low resolution graphics, high resolution graphics (3 modes are mixed)  
950 characters (58 lines, 80 columns)  
Screen Format: Lower case ASCII, 64 characters  
Character Type: 8 x 8 dot matrix  
Graphics Capacity: 1020 blocks (low resolution) in 40 x 40 array, 63780 dots (high resolution) in 200 x 100 array  
Keyboard: 48 alphanumeric and function keys  
Graphics: 48 alphanumeric and function keys  
Software: One various cassette tapes and cartridges  
Interface: Cartridge interface  
Printer: Connects to printers with Centronics I/O  
Display: Commands to control TV or video display  
Memory: Used for education & entertainment  
Speaker: 8 ohm, 55mm, 0.25W  
Power: A switching power supply is provided to convert and power the required power supply  
Dimensions: 243 x 175 x 30mm

- \* 64K of RAM SUPPLIED STANDARD all that you are ever likely to need.
- \* Text, Lo and Hi resolution graphics STANDARD
- \* Video ARVI TV (RF) output STANDARD
- \* Easy to use manual included in the price (over 248 pages) STANDARD
- \* Centronics printer interface STANDARD
- \* Multibyte BASIC is compatible with APPLE II BASIC. Most APPLE software will run on the Micro-Professor MKII

## MICRO-PROFESSOR II OUTSTANDING!

Low cost colour computer with APPLE compatibility\*

6 Colours  
Normally \$658



Cat YC1300

**WAS \$499  
NOW SAVE \$259**

\*Most Apple Soft II BASIC programs will run on the MPF II

# Excalibur 64

AUSTRALIAN DESIGNED AND DEVELOPED

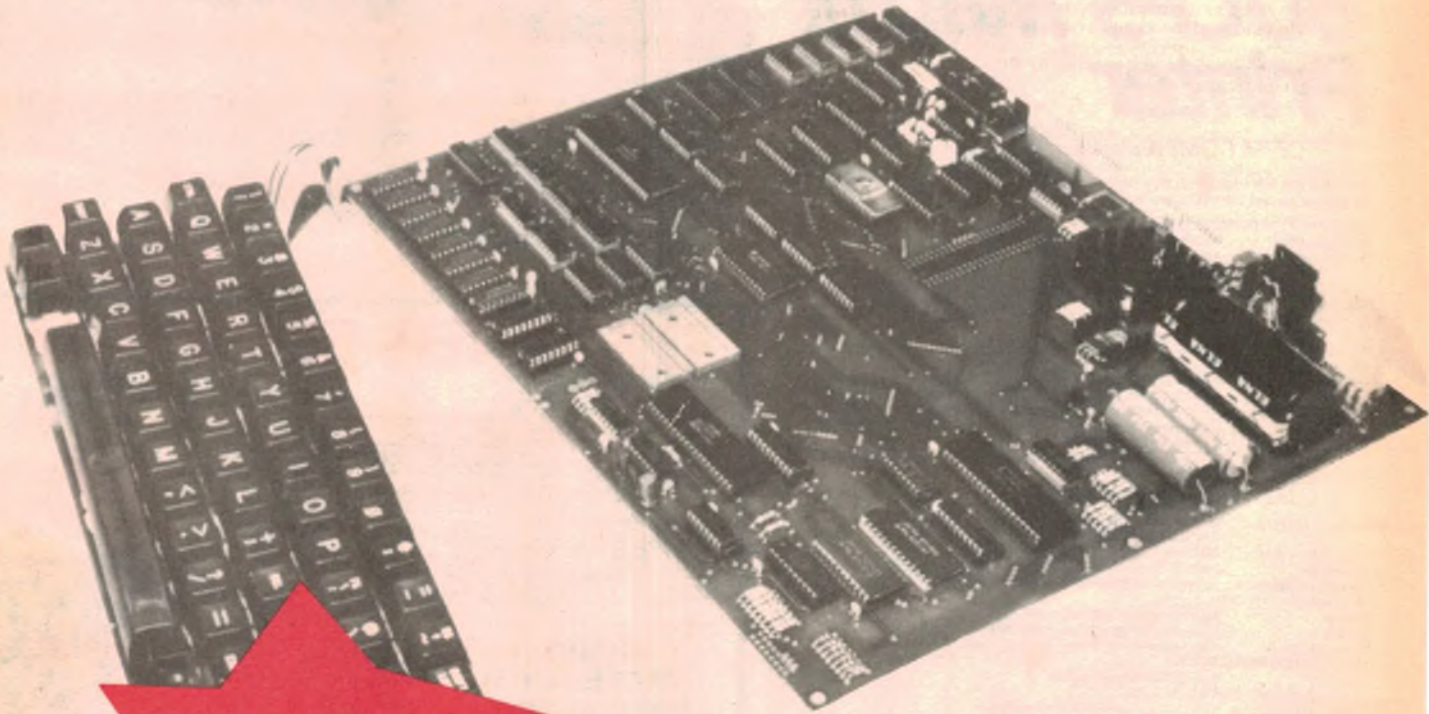

**\$399**

"Introductory offer of **\$399** ends 31st of October"

**"ORDER NOW"**

**THE PROFESSIONAL  
COLOUR COMPUTER KIT**

# UNBEATABLE FEATURES AT AN UNBELIEVABLE PRICE

## 16K ROM, 64K RAM

A powerful 16K ROM utilising extended Microsoft BASIC and a massive 64K RAM makes the EXCALIBUR 64 a truly versatile machine.

Microsoft BASIC is universally accepted as the world's most popular computer language. Thousands of books and programs have been written using this language so with the EXCALIBUR 64 you can immediately take advantage of this.

## CP/M COMPATIBLE

EXCALIBUR 64 is fully expandable to Disk Drives. Shortly we will have available, in kit form a disk controller board which will plug on board the EXCALIBUR 64. You then simply run an appropriate cable to a Disk Drive of your choice. EXCALIBUR 64 will also run CP/M giving you access to hundreds of exciting software packages and making it, we believe the lowest cost CP/M colour computer in the world.

## AUSTRALIAN DESIGNED

EXCALIBUR 64 is a unique and new computer which has been designed and developed here in Australia. Compare the EXCALIBUR 64 feature for feature with any other computer currently on the market and you will be convinced that it offers unparalleled value for money.

EXCALIBUR 64 has been designed and developed by BGR Computers Pty. Ltd. and a team of Australian engineers who believe that this country is as advanced as any other in the design of computer technology.

of using a small soldering iron and can solder neatly should have no difficulty in construction. This is due to our unique double sided board design which means there is no other wiring. Our board is covered with professional 'solder mask', this makes soldering much easier without the problems of bridges etc. To further simplify construction all components positions are marked on the PCB board.

## IMAGINE BUILDING YOUR OWN COLOUR COMPUTER

Modern technology now makes it possible for the average enthusiast to build this highly sophisticated piece of machinery with virtual ease. Although we would not recommend this kit to the absolute beginner, it is very easy to build. Any person capable

## SERVICE BACKUP

If for some reason you are unable to get your EXCALIBUR 64 to operate and you have fully built it using IC sockets as supplied in your kit, simply send us your complete board along with \$95 and our service centre will repair it. We will not complete half built kits, then get them to work: your kit must be complete before taking advantage of this service. Our service fee includes necessary replacement of components.

## COMPARISON CHART

	Excalibur 64	Microbee 32K	Apple II	Atari 800	Commodore 64	Tandy Colour
Base Price	\$399*	\$569	\$2100	\$1199	\$699	\$549
ROM	16K	16K	12K	10K	20K	8K
RAM	64K	32K	48K	48K	64K	4K
Colours	16	NO	15	16	16	8
Screen Display	40 x 24 or 80 x 24	64 x 16	40 x 24	40 x 24	40 x 24	32 x 16
Resolution	640 x 288	512 x 256	280 x 160	320 x 192	320 x 200	192 x 256
RF Output	YES	NO	NO	YES	YES	YES
RS232C	YES	YES	NO	NO	NO	YES
Centronics/Parallel Port	YES	NO	NO	NO	NO	NO
Extended Microsoft BASIC	YES	NO	YES	NO	NO	NO
CP/M Compatible	YES	NO	NO**	NO	NO**	NO
Power Supply Built-in	YES	NO	YES	NO	NO	NO

\* Does not include case  
\*\* Will accept modified CP/M

## TECHNICAL SPECIFICATIONS

<b>CPU:</b>	Z80A	<b>Cursor:</b>	Flashing block
<b>Clock Speed:</b>	3.5 Mhz	<b>Video:</b>	RF output or Direct video output
<b>RAM:</b>	64K	<b>Keyboard:</b>	Full size 64 key (QWERTY layout) 4 programmable function keys
<b>ROM:</b>	16K	<b>Cassette Interface:</b>	Built in: Software controlled at 1200 and 300 baud
<b>Screen Memory:</b>	2K (separate from User RAM)	<b>I/O Ports:</b>	Serial: RS232C Parallel: 8 bit centronics compatible
<b>Language:</b>	Extended Microsoft BASIC	<b>Expansion:</b>	2 expansion sockets providing all major Z80 control lines
<b>Colour:</b>	16 foreground and 8 background colours	<b>Audio:</b>	Programmable under BASIC
<b>VDU Display:</b>	24 lines by 40 characters 7 x 12 dot matrix (TV or monitor) 24 lines by 80 characters 7 x 12 dot matrix (monitor required) Low resolution: 320 x 288 pixels High resolution: 640 x 288 pixels Dot bit addressable graphics	<b>Power Supply:</b>	On board
<b>Graphics Mode:</b>	128 programmable characters 96 ASCII characters (upper and lower case) 128 graphic characters	<b>Optional Accessories:</b>	Professional case. Disc controller board (kit form).

**BGR**  
COMPUTERS P/L

PHONE ORDERS AND ENQUIRIES: (03) 267 2147  
MAIL ORDERS: G.P.O. BOX 5302BB, MELBOURNE, 3001  
SHOWROOM: SHOP 13, GROUND FLOOR, FAWKNER TOWERS,  
431 ST. KILDA ROAD, MELBOURNE, 3004



SAVE TIME - ORDER DIRECT



## REVIEWS OF RECENT

# Records & Tapes

CLASSICAL • POPULAR • SPECIAL INTEREST

## ELGAR VIOLIN CONCERTO: "A well worthwhile production"

**ELGAR — Violin Concerto in B Minor. Itzhak Perlman (violin) and the Chicago Symphony Orchestra conducted by Daniel Barenboim. DGG Digital Disc 2532 035.**

Elgar was a typical Englishman who happened to write music — fine music. This did not prevent him from drinking in the local with friends and placing a modest bet with the pub SP operator on what is described in court as a "contingency at . . .". He came of a musical family and played violin (his livelihood instrument), cello, bass, bassoon and trombone, the latter perhaps explaining the magnificence of his writing for brass.

His father was an organist who also ran a music shop and the boy grew up surrounded by good music. In his own scores, one of his favourite directions was "nobilimente"; much of his music was certainly that. But, except by name and reputation, he has always remained little more than "an English composer" outside his own country; this despite a brief period in Germany under the enthusiastic sponsorship of Richard Strauss.

Elgar wrote much passionate music but his passion was peculiarly English — governed by a certain "decent" reticence. All this leads up to the fact that Perlman's otherwise excellent performance of the Violin Concerto offers a much too emotional treatment of the first movement. It vibrates with so much passion that Perlman's instrument almost sounds as if it's sobbing!

Barenboim, in charge of the accompanying Chicago Symphony Orchestra suits his style to that of his principal. That aside, the technique of both soloist and orchestra is faultless, the balance fine, and the digital sound first rate, with a special mention of the clarity of Perlman's difficult double stopping.

The second movement brings more calmness to violin and orchestra alike, the latter producing some lovely massed string sound. By the way, my stylus got stuck in a groove in this section — a point to watch. Without the first movement's frenzy, the beauty of Perlman's tone can



"It vibrates so much with passion . . ."

be better appreciated. It does tend to coarsen a trifle in the fortissimos but this might be due to the recording. It is countered by this exquisite treatment of the pianissimos.

The Finale goes so fast that it reminded me of Heifetz at the height of his powers. Remember his Mendelssohn E Minor Finale? It is, however, without Heifetz' detachment. The highly scented emotional style of the first movement cannot possibly be used here or in the second movement either, so that it adds up to a well worthwhile production. (J.R.)

## BRITTEN, TCHAIKOVSKY: "Recommended"

**BRITTEN — Variations on a Theme of Frank Bridge.**

**TCHAIKOVSKY — Serenade in C for String Orchestra. Australian Chamber Orchestra, Dene Olding, leader. CBS Masterwork Digital disc DBR 002.**

Like the Sydney String Quartet, the Australian Chamber Orchestra has won an enviable reputation overseas. Founded seven years ago, it consists basically of 13 string players augmented from time to time — according to the composition played — by players of other instruments.

Usually conducted by the leader (first violin), in its expanded form it has performed under the baton of such celebrities as Neville Marriner, David Wilcox and Richard Bonyngé and collaborated with such eminent soloists as Yehudi Menuhin and his late sister Hephzibah and others. It is a regular feature of the Adelaide Festival, makes frequent country tours of Australia and generally distinguishes itself wherever it goes.

The record under review is a good example of its first class discipline, its splendid unanimity, and its response to its violinist/conductor — or rather leader, since he uses no baton but indicates his wishes with his bow, and for that matter

his posture. Out of a very wide repertoire it has chosen two popular pieces to record here.

The Britten has been popular with large and small organisations for many years. It is one of the composer's very earliest published works, commissioned while he was little more advanced than a student. It is no exaggeration to say that this work made his name, bringing him to the notice of a large public. His great talent and industry did the rest.

To those readers unlikely enough not to know, its variations embrace such diverse movements, among others, as a march, funeral march, Italian aria, Viennese waltz and a spirited fugue and finale. There are other movements too numerous to mention here, all full of happy inventions, some deeply felt. The ACO does justice to them all.

Contemporary dissonances are underlined to caricature a classical bourree. The Viennese Waltz would be disowned by the many Strausses responsible for theirs. It is comment at its most caustic. The work is full of good natured sarcasm and if the digital recording has the all-too-common fault of too wide a dynamic range for chamber music — and much of the other kind for that matter — the skill of the players provides adequate compensation.

On the reverse side, Tchaikovsky's Serenade for String Orchestra in C opens with just the right gush, followed by a

fast scherzo-like interlude presented with outstanding accuracy and verve. The second movement is rightly luscious and the Finale is spirited, with authentic Russian jollity. To be recommended to the most critical. (J.R.)

## FRANCK, WOLF

... excessive emotion?

**FRANCK — Piano Quintet in F Minor.**  
**WOLF — Italian Serenade. Juilliard String Quartet, Jorge Bolet (piano).**  
**CBS analog Masterwork 74002.**

The anti-romanticists seem to have selected Franck for the most bitter of all their attacks. Even his name is anathema and no credit is given him for the composition of that masterpiece, the Symphonic Variations for Piano and Orchestra.

Even at the first performance, the Piano Quintet was violently disapproved of by no lesser lights than Saint-Saens and Liszt. This however didn't prevent the mundane Saint-Saens playing the piano part in a public performance not more than about a year later — to enthusiastic public approval, I might add.

The basis of the Saint-Saens-Liszt disapproval was their opinion that the work was much too emotional to be genuine chamber music. This must have bewildered the gentle, modest church organist Franck, who used to play in St Clothilde, just behind what used to be the Australian Embassy in Paris.

The work is undoubtedly supercharged emotionally — a fact that is exaggerated by the ridiculously wide dynamic range of this recording which is strangely, for such a fault, analog and not



digital. I recommend a close watch on the volume setting while playing it. It is full of reminiscences of many of the composer's other works especially the Symphonic Variations in the D Minor Symphony.

After the steamy first movement, there is some very nice sound in the following quite Lento. As usual, the playing of the Juilliard and the pianist Jorge Bolet is impeccable. The work's full measure of passion will seem overdone only if you neglect to set the volume to suit the

## BEETHOVEN — RAVEL

### Sydney String Quartet

**BEETHOVEN — String quartet No. 11 in F minor.**

**RAVEL — Quartet in F Major. Sydney String Quartet. Cherry Pie/Festival analog Disc LA 07720.**

This disc has unusual interest for Australian record buyers. As the sleeve notes state, it was the first made by the new (1975) Sydney String Quartet; also the first classical release on the now eminent Cherry Pie label, always well recorded and now processed to Audiophile standards by Festival's special plant under their talented engineer, Max Harding, and distributed by them.

It was also the first string quartet recording made in the Recording Hall of the Sydney Opera House. Both Cherry Pie and Festival also express their thanks to Musica Viva for their very active support and promotion of the Sydney String Quartet which, in addition to its Sydney concerts, has made several Australian tours and successfully played at musical centres abroad.

In the tempestuous Beethoven, be careful how you adjust your gain to get the best from this otherwise beautifully sounding disc. All four parts are always clear and in perfect balance, and perfect too is the stereo separation. To verify

dynamic range.

But whatever reservations you might conceivably have about the Franck must surely disappear under the springlike influence of the Wolf Serenade. In the Juilliard's hands, it is deliciously nuanced with the most delicate of touches. The tempo is brisk and the effect is rather like that of a cool change after a steamingly hot day.

Despite an industrious output, including much orchestral work and the opera "Der Corregidor" — except for this Serenade — Wolf today is remembered only as a highly gifted song writer. Indeed, except for Richard Strauss, Wolf was just about the last of the great German lieder composers.

If you will indulge Franck's passion, you will find in the playing considerable recompense for the unlicensed dynamic range. (J.R.)

### Worthy performance bu . . .

**ROSSINI — Il Turco in Italia. Complete Opera. Samuel Ramey, Montserrat Caballe and others with the National Philharmonic Orchestra and Ambrosian Opera Chorus conducted by Riccardo Chailly. CBS 3 Digital Discs D3 37859. (3 discs.)**



this, play the fugato section in the second movement. This deeply felt music comes off splendidly, as does the rest of the work. There is no question of its being up to international standards.

The players work their way from rage and despair to occasional sweetness and, in the Finale, to light. With analog recording of chamber music as good as this, digital would be hard pressed to offer more!

The Ravel was made at an appreciatively lower recording level but is just as sensitive. Although some of the changes of mood are a bit violent, I liked it better than the not-to-be-despised Debussy I reviewed recently. I'd like to emphasise that these lapses are very rare; otherwise the playing couldn't be more sensitive — and French sounding. This, until we come to the Finale which is much too loud and suggests still another level of recording. Well worth the investment, nevertheless. (J.R.)

This eminently worthy performance left me with one grave difficulty in reviewing it. I couldn't conceive it in terms otherwise than as a competitor to the Callas set — and Caballe is no match for that great, if mercurial artist. True, this set includes more of the witty original than did Callas' but much of the additional material is irrelevant and some of it plain boring. There is also the vexed question of the authenticity of some of it.

It would be cruel to emphasise just how far ahead Callas is of Caballe. In the matter of interpretation alone, Callas makes her Fiorella cunning, ironical and above all witty. Beside that, Caballe is pedestrian indeed. If you have the Callas set, just compare one short item, the cavatina "Non si da follia maggiore" and note the difference in characterisation. And this is only one of very, yes, very many weaknesses in Caballe's performance in the role.

Nor do the majority of the cast and the conductor, Riccardo Chailly, measure up to the standards set in the old (1955) Callas recording. On the other hand, the new set is attractively got up with a handsome brochure, four-language libretto and splendid portrait on the box. (J.R.)

## Records & Tapes — continued

**BARTOK — Sonatas Nos. 1 and 2 for Violin and Piano. Pinchas Zukerman (violin) and Marc Neikrug (piano). CBS Masterworks Digital Disc D36697.**

Even those readers familiar with avant garde music will find these two sonatas difficult nuts to crack, especially the first. The reason for this is the diversity of the violin and piano parts. Particularly in the first, the two parts are so dissimilar that, although most readers have two ears, they will need to use them independently, as a chameleon does its eyes!

The difficulty is compounded by the nature of the instruments. Although the sound is very well recorded, the timbre of the violin will always tend to make it sound closer than the more powerful piano. True, this doesn't happen often here, but there are a few moments when it does upset the balance.

To add to these complications, there remain the technical difficulties of the parts themselves, although these are brilliantly handled by both performers. For instance, right at the beginning of the first movement of Sonata No. 1, the violin has a rhapsodic solo part over a quite independent piano part, yet after practice — and I must stress this — you will in time be able to separate them

spontaneously as you listen.

I realise that all this must be off-putting to potential buyers but these two works are important contributions to their genre and should be assimilated by anyone hoping for an understanding of contemporary music. There is an easier, quiet segment roughly in the middle of the first movement that calls for more sensitive treatment — and receives it. At first contact, try repeating this section a few times and you'll get well deserved encouragement.

While providing an exhibition of the virtuosity of the two players in handling their irreconcilable parts, it is also an example of the highest form of cooperation. Don't forget that, behind it all is the composer's earnest — and successful — efforts to make everything sound as dissonant as possible.

But, as I said before, don't be discouraged by these remarks. The compositions are too important to neglect. Good Luck! (J.R.)

☆ ☆ ☆

**LA VOIX HUMAINE. Music by Francis Poulenc. Libretto by Jean Cocteau. Carole Farley, soprano, with the Adelaide Symphony Orchestra conducted by Jose Serebrier. Digitally mastered stereo, RCA VRL 1-6658.**



Imagine a sparsely furnished stage, occupied by one lone young woman and a telephone. Unseen and unheard, at the other end of the line, is her former lover who has decided to abandon her and marry another in just two days time.

Interrupted from time to time by a poor line, and by other callers breaking into the conversation, she spends 40 minutes, posing, pleading, pretending, lying, but gradually being forced to the realisation that the affair is over.

This she can't accept and, in a final tragic moment, as she pleads with her beloved to hang up the phone, she winds the receiver cord around her neck and strangles herself — with traditional operatic finality!

The play was written by Jean Cocteau and premiered in Paris in 1932. The libretto was subsequently set to music by Francis Poulenc and presented at the Opera Comique in 1959, much to the delight of its original author.

It is presented here, with the Adelaide Orchestra, by Carole Farley, a widely experienced operatic soprano and one with a face and figure well suited to the role of a young woman in love. Hers is the task of building and sustaining the emotion, quite alone, over the whole 40 minutes. Hailed in the role overseas, she committed it to disc for RCA in the Adelaide studios of the Australian Broadcasting Commission.

Having said that, however, it is necessary to add that it will not be everyone's choice of a record. It is sung in French, but while a sheet in the jacket presents the English translation alongside the original French libretto, the words are uttered under such emotional stress, and often at such a rate, that they are not easy to follow, unless you happen to be relatively familiar with the language.

But then, arias abound in the world of opera which, although initially incomprehensible, can become a source of pleasure, with familiarity. I guess that there's no reason why this should not happen with *La Voix Humaine*.

The performance itself is of a high standard and the recording itself is of excellent quality. In short: one about which you'll need to make up your own mind. (W.N.W.)

# 1/2 PRICE





- Noise Suppression Transformers are half the price of constant voltage transformers
- Ideal for computer installations in cities where mains spikes are a problem
- Ratings to 3600VA
- No installation costs

TALK TO FERGUSON - THE AUSTRALIAN COMPANY  
WITH NEARLY 50 YEARS EXPERIENCE OF MANUFACTURING  
IN AUSTRALIA FOR AUSTRALIAN CONDITIONS

Ferguson Transformers Pty. Ltd.  
331 High Street, CHATSWOOD 2067 Tel: (02) 407 0261  
Telex: AA25728. Melbourne (03) 328 2843

FERGUSON



## CENTRONICS CONNECTORS

### FLAT CABLE TYPE

24 way	Plugs	\$3.17
24 way	Sockets	\$4.67
36 way	Plugs	\$6.94
36 way	Sockets	\$6.94
50 way	Plugs	\$7.60
50 way	Sockets	\$8.40

+ 20% Tax

### FLAT CABLE 'D' CONNECTORS

9 pin	Plug	\$9.10
9 pin	Socket	\$6.00
15 pin	Plug	\$6.82
15 pin	Socket	\$8.10
25 pin	Plug	\$9.14
25 pin	Socket	\$10.18
37 pin	Plug	\$13.50
37 pin	Socket	\$15.36

+ 20% Tax

### MAGRATHS THE RIGHT CONNECTION (AMPHENOL)

#### SOLDER TYPE 'D' CONNECTORS

25 pin	Plugs	\$1.85
25 pin	Sockets	\$2.45
9 pin	Plugs	\$1.72
9 pin	Sockets	\$2.58
15 pin	Plugs	\$2.02
15 pin	Sockets	\$3.58

+ 20% Tax

## Semiconductor Specials.



4001	23c	7406	30c	7474	30c	74LS42	30c
4002	30c	7407	30c	7475	45c	74LS74	30c
4007	23c	7408	30c	7476	45c	74LS83	75c
4013	30c	7410	23c	7490	45c	74LS85	30c
4015	55c	7411	30c	7493	45c	74LS90	30c
4042	45c	7413	45c	74121	45c	74LS93	30c
		7414	45c	74LS11	23c	74LS123	30c
7400	23c	7420	23c	74LS12	23c	74LS157	30c
7402	23c	7430	23c	74LS14	55c	74LS174	30c
7403	23c	7432	23c	74LS15	23c	74LS240	75c
7404	30c	7440	23c	74LS20	23c	74LS245	90c
7405	30c	7442	45c	74LS27	23c		
		7473	45c	74LS30	23c		
				74LS32	23c		

+ 20% TAX

NEC  
9 VDC  
10F  
P09

### SUPER CAP THE NEW RELIABLE POWER SOURCE TO MAINTAIN VOLATILE MEMORY BANKS

#### DURING AC POWER FAILURES

The high capacitance of one farad and low leakage current of this supercapacitor makes it an efficient, reliable and cost-effective storage device with the following advantages:

- It never needs replacing or maintenance
- Unlike nicads it does not exhibit discharge memory
- Lack of polarity enables it to be wired either way
- It can be soldered onto P.C.B.s with other components
- It can be charged at high and low current rates (i.e. microamps to amps)
- Completely safe. It will not explode under extremes of temperature nor will it leak

\$13.00 + 20% TAX.

SUPER BARGAINS AT MAGRATHS

## T.D.K. SUPER AVILYN VHS E180

3 Hr. video tapes \$17.10 tax inc.

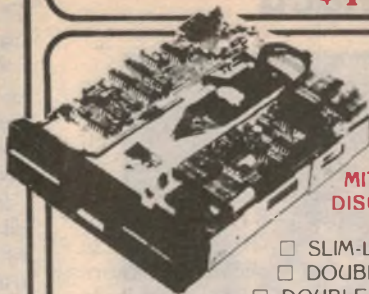

### MITSUBISHI DISC DRIVES

M4853

- SLIM-LINE 5.25"
- DOUBLE SIDED
- DOUBLE DENSITY
- 1.0M BYTES UNFORMATTED
- 80 TRACKS PER SIDE \$375.00 + 20% Tax

M2896-63

- SLIM-LINE 8"  DOUBLE SIDED
- DOUBLE DENSITY
- 1.6M BYTES UNFORMATTED
- 77 TRACKS PER SIDE \$489.50

M4854

- SLIM-LINE 5.25"  DOUBLE SIDED
- 1.6M BYTES UNFORMATTED
- DOUBLE DENSITY
- 77 TRACKS PER SIDE
- \$395.00 - 20% Tax

## TRANSISTOR SPECIALS

PN 3564	30	2N 5485	50	BC 556	22
PN 3567	30	2N 5770	30	BC 557	22
PN 3568	30			BC 557B	22
PN 3569	30	MJE 2955	\$1.60	BC 558	22
PN 3568A	30	MJE 3055	\$1.60	BC 559	22
PN 3641	30	MJE 340	\$1.60	BC 559C	22
PN 3643	30	MJE 350	\$1.60	BC 639	35
PN 3645	30	MJ 2955	\$1.60	BC 640	35
PN 3566	30	MJ 802	\$3.50	BD 135	49
2N 3866	\$1.70	AC 127	\$1.20	BD 136	49
2N 3904	36	AC 128	60	BD 139	50
2N 3906	30	AC 187	80	BD 140	50
PN 4121	30	AC 188	\$1.00	BD 237	90
PN 4250	30	BC 207	30	BD 238	90
PN 4258	30	BC 108	30	BD 262	\$1.20
PN 4355	30	BC 109	36	BD 263	\$1.20
2N 4403	60	BC 177	36	BD 266A	\$1.60
2N 5088	30	BC 178	36	BD 267	\$1.80
2N 5401	80	BC 179	40	BD 437	94
2N 697	53	BC 327	22	BD 438	94
2N 1613	60	BC 337	22	BF 173	69
2N 1711	80	BC 338	22	BF 180	75
2N 2102	\$1.00	BC 546	22	BF 469	80
2N 2219	80	BC 547	22	BF 470	80
2N 2222	90	BC 547B	22	BF 470	80
2N 2270	65	BC 548	22	BF 494	22
2N 2905A	54	BC 548C	22	BF 94	\$1.22
2N 2907A	54	BC 549	22	MFE 131	98
2N 3019	54	BC 549C	22	MFE 102	57
2N 3053	80	BC 550	22		
2N 3819	80				
2N 4036	80				
2N 4352	\$2.40				
2N 4360	50				
2N 5245	50				
2N 5458	50				
2N 5459	50				

ONLY AT MAGRATHS

32.5% TAX ON ALL ITEMS

## CAMBION I/C SOLDER SOCKETS

8 PIN	18c
14 PIN	25c
16 PIN	29c
24 PIN	41c
28 PIN	50c
40 PIN	66c

+ 20% TAX

## CRYSTALS

1 MEG	6.00
2 MEG	4.00
3.579 MHZ	1.50
4 MEG	4.00
4.194 MHZ	3.00
8 MHZ	4.00
10 MHZ	4.00

- 20% TAX

## Books & Magazines.

- COLOUR COMPUTER NEWS • COLOUR COMPUTER NEWS
  - SYSTEM 68 - APPLICATIONS • 68 MICRO JOURNAL
  - MICRO 80 • APPLE ORCHARD • CREATIVE COMPUTING
  - AUSTRALIAN PERSONAL COMPUTER
- WE ALSO HAVE A RANGE OF OTHER MAGAZINES IN STOCK!

### FAIRCHILD

Bipolar Memory Databook	
CMOS Databook	\$8.00
A Linear Databook	\$9.00
MOS Memon. Databook	\$12.50
	\$8.00

### MOTOROLA

CMOS Databook	\$9.00
Schottky TTL Databook	\$8.00

### PHILIPS

Building Hi-Fi Speaker Systems	\$6.50
Semiconductors Pt 2	\$10.00
Semiconductors Pt 3	\$10.00
General Catalogue 81-82	\$10.00

### DATA BOOKS

#### TEXAS INSTRUMENTS

Software Design for Micro Processors	\$14.95
1981 Supplement - TTL Data	\$6.25
Linear Control Circuits	\$3.90
Interlace Circuits	\$16.00
MOS Memory	\$8.35
Bipolar Microcomputer Components	\$9.99
TTL Data Book	\$12.50
Understanding Solid State Electronics	\$7.95
Understanding Computer Science	\$7.95
Understanding Communications Systems	\$7.95
Understanding Optronics	\$7.95
Beginners Basic Tl 99-4A	\$14.95

### NATIONAL SEMICONDUCTOR

Audio Radio Handbook	\$6.50
Advanced Bipolar Logic	\$6.50
Linear Applications Handbook	\$18.00
Transistor Data Book	\$7.50
Voltage Regulator Handbook	\$8.00
Memory Data Book	\$7.00
Series 80 Board Level Computer	\$6.00
Hybrid Products Databook	\$9.00
Logic Data Book	\$9.00
MM 54HC 74HC High-Speed CMOS	\$2.50
The Reliability Handbook	\$16.00
NEW Linear Databook 2Vol	\$14.00

Great Value!



## Bosch digitimer

a fully programmable Digital Computer  
Clock with 4 independently switched power outlets

- Time • Day of week.
- Calculator-type key entry for programme setting.
- 4 independently switched power outlets.

Equipped with a programmable computer which can switch four power outlets independently to control most appliances up to 10 amps. The computer is programmed via a calculator type key entry facility to perform up to 20 daily or weekly switching functions.

Ideal for both home and industry, the Bosch Digitimer DT201 can be used for:

- Security Lighting
- Shop Window Lighting
- Radio/Hi-Fi
- Electric Blankets
- Air Conditioners and Heaters.
- Most Kitchen Appliances

\$75 + 20% TAX

MAGRATHS ELECTRONICS Phone or Mail.  
55 A'BECKETT STREET, MELBOURNE, 3000  
Tele (03) 347 1122, Telex AA31001  
Prices subject to change without notice.

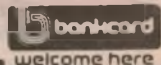

— Mail or phone orders add \$2.00 up to 1 kg pack post  
Special rates for heavy items on request

MC MG 612

SEAL OF SATISFACTION  
MAGRATHS  
WORLD OF ELECTRONICS



## Records & Tapes — continued

**THE LEGENDARY JAZZMEN.** Volume three. Produced by Ron Wills. Vintage series RCA VJL-20410. Two-record album.

Start to play these two discs and you'll be in for some surprises.

The first is coincident with the opening phrases of Side one track one: Observing the endorsement "Vintage" and the fact that the track was recorded in 1938, one expects a few moments of surface noise, followed by an indifferent 1938 sound. But no; out of silence comes a firm, clean recording that has little about it to betray its age.

Surprise number two takes a little longer to register. Most of these recordings would have to be mono, yet they don't sound like mono, nor do they sound like the usual heavy-handed stereo re-processing. They simply have about them a certain subtle dimension when heard through an ordinary stereo system. On phones, they sound "within the head" but not all crammed up at the centre of the head. And, watching the stereo output bargraphs, differences are apparent between the two channels.

If the stereo effect is intentional, it is cleverly judged; if it's an accident, it is most fortuitous!

And, by that time, surprise number



three will have registered: the record will have "grabbed" you, even if you aren't a dyed-in-the-wool jazz fan. It's as good as that.

The four sides are given over to (1) "The Brass" — trumpet, cornet and trombone soloists; (2) "The Bass" — an unfortunate misprint which should read "The Brass" — continued; (3) "The Reeds" — clarinet and saxophones; (4) "The Rhythm" — piano, guitar, string bass and drums.

Most of the recordings were made in the period 1928-1941, although one goes back to 1926 and a few are from the '50s and '60s. All are apparently taken from RCA masters and this fact, along with modern technology, probably means that the music is heard to

better advantage today than when the 78rpm originals were available over the counter.

All told, there are 26 tracks featuring, up front, musicians who appeared in Vols one and two of this series (VJ2-0267 and VJ2-0337) but generally in a supporting role.

Inside this most carefully prepared album, Ron Wills has provided pictures of as many as possible of those "legendary jazzmen", plus succinct biographies, and a resume of each of the tracks on the four sides.

To be complete, I should really list the soloists, the bands and the track titles but that would really turn this into a catalogue. Let's just say that, if you're the slightest bit interested in jazz or vintage jazz, you owe it to yourself to seek out this album and see for yourself what it contains. It's a good one. (W.N.W.)

☆ ☆ ☆

**UNSPUN SOCKS From A Chicken's Laundry.** Spike Milligan. Stereo, Powderworks POW-4013. Distributed by RCA.

Don't feel bad about it if the title doesn't make sense. It didn't to me either, until I observed from the jacket notes that the songs and poems in this album are from "the famous Puffin paperback: Unspun Socks From A Childen's Laundry" ... whatever that means!

... and now we have

# Collet Knobs\*

and caps and pointers  
and figure dials and nut  
covers ... and they all  
fit together to  
form competitively  
priced, vibration-proof  
and very satisfying  
knob  
assemblies

Call us NOW!  
to talk about your requirements ...  
from single to O.E.M. custom made quantities.

**C&K**  
COMPONENTS

**C&K Electronics (Aust.) Pty Limited**

15 Cowper Street Parramatta NSW 2150  
PO Box 229 Parramatta NSW 2150 Telephone (02) 635 0799 Telex 23404  
Agents: Melb. 598 2333/Adel. 277 3288/Bris. 369 1277/Perth 275 5522/Hobart 34 2233.  
Laun. 31 6533.

*Bringing you the excellence of International Professional components*

\* Manufactured by  
SIFAM LTD England



The description "poems" is something of a euphemism; most of them are four-line quips that either have an odd twist or are so bereft of one that they gain a giggle on that account. The real point of the whole thing is Spike Milligan's crazy, odd-ball presentation.

The same general remarks apply to the "songs" except that, behind Spike Milligan's vocal goings-on is some very apparent straight musical talent.

If you're not a Spike Milligan fan, you'll probably wonder why grown people would bother to commit it to record. If the Goons have had a hand in your education, you'll better appreciate the efforts of this solus Goon. If you're a Spike Milligan fan, you'll probably love it! It all depends whether you yearn to know more about the Ying-tong-iddle-l-po, The "veggy" lion or The Biddle-Box! (W.N.W.)

## Telarc digital — Russian Themes

**TCHAIKOVSKY:** March Slav;  
**RIMSKY-KORSAKOV:**  
Russian Easter Overture;  
**GLINKA:** Ruslan and  
Ludmila Overture;  
**BORODIN:** In the  
Steppes of Central Asia;  
**GLIERE:** Russian Sailors'  
Dance. Leonard Slatkin,  
the Saint Louis Symphony  
Orchestra. Digitally  
mastered stereo, Telarc  
DG-10072.



This new release by Telarc should find ready and widespread acceptance with record buyers. By way of content, it provides a top-flight performance of representative examples of Russian orchestral composition. To the hifi enthusiast, it offers a wide variety of orchestral sound and exploits to the full the dynamic range of a modern LP disc, along with very clean sound and a minimum of surface noise.

The five tracks on the disc do not follow in the same order as listed in the title but are as set out below, each with helpful jacket notes about the composer and the composition; "Ruslan and Ludmila" — Overture (5' 16") composed by Mikhail Glinka (1804-1857): dashed off at the last minute and presented to the orchestra almost "before the ink was dry", the overture turned out to be very effective and a very popular "curtain raiser" to what was to follow; an effective introduction, also, to this album!

"In the Steppes of Central Asia" (7' 12") by Alexander Borodin (1833-1887): an orchestral sound tapestry depicting the passing of a caravan linking the Orient and Europe.

"March Slav" op 31 (9' 21") by Peter I. Tchaikovsky (1840-1893): stirring music with plenty of orchestral fireworks and massive bass that will give any system a workout!

"Russian Easter Overture" (14' 43") by Nikolai Rimsky-Korsakov (1844-1908): a descriptive overture which seeks to explore and present the Easter themes of the Russian Orthodox Church, along with the pagan inspired music and celebrations that permeated Christian rejoicing for the resurrection. It's a composition with a wealth and variety of instrumental sound; indeed, the work of an "orchestral virtuoso".

"Russian Sailors' Dance" (3' 35") by Reinhold Gliere (1875-1956): picture one of those incredibly agile groups of Russian dancers, on this occasion in sailors' garb, and gradually building up from a formal beginning to a frantic prestissimo. This is the music for just such a dance.

Need I say any more except to indicate where to enquire if you can't get it from your local speciality record store: PC Stereo Pty Ltd, PO Box 272, Mount Gravatt, Qld 4122. Phone (07) 343 1612. Recommended. (W.N.W.)

# L. E. CHAPMAN

122 PITT ROAD, NTH CURL CURL.  
MAIL ORDERS: BOX 156, DEE WHY, NSW. 2099  
TELEPHONE 93-1848.

## SUPER SPECIAL

GRAMOPHONE motor and pickup 3 speed  
stereo balanced arm  
240 volt \$9.75

PP NSW \$2.25  
Interstate \$3.75  
WA \$4



## CLOCK MODULE

CIRCUIT  
DIAGRAM  
SUPPLIED

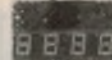

PP \$1.20

including transformer and touch micro  
switches to suit \$5.50

## SLIDE POTS

1/2 meg dual	50 cents
1 meg dual	50 cents
2 meg dual	50 cents
25K dual	50 cents
250K dual	50 cents
1K dual	50 cents
50K single	30 cents
250K single	30 cents
10K single	30 cents
250K dual slide	50 cents

## VU & BALANCE METERS



12KΩ 100μA \$2.00 STEREO VU \$3.00

## TV COLOUR POWER SUPPLY BOARDS KRIESLER \$25



P-P NSW \$2.80 INTERSTATE \$3.60 WA,  
NT \$6

## SUPER SPECIAL FM STEREO KITS

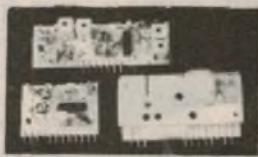

Sets of 3 modules includes FM tuner decoder  
and if detector. Circuit diagram supplied.

ONLY \$22 PP \$1.40

Send stamped envelope for copy of Elec-  
tronics Australia magazine review of the units.

## SUPER SPECIAL

SPEAKER SYSTEMS 30 Watt RMS each  
Size 19 x 11 in x 6 1/4"

\$58 pair



PP, NSW \$7, interstate \$11, WA, NT \$14

TRANSISTORS AD161-162 \$1 pair  
100 mixed Capacitors, fresh stock all  
handy values \$2  
100 mixed resistors, handy values \$2

## BSR DELUX RECORD PLAYER

11 INCH TURNTABLE CING DEVICE  
SHIELDED MOTOR MAGNETIC CARTRIDGE

P&P NSW — \$4.50; INT — \$5.50  
WA — \$6.50  
NT — \$6.50

\$55



SPEAKERS 2 x 10 INCH 2 FOR \$1

## MSP SPEAKERS

8 INCH DUAL CONE 15 OHM

\$5



8 WATT  
PP NSW \$1.80  
INTERSTATE \$2.75  
WA, TAS, NT, \$4

## DUAL VU METER \$3



## TUNING CAPACITORS 3 GANG \$2

## POTS ROTARY

1/2 Meg	30c
1 Meg	30c
100K	30c
100K Switch	50c
50K Double Pole Switch	50c
7 500	30c
10K Switch	50c
250K	30c
50K	30c
20K	30c
10K Min Pots	25c
50 ohm	50c
1/2 or 1 Meg Switch	50c
1/2 1 meg dual Concentric tapped at 100K	\$1
2 meg ganged double pole switch	\$1
1.5 meg dual ganged	50c
2 meg ganged log	\$1
1 meg dual ganged	\$1
1/2 meg dual ganged LIN	75c
25K 50K dual ganged Concentric double switch	\$1
200K single line	30c
20K wire wound	75c
dual log 10K	75c
100K dual ganged linear pots	75c
10K sub min log pots	50c
250K ganged pots	75c
25K lin ganged pots	75c

## SPECIAL MAGNAVOX SPEAKERS \$20 PAIR

8 INCH MID RANGE  
8 OHM 20 WATTS RMS



P&P NSW \$3.50 — INT \$4.50 — WA \$4.50  
NT \$6.50

## COLOR PUSH-BUTTON TV TUNER

## PYE OR KRIESLER \$15

P-P NSW \$2.25 INTERSTATE \$3.60  
WA, NT \$5

MAIL ORDER MAIL ORDER MAIL ORDER MAIL ORDER MAIL ORDER MAIL ORDER MAIL ORDER MAIL ORDER MAIL ORDER MAIL ORDER



# ACTIVE ELECTRONICS

4 KING STREET SANDRINGHAM VICTORIA 3191  
PHONE (03) 67 1137

OUR COMPUTERISED INVENTORY SYSTEM AND LOW OVERHEAD ALLOWS US TO GIVE YOU FAST DELIVERY OF YOUR ORDERS AND LOWEST POSSIBLE PRICES.

ALL PRICES INCLUDE SALES TAX

## NOW IN STOCK LUTRON DIGITAL LCD MULTIMETER

3 1/2 Digit, 5" Display, 10 meg input, Transistor HFE Tester up to 10 amp. DC current. 1% accuracy.

**\$69**



## NEW VIDEO MONITORS SAMKOR'S TRADITION OF QUALITY AFFORDS UNMATCHED MONITOR VALUE FOR AN ECONOMICAL PRICE HIGH PERFORMANCE VIDEO DISPLAY MONITOR

### OUTSTANDING FEATURES:

- LOW COST, HIGH QUALITY
- SMART, RELIABLE
- COMPACT DESIGN & LIGHT WEIGHT
- LOW POWER CONSUMPTION
- NON-GLARE, GREEN/AMBER OPTION
- WIDE VIDEO BANDWIDTH (20MHz) FOR CLEAR & SHARP PICTURE
- INTERFACES WITH ALL POPULAR PERSONAL COMPUTERS LIKE IBM PC, APPLE - FCC, UL APPROVE
- 1000 LINES RESOLUTION

MCG-12G (12")

### POST AND PACKING CHARGES.

	ORDER VALUE	P&P
POST & PACKING FOR GOODS SENT BY STANDARD MAIL IN AUSTRALIA ONLY	\$5 - \$9.99 \$10 - \$24.99 \$25 - \$49.99 \$50 - \$99.99 \$100 OR MORE	\$1.00 \$2.00 \$2.50 \$3.00 \$3.50

MAIL ORDER ONLY  
(NO SHOP SALES)

### VERBATIM VEREX

12 MONTH WARRANTY  
5 1/4 SOFT SECTORED

**\$35.00/10**

S-Side  
Double Density



GREEN PHOSPHOR .. \$185  
ORANGE PHOSPHOR ... \$210

ALL PRICES INCLUDE SALES TAX.

**\* NOW YOU CAN BUY YOURSELF COMPONENTS AT PRICES WELL BELOW THE NORMAL RETAIL PRICES. SO SAVE YOURSELF MONEY. SEND YOUR ORDER TODAY.**  
ALL COMPONENTS ARE FULL SPEC BY LEADING MANUFACTURERS

PRICES CORRECT AT TIME OF PUBLICATION BUT SUBJECT TO CHANGE WITHOUT NOTICE.



BANKCARD VIA YOUR PHONE



**\$7.50**

S2010 PVC weatherproof re-entrant horn/ speaker. Very attractive "off white" colour. 8 ohm 5 Watt RMS. Ideal P.A. use. Individually boxed.

## SPECIAL PRICE

S2000 8" (200mm) wide range general purpose. Includes transformer, mounting holes for P.A. and background use. Very smooth over-all response 45 Hz-12 KHz. Fitted to a 1.9 cubic ft vented enclosure they sound unbelievable. 8 Ohm 8 Watt RMS 5.6 oz magnet.

**\$8.95**



## AMAZING NEW CP-80 PRINTER

QUALITY PRODUCT MADE IN JAPAN  
MONEY BACK GUARANTEE

**\$525**



Bankcard Mail Orders Welcome

Please debit my Bankcard

Bankcard No. ....

Expiry Date .....

Name .....

Signature .....

AE 3/83

### DIP EXTRACTION TOOL

Ideal for the hobbyist or laboratory engineer. One piece spring steel construction. Will extract from 8 24 pin devices safely.

**\$5.25ea**

16 PIN

DIP INSERTION TOOL

**\$1.95**

Industrial quality. Narrow profile enables work in densely packed areas. Tool includes a remarkable pin straightener built into the handle.

POTS All with 1/4 in. shafts Linear 500/1K/10K/20K/50K/100K/500K/1M/2M Logarithmic 1K/5K/10K/20K/50K/100K/500K/1M/2M

All one price

**75c**

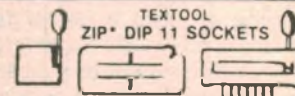

16 Pin Zip\* Dip 11 \$10.95  
24 Pin Zip\* Dip 11 \$10.95  
40 Pin Zip\* Dip 11 \$21.50  
\* Zero Insertion Pressure





# 50 & 25 YEARS AGO

"Electronics Australia" is one of the longest running technical publications in the world. We started as "Wireless Weekly" in August 1922 and became "Radio and Hobbies in Australia" in April 1939. The title was changed to "Radio, Television and Hobbies" in February 1955 and finally, to "Electronics Australia" in April 1965. Below we feature some items from past issues.



October 1933

**ABC takes over 2UW:** From the ownership of W. H. Paling and Company, Australia's largest music warehouse (the broadcasters of the first public concert to be transmitted in Australia in 1923) 2UW has this year passed into the control of the Australian Broadcasting Company, which provided the national programs for three years prior to the establishment of commission administration.

The studios and transmitter are being moved from Ash Street, Sydney, to the State Shopping Block, above the State Theatre, in Market Street. The new studios are most modern in design and equipment, even to the inclusion of an effects studio, which is playing a big part in the development of the new technique in radio entertainment which this station is perfecting.

☆ ☆ ☆

**Garbled — but better than nothing:** For the first time in history football fans throughout Australasia, and for that matter throughout the Empire, were enabled through the medium of shortwave wireless to listen in comparative comfort to a thrilling description of the first football Test, played by the Australians against England on a ground in the vicinity of London on Saturday afternoon, October 7. (In the early hours of Sunday morning, October 8, the first Test Match played in England by the "Kangaroos" was broadcast by the Australian Broadcasting Commission over the national network.)

☆ ☆ ☆

**Television in three years:** The BBC's announcement that it is ceasing its television broadcasts would seem to sound the knell of television.

It is pleasing, therefore, to hear that the BBC's decision does not mean that it has given television up as a failure: on the contrary, the three year interval will be given over to improving and refining the television processes with the object of producing a television set of efficiency equal to the talkie. (The forecast wasn't far out. The service started in 1937. Ed.)

☆ ☆ ☆

**Early step up the ladder:** Station 2BL's program for Saturday, October 28 was listed as a Radio Dance Night. Briefly mentioned was an "Associate Artist", J. Davey, crooner. The face in the accompanying photograph, young though it is, leaves no doubt as to the identity.

☆ ☆ ☆

**Hardly cricket old chap!** The French stations which were broadcasting British advertising in English have been told by the French Government that it is not quite the thing to do. This follows on protests from the British Government.



October 1958

**Russian receiver powered by kerosene lamp:** An ingenious Russian-built receiver has been produced for operation in the Middle East to receive broadcasts aimed at this part of the world. It uses one quart of fuel for each 8-16 hours.

The Russian set was built as a "poor man's radio" for the Middle East to enable the residents of these countries to pick up Russian radio broadcasts.

A thermocouple, mounted between the lamp's aluminium radiating fins, produces an output of 1.2 volts.

This is used for the filaments of the valves and to drive a vibrator power supply. The output of the vibrator

supply is 90 volts for valve plates and screens. The radio will continue to play even though lowered heat reduces the thermocouple voltage to about 0.8 volt.

☆ ☆ ☆

**Giant radio telescope:** A new radio telescope, the second largest in the world, is to be constructed for use by the CSIRO from 1961. It will help our scientists maintain their world reputation in the field of radio astronomy.

Some years ago the Radiophysics Laboratory of CSIRO proposed the construction of an instrument 200ft to 250ft in diameter, costing in the neighbourhood of £A500,000. The proposal received immediate support in Australia and overseas. In February 1958, it was decided to proceed with the design.

The site for the giant radio telescope must be in a region of the lowest possible electrical noise. A careful survey of sites within 50 miles of Sydney revealed none which would meet the stringent low noise requirement.

It was, therefore, decided to go into the interior and the choice finally fell on an excellent site near Parkes in New South Wales about 200 miles west of Sydney.

☆ ☆ ☆

**TV for India:** India will install a pilot television station in October to beam educational programs to villages round Delhi.

After months of research on closed circuits lent to India by foreign countries which exhibited at the 1955-56 Industries Fair here, the All-India radio will be ready to start television to a limited number of villages by early next year.

The pilot station will be installed in Delhi and will be received in the villages on community sets.

Widespread individual reception of television is not expected for many years yet as the cost of television sets is far beyond the reach of the average Indian's pocket.

☆ ☆ ☆

**The smellies:** A New York perfume company has fixed a date for release of the world's first film with scent effects.

It plans to waft scents suiting the moods of scenes into theatres through air-conditioning units.

A spokesman of the firm said an electronic apparatus attached to the film projector would set off scent sprays.

The first of the "scenties" would have no definite plot, but plenty of scent.

# Micronews

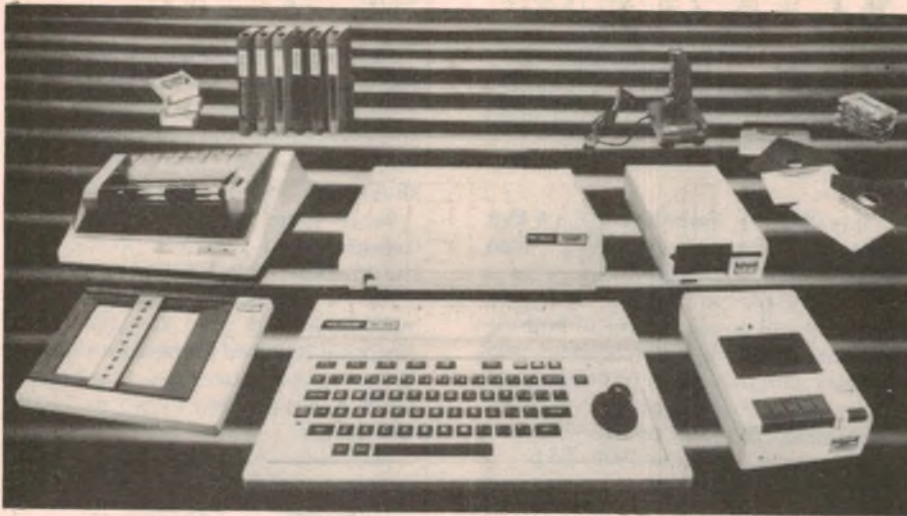

## Spectravideo SV-318 Computer

The Melbourne company, VideoActiv, are Australian agents for Spectravideo video games, and have recently introduced the Spectravideo SV-318 personal computer to Australia. Spectravideo is an American based electronics company with an affiliate, Bondwell, in Hong Kong.

The SV-318 computer is compact and constructed in a console unit with a keyboard and TV modulator. The keyboard unit can be conveniently linked with a full range of peripheral options or users devices through the SV601 Super Expander or an adapter to suit requirements.

Of particular interest will be the large memory capacity of the SV-318: 32K

ROM expandable to 96K ROM with a custom extended Microsoft Basic Interpreter built in. Also as standard is 32K RAM; 16K for graphics and 16K of user addressable memory. The SV-318 is designed to accommodate expansion up to a total of 144K of bank selectable RAM!

Other useful features include: Z80A microprocessor with 3.6MHz clock, CP/M compatability, combined cursor/joystick control, easy loading cartridge slot, arcade quality graphics and sound, 71 key multi-function keyboard and built in word processor keys.

The SV-318 will be followed later in the year by the more powerful SV-328. Recommended retail price will be \$499.00.

Details from VideoActiv Electronics, 70 St Kilda Road, St Kilda, Victoria 3182. (03) 537 2000.

## WordPlus — PC Word Processor

A new word processor for the IBM Personal Computer has been released in Australia by SCA Software Corporation of Australia Pty Ltd. Called WordPlus-PC, the system has been designed specifically for the IBM PC and "work-alike" computers and makes full use of the function keys of the IBM keyboard.

Supplied with WordPlus-PC are 10 adhesive labels to be affixed to the top of the function keys. The user does not have to remember or look up sequences of commands such as CTRL-K-J.

Features of the word processing program include global search and replace, cut and paste editing, three line headers and foot-notes and automatic

page numbering. One document can be printed at the same time as another is being edited and WordPlus also includes a powerful document merge facility at no extra cost.

WordPlus-PC can also be customised by the user to send its output to any of 40 different types of printer simply by selecting the appropriate menu entry. In particular, the Epson MX-80 dot matrix printer is fully supported by the program, allowing use of special graphics features and printing modes in conjunction with the word processor.

WordPlus-PC also support on-screen formatting of documents. Words which are to be underlined or printed in bold face are displayed in that fashion on the screen. A key marked VIDEO allows the user to see exactly how a document will

## "Hands-on" course by correspondence

The Australian School of Electronics Pty Ltd is now offering a practical "hands-on" course in microprocessor fundamentals.

Lessons are by correspondence, with the personal attention of a tutor available at all times to answer questions and help with difficulties encountered by students.

No previous knowledge of computers is necessary but previous training in basic electronics and transistor theory and circuits is required. Students with no previous training in electronics are required to undertake the school's course in basic electronics prior to beginning the microprocessor course.

A microcomputer trained based on the Z80 is supplied to each student participating in the course to ease the learning of fundamental machine code programming.

Fee for the course is \$390. This includes all hardware and software required, 11 lesson manuals and assistance from a tutor. Special rates are available for groups sponsored by firms and an Industrial Training Program is also available to companies.

Further details of the microprocessor course or the more fundamental electronics theory course are available from the Registrar, Australian School of Electronics, PO Box 108, Glen Iris, Vic, 3146. Phone (03) 523 5622.

look on paper: page breaks, margins, spacing, headers and footers are all displayed as they will appear in the printed document.

Recommended retail price of WordPlus-PC is \$395 plus sales tax. The price includes a user manual and advanced tutorial material, system disk, key-cap labels and an adhesive-backed card summarising all word processing functions. In addition SCA have set up a "Support Desk Hotline" which allows registered users of their products to get assistance over the phone telephone.

Stocks of WordPlus-PC are now being shipped to dealers throughout Australia. For further information contact SCA Software Corporation of Australia Pty Ltd, 449 Swanston St, Melbourne, Vic. Phone (03) 347 7011.



# SUPERAED THE CP/M YOU'RE HAVING WHEN YOU'RE NOT JUST HAVING CP/M

*In the first two years of manufacturing microcomputer systems AED became aware of many features that were not provided by the popular CP/M operating system. This shortcoming was holding back microcomputers from reaching their full potential in business, office automation, and engineering applications.*

*Analysis of alternative operating systems revealed that some had advantages in one area or another but still lacked the end user oriented features that were our primary concern. It appears that computer system programmers give total priority to computer hardware, disk file structures, programmers' facilities, and the command line power to impress engineers and technicians. This explains why these new operating systems, while more powerful, still lack the basic facilities that would make the computer infinitely more useful to the businessman, engineer, doctor, etc, who uses it from day to day.*

*Solving this problem by designing a new op-system was out due to the incredible software base available for CP/M. Other companies' CP/M look-a-likes all have compatibility problems and AED didn't want to join the list. The alternative of developing an extension package to the existing CP/M was adopted with some startling results, all achieved without corrupting one byte of CP/M or its CCP.*

*AED spent 12 months developing the first release of SUPERAED which was an immediate success leading to increased sales of the 'AED SUPERCOMPUTER I' and drawing considerable interest overseas. After a further 18 months development a new version with a unique multiple program selection capability ('MPS') was released, along with a new computer 'AED UNIVERSE Supercomputer II' which combined 8 & 16 bit operation in one machine.*

**SUPERAED provides many features unique to a CP/M based system including:**

**INTELLIGENT TERMINAL DRIVER.** A special driver for the extremely fast AED UN-SERIAL terminal, providing display speed control and intelligent software control over cursor and all screen characteristics and attributes.

**KEYBOARD SUBSTITUTION.** Allowing application software to talk to the computer as though it were the operator. For the first time one program can use another to participate in the job at hand.

**AUTOMATIC BACKGROUND MEMORY TESTING.** SUPERAED continuously scans the computer's memory, warning the operator of any faulty cells before they can cause subtle data errors to creep in to your files.

**SELECTION OF MULTIPLE PRINTERS.** CP/M provides for only one printer. 'SUPERAED' provides for up to 8 printers which may be selected directly from the keyboard as well as under software control. Orders can be automatically directed to a printer loaded with order forms, invoices to a printer with invoice forms, etc.

**A POWERFUL DIAGNOSTIC MONITOR.** This is one of the most startling features of SUPERAED. Unlike other systems the monitor can be entered even when a CP/M application program is in use. After using the monitor for diagnostics, experimental, developmental, or debugging purposes, you can return right back to the CP/M application. At last you can look deep into the software and hardware system of your computer while the sample is still under the microscope.

**MULTIPLE PROGRAM SELECTION (MPS).** This is a unique feature of SUPERAED and the UNIVERSE Supercomputer II. It allows the user to jump from program to program and back again. This topic was covered in depth in the first article in this series (July).

Next month we present details of the Universe's Ultra Intelligent, Dual Centronics, Dual Serial, Clock/Calendar, Priority Interrupt, Programmable Timer, and Power Supply Monitor Card, which boasts 256k byte dynamically allocated buffer.

## UNIVERSE SUPERCOMPUTER II



**SLOW:** Non standard 5 1/4" discs.  
**SLOWER:** 16 Bit only C.P.U.  
**LIMITED EXPANDABILITY:** Cards from only a small number of manufacturers.  
**FEWER APPLICATION PROGRAMS:** Due to 16 Bit only C.P.U.

**FASTER:** 8 & 16 MHz 8 & 16 Bit Dual C.P.U.'s.  
**MORE APPLICATIONS:** 16 CP/M, CP/M 86, MS-DOS, MULTIOS & MP/M 86.  
**HIGHER SPEED:** 8 & 12 MEG DMA Floppy & DMA 16 MEG hard disc fixed & removable.  
**MORE EXPANDABLE:** Due to 5100 IEEE 696 compliance from hundreds of manufacturers.  
**THE ONLY SYSTEM** with the magnificent 'MPS' INSTANT TASK SWAPPING CAPABILITY.

We can help you with:

• CONSULTANCY • SERVICE CONTRACTS • CUSTOM SOFTWARE • STANDARD SOFTWARE

## The choice is yours.



Sydney: AED COMPUTERS, 24 DARCY ST, PARRAMATTA, NSW 2150.  
Phone: (02) 689 1744, (02) 681 4966. Telex: AA70664 GIRFRI.

Melbourne: AED COMPUTERS (MELBOURNE), ELSTON MICRO, 53 WAVERLEY RD, EAST MALVERN, VIC 3145.  
Phone: (03) 211 5542. Telex: AA30624 ME447.

Canberra: AED COMPUTERS (CANBERRA), 217 NORTHBOURNE AVE, CANBERRA 2601.  
Phone: (062) 47 3403 | Telex: AA62898 HARSUR.

## Microbee Speech Program

Mr Mark Daniel of South Australia recently sent us a copy of "easysBEEker", a Z80 machine language program which works with the MicroBee computer and the EA Compuvoice project and translates ASCII text to speech.

The program uses a series of rules to translate individual letters to appropriate Votrax phoneme codes and outputs and codes to a Compuvoice unit attached to the parallel port of the MicroBee computer. Any text typed into the computer or output by a program can be spoken by the Compuvoice, without laborious manual translation. Five different operating modes are available:

- Ordinary speech – words are pronounced in sequence, with punctuation marks serving to mark pauses in speech.
- Speech plus spoken punctuation – a "." is pronounced as "full stop", for example.
- A mathematical mode in which arithmetic symbols are spoken correctly – the full stop is pronounced "point" for example, and an asterisk is pronounced as "multiplied by".
- A spelling mode – individual letters are spelt out.
- A Votrax phoneme mode in which only phoneme codes are accepted as input, to allow for fine tuning of pronunciation.

All modes can be selected at any time from within the text being spoken, and speed of pronunciation can also be varied from within the text.

The program is supplied on a cassette which loads into 4K of RAM at the top of the MicroBee's programmable memory space and is available in versions to suit 16K, 32K and 64K machines. Versions of the program can also be supplied in an EPROM, or re-located into any specified area of memory. Another special version includes phonetic pronunciations of all Basic keywords, and is intended particularly for the visually handicapped.

Connecting the Compuvoice unit to the MicroBee is easy, although it is essential to first modify the speech synthesiser to allow for a set-up delay on the STB line. The Compuvoice unit described in the June 1982 issue of EA should be modified as follows:

1. Cut the track leading to pins 3 and 4 of IC 2 (the 74121 monostable).
2. Connect this track to pin 5 of IC 2 instead of to pins 3 and 4.
3. Connect pins 3 and 4 of IC 2 to ground with a short length of wire.

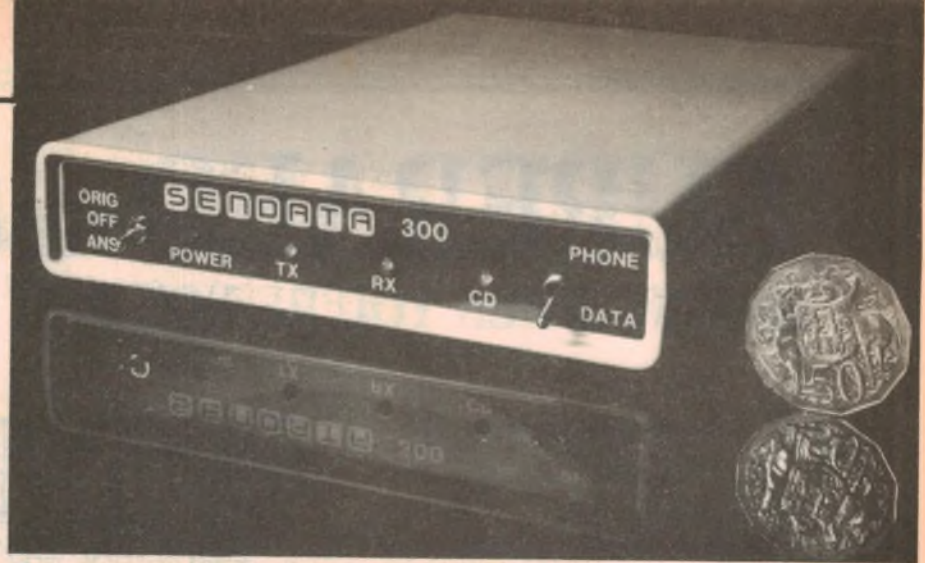

## Direct-connect 300bps modem

A new direct-connect 300bps modem that fits snugly under the base of a telephone has been released by Australian manufacturer Electromed. The new modem comes in a compact case the same size as a conventional telephone base and just 30mm high. It has been field-tested for almost a year by an independent evaluator and is Telecom approved.

Called the Sendata 300, the modem attaches to an existing telephone wall

socket plug and is fully operational at the flick of a switch. "It is by far the least complex direct-connect modem available in Australia and it is also the most simple to operate," says Electromed marketing manager Robert Powell. "In fact because of the success we have had overseas with our Sendata 700 Acoustic Coupler, we believe the new direct-connect modem will become a major export item for the company."

Recommended retail price of the Sendata 300 modem is \$240 and further information is available from Electro Medical Engineering Pty Ltd, 69 Sutherland Road, Armadale, Vic, 3143. Phone (03) 509 5844.

## Re-programmed Video Games

A United States company, Romox Inc, has announced plans to sell video games cartridges containing EPROMs which can be re-programmed with a new game for a third of the cost of buying a new cartridge. Terminals installed at retail stores would program the cartridges while the customer waits, at a cost of around \$US10 per game.

The terminals would be linked by modems over the telephone lines to Romox's mainframe computer and will store the 10 top-selling games for each week in RAM, with additional

Two 560Ω resistors must also be added to the control lines of the Compuvoice to ensure that the unit is not falsely triggered by spurious signals on the MicroBee PIO pins. Both of these modifications are fully described in the instructions which come with the easysBEEker software.

In operation we found Mr Daniel's software to work extremely well, allowing for the "accent" of the Votrax chip. Approximately 85% of words are pronounced correctly, and the remaining difficult letter combinations

games on floppy disks. Romox, a large supplier of games cartridges (of the non-reprogrammable type) for the Atari 400 and 800 and Commodore's VIC 20 and model 64 computers, announced the scheme at this year's National Consumer Electronics Show in Chicago.

Company president Paul Terrell is optimistic about the plan. "There are tens of thousands of our customers out there with programmable cartridges. This is a substantial customer base, and I expect it to grow to millions as we sign up other software publishers. Electronic software distribution is here; it works; and it is going to totally change the way software is distributed."

can be improved by adopting a form of phonetic spelling, substituting letter combinations which are more easily pronounced.

The letter-to-phoneme translation algorithm used by the program involves examining each letter in the text and looking at a list of rules which determine how the sound of the letter is modified by its context. Once the rule that best fits the context of the letter is found the phoneme code(s) prescribed by that rule is sent to the speech synthesiser.

*continued on page 130*

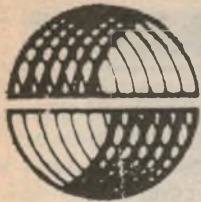

**SPHERE**  
COMPUTERS

**PRESENTS**  
AN INTELLIGENT TERMINAL



**Keyboard**

- Detachable, capacitive, typewriter-style keyboard
- N-key rollover with auto repeat capability
- 4 LED indicators for caps lock, on line, block mode and keyboard lock/protect
- Audible keyclick enable/disable
- Auto repeat enable/disable
- Keyboard lock enable/disable
- Repeat rate 20 characters per second
- 5 cursor control keys, 10 editing function keys with 14-key numeric key-pad

**Communication**

- Code: 128 ASCII characters
- Baud rate: 75, 110, 150, 300, 600, 1200, 1800, 2400, 4800, 9600, 19,200
- Parity: Odd, even, mark, space
- Operating Mode: Full duplex, half duplex or block mode
- Interface: EIA RS-232C or 20-mA Current Loop

**Emulation**

- LEAR SIEGLER ADM-3A, HAZELTINE 1500, ADDS VIEWPOINT

**Screen Presentation**

- Display format: 24 lines x 80 characters
- Display unit: 12-inch, non-glare Green CRT
- Character type: 7 x 9 dot matrix

- Refresh rate: 50/60Hz
- Character set: 96 ASCII characters, 15 graphic symbols, 32 control character symbols
- 5 screen attributes: Blink, underline, blank, reverse, dual intensity
- Cursor type: Selectable slow, fast blinking or steady cursor, block, underline or invisible cursor

**Editing Function**

- Cursor: up, down, left, right, home
- Insert character, delete character, insert line, delete line, erase to end of line, page and field, field tab, field back tab, column tab, column back tab, block mode on/off, protect mode on/off, graphic mode on/off, clear unprotected.

**External Control**

- Power on/off
- Contrast adjustment
- Baud rate
- Parity and data format
- End of message
- Emulation mode
- Refresh rate
- Half duplex or full duplex
- Auto line feed
- Auto new line
- EIA or 20-mA Current Loop
- Reverse video or standard video

**SPECIFICATIONS**

**ENQUIRIES FROM: AVAILABLE FROM OFFICES AND SHOWROOM PARIS RADIO ELECTRONICS, SHOP 1, 165 BUNNORONG ROAD, KINGSFORD, NSW 2032. POSTAL ADDRESS: PO BOX 380, DARLINGHURST, NSW 2010. TEL. (02) 344 9111. TELEX AA22579.**

**MAGRATHS ELECTRONICS 55 A'BECKETT ST, MELBOURNE, 3000 VICTORIA. TEL. (03) 347 1122.**

# OCTOBER CROSSWORD

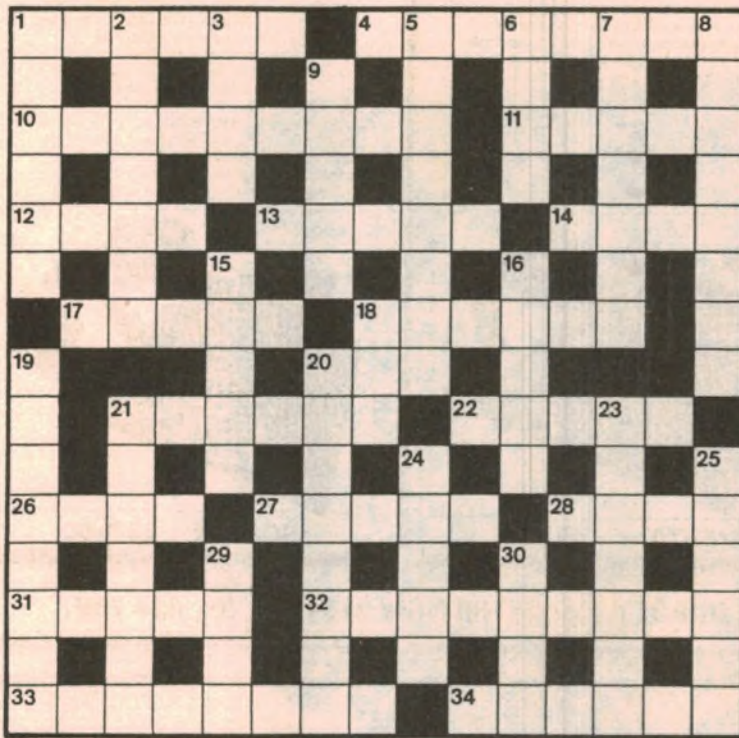

**DOWN**

1. Principles of electronics, rather than the practice. (6)
2. Property of mass. (7)
3. Input for a computer. (4)
5. Radio broadcast. (2,6)
6. Shown on a calendar. (4)
7. Measuring instrument. (7)
8. Device for removing insulation. (8)
9. CRO control. (5)
15. AC supply. (5)
16. Kind of semiconductor in which holes are majority carriers. (1-4)
18. Data storage unit. (3)
19. MTBF: Mean time between . . . . . (8)
20. Said of feedback which reinforces input. (8)
21. An atomic pile. (7)
23. Stipulations of operating conditions for components. (7)
24. Paging sounds. (5)
25. Current unit. (6)
29. Equivalent state of a logical one. (4)
30. Region of a parallel-plate capacitor with a non-uniform field. (4)

**ACROSS**

1. Type of valve. (6)
4. Kind of filter. (4-4)
10. Charge carriers. (9)
11. Interval recorder. (5)
12. Degree of parameter change. (4)
13. Abnormal increase in voltage. (5)
14. Part of a staircase waveform. (4)
17. Unit of capacitance. (5)
18. Series of electronic scans. (6)
20. Colour television system. (3)
21. Type of access to a RAM. (6)
22. Discharge. (5)
26. Unwanted loss of charge. (4)
27. Combines two frequencies. (5)
28. Unitary constituent of an element. (4)
31. Part of an electric motor. (5)
32. Measurable quality of an AC circuit. (9)
33. Shielded. (8)
34. The Loch Ness monster. (6)

## Micronews

The rule-based approach allows the software to distinguish between the various sounds represented by a given letter in different contexts. For example the letter "e" produces a different sound in each of the words "met", "later", "measure" and "meat", and this difference is reflected by the easyBEEker software.

It is not practical to provide a rule for every combination of letters used in the English language, and some degree of mispronunciation is inevitable. EasyBEEker uses around one hundred rules, out of a possible 400 or so in order to keep the size of the program within manageable limits. After about a hundred rules the law of diminishing returns comes into operation - more and more rules must be added, each producing a smaller and smaller improvement in pronunciation.

There is a problem in assessing the intelligibility of synthesised speech. The longer one listens the more understandable the Votrax pronunciation is, although it also helps to know what the synthesiser is supposed to be saying. Others coming fresh to the subject find Votrax synthesised speech to be quite garbled. If one is willing to make a slight effort to comprehend the Votrax accent the speech is adequate for games, educational and hobbyist use. After all, it's 1000% better than a mute computer!

The standard easyBEEker program is available on cassette for \$14.95 including postage and packing while prices for specialised versions will be notified on application. A two-page summary of the program notes is available on sending a stamped self-addressed envelope to Mark G. Daniel, 8/45 Stonehouse Ave, Camden Park, SA, 5038. Phone (08) 294 8961.

## Solution for September

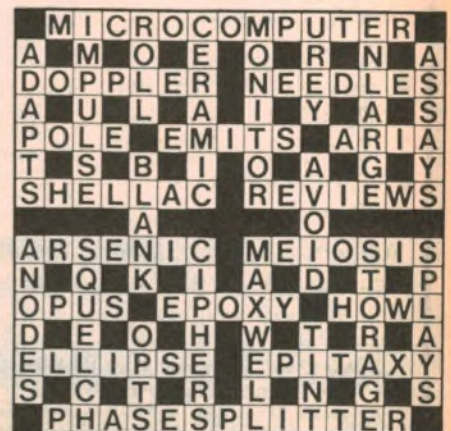

### STOP WASTING TIME TESTING BOARDS

MD will pin-point microtroubles in seconds. Portable and simple to use by non-technical staff in the REPAIR SHOP or on the PRODUCTION LINE. MD tests ROM, RAM & I/O and prints diagnostic reports. MICRODOCTOR can be plugged into an unknown system to perform a general diagnostic and print a MEMORY-MAP. The ENGINEER may enter sequences of CHECKSUMS and RAMTESTS. READS and WRITES to specific MEMORY and I/O locations. SHORTING tests on DATA and ADDRESS LINES. PRINT-OUTS of memory in ASCII or HEX. These sequences are retained in CONTINUOUS MEMORY, available always at the push of a key. \* FREE Z80 DISASSEMBLER with each MD (other disassemblers soon to retrofit at low cost). Get a DISASSEMBLER LISTING of ROM in any microsystem!



MICRODOCTOR — \$595.00

### Z80 DEVELOPMENT SYSTEM

MENTA puts out a TV PICTURE of memory in hexadecimal. The 40 key keyboard will accept inputs, both in hexadecimal and Z80 mnemonics, there is a quick cassette data storage system, a powerful editor which permits program debugging by showing contents of registers and stack. Also there are 24 bits of I/O for external control. A Z80 disassembler is also available which outputs to any RS232 device such as a printer or terminal. MENTA was designed as a low-budget device for teaching microprocessing in schools; professional course-material is available to teachers together with add-on boards for a variety of control functions and robotic applications.



MENTA — \$249.00

### INTELLIGENT EPROM PROGRAMMER

Good tools need not be expensive. SOFTY 2 is the latest version of the engineer's favourite EPROM HANDLER for anybody who uses 2516, 2716, 2532 and 2732 EPROMS. SOFTY will program any of these EPROMS or copy any type into another. SOFTY puts out a TV picture of memory contents, with many code-manipulating and editing facilities. There is also a fast cassette data storage system. SOFTY is also a ROMULATOR (a lead is supplied which may be inserted into a board under development to emulate the ROM using SOFTY's internal RAM. This procedure can also be used on the single-chipper piggy-back type MPU.) SOFTY is complete in itself as a PRODUCT DEVELOPMENT SYSTEM. Code may be entered in HEXADECIMAL via the keyboard also SERIAL and PARALLEL inputs and outputs allow downloading of object code from your computer or printing EPROM contents on your printer.



SOFTY 2 — \$379.00



ELECTRONICS

P.O. Box 311, Castle Hill NSW 2154. Ph. (02)634 7597.

**BEST SELLER**

## BEST ELECTRONICS SOURCES WIRELESS TELEPHONES PORTABLE FACSIMILES & MICRO COMPUTERS (DESK TOP & PORTABLE)

- 50-300 Km Long Distance VHF Mobile/Portable Wireless Telephones.
- Cordless/Handy Phone & Citizen Band (CB) 200/400 channels Radios.
- Amateur Communication Equipments (Yaesu/Icom/Kenwood) & Antennas.
- Portable Facsimile Transceiver, Transmit & Receive Documents/Pictures Through Normal Telephone.
- Business/Home Entertainment Microcomputer Best Software/Hardware Support, Fully Compatible with Apple II, CP/M.
- Car Driving Computers, Automobile/Marine Electronic Accessories.

All items are ex-stock and prompt delivery. For more details, please call, telex or write to:

**Airmail Order Available  
at Best Export Price**



## TECHTRON ENGINEERS CO PTE LTD

10, Anson Road, #02-97A, 1st Floor, International Plaza, Singapore 0207. Republic of Singapore.  
Cable: 'MICSYSTEMS' SINGAPORE  
Tel: 2209442/2237618 Telex: RS 20067 MITECH

LONG RANGE  
CORDLESS  
TELEPHONE



LONG DISTANCE WIRELESS  
MOBILE/  
PORTABLE  
TELEPHONE  
SE-850



WORLDWIDE TRANSCEIVER



TS-430S  
AMATEUR (HF/SSB) RADIOS

IC-2N VHF/UHF  
PORTABLE  
MOBILE  
TRANSCEIVER



TR-9130

PORTABLE  
FACSIMILE  
BY PHONE



PORT-A-FAX

LOW COST  
MICROCOMPUTER  
MEMORY  
64K TO 256K  
FULL  
SOFTWARE  
HARDWARE  
SUPPORT





# Information centre

**GARAGE LIGHT:** "Kambrook" have just brought to the marketplace an inexpensive 240V lamp which switches on automatically for a predetermined time period by a movement (of a person or object) near the lamp. The circuitry would be useful for automatically lighting a garage when a motor vehicle enters, for lighting outside paths, porches and stairways, turning on an air exhaust fan in toilets, bathrooms, etc.

How about producing a similar project which could be less expensive and better (more convenient – no hands) than your Touch Lamp Timer described in August 1983. Perhaps you could also include an LDR to prevent the lamp being turned on in the daytime. (J.B., Warana Beach, Qld.)

● We will consider your suggestion. In the meantime, at least one of the applications listed by you could be fulfilled by our Driveway Sentry described in December 1982.

**FRINGE VHF TV:** I live in Byron Bay and this is a fringe area for VHF television reception from the Gold Coast. I have a Kingray VHF masthead amplifier and the best antenna of several that I have tried. The pictures received are basically very good on all channels, (0, 7, 8 and 9) channel 0 being the best.

The picture is watchable but has fine snow. Could you suggest any way in which I could get that little extra boost in signal to eliminate this snow. (W.M., Byron Bay, NSW.)

● There are several ways in which you may gain the extra signal you require. First, installing the antenna on a higher mast may give a worthwhile improvement. If you already have a tall mast though, any advantage of an even higher mast may be cancelled by signal losses in a long cable. A second approach may be to try a masthead amplifier with a higher gain although this may possibly result in more obvious snow.

A third possibility is to try stacking two identical antennas using a stacking kit especially designed for the job. You will have to approach your antenna retailer for information on this.

**BALLAST RESISTOR:** I have just completed and installed the Transistor Assisted Ignition with extended dwell period as was featured in the February

1983 issue, in a Holden HG Brougham. My first question is to the safety of the removal of the ballast resistor to either unit or coil.

Does it present some problems? I further intend to change over the distributor points with the Optoelectronics trigger circuit which I have already assembled. I have found that there is no supply of the 5401 quad two-input NAND gate and notice in the relevant article that no substitute can be accommodated.

This poses me a problem. Since McGrath's, Dick Smith, and other suppliers cannot be of assistance I am placed in the position of either giving up on the project or look for some form of assistance from you. Can you help me with your source of supply or recommend some other line of action? I always read your excellent magazine and without qualification recommend others to read it. (M.O., Moorabbin, Vic.)

● We would not recommend placing the ballast resistor inside the TAI case as its power dissipation will add to that of the TAI. Mount it on a bracket anywhere in the engine compartment where it will have some airflow from the fan over it.

Both Jaycar and Electronic Agencies stock the 5401 quad NAND Gate.

**VIC 20 PROJECTS:** I note that you have recently featured some projects for the System 80 and TRS-80 computers, namely the project to add Compuvoice to these computers.

I note also that to date you have not featured any projects for the VIC 20 computer which is becoming a very popular home system. I wonder if you have any projects for the VIC in the pipeline and in the near future.

My chief reason for writing is an article in the February 1981 issue on an RS232C printer interface for the System 80. I wonder if this project can be easily adapted to the VIC 20. What I had in mind was using I/O port but the diver software in the article would not be suitable – I wonder if this software can be adapted for the VIC 20 as the VIC has only one cassette port.

I would also be interested in a method of adapting the Compuvoice articles for the VIC 20. Hoping to see more of the VIC 20 in your magazine very soon. (B.S.F., Arana Hills, Qld.)

● The system 80 RS-232C printer interface could not easily be adapted to the VIC 20. As you note the software is entirely unsuitable, being for the Z80 microprocessor rather than the 6502 used in the VIC 20. The circuit details are

## Conflicting views on CDI in rotary engines

**ROTARY ENGINES:** Regarding the August query on rotary engines, I would like to pass on the following information. All the top RX7 engines as raced by several leading drivers use two separate crankshaft-triggered CDI systems.

As far as using CDI systems on rotary engines I can only say, they need them badly. In fact the NSU RO-80 second model came from the factory equipped with a Bosch CDI. A fact not generally noticed is that they burn a two-stroke petrol/oil mixture and therefore need higher energy sparks to stop fouling.

The only figures I can quote regarding fuel consumption were taken roughly on a 13B bridgeported engine: city running using max RPM, and caning the engine, 8mpg; country run with speeds up to 147mph and

driven very hard, 27mpg.

This was done using a 48mm Weber carburettor. (It out-dragged a Falcon GTHO.) I hope that this will be of help to C.J. (J.D., Prospect, NSW.)

**ROTARY ENGINES:** After considerable experimentation with CDI for rotary engines, my advice is: don't. Two independent units were used and the first problem arose with the leading unit sympathetically triggering the second. After a lot of work this problem was solved.

However, the results in operation were poor. I understand that the plugs are pocketed in the cylinders and the erratic firing seemed to bear this out. TAI would be a better bet and two units would be essential. (P.L., Invercargill, NZ.)

also sufficiently different as to require a complete re-design of the hardware.

There is a much easier way to achieve the same effect. The VIC 20 user port is defined in software as logical device number 2. Routines in the operating system provide proper timing and logic to send and receive serial data by this device using an assembly language program. The port can also be controlled from Basic, in the same way as a printer.

Try this:

10 OPEN 1, 2

20 CMD 2

30 PRINT "THIS STRING WILL BE SENT  
OUT OF THE USER PORT"

40 CLOSE 1

The OPEN statement sets up a communication channel (channel number 1) and "turns on" the logical device number 2 (the user port). The CMD 2 statement redirects the output of the program. Instead of appearing on the screen, anything PRINTed by a basic program will be sent to the device attached to the user port. The CLOSE command turns off the communications channel, and must be used at the completion of the data transfer.

However, you can't just hook up a serial RS232C printer to the user port. The circuitry in the VIC 20 does not provide the voltages specified by the RS232C standard ( $\pm 12V$ ) but instead transmits data using TTL levels (0 and 5V). Thus the VIC 20 needs additional circuitry before it can be connected to an RS232C device.

Several articles in BYTE magazine for March, April and May of 1983 describe this circuitry in detail.

We suggest that you refer to these magazine articles for further information and directions for constructing the necessary interface circuitry.

The Compuvoice project can also be connected using one of the parallel ports provided by the VIA chip in the VIC 20. We can't go into details in a letter, but if there is sufficient demand from readers we may publish an article describing this procedure. Nick Hampshire's book "The VIC 20 Revealed" is an excellent reference on the features of the VIC 20, and may give you some guidelines on how to connect other devices to the VIC.

**LIVE CHASSIS:** I have doubts about using the EA Video amplifier described in August EA when used with a live chassis TV and RF modulator. On a recent model Sanyo with live chassis I measured 50 to 75VAC from the antenna socket to earth.

So, how much leakage, going to the modulator, could seep into the computer? To those people who have asked me about it I merely said, "I would not do it and suggest you don't".

## Electronics Australia Reader Service

"Electronics Australia" provides the following services:

**PHOTOSTAT COPIES:** \$3 per project, or \$6 where a project spreads over multiple issues (price includes postage). Requests can be handled more speedily if projects are positively identified, and if not accompanied by technical queries. We reserve the right to supply complete back issues instead of photostats, where these are available.

**CHASSIS DIAGRAMS:** For the few projects which require a custom metal chassis (as distinct from standard cases) dyeline plans showing dimensions are normally available \$3 including postage.

**PC BOARD PATTERNS:** High contrast, actual size transparencies: \$3, including postage. Please specify positive or negative.

**PROJECT QUERIES:** Members of our technical staff are not normally available to discuss individual projects, either in person at our office, or by telephone.

**REPLIES BY POST:** Limited to advice concerning projects published within the last three years.

Charge \$3. We cannot provide lengthy answers, undertake special research, or discuss design changes. Nor can we provide any information on commercial equipment.

**OTHER QUERIES:** Technical queries outside the scope of "Replies by Post" or submitted without fee may be answered in the "Information Centre" pages, at the discretion of the Editor.

**COMPONENTS:** We do not sell electronic components. Prices and specifications should be sought from advertisers or agents.

**BACK ISSUES:** Available only until our stocks are exhausted. Within six months of publication, face value plus 30c for post and packing for each issue. Seven months and older: \$3 (includes post and packing and storage fee).

**REMITTANCES:** Must be negotiable in Australia and made payable to "Electronics Australia". Where the exact charge may be in doubt, we recommend submitting an open cheque endorsed with a suitable limitation.

**ADDRESS:** All requests to the Assistant Editor, "Electronics Australia", Box 163, Chippendale, 2008.

Generally I thought that there were capacitors between the "outside world" and the internals of live chassis TVs. (A.W., Maylands, SA.)

● We assume that you measured the AC voltage with a high impedance voltmeter such as a DVM. This probably had an input impedance of 10 megohms which would explain the high readings. This would represent a leakage current of around six microamps which hardly amounts to a hazard for computers or people.

**IMPORTANT INFORMATION:** While reading through Information Centre, EA Dec, 1983, p145, I was taken by your reply to JN Kainantu, PNG, re: Car Radio interference. I subsequently referred to your suggested article "Installing a car radio" EA, Feb 1969, p46.

My reason for writing is that I feel your magazine sometimes concentrates too much on minority problems at the expense of the important information. My experience over the years has been that a choke in series with the supply at the radio, cassette or R/T cures the majority of interference problems. One of my most successful cures involves using an old speaker transformer with the secondary used as the choke and the primary short circuited.

I appreciate that a choke cure was mentioned (near the end of the article) briefly but I disagree with the comment that filtering is adequate in most receivers as my practical experience has been to the contrary.

I was prompted to write this letter as I am constantly frustrated by reading articles, text books, etc, and finding that I come away with more unanswered questions than I started with and by the writer not having sufficient practical experience to be able to pinpoint or

highlight the most relevant sections of his articles. I suppose you will feel by this stage (if you have read this far) that I am nit picking, I assure you that there have been many such occasions, as this, where I have been tempted to comment.

I hope you will accept this letter as constructive criticism as in general I find your magazine most informative. (T.C., Baulkham Hills, NSW.)

● Re-reading of the suggested article indicates that while it did include some worthwhile hints it really should be updated to take account of today's car equipment. When that article was written most car radios would have been made in Australia and most would have included very comprehensive filtering on all leads, whether they were to the speaker, battery supply or antenna.

Your point about unanswered questions is well taken but it highlights the problem of the perceived audience: who will be interested by the article and will they be put off by the inclusion of too much basic information? That is a perennial question.

## Notes & Errata

**ELECTRIC FENCE** (September 1983, File 3/MS/950: High gain BC338 transistors can cause the oscillator to operate in a spurious mode which results excessive secondary voltage. This can blow the PUT or cause arcing at the output terminals. The cure is to increase the 10k $\Omega$  bias resistors. Use the lowest value which will still permit reliable operation.

**LCD 4½-DIGIT EVENT COUNTER** (July 1983, File 7/CL/36): The 4.7 $\mu F$  capacitor is shown reversed on the PCB overlay diagram. The circuit diagram is correct.

## FOR SALE

**UV LIGHT BOX:** Commercial and Hobbyist types available. See Advertisement on page 31. Kalex. Phone (03) 458 2976.

**APPLE SOFTWARE:** Latest games direct from USA. Rent or Buy. Write for free catalogue of over 200 titles. Australian Software Library, PO Box 808, Renmark, SA 5341. (085) 88 2877 any time.

**ELECTRONICS MAGAZINES:** 250 Issues EA & ETI 80c each. Wireless World \$1.00 each. Ph B.H. (03) 786 7032.

**EL GRAPHIX:** Upper/Lower case Graphics Kit 4 for the Super-80 Computer. ● Full Upper and lower case characters ● 160 versatile graphics characters ● 9 new monitor commands ● Graphics subroutines built in ● Centronics AND RS 232 routines built in ● VDU page Dump/VDU shift/rotate/fill routines. Complete kit only \$55.50 inc P/P. ● Upgrade Kits 1, 2 or 3 only \$25.00 inc P/P. ● Even upgrade Dicks "Deluxe" Kit \$27.50 inc P/P. El Graphix PO Box 278, Croydon 3136, Victoria. Phone (03) 725 9842 (after 7pm).

**RISTON:** Negative Resist PCB Material. Write for information Sheet, Kalex, Box 174, Heidelberg 3084.

**BOOKS:** Packet Radio with less hardware Volume 1 Synchronous Packet Radio the software Approach by Robert Richardson. 220 Pages \$28.00 + \$3.00 P&P. Northern Digital PO Box 333, Charlestown 2290.

**SUPER-80 SOFTWARE:** Super Invaders \$15.00, Sea Wars \$15.00, Pacman \$15.00. All with sound, any character generator. Draw a Picture \$10.00, Hangman \$7.50, Life \$6.00. Send order or enquiry to: J. S. Hawley, 151 Denton Ave, St Albans, Vic 3021. P&P \$1.50.

**PCB ETCH TANK:** Commercial and Hobbyist Types. See Advertisement on page 31. Kalex (03) 458 2976.

**CPM USERS GROUP:** Discs up to No. 90 inc businessmaster II software cat \$8.00 discs \$9.00 inc. post various formats available R. B Archer & Assoc, PO Box 696, Ringwood, Vic 3134.

**AMIDON FERROMAGNETIC CORES:** Large range for all receiver and transmitter applications. For data and price list send 105 x 220 SASE to: R.J. & U.S. Imports, PO Box 157, Mortdale, NSW 2223. Business closed during October.

**ROBOTS:** Gears, motors and more for the robot designer builder. Send stamped self addressed envelope to Hitchcock Robotics, PO Box 21, Parkville, Vic 3052 for catalogue.

**AIRCRAFT STARTER-GENERATORS:** Gen Elec CM — 77, 30 HP 400 AMPS, with Driveshaft couplings, 400 Ammeters, Shunts, and 400 Amp. Silver contact relays. In good cond. Suitable as electric car motors or welders. These Hi quality surplus motors are widely used in USA as electric car motors. Several available, complete with accessories at \$750 (New price in excess of \$4000), also plans available Electricar Enterprises PO Box 223, Kuranda, Qld (070) 93 7139.

**SUPER 80 SOFTWARE: ASSEMBLER/EDITOR:** General purpose text editor and ZILOG mnemonic assembler program to run on any size SUPER 80, includes 21 page instruction manual. \$33.45. Fully proportional dual JOYSTICKS with four pushbuttons for real time games with Assembly manual, interface program and demo game. KIT \$39.95 (game on tape \$10). MONITOR V1.2 and V2.2 Original source listings of two versions of Super 80 Monitor Program with comments. Great for learning machine code. \$11.95 each. Blank C-10 COMPUTER TAPES good quality \$1.50 ea (7 for \$10.00). REAL-TIME GAMES: Snake, Fly Shoot and Invaders. Three games on cassette for \$14.95. Write to: Pelatronics, PO Box 807, Toowong, Q 4066. Include \$2 P&P.

**MICROBEE/TELEPRINTER OWNERS:** Have your teleprinter ON-LINE for LPRINT, LLIST etc. For listing send \$5 + SAE to Fletron Electronics, Talbot, Vic 3371.

## WANTED

**I.F. COIL:** Wanted for 1940 model thirteen valve Radiola, one only third I.F. Coil L23. L24, one only second I.F. Coil L20. L21. L22. Phone (02) 969 5768. S.G. Rogers, 15 Morella Road, Mosman, 2088.

**DISPLAY ADVERTS IN MARKETPLACE** are available in sizes from a minimum of 2cm x 1 col rated at \$15 for a col cm.

**CLASSIFIED RATES** \$3.60 for 40 letters or part thereof per insertion payable in advance. Minimum 80 letters.

**CLOSING DATE** is six weeks prior to the on-sale date. Issues are on sale the first Wednesday of each month.

## READER SERVICE

**COMPUTER CLINIC:** Repairs and service Tandy, Sorcerer, Apple, System 80, Microbee, Osborne etc, disk drives, and printers. Bankcard. (07) 269 8573. PO Box 68, Aspley, Q 4034.

## BUSINESS FOR SALE

**TELEVISION, VIDEO AND AUDIO:** Repair business. Successfully established over 6 Yrs. Takings in excess of \$6,000 per month. In Frankston, Victoria area. Price \$15,000. PH B.H. (03) 786 7032.

**RCS Radio Pty Ltd**

Tel. (02) 587 3491

IS THE ONLY COMPANY WHICH MANUFACTURES AND SELLS EVERY PCB & FRONT PANEL published in EA and ETI

651 Forest Road Bexley 2207 AUSTRALIA

RING FOR INSTANT PRICES 24 HOUR TURNAROUND SERVICE

## FUNDAMENTALS OF SOLID STATE

Fundamentals of Solid State has been reprinted, revised and updated showing how popular it has been. It provides a wealth of information on semiconductor theory and operation, delving much deeper than very elementary works but without the maths and abstract theory which make many of the more specialised texts very heavy going. It begins with atomic theory, diode types, unijunction, field effect and bipolar transistors, thyristor devices, device fabrication and microcircuits. A glossary of terms and an index complete the book. Fundamentals of Solid State has also been widely adopted in colleges as recommended reading — but it's not just for the student, it's for anyone who wants to know just a little bit more about the operation of semiconductor devices.

Available from: "Electronics Australia", 57 Regent St, Chippendale. PRICE \$3.50 OR by mail order from "Electronics Australia", PO Box 163, Chippendale, 2008. PRICE \$4.40.

## Nikola Tesla . . . ctd from p25

of filaments — the forerunners of modern fluorescent lamps — of much greater efficiency than the Edison lamp.

This lecture was so successful that Sir James Dewar called on Tesla and asked him to repeat it before the Royal Institution. Tesla replied that he never duplicated his lectures, preferring to always present new and original material. Sir James then escorted Tesla to a room, pushed him into a chair and "poured out half a glass of a wonderful brown fluid which sparkled in all sorts of

iridescent colours and tasted like nectar."

"Now," the Scotsman said, "you are sitting in Faraday's chair and you are enjoying whiskey he used to drink."

This singular honour convinced Tesla to accede and he repeated the lecture before the Royal Institution the next evening. Following that, he gave other lectures in Paris and Berlin. On his return to the United States, he became actively involved in the realisation of a boyhood dream — the harnessing of Niagara Falls.



BARGAIN PRICES • PERSONAL ATTENTION • SLICK MAIL ORDER SERVICE • SATISFACTION

**SORRY - LAST OFFER AT THESE PRICES**

## ETONE SPEAKER SPECIALS

GENUINE FACTORY PRICES

You'll kick yourself next month for not buying this month

Rugged top quality Aus. made brand new bargains - all with factory warranty.

Model	Size	Cone Type	V/Coil	Reson Hz	Freq Hz	Watts Rms	Price Ea or	2 for
6110	30cm	Ribbed surround	8 or 15 Ohms	65	50-8000	30	\$28.50 or	\$49.95
6160	30cm	Twin cone	8 or 15 Ohms	65	50-15000	30	\$29.50 or	\$52.00
6180	30cm	Foam surround	8 Ohms	30	30-4000	60	\$34.95 or	\$64.00
4310	38cm	Straight surround	8 or 15 Ohms	45	40-6000	60	\$63.00 or	\$120.00
4510	38cm	Straight surround	8 or 15 Ohms	45	40-6000	100	\$84.00 or	\$156.00
4350	38cm	Hi-Fi	8 or 15 Ohms	30	30-4000	120	\$63.00 or	\$120.00
141	25cm	Curvilinear	8 Ohms	50	50-10000	80	\$68.00 or	\$130.00
146	25cm	Twin cone	8 Ohms	50	50-14000	80	\$71.00 or	\$134.00
145	25cm	Curvilinear	8 Ohms	30	25-4000	120	\$78.50 or	\$150.00
149	25cm	Twin cone	8 Ohms	30	25-12000	120	\$82.50 or	\$160.00
235	30cm	Curvilinear	8 or 15 Ohms	30	30-5000	120	\$67.75 or	\$130.00
239	30cm	Twin cone	8 or 15 Ohms	30	30-12000	120	\$73.95 or	\$140.00
265	30cm	Ribbed	8 or 15 Ohms	50	40-8000	150	\$132.00 or	\$252.00
266	30cm	Twin cone	8 or 15 Ohms	50	40-14000	150	\$139.00 or	\$264.00
461	38cm	Straight	8 or 15 Ohms	45	40-6000	150	\$180.00 or	\$345.00
466	38cm	Twin cone	8 or 15 Ohms	45	40-12000	150	\$197.00 or	\$370.00
484	38cm	Straight	8 or 15 Ohms	40	40-4000	200	\$200.00 or	\$370.00
805	38cm	Ribbed	8 or 15 Ohms	30	30-2000	250	\$220.00 or	\$410.00

Pack - Postage add for one 25/30cm model. NSW \$3.50. Interstate \$5. For two 25/30cm models. NSW \$5. Interstate \$7. For one 38cm model. NSW \$4.00. Interstate \$6.00. For two 38cm models. NSW \$7. Interstate \$8.50.

## HIGH GRADE POTTER AND BRUMFIELD RELAY



P-P 95c **\$3.50**

KU series • 240 VAC 50Hz operation • 3 sets of 240V 10 amp change over contacts • perspex cover and mounting base included • size 50mm x 37mm x 35mm • ex-computer • as new condition. At less than 1/2 of the normal price

## EX-PMG HIGH POWER DIODES

PERFECT WORKING ORDER  
GUARANTEED



**125 AMP  
400 PIV  
WITH HIGH  
POWER HEAT SINK**

**\$13.95 2 FOR \$25**

P-P NSW \$1.00. INTERSTATE \$2.00.



## KRIESLER

BELT DRIVE STEREO PLAYER

WITH MAGNETIC CARTRIDGE  
DIAMOND STYLUS

**\$66.00**

P-P NSW \$5.50.  
Q, V, T, SA \$6.50.  
WA, NT \$7.50

LIMITED STOCK

Features - big aluminium turntable • 2 speeds 33-45rpm • Cue lever • Calibrated adjustable counterweight • Calibrated anti-skate • Auto return-stop • Switch click suppressor • Power cable, RCA connectors • 240 VAC

## EX-COMPUTER FAN MOTORS

!KEEP IT COOL!

**4" sq. 230V 50/60Hz**

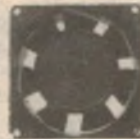

EXCELLENT WORKING ORDER GUARANTEED

Amps • Power Supplies • Electronic Equipment will operate far more efficiently • Imp protected •

**\$8.95 EA**

P.P. NSW \$2.50  
INTERSTATE \$3.50

## MAGNETIC STEREO CARTRIDGE

TOP BRAND - TOP QUALITY



STD 1/2in MOUNTING • OUTPUT 5MV • FREQ RESPONSE 15-22,000 HZ • TRACKING FORCE 1.5-3.5GR • WT. 5GR • EXCELLENT CH BAL AND SEPARATION

DIAMOND  
STYLUS

**\$15.95**

P-P 90c



## 12V HIGH POWER ALARM SIREN

WARBLER TONE 105dB at 1 METRE **\$21.95**

INDOOR/OUTDOOR

IDEAL FOR CAR, HOME, BOAT ETC

PP NSW \$2. INTERSTATE \$2.85

## GOLD PLATED

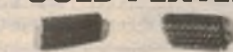

55 WAY PLUG AND SOCKET

A1 QUALITY EX-PMG 55x25mm CHASSIS MOUNT SIMPLE TO DISMANTLE TO MAKE YOUR OWN COMBINATION.

**\$3.50** P-P 90c

## POWER TRANSFORMER

**SALE**

Modern types. Brand new.



Primary  
240V 50Hz

No. 1. 0-12V. 1A	\$2.95
No. 2. 0-18V. 1.8A	\$3.95
No. 3. 12.0-12V. 5A	\$2.50
No. 4. 0-38V. 2A	\$4.95
No. 5. 34.0-34V. 1.5A	\$4.50
No. 6. 0-240V. 60MA	\$3.50
No. 7. 35.0-35V. 75A	\$4.00
No. 8. 0-40V. 200MA	\$1.75
No. 9. 0-20V. 2A. 6.3V 1A	\$2.50
No. 10. 0-15V. 1A. C-CORE	\$4.50
No. 11. Mini T'former	
0-5V. 1A. 0-15V. 1A	
0-31V. 1A. 0-96V. 1A	\$2.75
No. 12 Mini T'former	
9V 1.5V. -0-1.5V. 9V 1A	
0-17V. 1A	\$2.75

P.P. NSW \$2.50 INTERSTATE \$3.50

## HI-POWER BRIDGE RECTIFIER



400 PIV  
35 AMP

**\$3.75**

P-P 75c

DIODE IN 4004. 50 FOR \$2.50  
P-P 80c

## 2SD200 = BU205 TRANSISTOR

NPN VCBO  
1500V •



VCBO 700V

• 2.5 AMPS

4 FOR **\$3.75** P-P 75c

## ELECTROLYTICS



8000uF 75V DCW

2 FOR **\$9.75**

3300uF 75V DCW

2 for **\$6.50**

P-P  
NSW \$1.  
INTERSTATE \$1.60

## SANGAMO

24hr TIME SWITCH

240VAC  
50Hz  
INPUT



15 AMP  
CONTACTS

RECONDITIONED GUARANTEED  
PERFECT  
**\$22.50** P-P NSW \$2  
INTERSTATE \$3.50

## A1 QUALITY TRANSISTORS



2N3055

10 FOR **\$6.** P-P \$1.50

BACK ISSUES E.A.  
MAGAZINE from 1957  
**\$2.50 EA. P-P \$1.50**

## GEARED MOTOR

240VAC 50Hz 3W

**\$3.50** PP 75c

5 RPM Plenty of torque With Cam and N/O N/C microswitch 15 switch contacts per min OA size 65 x 60 x 35mm

## 500 uA FSD PANEL METERS



V-U  
SCALE

38 and 45mm. SQ

**\$3.50**

EACH

2

FOR

**\$6**

# EA Magazine Holders



The binders and magazine holders are available over the counter from Electronics Australia, 57 Regent Street, Sydney, NSW — Price: \$5.10 binders, \$4.50 holders.

Mail orders should be sent to Electronics Australia, PO Box 163, Chippendale, NSW 2008.

Prices including postage are:

Holders: \$5.50 NSW; \$5.60 other states; or six for \$29.00 NSW; \$31.50 other states, \$A33.00 NZ.

Binders: \$7.00 NSW; \$8.50 other states; or six for \$33.00 NSW; \$36.00 other states, \$A37.00 NZ.

## ADVERTISING INDEX

ADVERTISER	PAGE
Active Electronics	122, 123, 124
Ace Radio	135
AED Microcomputer Products	127
Altronic Distributors Pty Ltd.	20, 21, 58, 59, 90, 92, 106, 107
Ampec Electronics	2
Amtex Electronics	37
Applied Technology	42, 43
Audio One	47
Audioson Int. Pty Ltd.	36
Avtec Electronics	86
BGR Computers	114, 115
Bemak	80
Billco Electronics	110
Pat Byrne	109
C & K Electronics	120
Castle Electronics	131
Dandy Electronics	80
Daneva Australia	100
David Reid Electronics	14
Dick Smith Electronics Group	10, 11, 34, 38, 39, 64, 65, 77, 98, 103 + colour section
Electrocraft	89
Elmeasco	8 + colour section
Electronic Agencies	48
Ellistronics	26, 27, 28, 29
Emona Enterprises	63
Ferguson Transformers	118
Harman Aust.	41
Jaycar Pty Limited	4, 5, 50, 51, 82, 83, 112, 113
Kalextronics	31
L. E. Chapman	121
MaGraths	119
Parameters	55
Paris Radio	129
Place Electronics	105
Pulsar Electronics	57
R. C. S. Radio	134
Radio Despatch Service	78
Scientific Electronics	71
Sheridan Electronics	97
Sony	IFC
Stotts Technical Correspondence College	87
Systems Reliability	15
Techtron Engineers	131
Texas Instruments	OBC + colour section
Truscott Electronics	49
Video Bar	19
Wireless Institute of Aust.	111

## EA PC BOARDS AND FRONT PANELS

Some readers have problems obtaining PC boards and front panels for projects. Many of our advertisers sell these items and their advertisements should be checked in the first instance. Failing that, below is a list of firms which produce or sell PC boards and front panels.

### NSW

**Dick Smith Electronics,**  
125 York Street,  
Sydney, 2000.  
Telephone 290 3377.  
DSE also has branches and resellers throughout Australia.

**Electronic Agencies,**  
115-117 Parramatta Road,  
Concord, 2137.  
Telephone 745 3077.

117 York Street,  
Sydney 2000.  
Telephone 29 2098.

**Jaycar Pty Ltd,**  
125 York Street,  
Sydney 2000.  
Telephone 264 6688.

**Radio Despatch Service,**  
869 George Street,  
Sydney 2000.  
Telephone 211 0816.

**RCS Radio Pty Ltd,**  
651 Forest Road,  
Bexley, NSW 2207.  
Telephone: 587 3491

**VIC.**  
**Rod Irving Electronics,**  
425 High Street,  
Northcote, 3070.  
Telephone 489 8131.

**Kalextronics,**  
101 Burgundy Street,  
Heidelberg 3084.  
Telephone 743 1011.

Shop 11,  
Regional Shopping Centre,  
Melton 3338.  
Telephone 743 1011.

**Sunbury Printed Circuits,**  
Lot 14, Factory 3,  
MacDougal Road,  
Sunbury 3429.  
Telephone 744 2714

**Altronics,**  
105 Stirling Street,  
Perth 6000.  
Telephone 328 1599.

**Jemal Products,**  
8/120 Briggs Street,  
Welshpool, 6106.

**N.Z.**  
**Marday Services,**  
PO Box 19 189,  
Avondale, Auckland.

**Mini Tech Manufacturing Co Ltd,**  
PO Box 9194,  
Newmarket.

**Printed Circuits Limited,**  
PO Box 4248,  
Christchurch.

## SUBSCRIPTION SERVICE



**ELECTRONICS  
Australia**

### Subscription Rates

\$29.00 per year  
within Australia  
\$31.00 per year  
elsewhere

Make sure you receive every copy of the magazine by ordering it from your newsagent or the publisher. For publisher subscriptions post this coupon, with your remittance to Electronics Australia Subscription Dept. John Fairfax & Sons Ltd, GPO Box 506, Sydney 2001. Subscription will start with first available issue.

Name .....  
Address .....  
Postcode ..... Enclosed is ..... for ..... years

# Open your mind to the world of today...and tomorrow!

# OMEGA

**REVEALS! EXPLORES!  
VENTURES!**  
Where no other magazine dares.



We guarantee you'll find Omega the most exciting magazine you've ever read...prove it by subscribing and taking your next issue completely

# FREE.

This may be your first exposure to OMEGA. But we guarantee that once you've read even one issue, you'll agree that it contains topics to fascinate every aware, intelligent person. We promise you a journey of discovery...what we are, our minds and bodies. What science knows and doesn't know. What the media doesn't tell. But what you **should** know.

**Sex, science, space...body, brain behaviour...Omega stimulates and entertains like no other magazine.**

Each issue of OMEGA draws on brilliant minds that probe controversial subjects. Penetrating, sparking journalism...stunning, imaginative photography...mindblowing art...fascinating fiction. And no-one could accuse OMEGA of being predictable - you'll find surprise after surprise in every thick, meaty, value-packed issue!

## SPECIAL INTRODUCTORY OFFER YOURS FREE

**The Colours of Australia.**  
A superb 128 page full colour hardback book from Lansdowne Press of the work of noted photographers Reg Morrison and Mark Lang. It graphically displays our country of time-worn mountains and plains, majestic coastlines and quiet creeks, snowfields pristine and hushed, and the richly coloured deserts.  
Normally \$10, yours absolutely FREE as an OMEGA subscriber.

### What we've been up to lately!

Recent issues of OMEGA have featured -

- ESP - new findings
- A new theory on the origins of life
- Amazing techniques of future medicine
- The 'love virus' - Is there a cure?
- UFO's - who's deceiving whom?
- Australia's secret nuclear role
- Inside the sex labs

Just imagine what we have in store in the next few issues!

To: Omega Subscriptions  
John Fairfax & Sons Ltd.,  
GPO Box 506, Sydney,  
NSW 2001.

**YES.** Send me my FREE next issue of OMEGA and enrol me as a subscriber for 1 year (6 issues). I enclose my cheque/money order for \$17.50 (cost of 5 issues only) or process my bankcard. If not delighted I may cancel after my first free copy and receive a full refund. If I continue my subscription I will receive my FREE "The Colours of Australia" with my second copy of Omega.

Mr/Mrs/Ms \_\_\_\_\_

Address \_\_\_\_\_

Postcode \_\_\_\_\_

Signature \_\_\_\_\_

Please complete below if paying by Bankcard.

<input type="text"/>	<input type="text"/>	<input type="text"/>	<input type="text"/>	<input type="text"/>	<input type="text"/>	<input type="text"/>	<input type="text"/>
----------------------	----------------------	----------------------	----------------------	----------------------	----------------------	----------------------	----------------------

Expiry Date \_\_\_\_\_ TOTAL-08

# CLIP & MAIL TODAY

# TEXAS INSTRUMENTS HOME COMPUTER



A limitless learning environment  
for children to give them the  
Educational Edge.

Creating useful products  
and services for you.

**TEXAS INSTRUMENTS**



TEXI0086 B