

Registered by Australia Post —
publication No. NBP 0240

Australia's Top Selling Electronics Magazine

Electronics Australia

FEBRUARY 1987

ONLY \$2.95
NZ: \$3.95 incl. GST



**A RIDE ON
THE BOND
AIRSHIP**

**What's new in
power supplies**

**Digital
sound
store**

**Dual tracking
power supply**

**Review:
Multitech PC-700
computer**

BONUS! 84-page Altronics Catalog

The travelling soldering iron from Weller



Here's another clever new idea from Weller. Brand leader in soldering tools.

This 30 watt, 12 Volt Soldering Iron (SP30) can be battery powered so it can be used anywhere, especially where there are no usual power sources.

It's supplied with non-polar battery clips, so there's no need to worry about the positive and negative. And there's a 4.5 metre lead for ease of use at some distance from the battery power source.

Like all Weller irons, the SP30 12 Volt Soldering Iron is precision made to the highest standards. It's the perfect answer for everything from roadside repairs to outdoor hobbies.

Weller, the leading name in soldering irons.

CooperTools

CRESCENT LUFKIN NICHOLSON PLUMB TURNER WELLER WIRE-WRAP WISS XCELITE
Cooper Tools Pty Limited, P.O. Box 366, 519 Nurigong Street, Albury N.S.W. 2640, Australia
Telephone: (060) 21 5511, 21 6866, Telex: AA56995 CTGAUS, Fax: (060) 21 7403.

THIS MONTH'S COVER

What's it like to fly in the Bond airship? Our intrepid reporter hitched a ride to find out. See page 10

Electronics Australia

Volume 49, No.2

February
1987

Features

- 10 A RIDE ON THE BOND AIRSHIP *Porsche motors, gas & a gondola*
- 36 BUILDING LOUDSPEAKER ENCLOSURES *Handy hints and techniq*
- 104 MULTITECH'S PC-700 COMPUTER *High speed & a hard disc*

Electronic Engineering

- 22 WHAT'S NEW IN POWER SUPPLIES *The latest trends*
- 90 CUSTOM IC SOLUTIONS *Philips forges ahead*

Projects and Technical

- 42 DUAL TRACKING $\pm 21V$ POWER SUPPLY *Build it for your workshc*
- 56 THE SERVICEMAN *When should we have our heads examined?*
- 63 CIRCUIT AND DESIGN IDEAS *Sensitive trigger for slave flashguns*
- 64 FLASHING LIGHTS FOR MODEL RAILROADS *For greater realism*
- 80 UNDERSTANDING COLOUR TV PT.2 *Early colour TV systems*
- 91 BUILD A DIGITAL SOUND STORE *No tape and instant replay*

News and Comment

- 4 LETTERS TO THE EDITOR *The facts on turntables*
- 5 EDITORIAL *Slow motion replays and the illusion of reality*
- 6 NEWS HIGHLIGHTS *How hot is a broody emu?*
- 16 FORUM *Hifi howlers: yer can't help larfin'*
- 116 INFORMATION CENTRE *Answers to reader queries*

Departments

- 79 50 AND 25 YEARS AGO
- 86 EA CROSSWORD PUZZLE
- 108 NEW PRODUCTS
- 120 MARKETPLACE
- 122 COMING NEXT MONTH
- 119 NOTES AND ERRATA

Dual tracking $\pm 21V$ power supply



Build this new dual tracking power supply for your workshop. It uses readily available parts and can provide voltages from 0 to $\pm 21.5V$ at currents up to 2A. Details page 42.

What's coming

Next month, we intend to publish a very clever electronic rain gauge. We'll also be taking a look at car sound equipment. See page 122 for further details.

Review: Multitech PC-700 computer



This month, we take a look at the new Multitech PC-700 personal computer. Find out how it performed by turning to page 104.

MANAGING EDITOR
Leo Simpson, B.Bus. (NSWIT)

EDITOR
Greg Swain, B.Sc. (Hons. Sydney)

EDITORIAL CONSULTANT
Neville Williams, F.I.R.E.E. (Aust.)
(VK2XV)

EDITORIAL STAFF
John Clarke, B.E. (Elec. NSWIT)
Carmel Triulcio

GRAPHIC DESIGNER
Brian Jones

ART PRODUCTION
Alana Horak

PRODUCTION
Mark Moes

SECRETARIAL
Naomi Lenthen

ADVERTISING PRODUCTION
Brett Baker
Vikki Patching (Vic.)

ADVERTISING MANAGER
Selwyn Sayers

PUBLISHER
Michael Hannan

HEAD OFFICE
The Federal Publishing Company Proprietary
Limited, 180 Bourke Road, Alexandria, NSW
2015.
Phone: (02) 693 6666. Fax number: (02) 693
2842. Telex: AA74488.
Postal Address: PO Box 227, Waterloo 2017.

**INTERSTATE
ADVERTISING OFFICES**
Melbourne: 221a Bay Street, Port Melbourne,
Vic. 3207.
Phone: (03) 646 3111
Representative: John Oliver, B.A. (Hons.
Essex).

Adelaide: John Fairfax & Sons Ltd, 101
Weymouth Street, Adelaide, SA 5000.
Phone: (08) 212 1212.
Representative: Dane Hansen
Brisbane: 26 Chermiside Street, Newstead, Qld.
4006.

Phone: (07) 854 1119.
Representative: Bernie Summers.
Perth: John Fairfax & Sons, 454 Murray Street,
Perth, WA 6000.
Phone: (09) 481 3171.
Representative: Estelle de San Miguel.
New Zealand: 3rd Floor, Communications
House, 12 Heather Street, Parnell, Auckland,
New Zealand.
Phone: (09) 39 6096. Telex: NZ 63122
SPORTBY.
Representative: John Easton

ELECTRONICS AUSTRALIA is published
monthly by the Federal Publishing
Company Pty Limited.

Typeset and printed by Hannanprint, 140
Bourke Road, Alexandria, NSW for The
Federal Publishing Company Pty Ltd.

Distributed by the Federal Publishing
Company Pty Ltd.

Registered by Australia Post — publication
No. NBP 0240.
ISSN 0313-0150

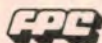

*Recommended and maximum Australian
retail price only



Letters to the editor

More "truth" about turntables

While reading the December issue of *Electronics Australia*, I was perplexed to read your "truth about turntables".

If I misunderstood your article — maybe you intended to say exactly the opposite — I ask you to excuse my reaction.

Are you really saying that CD is definitely better than good analog recordings?

Do you really write that hifi dealers, audio critics, yes, even all well-known Japanese audio critics included, are liars saying that analog is absolutely better?

I even read the word "stupid" if somebody is of the opinion that CD is inferior to vinyl.

Either you intended to write a double meaning article which unfortunately has not been understood as such, or you are just misinformed and never had the opportunity to compare real analog hifi with CD.

As well-known manufacturers of hifi with acknowledged expertise, I must write you that your opinion is contrary to the world's feeling after three years of experience with CD.

As a matter of fact, what we know is that everybody who has a good hifi equipment — not a \$1000 rack — is disappointed by the big promises of the CD industry.

Maybe you have not had the opportunity to compare a good analog turntable (belt drive, floating suspension, rigid conventional tone arm &c.) which is connected to good sounding electronics and speakers with a CD.

Literally, everybody recognizes that the CD sound is flat, metallic, clinic, unreal regarding high frequencies . . . just not natural. If you wish, we can give you more technical facts about this phenomena.

You say that those who do not hear the difference in favour of CD have non-functioning ears. I feel that you make unfair statements. Maybe the oc-

More on kits suppliers

In response to your request for loads of letters to your kit supplier clients, may I add a few comments from my experience as a distant country consumer (670km to Sydney, 1200km to Melbourne, from whence most kits originate.)

(1) Advertised kits which are featured in current journals that are not in stock or have many weeks delay in supply (not uncommon).

(2) Advertised postage and packing charges often differ from the real thing and the goods will often be held up until further monies are forwarded (par for the course).

(3) Kit charges are often raised between time of advertising and receipt of the order (as little as one week on one occasion.)

In one case, concerning a section of a multi-part kit, the cheque was returned due to the sudden sharp rise in the kit, "due to a sharp fall in the Australian

dollar" (almost as worn the computer fault excuse). The complete kit was then bought piecemeal from local retail outlets, at maximum country retail prices and still it was cheaper than the original kit price, without the added extras of post and packing.

So much for the statement that kits are cheaper.

(4) Kits often have faulty components (do they use seconds on some occasions?)

(5) Kits with missing components. Usually only resistors or small capacitors but this is disconcerting all the same.

(6) Wrong components which can be very serious. In one case the supplier argued that the transistors in the kit were correct when in actual fact they were of different polarity. The mistake was reluctantly conceded to when he was referred to the journal component list. They then promptly forwarded the correct replacements.

The main point however is would the supplier have made adequate compensation (if any) if these wrong devices had

casional cracks and pops are more important for you than the actual music. Wow and flutter, inner groove distortions &c. are not existent on a good turntable. The music information on good analog records is nearly unlimited and creates a definitely better and livelier sound than the CD format.

This fact is known and confirmed by any knowledgeable audiophile. If you wish, you may write us for the addresses of obviously more objective audio critics (including Japan) to discuss with them your strange view.

I suggest that you participate at a perfect comparison in your country which could easily be organized by any importer of quality products.

Your article says about the same as if today somebody alleges the earth is flat

I hope you correct your published viewpoint or if you do not understand what is really the truth, please publish this letter at least. Thank you.

Armin Graf, Managing Director,
Thorens-Franz AG, Wettingen
Switzerland.

Fair go, mate. Since when have inner groove distortion, wow and flutter been non-existent on vinyl records and turntables? When are Thorens coming out with a CD player?

been used with the resultant destruction these would have caused to the circuit?

(7) The high cost to the consumer of phone calls to correct these errors and the inevitable hold-ups are frustrating. The alternative of a letter is no better.

(8) Poor quality photostat copies of magazine articles as accompanying instruction sheets! There is also no additional data to illuminate the use of replacement parts or additions. In some cases, particularly overlays and component placements, the copies can be quite undecipherable.

Now this all might sound like sour grapes but being a country consumer I am forced to accept these difficulties as part of the high financial cost of living in the country. I admit that such frustrations are not reserved just for the electronics industry but are now a normal part of consumer supply in engineering as a whole. This is a sorry reflection on our current commercial scene.

D.C. Dehlsen,
Bushy Park, NSW.



Editorial Viewpoint

Slow motion replays and the illusion of reality

Anyone who has been watching television over the last few months will have been enjoying a feast of sport. Cricket, tennis, golf, yacht racing, surfing, you name it, it's been on TV. And there is no doubt that Australian TV sports coverage is the best in the world. You only have to watch videotapes of overseas events to realise this. Our cameramen and producers are more innovative in the way they use TV technology and the way the shows are put together to keep the viewer interested.

At the peak of sports broadcasting are the Channel Nine network and the Seven network. The Nine network is clearly the leader for its overall professionalism while the Seven network is the leader in technical innovation, especially with its development of Racecam technology.

No doubt there are many people who decry this emphasis on sport and it is undeniable that TV is otherwise a cultural desert at this time of the year. However, the majority of people like to watch sport and there is no doubt that the wide variety of sporting activity gives many opportunities for the TV broadcaster to use the medium in new and interesting ways. In fact, for readers of this magazine there is probably as much interest in the way that the medium is being used as the program itself. The inclusion of the story on the Bond airship this month will add an extra interest to the TV coverage of the Americas Cup yachting.

But with all this emphasis on TV coverage of sport it is easy to forget that television presents only an illusion of reality. What really happens at the event may be quite different. For example, when watching the cricket at the SCG, it is easy to forget just how vast the Sydney Cricket Ground really is and just how far away the players are from the live audience. Or just how difficult it is to judge who is the leader in match-racing at the Americas Cup — telephoto lenses foreshorten the field so much that visual perspective can be completely lost.

And consider the slow motion replay which is often used to judge the accuracy of the umpire's decision at cricket matches. What the camera sees and what actually happens can be very different. Consider for example, that a fast bowler may bowl the ball at 140km/h. That is about 39 metres per second. That means that between each video frame, the ball moves 1.5 metres and a lot can happen during this time. With that in mind, how can the camera consistently tell the truth: there can still be doubt as to whether the ball has come off the bat or the pad.

So as you sit back and enjoy the sport on TV, remember this. What you're seeing is only an illusion of reality.

Leo Simpson

EA

News Highlights

Robots increasing in Australian industry

The Australian electronics industry is progressively introducing robots in selective repetitive work areas to improve productivity, quality and manufacturing efficiency.

According to a spokesman for the Australian Electronics Industry Association (AEIA), local communications companies are using robots to perform tasks so exacting that manual labour cannot do them with the degree of accuracy needed to ensure a consistent standard of quality.

First introduced to Australian manufacturing in 1975, robots are now used by about 600 local companies. While the majority of these are heavy-industry type, such as those in steel-making and car manufacturing, robots are becoming an increasingly important part of the electronics industry's push towards plant automation.

"The robot is now taking over a number of laborious and exacting tasks and consequently speeding up the manufacturing operation tremendously," the AEIA spokesman said. "Only by maintaining the most up-to-date electronic manufacturing facilities can Australian companies expect to remain competitive on the local market and in export business," he said.

One AEIA member company, STC, is now using robotic operations for handset moulding. A robot is programmed to take metal rods out of the plastic moulds. The rods are automatically inserted and withdrawn once the mould has cooled and set.

"This is a difficult manual operation as the tools are very easily scratched", said STC's Manufacturing Director Bruce Stephens. "But once programmed correctly, the robot doesn't make any mistakes. STC is so impressed, it is installing another unit.

"With small business telephone systems, the pushbuttons have to be individually placed on the plastic cases. Even with overhead projection techniques, this is a repetitive and time-consuming task for manual operators. That is why we are installing a robot with a vision system to do this work. It is a case of accuracy rather than economics."

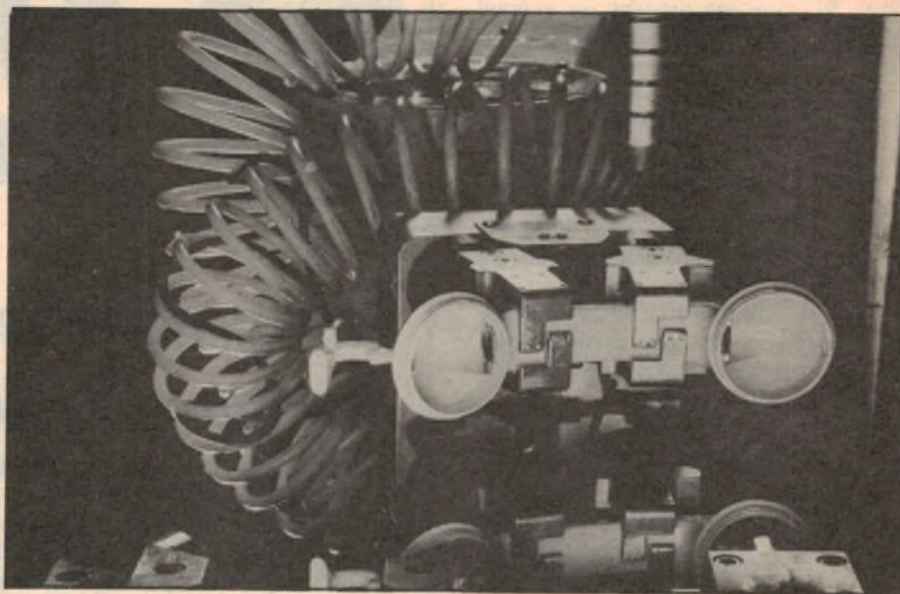

Microwaves could build lunar roads

A half-cup of dust from outer space may help Los Alamos National Laboratory researchers prove that building materials can be made on the Moon. The precious cargo was collected during the Apollo 11, 15 and 16 missions and came from three different areas of the Moon.

The 45 grams of lunar material is one of the largest samples ever allotted to one agency for experimental purposes. NASA provided the dust to find out whether lunar material will fuse in a microwave oven to produce such products as bricks or other structural materials.

If feasible, it would be much cheaper and easier than lifting these items into space from Earth, should a lunar base ever be established.

Experimenters with the Lab's Materials Science Division (MST) have already exposed synthetic moon dust to heat in a modified microwave oven and produced a low-density, high-strength product with good load-bearing characteristics.

This capability suggests that it might be possible to construct roads on the Moon by fusing the soil with microwaves!

Radio Dundee

Ray Gear, Philips Communication Systems, Brisbane, has been awarded a contract for mobile radio equipment (model FM828s) by the Queensland National Parks and Wildlife Service.

The system will give National Parks officers remote interrogation of crocodile traps. Yes, crocodile traps! When a trap operates the radio will alert the base and a LED display will show the location. An audible alarm will also alert officers in the vicinity — in case the croc isn't yelling loudly enough!

Ray, who has now adopted the middle name "Crocodile Dundee", has been warned to take his skinning knife when he inaugurates the system.

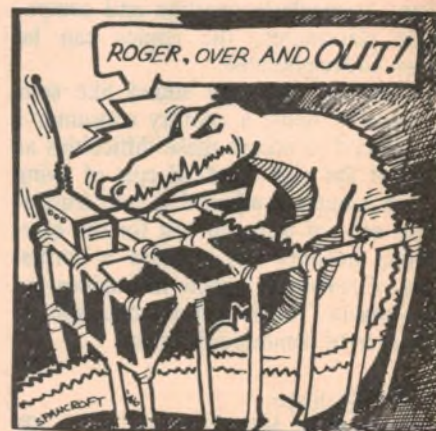

Radio training for older Australians

It's said that you can't teach old dogs new tricks but all over the country there are obedience schools doing just that!

Something of the Obedience School ideas must have rubbed onto the Australian Bicentenary Authority because they have put up a lot of money to teach old(er) Australians a whole range of new skills.

Called the "Older Australian Radio Training Scheme", or OARTS for short, the scheme is being conducted by the Australian Broadcasting Corporation on behalf of the ABA. Trainees have to be over 55 years of age and need no other requirement than an interest in radio as a "communication medium".

The pilot program was conducted in Tasmania with ten students from Hobart and Launceston. The program will continue later in Mainland cities with the ultimate aim of having a team of trained personnel capable of producing a series of 26 one-hour radio programs for the ABA in 1988.

Although the scheme is intended to provide the ABA with programs in 1988, it is hoped that the trainees will use their new skills to benefit public access radio and to supply occasional program material to the ABC.

The ten week pilot course covered every facet of radio production, from recording interviews to final production and presentation on air. The students were coached in writing, editing, music and effects, announcing and even the requirements of copyright and libel laws.

The lectures and practical sessions were given by ABC production, presentation and technical staff. At all times the students were encouraged to strive



for the highest professional standards.

Some of the students had on-air experience with public access radio and saw the OARTS scheme as a means to improve their skills. Others had no such experience and even handling a tape recorder was something entirely new.

The scheme has proved that being over 55 is no bar to learning new arts. When the courses are finished in the Mainland cities, there will be a corps of some eighty clever and enthusiastic oldies pouring their talents into AM and FM radio all over the country.

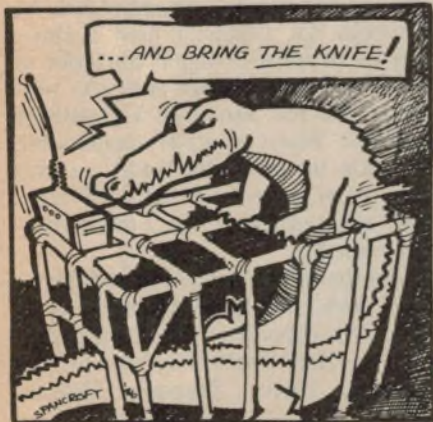

First deliveries to US navy

A ceremony at Philips Australian Defence Electronics Facility, Moorebank, marked the first delivery of Australian manufactured avionic components to the United States Navy Aviation Supply Office. Captain Wayne Moni, USN, accepted the delivery documentation for two F/A-18 radar power supply switches from operations manager, Bruce Hart.

Contracts worth \$12 million have

been signed between Philips and the US Navy for the supply of radar components manufactured at Moorebank under licence from the Hughes Aircraft Company.

These contracts with the US Navy are a logical progression from existing designated work — a quantity of 75 radars are being assembled and tested for the RAAF's own F/A-18 aircraft fleet.

News Highlights

Personal robots – the long march

Following hot on the heels of the personal computer is the personal robot. If you thought that robots were all brutish monstrosities which lurk on automated production lines, you will be pleasantly surprised at the prospect of a machine that can mix you a drink, lay the table or use a pushbutton telephone to make your call for you.

Recently in London, what was described as the world's first personal robot was unveiled. The RTX, as it is known, has been developed by Universal Machine Intelligence company. At around \$25,000, the six-axis machine is said to be 10 times cheaper than an industrial robot and can therefore be used for industrial and other applications where previously it was not possible to consider the use of expensive robots.

How hot is a broody emu?

Male emus are devoted parents. They do all the incubation of their partner's eggs. Reportedly, they neither eat nor drink while on duty. The physiological consequences of this dedicated eight-week fast have been studied by Dr Bill Buttemer and colleagues at the University of New South Wales.

For recording his results he used a Datataker, a versatile electronic data logger made by Data Electronics in Melbourne. Captured male emus were anaesthetized and implanted with miniature transmitters to monitor temperature and heart rate. One egg in their clutch was also fitted with a transmitter for the continuous recording of incubation temperature.

Radio signals from the transmitters were picked up by a receiver connected to the Datataker. Environmental conditions were logged at the same time, and all data downloaded to computer every eight hours.

Dr Buttemer chose the Australian-designed Datataker because of its accuracy, the flexibility of its 54 recording channels and easy computer connection. He used voltage inputs for solar radiation and total radiation, current inputs for temperature and heart rate, and type T thermocouples for air and dew-point temperatures.

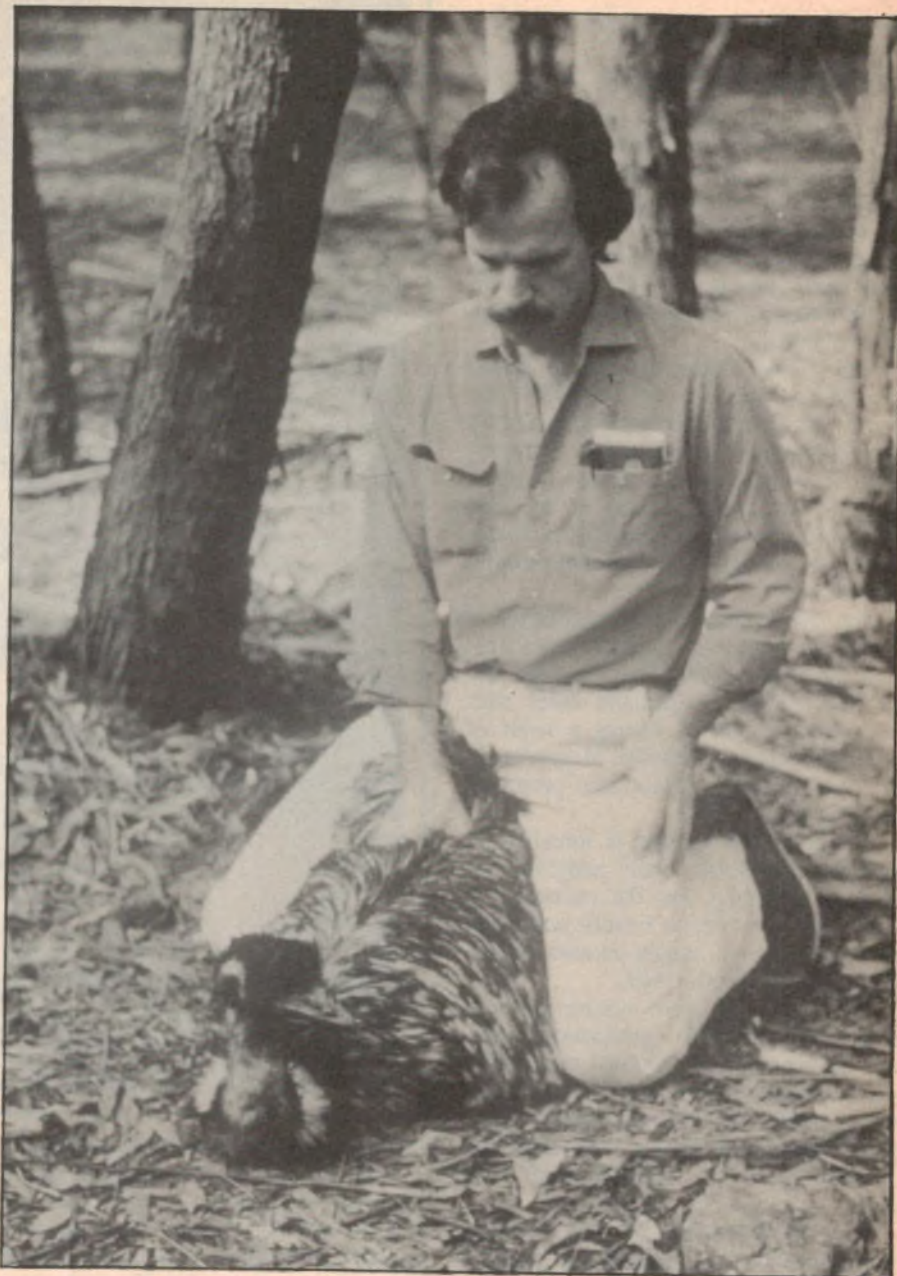

A high speed counter channel was coupled with the squarewave voltage output from a cup anemometer to directly sum the number of revolutions per recording period, proving a convenient way of measuring wind speed. A voltage output channel pulsed the radio receiver each minute, switching it to receive data from the next transmitter.

The results? Incubation is apparently no ordeal for male emus. They become deeply relaxed and maintain a stable body temperature. Egg temperatures are lower during the first week, and slowly rise over the incubation period. This helps the youngest embryos, in the last eggs laid, catch up with the others. So all the chicks hatch at about the

same time, even though the clutch is laid over about six days.

In another project, on water loss by tree frogs, Dr Buttemer used a Datataker as an analog-to-digital converter to permit real time control and data processing. He has also used a Datataker on Heron Island to study temperature regulation in the Black Noddy, a bird which nests in a wide range of sites, some fully exposed and others completely shaded.

Until the design of the low cost Datataker, such studies would have been much more expensive. The Datataker is made by Data Electronics Pty Ltd, 46 Wadhurst Drive, Boronia, Victoria 3155.



With one of these on your desk, you may not need a computer.

Thinking about a computer for the office? There's one fact that computer sales people generally won't be too keen to admit: most of the time, computers in offices are used for one thing: simple word processing. Typing up letters, memos and reports.

When they're not being used for that, they're most likely to be used as a communications terminal, fetching information from remote databases. Fairly basic information, too. Like how many Japanese yen the Australian dollar is worth today, or when the first plane leaves for Canberra tomorrow.

It tends to be pretty basic stuff, and doing

it with a computer costing thousands of dollars can be expensive overkill. Rather like using the space shuttle to do your weekend shopping.

Now Microbee Systems has the answer: a new desktop tool called the **TeleTerm**. It's a simple, easy to use word processor, combined with the two main kinds of communications terminal (ASCII and Videotex). It comes complete with built-in telephone and automatic dialling data communications modem. And it costs much less than any computer capable of doing the same jobs: only \$990.00 (not including the video monitor or printer of your choice).

Best of all, it's designed and made by Australians, specifically for Australian conditions.

By the way, we'll let you into a little secret: the TeleTerm is really a dedicated computer. But it's so friendly, you'd never guess.

You can try one for yourself at any of our Computer Centres. Or ring us, to arrange a demonstration in your office.

 **microbee**
computer

Sydney: Ryde (02) 886 4444
Waitara (02) 487 2711
Melbourne (03) 817 1371

Canberra (062) 51 5883
Newcastle (049) 61 1090
Gosford (043) 24 2711

Brisbane (07) 394 3688
Adelaide (08) 212 3299
Perth (09) 386 8289

New Zealand: Auckland (09) 88 1138
Prices quoted are subject to change
without notice.



A ride on the Bond airship

From May to November last year, Sydneysiders were regularly treated to the sight of a graceful white airship moving slowly through the skies above their city and harbour. During November and December, many other Australians also had a chance to see this unusual sight, as the airship travelled across the continent to Perth for the Americas Cup yacht races.

by TERRY AYSCOUGH

For many people, the word "airship" will create a mental image of old fashioned technology, dating back to the days before heavier than air flight, and terminating with the *Hindenberg* and other spectacular disasters in the 1930s. It is true that modern airships do have some features in common with those early pioneers, but the use of space age materials, more efficient motors and, above all, inert non-inflammable helium gas in place of extremely combustible hydrogen, have transformed the new generation of craft into a pleasant, highly manoeuvrable and very safe form of transport.

To emphasise the safety aspect, experiments have been conducted using industrial flame throwers and these have shown that a helium filled envelope acts

like a giant fire extinguisher and simply snuffs out any flames which penetrate from outside.

Skyships

Australia's first operational airship has the registration letters GS KSD and uses the radio call sign *Airship Sierra Delta*. It is operated by a newly formed company called Swan Airships, which is a joint venture between Airship Industries of the UK and Ansett Airlines. The Bond Corporation controls Airship Industries, however and thus has a big stake in the project. This resulted in *Airship Sierra Delta* being given the nickname *Bondenberg* during its stay in Sydney.

Airship Industries began design and construction of the present generation

of airships in the UK during 1976. The design became known as the Skyship 500 and the first production model flew in 1981. A larger version, called the Skyship 600, followed in 1984 and the Australian Swan Airship is of this later type. Many Skyships of both types are now flying in the USA, Europe and Japan.

Modern materials

The great airships of the 1920s and 1930s depended on a huge lattice framework to hold together a number of separate gas bags, to carry the weight of engines and accommodation quarters, and to support the crafts' outer skin. Because they were built around a firm framework, they became known as rigid designs.

By contrast, modern Skyships are non rigid and depend entirely on gas pressure to maintain the envelope's shape against the press of the slipstream and downward pull of the load it carries. The pilots, passengers and engines are all accommodated together in a cabin called the gondola, below the main envelope. This is about the size of a small bus and is suspended on Kevlar cables from the upper part of the envelope, as shown in our drawing. Kevlar is a recently developed synthetic fibre which is very light weight but immensely strong.

The two pilots sit side by side at the front end of the gondola and have an excellent view ahead, downwards and to

both sides. Controls and instruments are similar to those of a light aircraft, but there are no rudder pedals and turns are made by rotating a wheel on the control column. Electronic equipment on the flight deck includes one HF and two VHF transceivers, plus a weather and ground scan radar with multicolour display.

The Skyship's tough outer skin is made from non-rip laminated polyester fabric and there is an inner layer of polyurethane film to minimise gas seepage. On the outside, the envelope has a coating of polyurethane containing white titanium dioxide. This gives maximum reflection of sunlight to keep the gas inside cool and to prevent ultraviolet radiation from damaging the main polyester fabric.

Ballonets

Within the envelope there are two large air bags called ballonets (pronounced ballonays — French style), as shown in our drawing. Air can be blown into these bags from scoops behind the main propellers, or by electric pumps if the engines are not running. Large dinner plate-sized valves on the outside of the envelope allow air to be released when necessary. These ballonet bags provide three very important functions.

To ascend, the pilot expels heavy, slightly compressed air from the ballonets, allowing the lighter than air helium to expand and give the craft more buoyancy. To descend, more air is pumped into the ballonets. This compresses and outweighs the helium it has displaced, making the craft less buoyant.

This process can be taken a step further. If the rear ballonet contains more air than the front one, helium will be displaced forwards and the airship will adopt a nose up attitude, suitable for



Close-up view of the gondola. The pilots have excellent forward vision.

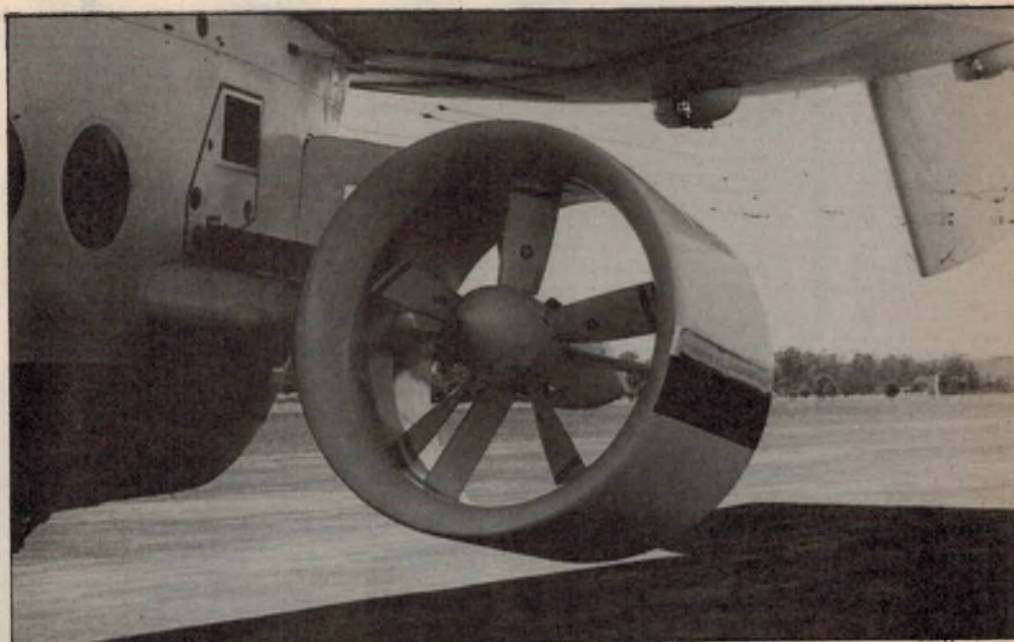

The 5-bladed variable pitch propellers are mounted in ducts on the outside of the gondola and are driven by separate Porsche 6-cylinder turbocharged motors.

take off. If the front ballonet has more air pumped into it the ship will be trimmed nose down, ready for landing.

We have already mentioned that non rigid airships depend on gas pressure to

keep the envelope correctly shaped. The relative pressure of the helium will vary with altitude, temperature and barometric pressure and the ballonets provide a means of compensating for

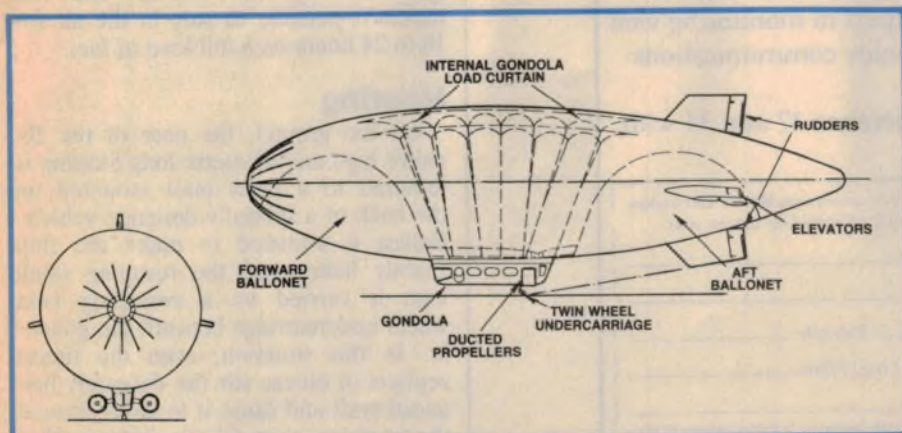

Diagram showing the general arrangement of the Skyship 600.

Main dimensions

Envelope volume	6666 cu.m
Ballonet volume	26% of envelope volume
Length (overall)	59.0m
Diameter	15.2m
Height (overall)	20.3m
Tailspan	19.2m

Gondola Dimensions

Length (overall)	11.67m
Width (overall)	2.56m
Main cabin headroom	1.92m
Main cabin length	6.89m

He-Ne LASERS

From \$450 plus tax

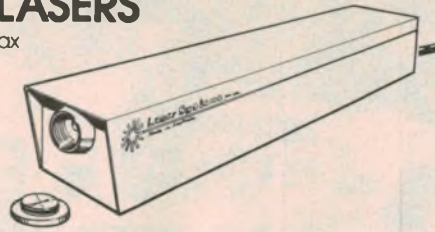

Helium Neon Lasers

High quality, attractive price

The Lab laser series are economical Helium Neon lasers designed for laboratories, schools or clean workshops.

They are ideal for experiments, alignment and demonstrations and can be fitted with a variety of optics.

The hard sealed plasma tubes are rubber mounted for protection and the attractive case is finished in durable epoxy powder coat. All lasers are factory burnt in during a thorough test procedure.

Tubes, injection moulded tube mounts and 240V power supplies available separately, in kit form.

Models

Models	Power	Beam divergence
LL05	0.5mw	1.54 mrad
LL1	1.0mw	1.23 mrad
LL2	2.0mw	1.23 mrad
LL5 M	5.0mw Multimode	8.0 mrad
LL5 S	5.0mw Single mode	0.96 mrad

Specifications:

Dimensions: height 75mm, width 75mm, length 405mm.

Power Source: 240V ac.

Wavelength: 632.8nm

Mode: Temoo except LL5 which is multimode

Polarization: Random

Beam diameter: (1/e²) 0.65mm, LL5M 2.0mm, LL05, 0.52mm

Output boss 1" x 32 tpi for scope or accessory mounts

Warm up time full specification: 10 mins

Operating Temp: -20°C - 50°C

Options: • 12 volt dc power • key switch

Designed, serviced and sold in Australia by

Laser Systems Pty. Ltd.



A BWD GROUP COMPANY

5 Dunlop Road, Mulgrave, Vic. 3170

P.O. Box 298, Mulgrave North, 3170, Australia

Telephone: 03 561 2888

Fax: 61-3-560 1164 Telex: AA35115

**If you know the
difference between a
diode and a transistor,
send us a signal.**

If your interest lies in electronics, the RAAF would like to make you an expert in monitoring vital ground and airborne electronics communications equipment.

To apply, you must be between 17 and 34 with Year 10 education.

Send off this coupon to find out more about your career as an RAAF Electronics Trainee to: RAAF Careers, GPO Box XYZ (in the Capital City nearest you).

Name _____

Address _____

Postcode _____

Telephone _____

Date of Birth _____

Highest Educ. level attained or being studied _____

Or phone an RAAF Careers Adviser on Adelaide 212 1455 Brisbane 226 2626 Canberra 57 2311 Hobart 34 7077 Melbourne 697 9755 Perth 325 6222 Sydney 219 5555

ELECTRONICS TRAINEE  **RAAF**

Authorised by Director-General of Recruiting, Dept. of Defence.

RG 132 QP106

these changes without the need to constantly jettison or top up with expensive lifting gas. Helium costs about \$14 per cubic metre or \$80,000 for a complete envelope fill, so it is always very carefully conserved.

Vectored thrust

Two Porsche air-cooled 3.3-litre 6-cylinder turbocharged motors each develop 186kW to drive the Skyship along. Both motors are installed inside the rear part of the gondola and each drives a 5-bladed variable pitch propeller mounted on the outside in a cylindrical duct. Placing the propellers inside ducts makes them more efficient, quieter and less likely to cause injury than open bladed types.

A major innovation with the Skyship design is that the propeller ducts can be swivelled through 200 degrees. This enables the thrust to be vectored rearwards for normal forward flight, upwards for rapid descent or downwards for almost vertical ascent or power controlled hovering. This feature gives the Skyships outstanding low speed manoeuvrability and makes it possible to land and take off from areas only a little larger than a football field.

At normal forward cruising speeds of between 35 and 50 knots (70 to 100 kilometres per hour), thrust is vectored straight back and the airship is flown like a conventional aircraft, using rudders and elevators mounted on the tail fins. The pilot operates these control surfaces manually via a control column and a system of cables and pulleys. A new "fly by light" system, using optical fibres to pass signals to actuators, is under development.

Because forward airspeed is needed to give normal control, both motors are kept running during flight. For most of the time they are only purring away at quite low speeds however, and this makes it possible to stay in the air for 18 to 24 hours on a full load of fuel.

Mooring

On the ground, the nose of the 20-metre high and 60-metre long Skyship is tethered to a hefty mast mounted on the back of a specially designed vehicle. Ballast is adjusted to make the ship slightly heavy and the resulting small load is carried by a swivelling twin wheel undercarriage beneath the gondola. In this situation, even the tiniest zephyrs of breeze stir the delicately balanced craft and cause it to swing around the mooring mast like a giant weather vane.

Flying high

Flying in a Skyship is a unique and exciting experience, as the writer found out during a visit to Swan Airships headquarters at Schofields Airfield west of Sydney.

In commercial service, Skyship 600s normally carry 18 passengers, but *Airship Sierra Delta's* gondola has been given a spacious executive style layout with eight large, very comfortable arm-chair seats and lots of leg room. Other features which add to comfort include a galley, bar and toilet, all located at the rear of the gondola just ahead of the motor compartment.

After fuel, pilots and passengers are all on board, the Skyship's weight is trimmed in preparation for take off. This is done by adding or removing small bags, each containing 10 kilograms of lead shot. With the ship slightly heavy and the weight being carried on the gondola wheel, the nose is released from the mooring tower. Ground handlers then pull the almost weightless craft sideways, using ropes attached to the nose, until there is a clear take off path into the breeze.

Suddenly everything happens very quickly. The ballonets are trimmed to give a nose up attitude, handling lines are let go, the motors rev up and the two propellers give a 45 degree downward thrust, pushing the craft forwards and upwards.

The initial climb out is rather like that of a jet airliner. Engine and propeller noise is quite loud and the angle of climb seems to be about 30 or 40 degrees.

When a safe manoeuvring height has been reached however, everything changes quite dramatically. Motor noise drops back to a steady drone, the ship levels up and there is a feeling of sedate movement rather than frantic rushing through the sky.

Seat belts can now be unfastened and passengers are free to stand up and move about as they wish. The cabin has big, sliding windows which have been left partly open, but there is no draft or wind noise. A cautiously extended hand detects a steady but not violent slipstream, similar to that of a car travelling at city speeds.

It is a warm sunny day and as we pass through thermals of rising air, there is a gentle lifting and falling motion, which is compensated by the pilot easing the control column backwards and forwards. Because of the large size and lower speed of airships, there is none of the twitching and jerking often experi-

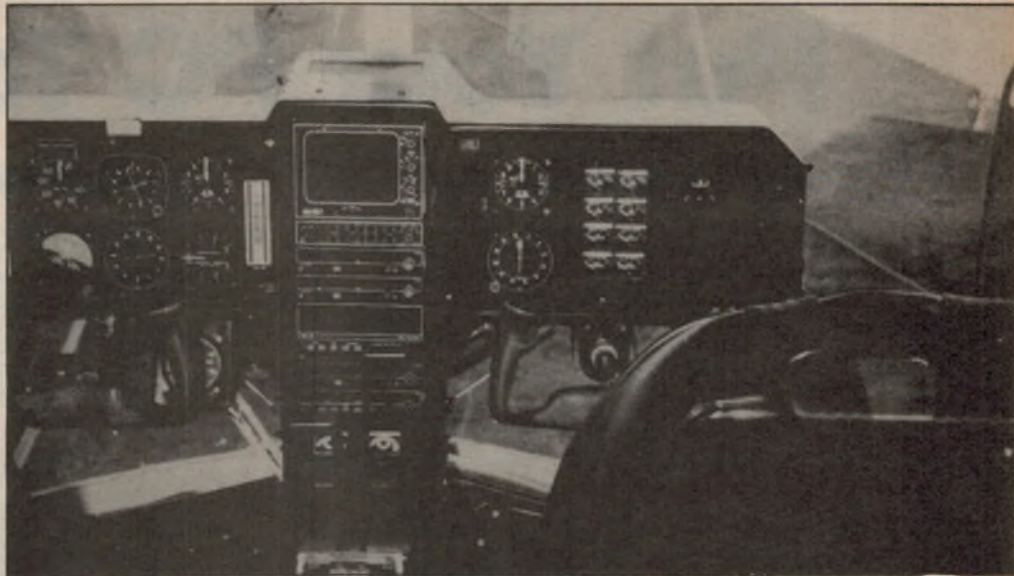

Above: view showing the controls and instrument console inside the cockpit.

Below: the nose of the airship is tethered to a mast mounted on the back of a specially designed vehicle. A swivelling twin-wheel undercarriage takes the weight of the craft.



Put Your PC To Work

Logic Analyzer

For the cost of 1 month lease, you can convert your accounts PC into a full 24 channel state and timing logic analyzer. 6 channels operate at up to 100MHz.

- Internal clock up to 100MHz ● External clock up to 25MHz
- 24 Channels in 25kHz to 25MHz ● 6 Channels in 100MHz
- Trigger set "0", "1", "don't care" ● Rising, Falling Edge Clocking ● Maximum input $\pm 25V$
- Threshold Voltage TTL, ECL, or variable in 0.2V steps between -10 to $+10V$ ● 4K/each channel in 100MHz
- 1K/each channel in normal mode ● Capture data before and after trigger ● State: ASCII, BINARY, HEXDECIMAL.



A-D/D-A Converters

12 bit resolution 16 channel A-D, 2 channel D-A. These units are ideal building blocks for data acquisition system. D-A: ● 12 bit, 1 channel ● Output voltage 0-9V (adjust by

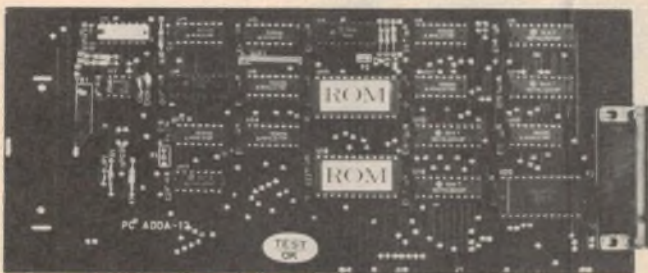

- VR) ● Unipolar or bipolar (select by jumper 2) ● Current settling time 500nsec ● Nonlinearity 0.2%.
- A-D: ● 12 bit, 16 channel ● Input voltage range 0-9V (adjust by VR) ● Unipolar ● Successive approximation method
- Conversion time 60 μ sec (each channel).

Eprom Programmer

Several models available to program 1, 4 or 10 EPROMS in a gang. A long list of components can be programmed, including all types of EPROM and CMOS EPROM including 2716, 2732, 2732A, 2764, 27128, 27256, and 27256A, (27512, 27512A, IBM only). ● Vpp can be automatically set to 25V, 21V or 12.5V ● Using intelligent programming 2764 in only 50 seconds ● Easy to use, no switch select required ● It can do programming from DISK file or save EPROM data in DISK.



Many Other Useful Boards

Many other boards available, including the following:

- High Speed 12 Bit Analog to Digital and Digital to Analog Converter with software.
 - 16 Bit Analog to Digital and Digital to Analog Converter with software.
 - Multi Output Card with 8 independent RS232 lines.
 - Millivolt and Milliamp Input Signal Conditioning Card with on-board A-D Converter.
 - Thermocouple Amplifier Card with 12 Bit A-D Converter.
 - Optically Isolated Input/Output Card.
 - Serial and Parallel I/O Cards.
 - Real Time Clock/Calendar with RS232 Output Port.
 - Solid State Relay Board with 16 Solid State Relays for Industrial Control.
- Mark the box and send for further information to:

Ampec Electronics Pty Ltd

21 Bibby St, Chiswick, NSW 2046. Tel 712 2466.
208 Whitehorse Rd, Blackburn, VIC 3130. Tel 878 8788.

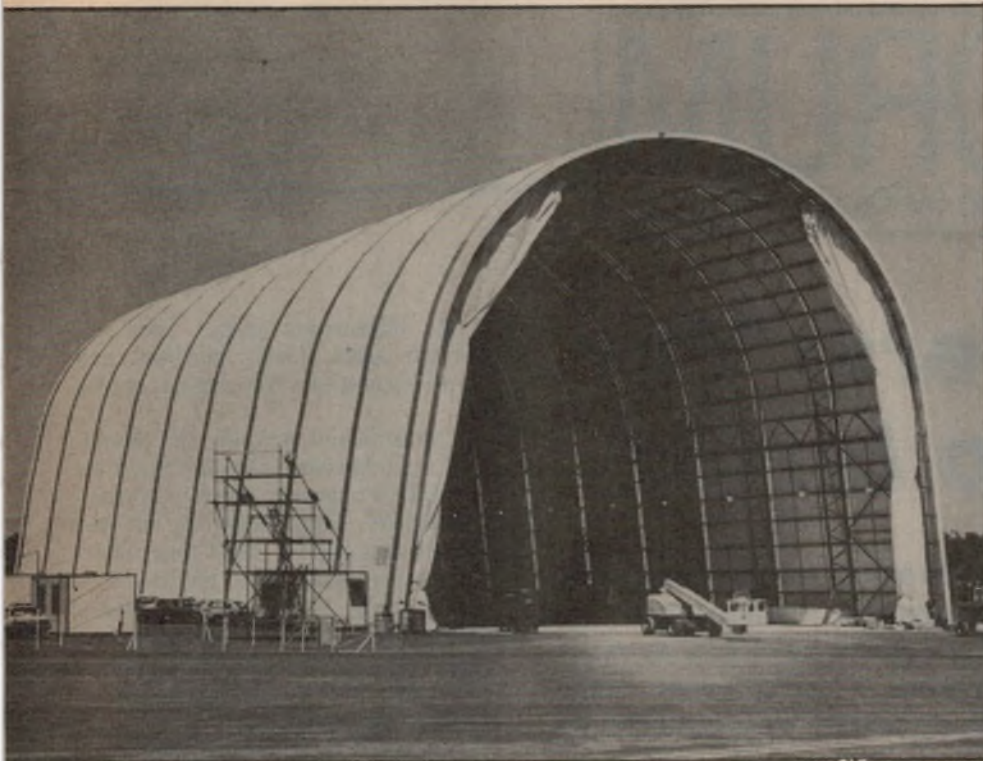

The beast's lair is 30 metres high, 32 metres wide and 70 metres long.

enced in conventional aircraft.

This is a final test flight before Sierra Delta's departure for Perth, so we go through various manoeuvres at between 2000 and 3000 feet before requesting permission from Sydney air traffic control to climb even higher. We are soon given the go ahead and ascend to 4400 feet, where the air outside suddenly starts to feel much cooler.

There is a perspex 'astrodome' inspection window in the gondola ceiling, to enable the crew to visually check what is going on inside the envelope. Enough light filters through the fabric to show that the two ballonets are now almost totally deflated, which means that further ascent would require helium to be jettisoned.

All good things come to an end and after a superb one and half hour flight we ease back down towards our base at Schofields. Air pumped into the ballonets compresses the helium, reducing buoyancy and we sink gently towards the waiting ground party. The vectored thrust propellers are angled downwards and a short burst of power checks our descent as the ground starts to get close.

Six beefy ground crew members grab the two ropes dangling from Sierra Delta's nose, whilst others take hold of a hand rail around the base of the gondola. The mobile mooring mast vehicle

drives up and within a few minutes all is secure. Passengers and pilots can then disembark to each be replaced by seven or eight of those ten kilogram ballast bags.

Historic journey

Soon after this flight in mid November last year, Sierra Delta and its entourage of ground support vehicles left Schofields for a history making trip around South East Australia and across the Nullarbor Plain. She was due to arrive in Perth before Christmas and will be used as a camera platform by Channel 9 to provide a major part of their coverage of the Americas Cup yacht races. With Sierra Delta's departure from Schofields, work commenced on the building of a second Skyship 600 and Swan Airships hope to have this flying early in the new year.

Commercial use

The Bond Corporation has shown its faith in the commercial future of airships in Australia by investing about \$20 million in Skyships, personnel and base facilities.

Overseas, Skyships are being used to provide sightseeing trips for tourists, as flying advertising signs hovering over major sporting events and as TV and film camera platforms. The advertising

role will be enhanced next year, when one of the Swan Skyships is fitted with special night signs, which are airborne versions of the giant video screens described in last month's EA. The plan is to brighten up the night skies above some of our cities by flying round, displaying various advertising messages, etc.

Coastal surveillance

A more serious use for Skyships in an island continent like Australia, with 30,000 kilometres of coastline to look after, is for marine surveillance, search and rescue, and defence.

Large radar antennas can be installed within the envelope itself, which simply acts like a big radome. Aerodynamic characteristics are unaffected and from a height of a few thousand feet, an area of 80,000 square kilometres can be surveyed. The airship can descend to investigate contacts, winch people up and down and even deploy a boarding or rescue party in an inflatable boat if necessary.

Although airships are physically large, their designers can make them very difficult to detect by conventional radar. The plastics and gas in the envelope and composite materials in the gondola are naturally transparent to radio waves whilst essential metal parts, such as motors, can be screened with radar absorbent materials.

Giant hangar

This article would not be complete without mention of the revolutionary hangar, designed and built for Swan Airships by Starch Industries of Albury, NSW. It is an arch shaped steel structure, ten storeys or thirty metres high, thirty-two metres wide and seventy metres long. The amazing thing is that it was built as a huge flat sheet at ground level, complete with all electrical fittings and fixtures. When finally assembled, it was then elevated into its final arch shape by pulling and pushing in the right places.

By using this system, the hangar was constructed in only four weeks, instead of the more usual six months, and at a fraction of the cost for conventional building techniques. It is designed to withstand cyclone strength winds and has a project life of 100 years. 

Footnote: the author would like to thank the management, pilots and ground crew of Swan Airships Pty Ltd for the information used and experiences described in this article.



FORUM

Conducted by Neville Williams

Hifi howlers: Yer can't help larfin'

In my younger days, a popular diversion involved collecting and recounting so-called malapropisms, spoonerisms and schoolboy howlers. I fancy that one could have just as much fun, these days, collecting hifi howlers — by definition: “glaring and ludicrous blunders” made by people who, professedly, should know better.

Curiously, while planning this instalment, I came across a news item to do with independent American and German studies — into our sense of humour. The findings were similar:

“Humorous and funny experiences originate in the right side of the cerebrum alone, because of its flair for nonsense and double meanings. The left side of the brain doggedly follows and develops a straight line of thought”.

On this basis, remarks about hifi howlers might be most appreciated by those possessing suitably balanced grey matter, able to take a light-hearted view of serious subjects!

Over the years, quite a few of the statements submitted for publication in these columns would have qualified for consideration as hifi howlers; the pity of it is that I hadn't thought sooner of collecting them as a possible source of amusement!

Among them would undoubtedly be the grossly exaggerated claim which gave rise to the first ever instalment of this column, back in September 1950: namely that the performance of an otherwise ordinary audio amplifier could be radically improved by simply getting rid of the coupling capacitor between the anode of the voltage amplifier and the grid of the output stage.

If only the path to perfection was as simple as that!

The idea of collecting hifi howlers

was largely prompted by a letter from a reader in Papua New Guinea. As it turned out, his pet “howler” was covered in these columns a couple of years back. I quote:

In regard to the sound of CD players, golden ears and et.al, you must also have been amazed by the observations and reviews published in certain British audio magazines.

In the period from the introduction of CD in 1983 to late 1984, there was a torrent of emotional opinion but, in the reviews, nary a measurement.

In early 1985, the same reviewers suddenly began to “hear” a problem with “stereo spatiality”. Curiously, their heightened perception followed on a Philips/Sony press release in late 1984 pointing out that some CD players contained only one digital to analog converter, time shared between the two channels.

Funny that they couldn't hear the problem before!

After tolerating the “revelation” for about six months, somebody pointed out to the reviewers that they could correct the disparity by moving their collective noggins 4mm to the right.

R.S., Lae, PNG.

By way of background, one signal of the stereo pair in a CD recording is delayed slightly, so that left and right channel samples can be time-multiplied — accommodated in sequence in

the pit information spiral. They are separated again during playback and used to reconstitute the original analog pair.

As an economy measure, the designers of most Japanese players settled for a single D/A converter, simply diverting its successive output pulses to left and right and ignoring the slight time difference between them; hence the fuss.

I remember, at the time, receiving a release from Technics, Osaka, pointing out that the delay in question amounted to one half of one sampling period — around 11 microseconds.

This seemed to be a remarkably small time difference to be concerned about, being of the same order as would result from a path difference of less than 4mm from the left and right loudspeakers to the listener's head. Who amongst us organises our listening situation with such precision?

It prompted a mental image, at the time, of a symmetrical hifi system in a symmetrical listening room, with loudspeakers bolted to the floor and a “golden eared” listener with his/her head clamped in an iron mask on a pillar set in concrete.

By way of a wall hanging, I suggested the Biblical text, Deuteronomy 9-6: “For thou art a stiffnecked people”.

While the Technics statement made good sense, one perceptive correspondent suggested that, having thus “saved face”, Japanese manufacturers would

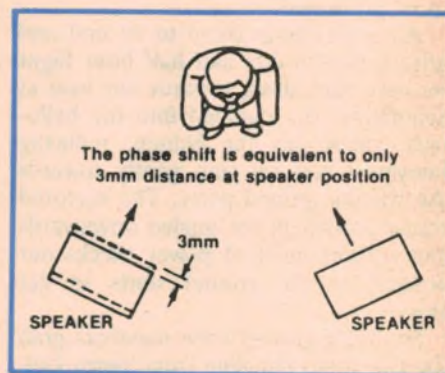

Part of the diagram from Technics, originally reproduced in “Forum” for March '84.



Sony's V50W component system. "The double cassette deck let's you dub with an optional turntable, CD player or from tape to tape".

nevertheless come up with a delay line and twin converters (at no extra cost), and publicise them as a feature in their new models. And this is just about what happened.

Back to the present:

If on the prowl for statements to boggle at or argue with, keep an eye on pronouncements emanating from hifi marketing cognoscenti. I drew critical attention, in the March issue, to a particular press release from CESA (Consumer Electronics Suppliers Association) but individual or collective opinions are often mirrored by audio/video columnists such as in "The Guide" ("Sydney Morning Herald", Mondays).

Think about this one, picked out of the *The Guide* dated October 13, 1986:

"Most audiophiles like to stress that the turntable is the most important part of their system: more so than amplifiers or speakers. The latter items can change a signal for the worse, but they cannot actually improve it: it is the source of the signal, be it FM tuner, turntable or CD player that is the most important".

In the context of an article devoted principally to prestige phono decks, the implication at first reading seemed to be that, unlike amplifiers and loudspeakers, a high quality phono player could somehow "improve" the quality of signal presented to it by the record groove, and passed on to the amplifier. On second and third reading, I'm still not sure what it's supposed to mean.

One thing is certain: there is no such device as a perfect or supra-perfect hifi transducer or amplifier. Some components are very good indeed but, in the real world, the output of even the best of them can never be a perfect replica

of the input.

All practical components will impose some imperfections of their own on the signal or "change a signal for the worse" and this applies to signal sources as well as to amplifiers and loudspeakers — no matter how exotic their design or their price tag.

For sure, it is vital to provide the best possible input signal, without which no sound system can perform to advantage. But equally, a superb signal will be wasted on a poor amplifier or loudspeaker system. The art in setting up a domestic sound system is to manage the available budget in such a way as to avoid any one disproportionately weak component.

Variety or uniformity?

The following issue of "The Guide", and still on the subject of prestige turntables, went on to say:

"There are some truly amazing machines still being produced at the top end of the turntable market. Where compact disc players tend to be designed by committees, and all sound much the same, many top-end turntables are designed by eccentric audio engineers — and each has its own very individual sound".

Again, one can draw an inference that may or may not be intended. The suggestion that something has been "designed by a committee" is usually interpreted as a criticism, leading to the implication here that CD players are in some way less worthy than top-end turntables — the product of individual initiative.

However, the subsequent observation that each top-end player "has its own very individual sound" can only mean that each one "colours" the source sig-

nal differently. More explicitly, that each produces a different electrical analog of the modulated groove pattern, imposing on the signal its own particular imperfections.

I recall a time-honoured truism about transducers in particular that, as their performance specifications converge towards perfection, the subjective differences between them diminish and it becomes progressively more difficult to distinguish between them in terms of sound quality.

CD players offer performance specifications about as close as we can currently get to the ideal for a record/replay system and to observe that they "all sound much the same" is not only factual (see Sept. 1986 issue) but also high commendation, whether intentional or not!

It would seem that this is one case where design by a committee worked out rather well. Mind you, the original DAD (Digital Audio Disc) committee was a rather large one, reflecting the consensus of more than 35 major hifi companies worldwide.

More about copyright

A reader from Western Australia has taken up the matter of copyright raised by P.S. in the October issue. I quote from his letter:

I find it hard to credit some peoples' moral and legal attitudes on such issues. Is P.S. worried that he might get caught or is he simply a model citizen?

One has to take a realistic view on such an ambiguous subject.

If I was to buy a compact disc of, say, Dire Strait's "Brothers in Arms" album, I would be paying partly for the medium and partly for the right to play that medium. If I should want to hear the album on my Walkman, I could either copy my disc to tape, a different medium which I pay for, or else buy a pre-recorded cassette and pay a second time for the right to listen to the same album.

I believe that one should have to pay only once for the right to play copyright material. I am not seeking to condone copying for friends, although I am guilty of this from time to time. However, in cases where the owner does keep all the copies where's the infringement?

M.D., Willeton, WA.

My own views on the subject were set out in the October issue — "Copyright isn't as simple as that" — and there would be no point repeating them here. However, I did draw attention to the fact that hifi equipment manufacturers appear to take copying for granted and

FORUM

I quoted specific examples from Philips, Pioneer and dbx that had come to my attention when involved with the original letter.

Similarly, while dealing with this one, I received information from Sanyo about three new system releases featuring twin cassette decks to facilitate dubbing, all with synchronising and single button operation and one with a high-speed option, as well. Sony's new V50W system, announced about the same time, lists as a feature, and I quote: "The double cassette deck let's you dub with an optional turntable, CD player, or from tape to tape."

Copyright law certainly exists on the statute books but, to invoke that odd, self-contradictory cliché, it appears to be honoured mostly in the breach!

Those soldering fumes

Also included in "Forum" for October last was a letter from a reader in Chelsea, Victoria, inquiring about possible health and safety hazards arising from solder and heatsink compounds. I commented briefly on the matter, leav-

ing it open for other readers who might be in a position to speak from experience.

One such reader, a friend and former staff member of this magazine, obliged with the letter reproduced herewith. He has found that some people are sensitive to the fumes from even "passive" rosin flux but that it is usually sufficient simply to disperse the fumes with a fan.

Greater care is necessary, however, with high temperature soldering and welding operations and in handling compounds containing beryllium.

Electromagnetic radiation

While referring to possible health hazards, I should perhaps mention an article in the *Journal of Electrical and Electronics Engineering, Australia* (Vol.6 No.3 Sept. 1986) entitled "An Instrument to Measure RF Emissions from, and an Emission Specification for, Visual Display Terminals"; by M.J. Bangay and K.H. Joyner.

The authors are associated respectively with the Dept. of Health, Australian Radiation Laboratory, in Yallambie, Vic. and the Telecom Research Laboratories in Clayton. In their summary, they point out that operators of VDTs (video display terminals) are concerned about possible risk from expo-

sure to EM (electromagnetic) radiation, to the point where requests for on-site measurements "are increasing at an astounding rate".

Scientists are almost unanimous that prototype testing is all that is required but employers and unions continue to negotiate costly and unrealistic agreements without proper recourse to scientific knowledge, they say.

Extensive measurements are documented in the literature covering possible radiation over the entire RF spectrum, through to infrared, visible light, ultraviolet and x-rays. Most scientists, say the authors, steadfastly maintain that radiation levels, as measured, are too low to be responsible for claimed traumas such as abortions, birth defects, cataracts, &c.

Their new portable RF emission VDT monitor is pictured but described only in broad terms, the main body of the article being devoted to a discussion of emission rationale, specifications and standards, and to calibration.

Anyone wanting to study the article in detail will obviously need to gain access to it via the IE Aust., the IREE or a corporate member of either body. To the casual reader, however, certain points are likely to catch the eye:

(1). Ultraviolet radiation from a VDT at 300mm is typically five orders of magnitude below the permissible limit and less than from a fluorescent lamp at one metre.

(2). There is less infrared radiation from a normal VDT than from the operator's hand.

(3). There are no Australian or international exposure standards for the range 50Hz-10kHz but a figure of 50V/m has been suggested, although on a rather speculative basis.

So what, you may ask, as you look at the last-named figure. Well, it's so low that it calls into question a number of domestic appliances.

Your TV set, and by inference your computer monitor, would get by easily enough at about 30V/m. Your electric iron and refrigerator would be just over the limit at 60, and your stereo system quite definitely so at 90. But that electric blanket that keeps you so warm and cosy on winter nights — it would be well over the top at 250V/m!

But don't throw it away on the basis of a purely speculative figure. As pointed out on previous occasions, we don't really know what ill effects, if any, result from living in an environment laced with AC power lines and shared with countless items of AC-powered equipment.

EA

Soldering fumes and heatsink compounds

Dear Sir,

I read with interest K.O.'s letter in the October issue on the subject of soldering fumes. Most of the potential irritation comes, not from the solder, but from heating the flux core. This is mainly rosin, derived from various North American pine trees and activated by such substances as ammonium chloride.

A number of colleagues, past and present, have encountered problems from inhaling flux fumes, even to bouts of asthma and hay fever. They have resorted to various cures, the most common being a desk fan to disperse and dilute the smoke. Devices are available on the market for the purpose, involving a small computer type fan, combined with a filter and a light source, but they are not cheap.

Where the fumes really constitute a major threat to health is in so-called "hard soldering" or silver soldering, where some of the low melting point alloys contain cadmium. Ingestion of cadmium oxide as a smoke can lead to illness and death

in extreme cases. A similar warning applies when brazing or welding galvanised metal.

Heatsink compounds are usually based on a silicone grease, with a filler of aluminium oxide or beryllium oxide to provide greater thermal conductivity.

Beryllium oxide is not listed as poisonous but any other beryllium compounds should be regarded as extremely toxic. Merck's Index gives a nasty list of possible consequences, warning that: "Death may result from short exposure to very low concentrations of the metal and its salts".

Very early fluorescent tubes contained beryllium compounds as phosphor activators and there were stories of people suffering from non-healing wounds when cut by a broken tube. This problem was overcome in the 1940s with the introduction of newer and more efficient phosphors.

Norman Marks (Pennant Hills, NSW).



JUMBO 5 1/4" DISK STORAGE
If you've got lots of disks, you'll appreciate the extra capacity of this disk storage unit when it comes to locating "that" disk!
Features
● 100 disk capacity
● Smoked plastic cover
● Lockable (2 keys supplied)
● 9 Dividers/spacers
C16020 **only \$24.95**
C16027 (Hinged Lid) **\$26.95**



5 1/4" DISK STORAGE
Efficient and practical. Protect your disks from being damaged or lost!
Features
● 70 disk capacity
● Smoked plastic cover
● Lockable (2 keys supplied)
● Dividers/spacers
Cat. C16025 **only \$24.95**



5 1/4" DISK STORAGE
Efficient and practical. Protect your disks from being damaged or lost!
Features
● 50 disk capacity
● Smoked plastic cover
● Lockable (2 keys supplied)
● Dividers/spacers
Cat. C16030 **only \$19.95**



3 1/2" DISK STORAGE UNIT
● Holds up to 40 x 3 1/2" diskettes
● Lockable (2 keys supplied)
● High impact plastic lid and base
● Anti-static
Cat. C16040 **only \$19.95**



3 1/2" DISK STORAGE UNIT
● Holds up to 40 x 3 1/2" diskettes
● Lockable (2 keys supplied)
● High impact plastic lid and base
Cat. C16035 **only \$19.95**

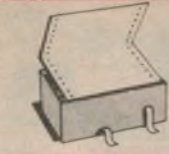

COMPUTER PAPER
Quality paper at a low price! 2,500 sheets of 11 x 9 1/2", 60 gsm bond paper.
Cat. C21003 **Normally \$49.95**
SPECIAL, ONLY \$44.95



PAPER TAMER
● Restores order to the top of your disk or work area
● Made of white plastic coated steel
● Stores up to 900 continuous sheets
● Allows perfect paper feed
● Allows easy examination of print out
C21050 **Normally \$59.95**
Special, only \$49.95
(Printer and paper not included)



CANON A-40 PRINTER
● Serial Impact Dot Matrix
● 140 C.P.S.
● Near Letter Quality Mode
● 1.4K Buffer
Cat. C20040 **\$525**



SUPER 5 EP-1090 DOT MATRIX PRINTER
● 80 C.P.S.
● Pica or Elite character set
● 9 pin head
● 100 million character life
Cat. C20030 **only \$435**

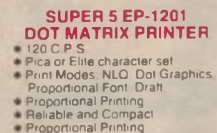

SUPER 5 EP-1201 DOT MATRIX PRINTER
● 120 C.P.S.
● Pica or Elite character set
● Print Modes: NLQ, Dot Graphics, Proportional Font Draft
● Proportional Printing
● Reliable and Compact
● Proportional Printing
● Logic Seeking
● 1K Printer Buffer
Cat. C20035 **only \$595**



2 & 4 WAY RS232 DATA TRANSFER SWITCHES
If you have two or four compatible devices that need to share a third or fifth, then these inexpensive data transfer switches will save you the time and hassle of constantly changing cables and leads around.
● No power required
● Speed and code transparent
● Two/Four position rotary switch on front panel
● Three/Five interface connections on rear panel
● Switch comes standard with female connector
2 WAY Cat. X19120 **\$225 \$100**
4 WAY Cat. X19125 **\$445 \$115**

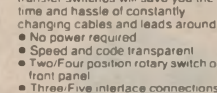

2 & 4 WAY CENTRONICS DATA TRANSFER SWITCHES
Save time and hassles of constantly changing cables and leads around with these inexpensive data transfer switches. These data switches support the 36 pin centronic interface used by Centronics, Printronics, Data Products, Epson, Micronics, Star, and many other printer manufacturers.
● No power required
● Speed and code transparent
● Two/Four position rotary switch on front panel
● Three/Five interface connections on rear panel
● Switch comes standard with female connector
● Baite locks are standard
2 WAY Cat. X19130 **\$165 \$100**
4 WAY Cat. X19135 **\$345 \$115**



SAKATA HIGH RESOLUTION COLOUR MONITOR
High quality IBM* compatible monitors, great with VCR's too!
SPECIFICATIONS:
CRT: 13" 90° deflection colour
Input Signal:
Video Signal: Separate video signal
Video Positive
Sync: Positive
Input Level: TTL Level
Scanning Frequency:
Horizontal: 15.7KHz
Vertical: 60Hz
Display Size: 245(H) x 182(V)mm
Resolution:
Horizontal: 640 dots
Vertical: 200 lines
Size: 343(H) x 362(W) x 421(D)mm
Weight: 11.6kg
Cat. X22222 **\$695**

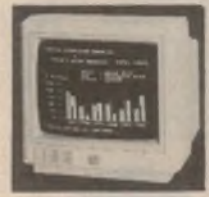

INTRA 14" RGB COLOUR MONITOR
Resolution: 640 x 200 dots
Display Format: 80 x 25 characters
Display Colours: 16
Dot pitch: 39mm
Sync Horiz: Scan Freq: 15.75 KHz
Sync Vert: Scan Freq: 50Hz
Band Width: 18MHz
Cat. X14520 **\$695**



INTRA 14" RGB HIGH RESOLUTION COLOUR MONITOR
Compatible with IBM* and compatibles, and EGA Cards
Why pay more?
Resolution: 640 x 350 dots
Dot pitch: 31mm
Display Format: 80 x 25 characters
Cat. X14514 **Normally \$1,095**
Our price \$995



RITRON 2 MONITORS
Stylish, swivel base monitor available in amber or green
Green Cat. X14506 **Normally \$235**
Amber Cat. X14508 **Normally \$239**
SPECIAL, ONLY \$199



APPLE* COMPATIBLE SLIMLINE DISK DRIVE
Japanese Chinon mechanism compatible with Apple 2+
Cat. X19901 **Normally \$225**
SPECIAL \$195



20 M/BYTE HARD DISK DRIVE FOR IBM* AND COMPATIBLES
Includes hard disk controller card
Cat. X20010 **WAS \$1,250**
SPECIAL, ONLY \$995



IBM* AT COMPATIBLE!
Assembled & Tested in Australia!
● 6 MHz
● 80286 CPU
● 8 slots
● 1 M/Byte main board
● 1 2 M/Byte Floppy disk drive
● 20 M/Byte Hard disk
● Colour graphics display card
● Floppy and Hard disk controller card
● Printer card and RS232
● 200W Power supply
● Keyboard
● Manual
All this for just \$3,995
(Monitor not included)

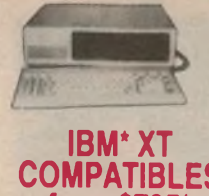

IBM* XT COMPATIBLES from \$795*
Assembled & Tested in Australia!
3 Months Warranty!
*\$795: 256K RAM Single Drive Graphics and Disk Controller Card
256K RAM, 2 Disk Drives, Multifunction Card, Colour Graphics, Disk Controller, 1 Parallel Port **only \$1,095**
640K RAM, 2 Disk Drives, Multifunction Card, Colour Graphics, Disk Controller, 2 Serial, 1 Parallel Port **only \$1,195**



SAMSUNG TTL MONITOR
A quality 12" TTL monitor with a high contrast, non-glare screen at a very reasonable price!
SPECIFICATIONS
Picture Tube: 12" diagonal 90° deflection
Phosphor: Green (P39)
Mode: TTL
TTL Input Signal:
Polarity: TTL Positive
Level: 4V p-p ± 1.5V
Impedance: 75ohm
Active Video Period:
Horizontal: 44.25 uS maximum
Vertical: 18.98 mS maximum
Video Band Width: 16 MHz (-3dB)
Scanning Frequency:
Horizontal: 18.432 ± 0.1 KHz
Vertical: 50 Hz ± 0.5%
Active Display Area:
216(H) x 160(V)mm
Display Characters: 80 characters x 25 lines
Input Connector: 9 pin connector
Controls:
Front: Power ON/OFF Contrast
Rear: V-Hold, V-Size, Brightness
Internal: Vertical Linearity
Horizontal Linearity, Horizontal Width Focus
Description Cat No 1-9 10-
Green X14517 **\$199 \$189**
Amber X14518 **\$199 \$189**

Rod Irving Electronics, No.1 for peripherals!



NEC DISK DRIVES
5 1/4" SLIMLINE
● AT compatible
● double sided, double density
● switchable 1.6 M/Byte to 1 M/Byte unformatted
● 1.2 M/Byte to 720K formatted
Cat. C11906 **\$295**
8" SLIMLINE
● Double sided, double density
● 1.6 M/Byte unformatted
Cat. C11908 **\$795**



APPLE* COMPATIBLE JOYSTICK FOR 2C & 2
Ideal for games or word processing
Features include selectable "spring centring" or "free floating"
Electrical trim adjustments on both axis
360 degree cursor control and dual fire buttons
Cat. C14201 **\$49.95**

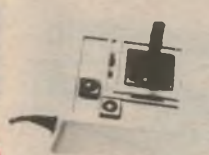

JOYSTICK FOR IBM
Features Selectable "Spring centring" or "free floating"
Electrical trim adjustments on both axis
360 degree cursor control
Cat. C14205 **\$49.95**



IBM* COMPATIBLE DISK DRIVES
Tired of paying out more for Japanese Disk Drives? We now have "direct import" Taiwanese disk drives at much lower prices!
Cat. No Description Price
C11801 500K **\$199**
C11803 1 M/Byte **\$239**
C11805 1.6 M/Byte **\$259**

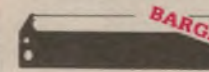

PRINTER RIBBONS
CP80, BX80, DP80, BX100, MB100
ALL A CRAZY LOW \$9.95

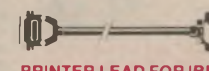

PRINTER LEAD FOR IBM*
● To suit IBM* PC XT and clones
● 25 pin "D" plug on computer end
● Centronics 36 pin plug
● Length 2 metres
Cat. P19029
1-9 10-
\$19.95 \$17.95 \$15.95



TTL MONITORS
Fantastic resolution! Enjoy a crisp sharp image with the latest Ritron TTL monitor! IBM* compatible green display, swivel and tilt base
Green Cat. X14510 **Normally \$289**
Amber Cat. X14512 **Normally \$289**
SPECIAL, ONLY \$269



Rod Irving Electronics
48 A Beckett St, MELBOURNE
Phone (03) 663 6151
425 High St, NORTHCOTE
Phone (03) 489 8866
Mail Order and Correspondence
P.O. Box 620, CLAYTON 3168
Telex: AA 151938



MAIL ORDER HOTLINE
008 335757
(TOLL FREE)
(STRICTLY ORDERS ONLY)

LOCAL ORDERS & INQUIRIES
(03) 543 7877

POSTAGE RATES:
\$1 \$9.99 \$2.00
\$10 \$24.99 \$3.00
\$25 \$49.99 \$4.00
\$50 \$99.99 \$5.00
\$100 \$199.99 \$7.50
\$200 \$499.99 \$10.00
\$500 plus \$12.50
FREE POSTAGE FOR ORDERS OVER \$75 & UNDER 3KG!!
The above postage rates are for basic postage only. Road Freight, bulky and fragile items will be charged at different rates.
Certified Post for orders over \$100 included free!
Registered Post for orders over \$200 included free!
All sales tax exempt orders and wholesale inquiries to RITRONICS WHOLESALE, 56 Renvar Rd, Clayton Ph. (03) 543 2166 (3 lines)
Errors and omissions excepted
*Apple and IBM are registered trade names
MasterCard VISA

FREE POSTAGE FOR ORDERS OVER \$75 & UNDER 3kg!!



PROGRAMMABLE 24 HOUR TIME SWITCH

- 48 switching possibilities per day
- 240V AC 2400 watt, 10 amp
- Suitable for turning on Heaters, Coolers, pool fillers, electric blankets, cooking appliances, waking you, even making the coffee lights etc. after you wake up while you're away from home!
- Bargain Price!

Cat. M22002 **only \$19.95**

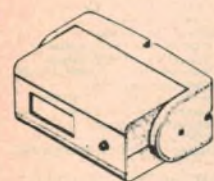

PASSIVE INFRA RED DETECTOR

Compact P.I.R. with adjustable corner or wall mounting bracket, dual pyroelectric infra red sensing element gives a coverage 2 x 14 zones 2m high and 10m wide

- Sensitively adjustable control
- Detecting range 12-15 metres at 90 degrees
- Detecting zones 9 long (up), 5 short (down)
- LED indicator for walk test (can be disabled)
- Shielded against RF interference
- Relay output NC or NO at 30V (AC-DC) 0.5A max
- Integral N.C lamper switch
- Operating voltage 10.5 - 16V DC
- Current 20mA with LED 25mA

Cat. S77777 **\$145**



10W HORN SPEAKERS

White durable plastic, 8 ohms

Cat. C12010 **Normally \$11.95**
SPECIAL, ONLY \$9.95



CODE KEY PAD

- Telephone type digital keypad
- Four digit, changeable code
- Over 5000 possible combinations
- Power consumption: 5mA standby, 50mA alarm
- Two sector LED and 1 arm LED
- Wrong number lockout
- 12V DC operation
- Relay output
- Panic button
- Normally open lamper switch
- Dimensions: 145 x 100 x 37mm
- ACP3 compatible

Cat. A13014 **R.R.P. \$79.95**
SPECIAL, ONLY \$69.95

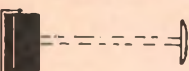

ARLEC SECURITY BEAM

This compact security system transmits an invisible, modulated beam of infrared light which can be directed across a doorway, path or any other to be monitored. Anyone walking through the beam immediately causes an audible warning to sound. Suitable for shops, homes, factories etc.

FEATURES

- Small compact design
- Infrared modulated beam
- Prismatic reflector allows up to 10% misalignment
- Effective range is 2 - 8 metres
- Low voltage (9V) operation via S.E.C. approved adaptor
- Negligible power consumption
- Simplified wiring
- Solid state electronic circuitry
- Produces audible warning
- Easy installation
- 12 months guarantee

Cat. A15060 **\$89.95**



RITRON KEYLESS CAR ALARM

The first shipment sold out immediately to the trade. They didn't reach our own retail stores!

- Activated and disarmed by ignition key so you never forget to turn it on
- Multi-function built in siren or external siren, car signal horn output
- Easy to install, no door switch required
- Automatic reset after 60 seconds (avoids noise pollution)
- Special sensor protects Stereo or CB
- 12V DC

Cat. S15054 **Normally \$39.95**
Now \$29.95



ELECTRONIC DOOR ALARM AND CHIME

Electronic control system with powerful built 100dB alarm. Changeable 3 digit, push button secret code controller that is tamper proof. 3 function switch provides off position, chime and 7 seconds delay entry. Emergency panic button. Suitable for left or right hand door opening. Simple installation, no wiring required. Low current 15mA at 9V. Operates on 9V battery.

Cat. S77777 **\$44.95**



PIEZO SIREN

- 4 piezo units in a high impact plastic cabinet
- Input 12V DC - 200mA
- Output 115dB at 1m dual tone
- Compact size 105 x 85 x 45mm
- Smart design suits interior use

Cat. S15071 **\$23.95**



RECHARGEABLE LANTERN

- Up to 1000 recharges
- No more expensive batteries
- Beam length 1.050 feet
- Cannot be over charged
- Shoulder strap included
- 240V charge lead connects direct
- 12V Car lighter recharging lead (ideal for camping, travel, boating etc)
- Red safety shade cover

Cat. A15053 **only \$29.95**



FLUORESCENT WORK & EMERGENCY LIGHT

- Suits cars, boating, caravan, camping etc.
- Shatterproof glare free
- Cigarette lighter plug and alligator clips
- 12V DC 8 watt transistorised

Cat. A15052 **\$25.95**



RACK MOUNTING CABINETS

These superbly crafted rack cabinets will give your projects a real professional appearance

- All dimensions conform to the International Standard
- Aluminium construction
- Removable upper and lower panels
- Ventilated lid
- Choice of Natural or Black finish
- Quality brushed finish anodised front panel

A - Internal Height mm	B - Rear Width mm	C - Depth mm		
A B C Finish	Cat.No.	Price		
38 430 254 Natural	H10401	\$49.50		
82 430 254 Natural	H10402	\$59.50		
126 430 254 Natural	H10403	\$69.50		
38 430 254 Black	H10411	\$59.95		
82 430 254 Black	H10412	\$69.95		
126 430 254 Black	H10413	\$79.95		



MAIL ORDER HOTLINE
008 335757 (TOLL FREE)
LOCAL: 543 7877

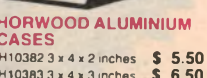

HORWOOD ALUMINIUM CASES

H10382 3 x 4 x 2 inches	\$ 5.50
H10383 3 x 4 x 3 inches	\$ 6.50
H10384 3 x 4 x 4 inches	\$ 7.50
H10385 3 x 4 x 5 inches	\$ 7.95
H10386 3 x 4 x 6 inches	\$ 8.50
H10387 3 x 4 x 7 inches	\$ 9.50
H10388 3 x 4 x 8 inches	\$10.50
H10389 3 x 4 x 9 inches	\$10.95
H10390 3 x 4 x 10 inches	\$11.95



SPECTROL MULTIDIAGS

Model 16-1-11 (9")	
Cat. R14400	\$26.95
Model 18-1-11 (1" x 1.75" Rect.)	
Cat. R14405	\$45.95
Model 21-1-11 (1.82")	
Cat. R14410	\$46.95



AEROSOLVE SPRAYPACKS

PCB Coating '201'	Cat. N11040	\$6.95
Freezing Spray '202'	Cat. N11042	\$6.95
Insulating Varnish '203'	Cat. N11043	\$7.95
Electric Motor Cleaner '204'	Cat. N11044	\$6.95
Electronic Super Clean (Froon) '205'	Cat. N11047	\$7.50
Flux Remover '206'	Cat. N11049	\$6.95
Elec Contact Cleaner & Lube '207'	Cat. N11051	\$5.95
Silver Coat '208'	Cat. N11054	\$6.95
Formula '66' '535'	Cat. N11057	\$5.95
Clear Coat Plastic Spray '540'	Cat. N11059	\$6.95



SOLDER ROLLS

Absolutely top quality, unlike our opposition's!

Cat No	Description	Price
T31000	71mm 250gm	\$8.95
T31002	71mm 500gm	\$15.95
T31010	91mm 250gm	\$7.95
T31012	91mm 500gm	\$14.95
T31020	1.6mm 250gm	\$7.50
T31022	1.6mm 500gm	\$13.95
T31030	71mm 1 metre	\$1.50
T31032	91mm 1 metre	\$1.25
T31034	1.6mm 1 metre	\$1.00



BREADBOARD SPECIALS

Why pay more?

Cat P11000	100 holes	\$2.75
Cat P11005	640 holes	\$10.75
Cat P11007	640 + 100 holes	\$13.00
Cat P11009	840 + 200 holes	\$17.50
Cat P11010	1280 + 100 holes	\$19.95
Cat P11011	1280 + 300 holes	\$32.50
Cat P11012	1280 + 400 holes	\$36.75
Cat P11015	1920 + 500 holes	\$57.50
Cat P11018	2560 + 700 holes	\$64.95



PUSH BUTTON DIALLERS

Tired of old fashion dialling and re-dialling engaged numbers? These convenient push button diallers include last number redial (up to 16 digits) and instructions for an easy changeover.

Cat. A12030 **NORMALLY \$19.95**
SPECIAL, ONLY \$14.95

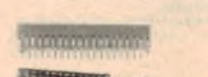

IC SOCKETS (LOW PROFILE)

How cheap can they go?

1 -	10 -	100 -	1000 -
8 Pin Cat	15c	14c	12c
14 Pin Cat	16c	15c	14c
16 Pin Cat	17c	16c	15c
18 Pin Cat	18c	17c	16c
20 Pin Cat	29c	28c	27c
24 Pin Cat	35c	33c	32c
40 Pin Cat	45c	40c	35c



PANEL METERS GALORE!

We have a great range of panel meters at great prices!

Cat No	Description	Price
Q10500	MU45 0-1mA	12.50
Q10502	MU45 50-0/50uA	12.50
Q10504	MU45 0-100uA	12.50
Q10510	MU45 0-5A	12.50
Q10518	MU45 0-1A	12.50
Q10520	MU45 0-1A	12.50
Q10525	MU45 0-20V	12.50
Q10530	MU52E 0-1A	14.50
Q10533	MU52E 0-5A	14.50
Q10535	MU45 VU PMetre	14.95
Q10538	MU65 0-50uA	16.95
Q10540	MU65 0-1mA	16.95
Q10550	MU65 0-100uA	16.95
Q10560	MU65 0-20V	16.95



WELLER WTCPN SOLDERING STATION

The WTCPN Features:

- Power Unit 240 V AC
- Temperature controlled iron, 24 V AC
- Flexible silicon lead for ease of use
- Can be left on without fear of damaged tips!

The best is always worth having

Cat. T12500 **R.R.P. \$149**
SPECIAL, ONLY \$129



ARLEC SUPER TOOL

A versatile 12V electric tool for:

- Sanding
- Engraving
- Gminding
- Polishing
- Cutting
- Drilling
- Milling
- Erasing etc.

Features:

- Operates on safe, low 12 volts from mains electrically via AC adaptor (supplied). Light and easy to handle with touch switch and lock for continuous running. High torque motor, 10.000 R.P.M. Can drill 2mm holes in steel. 2 year guarantee

Contents:

- 12V Super Tool
- Pluggack AC adaptor
- 1 spherical milling cutter
- 1 wire brush
- 1 grinding wheel
- 4 drill bits, 0.6, 0.8, 1.0, 1.2mm
- Set of 5 chuck collets
- 6 eraser sticks
- Instruction sheets

Cat. T12300 **\$59.95**



RCA GOLD PLATED PLUGS AND SOCKETS

For those who need the ultimate in connection. Essential for laser disc players to get that fantastic sound quality.

Plug Cat. P10151 **\$7.75**
Socket Cat. P10150 **\$2.95**



CANNON TYPE CONNECTORS

1-9	10
P10960 3 PIN LINE MALE	\$3.90
P10962 3 PIN CHASSIS MALE	\$3.50
P10964 3 PIN LINE FEMALE	\$2.50
P10966 3 PIN CHASSIS FEMALE	\$3.90
P10968 3 PIN CHASSIS FEMALE	\$4.95



FREE STANDING, FOLD UP MAGNIFIER

An economically priced 'hands free' magnifier, lets you take care of all those tricky fine detailed jobs so often encountered in electronics or any of many other practical uses such as home, work, hobbies etc.

Cat. T12083 **\$14.95**



ANTISTATIC SOLDER SUCKER

- Light weight
- Sturdy construction
- Easy to remove tip
- Excellent value for money!

Cat. T11281 **\$13.95**

METEX MULTIMETERS

These instruments are compact, rugged, battery operated, hand held 3 1/2 digit multimeters. Dual-slope A-D converters use C-MOS technology for auto-zeroing, polarity selection and over-range indication. Full overload is provided.



METEX 3800 MULTIMETER

This instrument is a compact, rugged, battery operated, hand held 3 1/2 digit multimeter for measuring DC and AC voltage, DC and AC current, Resistance and Diode, for testing Audible continuity and transistor hFE. The Dual-slope A-D Converter uses C-MOS technology for auto-zeroing, polarity selection and over-range indication. Full overload is provided. It is an ideal instrument for use in the field, laboratory, workshop, hobby and home applications.

Features:

- Push-button ON/OFF power switch
- Single 30 position easy to use rotary switch for FUNCTION and RANGE selection
- 1/2" high contrast LCD
- Automatic over-range indication with the "1" displayed
- Automatic polarity indication on DC ranges
- All ranges fully protected plus Automatic "ZERO" of all ranges without short circuit except 200 ohm Range which shows "000 or 001"
- High Surge Voltage protection 1.5 KV 3 KV
- Diode testing with 1 mA fixed current
- Audible Continuity Test
- Transistor hFE Test

SPECIFICATIONS

Maximum Display: 1999 counts

1/2 digit type with automatic polarity indication

Indication Method: LCD display

Measuring Method: Dual-slope in A-D converter system

Over-range Indication: "1" Figure only in the display

Temperature Ranges: Operating 0°C to +40°C

Power Supply: one 9 volt battery (006P or FC-1 type of equivalent)

Cat. O91530 **Normally \$109**
SPECIAL \$99



METEX 3530 MULTIMETER

This instrument is a compact, rugged, battery operated, hand held 3 1/2 digit multimeter for measuring DC and AC voltage, DC and AC current, Resistance and Diode, Capacitance, Transistor hFE and Continuity Test. The Dual-slope A-D Converter uses C-MOS technology for auto-zeroing, polarity selection and over-range indication. Full overload is provided. It is an ideal instrument for use in the field, laboratory, workshop, hobby and home applications.

Features:

- Push-button ON/OFF power switch
- Single 30 position easy to use rotary switch for FUNCTION and RANGE selection
- 1/2" high contrast LCD
- Automatic over-range indication with the "1" displayed
- Automatic polarity indication on DC ranges
- All ranges fully protected plus Automatic "ZERO" of all ranges without short circuit except 200 ohm Range which shows "000 or 001"
- High Surge Voltage protection 1.5 KV 3 KV
- Capacitance measurements to 1pF
- Diode testing with 1 mA fixed current
- Audible Continuity Test
- Transistor hFE Test

SPECIFICATIONS

Maximum Display: 1999 counts

3 1/2 digit type with automatic polarity indication

Indication Method: LCD display

Measuring Method: Dual-slope in A-D converter system

Over-range Indication: "1" Figure only in the display

Temperature Ranges: Operating 0°C to +40°C

Power Supply: one 9 volt battery (006P or FC-1 type of equivalent)

Cat. O91540 **Normally \$139**
SPECIAL \$129



MINIATURE HEATSINK!
A great little fellow if you are short of space. Great price too, because we import direct so you save!
Cat. H10606 1-9 10+
\$0.40 \$0.35



DB STAND OFFS
At incredible price! No need to pay abroad prices because we import them direct and pass on the savings to you!
2 Pack P10930 **\$1.00**
10 Pack P10932 **\$3.95**
100 Pack P10934 **\$20.00**



ELECTRET MIC INSERTS
With pins for easy board insertion.
Cat. C10170 1-9 10+ 100+
\$2.50 \$2.25 \$2.00



UHF/VHF/FM ANTENNA AMPLIFIER AND 2 WAY SPLITTER
Covers all Australian frequencies. Suitable for use in houses, caravans, boats etc.
● 1 x 75 ohm input
● 2 x 75 ohm output
● Gain 2 x 6dB
● Maximum output 2 x 96dBuV
Cat. L15041 **\$39.95**



TV INTERFERENCE FILTER
Cuts CB/Ham signals interference.
Cat. L11048 **\$5.95**

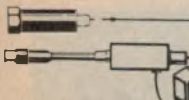

10dB IN-LINE COAXIAL AMPLIFIER
Reduces loss from splitters and long cable runs. Suitable for use with antennas, coaxial feed lines and VCR's. AC adaptor included.
SPECIFICATIONS
Frequency Range: 5-900MHz
Gain: 10dB
Power Requirements: 12V AC Adaptor (included)
Input Impedance: 75 ohm
Output Impedance: 75 ohm
Cat. L15043 **\$44.95**



3M SCOTCHCAL PHOTO SENSITIVE
All prices per box and include tax
8007 REVERSAL FILM
250 x 300mm (10 sheets) **\$39.95**
300 x 600mm (5 sheets) **\$54.95**
8005 BLACK ALUMINIUM
250 x 300mm (10 sheets) **\$69.95**
300 x 600mm (5 sheets) **\$79.95**
8005 BLUE ALUMINIUM
250 x 300mm (10 sheets) **\$69.95**
300 x 600mm (5 sheets) **\$79.95**
8011 RED/WHITE
250 x 300mm (10 sheets) **\$64.95**
300 x 600mm (5 sheets) **\$74.95**
8013 BLACK/YELLOW
250 x 300mm (10 sheets) **\$64.95**
300 x 600mm (5 sheets) **\$74.95**
8015 BLACK/WHITE
250 x 300mm (10 sheets) **\$64.95**
300 x 600mm (5 sheets) **\$74.95**
8016 BLUE/WHITE
250 x 300mm (10 sheets) **\$64.95**
300 x 600mm (5 sheets) **\$74.95**
8018 GREEN/WHITE
250 x 300mm (10 sheets) **\$64.95**
300 x 600mm (5 sheets) **\$74.95**



P.A. SPEAKERS
Low dual cone, wide range 200mm (8in.). Ideal for public address, background music, etc. Tremendous Value at these prices!
Cat. C12000 **\$7.95**

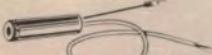

CAR ANTENNA BOOSTER
● In-line installation
● 12V boosts 100%
Cat. A12073 **\$7.95**

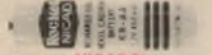

NICADS!
Size Desc 1-9 10+ 100+
AA 0.5 AH \$2.95 \$2.75 \$2.25
C 1.2 AH \$7.95 \$6.50 \$6.25
D 1.2 AH \$7.95 \$6.50 \$6.25



UNIVERSAL BATTERY CHARGER AND TESTER
Save money on expensive batteries with this universal battery charger. Features include meter tester, and provisions for D, C, AA, AAA, N, button and cell batteries. 9V and 6V (square types). Comes complete with detailed instructions.
Cat. M23533 **\$29.95**



BRAND NEW FANS
Quality, new fans for use in power amps, computers, hotspot cooling etc. Anywhere you need plenty of air.
240V 45# Cat. T12461 **\$14.95**
115V 45# Cat. T12463 **\$14.95**
240V 3 1/2" Cat. T12465 **\$14.95**
115V 3 1/2" Cat. T12467 **\$14.95**
10+ fans (mixed) only **\$10 each!**

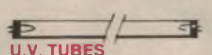

U.V. TUBES
Fits into standard 15W fluoro holder. Suitable for Scotchcal, Eprom erasing etc. As used in ETI Eprom Erasing Kit.
WARNING: Do not look directly into UV Tubes.
Cat. H28600 **\$24.95**
*If ordering by mail please include an extra \$2 for "special" packing.

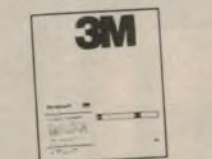

U.S. TELEPHONE EXTENSION CABLE
● U.S. plug to U.S. sockets
● Length 10 metres
Cat. Y16015 **\$15.95**

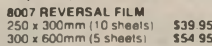

U.S. TELEPHONE EXTENSION CABLE
● U.S. plug to U.S. socket
● Length 10 metres
Cat. Y16024 **\$8.95**



TELEPHONE CURL CORD
● U.S. plug to U.S. plug
● Replacement hand set cord
● Length 4.5 metres
Cat. Y16023 **\$7.95**

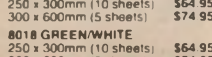

TELEPHONE ADAPTOR
● Australian plug to U.S. socket
● Length 10cm
● Cream colour cable
Cat. Y16026 **\$6.95**

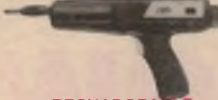

RECHARGEABLE ELECTRIC SCREWDRIVER
The perfect tool for professional or handyman!
● Long lasting Ni/Cad battery
● Forward/Reverse Modes
● Detachable pistol grip
● Simple to use chuck
● 2 Flat tips
● 2 Phillips tips
● Includes AC/DC charger
PERFORMANCE DATA:
Gear Ratio: 1:50
Max. R.P.M.: 150
Max. Torque: 3.2 (Newton Metre)
Screwing Capacity: 4 x 8/300 5 x 8/220
T12200 **\$99.50**

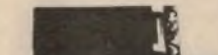

RECHARGEABLE 12V GELL BATTERIES
Leakproof and in 3 convenient sizes, these long service life batteries are ideal for burglar systems, emergency lighting or as a computer backup power supply. Ideal for many power needs.
Cat. S15029 12V 1.2 AH **\$17.50**
Cat. S15031 12V 2.6 AH **\$32.50**
Cat. S15033 12V 4.5 AH **\$39.50**



MAIL ORDER HOTLINE
008 335757 (TOLL FREE)
LOCAL: 543 7877



ECONOMY TRANSFORMERS
2155 240V 6-15V 1A Cat. M12155 **\$9.95** **\$8.95**
2156 240V 6-15V 2A Cat. M12156 **\$14.95** **\$13.95**
2840 240V 3V CT Cat. M12840 **\$5.95** **\$4.95**
2851 240V 12-6V CT 150mA Cat. M12851 **\$5.95** **\$5.50**
2860 240V 15V CT 250mA Cat. M12860 **\$5.95** **\$4.95**
6672 240V 15-30V 1A tapped Cat. M16672 **\$14.95** **\$13.95**

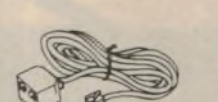

SPEECH SYNTHESISER CHIPS!
SPO256A-AL2: Speech synthesiser chip, needs programming to work. **\$16.95**
CTS256-AL2: Contains the code recognition circuit to enable the project to plug directly on the printer port, or into an IBM PC. **\$29.95**
A SET OF EACH **\$44.95**



HIGH INTENSITY RED LED BAR GRAPH
Dimensions:
Overall: 63mm across, 5mm high
LEDs: 10 x 5mm x 1mm
Cat No 1-9 10+
Y10180 **\$2.95** **\$2.75**

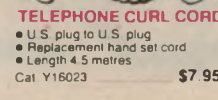

REGULATED DC-DC CONVERTER
Built on to a heavy duty aluminium heatsink with 7 amps. Ideal for trucks and boats.
● Input 24V DC
● Output 12V DC at 7 amps
● Fully regulated with short circuit protection
● Size 180(L) x 94(W) x 33(H)mm
Cat. A15056 **\$34.95**



SEMICONDUCTORS!
Always check with us before you buy!
1-9 10+ 100+
2716 \$9.95 \$9.50 \$8.95
2732 \$8.95 \$8.50 \$7.95
2764 \$7.95 \$7.50 \$6.95
2712B \$6.95 \$6.50 \$6.25
27256 \$11.50 \$10.50 \$10.00
4116 \$3.95 \$3.50 \$2.95
4164 \$2.95 \$2.75 \$2.50
41256 \$5.95 \$5.50 \$4.95
555 (pin 0.50) 0.40 0.35
6116 \$3.95 \$3.75 \$3.50
6264 \$6.50 \$5.50 \$5.25
6802 \$5.00 \$4.00 \$3.75
6821 \$2.00 \$1.80 \$1.70
6845 \$5.00 \$4.00 \$3.75
7406 \$0.40 \$0.30 \$0.25
8250 \$29.95 \$27.95

MEL9501
Have you blown up your Apple drive by plugging it in backwards or not turning off the power while changing boards? We have the MEL9501 chip!
SPECIAL, ONLY \$29.95

8087
Genuine Intel chips with manual and data sheets packed in boxes!
8087-3 (4.77MHz) **\$299**
8087-2 (8MHz) **\$399**
8087-1 (10MHz) **\$649**
80287-3 (6MHz) **\$499**
80287-7 (8MHz) **\$699**
8087-3 (4.77MHz) **\$299**

NE5534AN
SCOOP PURCHASE!!!
1-9 10+
\$1.95 \$1.85

WORLD MODEM CHIP
Cat. U21614 Normally \$49.50
Save **\$25, SPECIAL \$24.95**



RS232C NULL MODEM ADAPTOR
● Male to female connections
● Pins 2 and 3 reversed
● All 25 pins connected
Cat. X15658 Male to Female
Cat. X15659 Female to Female
Normally **\$22.95**
Our Price **\$14.95**

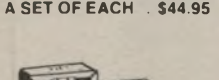

RS232 MINI PATCH BOX
● Interface RS232 devices
● 25 pin inputs
● 25 leads with tinned and supplied
● Complete with instructions
Cat. X15653 Male to Male
Cat. X15654 Female to Male
Cat. X15655 Female to Female
Normally **\$25.95**
Our Price **\$19.95**

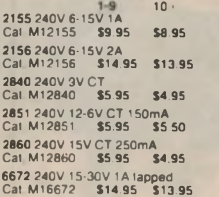

RS232 WIRING ADAPTOR BOX
● Male to female
● 25 Detachable plug on leads
● 2 mini jumpers
● Ideal for experimenting or temporary connections
Cat. X15665 Normally **\$39.95**
SPECIAL \$29.95

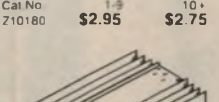

RS232 MINI TESTER
● Male to female connections
● All pin wired straight through
● Dual colour LED indicates activity and direction on 7 lines
● No batteries or power required
T.D. Transmit Data
D.S.R. Data Set Ready
R.D. Receive Data
C.D. Carrier Detect
R.T.S. Request to Send
D.T.R. Data Terminal Ready
C.T.S. Clear to Send
Cat. X15656 Normally **\$39.95**
SPECIAL, ONLY \$32.95



CENTRONICS GENDER CHANGERS
● Female to Female
● Saves modifying or replacing non-mating Centronics cables
● All 36 pins wired straight through
Cat. X15660 Male to Male
Cat. X15661 Male to Female
Cat. X15662 Female to Female
Normally **\$33.95**
Our Price **\$24.95**



HIGH EFFICIENCY RADIAL FIN HEATSINK
Black anodised with a thick base plate, this radial fin heatsink can dissipate large amounts of heat for maximum efficiency. Designed by Rod Irving.
105x30mm Cat. H10520 **\$ 3.50**
105x75mm Cat. H10525 **\$ 3.50**
105x100mm Cat. H10529 **\$ 4.90**
105x140mm Cat. H10534 **\$ 6.50**
105x150mm Cat. H10535 **\$ 6.75**
105x170mm Cat. H10538 **\$ 7.95**
105x195mm Cat. H10542 **\$ 9.90**
105x200mm Cat. H10543 **\$ 9.90**
105x225mm Cat. H10546 **\$10.50**
105x300mm Cat. H10549 **\$12.00**
105x600mm Cat. H10560 **\$24.95**



HEATSINK COMPOUND
Heatsink compound is applied to the base and mounting studs of transistors and diodes. It maintains a positive heatsink seal that improves heat transfer from the device to the heatsink, thus increasing overall efficiency.
Cat. H11800 **\$2.95**

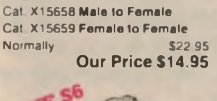

ROD IRVING ELECTRONICS
48 A Beckett St, MELBOURNE
Phone (03) 663 6151
425 High St, NORTHCOTE
Phone (03) 489 8866
Mail Order and Correspondence
P.O. Box 620, CLAYTON 3168
Telex: AA 151938

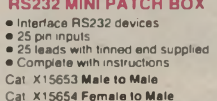

MAIL ORDER HOTLINE
008 335757 (TOLL FREE)
(STRICTLY ORDERS ONLY)
LOCAL ORDERS & INQUIRIES
(03) 543 7877



POSTAGE RATES
\$1 \$9.99 \$2.00
\$10 \$24.99 \$3.00
\$25 \$49.99 \$4.00
\$50 \$99.99 \$5.00
\$100 \$199.99 \$7.50
\$200 \$499.99 \$10.00
\$500 plus \$12.50
FREE POSTAGE FOR ORDERS OVER \$75 & UNDER 3KG!!

The above postage rates are for basic postage only. Road Freight bulky and fragile items will be charged at different rates.
Certified Post for orders over \$100 included free!
Registered Post for orders over \$200 included free!

All sales tax exempt orders and wholesale inquiries to RITRONICS WHOLESALE 56 Renner Rd. Clayton, Ph: (03) 543 2166 (3 lines)

Errors and omissions excepted
*Apply and 800 fee imposed order forms

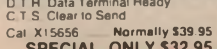

FREE POSTAGE FOR ALL ORDERS OVER \$75 & UNDER 3KG!!

What's new in power supplies

A power supply is a power supply, right? Nothing to get excited about and really quite boring, isn't it? Well, no. There are a lot of recent developments which have made the power supply scene complex and varied. A power supply is no longer just a power supply.

by LEO SIMPSON

Not so long ago, the power supply was the most uninteresting part of an electronic device, whether it was a computer, television set, test equipment or industrial equipment.

Virtually all power supplies for elec-

tronic equipment had much the same function. They converted incoming AC mains at relatively high voltage to DC at lower voltages. They generally all used an iron-core step-down transformer feeding a set of rectifier diodes

which in turn fed one or more filter capacitors, depending on the number of DC supply rails needed, the current capacity and the required hum filtering.

Comparatively few power supply circuits featured electronic regulation and those that did had relatively low current capacities or, to put it another way, relatively low power output.

Such simple transformer-based power supply circuits with capacitor filtering have the virtues of being simple to design and build, are reliable and are easy to service. Their load regulation, defined as the percentage variation in output voltage with change from no-load to full-load, can be quite good at better than 5% provided the transformer and filter capacitors are conservatively rated. In other words, for good load regulation you need a large transformer.



These Kikusui electronic loads can be set to draw any current up to their power ratings of 70 and 150 watts. They are distributed by Emona Pty Ltd.

So good load regulation is relatively easy to obtain with a transformer-based power supply. Line regulation is quite another matter. Line regulation is defined as the percentage variation in output voltage for a given change in the input voltage. Because the output voltage of a transformer is directly proportional to the change in input voltage, the line regulation of any simple transformer-based power supply must be poor.

For a 10% change in input voltage, you must get a 10% change in the output. For the old valve-based circuits this was not usually a problem but when transistors started to appear in electronic equipment, it became quite serious. If the mains supply went up by more than 10%, the transistors would be under severe threat of catastrophic failure.

There are two ways to obtain good line regulation from a power supply. The first is to use a ferro-resonant constant voltage transformer. These are complex units involving a transformer and a saturable reactor which may be built on the same iron core or on two separate cores.

Constant voltage transformers have a number of advantages beside keeping the mains output voltage constant. First, because they are a resonant circuit they ensure that the mains waveform is clean, so that higher order harmonics are removed and potentially damaging transient spike voltages are safely absorbed.

This means that the following rectifier and filter circuitry does not need to be so complex and the whole power supply is a more reliable unit. Typical constant voltage transformers can hold the output voltage to within a few percent of the designated value, for quite large changes in the mains input voltage.

On the debit side though, constant voltage transformers are very bulky and quite expensive.

Rifa announces fully isolated DC-DC converters

Rifa has announced that it now has new versions of its PKA series low profile DC/DC converters with 500VDC isolation between input and output.

Single, dual and triple output 25-30W, 24VDC and 48VDC in PCB and chassis versions are available. Dimensions are 76 x 76 x 17.8mm.

The 300kHz converters make use of Rifa inhouse facilities, including

bipolar ICs and magnetic components as well as thick-film hybrid technology. According to the company, the PKA range is the first commercially available product claiming an MTBF of 200 years at 45 degrees Celsius.

For further information contact Rifa Pty Ltd, 202 Bell Street, Preston, Victoria 3072 Telephone (03) 487 3333.

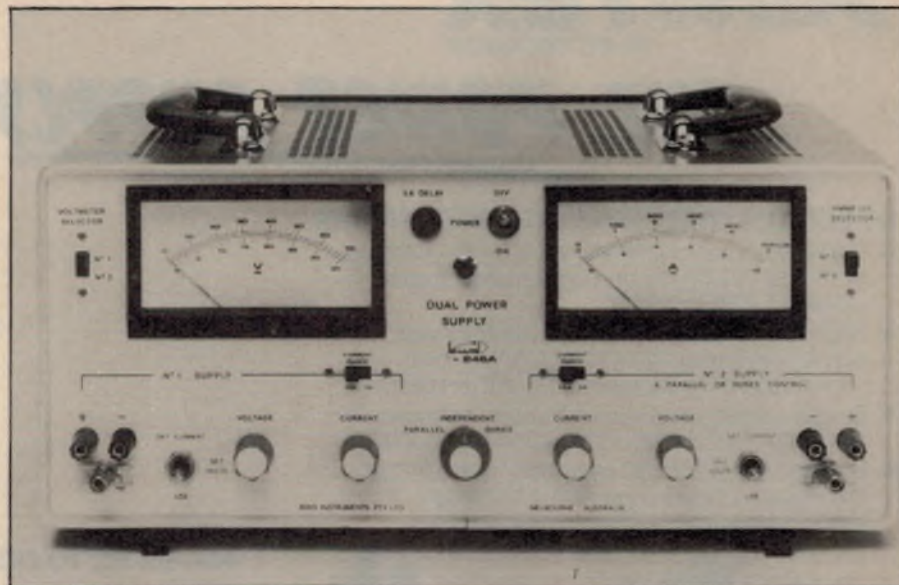

High performance dual power supply from BWD

BWD Precision Instruments Pty Ltd has released their Model 246A dual power supply. This contains two separate supplies which can provide constant voltage and constant current operation over the full operating range. Front panel switching enables the supply to be used independently, in parallel or in series at 36V 0-5A, 36V 0-10A, and 72V 0-5A respectively.

Using a single unit, switched to any of the three modes of operation,

the following output conditions can be obtained: remote load sensing, constant voltage remote resistance programming, constant voltage remote voltage programming, constant current remote resistance programming, or constant current remote voltage programming.

For further information, contact Parameters Pty Ltd, 25-27 Paul St North, North Ryde, NSW 2113. Phone (02) 887 1283.

Now that virtually all electronic equipment is solid-state, the performance requirements for the power supply have tended to become much more stringent. Load and line regulation must be much better. With modern op amp circuitry now used in power supplies this is relatively easy to achieve but

there is a price: size and efficiency. For a conventional linear power supply, good load and line regulation means relatively poor efficiency, lots of heat dissipation at maximum load, and bulk.

Power supply design began to change radically with the introduction of colour television. Colour TV chassis were largely solid-state from the beginning but used a lot more power than their monochrome counterparts, up to 300 watts or more in some cases.

Designing a conventional power supply for this task meant that a large and very heavy transformer was a must, not merely to supply the power demand but to have plenty of headroom to give good load and line regulation; not only must the TV power supply have very good filtering, which these days means electronic regulation, but it must also have very good line regulation to let the TV set run reliably at widely varying mains voltages.

AMTEX

ELECTRONICS

THE POWER SUPPLY SPECIALIST

BOSCHERT SWITCHING POWER SUPPLIES

- Multiple output switchers with output voltages of 5V DC to 24V DC and continuous output power of 40W to 450W.
- High power multiple output switchers with output voltages of 5V DC to 24V DC and continuous output power of 750W to 1500W.
- Single output switchers with output voltages 5V DC to 24V DC power ratings 30W to 1000W.
- High power DC to DC switchers with 10-60V DC input voltage range and 4.5V to 30V adjustable output voltage up to 20 amps.

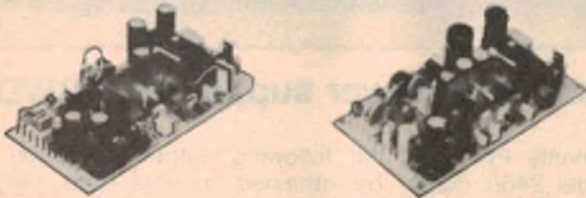

Boschert
SWITCHING POWER

AMTEX AC TO DC SWITCHING POWER SUPPLIES

- Low cost, high reliability multiple output switchers.
- Dual to Quintuplet outputs.
- Output voltage range 5V DC to 24V DC.
- Output power range 30W to 200W.

ETA DC TO DC SWITCHING POWER SUPPLIES

- Low cost, high reliability DC to DC enclosed switching power supplies.
- Single, dual and triple outputs.
- Output power 12.5W to 50W
- Input voltage range 12V DC, 24V DC or 48V DC.
- Output voltage range 5V DC to 24V DC. Floating outputs allow either positive or negative polarity.
- Input is isolated from outputs.

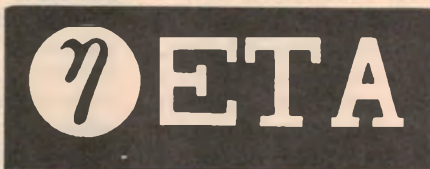

ETA

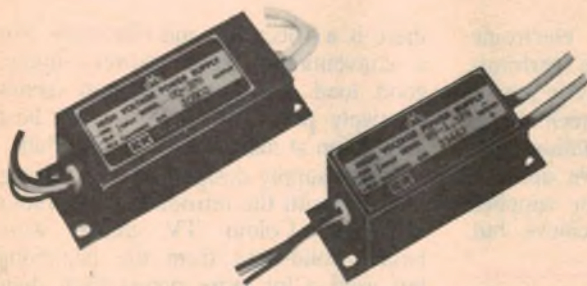

MATSUSADA HIGH VOLTAGE DC POWER SUPPLIES

- Compact, well regulated, high voltage DC power supplies.
- Output voltage range 0.18kV DC to 24kV DC.
- Input voltage range 1.5V DC to 24V DC.
- Output voltage is remote voltage and remote resistance programmable.
- Available in positive or negative polarity with respect to ground.
- Protected against short circuit, arc and reverse input polarity.
- Low ripple noise.



MINI UNINTERRUPTIBLE POWER SUPPLIES

- Input voltage – 240V AC \pm 15%.
- Output voltage – 240V AC \pm 2%.
- Waveform – Sine or square wave outputs.
- Signal Alarm.
- Battery backup – 10 minutes at full load.
- VA range – 250VA to 1000 VA.

AMTEX

ELECTRONICS

A DIVISION OF **TLE ELECTRICAL PTY LIMITED**
(Incorporated in New South Wales)

36 LISBON STREET
FAIRFIELD, N.S.W. 2165, AUSTRALIA
TELEPHONE: (02) 728 2121, 727 5444
TELEX: AA27922 ATTN AMTEX
FACSIMILE: (02) 728 6908, 728 2837

Power supplies

Switchmode power supplies

TV set manufacturers quickly came to the conclusion that there had to be a better way of providing a power supply. European manufacturers then pioneered the development of transformerless switchmode power supplies. The savings were major, in cost, efficiency, power dissipation and weight. These days most colour TVs use switchmode supplies even though overall power consumption has been reduced markedly, to below 100 watts in most cases.

At the same time as colour TV was being introduced, the microprocessor was beginning to make its mark. From the start, microprocessors and their supporting circuitry, the ever-growing banks of memory, have placed stringent demands on power supplies. With large amounts of current required at low voltage, switchmode power supplies are the only practical course.

Today, virtually all personal computers and their peripheral devices employ switchmode power supplies. The only application where conventional linear power supplies have the monopoly is for laboratory standard adjustable power

supplies where very tight regulation and extremely low ripple and noise are required. For the rest, the switchmode power supply, or switcher, is king.

A number of large companies have specialised in the design and manufacture of switchmode power supplies. In Australia, these include Setec, Scientific Electronics and Statronics. As well, there are quite a few companies importing switchers into this country. They include Amtex Electronics, Parameters, Rifa, and Westinghouse.

Most switchers are intended for the OEM (original equipment manufacturer) market and range from fully enclosed power supplies as used in the IBM PC or PC-clones, to open-frame and PC board assemblies. They range in power output from around 25 watts up to as much as 500 watts in some cases.

As the photos accompanying this article indicate, the big advantages of switchers are small size for a given output rating and high efficiency which means only small heatsinks are required.

Switcher circuit configurations tend to

Three switchers from Futuretech

Futuretech has released their 7700 range of switchmode power supplies which meet all SEC and Telecom requirements. There are three models in the range, all of which have over-voltage crowbar protection plus mains failure and undervoltage monitors.

Model 7702 features a nominal DC output of 13.2V at 12A. The output adjustment range is 10-16V for an output current range of 6-14A. The 7704 model has a nominal DC output of 52.8V at 5A. Its output adjustment range is 45-60V for an output current range 3-6A. Model 7706 also has a nominal DC output model of 52.8V at 8A. Again, its output adjustment range is 45-60V for a current of 5 to 10A.

For further information, contact Futuretech Pty Ltd, 56 Regent St, Oakleigh, Victoria, 3166. Phone (03) 568 1944.

be fairly standardised now, depending on the required power output and the number of supply rails. The simplest configuration is the flyback converter which is effectively a single transistor "ringing choke" inverter. This is fed

Dual rate battery charger from Futuretech

The Smart Charger 10100 is intended for charging all types of lead acid batteries but is specially suitable for the Gel type. It offers the benefits of rapid charging and is safe to use as a float charger.

The standard unit is intended for 12V 38 or 40 amp-hour batteries, but may be used to charge larger capacity batteries at the expense of longer charge times. A special reduced current version is available to order for 12V 24 amp-hour batteries.

There are two rates of charge in normal operation: a C/4 charge rate produced by a switching constant current regulator, and a constant potential charge to 13.8V DC for floating operation. The two rates of charge alternate every 10 seconds approximately and the charge current in the constant potential mode is used as a measure of the state of charge of the battery.

If this current is below about C/400, the battery is assumed to be

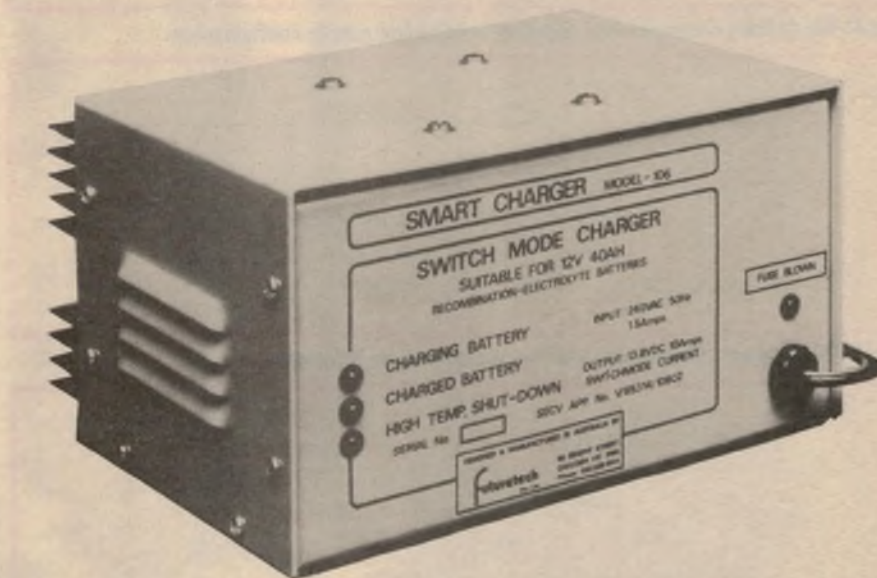

at or near full charge and the high rate charge is disabled. Both Recombination Electrolyte batteries and normal vented batteries benefit from this treatment and useful battery life can be greatly increased.

The charger is fully protected

against output short-circuit, reverse connection of batteries and thermal overload.

The supply voltage is 210 to 255VAC 50/60Hz. Dimensions are 215 X 185 x 130mm and mass is 5kg.

Power supplies

from the rectified AC mains supply and steps the voltage down via an isolating transformer (see Fig.1). This configuration is used for powers up to 100 watts.

For higher powers, the forward converter configuration is used (Fig.2). This looks very similar to the flyback converter but includes an inductive storage element, L_1 , on the output side of the transformer. This configuration is cost effective for powers over the range from 80 to 200 watts.

For even higher powers, the half-bridge forward converter is very popular (Fig.3). This also has the advantage of lower output ripple and noise, and better transient response.

All switcher designs essentially provide one DC output rail which is closely regulated. However, many circuits require more than one supply rail, espe-



This Goodwill dual tracking power supply can be connected to obtain 60 volts at 2 amps or 30 volts at 4 amps and also has two fixed 5V outputs. Available from Emona Pty Ltd.

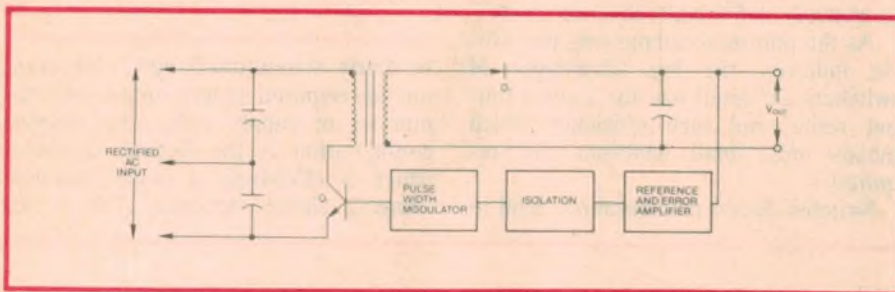

Fig.1: the flyback converter is a popular switchmode supply configuration.

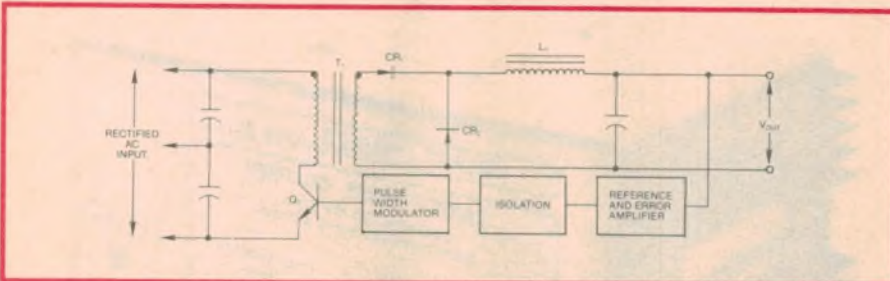

Fig.2: the forward converter is used for powers up to 200 watts.

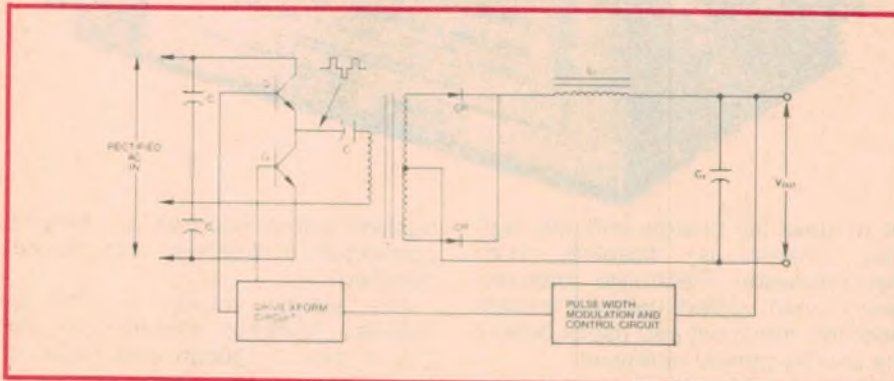

Fig.3: the half-bridge forward converter has good ripple and noise performance.

cially if analog circuitry or EPROMs are to be powered. In this case, switchers are often provided with several secondary windings on the transformer and these feed their own rectifier and filter networks to develop the required DC outputs. These other outputs are not controlled but their regulation is adequate for most circuits.

The only real disadvantage of switchers is an artefact of their mode of operation. Because they contain transistors which switch high currents at very fast rates, they inevitably have higher noise output than linear supplies and they also produce more electromagnetic interference.

Even so, the radiated interference of most switchers is kept within satisfactory limits defined by the United States FCC or the German VDE (Verband Deutscher Electrono-Techniker) standard.

Uninterruptible power supplies

With computers being so important to virtually all activities these days, whether it be defence, business, manufacturing, medicine, law-enforcement or even sport, it is vitally important that valuable data is not lost. Even a momentary break in the power supply of only a few milliseconds can mean the loss of valuable data.

Just think of the implications of the momentary interruption of data flow in a security system, or any of the applica-

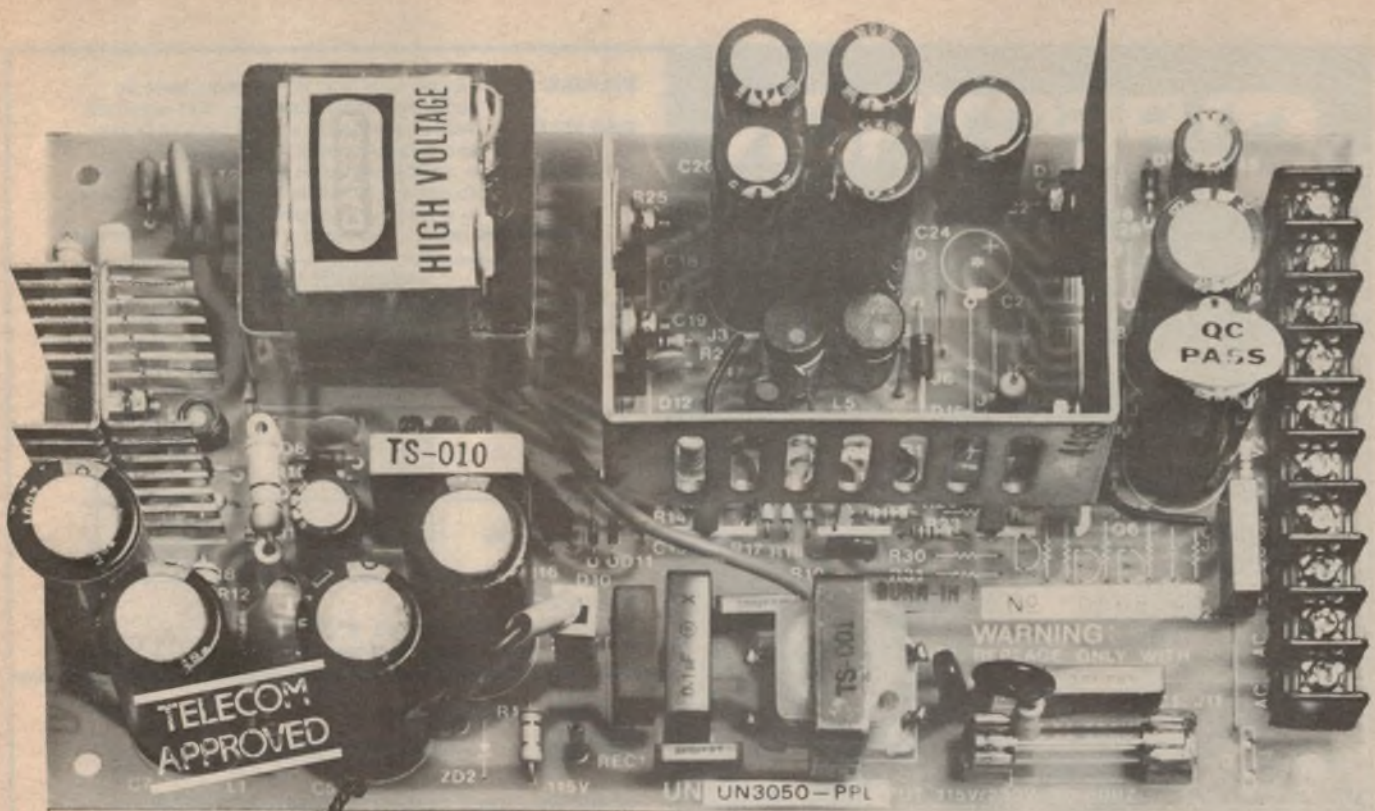

You couldn't do it for less yourself.

Power supplies. Every product needs them. How many have you designed so far? Too many? Here's a simpler approach.

Parameters' new range of switching power supplies can probably solve your problems. Off the shelf.

Over 50 models are available from stock. From 15 to 325 watts, single and multiple outputs. All are made to stringent international standards. Some already have Telecom approval. And the price? In production quantities you probably couldn't make them for less.

Ready to connect

All models are complete assemblies. Just connect your mains input and it's ready to go. Depending on the model they are supplied as a PC board,

mounted on a metal chassis or in a screened enclosure. All necessary heatsinks are integral. Some models include fan cooling, mains switches and input connectors.

Need something special?

No problem. Custom designs for volume buyers can be made quickly and economically.

DC-DC converters too

As well as power supplies, we have a range of compact DC-DC converters. With a wide choice of input and output voltages, these compact PC mount devices can easily solve local supply problems.

So if you have a power supply problem, call Parameters today.

Parameters Pty Ltd. SYDNEY: Centrecourt, 25 Paul Street Nth., North Ryde 2113. (02) 888 8777.
 MELBOURNE: 1064 Centre Road, Oakleigh South 3167. (03) 575 0222
 ADELAIDE: Trio Electrix (08) 212 6235. BRISBANE: L.E. Boughen & Co. (07) 369 1277.
 HOBART: Imbros (002) 34 9899. NEWCASTLE: DGE Systems (049) 69 4242.
 PERTH: W.J. Moncrieff (09) 325 5722. TOWNSVILLE: Nortek (077) 79 8600.
 WOLLONGONG: Macelec (042) 29 1455. CAIRNS: Thompson Instrument Services (070) 51 2404.

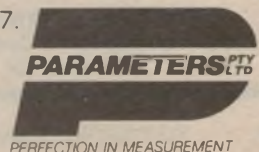

RECTRON

RECTIFIER SPECIALISTS

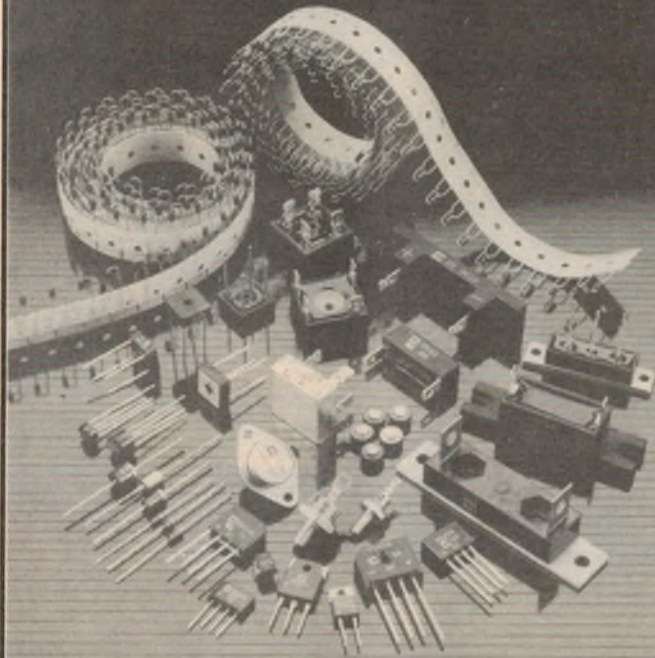

- RELIABLE:** Rectron have over 10 years experience in supplying reliable produce to OEM customers.
- AVAILABLE:** Adilam are stocking a broad range of Diode and Bridge Rectifiers for prompt delivery.
- AFFORDABLE:** A monthly production capability of 140 million Diodes and 10 million Bridge Rectifiers results in competitive pricing to customers.

IT ADDS UP: RELIABLE + AVAILABLE + AFFORDABLE = RECTRON

PRODUCT LINE		
PRODUCTS:	RANGE:	
Rectifiers	Regular	1A—6A
	Zener	100V—330V
	Glass Passivated	1A—6A
	High current/Voltage	1,200V—15,000V
	Fast Recovery	0.6A—30A
	Super Fast	1A—30A
	Schottky	1A—200A
Bridge Rectifiers	Button	25A
	SMD (MELF)	1A
	Regular	1A—35A
	Glass Passivated	1A—35A
	Fast Recovery	1.5A—35A

PACKAGES:

- Bulk (Box, Bag) ● Tube ● Ammo
- Reel (Axial, Radial, Panasert and Avisert)



Adilam Electronics
Pty Ltd

MELBOURNE: Suite 7, 145 Parker St. Templestowe PO BOX 52, Buleen 3105. Tel. (03) 846 2511. Tlx. 151369 Fax. 846 1467

SYDNEY: Suite 1, Ramsgate Plaza, 191 Ramsgate Rd, Sans Souci 2219 Tel. (02) 529 2277 Fax. 529 5893

ADELAIDE: N S Electronics (08) 46 8531

BRISBANE: F. HOE & Sons (07) 277 4311

CANBERRA: Electronic Components (062) 80 4654

PERTH: Atkins Carlyle (08) 481 1233

Goes under but not out...

The 'MINI-UPS' range UNINTERRUPTED POWER SUPPLY can protect your computer right around the clock.

Tuck a Westpower UPS under a desk and your computer will never be starved of power. Units ranging from 250VA to 1000VA contains integral battery back-up giving 12 to 20 minute standby periods. Larger sets also available up to 10KVA single phase.



Westinghouse Rectifier

80-86 Douglas Pde., (PO Box 267) Williamstown Vic 3016
Telex AA37477 WESSYS. Telephone: (03) 397 1033

NSW Distributor: **BRYAN CATT INDUSTRIES PTY. LTD.**
10/59-61 Gynea Bay Rd, Gynea NSW 2227. Phone: (02) 526 2222
PO Box 146, Cronulla NSW 2230

Power supplies

tions just mentioned. The results could be catastrophic. Total power failure can cause the heads of disc drive systems to crash and irrevocably damage the stored data which can include not just the raw data but valuable software too.

Even if a power failure does not cause physical damage, it can result in the shutdown of all computer equipment to the point where all systems would have to be re-booted and any data stored in random access memory (RAM) is lost.

With this in mind, more and more computer installations are incorporating uninterruptible 240VAC power supplies. These go much further than the large diesel-alternator sets employed by some organisations to ensure total power reliability. Such diesel alternator sets can



The Kenwood PR-630 dual tracking power supply can have the negative rail adjusted by $\pm 20\%$ with respect to the positive rail. Available from Parameters Pty Ltd.

Uninterruptible power supplies from Westinghouse

Westpower UPS units provide automatic or manual transfer from inverter operation to mains power or vice versa with absolutely no break in power.

Based on transistor regulated ferroresonant technology, the system is well proven, exceptionally robust and provides facility for very flexible load discrimination. The design provides an extremely low component count which significantly increases reliability when compared with other units. It can also operate continuously with a 100 percent imbalance of phases in a three-phase system (both single-phase and three-phase systems are available, as is any required output voltage).

Units rated up to 1kVA are normally available ex-stock and are housed complete with battery in attractive cabinets designed to harmonize with modern office decor.

Westinghouse Rectifier can also undertake on-site monitoring of power supplies using microprocessor-based equipment designed to identify a broad variety of mains aberrations. A full written report containing recommendations of the best solution to each client's individual problems is produced.

For further information contact Westinghouse Rectifier Pty Ltd, PO Box 267, Williamstown, Victoria 3016. Phone (03) 397 1033.

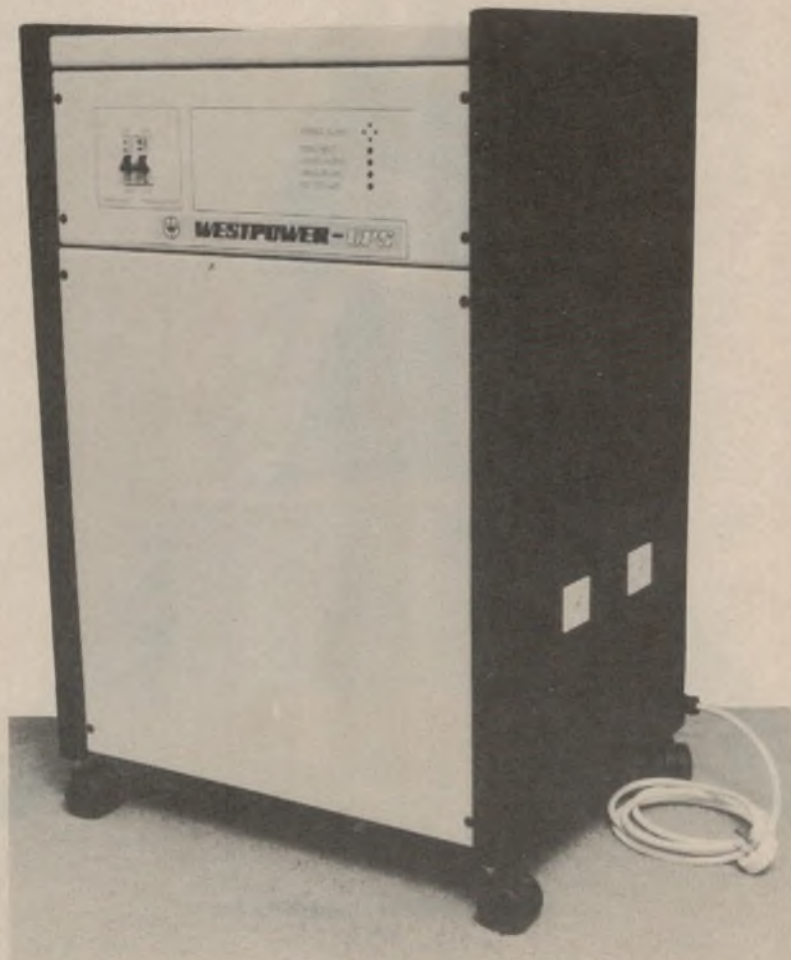

Power supplies

have power outputs of up to several megawatts but they inevitably have at least a few seconds delay between loss of the main supply and restoration of power by the dieselalternator.

By definition, an uninterruptible power supply is never interrupted, no matter how briefly. It consists of a battery and charger circuit, and an inverter which produces a 240VAC sinewave output. This feeds all parts of a computer system which are likely to lose data if power is interrupted.

Uninterruptible power supplies (UPS) can take two forms — off-line and on-line. The off-line UPS is also sometimes referred to as a battery-backup system. In this system, only the battery charger circuit is active all the time, keeping the batteries fully charged while ever the AC mains supply is present.

However, when the AC mains voltage

Bulgin power supplies and DC-DC converters

Rifa has released a range of encapsulated and Eurocard power supplies manufactured by Bulgin of the UK. The fully encapsulated DC-DC converters are available in a variety of input and output configurations and are packaged for convenient PCB mounting, enabling high board densities to be achieved.

The Eurocard DC-DC converters can be supplied in single and triple outputs with current ratings up to 20 amps.

For further information contact Rifa Pty Ltd, 202 Bell Street, Preston, Victoria 3072. Telephone (03) 487 3333.

drops below a preset trigger level, the UPS automatically comes on-line. The inverter switches on and the output sockets are switched from the AC mains to the inverter output. The typical switchover time for an offline UPS is under 10 milliseconds which is less than a half-cycle duration of the 50Hz mains.

An example of an off-line UPS is the Exide Powergard. This system has an off-line square wave inverter driving a

constant voltage transformer. Thus it serves a double purpose as line conditioner and UPS. Another off-line example is the Densel UPS range from Amtex Electronics.

By contrast, an on-line UPS has its inverter running all the time, supplying power to the load. In the event of a mains supply failure there is absolutely no power interruption, since there is no switchover function.

Exide UPS has inbuilt line conditioner

The new Exide Powerguard UPS (uninterruptible power supply) from Chloride is an off-line design which incorporates a constant voltage transformer to both condition mains power and provide up to one hour's standby power for computer and other crucial systems.

The Exide Powerguard uses explosion-proof RELB batteries which are totally sealed and maintenance-free. It comes in three models, rated at one, two or 10kVA. The 2kVA model takes up 430 to 500mm of floor space and sits 565mm high.

For further information, contact Chloride Industrial Division, 55 Bryant Street, Padstow, NSW 2211. Telephone (02) 774 0500.



Statronics

MODULAR POWER SUPPLIES

- Current Limiting • Compact Size • Modular or Bench Versions.
- Adjustable Crowbar Overvoltage Protection (except 53/2) • Over Temp Protection • 5mV Ripple • 0.5% Line Regulation • Wide Adjustment

VOLTAGE	CURRENT	MODEL
12 to 15V	1A Dual	53/2
12 to 15V	3A	53/3
24V	2.5A	53/4
5V	3A	53/5
12 to 15V	1A Dual	53/6
5V	0.25A	53/7
24V	0.7A Dual	

- Extremely high efficiency (>85%)
- Low output ripple and good regulation
- Cool running • No switching transients
- No R.F. interference • Protected against short circuits • Heavy duty industrial construction • Withstands 15% line fluctuations with no change in efficiency
- 5 year warranty

VOLTAGE	CURRENT	INPUT	MODEL
24V	5A	240V	FE1
28V	5A	240V	FE2
24V	5A	110V	FE3
28V	5A	110V	FE4
13.8V	10A	240V	FE5
13.8V	10A	110V	FE6

VOLTAGE	CURRENT	MODEL
24V	20A	FER339
28V	18A	FER344
24V	15A	FER3R

Statronics 53 Series

NEW COMPACT HIGH EFFICIENCY POWER SUPPLIES!

Just imagine a 12W supply in the space of a matchbox!



Made in Australia

... Yes it's possible with the new Statronics Thick Film Hybrid Switching Power Supplies. Look at the specs —

- No external Components
- Input Undervoltage Lockout
- 80 to 85% Efficiency (+0.5W overhead)
- 3750V rms 1min Input Isolation
- Better than 5% Regulation
- Better than 100mV Ripple and Noise on 5V supply
- 60° C ambient operation
- Converters over 5W have better than 1mV rms reflected input noise

Very competitive pricing. Check the table and call NOW!

Input Range	Sep. Outputs	Total Power (W)	Dimensions (mm) LxWxH
	Vrms	V	
Power Supplies			
90-280	5, 12, 12	5	70x25x15
95-280	5, 12, 12	7.5	70x25x15
200-280	5, 12, 12	10	70x25x15
90-280	5, 12, 12	15	95x30x20
90-280	12	15	95x30x20
200-280	5, 12, 12	20	95x30x20
200-280	5, 12, 12	30	95x30x25
Converters			
21-63 DC	5, 5	5	25x25x15
21-63 DC	5, 12, 12	7.5	70x25x15
21-63 DC	5, 12, 12	10	70x25x15
21-63 DC	5, 12, 12	20	95x30x20
21-63 DC	5, 12, 12	30	95x30x25
Conventional "Open Frame" Type			
21-63 DC	5, 12, 12	70	150x65x50
200-280	5, 12, 12	70	150x65x50
90-140rms	5, 12, 12	70	150x65x50

STATRONICS POWER SUPPLIES

103 Hunter Street
HORNSBY 2077
Tel: (02) 476 5714, 477 5152





MELCHER

POSITIVE SWITCHING REGULATORS — PSR
NEGATIVE SWITCHING REGULATORS — NSR

INPUT VOLTAGE RANGE

PSR — +8 ... +80VDC
NSR — -8 ... -80 VDC

OUTPUT VOLTAGE RANGE

5V, 12V, 15V, 24V, 36V
-5V, -12V, -15V, -24V, -36V

OUTPUT CURRENT

DEPENDENT ON TYPE
FROM 2 AMP TO 12 AMP

OTHER FEATURES

HIGH EFFICIENCY 77 ... 94%
ADJUSTABLE OUTPUT VOLTAGE
COMPACT DIMENSIONS

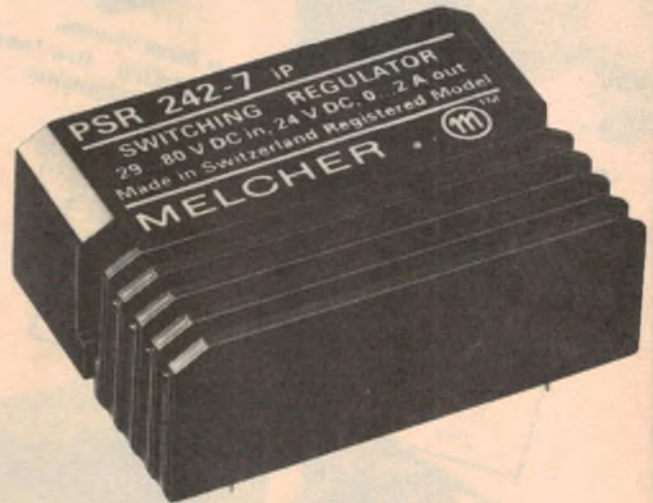

AVAILABLE FROM:

JESEC — SWITCHES PLUS COMPONENTS



569 Hampton Street,
Hampton, Vic. 3188
Telephone: 598 2333

AGENTS: N.S.W. — 635 0799
QLD. — 369 1277
S.A. — 277 3288
W.A. — 275 5522



LABORATORY POWER SUPPLIES

GPR-SERIES

- Single output, variable voltage and current
- Analog or digital display of voltage and current
- Fine and coarse voltage control
- Fully protected
- High regulation
- Excellent value
- Range limits: 0~18v to 500v and 0~1A to 30A



TYPICAL RANGES —

GPR-1810:	0~18V, 0~1A
GPR-1830:	0~18V, 0~3A
GPR-3020:	0~30V, 0~2A
GPR-3030:	0~30V, 0~3A
GPR-3060:	0~30V, 0~6A
GPR-6030:	0~60V, 0~3A

12 MONTH WARRANTY

GPQ-SERIES with QUAD output.

The new GPQ-Series power supplies have 2 VARIABLE outputs and 2 fixed, 5V outputs. Push button selection configures the VARIABLE outputs to any of the following operating modes:

- DUAL INDEPENDENT
- DUAL TRACKING
- SERIES OPERATION
doubles output voltage
- PARALLEL OPERATION
doubles output current



RANGES —

Models	Variable output configurations	Fixed outputs
GPQ-1850	2 x 18V, 5A or 36V, 5A or 18V, 10A	5V, 3A; 5V, 1A
GPQ-3020	2 x 30V, 2A or 60V, 2A or 30V, 4A	5V, 3A; 5V, 1A
GPQ-3030	2 x 30V, 3A or 60V, 3A or 30V, 6A	5V, 3A, 5V, 1A

12 MONTH WARRANTY



EMONA INSTRUMENTS

OUR NEW ADDRESS

86 Parramatta Road
Camperdown 2050
Phone: (02) 519 3933

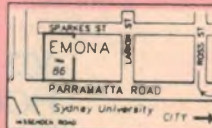

ALSO AVAILABLE FROM:

NSW David Reid Electronics	TAS George Harvey Electronics Hobart
Geoff Wood Electronics	George Harvey Electronics Launceston
QLD Ballec Systems Pty Ltd Brisbane	WA Hincro Engineering Pty Ltd Perth
Nortek Townsville	SA Int'l Communication Systems Pty Ltd
VIC Radio Parts Group Melbourne	Port Adelaide

What's new in power supplies

UPS time limitations

Regardless of whether a UPS is on-line or off-line, there is a definite limit on how long inverter operation can be maintained. On some models, with low battery capacity, this may only be a few minutes. The actual time of operation will also depend on the difference be-

tween the full load rating of the UPS and the power drawn by the computer.

In many cases, the UPS need only maintain computer operation long enough for all data to be saved and the computer safely shut down. In other cases operation must be maintained for much longer periods which necessitates

much larger battery capacity.

Another way of classifying uninterruptible power supplies is by their waveform shape. Many have a square wave output, some have sinewave output and others have a fair approximation to a sinewave. The square wave types are the simplest but they can cause prob-

150W 4-output switcher from Setec

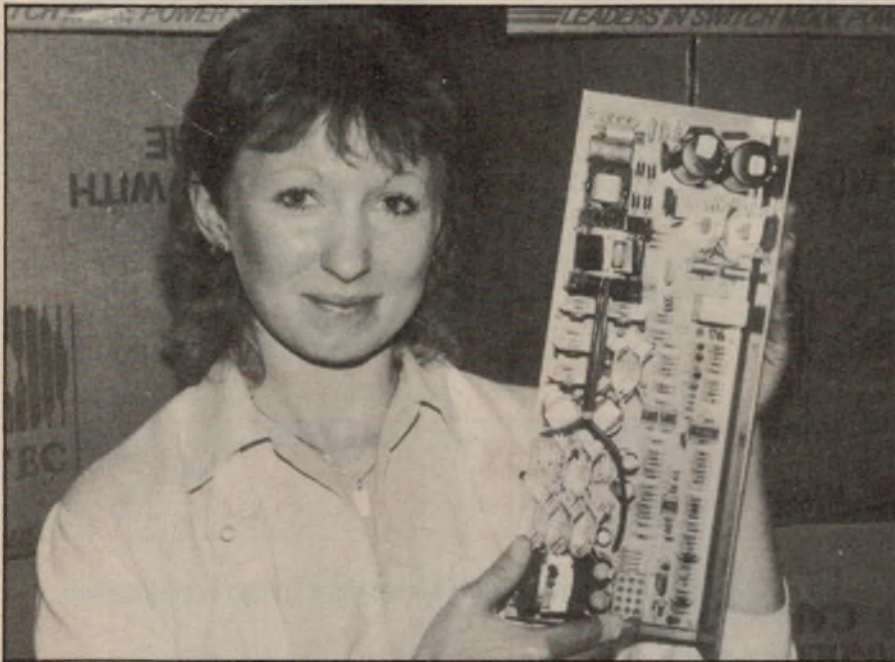

Australia's largest producer of switchmode power supplies Setec, has introduced a new 150 watt, 4-output rail switcher. The SP1502 quad output switcher has built-in line filtering designed to meet international requirements for isolation and EMI/RFI specifications, FCC and VDE 8071 level A. The SP1502 safety standards are designed to meet IEC 435, C22-2 No. 154 and has UL 478 certification. No. E98939.

The main 5V output is rated at 20 amps while the three auxiliary outputs are +12V at 2A (4A peak), -12V at 2A and -5V at 0.5A.

Hold up time is greater than 20ms at full load and efficiency is greater than 70% at full load. The unit features line and load regulation to better than 0.5% on all rails, along with overvoltage protection. Price is \$231 for quantities of 100.

For further information contact Ian Hansen, Setec Pty Ltd, 6 Holloway Drive, Bayswater, Victoria 3153. Phone (03) 762 5777.

"Hoots, mon! Let Angus Mac Westinghouse show you how to save your computer money."



Westinghouse Systems COMPUTER PROTECTOR

'After three years, still the most cost effective'

... protects your computer memory against spikes, glitches, lightning, on-off switches, electric motors etc. Max. peak surge current up to 4500 amps; transient energy absorption up to 75 joules.

PIF3-1A	1AMP	2STAGE	-ELC	\$88	PIF3-10A	10AMPS	2STAGE	-ELC	\$102
PIF3-3A	3AMPS	2STAGE	-ELC	\$91	Plus Sales Tax if applicable Add pack/post				
PIF3-6A	6AMPS	2STAGE	-ELC	\$96	Bankcard and Visacard, Vic & NSW only				

Prices subject to change without notice

80-86 Douglas Pde., Williamstown, Vic. 3016. Tel: (03) 397 1033. Tlx: 37477.

N.S.W.: Bryan Catt Industries P/L Tel: (02) 526 2222.

QLD: Colourview Wholesale. Tel: (07) 275 3188 S.A.: F.R. Mayfield P/L. Tel: (08) 212 3161.

W.A.: Geo. Moss P/L. Tel: (09) 446 8844



WS26

Power supplies

lems with computer switchmode power supplies which are running at close to their load limit.

The reason is that the peak and RMS values of a square wave are the same. In other words, the peak value of a 240V RMS square wave is 240V which is about 100 volts less than the peak value of a 240V RMS sine wave. This difference can prejudice the operation of most switchmode power supplies.

Sine wave outputs can be obtained from inverters by two methods. First, there is the square wave inverter feed-

ing the constant voltage transformer, as mentioned above. This method is simple and straightforward.

The second method involves an inverter with a pulse width modulated output. Here, instead of having an output pulse waveform with a 50% duty cycle (as in a square wave), the output is a train of pulses with varying width so that the power output approximates that from a 50Hz sine wave. The pulse width modulated waveform is applied to a filter network which then gives quite a clean sine waveform.

Novel Australian designed switchers from Statronics

A newly released range of hybrid switching power supplies and converters designed and manufactured in Australia have used novel techniques to achieve unusually good performance in a very small volume.

Superior regulation for very wide swings in input voltage is claimed to be easily achieved in these new power supplies and very tight transformer coupling and Schottky rectifiers yield good load regulation.

The transformers are insulated to VDE and IEC standards and vacuum impregnated. The entire converter is conformal coated — the package not being hermetically sealed. Feed-through pins for printed circuit mounting are PTFE insulated, and incorporate bushes to stand the package up off the board to enhance board washing and ventilation.

For further information contact Statronics Power Supplies, 103 Hunter Street, Hornsby, NSW 2077. Telephone (02) 476 5714.

New SMPS control circuits

Rifa has announced the release of two new SMPS control circuits. Both ICs are in 16-pin DIP packages, with the RL3525A featuring auto feed-forward compensation and programmable current limiting with auto symmetry correction in current

mode. The improved version RL3846 includes the above and drives mosfet or bipolar transistors directly.

For further information, contact Rifa Pty Ltd, 202 Bell St, Preston, Victoria 3072. Phone (03) 487 3333.

LABORATORY POWER SUPPLIES

APLAB offer a complete range of regulated DC bench rack power supplies combining high precision and regulation capabilities with continuously adjustable outputs.

Designed with single, dual and multiple outputs, these power supplies can be used in either constant voltage or constant current mode of operation.

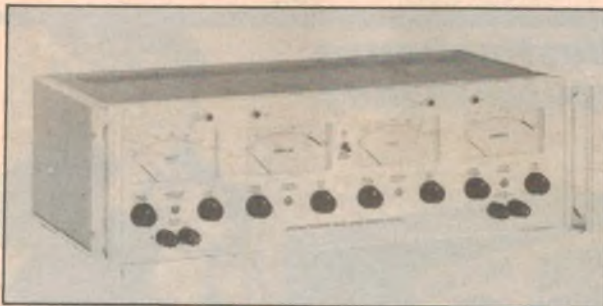

Standard models include:

SINGLE OUTPUT

OUTPUT: Output VOLTAGE: Current
0-30V 0-1A to 30A
0-70V 0-2A to 10A

DUAL OUTPUT
0-30V 0-1A to 2A

MULTIPLE OUTPUT
0-30V 0-2A to 5A



SCIENTIFIC DEVICES AUSTRALIA PTY. LTD.

VIC 2 JACKS RD. SOUTH OAKLEIGH 3167
PHONE: (03) 579 3622 TELEX: AA32742
NSW 559A WILLOUGHBY RD. WILLOUGHBY 2068
PHONE: (02) 95 2064 TELEX: AA22978
S A 31 HALSEY RD. ELIZABETH EAST 5112
PHONE: (08) 255 6575 TELEX: AA88125

**EX
STOCK**

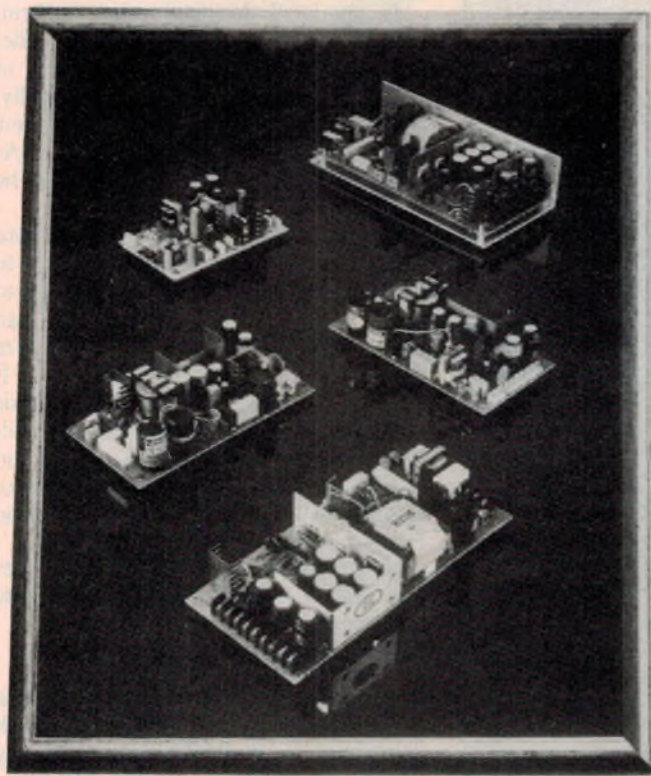

Boschert's XL range of switchers are flyback designs with multiple outputs. Available from Amtex Pty Ltd.

AN ASTONISHING NEW SOUND COMES TO CD

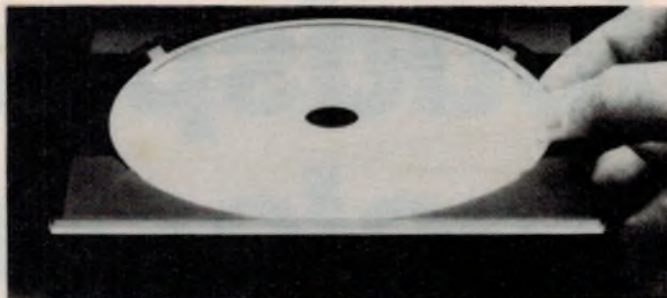

ULTRA



Clarity, transparency, imaging, openness...

Shure Ultra D6000 explodes the myth that all CD players sound pretty much the same. It ushers in a new generation of sound purity that transcends the whole notion of audio "reproduction" and brings the sense of the actual reality of a musical performance. It is the best and most natural music source available at any price.

Compensates for imperfect discs...

Its advanced laser system uses three beams instead of one: one reads the disc while the other two give micro-precise guidance to the reader beam—overcomes vibrations and disc imperfections.

PURELY PERFECT

The only 5-year laser warranty

The LONGLIFE™ laser tracking system is engineered for a minimum of 8000 hours of service (Replacing lasers on "bargain" CD units is prohibitively expensive)



ULTRA COMPACT DISC PLAYER



AUDIO ENGINEERS PTY. LTD
342 Kent Street, Sydney, NSW 2000
Ph: (02) 29-6731

AUDIO ENGINEERS (QLD) **MARKETEC PTY. LTD.**
Cnr. Jane & Buchanan Sts, 51 Scarborough Beach Rd,
West End, Qld 4101 North Perth, WA 6000
Ph: (07) 44-8947 Ph: (09) 242-1119

AUDIO ENGINEERS (VIC)
Ph: (03) 850-4329

How to build loudspeaker enclosures

You can build a pair of really beautiful loudspeaker enclosures, just like the ones shown on this page. All you need are a few standard domestic hand and power tools, and the ability to follow some simple techniques.

by GREG CARR



Photo 1: the finished loudspeakers, with and without the grille cloth.

C. Wright Mills noted that when the price of an item has nothing to do with the decision to purchase, then the buyer is among the super rich. Few readers are likely to be in this category so, when it comes to choosing loudspeakers, price inevitably forces a compromise.

In fact, it is not difficult to tie up \$10,000 of your capital on a pair of top-of-the-line loudspeakers, and that is not the top price if you are looking to get rid of some burdensome cash. No, dear reader, let's get back to the world in which the vast majority live, the world of hard choices and compromise. Sound familiar?

In any well designed stereo system, the loudspeakers, as a general rule, comprise a cost as high as the rest of the equipment combined. Additionally, their quality varies far more than any other component in the system. As such, careful consideration should be given to their selection.

Unfortunately, we can rarely afford the loudspeakers we would really like to have. However, if you are willing to build your own enclosures, you can have a far better loudspeaker system than would otherwise be the case! If you have a place to work, a few basic tools, patience and a willingness to follow the instructions herein, there is no reason why your loudspeaker enclosures should not be as well built and as good looking as any on the market.

In fact, your choice of finishes, sizes and shapes expands considerably if you build your own!

Designing Enclosures

The design of enclosures has been greatly aided by the original research conducted at the University of Sydney by Messrs Thiele and Small. Prior to their work, enclosure design had been, to a large extent, by rule of thumb and a lot of trial and error.

Thiele and Small replaced the guesswork with mathematics and revolutionised enclosure design forever. Now all reputable raw frame loudspeaker manufacturers publish "Thiele-Small Parameters" for use by designers. These parameters, when plugged into formulae, enable the designer to manipulate enclosure size, porting and performance to achieve a desired result.

The main drawback is that the formulae and parameters are not simple and, as a consequence, are beyond the scope of this article.

Fortunately, most manufacturers publish enclosure plans based on Thiele-Small parameters which provide considerable scope for the do-it-yourself enthusiast. If a suitable design is not available from the loudspeaker manufacturer, then a professional engineer should be consulted. Two such designers are: L & C Electro Acoustics, 50 Nowranie St, Summer Hill, NSW phone (02) 799 6742 and Mr. Richard Priddle, 123 Pacific Rd, Palm Beach, NSW phone (02) 919 5494.

A "prove the point" project

For many years I had wanted to upgrade my loudspeakers but couldn't afford any of the better quality commercial systems available on the market. Enter Mr Ian Muir of Emu Constructions in the Blue Mountains, west of Sydney. We discussed the problems of home loudspeaker builders and recently decided to build a pair of loudspeakers using standard domestic hand and power tools, and utilizing simple techniques. Most of what follows is a generic series of instructions which can be incorporated into any enclosure construction you choose.

On the other hand, if you want some enclosures built just for you, Ian Muir is one of the best for the job. You can telephone him on (045) 67 2195.

Selecting the driver

The Altec Lansing Model 604 duplex loudspeaker has been a standard for the music recording industry since World War II. In fact, the current-model Altec Lansing 604-8K serves in many recording studios as a master monitor.

This loudspeaker is a 15-inch (38cm) bass unit with a concentric horn tweeter mounted in the middle, hence the term 'duplex'. Not only is the quality of the reproduced sound extremely accurate, but they are also highly efficient, creating 100dB at a distance of 1.2 metres with an input of one watt!

Given that funds for amplifiers are generally limited, high efficiency is a



Photo 2: accurate mitre cuts can easily be made by clamping a straight plank to the panel and using this to guide the sole-plate of your power saw.

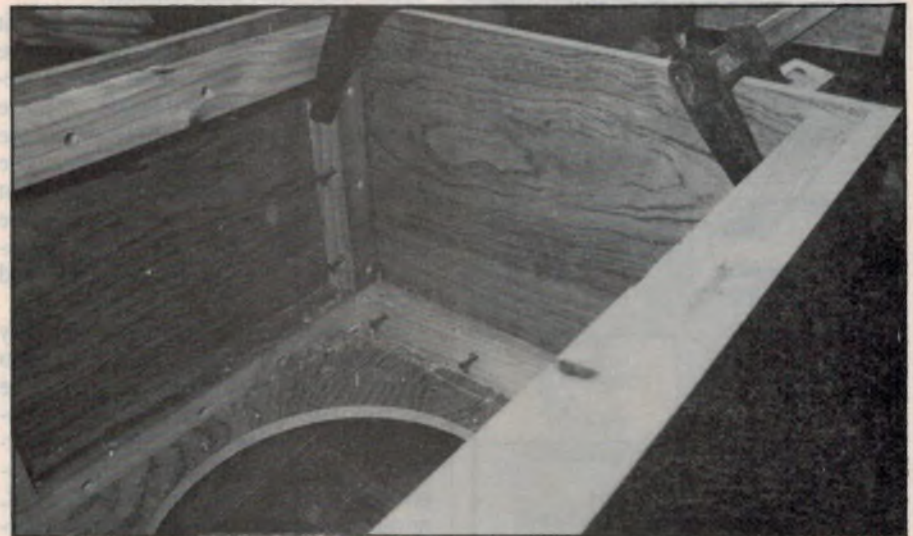

Photo 3: the partly assembled enclosure. Note the use of 45mm square cleats along the inside edges. The cleats should be glued and screwed into position as outlined in the text.

highly desirable trait. At an average listening level of 80dB, there is headroom of 40dB using a 100 watt amplifier. That amount of headroom enables the use of a compact disc player with no worries of overloading either the loudspeakers or the amplifier — unless I want more than 120dB SPL (sound pressure level) in my living room!

The 604-8K loudspeaker can be obtained from Altec Lansing (Australia), 133 Alexander Street, Crows Nest. Telephone (02) 439 488. The raw frame loudspeakers cost \$2730.00 retail and all other materials for the enclosures add about \$250.00. Therefore, for less than \$3000, I have a pair of loudspeakers in beautiful enclosures which would cost more than twice as much from your friendly hifi shop. That is an excellent deal!

The enclosure design

Mr Richard Priddle has designed a smaller than standard enclosure for the 604, the performance of which is quite flat down to 40Hz. The volume is 167 litres (5.9 cubic feet) and is moderate for a driver of this size and performance. This is an ideal combination of loudspeaker and enclosure and has been adopted by several Sydney recording studios for their master monitors. You can contact Richard at the telephone number given above if you wish to use his design.

The enclosure is of simple modern design and makes features of the loudspeaker, vents and crossover. There is an added plinth on the base and all front and top joints are mitred. The grille cloth is stretched over a simple

ECONOMIC ELECTRONICS

24 CAMPBELL ST
BOWEN HILLS, QLD 4006
TELEX: AA42883 FAX: (07) 52 2862
PH: (07) 52 3762

Also
SOUTHPORT ELECTRONICS SHOP
11 DAVENPORT ST
SOUTHPORT, QLD
PH: (075) 321 3622

**TEST EQUIPMENT
SALE!!!**

Topward

TFC 1211
COUNTER TIMER
5Hz-100MHz
25mVsens @ 80MHz
0.04uS-0.2S



\$429.00



TFC 1204
COUNTER
10Hz-650MHz
25mVsens @ 80MHz

\$490.00

TPS 2303D
POWER SUPPLY
LCD DISPLAY
30V/3A 4mVp-p
CAN BE USED AS
DVM UP TO 199.9V



\$346.00



TPS 4303
DUAL TRACKING
30V/3A POWER
SUPPLY 4mVp-p

\$498.00

TRIO

SG 402
RF SIGNAL
GENERATOR
100kHz-30MHz
O/PUT 0.1 Vrms
AM MODULATED



\$280.00



AG 202A
AUDIO SIG. GEN.
20Hz-200kHz
10Vrms MAX.
±1% DEV. DIST.
LESS THAN 0.5%

\$314.00

WE ARE NOW QLD AGENTS
FOR

chartpak

PRINTED CIRCUIT BOARD
ARTWORK AND ACCESSORIES
ALL PRICES PLUS 20% SALES TAX

frame and clipped to the front baffle. With or without the grille, the finished loudspeaker is indeed a handsome unit (see Photo 1).

Selecting the timber

The most economical material for constructing enclosures is a high quality particle board. There are many different types of particle board; some are suitable only for construction applications while some types are suitable for building furniture.

The finer particle, denser, multilayer boards are the most suitable for loudspeaker enclosure construction. The Brimsboard people make a 7-layer veneered panel of excellent quality and this is ideal for the job. Their panels are dense, rigid, machine well, and their acoustic qualities are unsurpassed. Furthermore, they hold screws and glue better than most solid timbers.

I selected the Brimsboard panels at Brims Distributors, in Fairfield (phone (02) 632 7583) and chose panels veneered in African Rosewood. I have never seen a more beautiful wood; the grain pattern looks like marble. The panels are veneered on both sides, but one side had more features than the other. For this project the most practical sheet size was 2.440m x 1.220m and 18mm thick.

The internal bracing was provided by 45mm-square pine, and this was used to assemble the panels and to brace the Brimsboard panels to render them non-resonant. It is important that the bracing be straight and square. The completed enclosure must be strong, rigid, non-resonant and airtight if it is to perform to specification.

To mitre or not to mitre

From the photo of the finished enclosures, it is obvious that the edges are mitre joints. Now most home builders consider that mitre joints are strictly in the province of the professional cabinet maker who has the necessary specialised tools. They further think that they should venture no further than butt joints and use veneer strips to cover the edges. As we have just indicated, such notions are incorrect.

The supposed advantage of butt joints is that cutting the panels and edge veneering is easier than cutting and aligning mitre edges. Of course, mitre joints look infinitely better and, to overcome the difficulties, Ian Muir and I have devised a few simple techniques. The resulting mitre joints take no more time and care than well made butt joints which require edge veneering.

Below is a guide for making accurate mitre cuts.

Setting up the circular saw: it is imperative to have a blade that is suitable for veneered particle board. Note that ordinary combination blades will chip or splinter the veneer on Brimsboard or any particle board.

If you happen to have a panel blade, it will be adequate provided it is sharp. Unfortunately, panel blades have been superseded by tungsten carbide tipped blades. If you must purchase a suitable blade, the description given in the list of tools is adequate.

Making accurate and straight cuts: first set the saw to make accurate 45 degree cuts by cutting scraps and adjusting the saw tilt until two bevelled cuts make a 90 degree joint when placed together. Use your square to judge the accuracy of the saw adjustment. Once done, mark the tilt indicator on the saw for quick resetting.

The method for making accurate long mitre cuts is to use a long straight plank (2.5m x 300mm x 20mm — see bill of materials) to guide the sole-plate of the saw (see Photo 2). You can obtain such a plank by cutting off a 300mm-wide strip from a plain piece of Brimsboard. The factory milled edge is accurate and, by clamping the plank to the panels, a rigid accurate guide is obtained.

Note that masking tape should be placed over the cut line as shown in the photograph. This further ensures that the saw will not chip or splinter the veneer. When removing the tape, peel parallel with the cut panel and out from the edge to prevent the tape from pulling away pieces of veneer.

Assembling mitre joints

Photo 3 shows a partly assembled enclosure. Note that there is a 45mm square cleat along the length of every inside corner. These cleats are screwed and glued in position. The screws serve to draw the mitre joints into position and to hold them firmly until the PVA glue sets. Result — an extremely strong and rigid construction!

The procedure is as follows: First, spread woodworking glue along one side of a cleat and carefully clamp it into position inside the bevel of one mitre joint. This done, screw the cleat to the panel at 150mm intervals and remove the clamps.

Next, spread a liberal layer of glue on the bevel and adjacent cleat side. You can now carefully mate the bevel of the next panel with the cleated panel and clamp them together. Finally, use

screws to secure the new panel to the cleat as before and you have a completed mitre joint!

Proceed in like fashion with all panels.

Order of assembling panels

Because you will be working inside the enclosures for much of the time, ease of access to the cleats and panels is important. Carefully consider the order of panel assembly which will be determined by the design of the enclosures.

The enclosures pictured in this article have mitred edges where the front sides and top meet; the back and bottom panels were butt jointed. The bottom uses a plain piece of Brimsboard and is fitted inside the surrounding panels against the cleats and screwed from the outside. The order of assembly was as follows: the two sides to the front baffle, then the top, next the back and finally the bottom.

Some notes on screws

Each enclosure for this project required about 200 screws, so let me give you a few hints to save your wits! First, always use 'twin fast' or particle board screws with Phillips or Posidriv heads. They are harder and stronger than most wood screws and the cross heads ease insertion of the screwdriver tip.

It is also a good idea to purchase hardened screwdriver tips which can be inserted into the chuck of a good variable speed drill. Using your drill to drive the screws will ease this task considerably, but be careful not to drive the screws all the way through the panels! The screws are used only for the purpose of clamping the panels to the cleats. Once the glue sets the screws are superfluous.

On a similar theme, each screw requires the drilling of a separate hole. In fact, for this project, it is necessary to drill a pilot, anchor and countersink hole for each screw. The countersink was necessary to give the 50mm-long screws a 10mm bite into the panels.

The easy way to do all this is to purchase a special purpose drill bit. The General Type Adjustable Screw Drill allows individual adjustment of the anchor, pilot and countersink, and a collar provides an accurate depth stop. Such a tool will save you many hours of tedious bit swapping.

Most enclosures have a grille cloth to hide the loudspeaker. However, there is a trend towards making a feature of the driver and crossovers in some designs. Photo 1 shows the enclosures with and without a grille cloth.



Photo 4: use your jig saw to make the cutout for the loudspeaker. Note use of masking tape to prevent chipping of the veneer.

If you want a grille cloth, simply make up a suitable frame and staple the cloth to the back. The frame can then be fastened to the enclosure using Velcro strips.

Finishing

Any imperfections in the joints can be filled with a colour matched wood filler. If you were careful in sawing and assembly, the gaps to be filled will be insignificant.

Use a fine garnet paper to sand the enclosures to a smooth finish. If you have a high speed orbital sander (10-20,000 rpm), use 280 or finer grit garnet paper. The Brimsboard is already well finished and needs only light sanding.

The veneer should be sealed and I chose *Satin Estapol*. The finish, however, is largely a matter of individual taste.

The final product

The completed loudspeakers come up in a very pleasing manner and their performance is equally impressive. Richard Priddle ran a frequency sweep to determine their range and cut off points. Measured in the 'far free field' their frequency response was 45Hz to 16kHz +/- 3dB and 42Hz to 20kHz +/- 5dB.

Subjective listening tests showed why these loudspeakers have been a standard reference monitor for over a generation. They are excellent and I look forward to many years of great stereo listening. In terms of value for money, they cost about \$3,000 all up and there is no doubt they would compare favourably with loudspeakers in the \$10,000 bracket.

In other words, the exercise proved to be well worthwhile. 

BILL OF MATERIALS

Below is a comprehensive list of all other materials used in the construction of the project:

- PVA glue
- screws: 10 x 50mm, 'twin fast' or particle board, Phillips head or Posidriv
- Wood Stop putty to match colour of veneer
- Satin Estapol
- R2 fibreglass insulation
- 50mm masking tape
- grille cloth to suit
- 12mm staples for staple gun
- No.280 garnet paper
- 25mm matching veneer strips

Tools

- circular saw, 7-1/4 inch or larger
- saw blade, tungsten tip, 10mm alternate top bevel with 60 or more teeth
- measuring tape
- F clamps x 2
- saw horses x 2 or a sturdy work bench
- planks x 2, 5mm x 25mm x 2.5m
- electric drill, variable speed
- jig saw
- hammer
- plank, straight and true, 2.5m x 300mm x 20mm (see text)
- staple gun
- drill bits
- Phillips or Posidriv bit for drill
- Countersink wood bit for screws
- square
- hand plane

F-111 cutaway

- 1 Hinged nose cone
- 2 Attack radar
- 3 Terrain-following radar
- 4 Nose hinges (2)
- 5 Radar mounting
- 6 Nose lock
- 7 Angle-of-sideslip probe
- 8 Homing antenna (high)
- 9 Forward warning antenna
- 10 Homing antenna (low and mid)
- 11 ALR-41 antenna
- 12 Flight control computers
- 13 Feel and trim assembly
- 14 Forward avionics bay
- 15 Angle-of-attack probe
- 16 UHF Comm/Tacan No 2
- 17 Module forward bulkhead and stabilization flaps (2)
- 18 Twin nosewheels
- 19 Shock strut
- 20 Underfloor impact attenuation bag stowage (4)
- 21 Nosewheel well
- 22 LOX converter
- 23 Rudder pedals
- 24 Control column
- 25 LOX heat exchanger
- 26 Auxiliary flotation bag pressure bottle
- 27 Weapons sight
- 28 Forward parachute bridle line
- 29 De-fog nozzle
- 30 Windscreen
- 31 Starboard console
- 32 Emergency oxygen bottle
- 33 Crew seats
- 34 Bulkhead console
- 35 Wing sweep control handle
- 36 Recovery chute catapult
- 37 Provision/survival pack
- 38 Attenuation bags pressure bottle
- 39 Recovery chute
- 40 Aft parachute bridle line
- 41 UHF
- 42 Stabilization-brake chute
- 43 Self-righting bag
- 44 UHF
- 45 ECM antennae (port and starboard)
- 46 Forward fuselage fuel bay (2,340 Imp gal/10,638 litres)
- 47 Ground refuelling receptacle
- 48 Weapons bay
- 49 Module pitch flaps (port and starboard)
- 50 Aft flotation bag stowage
- 51 Air refuelling receptacle
- 52 Primary heat-exchanger (air-to-water)
- 53 Ram air inlet
- 54 Rate gyros
- 55 Rotating glove
- 56 Inlet variable spike

- 57 Port intake
- 58 Air brake/undercarriage door
- 59 Auxiliary inlet blow-in doors
- 60 Rotating glove pivot point
- 61 Inlet vortex generators
- 62 Wing sweep pivot
- 63 Wing centre-box assembly
- 64 Wing sweep actuator
- 65 Wing sweep feedback
- 66 Control runs
- 67 Rotating glove drive set
- 68 Inboard pivot pylons (2)
- 69 Auxiliary drop tanks (500 Imp gal/2,273 litres)
- 70 Outboard fixed pylon (subsonic/jettisonable)
- 71 Slat drive set
- 72 Wing fuel tank (324 Imp gal/1,473 litres)
- 73 Leading-edge slat
- 74 Starboard navigation light
- 75 Flap drive set
- 76 Outboard spoiler actuator
- 77 Starboard spoilers
- 78 Inboard spoiler actuator
- 79 Flaps
- 80 Wing swept position
- 81 Auxiliary flap
- 82 Auxiliary flap actuator
- 83 Nuclear weapons and weapons control equipment package
- 84 Wing sweep/Hi Lift control box
- 85 Flap, slat and glove drive mechanism
- 86 Starboard engine bay
- 87 Yaw feel spring
- 88 Roll feel spring
- 89 Yaw trim actuator
- 90 Yaw damper servo
- 91 Roll stick position transducer
- 92 Pitch trim actuator (manual)
- 93 Roll damper servo
- 94 Pitch trim actuator (series)
- 95 Pitch feel spring
- 96 Pitch-roll mixer
- 97 Pitch damper servo
- 98 Pitch stick position transducer
- 99 Aft fuselage frames
- 100 Aft fuselage fuel bays (1,191 Imp gal/5,413 litres)
- 101 Horizontal stabilizer servo actuator
- 102 Starboard horizontal stabilizer
- 103 Aft warning antennae
- 104 HF antenna
- 105 Detector scanner
- 106 X-Band radar
- 107 Rudder
- 108 Integral vent tank
- 109 Fin aft spar
- 110 Fin structure

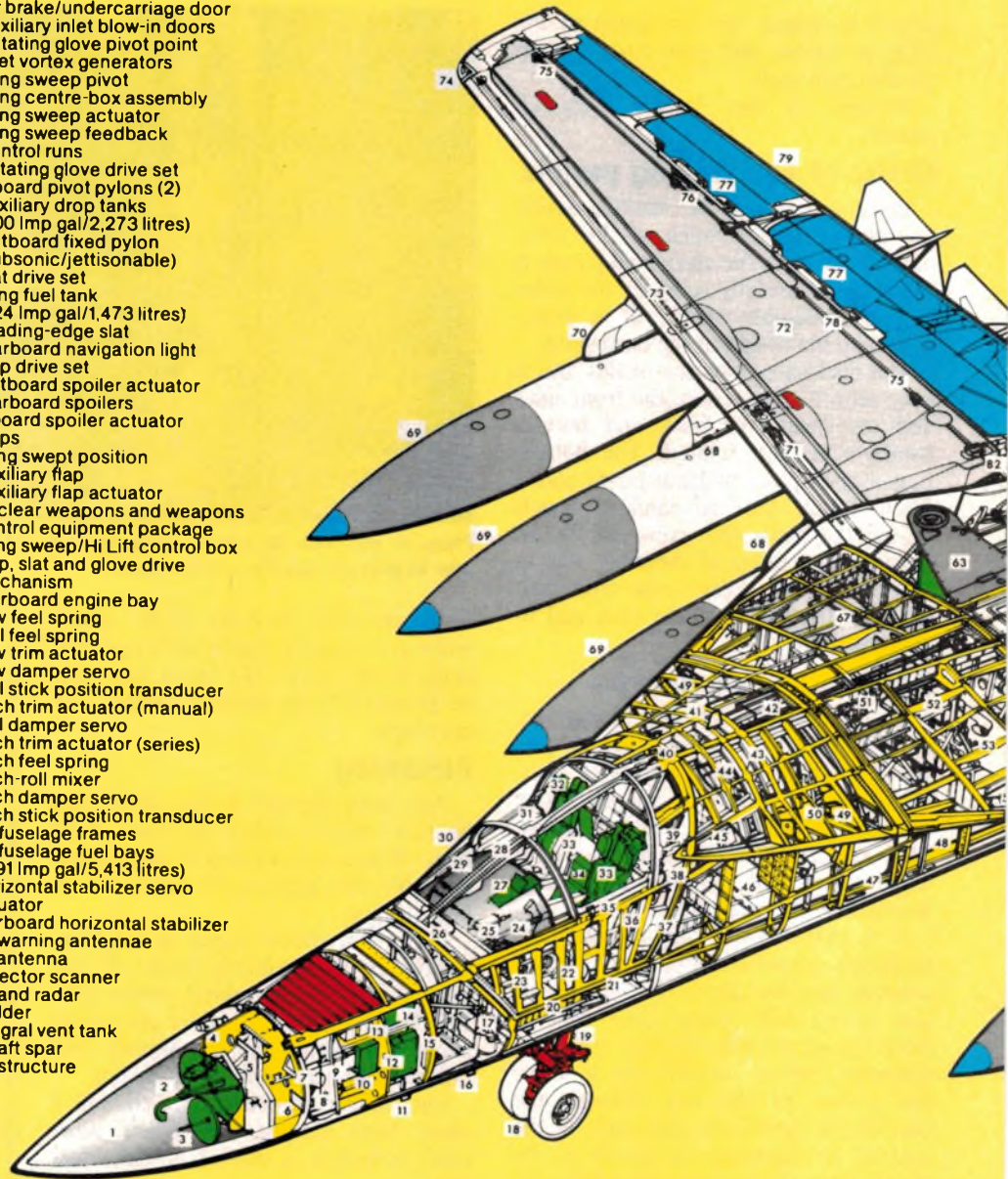

“Now put it back to

You're looking at a technological marvel.

It's called an F111C.

It's a high-performance, supersonic swing-wing strike reconnaissance aircraft.

An aircraft that has distinguished itself in several combat zones around the world.

It's a very complex machine made up of more than three million separate parts, each and every one vital to the aircraft's performance.

Indeed, for every hour of flying time, it must spend many on the ground being checked, double-checked and checked once again.

By perfectionists.

The men and women who perform the many tasks needed to keep it flying are RAAF technicians.

They learn their skills through our Certificate of Technology, Trade Apprentice and Adult Technical Training Schemes.

Quite frankly, RAAF technicians represent the very best in their various fields.

These include avionics, armaments, electronics, propulsion systems and even fibre optics.

Once posted to operational duties, we expect them to very quickly put themselves on a first-name basis with

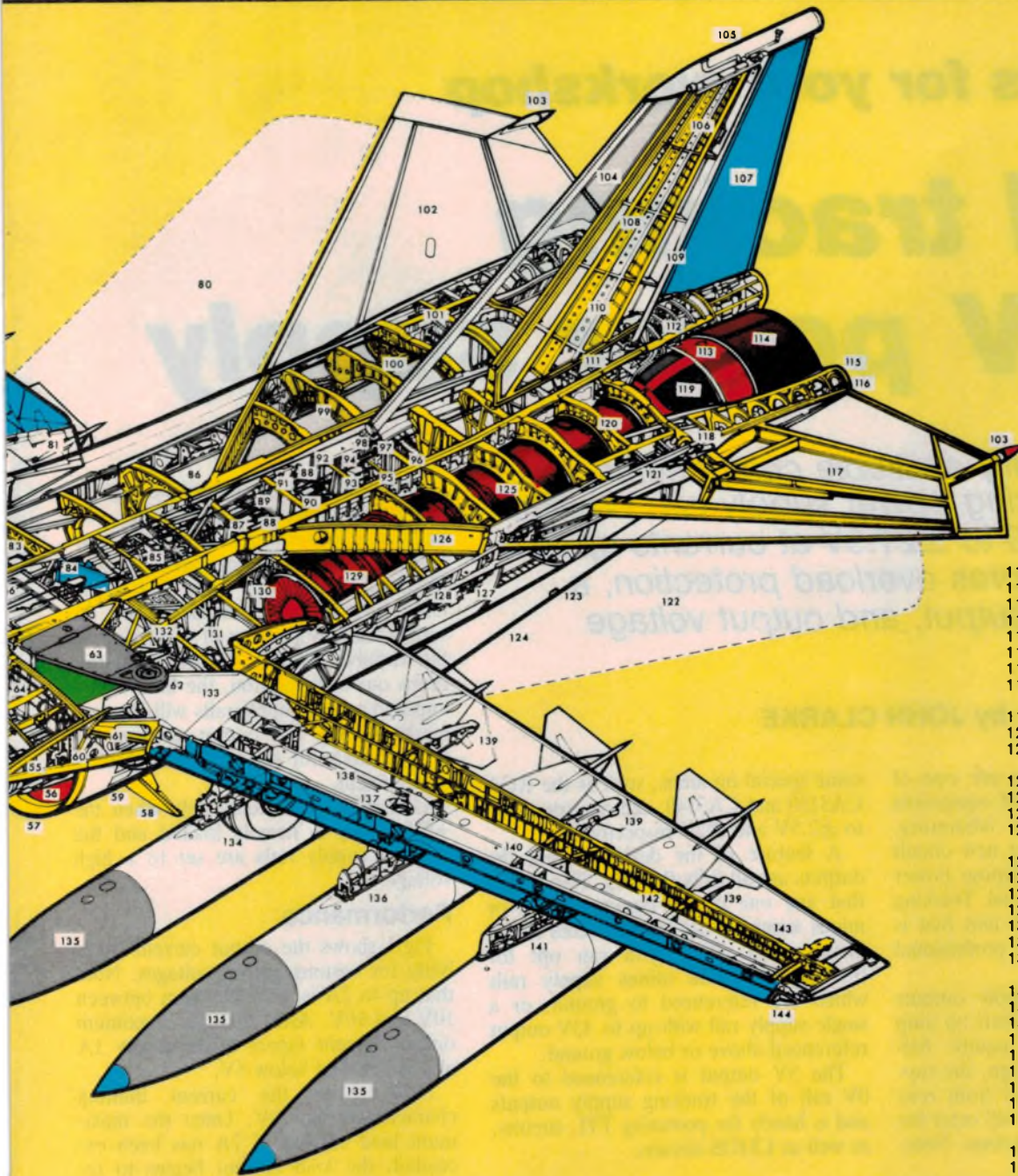

- 111 Fin/fuselage attachment
- 112 Rudder servo actuator
- 113 Variable nozzle
- 114 Tailfeathers
- 115 ECM antenna
- 116 ALR-41 antenna
- 117 Horizontal stabilizer structure
- 118 Horizontal stabilizer servo actuator
- 119 Free floating blow-in doors
- 120 Afterburner section
- 121 Horizontal stabilizer servo actuator
- 122 Wing swept position
- 123 UHF
- 124 Ventral fin
- 125 Fire detection sensing element loops
- 126 Cross frames
- 127 Engine access hatches
- 128 Engine accessories
- 129 Pratt & Whitney TF30 turbofan
- 130 Three-stage fan
- 131 Intake duct
- 132 Fire extinguishing agent container and nozzles
- 133 Wing box skinning
- 134 Port mainwheel
- 135 Auxiliary drop tanks
- 136 Pivot pylon
- 137 Pivot point
- 138 Pivot actuator
- 139 Flap racks
- 140 Fixed pylon strong point
- 141 Outboard fixed jettisonable pylon
- 142 Wing integral fuel
- 143 Wing box structure
- 144 Port navigation light

gether, Corporal!"

every nut, bolt, rivet and electrical circuit of their aircraft. And that could be any one of the 17 different types currently in service with the RAAF.

If this sounds demanding, you're absolutely right.

But these are the characteristics that make RAAF technicians the most sought-after by civilian employers.

If you think you've got what it takes to be the best in your field, fill in the coupon and send it off now.

All we require is that you're an Australian citizen.*

You must be between 16 and 21 with good results in English, Maths and Physics (17-34 years for Adult Training). You should also be reasonably fit.

*Or eligible to become one

To: RAAF Careers, GPO Box XYZ (in the Capital City nearest you).

Name _____

Address _____

Postcode _____

Telephone _____ Date of Birth _____

Highest Educ. level attained or being studied _____

Or phone an RAAF Careers Adviser on Adelaide 212 1455. Albury 21 8277. Bendigo 43 8008. Brisbane 226 2626. Canberra 57 2311. Geelong 21 1588. Hobart 34 7077. Launceston 31 1005. Melbourne 697 9755. Newcastle 26 3011. Parramatta 635 1511. Perth 325 6222. Sydney 219 5555. Townsville 72 4566. Wollongong 28 1855.

GROUNDCREW  **RAAF**

Authorised by Director-General of Recruiting, Dept. of Defence

RTA 116 DPS 96

Build this for your workshop

Dual tracking $\pm 21V$ power supply

Based on readily available components, this new dual tracking power supply can provide voltages from 0 to $\pm 21.5V$ at currents up to 2A. It also features overload protection, a fixed +5V 1A output, and output voltage metering.

by JOHN CLARKE

Variable power supplies are one of the most important items of equipment for the home workshop or laboratory. They are useful for testing new circuit designs and for general purpose power requirements. This new Dual Tracking Power Supply is a versatile unit that is ideal for both hobby and professional use.

The plus and minus supply outputs are ideal for powering modern op amp circuits which generally require balanced 15V rails. In this design, the supply outputs can be adjusted from zero up to about $\pm 21.5V$ which will cater for virtually all op amp applications. Note:

some special op amps, such as the RCA CA3130 and CA3140, can operate down to $\pm 2.5V$ and $\pm 2V$ respectively.

A feature of the design is that the outputs are all fully floating. This means that any one of the common, plus or minus terminals can be connected to the mains earth. Thus, you can opt for tracking plus and minus supply rails which are referenced to ground, or a single supply rail with up to 43V output referenced above or below ground.

The 5V output is referenced to the 0V rail of the tracking supply outputs and is handy for powering TTL circuits, as well as CMOS circuits.

Other features of this new design include load switching for both the +5V and variable outputs, short circuit protection, and a LED regulation dropout indicator. The latter does just as its name implies — it indicates when the supply has dropped out of regulation on the variable outputs. When the supply drops out of regulation, the hum superimposed on the supply rails will increase markedly and the output voltage will drop severely for any further increase in load current.

Generally, this occurs only when the +5V supply is heavily loaded and the variable supply rails are set to a high voltage.

Performance

Fig.1 shows the output current capability for various output voltages. Note that up to 2A is available from between 10V and 16V. After that, the maximum output current tapers off to below 1A above 20V and below 5V.

Fig.2 shows the current limiting characteristic at 10V. Once the maximum load current of 2A has been exceeded, the load current begins to reduce or "foldback" until, under short circuit conditions, the current is limited to 0.85A. The idea of this is to limit the dissipation in the output devices under overload conditions and thus prevent over-heating of the supply.

A 10-turn potentiometer is used to set the dual-tracking output voltage. Although a standard potentiometer could have been used here, the 10-turn pot allows easy adjustment of the output voltage to within 10mV of a desired value (provided that you have a digital multimeter).

A 10-turn pot also greatly reduces the risk of destroying a voltage sensitive circuit in the event that the control is accidentally knocked. This is because a 10-turn pot will only change the output by a small amount in these circumstances

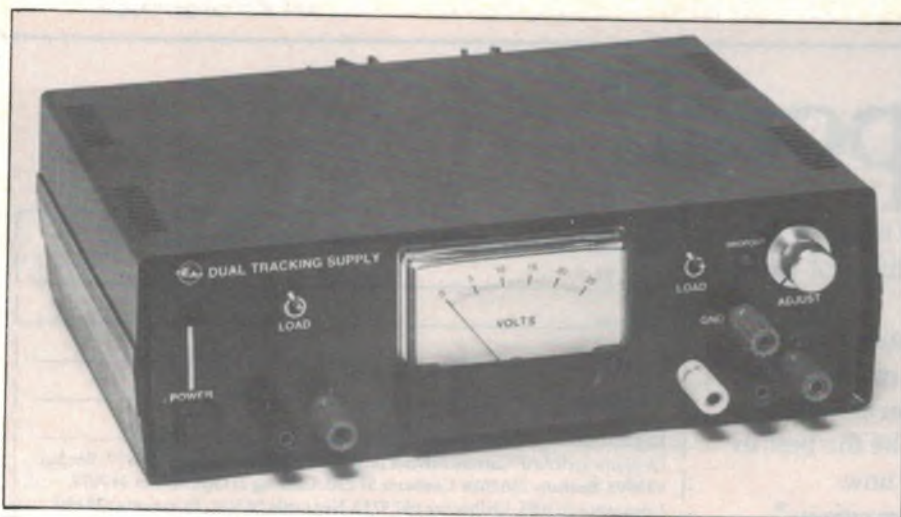

The supply is built into an attractive plastic instrument case.

Fig.3: the circuit uses a 3-terminal regulator to provide a 5V reference and series pass transistors for the tracking supplies.

while a standard pot could change the supply by several volts.

Tracking performance under no-load conditions between the positive and negative supplies is within 10mV. Note, however, that the absolute voltage difference between the plus and minus supplies could be as much as 100mV. The regulation performance is better than 100mV from no load to full load for each variable output.

How it works

The circuit for our new Dual Tracking Power Supply is rather unusual because it uses just one 3-terminal regulator — and that's to provide a reference voltage and the fixed +5V output. Conversely, the variable outputs rely on good old fashioned series pass transistors and operational amplifiers to provide regulation and tracking.

Regular readers of *Electronics Australia* may remember that our last dual tracking power supply in March 1982 used LM317 and LM337 3-terminal regulators for the tracking supply circuitry. We've discarded them for two reasons: first, they are now quite expensive; and second, their output voltage can only be adjusted down to a mini-

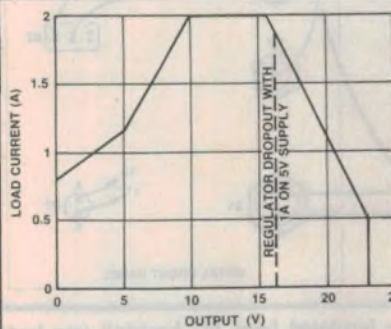

Fig.1: maximum output current vs. output voltage.

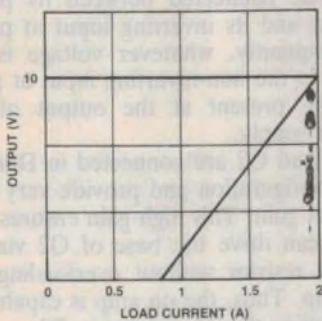
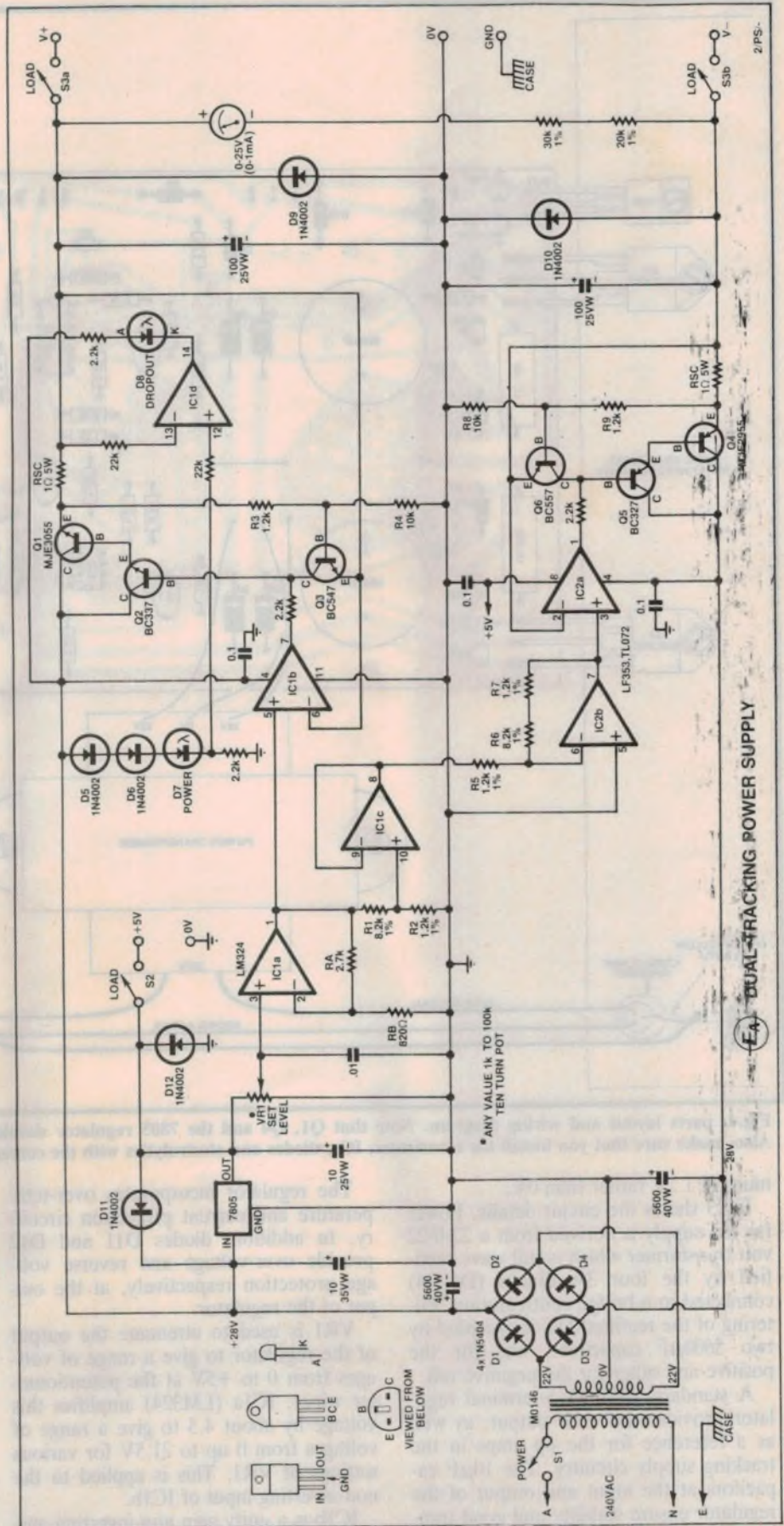

Fig.2: the current limiting characteristic at 2A. Note how the load current "folds back" after reaching 2A.



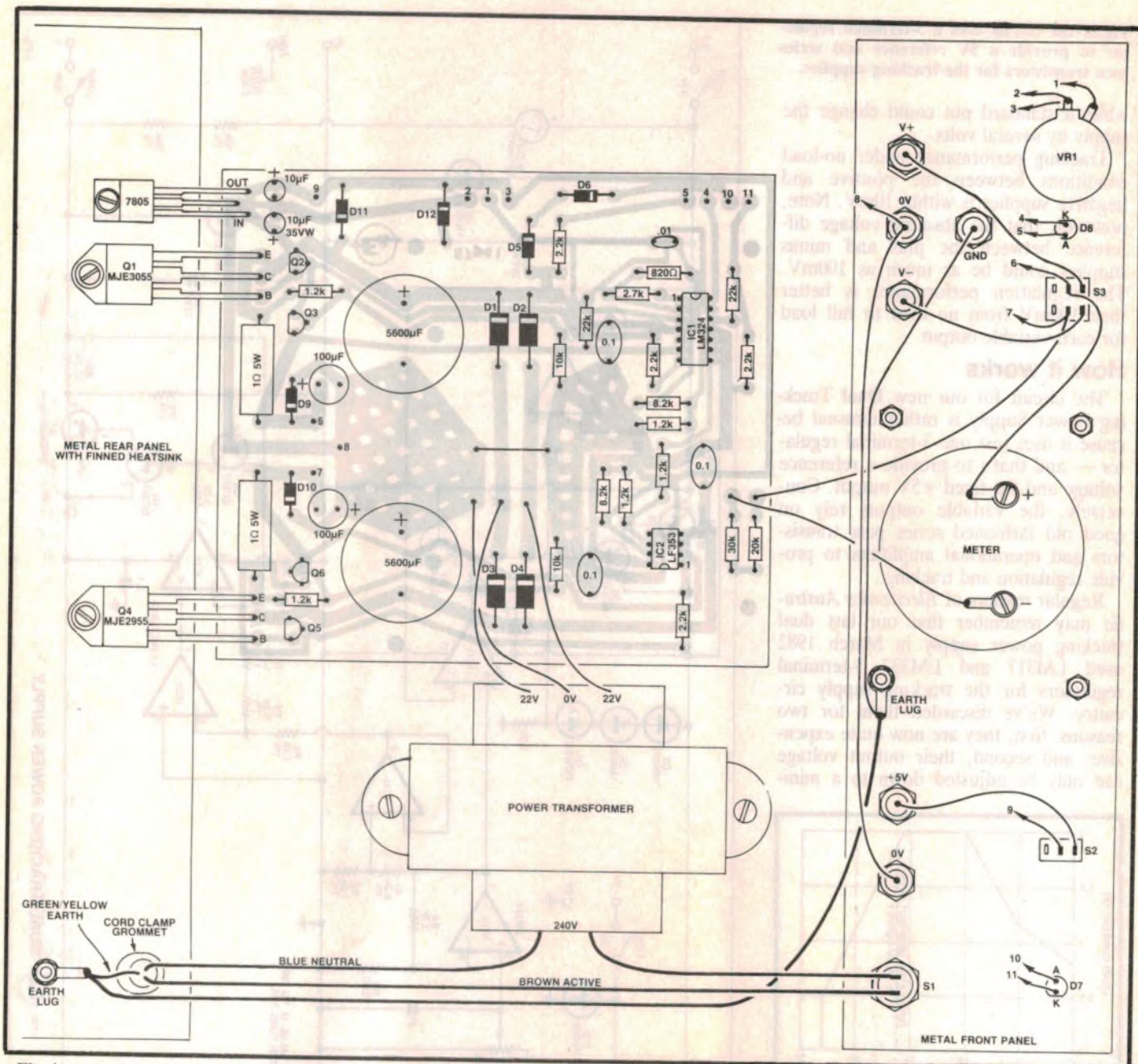

Fig.4: parts layout and wiring diagram. Note that Q1, Q4 and the 7805 regulator should all be insulated from the heatsink (see text). Also, make sure that you install the transistors, ICs, diodes and electrolytics with the correct polarity.

imum of 1.2V rather than 0V.

Fig.3 shows the circuit details. Power for the supply is derived from a 22-0-22 volt transformer which is full wave rectified by the four 3A diodes (D1-D4) connected in a bridge configuration. Filtering of the rectified DC is provided by two 5600µF capacitors, one for the positive and other for the negative rail.

A standard 7805 1A 3-terminal regulator provides the +5V output, as well as a reference for the op amps in the tracking supply circuitry. The 10µF capacitors at the input and output of the regulator ensure stability and good transient response.

The regulator incorporates over-temperature and current protection circuitry. In addition, diodes D11 and D12 provide over-voltage and reverse voltage protection respectively, at the output of the regulator.

VR1 is used to attenuate the output of the regulator to give a range of voltages from 0 to +5V at the potentiometer wiper. IC1a (LM324) amplifies this voltage by about 4.3 to give a range of voltages from 0 up to 21.5V for various settings of VR1. This is applied to the non-inverting input of IC1b.

IC1b is a unity gain non-inverting amplifier with a 2.2kΩ resistor, Q2, Q1

and Rsc connected between its pin 7 output and its inverting input at pin 6. Consequently, whatever voltage is applied to the non-inverting input at pin 5 will be present at the output of the power supply.

Q1 and Q2 are connected in Darlington configuration and provide very high current gain. This high gain ensures that IC1b can drive the base of Q2 via the 2.2kΩ resistor without overloading the op amp. Thus, the op amp is capable of controlling the 2A current in Q1.

Current overload protection for the positive supply is provided by Rsc and Q3. Rsc, a 1Ω 5W resistor, is used to

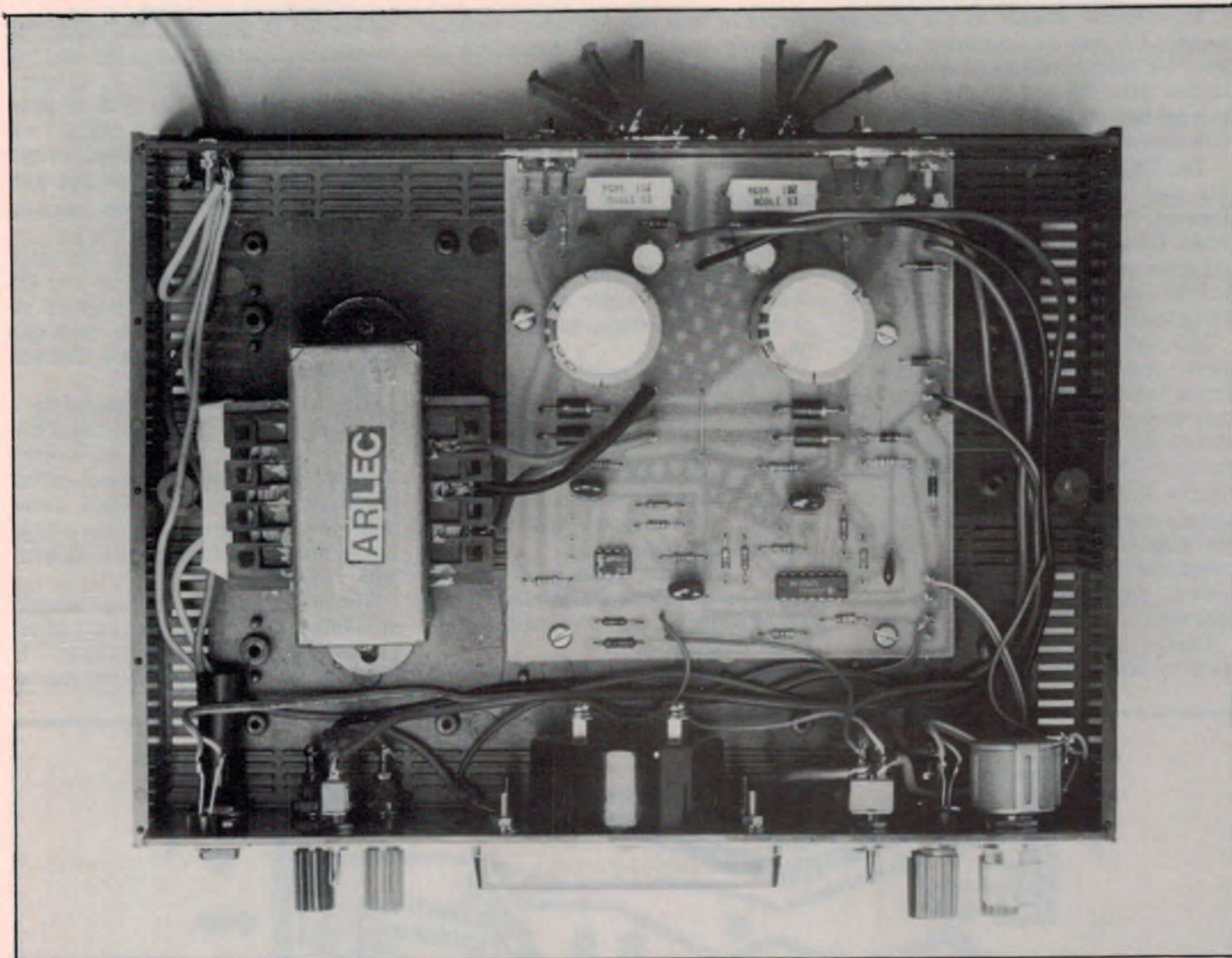

View inside the prototype. The two 1Ω 5W resistors should be mounted proud of the PCB to aid cooling.

detect an overload current through series pass transistor Q1.

At low load currents, the voltage at the emitter of Q3 is close to the voltage at the emitter of Q1 and so Q3 is biased off. As the load current increases, the voltage across R_{sc} also increases until, at about 2A, Q3 is biased on. This removes base drive to the Darlington pair (Q1 and Q2) and thus reduces the output voltage.

As the output voltage decreases, the voltage at the emitter of Q3 decreases at a faster rate than the voltage at the base. This effect is largely due to the voltage divider formed by R3 and R4. Less output current is now required to keep Q3 biased on, and thus the load current also decreases as the output voltage drops (see Fig.2).

This effect is commonly referred to as foldback current limiting and provides very effective short circuit and current overload protection for the series pass transistors.

Regulator dropout indicator

Comparator IC1d and LED D8 provide the regulation dropout indication. The non-inverting input (pin 12) of IC1d samples the input voltage to the regulator (via D5, D6 and D7), while the inverting input (pin 13) monitors the output voltage. When the voltage differential between the input and output of the regulator circuit becomes too small for regulation to take place, the output of IC1d goes low and the "dropout" LED turns on.

Diode D7 is the power indicating LED and typically has a voltage drop across it of 2V. In conjunction with the two 0.6V drops across D5 and D6, the total voltage drop between the collector of Q1 and the non-inverting input to IC1d is about 3.2V. Thus, the dropout LED lights when the input-to-output difference falls below 3.2V.

Note that the dropout indication circuit monitors the positive supply regulator only. However, the LED will also

light for negative supply dropouts. This is because any such dropout will also be reflected in the positive supply due to loading effects on the transformer.

The negative regulator circuit also derives its reference voltage from the +5V regulator. Resistors R1 and R2 attenuate the 0 to +21.5V output from IC1a by a factor of $R2/(R1 + R2)$, while IC1c buffers this attenuated voltage and feeds it to the inverting input of IC2b.

This attenuation is necessary to keep the output of IC1c (and thus pin 6 of IC2b) well below the +5V supply of IC2. To regain this loss of voltage, IC2b amplifies by $-(R6 + R7)/R5$. The resulting voltage at the output of IC2b (pin 7) is simply an inverse of the output from IC1a.

The negative regulator follows the voltage at the non-inverting input to IC2a. Q4 and Q5 are Darlington connected transistors which provide the gain and power handling capability for the negative supply.

In a similar manner to the positive supply, Q6 and its associated Rsc are used for short circuit and overload protection. Rsc, R8 and R9 determine the current limit threshold and the short circuit current.

The 100 μ F capacitors across the positive and negative outputs improve the transient response of the regulators, while D9 and D10 protect the output transistors from reverse voltages applied to the regulator outputs (eg, from charged capacitors).

The voltmeter circuit consists of a 1mA meter movement connected in series with two resistors across the plus and minus supply rails. Note that although the resistors set the full-scale deflection to 50V, the scale is calibrated 0 to 25V so that the meter indicates the voltage above and below the 0V rail. At the same time, because the meter is connected across both outputs, it will indicate any overload or shorts on either rail.

Finally, load switch S3a and S3b is used to disconnect the load from the

output of both plus and minus supplies. Similarly, load switch S2 disconnects the load from the +5V output.

Construction

Most of the parts are installed on a printed circuit board (PCB) coded 87ps1 and measuring 135 x 120mm. Start by checking the copper tracks for any breaks or shorts by comparing the published PC artwork with the actual PCB. It is far easier to locate and correct any problems at this stage, rather than later on.

Install the low profile parts on the PCB first, according to the parts layout diagram. These include the ICs, low power resistors, diodes and a wire link. Make sure that the ICs and diodes are oriented correctly before soldering them in place. Note that the two ICs face in opposite directions.

Next, install PC stakes at all external wiring points. These greatly simplify the job of wiring later on. You will require 16 PC stakes in all.

Assembly of the PCB can now be

completed by installing the capacitors, transistors, 3-terminal regulator and 5W resistors. The latter should be mounted about 1mm clear of the PCB to allow cooling. The TIP3055 and TIP2955 (or MJE3055 and MJE2955) transistors and 7805 regulator should be installed with full lead length as they must later be screwed to the rear panel.

Take care when installing the small signal transistors. Q2, Q3, Q5 and Q6 are all different and each must be installed at the correct location. Note also that Q6 faces in the opposite direction to the other transistors.

The completed PCB is housed in a plastic instrument case measuring 260 x 190 x 80mm and fitted with metal front and rear panels. The front panel carries the meter, controls and output terminals, while the rear panel carries a large finned heatsink to increase its heat dissipation capacity.

The PCB is supported on the integral standoffs in the base of the case and secured using self-tapping screws. It should be positioned towards the rear of

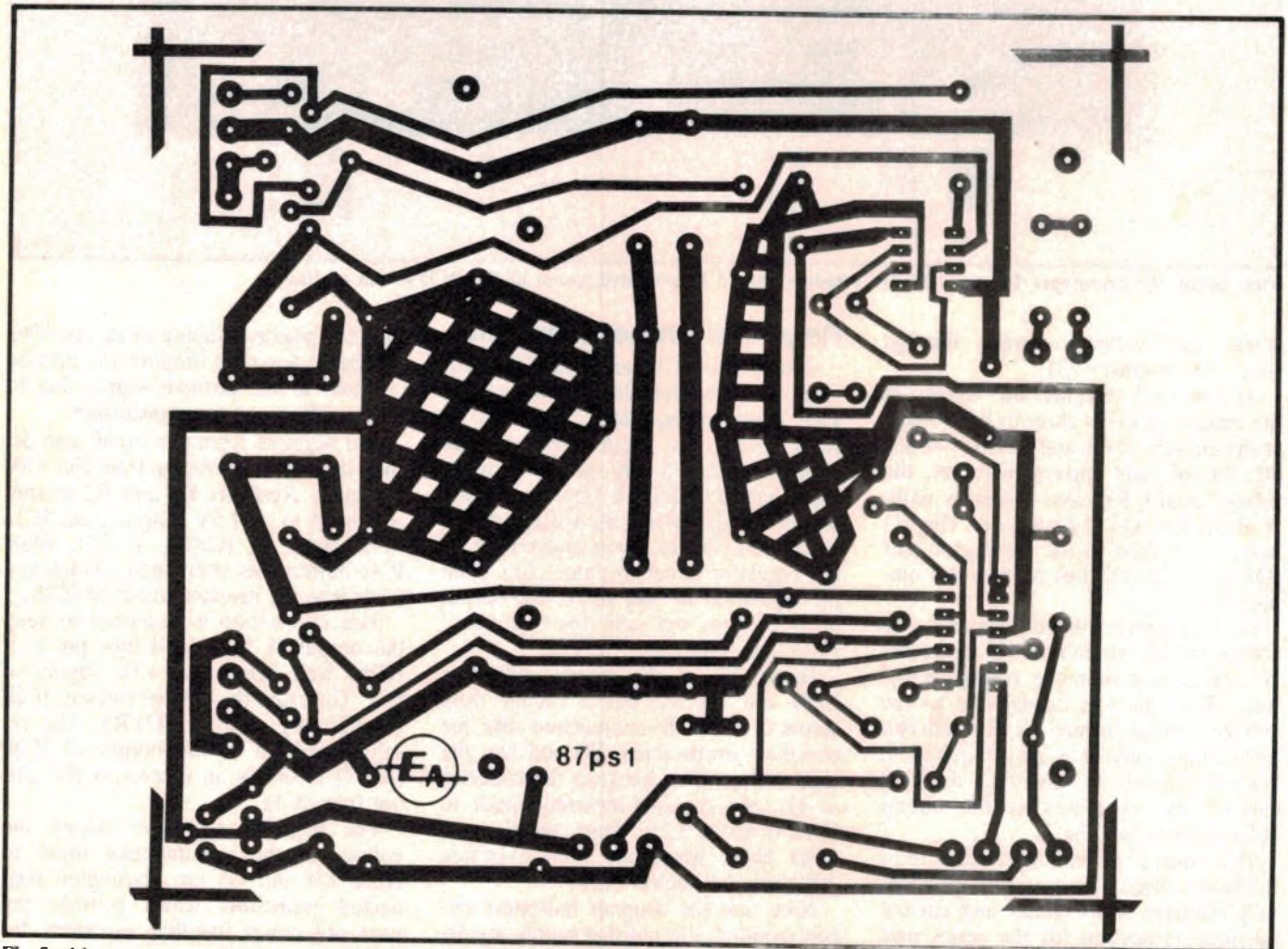

Fig.5: this actual size artwork can be used to make your own PCB. Ready-etched boards are available from retail outlets.

the case and with one row of plastic standoffs to the right of the PCB, as shown in the photograph.

Once the PCB has been installed, slide the metal rear panel into the case and mark the mounting hole positions for the transistors and regulator. You will have to bend the leads of each device slightly so that its metal face sits flush with the rear panel. The panel can then be removed and the mounting holes drilled to 2.5mm.

The heatsink is secured to the rear panel using the same mounting screws as for the series pass transistors. Use the rear panel as a template to mark out and drill the holes for the heatsink. In addition, you will have to drill holes in the rear panel to accept the cord clamp grommet and the earth lug mounting screw.

Fig.7 shows the heatsink assembly details. Note that a mica washer and insulating bush must be used to isolate each output device from the metalwork.

Before screwing the assembly together, make sure that all holes through the rear panel and heatsink have been countersunk and are free of swarf. This done, smear heatsink compound on all mating surfaces and screw the assembly

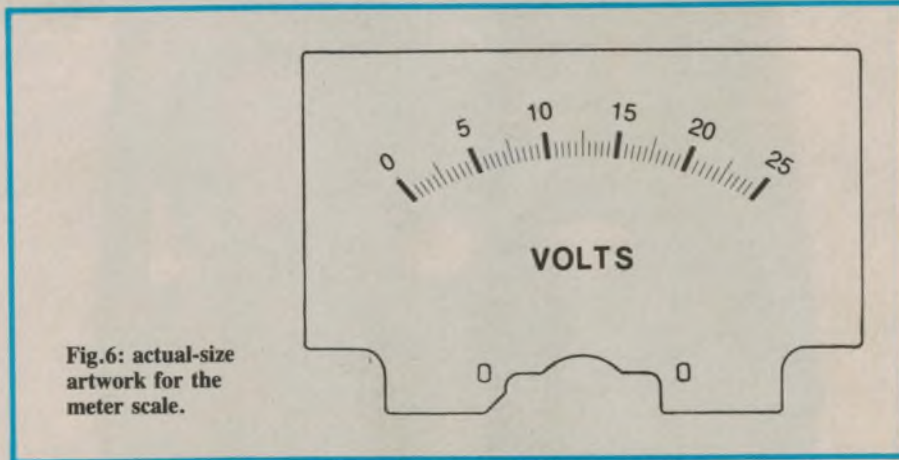

Fig.6: actual-size artwork for the meter scale.

together as shown in Fig.7. The nut for the regulator mounting screw should be installed on the inside of the case to give a neater result.

Finally, use your multimeter to check that the metal tabs of the output devices are indeed isolated from the heatsink. Repair any fault immediately if you detect a short circuit.

Front panel assembly

Work can now begin on the front panel. The first job is to mark out and drill the necessary holes, using the front

panel artwork as a guide. Do not secure the label to the front panel at this stage — that job comes later.

The meter is centrally located on the front panel and comes complete with a drilling template. Use this to mark out the panel, then drill the four mounting holes. The large clearance hole for the meter body can be made by drilling a series of small holes around the inside circumference of the marked circle and then filing to a smooth finish.

The front panel artwork can now be carefully affixed to the panel and the

52 ways to train for a job that pays more money!

FREE FACTS ON HOW YOU CAN QUALIFY FOR THE CAREER YOU WANT



No school can promise success, but if you want more security, more day-to-day satisfaction and a better future, send for the facts

Today, as never before, you need some kind of specialised training to qualify for the career of your choice.

International Correspondence Schools offers you the opportunity to qualify for the job you want ... more money ... more satisfaction and more personal growth. You need no previous experience and there is no need to change your daily routine. As an ICS student, you study at home, the hours you want. You waste no time travelling to and from class and you never have to miss a pay packet! But you are not alone. Skilled instructors are ready to help guide you step by step, grade your exams and make suggestions when needed. You move ahead one step at a time as fast or as slow as you want.

International Correspondence Schools
400 Pacific Highway, Crows Nest, NSW 2065 ☎ (all hours)
Sydney: 43 2121 or Austwide (TOLL FREE): (008) 22 6903
or ICS New Zealand Ltd, 45 Courtenay Place,
Wellington 1, New Zealand



MAIL COUPON FOR FREE FACTS

NOW!

International Correspondence Schools, a division of National Education Corporation
400 Pacific Highway, Crows Nest, NSW 2065 45 Courtenay Place, Wellington 1, New Zealand.

YES! Please send me without cost or obligation free facts on how I can study at home for the career I have chosen

TICK ONE BOX ONLY!

- Personal Computing
- Computer Programming
- Accounting for Managers
- Bookkeeping
- Practical Accounting
- Commercial Art
- Recreational Art
- Cartooning
- Auto Mechanic
- Small Engine Repair
- Motor Cycle Maintenance
- Diesel Mechanic
- Building Sciences
- Builders Drafting
- Architectural Assistant
- Carpentry & Joinery
- Drafting

- English Composition
- Basic English
- Secretarial Practice
- Clerk Typist
- Electronics
- TV Technician
- Basic Electronics
- Civil Engineering
- Electrical Engineering
- Mechanical Engineering
- Hydraulic & Pneumatic Power
- Restaurant & Catering Management
- Club Management
- Hotel/Motel Management
- Hotel/Motel Owners
- Interior Design
- Interior Decorating

- Executive Management
- Business Administration (IBA)
- Modern Management
- Small Business
- Marketing Mgmt. (AMI)
- Salesmanship
- Public Relations
- Copywriting for Advertising
- TV Script Writing
- Short Story Writing

- Journalism
- Fitness & Nutrition
- Dress Making & Pattern Cutting
- Pharmacy Assistant
- Classical Guitar
- Practical Photography
- Basic Refrigeration & Air Conditioning
- Commercial & Domestic Refrigeration & Air Conditioning 1986



Please complete:

Mr / Mrs / Miss _____ Age _____
(Please print clearly)

Address _____

Postcode _____

☎ (all hours) Sydney 43 2121 or Phone (Home) _____
Austwide (TOLL FREE) (008) 22 6903 (Optional)

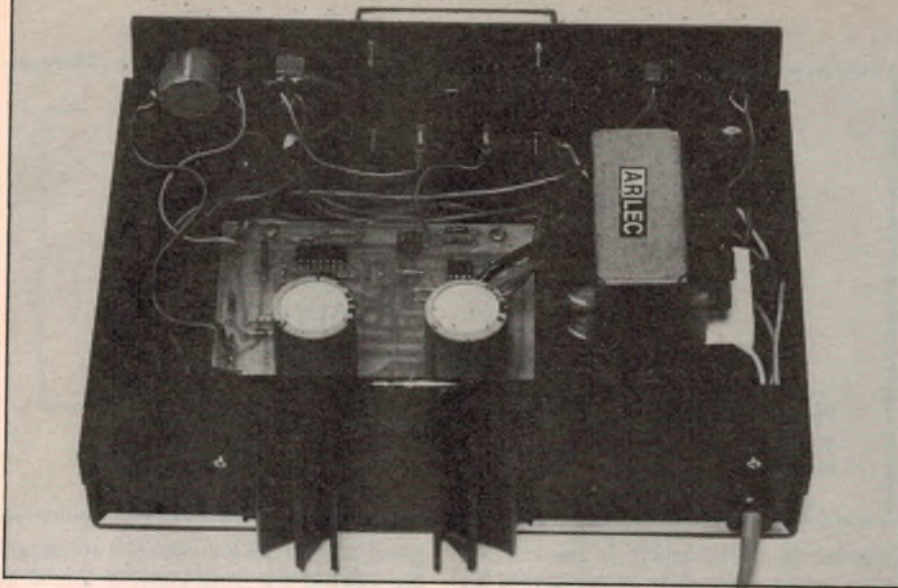

The finned heatsink aids heat dissipation and is secured to the rear panel using the transistor mounting screws. Note that the front and rear panels must be earthed (see Fig.4).

material covering the holes removed using a sharp knife. When this has been done, you are ready to mount the front panel hardware. Use red binding post terminals for the positive outputs, black for the 0V terminals, white for the negative terminal and green for the GND terminal.

A label is also provided for the meter. To fit this, first undo the two screws at the front, then remove the two small screws securing the original meter scale. The new scale can now be fitted and the meter reassembled.

All that remains now is to complete the wiring according to Fig.4. You can use rainbow cable to hookup the 10-turn pot, meter and the two LEDs only. All other wiring between the PCB and front panel should be run using heavy duty hookup wire (ie, to the switches and output terminals).

The transformer is mounted on two integral standoffs in the case and secured using self-tapping screws. Be sure to use 240VAC mains-rated cable for all mains wiring.

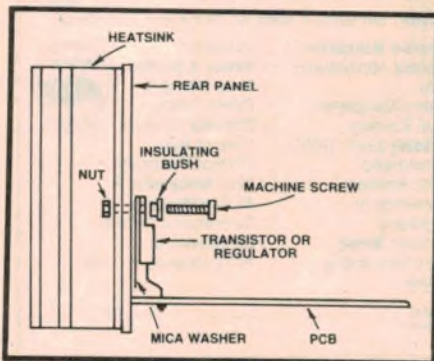

Fig.7: how the heatsink assembly goes together. Use your multimeter to check that the output devices are correctly insulated.

Before installing the mains cord, strip back the outer insulation so that the individual leads can reach from the rear panel to the power switch. The mains cord can then be clamped to the rear panel using the cord clamp grommet and the mains wiring completed. Sleeve the terminals on the mains switch and the transformer with plastic tubing to prevent accidental shock.

Now for the smoke test but first check your work carefully against the wiring diagrams. Do all leads go to their correct destinations? Are all components installed correctly? Is the mains wiring correct?

Powering up

Switch on and check that the unregulated supply rails are at about +28V and -28V. If these are OK, check that the output of the 3-terminal regulator is at +5V.

Now check that the voltage at pin 1 of IC1a can be varied from 0 to +21.5V by rotating VR1. Similarly, check that the voltage on pin 7 of IC2b can be varied between 0V and -21.5V. Finally, check that the tracking supply output voltage can be varied from 0V to $\pm 21.5V$ and that the two supplies track correctly.

The dropout indication circuit can now be checked by connecting a 4.7 Ω resistor across the +5V output. When this is done, the dropout indicator LED should light as soon as the tracking supply voltage is turned up beyond $\pm 17V$.

That's it — your new dual tracking power supply is ready for work. Just one final word: if the output voltage rises with anticlockwise rotation of the pot, simply reverse the outside connections for VR1 on the PCB.

PARTS LIST

- 1 PCB, code 87ps1, 135 x 120mm
- 1 front panel artwork, 252 x 77mm
- 1 plastic instrument case, 260 x 190 x 80mm
- 2 metal panels to suit case, 252 x 77mm
- 1 MU-52E 1mA panel meter
- 1 0-25V meter scale
- 1 22-0-22V 1.5A transformer
- 1 radial finned heatsink, 106 x 75mm
- 1 10-turn pot (any value 1k Ω to 100k Ω)
- 1 pushbutton mains switch
- 1 DPDT toggle switch
- 1 SPDT toggle switch
- 6 4mm binding posts, (2 black, 2 red, 1 white, 1 green)
- 1 20mm knob
- 1 cord clamp grommet
- 1 mains cord and plug
- 2 earth lugs
- 16 PC stakes

Semiconductors

- 1 7805T 5V regulator plus insulating hardware
- 1 LM324 quad op amp
- 1 LF351, TL072 dual op amp
- 1 MJE3055, TIP3033 NPN transistor plus insulating hardware
- 1 MJE2955, TIP2955 PNP transistor plus insulating hardware
- 1 BC337 NPN transistor
- 1 BC327 PNP transistor
- 1 BC547 NPN transistor
- 1 BC557 PNP transistor
- 4 1N5404 3A 400V diodes
- 6 1N4002 1A 200V diodes
- 2 5mm LEDs plus bezels

Capacitors

- 2 5600 μF 40VW PC electrolytic
- 2 100 μF 25VW PC electrolytic
- 1 10 μF 35VW PC electrolytic
- 1 10 μF 25VW PC electrolytic
- 3 0.1 μF metallised polyester
- 1 0.01 μF metallised polyester

Resistors (0.25W, 5% unless noted)

- 1 x 30k Ω 1%, 2 x 22k Ω , 1 x 20k Ω 1%, 2 x 10k Ω , 2 x 8.2k Ω 1%, 1 x 2.7k Ω , 4 x 2.2k Ω , 2 x 1.2k Ω 1%, 2 x 1.2k Ω , 1 x 820 Ω , 2 x 1 Ω 5W

Miscellaneous

Self tapping screws, machine screws and nuts, heatsink compound, mains wire, heavy duty hookup wire, light duty hookup wire, insulating tubing, solder.



With so many really expensive PCs available, why are people still buying our Classic Microbee?

Buying a personal computer is a little like buying a camera. There are always new models coming out, each one generally a little fancier than the last — and often with a price tag to match.

When it's all boiled down, though, the best camera for most people generally turns out to be an easy-to-use, fairly basic model without all the expensive bells and whistles. And the same tends to apply with personal computers.

That's why so many people are still buying our Classic Microbee models, despite the flood of fancy new models.

The fact is that most people use personal computers for basic jobs like word processing, spreadsheet planning, managing a small database, or as a communications terminal. For things like this, an 8-bit Classic Microbee

is generally just as good as any — and it'll cost you a great deal less than most.

Our latest Premium models come with 128K of memory and your choice of either 3.5 inch or 5.25 inch floppy disk drives. You can select either a single disk drive for economy, or twin drives for greater convenience. In each case they come complete with the widely-used CP/M operating system, enhanced with Microbee's own special user-friendly shells for easy operation. Plus a set of basic applications software: a word processor, Telcom and Videotex communications and so on.

We can supply a range of matching video monitors, from low-cost monochrome (green or amber) to top-quality RGB colour. We can also provide printers, modems and other accessories.

All for prices well below those you'll find

elsewhere. A Premium 128K model with single floppy disk drive and monitor costs less than \$1200, while a twin-drive model complete with printer and modem still costs less than \$2200.

How can we do it? Well, we've been building the Classic Microbee right here in Australia for nearly five years now, improving the design all the time. We've made and sold over 60,000 of them now, and this has made us very efficient in producing them.

Call into one of our Computer Centres or dealers for a demonstration. You'll be pleasantly surprised.

 **microbee**
computer

Sydney: Ryde (02) 886 4444
Waitara (02) 487 2711
Melbourne (03) 817 1371

Canberra (062) 51 5883
Newcastle (049) 61 1090
Gosford (043) 24 2711

Brisbane (07) 394 3688
Adelaide (08) 212 3299
Perth (09) 386 8289

New Zealand: Auckland (09) 88 1138
Prices quoted may be subject to
change without notice

JAYCAR FORGING AHEAD IN 1987

FIRST EVER UNDER \$200!!

DIGITAL MULTIMETER WITH FREQUENCY COUNTER

A compact DMM which not only has impressive voltage, current and resistance ranges BUT a digital frequency and capacitance meter to boot! Not to mention the diode and transistor checker as well. You will be proud to own this attractive meter moulded in yellow high impact plastic. Quality shrouded test leads, instructions and battery. See our January ad for full specifications. Cat. QM-1555 **\$159.00**

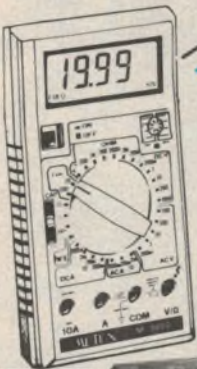

NEW

WORLD CLASS ADCOLA SOLDERING/DE-SOLDERING STATION

See our Jan ads for full details. **POWER CONTROLLER** Cat. TS-1475 (no iron or desolderer supplied) **\$139.50**

40 WATT SOLDERING PENCIL CT-6 Cat. TS-1478 **\$39.95**

80 WATT SOLDERING PENCIL CT-7 Cat. TS-1480 **\$42.50**

DESOLDERING PENCIL Cat. TS-1476 **\$59.95**

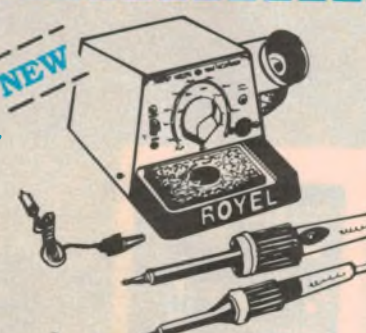

NEW

ADCOLA 240 VOLT IRONS

S30 30 watt Cat. TS-1492 **\$27.95**
S50 50 watt Cat. TS-1494 **\$29.95**



PIEZO TWEETER WITH WIDE DISPERSION LENS

The lens consists of 8 vanes set at a precise angle of 31°. These disperse the sound over a horizontal plane of 80°, wider than could be obtained with a horn alone. This pattern is well suited for such applications as sound reinforcement systems and high efficiency hi fi systems. Cat. CT-1920

ONLY \$34.50

#KSN1126A

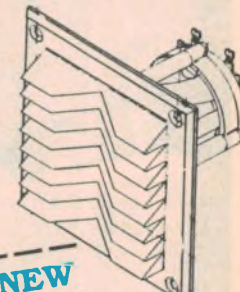

NEW

TIPS

For CT-6 and S30 irons 0.7mm Chisel point Cat. TS-1484	\$4.95	For Ct-7 and S50 irons 0.7mm Chisel point Cat. TS-1488	\$5.95
1.5mm Chisel (standard) Cat. TS-1485	\$4.95	2.5mm Chisel (standard) Cat. TS-1487	\$5.95
3mm Chisel point Cat. TS-1486	\$4.95	3mm Chisel point Cat. TS-1490	\$5.95

4 1/2 DIGIT MULTIMETER

including transistor & diode tester
Cat. QM-1550 **\$179.00**

10A DIGITAL

with transistor tester & capacitance meter
Cat. QM-1540 **\$129.00**

10A DIGITAL

with transistor tester
Cat. QM-1530 **\$89.95**



NEW GENERATION CORDLESS PHONE

Microprocessor controlled - 200 metres range and absolute security

Quite simply the finest cordless phone we have appraised. Naturally it is in total conformity to the 1986 Telecom specifications and is Telecom approved.

The range with the 39/30MHz RX/TX FM system is fabulous - as against the very short range cordless phones of yesterday.

FEATURES:

- Operating range up to 750ft (250m)
- Security code system with 16,384 combinations
- Last number redial
- LED indicator on handset for low battery indication
- Hearing aid compatible

Cat. YF-7065



ONLY \$269.00
IN STOCK NOW

6 x 4 8 ohm SPEAKER NORMALLY \$10.95 NOW ONLY \$2.95

10 up \$2.50 each
SAVE \$8.00
Cat. AS-3014

BE QUICK



ALSO 7 x 5 15 ohm speakers now available. Suit old car radios. Cat. AS-3017 **\$12.50**

TURN YOUR STOCK INTO CASH!

Jaycar will purchase your surplus stocks of components and equipment. We are continually on the lookout for sources of prime quality merchandise.

CALL GARY JOHNSTON OR BRUCE ROUTLEY TODAY ON (02) 747 2022

THERMAL/MAGNETIC 1/2 AMP CIRCUIT BREAKERS

QUALITY MADE E-T-A GERMAN MAKE

TYPE 1. Single pole plunger type, 240V AC or 65V DC. Will interrupt when current exceeds 0.5 amp. Has thermal overload (slow current increase) and magnetic overload (fast current increase) for double circuit protection. Has 2 auxiliary contacts (N/O & N/C) to trigger remote alarms if necessary. Cat. SC-2280

NOW \$2.00 each
10 up \$1.20 each

TYPE 2. 2 double pole toggle type (ganged). Basically the same as above but with toggle type actuator. Extra aux circuits provided. Ganged units can be split to single pole. Cat. SC-2282

NOW \$3.00 each
10 up \$2.00 each
FULL DATA SUPPLIED

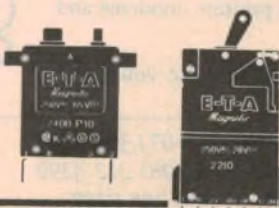

DIGITAL ALARM THERMOMETER /CLOCK

This unit has a built-in temperature sensor and displays temperature in either C or F. It also tells the time. An alarm will sound when the temperature falls below or above a preset temperature. Handy pocket size - measures 53 x 82 x 22mm.

Temperature measuring range -20°C to 70°C - 0°F to 160°F. Uses one AAA battery. Cat. XW-0390

WAS \$27.95
SAVE \$8.00



NOW ONLY \$19.95

ULTRAVIOLET EPROM ERASER

It's all very good being able to program EPROMs easily but how do you ERASE them quickly and safely? You can put them out in the sun for an underdetermined time or use a special high-power UV-tube in an unprotected fluoro batten. You could also end up with a white walking stick!

If you need to regularly erase the contents of EPOMs (even NEW EPROMs could be corrupted with random data) then this is your most cost-effective solution. It will erase up to 9 x 24 pin devices in complete safety to your eyes and your chips, in around 40 minutes for 9 chips (less for less chips). This US-designed product has a special safety conductive-foam chip drawer and has a double-insulated design for your safety.

FEATURES

- Erase up to 9 chips at a time
- Chip drawer has conductive foam pad
- Mains powered
- High UV intensity at chip surface ensures thorough erase
- Engineered to prevent UV exposure
- Long UV tube life

Cat. XE-4950

ONLY \$99.50



COMPUROBOTS 1987 RANGE

Jaycar is proud to announce our 1987 'Turtle' robot line-up.

ECONOMY Model CR-400 "FRIENDLY LITTLE ROBOT"

This unit is roughly 150mm diameter and 210mm high. The CR-400 is programmed via a 8-key membrane keypad on its 'chest'. Programmable actions include: Music sound, flash 'eye' (light on head), turn in either direction, circle, etc.

Uses 4 x AA & 1 x 9V x cell (not supplied)

PIC 'A'

Cat. XR-1020

ONLY 49.95

VALUE - MODEL CR-100 "COMPUROBOT"

A very sophisticated robot for the price. This unit which measures roughly 150mm diameter and 165mm high. This microprocessor controlled unit is programmed via a 25 key keypad on the 'head' of the robot. The robot has a multi-speed gearbox, can travel in 4 separate directions as well as at angles and curves. It has lights and can make sounds. Hundreds have been sold to primary schools throughout Australia. Requires 4 x AA & 1 x 9V cell (not included).

Cat. XR-1024

PIC 'B'

\$69.95

PERFORMANCE - MODEL CR-200 COMPUROBOT II

This highly sophisticated robot has it all. The robot is programmed via a wireless infra-red hand held controller with a 25 key keypad. A very comprehensive 30 page instruction booklet is also provided. Up to 64 program steps can be accommodated in the robot memory. The unit will go in any direction as well as make a number of different noises, flash lights etc.

The robot has two (non motorised) mechanical arms to actually carry a payload. A crayon attachment is also provided to enable the robot to "draw".

A highly recommended product.

Measures 230(H) x 210(W) x 175(D)mm

Rugged ABS plastic case. Uses Japanese quality Mabuchi motors.

Batteries required 4 x C (for robot); 4 x AA (for controller)

Cat. XR-1028

\$129.95

PIC 'C'

HIGH QUALITY AUDIO TRANSFORMER - MADE IN AUSTRALIA

A chassis mount audio transformer with a 33 ohm centre tapped primary and two 3.5 ohm secondaries (which can be connected in series). Power rating 10 watts RMS. Ideal for push-pull amps.

Cat. MM-1600

\$4.95 each

NEW



NEW

LUG PACKS

Two new "VALUE" lug packs from Utilux. Size is smaller than normal, so we've put twice as many in each pack!

EYE TERMINAL Pack 20

Cat. PT-4516

\$1.00



SLOTTED TERMINAL Pack 20

Cat. PT-4526

\$1.20



PENLIGHT NiCads

Don't throw away money buying non-rechargeable batteries - step up to NiCads - Cat. SB-2452 'ROCKET' BRAND AA PENLIGHT 450mA

\$2.95

each

SPECIAL 4 for \$10



NEGATIVE AIR IONISER INCREDIBLE BARGAIN

75% off manufacturers recommended price!

The 'Country Air' negative ioniser was advertised extensively on radio during last year for \$200.

Well, to make a long story short, 'Country Air' is no longer around. (Except as air in the bush).

Hundreds of partially assembled ionisers were left with the contract manufacturer. This manufacturer contacted Jaycar with their problem. Jaycar has underwritten completion of these ionisers but at a massive loss to the original parties.

Their loss is your gain however!

We can now offer you this very high quality product at only 25% of the manufacturers original selling price!

Grab one now and enjoy the benefit of a negative air ioniser at this price while they last.

ONLY \$49.95

SAVE \$150

Cat. XX-2902

over original price!

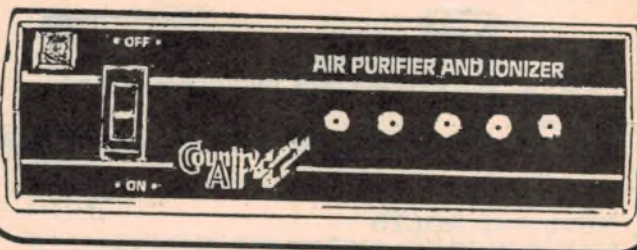

EXPERIMENTERS TELEPHONE LINE TRANSFORMERS - another JAYCAR SCOOP!!

We still have quantities of this superb transformer. They are Telecom type multiple line, line isolation transformers. They are also fitted with a tone winding. Brand new and are telecommunications grade, sealed in a grey painted metal can with all terminations clearly marked at one end. As you can see from the schematic, they have two line inputs and two equipment inputs, (apart from the ring winding). This is a VERY high quality transformer. It would be ideal for modern experimenters, PABX experimenters or anyone requiring a high quality multi-pole line isolating transformer.

Cat. MT-3800

ONLY \$2.00 each

NOTE: Due to weight (a whisper under one kilo) the P&P is \$5

Measures 90(H) x 58(W) x 48(D)mm

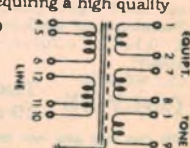

NEW PRODUCTS

470 ohm NTC Thermistor
0-120pF Compression Trim Cap
0-10pF Porcelain Tuning Cap
0-100pF Porcelain Trim Cap
100uF 10V Tantalum
3.3uF 63V Greencap

Cat. No.	Each	10 +
RN-3450	\$0.50	\$0.45
RV-5743	\$1.95	\$1.75
RV-5742	\$9.95	\$9.50
RV-5738	\$4.95	\$4.50
RZ-6648	\$2.50	\$2.25
RG-5179	\$2.25	\$2.00

TELEPHONE EXTENSIONBELL

This compact unit is supplied with 10 metres of cord fitted with a standard Telecom plug.

Simply plug it into a wall outlet and it will ring at the same time as your telephone. A LED is fitted as well which will flash. (Note. If you only have one telephone outlet a double adaptor will be required. (Cat. YT-6020 \$7.50).

Cat. YT-6030

ONLY \$24.95

CONCORD OPEN SATURDAY from 9am - NOON





BUILD A KIT

JAYCAR
No. 1 for
KITS

UNDER \$10

CD
ATTENUATOR

REF: EA 1/86
Cat. KA-1186

\$9.95



12V LAMP
FLASHER

REF: EA 2/86
Cat. KA-1630

\$9.95



ELECTRONIC
SIREN

Cat. KE-4002

\$8.90



FM
TRANSMITTER

REF: ETI 12/85
Cat. KE-4711

\$9.95



ELECTRONIC
DICE

Cat. KS-8107

\$8.95



SIMPLE
TIMER

Cat. KS-8129

\$9.95



UNDER \$20

LIGHT
SAVER

REF: EA 6/86
Cat. KA-1670

\$15.99



MICROWAVE
LEAK
DETECTOR

REF: ETI 7/79
Cat. KE-4013

\$17.95



SPEAKER
PROTECTOR

REF: ETI 10/82
Cat. KE-4023

\$19.95



NiCad
BATTERY
CHARGER

REF: ETI 3/83
Cat. KE-4029

\$16.95



RS232 TO
COMMODORE
ADAPTOR

Cat. KE-4722

\$16.95



TRANSISTOR
TESTER

Cat. KS-8103

\$12.90



UNDER \$20

BASIC AMP

Cat. KS-8105

\$13.95



NiCad
CHARGER

Cat. KS-8126

\$15.50



UNDER
\$30

ELECTRIC
FENCE

REF: EA 9/82
Cat. KA-1109

\$21.50



VOCAL
CANCELLER

REF: EA 4/82
Cat. KA-1430

\$24.95



TOUCH LAMP
DIMMER

REF: EA 4/83
Cat. KA-1508

\$29.95



CAR IGNITION
KILLER

REF: EA 2/84
Cat. KA-1535

\$23.50



UNDER \$30

AM STEREO
DECODER

REF: EA 10/84
Cat. KA-1555

\$26.50



SPEED
CONTROLLER

REF: EA 11/84
Cat. KA-1558

\$28.50



20W AMP
MODULE

REF: EA 11/84
Cat. KA-1567

\$24.50



VIDEO FADER

REF: EA 1/86
Cat. KA-1626

\$22.50



TURBO
(POWER OFF)
TIMER

REF: EA 9/86
Cat. KA-1679

\$29.95



TEMP. PROBE
for DVM

REF: ETI 7/83
Cat. KE-4033

\$27.95



UNDER \$30

50W MODULE

REF: ETI 4/80
Cat. KE-4050

\$26.50



POWER
SUPPLY SUIT
ETI480

Cat. KE-4048

\$26.50



HOUSE ALARM

REF: ETI 4/84
Cat. KE-4698

\$26.95



PARAMETRIC
EQUALISER
MODULE

REF: ETI 7/86
Cat. KE-4724

\$23.50



TELEPHONE
SCREAMER

REF: ETI 10/86
Cat. KE-4726

\$29.95



NEGATIVE ION
GENERATOR

SHORT FORM
Cat. KJ-6510

\$21.95



DIGITAL
COUNTER

Cat. KS-8114

\$21.95

UNDER \$50

BREAKERLESS
TRANSISTOR
ASSISTED
IGNITION

REF: EA 12/83
Cat. KA-1505

\$44.95



TRANSISTOR
ASSISTED
IGNITION

REF: EA 1/83
Cat. KA-1506

\$42.50



MOTORCYCLE
INTERCOM

REF: EA 2/84
Cat. KA-1533

\$43.50



"PEST OFF"
INSECT PEST
REPELLER

REF: EA 11/85
Cat. KA-1620

\$48.50



CAR CD
ADAPTOR

REF: EA 4/86
Cat. KA-1645

\$32.00



ELECTRIC
FENCE

REF: EA 12/85
Cat. KA-1660

\$49.95



THE ULTIMATE AM 6000 POWER AMPLIFIER

The 6000 series power amplifier by David Tillbrook is the culmination of over 7 years work on power amp design using Mosfet technology.

SPECIFICATIONS:

Output Power 240W RMS per channel into 8 ohms
(360W RMS into 4 ohms)
Damping Factor >300 (100Hz into 8 ohms)
THD <0.005% @ 1kHz @ 200 watts
S/N Ratio 4001Hz - 20kHz noise bandwidth
>118dB 'A' - weighted

The Jaycar kit includes -
- 300VA toroids (pre-amp toroid extra)
- Metal work identical to prototype
- Original diecast heatsink
Commercial equivalents cost between
\$2,500 & \$3,500
Cat. KM-3020

\$998.00



WORKHOUSE POWER AMP MODULE AEM 6506

This is the obvious successor to the failed ETI480 amps. This kit will give around 100W RMS into 4 ohms with recommended transformer. It is actually cheaper than the 480 which required an expensive power supply. The AEM 6506 has power supply filter caps INCLUDED! You only need to connect up a power transformer and bridge rectifier. It is very easy to build - even for a novice. No bias adjustment. Cat. KM-3050
Transformer extra.

ONLY \$35.00

DUE IN FEBRUARY

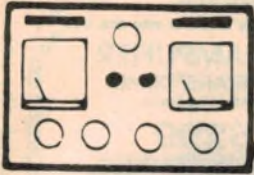

The Serviceman

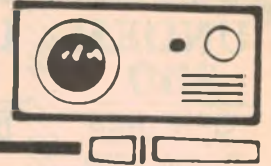

When should we have our heads examined?

"How long is a piece of string?" "How far can a rabbit run into the forest?" These, and similar childhood conundrums, came to mind recently as a result of a couple of incidents involving identical video recorders with completely different life patterns, and which emphasised the virtual impossibility of predicting the life of video heads.

Incidentally, do you know the "smart" answer to those two conundrums? The answer to the first one is: "Twice the distance between the middle and one end". (Oh, very clever!) And the second one? "Halfway — because after that the rabbit would be running out the forest". (Wouldn't it slay ya!)

Both answers are, of course, clever rather than informative. Which is how I sometimes feel about the answers I try to give customers who ask about the life to be expected from a set of video heads. It is a common question and, understandably I suppose, they imagine it should be possible to nominate a definite figure.

Unfortunately, it isn't as easy as that. It is very much a "how-long-is-a-piece-of-string" question, simply by reason of the many variable factors involved.

Some of the more obvious ones involve the environment in which the recorder is used. This, in turn, involves such factors as dust, tobacco smoke, and general care of the machine; the quality of tapes used in it (some are more abrasive than others, or may be badly worn); and the possibility that cleaning tapes have been used to excess.

So how does one answer the customer's question? About the best that I can do is to first list the various factors involved, as above, then quote examples from my own experience, usually including the worst and best cases. And it is on these latter lines that this story is based, because I recently encountered two examples of head life which were certainly right at the opposite ends of the scale as far as I am concerned.

The experience was particularly inter-

esting because it involved two recorders of the same make and model, and essentially of the same age. They were two National NV-370 machines, both about two years old. But I would hasten to add that I don't believe that there is anything particularly significant about the particular brand, either good or bad. I'm sure a similar coincidence could have happened with any other brand.

The first machine

The first machine belonged to one of my regular customers; a family I know well enough to know that they were scrupulously careful about the way they looked after their recorder, and also to believe their account of the amount of use the machine had had. The customer's complaint was that the picture quality had deteriorated to the point where it had a lot of streaks and blotches on it.

When I finally put it on test, with a known good quality tape in it, I was inclined to regard his description as something of an understatement. It was extremely noisy over most of the picture area, and not the kind of thing one would want to watch for any length of time. Even so, I imagined that it probably needed nothing more than a clean up, since it was no worse than many others I had cured in this way, plus the fact that I had been given to understand that the machine had not had a great deal of use.

So I pulled the covers off and went through a complete clean-up procedure; video heads, audio and erase heads, guides etc. In fact, all these parts were

remarkably clean, and this made me somewhat suspicious; a feeling that was confirmed when I tried the test tape again because there was very little improvement. I made a more careful examination of the heads using a fairly high powered glass, but could not detect any obvious contamination or damage.

The next step was to make some check with the CRO. Test point 3 gives access to the output of the video heads, while test point 4 provides a square wave which, if fed to the second trace, can be used to lock the CRO timebase and thus display a stationary image. Playing a test tape into this set-up quickly indicated the nature of the trouble; the output from one of the heads was extremely poor, being low in amplitude and having a distorted waveform.

This left little doubt as to the final diagnosis; one of the heads had developed a major fault and the only solution was to replace the drum, or the "upper cylinder unit" as the manufacturer describes it.

Naturally, I contacted the owner before going any further. Supplying and fitting a new drum was going to make a mess of a couple of hundred dollars and I needed his approval for this kind of expenditure. He accepted the situation rather philosophically and gave me the go-ahead.

So a new drum was ordered and duly arrived a couple of days later. Replacing a drum on this machine, is fortunately, relatively straightforward, and a good deal more so than on some machines. The old drum is removed by undoing two screws and desoldering, with the solder sucker, the four connections to the two heads. That done the drum may be worked carefully upwards until it is free.

In fact, this drum came away relatively easily, but this is not always the case. The fit varies from make to make, and even from model to model. The important thing, when a tight one is encountered, is to apply equal pressure to

opposite edges of the drum; any unequal pressure will cause it to bind. In fact, some distributors have marketed pullers for this function.

Fitting the new drum is essentially the reverse procedure, the main precaution being to avoid a 180 degree error in drum rotation. This is taken care of with a green and white colour coded label on the "upper cylinder" which has to be matched with a similar label on the "lower cylinder". This precaution is easily observed.

And that is all that is normally needed to get the system working, although some tracking adjustment will invariably be required. In this case a test tape produced a reasonably good picture, but a check with the CRO, using test points 3 and 4, as before, indicated that some adjustment of the guides was needed to bring the tracking spot-on. That done, the machine produced a first class picture.

Why was it crook?

While this was all quite satisfactory from a purely servicing angle, I was puzzled as to why the head had failed in the first place. So when I returned the machine I made further discreet enquiries as to just how many hours it had been used. While such assessments are always difficult, both the customer and his wife were reasonably definite in their estimate.

The recorder was used mainly for time shifting and only rarely to play a pre-recorded tape from the video shop. More importantly they estimated that they would average no more than a couple of programs, amounting to about three hours total, a week. And, since they had had the machine for exactly two years, we settled for a figure of around 300 hours.

This is not a long time by any standards and I found it difficult to account for the failure, at least in my own mind. I tended to discount a simple wear problem, for the reason that only one head had failed. This seemed to suggest some kind of catastrophic failure, though I could only guess at what form it took. Even careful examination with a jeweller's loupe (x12) failed to reveal any sign of mechanical damage to either head, although this would not be conclusive.

With the vital head dimensions quoted in microns it would take a much more powerful glass to reveal the more subtle forms of wear or damage. On the other hand, the worst cases are sometimes visible.

Of course it is also possible that the

fault may have been other than mechanical, although the most likely electrical fault, other than a simple open circuit, would seem to be a shorted turn. Unfortunately, I have no idea exactly what effect this would have. Would it kill the output altogether, or would it merely reduce and distort it, as in this case?

As I say, I don't know the answer. All I know is that the failure seemed to be premature, and certainly not typical. In short, it was just the luck of the game, and there is very little one can do about it. About the only consolation is to look at the price of cinema seats and reckon that, even at 300 hours, one has had one's money's worth.

The second machine

Well that was the worst case. As I implied earlier, the next case is the



exact opposite. But it is also interesting in another sense; the customer routine which created the situation.

In this case the people concerned, an elderly retired couple, were not my customers. The machine came to me via the local dealer from whom they had purchased the machine a couple of years earlier, and for whom I do regular service work.

He first raised the matter while we were working together on a job. He had sold a video recorder to a customer who owned an old Kreisler TV set, and which needed a routine modification for recorder use. So, while he introduced the customer to the intricacies of pushing the right recorder knobs, I set about modifying the set. And it was while I was thus engaged, and a trifle preoccupied, that he raised the matter of a National NV-370 which he wanted me to

overhaul, adding that it had had about 1600 tapes through it and wasn't performing too well.

I must admit the full impact of his statement didn't strike me immediately. It was only when he passed the machine over to me after we had finished the job that I started to do some mental arithmetic based on his quoted 1600 tapes. By the most conservative estimate it represented a lot of playing hours and, equally, a lot of viewing time. If the set was only two years old, as the dealer had intimated, how had such an amount of use been accumulated?

I finally concluded that the figure was most likely the result of someone's vivid imagination or a misunderstanding, and more or less dismissed it from my mind. However, it did occur to me that any machine which had really accumulated that many hours would almost certainly be a candidate for a new set of heads.

The following day I found time to set the machine up on the bench and run a test tape through it. The dealer's description of it "...not performing too well" turned out to be another understatement. The picture was unwatchable, for the simple reason that there was virtually no picture to watch; just an occasional glimpse of an image behind a mass of noise. It certainly looked as though it would need a new set of heads.

Nevertheless, the first thing to do was give it a routine clean and see what happened. When I opened the machine, it turned out to be surprisingly clean. To be sure, there was evidence of some oxide build-up on the guides and drum, but I've seen plenty worse. So I set to with cleaning fluid and tissues and gave everything a thorough clean. I also had a good look at the heads with a glass and, for what it was worth, could see no obvious damage.

Then I tried the test tape again. And would you believe it — the result was absolutely superb; virtually equal to that of a new machine. Which just goes to show just how bad performance can be and still need nothing more than a good clean-up. It also made me more suspicious about the 1600 tape figure. Just where had this come from and who had assessed it.

Let's find out

On the pretext of letting the customer know that the machine was ready, I rang the number which the dealer had given to me. The lady answered the phone and was delighted to learn that the recorder was working again and that the repair had been relatively simple

The Serviceman

and inexpensive.

Having thus created a favourable atmosphere, I gently broached the matter of playing time. The conversation went something like this:

"Mr Smith (the dealer) tells me that this machine has played something like 1600 tapes. Is that correct?"

"Oh yes. Sixteen hundred and twenty to be exact."

"How can you be so sure of the exact figure?"

"Oh, we keep a log listing of every tape we play. We always watch one picture in the afternoon, and at least one at night, sometimes two. So you see, we know exactly what we've played."

Doing my best to keep the astonishment out of my voice I thanked the lady and hung up. To tell the truth, I wasn't quite sure which was the most astonishing aspect of the whole setup. I suppose the real surprise was that anyone would want to watch programs to that extent. I learned later that they both suffered some physical handicap and that this was the only form of entertainment they could enjoy.

It's also surprising that they could find enough material in the local video shops to satisfy such an appetite. Maybe I'm fussy, but my tastes would totally exclude half the categories typically available and, of the remainder, only a small percentage would be worth watching.

Then there is the question of cost. If we assume \$2.00 a time for hiring tapes, the bill comes to \$3240 in just two years! I'll bet the local video shop rolls out the red carpet every morning when this customer appears in the doorway. A few more like that and he could retire early.

Finally, it is surprising that the machine had accumulated so many hours without suffering any significant wear. How many hours? Some estimation is involved but, from the firm figure of 1620 tapes, and assuming that typical programs run for at least one and half hours, and that doesn't take into account any off-air recording and replaying, which wasn't mentioned. Add a few longer than usual programs and we could be nudging 3000 hours.

So there we have it; a well documented 2500 hours, possibly more, with the heads still delivering near-new performance. How much longer before they need replacing is anyone's guess,

but it looked to me as though they had another 1000 hours in them at least.

So now, when customers ask me how long before they need to have their heads examined, I can tell them that, if they are unlucky, it might be as short as 300 hours or, if they are lucky, as long as 3000 hours.

Yes, I could tell them that — but I don't know whether I will.

Back to earth

At a more down to earth level, here is a story of a video recorder which led me something of a dance for a while. It was a Sanyo VCT-M10 and the owner's complaint was that, initially, it simply wouldn't go. Being a retired Telecom technician he felt confident enough to take the covers off and look for anything obvious, even if he wasn't quite sure what he would do if he found it.

In fact the basic cause was immediately obvious; a blown 500mA fuse in

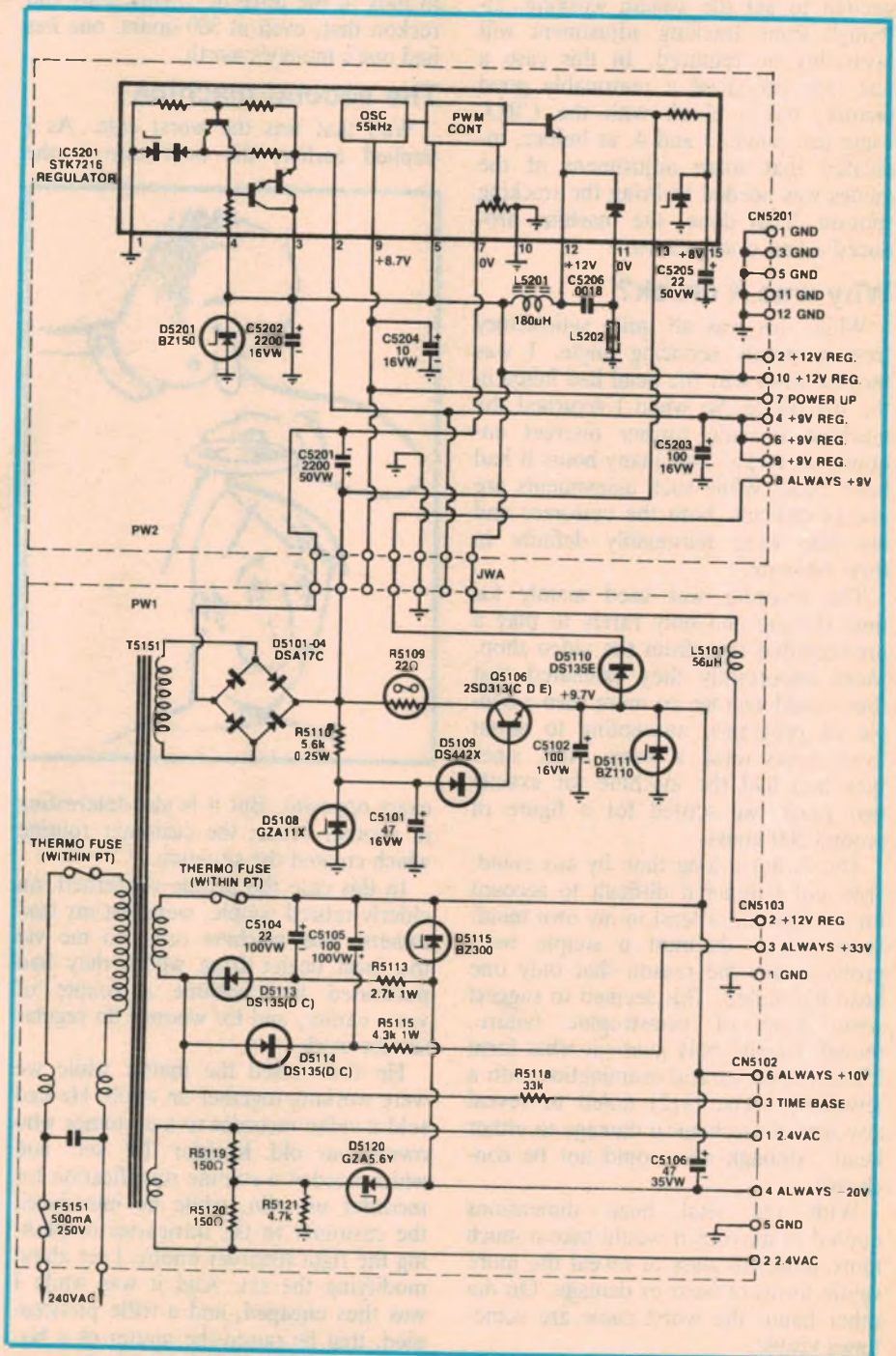

COMPARE OUR VALUE!

SALE

SPECIALS

5mm RED LED'S

5¢ EA.

4116 **55¢** EA
6821 **\$1.20** EA



8085A PROCESSOR

\$4⁸⁰ EA.



ASSORTED
TUBULAR
TANT CAPS

15¢ to 50¢ EA.

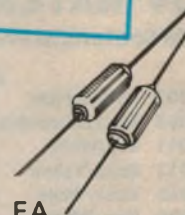

I.C. SOCKETS ½¢ PER PIN

MONOLITHIC CERAMIC
CAP 0.1µF 50 V

6¢ EA.



KBLO2
BRIDGE

80¢ EA.

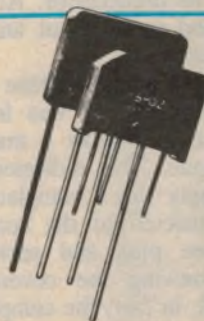

ASSORTED 8000
SERIES PERIPHERALS

\$3⁰⁰ to \$5⁰⁰ EA.



8086-2 I.C.

\$14⁷⁰ EA

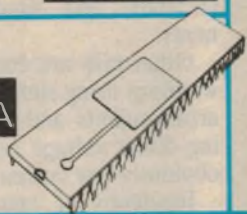

KBPO2
BRIDGE

60¢ EA.

THE MAGRATHS' PROMISE

SHOW US A COMPETITOR'S
ADVERTISEMENT OFFERING
SOMETHING WE HAVE IN
STOCK AND WE WILL
KNOCK 10% OFF THEIR
OFFERED PRICE.

SUITS TANDY & COMMODORE COMPUTORS

COLOUR VIDEO MONITOR

AT LAST A COLOUR
MONITOR AT A DOWN TO
EARTH PRICE, THIS FAMOUS
MAKE UNIT FEATURES A
14" SCREEN,
1.2 WATT AUDIO OUTPUT, AND CAN BE USED AS
A VIDEO MONITOR TOO EXCEPTIONAL VALUE!

\$299

PLUS S/TAX

**LOOK AT THESE EXAMPLES! MAGRATHS HAS AN EXTENSIVE
RANGE. SAVE MONEY ON ALL YOUR ELECTRONIC
COMPONENT AND COMPUTER PERIPHERAL NEEDS.**

THE ABOVE SPECIALS ONLY AVAILABLE WHILE STOCKS LAST! MAIL AND PHONE ORDERS WELCOME

MAGRATHS

MaGRATHS have a large range of
computer accessories and a
guaranteed quick delivery time

A DIVISION OF
RIFA

We accept
Bankcard
Visa Card
Master Card

55 A BECKETT STREET, MELBOURNE PH: (03) 663 1122

**GUARANTEED
LOWEST PRICES
FOR QUALITY
PRODUCT, IF
YOU DON'T LIKE
THE PRICE MAKE
US AN OFFER.**

KALEX

UV MATERIALS

3M Scotchcal Photosensitive

	Pack Price	
	250 x 300 mm	300 x 600 mm
8007 Reversal film	\$38.20	\$51.40
8005 Black/Aluminium	\$70.15	\$80.75
8011 Red/White	\$63.20	\$72.70
8013 Black/Yellow	\$63.20	\$72.70
8015 Black/White	\$63.20	\$72.70
8016 Blue/White	\$63.20	\$72.70
8018 Green/White	\$63.20	\$72.70

AUSTRALIA'S LARGEST STOCKISTS

UV PROCESSING EQUIPMENT

KALEX LIGHT BOX

- Autoreset Timer
- 2 Level Exposure
- Timing Light
- Instant Light Up
- Safety Micro Switch
- Exposure to 22in x 11in

\$599.00 + ST

KALEX "PORTU-VEE"

- UV Light Box
- Fully Portable
- Exposure to 10in x 6in

\$199.00 + ST

PCB PROCESSING

KALEX ETCH TANK

- Two Compartment
- Heater
- Recirculation (by Magnetic Pump)
- Two Level Rack
- Lid

\$595.00 + ST

RISTON 3400 PCB MATERIAL

SIZE INCHES	SINGLE SIDED	DOUBLE SIDED
36 x 24	\$90.00	\$117.00
24 x 18	\$45.00	\$ 58.50
18 x 12	\$22.50	\$ 29.25
12 x 12	\$15.00	\$ 19.50
12 x 6	\$ 8.00	\$ 10.00

All prices plus sales tax if applicable

KALEX

40 Wallis Ave.
East Ivanhoe 3079
(03) 497 3422
497 3034
Telex AA 37678

9.30 a.m. - 4.30 p.m.
Monday - Friday



ELECTRONIC COMPONENTS & ACCESSORIES
• SPECIALIST SCHOOL SUPPLIERS

The Serviceman

the power lead circuit feeding the power transformer. Naturally, our friend had few illusions about blown fuses; he knew as well as anybody that when a fuse blows there is usually a very good reason — and an equally good chance that another fuse will blow in exactly the same way.

On the other hand, it didn't look to be a drastic blowout; no blackened glass or splattered globules of cooper so, having a suitable fuse handy, he reckoned it was worth a try. But it wasn't going to be that easy and he wasn't really surprised when the new fuse went the way of its predecessor. At this point he decided to bow out and seek my assistance.

This was a machine I had not handled before, but I was fortunate in being able to borrow a manual from a colleague. This indicated that the power supply was a completely separate unit, connected to the recorder proper via three plug and socket combinations. Removing the covers confirmed this and, in fact, the complete power supply can be easily removed and set up on the bench.

The first thing I did was to fit another fuse. I was quite grateful to the customer for his observations and I didn't doubt his word, but I wanted to see the fuse blow for myself and observe the nature of its demise. Since it wasn't a drastic blowout, just how fast was it? Was it a slow failure following a red glow, or was it virtually instantaneous, if not violent?

Watching the new fuse carefully, I pressed the switch. The failure was virtually instantaneous, without being spectacular and, on that basis, I decided that the fault was most probably a direct short in the power supply itself, rather than some kind of vague overload in the recorder proper. Fortunately, it was easy to isolate the power supply by pulling the three connecting plugs (CN5201), CN5102) already mentioned.

I also took the precaution of connecting the ohmmeter across the power plug pins, just in case it was something fundamental. I wasn't quite sure what value to expect, but when the meter read around 50 ohms, rather than a dead short, I reckoned that that was reasonable for a transformer primary.

Then I fitted another fuse and tried again. This blew immediately, thus confirming my suspicion that the fault was

confined to the power supply. This was a relief because it eliminated the vast mass of circuitry involved in the recorder proper and meant that I could pull the power supply out and work on it, much more conveniently, on the bench. That done I took a closer look at both the supply itself and the circuit.

The supply generates a number of voltages. The power transformer has three secondary windings, the main one feeding a bridge rectifier (D5101-04) which supplies two of the rails. What appears to be the main one is a 12V regulated supply derived from a large regulator chip, IC5201 (STK7216). The other rail is 10V regulated, derived from a simple regulator made up from discrete components; a pass transistor (Q5106), a zener diode reference (D5108), and sundry minor components.

Other rails are derived from the other windings using simple half wave rectifier arrangements and zener diodes providing direct voltage regulation. These are obviously low current supplies.

Incidentally, I was intrigued by the rather quaint labelling of these various supplies, where they leave the board. Some were labelled simply "REG 12V", "REG 9V" etc, while others were labelled "ALWAYS 33V", "ALWAYS 9V" etc. The subtle difference between these two designations escapes me.

A likely suspect

A likely suspect was the STK7216 regulator IC, at least to the extent that I had heard stories from colleagues claiming that it was not the most reliable device. On the other hand, I had no experience of the device myself. The best way to check it was to disconnect it from the main supply rail (30V) from the bridge rectifier, then try another fuse. This wasn't as easy as it looked from the circuit because the path from the positive terminal of the bridge to the IC pin (13) was all copper track, and I preferred not to cut any tracks if I could avoid it.

The solution was to lift the two bridge diode leads where they fed the positive rail. And, since the other voltage regulator, involving Q5106, was also fed from this 30V rail it would eliminate all these components as well.

Before risking another fuse I made some component checks. First, the bridge diodes, all four of which checked

out OK. I then checked the pass transistor inside the IC, which is clearly shown on the circuit. The emitter connects to pin 12 — the 12V regulated output — and the collector to pin 13 — the 30V in from the bridge. A short here was a possibility, but a check ruled this out.

So now it was time to try another fuse. To be honest, I fully expected the fuse to hold because the remaining components seemed unlikely candidates for this kind of fault. It was something of a shock, therefore, when the next fuse blew just like all the rest. Or did it? I had a sneaking suspicion that the failure was, if anything, more violent than previously. This didn't seem very logical and I tended to dismiss it as imagination.

So what now? The remaining simple regulator circuits involved diodes, zener diodes, and electrolytic capacitors. Some of the zeners were obviously straightout regulators, others appeared to be protective devices aimed at preventing excessive voltages appearing on certain rails. In fact, some of the circuit arrangements were quite unusual, and I don't pretend that I could follow them all. But it did seem that most of them were likely candidates for the fault if they broke down.

And so began a process of methodically checking each component. In most cases this required that one end of the component be lifted from the board to avoid ambiguous readings. And having done that I left them disconnected, just in case there was a fault too subtle for simple measurement. Thus it was that I finished up with almost all the likely components disconnected and, as far as I could see, little left to blow a fuse.

The only snag was that another fuse blew and, this time, I felt sure that it was more violent than before. And that really set me back. What was there left to be at fault? Did I have shorted turns in the transformer? Even that idea didn't seem to fit because I have seen many transformers with shorted turns and, although they quickly get stinking hot — literally — the seldom act like a dead short.

Looking at the circuit again I was reminded that there was a capacitor (C5151) directly across the mains input and immediately following the fuse. Inasmuch as I had checked the resistance across the mains pins, and obtained a reading which seemed consistent with a transformer primary winding, I had thought no more about this capacitor which, incidentally, had no values shown on the circuit.

It was tucked out of the way somewhat but I eventually found it and it turned out to be a 0.0047uF. It was rated at 250V AC and was branded "Shizuki". I lifted one end of it and connected the ohmmeter. And there was the trouble; it wasn't a dead short but measured something over 100 ohm. I have no doubt that it would have broken down still further at 240V and, I suspect, was getting progressively worse each time it blew a fuse.

The 100 ohm resistance also explained how I had been deceived when I measured the resistance across the power pins. It turned out that the true resistance of the transformer primary was also around 100 ohm and the two in parallel had read around 50 ohm: a value which I had regarded as reasonable for a transformer primary.

In hindsight I felt a bit silly, and mentally kicked myself for not being more precise in interpreting the resistance readings. But it's easy to be wise after the event. More to the point, I feel, is the matter of the capacitor voltage rating. A rating of 250V AC across a 240V AC circuit is, in my opinion, cutting things much too fine. It should have a rating, at the very least, of twice this value, but preferably four times.

Another point of interest was the brand of the capacitor. It is not the first time I have encountered Shizuki capacitors and usually in the worst sense. I have also heard stories about them being used in some of the early English colour TV sets and giving so much trouble that they were eventually changed as a matter of routine whenever a set was serviced for any other reason.

As far as this job was concerned it was routine from then on. I put everything back together and, after some searching, found a suitable replacement capacitor, but one having a 1000V AC rating. That, hopefully, should solve that problem.

The only other comment concerns the number of fuses I destroyed. This may seem to be a drastic approach, but it is often the only really safe way to tackle faults of this kind. The fuses are not all that expensive, and certainly much cheaper than other components which might be damaged if one attempts to brute force the situation.

So there it is: not one of my most brilliant efforts I'm afraid, but worth relating I feel, if only for the benefit of others who might encounter a similar problem. If it saves them a run-around, it will have been worthwhile. 2

DEEP, TIGHT, BASS IN KIT FORM



\$1199
PAIR

vifa

AEM-6103
KIT SPEAKERS.

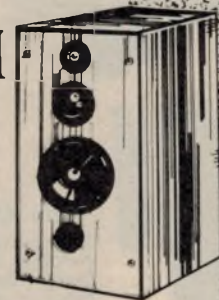

In the past, buying high quality loudspeakers has necessitated selecting a fully imported product, together with its increasingly high price tag. Today, if you can use a screwdriver and solder a few connections, those pecuniary problems are far behind.

Tilbrook's AEM6103 is a kit speaker designed to incorporate the world famous Vifa drivers. A 10" woofer is housed in a solid diecast chassis on which a huge magnet is fitted.

A most unusual 3" soft textile dome mid-range with magnificent dispersion and transient qualities ensures perfect reproduction of the critical mid-band area.

The classic Vifa 19mm dome tweeter with ferro fluid-cooled voice coil provides extremely clear and well balanced treble.

The crossover is a very advanced 18dB/octave design with impedance correction for the woofer. In the tweeter and mid-range section, only polyester

capacitors are used.

Many hundreds of these speakers have already been built with superb results. Capable of handling 130 watts, these masterpieces of quality retail at \$1199 a pair including drivers, pre-built crossovers and flat pack cabinets. On the other hand, you could spend an additional \$2000 or more for a comparable imported speaker! Ludicrous isn't it, especially when you consider that many of the most highly applauded international speakers (such as MISSION, DALI, ROGERS, JAMO, VANDERSTEEN, HEYBROOK, BANG & OLUFSEN, DCM and MAGNAT) choose Vifa drivers anyway!

For full details of Vifa speaker kits, priced from as low as \$449, please contact the Sole Australian Distributor:

SCAN AUDIO Pty. Ltd.
52 Crown Street, Richmond, 3121.
Telephone (03) 429 2199.

Stocked by leading electronic stores throughout Australia.

BANKCARD HOLDERS — PHONE ALTRONICS TOLL FREE 008 999 007 FOR NEXT DAY JETSERVICE DELIVERY

FOR NEXT DAY JETSERVICE DELIVERY PHONE ALTRONICS TOLL FREE 008 999 007 BANKCARD HOLDERS

ALTRONICS 1987 ELECTRONIC COMPONENTS CATALOGUE



YOURS FREE With this month's Electronics Australia Magazine **OR** send \$1 to cover P & P to Altronics, P.O. Box 8350 Stirling St., Perth, WA 6000



JACK O'DONNELL
Managing Director

REMEMBER

Altronics Staff are all keen Electronics Enthusiasts — just like yourself — so when you need a little technical help, give us a call. • Quality Products at direct import prices. • Save up to 50% on our competitors prices • Overnight delivery Australia wide • Bankcard phone orders service to 8pm Monday — Friday.

FOR THE VERY QUICK!

Here are some incredible bargains. We suggest you phone order now to reserve yours.

Please check inside our catalogue for full specifications on these items.
Special prices are available on current stocks only, sorry no back orders, strictly "1st come - 1st served"

Top Selling Blood Pressure Machine and Heart Rate Monitor

X 3055 ~~\$110~~ **\$89.00**



Microwave Leak Detector

A 0900

\$10.00



Simply Brilliant Solar Panel Array

18V at up to 600mA under ideal sunlight conditions. Intended for charging 12 volt systems such as Car, Caravan and Boat batteries etc.

Why Pay \$200?

A 0220 **Be Quick! \$90.00**



Solar Charger

For 4 AA's

\$8.00

A 0230

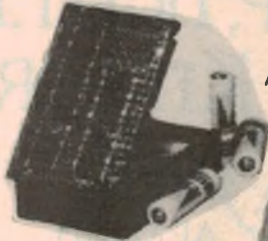

Digital Multimeter With Memory

Now is your opportunity to equip your workbench with a quality DMM. Full spec's in our catalogue.

Q 1075 **Now \$79.00**



Beta Video Head Cleaner

A 9300 **\$5.00**



Mini Alarm

Great for Doors, Windows, Drug Cupboards, etc. Surprisingly piercing alarm.

S 5315

1/2 Price **\$7.50**



Twin Cone HiFi Extension Speakers

10 Watt 8 ohm over 100,000 sold amazing value.

\$15.00 pair



C 2000 . . . **\$8.00**

Solar Desk Calculators

Never needs batteries - works great under fluro lighting.

X 1060

\$15.00



Alarm Stickers

WARNING

ALTRONICS SURVEILLANCE ALARM SYSTEM FITTED HERE

For Home or Office

S 5400 200mm x 75mm

\$1

Million Diode Sellout! From 1.5¢ each

Altronics have just purchased around 1 Million (yes million) factory fresh, premium quality IN914/IN4148 diodes. These became surplus to Fairchild Australia as the factory supplied bulk, loose pack diodes instead of the tape/reel diodes ordered. So unless you are a manufacturer with automatic component insertion equipment, these fine quality diodes represent the diode bargain of all time!! Cat. Z 0101

1-99	3¢ ea
100-499	2.5¢ ea
500 plus	1.5¢ ea



Ultrasonic Pest Repeller

Powered by 9V plug pack (supplied) this fantastic repeller is amazingly effective in ridding you of a variety of pests i.e. Cockroaches, Fleas etc.

A 0083 **Now \$25.00**



Professional Infra Red Movement Detector

12V DC operated. Incredibly sensitive. 2 function lens permits wide angle (for rooms) or narrow angle (corridors) operation.

S 5301 **\$75**



Circuit & Design Ideas

Interesting circuit ideas from readers and technical literature. While the material has been checked for feasibility, the circuits have not been built and tested by us. As a consequence, we cannot accept responsibility, enter into correspondence or provide constructional details.

Four utility circuits using a hex Schmitt trigger

CMOS logic ICs are so cheap and commonly available that it is easy to overlook them as powerful and flexible building blocks. The 4584 hex Schmitt trigger inverter is one such device which can be used to produce a number of different circuits with wide applications. Here are four circuits which can be easily built.

Fig.1(a) is a power-up timer. When power is applied, the output at pin 4 will initially be high and then will switch low after a time determined by R1, C1, C2, C3 and the supply voltage V_{dd}.

The first hex Schmitt inverter of the circuit is actually a free-running oscillator with its square wave frequency determined by R1 and C1. The output at pin 2 is applied to the half-wave voltage doubler consisting of the two diodes, C3 and C4. Because C3 is so small it takes quite a while to charge C4 and thus the voltage at pin 3 takes some time to build up to the point where the output at pin 4 switches low.

The time period for the circuit is given by the formula:

$$T = 2.5(C3.R1.C1)/(C2.V_{dd})$$

With the circuit values shown, T will be about five minutes.

Fig.1(b) is a positive edge-triggered monostable. When it receives a positive-going pulse via C1 its outputs change state and then flip back again after a period determined by R1 and C2. With

the values shown, T will be about 15 seconds.

Fig.1(c) is a Schmitt trigger with reduced hysteresis which is necessary if small AC signals have to be squared up. Reduced hysteresis is achieved by the 4.7M Ω feedback resistor and the two 390k Ω voltage divider resistors across the supply rails. With the values shown, the effective hysteresis will be reduced from around 500 millivolts to about 100 millivolts.

Finally, Fig.1(d) is a two-stage oscillator with an uneven duty cycle. The cir-

cuit oscillates at a frequency inversely proportional to the average of the two time-constants (R1.C1 and R2.C2) while the duty cycle will be proportional to the ratio of the time constants.

(Editor's note: while the pin-for-pin equivalents 40106 and 74C14 will work in these circuits, their higher hysteresis will result in different periods or oscillation frequencies).

P. Thompson,
Point Vernon, Qld.

\$25

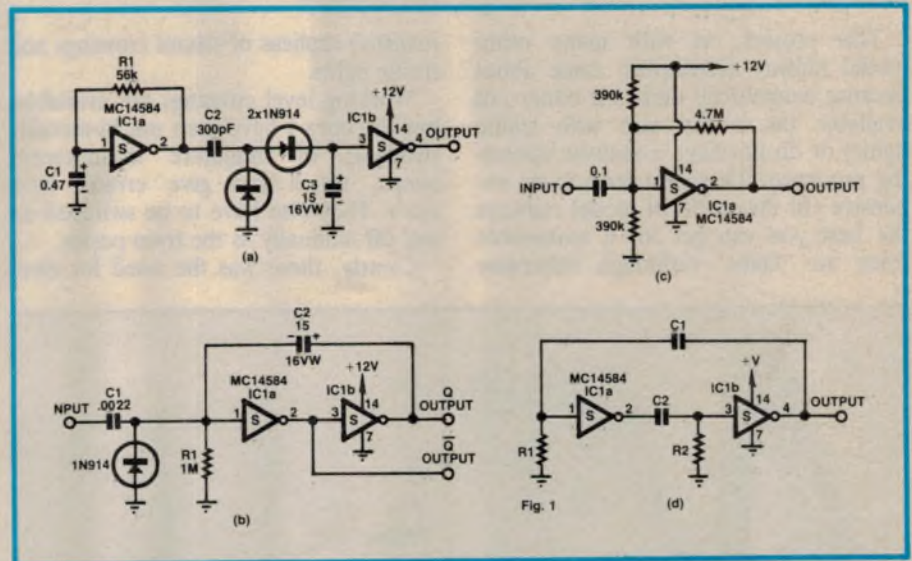

Sensitive trigger for slave flash guns

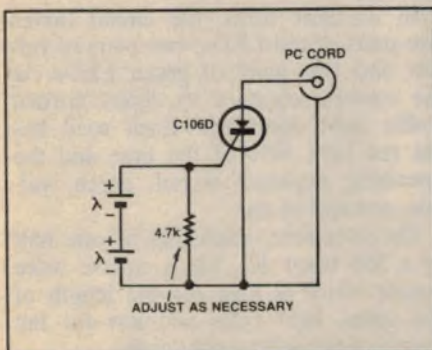

Two slivers of a solar cell and an SCR make a cheap and effective trigger circuit for a slave flash gun. The SCR should be a sensitive-gate type as shown and can be de-sensitized if necessary by the addition of the 4.7k Ω gate resistor.

The whole circuit assembly can be encapsulated in clear epoxy, after its operation has been proved.

W. Sherwood,
Exmouth, WA.

\$15

Wanted: your circuit and design ideas

If you have a circuit idea, why not share it with other readers and earn some cash into the bargain. We pay between \$5 and \$40 per item published, depending on the merit and how much work we have to do to publish it. Address your contribution to: The Editor, Electronics Australia, PO Box 227, Waterloo, NSW 2017.

Simple project adds realism

Level crossing lights for model railroads

Add that extra touch of realism to your model railway layout with this easy-to-build lighting circuit. It can provide three traffic lights, for a road intersection, a pedestrian crossing, and a level crossing which is switched on and off as the train passes.

by **JAMES MOXHAM**

This project, as with many other model railway accessories, came about because commercial units are either not available (as is the case with traffic lights) or do not have a realistic operating sequence. They also tend to be expensive. In the world of model railways the best you can get for a reasonable price are 'static' (although otherwise

realistic) replicas of school crossings and traffic lights.

Working level crossings are available, but the ones I have seen use bi-metallic switching of miniature incandescent lamps, which can give erratic flash rates. They also have to be switched on and off manually as the train passes.

Clearly, there was the need for elec-

tronic innovation. With the help of a few inexpensive ICs, these lifeless lilliputian lamp posts could be coaxed into lively luminescence.

The circuit itself was designed around the traffic lights, this being the most complicated section. Spare IC gates were then used to configure a simple flasher circuit which drives the pedestrian crossing and level crossing LEDs. In addition, a pair of infrared phototransistors, together with associated infrared LEDs, were used to detect the arrival of a train and hence to switch the level crossing on while the train actually passes.

As it stands, this circuit has already been put to use in two different applications. The first is the model railway layout for which it was originally designed, a simplified form of which is shown in the photograph of the prototype. The second application was for a demonstration display for road safety. In this case, only the school crossing and traffic lights were needed and so the components for the level crossing were omitted.

How it works

The traffic light circuit consists of an astable oscillator, a transistor inverter, a flipflop and four NAND gates (Fig.1). It is intended to drive a standard set of lights for a crossroad intersection, although it could be adapted to a T-intersection.

In its basic form, the circuit drives two pairs of red LEDs, two pairs of yellow and two pairs of green LEDs, in the correct sequence to depict normal traffic light operation. Each road has the red light 50% of the time and the operating sequence is red, green, yellow, red and so on.

The oscillator, consisting of one half of a 556 timer IC, has a square wave output which is high for the length of the green light cycle and low for the length of the yellow light cycle.

Initially, when power is first applied,

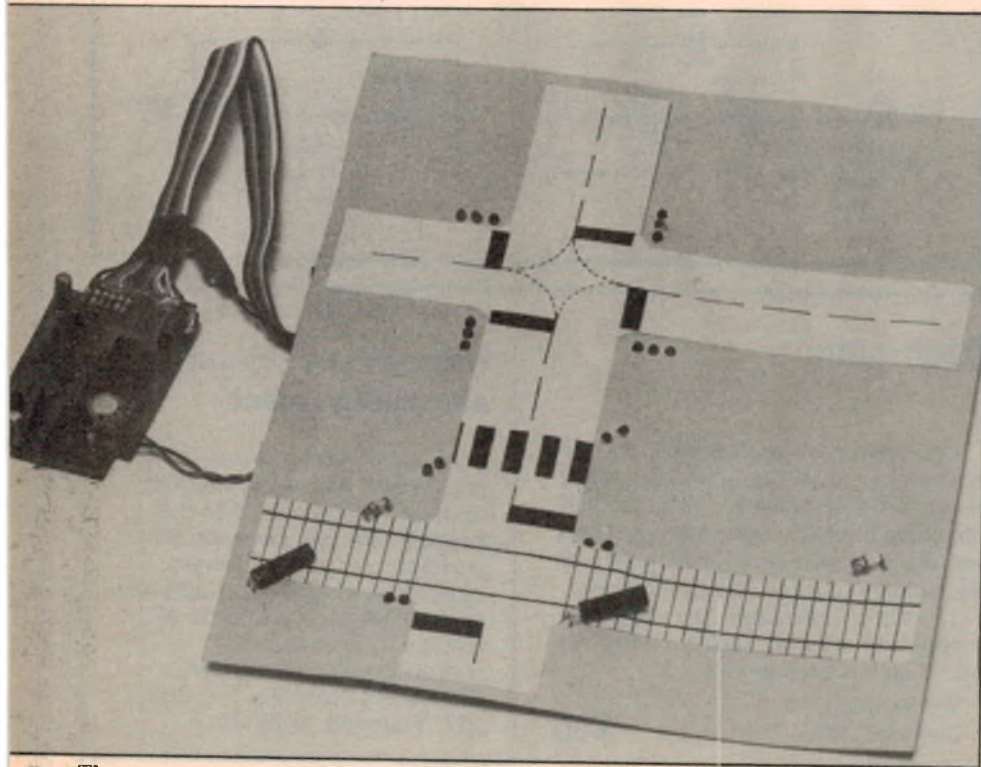

The prototype was tested by installing the LEDs on a mock cardboard layout.

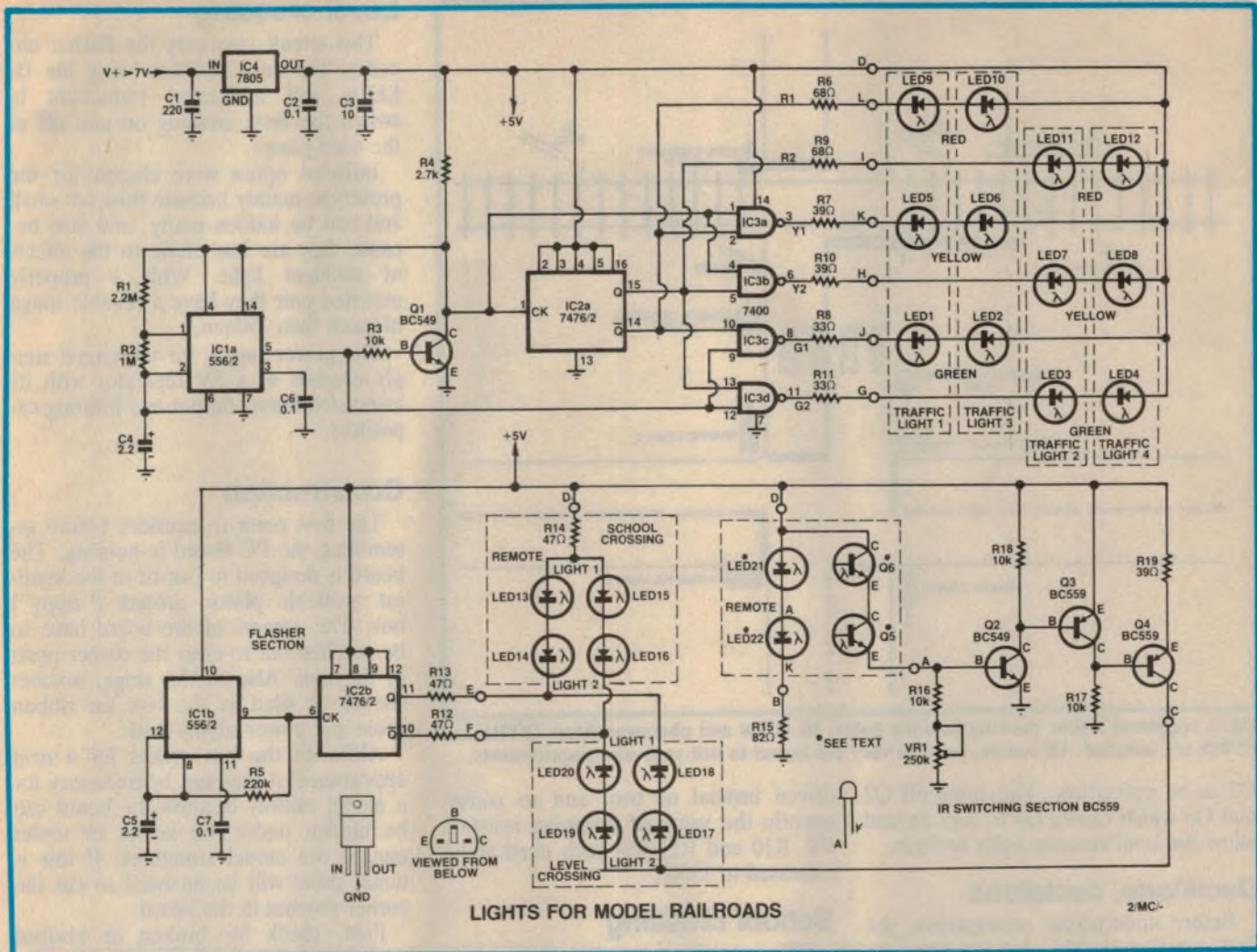

Fig.1: the circuit is built around just four ICs. IC1, IC2 and IC3 drive the various LEDs, while phototransistors Q5, Q6 and the two infrared LEDs switch the level crossing lights on and off as the train passes.

the internal discharge transistor of IC1a (pin 1) is off, C4 is discharged and the output, pin 5, is high. C4 then charges up via R1 and R2 until it reaches $2/3 V_{cc}$ whereupon it is discharged via pin 1 and R2. Thus the value of R1 + R2 determines the length of the green cycle — ie, the time that the green lights are on — while R2 determines the length of the yellow cycle.

The output from IC1a, pin 1, is inverted by transistor Q1 and fed into IC2a, which is half a 7476 negative edge-triggered flip-flop. The Q and Q-bar outputs change state at the end of each yellow cycle and drive the red LEDs when they are low respectively.

NAND gates are used to derive each of the other outputs. The logic gates and LEDs are connected such that when both inputs to a gate are high the associated series-connected LEDs will light.

Notice that the NAND gates are connected so that the correct yellow light is turned on in each case.

Depending on the tolerance of the capacitor C4, the yellow LEDs are on for about two seconds while the red LEDs are on for about eight seconds.

Low = "light" logic has been chosen in this circuit because of the internal layout of TTL driver transistors. These have a 130Ω current limiting resistor for high (source) outputs but no corresponding resistor for low (sink). To give an actual example, two green LEDs in series have a voltage drop of about 4.4V and so, if high = light logic were used, this 130Ω resistor would limit the current to 5mA. Thus low = on logic has to be used.

School crossing

This uses the other half of the 556 which is connected to produce a square wave of even duty cycle. This is achieved by charging and discharging capacitor C5 via the $220k\Omega$ resistor connected to the output (pin 9). The output drives flipflop IC2b which produces two out-of-phase waveforms with equal

mark/space ratio.

These outputs drive the school crossing LEDs directly and also drive the level crossing LEDs via a switching transistor. The switching frequency is determined by R5 and C5 and is about 1.5Hz.

Level Crossing

This section uses photosensitive devices to detect when a train is passing and hence to switch on and off the level crossing lights. Any light sensitive device with a high dark resistance and low light resistance can be used. Thus, either CdS light dependent resistors or IR photodiodes or phototransistors can be used. The prototype used two infrared phototransistors wired in series.

When the train passes it cuts off the light source to one or both of the phototransistors. Hence the total resistance between the 5V supply of the base of Q2 increases. At a threshold level determined by VR1 and R16, this increase in resistance causes the base of

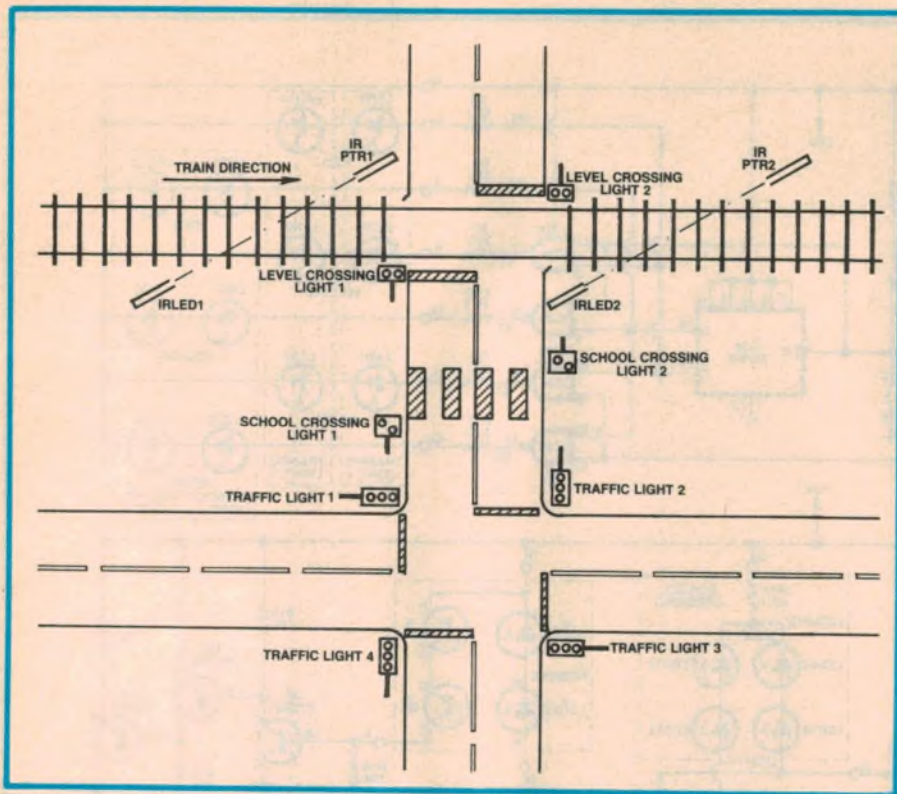

Fig.2: suggested layout showing how the lights, IR LEDs and phototransistors (PTR1 and PTR2) are installed. Of course, you can vary the layout to suit your own requirements.

Q2 to be pulled low. This turns off Q2 and Q3 which causes Q4 to turn on and allow the level crossing lights to flash.

Decisions, decisions

Before undertaking construction, the first step is to decide what functions are needed for your particular application, and consequently which components are required. Fig.2 gives a pictorial representation of what the project can do along with a possible layout configuration. As can be seen from Fig.3, one possible variation could be a "T" junction instead of the cross roads.

For a "T" junction two changes are necessary. First, since one of the roads has been omitted, the LEDs for that light are not required. This means that only one LED (of a pair) is being

driven instead of two, and so consequently the value of dropping resistors R9, R10 and R11 will each need to be increased to 150Ω.

School crossing

This section employs otherwise unused parts of IC1 and IC2 and is thus a relatively simple addition. The only variation is again the value of the LED dropping resistor. Put simply, if you are building the level crossing section as well as this one, then R12 and R13 are replaced with wire links. R14 is included and is soldered physically next to the LEDs as shown in Fig.5.

Alternatively, if the level crossing section is not being built, then R12 and R13 are included and R14 is not required.

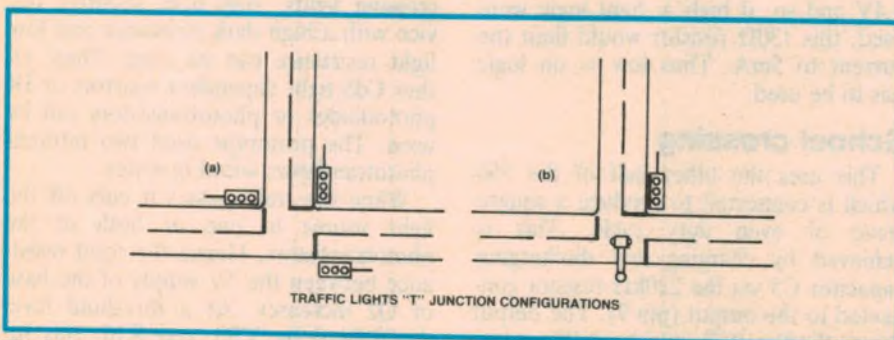

Fig.3: how the layout can be varied to suit "T" junctions.

Level crossing

This circuit also uses the flasher circuitry, the only addition being the IR LEDs and associated transistors to switch the level crossing on and off as the train passes.

Infrared optics were chosen for the prototype mainly because they are small and can be hidden easily, and also because they are less prone to the effects of ambient light. With a properly matched pair they have a reliable range of more than 150mm.

The power supply for the circuit simply consists of a 5V regulator with its associated input, output and filtering capacitors.

Construction

The first point to consider before assembling the PC board is housing. The board is designed to just fit in the smallest available plastic project ("zippy") box. The corners of the board have to be notched out to clear the corner posts of the box. Also at this stage, notches should be filed in the box for ribbon cable and power supply leads.

Although the box makes for a neat appearance, it may not be necessary for a model railway because the board can be hidden under the layout or under one of the model structures. If this is done, there will be no need to cut the corner notches in the board.

First, check for broken or bridged tracks and for hairline cracks in the printed circuit pattern. You should also check that all the holes have been drilled, and that the holes for the trim-pot and regulator are big enough.

Next comes the printed circuit board loading. Begin by installing five wire links (seven if R12 and R13 are not included). Next proceed with the resistors, inserting them with the colour codes all facing the same way (this makes it easier to check your work). Finally, continue with the capacitors, transistor and integrated circuits, making sure that the semiconductors and electrolytic capacitors are all installed the right way around.

Use a fine-tipped iron if possible, to avoid solder bridges.

External wiring

There are a few things to consider before you actually begin wiring. First, the power supply should be able to supply 200mA at 7V DC or more. Most model railway power supplies will have some sort of auxiliary DC outlet which can be used.

Don't take the power straight from the tracks; even if it is full wave rectified DC (some are AC), it will reverse polarity when the train changes direction and it will inevitably vary with the throttle setting. As an alternative to the loco power source, you could use a mains DC plugpack.

Terminate the power leads to the PC board with a suitable connector. The only other connection to the PC board is the 12-way ribbon cable. Measure the distance of the longest run and cut the cable to this length, plus a little extra. All the wires should be soldered to the board, however, the actual wires used will depend on which sections have been built.

With reference to the external wiring diagram, we can see that, in general, six wires go the traffic lights, one to the IR LEDs, one to the phototransistors and three to the level crossing, of which two go on to the school crossing. The +5V wire is common to the traffic lights, the school crossing lights and the phototransistors and IR LEDs.

Having wired the ribbon cable to the correct location and cut the wires to length, the next step is actually wiring up the lights.

Traffic lights: the lights for the road safety demonstration were constructed from balsa wood. This was glued together and painted. The poles were made from dowelling and the wires were run up the side. The LEDs were 5mm diffused lens types and the lights were about 100mm high.

If you wish to make HO scale (1:87) lights, you should use the smallest available LEDs.

Both Hewlett-Packard and Telefunken make very small LEDs which are ideal for this application. Those from HP are available in assemblies of three to eight LEDs (all the same colour). Their type numbers are HLMP-6650 (red), HLMP-6750 (yellow) and HLMP-6850 (green).

Telefunken miniature LEDs are available in single packages with a lens which is only 1.8mm in diameter, although they have slightly protruding shoulders for the leads. Their type numbers are TLUR-2401 (red), TLUO-2401 (orange-red), TLUY-2401 (yellow) and TLUG-2401 (green). They can be obtained from Geoff Wood Electronics Pty Ltd — phone (02) 427 1676.

School Crossing: much the same applies here as for the traffic lights. The only complication, as mentioned previously, is if this section is being built as well as the level crossing. In this case, the 47Ω

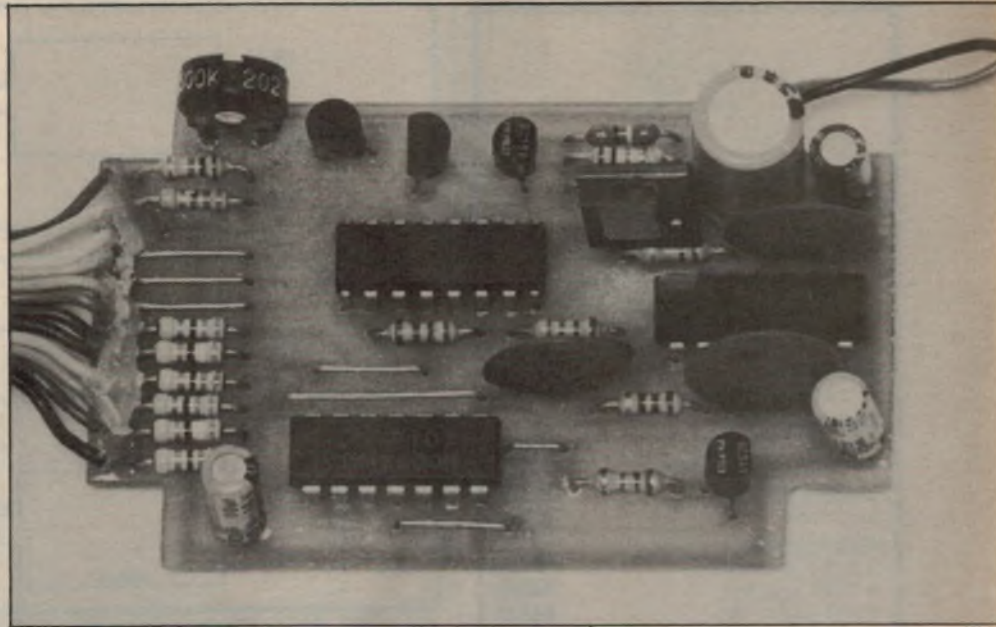

The PCB can be installed in a small plastic project box or hidden under the layout.

(R14) resistor must be included between the anodes of the crossing LEDs (LEDs 13 & 15) and +5V. If this section is being built without the level crossing section then this resistor is not needed; R12 and R13 provide current limiting.

3. **Level Crossing:** for the crossings themselves, the requirements are as for the traffic lights. However, several complications arise from the switching method chosen. First, the infrared light beams need some form of shielding. The prototype used ordinary drinking straws cut to 10mm and painted black.

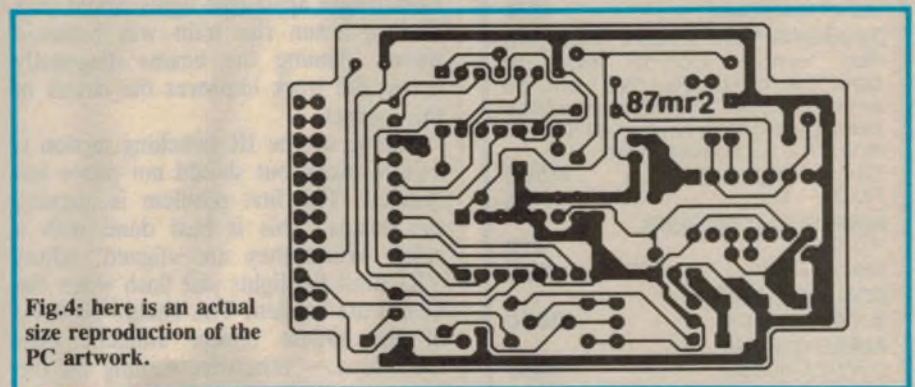

Fig.4: here is an actual size reproduction of the PC artwork.

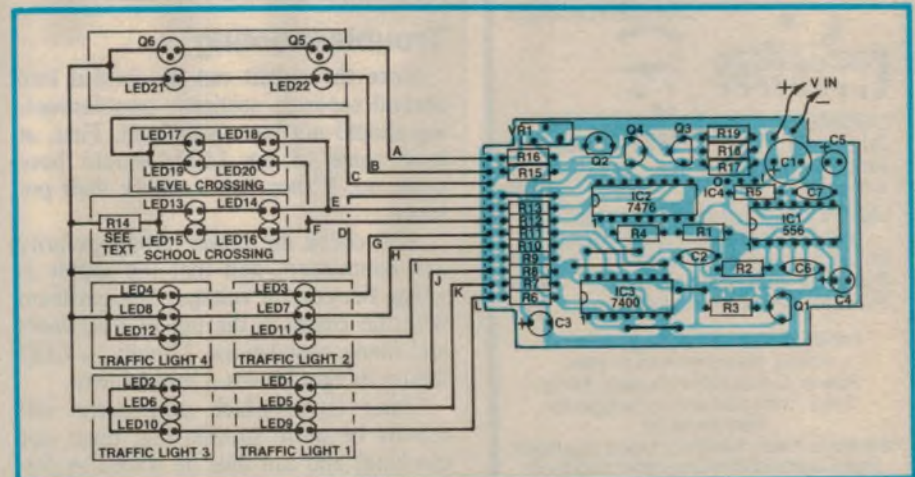

Fig.5: parts layout and wiring diagram. Note that, depending on the options used, R12, R13 and R14 may have to be replaced by wire links (see text).



Disco World Pty. Ltd.

Showrooms:

300 Main Street, Lilydale
P.O. Box 509, Lilydale, 3140
Melb. Vic. (03) 735-0588
673 High Street, Preston
(03) 470 5822

AMPLIFIERS

ZPE Series II (600W) **\$2500**

DISCO MIXERS

Citronic SM 350 **\$1100**

Arista with equaliser **\$450**

JUMBO STROBE **\$195**

Scanner **\$150**

HELICOPTER

2 ARM Spinner **\$300**

4 ARM Spinner **\$498**

6 ARM Spinner **\$580**



PINSPOT

Par 36 **\$59**

Par 56 **\$130**

MIRROR BALLS

MB 008-8" **\$58**

MB 012 **\$88**

MB 014 **\$120**

MB 018 **\$160**

MB 020 **\$198**

SMOKE MACHINES

Great for Special Effects

Hand Held 240V **\$375**

Dynamite 1200 Smoke Machine

Has remote control lead to operate off-stage. We are so excited about this that full money back guarantee will be valid for 10 days from purchase date. Our own product **\$1800**

Fluid—1 litre **\$15**

MIRROR BALL MOTORS

AC 240V **\$39**

Heavy Duty **\$100**

ROLLING LIGHTS

8 x 4515 lamps **\$1800**

AUDIO CHASER

(DW4LC4000) **\$700**

Musicolor and chaser all in one!!
Our own product

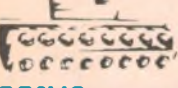

COSMO

24 lamps **\$2600**

Half Ball rotary light

6 lamps **\$780**

LAMPS all colours, so cheap!

No Warranty on Breakages

ES 240V 60W box of 25 **\$100**

BC 240V 40W box of 100 **\$90**

BC 240V 25W box of 100 **\$75**

Prices subject to change without notice. Items for hire or sale. Power Cords not included. Send S.A.E. with 60 cents postage for free price list.

We have Piezo tweeters, Etone speakers, Rope lights and many other products.

Do You Want To Be An Agent?

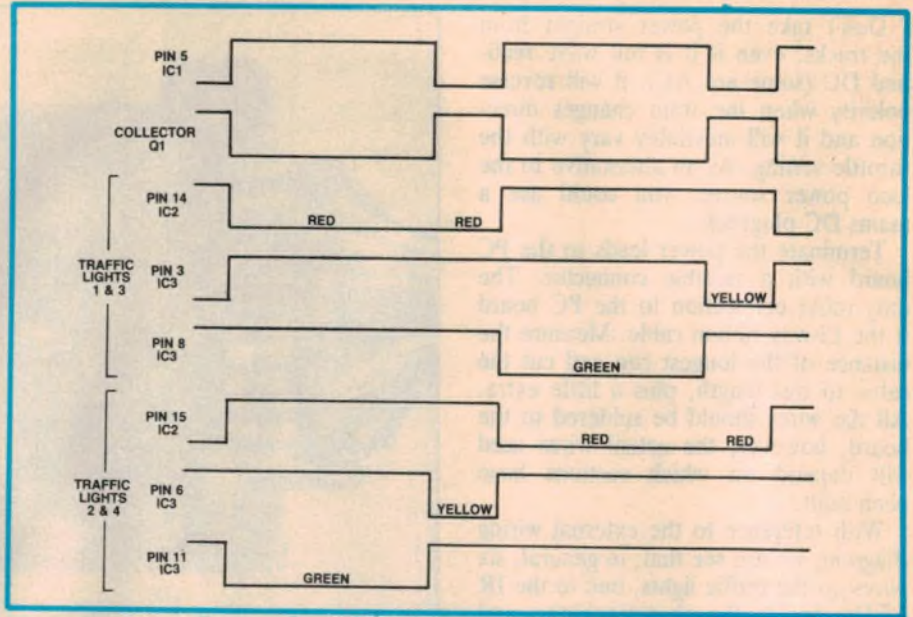

Fig.6: this timing diagram shows the pulse sequence for the traffic lights at various points in the circuit diagram.

Second, we need to consider where the beams are placed. The beams work on an either/or basis — if either one or the other is broken then the lights will flash. Thus, if the beams are placed across the track at 90 degrees, then the two beams cannot be more than one train length apart (the lights would stop flashing when the train was between them). Aiming the beams diagonally across the track improves the circuit in this respect.

Setting up the IR switching section is a little tricky but should not prove too difficult. The first problem is aligning the beams. This is best done with a ruler. When they are aligned, adjust VR1 until the lights just flash when the beams are broken. This should be done in the lowest typical ambient light conditions — otherwise turning off the lights may register as a broken beam.

Troubleshooting

Since the circuit can be divided into several separate sections, troubleshooting should not be too difficult. First, at least some of the LEDs should have come on. If they didn't, check their polarity.

Also check the power supply polarity and connection, and that the supply is giving the correct voltage. One problem with the circuit is the use of long wires and many connections. Usually, a LED failing to light means a broken wire.

Other faults which may occur will usually be more specific (eg, timer not clocking) and can thus be traced by following the timing diagram which shows the sequence for traffic lights (Fig.6).

The output from IC2b should generate 1.5Hz pulses and the collector of Q4 should go high when either of the beams are broken.

When all is working the result is a very realistic display for your model train layout. EA

PARTS LIST

- 1 printed circuit board, code 87mr2, 74 x 46mm
- 3 metres 12-way ribbon cable
- 1 plastic project box, 28 x 54 x 83mm

Semiconductors

- 1 556 dual timer
- 1 7476 TTL dual JK flipflop
- 1 7400 TTL quad NAND gate
- 1 7805 3-terminal 5V regulator
- 2 BC549 NPN transistors
- 2 BC559 PNP transistors
- 4 red LEDs
- 4 yellow LEDs
- 4 orange LEDs
- 4 green LEDs (see text)
- 2 CQY89 IR LEDs
- 2 MEL12, BPX25 phototransistors

Capacitors

- 1 220 μ F 10VW PC electrolytic
- 1 10 μ F 10VW PC electrolytic
- 2 2.2 μ F 10VW tantalum or low leakage electrolytic
- 3 0.1 μ F ceramic or metallised polyester

Resistors (0.25W, 5%)

- 1 x 2.2M Ω , 1 x 1M Ω , 1 x 220k Ω ,
- 4 x 10k Ω , 1 x 2.7k Ω , 3 x 150 Ω , 1 x 82 Ω , 2 x 68 Ω , 3 x 47 Ω , 3 x 39 Ω , 2 x 33 Ω

MULTIMETER BLITZ



PTY LTD



Check out the value! DSE prices and quality stand the hobbyist test of value-for-money...

Economy mini meter

Rugged little meter for the beginner's work bench or a handy second for handymen, technicians in the field. 11 ranges, 2000 ohms per volt for a variety of testing. Excellent value — now \$4 off! Cat Q-1010



\$12⁹⁵
Was \$16.95

Ranges:
AC & DC Volts:
10, 50, 250 & 1000
DC Current: 0.5, 100mA
Resistance: x10, x1k

Buzzer continuity & 10A DC range included!

It's the extras which make this 19 range/20,000 ohms per volt meter such a good buy! • Audible continuity • Battery checker • 10A DC range • Diode and fuse protection. Includes mirrored scale and banana plugs. Cat Q-1022



\$24⁹⁵
Was \$34.95

RANGES:
DCV: 2.5, 10, 50, 250, 1000
ACV: 10, 50, 250, 1000 DC (mA): 5, 50, 500
& 1A RES: x1, x10, x1k Batt: 1.5V, 9V
Continuity

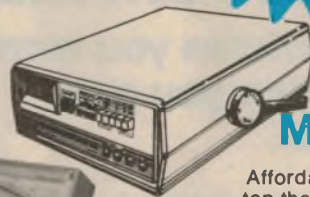

4.5 Digit Multimeter

Affordable 4.5 digit bench top take with you! Extremely accurate with high resolution. Cat Q-1550

- 10 voltage ranges — accuracy .05% DC
- 6 resistance ranges — accuracy .15%
- 200uA min — 10A max AC/DC
- 6,000 hours battery life.

Was \$289 \$199

Virtually a work bench in one meter!



- 100,000 ohms multimeter
- Tests capacitance & transistors too!

The affordable way for hobbyists to equip their work benches! More than just a multimeter, it measures transistor Ico and Hfe... great for diode testing too. Built-in oscillator for capacitance measurement. Cat Q-1140

Was \$125 \$80

RANGES:
DCV: 0.25, 2.5, 10, 50, 250, 1000
(100k/V) ACV: 4, 10, 50, 250, 1000 (10k/V)
DC: 10mA, 2.5mA, 25mA, 500mA, 10A
AC: 10A Decibels: -10 to -62
Resistance: x1, x10, x1k, x10k
Transistors: Hfe 0-1000 Ico 0-50uA
Capacitance: 50pF-3uF, 0.01uF-50uF

Hot value... Temperature/multimeter



Versatile meter for all standard checks PLUS conductance, capacitance and temperature measurements! Temperature range covers an impressive -20° to 1370° Celcius for testing heatsinks, amplifiers, etc. Includes: • 3.5 Digit display • Overload protection • Buzzer continuity. Cat Q-1512

\$169
Was \$199

RANGES:
DCV: .2, 2, 20, 100, 1kV
ACV: .2, 2, 20, 200, 750V
DC: 2, 20, 200mA, 10A
AC: 2, 20, 200mA, 10A
RES: 200, 2k, 20k, 200k TEMP: -20° to 1370°C
CAP: 2000pF, 2uF, 20uF

3.5 Digit meter/cap checker



A reliable work bench companion that offers more than multimeter functions. Also checks: • 5 ranges of capacitance • 2 ranges of conductance. Added features include: • Auto polarity • Diode check position • Over-load protection • High input impedance (10M). Cat Q-1460

\$89 Was \$129

RANGES: DCV: .2, 2, 20, 100, 1kV
ACV: .2, 2, 20, 200, 750V DC: 200uA, 2, 20, 200mA, 10A
AC: 200uA, 2, 20, 200mA, 10A
RES: 200, 2k, 20k, 200k, 2M, 20M
COND: 2uS, 20nS
CAP: 2, 20, 200nF, 2, 20uF
DIODE TEST: 1mA, -2.8V

Pocket the savings...

Pocket-size LCD meter that's brilliant value! 3.5 digit, wide angle display for accurate readings from virtually any position. RF shielding for stable readings. Overload protected too! Cat Q-1520

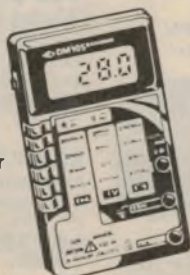

\$49⁹⁵ Was \$64.95

DC Voltage: 200mV, 20, 200, 1000
AC Voltage: 200V, 750V
Resistance: 2000, 20, 200, 2000 ohms

Meter with logic tester!



Double value at a bargain price! This superb 20 range multimeter includes a built-in logic tester indicating 'HIGH' 'LOW' and 'PULSE' states of logic circuits. Cat Q-1026

NOW \$32⁹⁵

RANGES: DCV: .3, 3, 12, 60, 300, 1200
ACV: 6, 30, 120, 300, 1200
DC: .06 3, 30, 300mA RES: x1, x10, x1k, x10K

3.5 Digit with MEMORY...

- Simple press button memory retains reading until cleared!



Don't forget this impressive meter — it's got the lot! • Voltage and resistance auto-ranging with two user selectable current ranges: 20mA or 10A. • Overrange indicator with audio tone in current/voltage measurements. Cat Q-1515

\$69 Was \$99
Save \$30!

DC Voltage: 200mV, 2, 20, 200, 1000V
AC Voltage: 2V, 20, 200, 750V
Resistance: 200-2M in 5 ranges

NEVER TO BE REPEATED SAVINGS

THIS MONTH ONLY WHILE STOCKS LAST—

BOOK CLEARANCE

Yaesu's 2m mobile now \$160 off!

The features you want, at a price you can afford...



State of the art performance with flexibility: that's the FT-270R! With 10 memories, dual VFOs and superb scanning facilities, you're ready to take on 2m pile-up — and win. High/low power (25W/3W) output. Cat D-3516

\$499
Was \$659

Design your own PLL circuits

Ideal for hobbyists tackling digital circuitry in communication projects. Cat B-1249

\$14⁹⁵ WAS \$24.95

How to tune the Secret Shortwave Spectrum

It gives you all those frequencies that are not usually published e.g. Military, Government, Espionage, Pirate, etc. Great reading. Cat B-1649

\$7⁹⁵ WAS \$12.95

333 Science Tricks & Experiments

Provides step-by-step instructions on a diverse range of experiments: gases, chemistry, light and many more. Cat B-1730

\$14⁹⁵ WAS \$19.95

Transistor Equivalents

This reference book enables the user to find substitutes for approximately 9,500 European, American and Japanese transistors. Cat B-4507

\$4⁹⁵ WAS \$8.95

The World Transistor Cross-Reference Guide

Covers specifications for all major manufacturers and some minor ones as well. Invaluable! Cat B-4506

\$4⁹⁵ WAS \$8.95

World Radio TV Handbook

The latest edition! Contains the complete listing of international radio and TV stations throughout the world. Includes frequencies, addresses, call signs, IDs and much more. Cat B-2086

\$4⁹⁵ WAS \$14.95

Digital ICs and LEDs

A superb source book for experienced hobbyists and novices alike! Teaches important fundamental circuit concepts, how to build useful digital devices, plus trouble shooting hints. Cat B-1785

\$10⁹⁵ WAS \$19.95

333 More Science Tricks & Experiments

If the first edition wasn't enough here's more! Just as stimulating and exciting as the first. Cat B-1735

\$14⁹⁵ WAS \$19.95

Laser Technology

Interested in laser technology? Covers laser radiation, construction, design and much, much more! Cat B-1861

\$12⁹⁵ WAS \$32.95

Motorola Small Signal Products Databook

All the JEDEC types plus all of Motorola's 'house' branded small signal transistors. Cat B-4036

\$12⁹⁵ WAS \$27.95

HF Linear amp

Adds a real boost to your rig over the full HF band: 2-30MHz. • 100W (plus) with only 4W input • 3-Level RF power selection • Input/output impedance: 50 ohms nominal. Famous TOKYO HY-POWER Brand. Cat D-2547



\$99 Was \$299

Famous Oskerblock HF Power/SWR meter

Checks accuracy/efficiency of your antenna and HF rig for optimum performance. • Covers 3-150MHz... suits 50 and 75 ohm lines • Directional coupler and through line techniques for minimal loss. Q-1340



Was \$125 **\$87**

Add Oomph to your 2m rig!

2m Linear amp does the job! Impressive 30W output with just 3W in • 13.8V Power supply (great for mobile) • Dual time constant for SSB or FM • Reverse polarity protection. Alinco All Mode Amp. Cat D-2546



\$79 Was \$124.95

2m Linear amp!

• Build it yourself and Save! Gives the power for those distant repeaters and DX: at an affordable price because you build it yourself! Ideal for mobile or base stations... up to 120W (CW) output from just 15W drive. 12VDC operated. Cat K-6313



\$199
Was \$299
Save \$100!

UHF GaAsFET preamp

• Save \$\$\$... build it yourself!

Truly affordable way to add power to your 70cm rig. • >15dB gain • Device noise: <2dB • Covers 430-440MHz • Auto rx/tx switching — suits masthead mounting • Strip line techniques for real stability • Coax relays included.

\$89
Cat K-6309
Was \$129



For VHF... an Oskerblock Power/SWR meter too!

Sensational value for a piece of equipment every keen amateur should own! • Covers 144-155MHz • Power range: 0-5W, 0-25W and 0-250W. Cat Q-1341

\$85
Was \$125



DICK SMITH ELECTRONICS

• NSW • Albury 21 8399 • Bankstown Square 707 4888 • Blacktown 671 7722 • Blakehurst 546 7744 • Bondi Junction 387 7444 • Brookvale (Warringah Mall) 93 0441 • Campbelltown 27 2199 • Chatswood Chase 411 1955 • Chullora 642 8922 • Gore Hill 439 5311 • Gosford 25 0235 • Hornsby 477 6633 • Liverpool 600 9888 • Maitland 33 7866 • Miranda 525 2722 • Newcastle 61 1896 • North Ryde 88 3855 • Parramatta 689 2188 • Penrith 32 3400 • Railway Square 211 3777 • Sydney City 267 9111 • Tamworth 66 1711 • Wollongong 28 3800 • ACT • Fyshwick 80 4944 • VIC • Ballarat 31 5433 • Bendigo 43 0388 • Box Hill 890 0699 • East Brighton 592 2366 • Coburg 383 4455 • Essendon 379 7444 • Frankston 783 9144 • Geelong 43 8522 • Melbourne City 67 9834 • Richmond 428 1614 • Ringwood 879 5338 • Springvale 391 6233 • Chermside 359 6255 • Rotherham 298 5695 • Rockhampton 27 9644 • Southport 32 9883 • Toowoomba 38 4300 • Townsville 72 5722 • Underwood 341 0644 • SA • Adelaide City 232 1200 • Darlington 298 8977 • Enfield 260 6088 • Salisbury 281 1593 • WA • Cannington 451 8666 • Fremantle 335 9733 • North Perth 328 6944 • Perth City 481 3261 • TAS • Hobart 31 0800 • NT • Stuart Park 81 1977

547 0522 • QLD • Brisbane City 229 9377 • Buranda 391 6233 • Chermside 359 6255 • Rotherham 298 5695 • Rockhampton 27 9644 • Southport 32 9883 • Toowoomba 38 4300 • Townsville 72 5722 • Underwood 341 0644 • SA • Adelaide City 232 1200 • Darlington 298 8977 • Enfield 260 6088 • Salisbury 281 1593 • WA • Cannington 451 8666 • Fremantle 335 9733 • North Perth 328 6944 • Perth City 481 3261 • TAS • Hobart 31 0800 • NT • Stuart Park 81 1977

Value that's Sea Worthy!

Catch a DSE marine bargain — Hurry limited stocks!

Barracuda 10-Ch. AM/SSB \$50 off!

Power and versatility you need! SSB for extra range at sea and AM for all local transmissions: covers all 10 channels. • Instant emergency Ch-88 • RF power/"S" meter • TX/RX indicator • 4W/AM and 12W P.E.P./SSB output. Can double as PA amplifier too. Cat D-1714

\$279 Was \$329

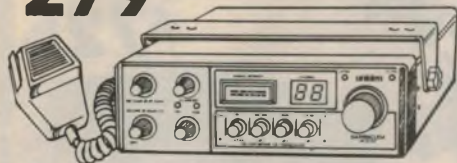

Here's the lowest priced VHF marine around!

Save \$100 on this portable power-house! Unique self-contained Tackle Box design is ideal for any sized craft. Full 60 channels in the VHF marine band with access to weather reports and auto Ch.16. DOC Approved. Cat D-1402

\$299
Was \$399



Power, performance and affordability!

Superb Uniden hand-held — it's a bargain for under \$200! All 6 channels in the 27MHz marine band are fitted with maximum legal power output. External antenna jack for long range power at sea. Fantastic value. Cat D-1125

\$199



Enjoy the advantages of a VHF hand-held...

Handy marine communications that fits virtually any budget! Goes anywhere — take it home to prevent theft. Covers any of the 12 VHF marine channels... re-programmable for coastal cruising. Switchable 0.5/2.5W power output. DOC Approved. Cat D-1404

\$299 Was \$399



Versatile 'Safety' hand-held

A popular communicator for go-anywhere adventurers. Nice, compact size for hikers, etc. ... even rock fisherman. Three channels: two open, one fitted with bushwalking frequency 27.620. Cat D-1102

\$86⁹⁶



Even on a budget have the best!

For the price you won't find better than our Dragon 27MHz AM transceiver. Reliable performance with all marine channels fitted and maximum legal power... the security you need at sea! All for a low price!

Cat D-1717

\$139



VHF Marine Seaphone

Enjoy the ultimate in marine communications without your budget taking a dive. • All 56 international VHF marine channels fitted • OTC's Seaphone link for land phone calls • Quick select emergency Ch.-16. Cat D-1400

\$449



Your marine radio deserves the best antenna!

27MHz Helical Whip. Suits most hull types. With base, cable & simulated ground plane. Cat D-4070

\$59⁹⁵



VHF marine whip antenna. Includes 'any which-way' base with emergency quick release lever. Cat D-4016

\$74⁵⁰

Anti-corrosion guard...

Protects metals for up to 2 years by emitting an invisible, odourless vapour which 'coats' components, etc. Ideal for marine radios — fitted internally. Cat D-1300

\$5⁹⁵

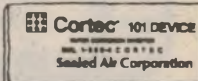

DICK SMITH ELECTRONICS

See DSE for Marine Communications... our prices won't sink your budget!

HEATH KIT

Take advantage of DSE's special Heathkit offer... A FREE catalogue & see the manual before you buy the kit.

DSE's service is second to none. Ordering Heathkit through DSXpress is as easy as fixing a stamp to an envelope or phoning. But our service doesn't end there.

Free Heathkit Catalogue — 103 pages — is available just by writing to us: Heathkit Information Service, Dick Smith Electronics, PO Box 321, North Ryde, 2113. Hurry: the Heathkit catalogue is popular reading and we have only a limited number.

See the manual before you buy... make sure that the Heathkit you want will suit your needs. We're sure it will and that's why we offer this unique opportunity: Buy the manual, check it out and if you decide to buy the kit we'll refund 50% of the manual price.

Build your own laser!

Our laser kit is better value for schools and hobbyists: the low cost includes a HeNe gas laser with modulator plus a beam detector receiver and sound amplifier. Definitely the best start to this exciting branch of tomorrow's technology. Cat G-2020



240-110V Transformer (M-1156) required.

\$799

Active Antenna

At last! An affordable MF/HF preamplifier with its own whip antenna plus provision for an external 50 ohm antenna too! It's perfect for the SWL with no room. Operates from 300kHz to 30MHz. Cat G-3005



\$199

Deluxe HF antenna tuner

Impressive 1kW (CW) rating over the entire HF band for proper antenna-transceiver matching. Features roller inductor, dual watt meters and built-in 4:1 balun. Cat G-3000



\$885

Coax switch

The Heathkit coax switch controls up to four antennas or interconnecting equipment without disconnecting hassles: one RF source is switched to any antenna or load while grounding all other outputs not in use. Handles 2kW PEP with maximum 1.1:1 SWR to 250MHz. Cat G-3010

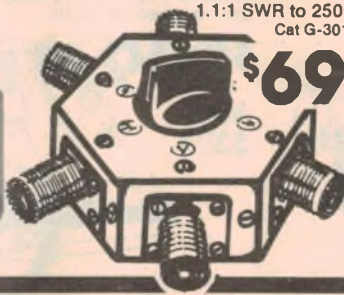

\$69⁹⁵

Ultrasonic cleaner for

Clean delicate valuables professionally with an Ultrasonic Cleaner: no scratching or abrasive cleaners. Ultrasonic method vibrates off dirt safely and thoroughly. * Requires external 240V to 110V transformer. (our M-1156 transformer is ideal). Cat G-2010



\$299

Digital LC bridge

Measure capacitance from less than 1pF to 2000uF and inductances from less than 1.0uH to 2000H: all with a basic accuracy of +/-0.5%. Cat G-4020



\$725

All the tools you need: 10-Pc. driver kit

Save \$7

* All in a transparent carry case!
For all those repairs that pop up again and again. Includes: • 4 Screwdrivers • Hammer • Magnifying glass • Magnet and tweezers • Wire prong holder. Cat T-4380



\$350

Was \$10.50

Value plus! 9-Pc. tool kit



All the basics in a handy zip-up wallet. Perfect for hobbyists (PCB work, etc.), jewellers and modellers. Includes: • Micro cutter • Snap-off mini knife with safety lock • Fine tip tweezers • 6 Assorted screwdrivers. Cat T-4836

\$695 Was \$13.95
Save \$7

Desoldering? It's easy!

Affordable 240V/30W desoldering tool — a 'must' for servicing or replacing components, etc. Does a neat job, quickly! Self-contained for on-site servicing. Energy Authority Approved.



Cat T-1340

\$40
Was \$79.95

'Scope' Cordless Solder Gun

Just the shot for on-site servicing when bench top performance is needed! 60W power, heats in just 60 seconds. 2 NiCad batteries provide 100 connections. Cat T-1600



\$69
Was \$119

Save \$50
1 Month Only!

Mini pliers

Stainless steel needle nose plier — ideal for delicate semiconductor work! Precise, non-serrated jaw with fine 1mm tip. Cat T-3570

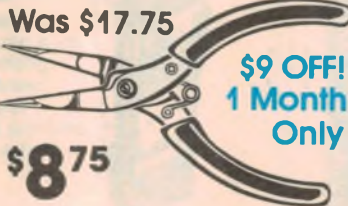

Was \$17.75

\$9 OFF!
1 Month Only

\$875

6-Pc. precision screwdriver kit

Chrome plated drivers, each with a running top for easy use!
• 4 Blade drivers from 1.4mm to 2.9mm • 2 Philips drivers: No. 1 and No. 2. Cat T-4360



Save \$7.65

\$595 set

Was \$12.65

Bargain Hole punch set

Neat holes, without filing, through 22 gauge steel or 16 gauge aluminium. Everything you need: • 12mm tapered reamer • Tommy bar • 5 punches — 16mm, 18mm, 20mm, 25mm and 30mm. Cat T-4900

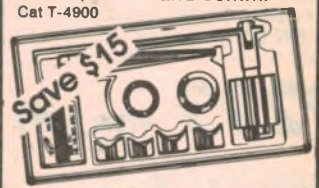

Save \$15

\$2995 Was \$44.95

'Scope' soldering iron.

* Massive 140W capability

The perfect iron for job requiring 200° — 400°C. And it's fast heating too: 20° — 200° or 200° — 400° in just 5 seconds. Complete with spare elements and tip. Requires 3V/30amp transformer (T-1692... \$58.75) for 240V use.

\$30

Was \$51.85
Save \$21.85

Cat T-1605

SPECIAL OFFER — SPECIAL OFFER MAGNAVOX SPEAKERS

For replacement speakers, hobbyist building their own system — nothing beats Magnavox for value. And now no one can beat our prices! If you find the same model at a lower price, we'll better it by 10%!!! Check our Magnavox range and prices — they'll be music to your ears.

12" Woofer (12W-099)	Cat C-2050	\$49.95 ea
10" Woofer (10J-101)	Cat C-2052	\$39.95 ea
8" Woofer (8W-020)	Cat C-2054	\$29.95 ea
5" Midrange (RM-120)	Cat C-2060	\$14.95 ea
4" Midrange (C10M-21)	Cat C-2062	\$9.95 ea
2½" Tweeter (C-65-N21)	Cat C-2070	\$9.95 ea
8" Twin cone for PA use (8AX)	Cat C-2080	\$19.95 ea
8" Twin cone aluminium voice coil (8JX)	Cat C-2082	\$24.95 ea

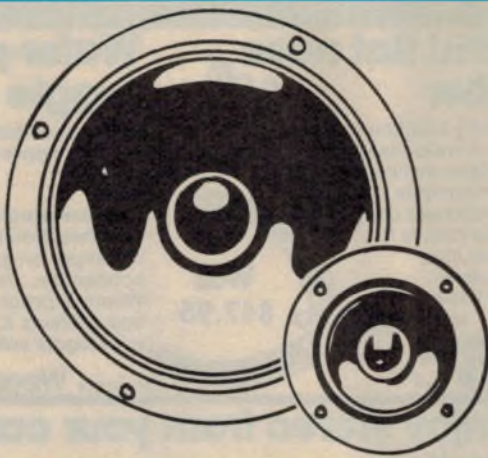

Hobby Vice

Compact vice that's ideal for all those small jobs: PCBs, etc. Clamps onto bench.

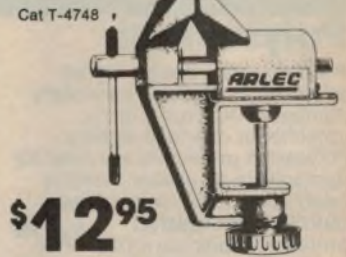

Protect your CB from theft!

The sure way to protect your valuable mobile CB against theft is removing it after parking — and with the Slide Mount it's easy. Allows no-fuss removal and replacement in seconds. Includes all mounting hardware plus connection plugs. Cat D-4525.

\$19.95 **NEW!!**

Royce Ultra Slim UHF CB

(Size only 27mmH, 162mmW, 143mmD)

NEW!!



Portapack Option

Turns your mobile UHF CB (D-1810) into a go-anywhere portable or base station rig that's instantly ready for action! Leatherette carry case (suits 170 x 190 x 50mm) contains battery compartment, whip antenna and connection to set. Gives unbelievable flexibility. Cat D-1812

Convenient slim size for today's smaller cars — but big on features and performance! • Full 40 UHF channels • Repeater and repeater reverse fitted • Easy 'one touch selection' for emergency and general call channels • Remote mic with up/down channel selection buttons • Full 5W output... Plus portapack option too! Cat D-1810

***SELCAL OPTION AVAILABLE \$599**



\$179

Low loss coax

Commercial quality 18 pitch RG 58C/U low loss coax for improved CB and amateur applications. Cat W-2092

95¢ per mtr.

Amateur TV Transmitter

What was originally designed for TV distribution (video/audio in from a VCR, etc... which is not approved in Australia) is ideal for ATV experiments. Outputs on UHF TV Ch. 35, and can be the basis of higher power transmission with a suitable amplifier.



Cat D-2500

It's here! The latest WIA Call Book

The amateur's Bible: the 1986-87 listings of Australian and international call signs, plus repeater and beacon information... everything an amateur needs to know. Cat B-2328



File valuable magazines!

Technical magazines are a handy reference, so protect them (they cost enough) with DSE's affordable Magazine File. Holds up to 13 magazines — even a couple of more with a tight fit.

Cat B-4047



JUST \$8.95

Turbometer — air speed indicator

* \$30 less than anywhere else!

NEW!!

\$159



It's a breeze to use! Yachties and balloonists can check wind strength: displays speed in knots, mph and metres per second. Handy tester for experiments and servicemen too. Cat Q-1405

DICK SMITH ELECTRONICS

PTY LTD

You need it, we've got it... Everything for the hobbyist!

Polyswitch!

Protects your valuable stereo speakers by blocking potentially damaging DC from a faulty amplifier or overload signals. Polyswitch protectors are ideal for domestic hi-fi speaker systems rated up to 100W music power.

50V/0.5A Thermistor: \$4⁹⁵
protects tweeter. Cat R-1798

50V/1.15A Thermistor: protects midrange and woofer. Cat R-1799

Mini flat nose plier

Handy addition to any tool box. 4mm wide blade, non-serrated surface avoids damaging components and a large component contact area makes it ideal as a heatsink. Cat T-3325

\$8⁹⁵ Was \$17.95

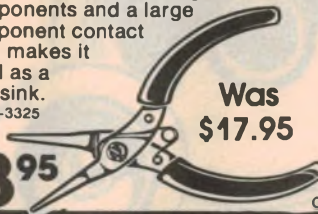

Water-proof toggle switch

12V spst switch for marine, outdoor applications. Cat S-1195

\$7⁶⁵

Weather-proof boot for toggle switches. Don't let the elements put a damper on your electrical appliances... marine radios, etc. Weather-proof boot fits over switch and protects it. Suits our range of mini toggle switches.

Cat H-1914 **Were 55¢ 20¢**

Latest and the best... DSE KITS!

60W Amp Module with Heat Sinks

Ideal for audio projects: build a PA, stereo... Increase the output of your moderately powered Hi-Fi. And DSE include drilled heat sinks! Cat K-3441



\$43⁹⁵ Was \$87.95
1/2 PRICE

Build a UHF Yagi and save!

What a bargain Assembling this 13- element Yagi saves \$\$\$! Delivers exceptional 11dBd gain over the 420-450MHz band. Cat K-8305

LIMITED STOCKS

\$15 Was \$29.95
1/2 PRICE

Ultra Fidelity Save Preamp \$24.95

Up-graded to a CD player? Improve your amp's performance with this magical kit! Improves dynamic range, noise & freq. response. Cat K-3037

\$30 Was \$54.95



Versatile Auto Minder...

Headlight 'on' reminder and door open warning light plus burglar alarm flasher — in an easy to build kit — could save hassles later. Cat K-2660

ONLY \$1 Was \$4.35



Instrument case

Bargain priced plastic instrument case. 150 x 60 x 155mm. Cat H-2508

NEW!! \$8⁹⁵

Enjoy stereo from your car's AM radio!

Expand your listening pleasure with AM Stereo — without the expense of a new AM-Stereo radio. AM Converter connects to your existing radio and transforms flat AM signals into sensational stereo. You'll love it! Cat A-6030



NEW!! \$69

"The Button" Surge protector

Affordable 240V spike protector could save you much more in damaged appliances or lost information. Plugs into power point or board protecting other appliances — computers, video, etc. — on the same line from power surges. A 'must' for home and office. Cat P-5310



NEW!! \$34⁹⁵

RP 50 Positive Photoresist

Make your own printed circuits and panels — saves time and \$\$\$! Ideal for use with 1:1 tapes and pads; exposes under UV (even Sunlight). Much easier to use than previous resists — virtually foolproof. Cat N-1001

\$9⁹⁵



RP 50 Photoresist developer. The convenient way to develop your printed circuit boards—it's easier than using caustic soda! Use with Positive Photoresist (N-1001). Cat N-1002

\$7⁹⁵

Silver paint spray

Quick drying, anti-glare paint adds style to any project, finishing touch to models, etc. Great value! 150g. Cat N-1076

\$4⁹⁵



Nickel screening conductive coating

Electro conductive spray turns plastic project boxes into electrically conductive surfaces. Ideal for RF screening, touching up connections and many other useful applications.



\$27⁵⁰

Matte black spray paint

Quick drying matte finish spray gives your project a professional finish. Cat N-1070

Was \$4.15

1/2 Price special!

\$2



DICK SMITH ELECTRONICS

Free power! Save \$\$\$ on Solar Panels

High output 20V/500mA

Perfect for boating or camping holidays: trickle charge and run battery operated appliances with FREE energy from the Sun! Cat Z-4844

\$74⁵⁰ Was \$149

LIMITED STOCKS

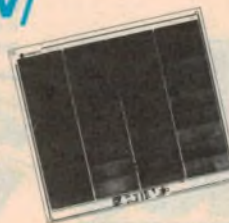

1/2 price!



Practical and Fun! 8V/180mA

Learn about solar energy and its potential with this affordable panel. Ideal for home or school projects plus recharge batteries and power small battery operated devices. Cat Z-4860

\$30 Was \$79

The best buys in Amateur radio!

Special Stock Offer:
Scoop purchase from a
Japanese supplier...
EXCLUSIVE TO DSE...
and we pass the savings
on to you.

**HURRY!
LIMITED STOCK**

Wide range Receive/ Transmit Discone antenna

- 80-480MHz
- 3.0dB gain!

You won't find better value for
amateur and scanning. Receive
AND transmit over 80 —
480MHz. Provides flat VSWR
(less than 1.5) and low
dispersion angle for effective
long distance communications.
• Maximum power: 500W PEP
• Impedance: 50 ohms • Vertical
polarisation. Cat D-4315

\$169

2m Colinear Mobile

$\frac{3}{4}$ plus $\frac{3}{4}$ wavelength gives
5.2dBi gain, with VSWR less
than 1.5:1 at cente band
(tunable with adjustable whip).
Designed for side-of-roof
mobile use, the PL-259 base
suits huge range of mounts (our
D-4035 SO-239 for example).
Stainless steel construction.
Cat D-4320

\$79

"Short" $\frac{7}{8}$ wave for 2m

Capacitively loaded whip for two
metres giving 4.2dBi gain —
almost the same as a full $\frac{7}{8}$
antenna! And even more: it's got
an inbuilt foldover — ideal for
low flying car parks. VSWR is
less than 1.5:1 (less than 1.1:1 at
band centre), adjustable. PL259
base terminated. Cat D-4325

\$69⁹⁵

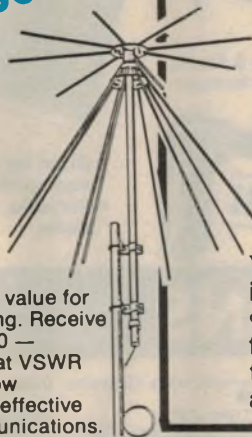

NEW!!

Magnavox world receiver

Your passport to international entertainment. Tune
into local AM, FM plus SSB and 11 SW bands.
• PLL for precise tuning • 16 preset memory
function • Auto search • Direct frequency key in and
triple speed manual tuning • Connections for
antenna, headphones, DC and line out. Cat D-2999

- Alarm clock
- Two loud speakers
- Bandwidth selector
- Quartz controlled

\$769

Hear's what scanning is all about! The Bearcat range...

Action breaker Bearcat!

Performance and features at an
affordable price. Hear it all:
emergency services, aircraft
and weather — from 29-512MHz
• 16 Channel memory • 8-Digit
display • Lockout and priority •
Direct channel with manual up/
down scanning or auto search.
Cat D-2812

- Frequencies covered:
- 29-54MHz
 - 118-136MHz
 - 136-174MHz
 - 406-512MHz

\$499

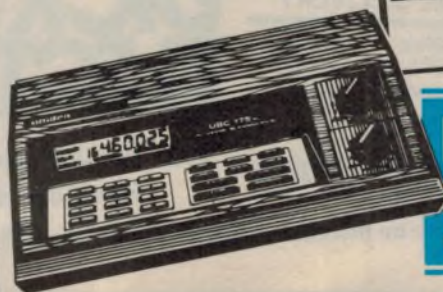

Budget 10-Ch hand-held

Full 10 channel performance
for real scanning power —
anywhere! • Direct channel
access • Manual and scan •
Lockout and review buttons.
Cat D-2814

- Frequencies covered:
- 29-54MHz
 - 136-174MHz
 - 406-512MHz

\$299

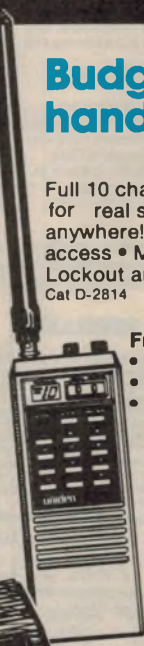

Hear action on the go... 16-Ch. hand-held

In the car, at work... hear news
as it happens! • Covers 9 bands
• Direct channel access and
auto search • Selective scan
and delay • Priority and auto
lockout. Cat D-2813

- Frequencies covered:
- 66-88MHz
 - 118-135MHz
 - 136-174MHz
 - 406-512MHz

\$399

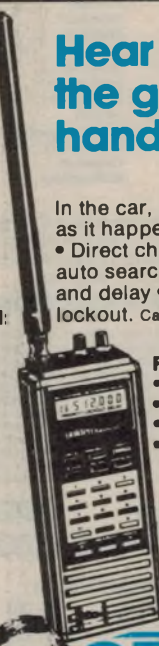

**DICK SMITH
ELECTRONICS**

PTY LTD

New Year celebration bargains!

RF Chokes

Wow! Fantastic value for hobbyists...

- 1 UH Cat L-1759
- 1.5 UH Cat L-1761
- 2.2 UH Cat L-1763
- 3.3 UH Cat L-1765
- 4.7 UH Cat L-1767
- 6.8 UH Cat L-1769
- 8.2 UH Cat L-1771

NEW!!

All only **\$1.30** each!

12V Car power lead

Ideal for campers, driving vacations. Lead plugs into car's cigarette lighter to power 12V appliances, kids video games, etc. 4 Way adaptor suits popular appliances. Cat P-1680

\$3.25

NEW!!



Economy 18V/2.2amp transformer

Ideal power pack for amateur or CB rigs. 240V primary, 18V/2.2 amp secondary. Cat M-1990

- Great Value!
- Compact Design

ONLY **\$14.95**



Adaptor Plugs & Sockets

2 x RCA Sockets to 1 x RCA Plug in "Y" format.

\$2.95

Cat P-6610



NEW!!

3.5mm stereo socket to 3.5mm stereo plug, right angle format.

\$3.95

Cat P-6620



NEW!!

3.5mm stereo socket to 6.5mm stereo plug, right angle format.

\$4.95

Cat P-6625



NEW!!

E-Z Cable tester

Beauty! Check audio or video cables and plugs without a multimeter. Just connect DSE's Cable Tester for a quick check. Tests cables and terminated leads, cannon, BNC, RCA and phono plugs. Cat Q-1532

\$79.95

NEW!!



- Great for bands and audiophiles
- Portable, self-contained tester

STORE LOCATIONS

NSW	Albury	(086)21 8399	ACT	Fyshwick	(062)60 4944	Cnr Pacific Hwy & Kingston Rd	Underwood	(07)341 0844
Swift & Young Sts. T55 Terrace Level Shop 1, 65-75 Main St 613 Princess Hwy Oxford & Adelaide Sts Shop 2, 18 Cross St. Warringham Mall Campbelltown Mall Queen St Shop 235, Archer St Entrance 147 Hume Hwy 164 Pacific Hwy 315 Mann St 4 Florence St Elizabeth Dr & Bathurst St 450 High Street 621-627 The Kingsway 173 Maitland Rd, Tighes Hill Lane Cove & Waterloo Rds George & Smith Sts The Gateway High & Henry Sts 818 George St 125 York St Treloar's Bldg, Brisbane St 263 Keira St	Bankstown Bq Blacktown Blakehurst Bondi Junction	(02)707 4888 (02)871 7722 (02)548 7744 (02)387 1444	96 Gladstone St VIC Creswick Rd & Webster St 145 McCrae St Shop 46, Box Hill Central, Main St Hawthorn Rd & Nepean Hwy 260 Sydney Rd 1150 Mt Alexander Rd Nepean Hwy & Ross Smith Ave Shop 9 110, High St 291-293 Elizabeth St Bridge Rd & The Boulevard Shop 2, 141 Maroonah Hwy Springvale & Dandenong Rds VIC 157-159 Elizabeth St 166 Logan Rd Gympie & Hamilton Rds Queen Elizabeth Dr & Bernard St 2nd Level Western Entrance Redbank Shopping Plaza Gold Coast Hwy & Welch St Kings Rd & Woolcock St	Ballarat Bendigo Box Hill East Brighton Coburg Essendon Frankston Geelong Melbourne City Richmond Ringwood Springvale	(053)31 5433 (054)43 0388 (03)690 0899 (03)592 2366 (03)383 4455 (03)379 7444 (03)783 8144 (052)43 8522 (03)87 8834 (03)428 1814 (03)879 5338 (03)547 0522	77 Grenfell St Main South & Flagstaff Rds Main North Rd & Darlington St 24 Park Terrace WA Wharf St & Albany Hwy 66 Adelaide St William St & Robinson Ave Raine Square, 125 William St TAB Shop 40A, Lower Level Cat & Fiddle Arcade NT 17 Stuart Hwy	Adelaide Darlington Enfield Salisbury	(08)232 1200 (08)298 8977 (08)260 6088 (08)281 1593
Brookvale Campbelltown Chateau House Chullora Gore Hill Gosford Hornsby Liverpool Maitland Miranda Newcastle North Ryde Parramatta Penrith Railway Square Sydney City Tamworth Wollongong	(02)93 0441 (048)27 2199 (02)411 1955 (02)642 8922 (02)439 5311 (043)25 0235 (02)477 8633 (02)800 8888 (048)33 7866 (02)525 2722 (048)81 1888 (02)88 3855 (02)689 2188 (047)32 3400 (02)211 3777 (02)287 8111 (067)86 1711 (042)28 3800	Brisbane City Buranda Chermside Rockhampton	(07)228 9377 (07)391 6233 (07)358 6255 (07)27 9844	Redbank Southport Toowoomba Townsville	(07)288 5599 (07)32 8863 (08)38 4300 (077)72 5722	Hobart Stuart Park	(002)31 0800 (088)81 1977	

Dear Customers,

Quite often, the products we advertise are so popular they run out within a few days, or unforeseen circumstances might hold up shipments so that advertised lines are not in the stores by the time the advert appears. And very occasionally, an error might slip through our checks and appear in the advert (after all, we're human too!) Please don't blame the store manager or staff; they cannot solve a dock strike on the other side of the world, nor fix an error that's appeared in print. If you're about to drive across town to pick up an advertised line, why not play it safe and give them a call first... just in case! Thanks, Dick Smith Electronics.

MAJOR DICK SMITH ELECTRONICS AUTHORISED RESELLERS

NSW: • Ballina: A. Cummings & Co. 91-93 River St. 88 2284 • Bowral: F.R.H. Electrical, 26 Station St. 81 1000 • Broken Hill: Hobbies & Electronics, 31 Oxide St. 89 4088 • Charles town: Newtronics, 131 Pacific Hwy. 43 9600 • Coffs Harbour: Coffs Harbour Electronics, Shop 3, Coffs Harbour Mall, Park Ave. 52 5604 • Deniliquin: Deni Electronics, 220 Cressy St. 81 3872 • Dubbo: Mavins Electronics, 35 Talbragar St. 82 8500 • Gosford: Tomorrrows Electronics & HIFI, 88 William St. 24 7248 • Inverell: Lyn Willing Electronics, 32 Lawrence St. 22 1821 • Lismore: Leon Record Centre, 121 Pine Ave. 53 2081 • Lightning Ridge: Lightning Ridge Newsagency, 40A Morilla St. 29 0579 • Lismore: Decro, 3A/6-16 Carrington St. 24 4137 • Port Macquarie: Hall of Electronics, Horton Centre, 124 Horton St. 83 7440 • Orange: Fyfe Electronics, 173 Summer St. 62 6491 • Springwood: Wellington's Electrical Discounts, 115 Macquarie Rd. 51 4888 • Taree: Brad's Electronics Shop 8, Civic Cinema Centre, Pulteney St. 52 6803 • Tamut: Tamut Electronics, Wynyard St. 47 1631 • Tweed Heads: Stuart Street Electronic Sales, Stuart St. 36 5744 • Ulladulla: Pauls Electronics, 10 Wason Street, 55 3989 • Wagga: Phillips Electronics, 80 Forsyth St. 21 8558 • Windsor: M & E Electronics, Shop 7, Mc Ewans Arcade, 206 George St. 77 5935 • Young: Keith Donges Electronics, 186 Boorowa St. 82 1279 VIC: • Echuca: Webster Electronics, 220 Packerham St. 82 2956 • Mildura: McWilliams Electronics, 81 Bourbong St. 72 1785 • Morwell: Morwell Electronics, 95 George St. 34 6133 • Rosebud: Penronics, 1243A Nepean Hwy. 86 7688 • Shepparton: GV Electronics Centre, Supertronic, 9 Tank St. 72 4321 • Mackay: Stevens Electronics, 42 Victoria St. 51 1723 • Maryborough: Keller Electronics, 218 Adelaide St. 21 4559 • Moooloolaba: Mai's Electronics, Shop 4, 129 Brisbane Rd. 44 6588 • Mt Isa: Outback Electronics, Shop 71, Barkly Hwy. 43 3331 • Nambour: Nambour Electronics, Shop 4, Lowan House, Ann St. 41 1604 • Noosa Heads: Sunshine Phone Systems, Shop 2, Forum Centre, Sunshine Beach Rd. 47 4444 • Rockhampton: Access Micro Electronics, 133 Lockyer Ave. 41 3432 TAS: • Launceston: Willis Electronics, 5A The Quadrant, 31 5688



ORDER SERVICE
(008)22 6610

ORDERS OVER \$75
FREE DELIVERY



PTY LTD

P.O. Box 321, North Ryde N.S.W. 2113
Fax: 888 3631 Tel: 888 3200

POST & PACKING CHARGES	Order Value	Charge	Order Value	Charge
	\$5.00 — \$9.99	\$2.00	\$50.00 — \$75.00	\$6.50
	\$10.00 — \$24.99	\$3.50	\$75.00 or more	N.A.
	\$25.00 — \$49.99	\$4.50		

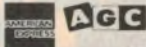

Terms available to approved applicants

SA Customers: Credit facilities available through Adelaide: 10 Pulteney St, Adelaide

Offer concludes 28/2/87 or until stocks last. Prices can be increased without notice due to fluctuations in currency, high interest rates, government taxes and imports.

50 and 25 years ago...

"Electronics Australia" is one of the longest running technical publications in the world. We started as "Wireless Weekly" in August 1922 and became "Radio and Hobbies in Australia" in April 1939. The title was changed to "Radio, Television and Hobbies" in February 1955 and finally, to "Electronics Australia" in April 1965. Below we feature some items from past issues.

Wireless Weekly

February 1937

Radio tradesmen: trained men are needed for the radio industry, and the problem of obtaining them is becoming quite acute in the Sydney radio trade. Stromberg-Carlson is establishing its own school to train operatives.

Noise detector: a small copper disc attached to the end of a wooden handle several feet long, with a shielded cable wire running to the other end of the handle, makes an excellent exploration tool for locating noise sources in a car when ironing-out auto radio installation. Connect the core of the cable to the

antenna and ground the shield. Then move the disc near various points under the hood and around the body.

Risk to watches: a reader has suggested that we should issue a special warning about the way in which watches can be ruined if they are brought within reach of the magnetic influence of the loud-speaker field. Even the modern permagnetics have such a strong field magnet that a watch can be affected at a range of several inches.

Air-cell batteries: of greatest interest to all country readers are the American "Air-cells" and these will be available to the public on March 1.

To look at, the air-cell resembles an ordinary accumulator, but actually it is not rechargeable. It runs with little attention supplying filament current for about 1000 to 1200 hours, and is then completely discarded.

RADIO, TELEVISION and HOBBIES

February 1962

Speed record attempt (caption): standing by the cockpit of his rebuilt "Bluebird", speed ace Donald Campbell is dwarfed by the massive jet-engined car in which he hopes to establish a new world land speed record sometime in 1962.

War on pigeons: scientists have been trying for fifty years to prevent pigeons and starlings from roosting on monuments and public buildings and fouling them with their droppings, and so far the birds have always proved immovable.

Time explosions, electric shocks, and high pitched musical notes have all been tried without lasting success.

But now, it looks as if the birds might have been outmanouevred by the latest experiment in London. A plastic gel is squeezed out like toothpaste on the edge of every ledge and cornice on which a pigeon is likely to alight. As soon as it settles, its feet sink into the stuff and the pigeon feels a sense of insecurity.

Package TV station: although TV stations are usually thought of as extremely costly and complex installations, there is a definite need for compact, economical, low power systems to suit isolated small communities, educational authorities, etc.

A simple design of low-cost 625-line television broadcasting equipment has been developed by Pye TVT Ltd of Cambridge. The system is suitable for general TV programs — such as news presentation, interviews and educational broadcasting — but not for live transmission of rapidly moving subjects. The "package" costs 17,000 pounds.

SCOPE TOOLS

NEW INFINITELY ADJUSTABLE 200° - 470° C

Illuminated Temp. readout monitors actual tip temperature.

Zero Voltage switching for maximum component safety.

Select the tip temp. required.



CODE ETC60L

60 Watts of back-up power - 30W Pencil optional.

Burnproof & flexible lead.

Ceramic encapsulated element for lowest earth leakage

SOLDER REMOVER METAL BODY - SELF CLEANING

CODE SR



SOLDER BLOTTER 2 M IN WIND BACK DISPENSER

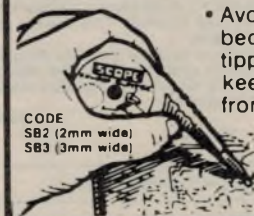

CODE SB2 (2mm wide) SB3 (3mm wide)

- Avoid burnt fingers because metal tipped container keeps fingers away from iron tip
- Dispenser locates tape positively



DAVID REID ELECTRONICS LIMITED
127 York Street Sydney, 2000
or Telephone (02) 267 1385

Back by Popular Dem

DATA & REFERENCE

DIGITAL IC EQUIVALENTS AND PIN CONNECTIONS
A. Michaels BP0140
Shows equivalents and pin connections of a popular user-orientated selection of European, American and Japanese digital ICs. Also includes details of packaging, families, functions, manufacturer and country of origin.

256 pages (Large Format)
(Available February 1987) \$18.00

LINEAR IC EQUIVALENTS AND PIN CONNECTIONS
A. Michaels BP0141
Shows equivalents and pin connections of a popular user-orientated selection of European, American and Japanese linear ICs. Also includes details of functions, manufacturer, and country of origin.

320 pages (Large Format)
(Available February 1987) \$18.00

INTERNATIONAL TRANSISTOR EQUIVALENTS GUIDE
A. Michaels BP0085
Helps the reader to find possible substitutes for a popular user-orientated selection of European, American and Japanese transistors. Also shows material type, polarity, manufacturer and use.

320 pages \$12.00

CHART OF RADIO, ELECTRONIC, SEMICONDUCTOR AND LOGIC SYMBOLS
M. H. Babani, B.Sc.(Eng) BP0027
Illustrates the common, and many of the not-so-common, radio, electronic, semiconductor and logic symbols that are used in books, magazines and instruction manuals, etc., in most countries throughout the world.

Chart \$4.00

RADIO AND ELECTRONIC COLOUR CODES AND DATA CHART
B. B. Babani BP0007
Covers many colour codes in use throughout the world, for most radio and electronic components. Includes resistors, capacitors, transformers, field coils, fuses, battery leads, speakers, etc.

Chart \$4.00

AUDIO AND HI-FI

BUILD YOUR OWN SOLID STATE HI-FI AND AUDIO ACCESSORIES
M. H. Babani BP0220
An essential addition to the library of any keen hi-fi and audio enthusiast. The design and construction of many useful projects are covered including: stereo decoder, three-channel stereo mixer, FET pre-amplifier for ceramic PUs, microphone pre-amp with adjustable bass response, stereo dynamic noise filter, loud-speaker protector, voice-operated relay, etc.

96 pages \$8.00

AUDIO PROJECTS
F. G. Rayer BP0090
This book covers in detail the construction of a wide range of audio projects. The text has been divided into the following main sections: Pre-amplifiers and Mixers, Power Amplifiers, Tone Controls and Matching, Miscellaneous Projects.
All the projects are fairly simple to build and have been designed around inexpensive and readily available components. Also, to assist the newcomer to the hobby, the author has included a number of board layouts and wiring diagrams.

96 pages \$8.50

COMPONENT SPECIFIC

MODERN OP-AMP PROJECTS
R. A. Penfold BP0108
Includes a wide range of constructional projects which make use of the specialised operational amplifiers that are available today, including low noise, low distortion, ultra-high input impedance, low slew rate and high output current types. Circuits using transconductance types are also included.
All of the projects are fairly easy to construct and a stripboard layout is provided for most of them so that even constructors of limited experience should be able to build any of the projects with the minimum of difficulty.

112 pages \$8.50

MODEL RAILWAY PROJECTS
R. A. Penfold BP0095
The aim of this book is to provide a number of useful but reasonably simple projects for the model railway enthusiast to build, based on inexpensive and easily obtainable components.
The projects covered include such things as controllers, signal and sound effects units, and to help simplify construction, stripboard layouts are provided for each project.

112 pages \$8.50

AERIALS

AERIAL PROJECTS
R. A. Penfold BP0105
The subject of aerials is vast but in this book the author has considered practical aerial designs, including active, loop and ferrite aerials which give good performances and are relatively simple and inexpensive to build. The complex theory and mathematics of aerial design have been avoided.
Also included are constructional details of a number of aerial accessories including a pre-selector, attenuator, filters and tuning unit.

96 pages \$8.50

25 SIMPLE AMATEUR BAND AERIALS
E. M. Noll BP0125
This concise book describes how to build 25 amateur band aerials that are simple and inexpensive to construct and perform well. The designs start with the simple dipole and proceed to beam, triangle and even a mini-rhombic made from four TV masts and about 400 feet of wire.
You will find a complete set of dimension tables that will help you spot an aerial on a particular frequency. Dimensions are given for various style aerials and other data needed for spacing and cutting phasing lengths. Also included are dimensions for the new WARC bands.

80 pages \$6.50

25 SIMPLE SHORTWAVE BROADCAST BAND AERIALS
E. M. Noll BP0132
Fortunately good aerials can be erected at low cost, and for a small fractional part of the cost of your receiving equipment.
This book tells the story. A series of 25 aerials of many different types are covered, ranging from a simple dipole through helical designs to a multi-band umbrella.

80 pages \$6.50

25 SIMPLE INDOOR AND WINDOW AERIALS
E. M. Noll BP0138
Written for those people who live in flats or have no gardens or other space-limiting restrictions which prevent them from constructing a conventional aerial system.
The 25 aerials included in this book have been especially designed, built and tested by Mr. Noll to be sure performers and give surprisingly good results considering their limited dimensions.

64 pages \$6.00

25 SIMPLE TROPICAL AND MW BAND AERIALS
E. M. Noll BP0145
Shows you how to build 25 simple and inexpensive aerials for operation on the medium wave broadcast band and on 60, 75, 90 and 120 metre tropical bands. Designs for the 49 metre band are included as well.

64 pages \$6.00

FAULT-FINDING

HOW TO GET YOUR ELECTRONIC PROJECTS WORKING
R. A. Penfold BP0110
The aim of this book is to help the reader overcome problems by indicating how and where to start looking for many of the common faults that can occur when building up projects.
Chapter 1 deals with mechanical faults such as tracing dry joints, short-circuits, broken PCB tracks, etc. The construction and use of a tri-state continuity tester, to help in the above, is also covered. Chapter 2 deals with linear analogue circuits and also covers the use and construction of a signal injector/tracer which can be used to locate and isolate the faulty areas in a project.
Chapter 3 considers ways of testing the more common components such as resistors, capacitors, op amps, diodes, transistors, SCRs, unijunctions, etc., with the aid of only a limited amount of test equipment.
Chapter 4 deals with both TTL and CMOS logic circuits and includes the use and construction of a pulse generator to help fault-finding.

96 pages \$8.50

AUDIO AMPLIFIER FAULT-FINDING CHART
C. E. Miller BP0120
This chart will help the reader to trace most common faults that might occur in audio amplifiers. Across the top of the chart are two "starting" rectangles, viz Low/Distorted Sound Reproduction and No Sound Reproduction. After selecting the most appropriate one of these, the reader simply follows the arrows and carries out the suggested checks until the fault is located and rectified.

Chart \$4.00

ELECTRONIC & COMPUTER MUSIC

ELECTRONIC MUSIC PROJECTS
R. A. Penfold BP0074
Provides the constructor with a number of practical circuits for the less complex items of electronic music equipment, including such things as fuzz box, wah-wah pedal, sustain unit, reverb/echo and phaser units, tremolo generator, etc.
The text is divided into four chapters as follows:

Chapter 1, Guitar Effects Units; Chapter 2, General Effects Units; Chapter 3, Sound General Projects; Chapter 4, Accessories. \$9.50

112 pages

ELECTRONIC SYNTHESIZER CONSTRUCTION
R. A. Penfold BP0185
Should enable a relative beginner to build, with the minimum of difficulty and at reasonably low cost a worthwhile monophonic synthesiser, and also learn a great deal about electronic music synthesis in the process. This is achieved by considering and building the various individual parts of the circuit that comprise the whole instrument as separate units, which can then be combined together to form the final synthesiser. Printed circuit designs are provided for these main modules. Later chapters deal with sequencing and some effects units.

112 pages \$11.00

MIDI PROJECTS
R. A. Penfold BP0182
Provides practical details of how to interface many popular home computers with MIDI systems. Also covers interfacing MIDI equipment to analogue and percussion synthesisers.

112 pages \$11.00

MORE ADVANCED ELECTRONIC MUSIC PROJECTS
R. A. Penfold BP0174
Intended to complement the first book (BP74) by carrying on where it left off and providing a range of slightly more advanced and complex projects. Included are popular effects units such as flanger, phaser, mini-chorus and ring-modulator units. Some useful percussion synthesisers are also described and together these provide a comprehensive range of effects including drum, cymbal and gong-type sounds.

96 pages \$8.50

COMPUTER MUSIC PROJECTS
R. A. Penfold BP0173
Shows some of the ways a home computer can be used to good effect in the production of electronic music. Topics covered include sequencing and control via analogue and MIDI interfaces, computers as digital delay lines and sound generators for computer control.

112 pages \$11.00

MISCELLANEOUS

COIL DESIGN AND CONSTRUCTION MANUAL
B. B. Babani BP0180
A complete book for the home constructor on "how to make" RF, IF, audio and power coils, chokes and transformers. Practically every possible type is discussed and calculations necessary are given and explained in detail. All mathematical data is simplified for use by everyone.

96 pages \$9.50

AN INTRODUCTION TO Z80 MACHINE CODE
R. A. & J. W. Penfold BP0152
Takes the reader through the basics of microprocessors and machine code programming with no previous knowledge of these being assumed. The microprocessor dealt with is the Z80 which is used in many popular home computers and simple programming examples are given for Z80-based machines including the Sinclair ZX-81 and Spectrum, Memotech and the Amstrad CPC 464. Also applicable to the Amstrad CPC 664 and 6128.

144 pages \$10.00

A Z-80 WORKSHOP MANUAL
E. A. Parr BP0112
This book is intended for people who wish to progress beyond the stage of BASIC programming to topics such as machine code and assembly language programming, or need hardware details of a Z-80 based computer.

192 pages \$12.00

GETTING THE MOST FROM YOUR PRINTER
J. W. Penfold BP0181
Details how to use all the features provided on most dot-matrix printers from programs and popular word processor packages like Wordwise, Visawrite and Quill, etc. Shows exactly what must be typed in to achieve a given effect.

96 pages \$11.00

CIRCUITS & CONSTRUCTIONAL PROJECTS

BEGINNERS GUIDE TO BUILDING ELECTRONIC PROJECTS
R. A. Penfold BP0227
Shows the complete beginner how to tackle the practical side of electronics, so that he or she can confidently build the electronic projects that are regularly featured in the popular magazines and books. Also includes examples in the form of simple projects that you can build.

112 pages \$8.50

and... Babani Books!

50 PROJECTS USING RELAYS, SCRs AND TRIACS
F. G. Rayer BP0037
 This book gives tried and practical working circuits which should present the minimum of difficulty for the enthusiast to construct. In most of the circuits there is a wide latitude in component values and types, allowing easy modification of circuits or ready adaption of them to individual needs.
 112 pages \$8.50

POPULAR ELECTRONIC PROJECTS
R. A. Penfold BP0049
 Provides a collection of the most popular types of circuits and projects covering a very wide range of interests including Radio, Audio, Household and Test Equipment projects.
 144 pages \$9.50

ELECTRONIC TEST EQUIPMENT CONSTRUCTION
F. G. Rayer BP0075
 This book covers in detail the construction of a wide range of test equipment for both the electronics hobbyist and radio amateur. Included are projects ranging from a FET amplified voltmeter and resistance bridge to a field-strength indicator and heterodyne frequency meter. Not only can the home constructor enjoy building the equipment but the finished product can also be usefully utilised in the furtherance of his hobby.
 96 pages \$8.00

REMOTE CONTROL PROJECTS
O. Bishop BP0073
 Aimed primarily at the electronics enthusiast who wishes to experiment with remote control as many of the designs are suitable for adaptation to the control of other circuits published elsewhere. Full explanations have been given so that the reader can fully understand how the circuits work and can more easily see how to modify them for other purposes, depending on personal requirements. Not only are radio control systems considered but also infra-red, visible light and ultrasonic systems, as are the use of logic ICs and pulse position modulation etc.
 176 pages (Available February 1987) \$9.50

ELECTRONIC GAMES
R. A. Penfold BP0069
 Contains a number of interesting electronic games projects using modern integrated circuits. The text is divided into two sections, the first dealing with simple games and the latter dealing with more complex circuits thus making the book ideal for both beginner and more advanced enthusiasts alike.
 96 pages \$8.00

IC 555 PROJECTS
E. A. Parr BP0044
 Every so often a device appears that is so useful that one wonders how life went on before without it. The 555 timer is such a device. Included in this book are basic and general circuits, motorcar and model railway circuits, alarms and nose-meters as well as a section on the 558, 559 and 559 timers.
 176 pages (Available February 1987) \$9.50

HOW TO DESIGN AND MAKE YOUR OWN P.C.B.s
R. A. Penfold BP0121
 Chapter 1 deals with the simple methods of copying printed circuit board designs from magazines and books and covers all aspects of simple P.C.B. construction as comprehensively as possible. Chapter 2 covers photographic methods of producing p.c.b.s and Chapter 3 deals with most aspects of designing your own printed circuit board layouts.
 80 pages \$6.50

POWER SUPPLY PROJECTS
R. A. Penfold BP0078
 The purpose of this book is to give a number of power supply designs, including simple unregulated types, fixed-voltage regulated types, and variable-voltage stabilised designs, the latter being primarily intended for use as bench supplies for the electronics workshop. The designs provided are all low-voltage types for semi-conductor circuits. This book should also help the reader to design his own power supplies.
 96 pages \$7.50

HOW TO DESIGN ELECTRONIC PROJECTS
R. A. Penfold BP0127
 The aim of this book is to help the reader to put together projects from standard circuit blocks with a minimum of trial and error, but without resorting to any advanced mathematics. Hints on designing circuit blocks to meet your special requirements where no "stock" design is available are also provided.
 128 pages \$9.00

ELECTRONIC SECURITY DEVICES
R. A. Penfold BP0056
 Many people associate the term "security device" with only burglar alarms of various types, but in fact any piece of equipment which helps to protect people and property against any form of danger could be termed a "security device". Therefore this book, besides including both simple and more sophisticated burglar alarm circuits using light, infra-red and ultrasonics, also includes many other types of circuits as well, such as gas and smoke detectors, flood alarms, doorphone and baby alarms, etc.
 112 pages \$9.50

COMMUNICATION
 (Elements of Electronics — Book 5)
F. A. Wilson BP0089
 A look at the electronic fundamentals over the whole of the communication scene. This book aims to teach the important elements of each branch of the subject. Most of the modern transmission system techniques are examined including line, microwave, submarine, satellite and digital multiplex systems, radio and telegraphy. To assist in understanding these more thoroughly chapters on signal processing, the electromagnetic wave, networks and transmission assessment are included, finally a short chapter on optical transmission.
 256 pages \$11.00

50 SIMPLE LED CIRCUITS
R. N. Soar BP0042
 Contains 50 interesting and useful circuits and applications, covering many different branches of electronics, using one of the most inexpensive and freely available components — the light-emitting diode (LED). Also includes circuits for the 707 common anode display.
 64 pages \$6.00

IC PROJECTS FOR BEGINNERS
F. G. Rayer BP0097
 Offers a range of simple projects based around a number of popular and inexpensive linear and digital integrated circuits. With most projects, complete layout and/or point-to-point wiring diagrams are included to help simplify construction.
 112 pages \$8.50

50 PROJECTS USING RELAYS, SCRs AND TRIACS
F. G. Rayer BP0037
 This book gives tried and practical working circuits which should present the minimum of difficulty for the enthusiast to construct. In most of the circuits there is a wide latitude in component values and types, allowing easy modification of circuits or ready adaption of them to individual needs.
 112 pages \$8.50

ELECTRONICS BOOKS ORDER COUPON

COUPON VALID FOR COVER DATE MONTH ONLY
 February 1987
 (If insufficient space enclose separate list)

BOOK SALES
 PLEASE ENCLOSE \$2.50 per book for postage, handling and insurance.

For airmail to Papua New Guinea, New Zealand, Oceania and Southeast Asia, add \$5.00 to these charges.

BOOK TITLE	BOOK NUMBER	QTY	PRICE TOTAL

Please tick box to indicate method of payment
Cheque*/Money Order *Please make payable to the Federal Publishing Company Pty Ltd

Total price of books \$
Add postage and handling \$
 (\$2.50 per book)

Put your cheque or money order in an envelope with this order and send it to:
Federal Direct, Freepost No. 4, P.O. Box 227, WATERLOO, NSW 2017
 No postage stamp required in Australia.

TOTAL \$

Or charge my Bankcard Visa Mastercard American Express

NAME:
ADDRESS:

POSTCODE:
TELEPHONE: ()
 Look for your order in 4-6 weeks **Date:**

Card No:
Card Expiry Date

Signature
 (Unsigned orders cannot be accepted)

Part 2: early colour television systems

Understanding colour television

This second part in our series on the principles of colour television deals with the history of early colour TV systems and looks at how the need to maintain compatibility between colour and monochrome transmissions and receivers has been satisfied.

by DAVID BOTTO

A modern colour television system must meet certain requirements. The signal transmitted by the colour television station must be compatible. In other words, the signal must be able to be received not only in colour on a suitable receiver, but also as a good quality black and white picture on an ordinary monochrome TV.

Also the colour television receiver ought to be able to receive monochrome transmissions as, for example, for a film made in black and white. This is called reverse compatibility.

When the transmission is in colour, a high standard of both detail and colour is essential, without colour changes caused by signal distortion in the transmission path.

In addition, since channel space is limited, with perhaps several TV stations transmitting on nearby frequencies, it is important that there is no increase in the bandwidth of the transmitted signal over that required by the existing monochrome TV stations.

Usually, an existing monochrome TV transmitter must be converted to handle colour signals. Since expense is a big factor, it is desirable that the colour system chosen enables an existing monochrome transmitter to be converted to the new colour system by the addition of extra components. The alternative, of building a complete new colour transmitter, is unacceptable.

The final points to consider when choosing a system of colour TV transmission and reception, are the probable cost and reliability of the proposed colour TV receiver. If the receivers are overly complex, they will be unreliable and expensive to service.

Let us accept for the moment that every country which now has television has either gone through the above process of selection, either via costly research and development or by the decision to adopt one of the now proven and refined colour TV systems such as PAL, NTSC or SECAM.

Colour television as we know it is a

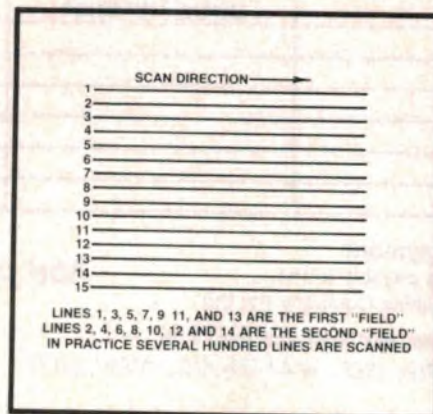

This diagram shows how the electron beam of the TV camera scans a scene. The fly-back lines are not shown as the TV receiver blanks them out.

refinement of the principles used in black and white television. Therefore, before studying colour TV principles, we will briefly revise those used in black and white television.

Scanning

You will remember that at the TV station, the monochrome TV camera scans the scene at a fixed rate, beginning at the top and moving from left to right. At each point of this scan a signal voltage proportional to the brightness of the scene appears at the output of the camera (see Fig.1)

The first line completed, the camera beam scan returns to the top left of the scene at high speed, but just slightly below the first "trace". The process is then repeated until the whole scene has been scanned.

To reduce flicker, the camera again scans the scene in a series of lines interlaced between the first set. The section of the scene traced by each set of lines is called a "field", and the complete picture from these two fields is referred to as a "frame".

In a monochrome television system using 625 lines, fifty fields each second are traced, so that each complete frame of the transmitted scene is repeated 25 times per second.

The viewer's TV receiver builds up a matching series of lines by the movement of the electron beam of the cathode ray tube across the tube face. The beam is synchronised with the scanning of the TV camera, and its intensity is controlled by the received signal, reproducing the same light intensity as the transmitted scene at each point of the scan.

Our eyes retain an impression of what we see for a brief moment — a quality we call persistence of vision. Because of this quality, helped by the brief after-glow properties of the picture tube phosphors, a complete black and white

picture, composed of a series of fine closely spaced lines is seen, despite the fact that only a single fast moving spot of light of changing brightness is actually present on the screen.

Colour television systems

As explained in the first part of this series, colour television employs additive colour mixing by using three primary colours: red, green and blue. This, you will recall, enables a wide range of colours to be reproduced by the colour television receiver.

A simple system to accomplish this is to send three colour pictures simultaneously, each picture containing only the separate red, green or blue components of the transmitted scene. To do this, three TV camera's are used. Camera 1 has a red filter fitted, Camera 2 a blue filter and Camera 3 a green filter (Fig.2).

From our study of colour we know that only the radiant energy of the red light in the scene will be registered by Camera 1, the blue light energy by Camera 2 and the green light energy by Camera 3. A separate transmission path carries each of the three colour components of the studio scene to the viewer. At the receiving end each camera colour picture signal is detected, amplified and then displayed by one of three separate cathode ray tubes.

Cathode ray tube 1 displays the red component of the received picture, cathode ray tube 2 the blue component, and cathode ray tube 3 the green component. The three CRTs are simply monochrome tubes fitted with individual red, green and blue colour filters. Alternatively, each tube could use a different coloured phosphor screen to produce the three primary colours. The separate red, green and blue received pictures are then optically combined to reproduce the colour picture.

Quite a good colour picture could be obtained using this system, although there would be problems in combining and synchronising the three pictures. The unacceptable drawback is that the transmitted signal needs a total channel bandwidth of three times that of a monochrome television signal!

To overcome the bandwidth problem the idea of transmitting the three colours in sequence, switching from one camera to another in turn at high speed, was tried. At the receiver end, another switch, synchronized with the camera signals, diverted the received signal to each picture tube in turn.

Since the change from one colour to the next is very fast the eye sees the

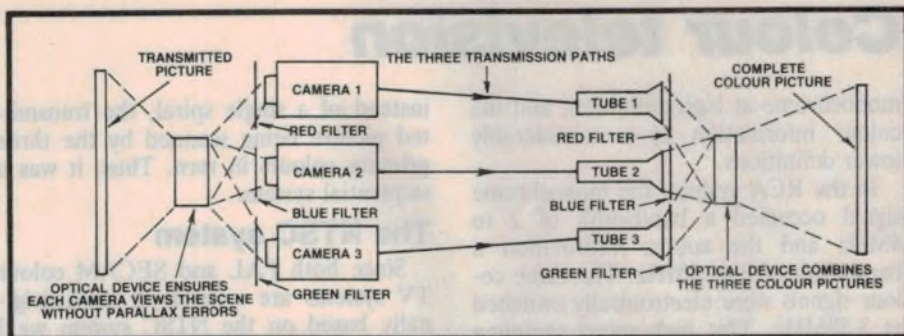

It would be possible to transmit and receive a colour picture by using three separate transmission paths for the red, blue and green information but the required bandwidth would be prohibitive.

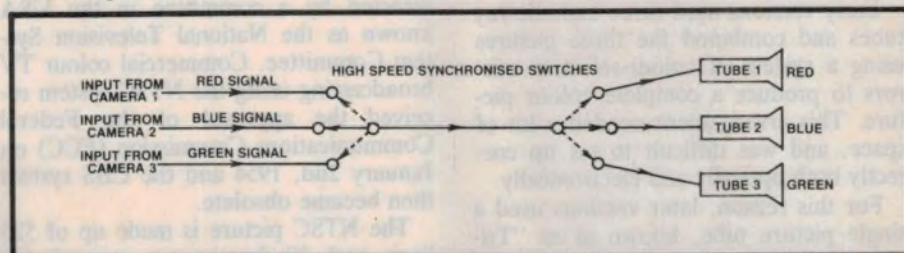

An alternative to using three transmission paths would be to send the red, blue and green picture information sequentially. Again, bandwidth would be a problem.

scene as a complete colour picture (Fig.3). By using this sequential system, the station bandwidth of the transmitted colour signal is no greater than that of a monochrome transmission. The main drawback was that the picture suffered from a nasty flicker effect.

CBS sequential system

To eliminate this defect, a version of the sequential system was further developed by the Columbia Broadcasting System in the USA from 1946 onwards. A monochrome television camera was used, in front of which was a rotating filter disc made up of colour filter sections, red, blue and green. At the viewer's end, a similar filter disc, synchronized to run at the same speed as the disc at the TV camera, rotated in front of the receiver's monochrome cathode ray tube. Because of the high rotation speed, persistence of vision caused the viewer to see a complete colour picture.

Once again, excessive bandwidth proved to be a problem. In fact, one early version of the CBS sequential system needed a channel bandwidth of 12MHz.

To keep the station bandwidth within the normal 6MHz channel allocation, the scanning lines in the picture were decreased from the standard 525 (for USA) to 405 lines. Each of the 144 fields per second consisted of 202.5 lines, with a horizontal scanning rate of 29,160Hz (202.5 x 144).

The colour disc rotated at 1440rpm and contained six filters coloured red,

green, blue, red, green, blue, in that order. Six fields were scanned in sequence for each disc rotation, so that each field of the picture was scanned in turn by all three primary colours.

A TV receiver with a monochrome picture tube of some 30cm in diameter or less was used so that the viewer's spinning synchronised colour disc was not excessive in size. The viewer could increase the picture size by fitting a large magnifying glass to the face of the picture tube.

This CBS field sequential system was not compatible, although the system was "convertible". The television receiver contained scanning circuitry that could be switched from 144 fields to 60 fields per second, the colour disc being removed for reception of monochrome transmissions.

RCA Sequential system

Colour television broadcasts using the CBS system began in the USA in mid-1951 in New York. However, Radio Corporation of America continued to develop their Dot-Sequential Colour TV system. This system was based on the standard USA monochrome television which employed 525 horizontal lines for each frame. Each frame therefore consisted of two fields of 262.5 lines scanned at 60 per second. This gave a frame rate of 30 per second.

Use was made of the principle of "mixed highs". This simply means that the fine detail of the picture is sent in

Colour television

monochrome at high definition, and the colour information at a considerably lower definitions.

In the RCA system, the monochrome signal occupied a bandwidth of 2 to 4MHz and the colour information a bandwidth of 0 to 2MHz. The three colour signals were electronically switched at 3.58MHz. This high speed sampling of the three colour signals caused the colour picture to be formed by a series of differently coloured dots.

Early versions used three cathode ray tubes and combined the three pictures using a system of colour-selective mirrors to produce a complete colour picture. This arrangement needed a lot of space, and was difficult to set up correctly both optically and electronically.

For this reason, later versions used a single picture tube, known as as "Tricolor" tube, on which the viewer could see the complete colour picture. When a monochrome picture was received the dots combined to produce a black-and-white picture, so that the RCA dot-sequential system was truly compatible. Picture flicker was the main drawback of this system.

A mechanical system

Long before the development of any other system, John Logie Baird demonstrated the world's first colour television pictures in 1928. Mechanical scanning of the picture was used, being developed from his earlier monochrome system.

The "Scanning Disc" as it was called included three spirals with colour filters

instead of a single spiral, the transmitted picture being scanned by the three primary colours in turn. Thus, it was a sequential system.

The NTSC system

Since both PAL and SECAM colour TV systems are a result of work originally based on the NTSC system we'll consider the operation of this system first.

The design of the NTSC system was directed by a committee in the USA known as the National Television System Committee. Commercial colour TV broadcasting using the NTSC system received the approval of the Federal Communications Commission (FCC) on January 2nd, 1954 and the CBS system then became obsolete.

The NTSC picture is made up of 525 lines and 30 frames per second (60 fields). The bandwidth is the same as for a monochrome signal (6MHz) which includes the sound carrier, and the colour information is cleverly interleaved with the monochrome information during picture transmission. We'll discuss this in detail in a later article.

Again the use of the principle of "mixed highs" is used, the picture detail being transmitted in monochrome at high definition. A transmission made using the NTSC system can be received as a good quality black and white picture using a monochrome receiver.

The monochrome or brightness signal for the NTSC system is referred to as the luminance or "Y" signal. What is

transmitted is the monochrome signal, with a frequency bandwidth of 0 to 4MHz, and only two of the three colour signals, the third colour signal being recovered by subtracting the two transmitted colour signals from the "Y" signal.

The two colour signals transmitted in the NTSC system are referred to as the "I" signal, which has a frequency range of 0 to 1.5MHz, and the "Q" signal with a range of 0 to 0.5MHz. These signals are sent as amplitude modulated colour subcarriers, both at 3.579545MHz but 90 degrees out of phase with each other. The frequency of 3.579545MHz was selected to avoid interference with the luminance signal.

In the first article in this series we saw that the "Y" (monochrome brightness) signal consists of a combination of the three primary colours expressed as:

$EY = 0.59 EG + 0.33 ER + 0.11EB$
with E standing for the relative voltages, and G, R and B for the colours green, red and blue.

Inverting the "Y" signal to produce "-Y" and subtracting "-Y" in turn from the red signal R, and the blue signal B, we obtain the $ER - EY$ and $EB - EY$ signals, which we'll now call the R-Y and G-Y signals.

Fig.4 shows the relative phase angles of the "I" and "Q" signals. Notice that the "+I" signal is displaced 33 degrees to the left of the R-Y signal, and the "+Q" signal is 33 degrees left of the B-Y signal. This produces better results than if the "I" and "Q" signals were made to correspond exactly with the R-Y and B-Y signals.

Once the R-Y and B-Y signals are obtained, the G-Y colour difference sig-

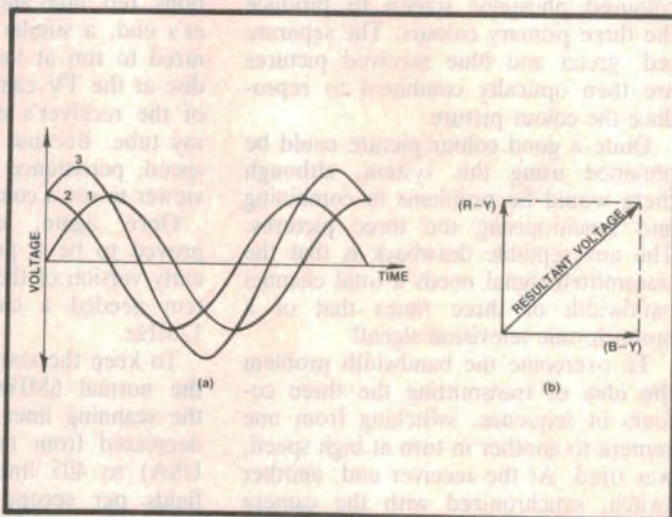
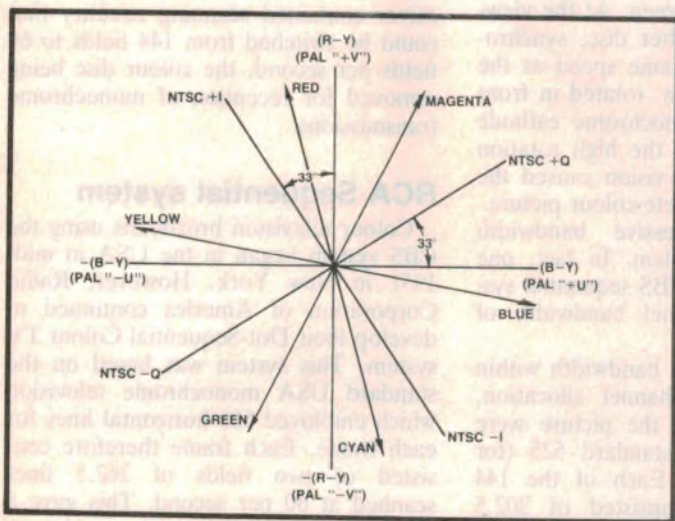

The result of combining two sine waves of the same frequency and amplitude but 90 degrees out of phase. 1 and 2 are sine waves while 3 is the resultant waveform. This is depicted at right in vector form.

This diagram shows the relative phase angles of the "I" and "Q" signals and the respective colours for NTSC and PAL systems.

Avocet puts you in the chips!

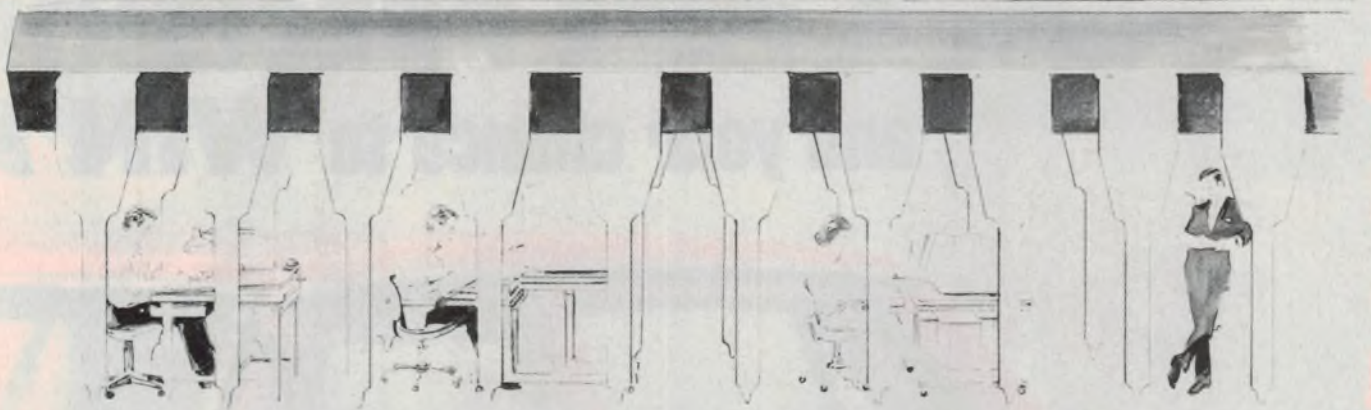

Now you can use your PC to develop software for virtually any microprocessor. Quickly. Easily. Inexpensively.

THE AVOCET CROSS-ASSEMBLER FAMILY.

AVMAC™ Macro Cross-Assembler
 MSDOS™, PCDOS™ US\$349
 VAX™/UNIX™ US\$995

XASM Cross-Assembler
 CP/M™-80, CP/M-86 US\$250

Target Microprocessors Supported:

6804	6502/65C02	Z8
6805	6800/01,6301	Z80
6809	NEC 7500	68HC11
1802/1805	8085	HD64180
8048/8041	COP400	68020
8051	F8/3870	68000/68010

New AVMAC Macro Cross-assemblers offer these important features: Powerful macro facility, relocatable code, linker and librarian, cross-reference by line and procedure, plain English error messages and much more.

™ Signifies manufacturer's trademark.

Avocet cross-assemblers, simulators, emulators and EPROM programmers will help put your design ideas into more chips than any other software development system on the market. You don't need a mainframe, or even a dedicated system. All you need is a PC, a good idea...and Avocet. It's as simple as that.

Avocet has been creating tools for software development since 1979 to help design engineers find easier and more productive ways to develop software for virtually any microprocessor—without

switching development systems.

Our customers turn ideas into real products. From data entry through assembly, debugging and final EPROMs, Avocet has everything you need to transform your personal computer into a fully integrated development system.

Cross-assembler capabilities.

No matter what the application, our family of cross-assemblers runs on any computer with CP/M* or DOS and processes assembly language for most microprocessors.

Taking the bugs out.

Avocet's new debugging tools will eliminate "crash and burn" from your vocabulary in two ways.

First, AVSIM software simulator/debuggers allow you to test program modules on your PC. No special hardware is required for executing your target code interpretively in a crash-proof, interactive environment. AVSIM's full screen display lets you see at a glance what your program is doing.

When you're ready to test your program in a working model, Avocet's TRICE in-circuit emulators allow you to examine target memory and register, set break-points, single-step, trace and more. A standard serial interface lets you control emulation and download code from your PC.

And best of all, TRICE costs less than US\$500

Progressive EPROM programming.

Avocet AVPROM programmers work with over 37 different devices including EPROMs through 27512, CMOS and E² PROMs, and MPU/EPROM combos using fast "adaptive" algorithms. These intelligent, self-contained units work with any personal computer using Avocet's GD_X driver software.

Made to order.

AVOCET software systems are manufactured in Melbourne. We turn your order around in just 24 hours.

Just call, toll free,

(008) 334 839

(in Melbourne 481 0155)

and we'll rush your order, send you more information, give you great technical backup, or, introduce you to our dealer nearest you.

AVOCET SYSTEMS PTY LTD
 PO Box 1066, North Fitzroy,
 Vic, 3068. Phone 481 0155,
 Fax 489 4646, Telex 151675

AVOCET 
SYSTEMS INC.™

SUBSCRIBE

receive **A FREE PRECISION**
and your chance to **WIN A**



CONDITIONS OF ENTRY

1. Entries close last mail February 27, 1987.
2. Entry to the prize draw is achieved by returning a completed subscription card and payment. Entry is open to both new and renewal subscribers.
3. Entry is open to all residents of Australia other than the employees and immediate families of The Federal Publishing Company Pty. Ltd and Daihatsu and their associated agencies and publications.
4. The draw will take place on March 4, 1987, and the winner will be notified by mail and the result published in The Australian newspaper date March 13, 1987, and a later issue of the magazine.
5. Prizes must be taken as offered. There is no cash alternative. Prizes are not transferable and cannot be altered in any way.
6. The vehicle prize of a Daihatsu Charade includes all on-road costs, including third party insurance and registration.
7. Federal Publishing will arrange delivery of the vehicle within Australia within one month of the winner being drawn. If delivery is required outside of Australia, this becomes the responsibility of the winner.
8. Permit No.: T.C. 85/2203 issued under the Lotteries and Art Unions act 1901. Raffles and Bingo Permits Road Permit No. 20/1013 issued on 15.9.86, ACT Permit No. TP86 650 issued under the Lotteries Ordinance, 1964.

• The Pace • The Feel • The Space • The Ride

• The Luxury • The Style • The Eco

NOW!

SCREWDRIVER SET

"CHARADE" from "DAIHATSU"

FREE SCREWDRIVER SET

with all new or renewed subscriptions

- ★ Chrome plated and presented in plastic storage case.
- ★ Free running top on each driver gives operator ease of use.
- ★ Consists of 4 blade drivers from 1.4 mm to 2.9 mm and 2 Phillips screwdrivers, No. 0 and No. 1.



LIMITED OFFER, SO POST SUBSCRIPTION CARD TODAY!!
(If card missing, please phone (02) 693-6666 and ask for the Subscriptions Department).



"Daihatsu.  That's who."

*See Subscription
Coupon*

conomy • The Options • The Safety

• The Ride • The Space • The Feel • The Pace

Colour television

nal can be recovered in the receiver's matrix circuitry, knowing that

$$Y = 0.41G - 0.30G - 0.11B$$

How this is done will be discussed in a later article, because the method of G-Y recovery from the matrix in an NTSC receiver is similar to that used in a PAL receiver.

Thus the amplitude-modulated 3.58 MHz colour subcarrier needs only to be modulated by two colour signals only, the "I" and "Q" signals. Fig.5a shows the result of combining two signals of the same frequency and same peak voltage, but out of step with each other by 90 degrees. Because these signals rise and fall evenly against a time scale they are sine waves.

According to the relative voltage of each colour signal, a resultant carrier will be produced (Fig.5b). The greater the depth or saturation of a transmitted colour, the higher this resultant voltage will be. The hue of the colour transmitted will determine the phase angle of the resultant (Fig.6).

As you may know, the resultant arrows shown in the diagrams are vectors.

If you look again at Fig.5 you will see the phase angles of various colours.

The 3.58MHz colour signal is transmitted with its carrier suppressed, only

the sidebands being sent. This carrier suppression (see Fig.7) prevents the generation of a beat note between the colour subcarrier and the sound carrier of the colour TV receiver, which would produce interference lines on the picture. Another advantage is that during a monochrome transmission no colour sig-

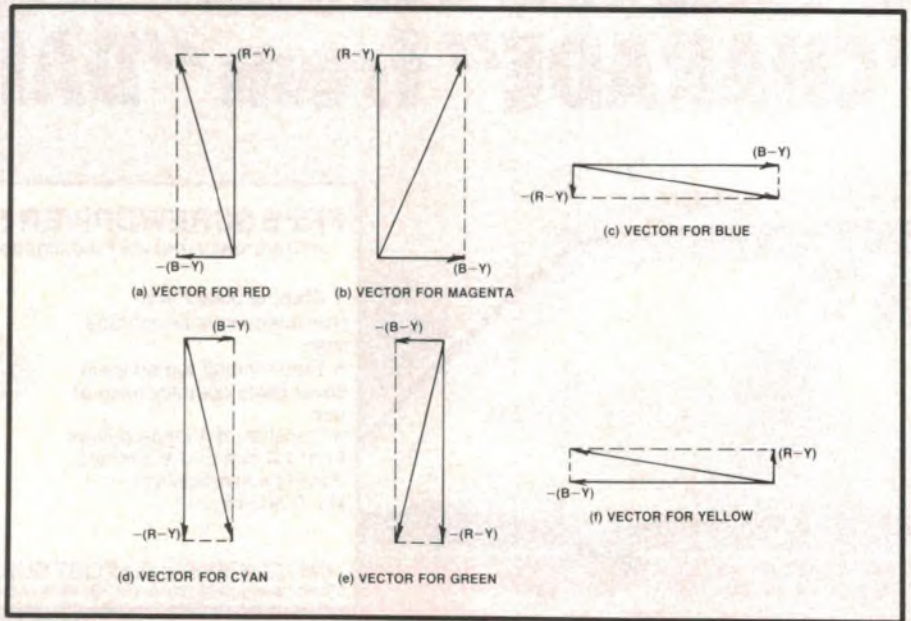

These vector diagrams show the colours produced by relative R-Y and B-Y voltages.

FEBRUARY CROSSWORD

ACROSS

1. Component of typical sound system. (9)
6. Tape-player's mode. (5)
9. Coding unit. (7)
10. Transmissions in communication system. (7)
11. Make contact at one end. (4)
12. Containing osmium. (5)
13. Its charge registers on the meter. (4)
16. Applies impedance for best power transfer. (7)

18. A physical state. (5)
20. Navigation system based on phase differences. (5)
21. Underlying radio wave. (7)
24. Dual modulation. (2-2)
25. Perceived change of frequency. (5)
27. Kind of iron with magnetic applications. (4)
30. Alloy used in tape heads. (7)
31. Unit change in potential. (3,4)
32. Copper wire is plastic at the — point! (5)
33. Cause wave interaction. (9)

DOWN

1. Part of 1 across. (7)
2. Again place components on chassis or board. (7)
3. Metric prefix. (4)
4. Lamp housings. (5)
5. Said of an impurity semiconductor. (9)
6. Bell contributed to such a sound (and it's not toll-free!). (4)
7. Part of the electromagnetic spectrum. (1,1,1,4)
8. Pattern-producing process. (7)
14. From some accounts it's what careless electricity consumers get. (5)
15. Name associated with Maxwell. (5)
17. Term for plastic tubing. (9)
19. Gossip on the two-way radio? (7)
20. Department with electronics serviceman. (7)
22. Mineral located with magnetometer. (4,3)
23. Change name. (7)
26. Decimal points may do it in calculators. (5)
28. Fourfold term. (4)
29. Factor affecting head life. (4)

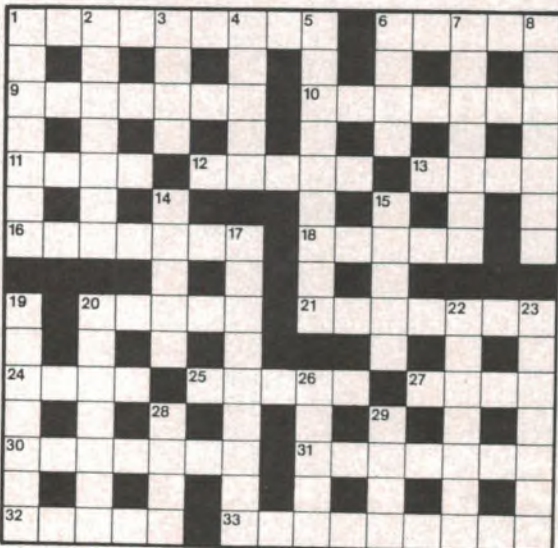

SOLUTION FOR JANUARY



nal carrier is present.

To recover the colour difference signals in the receiver so that the "I" and "Q" signals may be demodulated, the missing subcarrier is re-inserted. A local 3.58MHz oscillator, contained in the receiver circuitry and synchronized by a transmitted colour burst signal, is generally used to do this. The receiver circuitry can now recover the three basic colours (red, blue and green) which, together with the black and white picture information, are applied to the picture tube to display a colour picture.

Before adopting the PAL colour television system, the British Broadcasting Corporation experimented with its own version of NTSC using a 405-line version, this being the number of lines used by the existing monochrome TV system in England. The colour subcarrier chosen was 2.6578125MHz. This figure is an odd multiple of half the line scan frequency of 10,125Hz (5062.5 times 525).

At the time of its introduction the NTSC system made all other colour systems obsolete. However, if the NTSC TV signal is distorted for any reason in its transmission path the phase of the colour signal becomes incorrect, and the colour hues on the screen will be wrong. To compensate for this failing, an NTSC receiver usually has a phase control for the viewer to adjust when changing stations, or if the colours appear incorrect.

To overcome this failing, further efforts were made to develop new colour systems.

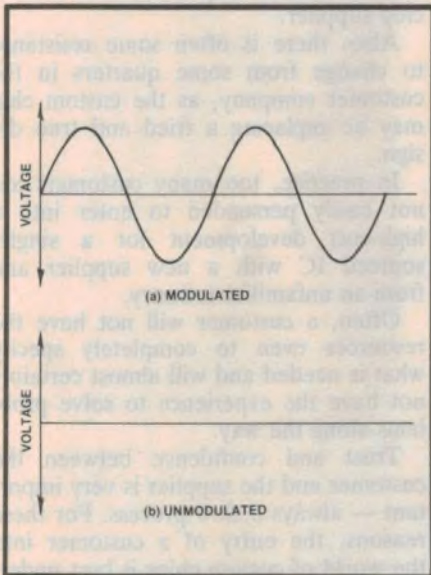

In suppressed carrier modulation, the waveform is present (a) when modulated by signal but absent when modulation is zero (b).

The SECAM system

In the SECAM system, only one colour difference signal for each line of the picture is used. The TV receiver "stores" each line (by means of a delay line) just long enough to use it again on the next line. For one line only, the B-Y signal is used plus the "stored" R-Y signal from the previous line. The next line uses the R-Y signal only plus the "stored" B-Y signal of the line before. The following line uses the B-Y signal again plus the "stored" R-Y signal of the previous line, and so on.

The subcarrier is frequency modulated, with each of the two colour difference signals having its own subcarrier. Phase distortion is no longer a problem and the colour hues remain constant. In these articles the emphasis will be on the PAL colour television system, considered by many engineers to be the best. (However, recently when visiting France the writer viewed both PAL and SECAM TV and could see little difference in the received pictures!)

The PAL system

The PAL system owes much to the NTSC system. Dr. W. Bruch, of the Telefunken TV Laboratories in Germany, who devised the PAL system, described it as a variant of NTSC. Again two colour difference signals are used. These are known as the "V" signal and the "U" signal (refer again to Fig.4). The PAL system renders unnecessary the displacement of the "V" and "U" colour difference signals by 33 degrees from the R-Y and B-Y axes and both

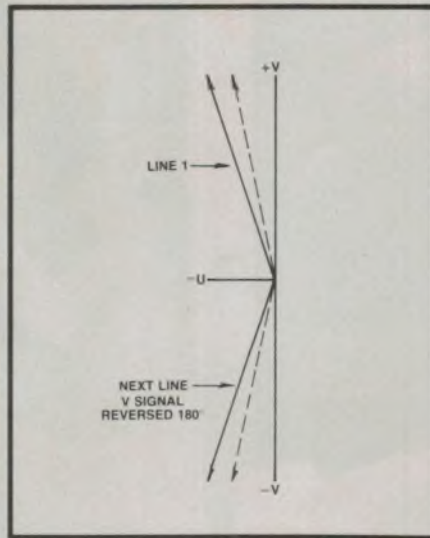

In the PAL system, phase distortion is corrected. The dotted lines show how phase distortion has delayed the red vector, taking it towards magenta. Averaging the phase errors restores the colour to red.

have equal bandwidths.

With the BBC 625 line PAL transmissions, the suppressed subcarrier frequency is 4.43361875MHz. To cancel out colour phase errors due to transmission path distortion, the phase of the R-Y (the "V" signal) is reversed by 180 degrees as alternate lines of the picture are transmitted.

So if one line of picture phase distortion takes the colour away from red, the next takes it toward the red, the average of the two lines producing the correct hue (Fig.8). Hence the term PAL standing for Phase Alternation Line.

As in the NTSC system, circuitry in the colour TV generates the missing subcarrier in order that the "U" and "V" signals can be demodulated and recovered. The phase of the subcarrier regenerator output must be switched by 180 degrees for each line when modulated by the R-Y signal.

The main advantage of PAL when compared to NTSC is that phase distortion has practically no effect on the picture, resulting in excellent colour reproduction.

Next month we will look further into the PAL colour system, colour TV cameras and PAL signal transmission. ④



The EP232 turns your PC or CPM computer into a versatile EPROM PROGRAMMER able to program all common EPROMS up to 27512.

- Software provided gives a comprehensive set of commands
- Simple interface via RS232 port
- TTL PROM programming modules available
- Locally made EP232 costs a fraction of imported programmers

CALL FOR DETAILS

Diamond Systems (03) 714 8269
P.O. Box 105 Hurstbridge 3099

Philips forges ahead with custom IC solutions

There are a number of companies in Australia offering custom chip design, but few offer the complete range from custom bipolar ICs through to thick-film hybrids. This article gives good advice to companies thinking about ICs and hybrids.

***by JOHN WARD**

John Ward is Microelectronics Factory Manager, Philips Electronic Components & Materials, Hendon, SA.

The Government's Microelectronics Application Centres were set up to advise potential users of microelectronics on the alternatives available to them. But they have a bias towards the use of esoteric custom monolithic or semi-custom chips — despite the fact that these can be very difficult to get working, and are not in fact very widely used in this industry.

Many companies without experience of having custom designs fabricated for them have dived into the design of a custom chip to find that it's nowhere near as simple as they had thought.

Over the past several years, Philips Elcoma have found that customers who are only slightly familiar with the area of electronics involved are unlikely to make the quantum leap from discrete components to a state-of-the-art custom chip. To make the leap they need a very sound knowledge of the chip fabrication technology, plus the total support of, and a lot of help from, their custom chip supplier.

Also, there is often some resistance to change from some quarters in the customer company, as the custom chip may be replacing a tried and true design.

In practice, too many customers are not easily persuaded to enter into a high-cost development for a single-sourced IC with a new supplier and from an unfamiliar industry.

Often, a customer will not have the resources even to completely specify what is needed and will almost certainly not have the experience to solve problems along the way.

Trust and confidence between the customer and the supplier is very important — always a slow process. For these reasons, the entry of a customer into the world of custom chips is best undertaken one easy step at a time.

A further set of problems is also encountered with small startup companies. These typically work with a "capital

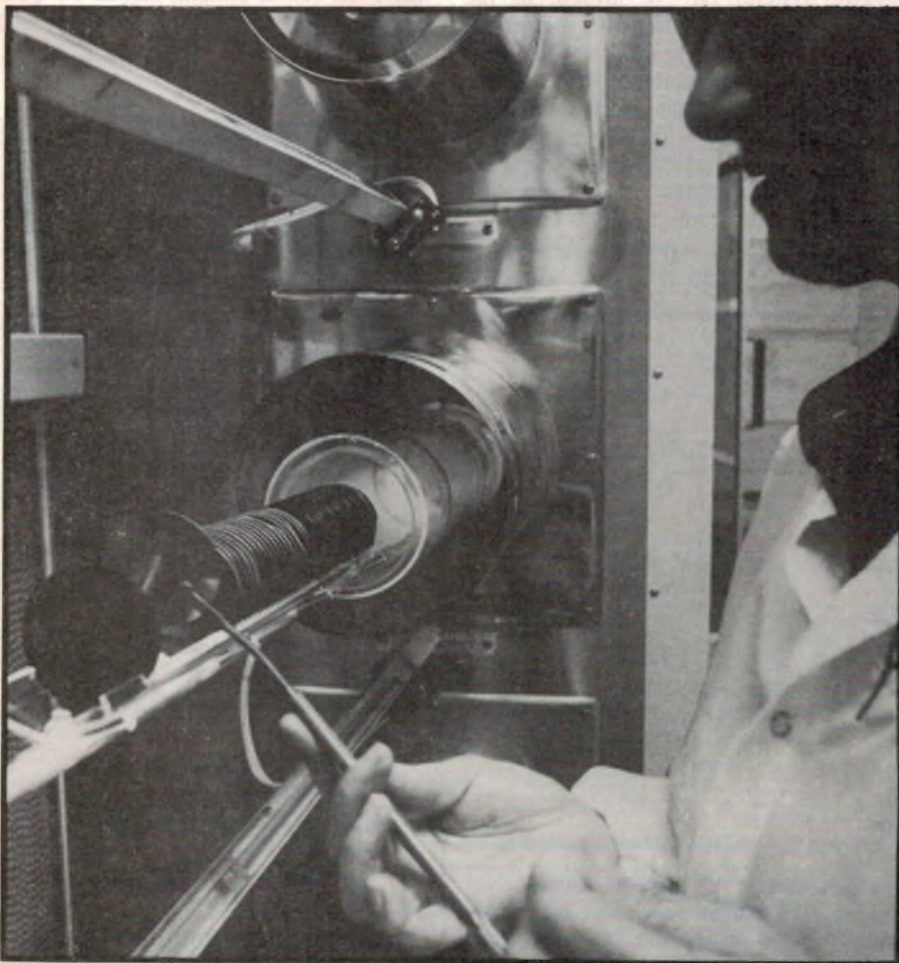

This photo shows the diffusion process for a custom IC.

ELECTRONICS

EXCITING JOBS WITH A FUTURE



GET YOUR TRAINING NOW AND BE PREPARED FOR THE FUTURE

If you're interested in electronics, a Stott's Home Study Course can make it even more interesting. It could lead to an exciting career in the fast growing field of electronics.

You can start with Stott's Introduction to Electronics which gives you an understanding of the basic principles, then choose from Stott's range of electronics courses. Radio and Television Servicing, Radio Receivers, Colour Television, Introduction to Micro Computers, Digital

Electronics for Technicians & Servicemen or Industrial Electronics.

Stott's electronics courses offer plenty of practical work and 'hands on' experience through custom designed kits. You'll be skilfully guided by experienced, professional instructors, with individual attention and advice. You study at home, at your own pace.

Make your move towards a brighter future. But do it now. Send the coupon today.



Athol H. Kelly
B. Com. (Hons), A.A.S.A. F.C.I.S.
PRINCIPAL

"Stott's Correspondence College is Australian in origin and ownership, with a tradition of nearly 80 years fine educational service to men and women throughout Australia."

Melbourne, 140 Flinders Street, 3000 Tel: 654 6211
Sydney, 383 George Street, 2000 Tel: 29 2445
Brisbane, 65 Mary Street, 4000 Tel: 221 3972
Adelaide, 275 Pulteney Street, 5000 Tel: 223 3700
W Perth, 25 Richardson Street, 6005 Tel: 322 5481
Hobart, 150 Collins Street, 7000 Tel: 34 2399
New Zealand, Box 30-990, Lower Hutt, Tel: 67 6592

Stotts 
CORRESPONDENCE COLLEGE
The name to trust in correspondence education

WITH STOTT'S YOU CAN START ANY COURSE ANY TIME OF THE YEAR AND PROGRESS AT YOUR OWN PACE.

PLEASE SEND ME FREE, AND WITHOUT OBLIGATION, FULL DETAILS OF THE FOLLOWING COURSE:

MR. MRS. MISS (PLEASE PRINT)

ADDRESS (AGE)

POSTCODE

Stott's undertake that no sales counsellor will visit you

ALA ST5959 EA287

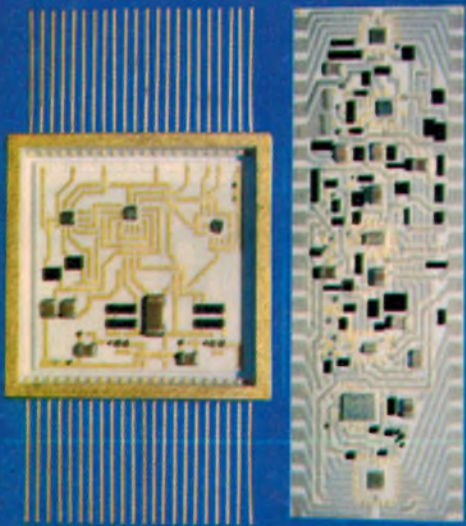

A combination of a thick film plus custom IC — a very flexible solution.

base” which consists mainly of the effort put in by the directors. While they might be prepared to work long and arduous hours on the product themselves, it is often difficult to convince them to spend even a few hundred dollars on input from a third-party engineer to specify their product or do the production design.

Many small companies have a good technical grounding but have limited production or component manufacturing resources. The supplier must be able to access, check and modify the design where necessary so that the customer's needs are met in a way that is able to be manufactured cheaply.

Hybrids

Of course, custom ICs and gate arrays are by no means the only way of

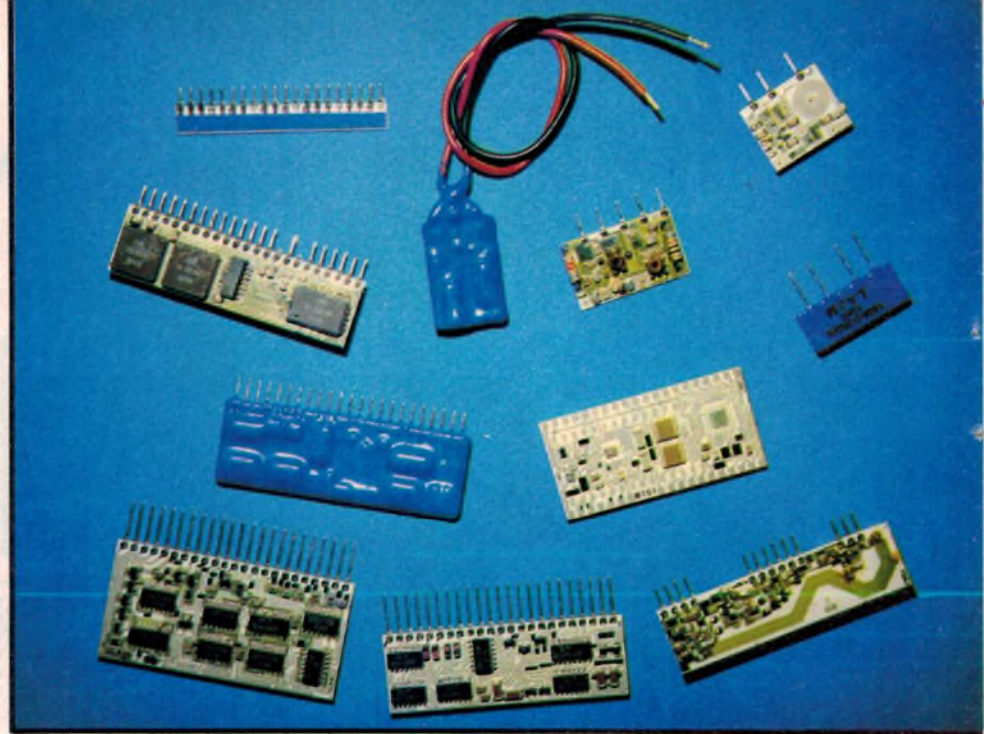

Typical thick film hybrids made by Philips at its South Australian facility in Hendon.

approaching a given problem. Hybrids are in fact much more widely used than custom or semi-custom chips in the industry as a whole.

Philips is the only Australian company thoroughly involved at a practical level with full production facilities in hybrid circuit and IC technology, so they have no particular preference for hybrids. Hybrids just do some jobs a lot better than ICs in a lot of cases.

Philips takes the view that a customer is not looking for “a hybrid” or “a gate array”, but is instead looking for “a solution”.

There are four areas in which Philips can provide that solution — and often a combination of two or more is used. All of these are carried out at the Hendon, South Australia plant:

(1) The design and manufacture of full

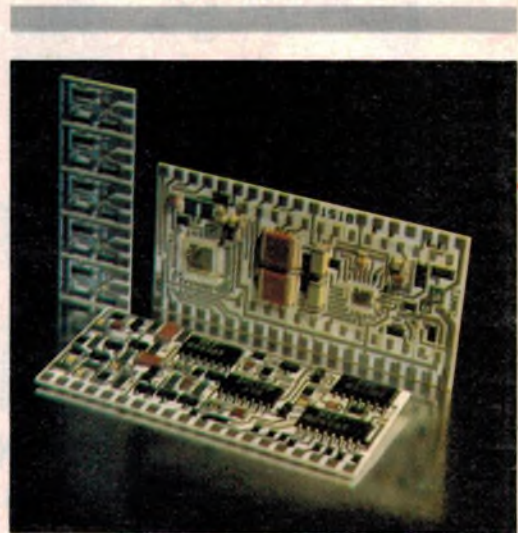

Automatic placement of small components before flow soldering.

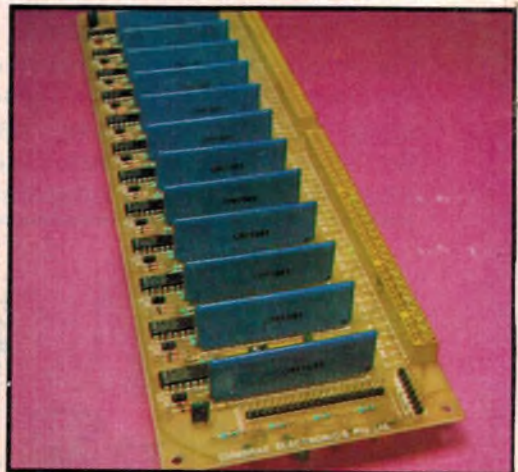
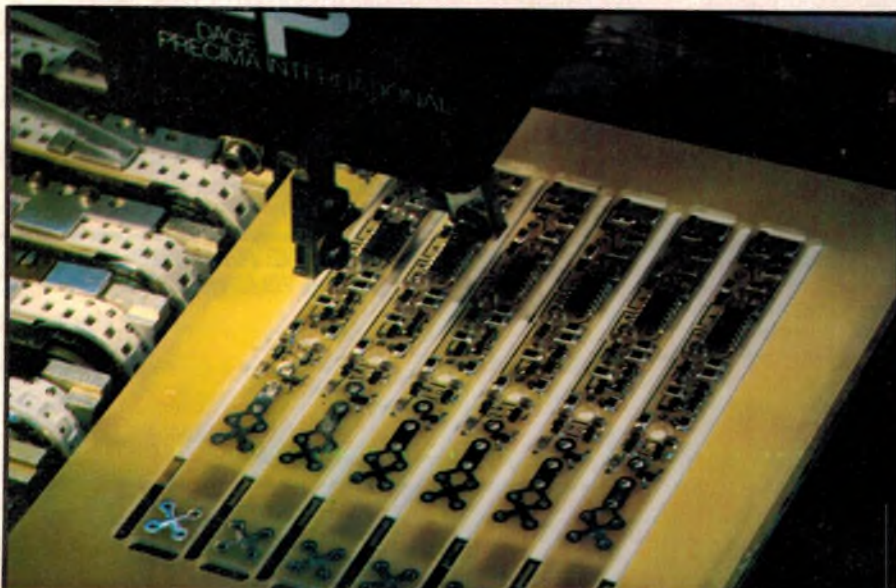



Laser trimming can adjust almost any circuit parameter to a very fine tolerance.

Recent custom IC projects at Philips Hendon

Customer: Electricity Trust of South Australia

Application: Remote control load management system

Conventional "ripple" signalling for turning three tariff ("off-peak") supplies on and off at a customer's premises uses a lot of power and has many other problems. The ETSA replaced ripple signalling with a more sensitive digital signalling system. This needed a complex solution, which included a Hendon-designed custom bipolar chip, a semi-custom CMOS chip and a standard Philips microprocessor, all assembled and tested as a thick film hybrid circuit.

Solution for ETSA — the ETSA thick film substrata, prior to protection of the semi-custom CMOS chip (LHS) and custom bipolar chip (RHS). The 28 pads where the micro-computer will be fitted "piggyback" are inset from the hybrid edge.

Customer: Cumbrae Electronics, Sydney

Application: Burglar alarm

Advanced alarms give added protection by continuously monitoring the resistance in the "loop" of reed switches, IR beam contacts and other devices in the alarm system. Each loop needs its own analog bridge, with filtering for noise suppression. Hybrids are used to monitor each loop (there may be a dozen loops per system). Each hybrid senses two loops and measures 60 x 20mm and contains six ICs and 34 other components. Laser trimming is used to achieve the tolerances needed for the bridge circuits.

Solution for Cumbrae Electronics. Modular design with "bus" orientated pinning allows a flexible system design. The photograph above shows 12 hybrids which service 24 sector loops.

custom bipolar chips for both analog and digital circuits (sometimes both on the same chip) using the integrated injection logic process.

(2) The design of full custom and semi-custom chips for fabrication overseas in all standard semiconductor processing technologies (in some cases, we can even arrange to customise the processing itself).

(3) The design and manufacture of thick-film hybrids using either chip-and-wire or surface mount techniques.

(4) The design and manufacture of surface-mounted assemblies (SMA), a process pioneered by Philips. Hendon has three SMA machines working and a fourth is scheduled for installation during 1987.

The combinations of the above are many and varied. For example, Philips has just begun manufacturing one product which is a combination of a custom chip mounted on a custom thick-film hybrid.

Dynamic trimming

Dynamic trimming of hybrids is standard practice at Hendon. This involves powering up the hybrid, and then "trimming" the value of one or more of the printed resistors with a laser while a parameter of the circuit (which might be anything from gain to centre frequency) is continuously monitored. Trimming stops when the parameter reaches the required value.

Dynamic trimming is used where one or more of the circuit's parameters have to be extremely accurate.

Often the development of a hybrid makes a good first step for a customer just evolving from discrete technology. Sometimes part of the hybrid can be replaced later with a custom chip to reduce the size or cost, or to improve the performance.

Hendon is also responsible for the development of its own automated test equipment — both the hardware and software is designed in the factory. Because of the high standard of testing carried out at Hendon, it can produce components to military specifications.

The Hendon plant represents a unique opportunity for Australian companies to find solutions for their particular products. By making use of the range of services provided, companies not familiar with custom microelectronics can start with one small step — say a hybrid — and then move onto "smaller and better things" later.

Some of the recent custom projects developed Hendon are depicted in photos accompanying this article. 

Use the technology of the eighties

Build a digital sound store

While the hifi scene is full of digital technology, this is our first audio project using 8-bit analog-to-digital and then digital-to-analog conversion. It is a digital sound store and may be used to record and play back audio signals of short duration. It could be used as a novel doorbell, as a musical accessory for a band or in other applications where a short voice message is required.

by JOHN CLARKE

In the professional video field, video frame stores are quite common — they store a complete video picture frame for processing. Sound stores are not nearly so familiar but have applications in the generation of such effects as echo and reverberation.

Our Digital Sound Store unit can be regarded as being similar to a portable cassette player whereby sound can be recorded and replayed. However, they are not directly equivalent since there is one

advantage and one disadvantage of the Digital Sound Store.

First, the bad news. Because the store is a digital memory, a large recording capacity would be very costly. Consequently, the Digital Store cannot directly compete with the conventional cassette player for long recordings.

The good news is that the Digital Sound Store has no rewind time so the recording can be played at the press of a button. This instant replay feature is very

useful for some applications and is not possible using a standard tape player.

For example, it can be used for a doorbell, to replay a recorded message each time the door switch is pressed. To deter burglars, a recording of a ferocious barking dog could be very effective. Alternatively, for those who are at home alone, a recording as mundane as “someone’s at the door” or “can you get the door” could indicate to a caller that there is more than one person in the home.

Again, as a doorbell it could be used to announce a particular message. For example, if you are having a barbeque in the backyard, rather than having to open the door, the doorbell could direct your guests to the barbeque.

For more elaborate uses it could be set up for announcement of a new item in a shop. The announcement could be initiated by a proximity switch or pressure mat on the floor. Again by the use of a proximity switch, the Digital Sound Recorder could warn a customer not to touch the fragile goods.

The Digital Sound Store (DSS) is housed in a plastic case with a minimum of controls on the front panel. These include a Record/Playback switch and start push button. An LED indicates the time during recording and playback. Also on the front panel is a microphone socket and terminals for an external loud speaker.

The DSS is powered from the mains and an optional battery backup facility is provided for the memory so that recorded information will not be lost when the mains is disconnected. A small amplifier is included so that a loudspeaker can be driven directly.

There are several other options available on the Digital Sound Store. These are the amount of memory that can be incorporated and the speed of the Analog to Digital and Digital to Analog conversion or sampling rate.

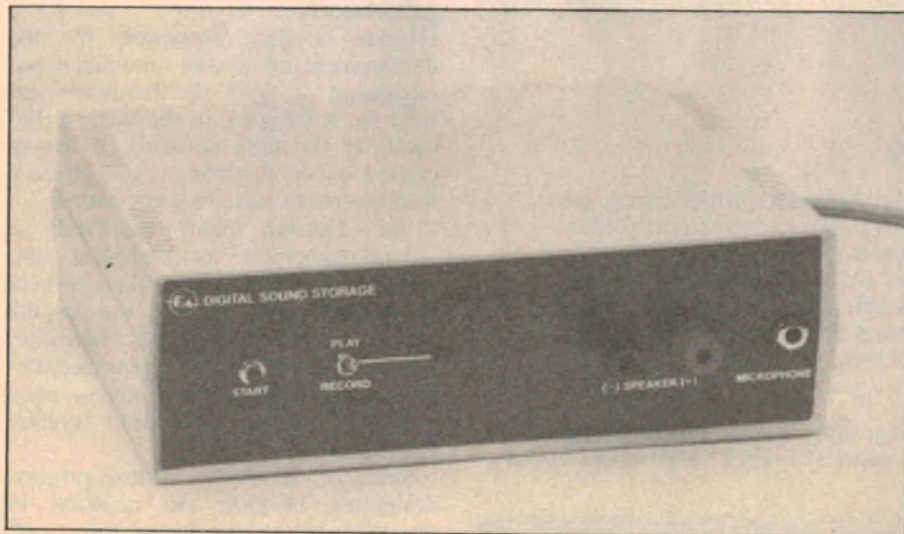

Memory storage time is related to both of the above parameters. The sampling rate is related to the frequency response of the DSS, however, and the faster the sampling speed, the more memory is required for a given recording duration.

For example, at the fastest available sampling rate in the DSS, 37.7kHz, the highest frequency that can be recorded is 18.8kHz. With this sampling rate, the recording time for each 16K bank of memory is 434ms or just under half a second. With the full complement of 62K memory, the recording time increases to 1.7 seconds.

At the slowest sampling rate of 3.75kHz, the highest frequency that can be recorded is about 1.9kHz. The recording time for each 16K bank of memory is then increased in inverse proportion to 4.37 seconds. For 62K of memory, the record/play duration time then becomes 16.9 seconds. This time is quite reasonable for some of the suggested applications.

What selection is used depends entirely on the application. For voice recordings, we recommend the second sampling slowest speed which gives 2.27 seconds per 16K of memory and provides telephone "quality" sound. Use of the higher sampling speeds is only necessary if recordings of higher quality are required.

Performance of the DSS is quite respectable. Output power is 600mW into 8-ohms and input sensitivity 10mV. Signal-to-noise ratio is 55dB with respect to full output and the available dynamic range is 48dB.

Circuitry

The circuitry of the DSS is based on a Texas Instruments TLC549 8-bit Analog to Digital Converter (ADC). This is a complete data acquisition system on a single 8-pin IC. It comprises an internal system clock, sample and hold circuit, an A-to-D converter and control logic.

It also has the distinct advantage of being the cheapest ADC available. It has serial data output as opposed to most ADCs which have parallel data output. This means it must be used in conjunction with an 8-bit shift register but even so, it's still the cheapest ADC by a long margin.

In conjunction with the TLC549 we have used 6116 static RAMs. These are 16K RAMs organised as 2048 8-bit words. This means that there are eight data lines and eleven address lines (to give 2048 memory locations). We have used the 6116 in banks of eight, to give a minimum memory size of 16K x 8 bits.

The particular advantage of using the 6116 RAMs — apart from their static

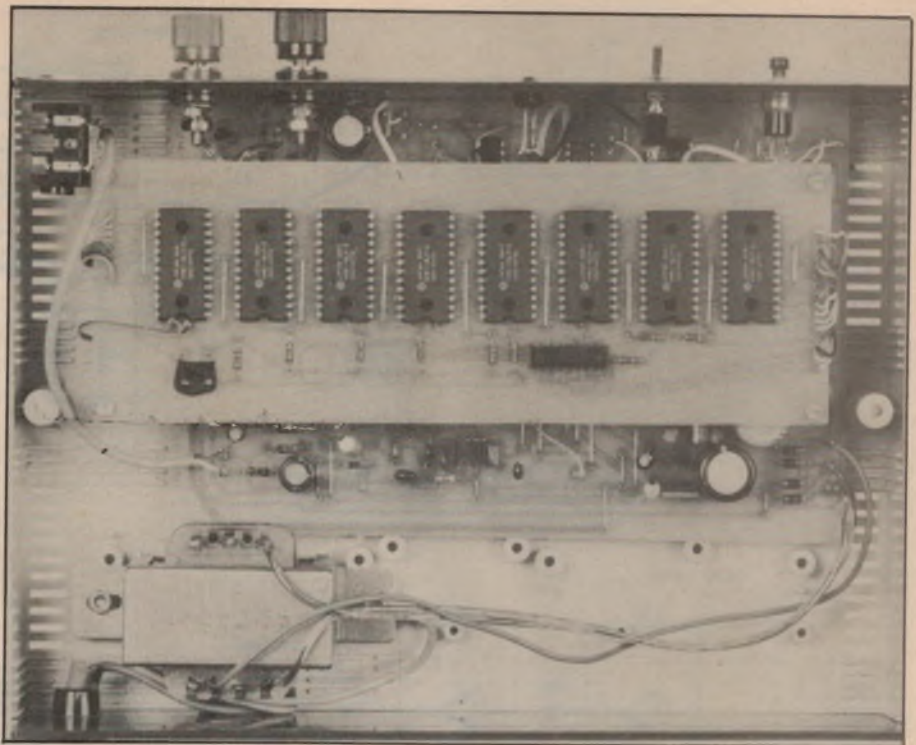

Inside view of the Digital Sound Store showing how the memory printed circuit board is stacked above the main printed circuit board.

operation, ready availability and low cost — is their very low standby current drain. This is handy where battery backup is desired to retain the memory contents.

Inputs of the TLC549 are the Chip Select, Clock I/O, Reference (+), Reference (-) and Analog in. The Ref (+) and Ref (-) inputs set the range of conversion of the analog signal. Analog signals above or equal to the Ref (+) input are converted to all 1's and signals below or equal to the Ref (-) input are converted to all 0's. The process of converting from analog to digital using the TLC549 is as follows:

When the Chip Select input is brought low, the chip waits for about 1.4us before recognising this transition. Then the most significant bit (D7) of the previous conversion appears on the Data Output pin. Negative edges of the first four I/O clock

inputs shift out the D6, D5, D4 and D3 data. Now the sample and hold circuit of the IC begins to sample the analog input. This involves charging of the internal capacitors to the analog voltage level.

The next three clock cycles applied to the I/O clock shift out the D2, D1 and D0 data. The final clock cycle initiates the hold function of the sample and hold circuit.

During the next 17us, the IC converts the voltage held in the sample and hold circuit to digital form. To ensure correct conversion, the Chip Select pin needs to remain high for at least this period of time.

The TLC549 is ideal for microprocessor applications since D-to-A conversions are simply made using a short software routine. We have used hardware to implement the necessary control signals for

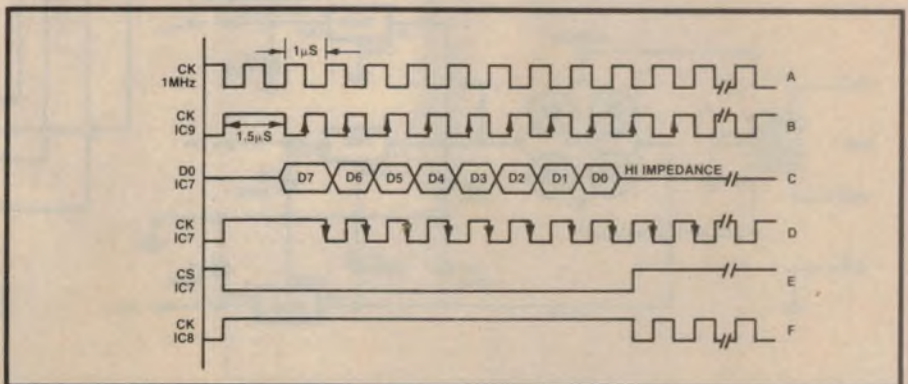
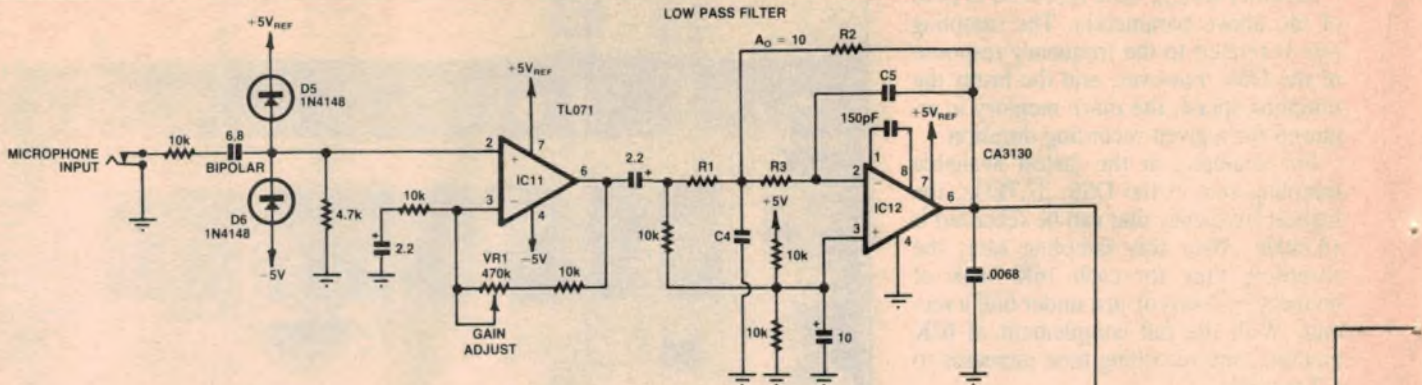
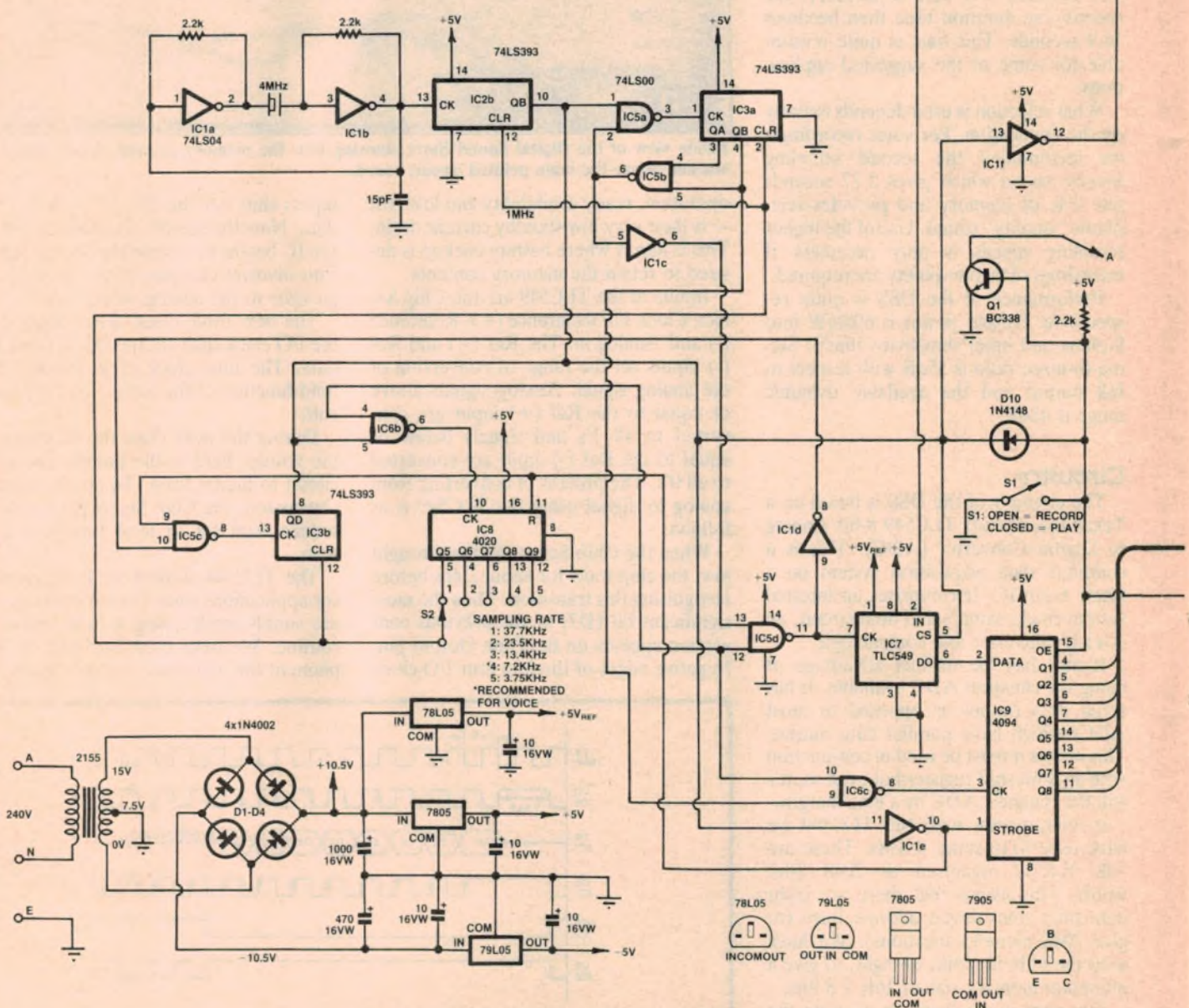

Fig.1: waveforms for the analog to digital conversion process.



RATE	R1	R2	R3	C4	C5	C1	C2	C3
1	3.9k	39k	3.6k	0.0033uF	150pF	0.0018uF	0.0015uF	150pF
2	6.8k	68k	5.6k	0.0033uF	150pF	0.0039uF	0.0033uF	270pF
3	4.7k	47k	4.7k	0.0068uF	330pF	0.0056uF	0.0047uF	470pF
4	2.7k	27k	2.4k	0.027uF	0.0012uF	0.01uF	0.01uF	820pF
5	4.7k	47k	4.7k	0.027uF	0.0012uF	0.018uF	0.015uF	0.0015uF



Here is the complete circuit diagram for the Digital Sound Store.

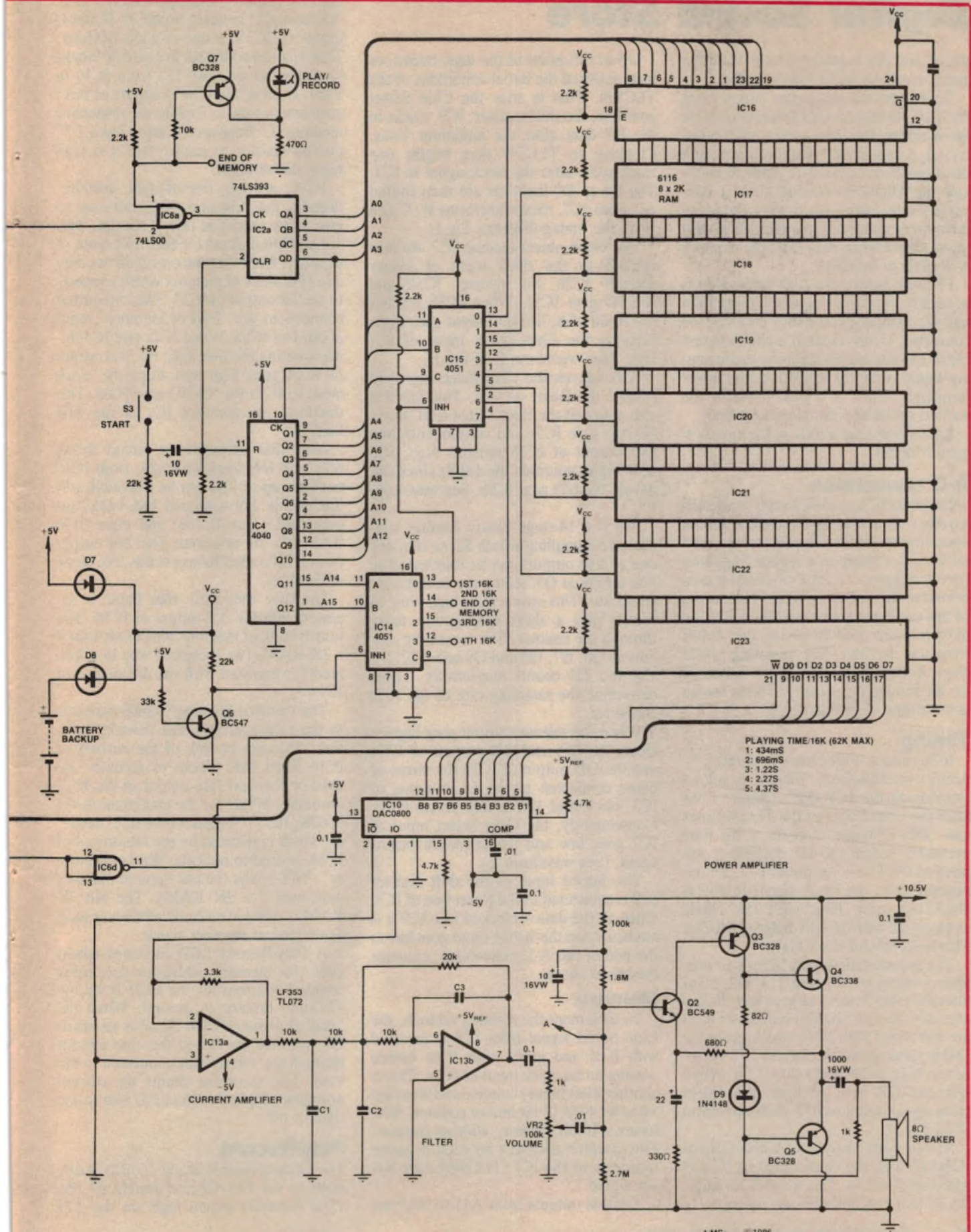

PLAYING TIME/16K (62K MAX)
 1: 434mS
 2: 696mS
 3: 1.22S
 4: 2.27S
 5: 4.37S

POWER AMPLIFIER

Digital Sound Store

the IC and this requires several counters, gates, inverters and a shift register.

To convert the serial data output from the TLC549 to a parallel form suitable for the memory, we have used a shift register, as noted above. Parallel data from the register is applied to both memory and the Digital-to-Analog (DAC) converter. This allows us to write data into memory or convert it to analog form during playback when data from the memory is applied to the DAC.

Filtering before the A-D conversion is necessary to prevent signals of more than half the sampling frequency entering the converter. If this happens a phenomenon called aliasing occurs whereby the incoming signal is falsely converted to a lower frequency which is a beat between the wanted signal and sampling frequency.

Let us now take a look at the circuit in greater detail.

A-D conversion

Inverters IC1a and IC1b are connected together in a standard oscillator circuit operating at 4MHz. To prevent the crystal from operating in a higher frequency (overtone) mode, a 15pF capacitor is connected to the output of IC1b. The output of this oscillator is fed to IC2b, a 4-bit binary counter used to divide the 4MHz frequency by four. The resulting 1MHz clock frequency is used as the timebase for the remaining circuitry. This is shown as waveform A in Fig. 1.

Timing

IC3a, also a 4-bit binary counter, performs two functions. Firstly, it allows clocking to the IC9 shift register, 1.5us after the Chip Select of the TLC549 goes low. This is longer than the 1.4us time necessary before the D7 data bit is applied to the Data Out pin of IC7. To implement this, the clock signal to IC9 is NANDed using IC6c with the 1MHz clock signal and the QB output of IC3a. This is waveform B on Fig. 1.

The second function of IC3a is to provide clocking of IC7, the TLC549, 2.5us after the Chip Select line goes low. To enable this, the QA and QB outputs of IC3a are NANDed with IC5b which gates the 1MHz clock signal through to IC7 via inverter IC1c and NAND gate IC5d. When QA and QB both go high, the 1MHz clock signal is sent to IC7. (See waveform D on Fig. 1).

At the same time as QA and QB (of IC3a) go high the clock signal to IC3a is gated off via IC5a. This stops IC3a counting so that QA and QB remain high.

Up to this point of the logic circuit we have satisfied the initial conditions of the TLC549. That is after the Chip Select goes low, the shift register, IC9, clocks in the D7 data after the minimum 1.4us. Clocking to TLC549 then begins one clock pulse after the clock signal to IC9. The D6 to D0 data bits are then shifted out from IC7. (See waveforms B, C and D on the timing diagram, Fig. 1).

The clock pulses feeding IC7 are also applied to the clock input of binary counter IC3b via inverter IC1d and NAND gate IC5c. When IC3b reaches the count of 8, its QD output goes high, bringing the Chip Select input of IC7 high. (See waveform E of Fig. 1).

IC1e inverts the Chip Select signal to release the Reset on IC8. This inverter also gates off the clock signal to IC3b via NAND gate IC5c and consequently the QD output of IC3b remains high. IC8 now begins counting the 1MHz clock signal via NAND gate IC6b. See waveform F.

IC8 is a 14-stage binary counter connected to sampling switch S2, so that any one of five outputs can be selected. The first output at Q5, selects the fastest sampling rate. This output goes high after 16 counts plus a short propagation delay through the counter. The remaining outputs at Q6, Q7, Q8 and Q9 select 32, 64, 128 and 256 counts respectively. These determine the sampling rate of the A-D converter.

When the selected output goes high, it clears the QA and QB outputs of IC3a and the QD output of IC3b (by virtue of being connected to the CLR inputs of IC3, pin 2 and 12). It also resets IC2b. Consequently, the Chip Select input of IC7 goes low and the sequence begins again. (See waveform E).

The Strobe input of the shift register IC9 is connected to the Reset line of IC8. Once all the data is clocked into IC9 it is latched when the strobe input goes low at the end of the A-D conversion sequence described above.

Memory

To increment the memory address, the Chip Select signal from IC7 is inverted with IC1f and gated with IC6a before passing to the clock input of IC2a. This is another 4-bit binary counter and together with the 4040 12-bit binary counter, IC4, forms a 16-bit memory address counter. This counter advances on each negative transition of the IC7 (TLC549) Chip Select signal.

Address outputs from A11 to A15 are

used for memory address decoding. A11, A12 and A13 connect to the A, B and C inputs of IC15, a one-of-eight decoder. This decodes addresses in eight 2K blocks to select the memory ICs from IC16 to IC23. Each of the 0 to 7 outputs of IC15 goes low in turn to Enable the respective memory IC. Each enable input has a 2.2k pull-up resistor to ensure that it is high when not selected.

IC14, another one-of-eight decoder, decodes the A14 and A15 addresses to give a low output at one of the 1st, 2nd, 3rd and 4th outputs for each 16K bank of memory. Note that the circuit shows only one 16K block of memory which connects to the 1st output of IC14. The 2nd output connects to the "End of Memory" input at pin 1 of IC6a. When IC2a and IC4 finish counting the first 16K, the 2nd output of IC14 goes high and stops the clock input to IC2a via NAND gate IC6a. This deselected the memory ICs in the first bank.

Note that although the circuit shows only one 16K bank of RAM, from IC16 to IC23, up to 62K can be provided with this circuit. For a second 16K bank, another 4051 (say IC15b) and eight 6116 RAM ICs are required. The 2nd output from IC14 is used to access this 16K block of memory.

Similarly the third 16K bank is accessed with the 3rd output of IC14. The fourth bank of memory which only uses 7 x 2K RAMs (we'll explain why in a moment) is accessed with the 4th output of IC14.

The "End of Memory" signal connects to the next available free memory location. This can be one of the outputs of IC14 when 16K blocks of memory are used or the next free output of the IC15 decoders. In fact for the maximum RAM of 62K, the "7" output of the IC15 decoder, which is selected by the 4th output of IC14, is used to indicate "End of Memory". This is why the last bank of memory only uses 7 x 2K RAMs. The 8th 2K RAM is omitted since its address is used as the end of memory signal.

A Play/Record LED indicates whenever the memory addresses are being counted. Current for the LED is via the 470 ohm resistor to ground. When the "end of memory" low signal is reached, Q7 is turned on due to the base current through the 10k resistor connected to the base. This transistor shunts the current normally supplied to the LED and so the LED is off.

Play/Record

The Output Enable at pin 15 of IC9 connects to the Play/Record switch, S1. Pin 15 is normally pulled high via the 2.2k

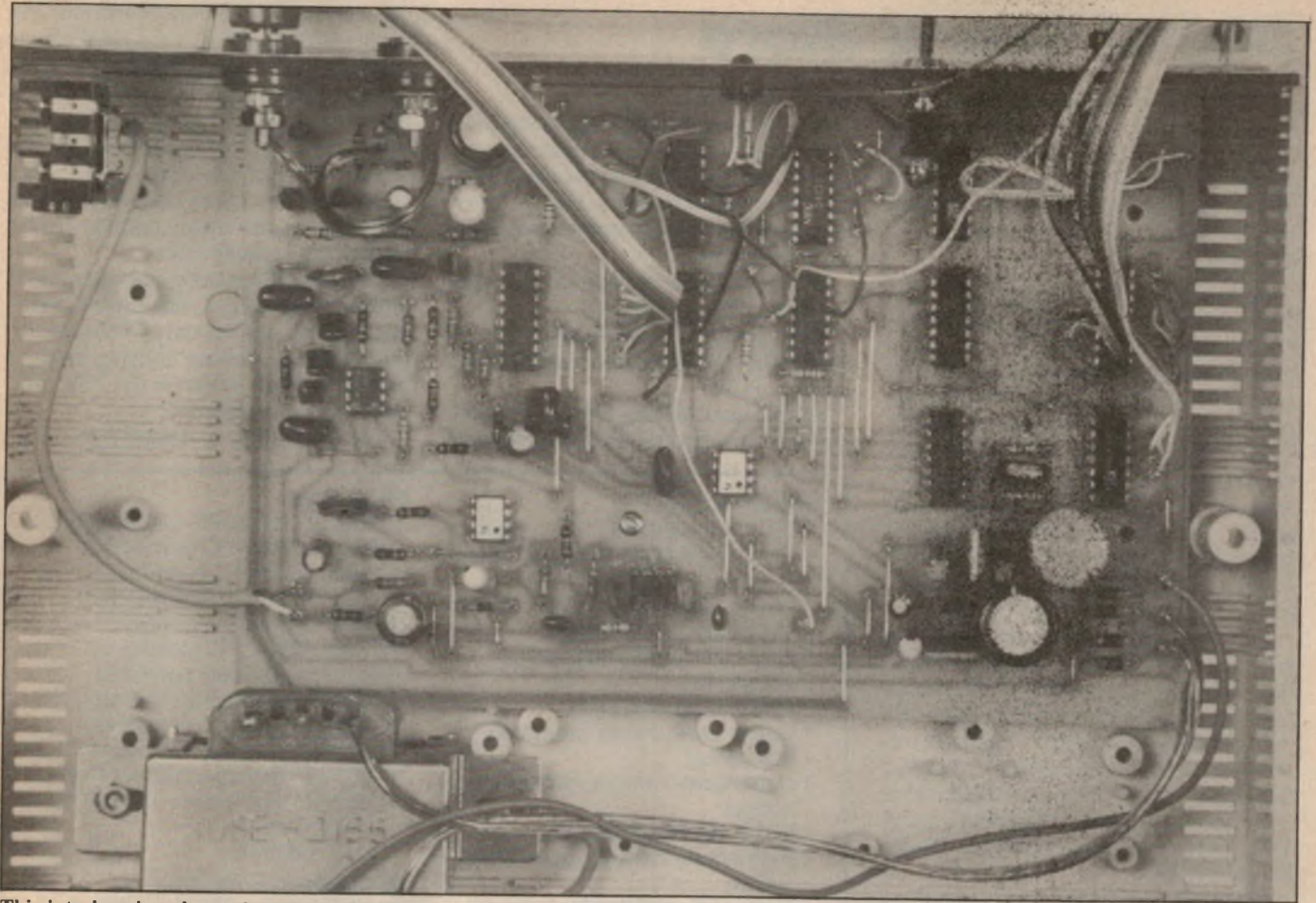

This interior view shows the main printed circuit board just prior to installation of the memory board.

resistor when S1 is open. In this position, S1 sets the Tristate lines from Q1 to Q8 of IC9 as outputs. The high Output Enable on Q9 is inverted with IC6d to drive the Write line of the RAM. When low, the Write line sets the memory into the write mode. This allows data from the outputs of IC9 to be written to the RAM.

Note that the input to IC6d can be pulled low via diode D10 when the Chip Select input of IC7 is low. This sets the Tristate outputs of IC9 into the high impedance mode and the RAM into the write mode.

The reason for doing this is to prevent false memory storage by disabling writing to the RAM when the memory addresses change. The RAM is only written to while the Chip Select of IC7 is high, when new data is at the IC9 outputs.

During playback of the signal stored in memory, the memory data lines drive the D-A converter IC10.

D to A conversion

IC10 is National Semiconductor's DAC0800, an 8-bit DAC with a typical settling time of 100ns. It uses current references to determine the full scale output. We have used a 5V reference with

4.7k current resistors for the internal reference amp. For the output, we used op amp IC13a to convert the current output at pin 4 to a voltage.

Filtering

IC13b is a 3-pole filter which filters the stepped output of the DAC. The roll-off frequency of the filter is dependent upon the sampling rate selected. The table shown on the circuit diagram gives the filter component values for each sampling rate.

Following the filter, the signal is capacitively coupled to the volume control. This controls the level of signal applied to the power amplifier. The amplifier is a simple class AB four transistor configuration with capacitive coupling to the loudspeaker. Gain is set to about three by the 680 ohm and 330 ohm feedback resistors at the emitter of Q2. Low frequency roll-off is set to about 22Hz by the 22uF capacitor connected in series with the 330 ohm resistor.

Transistor Q1 is used to disable the amplifier during recording. This is achieved by connecting the base via a 22k resistor to the Output Enable of IC9. During playback, the base is pulled low via S1

and the transistor is switched off to allow normal bias voltage to be applied to the base of transistor Q2.

Input

The input to the Digital Sound Store is suitable for a standard high impedance microphone. Diodes D5 and D6 clamp the input to a maximum of about 10V p-p (insurance against abusive inputs) and the signal is fed to amplifier IC11 which has a maximum gain of about 49. Trimpot VR1 is used to adjust the gain by varying the negative feedback. The signal from IC11 is then coupled via a 2.2uF capacitor to the low pass filter stage, IC12.

For IC12 we have specified a CA3130 because of its CMOS output stage which allows its output signal swing to equal the supply rail. This is important since it is used to drive the analog input of the A-D converter and must be capable of swinging its output between 0V and 5V.

IC12 is therefore biased to half supply with the two 10k resistors connected across the 5V supply to ground. This sets the signal to swing above and below 2.5V.

Gain of the 2-pole filter is set at 10 and the roll-off frequency is set by the compo-

Digital Sound Store

nent values listed on the circuit diagram table. Again, the component values depend on the desired sampling frequency. A .0068uF capacitor at the output of IC12 shunts any high frequency spikes caused by the digital section of the circuitry.

Power

Power for the DSS is derived from a 2155 15V centre tapped transformer. Diodes D1 to D4 rectify the AC waveform and this is filtered with the 1000uF capacitor for the positive half of the supply and a 470uF for the negative supply. Two 5V regulators are used on the positive supply. One is for use exclusively as a reference voltage and to supply the op amps. The second regulator supplies power to the digital ICs. Finally, a 5V negative regulator provides the -5V necessary for the op amps and the DAC.

Battery back-up for the RAM is achieved using diodes D7 and D8. When the 5V supply is powered, D7 supplies the Vcc rail voltage to the memory ICs and 4051 decoders. D8 is therefore reverse-biased due to the lower voltage of the battery, which only uses three cells. Also transistor Q6 is switched on via the 33k resistor and this enables the inhibit input of IC14.

When the 5V power is off, supply to the memory ICs is via the battery and diode D8. Also Q6 is switched off and the subsequent high at the inhibit input of IC14 disables the outputs and deselects the IC15 decoder(s). Thus all the memory ICs are deselected and are in a power-down state. Current drawn in this state is only 100uA (maximum) per 2K RAM IC.

Construction

The DSS circuit is constructed on a main PCB coded 86da9 and measuring 126 x 190mm, plus at least one memory PCB coded 86mb9 and measuring 129 x 74mm. Up to four memory PCBs can be incorporated, with each PCB holding up to 16K of RAM. The PCBs are housed within a plastic case measuring 260 x 190 x 80mm. A Scotchcal label measuring 251 x 76mm is affixed to the front panel.

Construction can start with the main PCB. Insert all the low profile components first such as the links, diodes, resistors and ICs. Take care with the orientation of the polarised components and check their location against the overlay diagram before soldering. We suggest that the circuit be initially wired for the 7.2kHz sampling rate which is shown as the number 4 rate on the circuit tables. This sets R1, R2 and R3 as 2.7k, 27k and

2.4k respectively.

Now the transistors and capacitors can be inserted into the PCB. Again, be careful with the orientation of the electrolytic capacitors and transistors. Finally, insert the regulators and trimpots and solder them in position.

We recommend the use of PC stakes for all external connections.

That completes construction of the main PCB. Work can now begin on the memory PCB.

Firstly, insert all the links. This is important since several links run beneath

the memory ICs. Before proceeding any further with the PCB, it is a good idea to check the PCB tracks for shorts or breaks in the copper tracks. The artwork is very fine with close track spacings so it is possible there may be some problem with the pattern. Scrape between the tracks with a sharp knife to ensure that there are no short circuits and check continuity of the tracks using a multimeter.

Insert the ICs making sure they are all oriented correctly. A fine-tipped soldering iron will be necessary to ensure correct soldering without bridging between the tracks. Now solder in the 2.2k resistors and 0.1uF capacitor.

The main PCB is designed to be se-

PARTS LIST

- 1 PCB, code 86da9, 126 x 190mm
- 1 PCB, code 86mb9, 129 x 74mm
- 1 Scotchcal label, 251 x 76mm
- 1 plastic case, 260 x 190 x 80mm (Altronics Cat. H-0482)
- 1 2155 15V centre-tapped 1A transformer
- 1 mains cord and plug
- 1 mains cord clamp grommet
- 1 solder lug
- 1 mono panel mount microphone socket
- 1 SPDT miniature switch
- 1 momentary contact pushbutton switch
- 1 5mm LED and bezel
- 1 4MHz crystal
- 2 speaker terminals, 1 red, 1 black
- 33 PC stakes
- 1 4 x AA battery holder (optional)
- 3 AA batteries (optional)

Semiconductors

D to A Converter

- 2 74LS00 quad NAND gates
- 1 74LS04 hex inverters
- 2 74LS393 dual binary counters
- 1 4020 14-stage binary counter
- 1 4040 12-stage binary counter
- 1 4051 8-channel analog multiplexer
- 1 4094 8-bit shift register
- 1 TLC549 8-bit A-D converter
- 1 DAC0800 8-bit D-A converter
- 1 LF353, TL072 dual op amp
- 1 LF351, TL071 single op amp
- 1 CA3130 CMOS output op amp
- 4 1N4002 diodes
- 6 1N4148, 1N914 diodes
- 1 7805 +5V regulator
- 1 78L05 +5V regulator
- 1 7905 -5V regulator
- 3 BC328 PNP transistors
- 2 BC338 NPN transistor
- 1 BC547 NPN transistor
- 1 BC549 NPN transistor
- 1 red LED

Capacitors

- 2 1000uF 16VW PC electrolytic
- 1 470uF 16VW PC electrolytic
- 1 22uF 16VW PC electrolytic
- 7 10uF 16VW PC electrolytic
- 1 6.8uF bipolar electrolytic
- 2 2.2uF 16VW PC electrolytic
- 4 0.1uF metallised polyester
- 1 .027uF metallised polyester
- 3 .01uF metallised polyester
- 1 .0068uF metallised polyester
- 1 .0012uF metallised polyester
- 1 .820uF polystyrene or ceramic
- 1 150pF ceramic
- 1 15pF ceramic

Resistors (0.25W, 5%)

- 1 x 2.7M, 1 x 1.8M, 1 x 100k, 1 x 33k, 1 x 27k, 3 x 22k, 1 x 20k, 10 x 10k, 3 x 4.7k, 1 x 3.3k, 1 x 2.7k, 1 x 2.4k, 5 x 2.2k, 2 x 1k, 1 x 680 ohm, 1 x 470 ohm, 1 x 330 ohm, 1 x 82 ohm, 1 x 470k miniature vertical trimpot, 1 x 100k miniature vertical trimpot

Note: The above component values assume the use of a 3.6kHz cut-off frequency for the input and output filters.

Memory board (for each 16K bytes)

- 1 4051 8-channel analog multiplexer
- 8 6116 2k x 8 RAM
- 1 0.1uF metallised polyester capacitor
- 9 2.2k 0.25W resistors

Miscellaneous

Rainbow cable, hookup wire, screws and nuts, shielded cable, solder etc.

Component availability: Most of the parts for this project should be readily available. The TLC549 is distributed by VSI Electronics and will be available to retail customers from Geoff Wood Electronics.

cured to the integral pillar standoffs on the base of the plastic case. The memory PCB is mounted above the main PCB on long screws which also screw into the integral pillars of the case.

Wiring between the main PCB and memory PCB should be done using rainbow cable. Note that the address outputs on the main PCB, from A0 to A10, which connect to the A0 to A10 inputs on the memory PCB can be connected in any order. This means that the wiring can be made as a single bus of wires without crossing over. Note however that the A11, A12 and A13 connections should connect correctly so that the RAM IC numbering shown on the memory PCB is correct.

Similarly, the data lines from D0 to D7 can also connect in any fashion so that the wiring between the PCBs are neat.

If a second, third or fourth memory PCB is added, then these are designed to stack one on top of the other. The address and data lines all connect in common between PCBs.

Extra connections are the W bar-signal, the Vcc supply and ground from the main PCB to the memory PCB(s).

The inhibit input to IC15 comes from IC14. For the first 16K PCB, the connection is to the 1st output; the second, third and fourth memory PCBs connect to the 2nd, 3rd and 4th outputs respectively. End of Memory signal is from the next available free memory location. When only the first, second or third memory PCBs are used, then the 2nd, 3rd and 4th outputs respectively from IC14 set the end of memory signal.

The fourth memory PCB can only be filled with a maximum of seven memory

ICs. IC23 must be left off the PCB. The "7" output from IC15 of this PCB connects to the End of Memory input on the main PCB.

That completes the inter-board wiring. Now attention can be applied to the case. The transformer mounts at the rear of the case close to the rear panel. Since there are no available integral plastic standoffs for the transformer in this area, screws will need to be drilled through from the base of the case and the transformer mounted on spacers.

The mains cord enters the back panel through a cord clamp grommet. The Active and Neutral wires solder directly to the transformer primary terminals and the Earth lead is connected to one of the transformer mounting feet using a solder lug. Keep the earth lead longer than the Active and Neutral leads so that if the

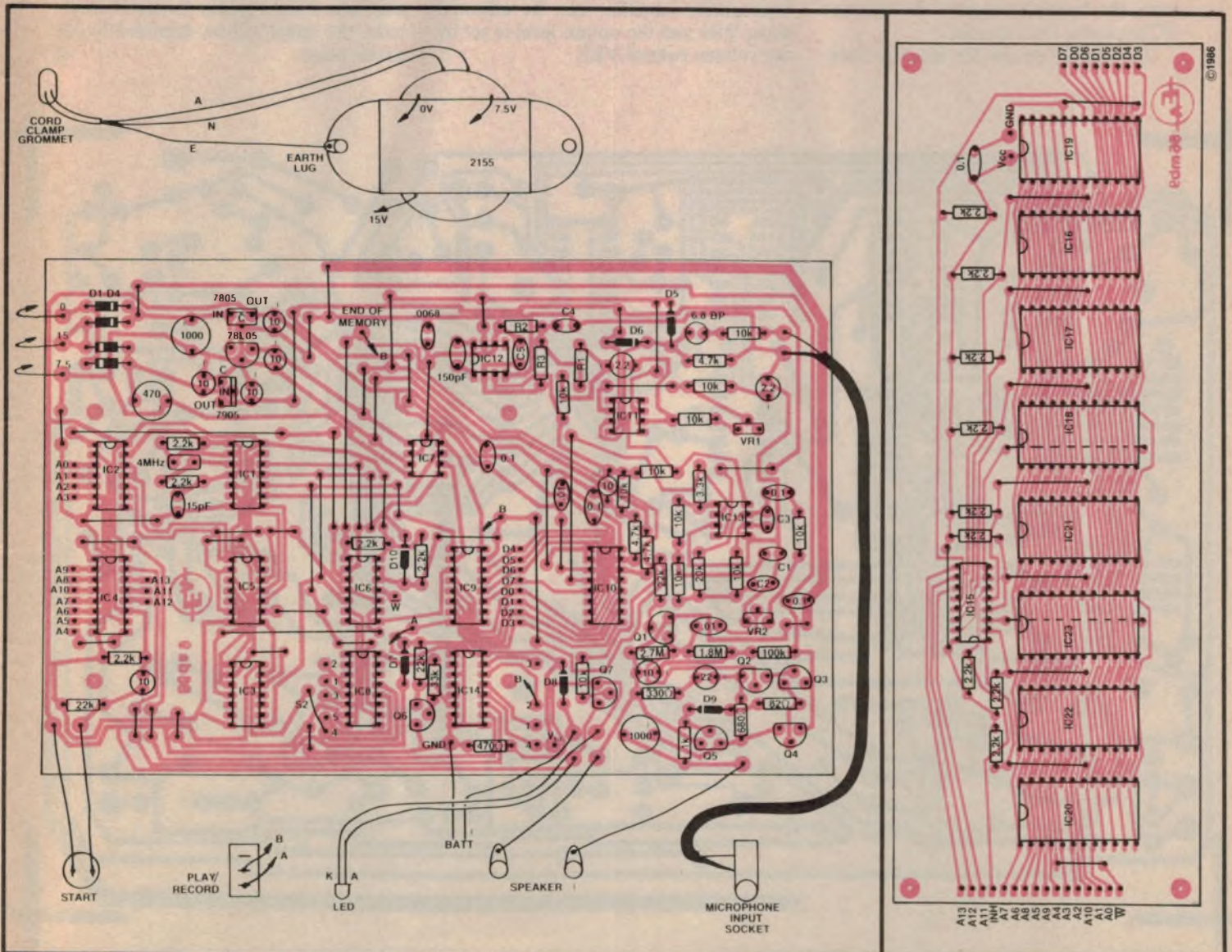

Above is the parts layout and wiring diagram for the main printed circuit board.

Above: parts layout for the memory PCB.

Digital Sound Store

mains wires are accidentally pulled out from the transformer, the earth wire will remain intact.

Wire the secondary of the transformer as shown on the wiring diagram.

The front panel label should be cut to size and secured to the front panel. Holes can then be drilled where indicated on the label to accommodate the Start and Record switches plus the LED, speaker terminals and microphone socket. Screw these to the front panel and complete the wiring.

Note that shielded cable is used for the microphone input.

The main PCB is secured to the base of the case with two self-tapping screws adjacent to IC12 and IC14. The left hand mounting holes near IC4 and IC2 have the long screws from the memory PCB passing through them.

The battery holder for memory back-

up needs to be modified to hold only three cells. This is accomplished by soldering a wire across one of the cell positions.

Testing

On powering up the Digital Sound Store, check the power supplies immediately. If these are not correct, immediately disconnect the mains and locate the fault. When the supplies are correct, plug in a microphone, switch the the Play/Record switch to record, press the start switch and speak into the microphone.

To replay the stored sound, switch to Play, connect a loudspeaker and press the Start switch. The unit should faithfully replay the recorded sound. The gain of the microphone amplifier can be adjusted using VR1 and the output level is set by the volume control VR2.

If the unit does not work, do not replace the ICs. The best procedure is to methodically check through the operation of the circuit. This task is not very complex since the circuit is made up of circuit blocks. These include the microphone amplifier and filter, A-D converter circuitry, D-A circuit and finally the output filter and power amplifier.

Most problems will be related to short circuits between tracks or breaks in the copper pattern. Also check transistors in the power amplifier stages.

Recording

Making a satisfactory recording of your barking dog or particular announcement may be difficult at first. It is important to make a recording where the signal level is as high as possible but without clipping. Clipping will be heard as distortion upon playback. If the signal is too low in amplitude, the signal will be degraded by the circuit noise. E2

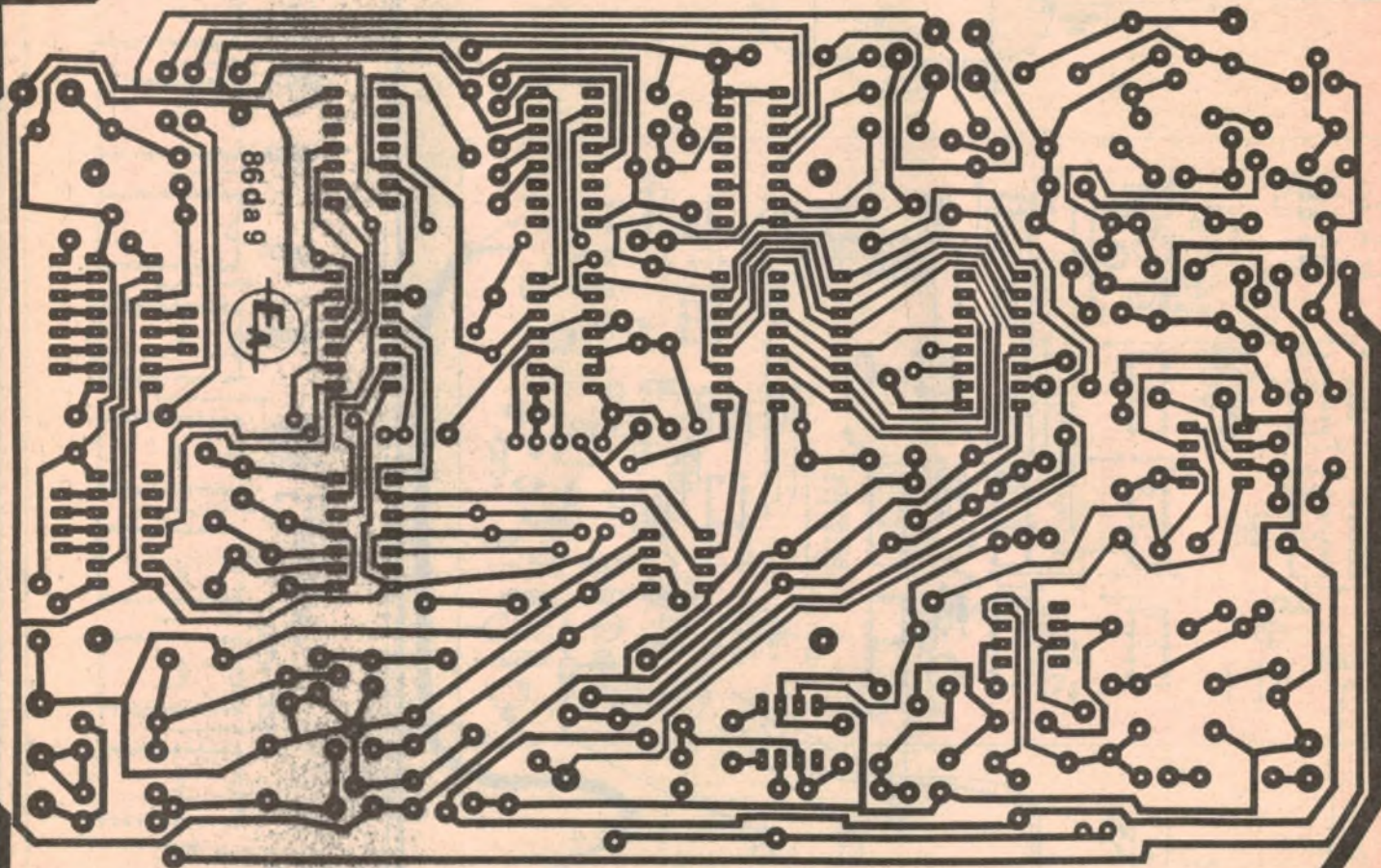

Here is the full size reproduction of the main circuit board artwork.

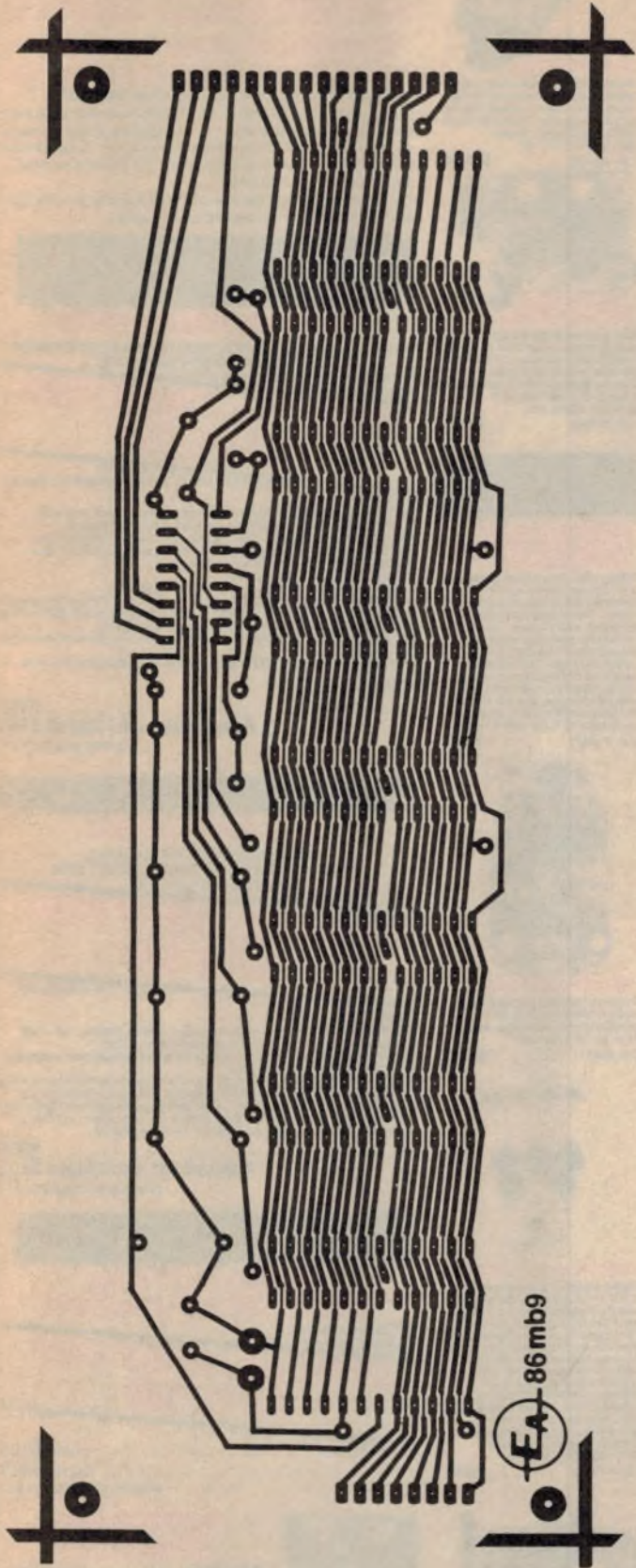

EA 86mb9

Above is the full size artwork for the memory circuit board. Ready etched PCBs will be available from the usual retailers (see advertisements in Marketplace)

At right is the actual size front panel artwork.

EA DIGITAL SOUND STORAGE

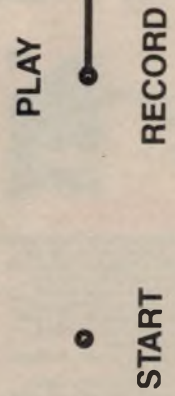

(-) SPEAKER (+) MICROPHONE





VIDEO AMPLIFIER

Bothered by smeary colours, signal beats and RF interference on your computer display? Throw away that cheap and nasty RF modulator and use a direct video connection instead, it's much better! The Video Amplifier features adjustable gain and provides both normal and inverted outputs. Power is derived from a 12V DC plugpack supply. (EA Aug '83) 83VA8

Cat. K83081 **\$18.95**



LAB SUPPLY

Fully variable 0-40V current limited 0.5A supply with both voltage and current metering (two ranges: 0.0-5A/0.5A). This employs a conventional series-pass regulator, not a switchmode type with its attendant problems, but dissipation is reduced by unique relay switching system switching between taps on the transformer secondary. (ETI May '83) ETI 163

Cat. K41630 **\$249**



ZENER TESTER

A simple low cost add-on for your multimeter. This checks zeners and reads out the zener voltage directly on your multimeter. It can also check LEDs and ordinary diodes. (ETI May '83) ETI 164

Cat. K41640 **\$11.95**



LOW BATTERY VOLTAGE INDICATOR

Knowing your batteries are about to give up on you could save many an embarrassing situation. This simple low cost project will give you early warning of power failure, and makes a handy beginner's project. (ETI 280, March '85)

Cat. K42800 **\$9.95**



PARALLEL PRINTER SWITCH KIT

Tired of plug swapping when ever you want to change from one printer to another? This low-cost project should suit you down to the ground. It lets you have two Centronics-type printers connected up permanently, so that you can select one or the other at the flick of a switch. (ETI 666 Feb '85)

Cat. K46660 **\$79.95**



COMPUTER DRIVEN RADIO-TELETYPE TRANSCIVER KIT

Here's what you've been asking for, a full transmit-receive system for computer driven radio teletype station. The software provides all the latest "whizz bangs" like split-screen operation, automatically repeating test message, printer output and more. The hardware uses tried and proven techniques. While designed to team with the popular Microbee, tips are available on interfacing the unit to other computers. (ETI Nov. '84) ETI 755)

Cat. K47550 **\$135**

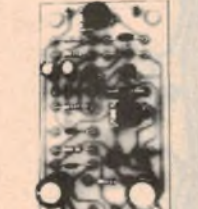

1W AUDIO AMPLIFIER

A low cost general-purpose 1 watt audio amplifier, suitable for increasing your computers audio level, etc. (EA Nov '84)

Cat. K84111 **\$9.95**



50 W AMPLIFIER MODULE (ETI 480)

Cat. K44880 (Heatsink optional extra) **\$29.50**

100 W AMPLIFIER MODULE (ETI 480)

Cat. K44801 (Heatsink optional extra) **\$34.50**



DIGITAL SAMPLER KIT

Digital sampling is at the core of many of the special sound effects used by modern musicians. A trigger input (usually a construction drum pad) triggers a pre-recorded sound from the digital sampler. This sound has been recorded into the 4K of onboard memory and can be digitally manipulated so that it sounds completely different on playback. The unit has controls for gain, regeneration and mixing. It also gives a choice of a number of different triggering methods. (ETI 1402, May-July '86)

Cat. K41420 **\$119**



HUMIDITY METER

This project can be built to give a readout of relative humidity either on a LED dot-matrix display or a conventional meter. In addition it can be used with another project as a controller to turn on and off a water mist spray in a greenhouse, for example. (ETI May '81) ETI-256 (Includes humidity sensor \$19.50)

Cat. K42560 **\$49.95**

SERIES 5000

INDIVIDUAL COMPONENTS TO MAKE UP A SUPERB HI-FI SYSTEM!

By directly importing and a more technically orientated organisation, ROD IRVING ELECTRONICS can bring you these products at lower prices than their competitors. Enjoy the many other advantages of RIE Series 5000 kits such as "Superb Finish" front panels at no extra cost, top quality components supplied throughout. Over 1,000 sold!

For those who haven't the time and want a quality hi-fi, we also sell the Series 5000 kits assembled and tested



POWER AMPLIFIER

WHY YOU SHOULD BUY A "ROD IRVING ELECTRONICS" SERIES 5000 POWER AMPLIFIER...

- 1% Metal Film resistors are used
- Aluminium electrolytic capacitors

SPECIAL, ONLY \$399 SAVE \$50

ROD IRVING ELECTRONICS is being supplied to other kit suppliers.

SPECIFICATIONS: 150 W RMS into 4 ohms (per channel) POWER AMPLIFIER: 100W RMS into 8 ohms (+ -55V Supply) FREQUENCY RESPONSE: 8Hz to 20KHz +0/-0.4 dB 20KHz to 65KHz, +0/-3 dB. NOTE: These figures are determined solely by passive filters.

INPUT SENSITIVITY: 1 V RMS for 100W output. HUM: 100 dB below full output (flat). NOISE: 116 dB below full output (flat, 20KHz bandwidth) 2nd HARMONIC DISTORTION: 0.001% at 1 KHz (0.0007% on Prototypes) at 100W output using a + -56V SUPPLY rated at 4A continuous-0.0003% for all frequencies less than 10KHz and all powers below clipping.

TOTAL HARMONIC DISTORTION: Determined by 2nd Harmonic Distortion (see above). INTERMODULATION DISTORTION: 0.003% at 100W (50Hz and 7KHz mixed 4:1). STABILITY: Unconditional

Cat. K44771 **\$449**

Assembled and tested **\$599** packing and post \$10

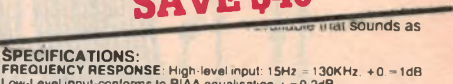

PREAMPLIFIER

THE ADVANTAGES OF BUYING A "ROD IRVING ELECTRONICS" SERIES 5000 PREAMPLIFIER KIT ARE

- 1% Metal Film Resistors

SPECIAL, ONLY \$359 SAVE \$40

...producing 11 flat sounds as

SPECIFICATIONS: FREQUENCY RESPONSE: High-level input: 15Hz - 130KHz. +0 -1dB Low-level input conforms to RIAA equalisation. + = 0.2dB DISTORTION: 1KHz - 0.003% on all inputs (limit of resolution on measuring equipment due to noise limitation)

S/N NOISE: High-level input, master full, with respect to 300mV input signal at full output (1.2V): 92dB flat; 100dB A-weighted. MM input, master full, with respect to full output (1.2V) at 5 mV input: 50ohms source resistance connected: 86dB flat; 92dB A-weighted. MC input, master full, with respect to full output (1.2V) and 200uV input signal: 71dB flat; 75dB A-weighted.

Cat. K44791 **\$399**

Assembled and tested **\$699** packing and postage \$10



THIRD OCTAVE GRAPHIC EQUALIZER

SPECIFICATIONS: BANDS: 2R Bands

SPECIAL, ONLY \$209 SAVE \$30

Cat. K44590 **\$239** 1 unit, **\$429** 2 units, packing and postage \$10

SERIES 4000 SPEAKERS

- 8 Speakers **only \$549**
- 8 Speakers with Crossovers **\$795**
- Speaker Cabinet Kit (complete) **\$395** (Please specify cabinet to suit 7" or 8" mid range woofer)
- Crossover Kits **\$295**
- Complete kit of parts (speakers, crossovers, screws, innerband boxes) **\$1,095**
- Assembled, tested and ready to hook up to your system **\$1,295** (Approximately 4 weeks delivery)

Errors and Omissions Excepted



BIT PATTERN GENERATOR KIT

In applications where you are required to look for a particular byte of information in a serial or parallel data path, short of a logic analyser or a storage oscilloscope, there is not a lot to help you. However, this Bit Pattern Generator gives you a simple and economical way to detect and display specific bytes of data. It may be used on both parallel and serial data paths. (ETI 172, May '86)

Cat. K41720 **\$54.95** (Serial/Parallel Kit)



ELECTRONIC MOUSETRAP

This clever electronic mousetrap disposes of mice instantly and mercifully, without fail, and resets itself automatically. They'll never get away with the cheese again! (ETI Aug. '84) ETI 1524

Cat. K55240 **\$39.95**



AEM DUAL SPEED MODEM KIT

The ultimate kit modem featuring 1200/300 baud, case and prepunched front panel. Exceptional value for money! (AEM 4600 Dec '85)

Normally \$169 **SUPER SPECIAL, ONLY \$139**



EA AM STEREO DECODER

AM stereo is now broadcast in Australia on an experimental basis. This add-on decoder works with the Motorola C-QUAM system. (EA Oct. '84) 84MS10

Cat. K84100 **\$26.95**



50V 5A LABORATORY POWER SUPPLY

New switchmode supply can deliver anywhere from three to 50V DC and currents of 5A at 35V or lower. Highly efficient design. (EA May, June '83) 83P55

Cat. K83050 **\$199**



MOTORCYCLE INTERCOM

OVER 500 SOLD! Motorcycling is fun, but the conversation between rider and passenger is usually just not possible. But build this intercom and you can converse with your passenger at any time while you are on the move. There are no "push-to-talk" buttons, adjustable volume and it's easy to build! (EA Feb. '84) 84MC2

Cat. K84020 **\$49.95**



DELUXE CAR BURGLAR ALARM

Stop your car from being one of the 70,000+ stolen cars stolen each year with this "state of the art" car burglar alarm. Features include key switch operation, delayed entry and exit, automatic reset, and provision for an auxiliary battery. Further more, of the 10 most important features listed by NRMA, this EA Deluxe Car Alarm has 9 of them! (84ba5, EA May '84)

Cat. K84050 **\$99.50**



30 V/A FULLY PROTECTED POWER SUPPLY

The last power supply we did was the phenomenally popular ETI-131. This low cost supply features full protection, output variation from 0V to 30V and selectable current limit. Both voltage and current metering is provided. (ETI Dec. '83) ETI 162

Cat. K41620 Normally \$69.50 **SPECIAL, \$59.50**



MICROBEE SERIAL-TO-PARALLEL INTERFACE

Most microcomputers worth owning have an RS232 connector, or port, through which serial communications (input/output) is conducted. It is a convention that, for listing on a printer, the BASIC LIST or LPRINT command assumes a printer is connected to the RS232 port. Problem is, serial interface printers are more expensive than parallel Centronics interface printers. Save money by building this interface. (ETI Jan. '84) ETI 675

Cat. K46750 **\$39.50**



MULTI SECTOR ALARM STATION

Protect your home and possessions from burglars with this up to the minute burglar alarm system. It's easy to build, costs less than equivalent commercial units, and features eight separate inputs, individual sector control, battery back up and self-test facility. Specifications:

- Eight sectors with LED status indication.
- Two delayed entry sectors.
- Variable exit entry and alarm time settings: entry delay variable between 10 and 75 seconds; exit delay variable between 5 and 45 seconds; alarm time variable between 1 and 15 minutes.
- Resistive loop sensing suits both normally open and normally closed alarm sensors.
- Battery back-up with in-built charger circuit.
- Built-in siren driver.

The RIE kit includes a superb printed and prepunched metal case and inside metal work, plus a gel battery! Unbeatable VALUE! Cat. K85900 Normally \$169 **SPECIAL, \$159**



PARALLEL PRINTER SWITCH KIT

Tired of plug swapping when ever you want to change from one printer to another? This low-cost project should suit you down to the ground. It lets you have two Centronics-type printers connected up permanently, so that you can select one or the other at the flick of a switch. (ETI 666 Feb '85)

Cat. K46660 **\$79.95**



PH METER KIT

Build this pH meter for use with swimming pools to fish tanks to gardening, this pH meter has many applications around the home. This unit features a large 3 1/2 digit liquid crystal display and resolution to 0.1 pH units, making it suitable for use in the laboratory as well! (EA Dec '82) 82PH12

Cat. K82123 **\$199**



CRYSTAL CONTROLLED TV PATTERN GENERATOR

Anyone wishing to obtain the maximum performance from a colour TV receiver needs a pattern generator. Why not build this superb unit which provides live separate patterns: dot, crosshatch, checker board, grey scale and white raster? Note: The RIE kit includes a large ABS type case! (80pg6, EA June '80)

Cat. K80033 **\$97.50**

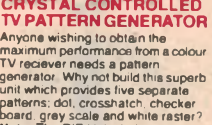

ELECTRIC DUMMY LOAD

With this unit you can test power supplies at currents up to 15 Amps and voltage up to 60 Volts. It can "sink" up to 200 Watts on a static load and you can modulate the load to perform dynamic tests. (ETI Oct. '80) ETI 147

Cat. K41470 Normally \$129 **SPECIAL, \$119**



ZENER TESTER

A simple low cost add-on for your multimeter. This checks zeners and reads out the zener voltage directly on your multimeter. It can also check LEDs and ordinary diodes. (ETI May '83) ETI 164

Cat. K41640 **\$11.95**

No. 1 for semiconductors!

MELBOURNE 48 A Berrick Street, Phone (03) 663 6151. NORTHCOE 425 High Street, Phone (03) 489 8866.
MAILORDER HOTLINE: (03) 543 8777

4000	7432	70	74LS91	60	74LS622	2.75	74C162	2.00	74S281	P.O.A.	LM735	4.75	COM1818	24.00	HP5082	2811	BC639	1.50	MRF646	53.00	2N5458	90	7812UC	1.90
4001	7430	90	74LS92	60	74LS623	2.75	74C163	2.00	74S282	7.90	LM736	1.50	BR1941	23.00	BC640	4.85	BC640	1.90	MRF901	2.90	2N5459	90	7812KC	2.50
4002	7448	90	74LS93	70	74LS624	2.75	74C164	2.50	74S283	4.80	LM737	1.75	CR1007A	59.00	BC641	1.90	MRF131	1.90	2N5461	90	7815UC	1.90	7815KC	2.50
4006	7448	1.00	74LS94	70	74LS625	2.75	74C165	2.50	74S284	4.80	LM738	1.75	LEDS		BCY71	1.90	TIP31A	1.00	2N5462	90	7818UC	1.90	7818KC	2.50
4007	7448	1.00	74LS107	90	74LS626	2.75	74C174	1.80	74S299	13.90	UA747	1.30	3mm RED 25		BD138	30	TIP31B	1.00	2N5465	90	7818UC	1.90	7818KC	2.50
4008	7448	1.20	74LS109	90	74LS627	2.75	74C175	1.90	74S314	10.90	MC1310	9.90	5mm GRN 30		BD232	90	TIP32C	1.00	2N5486	90	7824UC	1.90	7824KC	2.50
4010	7449	1.20	74LS112	70	74LS628	2.75	74C182	2.00	74S320	P.O.A.	MC1312	7.95	5mm RED 15		BD233	90	TIP32B	1.00	2N5590	28.50	7812 UC	30	7812 UC	30
4011	7450	90	74LS114	70	74LS629	2.75	74C193	2.00	74S323	P.O.A.	MC1315	8.95	5mm YELL 30		BD235	90	TIP32C	1.00	2N5591	28.50	7815 UC	30	7815 UC	30
4013	7451	90	74LS122	1.50	74LS630	2.75	74C200	4.00	74S331	P.O.A.	MC1350	1.95	8088	19.50	BD236	90	TIP32A	1.00	2N5641	19.50	7818 UC	30	7818 UC	30
4014	7470	90	74LS123	90	74LS631	2.75	74C221	2.75	74S387	3.90	MC1408	7.50	8121	5.00	BD237	90	TIP42A	1.40	2N5656	2.50	7812 UC	30	7812 UC	30
4018	7475	90	74LS125	90	74LS632	2.75	74C244	3.95	74S412	8212	MC1437	4.95	8123	4.00	BD238	90	TIP42C	1.50	2N5670	2.50	7815 UC	30	7815 UC	30
4019	7475	90	74LS126	1.20	74LS633	2.75	74C244	3.95	74S412	8212	MC1437	4.95	8123	4.00	BD239	90	TIP42C	1.50	2N5670	2.50	7815 UC	30	7815 UC	30
4018	7475	90	74LS127	1.50	74LS634	2.75	74C244	3.95	74S412	8212	MC1437	4.95	8123	4.00	BD240	90	TIP42C	1.50	2N5670	2.50	7815 UC	30	7815 UC	30
4018	7475	90	74LS128	1.20	74LS635	2.75	74C244	3.95	74S412	8212	MC1437	4.95	8123	4.00	BD241	90	TIP42C	1.50	2N5670	2.50	7815 UC	30	7815 UC	30
4018	7475	90	74LS129	1.20	74LS636	2.75	74C244	3.95	74S412	8212	MC1437	4.95	8123	4.00	BD242	90	TIP42C	1.50	2N5670	2.50	7815 UC	30	7815 UC	30
4018	7475	90	74LS130	1.20	74LS637	2.75	74C244	3.95	74S412	8212	MC1437	4.95	8123	4.00	BD243	90	TIP42C	1.50	2N5670	2.50	7815 UC	30	7815 UC	30
4018	7475	90	74LS131	1.20	74LS638	2.75	74C244	3.95	74S412	8212	MC1437	4.95	8123	4.00	BD244	90	TIP42C	1.50	2N5670	2.50	7815 UC	30	7815 UC	30
4018	7475	90	74LS132	1.20	74LS639	2.75	74C244	3.95	74S412	8212	MC1437	4.95	8123	4.00	BD245	90	TIP42C	1.50	2N5670	2.50	7815 UC	30	7815 UC	30
4018	7475	90	74LS133	1.20	74LS640	2.75	74C244	3.95	74S412	8212	MC1437	4.95	8123	4.00	BD246	90	TIP42C	1.50	2N5670	2.50	7815 UC	30	7815 UC	30
4018	7475	90	74LS134	1.20	74LS641	2.75	74C244	3.95	74S412	8212	MC1437	4.95	8123	4.00	BD247	90	TIP42C	1.50	2N5670	2.50	7815 UC	30	7815 UC	30
4018	7475	90	74LS135	1.20	74LS642	2.75	74C244	3.95	74S412	8212	MC1437	4.95	8123	4.00	BD248	90	TIP42C	1.50	2N5670	2.50	7815 UC	30	7815 UC	30
4018	7475	90	74LS136	1.20	74LS643	2.75	74C244	3.95	74S412	8212	MC1437	4.95	8123	4.00	BD249	90	TIP42C	1.50	2N5670	2.50	7815 UC	30	7815 UC	30
4018	7475	90	74LS137	1.20	74LS644	2.75	74C244	3.95	74S412	8212	MC1437	4.95	8123	4.00	BD250	90	TIP42C	1.50	2N5670	2.50	7815 UC	30	7815 UC	30
4018	7475	90	74LS138	1.20	74LS645	2.75	74C244	3.95	74S412	8212	MC1437	4.95	8123	4.00	BD251	90	TIP42C	1.50	2N5670	2.50	7815 UC	30	7815 UC	30
4018	7475	90	74LS139	1.20	74LS646	2.75	74C244	3.95	74S412	8212	MC1437	4.95	8123	4.00	BD252	90	TIP42C	1.50	2N5670	2.50	7815 UC	30	7815 UC	30
4018	7475	90	74LS140	1.20	74LS647	2.75	74C244	3.95	74S412	8212	MC1437	4.95	8123	4.00	BD253	90	TIP42C	1.50	2N5670	2.50	7815 UC	30	7815 UC	30
4018	7475	90	74LS141	1.20	74LS648	2.75	74C244	3.95	74S412	8212	MC1437	4.95	8123	4.00	BD254	90	TIP42C	1.50	2N5670	2.50	7815 UC	30	7815 UC	30
4018	7475	90	74LS142	1.20	74LS649	2.75	74C244	3.95	74S412	8212	MC1437	4.95	8123	4.00	BD255	90	TIP42C	1.50	2N5670	2.50	7815 UC	30	7815 UC	30
4018	7475	90	74LS143	1.20	74LS650	2.75	74C244	3.95	74S412	8212	MC1437	4.95	8123	4.00	BD256	90	TIP42C	1.50	2N5670	2.50	7815 UC	30	7815 UC	30
4018	7475	90	74LS144	1.20	74LS651	2.75	74C244	3.95	74S412	8212	MC1437	4.95	8123	4.00	BD257	90	TIP42C	1.50	2N5670	2.50	7815 UC	30	7815 UC	30
4018	7475	90	74LS145	1.20	74LS652	2.75	74C244	3.95	74S412	8212	MC1437	4.95	8123	4.00	BD258	90	TIP42C	1.50	2N5670	2.50	7815 UC	30	7815 UC	30
4018	7475	90	74LS146	1.20	74LS653	2.75	74C244	3.95	74S412	8212	MC1437	4.95	8123	4.00	BD259	90	TIP42C	1.50	2N5670	2.50	7815 UC	30	7815 UC	30
4018	7475	90	74LS147	1.20	74LS654	2.75	74C244	3.95	74S412	8212	MC1437	4.95	8123	4.00	BD260	90	TIP42C	1.50	2N5670	2.50	7815 UC	30	7815 UC	30
4018	7475	90	74LS148	1.20	74LS655	2.75	74C244	3.95	74S412	8212	MC1437	4.95	8123	4.00	BD261	90	TIP42C	1.50	2N5670	2.50	7815 UC	30	7815 UC	30
4018	7475	90	74LS149	1.20	74LS656	2.75	74C244	3.95	74S412	8212	MC1437	4.95	8123	4.00	BD262	90	TIP42C	1.50	2N5670	2.50	7815 UC	30	7815 UC	30
4018	7475	90	74LS150	1.20	74LS657	2.75	74C244	3.95	74S412	8212	MC1437	4.95	8123	4.00	BD263	90	TIP42C	1.50	2N5670	2.50	7815 UC	30	7815 UC	30
4018	7475	90	74LS151	1.20	74LS658	2.75	74C244	3.95	74S412	8212	MC1437	4.95	8123	4.00	BD264	90	TIP42C	1.50	2N5670	2.50	7815 UC	30	7815 UC	30
4018	7475	90	74LS152	1.20	74LS659	2.75	74C244	3.95	74S412	8212	MC1437	4.95	8123	4.00	BD265	90	TIP42C	1.50	2N5670	2.50	7815 UC	30	7815 UC	30
4018	7475	90	74LS153	1.20	74LS660	2.75	74C244	3.95	74S412	8212	MC1437	4.95	8123	4.00	BD266	90	TIP42C	1.50	2N5670	2.50	7815 UC	30	7815 UC	30
4018	7475	90	74LS154	1.20	74LS661	2.75	74C244	3.95	74S412	8212	MC1437	4.95	8123	4.00	BD267	90	TIP42C	1.50	2N5670	2.50	7815 UC	30	7815 UC	30
4018	7475	90	74LS155	1.20	74LS662	2.75	74C244	3.95	74S412	8212	MC1437	4.95	8123	4.00	BD268	90	TIP42C	1.50	2N5670	2.50	7815 UC	30	7815 UC	30
4018	7475	90	74LS156	1.20	74LS663	2.75	74C244	3.95	74S412	8212	MC1437	4.95	8123	4.00	BD269	90	TIP42C	1.50	2N5670	2.50	7815 UC	30	7815 UC	30
4018	7475	90	74LS157	1.20	74LS664	2.75	74C244	3.95	74S412	8212	MC1437	4.95	8123	4.00	BD270	90	TIP42C	1.50	2N5670	2.50	7815 UC	30	7815 UC	30
4018	7475	90	74LS158	1.20	74LS665	2.75	74C244	3.95	74S412	8212	MC1437	4.95	8123	4.00	BD271	90	TIP42C	1.50	2N5670	2.50	7815 UC	30	7815 UC	30
4018	7475	90	74LS159	1.20	74LS666	2.75	74C244	3.95	74S412	8212	MC1437	4.95	8123	4.00	BD272	90	TIP42C	1.50	2N5670	2.50	7815 UC	30	7815 UC	30
4018	7475	90	74LS160	1.20	74LS667	2.75	74C244	3.95	74S412	8212	MC1437	4.95	8123	4.00	BD273	90	TIP42C	1.50	2N5670	2.50	7815 UC	30	7815 UC	30
4018	7475	90	74LS161	1.20	74LS668	2.75	74C244	3.95	74S412	8212	MC1437	4.95	8123	4.00	BD274	90	TIP42C	1.50	2N5670	2.50	7815 UC	30	7815 UC	30
4018	7475	90	74LS162	1.20	74LS669	2.75	74C244	3.95	74S412	8212	MC1437	4.95	8123	4.00	BD275	90	TIP42C	1.50	2N5670	2.50	7815 UC	30	7815 UC	30
4018	7475	90	74LS163	1.20	74LS670	2.75	74C244	3.95	74S412	8212	MC1437	4.95	8123	4.00	BD276	90	TIP42C	1.50	2N5670	2.50	7815 UC	30	7815 UC	30
4018	7475	90	74LS164	1.20	74LS671	2.75	74C244	3.95	74S412	8212	MC1437	4.95	8123	4.00	BD277	90	TIP42C	1.50	2N5670	2.50	7815 UC	30	7815 UC	30
4018	7475	90	74LS165	1.20	74LS672	2.75	74C244	3.95	74S412	8212	MC1437	4.95	8123	4.00	BD278	90	TIP42C	1.50	2N5670	2.50	7815 UC	30	7815 UC	30
4018	7475	90	74LS166	1.20	74LS673	2.75																		

Multitech's PC-700 personal computer

While the name Multitech may be not particularly well known, it is one of the largest manufacturers of IBM PC-compatible computers in the world with a very good record for quality control. With the recent release of the new Multitech range, we decided to take a close look at their Model PC-700 optioned up with a 20M hard disc.

by LEO SIMPSON

Dick Smith Electronics have been selling Multitech IBM PC-compatible computers for just over a year now and have had very good sales with the Popular 500 model. Now Multitech have released an extended range of three new machines. They are the PC-500, PC-700 and PC-900.

The PC-500 is very similar to the old

Popular 500 model. It has one 360K disc drive, 256K of RAM, a single expansion slot and optional extra floppy or hard disc drive, and the capacity for up to 512K of RAM. The 500 also has been slightly restyled and to this reviewer's eyes, does look better.

The PC-700 is a somewhat larger and more capable model, which comes with

two 360K disc drives as standard, the full 640K of RAM, a larger keyboard and a nominal six expansion slots, although, as we shall discuss later, at least two of these are already occupied, depending on how the machine is configured.

The top of the range PC-900 model is Multitech's answer to the IBM PC/AT and it has a similar specification to that machine. It uses the 80286 processor, is supplied with 512K of RAM which can be increased to a maximum of one Megabyte, and has a 20 Megabyte hard disc as standard.

We decided to have a look at the middle-of-the-range machine, the PC-700 but fitted with a 20MB hard disc and one 360K floppy disc drive. This configuration would appear to be a popular one among PC/XT compatible buyers.

The 700 is quite an attractive unit and is certainly a welcome change from so many compatible machines which at-



The keyboard of the Multitech PC-700 has much the same features as that of the IBM PC/AT except for the separate cursor keys.

tempt to be almost identical in appearance to the IBM PC. The case is slightly smaller than the IBM machine but has the now industry standard cream/beige finish. It is fitted with half-height disc drives and the front panel is otherwise devoid of features apart from the very discreet power-on indicator next to the Multitech logo and the reset button below it.

The indicator really is not a power indicator but a speed indicator because the 700 model has two clock speeds. These are the IBM-standard 4.77MHz and the non-standard 8MHz. Running software at the higher clock rate gives a useful increase in speed (although not necessarily as much as the ratio between the two clock rates would suggest).

However, some software designed for the IBM PC will not run reliably at the higher speed and so it is necessary to be able to shift down to the lower clock rate at will. This is a "toggle" function activated by simultaneously pressing the Ctrl, Alt and "+" keys; ie, press them once and the unit goes to the higher speed, press them again and it switches to the lower speed, and so on. The green indicator comes on for the higher speed. Green for "Go," eh?

The reset button on the front panel is a good feature for two reasons. First, it lets you re-boot the machine after a "crash" in those cases where you can't use the Ctrl, Alt and Del keys together, because the computer will not respond to the keyboard (which can be more frequent than you might think).

Second, by allowing the warm boot procedure you not only avoid the RAM check routine (although the Multitech does not appear to do a full parity check on memory, which takes much longer) but also eliminate any problems of otherwise having to turn off the machine and thus remove power from the hard disc. The last point is important because it is not wise to turn off the machine until the heads of the hard disc drive have been properly parked (by the "Ship Head" routine).

Removing the case of the Multitech is relatively easy. You just undo four small screws at the rear, slide the cover forward and tilt it to clear the front of the chassis. The cover section retains the front panel together with the hard and floppy disc drives. With the cover off there is good access to change or remove accessory boards. Note that if you want to remove the top cover completely, it is necessary to detach the cables to the hard disc and floppy disc drives.

As with most machines of this type the construction involves a single large



The standard Multitech PC-700 comes with two 360K floppy drives. This machine was fitted with the optional 20M hard disc drive.

motherboard with slots for six standard IBM boards. In the PC-700, three of these slots are already occupied with the controller boards for the hard and floppy disc drives, plus the colour graphics board. The latter has a standard 9-pin D socket for the RGB output to the monitor plus two RCA sockets for composite video signals.

There is no need to install cards for RS-232C and Centronics printer outputs since these are already present on the motherboard. Nor is there any need to fit boards to accommodate extra memory or a real time clock. The mother board has sockets to accommodate the 640K maximum memory addressable by the 8088 processor and as noted above, the review machine was "fully populated". A real time clock is a feature of the colour graphics board.

Effectively then, the PC-700 can accommodate three full-size IBM standard boards although the battery for the real-time clock on the colour graphics board does seem to protrude a little into the space for an adjacent board.

Looking from the rear, a substantial portion of the chassis at the righthand

side is occupied by the switchmode power supply which has a stated capacity of 103 watts. It is fitted with IEC standard power sockets for mains input and monochrome monitor output. The on/off switch is also at the rear although we would prefer the scheme used by some other computers of having the power switch under a cover on the front panel, to make it more accessible.

A common criticism which can be made of the IBM PC is that it has a noisy power supply and a noisy fan. In the Multitech, the power supply is certainly quiet and has no audible whistles at all, and the floppy disc is quite unobtrusive too. However both could be quite noisy and you would not notice it because of the loud whine of the cooling fan. There is no excuse for this; fans can be made virtually silent.

Keyboard

The keyboard of the Multitech is impressive and is no less than 557mm wide. That's almost twice as wide as the keyboards on some small machines, particularly portables. The main difference between it and the IBM PC key-

Multitech computer

board is that it has separate cursor control keys and the numerical keyboard is separated from the other keys. As well, there are LED indicators for power, Caps Lock, Num Lock and Scroll Lock.

We had few quibbles with the location of individual keys although the overall layout is more similar to that of the IBM PC/AT than the PC/XT with which this model has "compatibility". If the Multitech is the only PC-compatible you will own the keyboard differences are probably unimportant but if you already have an IBM PC or a compatible the differences could be a source of irritation.

The keyboard has adjustable feet and this, combined with its fairly thin profile, means that a comfortable typing position can be obtained. It has a fairly long coiled connecting cord too which means that the keyboard is not so closely tethered to the main processor. The action of the keys is not too bad either although they do not have the over-centre click action of the IBM keyboard.

Software and Documentation

Quite a lot of good documentation is supplied with the Multitech PC-700. There is a very substantial softcover

book which could be regarded as the operations manual, a similarly sized book on the Microsoft MS-DOS which is supplied with the unit, a book on the colour graphics adapter card (if fitted) and a 32-page manual on the keyboard.

In addition, if you have the hard disc option, you receive a 136-page supplement to MS-DOS which covers the utility programs relevant to the hard disc and small booklets on formatting and protection of the hard disc drive.

The software includes MS-DOS version 2.11, a utilities disc pertaining to the real-time clock and (for the hard disc) MS-DOS version 3.1 on two discs. As well, the PC-700 can be obtained bundled with Microsoft Windows (including Mouse) and the large integrated package Open Access (which includes word processor, database, spreadsheet and communications programs).

In use, the PC-700 was able to run a variety of software without problems other than those involving the adaptation of programs to run on a hard disc machine instead of one with two floppy drives. Those programs which can make use of the real time clock also have to be modified to suit that in the Multitech.

The higher clock speed in the PC-700 is certainly useful although the speed in-

crease is not necessarily the 67% increase predicted by the ratio of the clock speeds or the Norton Utilities disc. Rather it depends on how much use is made of the disc drives during operation of the programs.

Overall, our impression of the PC-700 with hard disc is quite favourable although unless the prospective user has a lot of software in use daily, or is dealing with a large database, a twin floppy drive machine would be a more useful proposition than the hard disc.

Similarly, unless the proposed use involves graphics, the monochrome monitor and relevant adaptor card would be a more useful combination than the colour monitor we reviewed.

Recommended retail price of the PC-700 with two 360K floppy drives, monochrome adaptor card and 12-inch green screen monitor is \$2995 including tax. Fitted with a hard disc and one floppy drive, the price is \$4595 including tax and bundled with Microsoft Windows. With a colour graphics card and RGB colour monitor, the price is \$5095.

Both the latter packages can have Open Access substituted for Windows for an extra \$400 or added for an extra \$800. For machines fitted with a hard disc, the above prices include six months on-site free service.

For further information on the Multitech range of computers contact the distributor, Dick Smith Electronics. ☎

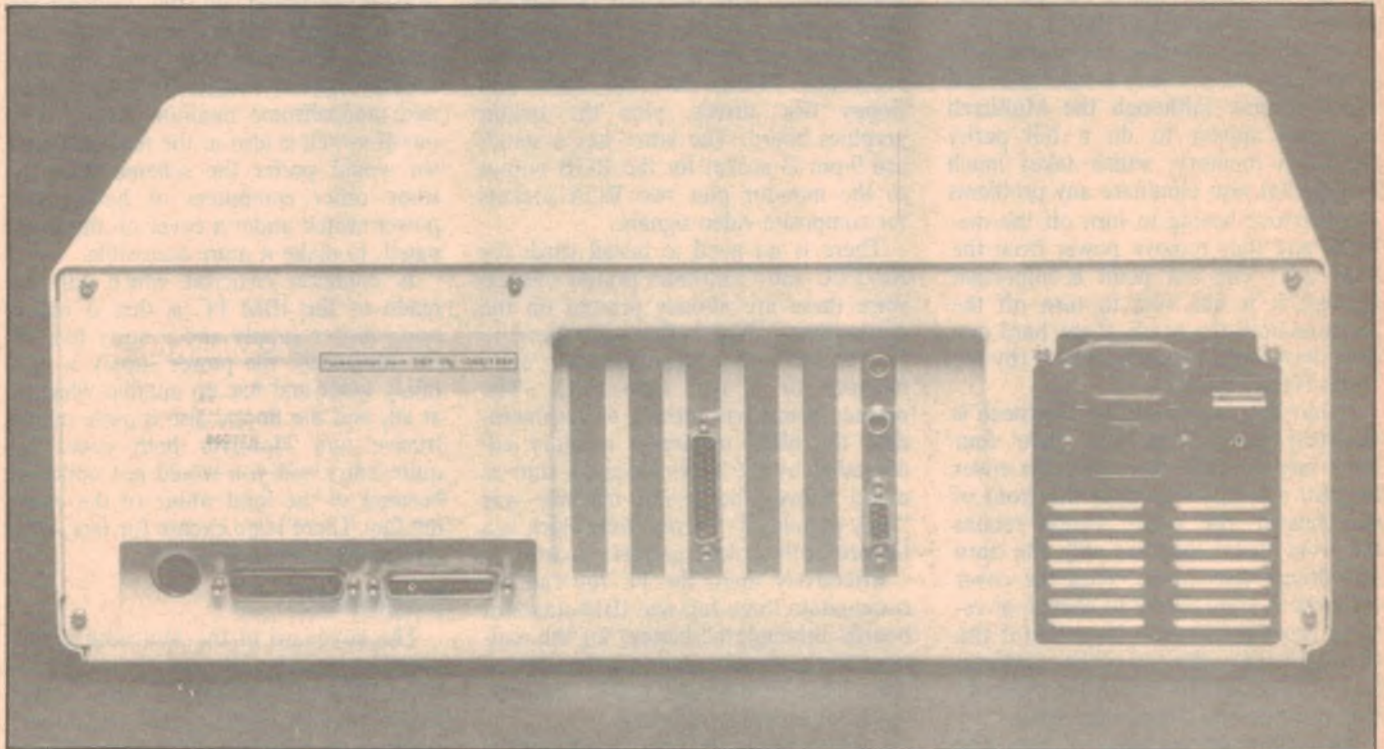

The processor of the PC-700 has provision for six slots of which two to three are already occupied.

New Products...

Product reviews, releases & services



Intelligent workstation has autodial modem

A new low-cost desktop workstation which combines an easy-to-use word processor with an intelligent data communications terminal has been released by Microbee Systems.

Designed and manufactured in Australia, the new Microbee TeleTerm is a compact package which performs most of the information processing and communications functions required in the modern office — at a much lower price than previously possible. In addition to the word processor and data terminal functions, the TeleTerm also features "Offsider" — a set of pop-up desk utilities including a phone number index, a clock/calendar and an electronic notepad.

Physically, the TeleTerm is a compact keyboard unit incorporating an inbuilt data communications modem and push-button telephone. Its keyboard provides 92 keys, including 12 programmable function keys and a numeric keypad. All that is needed apart from the TeleTerm itself is an external video monitor and optional printer.

All basic functions of the TeleTerm are controlled by internal software resident in ROM chips. This means that these functions are instantly available at any time, with the touch of a key — there are no fiddly disk programs to load.

As a word processor the TeleTerm is particularly easy to use, thanks to its inbuilt TeleWord program. Newly written by Microbee's software engineers, TeleWord features pull-down menus for full user guidance at every step.

Total file storage capacity is 30,000 characters, or approximately 15 typical A4 pages. This may be used for preparation and storage of a single long document, or a number of smaller letters and memos.

In data terminal mode the TeleTerm has two different options: Telecom for conventional ASCII communications, or Videotex for text-and-graphics communications. Each is available at the touch of a key, and both offer automatic dialling and log-on facilities for remote database accessing and electronic mail services. This makes it possi-

UHF Omnidirectional antenna for 1500MHz band

With a gain of 8dBi, the Model RA506 omnidirectional antenna from Kensor Pty Ltd is designed for use as a control station antenna. It is enclosed in a rugged black ABS radome with an overall height of one metre and a weight of 2.8kg.

Also available from Kensor is a new Repeater Control Unit (model IRC200) which converts any suitable transmitter-receiver combination into an automatic repeater.

Model IRC200 is a compact wall or desk mounting assembly, operating from a 12 volt DC supply, with very low current drain. Under normal circumstances, the control unit can be connected to the internal DC rail of the receiver.

The unit senses receiver squelch operation, operates the associated transmitter, and transfers audio from the receiver to the transmitter input.

Additional facilities may be added, including Morse identification, which can be programmed for up to five digits, letters or numerals.

For further details contact Kensor Pty Ltd, 13/147 High St, Preston, Vic. 3072. Telephone (03) 470 2664.

ble to dial up and log into services such as Viatel or TeleMemo very simply indeed, using a few keystrokes.

Both the word processing and terminal functions of the TeleTerm operate in colour, and require only the use of an RGB colour monitor for colour to be displayed. However they are also designed to give acceptable results with a lower-cost monochrome monitor, for applications where colour is not necessary.

The automatic dialling facilities provided by the TeleTerm are made possible by its inbuilt autodialling data modem. This is of the direct-connect type for best performance and operates at either of two data communication rates: 300/300 bps or 1200/75 bps. The modem is also auto-answering, and is fully authorised by Telecom for connection to the Australian telephone network (authorisation number C86/39/1515).

For further information, contact Microbee Systems Ltd, Koala Crescent, West Gosford, 2250 Telephone (043) 24 2711.

Rightangle-mounting DIP switches

EECO Inc. has introduced a new version of its 3300 series Micro-Dip Switches for rightangle PCB mounting. The space required is 20% less than most DIP switch configurations, making it particularly suitable for use with closely stacked PCB assemblies.

The 3300 series allows selection of binary coded decimal or hexadecimal, true or complement codes. The code is selected by simply rotating a shaft.

For further information contact Technico Electronics, 11 Waltham St, Artarmon, NSW 2065. Telephone (02) 439 2200.

Wideband portable RF power meter

A.C.L. Special Instruments has released the JRC model NJL-70W microprocessor-based programmable portable power meter. It can measure relative power from -70dBm to $+20\text{dBm}$, in the bands between 10MHz and 26.5GHz. It is designed for automatic zeroing and calibration, compensation for loss and gain, and storage of setting data in a battery protected memory.

For more information contact A.C.L. Special Instruments, 27 Rosella St, East Doncaster, 3109. Telephone (03) 842 8822.

Absolute phase meter for professional audio systems

The SCV PC80 is an absolute phase measuring instrument for checking any electronic audio system including microphones, compression drivers, passive or electronically crossed over loudspeaker systems, power amplifiers, mixing console patch points and patch bays. It can make the phase measurement acoustically or electronically.

To this end, the PC80 generates a one Hertz wideband pulse and reads it with a built-in microphone. It also has an XLR output socket and a level control for measuring wired systems.

For further information contact AR Audio Engineering, Suite 402, 2nd Floor, 720 George St, Sydney, 2000. Telephone (02) 211 3026.

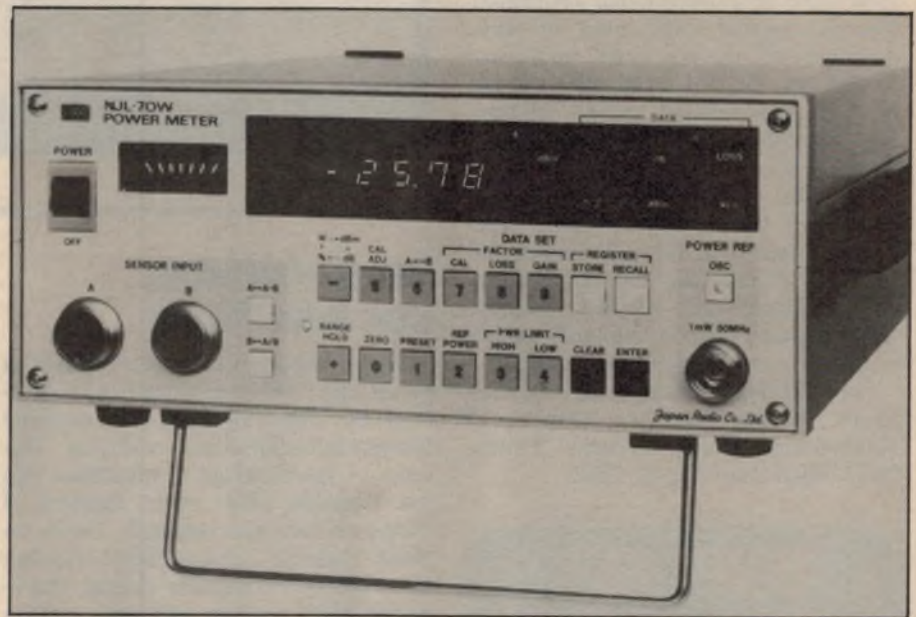

Hand-held digital thermometer

The INS pocket-sized digital thermometer is lightweight, compact and designed to meet virtually all industrial measuring requirements. Four styles of probes are available: immersion, air, penetration and surface. When combined with the various types of heads, a total of 13 different probe combinations is available, one for every requirement.

The thermometer has a wide temperature range and stringent quality control procedures are employed to ensure accuracy and reliability in the most demanding industrial conditions. It features all solid state design and is housed in a high strength injection moulded case, with the electronics protected from moisture and contamination. There is an easy to read LCD display and the thermometer uses one conventional 9V battery.

For further information contact Wattmaster Alco Pty Ltd, 11 Rachael Close, Silverwater, NSW 2141. Telephone (02) 648 3755.

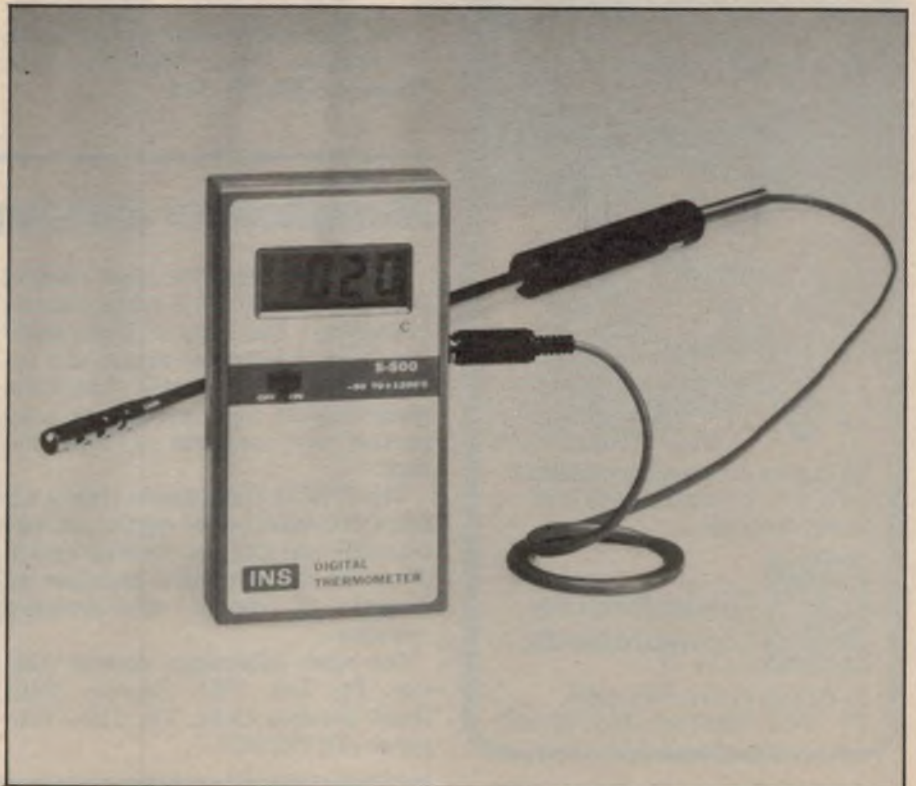

New Products...

Epson's new high-speed letter-quality printer

A 24 pin dot matrix printer is Epson's latest release in the field. Epson claim that the LQ-2500 is the fastest 24-pin printer available and has more standard features than competing machines.

In high speed draft mode, the LQ-2500 prints at a phenomenal 324 characters per second. And even in letter quality mode, the rate is still impressive at 108 cps. So that terminals need not be tied up needlessly during printing, the LQ-2500 has a buffer with a capacity of 8K.

The most unusual feature is a control panel and liquid crystal display. This gives a readout of the print mode and printer settings. Four different settings can be stored and recalled instantly. Other features include five letter-quality print fonts, and cut sheet paper loading.

For further information contact Epson Australia Pty Ltd, Unit 3, 17 Rodborough Road, Frenchs Forest, 2086. Telephone (02) 452 5222.

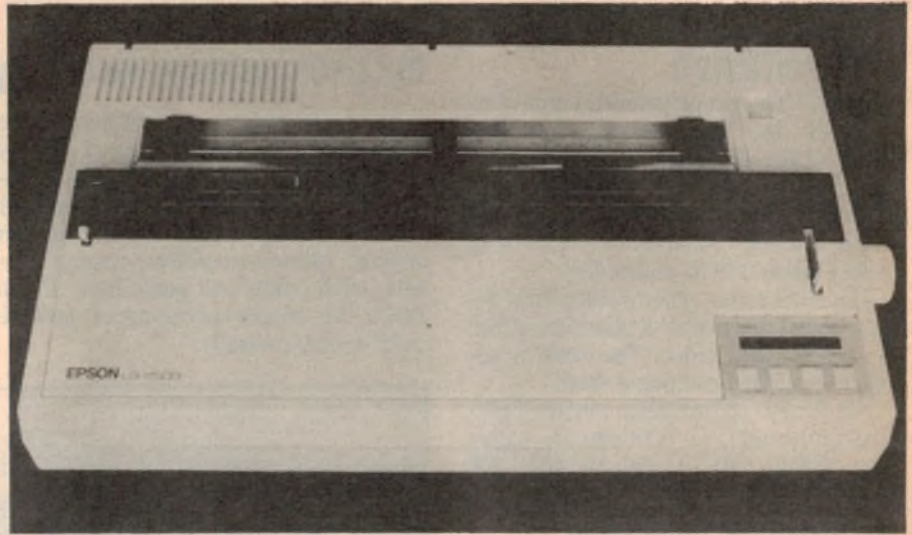

Pencil soldering iron from Scope

Scope Laboratories have released a pencil thin 30W iron which can be powered by either of their electronically temperature-controlled soldering stations. A special range of miniature tips are available while other features of Scope stations are retained. These include stepless temperature selection from 200 to 470 degrees Celsius, three-colour LED readout and zero voltage switching for "spike-free" operation.

For more information contact Scope, 3 Walton St, Airport West, Vic, 3042. Telephone (03) 338 1566.

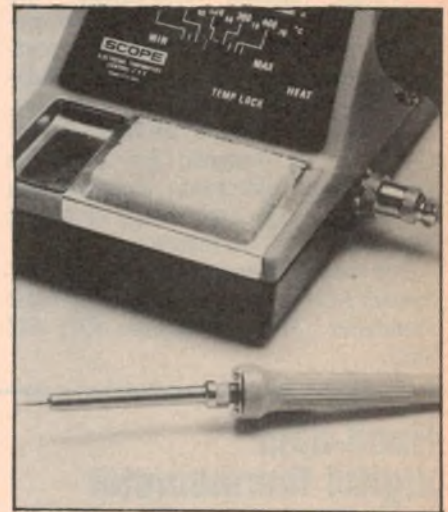

DON'T GET WOUND UP OVER YOUR WINDING PROBLEMS



We custom design and manufacture in volume, transformers and coils for any application.



Selectronic Components
PTY. LTD.

25 Holloway Drive, Bayswater, Vic., 3153. Telephone: (03) 762 4822.

Microprocessor watchdog

Dallas Semiconductor have released what they describe as a microprocessor "watchdog". This is an IC which monitors the most important aspects of a microprocessor based system. Previously, many separate chips and discrete components were required to fulfill this need.

The DS1232 continuously checks the microprocessor's power supply, software execution and external override button. These are the three most important indicators of correct microprocessor operation.

For more information contact Alfa-tron Pty Ltd, 1761 Ferntree Gully Road, Ferntree Gully, Vic. 3156. Telephone (03) 758 9421.

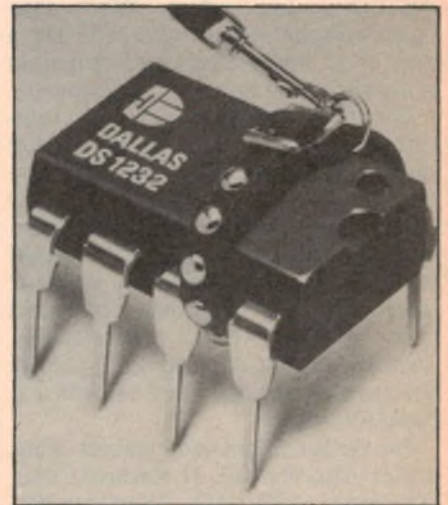

New Products...

New PC-compatible from Amstrad

Amstrad is set to shake the IBM-compatible market with a sleek new PC offering a host of inclusive extras for less than the cost of similar models.

The new computer, the Airo, is Amstrad's first IBM compatible model. Standard features include 512K of internal RAM, dual 360k floppy disc drives, a keyboard, a high resolution grey or colour monitor, a two-button mouse, and an impressive range of software. In addition, the Airo offers a number of Amstrad enhancements, such as multi-tasking and multi-media flexibility as well as a number of hardware features which are extras on other PCs.

The Airo is supplied with two comprehensive User Manuals. Book One covers getting started, GEM MS DOS, the utilities and DOS PLUS. Book Two



is a tutorial and reference manual for BASIC 2.

The Airo will be available from specialist computer outlets in all states and will be distributed and serviced by Mit-

subishi Electric AWA. For further information contact Mitsubishi Electric AWA Pty Ltd, 348 Victoria Rd, Rydalmere, NSW 2116. Telephone (02) 638 8444.

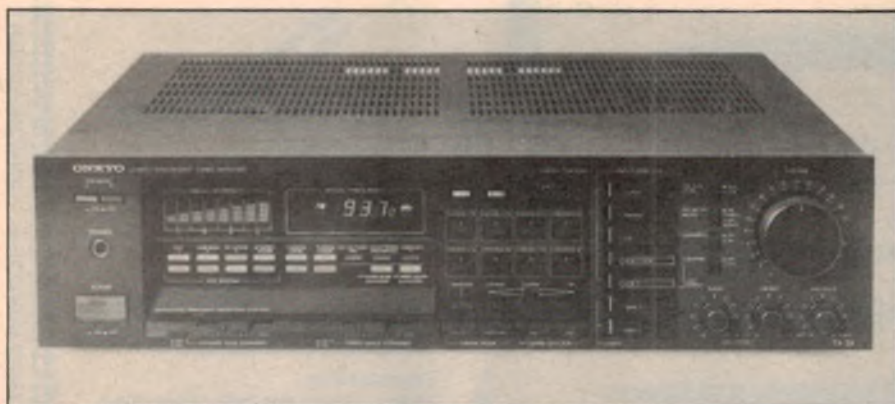

New receiver from Onkyo

Onkyo Corporation of Japan has announced a new addition to its range of receivers.

Rated at 55 watts per channel, the TX-38 is equipped with seven program inputs — tuner, phono, CD player, two tape inputs and two video inputs — making video and audio dubbing simple with no extra connections or rewiring.

In addition, the TX-38 boasts two new Onkyo design features:

(1). A Dynamic Bass Expander which expands low range response in varying degrees, depending on the level of the input signal. This is said to give increased definition without the midbass and midrange colouration associated

with conventional bass boost circuits; and

(2). A Stereo Image Expander which creates a sensation of broadening the listening room. The ambience on sound tracks on video sources is said to benefit considerably from this feature.

The TX-38 also features Onkyo's "Automatic Precision Reception System". This system optimises the FM signal by automatically selecting the best reception mode (stereo or mono). The selection chosen is indicated on the front panel.

Recommended retail price of the new TX-38 receiver is \$999. For further information contact Hi-phon Distributors Pty Ltd, Unit 7, 56 Victoria Street, North Sydney, NSW 2060. Telephone (02) 923 2011

Voltage suppressors for computer modems

General Semiconductor's new Transorb based MP-11 and MP-45 devices are specifically designed to protect computer modems and other telecommunications equipment from damage caused by overvoltage transients. These two-stage hybrid protectors are designed with a short circuit failure mode to give maximum protection, while internal fuses to guard against AC line cross-over.

The MP-11 is used with RJ11 (6-position) modular jacks, while the MP-45 is used with RJ45 (8-position) jacks. Both protect the modem's voltage sensitive microprocessor against transients caused by induced lightning, inductive switching and electrostatic discharge. Both offer a maximum clamping voltage of just 330V at 500A (8 x 20us pulse), or 350V at 2000A (8 x 20us pulse). The theoretical protection time is less than 10 nanoseconds.

These cost-effective, reliable devices are extremely easy to install — you simply plug the male connector into the telephone company's jack, the modem into the protector jack, and connect the ground wire.

For further information contact Electronics and Semiconductor Distributors Pty Ltd, PO Box 144 Tullamarine, Vic. 3043. Telephone (03) 338 8033.

RITRONICS WHOLESALE Pty. Ltd.

56 Renver Road, CLAYTON, 3168, VICTORIA, AUSTRALIA. Phone (03) 543 2166 (4 lines). Telex AA151938

N.S.W. DISTRIBUTOR: Bill Edge Electronics Pty. Ltd. 76 Porters Rd, KENTHURST 2156. Phone (02) 654 2046

Minimum account order is \$50, minimum cash sale is \$25. Minimum post/pack \$3.00 Minimum account post/pack \$5.00. Comet Road Freight, bulky items and/or over 10kg is extra. Bank Card, Visa and Master Card Welcome!

Errors & Omissions Excepted



SAMSUNG TTL MONITORS

Cat No	Desc	1-3	4-
X14500	Green	\$130	\$125
X14502	Amber	\$135	\$130

Plus 20% tax where applicable



TRANSFORMERS

Cat.No. & Desc.	1-99	100 - 1000+
M12851 2851	3.00	2.75 2.50
240V 12-0V CT 150mA		
M12155 2155	5.50	4.95 4.50
240V 6-15V 1A tapped		
M12156 2156	8.50	8.25 7.90
240V 6-15V 2A tapped		
M12840 2840	3.20	3.00 2.70
240V to 9V C.T. at 150mA		
M12860 2860	3.50	3.00 2.80
240V to 15V C.T. at 250mA		
M16672 6672	8.50	7.95 7.70
240V 15-30V 1A tapped		

Plus 20% tax where applicable



FANS

Cat.No. Description	1-9	10+	100+
T12461 240V 4 1/2"	10.50	10.00 8.00	
T12465 240V 3 1/2"	10.50	10.00 9.00	
T12483 115V 4 1/2"	10.50	10.00 8.00	
T12487 115V 3 1/2"	10.50	10.00 8.00	

(Fan guards to suit also available)
Plus 20% tax where applicable



500K DISK DRIVE FOR IBM*

1-9	10-	100-
\$145	\$135	\$125

12 months warranty!
Plus 20% tax where applicable
(*IBM is a registered trademark)



12V SEALED LEAD ACID BATTERIES

Description/Cat.No.	1-9	10-
1.2 AH S15029	\$12.50	\$11.75
2.6 AH S15031	\$17.70	\$16.50
4.5 AH S15033	\$23.40	\$22.00

Plus 20% tax where applicable

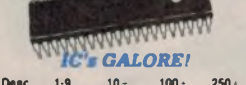

IC'S GALORE!

Desc	1-9	10-	100-	250+
8035	3.80	3.70	3.50	3.00
8085	4.00	3.90	3.50	3.00
8088	15.00	14.00	12.00	11.00
8155	3.80	3.75	3.50	3.00
8156	3.50	3.30	2.90	2.50
8212	1.90	1.70	1.50	1.00
8224	2.40	2.00	1.90	1.50
8228	1.90	1.70	1.50	1.00
8237A	35.00	31.00		
8253	3.90	3.70	3.50	3.00
8255	4.00	3.50	2.90	2.00
8257	3.90	3.50	3.00	2.50
8259	3.90	3.50	3.00	2.70
8237A	35.00	31.00		
8279	3.90	3.50	3.30	2.70

Plus 20% tax where applicable

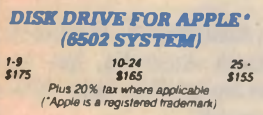

DISK DRIVE FOR APPLE* (6502 SYSTEM)

1-9	10-24	25-
\$175	\$165	\$155

Plus 20% tax where applicable
(*Apple is a registered trademark)

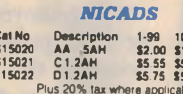

NICADS

Cat No	Description	1-99	100 - 1000+	250+
S15020	AA 5AH	\$2.00	\$1.90	\$1.70
S15021	C1 2AH	\$5.55	\$5.45	\$5.15
S15022	D1 2AH	\$5.75	\$5.50	\$5.25

Plus 20% tax where applicable

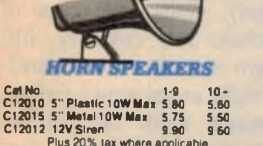

HORN SPEAKERS

Cat No	Description	1-9	10-
C12010	5" Plastic 10W Max	5.80	5.80
C12015	5" Metal 10W Max	5.75	5.50
C12012	12V 5W	9.90	9.60

Plus 20% tax where applicable



TANTALUM CAPACITORS

Cat No	Description	10 -	100 -
R18124	4.7uF 16V	\$0.24	\$0.18
R16125	10uF 16V	\$0.25	\$0.23
R18126	15uF 16V	\$0.38	\$0.36
R18128	22uF 16V	\$0.42	\$0.40
R18132	47uF 16V	\$1.15	\$1.20
R18134	68uF 16V	\$1.80	\$1.50
R16220	4.7uF 16V	\$0.35	\$0.33
R16224	10uF 16V	\$0.38	\$0.37
R16228	22uF 16V	\$1.20	\$1.00
R16300	0.1uF 35V	\$0.13	\$0.12
R16302	0.15uF 35V	\$0.13	\$0.12
R16304	0.22uF 35V	\$0.15	\$0.12
R18306	0.33uF 35V	\$0.15	\$0.14
R16308	0.47uF 35V	\$0.15	\$0.14
R16310	0.68uF 35V	\$0.16	\$0.15
R16311	0.82uF 35V	\$0.18	\$0.15
R16312	1uF 35V	\$0.15	\$0.12
R16314	1.5uF 35V	\$0.24	\$0.20
R16318	2.2uF 35V	\$0.24	\$0.23
R16318	3.3uF 35V	\$0.26	\$0.27
R16320	4.7uF 35V	\$0.35	\$0.33

30% Sales tax where applicable

FREE 58 PAGE WHOLESALE PRICE LIST!
Simply supply a Business Card!

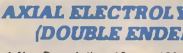

AXIAL ELECTROLYTICS (DOUBLE ENDED)

Cat No	Description	10 -	100 -	1000 -
R15705	0.47uF 63V	\$0.12	\$0.10	\$0.09
R15715	1uF 63V	\$0.12	\$0.10	\$0.09
R15725	2.2uF 63V	\$0.12	\$0.10	\$0.09
R15742	4.7uF 25V	\$0.11	\$0.09	\$0.08
R15794	22uF 25V	\$0.17	\$0.15	\$0.13
R15781	10uF 16V	\$0.12	\$0.10	\$0.09
R15782	10uF 25V	\$0.13	\$0.12	\$0.11
R15785	10uF 63V	\$0.15	\$0.14	\$0.13
R15782	22uF 25V	\$0.13	\$0.12	\$0.11
R15812	25uF 25V	\$0.13	\$0.12	\$0.11
R15815	25uF 63V	\$0.17	\$0.15	\$0.13
R15831	47uF 16V	\$0.16	\$0.13	\$0.12
R15832	47uF 25V	\$0.16	\$0.13	\$0.12
R15835	47uF 63V	\$0.21	\$0.18	\$0.17
R15841	100uF 16V	\$0.18	\$0.16	\$0.15
R15842	100uF 25V	\$0.18	\$0.16	\$0.15
R15845	100uF 63V	\$0.27	\$0.24	\$0.22
R15851	220uF 16V	\$0.27	\$0.15	\$0.14
R15852	220uF 25V	\$0.21	\$0.18	\$0.17
R15855	220uF 63V	\$0.50	\$0.48	\$0.46
R15871	470uF 16V	\$0.27	\$0.24	\$0.22
R15872	470uF 25V	\$0.29	\$0.27	\$0.25
R15873	470uF 35V	\$0.75	\$0.70	\$0.60
R15875	470uF 63V	\$0.75	\$0.70	\$0.65
R15885	1000uF 63V	\$0.60	\$0.58	\$0.55
R15891	1000uF 16V	\$0.39	\$0.35	\$0.30
R15892	1000uF 25V	\$0.45	\$0.40	\$0.38
R15893	1000uF 35V	\$0.70	\$0.65	\$0.55
R15894	1000uF 50V	\$0.80	\$0.70	\$0.60
R15903	2200uF 35V	\$1.20	\$1.10	\$0.90
R15904	2500uF 50V	\$1.30	\$1.20	\$1.00
R15911	2500uF 16V	\$0.59	\$0.50	\$0.40
R15912	2500uF 25V	\$0.95	\$0.90	\$0.80
R15913	2500uF 35V	\$1.10	\$1.00	\$0.90
R15914	2500uF 50V	\$1.70	\$1.20	\$1.00
R15932	4700uF 25V	\$1.90	\$1.80	\$1.60
R15933	4700uF 35V	\$2.40	\$2.15	\$1.90

Plus 30% tax where applicable



TELEPHONE CABLE (200 METRE ROLLS)

Cat No	Description	1-9	10-
W11302	2 Pair	\$30.00	\$27.00
W11303	3 Pair	\$39.00	\$37.00
W11310	10 Pair	\$120.00	\$115.00

Per 200m Roll
Plus 20% Sales tax where applicable



PANEL METERS

Cat No	Description	1-9	10 -	100 -
Q10500	MU45-D-1mA	7.50	6.95	6.75
Q10502	MU45-S-50uA	7.50	6.95	6.75
Q10504	MU45-D-100uA	7.50	6.95	6.75
Q10505	MU45-D-50uA	7.50	6.95	6.75
Q10510	MU45-S-1A	7.50	6.95	6.75
Q10520	MU45-D-20V	7.50	6.95	6.75
Q10535	MU45-VU	8.50	7.75	7.50
Q10530	MU52E-0-1mA	9.95	8.35	
Q10533	MU52E-0-5mA	9.95	8.35	
Q10538	MU85-0-50uA	11.50	9.35	8.95
Q10540	MU85-0-1mA	11.50	9.35	8.95
Q10550	MU85-0-100uA	11.50	10.35	9.95
Q10560	MU85-0-20V	11.50	10.35	9.95

Plus 20% tax where applicable

MEMORY PRICES!
"Check for the latest memory prices!"

27512	10-99	100 -	1000 -	10K
4164-15P	\$24.00	\$22.00	\$22.00	\$22.00
41256	\$ 2.00	\$ 1.70	\$ 1.65	\$ 1.60
6116P-3	\$ 4.00	\$ 3.50	\$ 3.45	\$ 3.20
2716	\$ 3.00	\$ 2.90	\$ 2.20	\$ 2.00
27128	\$ 7.50	\$ 7.00	\$ 6.50	\$ 6.00
2532	\$ 7.00	\$ 6.50	\$ 6.00	\$ 5.50
2732	\$ 8.50	\$ 8.00	\$ 7.50	\$ 7.00
27256	\$ 7.50	\$ 6.50	\$ 6.00	\$ 5.50
6264	\$ 9.00	\$ 8.00	\$ 7.00	\$ 6.50
2764	\$ 5.50	\$ 5.00	\$ 4.50	\$ 4.00

Plus 20% tax where applicable



CRYSTALS

Cat No	Frequency	Can	10 -	100 -
Y11000	1MHz	HC33	4.75	4.00
Y11005	2MHz	HC33	1.95	1.70
Y11008	2.4576MHz	HC18	1.95	
Y11015	3.57954MHz	HC18	1.20	.95
Y11020	4.00MHz	HC18	1.20	.95
Y11022	4.194304MHz	HC18	1.20	.95
Y11025	4.75MHz	HC18	1.20	.95
Y11026	4.9152MHz	HC18	1.20	.95
Y11042	6.144MHz	HC18	1.20	.95
Y11050	8.00MHz	HC18	1.20	.95
Y11055	8.96738MHz	HC18	1.20	.95
Y11070	12.00MHz	HC18	1.20	.95
Y11072	14.318MHz	HC18	1.20	.95
Y11080	16.00MHz	HC18	1.20	.95
Y11085	18.432MHz	HC18	1.20	.95
Y11090	20.00MHz	HC18	1.20	.95

Full range of crystals available on indent.
Plus 20% tax where applicable



MICRODOT 5 1/4" FLOPPY DISKS

Have a look at these prices!
These are 100% certified, prime spec disks in labelled jackets (not like our oppositions)

Description	1-9	10 -	100 -	100+
S/S/D/D C12440	\$14.50	\$13.90	\$13.00	\$13.00
D/S/D/D C12445	\$16.50	\$14.90	\$13.50	

Plus 20% tax where applicable

Attention Schools, Government Depts etc
FREE sample disk available on request!
(Please send \$2 to cover postage)



POLYESTER 100V "GREENCAP" TYPE

Cat No	Description	1-99	100 -	1000 -
R15131	001uF	0.06	0.04	0.03
R15137	0012uF	0.06	0.04	0.03
R1				

New Products...



Sawtron KG105 VHF transceiver

Imark Pty Ltd has released the Sawtron KG105 VHF transceiver for use on the 68-88MHz commercial radio band.

The Sawtron KG105 is a VHF FM mobile transceiver with up to 16 frequency synthesised channels and 10-20W adjustable RF power output. It operates in the 68-88MHz band.

The Sawtron KG105 is compact and will fit in the smallest DIN size radio aperture vehicle dashes. Furthermore, it has the ability to be remote mounted in vehicles.

State of the art synthesized circuitry includes an EPROM for frequency control and a phase lock loop (PLL). A double balanced local oscillator mixer, two monolithic crystal filters and a multipole ceramic filter ensure excellent receiver sensitivity, selectivity and blocking.



New video recorders from JVC

Hagemeyer (Australasia), marketers of JVC products in Australia, has announced the release of five new video recorders in Australia.

Included in the lineup is the new HR-D470E which is a midi-sized recorder with 90-degree loading (ie, the tape is inserted sideways). Other features of the machine include HQ circuitry, hifi stereo sound, two speed audio recording, a one year/eight event timer (which can be programmed from the remote control or from the deck itself), and music scan of up to nine selections.

The four remaining models all feature contentional front loading systems. They include the budget-priced HR-D170EA with HQ picture improvement



Upgraded power supply for IBM PCs

Does your IBM PC need a bit of a power boost? Are Taiwanese clones kicking sand in its face? Seriously, there are many IBM users finding that the 63 watt power supplies in their PCs just can't cope with all the extras they want to bolt on. Memory cards, multifunction cards, hard disks etc all consume power.

The answer until now has been an expensive power supply upgrade — often running into several hundred dollars.

Not any more! Electronic Solutions of

The Power Amplifier is a broadband amplifier and includes circuits to automatically reduce the power level to protect the PA transistors from damage which could result from extreme temperatures or excessive VSWR's.

The control head can be remotely mounted if necessary and includes controls for Channel Selection, Volume, Squelch and optional Selecall Tone Selection (last two digits only). LEDs are included for channel display and flash if a non-programmed channel is selected.

A comprehensive range of accessories is available including 5-tone Selecall with Automatic Answer Back, Automatic Identification, Data Transmission, single and multiple tone CTCSS squelch system, DTMF and Dual Tone signalling and an adjustable Time Out Timer.

Further details are available from Imark Pty Ltd, 167 Roden Street, West Melbourne, Vic. 3003. Telephone (03) 329 5433.

circuitry, a 14-day 4-event timer, and remote control; the up-market HR-D180EA and HR-D370EA models; and the top-of-the-line HR-D755EA.

The latter comes with a comprehensive remote control unit which features a built-in LCD panel. There are clock and alarm functions, an on-screen timer and mode check, and the user can program up to eight events one year in advance. Other features of the machine include HQ technology, two speed audio and video recording, nine automatic functions, variable speed search, audio dubbing, insert editing and a perfect field still.

For further information contact Hagemeyer (Australasia) BV, 5-7 Garema Circuit, Kingsgrove, NSW 2208. Telephone (02) 750 3777.

Lane Cove is now offering a low-cost (\$136) upgraded supply that is a direct replacement for the IBM unit. Fitting it is well near idiot proof. The supply comes complete with connectors for the mother board, two floppy drives and two winchester drives, and pumps out a sturdy 150W — more than man enough to drive any number for extras.

As a bonus, it incorporates a very quiet fan — a boon for IBM owners tired of the drone of their PC's fan.

For further information contact Electronic Solutions, PO Box 426, Gladesville, NSW 2111. Telephone (02) 427 4422.

In-circuit emulator

Recently released by Microtek International, the MICE II 80515/80535 micro-in-circuit-emulator consists of a Control and Emulation Processor (CEP) and Realtime Trace (RTT) module. High performance Emulation Memory (HUEM) is also required for the 80535 which covers the entire internal and external memory range of 128K bytes.

Features include: realtime emulation up to 12MHz with zero wait state; up to

six hardware breakpoints; realtime trace up to 2048 frame "snap shot" trace buffer, and 2, 4, 8 or 16K bytes of on-board internal program emulation memory.

The MICE II 80515/80535 provides complete debug and emulation support for the Siemens SAB80515/80535 micro controllers.

For further information contact Macro Dynamics, 80 Lewis Road, Wantirna South, Vic. 3182. Telephone (02) 220 7260.

THEY DON'T JUST LOOK TOUGH,
THEY'LL BE TOUGH
FOR YEARS AND YEARS.

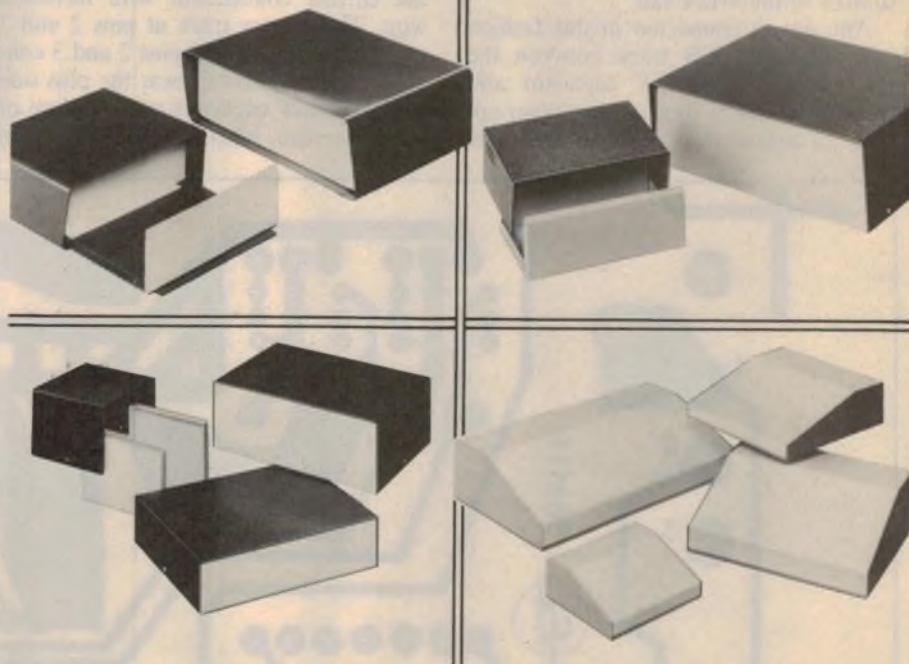

For that total professional look, put your components into one of BETACOM's smart strong Instrument Case Enclosures.

Made of strong powder coated aluminium with the unique flat fold lip for strength, these enclosures will look good for years.

Easy to assemble in a variety of sizes, supplied with all the hardware and shrink wrapped for protection.

IC1, a 4 piece box available in 3 sizes with its cover screwed from the bottom. IC2, a 2 piece box available

in 4 sizes with the cover screwed from the ventilated sides. IC3, a 2 piece box available in 4 sizes with the cover screwed from the sides. IC5 is a 2 piece slopping front box with the cover screwed from the bottom.

All come in bright distinctive colours for that totally professional look for all your projects. Call us today for more information. BETACOM has the enclosure to solve your needs.

BETACOM

TSA

TEMPLE-SMITH AUSTRALIA PTY. LTD.

2-12 Harp Street, Campsie. PO Box 196, NSW 2194
Telephone (02) 78 3436 Fax (02) 787 2529

VICTORIA: Temple-Smith Australia Pty. Ltd. 12 Rosella St., Frankston. Victoria. Telephone (03) 781 1013. Fax: (03) 783 9151
SOUTH AUSTRALIA: Graphic Electronic Industries Pty. Ltd. 168 Payneham Rd. Telephone (06) 363 0277
WESTERN AUSTRALIA: J.G. Thomas & Associates 5 Durnham Rd., Bayswater 6053. Telephone (09) 272 7122
QUEENSLAND: Conwell Trading Company Pty. Ltd. 52 Doggett St., Fortitude Valley 4006. Telephone (07) 52 7850



Information centre

Addendum to Fence Master

The Fence Master project described in October 1986 contains an error in the PCB pattern. The circuit shows the centre tap of transformer T1 connected to the positive supply and the source electrodes of Q2 and Q1 connected to ground, which is correct. However, the PCB pattern connects the centre tap of T1 to ground and the Q1 and Q2 sources to the +12V rail.

Any circuit connected in this fashion will blow the PCB track between the plus side of the 4700 μ F capacitor and the V+ terminal. Readers have two options to correct the problem. First, you

can use the revised PCB which will be available from the usual parts suppliers or, second, you can modify the original PCB.

Readers with the corrected PCB artwork should follow the accompanying overlay diagram for the placement of components on the PCB. Note the extra link required located nearby the 4700 μ F capacitor.

Altering the original PCB pattern involves cutting two tracks and making the correct connections with insulated wire. The copper track at pins 2 and 3 of T1 must be cut and pins 2 and 3 connected to the plus rail near the plus side of the 4700 μ F capacitor using a piece of insulated wire. Next, the track between

the 4700 μ F capacitor and Source of Q1 must be cut and a wire connected between the Sources of Q1 and Q2 to the ground near the negative terminal of the 4700 μ F capacitor.

The diagram shows how to modify the PCB. Use a sharp knife to cut the tracks in the position indicated by the crosses and make a cut at least a 2mm wide. Now connect each of the wires between those points indicated.

Notes & Errata

FENCE MASTER (October 1986, File 3/MS/123). There is a bad error in the PCB pattern. While the circuit shows the centre tap of T1 connected to the positive supply and the Source elec-

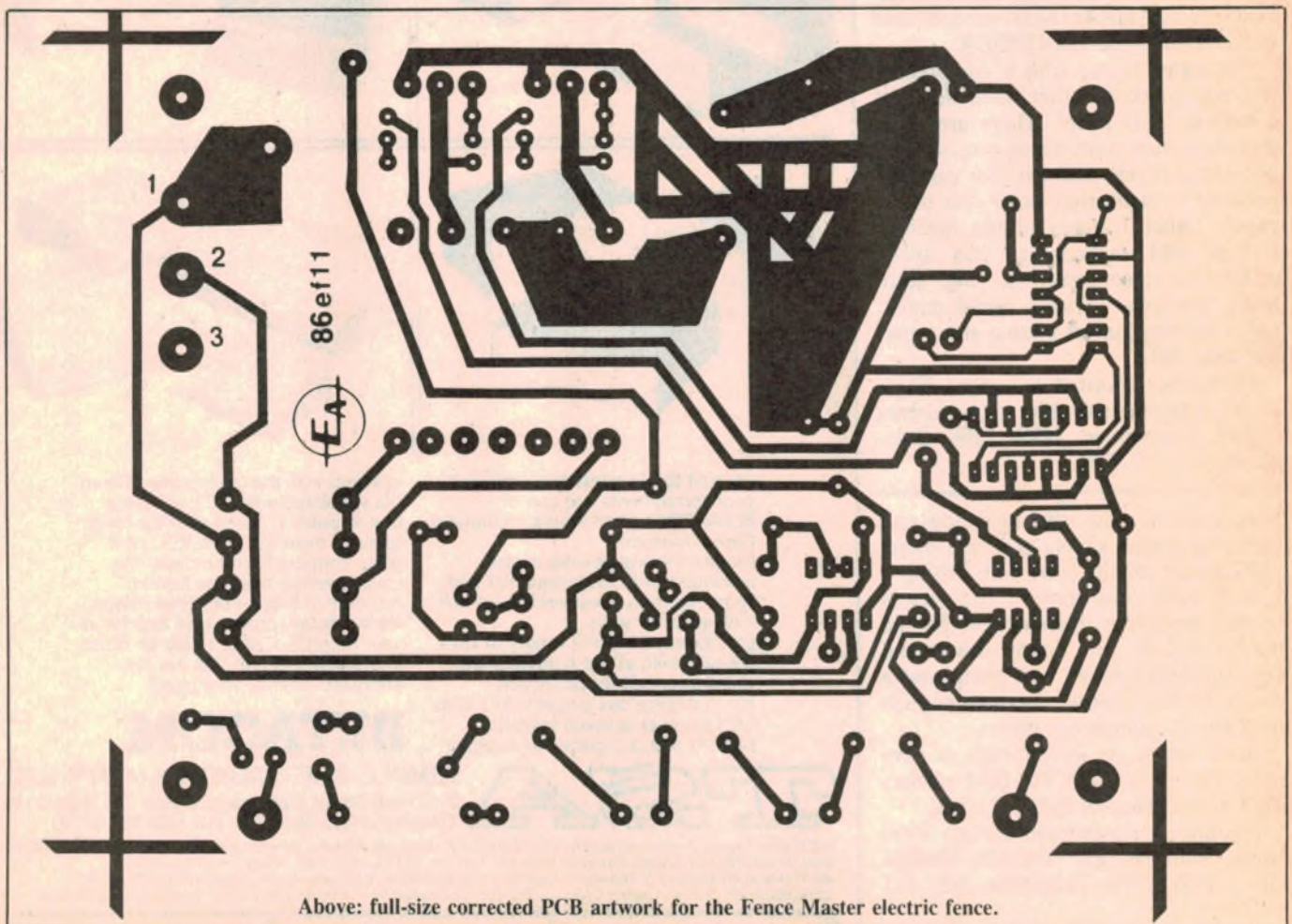

Above: full-size corrected PCB artwork for the Fence Master electric fence.

trodes of Q2 and Q1 connected to ground, the PCB actually connects the centre tap to ground and the Sources to the positive rail.

To correct this, the copper track at pins 2 and 3 of T1 must be cut and pins 2 and 3 connected to the plus rail near

the plus side of the 4700 μ F capacitor using a piece of insulated wire. This done, cut the track between the 4700 μ F capacitor and Source of Q1. Finally, connect a wire between the Sources of Q1 and Q2 to Ground near the negative terminal of the 4700 μ F capacitor.

Stable components a must for AM stereo decoder

In the December 1986 EA Information Centre, the AM stereo decoder has been criticised for stability. I wish I could let things lie, but no, I must again pick up my pen to write.

I did write to you several months ago about my early experience with the EA decoder, built into a rather complex valve tuner concocted especially to work into it. This was depicted photo and all in "Letters to the Editor" some six months ago. The system was stable, worked well and still does. This decoder was from a kit. So far so good.

Thus enthused I constructed from scratch another set, somewhat simplified — the first one was a bit of an overkill, but this time the machine was a complete AM stereo 5 watts per channel valve radio. Some problems arose. It dropped out of lock from time to time and sometimes sounded a bit odd as it tried to drop out. That was odd as the tuning system was a stabilised system that worked well on the first unit.

Maybe, just maybe, it was the decoder. Some work with a frequency counter and a CRO — and yes it was the decoder, not the tuner. This time I had built the unit from selected parts from the various bits boxes. Individual testing of components pointed to thermal stability of some of the capacitors in the x8 oscillator circuit, and in one or two other places. I replaced all these with mica or NPOs and the unit is now fully stable.

A word on adjusting the coil though: it does have temperature drift, causing an increase in inductance. The solution — adjust it at switch-on for centring of the coil slug. After running it for an hour, find the new centre lock position of the slug and readjust the slug at some point between the two centre points such that the lock range always includes that point.

Well, to continue the saga. Thus further enthused I thought, why not re-vamp the old 2 x 20W stereogram taken out of service some years ago and relegated to the workshop (valve also)?

Fair enough — another selected bits version was started. Now, I thought, why not have a look at a commercial unit (Tandy) to see how they did it. Fascination — they used a 3.6MHz crystal as the IC oscillator and set the IF filters to 3.6/8 = 450kHz. OK well, me too, I thought. 3.58MHz crystals are ten a penny (figuratively). Why not?

I set up a stabilised oscillator system

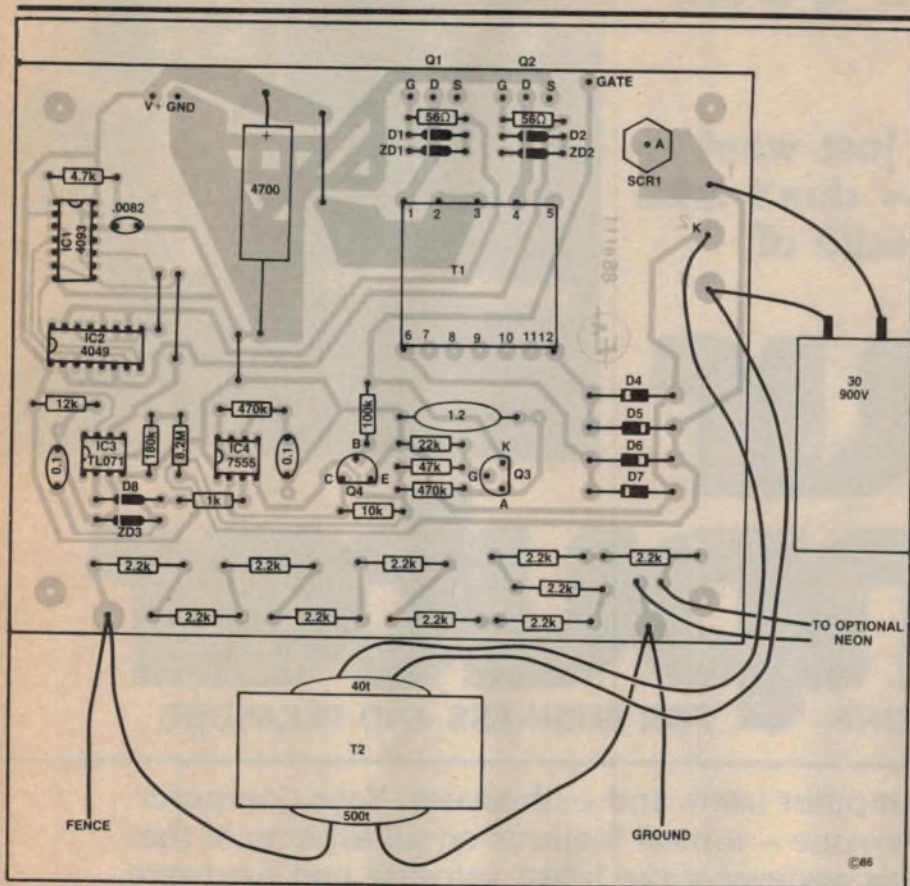

Above: this new wiring diagram shows the parts layout on the corrected PCB pattern. Note the extra link near the 4700 μ F capacitor.

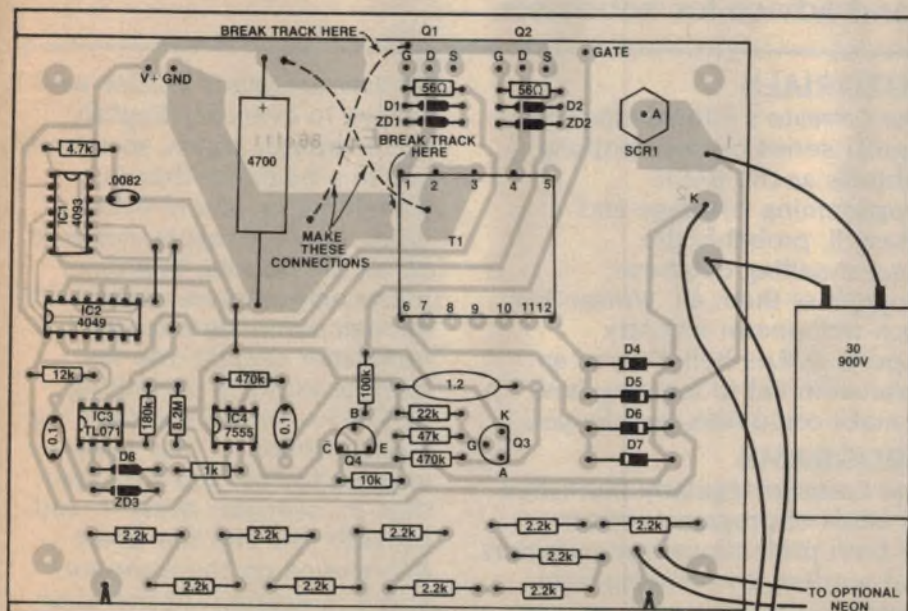

If you have the original PCB, it can easily be modified by cutting the copper tracks adjacent to Q1 and T1 and installing two insulated wire links (shown dotted).

Do computers play any part in your life?

If they do — or if you just want to find out about them — don't miss each month's issue of

your computer

MAGAZINE FOR BUSINESS AND PLEASURE

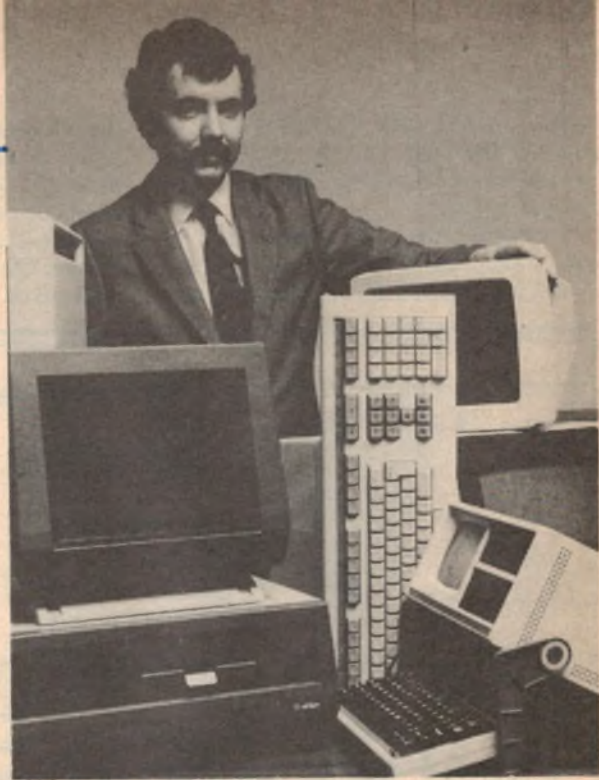

A magazine for all computer users and enthusiasts, *Your Computer* has something for everyone — topical features on all aspects of the computing world, expert reviews of the latest software and hardware, up-to-the-minute information for business people, and even games and advice for hobbyists.

NEWS

Your Computer brings you all that's interesting, innovative and inventive in the microcomputing world — news of products, plans and politics to keep you up-to-the-date with what's going on in this fast-moving industry.

REVIEWS

The latest machines and software from all the computer manufacturers are reviewed each month in *Your Computer*. Keep informed about what's available, and use our reviews to help you assess which products are right for you.

TUTORIALS

Your Computer's tutorials include regular series on such popular subjects as the BASIC programming language and dBase II, probably the biggest-selling database program of them all. Written by such well-known industry experts as Les Bell, they're an invaluable aid to learning how to make computers work for you.

PROGRAMS

Your Computer regularly publishes all kinds of programs written by both professional programmers and readers, and ranging from games to business uses, utilities to additions and alterations to well-known programs.

All *Your Computer's* articles are written in everyday English, not computer jargon, so even if you're a beginner there's something for you in every issue. And our regular columns on all the popular brands of microcomputers are packed with enough information to get any newcomer straight into the exciting world of computing. At \$2.95 — less if you take out a subscription — *Your Computer* is going to cost you a lot less than its overseas rivals — and provide you with the latest information on the computer scene in Australia at the same time. Look for it every month at your newsagent.

Information Centre . . . ctd

on ye old radiogram, plus a suitable impedance changer to load into the decoder, and reset the IFs to 447.5kHz (f/8). I used a voltage doubler on the heater supply to feed the decoder, wired it in and . . . amazingly, it didn't work.

Incredibly all the lock voltages were according to Hoyle or EA rather; the oscillator was roaring at 3.58MHz, but no way would it lock. Inching the tuner past the lock frequency had no effect. Nothing was going to get the stupid crystal to pull in.

Oh well, maybe it was a crystal with a mind of its own. I took it out, put in the coil as per EA, aligned it as above in this letter and it's never missed a beat since.

The final point in the saga. The statement in the EA article of October 1984 said something discreditable about old valve sets. Well, why not refute that and try an el cheapo version? I fussed around and found an Astor (I think) valve mantel radio. I took the inwards out from the detector to the speaker, fitted an upmarket valve power supply and added a cathode follower

Success with AM stereo decoder

I refer to the Information Centre in *Electronics Australia*, December 1986, regarding "add on AM stereo decoders". Having read about another unsuccessful conversion, I would like to relate my success with this decoder.

The tuner used for my conversion was not one the latest synthesised units but in fact a 60's AWA Cruiser Car Radio which has a reasonable audio bandwidth in comparison with tuners manufactured more recently.

Alignment of the VCO was achieved as follows:

- Tune to required stereo station;
- Adjust IF signal via a potentiometer until audio is distorted;
- Tune the slug in the VCO until a heterodyne whistle is heard, keep turning the slug until another heterodyne whistle is heard, then adjust slug so it is about midway between the two whistles;
- Readjust IF signal and the decoder locks into stereo;
- Repeat steps c & d if locking doesn't occur on the first attempt.

My experience revealed that it was necessary to overload the IF signal before adjusting the VCO, as the heterodyne whistles were inaudible at lower

before the decoder and an equalizer "toob" after it.

Once again, power for the decoder was derived from a voltage doubler on the heater supply. Result — a stable valve AM stereo tuner. It hasn't missed a beat either.

The moral of the stories is obvious. There is nothing wrong with your AM decoder design. There is a vital need to use stable components, especially capacitors. Spend a few bob on solid tantalums and mica or NPO capacitors and stable resistors and it is beyond criticism. (I wish I knew why that crystal wouldn't lock though, and Tandy's does. (B.B., Indooroopilly, Qld.)

• We love you for defending our decoder design and we've changed our opinion on converting valve radios to stereo reception. There's nothin' wrong with either of 'em.

The reason why you could not get the 3.58MHz crystal to work may be that it is really 3.579545MHz (the US colour TV intercarrier frequency) and so the intermediate frequency should be 447.443kHz, not 447.5kHz. N'est pas?

levels. Also it was important to minimize touching and moving the decoder whilst making these adjustments as the decoder would not lock if subjected to any type of movement when connected to this tuner.

Considering the cost of this tuner (\$2.00 at a flea market), the audio bandwidth and stereo separation are quite remarkable.

I have experimented using the above alignment process with other tuners, eg. cassette/radios, and other car radios with success on each occasion. However, the audio bandwidth was limited.

Hoping this information may be of assistance to your readers. (R.G., Tarragindi, Qld.)

• We're glad to know that you have succeeded with the AM stereo decoder. Isn't it an indictment of present day Japanese AM radio design when an antiquated Australian design of the sixties is shown to have better performance? And consider that AWA's car radios were not regarded as the top radio of the day — they were just good dependable performers, designed to cope with the electrically noisy environment of a car.

No wonder the present-day Australian-designed Eurovox radios are doing so well.

Hundreds of other items not listed — Send 40c postage stamp for list

L. E. CHAPMAN

122 PITT ROAD, NTH CURL CURL
MAIL ORDERS, BOX 156, DEE WHY NSW 2099
TELEPHONE 93-1848

<p>POWER TRANSFORMERS</p> <p>240V 225V 6.3V \$10 P.P. \$3 interstate \$4 20 240V 150V 6.3V \$7 P.P. \$3 interstate \$4 20</p>	<p>SPEAKER</p> <p>2 way crossover networks. Crossover Frequency 4KHz \$2 30W</p>																				
<p>SUPER SPECIAL FM STEREO KITS</p> <p>All three modules supplied are fully assembled and aligned. Circuit diagram supplied.</p> <p>ONLY \$22 P.P. \$1.90</p>																					
<p>BSR BELT SUPER SPECIAL DRIVE</p> <p>Record player 2 speed 33 and 45 RPM 11 inch turntable pickup arm counter balanced cuing facility Ceramic cartridge diamond stylus works off 240V 9V or 12V \$39 P.P. \$5.50</p>																					
<p>SPECIAL BALANCE METERS CENTRE ZERO</p> <p>\$2 PP \$1</p>																					
<p>SPECIAL DUAL VU METERS</p> <p>\$3 pp \$1</p>																					
<p>TOUCH MICRO SWITCHES 4 for \$1</p>	<p>TRANSISTORS AD 161-162 \$1 pair AD 149 \$2 pair</p>																				
<p>MICRO SWITCHES 5A 250 volt 50c.</p>	<p>VALVES EF86 \$5</p>																				
<p>IFs 455kHz For valve radios \$1 ea.</p>	<p>VALVE SOCKETS 7 pin 4 for \$1 9 pin 4 for \$1 OCTAL 4 for \$1</p>																				
<p>OSCILLATOR COILS 75c</p>	<p>5 MIXED ROTARY SWITCHES \$2.50</p>																				
<p>TAG STRIPS Mixed 10 for \$1</p>	<p>CHROME 1/4 PUSH ON KNOBS 10 for \$1</p>																				
<p>MIXED SWITCHES 12 for \$4.50</p>	<p>SLIDE POT KNOBS 10 for \$1</p>																				
<p>MIXED RESISTORS 100 for \$2 all handy values</p>	<p>MIXED CAPACITORS Fresh stock 100 for \$2</p>																				
<p>SHIELDED CABLE Single strand 25 metres for \$2.50</p>	<p>TV COLOUR CRYSTALS 4433 — 619kHz \$2</p>																				
<p>TOGGLE SWITCHES 4 for \$1</p>	<p>VALVES: 6 B05 \$5, 6 BMB \$5 6 BL8 \$4</p>																				
<p>TRANSISTOR EARPIECE PLUG & LEAD 4 for \$1</p>	<p>SPARK GAPS 10 for \$1</p>																				
<p>STICK RECTIFIERS TV 20 SC \$1 each</p>	<p>THERMISTERS 4 for \$1</p>																				
<p>CAR RADIO SUPPRESSORS 4 for \$1</p>	<p>SLIDE POTS</p> <table style="font-size: x-small; width: 100%;"> <tr> <td>1 1/2 Meg DUAL</td> <td>\$1</td> <td>5K single</td> <td>50c</td> </tr> <tr> <td>1 Meg dual</td> <td>\$1</td> <td>250K single</td> <td>50c</td> </tr> <tr> <td>2 Meg dual</td> <td>\$2</td> <td>10K single</td> <td>50c</td> </tr> <tr> <td>250K dual</td> <td>\$1</td> <td>2 Meg single</td> <td>50c</td> </tr> <tr> <td>1K dual</td> <td>\$1</td> <td>25K dual ganged</td> <td>\$1</td> </tr> </table>	1 1/2 Meg DUAL	\$1	5K single	50c	1 Meg dual	\$1	250K single	50c	2 Meg dual	\$2	10K single	50c	250K dual	\$1	2 Meg single	50c	1K dual	\$1	25K dual ganged	\$1
1 1/2 Meg DUAL	\$1	5K single	50c																		
1 Meg dual	\$1	250K single	50c																		
2 Meg dual	\$2	10K single	50c																		
250K dual	\$1	2 Meg single	50c																		
1K dual	\$1	25K dual ganged	\$1																		

postage stamp for list — Hundreds of other items not listed — Send 40c postage stamp for list

postage stamp for list — Hundreds of other items not listed — Send 40c postage stamp for list

EA marketplace EA marketplace

ADVERTISING RATES FOR THIS PAGE

SMALL ADS: The minimum acceptable size of 2 centimetres x one column costs only \$40. Other sizes up to a maximum of 10 centimetres are rated at \$20 a centimetre. CLASSIFIEDS: \$4 for 40 letters. Just count the letters divide by 40 and multiply by \$4, ROUND UP TO NEAREST WHOLE NUMBER. CLOSING DATE: Ads may be accepted up to the 18th of the month two months prior to issue date. PAYMENT: Please enclose payment with your advertisement. Address your letter to THE ADVERTISING MANAGER, ELECTRONICS AUSTRALIA, PO BOX 227, WATERLOO, NSW 2017.

FOR SALE

INTO RS232/DB-25 INTERFACING?

Save money and make your own mini-testers, break out boxes, 2 way gender benders, etc. Plated through boards \$5 each, 4 way gender bender boards \$16, 256K printer buffer short form kits from \$39, computer & printer switches \$12, serial board for buffer \$18. For more info. Send SAE to Don McKenzie, 29 Ellesmere Cres, Tullamarine 3043.

AMIDON FERROMAGNETIC CORES:

Large range for all receiver and transmitter applications. For data and price list and 105X220 SASE to: R.J. & U.S. Imports, P.O. Box 157, Mortdale, N.S.W. 2223. N.S.W.: Geoff Wood Electronics, Lane Cove. Webb Electronics, Albury. A.C.T.: Electronic Components, Fyshwick Plaza. Vic: Truscott Electronics, Croydon. W.A.: Willis Trading Co., Perth.

EX-ABC AUDIO TAPES: 1/4" wide on 10 1/2" Standard metal spool \$6.85. Robust metal spool \$12.85 7" spool \$2.25. 5" spool \$1.25. Post extra. Also in stock 1/2", 1" and 2" tapes. Waltham Dan, 96 Oxford St., Darlinghurst, Sydney. Phone (02) 331-3360.

NEW RADIO VALVES: For entertainment or industrial use. Waltham Dan, 96 Oxford St., Darlinghurst, Sydney, Phone (02) 331-3360.

RCS RADIO PTY. LTD.

Established 1933
IS THE ONLY COMPANY
WHICH MANUFACTURES AND
SELLS EVERY PCB & FRONT PANEL
published in EA and ETI
651 Forest Road Bexley 2207
AUSTRALIA
RING (02) 587 3491 FOR INSTANT PRICES
24 HOUR TURNAROUND SERVICE

PRINTED CIRCUIT BOARDS

Minimum postage & packaging on all EA & ETI
Project PCBs
Catalogue 1976-85 (inc components) \$1.50.
PCBs made to order — 48 hr prototype service.
Bankcard/Mastercard
Acetronics PCBs
112 Robertson Rd, Bass Hill 2197
(02) 645 1241

DO YOU WANT TO BE A RADIO AMATEUR?

The Wireless Institute of Australia, established in 1910 to further the interests of Amateur Radio, conducts a Correspondence Course for the A.O.C.P. and L.A.O.C.P. Examinations conducted by the Department of Communications. Throughout the Course, your papers are checked and commented upon to lead you to a successful conclusion. For further information, write to:



THE COURSE SUPERVISOR W.I.A. (N.S.W. DIVISION)



P.O. Box 1066
PARRAMATTA, N.S.W. 2150.

your computer year book

MAKING YOUR MICRO WORK

Once a Year—
Don't Miss it!



Available at your Newsagent now!

Or simply send \$4.95 plus \$1.50 post and packing to The Federal Publishing Co,
PO Box 227, Waterloo 2017 NSW.

OPEN FOR BUSINESS: Monday to Friday 8.30 am to 5.00 pm.
Saturday Morning 8.30 am to NOON.

A.C.E.
RADIO

10B/3 Kenneth Road, Manly Vale, 2093 PROUD TO BE AUSTRALIAN
Phone: (02) 949 4871

ELECTRONICS CENTRE

W
E
S
T
O
C
K
A
R
A
N
G
E
O
F
M
O
S
T
E
L
E
C
T
R
O
N
I
C
C
O
M
P
O
N
E
N
T
S

W
E
B
U
Y
E
L
E
C
T
R
O
N
I
C
E
Q
U
I
P
M
E
N
T
&
C
O
M
P
O
N
E
N
T
S

POLYPROPYLENE CONE TOP QUALITY HI-FI WOOFERS



80hm Voice Coil — Foam Poly Surround —
Sturdy Suspension — Fitted Moulded Gasket —
Ferrite Magnet — 90 days factory warranty

Model	Size	Reson.HZ	Resp.HZ	Watts	R.M.S.	Price Ea.	or 2 For
12 POL 12"	12"	25	30-4000	80		\$44.00	\$82.00
10 POL 10"	10"	30	35-4000	50		\$39.95	\$73.95
8 POL 8"	8"	35	40-5000	50		\$34.95	\$64.95

P & P for 1 Spkr — NSW \$6.00, VIC/SA \$7.50, QLD/TAS \$8.00, NT/WA \$9.50
P & P for 2 Spkr — NSW \$8.00, VIC/SA \$9.50, QLD/TAS \$10.50, NT/WA \$11.50

5" Polypropylene Mid-Range Speaker to suit above Woofers P.O.A.

****FANTASTIC VALUE****

Upgrade your stereo system. These quality kits will give your system a NEW SOUND.



***** NEW ***
RELEASE**

*** LOOK AT THESE SUPER KITS ***

ACE8701 — 12" 80 watts R.M.S. HiFi 3 way speaker kit including crossover. Mono \$94.50. Stereo \$186.95

ACE8702 — 10" 60 watts R.M.S. HiFi 3 way speaker kit including crossover. Mono \$90.50. Stereo \$178.75

ACE8703 — 8" 50 watts R.M.S. HiFi 3 way speaker kit including crossover. Mono \$85.50. Stereo \$169.75

P & P for Mono NSW/VIC \$7.50 Q/T \$10.50 NT/WA \$11.95 SA \$10.50
P & P for Stereo NSW/VIC \$10.00 Q/T \$15.50 NT/WA \$17.20 SA \$13.50

**** I.C. SPECIALS ****

MC10101 — MC10107, MC10109, MC10110, MC10113, MC10117, MC10119, MC10123, MC10128, MC10129, MC10130, MC10131, MC10134, MC10136, MCM10148, MCM10147, MCM10149, MC10159, MC10160, MC10162, MC10163, MC10164, MC10171, MC10173, MC10174, MC10175, MC10186, MC10188, MC10189, MC10195, LD3150, A4102, M53293, LD3120, TAA293, 4585, MC1595, 74LS138, 74S04, 74H51, 7438, 8126, 8195, 8198, 2104A3, LM3900, LM3401, LM3301, 74157, A1230, TA7027, TA7122, A3300, A3350, 4011, 7406, 7441, 7450, 7104, 7403, 7430, 7490, 7407, MC1458, MC3456, 7416, 7421, 74C00, RA08100N, MC14543.

In case your preference is out of stock please indicate substitute for above.

10 mixed \$45.50 P&P \$2.00

EX COMPUTER

86 Key Qwerty Keyboard



54 Qwerty keys
10 Key Numeric Pad
12 Designated keys
10 Special Function keys
7 Position LED Indicator Panel
Housed in sturdy fibreglass case
Exceptional value at

\$65 each **\$35.00** P&P \$8.00

S.I.L. 8 pin 100 ohm Resistor Networks.
5 for \$1.25. 10 for \$2.00

EXTRA SUPER BARGAIN!

EX-COMPUTER PROFESSIONAL VIDEO DISPLAY UNIT



Although not tested these units are in good clean condition. Featuring:-
30cm B&W C.R.T. — combined on/off switch — indicator — brightness control — resettable built-in, thermal cut-out — B.N.C. Video input socket — quick release cover permits ready access to all other adjustments — 230 volt 50Hz.

Limited quantity only available. Therefore to avoid disappointment place your order early as this unit represents a GENUINE BARGAIN PURCHASE.

When seeking POWER TRANSFORMERS. See us FIRST. Phone for Prices

*** SEMI-CONDUCTORS ***

C106Y1	\$1.10ea.	10up \$1ea.
C106D	\$1.50ea.	10up \$1.35ea.
C203YY	\$0.90ea.	10up \$0.79ea.
C203B	\$1.10ea.	10up \$0.92ea.
SC141D	\$1.60ea.	10up \$1.40ea.
SC151D	\$3.00ea.	10up \$2.80ea.
V275LA20A	\$2.80ea.	10up \$2.50ea.
V275LA40A	\$3.10ea.	10up \$2.80ea.
A14P	\$0.80ea.	10up \$0.65ea.
A15N	\$1.50ea.	10up \$1.25ea.
IN4004	\$0.13ea.	10up \$0.10ea.
IN914	\$0.13ea.	10up \$0.10ea.
RB154	\$1.10ea.	10up \$1.00ea.
CM3504	\$7.00ea.	10up \$6.50ea.
2N6027	\$0.80ea.	10up \$0.75ea.
ST2SYM (Diac)	\$0.90ea.	10up \$0.75ea.
ST4ASSYM (Diac)	\$1.10ea.	10up \$1.00ea.
2N2646 (Met)	\$1.30ea.	10up \$1.20ea.
GES2646 (Plas)	\$1.00ea.	10up \$0.90ea.
4N25 (Opto Coup)	\$1.50ea.	10up \$1.40ea.

The above prices do not include P&P. P&P extra.

ETONE SPEAKER SPECIALS

GENUINE FACTORY PRICES

Rugged top quality Aust. made brand new bargains — all with factory warranty

Model	Size	Cone Type	V/Coil	Reson Hz	Freq Hz	Watts Rms	Price Ea or	2 for
4310	38cm	Straight surround	8 or 15 Ohms	45	40-6000	60	\$92.00 or	\$180.00
4510	38cm	Straight surround	8 or 15 Ohms	45	40-6000	100	\$132.00 or	\$258.00
4350	38cm	Hi-Fi	8 or 15 Ohms	30	30-4000	120	\$118.00 or	\$233.00

Pack and Post for 1 speaker NSW/VIC \$8.75; Q/T \$13.50; NT/WA \$17.50; SA \$11.50
Pack and Post for 2 speakers NSW/VIC \$15.00; Q/T \$23.00; NT/WA \$30.00; SA \$20.00

ETONE FACTORY SCOOP
EVEN LOWER THAN FACTORY PRICE
A PAIR FOR \$54.95 OR \$31.95 EACH

RUGGED TOP QUALITY HI-FI WOOFER 30cm 8 ohms ● 90 DAYS FACTORY WARRANTY ● FOAM POLY SURROUND ● STURDY SUSPENSION FOR RICH REPRODUCTION ● 3.5cm VOICE COIL ● FERRITE MAGNET ● FREQ. RESPONSE . . . 35.4500Hz RESONANCE 35Hz

P&P for 1 NSW \$6; VIC & SA \$7.50; QLD & TAS \$8; NT & WA \$9.50
P&P for 2 NSW \$8; VIC & SA \$9.50; QLD & TAS \$10.50; NT & WA \$11.50

****BONUS OFFER****

Upon request, all orders exceeding \$35.00, received in February shall include a set of headphones absolutely free. To avoid disappointment place your orders early.

Don't forget we have an excellent range of valves & CRT's

FOR POSTAL INSURANCE ADD: \$2.00 for parcel up to \$200.00 value plus \$1.00 for each additional \$100.00 value.

Next month in

Electronics Australia

Electronic rain gauge

Have you always wanted a rain gauge but could never be bothered going out to empty it? Well, how about this nifty design. It automatically empties itself, has a remote readout which can be indoors (you don't want to get wet now, do you?) and reads up to 999mm rainfall with 1mm resolution. Best of all, it uses cheap and readily available parts. Build it before the wet weather sets in.

The latest in car sound

In March we will have a feature article on all the latest sound gear for cars: CD players, receivers, bi-amplification, speaker systems, the lot. What is the most popular car sound installation of the moment? Find out in the March issue.

Commodore's Amiga computer

Released with a lot of fanfare some time ago, Commodore's Amiga computer has been a bit of a dark horse ever since. We take a close look at this innovative machine and put it through its paces.

**Note: although these articles have been prepared for publication, circumstances may change the final content.*

Electronics Australia Reader Service

"Electronics Australia" provides the following services:
BACK ISSUES: available only until stocks are exhausted. Price: \$4.00
PHOTOSTAT COPIES: when back issues are exhausted, photocopies of articles can be supplied. Price: \$4 per project or \$8 where a project spreads over several issues.
PCB PATTERNS: high contrast, actual size transparencies for printed circuit boards and front panels are available. Price: \$5 for boards up to 100 square centimetres; \$10 for larger boards. Please specify positive or negative.
PROJECT QUERIES: advice on projects is limited to postal correspondence only, and to projects less than five years old. Price: \$5. Please note that we cannot undertake special research or advise on project modifications. Members of our technical staff are not available to discuss technical

problems by telephone.
OTHER QUERIES: technical queries outside the scope of "Replies by Post", or submitted without fee, may be answered in the "Information Centre" pages at the discretion of the Editor.
PAYMENT: must be negotiable in Australia and made payable to "Electronics Australia". Send cheque, money order or credit card number (American Express, Bankcard, or Mastercard), name and address (see form). All prices include postage within Australia and to New Zealand.
ADDRESS: send all correspondence to The Secretary, "Electronics Australia", PO Box 227, Waterloo, NSW 2017. Please note that we are unable to supply back issues, photocopies or PCB artwork material over the counter.

Back Issues

Photostat copies

Total price of magazines/photocopies, including postage and handling

No off issues reg x \$4 = \$

Cheque/Money Order Please tick box to indicate method of payment:

*Please make payable to the Federal Publishing Company Pty Ltd.

Mastercard American Express Visa Bankcard Tick ;

Card Expiry Date

Credit Card No

Signature

(Unsigned Orders cannot be accepted)

NAME

ADDRESS:

..... POSTCODE

ADVERTISING INDEX

Ace Radio	121
Acetronics	120
Adilam	28
Altronic	62
Ampec	14
Amtex	24
Applied Communications	83
Audio Engineers	35
Chapman LE	119
Cooper Tools	IFC
Dept. of Defence	12,40,41
Diamond Systems	87
Dick Smith Electronics	69-78
Disco World	68
Ellistronics	107
Elmeasco	IBC
Emona	32
Economic Electronics	38
Federal Publishing	84,85,116,117
Geoff Wood	111
Jaycar	50-55
Jessic Controls	32
Kalextronics	60
Laser Systems	12
Microbee	9
Parameters	27
Philips	89
RCS Radio	120
Rifa	59
Rod Irving Electronics	19-21,102
Ritronics	103
Scan Audio	61
Scientific Devices	34
Scope	79
Selectronic Components	110
Statronics	31
Stotts	89
TSA	115
VSI	OBC
Westinghouse	28,33
WIA	120

How to beat the high cost of cheap meters.



You get what you pay for.
So get the Fluke 70 Series.

You'll get more meter for your money, whether you choose the affordable 73, the feature-packed 75 or the deluxe 77.

All of them will give you years of performance, long after cheaper meters have pegged their fishhook needles for the last time.

That's because they're built to last, inside and out. So they're tough to break. They don't blow fuses all the time. You don't even have to replace batteries as often.

And they're backed by a 3-year warranty. Not the usual 1-year.

Of course, you may only care that the world-champion 70 Series combines digital and analog displays with more automatic features, greater accuracy and easier operation than any other meters in their class.

You may not care that they have a lower overall cost of ownership than all the other "bargain" meters out there.

But just in case, now you know.

FROM THE WORLD LEADER
 IN DIGITAL MULTIMETERS.



FLUKE 73	FLUKE 75	FLUKE 77
Analog/digital display	Analog/digital display	Analog/digital display
Volts, ohms, 10A, diode test	Volts, ohms, 10A, mA, diode test	Volts, ohms, 10A, mA, diode test
Autorange	Audible continuity	Audible continuity
0.7% basic dc accuracy	Autorange/range hold	"Touch Hold" function
2000+ hour battery life	0.5% basic dc accuracy	Autorange/range hold
3-year warranty	2000+ hour battery life	0.3% basic dc accuracy
	3-year warranty	2000+ hour battery life
		3-year warranty
		Multipurpose holster

ELMEASCO **Instruments Pty. Ltd.**

Talk to your local Eimeasco distributor about Fluke —

- **A.C.T.** John Pope Electrical (062) 80 6576 • J Blackwood & Sons • George Brown (062) 80 4355
- **N.S.W.** Ames Agency 699 4524 • George Brown 519 5855 Newcastle 69 6399 • Bryan Catt Industries 526 2222 • D.G.E. Systems (049) 69 1625 • Petro-Ject 550 1388
- David Reid 267 1385 • W. F. Dixon (049) 61 5628 • Macelec (042) 29 1455 • Ebson 707 2111 • Selectroparts 708 3244 • Geoff Wood 427 1676
- **N. TERRITORY** J Blackwood & Son (089) 84 4255, 52 1788 • Thew & McCann (089) 84 4999
- **QUEENSLAND** Auslec • Elecnic (075) 91 4199 • St Lucia Electronics 52 7466 • Cliff Electronics 341 4655 • L. E. Boughen 369 1277 • Fred Hoe & Sons 277 4311
- The Electronic Shop (075) 32 3632 • Thompson Instruments (Cairns) (070) 51 2404
- **S. AUSTRALIA** Protronics 212 3111 • Trio Electrix 212 6235 • Industrial Pyrometers 352 3688 • J Blackwood & Son 46 0391 • Petro-Ject 363 1353
- **TASMANIA** George Harvey (003) 31 6533 (002) 34 2233
- **VICTORIA** Radio Parts 329 7888 • George Brown Electronics Group 878 8111 • G B Telespares 328 4301 • A W M Electrical Wholesalers • Petro-Ject 419 9377
- J Blackwood & Sons 542 4321 • R K B. Agency 29 7336 • Sirs Sales (052) 78 1251 • Mektronics Co 690 4593 • Truscott Electronics 723 3094
- **W. AUSTRALIA** Atkins Carlyle 481 1233 • Dobbie Instruments 276 8888 • Protronics 362 1044

Bourns resistor networks...designed for reliability.

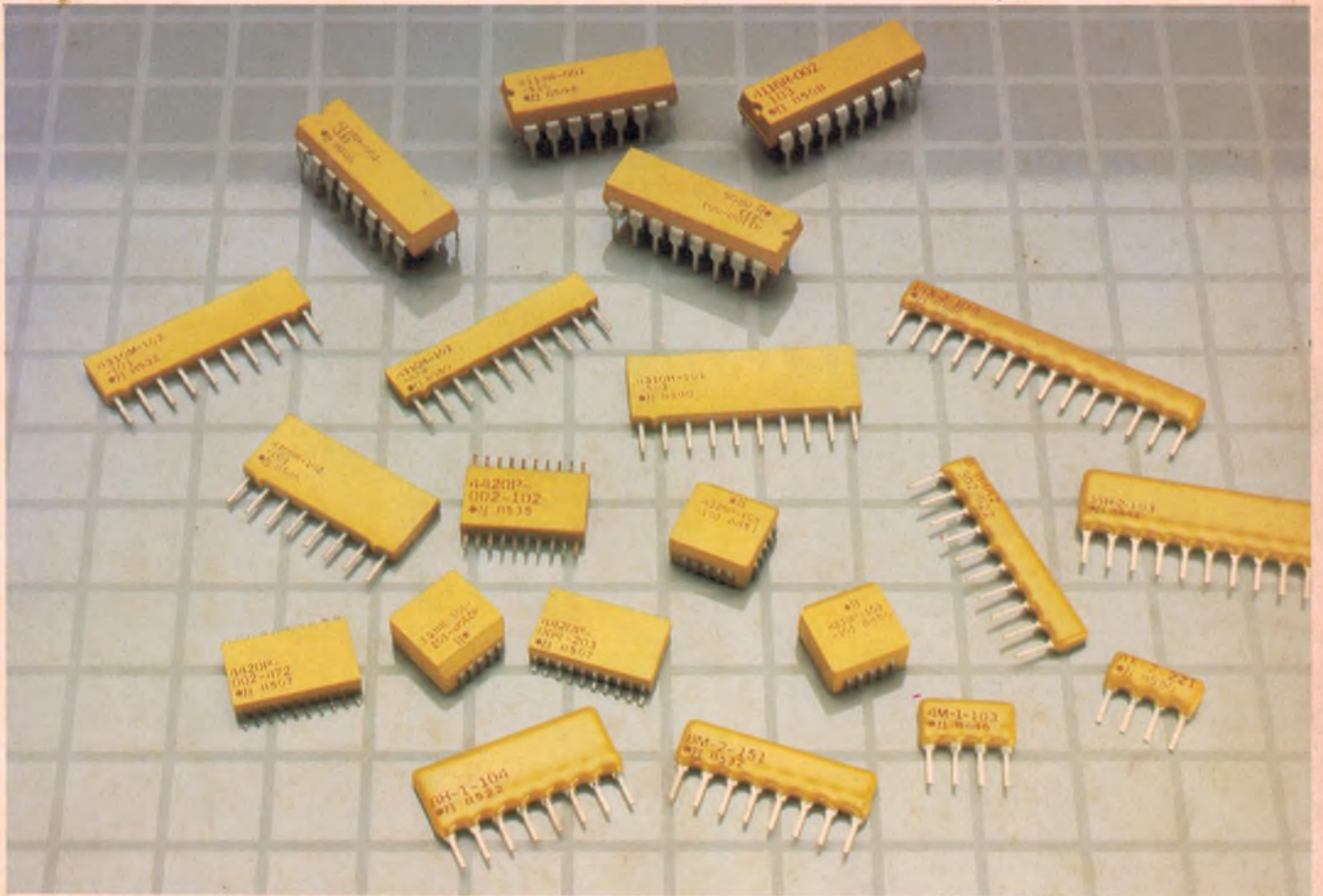

Compare the design features and your application benefits

For over 40 years Bourns has provided leadership in resistive components. Bourns extensive offering of resistor networks continues in this tradition. Based on computer aided design with built-in reliability along with advanced manufacturing automation and statistical process control, the Bourns resistor networks capabilities are without rival. New technologies of surface mounted PCC and SOIC styles have been recently added to the well-established molded/conformal DIP and SIP styles.

BOURNS DESIGN FEATURES

- High-temperature solder-to-bond terminations.

- Copper (Olin 194) terminations.
- 90% tin/10% lead electroplated pins.
- Trifurcated terminations in DIPs and SIPs.
- High density epoxy housing
- Laser marking.

APPLICATION BENEFITS

- Ensures compatibility with all soldering techniques.
- Longer life from efficient heat dissipation.
- Reliable solder joints and less board rework
- Strong and reliable termination.
- Excellent moisture protection
- Easy to read permanent identification.

VSI

THE SOURCE OF



COMPONENTS

VSI Electronics (Aust) Pty. Ltd.,
16 Dickson Avenue, ARTARMON
NSW 2064, AUSTRALIA.
Telephone (02) 439 8622
Telex AA 22846 Fax (02) 439 6435