

Australia's Top Selling Electronics Magazine

Registered by Australia Post
publication No. NBP 0240

Electronics Australia

JUNE 1987

Aust* \$3.50

NZ \$4.95 Incl GST



● **Multi-channel
remote control
to build**

● **Satellite TV:
what you need**

● **Stereo
VU Meter**

● **Local Area
Networks:
What they are,
What they do**

● **Simple Car
Burglar Alarm**

The all-important high-speed CMOS question. Will latch-up cause burn-out?

With Philips high-speed CMOS (HCMOS) logic ICs, the answer's no. Because they're free from latch-up.

What causes latch-up?

Latch-up occurs when SCRs (formed by parasitic bipolar transistors found in all CMOS structures) are triggered by current transients arising from over-voltage at the input, output or supply pins, or by ringing on the signal pins. The resulting

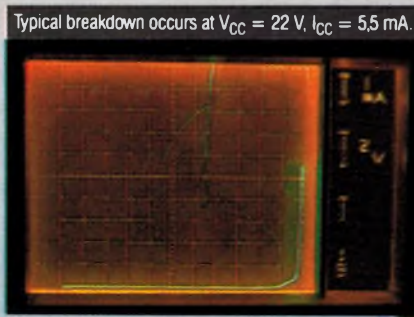

Curve tracer display from latch-up test with excess supply voltage. At no time did latch-up occur in the Philips HCMOS IC, since the supply voltage snaps back to 13V.

short-circuit across the supply rails causes excessive current and inevitably destructive power dissipation.

How is it overcome?

We prevent any current injection into the SCR structures by growing an epitaxial layer on a very low-resistivity substrate. And by using unique design and process parameters to minimize the gain of the parasitic transistors, we achieved complete latch-up immunity. No burn-out.

So you improve system performance, and by eliminating additional components to protect against latch-up you not only cut

component costs but also optimise system speed.

And you gain reliability. With a product that will not fail during system test. Or in the field.

Harsh environments?

Even in noisy, high-temperature environments such as automotive and industrial applications, Philips HCMOS Logic goes on working. And you get exceptional noise immunity because the input switching levels of 74HC/HCU circuits are 30% and 70% of the supply voltage. Moreover, the whole Philips 74HC/HCT/HCU family has a standard temperature range from -40 to $+125^{\circ}\text{C}$.

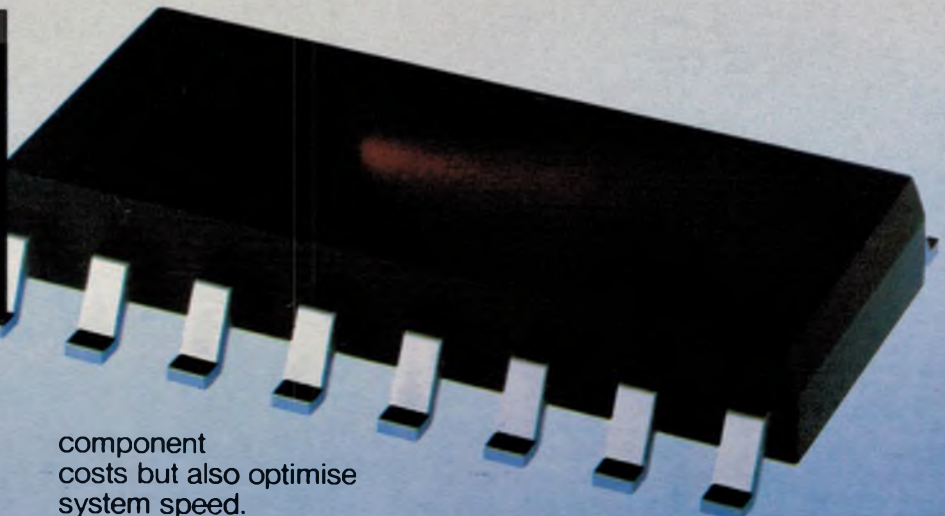

HCMOS
HIGH-SPEED LOGIC

The name is Philips
The product is HCMOS

Want to know more? Then call your local Philips Electronic Components and Materials office. We're on-hand with full technical documentation, including a Designer's Guide to your all-important questions about HCMOS.

Sydney	(02) 439 3322
Melbourne	(03) 542 3333
Adelaide	(08) 243 0155
Perth	(09) 277 4199
Brisbane	(07) 44 0191

RCA is an alternate source for Philips HCMOS ICs.



Electronic
components
and materials

PHILIPS

Electronics Australia

June
1987

THIS MONTH'S COVER

Here's a multi-function IR remote control that's easy to build and easy to install. Build it and press the buttons to control your TV set, CD player or model railway. Details page 44.

Features

- 10 NEW-GENERATION AIRLINERS *Quieter and packed with electronics*
- 16 RADAR: ITS WARTIME ROLE *Recollections of an RAF instructor*
- 26 SATELLITE TV IN AUSTRALIA *A practical guide*
- 36 TETIA AND TESA *Professional organisations for the electronics technician*
- 88 LOCAL AREA NETWORKS *What they are & what they do*
- 93 WIN A LAN DEVELOPMENT SYSTEM *\$10,000 prize from TI*

Entertainment Electronics

- 104 AN INTRODUCTION TO HIFI PT.14 *FM radio tuners — 2*
- 124 COMPACT DISC REVIEWS *Janos, Handel, Mozart*

Projects and Technical

- 44 MULTI-FUNCTION REMOTE CONTROL *Switch up to eight channels*
- 60 REMOTE CONTROLLED CAR ALARM *Combines two popular projects*
- 64 CIRCUIT & DESIGN IDEAS *Screecher protection for bonnet & boot*
- 68 THE SERVICEMAN *When skies are grey, Sony boy*
- 84 LOW-COST STEREO VU METER *Build it for the Mini Mixer*
- 96 A VERSATILE OP AMP TESTER PT.2 *How it's used*
- 112 UNDERSTANDING COLOUR TV PT.5 *The colour decoder — 1*

News and Comment

- 4 LETTERS TO THE EDITOR *For and against the Australia Card*
- 5 EDITORIAL *Australia at the forefront of superconductivity research*
- 6 NEWS HIGHLIGHTS *IBM launches new-generation PCs*
- 38 FORUM *Technology: has it gone over the top?*
- 126 INFORMATION CENTRE *Answers to reader queries*

Departments

- 74 BOOKS REVIEWS
- 83 EA CROSSWORD PUZZLE
- 83 50 AND 25 YEARS AGO
- 118 NEW PRODUCTS

- 128 MARKETPLACE
- 130 COMING NEXT MONTH
- NIL NOTES AND ERRATA

Eight channel IR remote control



Up to eight relay channels can be switched with our new infrared remote control, and you can add power on/off, muting and volume control. Construction begins on page 44.

10,000 prize from Texas Instruments

Do you need a local area network (LAN) development system. If so, tell us about it. You could win a \$10,000 prize from Texas Instruments. See page 93.

Remote controlled car burglar alarm



This month, we show you how to combine the UHF remote switch featured in January with the ultrasonic alarm described in April. Together, the two make a very effective radio-controlled car burglar alarm. Details page 60.

MANAGING EDITOR
Leo Simpson, B.Bus. (NSWIT)

EDITOR
Greg Swain, B.Sc. (Hons. Sydney)

EDITORIAL CONSULTANT
Neville Williams, F.I.R.E.E. (Aust.)
(VK2XV)

EDITORIAL STAFF
John Clarke, B.E. (Elec. NSWIT)
Carmel Triulcio

GRAPHIC DESIGNER
Brian Jones

ART PRODUCTION
Alana Horak

PRODUCTION
Mark Moes

SECRETARIAL
Naomi Lenthén

ADVERTISING PRODUCTION
Brett Baker
Vikki Patching (Vic.)

ADVERTISING MANAGER
Selwyn Sayers

PUBLISHER
Michael Hannan

HEAD OFFICE
The Federal Publishing Company Proprietary
Limited, 180 Bourke Road, Alexandria, NSW
2015.

Phone: (02) 693 6666. Fax number: (02) 693
2842. Telex: AA74488.

Postal Address: PO Box 227, Waterloo 2017.
NSW Representative: Mark Lewis.

**INTERSTATE
ADVERTISING OFFICES**
Melbourne: 221a Bay Street, Port Melbourne,
Vic. 3207.

Phone: (03) 646 3111
Representative: John Oliver, B.A. (Hons.
Essex).

Adelaide: John Fairfax & Sons Ltd, 101
Weymouth Street, Adelaide, SA 5000.
Phone: (08) 212 1212.

Representative: Michael Mullin

Brisbane: 26 Chermiside Street, Newstead, Qld.
4006.

Phone: (07) 854 1119.
Representative: Bernie Summers.

Perth: John Fairfax & Sons. 454 Murray Street,
Perth, WA 6000.

Phone: (09) 481 3171.
Representative: Estelle de San Miguel.

New Zealand: 3rd Floor, Communications
House, 12 Heather Street, Parnell, Auckland,
New Zealand.

Phone: (09) 39 6096. Telex: NZ 63122
SPORTBY.

Representative: John Easton

ELECTRONICS AUSTRALIA is published
monthly by the Federal Publishing
Company Pty Limited.

Typeset and printed by Hannanprint, 140
Bourke Road, Alexandria, NSW for The
Federal Publishing Company Pty Ltd.

Distributed by the Federal Publishing
Company Pty Ltd.

Registered by Australia Post — publication
No. NBP 0240.
ISSN 0313-0150

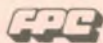

*Recommended and maximum Australian
retail price only



Letters to the editor

Comment on April Editorial

Your editorial in the April copy of *Electronics Australia* is a most courageous stand and one that I would like to endorse. It is high time that the people of Australia took the trouble to look more closely at what is being put into our legislation, and not accept as inevitable that which goes on in Parliament House.

If I may, I would like to quote a small section of your editorial which I feel is the most ugly aspect of this legislation; ie. "There are clauses in the legislation which would easily enable any future totalitarian Government to withdraw your card, which would tantamount to removing your citizenship".

This is a virtual duplicate situation to that which prevailed when the Third Reich came to power and quietly introduced legal criteria which ultimately led to the dehumanising of many people of many nationalities. The scenes which appear in the mind's eye are horrific.

Thank you once again Mr Simpson for your unqualified stand in bringing this frightful evil to the notice of readers of *Electronics Australia*.

K.E. McWilliam,
Hilltop, NSW.

In support of the Australia card

Was the Metric Time article the only April Fool's joke in your last journal or was there a second in your editorial opposing the Australia Card in view of the incredible logic therein.

You state that the proposed law will become an invasion of privacy because "many government departments will inevitably have access to this information". As a holder of numerous bank credit cards and user of credit, I am sure that many of my financial details are held on computer files with access given to a variety of bodies. I much prefer the Australia Card legislation which, by law, will establish a Data Protection Agency to the aforementioned arrangement.

I am a subscriber to several maga-

zines, currently including yours, and I often receive telephone calls and postal offers from persons and organisations who have obtained my name, address, telephone number and interests from these magazines. Do you sell your subscription lists or are your subscriber's private details not divulged to anyone?

As a member and delegate of the Administrative and Clerical Officer's Association, I resent your bald assertion that ACOA is "actively against" the card, especially when our Council's last policy resolution of November 1985 supported the concept of the card and recognised the need for an adequate and cost-effective means of implementation.

Let's forget the trivialities to which you refer such as "card subjects" and concentrate on the real issue. Do we want to support tax evaders, welfare cheats and the like to the detriment of honest taxpayers? The overall fairness of the Card outweighs the negatives you espouse.

We are not a society of individuals on our own desert islands and as such we have an overall responsibility — hence I don't for instance exercise an individual's right to drive through red traffic lights. In countries such as the USA you cannot, for example, bank money, transfer money out of the country, or buy a motor car over a specified price without an identifier such as the Australia Card will become.

The Tax Office has the will to cross match incomes with interest and dividends and when the Australia Card provides a valid identifier they can put plans for computer purchases into reality.

Your editorial has made me change my mind but about your magazine, not about the Australia Card. With regret I cancel my subscription but hope that you can either take a more responsible stance or confine your views to the electronic interests of your readers.

I. Smillie,
Sunnybank, Qld.

Comment: Our Editorial makes the point that the Australia Card will not solve the serious problems of social security fraud or tax evasion. We regret

that you have cancelled your subscription because we have published an opinion which is contrary to your own.

Nothing to do with electronics

What has the content of your Editorial in the April 1987 issue got to do with electronics?

If I want to read political opinions there is a host of specialised journals etc. that cater for this purpose. I suggest to you that you may write to these publications as an individual as you are so motivated to express your opinion.

Please in future make the contents of your Editorial more relevant to electronics and do not use your space for politics.

V. Tantaró,
Avondale Heights, Vic.

Comment: the content of the April 1987 Editorial is relevant to an electronics magazine. The Australia Card is a particular application of computer technology which has far reaching social implications for every Australian.

Exide Powerguard is a no-break UPS

I fear the "no-break" Exide Powerguard UPS has been inadvertently sold short by your otherwise excellent feature "What's new in power supplies" (February 1987).

This comes about by categorising the Exide Powerguard as an "off-line UPS".

As you correctly stated, "The typical switchover time for an off-line UPS is under 10ms which is less than a half-cycle duration of the 50Hz mains".

To demonstrate just how unlike an off-line UPS the Exide Powerguard is, consider that its switchover time is less than 1ms. This is one tenth the typical figure for an off-line UPS.

As you know, this is an important difference.

As far as a computer is concerned, 1ms is undetectable from a continuous supply of power. But anything approaching 10 milliseconds can cause serious data corruption or loss.

The superior response of the Exide Powerguard UPS comes about from the fact that the mains and battery are never really "off-line" — each being connected to its own separate primary of a tri-port transformer, the battery via an inverter. The secondary of the transformer passes through a filter to provide

continued on page 129



Editorial Viewpoint

Australia at the forefront of research into superconductivity

Everyone will welcome the recent news that there have been real breakthroughs in research into superconductivity. Previously, superconductivity has been thought of as a phenomenon which only occurred at extremely cold temperatures, close to absolute zero. It is a very important phenomenon whereby electrical resistance in conductors drops to very low values. Discovered in 1911, there had previously been very little progress in research and interest in this area has been very low.

Now, a number of scientists from around the world have announced that superconductivity can be made to occur at quite "warm" temperatures, as high as 100 degrees Kelvin (-173 degrees Celsius). This means that no longer is it necessary to use liquid helium as the refrigerant; liquid nitrogen can be used instead.

It is gratifying to know that scientists at the University of NSW, Australian National University and the CSIRO are well to the forefront of the current research although Australia would be in a much better position if we had more physicists who could turn their talents to this area.

The immediate effect of these breakthroughs is to rekindle interest in superconductivity and already there are predictions of superconductivity being made to occur at room temperature within 10 years. The really startling aspect of the recent breakthroughs is that they do not involve metals as such, but use exotic new ceramic mixtures which at normal temperatures are insulators. Mind-boggling indeed!

If superconductivity does become possible at normal temperatures the ramifications will be extreme. They could be more far-reaching than the development of the transistor which has changed virtually every aspect of life. Just think of the possibilities, in power generation and transmission, including fusion, in transportation, in medicine (nuclear magnetic resonance), in computers, in manufacturing and so on. If just some of these possibilities become reality, superconductivity could effect a major reduction in world energy consumption.

Really though, no-one can possibly foresee the full ramifications of superconductivity, just as no-one could have foreseen all the applications of the laser 25 years after its initial development.

Leo Simpson

News Highlights



Jaycar Electronics opens in Melbourne

Jaycar Electronics has at last opened a branch in Melbourne.

Situated at 45 A'Beckett St, the store is in the heart of the Melbourne retail

electronics area. It is only a few minutes walk from other major suppliers and from RMIT.

The new store carries the full range of Jaycar merchandise and is under the management of Mr Tim Rimington. The telephone number is (03) 663 2030.

Americans catch "kangaroo paw"

A recent report in the US-based *Columbia Journalism Review* has revealed that large numbers of American journalists are suffering from repetitive strain injury, or RSI. The report explodes the myth that RSI is simply a case of "kangaroo paw" — an "imaginary" injury confined strictly to Australian journalists and office workers.

In the US, the injury is commonly referred to as "computeritis" or "computer complaint". According to the report, serious and disabling arm and hand disorders have afflicted employees using video display terminals at newspapers across the country, including the San Francisco Chronicle and Examiner, Newsday, the New York Daily News,

the Los Angeles Times, The Philadelphia Inquirer and the San Diego Tribune.

As in Australia, American newsrooms rely extensively on VDT equipment. But why does the problem arise with computer keyboards and not with the now outdated manual typewriters? One answer, say occupational health specialists, is that although some typists do develop such injuries, VDT users may be at greater risk because they can make many more hand movements per hour.

Another factor that may contribute to injuries is that reporters are simply using their VDTs more than they used typewriters. Preliminary studies have shown that users are more likely to suffer RSI if they work on the computer for long periods of time, concentrating very hard, and rarely taking breaks.

Business Briefs

- Rifa Pty Ltd has expanded its operations in Preston, Victoria. In addition to extra office space, Rifa has included a new trade counter which is intended to supply all the electronic component needs of tradesmen and professional hobbyists.
- Allen-Bradley Pty Ltd has announced new distributors in South Australia and for the first time in the ACT.

The new contact in South Australia is Electronic Components and Equipment Pty Ltd, 30-40 Hurtle Square, Adelaide. Telephone Arthur Watson on (08) 232 0001.

The distributor in the ACT is Electronic Components Pty Ltd, PO Box 534, Fyswick 2609. Telephone (062) 80 4654.



Philips exports a parrot - but it's legal

A TV commercial produced for Philips Australia, and starring a parrot, should bring some extra colour to Morocco.

Rick's Cafe Americain must be the most famous location in Morocco. Millions of moviegoers and TV viewers can describe the decor of the fictitious Rick's Cafe but only in the black and white details of the 1942 Bogart-Bergman classic *Casablanca*.

Yet Morocco does have colour — since 1977 in fact, when colour television was introduced to this north-west

NSW Innovation centre

As from the 1st May, 1987 the Innovation Centre of NSW will manage a service which will enable creators of new products, processes and materials to quickly reach manufacturers, investors and entrepreneurs.

It is the only such scheme in Australia and is expected to be one of several services that will help to generate a growing private manufacturing sector which is responsive to the needs of local and overseas markets.

A major problem faced by product developers is that they cannot readily present their products to appropriate manufacturers, investors or marketers. At the same time, the Centre is often approached by manufacturing companies looking for new products.

By registering with the AISS (Australian Innovation Sourcing Service), both parties can be brought together. The Innovation Centre also provides other services to members, such as help with business planning and marketing advice.

The Australian Innovation Centres are supported by Federal and State Governments, as well as industry groups. Enquiries can be directed to the Innovation Centre of NSW, PO Box 1, Kensington, NSW 2033. Telephone (02) 399 6111.

African nation's population. One third of the 1.1 million homes now own colour a TV set and annual sales are about 100,000 sets.

So what's that got to do with the parrot? Well, Philips has proved to be the most popular brand of colour television in Morocco and marketing executives intend to keep it that way by pushing the "Natural Colour" theme that is so well known to Australian viewers.

To promote this theme, the 1987 advertising campaign will include a commercial that was originally made in Australia in 1985. This advertisement features an artist painting onto canvas the details of a live parrot she is studying on a Philips screen. The commercial was judged by Philips executives in Morocco to have been the best TV spot on a reel of Philips commercials made around the world in the last few years.

Of course, there will be a few production costs. First, the video signal will have to be converted from the PAL system, as used in Australia, to Morocco's SECAM system. In addition, the narrative will be translated into French, while the sound effect will be repeated — parrot fashion of course.

Spaceplane contract

British Aerospace Australia and the University of Queensland have won a contract from the Australian Government to study the feasibility of developing a Re-Entry Air Data System (READS) for space vehicles re-entering the Earth's atmosphere.

Conventional aircraft calculate their air speed by measuring the pressure inside tubes ("pitot" tubes) protruding into the airstream. At hypersonic speeds high in the atmosphere, these tubes would be burnt off.

The research is applicable to a number of advanced projects — HOTOL in Britain, Hermes in France and America's National Aerospaceplane. Results could also be used to upgrade systems already in use on NASA's space shuttle.

Engineers from British Aerospace Australia and the University of Queensland will be conducting their studies in Europe and the United States. The Hypersonic Shock Tube facility at Queensland will be used in the early design stages of these projects.

British Aerospace Australia's other space-related contracts include the design of the Earth Resources Satellite ground system and the Queensland Government space launch site study.

- Ian Graham, UK.



Plessey's working on the railroad

Communications within the State Rail Authority will be substantially upgraded following the installation of a \$5 million Plessey dial-up radio telephone network.

Details of the system, which puts maintenance and emergency personnel in immediate contact with any SRA telephone extension throughout the coverage area, were announced on April 10th during a visit to Plessey's Meadowbank Sydney plant by the NSW Deputy Premier and Minister for Transport, Mr Ron Mulock.

Designed and manufactured by Plessey in Australia, the SRA system includes more than 1000 Plessey MTR8000 Series UHF vehicle and personnel transceivers, nine base station sites, and a network management centre

at the State Rail Authority's Chullora depot.

All sites are interconnected by microwave radio links which were also supplied by Plessey.

An area from Helensburgh south of the Sydney metropolitan area to Wyong on the NSW Central Coast is covered by the new dial-up network, with the system design also catering for future extension to Wollongong and Newcastle.

Plessey has substantially upgraded its Meadowbank facility in recent years. The company is now successfully involved in a number of new technology fields ranging from B-MAC satellite TV systems to the Raven field radio system for the Army. The latter is said to be the most advanced battlefield radio system in the world and has definite export potential.

News Highlights

Robots on patrol

Sam Technology of Marayong, Australia is now distributing an impressive new surveillance robot which can do many of the things that a human guard can do.

Called the *Sentry*, the new robot resembles R2D2 from *Star Wars*. It weighs 220kg, stands 120cm tall, and is ideal for firms that do not like the idea of anyone — not even security people — roaming free to peruse confidential material.

Once led through its route, the *Sentry* robot creates in its memory banks a map which it uses to continue its patrol at up to 6km/h for 12 hours at a stretch before its on-board power supply run low. The robot then seeks out its own "sentry box" for recharging.

The new robot comes with an impressive array of electronic sensors, including 24 ultrasonic sensors around its circumference which detect objects in its path. Also featured are infrared sensors which are able to detect fire or body heat.

In addition, the robot has a miniature video camera through which it can send back to a central security room a picture of what is happening as it on patrol. If the *Sentry* detects trouble, it sends a silent alarm to either the central security station or to the proper authorities.

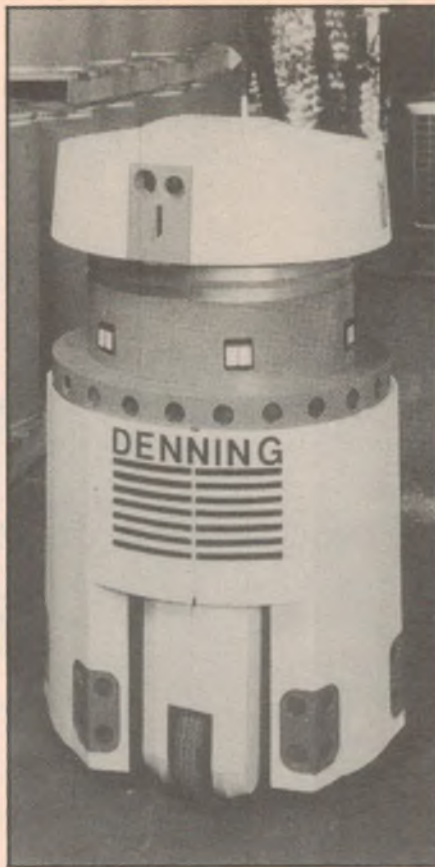

With optional attachments, the *Sentry* is expected to find applications for handling hazardous waste and explosive. At present the US Army is investigating military implications.

And the price of all this electronic wizardry? — around \$160,000. (Sam Technology, 36 Binney Rd, Marayong, NSW 2148).

New electronics course at Footscray TAFE

A new syllabus to train technical officers and engineers' assistants in Computer Integrated Manufacturing (CIM) has been developed at Footscray College of TAFE. The course will lead to a new qualification: the Certificate of Technology (Electronics — CIM).

Following accreditation by the Victorian TAFE Board, the syllabus is likely to be introduced Victoria-wide and possibly nationally. It will lead to a new qualification — the Certificate of Technology (Electronics — CIM).

One of the developers of the course, Footscray College's Bill Green, says that while the use of high technology in Australia has advanced rapidly, training for technicians and technical officers in the electronics industry has lagged behind.

Mr Green, who developed the syllabus with fellow Footscray College staff member Bert Leckie, and Keith Robinson of RMIT, says that they initiated the project about three years ago. Also involved at every stage was an industry panel which included Don Bryant of the Government Aircraft Factory; Paul Dunn, Division of Manufacturing Technology, CSIRO; Dan Lambert, L.M. Ericsson Pty Ltd; Don Sheridan, Telecom Research Laboratories; and Ray Smith, RCS Design Pty Ltd.

For further information contact Bill Green, Footscray College of TAFE, Cnr Nicholson & Buckley Sts, Footscray, Vic. 3011. Phone 688 3400.

Government abandons ABC/SBS merger plan

The proposed merger of the SBS (Special Broadcasting Service) with the ABC has been abandoned by the Federal Government.

The announcement was made by the Prime Minister, Mr Hawke during a recent address in Melbourne.

The controversial merger was first announced in the 1986 Budget but the legislation was blocked by the Senate last December. This rejection meant that SBS were prevented from receiving any benefits by the Government.

Mr Hawke's decision not to proceed has pre-empted any recommendation to the Senate Select Committee which has been hearing submissions on the pros and cons of the merger.

Superconducting chips a possibility says IBM

Researchers at the IBM Thomas J. Watson Research Centre (Yorktown Heights, NY, USA) have announced a major breakthrough in the development of the first thin-film superconducting devices that operate at temperatures high enough to be of practical use.

IBM's ability to make such devices opens the door to producing instruments and chips that are the superconducting counterparts to those used in computers and other electronic products. A superconductor is a material that loses all resistance to electricity below a specific "transition" temperature.

The new IBM devices, called SQUIDS (Superconducting Quantum Interference Devices), are the most

sensitive magnetic detectors known to science. Composed of two thin-film Josephson devices each, the SQUIDS are only one one-hundredth the thickness of a human hair and are superconducting at up to 68 degrees Kelvin (K) (minus 337 degrees Fahrenheit).

These new SQUIDS become completely superconducting in the range where liquid nitrogen can be used as the coolant. Liquid nitrogen boils at 77 degrees K and can be effectively employed at 68 degrees K by reducing its pressure.

Liquid nitrogen is much less expensive and more convenient than the liquid helium used in current superconductivity applications.

BIG NEWS • BIG NEWS • BIG NEWS

EVERY ISSUE OF EA.

FREE!



Announcing the best news in electronics magazines since Wireless Weekly started back in the thirties!

If you're a regular Dick Smith Electronics customer, you can get your copy FREE: you could save up to \$42 at current prices (per annum)!

That's right: the current issue, as soon as it's released — not last month's or a left-over copy. Exactly the same as the one you'd buy at the news-stand.

Why?

Simple! We want to say "thank you" for supporting Dick Smith Electronics. And for supporting Australia.

When you buy your kits, your components, your tools . . . when you buy anything from Dick Smith Electronics, you're helping the Australian Electronics Industry. You're directly helping to keep over 600 Australians employed. And through our suppliers, and their suppliers, that adds up to thousands!

And that's good for all of us.

What's a regular Dick Smith Electronics customer? Your local DSE store manager will know. You'll probably be known by name. Or at least by sight. And they'll know that those dollars you spend to enjoy your hobby are mostly spent at a DSE store.

Obviously, we've given our store managers guidelines. But to be classed as a regular customer is easy — if you're a regular customer!

DSXpress customers: You don't miss out!

Any DSXpress customer who regularly orders \$70 or more per month will automatically be entitled to the free magazine. We'll simply include it with the order that meets this figure (our computer will tell us when!)

This exclusive offer is available only from Dick Smith Electronics, and commences with this (June 1987) issue.

*** Offer expires June 30th, 1987**

**Only
from...**

**DICK SMITH
ELECTRONICS**

PTY LTD

Quieter, fuel efficient



Airbus Industrie's A300 fly-by-wire demonstrator goes through its impressive flying display at the 1986 Farnborough Air Show. (Photo: British Aerospace).

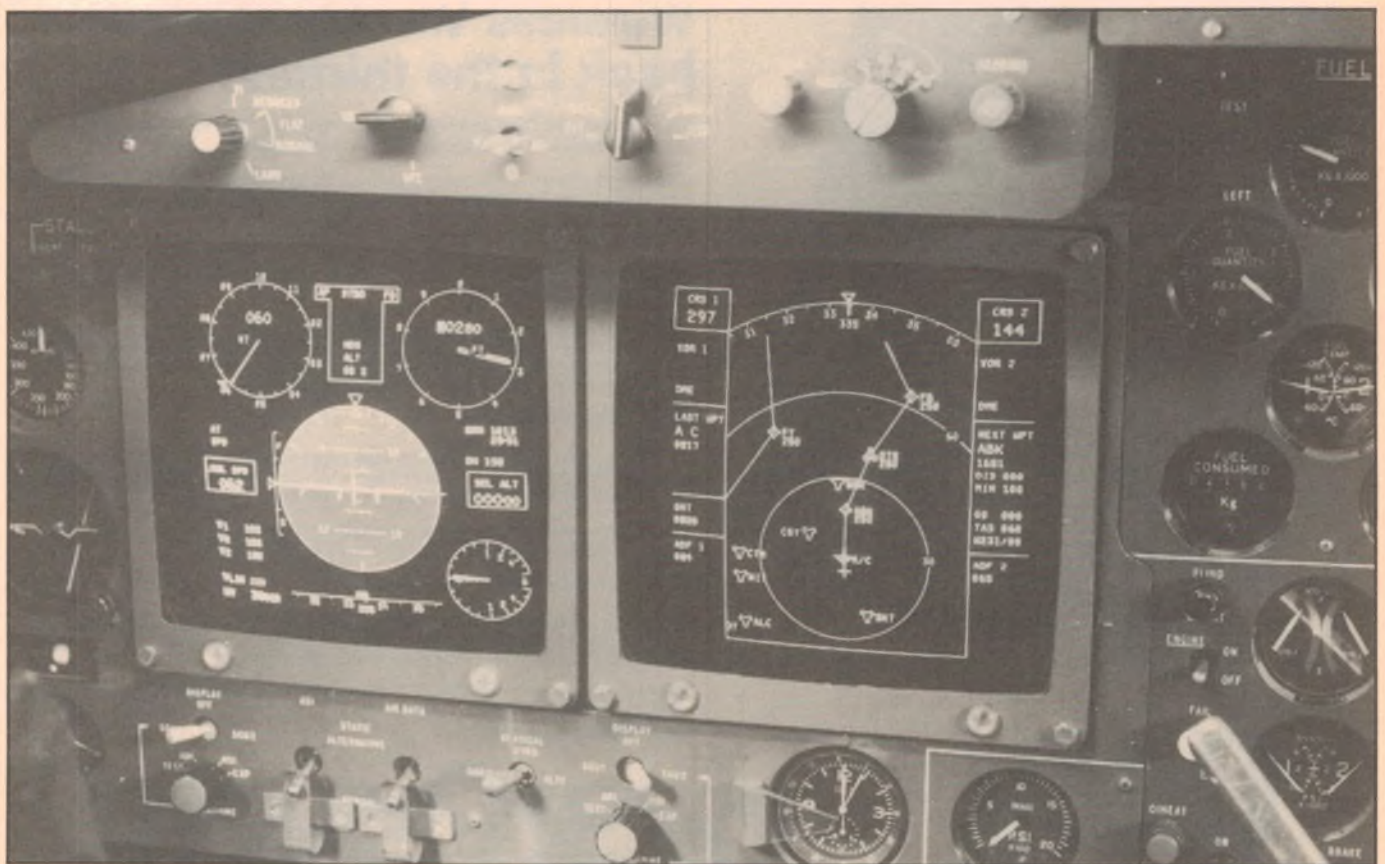

Computer text and graphics present information about the aircraft to the crew in a clearer and more flexible way than conventional instrumentation.

and packed with electronics

New-generation airliners

It is not an exaggeration to say that electronics is revolutionising aviation. Of course, most of the leading edge research is devoted to military aircraft but civil aircraft, too, are experiencing rapid advancements.

by IAN GRAHAM

As you board your aircraft in ten years time, will it be a sleek supersonic dart? Probably not. It's more likely to be a subsonic aircraft with propellers (yes, propellers!) and a remarkable new control system.

Within ten years, aircraft will begin to lose the familiar control column that has been a feature of the flight deck since the first planes took to the air at the beginning of the century. The control column, or "joystick", is designed and built the way it is because the pilot needs the extra leverage of the column height to help him physically pull the plane's control surfaces (rudder, tail-plane, etc) into position.

The column is linked to the control surfaces by a network of cables, pulleys and other mechanical and hydraulic linkages. But that arrangement will certainly change dramatically as a result of implementing a system called "fly-by-wire" that has already been used by military plane-makers for the past decade.

To survive in the air, modern fighters have to be very nimble indeed. Very stable aircraft — aircraft that will return to straight, level flight if the pilot takes his hands off the controls — tend to very sluggish to manoeuvre, because they're always trying to return to their stable attitude. Aircraft designed for

aerobatic displays achieve increased manoeuvrability by having a degree of in-built instability. The less stable they are, the more quickly and easily they respond to the controls, because they're not continually trying to return to stable flight.

Fighter aircraft use this reduction of stability for increased agility. But there comes a point where the plane can be made so unstable that a human pilot cannot possibly fly it. But a computer can.

Computer control

A computer can monitor the plane's attitude perhaps 50 times a second and apply tiny adjustments to maintain good trim. The computer sits between the pilot and his plane. The pilot moves the controls, but all he is doing is signalling the computer what he wants the plane to do. It is the computer that decides how best to do what the pilot wants.

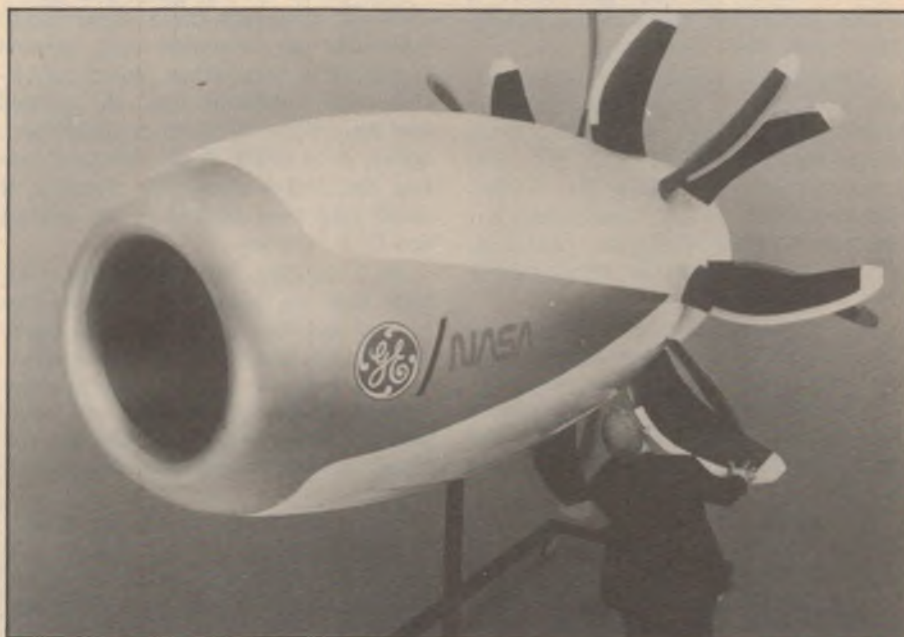

This engine, developed in America by General Electric and NASA, is the forerunner of the new generation of 'propfan' or 'unducted fan' aircraft engines. (Photo: General Electric).



In this mock-up of a future cockpit, computer generated images on cathode ray tubes replace conventional needle gauges. (Photo: British Aerospace).

Planes like British Aerospace's EAP (Experimental Aircraft Program) and the French Dassault-Breguet Rafale, forerunners of the next generation of European fighters, could not fly without this "fly-by-wire" technology.

Compared to modern fighter aircraft, civil airliners are aerodynamically very stable indeed. Some designers plan to incorporate fly-by-wire into the next generation of civil airliners for a different reason. At the last Farnborough Air Show in September last year, Airbus Industrie demonstrated an A300 Airbus with a difference.

In a very impressive demonstration of the capabilities of fly-by-wire, the pilot flew the A300 along the runway very low, very slow and with its nose pitched up. It was dangerously close to the point where it would stall and fall out of the sky.

An aircraft of that size would normally need several hundred feet of space underneath it to recover from a stall. If this aircraft had stalled, it would certainly have had a close (and expensive) encounter with the runway. But whether the pilot had inadvertently allowed his plane to reach the beginning

of a stall or deliberately decided to fly it into the ground, the plane would not have done so!

This plane was equipped with fly-by-wire. Its computer could sense conditions like an imminent stall, ground proximity or wind shear (potentially lethal wind conditions near the ground that can cut the lift from an aircraft as it comes in to land). If the computer system detected a dangerous situation, it could take over control of the aircraft and fly it to safety.

As if to drive this point home, the pilot flew the plane slowly along the runway and then pulled the stick back. Any normal aircraft would have stalled, but the computer system automatically brought up the engine power and modified the nose-up attitude so that the plane could climb away from the ground safely.

Fly-by-wire promises to make a positive contribution to air safety. Of course, it's advantages are all lost if the system fails or if all channels of the system suffer from an identical fault. The designers have naturally given all the systems back-ups. For example, there are at least four power generation sys-

tems, driven from a number of different power plants. If one fails, another trips in automatically.

Primary systems and their back-ups are not only run by different computer programs, but the hardware in the primary systems and their back-ups is also different. Different companies supply different computers, using different microprocessors to guarantee that the same fault cannot possibly exist in more than one channel of the system. Cables are run along different routes, so that minor physical damage to the aircraft should not knock out any more than one channel.

But what if all the electronics do fail? Just as computers occasionally issue gas bills for millions of pounds or signal the Pentagon that World War Three is imminent, aircraft systems aren't perfect and never will be. If the Airbus loses all electrical power from its control system, an emergency mechanical system can be engaged, giving the crew just enough control to fly the plane.

As the crew is normally only sending electrical signals to a computer system, the control column can be dispensed with altogether and be replaced by a

tiny hand controller reassembling a computer games joystick.

Of course, the move away from "needle and dial" instruments to multi-purpose cathode ray tubes (television screens) linked to computerised flight management systems has already begun and the Airbus was also "instrumental" in implementing this leap in technology. The trend now, with the computerisation of more and more systems on the aircraft, is to gradually integrate these individual systems into one super-system.

Back to propellers

As aircraft become increasingly computerised "space-age" machines, why should propellers be making a comeback? They're old hat, aren't they? They disappeared from large passenger aircraft in the 1960s when suitable jet engines were developed. Twenty years ago, fuel was a fraction of today's prices and so it made sense to move away

from noisy propellers to quieter (inside the passenger cabin) and faster jet power.

Now, though, fuel economy is a critical factor in airline economics and designers are looking again at the more fuel-efficient propeller. The high speed designs have curious curling swept-back blades. The first experimental "prop-fan" engines (also called UnDucted Fans or UDF) have been run up to speed on test beds and in flying trials and appear to be capable of the same order of power outputs as current jet engines.

New materials and improved control of the propeller blades by a technique called synchrophasing all help to reduce this propeller's noise problem. Inside the cabin, wall panels may be vibrated like flat loudspeakers out of phase with the engine vibrations in order to "cancel" them out and dramatically reduce the noise and vibration levels experienced by passengers. This technique is

also known as active anti-sound.

Boeing has already enlisted the support of several Japanese aerospace companies to build a new aircraft, code-named the 7J7, which will be powered by prop-fans. The 7J7 is expected to fly in 1991 and to enter service in the world's airways in 1992. McDonnell-Douglas has also unveiled plans to build a prop-fan-powered aircraft, code-named the MD-91X. All the major engine and aircraft manufacturers are involved in the development of prop-fan engines and the aircraft that will carry them, so propellers are certain to reappear in the 1990s.

So, the plane that whisks you off for your holidays in the 1990s will probably have exotic curling, swept-back propellers. It will also have a "Buck Rogers" flight deck bristling with computer screens and hand controllers, be eerily quiet inside the cabin, and will actually be flown by a computer system "managed" and supervised by the aircrew. 



British Aerospace's Experimental Aircraft Program (EAP) technology demonstrator — a flying test bed for the military aircraft of the future. (Photo: British Aerospace).

UPGRADE NOW!

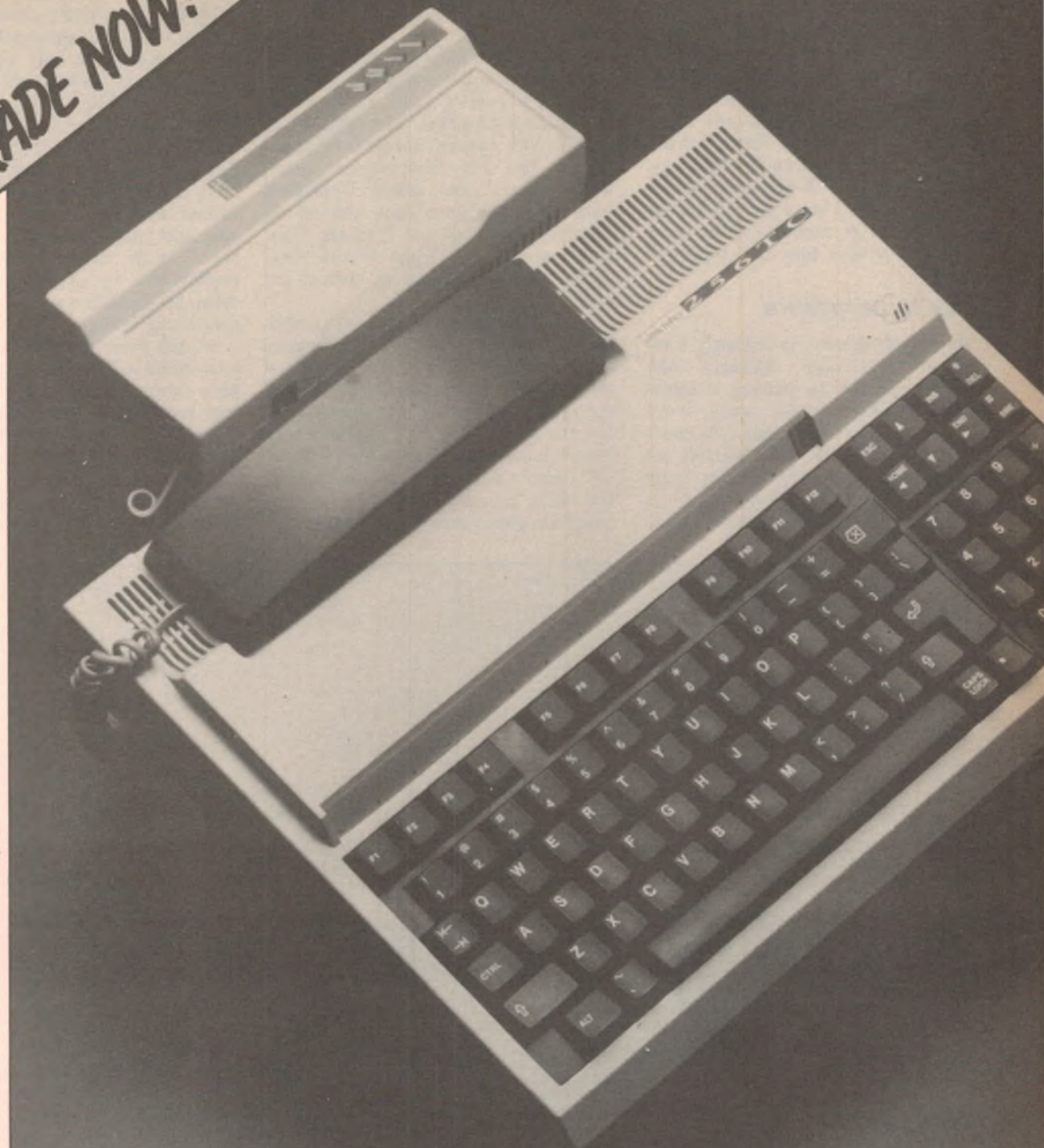

MICROBEE 256TC

A breakthrough in Australian informatics

- 256k of Dynamic RAM
- Single or dual 3.5" 800k double density disk drives
- Ergonomic, Australian designed keyboard with numeral pad and function keys
- Optional AUTOMODEM for the complete communications package.

IT'S FOR YOU

It's a new class of very personal computer for Education and Communication the Microbee 256TC is in a class of its own.

The product of over \$1,000,000 of Australian research and development. Designed by Australians for the World market, the 256TC is a totally new concept for the Education Information Revolution. Whether you are simply seeking a better education for your family, or wishing to improve your letter writing, personal business and communication skills, the new 256TC is your kind of computer. From Homework assignments to 'Learning Can Be Fun' Educational games and even Adventure and Graphic Games of skill, the 256TC will stimulate and entertain the whole family, and what's more the education approved Microbee software will ensure your family's home learning is in tune with their day time studies.

The powerful 256 TC Executive Solution with its twin 3.5" 800k disk drives and brilliant, low cost Microbee Automodem delivers you the complete Executive Computer for your home or office. Send and receive your own Telex messages, use Viatel, do your banking at home and communicate with other systems. With this new Microbee you can do it all.

EDUCATION SOLUTION

Price \$1299.00

Package includes: Microbee 256TC single drive, M-15 High resolution monitor 15KHz, 256TC manuals and software including Simply Write, Videotext, Telcom and Learning Can Be Fun.

HOME OFFICE SOLUTION

Price \$1899.00

Package includes: Microbee 256TC dual drive, M-15 High resolution monitor 15KHz, DP-100 Near letter quality, dot matrix printer and parallel printer cable, 256TC Manuals and software including Simply Write, Videotext, Telcom, and Learning Can Be Fun.

EXECUTIVE SOLUTION

Price \$2999.00

Package includes: Microbee 256TC dual drives, 7030 High resolution RGB colour monitor, power supply 1.5A (for colour monitor), DP-100 Near letter quality dot matrix printer, parallel printer cable, Microbee Automodem 300+1200/75 bps RS232 serial M-M cable 256TC Manuals and software including Simply Write, Videotext, Telcom, Typing Drill, and Learning Can Be Fun.



microbee

256TC

UPGRADE

Yes. You can upgrade your old Microbee keyboard and disk unit to a brand new 256TC. Write in, phone or call in at a Microbee Computer Centre now for a free catalogue.

MICROBEE COMPUTER CENTRES AND DEALERS

GOSFORD CENTRE
Koala Crescent,
West Gosford, N.S.W. 2250
(043) 24 2711

MELBOURNE CENTRE
50 - 52 Whitehorse Road,
Deepdene, Vic. 3101
(03) 817 1371

ADELAIDE CENTRE
117 - 119 Gouger Street,
Adelaide, S.A. 5000
(08) 212 3299

PERTH CENTRE
141 Stirling Highway,
Nedlands, W.A. 6009
(09) 386 8289

WAITARA CENTRE
1a Pattison Avenue,
Waitara, N.S.W. 2077
(02) 487 2711

NEWCASTLE CENTRE
2/956 Hunter Street,
Newcastle West, N.S.W. 2302
(049) 61 1090

BRISBANE CENTRE
455 Logan Road,
Stones Corner, Qld. 4120
(07) 394 3688

NETWORK A.B. SWEDEN
Box 10 264,
43401 Kungsbacka, SWEDEN
(300) 19500

COMPU-K (066) 21 8180 • TIMBERTOWN COMPUTERS (065) 85 3311
SHORE COMPUTER SERVICES (044) 21 4522 • MICROZED COMPUTERS (067) 72 2777
SPICER'S OFFICE EQUIPMENT (080) 88 2188 • COUNTRY OFFICE SUPPLIES (069) 53 4155
COUNTRY OFFICE SUPPLIES (069) 21 1600 • CLIMBERLAND COMPUTERS (02) 819 6666
THE WORDWORKS (062) 47 7739 • THE XEROX SHOP (070) 51 4341 • SOFTWARE 80 (07) 369 6888
TOWN & COUNTRY COMPUTERS (077) 75 4000 • CABBS COMPUTER SERVICE (053) 52 4326
C & G SOVEREIGN (050) 22 1777 • AUSTRALBEE MICROCOMPUTER PROMOTIONS (03) 233 9665
SIMPLY COMPUTERS (055) 62 8140 • COLAC COMPUTER SERVICE (052) 36 6290
LINCOLN COMPUTER CENTRE (086) 82 1666 • PINE STREET TRADING (091) 89 1383

Radar: its wartime role

Radar played a crucial role in the outcome of the Second World War. Here, the author reflects on some of the developments that took place during his six years as a technical instructor with the Royal Air Force.

by DOUG THWAITES

During the last war many new ideas emerged and were rapidly developed. Of these, radar was one of the most significant.

Early in 1940, I entered the RAF and joined a group of technicians who were called "Radio Mechanics" but who would never touch a radio. It was radar we were going to service but it was called "RDF" (Radio Direction Finding) in those days.

After a quick course in VHF techniques, we got an introduction to the first airborne equipment. We were then split up and sent to different areas. I was sent to the east coast of Scotland. The flying activities in this area involved patrolling the sea and coast of occupied Denmark and Norway.

The RDF sets used for this purpose were called "ASV" (Aircraft to Surface Vessel) and the first ones were a mixture. The receiver was, in fact, part of a commercial TV, but the transmitter was made for the job.

Two transmitting valves with quarter wave stubs as the anode circuit, and working as a blocking oscillator, sent out pulses of radiation at VHF. The reflected signal, after passing through the receiver, was displayed on the vertical

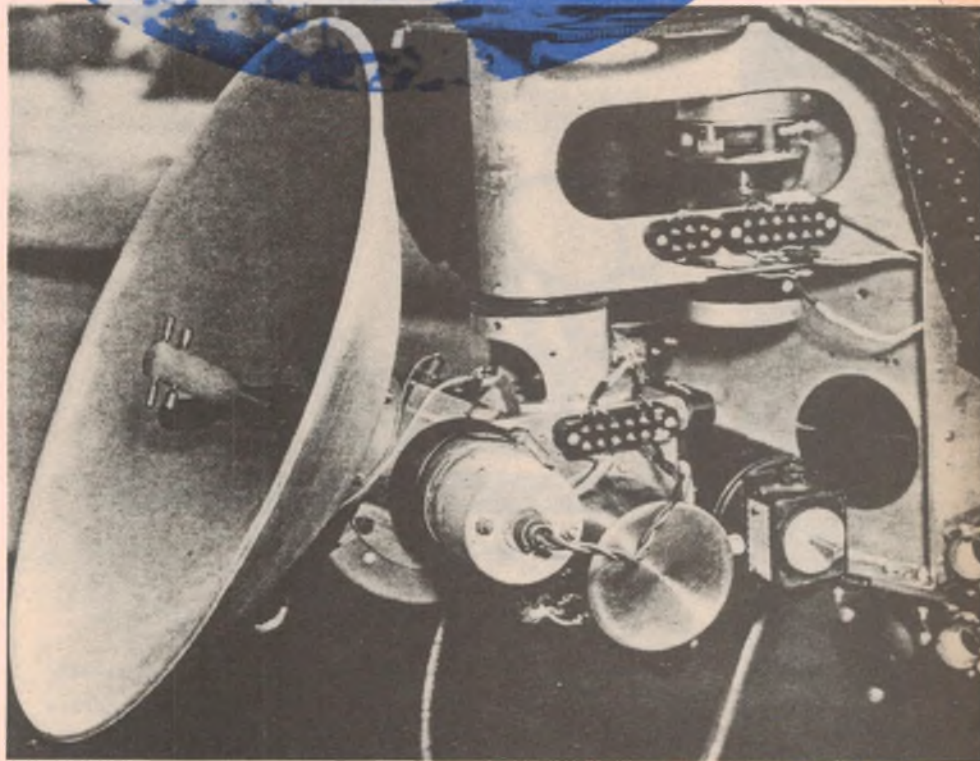

Centimetric AI (Aircraft Interception): this dish with dipole antenna produced a torch-like beam and scanned in a spiral from dead ahead outward to the circumference and then in a decreasing spiral back to the centre again.

trace of a small CRT. This trace was started by the transmitter pulse, so the distance up the trace was related to the distance of the object from the aircraft. The target direction was determined by two stub antennas, mounted one either side of the aircraft's nose, which were switched in synchronism with the receiver output. The output from the left antenna deflected the trace to the left, and vice versa.

At the same time, it was important that ground stations could identify friend from foe and so IFF was born. When IFF received an RDF pulse, it transmitted a series of pulses that produced a recognisable effect at the ground station.

The trouble with these devices was that they were fitted with an explosive charge detonated by a gravity switch on the nose of the aircraft. The idea of this was that it would go off when the aircraft crashed, but it could also be tripped accidentally if someone knocked the switch with a ladder when working on the motors.

One of our jobs was to connect the plug to the detonator, prior to take off. Just think of the shock if, in the middle of the night, you put the plug in and it blew up. And they did, but luckily not on me.

We also had a Beacon to guide aircraft home. It was an IFF but coded to identify our aerodrome. ASV had its drawbacks of course, one being that it was a forward seeking device. This meant that ships or submarines on the surface could be missed if they were some way to either side of the aircraft's track.

To overcome this problem, phased arrays were fitted to some aircraft behind the wings. This gave a narrow beam to either side of the aircraft.

Night fighters

Night fighters used an RDF system but it was called AI (Aircraft Interception). The ground RDF stations could determine the number of enemy aircraft approaching the coast, and their height, distance and bearing. By this means, ground controllers were able to direct the fighters to the "Bandits", with IFF sorting out who was who.

By 1941, I had joined Technical Training Command and was training aircrew in the use of ASV as a method of navigating as well as detecting surface vessels. This entailed in-flight training in a blacked out cabin, flying six hours a day six days a week at Prestwick, on the west coast of Scotland.

As the situation in Europe had de-

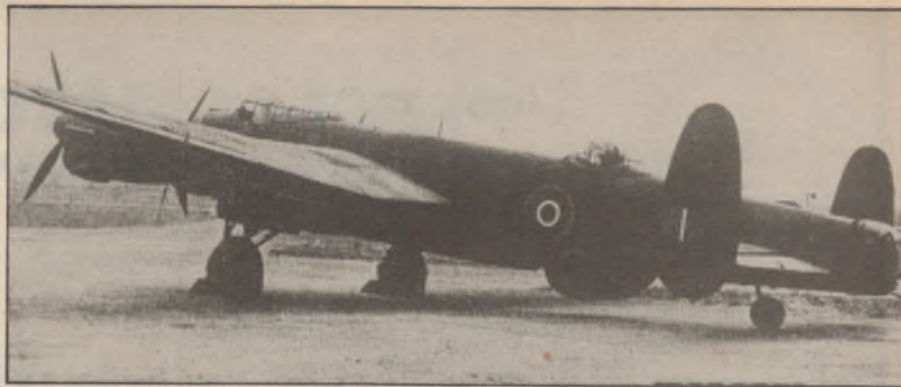

A Lincoln bomber showing the blister shielding the H2S scanner directly under the gun turret.

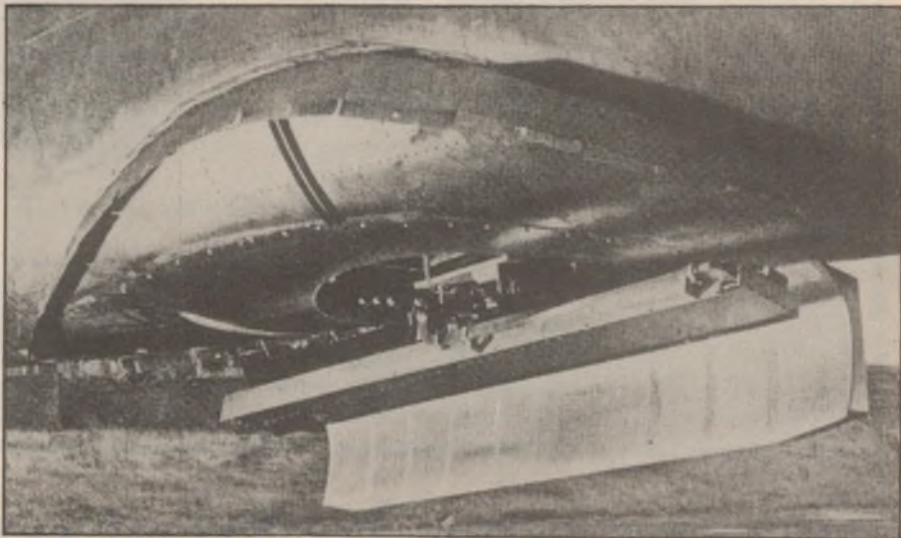

H2S scanner with blister removed, showing the dish that is fed by a slotted waveguide antenna array.

teriorated, half of the school staff were sent to Canada to start a similar school there, "just in case". By now we had better equipment as the country had geared up for war, and radar was in full production.

As technicians were required in large numbers to service this new equipment, hundreds of personnel had been training for the past year in different schools as electronic technicians. I was moved to London where a radar school had been set up in the Royal School of Arts building in South Kensington, ready to give them their training in the new radar that would soon be fitted to thousands of bombers for the mass raids on Germany. I went to Malvern University to find out what this new radar would do.

The Magnetron

With the development of the Magnetron the whole radar scene had changed, as by using centimetric wavelengths very narrow beams could be

achieved without huge cumbersome arrays.

Just like a torch, a dish antenna could focus the energy into a narrow beam. The new radar was called "H2S", and worked on a wavelength of 10 centimetres. It used a beam that rotated and covered a large circle, the middle of which lay directly under the aircraft. The beam had to be wide in the vertical direction and very narrow in the horizontal to get good definition of objects.

This was achieved by using a portion of a dish which was narrow in height to give a narrow beam, and feeding the wide section with a slotted waveguide antenna.

However, to have this dish scanner stuck in the slipstream would affect the aircraft's flying performance so it was fitted inside a streamlined blister on the underside of the fuselage.

The display method was new, using two CRTs mounted one above the other. The upper one had an electromagnetic winding (yoke) which rotated



"PERFECT MATCH" FROM "CRUSADER" THE



ULTIMATE IN SEVEN SEGMENT L.E.D. DISPLAY UNITS. INTERCHANGEABLE WITH "G.E.F.E." CODE SWITCHES. AVAILABLE IN — HEXADECIMAL — B.C.D. POSITIVE LOGIC INPUTS & FACILITY FOR DECIMAL POINT.

FREE SPECIFICATIONS AND DATA FROM:
CRUSADER ELECTRONIC COMPONENTS PTY. LTD.



81 PRINCES HWY, ST PETERS, NSW 2044. Phone **516 3855** 519 6685 517 2775. Telex: 123993 Fax: (02) 517 1189
APPOINTED DISTRIBUTORS:

SYDNEY: GEORGE BROWN & CO PTY. LTD. PHONE 519 5855 GEOFF WOOD ELECTRONICS PTY. LTD. PHONE 810 6845
WOLLONGONG: MACELEC PTY. LTD. PHONE 29 1455 CANBERRA: GEORGE BROWN & CO PTY. LTD. PHONE 80 4355
NEWCASTLE: NOVOCASTRIAN ELECTRONIC SUPPLIES PHONE 61 6055 MELBOURNE: R. PG. AGENCIES PTY. LTD.
PHONE 439 5834 JESEC COMPONENTS PTY. LTD. PHONE 598 2333 GEORGE BROWN & CO PTY. LTD. PHONE 419 3355
BRISBANE: L.E. BOUGHEN & CO PHONE 369 1277 COLOURVIEW WHOLESALE PTY. LTD. PHONE 275 3188 ST LUCIA
ELECTRONICS PHONE 52 7466 ADELAIDE: PROTRONICS PTY. LTD. PHONE 212 3111 D.C. ELECTRONICS PTY. LTD.
PHONE 233 6946 PERTH: SIMON HOLMAN & CO PHONE 381 4155 PROTRONICS PTY. LTD. PHONE 362 1044

Turn your hobby into a profitable career in computers.



You're obviously interested in electronics. Why else would you be reading this magazine?

But have you ever considered turning your interest into a rewarding career as a computer maintenance engineer?

The Control Data Institute can help you fulfil your goal in the shortest possible time by teaching you such subjects as basic electronics, microprocessors, data communication, disk drives and machine language programming.

We then help you further by helping more than

90% of our graduates get their first jobs in this exciting, expanding industry.

Don't delay, contact Control Data now.
Sydney 438 1300, Melbourne 268 9666.

GD CONTROL DATA INSTITUTE
A computer career starts here.

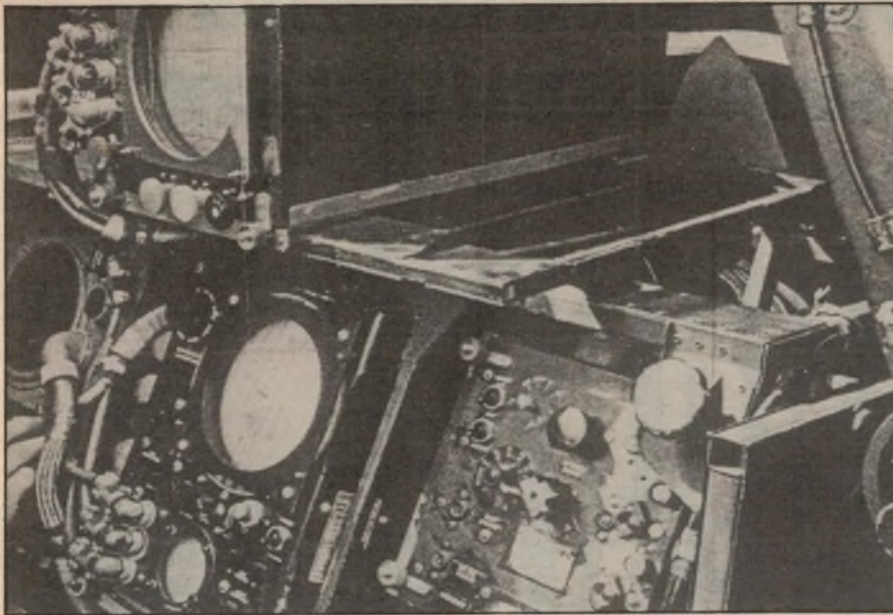

H2S equipment in a Lincoln bomber. The transmitter is to the right of the display unit. The other CRTs are for navigation systems.

around the neck and produced a trace that started in the middle of the tube face and travelled to the circumference. This rotation was synchronised with the antenna rotation and, each time the antenna faced ahead, the trace was illuminated.

This produced a radar map of the area over which the plane was flying, and the bright trace was the aircraft's course. Bright-up pulses were fed to the tube at set intervals to give the range rings. We now had a method of flying over sea or land at night and navigating with this aid, but more was needed to bomb with accuracy.

To hit a target with a bomb, the distance from the target to the point on the ground directly under the aircraft had to be determined. This was done using the radar to measure the height (one side) and the distance from the plane to the target (hypotenuse). It was then a simple matter of using Pythagoras's Theorem to determine the distance to the target from the point on the ground directly beneath the aircraft.

How it was done was almost equally as simple. Under the PPI (plan position indicator) display was a small tube with a normal vertical trace, on which the first visible echo was that of the land underneath.

The distance of this echo up the trace was of course the height. A pulse with a variable delay was used to measure this. Another variable delay produced a range ring that could be set on the selected target on the PPI. The two controls were in a small box with interacting controls and a scale from which the

ground range could be read.

This new equipment was called H2S from the Theorem. So H2 is the height squared (one side) and S is the slant range from aircraft to target (hypotenuse). To make this system even more effective, an aerial photo of the target area was obtained, and from this a three dimensional reproduction of the target was constructed on a sheet of glass.

This was submerged in a tank of water and scanned by a beam of ultrasound from a rotating transducer just beneath the surface. The transducer itself was driven by a motor synchronised with a PPI yoke. By this means, it was possible to produce a simulated radar picture.

This was photographed and copies used to make it easier for the radar operator to identify the target. The H2S equipment was fitted to Mosquito "pathfinder" aircraft which would locate the target and identify it by the use of pyrotechnical bombs. These created large coloured flares that could be seen by the bomber streams approaching the area.

Maritime radar

H2S ASV was also used in the war against the submarine. An unexpected benefit was the ability to detect wind direction at sea level. It was soon discovered that the sea return at the centre of the PPI was elongated in the direction of the wind source. This was because the pulses were reflected more strongly from the back of a wave than from the sloping front.

As pulse technology developed, use was made of strobe pulses to lock on to echos and stay with them. A strobe pulse was placed on an echo, and then only that signal was allowed through a gating circuit. Two strobe pulses were then used to gate both the leading half of the signal and the trailing half.

The two signals were compared and, as the range decreased, the leading half would become longer. This, in turn, would cause the delay producing the strobe pulses to change until the signals were once again equal. Thus, a target's range from the aircraft was now produced as an electronic value.

This information was used to develop an ASV that would release depth charges at exactly the right time with deadly accuracy. Now all a pilot had to do was lock the strobe onto a selected echo on his PPI and then fly with that echo on his illuminated course trace. The equipment even opened the bomb doors for him.

As submariners in those days had to surface every night to recharge their batteries, they were sitting ducks for this equipment. However, initial enthusiasm was lowered after the rumoured sinking of some Spanish fishing boats one night. But constant research was taking place and radar equipment working at 3cm and then 1.25cm was produced. These gave more detailed pictures but had much higher losses in cloud or rain.

As D-Day approached it was essential that all enemy coastal radars be put out of action. The "boffins" loved fancy names and "Wire Basket" was no exception. This device scanned the radar bands and marked any received signals on a roll of paper.

The position of the marks would give the frequency and a scale on the paper edge gave the time. If fitted to an aircraft that then flew a predetermined course at a set speed, information would be recorded on all radar sites in the area covered.

A team of trained airwomen extracted from these rolls of paper the exact position of every radar site along the French coast, and mass bomber raids made sure that they were not working when the Allied invasion fleet crossed the channel.

Since the end of that war, military radar has become so sophisticated that the wartime radar now seems primitive. But, primitive or not, it played a crucial role in many theatres of conflict and set the stage for rapid post-war development..

Melbourne Electronics



MELBOURNE 48 A'Beckett Street, Phone (03) 663 6151.

NORTHCOE 425 High Street, Phone (03) 489 8866.

MAILORDER HOTLINE: (03) 543 7877

IC SPECIALS!

8087 CHIPS! from \$279

- 8087-3 (4.77MHz) \$279
- 8087-2 (8MHz)... \$399
- 8087-1 (10MHz).. \$649
- 80287-3 (6MHz)... \$499
- 80287-7 (8MHz).. \$699
- 8087-3 (4.77MHz) \$279

SPO256A-AL2 SPEECH CHIP

Speech synthesiser chip, needs programming to work.

1-9 10+ 100+

\$15.00 \$14.50 \$14.00

CTS256-AL2 SPEECH CHIP

Contains the code recognition circuit to enable the recognition plug directly on to the printer port, or into an IBM PC.

1-9 10+ 100+

\$27.00 \$26.50 \$26.00

41256-15

1-9 10+ 100+
\$5.95 \$5.50 \$4.95

4164

1-9 10+ 100+
\$2.25 \$1.95 \$1.75

27128

1-9 10+ 100+
\$7.50 \$7.00 \$6.50

27512

1-9 10+ 100+
\$19.50 \$18.50 \$17.50

CA3130E

1-9 10+ 100+
\$1.95 \$1.75 \$1.50

6116 LP-3

1-9 10+ 100+
\$3.95 \$3.75 \$3.50

NE553AN

1-9 10+ 100+
\$1.95 \$1.85 \$1.75

INS8250

1-9 10+ 100+
\$24.50 \$22.50 \$20.50

AM 7910

(WORLD MODEM CHIP)
\$24.95

4000	50	74150	1.50	74F533	4.84	74LS298	1.20	74S473	9.00	NE555	4.00	2101 (5101)		RC559	20	2N1813	1.20	2SK45	3.95
4001	50	74151	1.20	74F534	4.84	74LS299	1.20	74S474	9.00	NE556	1.90	(80) 2101	7.90	RC560	20	2N1814	1.20	2SK46	3.95
4002	50	74152	1.20	74F535	4.84	74LS300	1.20	74S475	9.00	NE557	5.00	5101	7.90	RC640	50	2N2119	1.50	2SJ56	17.50
4003	1.80	74181	1.20	74HC00	80	74LS321	3.95	74S482	11.90	NE560	4.60	8101	7.90	RC700	1.90	2N2222A	1.00	2SK134	7.95
4004	1.80	74182	1.20	74HC01	80	74LS322	3.95	74S483	11.90	NE562	2.00	27265	12.50	RC710	1.90	2N2269	1.00	2SK176	17.50
4005	1.80	74183	1.20	74HC02	80	74LS323	3.95	74S484	11.90	NE570	5.90	NE570	5.90	BD138	60	2N2484	1.00		
4006	1.80	74184	1.20	74HC03	80	74LS324	3.95	74S485	11.90	NE571	5.90	NE571	5.90	BD140	60	2N2646	1.95	DIGIDES	
4007	1.80	74185	1.20	74HC04	80	74LS325	3.95	74S486	11.90	NE582	6.90	NE582	6.90	BD142	60	2N2647	1.95	1N4007	15
4008	1.80	74186	1.20	74HC05	80	74LS326	3.95	74S487	11.90	NE594	5.90	NE594	5.90	BD144	60	2N2694	1.00	1N4148	10
4009	1.80	74187	1.20	74HC06	80	74LS327	3.95	74S488	11.90	NE600	6.00	NE600	6.00	BD146	60	2N2904	1.00	0A80	40
4010	1.80	74188	1.20	74HC07	80	74LS328	3.95	74S489	11.90	NE602	6.00	NE602	6.00	BD148	60	2N2905	1.10	0A85	40
4011	1.80	74189	1.20	74HC08	80	74LS329	3.95	74S490	11.90	NE604	6.00	NE604	6.00	BD150	60	2N2906	1.10	1N4508	10
4012	1.80	74190	1.20	74HC09	80	74LS330	3.95	74S491	11.90	NE606	6.00	NE606	6.00	BD152	60	2N2907	1.10	0A47	80
4013	1.80	74191	1.20	74HC10	80	74LS331	3.95	74S492	11.90	NE608	6.00	NE608	6.00	BD154	60	2N3019	1.60	0A90	40
4014	1.80	74192	1.20	74HC11	80	74LS332	3.95	74S493	11.90	NE610	6.00	NE610	6.00	BD156	60	2N3054	1.90	W04	5.00
4015	1.80	74193	1.20	74HC12	80	74LS333	3.95	74S494	11.90	NE612	6.00	NE612	6.00	BD158	60	2N3055	1.20	5082-2800	2.95
4016	1.80	74194	1.20	74HC13	80	74LS334	3.95	74S495	11.90	NE614	6.00	NE614	6.00	BD160	60	2N3055	1.20	5082-2811	4.95
4017	1.80	74195	1.20	74HC14	80	74LS335	3.95	74S496	11.90	NE616	6.00	NE616	6.00	BD162	60	2N3096	1.90	HM6520	5.95
4018	1.80	74196	1.20	74HC15	80	74LS336	3.95	74S497	11.90	NE618	6.00	NE618	6.00	BD164	60	2N3106	1.90		
4019	1.80	74197	1.20	74HC16	80	74LS337	3.95	74S498	11.90	NE620	6.00	NE620	6.00	BD166	60	2N3221	1.90		
4020	1.80	74198	1.20	74HC17	80	74LS338	3.95	74S499	11.90	NE622	6.00	NE622	6.00	BD168	60	2N3259	1.90		
4021	1.80	74199	1.20	74HC18	80	74LS339	3.95	74S500	11.90	NE624	6.00	NE624	6.00	BD170	60	2N3440	1.80	W05	5.00
4022	1.80	74200	1.20	74HC19	80	74LS340	3.95	74S501	11.90	NE626	6.00	NE626	6.00	BD172	60	2N3441	1.80	W02	40
4023	1.80	74201	1.20	74HC20	80	74LS341	3.95	74S502	11.90	NE628	6.00	NE628	6.00	BD174	60	2N3442	1.80	W04	5.00
4024	1.80	74202	1.20	74HC21	80	74LS342	3.95	74S503	11.90	NE630	6.00	NE630	6.00	BD176	60	2N3563	3.00	EAMP	
4025	1.80	74203	1.20	74HC22	80	74LS343	3.95	74S504	11.90	NE632	6.00	NE632	6.00	BD178	60	2N3564	3.00	BPC602	2.90
4026	1.80	74204	1.20	74HC23	80	74LS344	3.95	74S505	11.90	NE634	6.00	NE634	6.00	BD180	60	2N3565	3.00	KBPC604	3.90
4027	1.80	74205	1.20	74HC24	80	74LS345	3.95	74S506	11.90	NE636	6.00	NE636	6.00	BD182	60	2N3566	3.00	KBPC606	4.90
4028	1.80	74206	1.20	74HC25	80	74LS346	3.95	74S507	11.90	NE638	6.00	NE638	6.00	BD184	60	2N3567	3.00	15AMP	
4029	1.80	74207	1.20	74HC26	80	74LS347	3.95	74S508	11.90	NE640	6.00	NE640	6.00	BD186	60	2N3640	3.00	KBPC3502	9.90
4030	1.80	74208	1.20	74HC27	80	74LS348	3.95	74S509	11.90	NE642	6.00	NE642	6.00	BD188	60	2N3641	3.00	A3504	6.90
4031	1.80	74209	1.20	74HC28	80	74LS349	3.95	74S510	11.90	NE644	6.00	NE644	6.00	BD190	60	2N3643	3.00	KBPC3510 MDA	
4032	1.80	74210	1.20	74HC29	80	74LS350	3.95	74S511	11.90	NE646	6.00	NE646	6.00	BD192	60	2N3644	3.00	3510	6.90
4033	1.80	74211	1.20	74HC30	80	74LS351	3.95	74S512	11.90	NE648	6.00	NE648	6.00	BD194	60	2N3645	3.00		
4034	1.80	74212	1.20	74HC31	80	74LS352	3.95	74S513	11.90	NE650	6.00	NE650	6.00	BD196	60	2N3646	3.00		
4035	1.80	74213	1.20	74HC32	80	74LS353	3.95	74S514	11.90	NE652	6.00	NE652	6.00	BD198	60	2N3647	3.00		
4036	1.80	74214	1.20	74HC33	80	74LS354	3.95	74S515	11.90	NE654	6.00	NE654	6.00	BD199	60	2N3648	3.00		
4037	1.80	74215	1.20	74HC34	80	74LS355	3.95	74S516	11.90	NE656	6.00	NE656	6.00	BD200	60	2N3649	3.00		
4038	1.80	74216	1.20	74HC35	80	74LS356	3.95	74S517	11.90	NE658	6.00	NE658	6.00	BD202	60	2N3650	3.00		
4039	1.80	74217	1.20	74HC36	80	74LS357	3.95	74S518	11.90	NE660	6.00	NE660	6.00	BD204	60	2N3651	3.00		
4040	1.80	74218	1.20	74HC37	80	74LS358	3.95	74S519	11.90	NE662	6.00	NE662	6.00	BD206	60	2N3652	3.00		
4041	1.80	74219	1.20	74HC38	80	74LS359	3.95	74S520	11.90	NE664	6.00	NE664	6.00	BD208	60	2N3653	3.00		
4042	1.80	74220	1.20	74HC39	80	74LS360	3.95	74S521	11.90	NE666	6.00	NE666	6.00	BD210	60	2N3654	3.00		
4043	1.80	74221	1.20	74HC40	80	74LS361	3.95	74S522	11.90	NE668	6.00	NE668	6.00	BD212	60	2N3655	3.00		
4044	1.80	74222	1.20	74HC41	80	74LS362	3.95	74S523	11.90	NE670	6.00	NE670	6.00	BD214	60	2N3656	3.00		
4045	1.80	74223	1.20	74HC42	80	74LS363	3.95	74S524	11.90	NE672	6.00	NE672	6.00	BD216	60	2N3657	3.00		
4046	1.80	74224	1.20	74HC43	80	74LS364	3.95	74S525	11.90	NE674	6.00	NE674	6.00	BD218	60	2N3658	3.00		
4047	1.80	74225	1.20	74HC44	80	74LS365	3.95	74S526	11.90	NE676	6.00	NE676	6.00	BD220	60	2N3659	3.00		
4048	1.80	74226	1.20	74HC45	80	74LS366	3.95	74S527	11.90	NE678	6.00	NE678	6.00	BD222	60	2N3660	3.00		
4049	1.80	74227	1.20	74HC46	80	74LS367	3.95	74S528	11.90	NE680	6.00	NE680	6.00	BD224	60	2N3661	3.00		
4050	1.80	74228	1.20	74HC47	80	74LS368	3.95	74S529	11.90	NE682	6.00	NE682	6.00	BD226	60	2N3662	3.00		
4051	1.80	74229	1.20	74HC48	80	74LS369	3.95	74S530	11.90	NE684	6.00	NE684	6.00	BD228	60	2N3663	3.00		
4052	1.80	74230	1.20	74HC49	80	74LS370	3.95	74S531	11.90	NE686	6.00	NE686	6.00	BD230	60	2N3664	3.00		
4053	1.80	74231	1.20	74HC50	80	74LS371	3.95	74S532	11.90	NE688	6.00	NE688	6.00	BD232	60	2N3665	3.00		
4054	1.80	74232	1.20	74HC51	80	74LS372	3.95	74S533	11.90	NE690	6.00	NE690	6.00	BD234	60	2N3666	3.00		
4055	1.80	74233	1.20	74HC52	80	74LS373	3.95	74S534	11.90	NE692	6.00	NE692							

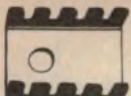

MINIATURE HEATSINK!
A great little fellow if you are short of space. Great price too, because we import direct so you save!

Cat. H10606 1-9 10+
\$0.40 \$0.35



COMPUTER CABLE
CIC6 6 conductor computer interface cable. Colour coded with braided shield.
(to IE422 specifications)
Copper conductor 6 x 7/0 16mm
1-9 metres 10+ metres
\$1.90/m \$1.70/m

CIC9 100 9 conductor computer interface cable. Colour coded with mylar shielding 9 x 7/0 16mm
1-9 metres 10+ metres
\$2.50/m \$1.95/m

CIC12 12 conductor computer interface cable. Colour coded with mylar shielding 12 x 7/0 16mm
1-3 metres 10+ metres
\$2.70/m \$2.50/m

CIC16 16 conductor computer interface cable. Colour coded with mylar shielding 16 x 7/0 16mm
1-9 metres 10+ metres
\$3.90/m \$3.40/m

CIC25 25 conductor computer interface cable. Colour coded with mylar shielding 25 x 7/0 16mm
1-9 metres 10+ metres
\$4.90/m \$4.40/m

RAINBOW CABLE

Suitable for IDC connectors

Cat No	Description	\$/metre
W12714	28AWG 14W	\$1.80
W12716	28AWG 16W	\$1.80
W12720	28AWG 20W	\$2.20
W12726	28AWG 26W	\$2.90
W12734	28AWG 34W	\$3.60
W12740	28AWG 40W	\$4.40

COUNTER

Cat. \$12.95

MAINS MUFFLER

Sudden mains disturbances can seriously affect your computer equipment, and stored data. So why risk it when you can have a Mains Muffler, particularly when the cost of one failure is likely to be greater than the purchase price! So vanish those dangerous clicks and voltage spikes forever with the Mains Muffler!

SPECIFICATIONS
Maximum total load
1000W 4 AMP 250V 50Hz
Outlet Sockets
Attenuation: 150KHz - 47dB
500KHz - 68dB
10MHz - 66dB
Dual T Section:
VDR Transient suppression
Surge capacity 200 Amp 8 x 20uS
2 WAY Cat. X10089 **\$199**
4 WAY Cat. X10090 **\$299**

HIGH EFFICIENCY RADIAL FIN HEATSINK

Black anodised with a thick base plate, this radial fin heatsink can dissipate large amounts of heat for maximum efficiency. Designed by Rod Irving

105x30mm	Cat. H10520	\$ 3.50
105x75mm	Cat. H10525	\$ 3.50
105x100mm	Cat. H10529	\$ 4.90
105x140mm	Cat. H10534	\$ 6.50
105x150mm	Cat. H10535	\$ 6.75
105x170mm	Cat. H10538	\$ 7.95
105x195mm	Cat. H10542	\$ 9.90
105x200mm	Cat. H10543	\$ 9.90
105x225mm	Cat. H10546	\$10.50
105x300mm	Cat. H10549	\$12.00
105x600mm	Cat. H10560	\$24.95



RS232 GENDER CHANGERS

● Saves modifying or replacing non-mating RS232 cables.
● All 25 pins wired straight through
Cat. X15650 Male to Male
Cat. X15651 Male to Female
Cat. X15652 Female to Female
Normally \$19.95 each
Only \$14.95



RS232C NULL MODEM ADAPTOR

● Male to female connections
● Pins 2 and 3 reversed
● All 25 pins connected
Cat. X15657 Male to Male
Cat. X15658 Male to Female
Cat. X15659 Female to Female
Normally \$22.95
Only \$14.95



RS232 WIRING ADAPTOR BOX

● Male to female
● 25 Detachable plug on leads
● 2 mini jumpers
● Ideal for experimenting or temporary connections
Cat. X15665
Normally \$39.95
Only \$29.95



RS232 MINI JUMPER PATCH BOXES

● Interface RS232 devices
● 25 pin inputs
● 25 leads with tinned end supplied
● Complete with instructions
Cat. X15653 Male to Male
Cat. X15654 Female to Male
Cat. X15655 Female to Female
Normally \$25.95
Only \$19.95



RS232 MINI TESTER

● Male to female connections
● All pin wired straight through
● Dual colour LED indicates activity and direction on 7 lines
● No batteries or power required
T.D. Transmit Data
D.S.R. Data Set Ready
R.D. Receive Data
C.D. Carrier Detect
R.T.S. Request to Send
D.T.R. Data Terminal Ready
C.T.S. Clear to Send
Cat. X15656
Normally \$39.95
Only \$29.95

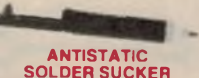

ANTISTATIC SOLDER SUCKER

● Light weight
● Sturdy construction
● Easy to remove tip
● Excellent value for money!
Cat. T11281 **\$13.95**

ELECTRONIC DOOR ALARM AND CHIME

Electronic control system with powerful in-built 100dB alarm. Changeable 3 digit, push button, secret code controller that is tamper proof. 3 function switch provides off position, chime and 7 seconds delay entry. Emergency panic button. Suitable for left or right hand door opening. Simple installation, no wiring required. Low current 15mA at 9V. Operates on 9V battery.
Cat. S7777 **\$44.95**

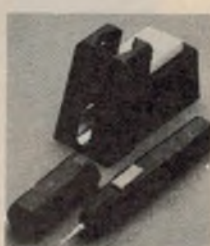

CORDLESS RECHARGEABLE SOLDERING IRON

● Built in solder point illumination
● Easy replacement of solder tip
● Protective stand which also functions as charging unit
● Sponge pad attach to stand
● Plug pack power adaptor
● Includes Nicad battery
● Instruction manual
● 12 months warranty
Cat. T12480
Normally \$79.95
SPECIAL, \$69.95

FLUORESCENT WORK & EMERGENCY LIGHT

● Suits cars, boating, caravan, camping etc.
● Shatterproof, glare free
● Cigarette lighter plug and alligator clips
● 12V DC, 8 watt, transistorised
Cat. A15052 **\$25.95**



ELECTRONIC CASSETTE DEMAGNETISER

Cat. A10006 **\$22.95**

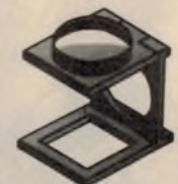

FREE STANDING, FOLD UP MAGNIFIER

An economically priced "hands free" magnifier, lets you take care of all those lanky line detailed jobs so often encountered in electronics, or any of many other practical uses such as home, work, hobbies etc.
Cat. T12083
Normally \$14.95
SPECIAL, ONLY \$12.95

SEMICONDUCTORS!

Always check with us before you buy!

	1-9	10+	100+
2716	\$9.95	\$9.50	\$8.95
2732	\$8.95	\$8.50	\$7.95
2764	\$7.95	\$7.50	\$6.95
27128	\$6.95	\$6.50	\$6.25
27256	\$11.50	\$10.50	\$10.00
4116	\$3.95	\$3.50	\$2.95
4164	\$2.95	\$2.75	\$2.50
41256	\$5.95	\$5.50	\$4.95
5558m	0.50	0.40	0.35
6116	\$3.95	\$3.75	\$3.50
6264	\$6.50	\$5.50	\$5.25
6802	\$5.00	\$4.00	\$3.75
6821	\$2.00	\$1.80	\$1.70
6845	\$5.00	\$4.00	\$3.75
7406	\$0.40	\$0.30	\$0.25
8250	\$29.95	\$27.95	

MEL9501

Have you blown up your Apple drive by plugging it in backwards or not turning off the power while changing boards? We have the MEL9501 chip!
SPECIAL, ONLY \$29.95

8087

Genuine Intel chips with manual and data sheets packed in boxes!

8087-3 (4.77MHz)	\$299
8087-2 (8MHz)	\$399
8087-1 (10MHz)	\$649
80287-3 (6MHz)	\$499
80287-7 (8MHz)	\$699
8087-3 (4.77MHz)	\$299

NE5534AN

SCOOP PURCHASE!!!
1-9 **\$1.95** 10+ **\$1.85**

WORLD MODEM CHIP

Cat. U21614
Normally \$49.50
Save \$25, SPECIAL \$24.95

PROGRAMMABLE 24 HOUR TIME SWITCH

● 48 switching possibilities per day
● 240V AC, 2400 watt, 10 amp
● Suitable for turning on:
Heaters/Coolers
pool filter
electric blankets
cooking appliances
waking you even making the coffee lights etc for security while you're away from home!
● Bargain Price!
Cat. M22002 **only \$19.95**

TV INTERFERENCE FILTER

Cuts CB/Ham signals interference
Cat. L11048 **\$5.95**

10dB IN-LINE COAXIAL AMPLIFIER

Reduces loss from splitters and long cable runs. Suitable for use with antennas, coaxial lead lines and VCR's A/C adaptor included.
SPECIFICATIONS:
Frequency Range: 5-900MHz
Gain: 10dB
Power Requirements: 12V A/C Adaptor (included)
Input Impedance: 75 ohm
Output Impedance: 75 ohm
Cat. L15043 **\$44.95**

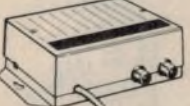

UHF/VHF/FM ANTENNA AMPLIFIER AND 2 WAY SPLITTER

Covers all Australian frequencies. Suitable for use in houses, caravans, boats etc.
● 1 x 75 ohm input
● 2 x 75 ohm output
● Gain 2 x 6dB
● Maximum output 2 x 96dBuV
Cat. L15041 **\$39.95**

UV EPROM ERASER

Erase your EPROMs quickly and safely. This unit is the cost effective solution to your problems. It will erase up to 9 x 24 pin devices in complete safety, in about 40 minutes (less for less chips).
Features include:
● Chip drawer has conductive foam pad
● Mains powered
● High UV intensity at chip surface ensures EPROMs are thoroughly erased.
● Engineered to prevent UV exposure
● Dimensions 217 x 80 x 68mm

WITHOUT TIMER

Cat. X14950
Normally \$119
Special, \$89

WITH BUILT-IN TIMER

Cat. X14955
Normally \$139
Special, \$119

CAR ANTENNA BOOSTER

● 12V boosts 100%
Cat. A12073 **\$7.95**



NICADS!

Size	Desc	1-9	10+	100+
AA	0.5 AH	\$2.95	\$2.75	\$2.25
C	1.2 AH	\$7.95	\$6.50	\$6.25
D	1.2 AH	\$7.95	\$6.50	\$6.25

UNIVERSAL BATTERY CHARGER AND TESTER

Save money on expensive batteries with this universal battery charger. Features include meter tester, and provisions for D, C, AA, AAA, N button and cell batteries. 9V and 6V (Square types). Comes complete with detailed instructions.
Cat. M23533 **\$29.95**

FLUX REMOVER

AEROSOLVE SPRAYPACKS
PCB Cleaning '201'
Cat. N11040 **\$6.95**
Freezing Spray '202'
Cat. N11042 **\$6.95**
Insulating Varnish '203'
Cat. N11043 **\$7.95**
Electric Motor Cleaner '204'
Cat. N11044 **\$6.95**
Electronic Super Clean (Froon) '205'
Cat. N11047 **\$7.50**
Flux Remover '206'
Cat. N11049 **\$6.95**
Elec Contact Cleaner & Lube '207'
Cat. N11051 **\$5.95**
Silver Cote '208'
Cat. N11054 **\$6.95**
Formula "66" '535'
Cat. N11057 **\$5.95**
Clear Coat Plastic Spray '540'
Cat. N11059 **\$6.95**

SENNHEISER HEADPHONES!!

The world's best headphones are now available from Rod Irving. Electronicall 3 models to choose from, other models are available on request! (Phone Tony DiPaolo on (03) 543 2166)



SENNHEISER HD 40

The HD40 is leather light, at just 60g! This HiFi stereo headphone is uncommonly convenient to use. Its systems can be rotated so it can fit into any drawer. It is also available as a TV headphone.
SPECIFICATIONS:
Frequency Range: 22 - 18,000Hz
Impedance: 600ohm
Distortion Factor: Approx. 1.5%; pressure on ear: approx. 1.3 N
Weight: Approx. 60g
Length of lead: 3 metres
Cat. A10515 **\$49.95**



While durable plastic, 8 ohms
Cat. C12010
Normally \$11.95
SPECIAL, ONLY \$9.95

Rod Irving Electronics

48 A Beckett St, MELBOURNE
Phone (03) 863 6151
425 High St, NORTHCOTE
Phone (03) 489 8866
Mail Order and Correspondence
P O Box 620, CLAYTON 3168
Telex: AA 151938



MAIL ORDER HOTLINE 008 335757 (TOLL FREE) (STRICTLY ORDERS ONLY)

LOCAL ORDERS & INQUIRIES (03) 543 7877

POSTAGE RATES:
\$1 - \$9.99 \$2.00
\$10 - \$24.99 \$3.00
\$25 - \$49.99 \$4.00
\$50 - \$99.99 \$5.00
\$100 - \$199 \$7.50
\$200 - \$499 \$10.00
\$500 plus \$12.50

The above postage rates are for basic postage only. Road Freight bulky and fragile items will be charged at different rates.

All sales tax exempt orders and wholesale inquiries to RITRONICS WHOLESALE, 56 Renner Rd, Clayton Ph. (03) 543 2166 (3 lines)

Errors and omissions excepted

Apple and IBM are registered trade names

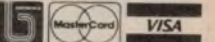



IBM* XT COMPATIBLE COMPUTERS from \$795*

Check these features and our prices. We're sure you'll agree they're exceptional value for money!

- Assembled in Australia!
 - Tested by us for 24 hours prior to delivery!
 - 150W power supply
 - AT style keyboard
 - Operating manual
 - 8 Slot motherboard
 - 6 Months warranty!
- (Japanese drives available for an extra \$50 each)

* \$795 COMPATIBLE COMPUTER

256K RAM Single Drive, Graphics and Disk Controller Card \$795

256K RAM COMPATIBLE COMPUTER
2 x 360K Disk Drives, Multifunction Card, Colour Graphics, Disk Controller, 1 Parallel Port. (Includes Timer Disk) \$1,095

640K RAM COMPATIBLE COMPUTER
2 x 360K Disk Drives, Multifunction Card, Colour Graphics, Disk Controller, 2 Serial, 1 Parallel Port (Includes Timer Disk) \$1,195

20 M/BYTE HARD DISK COMPATIBLE COMPUTER

20 M/Byte Hard Disk, 360K Disk Drive(s), 640K RAM, Multifunction Card, Colour Graphics, Disk Controller, 2 Serial, 1 Parallel Port (Includes Timer Disk)
Single 360K Floppy Disk Drive only \$1,995
Dual 360K Floppy Disk Drives only \$2,150

IBM* AT COMPATIBLE

Assembled & Tested in Australia!

- 1 M/Byte Main Board
- 1 2 M/Byte Floppy Disk Drive
- Colour Graphics Display Card
- Floppy & Hard Disk Controller
- Printer Card and RS232
- 200W Power Supply
- 6 Months Warranty
- 6 MHz
- 80286 CPU
- 20 M/Byte Hard Disk
- Keyboard
- Manual

only \$3,395

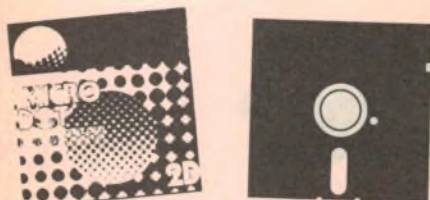

Now you can buy top quality 5 1/4" disks that are also the cheapest in Australia! They even come with a 5 year guarantee, which indicates the quality of these disks. So why pay 2-3 times the price for the same quality?

MICRODOT 5 1/4" DISKS!

DESCRIPTION	1-9 BOXES	10+ BOXES
5 1/4" S/S D/D	\$14.95	\$13.95
5 1/4" D/S D/D	\$18.95	\$17.95

(SEND \$2 FOR SAMPLE DISK!)

MICRODOT 5 1/4" HIGH DENSITY

1-9 BOXES	10+ BOXES	100+ BOXES
\$49.95	\$44.95	\$39.95

(PER 10 DISKS) (PER 10 DISKS) (PER 10 DISKS)

5 1/4" D/S "NO FRILLS" DISKS FROM 90c EACH!!

Bulked packed, Microdot D/S D/D without boxes, or brand name, just their white card jacket!

10-99 DISKS	100+ DISKS	1,000+ DISKS
\$1.20 ^{ea}	\$1.10 ^{ea}	\$0.90 ^{ea}

(SEND \$2 FOR SAMPLE DISK!)
(TAX EXEMPT PRICES LESS 20c PER DISK)

3 1/2" "NO FRILLS" DISKS!

D/S D/D disks with white boxes but no brand name. (These are a top name brand, but we can't tell you which.)

10-99 DISKS	100+ DISKS	1,000+ DISKS
\$42.50	\$39.95	\$35.00

(PER 10 DISKS) (PER 10 DISKS) (PER 10 DISKS)
(SEND \$5 FOR SAMPLE DISK!)
(TAX EXEMPT PRICES LESS 40c PER DISK)



SEMICONDUCTORS!

Always check our prices before you buy!

	1-9	10+	100+
2716	\$9.95	\$9.50	\$8.95
2732	\$8.95	\$8.50	\$7.95
2764	\$7.95	\$7.50	\$6.95
27128	\$6.95	\$6.50	\$6.25
27256	\$11.50	\$10.50	\$10.00
27512	\$19.50	\$18.50	\$17.50
4116	\$3.95	\$3.50	\$2.95
41256	\$2.25	\$1.95	\$1.75
41256	\$4.95	\$4.50	\$3.95
5558pin	\$0.50	\$0.40	\$0.35
6116	\$3.95	\$3.75	\$3.50
6264	\$6.50	\$6.00	\$5.75
6802	\$5.00	\$4.00	\$3.75
6821	\$2.00	\$1.80	\$1.70
6845	\$5.00	\$4.00	\$3.75
7406	\$0.40	\$0.30	\$0.25

INS8250 \$29.95 \$27.95

MEL9501

Have you blown up your Apple drive by plugging it in backwards or not turning off the power while changing boards? We have the MEL9501 chip! SPECIAL, ONLY \$29.95

8087

Genuine Intel chips with manual and data sheets packed in boxes!

8087-3 (4.77MHz)	\$279
8087-2 (8MHz)	\$399
8087-1 (10MHz)	\$649
80287-3 (6MHz)	\$499
80287-7 (8MHz)	\$699

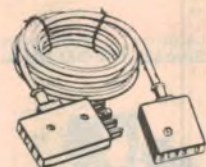

TELECOMMUNICATIONS AUSTRALIAN STYLE ADAPTOR CABLE

- Australian socket to plug/socket
 - Length 10 metres
- Cat. Y16015 \$14.95



TELEPHONE CURL CORD

- U.S. plug to U.S. plug
- Replacement hand set cord
- Length 4.5 metres

Cat. Y16023 \$6.95



TELEPHONE ADAPTOR

- Australian plug to U.S. socket
 - Length 10cm
- Cat. Y16026 \$5.95



TELEPHONE EXTENSION CABLE UNIT
Allows 15 metres of telephone extension cable to be neatly wound into a portable storage container. The reel sits on a flat base and has a handle to wind cable back on to it after use. No tangles - no mess! Ideal for the workshop, around the house, office, pool etc.
Cat. Y16013 \$22.95



JUMBO 5 1/4" DISK STORAGE

If you've got lots of disks, you'll appreciate the extra capacity of this disk storage unit when it comes to locating "that" disk!

Features:

- 100 disk capacity
- Smoked plastic cover
- Lockable (2 keys supplied)
- 9 Dividers/spacers

C16020 only \$24.95
C16027 (Hinged Lid) \$26.95



5 1/4" DISK STORAGE

Efficient and practical. Protect your disks from being damaged or lost!

Features:

- 70 disk capacity
- Smoked plastic cover
- Lockable (2 keys supplied)
- Dividers/spacers

Cat. C16025 only \$19.95



5 1/4" DISK STORAGE

Efficient and practical. Protect your disks from being damaged or lost!

Features:

- 50 disk capacity
- Smoked plastic cover
- Lockable (2 keys supplied)
- Dividers/spacers

Cat. C16030 only \$19.95



3 1/2" DISK STORAGE UNIT

- Holds up to 40 x 3 1/2" diskettes
 - Lockable (2 keys supplied)
 - High impact plastic lid and base
 - Anti-static
- Cat. C16040 only \$19.95



3 1/2" DISK STORAGE UNIT

- Holds up to 40 x 3 1/2" diskettes
 - Lockable (2 keys supplied)
 - High impact plastic lid and base
- Cat. C16035 only \$19.95



RS232 GENDER CHANGERS

- Saves modifying or replacing non-mating RS232 cables
 - All 25 pins wired straight through
- Cat. X15650 Male to Male
Cat. X15651 Male to Female
Cat. X15652 Female to Female
- Normally \$19.95 each
Only \$14.95



RS232C NULL MODEM ADAPTOR

- Male to female connections
 - Pins 2 and 3 reversed
 - All 25 pins connected
- Cat. X15657 Male to Male
Cat. X15658 Male to Female
Cat. X15659 Female to Female
- Normally \$22.95
Only \$14.95



RS232 WIRING ADAPTOR BOX

- Male to female
 - 25 Detachable plug on leads
 - 2 mini jumpers
 - Ideal for experimenting or temporary connections
- Cat. X15665 Normally \$39.95
Only \$29.95



RS232 MINI JUMPER PATCH BOXES

- Interface RS232 devices
 - 25 pin inputs
 - 25 leads with tinned end, supplied
 - Complete with instructions
- Cat. X15653 Male to Male
Cat. X15654 Female to Male
Cat. X15655 Female to Female
- Normally \$25.95
Only \$19.95



RS232 MINI TESTER

- Male to female connections
 - All pin wires straight through
 - Dual colour LED indicates activity and direction on 7 lines
 - No batteries or power required
 - T.D. Transmits Data
 - D.S.R. Data Set Ready
 - R.D. Receive Data
 - C.D. Carrier Detect
 - R.T.S. Request to Send
 - D.T.R. Data Terminal Ready
 - C.T.S. Clear to Send
- Cat. X15656 Normally \$39.95
Only \$29.95



PRINTER LEAD FOR IBM*

- Suits IBM* PC XT and compatibles
 - 25 pin "D" plug (computer end)
 - 10 Centronics 36 pin plug
- Cat. P19029 1.8 metres \$19.95
Cat. P19030 3 metres \$29.95

UV EPROM ERASER
Erase your EPROMs quickly and safely. This unit is the cost effective solution to your problems. It will erase up to 9 x 24 pin devices in complete safety, in about 40 minutes (less for less chips).
Features include:

- Chip drawer has conductive foam pad
- Mains powered
- High UV intensity at chip surface ensures EPROMs are thoroughly erased
- Engineered to prevent UV exposure
- Dimensions 217 x 80 x 68mm

WITHOUT TIMER
Cat. X14950 Normally \$119
Special, \$89

WITH BUILT-IN TIMER
Cat. X14955 Normally \$139
Special, \$119



"IBM" AT COMPATIBLE KEYBOARD

- 100% IBM* PC, XT compatible
 - Low profile keyboard design
 - Proper placement of shift keys with large key tops to suit professional typists
 - 3 step height/angle adjustment
 - Cherry brand TS-M00001 19mm low profile switches, meet 30mm ergonomic requirement and provides high performance and maximum reliability
 - Coil lead plugs straight into PC, XT
 - 3 Status displays
- Just like the "Real McCoy" only at a fraction of the price!
Cat. X12020 only \$129



IBM* XT & AT COMPATIBLE EXTENDED KEYBOARD (105 KEYS)

- These new keyboards are both XT and AT compatible!
- 20 Dedicated function keys
 - Enlarged "Return" and "Shift" key
 - Positive feel keys
 - Low Profile Design, DIN standard
 - Separate Numeric and Cursor control keyboards
 - Additional Functions:
 - Key-in-Lock, Audio Beep, Previous Word, Next Word, Fast Repeat, Line Feed, Pause, Clear Screen, Reset
- Cat. X12022 **WAS \$299**
SPECIAL, ONLY \$199



APPLE II SERIES COMPATIBLE JOYSTICK

- These joysticks have adaptor connectors to suit the Apple II, IIC, IIE and II+ computers. Features include selectable "spring centring" or "free floating". Electrical trim adjustments on both axis. 360° cursor control and dual fire buttons.
- Cat. C14201 \$49.95



JOYSTICK FOR IBM

- Features Selectable "Spring centring" or "free floating". Electrical trim adjustments on both axis. 360 degree cursor control.
- Cat. C14205 \$49.95



IBM XT COMPATIBLE CARDS

NEW! NEW! NEW! NEW!

20M/BYTE HARD DISK CARD
XT compatible, simply plugs straight in to your computer!
Cat. X18002 \$1,295

Colour Graphics Card
Cat. X18002 \$129

Graphics Card (Hercules compatible)
Cat. X18003 \$165

Floppy Disk Drive Controller Card (2 Drives 16 Bit)
Cat. X18005 \$59

Floppy Disk Drive Controller Card (4 Drives 16 Bit)
Cat. X18006 \$65

High Resolution Mono Card
Cat. X18007 \$199

Colour Graphics & Printer Card
Cat. X18010 \$149

768k RAM Card (without memory)
Cat. X18012 \$89

Printer Card
Cat. X18017 \$34.95

Game I/O Card
Cat. X18019 \$37.95

XT Motherboard (without memory)
Cat. X18020 \$225

Clock Card
Cat. X18024 \$57.50

RS232 Card (without cable)
Cat. X18026 \$59.50

RS232 & Clock Card
Cat. X18028 \$95

XT Turbo Motherboard (without memory)
Cat. X18030 \$275

Multi I/O & Disk Controller Card
Cat. X18040 \$179

I/O Plus Card
Cat. X18045 \$129

768k Multifunction I/O Card (includes cable but not 41256 RAM)
Cat. X18050 \$199

Hard Disk Controller Card
Cat. X18060 \$195

Enhanced Graphics Adaptor Card 256K RAM on board
Cat. X18070 \$375

64K Printer Buffer Card
Cat. X18077 \$139

(AT COMPATIBLE)

Enhanced Graphics Adaptor Card (Award Bios)
Cat. X \$495

APPLE* COMPATIBLE CARDS

PRINTER CARD
Cat. X17029 \$89

DRIVE CARD
Cat. X17019 \$79

80 COLUMN CARD
Cat. X17025 \$85

SUPER SERIAL CARD
Cat. X17035 \$119

RGB CARD
Cat. X17039 \$79

PAL COLOUR CARD
Cat. X17027 \$95

Z80 C/M CARD
Cat. X17041 \$59

APPLE* IIe COMPATIBLE CARDS

80 COLUMN/64K CARD
Cat. X \$69

64K/128K CARD
Cat. X \$69

ANTI GLARE SCREEN

Half the price of other brands! Relieve eye strain and headaches and increase productivity with these Anti Glare Screens. Suitable for 12" monochrome and colour monitors.
Cat. X99995 \$24.95



NEC DISK DRIVES

3 1/2" DISK DRIVE
● 1 M/Byte unformatted (640K formatted).
● Double sided, double density
● Access Time 3msec
Cat. \$265

5 1/4" SLIMLINE
● Switchable 1.6 M/Byte to 1 M/Byte unformatted
● 1.2 M/Byte to 720K formatted
● Double sided, double density
● AT compatible
Cat. C11906 \$295

8" SLIMLINE
● Double sided, double density.
● 1.6 M/Byte unformatted.
Cat. C11908 \$795



SAMSUNG TTL MONITOR

A quality 12" TTL monitor, with a high contrast non-glare screen at a very reasonable price!
SPECIFICATIONS:
CRT: 12" diagonal 90° deflection non-glare screen
Active Display Area: 216(H) x 160(V)mm
Display Characters: 2,000 (80 characters x 25 lines)
Scanning Frequency: Horizontal: 18.432 ± 0.1KHz Vertical: 50 Hz ± 0.5%
Description Cat.No 1-9 10+
Green X14517 \$189 \$179
Amber X14518 \$189 \$179



SAKATA 13" RGB COLOUR MONITOR

High quality IBM* compatible monitors, great with VCR's too!
SPECIFICATIONS:
Video Signal: Separate video signal
Input Signal: Video: Positive Sync: Positive Input Level: TTL Level
Scanning Frequency: Horizontal: 15.7KHz Vertical: 60Hz
Display Size: 245(H) x 182(V)mm
Horizontal: 640 dots Vertical: 400 lines
Cat. X14530 \$695



INTRIA 14" RGB HIGH RESOLUTION COLOUR MONITOR

Compatible with IBM* and compatibles, and EGA Cards. Why pay more? Resolution: 640 x 350 dots Dot pitch: 31mm Display Format: 80 x 25 characters Cat. X14514 Normally \$1,295 Our price \$995

INTRIA 14" RGB COLOUR MONITOR

Resolution: 640 x 200 dots Display Format: 80 x 25 characters Display Colours: 16 Dot pitch: 39mm Sync Horiz. Scan Freq: 15.75 KHz Sync Vert. Scan Freq: 50Hz Band Width: 18MHz Cat. X14520 \$695



RITRON 2 MONITORS
Stylish 20MHz non-glare 12 inch monitors available in green or amber displays and featuring swivel base that lifts forward and back and swivels right to left!
Green Cat. X14506 Normally \$235
Amber Cat. X14508 Normally \$239
SPECIAL, ONLY \$199

ROD IRVING ELECTRONICS FOR ONE STOP BARGAIN SHOPPING!



IBM* COMPATIBLE DISK DRIVES
Tired of paying out more for Japanese Disk Drives? These "direct import" Hong Kong disk drives are the solution! They feature Japanese mechanical components yet cost only a fraction of the price!
Cat No Description Price
C11801 500K Normally \$199
SPECIAL, ONLY \$179
C11805 1.6 M/Byte \$259



PAPER TAMER
● Restores order to the top of your desk or work area
● Made of white plastic coated steel
● Stores up to 900 continuous sheets
● Allows perfect paper lead
● Allows easy examination of print out
C21050 (10") only \$49.95
C21050 (15") only \$79.95
(Printer and paper not included)



CANON A-40 PRINTER
● Serial Impact Dot Matrix
● 140 C.P.S.
● Near Letter Quality Mode
● 1.4K Buffer
Cat. C20040 \$595



INSIDE THE IBM PC
(Revised and expanded edition)
Peter Norton
The widely acclaimed guide to the IBM PC's inner workings. The latest edition now covers every model of the IBM micro PC XT and AT, and every version of DOS from 1.1 to 3.0
B20080 \$44.95



SENDATA DIRECT CONNECT MODEM
● CCITT V21 300 baud full duplex
● CCITT V23 1200/75
● Bell 103 300 Full duplex
● Bell 202 1200 Half duplex
● Auto answer, auto disconnect
● LED display for Power, TX, RX, CD
● AC power adaptor included
● DB25 pin connector
● Telecom Approval No C83/37/1045
Cat. X19120 \$295
(SOFTWARE FOR VIATEL \$95)



APPLE* COMPATIBLE CARDS
PRINTER CARD
Cat. X17029 \$89
DRIVE CARD
Cat. X17019 \$79
80 COLUMN CARD
Cat. X17025 \$85
SUPER SERIAL CARD
Cat. X17035 \$119
RGB CARD
Cat. X17039 \$79
PAL COLOUR CARD
Cat. X17027 \$95
Z80 C/M CARD
Cat. X17041 \$59

APPLE* IIe COMPATIBLE CARDS
80 COLUMN/64K CARD
Cat. X \$69
64K/128K CARD
Cat. X \$69



ANTI GLARE SCREEN
Half the price of other brands! Relieve eye strain and headaches and increase productivity with these Anti Glare Screens. Suitable for 12" monochrome and colour monitors.
Cat. X99995 \$24.95



20 M/BYTE HARD DISK DRIVE FOR IBM* AND COMPATIBLES
NEC drive with DTC controller card.
Cat. X20010 WAS \$995
SPECIAL, ONLY \$850
*IBM is a registered trade mark.

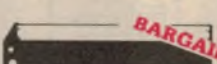

PRINTER RIBBONS
CP80 BX80 DP80 BX100 MB100
ALL A CRAZY LOW \$9.95

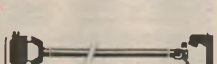

PRINTER LEAD FOR IBM*
● Suits IBM* PC XT and compatibles
● 25 pin "D" plug (computer end)
● to Centronics 36 pin plug
Cat. P19029 1.8 metres \$17.95
Cat. P19030 3 metres \$22.95



SUPER 5 EP-1201 DOT MATRIX PRINTER
● 120 C.P.S.
● Pica or Elite character set
● Print Modes: NLQ, Dot Graphics
● Proportional Font, Draft
● Proportional Printing
● Reliable and Compact
● Proportional Printing
● Logic Seeking
● 1K Printer Buffer
Cat. C20035 only \$595



IBM PC TROUBLESHOOTING & REPAIR GUIDE
-Robert C. Brenner
Keep your IBM PC in top operating condition with this handy reference book. Inside you will find pages of schematics, photos and block diagrams to help you identify problems. Simple instructions tell you what's wrong and how to fix it last.
● Make most repairs with few or no tools
● Quickly zero-in on a malfunctioning component
● Reduces downtime
● Pays for itself many times over in repair savings
● Easy to understand circuit diagrams
The IBM PC Trouble Shooting & Repair Guide will make even the computer novice feel comfortable with the complex world of electronic trouble shooting. This fully illustrated book is recommended for anyone who uses an IBM PC.
Cat. B \$44.95



DB25 CONNECTOR SPECIALS!
We have just imported 50,000. So you get to save a small fortune!
DB25 MALE (P10900)
1-9 10+ 100+
\$1.50 \$1.20 \$1.00
DB25 FEMALE (P10901)
1-9 10+ 100+
\$1.70 \$1.40 \$1.20



PASCAL PRIMER
-Mitchell Waite, David Fox
If you are learning programming or have dabbled in the popular language BASIC and wish to learn the capabilities of Pascal, this book is definitely written for you. Written and illustrated with a touch of humour, the informative text describes Pascal program structure Pascal variables, Pascal procedures and many other features. There are chapters on decision making statements, numeric functions, string functions, arrays and sets, and much more. The eight appendices present facts about the advantages and disadvantages of Pascal components of a Pascal system, interfacing assembly language routines, and other useful information.
Cat. B \$24.95



COMPUTER PAPER
Quality paper at a low price! 2,500 sheets of 60 gsm bond paper.
Cat. C21003 11 x 9 1/2" \$49.95
Cat. C21005 15 x 11" \$67.95



Rod Irving Electronics
48 A Beckett St, MELBOURNE
Phone (03) 663 6151
425 High St, NORTHCOLE
Phone (03) 489 8866
Mail Order and Correspondence
P O Box 620, CLAYTON 3168
Telex: AA 151938



MAIL ORDER HOTLINE 008 335757 (TOLL FREE) [STRICTLY ORDERS ONLY]
LOCAL ORDERS & INQUIRIES (03) 543 7877

POSTAGE RATES:
\$1 - \$9.99 \$2.00
\$10 - \$24.99 \$3.00
\$25 - \$49.99 \$4.00
\$50 - \$99.99 \$5.00
\$100 - \$199 \$7.50
\$200 - \$499 \$10.00
\$500 plus \$12.50

The above postage rates are for basic postage only. Road Freight, bulky and fragile items will be charged at different rates.

All sales tax exempt orders and wholesale inquiries to: RITRONICS WHOLESALE, 56 Renner Rd, Clayton Ph. (03) 543 2166 (3 lines)

Errors and omissions excepted

*Apple and IBM are registered trade names





UNDERSTANDING UNIX
James R. Groff, Paul N. Weinberg
The exploding popularity of the UNIX operating system is one of the most important trends in computing in the 1980's. UNIX is available on hundreds of different computers, ranging from personal computers to mainframes and supercomputers. *Understanding UNIX* offers an overall perspective on UNIX, including a discussion of where UNIX fits in the worlds of computing, business, and education. Individual chapters address the UNIX structure, file system, multiuser capability, specific applications tools, and more.
"A book that balances scope with depth; comprehensiveness with brevity."
- Alan Kaplan
Cat B \$44.95



HANDS ON
Practical tips and useful programs for IBM PC's from the editors of PC World. A collection of the best tips, programs, and routines for IBM computers from the popular "hands on" and "columns" covering both hardware and software, the book is organized so that you can quickly find information on virtually everything you need to know.
B20100 \$34.95



IBM PC TROUBLESHOOTING & REPAIR GUIDE
-Robert C. Brenner
Keep your IBM PC in top operating condition with this handy reference book. Inside you will find pages of schematics, photos and block diagrams to help you identify problems. Simple instructions tell you what's wrong and how to fix it fast.
● Make most repairs with few or no tools
● Quickly zero-in on a malfunctioning component
● Reduces downtime
● Pays for itself many times over in repair savings
● Easy to understand circuit diagrams
The IBM PC Trouble Shooting & Repair Guide will make even the computer novice feel comfortable with the complex world of electronic trouble shooting. This fully illustrated book is recommended for anyone who uses an IBM PC.
Cat. B \$44.95



WALL MOUNTING SPEAKER HOLDERS
Mount your speakers at ear level on your wall!
Features:
● Holds speakers up to 260mm deep
● Left/Right adjustment
● Up/Down adjustment
● Includes mounting screws
● Nipping-screw pins hold speakers firmly in place
● Installation instructions
Cat. \$89.95



MASTER RACK MOUNTING CABINETS
These superb rack mount cabinets will give your projects a real professional appearance!
Just look at these features:
● All dimensions conform to the International Standard
● All aluminium construction
● Choice of black or natural finish
● Deluxe brush finish anodised front panel
● Removeable top and bottom lid
● Ventilated lid
A = Internal Height mm
B = Rear Width mm
C = Depth mm
A B C Finish Cat.No Price
38 430 254 Natural H10401 \$49.50
82 430 254 Natural H10402 \$59.50
126 430 254 Natural H10403 \$69.50
38 430 254 Black H10411 \$59.95
82 430 254 Black H10412 \$69.95
126 430 254 Black H10413 \$79.95



HOOK UP WIRE
Cat. No. Description
W11251 13/ 12 TND BLK
W11252 13/ 12 TLD BROWN
W11253 13/ 12 TLD ORANGE
W11254 13/ 12 TLD YELLOW
W11255 13/ 12 TLD GREEN
W11256 13/ 12 TLD BLUE
W11257 13/ 12 TLD WHITE
PRICES PER 100 METRE ROLL
1-9 10+
\$5.95 \$5.00
\$5.35 \$4.50



MAIL ORDER HOTLINE
008 335757
(TOLL FREE)
LOCAL: 543 7877



DIECAST BOXES
Diecast boxes are excellent for RF shielding, and strength. Screws are provided with each box.
H11451 100 x 50 x 25mm \$ 5.95
H11452 110 x 60 x 30mm \$ 6.50
H11453 120 x 65 x 40mm \$ 6.95
H11461 120 x 94 x 53mm \$11.50
H11462 188 x 120 x 78mm \$13.50
H11464 188 x 188 x 64mm \$29.50

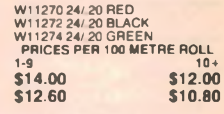

RECHARGEABLE 12V GELL BATTERIES
Leakproof and in 3 convenient sizes, these long service life batteries are ideal for burglar systems, emergency lighting or as a computer backup power supply ideal for many power needs.
Cat. S15029 12V 1.2 AH \$17.50
Cat. S15031 12V 2.6 AH \$32.50
Cat. S15033 12V 4.5 AH \$39.50



PASCAL PRIMER
-Mitchell Waite, David Fox
If you are learning programming or have dabbled in the popular language BASIC and wish to learn the capabilities of Pascal, this book is definitely written for you. Written and illustrated with a touch of humour, the informative text describes Pascal program structure, Pascal variables, Pascal procedures and many other features. There are chapters on decision making statements, numeric functions, string functions, arrays and sets, and much more. The eight appendices present facts about the advantages and disadvantages of Pascal, components of a Pascal system, interfacing assembly language routines, and other useful information.
Cat B \$24.95



THE C PROGRAMMER'S HANDBOOK
-Thom Hogan
While other books will tell you how to learn C, this one shows you how to use it. It is a literal encyclopedia of the information you'll need to get it to work for you, efficiently and effectively. Handy and well organized, it gives you quick access to the things you need, when you need them, plus a clear definition of C language with examples and explanations of restrictions and defaults. You won't find an approach this understandable and objective anywhere else.
B20120 \$39.95



"C" SELF STUDY GUIDE
-Jack Purdum
Learn at your own pace as this self directed study guide takes you through the basics and into advanced areas of the C programming language. The unique format allows you to advance quickly or proceed slowly. The book is divided into two parts.
Questions: of varying degrees of difficulty to guide beginners over the rough spots and to challenge the more experienced C programmers.
Answers: that include many complete programs for testing new functions and for illustrating tips, traps, techniques and short cuts.
Cat B \$37.95



PANEL METERS GALORE!
We have a great range of panel meters at great prices.
Cat.No. Description Price
Q10500 MU45 0-1mA 12.50
Q10502 MU45 50-0/50uA 12.50
Q10504 MU45 0-100uA 12.50
Q10510 MU45 0-5A 12.50
Q10518 MU45 0-1A 12.50
Q10520 MU45 0-1A 12.50
Q10525 MU45 0-20V 12.50
Q10530 MU52E 0-1A 14.50
Q10533 MU52E 0-5A 14.50
Q10535 MU45 VU PMair 14.95
Q10538 MU65 0-50uA 16.95
Q10540 MU65 0-1mA 16.95
Q10550 MU65 0-100uA 16.95
Q10560 MU65 0-20V 16.95



BREADBOARD SPECIALS
Why pay more?
Cat P11000 100 holes \$2.75
Cat P11005 640 holes \$10.75
Cat P11007 640 + 100 holes \$13.00
Cat P11009 840 + 200 holes \$17.50
Cat P11010 1280 + 100 holes \$19.95
Cat P11011 1280 + 300 holes \$32.50
Cat P11012 1280 + 400 holes \$36.75
Cat P11015 1920 + 500 holes \$57.50
Cat P11018 2560 + 700 holes \$64.95



DIECAST BOXES
Diecast boxes are excellent for RF shielding, and strength. Screws are provided with each box.
H11451 100 x 50 x 25mm \$ 5.95
H11452 110 x 60 x 30mm \$ 6.50
H11453 120 x 65 x 40mm \$ 6.95
H11461 120 x 94 x 53mm \$11.50
H11462 188 x 120 x 78mm \$13.50
H11464 188 x 188 x 64mm \$29.50



CPM PROGRAMMER'S ENCYCLOPEDIA
-Bruce Brigham
The CPM Programmer's Encyclopedia is a time saving, comprehensive reference for serious CPM users. Covering all the commands and syntaxes for CPM 2.x and CPM 3.0, this encyclopedia gives you the information you need in an easy-to-use format especially designed for programmers. The CPM Programmer's Encyclopedia is the only major compilation of CPM commands and syntaxes. If you use CPM extensively, you should not be without this important reference guide.
Cat B \$39.95

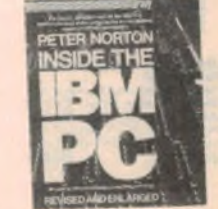

INSIDE THE IBM PC
(Revised and expanded edition)
-Peter Norton
The widely acclaimed guide to the IBM PC's inner workings. The latest edition now covers every model of the IBM micro: PC, XT and AT, and every version of DOS from 1.1 to 3.0.
B20080 \$44.95



APPLE II CIRCUIT DESCRIPTION
-Winston D. Gaylar
● Covers all Apple II motherboard and keyboard versions
● Helps you learn about microcomputer hardware in general and Apple II hardware in detail
● Provides you with accurate schematics and verified waveforms to rely on for servicing and repair
● Explains the advanced concepts of daisy chains, interrupts, direct memory access, and the ready line
● Gives you many valuable hints for successful interlacing
● Contains tutorials on video signals, memory IC's and the 6502 microprocessor, as well as full explanations of advanced concepts
● Each chapter contains an overview for the beginner and a detailed section for the more adventurous
● Ideal for students, technicians, hobbyists, engineers, and others who need Apple II technical information.
Cat. B \$52.95



3M SCOTCHCAL PHOTOSENSITIVE
All prices per box and include tax
8007 REVERSAL FILM
250 x 300mm (10 sheets) \$39.95
300 x 600mm (5 sheets) \$54.95
8005 BLACK ALUMINIUM
250 x 300mm (10 sheets) \$69.95
300 x 600mm (5 sheets) \$79.95
8009 BLUE ALUMINIUM
250 x 300mm (10 sheets) \$69.95
300 x 600mm (5 sheets) \$79.95
8011 RED/WHITE
250 x 300mm (10 sheets) \$64.95
300 x 600mm (5 sheets) \$74.95
8013 BLACK/YELLOW
250 x 300mm (10 sheets) \$64.95
300 x 600mm (5 sheets) \$74.95
8015 BLACK/WHITE
250 x 300mm (10 sheets) \$64.95
300 x 600mm (5 sheets) \$74.95
8016 BLUE/WHITE
250 x 300mm (10 sheets) \$64.95
300 x 600mm (5 sheets) \$74.95
8018 GREEN/WHITE
250 x 300mm (10 sheets) \$64.95
300 x 600mm (5 sheets) \$74.95

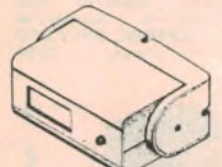

PASSIVE INFRA RED DETECTOR
Compact P.I.R. with adjustable corner or wall mounting bracket, dual pyroelectric infra red sensing element gives a coverage 2 x 14 zones 2m high and 10m wide.
● Sensitivity adjustment control
● Detecting range 12-15 metres at 90 degrees
● Detecting zones 9 long (up), 5 short (down)
● LED indicator for walk test (can be disabled)
● Shielded against RF interference
● Relay output NC or NO at 30V (AC/DC) 0.5A max.
● Integral NC lamp switch
● Operating voltage 10.5 - 16V DC
● Current 20mA with LED 25mA
Cat. S77777 \$145



CENTRONICS GENDER CHANGERS
● Female to Female
● Saves modifying or replacing non-mating Centronics cables
● All 36 pins wired straight through.
Cat. X15663 Male to Male
Cat. X15661 Male to Female
Cat. X15664 Female to Female
Normally \$33.95
Only \$24.95



BASIC COMMODORE 64 BASIC
James S. Coan
Here's the key to using and enjoying the Commodore 64 microcomputer. A fast reading guide to computer operation and BASIC programming that is suitable for use at home or in the classroom. The approach is simple and direct.
Cat B \$29.50



THE PLAIN ENGLISH MAINTENANCE & REPAIR GUIDE FOR IBM PC'S
-Henry F. Beechold
Even if you've never held a soldering gun in your hand you will appreciate these clear, simple, witty explanations of computer electronics. With its lucid line drawings and diagrams, this book gives you expert instructions on every fix-up and keep-up operation for your IBM PC and its components - DOS peripherals, disk drive, and the rest.
B20060 \$53.95



WELLER WTCPN SOLDERING STATION
The WTCPN Features:
● Power Unit 240 V AC
● Temperature controlled iron, 24 V AC
● Flexible silicon lead for ease of use
● Can be left on without fear of damaged tips!
The best is always worth having.
Cat. T12500 R.R.P. \$149
SPECIAL, ONLY \$129



CODE KEY PAD
● Telephone type digital keypad.
● Four digit, changeable code
● Over 5000 possible combinations
● Power consumption: 5mA standby 50mA alarm
● Two sector LED and 1 arm LED
● Wrong number lockout
● 12V DC operation
● Relay output
● Panic button
● Normally open lamp switch
● Dimensions: 145 x 100 x 37mm
● ACP3 compatible
Cat. A13014 R.R.P. \$79.95
SPECIAL, ONLY \$69.95



DPM-200 PANEL METER
● Ultra Low Power
● Separately Addressable Annunciator
● 15mm Digits
● Bandgap Reference
A low profile LCD DPM with a range of useful symbols as shown. The DPM 200 features 15mm 3 1/2 digit display, and ultra low current consumption and a bandgap reference for high stability. It also features Auto zero, Auto-polarity, 200mV f.s.d. It may be used in single-ended, differential or ratiometric modes. The f.s.d. can be easily changed by the user to indicate any other limits. The decimal points and symbols can all be driven from an internal source. Wide supply and symbols can all be driven from an internal source. Wide supply rail (5-15V DC) with a variable threshold low battery warning indicator. Supplied with mounting clips and comprehensive data sheet.
SPECIFICATIONS:
Accuracy: 0.1% + 1 digit
Linearity: + 1 digit
Stability/sec: 3
Temp. Stability: 50 ppm typical
Temp. Range: 0 - 50°C
Supply Voltage: 5 - 15V DC
Supply Current: 50uA typical
Max DC Input Volts: + 20V
Cat. Q15510 \$99.95

Audio Audio Audio Audio Audio

TOLL FREE
MAIL ORDER NUMBER
008 33 5757
 (STRICTLY ORDERS ONLY)
 INQUIRIES TO (03) 543 7877



VIFA/AEM 3 WAY SPEAKER KIT!
 This superb 3 way speaker kit competes with systems that cost 2-3 times the cost of these units! (which may even be using VIFA drivers etc.) Never before has it been possible to get such exceptional value in kit speakers! Call in personally and compare for yourself!

The system comprises:
 2 x D19 dome tweeters
 2 x D75 dome midrange
 2 x P25 woofers
 2 x pre-built quality crossovers
 The cabinet kit consists of 2 knock-down boxes in beautiful black grain look with silver baffles, speaker cloth, innerboard, grill clips, speaker terminals, screws and ports.

D19 DOME TWEETER SPEAKER SPECIFICATIONS
 Nominal Impedance: 8 ohms
 Frequency Range: 2.5 - 20kHz
 Free Air Resonance: 1.700Hz
 Sensitivity 1W at 1m: 89dB
 Nominal Power: 80 Watts (to 5.000Hz, 12dB/oct)
 Voice Coil Diameter: 19mm
 Voice Coil Resistance: 6.2ohms
 Moving Mass: 0.2 grams
 Weight: 0.28kg

D75 DOME MIDRANGE SPECIFICATIONS
 Nominal Impedance: 8 ohms
 Frequency Range: 350 - 5.000Hz
 Free Air Resonance: 300Hz
 Sensitivity 1W at 1m: 91dB
 Nominal Power: 80 Watts (to 500Hz, 12dB/oct)
 Voice Coil Diameter: 75mm
 Voice Coil Resistance: 7.2ohms
 Moving Mass (incl. air): 3.6 grams
 Weight: 0.65kg

P25 WOOFER SPECIFICATIONS
 Nominal Impedance: 8 ohms
 Frequency Range: 25 - 3.000Hz
 Free Air Resonance: 25Hz
 Operating Power: 5 watts
 Sensitivity 1W at 1m: 89dB
 Nominal Power: 50 Watts
 Music Power: 100 Watts
 Voice Coil Diameter: 40mm
 Voice Coil Resistance: 5.7ohms
 Moving Mass (incl. air): 44 grams
 Thiele/Small Parameters:
 Qm: 3.15
 Qe: 0.46
 Qt: 0.40
 Vas: 180.1
 Weight: 1.95kg

Complete Kit Cat K16030 \$1,199
 Speaker Kit Cat K16031 \$949
 Cabinet Kit Cat K16032 \$349



VIFA/AEM 2 WAY SPEAKER KIT!
 This exciting new speaker kit, designed by David Tillbrook (a name synonymous with brilliant design and performance) uses VIFA's high performance drivers from Denmark. You will save around \$800 when you hear what you get from this system when compared to something you buy off the shelf with similar characteristics! Call in personally and compare for yourself!

The system comprises:
 2 x P21 Polycone 8" woofers
 2 x D25T Ferrofluid cooled dome tweeters with Polymer diaphragms
 2 pre-built quality crossovers
 The cabinet kit consists of 2 knock-down boxes in beautiful black grain look with silver baffles, speaker cloth, innerboard, grill clips, speaker terminals, screws and ports.

D25T SPEAKER SPECIFICATIONS
 Nominal Impedance: 8 ohms
 Frequency Range: 2 - 24kHz
 Free Air Resonance: 1500Hz
 Operating Power: 3.2 watts
 Sensitivity 1W at 1m: 90dB
 Nominal Power: 90 Watts
 Voice Coil Diameter: 25mm
 Air Gap Height: 2mm
 Voice Coil Resistance: 4.7ohms
 Moving Mass: 0.3 grams
 Weight: 0.53kg

P21 WOOFER SPECIFICATIONS
 Nominal Impedance: 8 ohms
 Frequency Range: 26 - 4.000Hz
 Free Air Resonance: 33Hz
 Operating Power: 2.5 watts
 Sensitivity 1W at 1m: 92dB
 Nominal Power: 60 Watts
 Voice Coil Diameter: 40mm
 Voice Coil Resistance: 5.8ohms
 Moving Mass: 20 grams
 Thiele/Small Parameters:
 Qm: 2.4
 Qe: 0.41
 Qt: 0.35
 Vas: 80.1
 Weight: 1.65kg

Complete Kit Cat K16020 \$799
 Speaker Kit Cat K16021 \$649
 Cabinet Kit Cat K16022 \$209



SUPERB NEW VIFA/EA 60-60 SPEAKER KIT!

The new Vifa/EA 60-60 loudspeaker kit has been designed to completely outperform any similarly priced speakers. This is a 2-way design incorporating drivers which give a deeper, more natural bass response and 19mm soft-dome ferro fluid cooled tweeters which provide clear, uncoloured sound reproduction.

These Vifa drivers are identical to the ones used in such fine speakers as Mission Rogers, Bang & Olufsen Monitor Audio and Haybrook just to name a few. Some of which cost well over \$1,000 a pair!

The dividing network is of the highest quality and produce no inherent sound characteristics of their own, they simply act as passive devices which accurately distribute the frequency range between both drivers in each speaker.

The fully enclosed acoustic suspension cabinets are easily assembled. All you need are normal household tools and a couple of hours and you've built yourself the finest pair of speakers in their class!

D19 TWEETER SPECIFICATIONS
 Nominal Impedance: 8 ohms
 Frequency Range: 2.5 - 20KHz
 Free Air Resonance: 1.700Hz
 Sensitivity 1W at 1m: 89dB
 Nominal Power: 80 Watts (to 5.000Hz, 12dB/oct)
 Voice Coil Diameter: 19mm
 Voice Coil Resistance: 6.2 ohms
 Moving Mass: 0.2 grams
 Cat. C110301 \$38

C20 WOOFER SPECIFICATIONS
 Nominal Impedance: 8 ohms
 Frequency Range: 35 - 6.000Hz
 Resonance Frequency: 39Hz
 Sensitivity 1W at 1m: 90dB
 Nominal Power: 50 Watts (12dB/oct)
 Voice Coil Diameter: 25mm
 Voice Coil Resistance: 5.5 ohms
 Moving Mass: 15 grams
 Cat. C10322 \$89

Cat. K86092 (speakers only) \$379
 Cat. K86091 (complete kit) \$449



WIRELESS MICROPHONE RECEIVER WA100
 Made by Piezo (Arden) of Japan, this device will turn any microphone fitted with a Cannon Type male socket into a wireless microphone. The receiver will plug into any 6.35mm microphone input. Both transmitter and receiver can be tuned from 76 - 81MHz.
 Freq. Response: 50 - 16kHz
 Tunable: 76 - 81MHz
 Field Strength:
 Transmitter: 100V/100 metres
 Receiver: 15mV (100%)
 Battery: Transmitter: LR44 (1.5V)
 Receiver: 3 x UM4 (4.5V)
 Instructions: Japanese (English not available)
 Cat. A10520 R.R.P. \$199
 Our price, only \$189

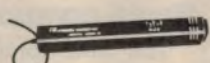

OMNI-DIRECTIONAL WIRELESS MICROPHONE
 Tunable: 92 - 104MHz
 Freq. Response: 50 - 15kHz
 Range: Over 300 feet in open field
 Modulation: FM
 Power Source: 9V Battery
 Type: Electret Condenser
 Dimensions: 185 x 27 x 38mm
 Weight: 160 grams
 Cat. A10450 \$19.95



CRYSTAL LOCKED WIRELESS MICROPHONE AND RECEIVER
MICROPHONE SPECIFICATIONS
 Transmitting Frequency: 37.1MHz
 Transmitting System: crystal oscillation
Microphone: Electret condenser
Power Supply: 9V battery
Range: 300 feet in open field
Dimensions: 185 x 27 x 38mm
Weight: 160 grams
RECEIVER SPECIFICATIONS:
Receiving Freq: 37.1MHz
Output Level: 30mV (maximum)
Receiving System: Super heterodyne crystal oscillation
Power Supply: 9V Battery or 9V DC power adapter
Voice control
Tuning LED
Dimensions: 115 x 32 x 44mm
Weight: 220 grams
 Cat. A10452 R.R.P. \$113
 Our price, \$99

PHILIPS SPEAKERS
 This month we are offering 20% off these prices! But, you'd better be quick as this offer is limited.

Description	Cat No	Price
AD01610T8 (C12030)		\$24.95
AD02160S08 (C12040)		\$69.95
AD80652W8 (C12042)		\$69.95
AD070620M8 (C12045)		\$69.95
AD12250W8 (C12050)		\$129.00



PORTABLE MINI P.A. AMPLIFIER
 A completely portable system, sets up anywhere in seconds. Inputs for microphone, electronic organ and cassette players. Variable echo makes this an ideal unit for buskers and budding singers.
SPECIFICATIONS
Output power: 1W RMS 2W max.
Frequency Response: 100 - 15kHz
Speaker: 5" full range, 4 ohms
Echo Time: Variable 5 - 52msec
Power Source: 6 x "D" size batteries (position for power adaptor also)
Size: 280(H) x 120(W) x 180(D)mm
Weight: 1.3kg
 Cat. A12022 \$89.95

SENNHEISER HEADPHONES!!
 The world's best headphones are now available from Rod Irving Electronics!! 3 models to choose from, other models are available on request! (Phone Tony DiPaolo on (03) 543 2166)



SENNHEISER HD 40
 The HD40 is leather light, at just 60g! This HiFi stereo headphone is uncommonly convenient to use. Its systems can be rotated so it can fit into any drawer. It is also available as a TV headphone.
SPECIFICATIONS:
 Frequency Range: 22 - 18,000Hz
 Impedance: 600ohm
 Distortion Factor: Approx. 1.5%
 Pressure on ear: approx. 1.3 N
 Weight: Approx. 60g
 Length of lead: 3 metres
 Cat. A10515 \$49.95



SENNHEISER HD 410 SL
 The HD 410 SL embodies all the advantages of the new "Slim-line" concept brilliant sound characteristics with an optimum of sound volume combined with high wear comfort.
SPECIFICATIONS:
 Frequency Range: 20 - 18,000Hz
 Impedance: 600ohm
 Distortion Factor: Less than 1%
 pressure on ear: approx. 2.5 N
 Weight: Approx. 82g
 Length of lead: 3 metres
 Cat. A10518 \$74.95



SENNHEISER HD 540 REFERENCE
 The HD 540 reference headphones are open dynamic stereo headphones. They are among the best ever made. Designed according to latest findings in acoustics, their reproduction is of extraordinary transparency and the highest transients fidelity. The test with a CD player shows their acoustic properties are outstanding. The ear cushions play a major role. They provide a completely resonance-free treble reproduction up to 25 kHz and assure an impressively clear bass reproduction down to 16 Hz.
SPECIFICATIONS
 Frequency Range: 16 - 25,000Hz
 Impedance: 600ohm per capsule
 Harmonic Distortion Factor: Less than 0.4%
 Contact Pressure: Approx. 3 N
 Weight: Approx. 250g
 Length of lead: 3 metres
 Cat. A10519 \$199



1" DOME TWEETER SPEAKER
 Mylar diaphragm
SPECIFICATIONS:
 Sensitivity: 95dB
 Frequency Response: 2-20 kHz
 Impedance: 8 ohms
 Power RMS: 15 watts RMS
 Magnet Weight: 5.4c z
 Size: 96mm diameter
 Cat. C10234 \$10.95



2" HORN TWEETER SPEAKER
 Mylar diaphragm, aluminium voice coil
SPECIFICATIONS:
 Sensitivity: 95dB
 Frequency Response: 1.5-20 kHz
 Impedance: 8 ohms
 Power RMS: 10 watts RMS
 Magnet Weight: 2.5oz
 Cat. C10232 \$8.95



5" MIDRANGE SPEAKER
 Sealed back, foam edge, black cone, silver dust cap
SPECIFICATIONS:
 Sensitivity: 98dB
 Frequency Response: 500-8 kHz
 Impedance: 8 ohms
 Power RMS: 10 watts RMS
 Magnet Weight: 5.4oz
 Cat. C10230 \$12.95



6 1/2" TWIN CONE FULL RANGE SPEAKER
 Foam edge, black cone, black whizzer cone
SPECIFICATIONS:
 Sensitivity: 89dB
 Frequency Response: 60-15 kHz
 Impedance: 8 ohms
 Power RMS: 10 watts RMS
 Magnet Weight: 5.3oz
 Cat. C10222 \$14.95



8" TWIN CONE FULL RANGE SPEAKER
 Foam edge, black cone, black whizzer cone
SPECIFICATIONS:
 Sensitivity: 98dB
 Frequency Response: 45-16 kHz
 Impedance: 8 ohms
 Power RMS: 30 watts RMS
 Magnet Weight: 13oz
 Cat. C10224 \$23.95



8" WOOFER HIGH POWER SPEAKER
 Cloth edge, dark grey cone, rubber mounting seal, cloth dust cap
SPECIFICATIONS:
 Sensitivity: 90dB
 Frequency Response: 60-4 kHz
 Impedance: 8 ohms
 Power RMS: 50 watts RMS
 Magnet Weight: 20oz
 Cat. C10226 \$34.95



10" WOOFER HIGH POWER SPEAKER
 Cloth edge, dark grey cone, rubber mounting seal, cloth dust cap
SPECIFICATIONS:
 Sensitivity: 93dB
 Frequency Response: 50-2.5 kHz
 Impedance: 8 ohms
 Power RMS: 100 watts RMS
 Magnet Weight: 30oz
 Cat. C10228 \$59.95



12" WOOFER HIGH POWER SPEAKER
 Cloth edge, dark grey cone, rubber mounting seal, cloth dust cap
SPECIFICATIONS:
 Sensitivity: 97dB
 Frequency Response: 28-4 kHz
 Impedance: 8 ohms
 Power RMS: 50 watts RMS
 Magnet Weight: 30oz
 Cat. C10229 \$69.95



Rod Irving Electronics
 48 A Beckett St, MELBOURNE
 Phone (03) 863 6151
 425 High St, NORTHCOLE
 Phone (03) 489 8866
 Mail Order and Correspondence
 P.O. Box 620, CLAYTON 3168
 Telex AA 151938

MAIL ORDER HOTLINE
008 335757
(TOLL FREE)
 (STRICTLY ORDERS ONLY)

LOCAL ORDERS & INQUIRIES
(03) 543 7877

POSTAGE RATES:

\$1 \$9.99	\$2.00
\$10 \$24.99	\$3.00
\$25 \$40.99	\$4.00
\$50 \$99.99	\$5.00
\$100 - \$199	\$7.50
\$200 - \$499	\$10.00
\$500 plus	\$12.50

The above postage rates are for basic postage only. Road Freight, bulky and fragile items will be charged at different rates.

All sales tax exempt orders and wholesale inquiries to
TRITRONICS WHOLESALE
 56 Renner Rd, Clayton
 Ph. (03) 543 2166 (3 lines)

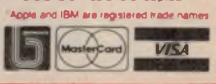

Satellite television in Australia

A practical guide to the reception of satellite television in Australia and the Pacific

by GARRY CRAPP VK2YBX/T

HAVE YOU EVER wondered, as you drove past your local TV station, what that large dish was doing, pointing skywards? Chances are that it is a vital part of a satellite television earth station. Those dishes are just part of the very large investment that the major television networks have made in satellite broadcasting. But the game is not closed to the small players.

Recent advances in low noise amplifier technology have brought the world of satellite television into the backyards of hundreds of thousands of enthusiasts worldwide and, with it, access to international television. Now these advances can be used by enthusiasts in Australia.

To explain how satellite television came about requires a brief look at history. The first man-made satellite was Russia's *Sputnik* launched in 1957. It beeped a Morse code message around the Earth, proving that reception from space was possible.

Subsequently, the US Air Force launched *SCORE* in December 1958 which broadcast a recorded message of Christmas greetings from the President of the USA to all who cared to listen.

This was the dawn of satellite communications.

By 1963, space technology and propulsion systems had progressed to the stage where satellites could be launched into geosynchronous orbit rather than a low orbit which required continuous antenna tracking. Geosynchronous (or geostationary) satellites orbit directly over the equator and their angular velocity is identical to that of the Earth — hence the position of a reception antenna remains fixed.

Intelsat

SYNCOM, which was launched in 1963, provided a single TV channel (or 50 telephone circuits) between North America and Europe and allowed real-time television transmissions. By 1965, 19 countries had realised the importance of such communications and formed an organisation called Intelsat which would fund and launch a series of satellites. Today, over 100 nations belong to the Intelsat network.

This network consists of 12 satellites located in three separate groups. These groups are located over the equator in the Pacific, the Indian Ocean, and between Africa and South America (Atlantic). Each satellite group has one primary and one secondary satellite al-

though heavy traffic in the Atlantic and Indian Ocean areas has required additional satellites in both these groups.

In 1971, Intelsat agreed that identical frequency satellites should be spaced over the equator in increments of four to five degrees. This allows reception of the desired satellite without adjacent channel interference. Of course, many countries have a far greater need for satellite communications than Intelsat can provide. These include Australia, the USA, Canada, Russia, India, Indonesia, Saudi Arabia, Mexico, Japan and many others.

In each of these countries, reception of satellite television is possible with relatively inexpensive equipment providing not only a basis for cultural exchange, but an ideal vehicle for hands-on experience of satellite reception.

Basic components

The basic components of a satellite television reception system or TVRO (TV Receive Only) system, are as follows:

(1). **The Antenna:** This needs to collect as much signal energy as possible. The most suitable type for TVRO use is the parabolic dish antenna, which provides the optimum size/gain ratio.

The most important feature of the dish, apart from size (bigger is better) is the accuracy of the surface. It is important that the surface conform as closely as possible to a true parabolic curve. A variation of more than 3mm from a true parabolic surface can cause a significant reduction in signal gain.

(2). **The Feedhorn:** This collects the signal focussed upon it from the surface of the dish and, through an integral waveguide, presents the signal to the low noise amplifier (LNA). The most popular and widely used type is the prime focus feedhorn, so called because

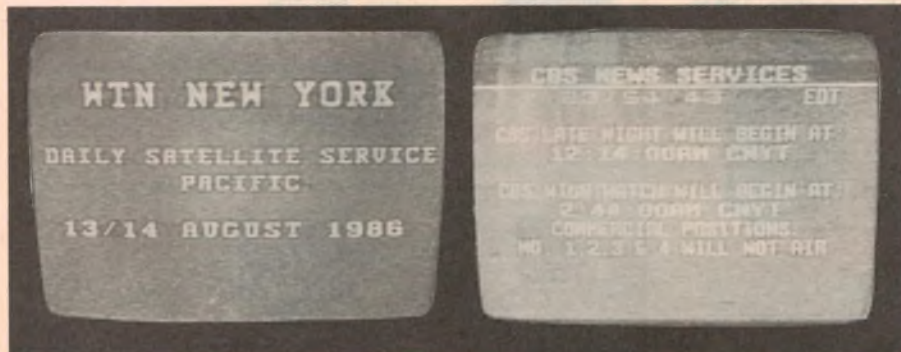

These pictures were received in Australia via the Intelsat network on typical equipment as described in this article.



This 3.5-metre dish is available from Dick Smith Electronics

it is placed at the focal point of the dish.

The mouth of a feedhorn may be surrounded by a series of concentric rings called *scalar* rings. These are used to help direct microwave signals in the general area of the feedhorn into the opening of the waveguide.

Most of the energy picked up by a typical feedhorn comes from the inner three quarters of the surface area of the dish. The advantage of the scalar ring feedhorn is that it gathers signals all the way to the perimeter of the dish and thus increases the overall gain of the system. As an aside, some parabolic

dishes have their outer curvature modified to compensate for the characteristics of a particular feedhorn and so optimise the gain in that way.

(3). **Low Noise Amplifier:** The signal from the feedhorn goes via a waveguide to a small antenna probe which is normally only about 12mm long because of the short wavelengths involved.

The antenna probe is cut so that it is resonant across the band of frequencies being used. Its length and shape are critical because it must favour signals over wideband noise. From the antenna probe, the signal is coupled to the low noise amplifier (LNA) which uses Gal-

lium Arsenide (GaAs) Fets to provide an extremely low noise figure. LNAs are rated in Kelvins (formerly called degrees Kelvin) and the lower the Kelvin rating, the lower the noise contributed by the LNA to the overall receiving system.

(4). **The Down-converter:** Basically the down-converter is equivalent to the front end of a superheterodyne receiver and consists of a mixer and a local oscillator. The output of that mixer/local oscillator arrangement is an intermediate frequency (IF) which, for most TVRO systems, is 70MHz.

In a superhet receiver, the mixer and local oscillator circuits are tuned simultaneously so that the IF is always constant. Since the down-converter is located outdoors, close to the LNA, it is tuned remotely by a variable DC voltage. This is furnished by the satellite receiver and varies between 4 and 14 volts DC in most cases. The receiver has a tuning dial permitting selection of any transponder on a satellite.

A further development in down-converter technology involves the combination of both the low noise amplifier and the down-converter at the dish. This combination is called a low noise converter (LNC) and has several advantages. The need for a cable link between the LNA and the down-converter is eliminated, and the two units are mounted in a single waterproof enclosure. As a result, installation is considerably simplified.

The latest down-converter technology is called *Blockdown* conversion. This utilises an LNA/down-converter combination called an LNB. In this approach, all the channels presented at the input of the down converter are handled simultaneously and a complete block of frequencies is fed to the satellite receiver. This technique is favoured by hotels, motels and high-rise apartment houses as a way of permitting individual channel selection whilst minimising the re-

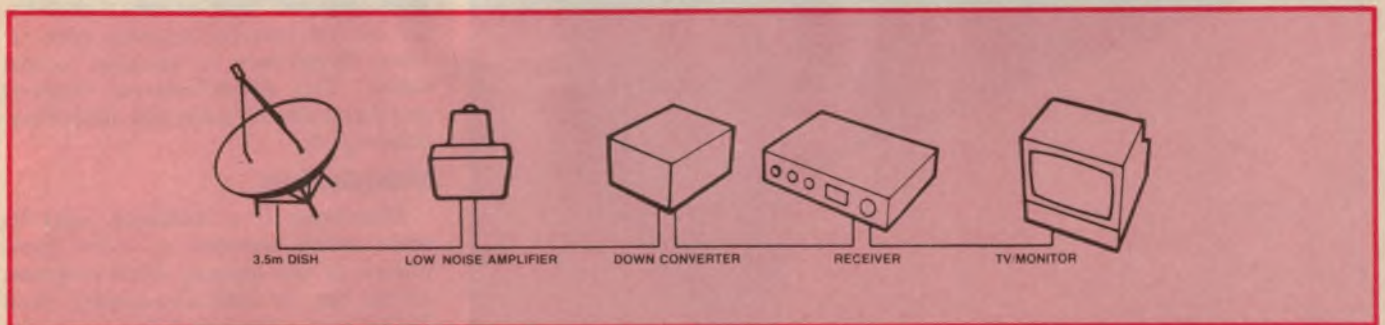

This block diagram shows the basic equipment needed for an Intelsat home earth station. Note that the monitor used must be compatible with the signal received from the satellite (eg, NTSC for the American Armed Forces Radio & TV Service, PAL for Australian/NZ feeds, SECAM for Gorizont).



Designed for use with the Intelsat system, this satellite receiver accepts a 70MHz IF signal from a down converter and features audio subcarrier tuning from 5.3-8MHz. (Dick Smith Electronics).

quirement for multiple down-converters and LNAs.

With blockdown conversion, the entire downlink band from 3.7GHz is converted to a standard block of intermediate frequencies from 950MHz to 1450MHz.

Practical results

Now that you have an understanding of the basic hardware of a TVRO system, we should discuss the sort of results that can be expected. Over the years, the minimum requirements for a home TVRO system which will give "near entertainment quality" have been evolved by satellite TV enthusiasts to the following:

(1). A parabolic dish about 3.5 metres in diameter and having a gain of over 40dBi. The material of the dish is not critical although it must be accu-

rately paraboloid. In this regard, aluminum mesh dishes, which may be lighter and cheaper, may suffer, whereas solid dishes are less likely to distort from the ideal paraboloid shape. However, good results from mesh dishes are possible provided the surface is accurate.

(2). A low noise amplifier (LNA, LNB or LNC) having a minimum gain of 40dB (preferably 50dB) and a noise figure of better than 60°K.

(3). A receiver capable of an IF bandwidth of 12MHz (compared with standard US models having an IF bandwidth of 26 to 30MHz). The narrower the IF bandwidth can be made without destroying the colour video information, the better the signal-to-noise ratio. By way of explanation, this is similar to using a narrowband IF filter to improve reception of CW signals on a communications receiver.



This low noise amplifier (LNA) covers the 4GHz 'C' band of the Intelsats. (Dick Smith Electronics).

Additional requirements

Because satellite TV is international in nature, it is often possible to view television of different standards on the one satellite. For instance, on Intelsat 5, at 180 degrees East, most programming is in NTSC, although sometimes transmissions are in PAL. Also the Russian satellite Gorizont 6, at 140 degrees East, uses SECAM.

This means that either a multi-standard TV, monitor or VCR is needed if you want to receive all transmissions in colour. However, most enthusiasts rely on an NTSC monitor or television set as most transmissions on the Intelsat satellites visible in Australia originate from either the USA or Japan. Both SECAM and NTSC can be viewed in black and white on a PAL receiver. Audio can also be recovered if a PAL modulator is fitted to the satellite receiver.

Audio requirements

Most TV transponders on Intelsat and Gorizont modulate a subcarrier in the range of 5.0 to 8.0MHz with audio information. Many transponders carry multiple audio subcarriers — some carry mono or stereo TV sound, others carry FM radio, etc. Because the bandwidth of these audio subcarriers can vary from transponder to transponder, it is preferable to select a receiver that has switchable audio bandwidth, particularly if some narrow subcarriers are to be received.

Scrambling

Most of us have heard, at some time or another, of scrambling. Scrambling prevents unauthorised users from gaining access to program information. The BMAC system used by AUSSAT is an example of hard scrambling or encoding.

It is very difficult, if not impossible, to "break" an encoding method such as BMAC. Don't even think about trying. If you want to watch BMAC transmissions, you will have to buy a decoder. To use an external decoder your receiver should have "a baseband" output socket. This allows external decoding and processing of video and audio baseband signals.

Vidiplexing

Vidiplexing is a technique used by some uplink operators to allow transmission of two separate video programs on the one (or half) transponder. Both TCN-9 and ATN-7 downlinks from the USA use this frame interlacing system. External vidiplex decoders are available (Satel in Motueka, NZ) but require

good signal levels. In Australia, the highest footprint on transponders, using the vidiplex technique approximates 17dBw, which is very weak indeed.

To display both frames separately, a far more economical technique is available even though it is in black and white. By obtaining a black and white television receiver and rotating the picture tube yoke 90 degrees, both frames can be displayed separately, vertically stacked, once the vertical hold is adjusted.

Microwave power level and space loss

The ground to satellite signal path in the 6GHz range requires substantial transmitter power between 1kW to 3kW plus large antenna gains of 50 to 60dB to saturate the input of the satellite with high quality noise free signals. Like any relay station, the signal quality returning to Earth is only as good as that initially transmitted to the satellite. On the uplink path free space loss approximates 198dB. Our primary interest is in the downlink since this is where we can participate.

The downlink frequency band limits are 3.7GHz to 4.2GHz. This is often a shared band with terrestrial microwave links so interference may occur at some sites. This is the first thing to check before installing a TVRO system. The satellite's signal is contained within a 35MHz wide frequency band. The video signal is FM and the audio signal is FM, being transmitted as a sub-carrier between 5 and 8MHz. Because this is an FM system, one important factor must be considered that is not part of a normal AM terrestrial television transmission.

The most important factor is called the FM threshold. On any FM receiver, when an FM signal reaches full quieting, all background noise is gone. As long as the signal stays above the threshold of noise, you have no way of judging without complicated test equipment how close you really are to the noise since, in full quieting, there is virtually no noise. The signal may be far above that required for full quieting or it may only be marginally above the level required for full quieting.

This means that if the frequency modulated satellite signal can be maintained just above the noise threshold and, if the satellite signal is very stable, we can get by with a low margin receive system. To normal visual inspection, this would give the same apparent picture quality as a signal that is many dB stronger than full quieting.

Even with the weak signal provided by Gorizont and Intel-sat satellites in Australia, it is possible to achieve a signal level marginally above threshold by adjusting the IF bandwidth and using "threshold extension techniques" in the receiver.

Conclusion

The science of satellite reception is a very exacting one at its present stage of development. One of the mental hurdles you must adjust to, is thinking in terms of 0.1dB or 0.5dB differences as being substantial.

As previously mentioned the down link path loss approximates 200dB and is proportional to the distance squared between the Earth and the satellite. This Earth-to-satellite distance is about 37,000km.

Because the satellite transponder power is limited by battery and solar cell capacity to 5 watts DC input power (typically), and because of the tremendous distance involved, the signal reaching the Earth has an approximate signal strength of 0.5×10^{-20} watts. This is less than the thermal noise level present at the ground. (2)

One Machine Workshop

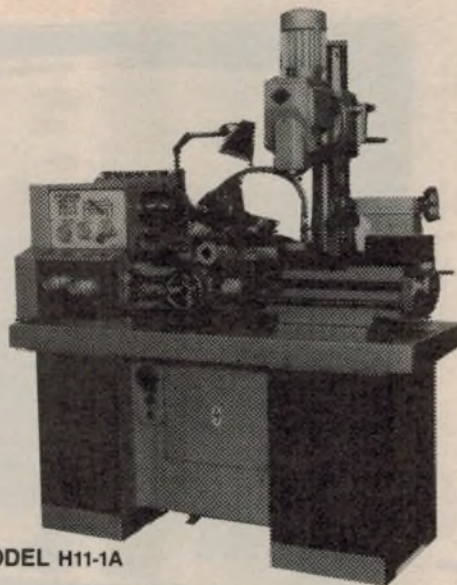

MODEL H11-1A

A multi-function machine tool

A heavy-duty professional unit which Turns, Mills, Screw Cuts, Grinds, Drills, Slots, Cuts Gears . . . and more. All cutters, slot drills, etc., are Standard Equipment. Workable diameter 300mm. Max. Length of work 550mm. Driven by 2-speed heavy-duty electric motor. A real workhorse at an economical price. Built to Government Ordinance Factory Standards. Available 240 volt 1 Phase.

SERMAC

PTY. LTD.

(VIC)
129-131 McEwan Road,
West Heidelberg. 3081.
Ph: (03) 459 6011
(NSW)
25 Cosgrove Road,
Enfield. 2136.
Ph: (02) 642 5363

Please send me further information on the H11-1A Multi-function Machine Tool without obligation.

NAME

ADDRESS

..... P.CODE

**NOW
OPEN**

MELBOURNE

45 A'BECKETT STREET CITY

TELEPHONE 663 2030

SENSATIONAL BUY OF '87!!!!



Sensational at **\$499**



Jaycar is proud to announce that we have made a SCOOP PURCHASE of genuine VIATEL terminals WITH 14" COLOUR MONITOR at an unbelievable price!! We can pass ENORMOUS SAVINGS on to you as a result! Here's the story.

A large National Electronic goods rental company came to us. They had a quantity of professional (European made) "Viate" terminals which they wanted to sell. They wanted to sell them because they had a new terminal that had an integrated monitor and larger page memory storage. There is nothing wrong with the ones offered, they said. They were between 3 & 5 years old and had been in typical office environments, were very clean and in good condition and had been in constant service contract. They were very reliable anyway however. The units sold for over \$1,900 new but the batch being offered was ex-rental.

Well, we bought them, and they ARE in very good condition! Now, thru JAYCAR, you can own a fully dedicated VIATEL TERMINAL at a FRACTION OF THE PRICE of new or equivalent units! As far as we can tell the nearest new commercial unit costs \$1,400, so at \$499 you are making a massive saving (although the goods offered are NOT new).

RGB MONITOR. Such is the quality of this system the monitor has RGB input. RGB signals from a suitable computer can be connected to the monitor so that it can double as a high res COLOUR computer monitor! With a composite to RGB adaptor you can use virtually any computer!

VIATEL ADAPTOR. The adaptor is professionally made by Philips & INCLUDES an inbuilt modem to Viate standard (1200/75). It features:

- Detachable remote keypad
- Keylock ON/OFF switch
- Centronics type printer port
- Telecom approved (C82/39/489)
- Tape record port
- Full keyboard port
- Instructions

WANT TO KNOW MORE?
Ring
(02) 747 2022
and ask for
"Mr Viate!"
for full details!

QUANTITIES LIMITED! We DO NOT have a warehouse full of these and we do expect them to sell FAST! PLEASE! if you do want one of these GET IN EARLY. Stock will be sold strictly to the first buyers.

PERSONAL SHOPPERS ONLY. Stock is limited to personal shoppers only. (At this price we do not have time to pack them in a box!)

WARRANTY. Because the goods are ex-rental no warranty applies. We do, however, check each unit out for operation BEFORE they leave the store. The rental company are happy to provide a SERVICE CONTRACT for the goods if you wish. We also can provide service manual sets for \$20 extra. We must emphasise that this product has proven to be very reliable but the goods are sold as is.

SCOOP PURCHASE

12 VOLT 15 AMP SPST RELAY
- NORMALLY OPEN CONTACT -

Japanese made, chassis mount with quick connect terminals.
Can be used for 240 volt applications.
Silver alloy contacts.
1 amp 400V quenching diode fitted across coil.
Data sheet supplied.
Cat. SY-4048

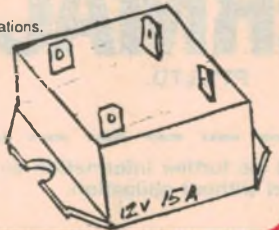

\$5.00

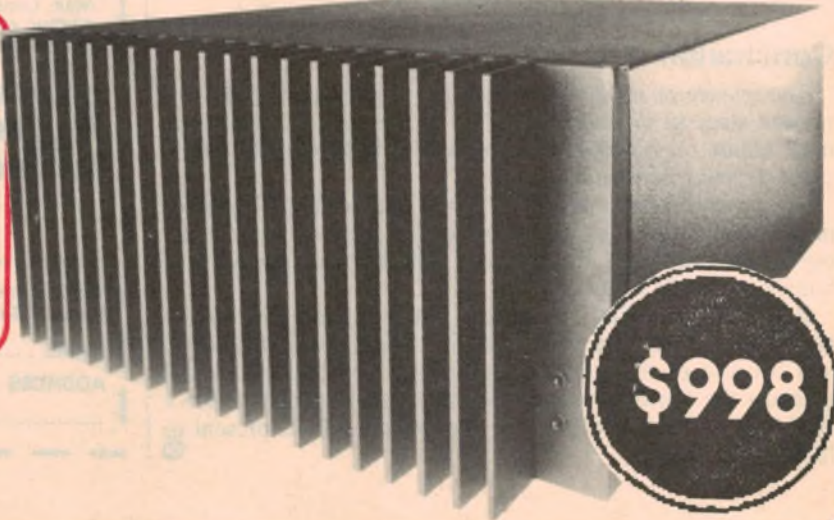

\$998

FINALLY RELEASED!

The AEM 6000 amplifier system kit is NOW AVAILABLE ex-stock.
240 watts RMS per channel of pure power. \$998 gets you the complete kit, nothing else to buy.
Cat. KM-3020

**NOW
OPEN**

MELBOURNE

**45 A'BECKETT ST.,
CITY
TELEPHONE
663 2030**

IONISER KITS - FINAL SELLOUT

GET A BARGAIN WHILE YOU CAN!

Jaycar is discounting its two ioniser kits. We are only doing this because we have purchased some built units from bankrupt stock at very low prices. It would cost us in components for these kits, more next time than we are paying for current distress stock built up products.

We have sold thousands of ioniser kits over the years and they are still popular. Now is your chance to grab a bargain!

Cat. KJ-6510 SHORT FORM (no case)

NORMALLY \$27.50

THIS MONTH \$13.50!!

Cat. KJ-6511 FULL IONISER KIT

NORMALLY \$49.50

THIS MONTH \$29.50

SAVE \$20.00 (Quantities strictly limited on both!)

**UP TO
50%
OFF!**

(Photo shows KJ-6511 with lid removed)

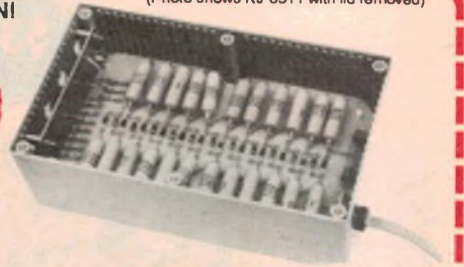

**SEND A LARGE SAE AND \$1.00
FOR THE 1987 JAYCAR 116
PAGE CATALOGUE FULL
OF ELECTRONIC PRODUCTS
FOR THE HOBBYIST**

FIBRE OPTIC EVALUATION KIT

The EDU-LINK kit is a fibre optic evaluation system consisting of TTL compatible transmitter board IR LED, 1 metre of fibre optic cable, photodiode and TTL compatible receiver board. The fibre optic connectors are also included. Manual includes instructions, theory and tutorial.

DIRECT IMPORT - YOU SAVE HEAPS!
Cat. KJ-6520

\$49.95

INFRA RED MOVEMENT DETECTOR

The ideal unit to add to an alarm system. IR units such as this unit do not respond to non-heat radiating objects - even the cat is unlikely to trip this unit. When a human being passes the lens the unit will selectively pick up IR radiation and then not. A series of pulses are then sent to a detector unit.

FEATURES:

- 12V DC powered
- Double sensor
- Computerised OC to lower failure rate
- Built-in test lamp
- Alarm output SPST 30V DC @ 1 amp
- Cat. LA-5017

\$109

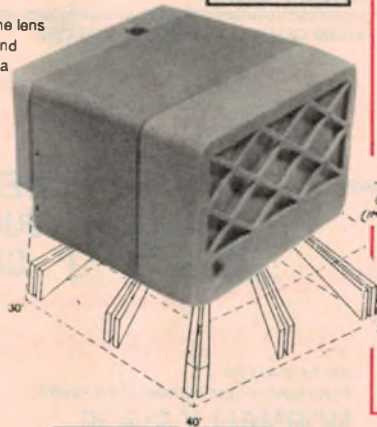

AVTEK MEGA-MODEM

Brand new 'smart' modem from an Aussie leader. Has full auto recognition of outgoing and incoming calls. Permanently connected to your phone and computer. High speed 1200/1200 (V22), Bell 212 option is available that can be fitted internally. 300/300, 1200/75, V21/V23
Cat. XC-4832

\$499.00

V21/V22/V23 (1200/1200)

Option fitted

Cat. XC-4834

\$699.00

Full specifications in the Jaycar 1987 Catalogue - available for \$1 from all stores or via mail (included large SAE)

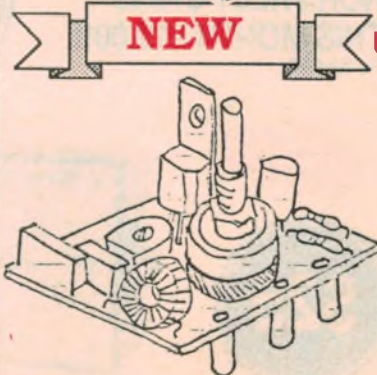

NEW

SCOOP BUY VEHICLE BACK-UP BEEPER

Genuine Mallory 'Sonalert'.

This device mounts near the rear of any 12V vehicle. When +12V is connected (i.e. from reverse gear switch) it will give that familiar "beep-beep" noise. Simple panel mount fixing. (Operates 4-28V) 69dBA min - 80dBA max.
Cat. AB-3442

A BARGAIN AT ONLY

\$9.95



**DIRT
CHEAP!!**

DELUXE RACK CABINETS

These beautifully crafted rack cabinets will give your equipment a real 1st class appearance. All aluminium construction. Removable top and bottom panels. Natural or black finish. All dimensions conform to the International standard. Ventilated lid. Deluxe brush finish anodised front panel. Individually cartoned. Supplied in flat pack form and easily assembled in a few minutes.

SIDE ELEVATION: D = 254mm; C (internal chassis height); B (mounting bolt centres).

	Finish	A	B	C	Each	+5
Cat. HB-5411	Natural	44	34	38	\$65.00	\$62.00
Cat. HB-5413	Natural	88	57	82	\$75.00	\$71.00
Cat. HB-5415	Natural	132	89	126	\$85.00	\$80.00
Cat. HB-5410	Black	44	34	38	\$65.00	\$62.00
Cat. HB-5412	Black	88	57	82	\$75.00	\$71.00
Cat. HB-5414	Black	132	89	126	\$85.00	\$80.00

Beware of other rack cabinets that do not conform to International Rack sizing.

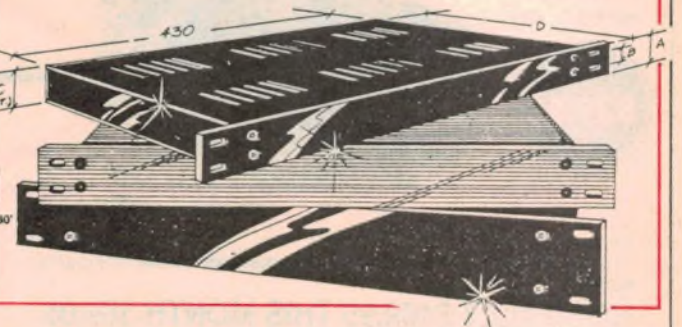

UNIVERSAL SPEED/LIGHT/HEAT CONTROLLER KIT ASTONISHING LOW PRICE!

We have once again made a scoop purchase of a partially assembled fan speed controller that was part of a well known Australian made product.

The controller consists of a PCB measuring 45 x 50mm with most of the components professionally soldered in. Two other components, a set of 3 brass connection terminals and the control switch/potentiometer must be soldered in place by the user. That's the only assembly work required.

You can connect the controller up to many 240V mains powered devices such as: incandescent lighting, electric motors (both series wound and shaded pole) or heating elements etc. It will control up to 3 amps (i.e. 750VA). A small heatsink may be required on the TRIAC over 2 amps.

The kit is complete and includes all assembly/connection instructions. You only need a suitable knob for the nylon insulated pot shaft.

Cat. KJ-6522

ONLY \$9.95

POLYSWITCHES

Ref: EA July 1986
The very latest in speaker protection. Polyswitch protectors are based on conductive polymers and act like resettable solid state circuit breakers.
RN3410 is suitable for protection of tweeters in systems up to 100 watts. It's rated at 50V & 0.5A. Nominal resistance is 0.4 ohms.
Cat. RN-3410
RN3415 will protect midrange and woofers up to 100 watts. Rated at 50V & 1.15A. Nominal resistance is 0.12 ohms.

BOTH UNITS

\$6.98 ea
10 or more
\$6.50 each



pH CHLORINE METER

Two probes coming out of one end of this hand held device are inserted into the water to be tested. An instant reading of the Chlorine level and pH value is given on the panel meter display. Battery powered and great for fish tanks too!
Cat. OM-6135

WINTER SPECIAL
\$29.95

DIRT CHEAP!!



SAVE \$10

Sensational Ultrasonic Pest & Insect Repeller

This one is \$15.50 cheaper than last year!
It will control mice, rats, roaches, crickets, silverfish, waterbugs, moths, etc.
Size: 100 x 90 x 80mm.
Power adaptor supplied 240V/9V DC. Output level 130dB from 30kHz to 65kHz.
Cat. YS-5510



ONLY \$39.50

300 VA TOROIDAL - SLASHED

We're heavily overstocked on our MT-2136 Toroid. It is a 300 VA unit with two separate 30V 5 amp winding as secondaries.
They are normally \$75 but this month you can grab one (or 2) for only \$49.95 each a massive saving of over 33.3%!!
Cat. MT-2136
NORMALLY \$75
JUNE SPECIAL \$49.95
SAVE OVER \$25/unit

DIRT CHEAP!!

OVER 1/3 OFF



FRIGI-FRESH

ELECTRONIC REFRIGERATOR DEODORISER
Frigi-Fresh automatically circulates the air inside a refrigerator after each door opening. Air is drawn thru the inlet grille (shown). It passes through a special filter that absorbs odours. The Frigi-Fresh automatically turns itself off approx 12 seconds after the door is closed.
Cat. YF-5522 (inc. filter)
Spare filters Cat. YF-5523 \$3.00 each
Requires 4 x AA cells (not supplied)

\$24.95

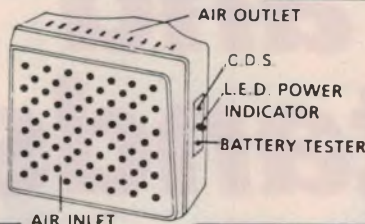

RECHARGEABLES & CHARGERS

PENLIGHT NiCads

Don't keep wasting money buying throw-away batteries. Step up to NiCad rechargeables.

SUPERB ROCKET BRAND AA PENLIGHT 450mA

Cat. SB-2452

\$3.50 ea
4 for \$12

UNIVERSAL NiCad CHARGER

Features:

- * Operates from 240V mains
- * Accepts AA, C, D & 9V NiCads
- * Charges singly or in groups
- * Charge different size units together
- * Charging indicator lamp at each battery position
- * Incorporates battery test facility

Cat. MB-3504

\$32.50



GEL BATTERY CHARGER

This handy charger will recharge your Gel batteries. Delivers 300mA current at 12 volts DC. Supplied with quick connect lugs for easy connection to the battery.
Cat. MP-3506

\$13.95

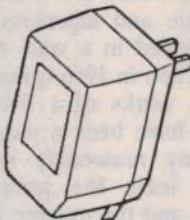

NEW LOWER EVERYDAY PRICES ON 4164 RAM

200ns	150ns
1-9 \$2.95	1-9 \$3.50
10 up \$2.50	10 up \$3.25
100 \$1.80	100 \$2.20
Cat. ZZ-8420	Cat. ZZ-8422

DIRT CHEAP!!

COMMODORE EDGE CONNECTOR

Cat. PA-0888

\$6.95



MELBOURNE NOW OPEN 45 A'BECKETT ST CITY TELEPHONE 663 2030

LEAD ACID RECHARGEABLE

Ideal for alarms or anywhere where constant use depletes batteries quickly.
12 VOLT 1.2AH **\$28.50**
Cat. SB-2480
12 VOLT 4.5AH **\$49.50**
Cat. SB-2486

MULTI-FUNCTION NiCad CHARGER

This one does everything!

FEATURES

- * Charges 8 - AAA, AA, C or D cells at once
- * Charges 3 to 9V cells via universal connector
- * Charges 3, 6 and 12V Gel batteries
- * Charges button cells
- * Test meter and LED charging
- * 240V operated

Cat. MB-3508

\$59.50

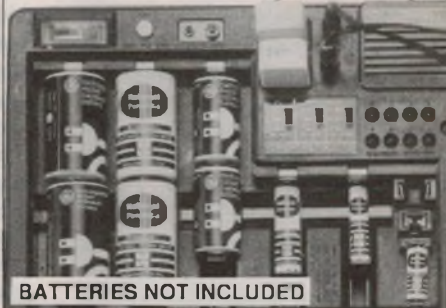

BATTERIES NOT INCLUDED

SOLAR BATTERY CHARGER

The solar panel in the lid will charge up to 4 x AA NiCads in a fairly short time. It is ideal for yachts, campers, or anywhere where 240V is not available.
Cat. MB-3502

\$17.95



Jaycar ELECTRONICS



POST & PACKING
\$5 \$9.99 \$ 2.00
\$10 \$24.99 \$ 3.75
\$25 \$49.99 \$ 4.50
\$50 \$99.99 \$ 6.50
OVER \$100 \$10.00

ROAD FREIGHT ANYWHERE IN AUSTRALIA \$13.50

SHOWROOMS

SYDNEY - CITY

117 York St. (02) 267 1614 - Mon-Fri 8.30 - 5.30 Thurs 8.30 pm - Sat 9 - 12

CARLINGFORD

Cnr. Carlingford & Pennant Hills Rd (02) 872 4444 - Mon-Fri 9 - 5.30 Thurs 8.30 pm - Sat 9 - 2pm

CONCORD

115 Parramatta Rd (02) 745 3077 - Mon-Fri 8.30 - 5.30 - Sat 8.30 - 12

HURSTVILLE

121 Forest Rd (02) 570 7000 - Mon-Fri 9 - 5.30 Thurs 8.30 pm - Sat 9 - 12

GORE HILL

188 Pacific Hwy cnr Bellevue Ave (02) 439 4799 - Mon-Fri 9 - 5.30 Sat 9 - 4pm

BRISBANE

144 Logan Rd Buranda (07) 393 0777 - Mon-Fri 9 - 5.30 Thurs 8.30 - Sat 9 - 12

MELBOURNE - CITY

Shop 2, 41-49 A'Beckett St City (03) 663 2030 Mon-Fri 9 - 5.30 Thurs 8.30 - Sat 9 - 12

HEAD OFFICE

115 Parramatta Road
Concord 2137
(02) 747 2022
Telex 72293

FACSIMILE
(02) 744 0767

MAIL ORDERS

P.O. Box 185
Concord 2137
HOTLINE
(02) 747 1888

FOR ORDERS ONLY TOLLFREE
(008) 022 888

MAIL ORDER VIA YOUR PHONE



Professional organisations for the electronics technician



TETIA and all it stands for

Ever wondered what the word "TETIA" stands for in the Fault of the Month item published in the Serviceman column? It's just one of two professional organisations for technicians in the electronics industry.

by **JIM LAWLER**

The "TETIA Fault of the Month", at the foot of "The Serviceman" stories, has become one of the magazine's more popular features.

I have been supplying the FOTM since its inception, and it appears fairly regularly. On the occasions when the paragraph does not appear, I can rely on getting phone calls from all parts of Australia asking "What's happened?" Equally, at other times, I can expect calls asking, "What is TETIA and how can I join?" The fact that callers want to join an organisation they seem to know nothing about implies that FOTM (Fault of the Month) is pretty powerful material.

In fact, FOTM began about three years ago after Leo Simpson, the then Editor of EA, asked the same question over lunch at the TETIA/TESA Convention at Launceston. Leo had accepted my invitation to speak at the Convention and then had to admit that he knew nothing of either TETIA or its sister organisation TESA, (of which more later).

The explanation which I gave Leo then forms the basis for this article. In return he invited us to promote the Institute by means of the paragraph now known as Fault of the Month.

Mr Fixit

To know the origins of The Electronic Technicians Institute of Australia (TETIA), it is necessary to go back to

the early 1950s and look at the local radio repairman's shop.

In most cases he was the village "Mr Fixit", able to attempt repairs to anything remotely based on technology. Apart from radios, he would repair irons and jugs, fans, toasters and radiators. One man I knew even did a first class job fixing sewing machines.

As well as repairs, the local radio shop sold "wireless sets" and "gramophone records", torch batteries, light globes and other small appliances. Most radio mechanics also rented out public address systems to various events and functions.

In a word, the radio repairman was versatile and ingenious. Above all, he was skilled in a wide variety of village arts. Then in 1956 came television.

The works of a five valve superhet might have been a puzzle to its owner, but any reasonably intelligent person could learn the principles in a few weeks and the practise in a year or two. Television, on the other hand, involved totally new principles and practises that few people had ever heard of, let alone understood.

The brighter and more enthusiastic radio mechanics went back to school to learn the new technology. Although they were able to use their new skills as soon as TV transmissions started, their qualifications were slow to be acknowledged by both the public and employers. Many servicemen felt that some or-

ganisation was needed to promote the Professional status of the new "technician".

The beginning

A group of technicians in Melbourne started the Institute in 1956 and, under several names, it has grown to become a nationwide organisation with something like a thousand members. The Institute is governed by a Federal Council and Constitution, with administration in the hands of each State Division.

Full membership of TETIA requires both educational qualifications and practical experience. Associate membership is open to those who have either the certificate or the experience but not both. Apprentices and those undertaking approved courses of training are eligible for student membership.

The original members of the Institute were radio tradesmen, mostly holders of an apprenticeship certificate with post-trade qualifications in television. The modern version of this certificate issued by State Technical Colleges, includes basic television, and is the minimum qualification for admission to the Institute.

Trade or technician certificates awarded by Telecom, the armed services or similar authorities, are also acceptable as membership qualifications. Graduates of commercial correspondence courses may qualify if they gain a pass at a supervised examination arranged or approved by the Institute.

As its name implies, the Institute was founded for the benefit of electronic technicians and it has been argued that a radio trade certificate is hardly technician level. But radio apprentices now graduate with television qualifications and often with extensive digital electronics training, quite sufficient to grade the modern technician above the one time radio tradesman.

Gaining this certificate requires at least three or four years practical training. This, with subsequent post-trade experience to a total of five years, is accepted as the minimum practical requirement for admission to the Institute.

Post trade courses

So a certificate and five years experience will gain for you access to TETIA but the learning process goes on for ever. The Institute sponsors post-trade courses wherever they can be organised and has often conducted its own courses to supplement those offered by educational authorities.

Lectures and training seminars are held regularly and the Institute publishes and distributes printed material for the use and information of its members. Some educational material is now being distributed on videotape and regular newsletters keep members up to date with activities within their Divisions.

Every two years, the Institute joins with TESA to stage the National Electronic Services Convention. The Convention is held in each state in turn and provides an opportunity for members to meet each other and with representatives from manufacturer's service departments. Lectures and displays presented at the convention enable members to keep up-to-date with this fast changing industry.

Originally the Institute catered mostly for technicians engaged in domestic electronics, meaning television. In recent years, the range of electronic services have spread so widely that today membership is open to an enormous range of occupations.

For example, in Tasmania our membership extends to employees in Telecom, the Hydro Electric Commission, the University, CSIRO, the Education Department and the Australian Broadcasting Corporation, to name just a few. Members are engaged in such diverse fields as industrial electronics, medical electronics, commercial computer installation and service, and two-way radio installation and maintenance. There is even one member who spends most of his time installing and repairing electric fences.

For most members of TETIA, our days consist of solving problems like those described by the Serviceman. Other members have similar problems in other fields or industries. For all of us, electronics is a fascinating but ever-changing occupation. We keep up to date only by constant study and TETIA is there to guide and help us.

Enquiries about membership should be addressed to the Secretary, TETIA, in each state. Their addresses follow:

- The Secretary, TETIA NSW Division, 762 Victoria Road, Ryde 2112.
- The Secretary, TETIA Victorian Division, 21 Burwood Road, Hawthorn 3122.
- The Secretary, TETIA SA Division, 28 Church Street, Highgate 5063.
- The Secretary, TETIA WA Division, PO Box 220, Willetton 6155
- The Secretary, TETIA Tasmanian Division, 16 Adina Street, Geilston Bay 7015.

Queensland enquiries should be addressed to NSW Division.

All about TESA

The constitution adopted by the founders of TETIA set the aims of the Institute as "educational" and deliberately excluded industrial or commercial activities.

Some members of TETIA were self-employed servicemen or the managers of service companies and the Institute was unable to provide assistance with their "business" problems. It was felt that another, parallel organisation was warranted and in 1962 the Television and Electronics Services Association (TESA) was formed.

TESA is an association of service businesses and it is the businesses themselves that are the members, not the persons engaged in the business. Usually the owner or manager is the member's representative at Association meetings.

The Association speaks for members in matters before Industrial Commissions, at Consumer Protection Council hearings, and at similar official meetings. TESA is a member of a buying group for the benefit of its members and, among other things, it supplies a range of standard business stationery at minimal cost to its members.

To the benefit of consumers, the Association imposes a discipline on its members which guarantees ethical practices and a recourse to higher authority in the event of disputes.

So TETIA and TESA work closely with each other. TETIA looks after the technician's education, qualifications and professional status, while TESA attends to the commercial and industrial side of the technician's business activities.

Enquiries about membership of TESA should be addressed to Mr Ray White, Secretary TESA, PO Box 154, Carlingford, NSW 2118.

Looking to purchase instruments

We are stockists of Hitachi, Fluke, Trio, Goodwill, Meguro, Aaron and Kikusui: so if you're in the market for an oscilloscope, think of David Reid.

ESCORT MULTIMETERS

- EDM 1105 \$78.89**
• 3½ digits • Six functions: DCV ACV DCA ACA OHM Diode Testing
• 0.8% basic DC accuracy
- EDM 1116 \$104.92**
• New model complete with transistor and capacitor tester
- EDM 1118 \$125.78**
• 3½ digits with DB range
- EDM 1125 \$113.95**
• 3½ digits • Seven functions: DCV ACV DCA ACA OHM Diode Testing Audible Continuity
• 0.25% basic DC accuracy
- EDM 1135 \$141.00**
• 3½ digits • Eight functions: DCV ACV DCA ACA OHM Diode Testing Audible Continuity
• 0.1% basic DC accuracy
- EDM 1346 \$250.87**
• 4½ digits • Eight functions: DCV ACV DCA ACA OHM Audible Continuity Testing Diode Testing Data Hold
• 0.05% basic DC accuracy



All multimeters + 20% Sales Tax

Ring us first for your 20 Meg. Oscilloscope enquiries!

NEW GOS-522 1 YEAR WARRANTY!

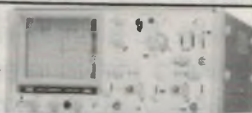

FEATURES

- Large 6 inch rectangular internal graticule CRT
 - CH1 & CH2 ALT Triggering (Alternate triggering function)
 - High Sensitivity 1mV/div
 - Hold-off function
 - TV Sync. Separation circuit
 - CH1 Signal output
- \$730.00**
+
20% TAX
- Plus 2 probes included in this deal.

Check out our kit range!
Here's two to have a go at —

Megohm Meter

It uses a transistor inverter to produce a regulated 1000V DC supply which is applied to the insulation under test. Insulation resistances between 2M Ohm and more than 2000 Ohm can be measured. K 2500 (See EA July '85).



\$59.00

8 SECTOR ALARM SYSTEM KIT

Features:

- Alarm has 8 separate input circuits — 8 sectors can be monitored independently
- Each input circuit is provided with an indicator LED and a sector On/Off switch
- Individual sector isolation allows the user to have some areas of the premises habited while others remain protected e.g. Inside Off/Outside On
- Inputs accept both normally closed and normally open sensors
- Two inputs provided with an entry delay between 10-75 seconds
- Internal trip warning buzzer — alerts owner/occupant of pending alarm operation — great for the "forgetful" amongst us. This buzzer is pre-settable between 5 and 55 seconds prior to Alarm
- Unique circuit detects automatically when any N/O or N/C loops are either open circuit or dead short, e.g. someone trying to bridge reed switches etc.
- Switched output can be used to send a silent alarm through an auto-dialler circuit or similar



K 1900 (without Back up Battery) \$139.50
S 5065 (12V 1.2AH Backup Battery) \$22.95

These are just a few of the many 100's of up-to-date Electronic items on display at



DAVID REID ELECTRONICS LIMITED
127 York Street, Sydney, 2000
or Telephone (02) 267 1385



FORUM

Conducted by Neville Williams

Technology: has it gone over the top?

There's long been a readiness to question new technology — maybe ever since that far off day when someone invented the wheel. In a letter recently to hand, a reader who has spent his working life in electronics complains that the industry seems currently more interested in gee-whiz technology than in real consumer needs.

By way of background, the writer says that his interest in radio dates back to the days when he had to save up sixpence from his pocket money to buy his copy of *Radio and Hobbies* — the name under which this journal was launched as a monthly in 1939.

The letter is too long to accommodate in full but the abbreviated version that follows should indicate what the writer is concerned about. He continues:

In the past, technology was developed to meet specific needs; large valves gave way to progressively smaller ones, &c. Today, it seems, technology has outstripped our needs and is looking for an application.

The above remark is prompted in part by EA's remote controlled preamp project — a "you beaut" device, using the latest technology, but why? Where is the point in selecting radio from your armchair and then having to walk over to it to change stations? Or selecting cassette input and then having to walk over to insert the cassette and press Play? Maybe there are other useful functions but why source selection?

Take a look at today's TV receiver remote controls. The bodies are so small that they are difficult to handle, and the buttons so tiny and closely spaced that they are difficult to operate one at a time. Again, some of the buttons are rarely used by non-technical viewers.

I have a 6-year old remote control which is large enough to fit comfortably

in the hand, with six large buttons providing sound up/down/mute, channel up/down and power on/off — basic, simple and useful. Contrast this with my recent attempt to buy something similar for my 80-year old mother, who was confined to a chair by arthritis. I was obliged to settle for one too small to handle easily and with so many tiny buttons that, to the day she died, she could never figure it out.

Why are controls built like this, despite the fact that they present real problems to non-technical and handicapped people, who must surely represent a significant proportion of the buying public? Because technology says they can be!

Along similar lines, I recently purchased an AIWA AD-WX220 twin cassette deck to facilitate dubbing and editing of conference tapes. It's a great machine but who needs the "Random Program Music Sensor"? And at what cost? Maybe it's an attempt to keep up with CD players, but in vain because who wants to wait while the tape shuffles back and forth to reach the desired track?

Another major grouch concerns TV and stereo sound. In a cinema, pains are taken to match the visual and sound images in the cause of realism but, in the home, a typical stereo TV has the loudspeakers immediately adjacent to the relatively small screen. At family viewing distance, the sound image seems little wider than a point source and the stereo

effect is lost. If the loudspeakers are detached or a hifi system is used, a full stereo sound image will result but the visual image remains minuscule.

The problem becomes most noticeable with simulcasts, when the sound qualifies as a stereo program in its own right. To match it, the picture would require a single stationary camera with fixed lens — hardly the sort of visual fare to attract viewers.

As matters stand, while listening to instruments in acoustically specific and fixed positions, the TV viewer is forced to view proceedings from different angles, sometimes close-up and even looking face-on to the conductor. I find it an unreal and confusing situation, such that I prefer either to switch off the picture, or to retain it and listen to the sound in mono.

A report on stereo TV sound in "Broadcast Engineering News" (Oct. 1986) quoted comment which tended to support my own view. It reminded me of unofficial experiments which I witnessed back around 1960 at ABS, Adelaide, where the disparity between picture and sound was evident to all.

Once again, it seems that we don't need the facility but the technology is there and, if we don't have it, the "other" channel may steal a march! At a time when everyone is crying poor, I wonder about the justification — and the ethics — of having these high technology gimmicks foisted upon us.

D.S. (North Rocks, NSW).

It so happened that, about the time I received the above letter, I had a phone conversation with a now-retired professional musician and concert critic. Prompted by a chance reference to compact discs, he sounded off in a manner that would have done credit to

someone half his age!

"Ethics", as mentioned above by D.S., was much too tame a word to find a place in his outburst.

To my musician friend, rejection of the faithful black disc and the change-over to CDs was a scandal of international proportions, a gigantic conspiracy, a massive fraud, the greatest confidence trick that had ever been pulled on lovers of good music.

In modern LPs, he insisted, the recording industry had a medium that offered all the quality and subtlety needed to satisfy music lovers. But manufacturers were looking for a new gimmick — a new product that would force consumers to scrap their existing equipment and start all over again — and they'd found it in the compact disc.

Mention of technical specifications, the lack of surface noise, freedom from wear, etc, served only to impart renewed vigour to his scathing remarks. I gained the distinct impression that aspiring CD equipment salesmen could delete his name from their prospect list!

It was somewhat reassuring to recall a review of a then new CD release by Roger Covell in the Sydney Morning Herald "Guide" for Feb 23. You may have noticed it:

Rigoletto (complete opera) Callas, Gobbi, La Scala/Serafin. EMI CDS 7 47469 8 (two discs).

Said Roger Covell: "In the long run, the greatest blessing of the compact disc will probably be its ability to renew old recordings in a more or less permanent manner . . ."

The old EMI/La Scala version of Rigoletto (recorded in 1955) is one of the prime documents of 20th century Verdi performance . . .

"CD recording not only restores the performance to that of a mint LP, it eliminates most of the noises made by even the quietest LPs of the period; and it gives the impression of improving the basic sound in one or two of its aspects . . ."

Maybe, just maybe, and despite the foregoing passionately held conviction to the contrary, even this new fangled compact disc technology may have something to commend it to consumers!

The good old days:

Getting back to D.S.'s letter, one's immediate reaction may well be to agree that most of the technological advances made during past years do appear to have been prompted by an identifiable demand; but that, more recently, consumer requirements often seem

to have been overtaken by the urge to exploit new technology for its own sake.

We must, however, allow for the fact that recent developments are, of necessity, evaluated without the benefit of hindsight and what we lightly dismiss as today's gimmick may well turn out to be tomorrow's necessity. The promoter(s) may simply be more astute than the rest of us in identifying latest needs!

In the matter of remote controllers, a great many present-day consumers are willing to pay for the privilege of not having to put aside their beer and bikkies to make that tedious journey across the room — not for every single knob adjustment, anyway!

The remote controller for the preamplifier described in our October and November 1986 issues provides for all the functions that are reasonably accessible in such a unit, including input selection. As such, it's essentially no different in concept to other controllers dedicated to individual modules and it remains for the buyer/builder to decide whether it matches their needs.

Even so, I've always felt that the remote control concept can all too easily develop into a jungle. The mind boggles at the idea of a complete one-brand audio/video entertainment system with the essential functions of every unit brought together in a single armchair controller. Apart from the need for a pilot's licence, the owner would be locked into a particular group of components until the day came to scrap the entire outfit.

But the prospect of multiple indepen-

dent units, each with their own separate controller, is not very inviting either. It's easy enough to mislay a single VCR or TV remote control, without having to search for and sort through half a dozen of the things!

Yes, D.S., some controllers are needlessly small and needlessly difficult to operate and, even without the limitations of arthritis and a wheelchair, I've experienced at first hand the difficulty of finding, interpreting and manipulating them in the semi-gloom of a TV viewing room.

Maybe we should blame the engineers who, I am sure, found no problem at all in manipulating gadgets of their own creation, smaller and with more buttons than their competitors' models and demonstrated to management in the bright lighting of a conference centre!

As for AIWA's Random Program Music Sensor, I'm not in a position to offer an opinion about its cost component or its potential value to particular buyers. I probably wouldn't have much use for it either but if, as a facility, it adds only modestly to the price, it would scarcely be worth getting uptight about.

Frankly, I hear far fewer grumbles about supposedly gimmick features in consumer electronic equipment than I do about electronic "gimmickry" in modern cars. Electronic ignition is fair enough, because it's an isolated fitment and obviates the tedious chore of checking and replacing distributor points. But enigmatic electronic "brains" that control most of the works, and electronic

Interchanging VHS & NTSC tapes

Att: Neville Williams,

Firstly, full marks for an excellent monthly column. You might like to comment on the following observations:

(1). I purchased some Memorex T120 video cassettes in the USA as they were much cheaper than E180 tapes in Australia. They run for 170 minutes here, with good results.

(2). According to information on the package, the actual tape is equally suitable for NTSC and PAL/SECAM.

(3). I have exchanged recorded cassettes with people in the USA but without success either way. The National brand VCRs look much the same except that the American models use a 3-speed system.

I am aware that the PAL and NTSC systems encode the signal differently for transmission from station to receiver. A VHS tape system, however, is presented with decoded video and audio signals and, although I lack background knowledge of the subject, I suspect that the method of retrieving the information is the same on all VHS units, wherever sold.

The differences in tape speed pose an immediate problem but it seems to me that, if VHS units were equipped with speed adjustments of sufficient range (either as standard or user modified) then synchronising may occur. Some guidance in the matter may be appreciated by your readers.

D.K. (Belmont, Vic).

Keyboard Specials

A full 20-key numeric keypad for only **\$18.00**. And it has a rigid metal backplate and large typewriter sized keys. Contacts are rated to 30V, 20mA max and have a life in excess of 20 million operations. Measures approximately 125 x 80 x 20mm and has a rows-and-columns configuration. Supplied complete with flexible printed circuit type connecting lead and connector for mounting on your printed circuit. Building your own computer then we also have a full QWERTY keyboard with function keys. Configuration is again in rows-and-columns format and there is NO encoder. Full data supplied. There are 15 function keys in addition to the 67



main keys. One of the cursor keys incorporates a miniature LED. Connection is again by flexible printed circuit leads and connectors are

supplied. Measures 330 x 161 x 20mm approx. A bargain at **\$65.00**. Limited quantities only. Both are quality German manufacture.

Why pay \$10 more for a toroidal transformer for your E.A. 60/60 Amplifier?

Geoff has the Jones Transformers JT353 as specified for the E.A. 60/60 amplifier. It's a balanced C core, diagonally slot wound to improve efficiency and reduce external fields. An alloy mounting bracket is used to reduce fields in steel chassis. Low interwinding capacity reduces the possibility of powerline interference from control tones and switching transients, etc. But best of all it's locally made so it costs less! Geoff's price is **\$69.50**.

Specs JT353
Input: 240V 50 Hz
Outputs: Two 35V windings at 2.5A
Two 15V windings at 0.25A

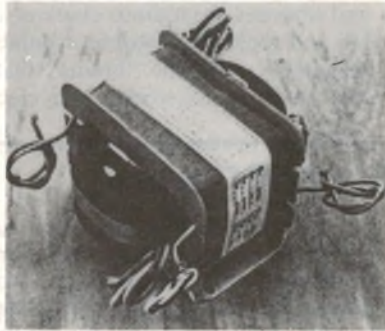

Interlocked Push-Button Switch

Highest quality 5 way DPDT interlocked push-button switch bank with those fancy blinking eye indicators. When you press the white knobs, a green indicator shows so you can see at a glance which circuit you've selected. Switch spacing is 12.5mm. Fitted with solder tags for easy wiring. Limited number only at **\$4.50**.

20MHz SCOPE WITH ALTERNATE TRIGGERING

Compact and easy to operate for hobbyists and professionals



12 MONTH WARRANTY

The GOS-522 is an ideal general purpose scope which we've selected because of its excellent triggering functions. Two channels with big 150mm (6") screen and internal graticule. Fast 20ns/div sweep speed for high precision. Features alternate triggering mode to ensure stable display of both channels - saves a lot of knob twiddling!! Trigger circuit is dc coupled too for low frequency signals. Trigger level lock and variable hold-off all add to ease of use. Auto, normal and single shot

sweep modes. Call in for a demo, you will be delighted with the performance and the price -

\$869.95 (incl. tax)
\$745.67 (ex tax)

includes FREE PROBES and a 12month warranty.

IBM PRINTER CABLE

Approx 1.5m long with quality connectors on each end. You couldn't buy the parts and make one yourself for the price. Were \$22.50 but till current stock is exhausted you can have one for just **\$15.00**.

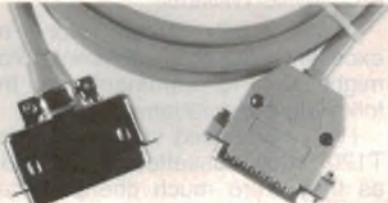

DRAFTING AIDS

We stock a full range - prices on application.



Potted Transformer Special

Here's a handy 240V/24V 250mA (single secondary) transformer for projects and other applications. Quality Australian made and a bargain at only **\$10.00** each.

Heat Shrink now available in metre lengths

There's a thousand and one uses for heatshrink! You can now pick it up in handy metre lengths in red, blue, white, black or clear as follows:

1.5mm	shrinks to	0.8mm	\$1.20
2.5mm		1.5mm	\$1.20
3.5mm		2.0mm	\$1.45
5.0mm		2.9mm	\$1.45
7.0mm		4.2mm	\$1.80
10mm		6mm	\$2.05
13mm		8.5mm	\$2.65
16mm		11mm	\$3.00
32mm		16mm	\$6.79
38mm		20mm	\$8.50
51mm		25mm	\$11.30

8.30 to 5 Monday to Friday, 8.30 to 12 Sat.
Mail Orders add \$5.00 to cover postal charges.

All prices INCLUDE sales tax.

Tax exemption certificates accepted if line value exceeds \$10.00.

BANKCARD, MASTERCARD, VISA, CHEQUES



GEOFF WOOD ELECTRONICS P/L (02) 427 1676

INC IN NSW
229 BURNS BAY RD. TWX 71996
(CORNER BEATRICE ST.) P.O. BOX 671
LANE COVE WEST N.S.W. LANE COVE N.S.W. 2066

OR CASH CHEERFULLY ACCEPTED

specialising in electronic components for the professional and hobbyist.

FORUM — continued

instrument arrays that cost the earth to replace are seen by many — rightly or wrongly — as examples of gee-whiz technology gone mad!

Stereo TV sound

I was interested to read D.S.'s ideas about TV stereo sound and, in the short term, I would have no great inclination to quarrel with them. It is indeed true that, when listening to good stereo sound, one tends to visualise the layout of the orchestra or ensemble and, according to the mood of the moment, either to listen to the sound as a whole or else focus upon some particular component of it.

In a live situation, the eyes would follow the ears, or vice versa, with the senses tending to complement each other unconsciously and automatically.

In a TV stereo presentation, that facility is not available for reasons which D.S. explains. You have either to look at a picture which is chronically small or else, at the whim of the video producer, leave your ears on the seat and go flitting hither and yon with your eyes.

D.S. chooses to break the nexus by discarding either the picture or the stereo facility, which would seem to be a rather drastic course. Maybe, given a little more patience, he may learn to concentrate rather more heavily on the audio and to relegate the visual to a supplementary role.

In the longer term, I would expect the ubiquitous cathode ray tube to give way to other forms of presentation, which will offer a much larger and brighter image. When that happens, stereo sound will much more naturally fit the picture!

A problem with standards

Still on the general subject of television, a Victorian reader, D.K., has been wrestling with the compatibility problem between video cassettes recorded on superficially similar VHS decks but to American and Australian television standards. His letter (considerably abbreviated) appears in the accompanying panel.

Perhaps I should add that, although referring specifically to National/Panasonic VHS format VCRs, the remarks apply equally to other brands and to both VHS and Beta.

While D.K. realises that the video signal is encoded in different ways for CCIR/PAL and NTSC transmissions, he has not caught up with the fact that the

signal encoding on video tape is no less distinct and different for the respective systems.

Without getting involved in a lot of detail, the tape in virtually all VCRs is pulled obliquely around a polished, rapidly spinning drum carrying a number of video heads. These impose the video signal obliquely across the tape as a series of side-by-side tracks, each track containing the synchronising, luminance and chrominance information pertaining to one single field.

In the NTSC system, the field repetition rate is 60 per second, with each field containing 525 lines. In CCIR/PAL, the respective figures are 50 and 625. Whichever one is recorded on the tape will obviously be recovered on playback and no amount of fiddling with drum speed can translate one to the other; it can only falsify both figures.

The linear speed of the tape affects the width and the slant of the oblique tracks but not the field rate or the number of lines per field so, again, fiddling the linear speed could do nothing to bridge the gap between the standards; it would only add to the confusion and, for extra measure, change the sound from drawl to "duck talk", as with any other linear sound recording.

One could suggest other discrepancies to do with colour encoding, &c, but enough has been said to indicate that D.K.'s proposition is quite impractical. Behind the facia of other-country models that look superficially similar, the differences extend far beyond the linear speed of the tape.

If one really must view cassettes based on other standards, or record them for use overseas, it is possible to buy multi-standard VCRs — but at a price and at a likely premium for service charges, because of the extra inclusions. Moreover, you don't normally use them with your everyday TV set but with a receiver or monitor which can itself accommodate different standards.

Sick of soldering?

Another Victorian reader has prompted a further instalment in the seemingly never ending saga about the possible undesirable effects of soldering fumes. His letter was addressed in the first instance to Norman Marks, a former member of the EA staff, whose observations on the subject were quoted on page 16 of the February issue. He says:

Dear Sir,

After three months under the care of the medical profession (no hoppers) I read in EA for February Norman Marks' letter to Neville Williams, which appears to be the answer to my problem.

I am silver soldering (Easy Flow, 2 SBA rods) a copper boiler for a 5-inch gauge model steam engine — but now, I realise, not in the correct environment.

Could you please advise where I could find out further information, and what is Merck's Index? Just head me in the right direction.

M.W. (Essendon, Vic).

Talking the letter over with Norman Marks, we agreed that there was no guarantee whatever that M.W.'s indisposition, whatever it was, had anything to do with his model building efforts. Even if there was a possible connection, one wonders how a member of the medical profession could, out of the blue, come up with the question:

"Hmm . . . you haven't by any chance been silver-soldering a copper boiler lately, have you?"

That aside, Norman Marks emphasised again that it was very wise to ensure adequate ventilation, forced if necessary, when brazing, soldering or welding. He added:

"One of the problems with hard soldering, where low working temperatures are required, lies in the inclusion of the low melt metals such as cadmium and cerium. If the alloy is overheated, oxides are given off, with cadmium high on the list of problem materials.

"Metal oxide fume ingestion can cause what is known as "metal fume fever".

"Companies in this general field which might be able to supply further information include:

- Harringtons Metallurgists Ltd, 37-49 O'Connor St, Chippendale, 2008.
- Johnson Matthey Ltd, 160 Rocky Pt, Rd, Kogarah, 2217.
- Engelhard Industries Pty Ltd, 50 Park St, Sydney, 2000.

As for Merck's Index, I gather that it is a very large reference manual published by a Division of Merck, Sharpe and Dohme, a large American drug and chemical company. Comprising more than 2000 pages, it is an exhaustive reference on drugs, industrial chemicals, organic chemicals, natural elements, standard tests for the presence of elements, &c.

Norman Marks managed to get a fire-damaged copy but otherwise, he said, "it would probably cost an arm and a leg". Check for it in the reference section of any large, accessible library. ☛

F-111 cutaway

- 1 Hinged nose cone
- 2 Attack radar
- 3 Terrain-following radar
- 4 Nose hinges (2)
- 5 Radar mounting
- 6 Nose lock
- 7 Angle-of-sideslip probe
- 8 Homing antenna (high)
- 9 Forward warning antenna
- 10 Homing antenna (low and mid)
- 11 ALR-41 antenna
- 12 Flight control computers
- 13 Feel and trim assembly
- 14 Forward avionics bay
- 15 Angle-of-attack probe
- 16 UHF Comm/Tacan No 2
- 17 Module forward bulkhead and stabilization flaps (2)
- 18 Twin nosewheels
- 19 Shock strut
- 20 Underfloor impact attenuation bag stowage (4)
- 21 Nosewheel well
- 22 LOX converter
- 23 Rudder pedals
- 24 Control column
- 25 LOX heat exchanger
- 26 Auxiliary flotation bag pressure bottle
- 27 Weapons sight
- 28 Forward parachute bridle line
- 29 De-fog nozzle
- 30 Windscreen
- 31 Starboard console
- 32 Emergency oxygen bottle
- 33 Crew seats
- 34 Bulkhead console
- 35 Wing sweep control handle
- 36 Recovery chute catapult
- 37 Provision/survival pack
- 38 Attenuation bags pressure bottle
- 39 Recovery chute
- 40 Aft parachute bridle line
- 41 UHF
- 42 Stabilization-brake chute
- 43 Self-righting bag
- 44 UHF
- 45 ECM antennae (port and starboard)
- 46 Forward fuselage fuel bay (2,340 Imp gal/10,638 litres)
- 47 Ground refuelling receptacle
- 48 Weapons bay
- 49 Module pitch flaps (port and starboard)
- 50 Aft flotation bag stowage
- 51 Air refuelling receptacle
- 52 Primary heat-exchanger (air-to-water)
- 53 Ram air inlet
- 54 Rate gyros
- 55 Rotating glove
- 56 Inlet variable spike

- 57 Port intake
- 58 Air brake/undercarriage door
- 59 Auxiliary inlet blow-in doors
- 60 Rotating glove pivot point
- 61 Inlet vortex generators
- 62 Wing sweep pivot
- 63 Wing centre-box assembly
- 64 Wing sweep actuator
- 65 Wing sweep feedback
- 66 Control runs
- 67 Rotating glove drive set
- 68 Inboard pivot pylons (2)
- 69 Auxiliary drop tanks (500 Imp gal/2,273 litres)
- 70 Outboard fixed pylon (subsonic/jettisonable)
- 71 Slat drive set
- 72 Wing fuel tank (324 Imp gal/1,473 litres)
- 73 Leading-edge slat
- 74 Starboard navigation light
- 75 Flap drive set
- 76 Outboard spoiler actuator
- 77 Starboard spoilers
- 78 Inboard spoiler actuator
- 79 Flaps
- 80 Wing swept position
- 81 Auxiliary flap
- 82 Auxiliary flap actuator
- 83 Nuclear weapons and weapons control equipment package
- 84 Wing sweep/Hi Lift control box
- 85 Flap, slat and glove drive mechanism
- 86 Starboard engine bay
- 87 Yaw feel spring
- 88 Roll feel spring
- 89 Yaw trim actuator
- 90 Yaw damper servo
- 91 Roll stick position transducer
- 92 Pitch trim actuator (manual)
- 93 Roll damper servo
- 94 Pitch trim actuator (series)
- 95 Pitch feel spring
- 96 Pitch-roll mixer
- 97 Pitch damper servo
- 98 Pitch stick position transducer
- 99 Aft fuselage frames
- 100 Aft fuselage fuel bays (1,191 Imp gal/5,413 litres)
- 101 Horizontal stabilizer servo actuator
- 102 Starboard horizontal stabilizer
- 103 Aft warning antennae
- 104 HF antenna
- 105 Detector scanner
- 106 X-Band radar
- 107 Rudder
- 108 Integral vent tank
- 109 Fin aft spar
- 110 Fin structure

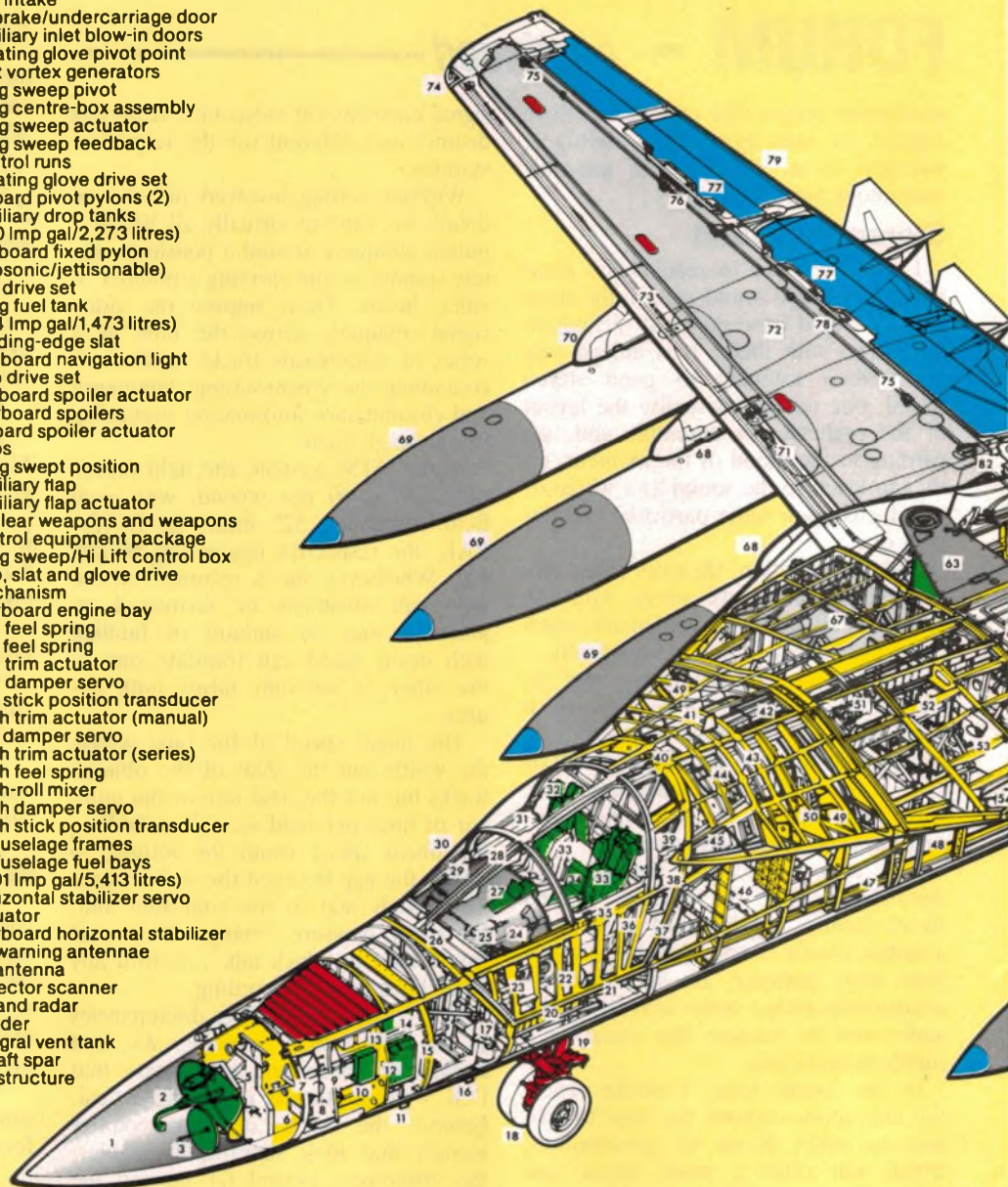

“Now put it back to

You're looking at a technological marvel.

It's called an F111C.

It's a high-performance, supersonic swing-wing strike reconnaissance aircraft.

An aircraft that has distinguished itself in several combat zones around the world.

It's a very complex machine made up of more than three million separate parts, each and every one vital to the aircraft's performance.

Indeed, for every hour of flying time, it must spend many on the ground being checked, double-checked and checked once again.

By perfectionists.

The men and women who perform the many tasks needed to keep it flying are RAAF technicians.

They learn their skills through our Certificate of Technology, Trade Apprentice and Adult Technical Training Schemes.

Quite frankly, RAAF technicians represent the very best in their various fields.

These include avionics, armaments, electronics, propulsion systems and even fibre optics.

Once posted to operational duties, we expect them to very quickly put themselves on a first-name basis with

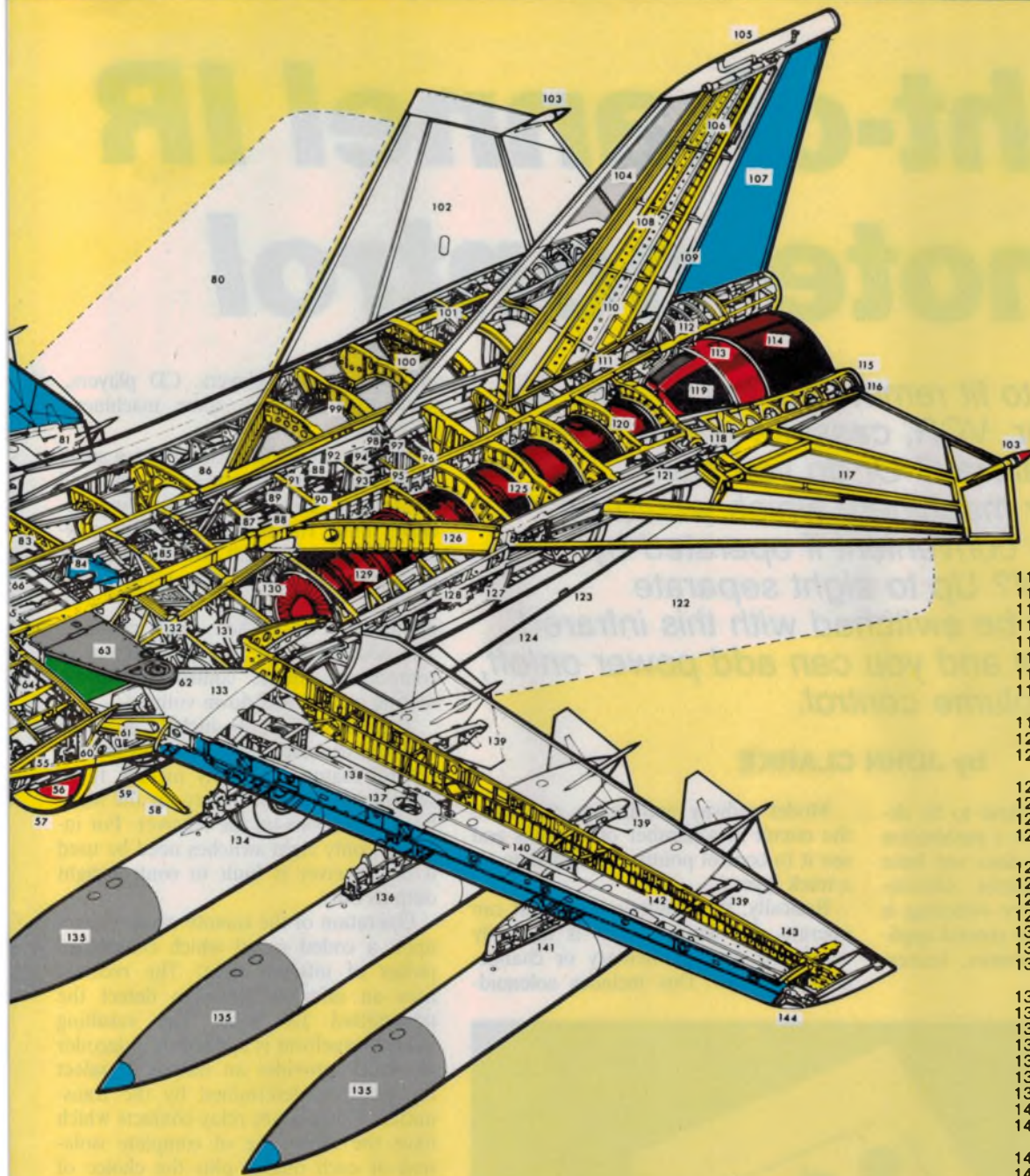

- 111 Fin/fuselage attachment
- 112 Rudder servo actuator
- 113 Variable nozzle
- 114 Tailfeathers
- 115 ECM antenna
- 116 ALR-41 antenna
- 117 Horizontal stabilizer structure
- 118 Horizontal stabilizer servo actuator
- 119 Free floating blow-in doors
- 120 Afterburner section
- 121 Horizontal stabilizer servo actuator
- 122 Wing swept position
- 123 UHF
- 124 Ventral fin
- 125 Fire detection sensing element loops
- 126 Cross frames
- 127 Engine access hatches
- 128 Engine accessories
- 129 Pratt & Whitney TF30 turbofan
- 130 Three-stage fan
- 131 Intake duct
- 132 Fire extinguishing agent container and nozzles
- 133 Wing box skinning
- 134 Port mainwheel
- 135 Auxiliary drop tanks
- 136 Pivot pylon
- 137 Pivot point
- 138 Pivot actuator
- 139 Flap racks
- 140 Fixed pylon strong point
- 141 Outboard fixed jettisonable pylon
- 142 Wing integral fuel
- 143 Wing box structure
- 144 Port navigation light

gether, Corporal."

every nut, bolt, rivet and electrical circuit of their aircraft.

And that could be any one of the 17 different types currently in service with the RAAF.

If this sounds demanding, you're absolutely right.

But these are the characteristics that make RAAF technicians the most sought-after by civilian employers.

If you think you've got what it takes to be the best in your field, fill in the coupon and send it off now.

All we require is that you're an Australian citizen.*

You must be between 16 and 21 with good results in English, Maths and Physics (17-34 years for Adult Training). You should also be reasonably fit.

*Or eligible to become one.

To: RAAF Careers, GPO Box XYZ (in the Capital City nearest you).

Name _____

Address _____

Postcode _____

Telephone _____ Date of Birth _____

Highest Educ. level attained or being studied _____

Or phone an RAAF Careers Adviser on Adelaide 2121455. Albury 218277. Bendigo 43 8008. Brisbane 226 2626. Canberra 57 2311. Geelong 211588. Hobart 34 7077. Launceston 311005. Melbourne 697 9755. Newcastle 26 3011. Parramatta 635 1511. Perth 325 6222. Sydney 219 5555. Townsville 72 4566. Wollongong 28 1855.

GROUNDCREW  **RAAF**

Authorised by Director-General of Recruiting, Dept. of Defence.

RTA 116 DPS 96

Eight-channel IR remote control

Ever wanted to fit remote control for your TV set, CD player, VCR, cassette player or even your model railway? Or do you have appliances or machinery which would be safer or more convenient if operated by remote control? Up to eight separate functions can be switched with this infrared remote control and you can add power on/off, muting and volume control.

by JOHN CLARKE

The remote control system to be described could be added to a pushbutton TV set which presently does not have the luxury of remote control. Alternatively, if mains-rated relay switching is added, it could be used to control appliances such as lamps, alarms, heaters and so on.

Model railway enthusiasts can build the circuit in a number of versions and use it to control points and signalling on a track layout.

Basically, the remote control unit can operate any device which is normally controlled with momentary or change-over contacts. This includes solenoid-

operated cassette players, CD players, pushbutton TV sets, some machinery and models.

The remote control comprises a small hand-held battery-powered infrared transmitter and an accompanying receiver unit. The receiver is mains powered and can be built with a minimum of components to provide remote control of up to eight functions with momentary or latched relay contacts. The addition of the full complement of components allows control of on/off, muting and up and down volume.

The transmitter can include up to 12 switches to enable the use of all remote control features, or only include those switches that are necessary for the number of functions on the receiver. For instance, only eight switches need be used if the receiver is built to control eight outputs only.

Operation of the remote control relies upon a coded signal which consists of pulses of infrared light. The receiver uses an infrared diode to detect the transmitted IR light. The resulting pulsed waveform is applied to a decoder IC which provides an output to select the function determined by the transmitter. Outputs are relay contacts which have the advantage of complete isolation of each output plus the choice of normally open or normally closed contacts.

A choice of decoders provides for either latched (ie, stays on after being selected) or momentary contact relay outputs. The latched output decoder can be one of two types. One type simply is a 4-bit output suitable for selecting each of the eight relays. The second type has the 4-bit output plus a separate output for mute and volume control.

If momentary contacts, volume and muting are all required then two decoders are required.

The volume control output is a current source which can be used to directly control volume on DC volume controlled TV sets or via a Light Dependent Resistor. The LDR connects across the volume control potentiometer



The project can be used to provide full remote control for a TV receiver. This version of the transmitter uses the smaller of the two optional plastic cases.

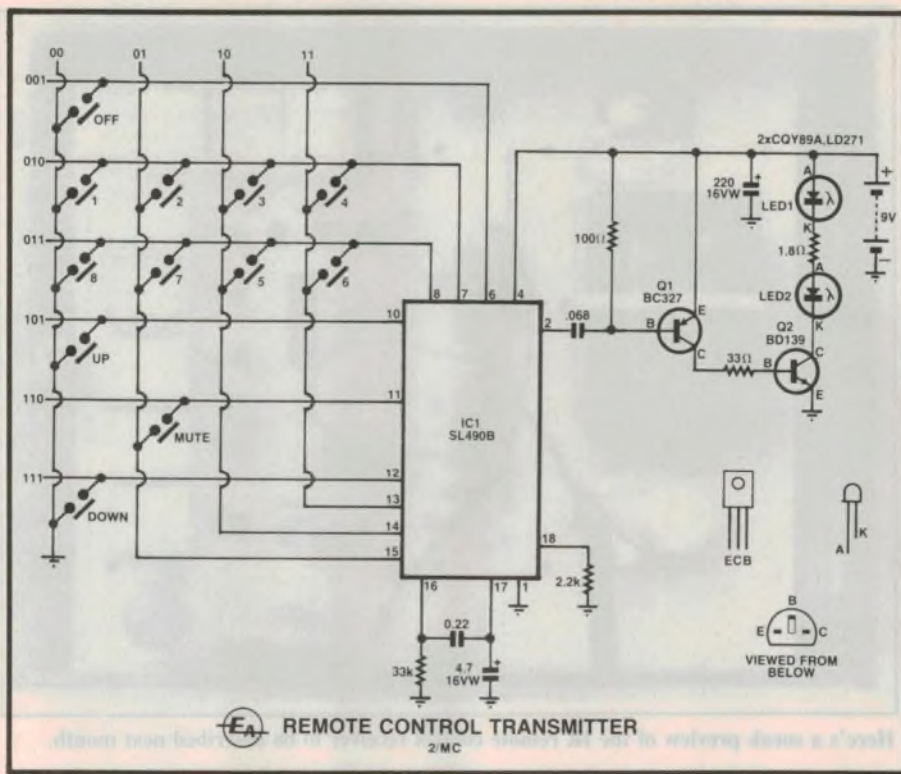

4.7µF capacitor connected between pin 17 and the 0V line.

Power for the transmitter is derived from a 9V battery while a 220µF capacitor across the supply provides the high current surges required when the IR LEDs are pulsed on. The standby current of the circuit is less than 10µA.

Receiver circuitry

IR diode D5 is the detector for the transmitted IR signal. It is connected across the differential input stage of IC2 at pins 1 and 16. The differential input stage provides for rejection of common mode noise from the diode and connecting leads.

Following this is a gyrator and four gain stages (all inside IC2). Each of these has a low frequency roll-off below 2kHz to effectively reject any 100Hz signals picked up by the receiver diode. The 6.8µF, 47µF, 0.015µF, 0.033µF and 0.0047µF capacitors at pins 2, 3, 15, 5 and 6 respectively are used to provide this roll-off.

A 0.15µF capacitor at pin 8 filters the output from an internal peak detector which measures the final output at pin 9. The resulting signal is used to automatically control the gain of the first three amplifier stages.

The input to an internal regulator at pin 12 is supplied via a 220Ω resistor to reduce the supply voltage and is filtered with the 22µF capacitor. Supply decoupling between the sensitive input circuitry and the output circuit is via the 47Ω resistor and 0.33µF capacitor.

After amplification in IC2, the received signal is sent to the input of IC3 and/or IC5. These devices convert the received serial stream into a 4-bit parallel code. (This means that they can only decode 16 of the possible 32 codes from the transmitter).

Both decoders contain an internal oscillator and this is at pin 2 for IC5 and pin 1 for IC3. The 0.027µF capacitor and series connected 22kΩ resistor and 50kΩ trimpot provide the reference frequency for each of the decoder ICs. In

The transmitter circuit. IC1 delivers a series of pulses to drive the two infrared LEDs.

and provides complete isolation from the receiver circuit.

Circuitry

The transmitter circuit comprises one SL490B integrated circuit (IC1), two transistors, two infrared (IR) LEDs and a few resistors and capacitors. The IR LEDs transmit a pulse position modulation (PPM) 5-bit code whenever one of the switches is pressed.

We have used 12 of the possible 32 separate code commands available with the SL490B. Connections for the switches are arranged in a matrix form from pins 6 to 15 and ground. The code for each matrix line is shown on the circuit. This means that switches 1 to 8 have codes from 01000 to 01111, while the Up, Mute and Down volume controls have codes 10100, 11001 and 11100. The OFF switch sends the code 00100.

The transmitter circuit is actually very

similar to and compatible with the remote control for the Playmaster Stereo AM/FM Tuner (described in the July 1986 issue of EA). The 8-channel keys and the on/off key would therefore operate the tuner memory, up/down tuning and AM/FM selection. The Mute and the Up and Down volume controls will not affect the tuner.

The transmit code output is at pin 2 of IC1, which is AC-coupled via the 0.068µF capacitor to the base of transistor Q1. This produces a 15µS current pulse each time pin 2 goes low. The 100Ω resistor at the base of Q1 ensures that Q1 is off after each 15µS pulse. Q2 is driven by Q1 via a 33Ω resistor which in turn drives the IR LEDs with the short high current pulses.

The PPM rate of transmission is set by the 33kΩ resistor and 0.22µF capacitor. Filtering for the internal 4.5V supply of the SL490B is provided by the

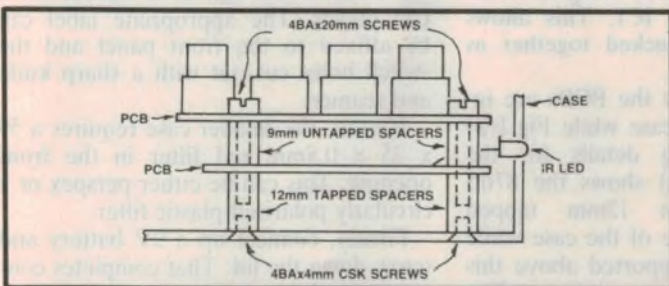

Fig.1a: this diagram shows how the two transmitter PCBs are installed in the larger case. The IR LEDs protrude through holes drilled in one of the end panels.

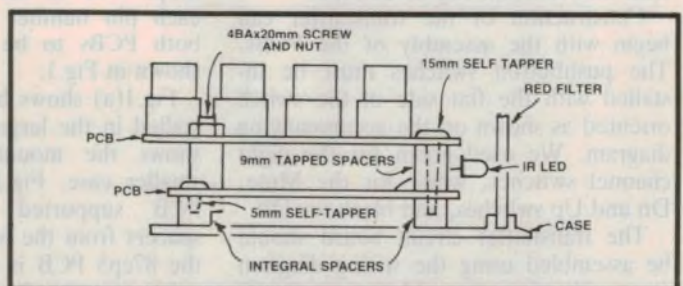
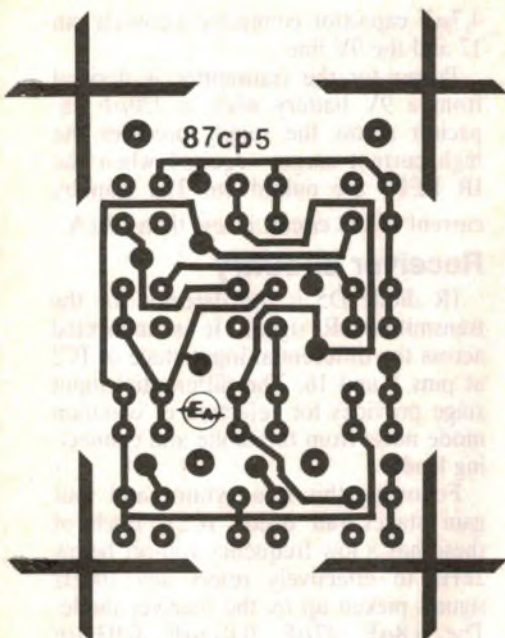
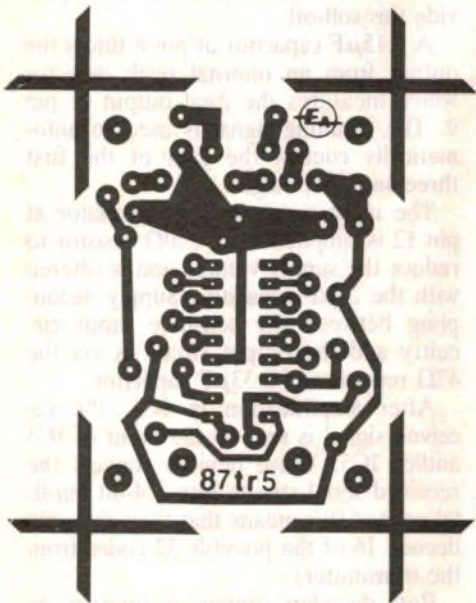

Fig.1b: PCB mounting details for the optional smaller case. In this version, the IR LEDs are positioned behind a red plastic filter.



Above & below: actual size PC artworks for the transmitter.



ing the eight channel selections plus Off, Mute, Dn and Up. For those functions not required, the switch associated with that function can be deleted.

Construction of the transmitter can begin with the assembly of the PCBs. The pushbutton switches must be installed with the flat side of the switch oriented as shown on the accompanying diagram. We used green for the eight channel switches, white for the Mute, Dn and Up switches, and black for Off.

The transmitter circuit board should be assembled using the wiring diagram as a guide. Start by soldering in the IC and resistors. Before installing the remainder of the components, it is easier

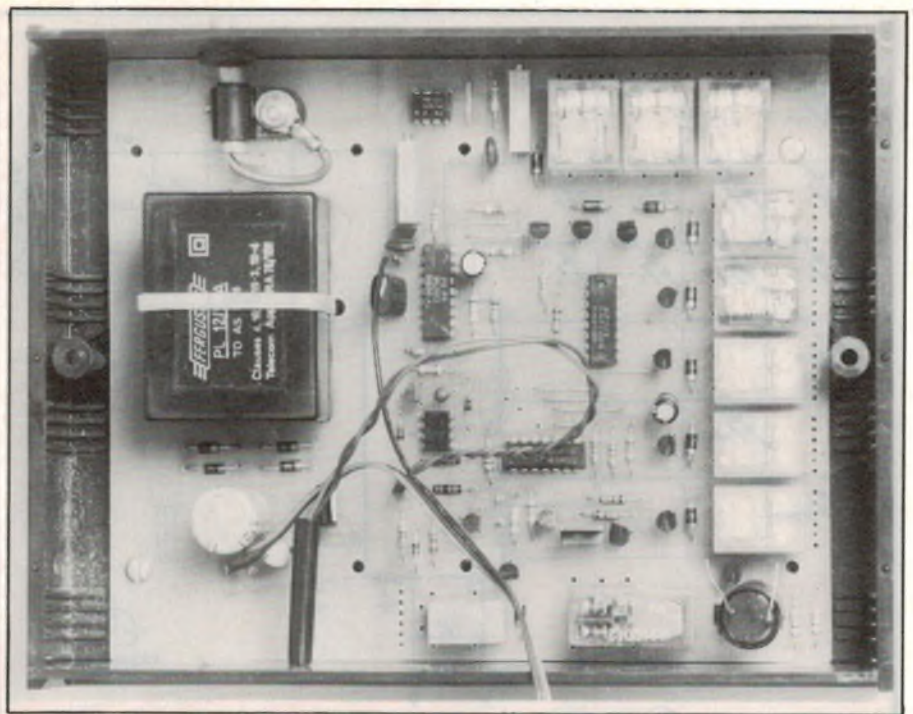

Here's a sneak preview of the IR remote control receiver to be described next month.

to solder in the wires for connection to the other PCB.

We used a 50mm-long piece of 10-way rainbow cable to do this job. The wiring is at IC1 pin numbers 6, 7, 8, 10, 11, 12, 13, 14, 15 and ground. Note that if the Off, Mute, Dn and Up switches are not used, then wires into pins 6, 10, 11 and 12 are not necessary.

All the capacitors lie side-on to allow the switch PCB to stack on top of this board. The 220µF capacitor is mounted off the edge of the PCB using the leads to support it in this position.

Transistor Q1 is inserted hard down onto the PCB, while Q2 is bent over as shown in the photograph. The infrared LEDs are mounted above the PCB by about 5mm, and their leads bent so that they protrude over the edge of the PCB by about 7mm.

The 9V battery clip can now be soldered in place. Wiring from the 87tr5 PCB is made to the underside of the 87cp5 PCB to the pads designated for each pin number of IC1. This allows both PCBs to be stacked together as shown in Fig.1.

Fig.1(a) shows how the PCBs are installed in the larger case while Fig.1(b) shows the mounting details for the smaller case. Fig.1(a) shows the 87tr5 PCB supported on 12mm tapped spacers from the base of the case while the 87cp5 PCB is supported above this using untapped 9mm spacers. The LEDs protrude through holes drilled in the front face of the case.

Fig.1(b) shows the 87tr5 PCB supported on the integral spacers in the base of the case. The 87cp5 PCB is supported above this using untapped 9mm spacers. The LEDs are positioned so that they are located just behind a red plastic filter. The filter measures 59 x 25 x 0.8mm and is slotted into the front of the case.

Install the PCB assembly in the box and measure the distance from the first row of switches to the front of the box. Use this distance and the front panel artwork to mark out the hole locations in the front panel. Remember to mark out only for the number of switches used.

Drill the holes out carefully with a 4mm drill and ream each hole out to 9mm diameter. Check that the lid will fit without fouling any of the switches.

Two front panel labels have been designed. One will suit if the unit is used as a remote control for a TV set while the other would suit as a control for a CD player. The appropriate label can be affixed to the front panel and the switch holes cut out with a sharp knife and reamer.

If used, the smaller case requires a 59 x 25 x 0.8mm red filter in the front opening. This can be either perspex or a circularly polarised plastic filter.

Finally, connect up a 9V battery and screw down the lid. That completes construction of the transmitter.

Next month we will describe the construction of two versions of the receiver.

PARTS LIST FOR IR REMOTE CONTROL

TRANSMITTER

Transmitter

- 1 PCB, code 87cp5, 44 x 62mm
- 1 PCB, code 87tr5, 40 x 57mm
- 1 front panel, 65 x 120mm
- 1 9V battery clip
- 1 plastic case, 65 x 120 x 40mm (W x H x D) or 67 x 110 x 33mm (see text)
- 1 red filter, 59 x 25 x 0.8mm (for smaller case)
- 4 9mm untapped spacers
- 4 12mm tapped spacers
- 8 green PCB pushbutton switches
- 3 white PCB pushbutton switches
- 1 black PCB pushbutton switches

Semiconductors

- 1 SL490 remote control transmitter
- 2 CQY89A or LD271 IR LEDs
- 1 BC327 PNP transistor
- 1 BD139 NPN transistor

Capacitors

- 1 220 μ F 16VW PC electrolytic
- 1 4.7 μ F 16VW PC electrolytic
- 1 0.22 μ F metallised polyester
- 1 0.068 μ F metallised polyester

Resistors (0.25W, 5%)

- 1 x 33k Ω , 1 x 2.2k Ω , 1 x 100 Ω 0.25W, 1 x 33 Ω , 1 x 1.8 Ω

Miscellaneous

- Screws, nuts, solder, 50mm of 10-way rainbow cable

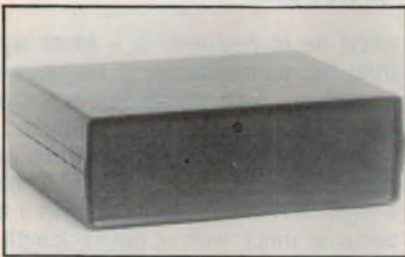

The receiver circuitry is installed in a standard plastic instrument case.

RECEIVER (8-RELAY CONTROL ONLY)

- 1 PCB, code 87rc5, 173 x 146mm
- 1 PCB, code 87pa5, 46 x 46mm
- 1 transformer PL12/5VA
- 1 mains cord and plug
- 1 cord clamp grommet
- 1 grommet for mains cord
- 1 cable clamp (for transformer)
- 1 plastic instrument case, 200 x 160 x 70mm (W x H x D)
- 1 piece of tinplate 70 x 70mm (optional)
- 1 piece of tinplate 47 x 47mm (optional)
- 8 DPDT 12V relays (Jaycar or Altronics S-4061, or Original OUB12V from Hi-Com Unitronics)

Semiconductors

- 1 SL486 remote control preamplifier
- 1 BPW50 or BP104 IR diode
- 1 ML926 or ML928 remote control receiver
- 1 4051 8-channel analog demultiplexer
- 1 4011 quad two-input NAND gate
- 1 7812 12V three terminal regulator
- 8 BC337 NPN transistors
- 12 1N4002 1A diodes

Capacitors

- 1 470 μ F 25VW PC electrolytic
- 2 47 μ F 16VW PC electrolytic
- 1 22 μ F 16VW PC electrolytic
- 1 10 μ F 16VW PC electrolytic
- 1 6.8 μ F 16VW PC electrolytic
- 1 2.2 μ F 16VW PC electrolytic
- 1 0.33 μ F metallised polyester
- 1 0.15 μ F metallised polyester
- 1 0.033 μ F metallised polyester
- 2 0.027 μ F metallised polyester
- 1 0.015 μ F metallised polyester
- 1 0.0047 μ F metallised polyester

Resistors (0.25W, 5%)

- 6 x 56k Ω , 1 x 22k Ω , 1 x 4.7k Ω , 1 x 220 Ω , 1 x 47 Ω , 1 x 50k Ω horizontal 10-turn trimpot

Miscellaneous

- Screws, nuts, PC stakes, hookup wire, solder etc.

RECEIVER (FULL VERSION)

- 1 PCB, code 87rc5, 173 x 146mm
- 1 PCB, code 87pa5, 46 x 46mm
- 1 transformer, PL12/5VA
- 1 mains cord and plug
- 1 cord clamp grommet
- 1 grommet for mains cord
- 1 cable clamp (for transformer)
- 1 plastic instrument case, 200 x 160 x 70mm (W x H x D)
- 1 piece of brass shim or tinplate, 70 x 70mm
- 1 piece of brass shim or tinplate, 47 x 47mm
- 1 DPDT 12V 5A relay
- 9 DPDT 12V relays (Jaycar or Altronics S-4061, or Original OUB12V from Hi-Com Unitronics)
- 3 3mm red LEDs
- 1 Light Dependent Resistor (Philips 2322 600 95001 or Jaycar Cat. RD-3480, or similar)

Semiconductors

- 1 SL486 remote control preamplifier
- 1 BPW50 or BP104 IR diode
- 1 SL486 remote control preamplifier
- 1 ML923 remote control receiver
- 1 ML926 remote control receiver
- 1 4051 8-channel analog demultiplexer
- 1 4011 quad two-input NAND gate
- 1 555 timer
- 1 7812 12V 3-terminal regulator
- 1 BC558 PNP transistor
- 1 BC547 NPN transistor
- 1 BC327 PNP transistor
- 11 BC337 NPN transistors
- 1 TIP32 PNP transistor
- 14 1N4002 1A diodes
- 3 1N914, 1N4148 diodes

Capacitors

- 1 470 μ F 25VW PC electrolytic
- 3 47 μ F 16VW PC electrolytic
- 1 22 μ F 16VW PC electrolytic
- 1 10 μ F 16VW PC electrolytic
- 1 6.8 μ F 16VW PC electrolytic
- 2 2.2 μ F 16VW PC electrolytic
- 1 0.33 μ F metallised polyester
- 1 0.15 μ F metallised polyester
- 1 0.1 μ F metallised polyester
- 1 0.033 μ F metallised polyester
- 2 0.027 μ F metallised polyester
- 1 0.015 μ F metallised polyester
- 1 0.0047 μ F metallised polyester

Resistors (0.25W, 5%)

- 1 x 3.3M Ω , 2 x 100k Ω , 7 x 56k Ω , 2 x 39k Ω , 2 x 33k Ω , 2 x 22k Ω , 1 x 10k Ω , 1 x 6.8k Ω , 4 x 4.7k Ω , 1 x 2.2k Ω , 2 x 470 Ω , 1 x 220 Ω , 1 x 47 Ω , 2 x 50k Ω horizontal 10-turn trimpots

Miscellaneous

- Screws, nuts, PC stakes, hookup wire, solder etc.

IC6 selects one of the eight outputs according to the code at the A, B and C inputs. This switches on the associated transistor to power the accompanying relay. The diode across each relay quenches the back EMF of the coil and prevents damage to IC6 and the associated transistors.

Note that each relay is a double pole double throw type to duplicate the action of double pole switches used in some equipment. For selection of the relays to take place, the INH input to IC6 must be low. Consequently, when IC3 or the ML926 (IC5) is used for selection, the D output is inverted so that the D-bar signal can be applied to the INH input of IC6.

When the ML928 is used for IC5, inversion of the D output is unnecessary since the outputs are already inverted. This also means that the order of relay selection will not comply with the relay numbering designated for the ML926 and ML923 ICs. Instead of being selected sequentially from 1 to 8, the order is 6, 5, 7, 8, 2, 1, 3 and 4.

Apart from providing latched A, B, C and D outputs, IC3 has an analog output at pin 10 and Mute control at pin 8. The Mute output goes high for muting and is low otherwise. For each transmitted Mute signal, the output at pin 8 changes state.

The analog output at pin 10 is a current mirror which delivers up to 1.3mA in 32 increments. The down transmission reduces the current while the up transmission increases the current. It takes about three seconds to span the entire current range with the transmitter Up or Down button continuously pressed.

When power is first applied, the RC time constant at pin 17 resets the analog output to 3/8th the maximum current and the muting is reset. The 0.1µF capacitor and 3.3MΩ resistor at pin 7 allows correct operation of the muting and analog steps.

The current output from pin 10 of IC3 is fed to a series resistor string consisting of a 6.8kΩ and 39kΩ resistor, the latter being shunted by transistor Q4. The voltage across Q4 can be used for controlling DC volume controls of TV sets. As an alternative, a Light Dependent Resistor (LDR) provides for a fully isolated volume control that can be substituted for a conventional potentiometer.

This facility is provided by Darling-ton-connected transistors Q5 and Q6 which are driven from the collector of Q4, via a 39kΩ resistor. Q6 drives two LEDs through 470Ω resistors from the



Alternative version of the transmitter, mounted in the larger of the two standard cases. Leave out the buttons for those functions that you don't need.

12V power supply. The LEDs in turn provide light for the LDR so that its resistance changes with the varying current available from pin 10 of IC3.

Muting here, muting there

Muting of the current source at pin 10 of IC3 occurs under three separate conditions whenever diode D6, D7 or D8 is forward biased. When this happens, Q4 turns on and shorts the voltage at its collector to ground. This also causes transistors Q5 and Q6 to turn on fully and drive the LEDs to full brightness. This gives minimum resistance through the LDR.

Diode D7 is forward biased when the Mute output at pin 8 of IC3 goes high. This happens under two conditions. It

could be in response to a Mute signal from the transmitter or if the transmitter volume down switch brings the output on pin 10 of IC3 to a minimum.

Diode D8 is forward biased for muting whenever the output of IC4 at pin 3 is high. IC4 is a 555 connected as a monostable timer with a timing length of about 240ms. Triggering of the timer occurs whenever the AFC output of IC3 at pin 5 goes low. This occurs for every code transmission from the transmitter which changes one of the eight output relays.

When pin 5 of IC3 goes low it triggers IC4 and sets its output at pin 3 high. For as long as the transmitter switch is pressed the AFC output will supply low going pulses to the base of

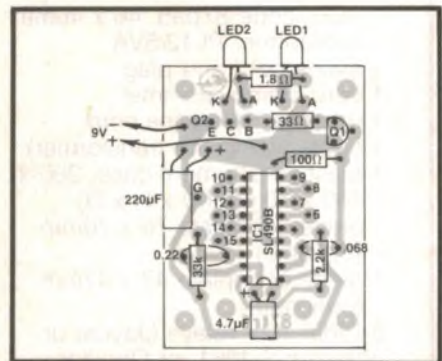
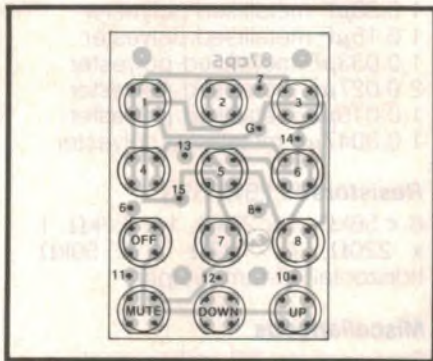

Here are the parts layout diagrams for the two transmitter PCBs. The numbers adjacent to various pads correspond to the external wiring points (see also photo page 46).

IT'S NO SURPRISE!



Light Bar Modules.

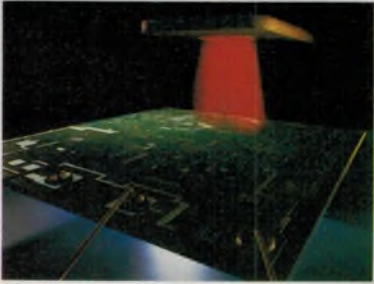

Opto Couplers.

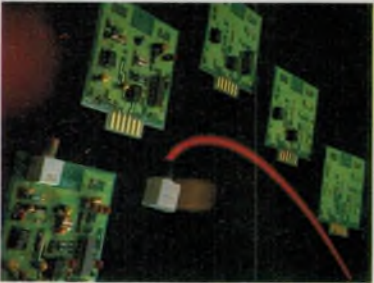

Fibre Optic Components.

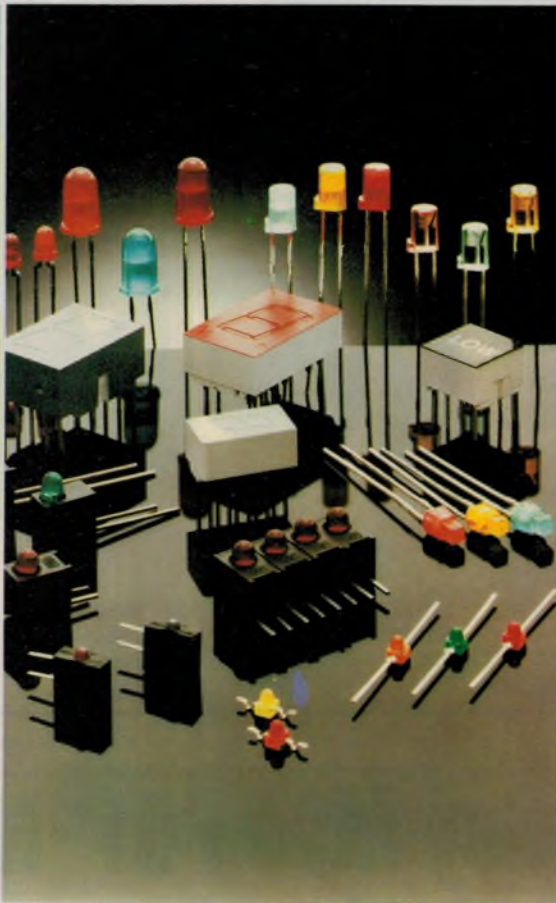

LED's and displays.



Bar Code Wands.

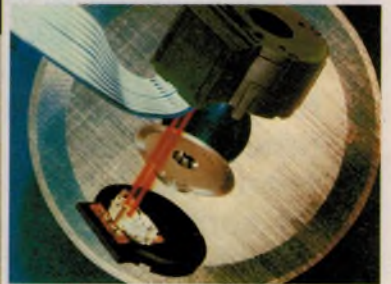

Optical Encoding.



Microwave Semiconductors.

H.P. stands for high performance

HP's quality and reliability ensures top performance. You can design in HP products with confidence that they will perform as specified, even in the most demanding environments. Their reliability has been proven over and over in a wide variety of applications, and they

are backed by HP's worldwide reputation.

If you require LEDs, light bar modules, fibre optic devices, bar code wands, optical encoders, microwave semi-conductors or the world's fastest opto couplers – choose Hewlett-Packard, and call VSI, Australia's authorised distributor.

VSI

THE SOURCE OF
 **HEWLETT
PACKARD**
COMPONENTS

VSI Electronics (Aust) Pty. Ltd.,
16 Dickson Avenue, ARTARMON,
NSW 2064, AUSTRALIA.
Telephone (02) 439 8622.
Telex AA22846.



VARTA

Positively the Battery Experts

VARTA NICAD RE-CHARGEABLE

The professional quality battery for the frequent user, resulting from exhaustive research, sophisticated product development and high-tech production. Recharges up to 1000 times. This is the economical alternative for constant long lasting trouble free operation.



150 RS

RSH 1.8

RSH 4

180 RS

501 RS

TR 7/8

VIC: 150 Buckhurst St. Sth Melbourne 3205. (03) 690-4911. Telex: Adeal AA 37011.
NSW: 405 Sussex St. Sydney 2000. (02) 211-0422
QLD: (07) 299-6992. S.A. (08) 258-5865.
WA: (09) 279-8811.

Distributed by **ADEAL PTY. LTD.**

Allen-Bradley MOD POT[®] - Now you can have the best when you want it.

Because the Allen-Bradley Mod Pot, which has a world-wide reputation for consistent quality and performance, is assembled right here in Australia at our newly-established Mod Pot assembly centre. The entire standard Mod Pot range is now available for extra fast delivery to anywhere in Australia - Allen-Bradley, the company you can rely on.

FEATURES:

- Hot moulded Carbon.
- Cermet.
- Conductive Plastic.
- Single or Concentric shafts.
- Push/Pull or Rotary switches.
- PC Pin Type or Lug terminals optional.
- Vernier Drives, 4 or 16 turns.

The most versatile standard potentiometer available today - mix and match the amazing Mod Pot Modules for over 1 billion possible control combinations.

A-B MOD POT ASSEMBLY AUSTRALIA



These pre-engineered, pre-tested modules form 1, 2, 3 or 4 control sections - one family of variable resistors to solve your unique control problems.

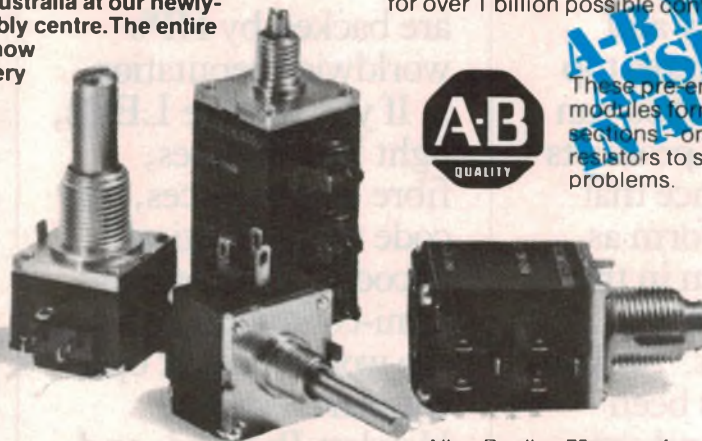

Call your Allen-Bradley Electronic Components Sales Centre today, and you'll be amazed at how fast we will deliver.

Allen-Bradley, 75 years of cost effective, innovative electronic component manufacturing.

VIC.: 37 Chapman Street, Blackburn 3130. Ph. 899-0335
N.S.W.: 22 Parramatta Road, Lidcombe 2141. Ph. 648-2652
QLD.: 1925 Logan Road, Upper Mt. Gravatt 4122. Ph. 343-7900
W.A.: P.O. Box 23, Subiaco 6008. Ph. 387-1702
S.A.: Electronic Components and Equipment
30-40 Hurtle Sq., Adelaide 5000. Ph. 232-0001
A.C.T.: Electronic Component P/L. P.O. Box 534,
Fyshwick 2609. Ph. (062) 80-4654



ALLEN-BRADLEY

A ROCKWELL INTERNATIONAL COMPANY

Design excellence and quality in the best tradition.

Q3. This transistor discharges the 2.2 μ F capacitor to keep the timer output high. When the transmission ceases, the 555 timer output goes low after 240ms and unmutes the circuit.

Finally, diode D6 is forward biased to cause muting whenever transistor Q9 is off. Q9 is switched on whenever the output of IC7b goes high. This occurs in response to an off signal from the transmitter. Relay 9, the power relay, then turns off and removes mains power to the remotely controlled appliance via its normally open contacts.

Consequently, diode D6 is forward biased via the denegised relay 9 coil to provide muting when the power is switched off.

Muting on power off is done so that if a direct DC connection is made between the TV volume control and the DC output of IC3, there is no voltage present when power to the TV is switched off.

Note also that transistor Q7 is switched on and off via IC7a which has a low output when the power relay is

off. The IC7a output follows the IC7b output. Thus, Q7 is switched off when the power to the remotely controlled appliance is switched off. Q7 controls the power to the LEDs so that LEDs are not driven during power off and this conserves power consumption. As soon as power is re-applied, the output of IC7a goes high to supply power to the LED driving circuit.

When muting occurs, the drive from D6, D7 or D8, apart from driving Q4, also turns on Q8. This transistor powers the Mute relay RLA10. This relay can be used to switch off the loudspeaker of a TV set, or to switch the volume control potentiometer to provide complete volume cut-off.

LED 5 is connected across the Relay 10 windings to indicate both when the volume is muted and also when the remotely controlled appliance is powered off.

Power for the receiver circuit is derived from a PCB mounted mains transformer which provides 12VAC. This feeds a bridge rectifier, D1 to D4, and a

470 μ F filter capacitor. The unregulated DC is fed to a 7812 3-terminal regulator to provide a fixed +12V DC output.

Transmitter construction

The remote control transmitter is constructed on two printed circuit boards. One PCB accommodates the pushbutton switches and measures 44 x 62mm (code 87cp5); the other accommodates the remainder of the circuitry and measures 40 x 57mm (code 87tr5).

The transmitter can be housed in one of two cases. The first is a standard plastic case measuring 65 x 120 x 40mm (W x H x D) and available from many kitset suppliers. The alternative is smaller but more expensive, has a 9V battery compartment, and includes provision for a plastic window in the front of the unit. It measures 67 x 110 x 33mm and is available from Hi-Com Unitronics, 7 President Lane, Caringbah, NSW 2229.

The 87cp5 PCB can accommodate up to 12 switches, all of which are required for the full remote control circuit featur-

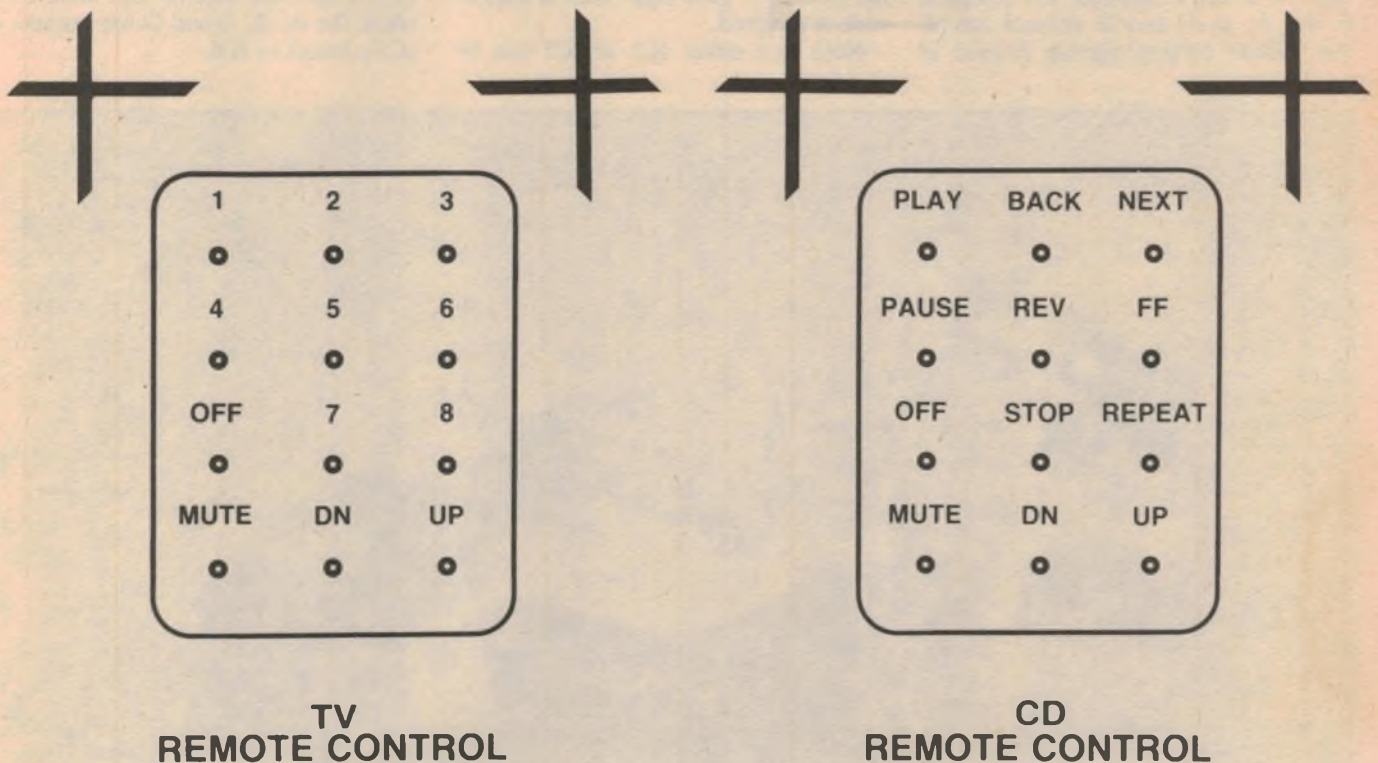

These actual-size front panel artworks can be used with the larger case.

theory, both of these oscillator inputs could be tied together and only one set of oscillator components used. In practice though, we found that this resulted in IC3 not operating.

One of two ICs can be used for IC5, either the ML926 or the ML928. The former provides momentary 4-bit outputs while the latter provides latched 4-bit outputs.

For the ML926 IC, the outputs normally are low until a correct code is received from the transmitter. It responds to the 1 to 8 selections with the D output going high. Reception of selection 1 results in the D output going high and the A, B and C outputs low. For selection 6, A, B, C and D are all high. These outputs are maintained until cessation of the transmitted signal, whereupon the outputs return to zero.

For the ML928 IC, the outputs are initially high until a correct code is received from the transmitter. It also responds to the 1 to 8 selections with the D output going low. Reception of selection 1 results in a low D output and high A, B and C outputs. For selection 6, the A, B, C and D outputs are all low. These outputs remain latched in

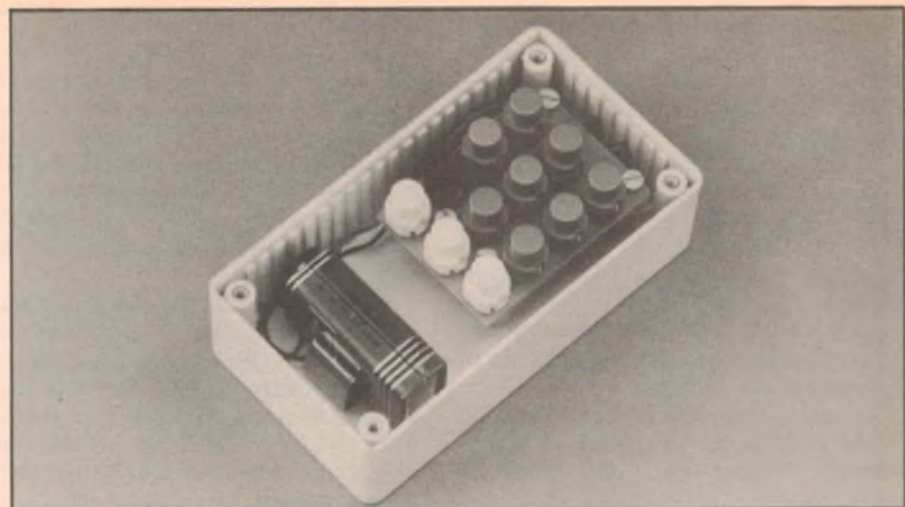

This view shows the transmitter PCBs installed inside the larger case. The 9V battery is secured by a metal clip.

the state of the last received signal until a new transmission changes the output code. The A, B, C and D outputs for IC3 are latched and have the same logic sense as the ML926. That is, the outputs are normally low at power-on and the D output goes high when a correct code is received.

Note that either IC3 or IC5 can be

connected to the eight channel demultiplexer (IC6). This is to allow the omission of IC3 when volume control and mute is not required. When muting and volume are required together with momentary contacts for the 1-8 outputs, IC3 is used for volume and mute only, while the A, B, C and D-bar outputs of IC5 connect to IC6.

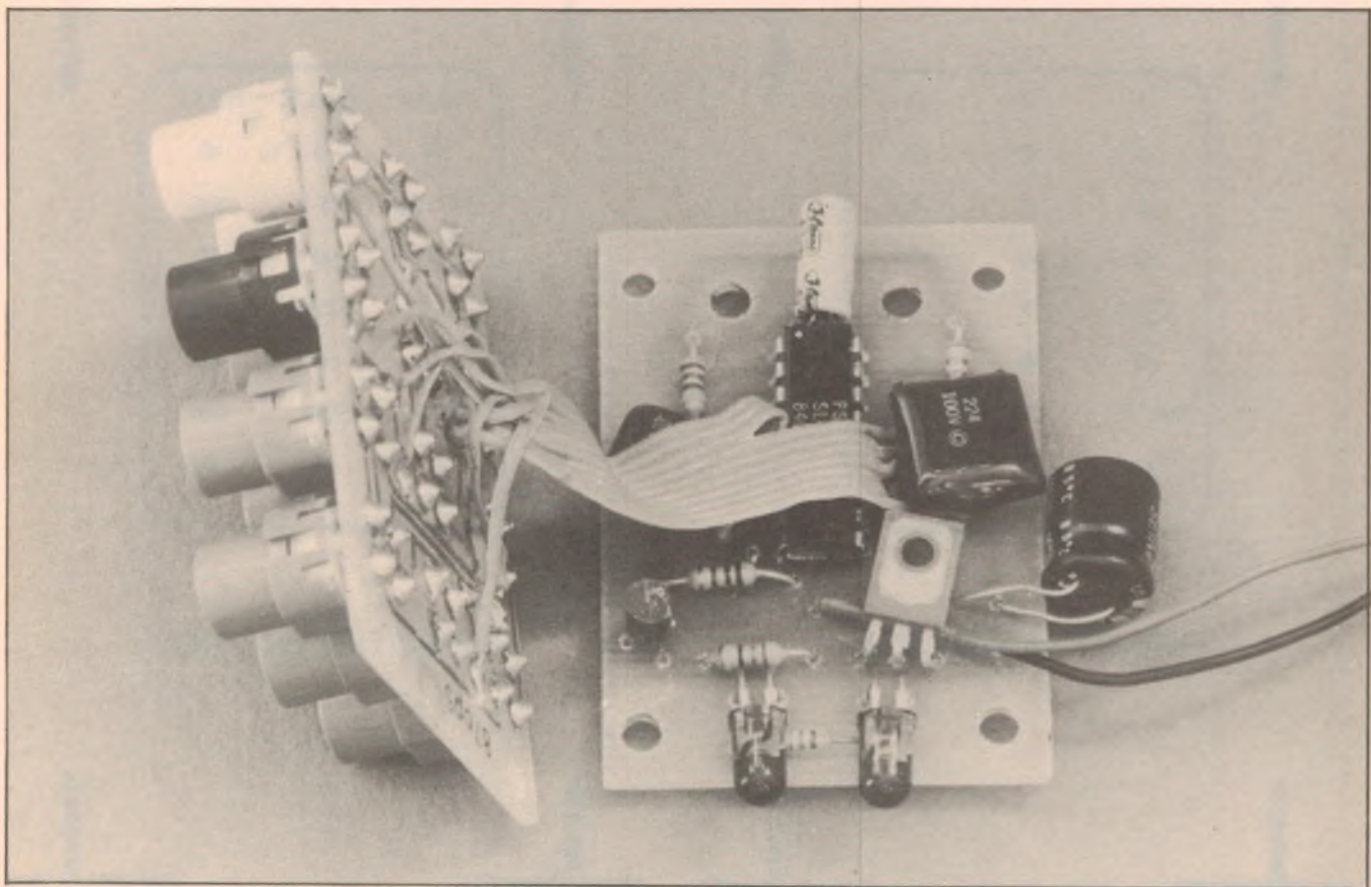

The transmitter is built on two PCBs which are wired together using ribbon cable. The BD139 transistor and the 220 μ F and 0.22 μ F capacitors must be mounted as shown so that the PCBs can be stacked together.

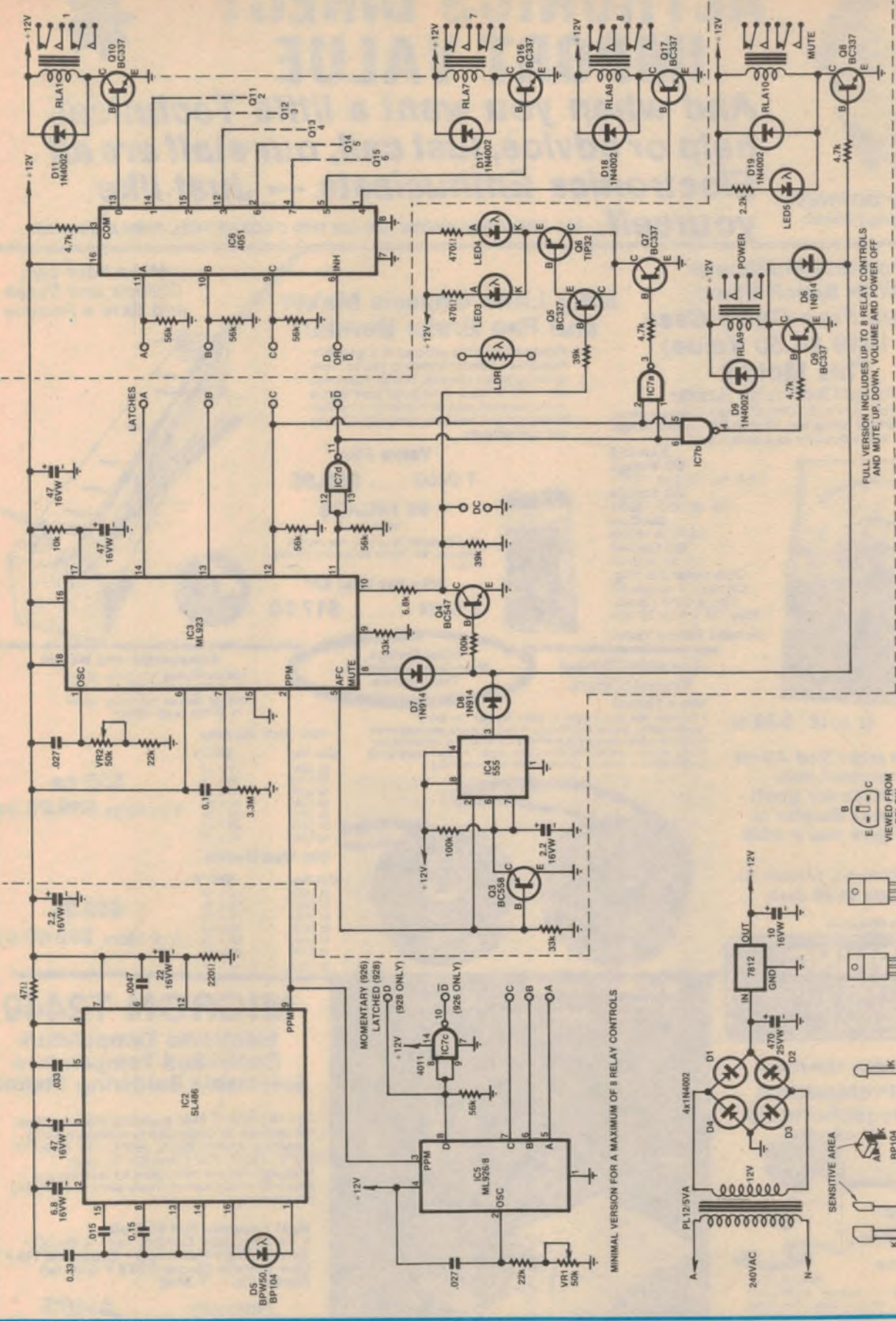

MULTIFUNCTION IR REMOTE CONTROL

FULL VERSION INCLUDES UP TO 8 RELAY CONTROLS AND MUTE, UP, DOWN, VOLUME AND POWER OFF

MINIMAL VERSION FOR A MAXIMUM OF 8 RELAY CONTROLS

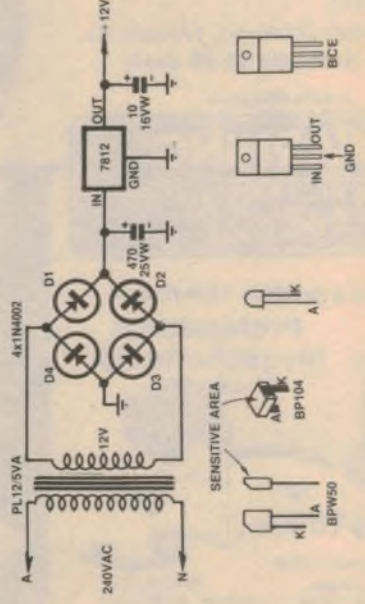
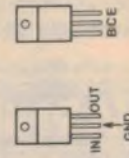

FOR NEXT DAY JETSERVICE DELIVERY
ALTRONICS TOLL FREE 008 999 007
BANKCARD HOLDERS — ALTRONICS TOLL FREE 008 999 007



JACK O'DONNELL
Managing Director

ALTRONICS DIRECT IMPORT VALUE



And when you want a little Technical help or advice, just call, our staff are all Electronics Enthusiasts — Just like yourself. ALL ENQUIRES PHONE (09) 328 1599 ORDERS TOLL FREE 008 999 007

Portable Multimeter With Bench Stand Bonus Free Carry Case (Q 1019 \$4.50 Value)

This Month
Includes Continuity Buzzer

20,000 Ohms/Volt DC • 8,000 Ohms/Volts AC. Mirror backed scale • Overload protected. 10 amp DC current range. Unique carry handle doubles as a bench stand.

RANGES
DC Voltage
2.5, 10, 50, 250, 1000V
AC Voltage
10, 50, 250, 1000V
Decibels
-8db to +62db
DC Current
5, 50, 500mA
Ohm meter 0-6 meg.
Ohms in 3 ranges, 50
Ohms centre scale.
Size 135 x 91 x 39 mm
Includes Battery Tester



Q 1018 \$39.95

Fit these large Red Alarm Stickers around your House, Office (or Boat) and the next Burglar to visit will give you a wide berth!

S 5400 200mm x 175mm \$1
Normally \$1.95 each

Alarm Stickers

WARNING

ALTRONICS SURVEILLANCE
ALARM SYSTEM
FITTED HERE

Up to Incredible 1KM Range

Professional Megaphone PA



A 1990

~~\$109.50~~

\$99

SPECIFICATIONS:

Power Output 20 Watts max
Effective Range Approx. 400M (up to 1KM in ideal conditions)
Power 8 Pcs Cell (not included)
Dimensions 230 Diam. 360 Length
Weight 1.5K (less batteries)
Shoulder Strap Supplied

Nifty Little Chassis Maker and Pan Brake Bender

Please Note: This product is a genuine Pan Brake Bender allowing you to make quite complex chassis, boxes, lids, trays etc. — It is made from solid steel and is not to be confused with inferior Non Pan Brake simple benders currently sold by our competitors.

Value Plus

T 2400 \$99.95

9V NICADS 150mAh

The finest 9V Nicad on the market. Genuine 9V (many others are actually 7.2V)

Why Pay Over \$20

S 5024 \$17.50

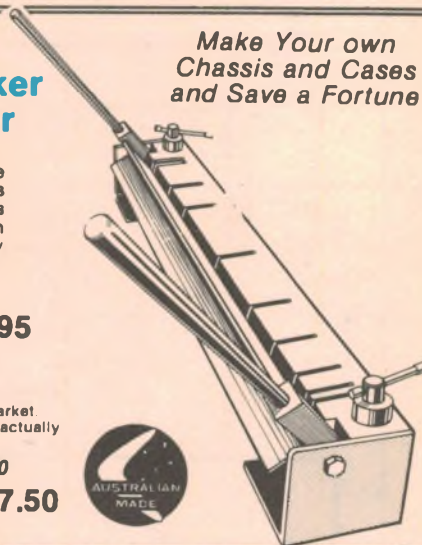

Make Your own
Chassis and Cases
and Save a Fortune



Toroidal Power Transformers

Great Savings
Over Conventional E.I.
Transformers

Why a Toriod?

• Smaller size and weight to meet modern "slimline" requirements • Low electrically induced noise demanded by compact equipment • High efficiency enabling conservative rating whilst maintaining size advantages • Lower operating temperature • Simple, quick single bolt mounting.

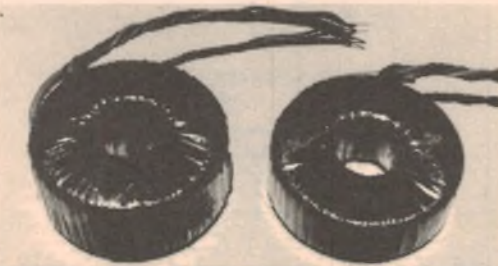

Dimensions and Weight

160 VA Models 110 Diam. 45mm
H. 1.8Kgs Leads 200mm
300 VA Models 125 Diam. 45mm
H. 2.5Kgs Leads 200mm

160 Watt Models

Cat.No.	SEC.V
M 3050	12 + 12
M 3055	18 + 18
M 3060	25 + 25
M 3065	30 + 30
M 3070	35 + 35
M 3075	40 + 40
M 3080	45 + 45

\$55 ea
5 or More \$49.95 ea

300 Watt Models

Cat.No.	SEC.V
M 3085	12 + 12
M 3086	18 + 18
M 3088	25 + 25
M 3090	30 + 30
M 3092	35 + 35
M 3100	40 + 40
M 3105	45 + 45

\$69.95
5 or More \$65 00 ea

MICRON T2440

ELECTRONIC TEMPERATURE CONTROLLED TEMPERATURE
SELECTABLE SOLDERING STATION

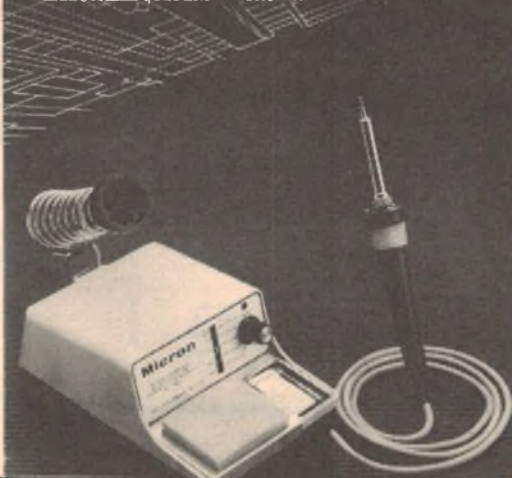

MICRON T2440

Electronic Temperature Controlled Temperature Selectable Soldering Station

The MICRON T 2440 soldering station, offers the ultimate in controlled temperature hand soldering. 320°C, 350°C, 380°C, 410°C (608°F, 662°F, 716°F, 770°F and 824°F) fixed temperatures are selectable by rotating the detained rotary switch freely without changing heater or tip.

Heat Capacity Full 48 Watts
• Temperature Control + or - 3 deg.C •
Zero Voltage Switching • Grounded Tip •
Low Voltage Element 24V • Chrome
Plated Tip. T 2440

Normally ~~\$119.95~~
This Month \$99.00

FOR NEXT DAY JETSERVICE DELIVERY
ALTRONICS TOLL FREE 008 999 007
BANKCARD HOLDERS — PHONE ALTRONICS TOLL FREE 008 999 007

FOR NEXT DAY JETSERVICE DELIVERY

BANKCARD HOLDERS — PHONE ALTRONICS TOLL FREE 008 999 007

FOR NEXT DAY JETSERVICE DELIVERY



Why Pay \$49.95
NOW \$30

Ultrasonic Insect and Pest Repeller

Pestrepeller is effective in controlling mice, rats, roaches, fleas, flies, crickets, silverfish, waterbugs, moths, ants and most other common pests. Laboratory research has shown ultrasonic sound waves attack the auditory and nervous systems of most common pests causing them pain and discomfort. **Specifications—Dimensions:** 100 x 90 x 80 **Power Supply** adaptor supplied 240/9V **Frequency Range** 30KHz to 65KHz variable **Output Level** 130db.

Telephone Pickup



Super nifty little pickup coil with suction pad, lead and 3.5mm plug. Great for recording or amplifying phone conversations.

A 0485 . . . \$2.95

Push Button Telephone

With memory Re-Dial Great for use as a 2nd phone around the House or Office. This nifty little phone has all the features of units selling near twice the price! Last number Re-Dial memory and Mute Key. Rings On/Off switch and Dialing indicator



A 0490
~~\$25~~ \$20



Desk Mounted Lamp Magnifier

A 0980 \$189

If you have trouble with fine PCB work or component identification but still want both hands free, this is for you. We thoroughly recommend this quality Australian made product. **TECHNICAL INFORMATION** Illumination: 22W Fluorescent Weight: 8.16kg **Lateral Extension:** 254mm **Vertical Extension:** 254mm **Fixing:** Heavy table base (grey & Ivory) with two chrome plated flexible arms. Cat A 0980



Amazing Price On Micron Data Tape

1-99 90¢
100 Up 60¢ each
Cat. D1141 *Be Quick*

Microwave Leak Detector

A 0900

~~\$10.95~~
\$16

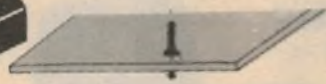

MATRIX/P.C.B. PINS TIN PLATED

Pack of 1000 Buy Bulk and Save

H 0806 0.9mm \$25.90
H 0810 1.2mm \$25.90



GENTLE ACTION HEAD CLEANER

Suits all Beta Video Players. Why risk expensive damage with inferior units.

A 9300 ~~\$12.90~~ \$8.00



VELOSTAT

Great For storing all IC's. Protects CMOS LSI's etc. from static damage. Stores up to 150 IC's on one sheet

H 0600 *Only \$3.95 save \$1*

Video Tape Repair Kit



A VHS/BETA Video Tape Repair Kit. No need to throw out your damaged tapes—this nifty splicing kit can save you a fortune (if you've got small children this bit will save you several fortunes!) All accessories included for joining tape and retaping leader ends etc. Cat No. A 9315

A 9315
~~\$7.95~~ \$5

CANNON TYPE CONNECTORS

Rugged reliable connector for every-day use.

	WERE	NOW
P 0960 3 Pin Line Male	\$5.50	\$4.80
P 0962 3 Pin Chas. Male	\$4.25	\$4.00
P 0964 3 Pin Line F.	\$5.50	\$4.80
P 0966 3 Pin Chas F.	\$5.98	\$5.12

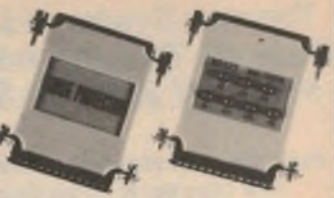
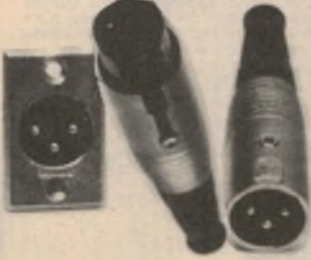

QUALITY IMPORTED RS-232 ACCESSORIES

Surge Protector

D 1510 \$19.50

The RS-232 Surge Protector is used to protect RS-232 ports from the possibility of costly damage from large voltage peaks caused by lightning or other power problems. The surge protector used Metal-Oxide Varistors (MOV) to protect pins 2,3 and 7. The MOV's will suppress any voltage above 26 volts without affecting the normal RS-232 voltage levels.

Jumper Box

D 1520 \$9.95

The RS-232 Jumper Box is used to make custom RS-232 interfaces. It consists of a small board with a connector on each end.

Mini Tester

D 1500 \$19.50

This Tester indicates the presence of all important interface lines by LED illumination when signal is active.

Null Modem

D 1530 \$9.95

The RS-232 Null Modem is used to replace a set 25-pin RS-232 connectors with transit DATA and receive DATA CROSS CONNECTED (Pin 2 of each connector goes to pin 3 of the other connector). Pins 1 and 7 are connected straight through. Each connector is set up in the loop back mode with pins 4 and 5 shorted together and pins 6,8 and 20 shorted together. The RS-232 Null Modem is used when the proper operation of a set of modems is in doubt. It also is handy when Transmit DATA and Receive DATA need to be reversed.

SILKY QUIET 240V COMPT FANS



F 1020 80mm Diam. \$24.50

4 or More \$21.00

SAVE \$ \$ \$ SAVE \$ \$ \$ Great Little PA Amplifier



This natty little amplifier includes some remarkable features which, until now have only been available on very expensive commercial items e.g. Balanced Mic Input—This enables you to run very long microphone leads without troublesome interference or hum pickup. **Balanced line output** - This enables you to run the speaker lines right alongside the microphone line without instability. **Constant voltage design** allows you to switch on one speaker circuit or all circuits together without any noticeable variance in output sound level.

Output Power is a genuine 30 watts into either 100V line or 4 Ohms.

A 2000 \$259

Mini Headphones

Fitted with 8.5mm Stereo plug light weight and comfortable. Amazing performance for low cost phones.

C 9001
\$7.95



High Performance Mini Headphones

Superb light weight High Fidelity Stereo phones. Super comfortable to use. **Samarium Cobalt Magnets.** Frequency response to 20KHz. Weight 42g.

C 9005
\$17.50



Mylar Stereo Phones with Dynamic Mic.

Simply Brilliant Mylar Stereo headset and Dynamic Mic combination. **Phones** 30-18KHz 28 Ohms, 6.5mm Stereo Jack Max. input 400mm Mic. 84db, 600 Ohms, 6.5mm Mono Jack.

C 9050 \$29.50



BANKCARD HOLDERS — PHONE ALTRONICS TOLL FREE 008 999 007 FOR NEXT DAY JETSERVICE DELIVERY

Twenty Systems Left Only At The Incredible Price Of \$69 Per Set!

Protect Your Home for Just ~~\$99~~
New Ultra Sonic Home/Office
Alarm System

Fantastic system for the price. Frankly we were amazed at the performance of this very compact system. Very simple to connect and operate — New Technology has enabled very compact overall dimensions (master unit only 180 x 100 x 85) hence ideal for concealing among book shelves etc.



Look At The Features:

Exit Delay 30 - 35 secs.
Entry Delay 10 secs
DC Source
Battery Backup 9V Nicad Rechargeable (additional Cost S 5024 \$17.50)

Auto Reset 3 minute operate cycle and auto reset. Range Reliable to 30ft. (9M) included.

Low Battery Indicator
Accessories Included for the one Low Price
4 Sets Reed Switches for Window/Doors
1 Roll fig "8" cable
1 External Type Horn Speaker
1 AC/DC plug pack adaptor

Now there is no excuse for not Protecting yourself, your family and all your hard earned possessions!

S 5310 Only ~~\$99.00~~

Out performs our main competitors system which, incidentally sells at around \$50 more for the comparable system and accessories.

Strobe Signal Lamp

Uses Xenon Strobe tube for High energy strobe flash output at a rate approx. 1 per second. Fantastic light energy output for the DC power used. DC input 12V 320mA Dimensions 97 dia. 90H



S 5455 Blue \$24.50

Universal Monitor Stand

With Pan & Tilt Adjustment
This brilliant monitor stand enables you to swivel left/right and tilt up/down i.e. to position monitor to any desired position. Hence viewing position is enhanced and screen glare eliminated. Cat.D 1100

Why Pay \$50



MAINS TRANSFORMERS

PCB Mount Mains Transformers

7/9 VA Rating. Super Compact, wound on Grain Oriented Steel Core for High efficiency and low temperature rise.

POWER RATING:

7VA Load Full voltage +3% -0%
9VA Load Full voltage +6% to -8%

Model Prim/SEC's

M 7012 240/6+6
M 7015 240/7.5 + 7.5
M 7018 240/9+9
M 7024 240/12+12
M 7030 240/15+15

Overall Height 35mm
Length 43mm
Width 36mm

1—9 \$12.50
10—24 \$11.00
25 Plus \$10.00

PINOUT VIEWED FROM UNDERNEATH

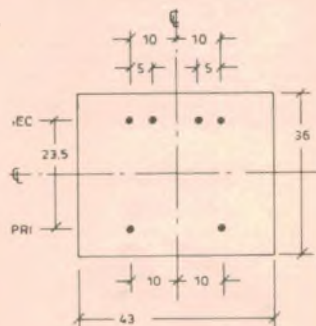

Million Diode Sellout! From 1.5¢ each

Altronics have just purchased around 1 Million (yes million) factory fresh premium quality IN914/IN4148 diodes. These became surplus to Fairchild Australia as the factory supplied bulk, loose pack diodes instead of the tape/reel diodes ordered. So unless you are a manufacturer with automatic component insertion equipment, these fine quality diodes represent the diode bargain of all time!! Cat. Z 0101

1-99 3¢ ea
100-499 2.5¢ ea
500 plus 1.5¢ ea



World Class Build Yourself Kits

Build These Fantastic New Playmaster HiFi Loudspeakers \$449

See Electronics Australia Sept '86 full kit K 5090

If your budget won't run to the \$600 to \$800 needed for a fully imported pair of equivalent speakers, these are the ones to go for.

Some extracts from Electronics Australia Magazine — Each woofer has a foam roll surround and a doped paper cone with an effective (piston) diameter of about 155mm. The Tweeters — The Tweeters are exotic little beasts! (Editor EA Magazine) each is a 19mm soft dome unit with a ferro-fluid damped voice coil for high power handling and a very smooth frequency response. Its resonant frequency is around 1.7kHz.

Power Handling (60 watts plus RMS) In an average sized lounge room and driven by the Playmaster Sixty-Sixty or an equivalently rated amplifier, these speakers will deliver enough sound volume to satisfy the most power crazed enthusiast.

Construction Only the most basic of tools are required to assemble these loudspeakers. Even if you are a rank amateur at carpentry you will have no problems putting them together. You don't need special clamps or jigs and all timberwork has been precisely machined. You do have to be able to use a soldering iron though, to connect the loudspeakers to the crossover network.

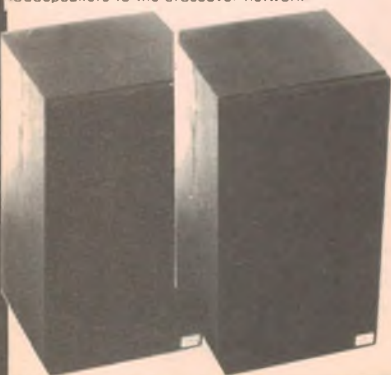

The reproductive purity of these speakers simply amazed us. The secret, of course is the DANISH VIFA Drivers. VIFA drivers are used in many top selling imported systems such as Bang & Olufsen, Rogers, Mission, Jamo DCM Timewindow etc.

Don't Be Mislead

The Altronic 60-60 Kit is the genuine product as per the construction article. It employs the genuine Toroid Power Transformer — the resultant low noise obviates any necessity for additional D.C. supply electrolytics as one of the other kit suppliers feels are necessary with his kits! There is absolutely no need to pay more than the Altronics price for the fantastic 60-60 amp.

'Sixty-Sixty' Integrated Amplifier Kit (EA May, June, July '86)

Features:

• 60 watts per channel into 8 ohm loads • Very low noise on all inputs - better than CD performance • Very low distortion • Excellent headroom • Tape monitor loop • Tone controls with centre detent and defeat switch • Mono/stereo switch • Toroidal power transformer • Easy-to-build construction • Very little wiring.

Performance Specification

Power Output — 8 ohms 82W Distortion - Less than .0% at 1kHz. Frequency Response - Phono Inputs - RIAA/IEC equalisation within + - 0.5db from 40Hz to 20kHz. Line Level Inputs — -0.5db at 20kHz and -1db at 20kHz. Input Sensitivity - Phono 1kHz -4.3mV • Line Level - 270mV. Hum & Noise - Phono - 89db • High Level Inputs - 103db. Tone Control - Bass - + -12db at 50Hz Treble - + -12db at 10kHz. Damping factor - At 1kHz and 30Hz - greater than 80 Stability — Unconditional.



K 5060 \$299

"This New Amplifier offers a standard of performance far ahead of anything we have previously published and ahead of most commercial integrated Stereo Amplifiers".

"It is half to one third of the cost of an imported Amplifier with equivalent power output and performance". Says Leo Simpson Managing Editor Electronics Australia Magazine.

Beginner constructors can Build this Amplifier Kit — It looks terrific and will last you a lifetime.

Save \$200 or more on comparable performance commercial units

FOR NEXT DAY JETSERVICE DELIVERY

BANKCARD HOLDERS — PHONE ALTRONICS TOLL FREE 008 999 007 FOR NEXT DAY JETSERVICE DELIVERY

FOR NEXT DAY JETSERVICE DELIVERY — PHONE ALTRONICS TOLL FREE 008 999 007 — BANKCARD HOLDERS

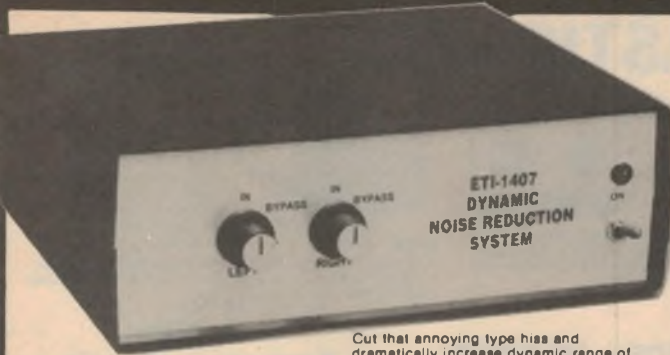

Stunning Design Makes Your Tape Machine Sound Like A CD Player

Dynamic Noise Reduction System

(See ETI Dec. '85)

Cut that annoying type hiss and dramatically increase dynamic range of your cassette recordings with this Dynamic Noise Reduction System II. This fantastic system improves signal to noise of your tape deck by up to an incredible 18dB without treble attenuation. It also expands dynamic range, allowing greatly improved recordings from compact disc players.

K 5575 **\$99.00**



TRANSISTOR ASSISTED IGNITION WITH DWELL EXTENSION

Dead easy to build and (even better) there are only 3 electrical connections required to the car wiring system.

K 4010 **\$39.50**



VIDEO ENHANCER

Sharpens up your picture when copying Video to Video.

Here's a simple but effective video enhancer that is super easy to build at a fraction of the cost of commercial models. Unit sharpens picture detail, and can actually improve the quality of a copy by amplifying the top end of the video signal.

K 5825 **\$35.00**

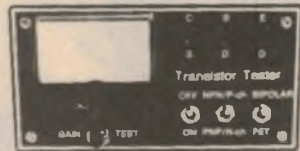

TRANSISTOR AND FET TESTER

Electronics Australia Project. Tests Bipolar Transistors, Diodes, Fets, SCR's and PUT's. Excellent service aid for the hobbyist and serviceman. Complete Kit and instructions.

K 2525 **\$25.00**

Ultrasonic Pest Repeller

Build EA's new "Pest-Off" and save a small fortune on insect sprays.

The "Pest-Off" generates frequencies between 23KHz and 64KHz. Claimed to be the best for driving off most vermin.

K 1600 **\$39.95**



ULTRASONIC MOVEMENT DETECTOR

This Ultrasonic Movement Detector provides added protection against illegal entry via an open window etc. Connects directly to an alarm with a normally open input. Detects any movement up to 3 metres within an angle of 30 degrees. Will operate directly off 12V i.e. Car Battery etc.

K 4400 **\$29.50**



Checks audio & RF circuits Signal Tracer for Trouble-Shooting

This simple signal tracer makes a valuable servicing aid and can be used to trouble-shoot both RF and audio circuits. It features an RF probe, battery operation and an in-built loudspeaker.

K 2560 **\$24.50**

Balanced Input Pre-Amp

(ETI Dec. '82)



K 5530

\$18.50

High Performance balanced line input pre-amp — makes a superb Mic I/P Stage -30db gain.

ALTRONICS KIT FEATURES:

- 5534 AN's for super low noise
- TL 071 Bifet Op Amp (Great common mode rejection ratio) genuine Texas instruments

SPECIFICATIONS:

- Frequency response (10K load) —12Hz —60KHz + 0 1db
- T.H.D. (output)—100Hz 0.007% —1KHz 0.006% —10KHz 0.012%
- Input impedance—nominal 560 Ohms
- Output impedance—nominal 260 Ohms
- Common-mode rejection ratio—easily adjustable to 80db.

Mosfet Power Amp Module 150 Watt

Here is a high power, general purpose power Amplifier module suitable for HiFi, guitar and PA applications employing sturdy, reliable MOSFET's in the output stage.



K 5120 **\$75**

SPECIFICATIONS:

- Power Output**
150W RMS into 4 Ohms
100W RMS into 8 Ohms
(At onset of clipping)
- Frequency Response**
20Hz to 20KHz +0 -0.5db
10Hz to 60KHz +0 -3db
(Measured at 1W and 100W Levels)
- Input Sensitivity**
1 Volt RMS for full output

Hum
98db below full output

Noise
114db below full output
Total Harmonic Distortion
0.006% @ 1KHz 12W
0.03% @ 10KHz 12W

Stability
Exceptional (tested to full output driving 3.3uF into short circuit at 10KHz)

General Purpose Pre-Amp

Based upon a Single LM 382 IC

This Unit contains all necessary components to complete:-

- A Phono Pre-amp with RIAA frequency response
- A tape Pre-amp with NAB response
- A microphone Pre-amp with either 40,55 or 80db of gain
- Or a Pre-amp for just about anything!

Pre-amp may be powered by any DC Voltage between 10 and 40 volts. The output being automatically biased to about +6 Volts High 100db Ripple Rejection.

K 5510 **\$14.50**



K 5112

\$19.50

20 WATT UTILITY AMP MODULE

All components mount entirely on one printed circuit board, even the heatsink!

SPECIFICATIONS:
Input Impedance 100K Ohm approx.
Load Impedance 4 Ohms or Greater

DC IN	PWR INTO 4 OHMS	PWR INTO 8 OHMS
20V	6.6W	4W
30V	12W	8W
35V	19W	15W



TV MASTHEAD AMP

Reduces snow in low signal areas.

K 1798 **\$39.00**

MUSICOLOUR IV

Ideal for Parties, Shop Signs, Display Windows, special lighting effects etc. Combination Colour Organ and Light Chaser. Four channel colour organ operation. Output lamp load capacity a massive 2400 watts.

K 5800 **\$115.00**



FOR NEXT DAY JETSERVICE DELIVERY

BUILD THESE FANTASTIC KITS

ZENER DIODE TESTER

"Simply plugs into Your Multimeter"

By simply plugging this handy little tester into your multimeter, it allows you to read out the actual Zener voltage of any Zener Diode up to 60 volts and will also test LEDs! as well as give you a reading of its forward voltage drop K 2620

\$12.50



DRILL SPEED CONTROLLER

K 6005 **\$24.50**

For Brush Motors up to 3 Amps Varies motor speed from a few RPM to full speed while maintaining good torque Suitable for - Drills and Drill Presses - Circular Saws - Jig Saws - food Mixers - Movie Projectors

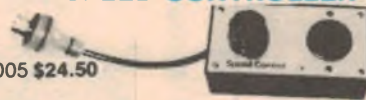

FM RADIO MICROPHONE

This simple FM Microphone kit only requires an ordinary FM Radio for reception

- runs from single 9V battery
- High Sensitivity • Long range approximately 100 ft.

USES:

- Wireless Microphone • Professional Eavesdropping
- Listen to the TV in the kitchen • Makes an excellent child minder. K 1106 **\$9.50**

ELECTRONIC FLURO STARTER

\$9.50

• Extend fluro Tube life by 1000's of hours • Mounts on single PCB - fits into original starter capsule • Smooth rapid start - no more flicker • No light wiring mods needed. K 6300



FANTASTIC HI TECH - HI SPEC Audio Oscillator and Function Generator

This Ultra low distortion oscillator is comparable with the very best laboratory standard sine wave oscillators. As well as having very low distortion it has excellent envelope stability, square wave output and output metering

2 Models to choose from (metered and un-metered)

- Frequency range 10Hz - 100KHz in 4 ranges • Output level 3V RMS max adjustable
- Attenuator 0db, -10db, -20db, -30db, -40db, -50db plus fine adjustment • Output impedance - 600 ohms unbalanced • Output waveforms - sine and square

All components mount on one single PCB making it a breeze to Construct **Save \$200 and More by Building this Fine Kit Project**

K 2540 Complete Kit with Front Panel Metering **\$155**

K 2545 Complete Kit Without Metering **\$139**



7 Digit Frequency Counter

Unbelievable 0.005% Accuracy

- Frequency and Period measurement to 500 MHz (with optional prescaler) • High input sensitivity. Professional unit at a fraction of the cost of built up units.



• IC sockets provided throughout • Low age rate 10,000 MHz XTAL • Quality ABS plastic case with deluxe front panel • Specified LS1

K 2500 **\$149.50**

PRESCALER

K 2501 **\$42.00**

DECIMAL POINT

K 2502 **\$12.50**

Bench Top Power Supply

3-30V to 1 amp Max. with variable current limit



\$79.00

FEATURES:

- Output 3 to 30V at 1A • Short circuit protected • Load switching • Current limiting
- Dual scale meter • Housed in our Deluxe "ABS" instrument case

SPECIFICATIONS:

- Output Voltage - 3 to 30V • Output Current - 0 to 1 amp (fully variable) • Load Regulation - Better than 0.2% from 0 to full load • Output Ripple - Less than 2mV RMS. Cat. K 3210

TEMP. CONTROLLED SOLDERING STATION

(EA Sept. '86)

Controls the temperature of your standard soldering iron. Suitable for irons rated from 20W - 75W - Standard soldering iron plugs straight in, no need for modification. The Altronics Kit comes complete - pre-punched and silk screened



K 6400 **\$35.00**

VOICE OPERATED RELAY

Great for Voice Control of PA Systems, Transmitters, Tape Recorder, Slide Projector, Intercom etc

K 5540 **\$14.95**



TOUCH LAMP DIMMER

Controlled by the latest Siemens Light Dimmer IC. The S 576A.

Instantly turn lamps on and off with just a light touch on a wall panel. Alternatively you can dim or brighten the lamps to any desired level by merely touching the panel for two or three seconds - very classy!

Supplied With Gold Touch Plate

K 6319 **\$35.00**

INFRA RED REMOTE CONTROL FOR TOUCH LAMP DIMMER

Operate your touch lamp dimmer from your favourite arm chair!

K 6322 **\$25.00**



MICROWAVE OVEN LEAK DETECTOR NO BATTERIES REQUIRED

Monitor your microwave oven with this easy to build kit. All components mount on single PCB, including the meter.

K 1724 **\$17.50**

A 'Dual-Speed' Direct-Connect Computer Modem

Features: The project supports 300 Baud full duplex operation and 1200/75 Baud half duplex operation. That is, you can transmit and receive at 300 Baud in both directions or 1200 Baud one way, 75 Baud the other. A switch has been incorporated allowing you select either 1200 baud.

K 9600 A Fantastic Performing Modem Only **\$169**

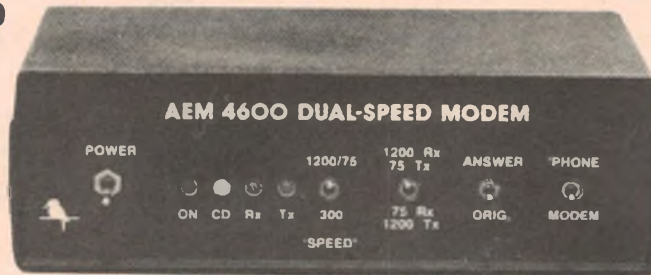

EA DUAL TRACKING POWER SUPPLY

The Ideal Power Supply For The Audiophile Experimenting With Linear Op Amp Designs

- Floating Ground • Meter Switchable V to A • Voltage adjustable to within 10mV
- Output + or - 1.3V to + or - 22V at 2 Amps • 5V @ 1.0 Amps. K 3320

\$129.95



FOR NEXT DAY JETSERVICE DELIVERY

BANKCARD HOLDERS — PHONE ALTRONICS TOLL FREE 008 999 007 FOR NEXT DAY JETSERVICE DELIVERY

FOR NEXT DAY JETSERVICE DELIVERY — PHONE ALTRONICS TOLL FREE 008 999 007 BANKCARD HOLDERS

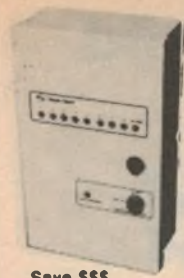

Super Low Price on Famous EA 8 Sector Alarm System Kit

(See EA Mag. Jan '85)
Fantastic Value

FEATURES:
Alarm has 8 separate input circuits - 8 sectors can be monitored independently. Each input circuit is provided with an indicator LED and a sector On/Off switch. Individual sector isolation. Inputs accept both normally closed and normally open sensors. Two inputs provided with an entry delay (between 10-75 sec.) Internal trip warning buzzer - alerts owner/occupant of pending alarm operation - great for the "forgetful" amongst us. This buzzer is pre-settable between 5 and 55 seconds prior to Alarm. Unique circuit detects automatically when any N/O or N/C loops are either open circuit or dead short. e.g. someone trying to bridge reed switches etc. Switched output can be used to send a silent alarm through an auto-dialler circuit or similar. Full battery back up via 12V - 1.2Ah battery. Supplied in an attractive functional security case.

Save \$\$\$ on the cost of commercial equivalents
Within the Capacity of the beginner constructor

- K 1900 (without Backup Battery) **\$139.50**
- S 5065 12V 1.2AH Backup Battery **\$22.95**



Digital Capacitance Meter Checks capacitor value from 1pF to 99.99uF over three ranges. Features include a nulling circuit and bright 4-digit LED display. (See EA Aug. '85)

Low-Cost Unit Checks Values from 1pF to 100uF
Upgraded Digital Capacitance Meter



K 2522

240V Mains Power From Your 12V Battery

300 Watt Inverter with Auto Start (See EA Sept. '85)



Just think how handy it would be to have 240 Volt AC Mains Power when camping or for your boat or Caravan. Auto Start draws power from your battery only when appliance is plugged in and "turned on" i.e. battery can be left permanently connected if desired. Thermal Over Load. Current Regulated. Current Overload.

- K 6752 Complete Kit **\$229.00**
- K 6754 Fully built & tested **\$329**

ALTRONICS

174 ROE STREET, PERTH
FOR INSTANT SERVICE
PHONE ORDER
TOLL FREE
008 999 007
PERTH METRO
AND A/HRS
(09) 328 1599

ALL MAIL ORDERS
P.O. Box 8350, Perth Mail Exchange
Western Australia 6000

PACKING & DELIVERY CHARGE
\$3.00 DELIVERY AUSTRALIA WIDE
- We process your order the day received and despatch via. Australia Post. Allow approx. 7 days from day you post order to when you receive goods. Weight limited 1Kgs.

\$6.00 OVERNIGHT JETSERVICE - We process your order the day received and despatch via. **Overnight Jetservice Courier** for delivery next day. Country areas please allow additional 24-48 hours. Weight limit 3Kgs.

\$8.00 HEAVY SERVICE - For deliveries exceeding 3kgs and less than 10kgs - allow 7 days for delivery.
\$10.00 HEAVY HEAVY SERVICE - All orders of 10Kgs. or more must travel Express Road - please allow 7 days for delivery.

INSURANCE - As with virtually every other Australian supplier, we send goods at consignees risk. Should you require comprehensive insurance cover against loss or damage please add 1% to order value (minimum charge \$1). When phone ordering please request "Insurance".
TOLL FREE PHONE ORDER - Bankcard Holders can phone order toll free up to 6pm Eastern Standard Time. Remember with our **Overnight Jetservice** we deliver next day.

Altronics Resellers

Chances are there is an Altronics Reseller right near you - check this list or phone us for details of the nearest dealer. **Blue Ribbon Dealers** are highlighted with a ■. These Dealers, generally carry a comprehensive range of Altronics products and kits or will order any required item for you. **Don't forget our Express Mail and Phone Order Service** - for the cost of a local call, Bankcard, Visa or Mastercard holders can phone order for same day despatch. **Please Note:** Resellers have to pay the cost of freight and insurance and therefore the prices charged by individual Dealers may vary slightly from this Catalogue - in many cases, however, Dealer prices will still represent a significant cost saving from prices charged by Altronics Competitors.

MORE ALTRONICS DEALERS WANTED

If you have a Retail Shop, you could increase your income significantly by becoming an Altronics Dealer. Phone Steve Wroblewski (09) 328 2199 for Details.

WA	SA	VICTORIA	NSW	ORANGE	COUNTRY CAIRNS
COUNTRY ALBANY BP Electronics ■ 412681	CITY Electronic Comp & Equip. 2125999	CITY Active Electronics ■ 6023499	CITY David Reid Electronics ■ 2671385	Fyle Electronics 626491	Thompson Instrument Services 512404
ESPERANCE Esperance Communications 713344	Force Electronic ■ 2122672	All Electronic Components 6623506	SUBURBAN BLACKTOWN Wavefront Electronics 8311908	RAYMOND TERRACE Alback Electronics 873419	CALOUNDRA Electro Mart 914270
GERALDTON K B Electronics & Marine 212176	Protronics 2123111	Elitronics ■ 6023499	CARINGHAH Hicom Unitronics 5247878	TENTERFIELD Nathan Ross Electronics 362204	BUNDBERG Bob Elkins Electronics 721785
KALGOORLIE Todays Electronics ■ 212777	SUBURBAN BRIGHTON Brighton Electronics ■ 2963531	MaGraths Electronics 6631122	LEWISHAM PrePak Electronics 5699770	TOUKLEY TES Electronics 964144	GLADSTONE Supertronics 724321
KARRATHA Daves Oscitronics 854836	CHRISTIES BEACH Force Electronics ■ 3823366	SUBURBAN ASPENDALE Giltrons 5809839	SMITHFIELD Chantronics 6097218	WINDSOR M & E Electronics ■ Communications 775935	MACKAY Philtronics ■ 578855
MANDURAH Lance Rock Retravision 351246	ENFIELD Force Electronics ■ 3496340	CHELTHENHAM Talking Electronics 5502386	COUNTRY ALBURY Webb's Electronics ■ 254066	WOLLONGONG Newtek Electronics ■ 271620	NAMBOUR Nambour Electronics 411604
NEWMAN Watronics 751734	PROSPECT Jensen Electronics ■ 2694744	CROYDEN Truscott Electronics ■ 7233860	COFFS HARBOUR Coffs Harbour Electronics 525684	QUEENSLAND	PALM BEACH The Electronic Centre 341248
WYALKATCHEM D & J Pease 811132	COUNTRY MT. GAMBIER South East Electronics 250034	PRESTON Preston Electronics 4840191	GOSFORD Tomorrows Electronics ■ 247246	CITY Delsound P/L 2296155	ROCKHAMPTON Electron World 278988
NT	PT. LINCOLN West Coast Elect Supplies 825802	SPRINGVALE Active Electronics ■ 5471046	COFFS HARBOUR Coffs Harbour Electronics 525684	SUBURBAN CALOUNDRA Hume's Electro-Mart 914270	Access Electronics (East St.) 21058
DARWIN Ventronics 813491	WHYALLA Eyre Electronics ■ 454764	COUNTRY BENDIGO KCJohnson 411411	GOSFORD Tomorrows Electronics ■ 247246	FORTITUDE VALLEY F.H.S. Electronics 8323700	Purely Electronics (Shopping Fair) 280100
ALICE SPRINGS Ascom Electronics 521713	TASMANIA	MORWELL Morwell Electronics 346133	KURRI KURRI Kurri Electronics 372141	TOOWOOMBA Hunts Electronics 278952	Xanthos Electronics 278952
Ascom Farmer Electronics 522967	HOBART George Harvey ■ 342233	SALE Gippstech ■ Communications 447402	NEWCASTLE D G E Systems ■ 691625	TOOWONG Economic Electronics 523762	TOWNSVILLE Solex ■ 722015
ACT	LAUNCESTON Advanced Electronics 315688	SHEPPARTON GV Electronics ■ 218866	GEORGE BROWN & COMPANY Company 696399	PADDINGTON Jacques Electronics 3698594	
CITY Bennett Commercial Electronics 805359	NICHOLS Radio TV 316171	SWAN HILL Cornish Radio Services 321427	NOVACASTRAN Elect. Supplies 616055	SLACKS CREEK David Hall Electronics 2088808	
Scientronics 548334	LEGANA Frank Beech Electronics 301379		NOWRA Ewing Electronics 218412	TOOWONG Techniparts 3710879	
			EAST MAITLAND East Maitland Electronics 337327		

Combine two popular projects to build this:

Remote controlled car burglar alarm

Protect your home or car with this unit. It combines the UHF remote switch featured in January with the ultrasonic alarm described in April. Together, the two make a very effective radio-controlled burglar alarm which is comparable to commercial units costing hundreds of dollars more.

by BRANCO JUSTIC

The two main components of this project are not new. We published the UHF Remote Switch in January 1987 and it has proved very popular indeed. It seemed that everybody who had a

burglar alarm wanted to add UHF remote control.

The Ultrasonic Burglar Alarm was published in April 1987 and, as described, was activated by a remote me-

chanical switch. It is a versatile low-cost unit that could be used as a self-standing alarm for the home or car, or as an ultrasonic movement detector.

The combined alarm system presented here features the ultrasonic alarm with the added luxury of activation by the UHF remote control switch. Some of our more experienced readers may already be using a similar combination. The unit described here is the simplest version possible in order to keep installation simple.

In its simplest form you will only need to make two connections to the vehicle's electrical system; ie, to +12V and chassis. If you want to protect the bonnet and boot, you may add an extra wire and connect it to several normally open automotive switches. Alternatively, for a home system, this extra lead could be connected to normally open reed window/door switches.

We've also managed to eliminate the need for an extra off/on indicator loudspeaker. Instead we've wired the system so that the existing siren/screamer doubles up as the off/on indicator. This was achieved simply by connecting the indicator speaker output from the UHF receiver PCB to the siren via an isolating diode (see wiring diagram).

For a car burglar alarm, you will find that the receiver PCB from the remote switch fits comfortably in the plastic zippy case used for the ultrasonic alarm. The best approach is to mount the receiver PCB on the lid of the case and secure it using machine screws and nuts. The antenna can exit through the same slot as the transducer leads.

Some notes on the UHF remote switch

When the UHF remote switch is correctly assembled and tuned it should have a range of approximately 50 metres in an open field (no obstructions). Some readers have, however, struck problems due to incorrectly in-

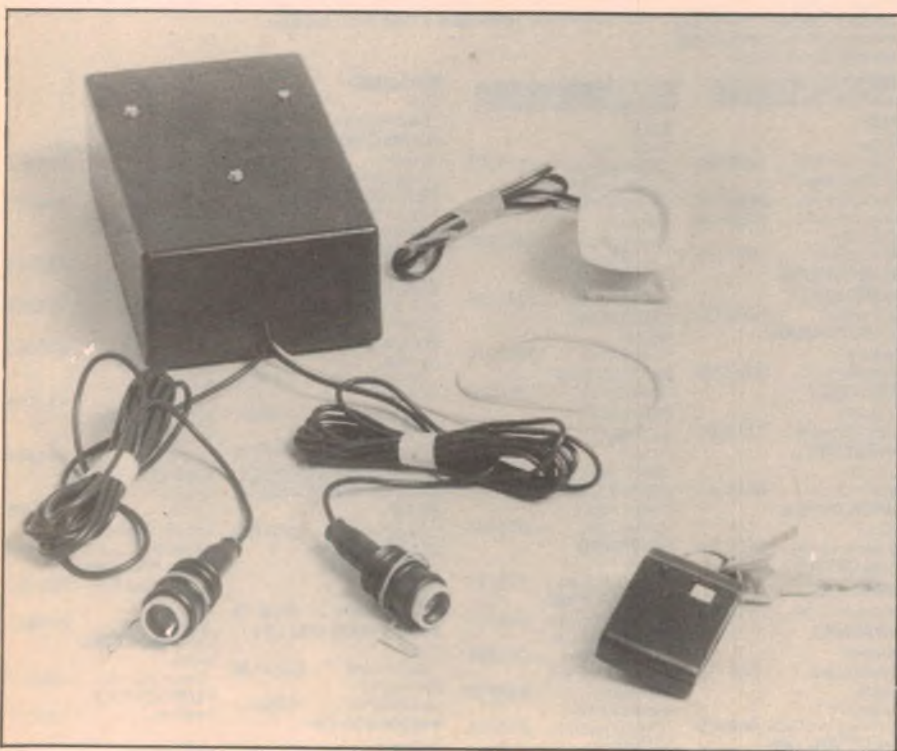

All you need for a complete car burglar alarm system: main alarm module, piezoelectric siren, ultrasonic transducers, and remote control transmitter.



The remote control transmitter is small enough to attach to your key ring.

stalled trimmer capacitors.

An incorrectly installed trimmer results in a reduced range (approximately 10cm) of operation. When using a trimmer which has three legs, note that the legs opposite each other are actually

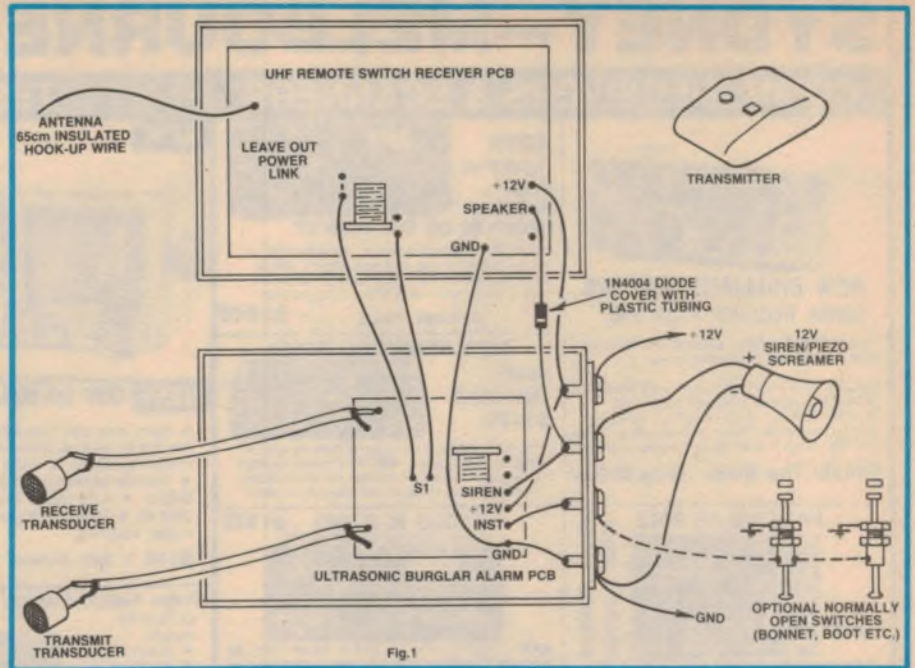

Fig.1: this wiring diagram shows how to combine the UHF remote control switch with the ultrasonic alarm module. The boot and bonnet switches connected to the instant trip line are optional.

short circuit. Only one of these legs should be used.

Some readers also installed the three disc ceramics in the front end in the wrong locations. This is mainly due to confusion regarding the coding systems

used. Note that a 330pF capacitor is normally coded 331. Also, the decimal point on the 3.3pF capacitor is sometimes very small.

You don't need an oscilloscope to align the unit. An analog multimeter

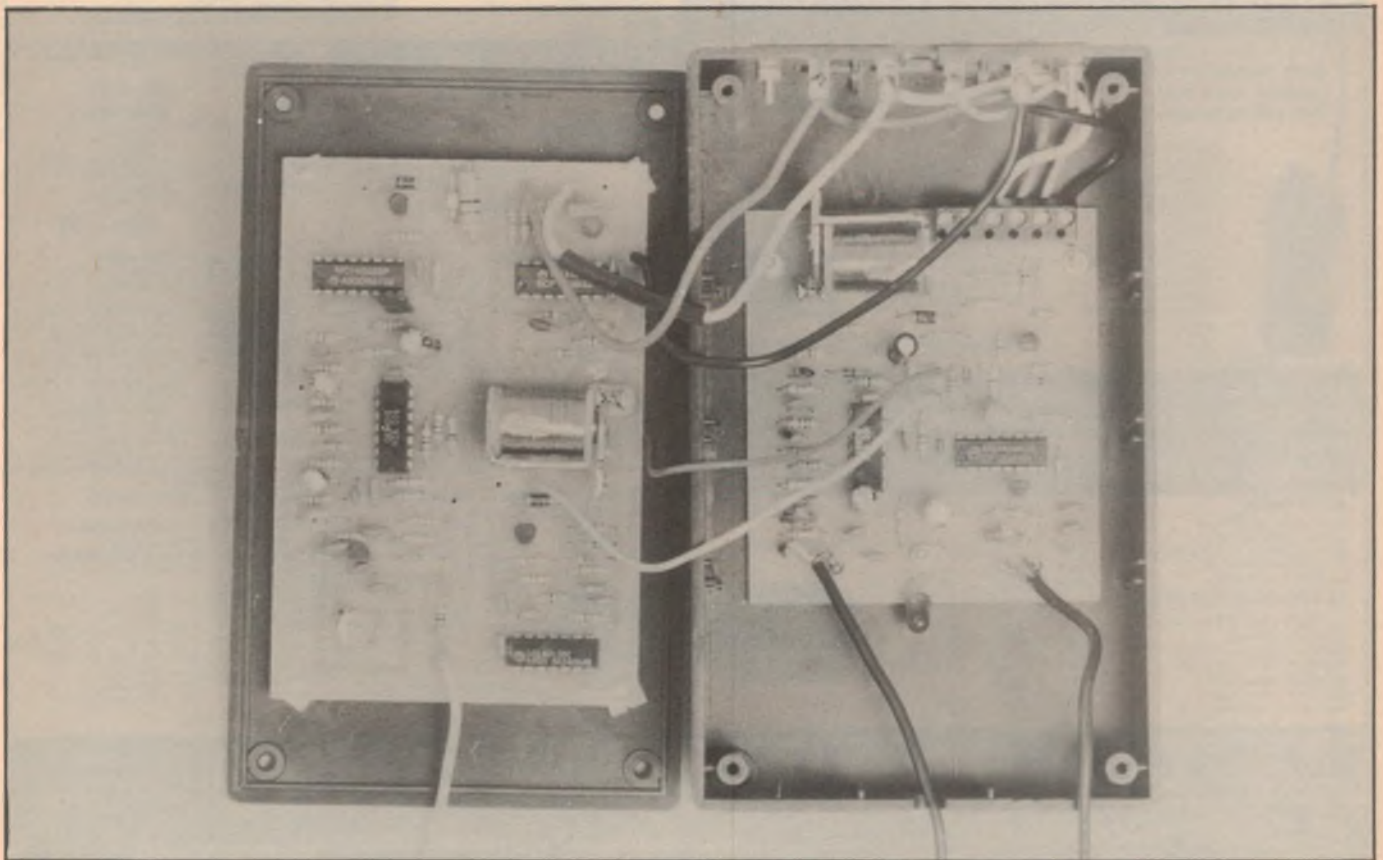

View inside the main alarm module. The PCBs should be mounted using machine screws and nuts fitted with shakeproof washers.

SYDNEY—MELBOURNE—BRISBANE

COMM. RECEIVERS & SCANNERS



NEW BRILLIANT NRD 525 COMM. RECEIVER FROM JRC

The new NRD 525 combines advanced performance and construction not seen on any other receiver.

Features — * Wide freq. range — HF 90 KHz to 39 MHz and optional VHF/UHF band * 200 channels memory * Scan reception * Teletype reception (optional) * Direct access tuning * Wide dynamic range * Clock timer * Interface with PC

Simply The Best! only \$2299



ICOM IC-R71A MOST POPULAR RECEIVER ON THE MARKET

ICOM IC-R71A commercial receiver: one of the most popular receivers among short wave listeners. With 32 memories, keyboard entry, extremely high stability and superior performance makes R71A a highly respected radio!

SPECIAL PRICE \$1549



NEW KENWOOD R5000 Just Released \$1175

This latest addition to the respected Kenwood range of receivers is really unique. With 100 memories, keyboard entry, superb interference reduction and absolutely latest technology makes R5000 the best value on the market.



FAMOUS AR 2002
\$949

This unique scanner covers 25 to 350 MHz and 800 to 1300 MHz range. 20CH memories



UNIQUE IC-R7000 \$1879

ICOM IC-R7000 is a top groove scanner, with 99 memories, keyboard entry and many other features making it an ideal monitoring source from 25 MHz to 2 GHz.



NEW — ANTENNA TUNER WITH LOW NOISE PREAMPLIFIER
ETP — 1
\$159

ETP-1 is an ideal accessory for all short wave receivers in the HF band. It tremendously improves the reception of weak stations!

CODE CONVERTERS
For short wave listeners
In CW-RTTY-ASCII-AMTOR and FAX Mode!
To monitor marine, police, Interpol, weather, embassy, amateur and press services!
CD 670: High performance decoder for CW RTTY, AMTOR (SITOR CCIR 476) and ASCII \$599
CWR 860: CW-RTTY ASCII-TOR-AMTOR Converter \$459
M 800 FAX: Unique new radio Fax Converter — Ideal for marine, weather maps, professional, commercial \$1099
M 6000: A unique highly professional decoder that does everything \$1899

CB RADIO Full range including, EMTRON, ICOM, ELECTROPHONE & UNIDEN

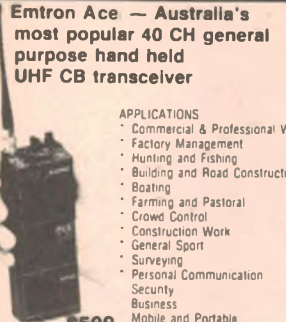

Emtron Ace — Australia's most popular 40 CH general purpose hand held UHF CB transceiver

- APPLICATIONS
- Commercial & Professional Work
 - Factory Management
 - Hunting and Fishing
 - Building and Road Construction
 - Boating
 - Farming and Pastoral
 - Crowd Control
 - Construction Work
 - General Sport
 - Surveying
 - Personal Communication
 - Security Business
 - Mobile and Portable



STOP PRESS
UNIQUE NEW SCANNER FROM AOR — THE WORLD'S SMALLEST HAND HELD SCANNER AT A SUPER LOW PRICE

AOR — manufacturers of the famous AR 2002 have done it again! The HX850 is a micro with maxi features. Bands 60-90, 118-136, 140-174, 436-512 Mhz. AM & FM models, 20 memory channels. Band scanning, memory scanning, delay, hold, excellent sensitivity.

PRICE ONLY \$399

VISIT OUR STORES FOR THE MOST COMPREHENSIVE SELECTION OF RADIO COMMUNICATION EQUIPMENT IN AUSTRALIA — COMMERCIAL, AMATEUR AND CB. THERE IS NO STORE LIKE EMTRONICS!

ANTENNAS:

Stationmaster 27 MHz base	\$69
TE11FJ 27 MHz ele beam	\$139
DA300 25 MHz to 1.3 GHz scanner ant	\$199
AR4500 Active scanner ant	\$339
AH7000 Scanner discone	\$225

ANTENNA ROTATORS:

We stock all popular antenna rotators	
KR 400 medium duty	\$329
KR400RC medium duty 360° dial	\$399
KR600RC medium to heavy duty	\$529
KR2000RC heavy duty	\$899
Create RCS 3 heavy duty	\$499
Daiwa MR 750 medium to heavy	\$499

REGULATED POWER SUPPLIES

We stock Australia's largest selection of high quality regulated power supplies.

DAIWA:

PS120M — 3-15V 12A	\$299
PS310M — 3-14.6V 31A	\$549

ALINCO:

EP-570 — 13.8V 6A	\$220
EP-1510 — 13.8V 15A	\$399
EP-2510 — 13.8V 25A	\$459
EP-3030 — 13.8V 25A	\$549

WELZ:

RS3050 — 3-15V 25A	\$539
RS650 — 13.8V 6A	\$189

TEST INSTRUMENTS



KIKUSUI 60 MHz-TRIPLE TRACE OSCILLOSCOPE — COS5060

Total Performance, multi-purpose. 3CH-Multi Trace. Dome-mesh type 12KV P.D.A. CRT A and B Alternate sweep. Hold-Off function. VERT MODE trigger function. Energy-Saving design (PAT Pending). Designed for Laboratory, Production line, Maintenance and Field service use.

\$1904 + tax

INCLUDES 2 HIGH QUALITY PROBES

NEW GW 20 MHz, DUAL TRACE OSCILLOSCOPE — GOS522

A heavy duty and accurate scope for service as well as production use
Features include ● Wide freq. bandwidth ● Optimal sensitivity ● Extremely bright display ● Auto trigger level ● Variable hold off ● Alternate triggering ● DC trigger coupling

\$745 + tax Includes 2 high quality probes



10 MHz SINGLE CHANNEL CRO GOS-3310 \$412 + tax

Features:

- 5mV/div sensitivity
- Light & compact
- Easy to operate
- Low cost
- High performance
- TV sync. mode
- Ideal for education, hobby and service work

5MHz OSCILLOSCOPE GOS-955 \$396 + tax

Features:

- Low cost
- High performance
- User friendly
- 10mV/div Sensitivity
- Ideal for education, hobby and service

FREQUENCY COUNTERS

A whole range of Lab-quality freq. counters at a breakthrough price!

GFC 8010F (120 MHz) \$276 + tax
GFC 8055F (550 MHz) \$471 + tax
GFC-8100G (1GHz) \$656 + tax

Features:

- Microprocessor controlled
- High resolution
- Self diagnosis routine

GUC-2010 UNIVERSAL COUNTER \$414 + tax

From 5 Hz to 100 MHz
* Frequency, period, totalize, freq. ratio and time interval

DIGITAL MULTIMETERS

GDM-8035F \$252 + tax

- 6 Functions (AC/DC) Volt & Current Resistance & Diode Test
- 3 1/2 Digit
- High resolution 0.1mV 0.1uF
- High accuracy 0.1%

Escort EDM 1111A DIGITAL MULTIMETER \$98 + tax

Features:

- High accuracy in measuring
- One rotary range switch allows fast and convenient operation
- Diode check DC/AC 10A
- Instant continuity check
- Low battery indication
- 200 hrs long battery life
- Overload protection on all ranges
- Capacitance measuring
- Transistor hFE test
- 4 test drop proof durability

GDM-8135T \$345 + tax

- High Voltage 1200V 20A
- Auto Zero Circuit
- Range Protection
- Diode Test Function

GDM 8145 (GDM 8045) \$462 + tax

- 6 Function
- 4 1/2 Digit
- High accuracy 0.03%
- High range — 1200V 20A
- Auto zero
- True RMS

EDM 1105A \$83 + tax

- 3 1/2 digit LCD display
- Diode testing

V DC 0.2-1000 V 5 ranges
100 uV max resolution 0.08%
V AC 0.2-750 V 5 ranges
100 uV max resolution 1.5%
A DC 2 mA-10 A 5 ranges
1 uA max resolution 1.25%
A AC 2 mA-10 A 5 ranges
1 uA max resolution 2%
Ohm 200 Ohm - 20 M Ohm 6 ranges
0.1 max resolution 1.0%
Auto zero & polarity indication.

ANALOGUE MULTIMETERS — SOLID PERFORMER — BUILT IN BUZZER \$211 + tax

ELC-120

- 3 1/2 digit LCD display
- Wide measuring ranges
- 3 inputs: hi lo & guard

RANGES

Capacitance 200pF-200uF 7 ranges
0.1uF max resolution 1%
Inductance 2mH-200H 6 ranges
0.1uH max resolution 2%
Resistance 200-20k Ohm 7 ranges
10m Ohm max resolution 1%
Accessories included: Test clips spare fuse, instruction Manual.

ANALOGUE MULTIMETERS SOLID PERFORMER — BUILT IN BUZZER \$30.66 + tax

ST-380TR

- Transistor checker
- Mirror scale
- Fuse & diode protection
- 20k Ohm/V sensitivity

V DC 0-0.1 0.5 2.5 10 50 250 1000
V AC 0-10 50 250 1000
A DC 0-50uA 2.5m 25m 250m
Ohm Rx1 Rx10 Rx100 Rx1k
dB — 10-50 dB
Continuity buzzer.
Dim: 106 x 149 x 55 mm.

CORRESPONDENCE:
BOX K21,
HAYMARKET, NSW. 2000

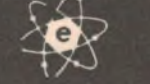

EMTRONICS
Retail Division of EMONA ELECTRONICS P/L

WE WELCOME BANKCARD, VISA & MASTERCARD

MAIL ORDERS WELCOME

NSW & HEAD OFFICE:
92-94 Wentworth Ave, Sydney
NSW. 2000. TLX:AA73990
P.O. Box K21 Haymarket, NSW. 2000.
Ph: (02) 211 0988
FAX: (02) 281 1508

VICTORIA:
288-294 Queen St, Melbourne
Vic. 3000.
(Entrance from Lt. Lonsdale St)
Ph: (03) 67 8551 or 670 0330
FAX: (03) 670 0671

QUEENSLAND:
416 Logan Road, Stones Corner
Qld. 4120. TLX: 144696
Ph: (07) 394 2555
FAX: (07) 394 4316

switched to its lowest AC voltage range, and with a $0.1\mu\text{F}$ capacitor series with the positive test lead, is sufficient. The test leads are connected between TP1 and earth on the receiver PCB.

Not all of us have access to a frequency counter which is suitable for 304MHz operation and offers good sensitivity. However, a counter is not really needed to test the unit. Simply set the transmit trimmer to the middle of its travel (half mesh) and adjust the receiver trimmer for a maximum waveform amplitude as measured at TP1. Having quickly tested the unit for proper operation, you must now adjust the frequency to 304MHz to meet DOC (Department of Communications) requirements.

If you don't have a counter, a calibrated signal generator with amplitude modulation can be used to set the correct frequency of operation. With the signal generator's output lead placed in the vicinity of the receiver, adjust the trimmer on the receiver PCB for maximum amplitude at TP1. This done, switch off the signal generator, activate your transmitter (link included), and adjust the trimmer on the transmitter for maximum amplitude at TP1.

Current consumption

Some readers have expressed concern at the 100mA of current drawn by the relay on the receiver PCB when the alarm is switched on. This will not normally cause problems as a car battery should be able to provide this amount of current for hundreds of hours. However, you could strike trouble on with a partially run down battery on a cold winter's day.

The way around this problem is to wire your alarm unit to the relay contacts so that the alarm is on when the relay is off (ie, just use the other relay contact). In this case, 100mA will be consumed by the relay only when the

Wireless Home Burglar Alarm

As mentioned in the January 1987 issue, the UHF Remote Switch can be used to eliminate the wiring between the various sensors and the control unit in a home burglar system. This, however, requires a small modification to the transmitter circuit so that it only transmits for a short period of time when the sensor is tripped.

The required modification is quite simple and involves the addition of a parallel $100\text{k}\Omega$ resistor and $1000\mu\text{F}$ capacitor in series with the positive supply rail. Fig.2 shows the details.

Now, when the sensor contacts close, the transmitter will only transmit for a brief period until the $1000\mu\text{F}$ capacitor charges up. This brief transmission is more than enough to trigger the control unit and ensures that the device

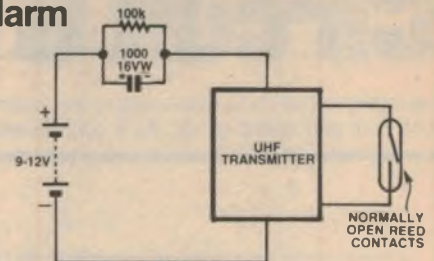

Fig.2

Fig.2: how to wire the UHF transmitter for use in a home burglar alarm system.

meets the required regulations.

At the end of the transmission, the circuit draws negligible current as set by the $100\text{k}\Omega$ resistor. This means that you can turn the alarm off and leave a window open without flattening the transmitter battery. Changing the $100\text{k}\Omega$ resistor to $180\text{k}\Omega$ will reduce the quiescent current even further but increase the reset time from 100 seconds to 180 seconds.

car is running and the battery is being charged. However, you will now have a long "beep" for on indication and a short "beep" for off indication unless R27 and R28 on the receiver PCB are reversed.

Note that a power link was included in the final version of the PCB between the +12V rail and the relay wiper. With the power link included, the relay switches the +12V rail as per the prototype described in January. With the power link removed, the relay contacts are isolated and may simply be used as a switch.

Finally, readers should note that, as far as this project is concerned, the fol-

lowing ICs are direct equivalents: MC145026 = SG41342; MC145028 = SG41344; 74C14 = 40106 = 4584.

Feedback on the ultrasonic alarm

Construction of the ultrasonic alarm is straightforward, although some readers have encountered difficulties in correctly adjusting the unit.

The first thing to note is that the transmitter frequency adjustment is fairly critical. To adjust the unit, the two transducers should be placed side by side closely facing towards a blank wall. Alternatively, they can be posi-

continued on page 129

Footnote: kits for the UHF Remote Switch and the Ultrasonic Burglar Alarm are available from Oatley Electronics, 5 Lansdowne Pde (PO Box 89), Oatley, NSW 2223. Phone (02) 579 4985.

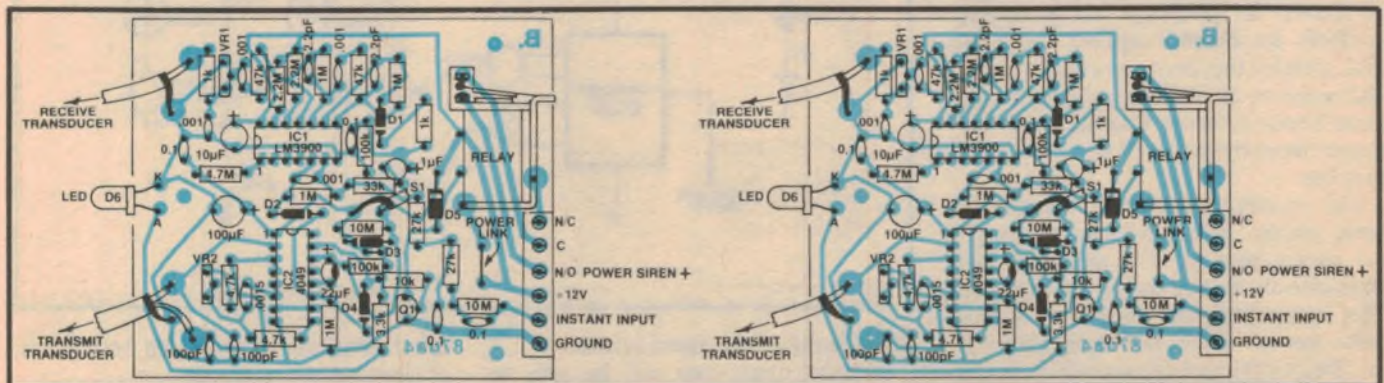

Fig.3a: twin core shielded cable must be used to wire the transmitter for maximum drive.

Fig.3b: how to wire the transmitter for reduced drive. Single core shielded cable can be used here.

Circuit & Design Ideas

Interesting circuit ideas from readers and technical literature. While this material has been checked as far as possible, the circuits have not been built and tested by us. As a consequence, we cannot accept responsibility, enter into correspondence or provide constructional details.

Quiz game adjudicator

This circuit was designed as a quiz game adjudicator and is used as a teaching aid for children.

The circuit uses a single quad NOR gate IC, four transistors and 12 diodes. IC1a, b & c are wired as inverters with one input of each gate connected to ground. When a contestant presses a button (S2-S4), the remaining input of the associated NOR gate is pulled high and thus the output of the gate goes low.

This low output does three things. First, it inhibits the other two gates so that pressing the other two buttons has no effect. Second, it turns on an associated PNP driver transistor (Q1-Q3) via a 2.2kΩ resistor to light one of the LED displays. And third, it momentarily turns on Q4 via inverter IC1d and timing circuit C4R8 to operate an electronic buzzer for approximately two seconds.

Finally, pushbutton switch S1 discharges the 47μF capacitors C1-C3 to reset the game. Construction of the circuit is not critical and the pushbutton switches can be mounted inside 35mm film canisters.

D. Harvey,
Stanthorpe, Qld.

\$20

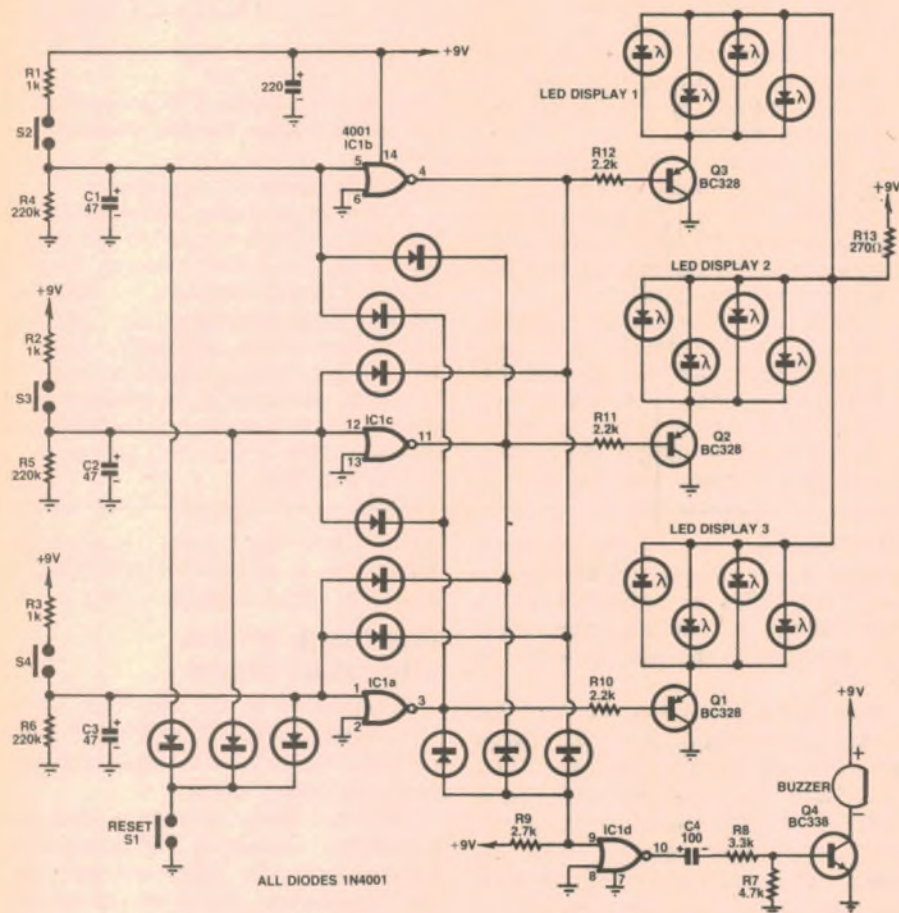

Screecher protection for bonnet and boot

While the Screecher car burglar alarm (EA, August 1986) is marvellous for protecting the passenger compartment, it offers no defence against the thief who attacks the boot or engine areas. The solution is obvious — simply add extra sirens to protect these areas and trigger them by means of normally open switches.

The accompanying circuit shows the basic scheme. Switch S1 from the original circuit now controls the additional siren circuits as well as the main alarm. This means that the peripheral alarms only operate when the main alarm is on. Diodes D1 and D2 provide isolation for the peripheral sirens so that the boot and bonnet lamps can be used in-

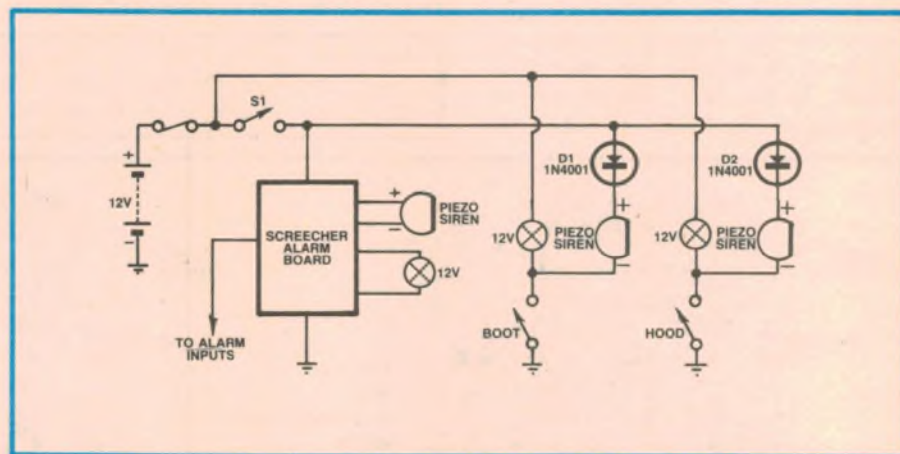

dependently of the alarm system.

In most cases, you will be able to make use of the existing boot switch, although a bonnet switch will have to be

fitted. The bonnet lamp can be left out of circuit if not required.

R. Hicks,
Pennant Hills, NSW.

\$10

Magnetic pickup for digital speedometer

This simple circuit shows how a magnetic pickup may be used to replace the optical sensor in the digital speedometer (EA, January 1987, page 60). It consists of four magnets, a pickup coil and a BC548 transistor (Q1).

Here's how the circuit works: The rotating magnets induce a series of pulses in the pickup coil and these are coupled via C1 to the base of Q1. Q1 is normally just biased off by R1 and R2, but turns on briefly each time a pulse is received. The resulting pulse train produced at Q1's collector is then gated through IC1a to the CLK input (pin 12) of IC3.

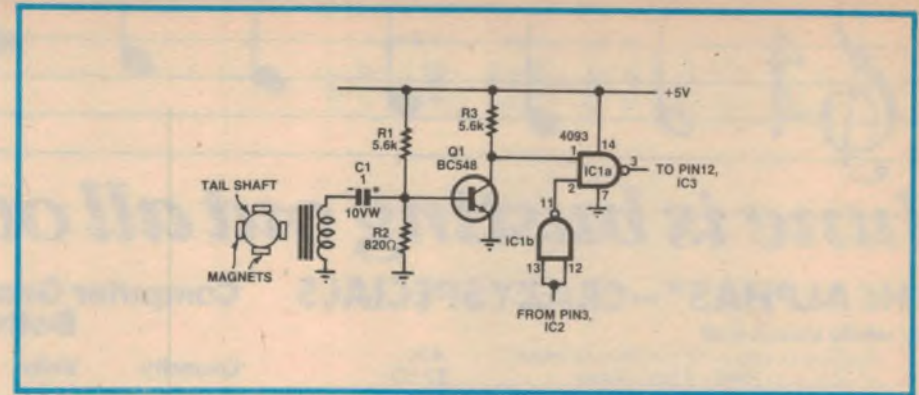

of IC3.

The coil consists of 200-300 turns of 0.4mm enamelled copper wire, about 20mm in length, wrapped onto a 2BA

bolt. The rest of the circuit operation is as described in the January issue.

M. Duperouzel,
Beckenham, WA.

\$10

Transistor tester add-on for multimeter

Transistor test circuits generally seem to do little more than can be achieved with a multimeter. The circuit shown here improves on that described by D. Shawcross (EA, July 1982) as it can identify the emitter and collector leads. This is important if you mostly use recycled transistors and have no data on their pinouts.

To use the device, the base lead must be known and correctly connected. The connections to the other two leads don't matter, and the ohmmeter can also be coupled without regard to polarity.

The first test step is to obtain the typical "diode" reading by trial and error using the polarity switch. Once this has been done, the pushbutton is pressed and the reading noted. If the resistance increases by about 12-20%, the selector switch indicates the emitter;

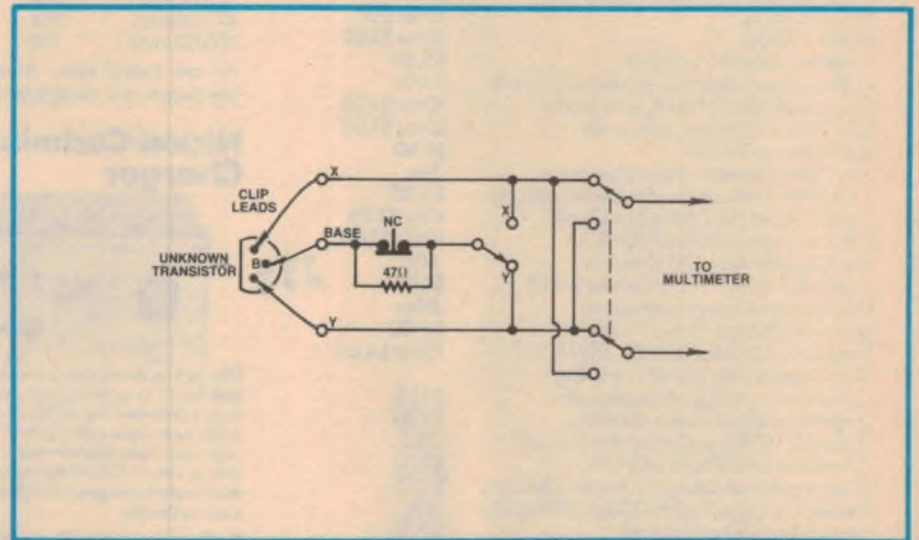

if the change is only of the order of 2-5%, the selector indicates the collector.

Note that the above is only valid if

the transistor is OK. Abnormal readings indicate a defunct transistor,

A. Corben,
Lillian Rock, NSW.

\$10

Dual rails from a single battery

This circuit was originally designed to power an op amp project from a single rail power supply but could also be used to power other appliances which require plus and minus supply rails eg, the Technics SLP-X7 CD player which requires $\pm 6V$.

The circuit is based on a 555 timer IC oscillator driving a complementary NPN/PNP transistor stage. C1, R1 and R2 set the oscillator frequency to 1kHz and the square wave output at pin 3 drives Q1 and Q2 via 1k Ω current limiting resistors. Q1 and Q2 thus alternately switch on and off and this switching action causes C3 and C4 to charge

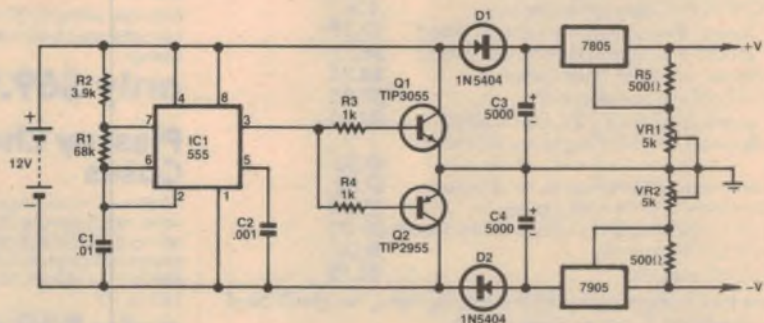

via D1 and D2 to +12V and -12V respectively.

These voltages are then applied to positive and negative 3-terminal regulators. The 5k Ω trim pots allow each rail to be independently adjusted to the de-

sired output voltage (up to +9V and -9V). Note that Q1, Q2 and the two 3-terminal regulators should be provided with adequate heatsinking.

J. Webb,
Maryborough, Vic.

\$20

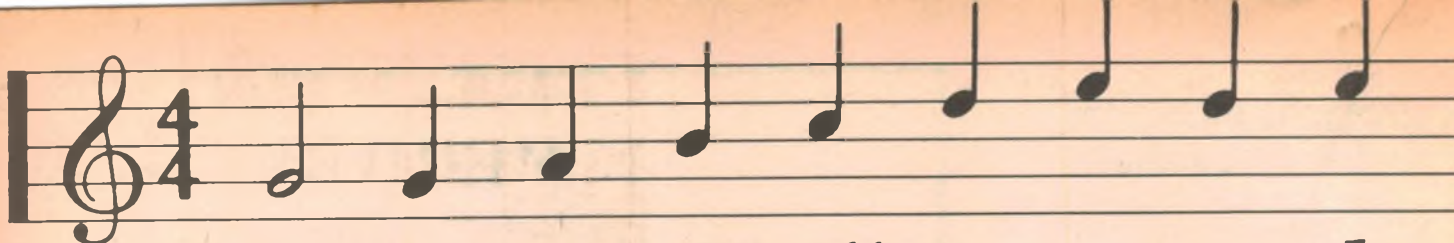

June is busting out all over . . . with

"THE ALPHAS" - CRAZY SPECIALS

Only while stocks last

"A"	Pye Cradle relays-4P c/o 24V c/w base	.45c
"B"	5117 (6116) 2048 x 8 Static RAM	\$2.50
"C"	Resistor networks. 10 assorted, SIP and DIP	\$1.00
"D"	240VAC Garrard Turntable motors	\$0.75c
"E"	Transistors - BD679 Darlington NPN (TO126)	.25c
"F"	2532 - 4K x 8 EPROM	\$3.50
"G"	TIL312 Common cathode 7 segment LED display	.60c
"H"	2SK133 MOSFET (TO3 case)	\$3.95
"I"	2SJ48 MOSFET (TO3 case)	\$3.95
"J"	2SK216 MOSFET (TO220 case)	\$1.50
"K"	4001A CMOS	10 for 80c
"L"	4020A CMOS	10 for \$1.00
"M"	Pressure Mats 175 x 530mm	\$5.50
"N"	12 Digit seven segment displays inc. data	.60c
"O"	Mini lamps, 28V/0.024A, wire leads	10 for \$1.00
"P"	NE2 90V neon lamps, wire ends	10 for \$1.00
"Q"	100 Nylon cable ties	\$1.50
"R"	20 x 7mm diameter cable clamps	.50c
"S"	5 x 6 5mm enclosed switch stereo sockets	\$2.25
"T"	Zener Diodes, 51V 20W, Stud Type,	4 for \$1.25
"U"	GE Glass bead diodes 100V 2.5A	10 for \$1.00
"V"	Mini Transformers 600 ohm 1 to 1	.40c
"W"	1 pole 10 position Thumbwheel switch	\$1.00
"X"	Mini electret microphone inserts	.80c
"Y"	Spectrol 50Kohm 10 turn "Helipot"	\$5.00
"Z"	Transistor, BUX66, 200V/2A 35W PNP	10 for \$4.00
"AA"	PCB Chassis with 12V 4P c/o Relay,	
	Components, edge connector etc.	\$1.25
"BB"	Large wound pot core assembly	\$1.00
"CC"	15 way 0.15" Edge Connector (ex-unit)	.35c
"DD"	10 assorted thermistors & VDR	\$1.00
"EE"	21 way polarised plug, socket and B/shell	\$1.75
"FF"	Plessey Can type Electro 200uF 350V & clip	.40c
"GG"	5 asstd. Multi-turn Trimpots	\$2.50
"HH"	10 asstd. Tag strips, 2 to 7 way	\$1.00
"II"	30 asstd. disc ceramic caps	\$1.00
"JJ"	Belling Lee size "OO" panel fusholder	.30c
"KK"	4 wire-wound pot meters PCB 100, 220,	
	470 ohms 1K ohm	\$1.50
"LL"	150 ohm 25 watt wire wound rheostats	.75c
"MM"	4 mini-trimcaps 15-60, 6-60, 12-75, 1-90pf	\$1.00
"NN"	Transistor type Var. Tuning Capacitor	\$1.25
"OO"	12VDC S/P c/o Open Frame Relays	.40c
"PP"	Mini "Jones" 8 way plug, socket and Hood	\$2.25
"QQ"	Mini "Jones" 4 way plug, socket and Hood	\$1.75
"RR"	Lock-down car aerial, lead and plug	\$4.25
"SS"	100M roll of Twin Speaker Wire	\$9.95
"TT"	Transformer, 240V to 2 x 9V, 800 & 50mA	\$2.50
"UU"	6' Audio Lead, 5P DIN Plug to 4 x 6.5 mono	
	plug	\$1.50
"VV"	6' Audio Lead, 5P DIN Plug to 1 x 3.5 plug	\$1.00
"WW"	Stainless Steel mini flat-nose pliers	\$5.50
"XX"	Pushbutton telephone unit (component value)	\$9.00
"YY"	10 16 pin DIL IC sockets	\$1.00
"ZZ"	10 40 pin IC sockets	\$3.75

Due to the very low budget prices of the above items, no credit card orders can be accepted. Cash or cheque only.

Computer Grade Electros at Rock Bottom Prices

Capacity	Volts	Make	DIA mm	Height mm	Price
500mfd	250	Sprague	35	85	\$5.00
8,700mfd	40V	Sprague	35	110	\$7.00
9,100mfd	60V	Sangamo	50	110	\$9.00
10,000mfd	40V	Sprague	50	85	\$6.50
14,000mfd	25V	Sprague	50	85	\$5.00
14,000mfd	40V	Sprague	50	110	\$8.50
22,000mfd	10V	Philips	35	120	\$6.00
33,000mfd	16V	Philips	50	115	\$10.00
47,000mfd	25V	Philips	65	115	\$15.00
100,000mfd	10V	Philips	65	120	\$9.00

All are brand new, unused stock. Mounting clips and hardware are available for 75c per set.

Nickel Cadmium Charger



Plessey has developed a charger specifically for professional users of ni-cad batteries. The A100 will charge single or multiple cells (up to 20) with capacities from 100mAh to 8Ah at a charge rate of 10% of their rated output. Accelerated charging at higher currents is also possible.

- will charge single cells or packs up to 20 cells
- 7 switch selected, constant current charge rates - 10, 50, 100, 120, 200, 400mA and 800mA
- 240VAC operation
- Extensive protection against short and open circuit
- Automatic overload against cut-out and cut-in

Normally selling for \$216.00, but we have obtained limited stocks at massive savings

only \$69.95

Plessey Charger Cases

All aluminium construction, matt black cover, ready punched for switches, terminals, LED indicators. Perfect for many small projects. Size 80mm (H) x 140mm (W) x 150mm (D)

only \$10 each

Computer Cables from Hitachi



Top quality UL style

- Easy termination to 0.050" I.D.C. connectors
- Black protective outer jacket
- EMI/RFI shielding via aluminium foil inner jacket
- 2 drain wires with tin overcoating for added reliability
- Capacitance 40pF/ft
- Characteristic impedance 60 ohms
- Crosstalk 1.1 - 2.7%/10ft (10nS rise time pulse)
- Propagation delay 1.53nS/ft

40 Way
\$5.80 per metre
34 way
\$4.80 per metre

Sealed Lead-Acid batteries at baffling prices

The LCR series is a new type of sealed lead-acid rechargeable system. Withstands rough operating conditions, overcharge and overdischarge. Perfect for portable equipment, standby use, photographic, and security equipment.

- Low internal resistance (40mohm)
- Low self discharge (64% capacity after 12 months)
- Excellent for standby use. Expected float life greater than 8 years

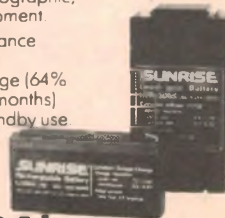

6V - 1.2Ah
only \$16.50
6V - 3.2Ah
only \$23.50

EX-TELECOM 'QWERTY' KEYBOARDS

We don't know much about these, but they contain approximately 90 PB keyboard switches (easily worth \$1.50 each), I.C.s and sundry components.



only
\$30.00 each

Sheridan's Mid-Year Giveaways

68000 CPUs - Prices Slashed

Hitachi chips at low prices. Normally selling for \$99.00 each. High performance 8MHz HD68000 CPU chips.

only \$45.00

Top quality "Soft" NiCad Rechargeable Batteries

The best there is in NiCads.

type C

1.2V - 2Ah

\$8.00 ea.

type sub C

1.2V - 1.15Ah

\$5.50 ea.



Crouzet Synchronous Motors

A motor drive system for accurate time driving in instrumentation, machine and process control. 1000s of uses including robotics. 240VAC, 50Hz, 2.8W/15mA. Direction: Anti-clockwise, 60rpm

only \$7.50 Slashed from \$10.00



E-cell Timers at timely prices

Plessey E-cells (type 560-0002). For timing, integrating and counting. Case - silver. Anode - gold

only \$2.00

10 for \$17.50

inc data sheet

240V-100V Stepdown Tranny

Manufactured by DYNE, this sturdy transformer is rated at 100VAC/2A and has three parallel American style

outlets. Worth \$110.00

only \$40.00

IC and Transistor Pack

A Bonza collection of 50 new I.C.s, transistors & I.C. Amplifiers, too numerous to mention. All guaranteed, all unused and in mint condition. Value approximately \$60. Limited quantity available for this month only

\$12.50 the lot

'Cliff' insulated jack sockets

High quality imported 'Cliff' brand jack sockets at massive savings.

- 6.5mm jacket size
- Panel mounting, fully insulated
- 2 mono and 2 stereo types

4 sockets, total value \$3 - look at the savings

only \$1.50 for 4

Arlec 12V/4A Battery Chargers

■ Powerful 12 Volt/4 Amp battery charger from ARLEC

- Circuit breaker protection,
- Double insulation. S.E.C. Approved
- 12 month warranty

Special low introductory price - save up to \$15.00

only \$29.95

Fans at Cool Prices

Keep your equipment cool. Super efficient 'muffin' style fan. 80mm(W) x 80mm(H) x 42mm(D). 220/230 V operation 50/60Hz 9W, 2650 RPM. Going for a song!

only \$19.95

"D" type Connectors slashed

Lowest Prices in Australia, by the truckload!! All prices include sales tax.

DE9P	9 pin male	\$1.25
DE9S	9 pin female	\$1.50
DE9P/RA	9 pin male right angle	\$1.45
DE9S/RA	9 pin female right angle	\$2.00
D9	Metallised backshell	\$2.00
DA15P	15 pin male	\$1.75
DA15S	15 pin female	\$2.00
DA15P/RA	15 pin male right angle	\$2.25

Look at these bonus offers

★ Spend \$10.00 and over and you get 10 x 100V 2.5A power diodes

★ Spend \$20.00 and over and you get as above plus 10 x BZX70/18 zener diodes

★ Spend \$30.00 and over and get 1 set RS232 connectors with backshell

Spend \$100.00 and over and get your **10% discount**

Note: above offers are exclusive of P&P charge. They are exclusive of account orders and credit card purchases.

RS232 Gender Changer

Top quality DB25 male to DB25 male or DB25 female to female

only \$12.50 each

Ferguson Power Transformer

PRI.1 0-110V-120V-130V, 50Hz
PRI.2 0-110V-120V-130V, 50Hz
SEC.1 8.5A at 10A
SEC.2 15.5V per side C.T. at 1A
SEC.3 14.5V per side at 0.5A
Size: 95x90x80mm.
Further reduced from \$45.00
UNDER HALF PRICE!
- LIMITED QUANTITY

only \$35.00

DA15S/RA	15 pin female right angle	\$2.75
D15	Plastic backshell	\$1.75
DB25P	25 pin male	\$2.00
DB25S	25 pin female	\$2.50
DB25P/RA	25 pin right angle male	\$2.30
D25	Metallised Plastic Backshell	\$2.50
D25	Plastic backshell	\$1.75
DC37	37 Way, Plug, Socket & Back-Shell	\$7.00
DD50	50 Way Plug and Socket & Backshell	\$9.00
D940003	"D" Type Screwlock Assembly per pr.	50c
D940002	"D" Type Retaining Clips per pair	35c

SHERIDAN ELECTRONICS PTY. LTD.

164-166 Redfern St., Redfern NSW 2016.
Phone (02) 699 5922, 699 6912.

Mail Orders to: PO Box 229 Redfern NSW 2016.

Note: We accept Bankcard, Mastercard & VISA. However, we cannot give quantity discounts on Credit Card purchases or account orders. Minimum for account orders is \$50.00. Minimum order is \$10.00 exclusive of postage and packing. All prices include Sales Tax.

ALL PRICES ARE FOR THIS MONTH ONLY OR UNTIL STOCKS ARE SOLD.

Mail Charges:

\$5.00-\$9.99	\$3.50
\$10.00-\$24.99	\$4.50
\$25.00-\$49.99	\$6.50
\$50.00-\$99.99	\$8.00
\$100 or over	\$9.00

Large and overweight articles sent Skyroad Freight Forward.

Trading Hours:

Mon-Fri	9am - 5.30pm
Thurs.	9am - 6.30pm
Sat.	9.30am - 1.00pm

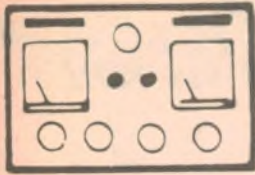

When skies are grey, Sony Boy

At what stage of its existence should a TV set — or any appliance for that matter — be considered to be beyond economical repair? Age alone need not necessarily condemn it; it is merely one of several factors which would influence a decision. And even then there is a good deal of luck involved.

This is not a new theme in these notes, but it surfaced again recently when I rescued a couple of sets which might otherwise have been on their way to the tip. More particularly, it was prompted by what appears to be an unfortunate tendency on the part of some of my colleagues; a tendency to become "tip-happy", whereby any set which exhibits an unusual fault and/or is one with which they are not familiar is condemned as being beyond repair and fit only for the tip.

More specifically, the present story concerns a number of Sony Model KV-1830AS and KV-2000AS colour sets, these being 46cm and 51cm versions respectively, but using virtually the same chassis. I last dealt with one of these sets in the January 1986 notes and mentioned at that time that there seemed to be an aversion to these sets on the part of some servicemen.

That was a fairly general statement, but the latest episode produced much more specific evidence that this is a very real problem. At one stage I had no less than seven of these sets through the workshop in quick succession. Only two were from regular customers, while at least two had bounced from colleagues in the district. The remaining three were also new customers and I have good reason to suspect that they had had similar experiences and had learned by word of mouth that I would at least take the job seriously.

Set number one

But let's start at the beginning. The first job was from one of my regular customers and, while a little puzzling technically, did not involve any other sort of hassles. However, it will help to acquaint the reader with the "feel" of the set.

The primary fault was simply that the set had shut down, and I didn't expect that this would present much of a problem. However, the owner had approached me on a previous occasion, when visiting the shop, regarding what he described as "... lines on the screen". Closer questioning revealed that they were vertical lines, which he further described as being "... all over the screen". I must admit that the "all over" puzzled me, and I simply suggested that he bring it in for me to see. In the event, it took the total failure to get it on my bench.

The most likely cause of total shut-down in these sets is failure of the SCR, Q901 (SG613), in the horizontal output stage, and it doesn't take a genius to find this and fit a new SCR, even the first time. Sure enough, a simple check confirmed that the SCR was shot, and fitting a new one brought the set back to life. So what about the "... vertical lines all over the screen"?

In fact, there were vertical lines, but they weren't all over the screen. They were quite prominent on the left hand side, becoming progressively weaker towards the right, and virtually invisible halfway across. In short, a classic case of ringing in the horizontal output stage. Unfortunately, having diagnosed it that far, I could make no further suggestions because I had not encountered that fault in this set before.

I fished out the manual and turned to the "E" board diagram. Tracing the 135V rail from Q901 up to pin 16 of the horizontal transformer, T801, I was reminded that a diode connected to this line, D806, has a reputation for going short circuit and shutting things down. And, while the symptoms didn't fit this possibility, I did wonder what a partial breakdown might do.

But I didn't speculate on this for long because the next thing I noted was an inductor in the line, L805, 3.3uH, shunted by an 18Ω, 2W resistor, R812. I'm not sure of the inductor's role, but I imagine it is a linearising device of some kind. More to the point, what was the shunt resistor's role? Since resistors are often connected across inductors to provide a damping action, I wondered what would happen if R812 was open circuit.

Well, I'd picked it in one — except that the resistor was not open circuit, but had jumped from 18Ω to around 170Ω. Why, I can't imagine. Anyway, I replaced it with an 18Ω, 5W resistor which was the nearest I had. There was plenty of space and I reasoned that the extra rating would do no harm. And that fixed it; the set was as good as new.

Set number two

The next set belonged to someone I had not seen before. Again there was a primary fault which was shutting the set down, plus a secondary fault which was spoiling the picture. But there the similarity ended because the nature of the secondary fault, and its history, were both quite different.

The customer introduced himself by explaining that he had previously had the set serviced by a colleague whom I shall call "Joe". Now I know Joe reasonably well and he's a nice enough sort of bloke at a social level. He's probably also very kind to his mother and all that (makes sure she has adequate illumination at the wood heap) but his approach to servicing — and particularly his approach to servicing Sony receivers — leaves a great deal to be desired.

Basically it seems that Joe, along with at least one other colleague, has a bias against the Sony sets. The only reason for this seems to be the fact that these sets are a little different — even unconventional — compared with a lot of other sets and, for some reason or other, these fellows seem unable to make the transition to a different ap-

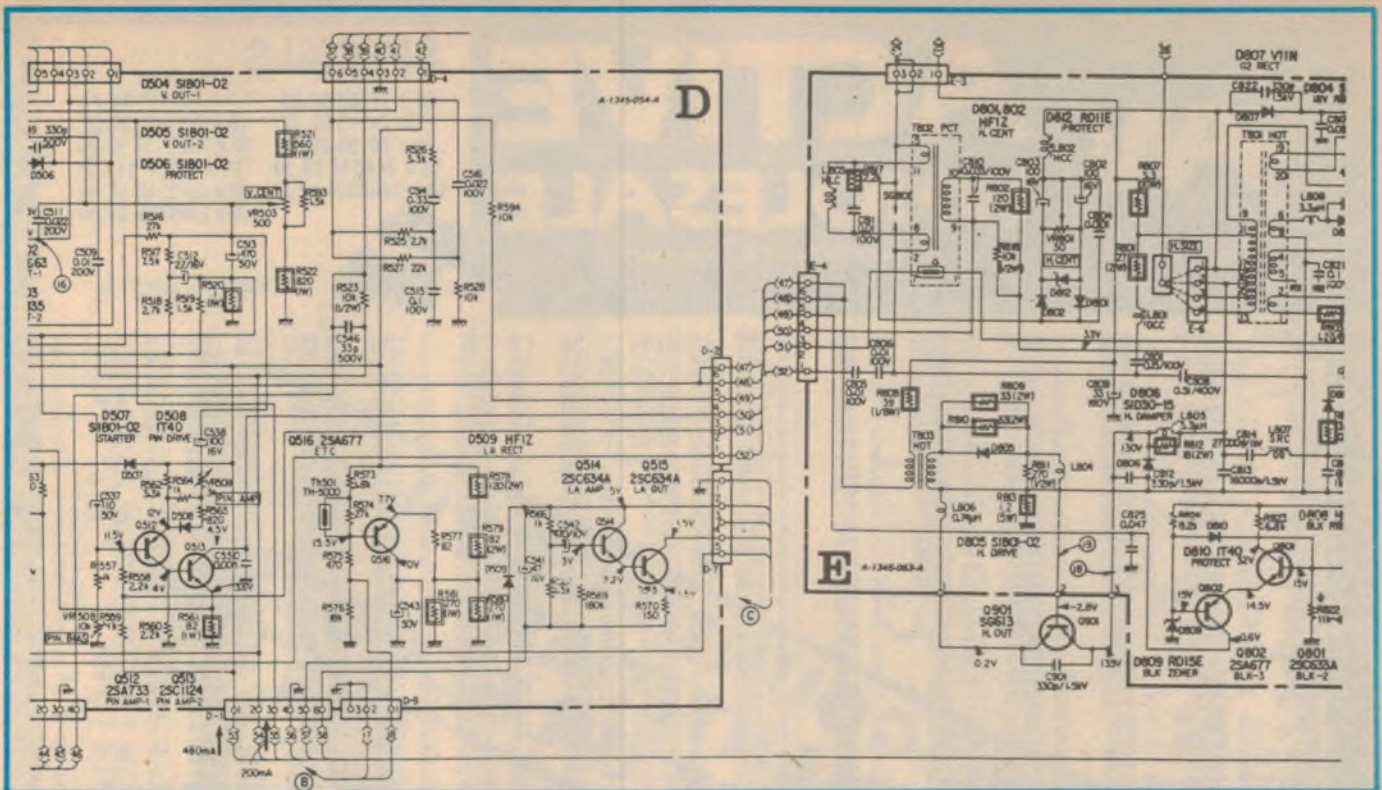

This diagram shows portions of the "D" and "E" boards in the KV-1830AS and KV-2000AS Sony receivers where two of the faults occurred. A third fault was on the "F" board.

proach. This is surprising when one considers that most set designs are unique, and can often present quite a challenge at first encounter. But that's all part of the game.

Anyway, that's the broad background. In greater detail, this customer's story went something like this: on the last occasion he had taken the set to Joe it was suffering from two faults: one main fault which caused a complete failure; and a second which caused a severe bowing or pincushion effect to the sides of the picture.

Joe fixed the main fault (whatever it was), but did nothing about the pincushion problem. When the customer pointed this out, Joe insisted that it was a major problem with these sets and could not be fixed. Then he went on to berate Sony sets in general, claiming that parts were hard to get, were too expensive, and that the sets were never much good anyway. He rounded this all off by suggesting that, the next time it failed, the customer should send it to the tip and buy himself a new set. And he made it clear that he didn't want to see the set again.

With this advice ringing in his ears, the customer took the set home and, for the next two months, put up with the badly distorted picture. Then it completely failed again, which is how it ended up on my bench.

The owner was apparently clutching at the straw of a second opinion in the faint hope that a repair might still be possible, but clearly not very confident that it would be. He was as much concerned about the pincushion effect as he was about the total failure because, as he put it, there was little point in getting the set going if this could not be fixed; he simply could not tolerate

watching such a grossly distorted picture any longer.

Well, the total failure was no problem; it was another Q901 SCR failure, so it took only a few minutes to get the set running again. It was only then that I realised just how bad this bowing effect was and could only wonder how the owner had put with it for so long. It wasn't exactly the same as a true pin-

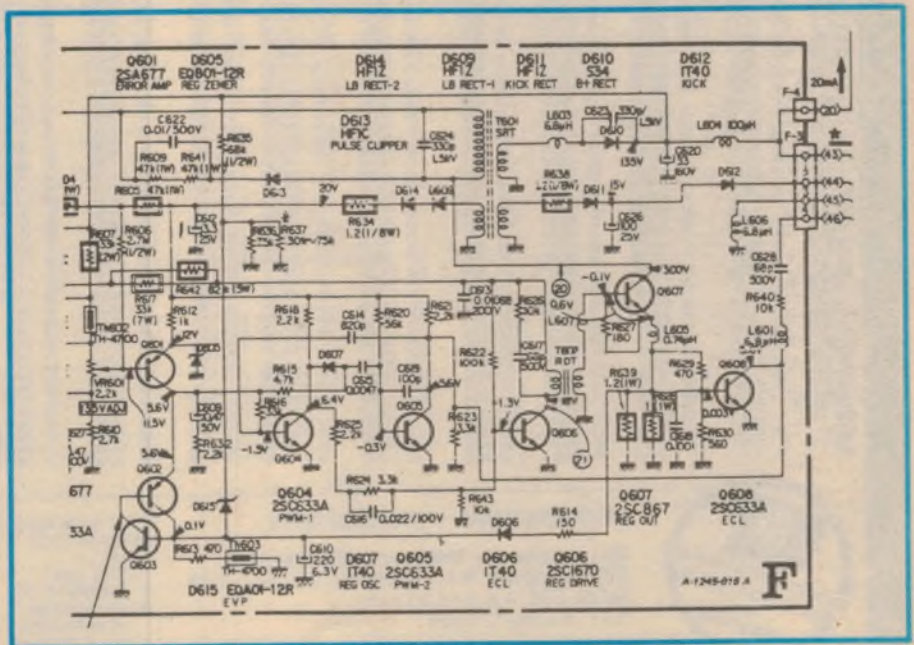

Relevant section of the Sony "F" board. A simple fault is sometimes hard to find.

The Serviceman

cushion, since it was mostly on the sides, but the difference would have been purely academic from the customer's point of view.

Unfortunately, I didn't have a clue as to the cause, never having seen the effect before. All I could do was go to what seemed like the most appropriate part of the circuit and play it by ear. This was the "D" board which contains the vertical and horizontal oscillators, the vertical drive and output stages, horizontal drive, and the convergence circuitry and controls. The horizontal drive from this board goes to the previously mentioned "E" board and the Q901 horizontal output stage.

A preliminary check with the CRO brought me to a combination of two transistors, Q512 and Q513, described as "PIN AMP-1" and "PIN AMP-2" respectively. I sensed there was something wrong here, and this was confirmed when I made some voltage measurements and found that they were nothing like those quoted on the circuit.

I also realised something else while making these checks; someone else had been to this part of the board before me, and the copper side was in pretty much of a mess. In fact it appeared that almost every component — resistors, capacitors, transistors etc — had been removed and refitted or replaced at some stage. I spent some time cleaning up the copper side before I could be reasonably sure that there were no dry joints, fractured tracks, or solder slivers fouling things up.

I first suspected the transistors, so I pulled them out and checked them but drew a blank. As far as I could tell they were well within tolerance. So what was upsetting the voltages. There are two preset pots in this part of the circuit: VR509, a 3k Ω unit designated "PIN-AMP", and VR508, 1 10k Ω unit designated "PIN.BIAS".

It was the latter unit which caught my eye because it obviously formed part of the base bias network for Q512 and, if it was faulty or incorrectly set, it could upset all the voltages in this network. So what would happen if I varied it? Taking the precaution of connecting a couple of meters to vital voltage points, I attacked it with a screwdriver.

In fact, attacked is hardly the right word because I had barely touched it when everything came good; the voltages snapped into their correct values and, more important, the bowing vanished completely. The fault was nothing

more than a dead spot on the pot — it was as simple as that. I fitted a new pot, set it up according to the manual, and the set was as good as new. The whole operation had taken me about half an hour.

So why had Joe been unable to find it? Granted, I had had to find my way around the circuit to these two transistors but then, if the state of the board was anything to go by, Joe had finished up there too. So why the "... major fault that could not be fixed" routine? Frankly I don't know, but it is a pretty scathing indictment of Joe — and anyone else like him — when they condemn a set to the tip for such a simple fault.

Needless to say, the customer was both surprised and delighted at the result. In fact, he could hardly believe it. He stood looking at the picture for several moments and then, as if trying to convince himself that something impossible had happened, remarked, "You've actually been able to fix it!"

It was almost worth fixing for that comment alone.

The only criticism I can level at this Sony set — and it is a minor one — is that a number of preset pots on the "D" board carry designations which are rather puzzling, or even confusing in some cases. VR509, for example, is designated "PIN.AMP" which I take it means "pincushion amplitude". In fact, it acts more like a width control, this effect being quite substantial, while the effect on pincushion distortion appears to be minimal.

Similarly, VR505 "HOR.AMP" (horizontal amplitude) appears to have more effect on convergence than anything else. And VR507, designated "Y BOW", which I assumed might be a pincushion adjustment on the "Y" axis, also appears to be mainly a convergence adjustment.

But confusing designations of this kind are nothing new in this game, and certainly not peculiar to the Sony sets. When it comes to the crunch one often has to find out what particular control is supposed to do by simply observing what it does.

Set number three

The next Sony set belonged to one of my regular customers and is interesting only in the technical sense. The owner had originally contacted me with the complaint that the set would sometimes not function at switch-on, but would

usually come good at the second or third attempt, but with a substantial waiting period in between.

I had called in to look at the set while making calls in the vicinity but, typically, it refused to misbehave on demand. And, since the owner wasn't keen to put it in for service at that time, we agreed to leave it and see what happened. I heard nothing more for a couple of weeks, then he was on the phone with the news that the set had failed completely. And so it finished up on the bench.

I pulled the back off, made a cursory inspection for any obvious damage and, finding nothing, switched the set on. And, just to make it harder, it fired up immediately. Since it was obviously going to be cranky I decided to monitor some of the vital voltages while it was running, and thus provide a reference for when it failed.

My first check point was the HT rail, and I struck oil immediately. This normally runs at 135V but was actually up to 149V. This seemed the most likely explanation for the failure to start, since the power supply will normally shut down at somewhere near this rail voltage. On this basis I turned my attention to the power supply ("F") board.

More particularly I went to the 135V adjustment pot, VR601 (2.2k Ω), feeding the base of error amplifier Q601. The rail voltage responded immediately to this adjustment and I was able to bring it back to 135V. I didn't imagine for one moment that this was going to be the answer, but I wanted to see what happened.

I let the set run for about 15 minutes, while monitoring the HT rail, by which time the voltage had dropped to 123V. I reset it to 135V and let the set run for an hour or so, during which time the voltage remained stable. Then I switched it off, left it for an hour or so, and switched it on again. And I wasn't really very surprised when the voltage shot up again, nudging 150V.

I repeated this ritual several times and on a couple of occasions the voltage went over the 150V mark and the set refused to start. Well, at least I knew what was happening, even if I didn't know exactly why. But, based on previous experience, there were several components which needed to be checked. (Readers would be well advised to refer to the January 1986 notes for a list of some likely power supply faults).

Transistor Q604 is a common offender in regard to erratic HT voltage, as is electrolytic capacitor C612, a

The Serviceman

3.3 μ F which was the main culprit in the January story. I replaced both of these components and put the set through another cycle, but drew a blank; the fault was still there. Another suspect was the previously mentioned error amplifier, Q601. I first tried spraying it with freezer and when this had no effect, I replaced it. But, again, no joy.

I also removed and checked transistors Q602, 603, 605 and 606. As far as I could tell all were functioning correctly. After all that highly scientific approach (ahem!), the manner of the ultimate solution was something of an anticlimax. I had left the set running for some time and decided to remove the "F" board for a closer examination, just in case there was a visual clue.

Well, there was a clue all right, but it was tactile rather than visual. As I handled the board I became aware that a part of it was quite warm. This led me to C620, a 33 μ F, 160V unit on the main HT rail — and it was more than warm, it was hot! Well, that was enough for yours truly; I pulled it out and fitted a new one.

Needless to say, that fixed it. I reset VR601, then put the set through several cycles of lengthy on and off periods, during which the HT rail remained within a fraction of a volt of its assigned 135V value. I considered the point proved and returned the set to the customer.

But I must confess to being puzzled as to why the capacitor caused the set to behave as it did. I checked the capacitor and found that its value had dropped to about 20 μ F, while its leakage was quite high. But why did it allow the rail voltage to go high at switch-on? The only theory I can advance is that its leakage was low when it was cold, but increased substantially when it was hot. Also, I suspect that it had always exhibited this characteristic, to some extent, even when new.

Assuming that VR601 was originally adjusted when the set had been running on the bench for some time, it is likely that it was set too high for the cold condition. This may not have mattered at the time, with the cold leakage being high enough to hold the rail voltage below the critical point at switch-on. However, with the passage of time, and loss of capacitance as the capacitor dried out, it is likely that the cold leakage would become less, thus allowing the voltage to rise to the shut-down point.

I know all that relies on a lot of assumptions, but it is the best I can suggest. If anyone has any other ideas

Set number four

The next set was another one that had bounced, this time from a colleague conveniently referred to as "Jack". Earlier, I suggested that Joe's attitude to servicing in general, and to Sony sets in particular, left a lot to be desired. Without retracting that comment in the slightest degree I can only say that, compared to Jack, Joe is a paragon of serviceman virtues.

Jack is what some people would euphemistically refer to as a "character" or, if he was very wealthy, as "eccentric". Most people, and particularly those who have crossed him, would probably use a more realistic, down-to-earth, Australian expression. In more precise terms, Jack is one of those people who is never happy unless he is miserable and, to boot, suffers from a violent temper.

If Jack is having a bad day — ie, is chasing a stubborn fault — he is completely unapproachable. One potential customer, who wanted to make a minor purchase, discovered this to his cost when, after waiting patiently at the counter for some time, he had the temerity to suggest that Jack might leave what he was doing and attend to his wants.

Snarling, "Can't you see I'm busy", Jack erupted from the workshop, leapt over the counter, seized the customer by the arm, and forcibly ejected him from the shop. When the unfortunate victim related this story to me he was able to show me the bruises on his arm. At the time, he was seriously contemplating taking legal action, but he later decided that it wasn't worth the hassle.

Well, that's some of the background on Jack.

And, as I intimated earlier, he also hates Sony sets. In rejecting the set which came to me, Jack had turned on a real tantrum. According to him, these sets are no adjectival good, you can't get parts for them, there is no service data available for this model, and they were only a load of rubbish in the first place. Then, "Take it away, I don't want to see it".

Which is how it finished up on my bench.

Now I don't carry any special brief for Sony, any more than any other brand, and I will criticise a model or

firm if I feel it is justified, but those statements are demonstratively untrue. Granted some parts may be a bit hard to get from time to time, but this problem is by no means unique to Sony. As for service data, I have had no difficulty in obtaining whatever information I need. As for the "load of rubbish" — well, I just don't agree; the Sony sets are as good as any.

Anyway, enough of that. The real clincher was the nature of the fault now on my bench. Would you believe it was the same pincushion-like fault which had floored our friend Joe, and only the second one I had ever seen. Needless to say, I was able to fix it in short order, much to the surprise and delight of the owner. I have no doubt I have scored another loyal customer.

And those are the main Sony stories. There were actually three more sets through the workshop at this time, all belonging to new customers, but none was particularly noteworthy in either the technical or historical sense. I mention them only because, as I intimated earlier, I suspect that they came to me as a result of word-of-mouth advertising.

And that's the best kind.

But the real point of these stories is the fact that, using only ordinary test equipment, and ordinary servicing techniques, I was able to find and fix three faults which were all new to me, and this in a brand and model of set which Joe and Jack insist is too hard to service.

Something doesn't add up somewhere.

Time delayed faults

To change the subject, in the March notes I commented that I had not been able to find anyone who could explain exactly what mechanism one would employ to create a time delayed fault; a practice supposedly employed by servicemen in general to boost business — and profit.

Well, I would stick my neck out and Mr P.T. of Clontarf, Queensland has applied the verbal axe. He writes:

Towards the end of the monochrome TV era there was a bargain TV maintenance contract available for a mere \$10 per year. If service was required the customer paid a flat rate of \$10 per service call. The \$10 premium went to the company and the call fee went to the serviceman.

Towards the end of the monochrome TV era there was a bargain TV maintenance contract available for a mere \$10 per year. If service was required the cus-

tomers paid a flat rate of \$10 per service call. The \$10 premium went to the company and the call fee went to the serviceman.

This created an incentive on the part of the serviceman to make as many calls a day as possible, with 12 jobs a day being regarded as normal. Unfortunately, it also tempted unscrupulous servicemen to help things along by making the faults more predictable; by always carrying a pocket full of 1A fuses.

The average set was equipped with a 2A mains fuse so, after repairing a fault, a new 1A mains fuse would be fitted whether it was needed or not. Usually the lighter fuse would hold up for a couple of days, or up to a week at most.

If he was a smooth talker the serviceman was even praised by the customer by knowing how to find the "fault" so quickly! And he scored another \$10 for five minutes' work. Under this scheme the serviceman paid for his own parts (a 6CM5 or a 6AL3 cost about \$3) and he did not get a call fee for jobs requiring workshop attention. Tube brighteners were often used. Since people are generally suspicious, and bad news is always popular, it is quite likely that rumours of this practice have endured, and travelled. It takes only a few such practices to be revealed and we all get tarred with the same brush. Why should we all have to bear the bad will created by a minority.

Thank you, P.T., for that little bit of informative history. I admit I hadn't heard of it before, but let's hope it is history. These days most servicemen who value their business would never think of resorting to such tactics, and most of them would make some kind of a concession in the event that a set bounced within a few days, regardless of the actual cause. That's about all we can do to build up public confidence and goodwill. ⑦

TETIA Fault of the Month

AWA G Chassis

Symptom: Picture starts with excessive brightness, low height, vertical foldup and no 150V rail. Picture then fades as set warms up, leaving only bright white screen.

Cure: R581 (4.7Ω 0.5W watt fusible) open circuit, or break in track to plug EC. This fault was found while repairing damage done by a dry joint under C571, the yoke isolating capacitor.

SIMPLIFY YOUR POWER SUPPLY DESIGN

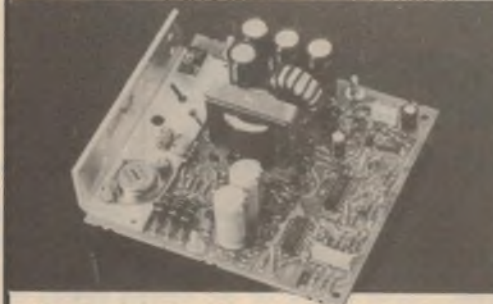

THREE TERMINAL REGULATORS

These wide-range input three-terminal regulators are flexible, inexpensive, efficient design modules providing a single adjustable output from any raw positive DC Source. These 3T modules are complete functional blocks whose input and output flexibility easily and quickly solves unique power system requirements.

Standard features

- 25 kHz switching frequency • 75% typical efficiency • Overload and short circuit protection • Adjustable output voltage • No external components needed • Remote sensing
- Parallelability • Remote On/Off

Selection guide

Model	Input voltage range (DC)	Output voltage adjustment range	Max. current
3T12AP6130	+10 to +60V	+4.5 to +30V	12A
3T20AP6115	+10 to +60V	+4.5 to +15V	20A
3T 5AN4030	+10 to +40V	-4.5 to -30V	5A
3T 5AN6030	+20 to +60V	-4.5 to -30V	5A

AVAILABLE EX STOCK

AMTEX
ELECTRONICS

A DIVISION OF METAL MANUFACTURES LIMITED
(Incorporated in Victoria)

36 LISBON STREET, FAIRFIELD, NSW 2165, AUSTRALIA
TELEPHONE: (02) 728 2121, 727 5444
TELEX: AA27922 ATTN AMTEX
FACSIMILE: (02) 728 6908, 728 2837

MELBOURNE
SUITE 1, 32-34 RUTLAND ROAD, BOX HILL VIC 3128
TELEPHONE: (03) 890 6999
FACSIMILE: (03) 898 6427

Among other things, you'll tear the wings off hornets.

Earn your Certificate of Technology with the RAAF and you'll work on some of the world's most sophisticated military aircraft, including the new F/A-18 Hornet.

To find out more, send off the coupon now.

Post this coupon to find out more about earning your Certificate of Technology to: RAAF Careers, GPO Box XYZ (in the Capital City nearest you).

Name _____

Address _____

Postcode _____ Telephone _____ Date of Birth _____

Highest Educ. level attained or being studied _____

Or phone an RAAF Careers Adviser on Adelaide 2121455. Brisbane 2262626. Canberra 572311. Hobart 347077. Melbourne 6979755. Perth 3256222. Sydney 2195555.

CERTIFICATE OF TECHNOLOGY  RAAF

Authorised by the Dept. of Defence

RTA 149 QP 106 A

ELECTRONICS Australia, June 1987

73

Books & Literature



Data Communications

DATA COMMUNICATIONS, NETWORKS, AND SYSTEMS: by Thomas C Bartee, Editor-in-Chief. Published 1985 by Howard W. Sams and Co., Inc. Indiana. Hard covers, 260 x 200mm, 359 pages. Illustrated with diagrams. ISBN 0 672 22235 3. Recommended retail price \$75.

This book covers the areas of data communications, networks and systems. As such, it covers such topics as local area networks, protocols, network security, error control, modems, multiplexers and concentrators, gives a general review of transmission media and looks at common carrier regulation in the USA.

The text is aimed at engineers, system managers, and technicians and brings together a great deal of material on data communications which has previously been hard to come by. There are ten chapters in all, each prepared by an

expert in the associated field. At the beginning of each chapter there is an introduction to the author and then a brief review of the subject before it is treated in detail.

Each chapter ends with a lengthy list of references suitable for readers inter-

ested in following up a particular area of interest.

The first chapter is on Transmission Media and discusses open wire lines, paired cable, coaxial cable, waveguides, optical fibre and radio. The following chapter on Carriers and Regulation is mainly relevant to the USA market. Modems, Multiplexers and Concentrators are covered in chapter 3, while the important subject of Protocols is covered in the next chapter.

The next three chapters are devoted to PBX, Baseband and Broadband Local Area Networks in that order, while chapter eight is on Computer and Communications Security and includes a major portion on encryption. The last two chapters are on LAN standards and Error Control.

This is an excellent reference book for engineers working in this field and covers a broad field with detailed information. Our review copy came from Jaycar Electronics. (L.D.S.)

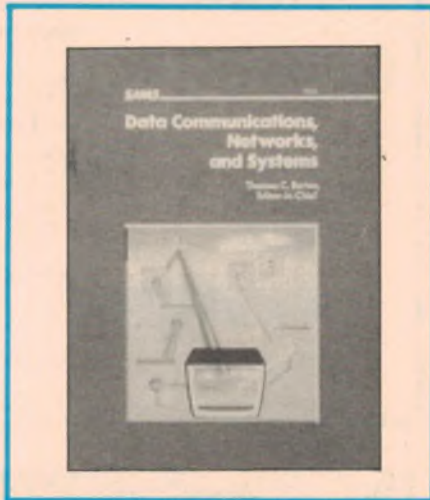

Semiconductor Physics

RATE EQUATIONS IN SEMICONDUCTOR ELECTRONICS: by J.E. Carroll. Published 1985 by Cambridge University Press, Cambridge. Hard covers, 234 x 157mm, 177 pages. Illustrated with diagrams and equations. ISBN 0 521 26533 9. Recommended retail price \$74.

This text concentrates on the dynamic behaviour of semiconductors rather than the steady-state approach which is normally taught. It is intended to give engineering students a far greater insight into the behaviour of semiconductors and optoelectronics. This is important in view of the ever increasing demand for faster devices and circuits.

As might be expected, such a text is full of mathematics which will probably discourage the casual reader but the author has gone a long way to make his material as readable and relevant as possible.

Chapter 1 is an introduction to rate equations as they apply to everyday events such as traffic flow, chemical

reactions and buying and selling houses. The example involving houses revolves around A. N. Electron who, if he sells his house, leaves a hole suitable for potential buyers to fill!

Further chapters move on to elementary rate equations in semiconductors

concerning mobility and recombination. Rates of switching follows and includes the Schottky barrier diode, the FET and bipolar transistor. Rate equations are also covered for quantum electronics, optoelectronics and transfer in phase space.

Maxwell's equations are introduced in chapter 7 for photon rate equations. This is to show how quantum and the classical concepts are unified.

Appendix A is on Counting States, while appendix B covers the differences between gas and diode laser rate equations.

Each chapter includes several questions to ensure that the material covered in the chapter is understood. Solutions are at the rear of the book.

Overall this book is not for the light reader and can be regarded as heavy going. Still, it does present a new approach to semiconductors and could be very useful as a reference or text for physics and engineering students.

Our copy came from Cambridge University Press 10 Stamford Road Oakleigh Melbourne, Vic 3166. Ph (03) 568 0322. (J.C.)

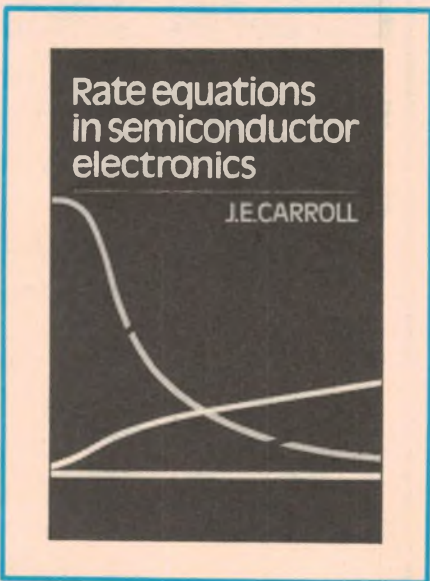

AMATEUR BARGAINS • AMATEUR BAR

FREE!

Huge Amateur Savings all this month!!

With every Hand-Held sold this month we're giving away a **FREE Welz Power**

Meter valued at \$29! Cat Q-1343

The \$100 Yaesu bonus offer!

You won't believe your luck! The incredible Yaesu FT-209RH 2 metre hand-held is now better value than ever. With every FT-209RH sold we're giving away a **FREE** battery valued at \$98.90!! Yes, you can now have all the features and quality of Yaesu at the lowest price ever! With up to 5 watt output (3.7W with FNB3 battery) 10 memories (it even remembers the repeater split), keyboard entry for everything, huge range of scanning options and much, much more! Cat D-3503

FREE!!!

\$599

FNB-3 NiCad Battery valued at \$98⁹⁰

Cat D-3508

Below cost charger!!

Just what your mobile needs! The PA-3 Car Charger is intended for operating 10.8 volt transceivers from a car cigarette lighter socket. Includes charging as well as power and now it's **BELOW COST!!** Suits FNB-3 pack as well as older style transceivers. Cat D-2899



SAVE OVER \$32!
WAS \$62.65
NOW ONLY **\$29⁹⁵**

Hand-held Power Meter

The perfect way to check the power output of your hand-held — anywhere between 6 metres and 70cm!! Famous Welz brand so you know it's quality. Simply replaces your antenna and you get a direct readout of power! Cat Q-1343

This Power Meter **FREE** with all hand-helds sold this month!!!



JUST **\$29**

Play it safe — bright spark!

We realize that you amateurs are a bright lot and we'd hate to see your base stations zapped out. So here's a great value station protector! The Welz Coax Lightning Protector. Fits easily to your antenna system and it'll absorb that surge if your antenna gets zapped! Cat D-5210



ONLY **\$49⁸⁵**

Talk's Cheap!!

It's **BELOW COST!** The Yeasu YM24A Speaker Mic. An 8 ohm speaker and 2k microphone all rolled into one! The 6 pin plug suits all FT207/FT208 transceivers and the mounting bracket is attached to the mic. Cat C-1111



SAVE \$25!
WAS \$54.95
ONLY **\$29⁹⁵**

Hand-held Scan Mic

This'll make life easy! Suits all Yaesu transceivers with scanning function. Has 8 pin plug for easy hook up and the compact design makes it easy to hold for long periods. 500 ohms impedance. Cat C-1116



WAS \$56.95
NOW **\$29⁹⁵**

Huge Mobile Saving!

Here's value! The MMB-21 Mobile Bracket to suit the FT-203/209/709 transceivers — and it's **1/4 PRICE!!** Saves your equipment slopping all over the car and saves you money to boot. But hurry, they can't last forever at this **LOW** price! Cat D-3501



WAS \$29.95
NOW **\$14⁹⁵**

1/2 PRICE!!!

More below cost mobiles!

We've done it again! The MMB20 mobile bracket is designed specifically for the FT757GX. Allows mounting in either standing or slung position with three different mounting angles! Cat D-2949

JUST **\$29⁹⁵**



DICK SMITH ELECTRONICS
PTY LTD

YAESU'S MASTERPIECE: FT767GX

• All mode, all band super transceiver

Take a bow Yaesu! The FT767GX is everything when it comes to transceivers. If a transceiver could get up and dance this one would be the Prima Ballerina! The very latest in technology so you can drag in those illusive signals or to make sure your signal is heard above the QRM. All modes on ALL amateur bands, continuous coverage triple conversion superhet receiver, built-in automatic antenna tuner, die-cast aluminium and ducted cooling giving an incredible 30 minutes output at full power and much, much more! Try Yaesu at DSE — the advantages are easy to see! Cat D-2935

Specifications

Receiver: 100kHz to 29.9999MHz, 50 to 53.999, 144 to 147.999, 430 to 439.999MHz
Transmitter: All WARC bands to 30MHz, VHF and UHF as above.
Output: 100W (AM 25W carrier) on HF, 10W (2.5W AM) VHF & UHF
Antenna Impedance: 20-100 ohms HF (nominal 50 ohms), 50 ohms UHF/VHF
Emission: J3E, A1A, J1B, A3E, F3E
Sensitivity: 0.25uV (S&B/CW/F8K, 1.5-450MHz, 10dB stn/N)



JUST **\$4995**

Includes 2m, 6m & 70cm and auto antenna tuner modules

Even Our Competitors Agree!!

"We all know that the world's best selling Electronics Kits are from HEATHKIT..." *Jack O'Donnell — Managing Director, Altronics.*

And Now They're Even Cheaper!

EXCLUSIVE TO DICK SMITH ELECTRONICS

Heathkit®

The Weather Detector!

The Digital Weather Computer displays everything from wind chill factor to indoor/outdoor temperatures, to wind speed and direction with accurate 16-point compass resolution. It even has microprocessor controlled memory for data storage by date and time! Yes, you can compare minimum and maximum readings from indoor temperature to peak wind gusts. No sports or outdoor person should be without one! But what's best is; You can build it yourself!

- FEATURES:**
- Digital clock/4 year calendar. • Four digit accuracy. • Barometer. • Thermometer. • Wind vector. • Memory. • Compact size. • Solid oiled walnut cabinet. Cat G-2000

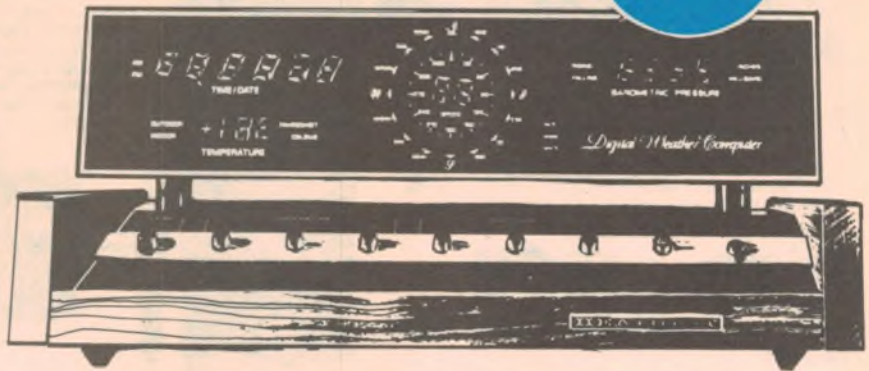

WAS \$1100 **\$999** NOW **SAVE OVER \$100**

4 Position Coax Switch

Route up to 4 antennas or interconnecting equipment at the touch of a dial. Switch from one RF source to any other while grounding all outputs not in use. Handles 2kW PEP. Build it in a night! Cat G-3010



\$69⁹⁵

Cantenna Dummy Load

Ideal for on-air testing without any RF escaping (ya gotta watch those sneaky little RFs). 1kW dummy load in a 4 litre can with less than 1.5:1 VSWR up to 450MHz. (Transformer oil not supplied) Cat G-3015



\$54⁹⁵

Audio Signal Generator

Economy plus! A quality piece of test gear that's essential for all audio and digital circuits. 10Hz to 100kHz range with both sine and square wave output. Battery operated (not supplied). Cat G-4010



\$159⁹⁵

Quality RF Generator

Here's value and quality — all rolled into one! Modulated and unmodulated signals from 310kHz to 110MHz with calibrated harmonics to 220MHz. Hobbyist or technician — you can't do better! Cat G-4005

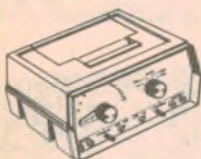

\$199

Abrasion Free Cleaning

Clean virtually anything ultrasonically — without abrasion — components, jewellery, coins...even dentures! With 150mm x 100mm tank you can professionally clean those precious items without fear of damage. (not suitable for pearls or turquoise) Cat G-2010



Requires 115V Transformer

\$299

Laser Technology

Ideal for schools, clubs, colleges, etc. The Laser Trainer is the perfect way to learn. Uses a HeNe gas laser to generate intense coherent light. It even includes receiver/monitor for measuring signal strength and built-in amplifier for sound transmitted over the laser beam! Cat G-2020

Requires 115V Transformer

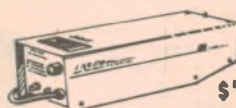

\$799

Save Money With The R-L-C Bridge

A must for all hobbyists and technicians! Don't throw out those old unmarked components. Check them with this R-L-C bridge. Build it in about 4 hours! Resistance; 10 ohms to 10M. Capacitance; 10pF to 10uF. Cat G-4025



\$199

Portable FM Deviation Meter

Anyone who works with FM will appreciate this! Quickly; and accurately measures deviation from 2 to 75kHz over the range 25 to 1000MHz. Can be used in-line for continuous readings or used as a portable 'in-field' test unit! Cat G-4000



\$550



\$69⁹⁵

Need 115 Volts?

Our M-1156 stepdown transformer is ideal for powering many of the Heathkit projects and it's amazing value! With 240 volt input and 60VA capacity. Fitted with US style pin socket and fully enclosed for safety! Cat M-1156

Hero's Already Saving!

Hero Jr is the most advanced robot we've ever seen — and you can build it yourself. A great way to learn about the future. Hero Jr is preprogrammed, it'll wake you up, remember all those things you keep forgetting (like anniversaries, etc.) Program Hero Jr with its own keypad or with your home computer*. It's battery operated and right now we're giving a FREE M-1156 transformer with every Hero Jr sold. You'll SAVE \$69.95. Cat G-1005

* With optional accessories



\$879

SAVE \$575.95!

50% MANUAL SAVER!

Don't know if this is the kit you want. Is it too hard? We've got the answer! Buy the Heathkit manual for the project you think you want — check it out. If you buy the kit we'll refund half the manual cost. Trust DSE!

A New Age in Photocopying

ALL NEW!!

Totally portable photocopying is now a reality! The Sharp Z-HC1 Handy Copier is here. At about the size of a paperback book the Handy Copier will go anywhere. With the revolutionary pen-style scanner you can selectively copy an entire text or any part you need. Even gives enlarged copy and graphics model! Fantastic for students, journalists, engineers... anyone!
Cat V-5000



ONLY \$399

Listen to the world

The '87 edit. of World Radio TV Handbook gives you a complete listing of international radio and TV stations. Everything that's worth listening to and more besides!
Cat B-2087

\$29⁹⁵

Giant Handbook of Electrical Circuits

Nearly 900 pages and over 60 chapters. Puts the epics to shame! Everything from crystal sets to computer circuits. If you want it — it's in here!
Cat B-1780

\$20

Alternative Energy Projects

Here's the book for any serious environmentalists! 286 pages of circuits and designs, building instructions and even component part numbers for alternative electronic projects. Control devices for wind and solar power systems — even an electric vehicle.
Cat B-1775

\$24⁹⁵

National Logic Data 11

Everything you ever wanted to know about National conductors but didn't know who to ask. A valuable reference source for any library.
Cat B-4016

\$31⁹⁵

Mail Order Super Special

Ring or write (but you'd best ring — these won't last!) Quality Tasco 10 x 50 wide angle binoculars complete with carry case and strap at an unbelievable price.
Cat Y-1115

SAVE \$50!!

Now Only \$99 MAIL ORDER ONLY!!!



Quality Needle Nose

The best in quality tools with these Mini Needle Nose Pliers. Stainless steel construction with tiny 1mm non serrated tip for that fine work. Fantastic value!
Cat T-3570

\$8⁷⁵

E-Z Cable Checker

Every roadie, every band should have one! Anyone who's involved in audio will find this the ultimate time saver. Simply plug your cable in (and there's a socket for every standard type) and a series of LEDs tells you if it's OK.
Cat Q-1532

\$79⁹⁵

24 piece Socket Saver!

Save time and money with this 24 piece socket set. Complete with 9 long sockets and 9 standard hex sockets from 3/16" to 1/2". 1/4" drive ratchet, two extension bars, universal joint and much more!
Cat T-4837

NOW ONLY Save \$10 \$29⁹⁵

Auto Ranging 3.5 Digit

The compact Multimeter with memory, two selectable current ranges, auto ranging for voltage and resistance, visual overrange indicator and everything a good workbench needs!
Cat Q-1515

\$69

Computer Saver

The Jabel line filter eliminates spikes and other garbage from the mains supply. Give your computer a clean line of supply — and now you'll save \$10 off our normal price!
Cat M-9850



ONLY \$139

An easy change

The RS232 Breakout Box is ideal for modems and other serial applications. DB25 male to female with pin 1 permanently wired — all the others are open and supplied with wire links.
Cat X-3568

\$27⁵⁰

Permanent Connections

The RS232 Jumper Box is the DB25 connector made for permanent connections. All 25 pins are open with wire links supplied ready for soldering.
Cat X-3569

\$17⁵⁰



Videotext Access

Now you can have Videotext access without having to own a computer! The VDX 1000 Videotext Decoder connects to your phone line and the Videotext computer bank. Once you become a registered user you'll have access to hundreds of pages of information.
Cat X-9700

\$299

Antistatic Computer Cleaner

Designed to keep your your valuable computer, screen, etc. looking like new. Cleans and deodorizes in one action!
Cat X-3562

\$3⁹⁵

Computer Vacuum Cleaner

A great idea for removing grit and dust from keyboards and circuit boards. The Mini Vacuum Cleaner is battery operated and comes with interchangeable heads for all those hard to get at places!
Cat C-7525

\$19⁹⁵

Beat Corrosion

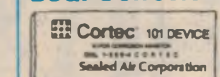

With Cortec 101 you need never worry about corrosion again! Simply slip Cortec into your electronic device and an invisible vapour protects it against corrosion for up to three years. Ideal for marine use.
Cat D-1300

\$6²⁵

Famous Xidex Disks

From the world's leading disk manufacturer Xidex. Premium quality soft sectored diskettes for the ultimate in reliability!

5 1/4" (13cm) format

Single sided/double density (40 track) **\$4⁵⁰** ea
Cat X-3510

Single sided/double density (Box of 10) **\$44⁹⁵** box
Cat X-3512

Double sided/double density (Box of 10) **\$49⁹⁵** box
Cat X-3514

Double sided/high energy, 80 track **\$99**
(Box of 10)

For AT machines with high capacity drives (1.2Mb)
Cat X-3516

Diskette Files

Top quality diskette files to protect those valuable disks. Constructed of durable plastic with see-thru lids.

5 1/4" (13cm) Format

30 disk storage, with 3 fixed dividers and 5 movable dividers/labels. **\$15⁹⁵** Cat X-3528

50 disk storage. Lockable with 9 movable dividers. Cat X-3531 **WAS \$26.50 NOW \$22⁵⁰**

100 disk storage. Lockable with 9 movable dividers.
Cat X-3534

SAVE OVER \$7 ONLY \$29⁹⁵

3 1/2" (9cm) Format

40 disk storage. Lockable with 4 movable dividers.
Cat X-3533

\$28⁹⁵

Speech Saver

Save \$50 on Votalker Speech Synthesiser! Votalker board slips into any PC compatible slot and converts written English into speech with amazing clarity. Operates from DOS level or from word processor. Now talking to your machine isn't so silly after all!
Cat X-3572

SAVE \$50 ONLY \$699

\$50 off Colour Graphics Adaptor

Slots straight into your Multitech for improved games playing capabilities! Who said computers are all work and no play?
Cat X-8140

WAS \$249 NOW \$199

Mono Graphics Adaptor

The Hercules-compatible card for software requiring MGA standard. Also includes a second parallel port and a \$50 saving!
Cat X-8141

Now Only \$249

Enhanced Graphics— Lower price!

The most versatile all rounder you can get — PLUS you'll save \$50. The Enhanced Graphic Adaptor gives you switch selectable MGA, CGA or EGA format. Perfect for desktop publishing or highly graphics oriented software!
Cat X-8142

\$699

Serial Data Cable

2.35 metre serial cable (yes, we're serial about this) with male and female DB25 adaptors at either end (we found it better to put them on the ends). For computer/ computer connections, modems, etc.
Cat X-3564

\$39

Male Gender Bender

You guessed it! It's just like the one next door but this one has a strong macho image. Turns her into him.
Cat X-3565

\$15⁹⁵

Parallel Printer Cable

Standard Centronics type printer cable with 36 pin Centronics plug on one end and 25 pin D socket on other. 1.7m long!
Cat X-8614

\$34⁹⁵

Female Gender Bender

Adapts male serial cables without re-soldering or reconnecting. Simply plug in twin female DB25 sockets with all pins wired.
Cat X-3566

\$15⁹⁵

Budget Swivel Base

Quality constructed Monitor Swivel Base for your computer screen (or your telly). It's easier to twist the screen than it is your neck!
Cat X-1190

\$24⁹⁵

Deluxe Swivel Base

If you're constantly having to adjust the monitor — so others can see the screen, etc — then this is the one for you! Has knurled knob for locking and freeing screen.
Cat X-1191

\$39⁵⁰

Gas-Lift Monitor Arm

Allows you to move the monitor into almost any position with the little to no effort. The computer cables are hidden away in the arm so it looks neat too!
Cat X-1192

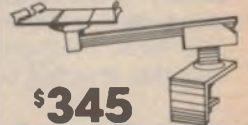

\$345

Just a Shade of Difference!

Great value monitors in the two most sought after colours — Green or Amber.



Amber Cat X-1224
Green Cat X-1223

\$249

Get your computer on line! Dataphone 1200

With pushbutton 12 memory phone 300/300, 600/75 and 1200/75 modes. Plus auto answer/answer/originate! Comes complete with RS232 serial interface, 240V supply cable and phone plug.
Cat X-3300

\$349

Dataphone 300

For the budget conscious and now with a huge \$30 saving! 300 Baud full duplex modem with pushbutton phone. Simply plug it in for instant communication.

Cat X-3301 **Save \$30**

Now Only \$169

Dataphone 1200/Smart

We don't call it Smart for nothing! State-of-the-art data transfer is made easier and quicker than ever before. Hayes-compatible offering auto selectable 300/300, 1200/75 baud transmission. Comes ready to plug in!
Cat X-3302

All DSE Modems are Telecom Approved **\$499**

DICK SMITH ELECTRONICS

PTY LTD

• NICAD SAVINGS • NICAD SAVINGS •

GET UP TO 400 CHARGES OUT OF OUR HEAVY DUTY NICADS.

Ideal for all your toys, radios...

Why buy Nicads?

You should expect at least 400 charges from a NiCad battery. If looked after, this can easily be doubled. Taking worst case, each charge for a "AA" cell costs about 1c (electricity costs are negligible). Compare this to 400 dry batteries at about 60c each. . . the savings are enormous!

But there's more!

A NiCad cell holds its voltage virtually constant over 90% of the discharge cycle. A dry cell starts dropping voltage immediately. You don't get the same "drop off" in a NiCad as a dry cell. Therefore motors continue to run at the correct speed, lamps glow at the right brightness, and so on — very close to complete discharge.

And even more!

The internal resistance of a NiCad Cell is much lower than a dry cell. (less than 0.05 ohms Vs 0.4 to 0.8 ohms) Therefore devices which require high currents (e.g. photoflashes, high torque motors, etc) are much better off with NiCad cells than dry cells.

Still not convinced?

You can get much higher continuous current ratings in a NiCad cell than a dry cell. While not rated the same way, a dry cell discharged at 90mA is considered "flat" (1.1V) after approx. 2.5 hours. A NiCad cell lasts almost 5.5 hours under the same conditions. Even under non-continuous discharge conditions, the NiCad cell wins hands down: because the NiCad can be re-charged between uses!

Battery Packs

Qty	Type	Cat No.	Price
4 x AA	500mAh	S-3150	\$16.95
2 x C	1.2Ah	S-3152	\$15.95
2 x D	1.2Ah	S-3154	\$16.50
4 x AA	600mAh	S-3160	\$19.95
2 x C	2.0Ah	S-3162	\$24.95
2 x D	4.0Ah	S-3164	\$27.95

Extra Heavy Duty NiCads

Type	Cat No.	Price
C 2.0Ah	S-3311	\$14.50
AA 600mAh	S-3312	\$5.50
D 4.0Ah	S-3310	\$14.50
Sub C Fast Charge	S-3324	\$6.50

DICK SMITH
ELECTRONICS
PTY LTD

BATTERY HOSPITAL

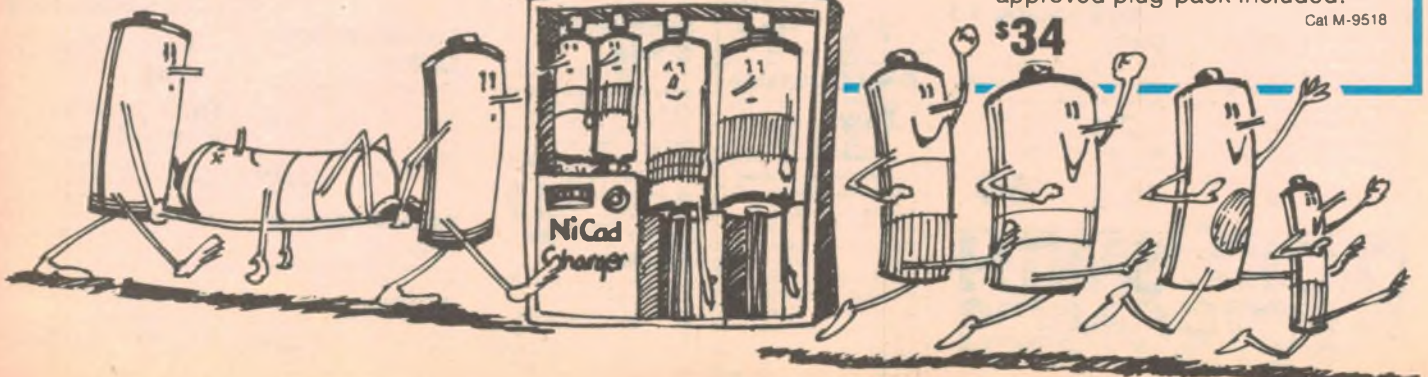
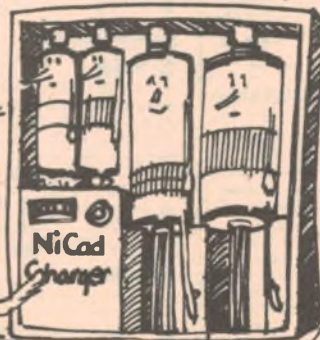

CHARGERS • SAVE ON CHARGERS • SAVE ON CH

Eveready NiCad Charger



Multi-size (AA, C, D or 9V) NiCad battery charger. Takes two 1.2V cells at a time or one 9V. Complete unit including plug-pack: nothing extra to buy. Cat M-9515

\$27⁵⁰

Multi-cell Charger

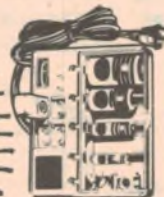

Charge up to 4 batteries at a time — AA, C, D, 6V or 9V. AND you can also charge AAA, and button cells too! But there's more: a test meter to check NiCad voltage under load — the only way to check your battery properly. Fully approved plug-pack included.

\$34

Cat M-9518

ALL YOUR RECEPTION PROBLEMS SOLVED... AT DICK SMITH ELECTRONICS

THE MAST

If reception's not the best, get your antenna up above the noise, up above the obstructions! This 9 metre 3-section telescopic mast will do it: and it comes complete with all mounting hardware. Accepts virtually all TV antennas. Cat L-4520

\$110

THE GUY WIRE

Ultra-strong plated steel guy wire to hold mast up against mother nature: breaking strain is greater than 10 tonnes. 180 metre roll: just right for mast installation. Cat L-4564

\$44

THE TURNBUCKLES

There's no safer way of making fast the guys. Turnbuckles allow fine adjustment of tension to ensure mast is vertical, too. Heavily plated. 8mm size (94mm long). Cat L-4544

\$1.65

THE WIRE CLAMPS

Gives the safest, strongest method of tying off guy wires. Minimum strain, no kinks to become weak points. Use wherever guy wire ends. Cat L-4522

70¢

THE THIMBLES

Makes guy wires follow wide radius wherever they change direction (eg at top and bottom) to avoid creating weak points. A must for safety — and they're so cheap! Cat L-4530

80¢

THE DYNABOLTS

Use for anchoring the guy wires into concrete, etc. Two styles to choose from — one standard hex nut type and the other with "eye" for taking turnbuckles or guy wires. 10mm Hex Head: Cat L-4570. Pack of 3

\$2.95
\$2.95

THE ANTENNA

No, we haven't shown the antenna — because the type is up to you! VHF, UHF Band 4, UHF Band 5, Combined VHF/UHF, FM Radio, metropolitan, fringe... there's a huge range to suit from — but one will be just right for you. See next page for just some of our value-packed antennas.

THE MASTHEAD AMP

If you're scratching for that last bit of signal (because of area, ghosting, etc) a masthead amp often works wonders. Amplifies signal right at antenna — and it is especially designed to minimise CB interference, too. 24dB gain, includes power supply and amplifier unit. Cat L-4200.

\$75

THE LEAD-IN

Choosing the right lead-in makes a world of difference. In strong signal areas, 300 ohm ribbon is usually fine, but for best results you need our low-loss 5C2V low-loss air dielectric coax. Black coloured to minimise UV damage. Cat W-2082

75¢

THE ROTATOR

Trying for a number of stations? If you're on the fringe, a rotator will allow best aiming. Simply clamp to mast and antenna, needs only three-wire control cable. Includes rotator and inside control box. Cat D-5005

\$229

THE SPLITTER

Want to run more than one TV? You need a splitter. Choose from two or four way, coax or ribbon lead-in type. For example, look at the low price of our 2-way coax-type splitter! Cat L-4270

\$2.75

THE WALL SOCKET

Makes a neat, professional finish at low cost. Mount on skirting board wherever you want TV outlets. Cat L-4504

\$4.75

DO IT YOURSELF? YOU BET!

Why pay big \$\$\$ to have a TV antenna installed — when it's so easy to do it yourself. Our specially written guide shows how: what to do, how to do it, everything. And the price? Just 50¢! (Or buy any TV antenna or mast and we'll give you a copy!)

Cat B-6010

50¢

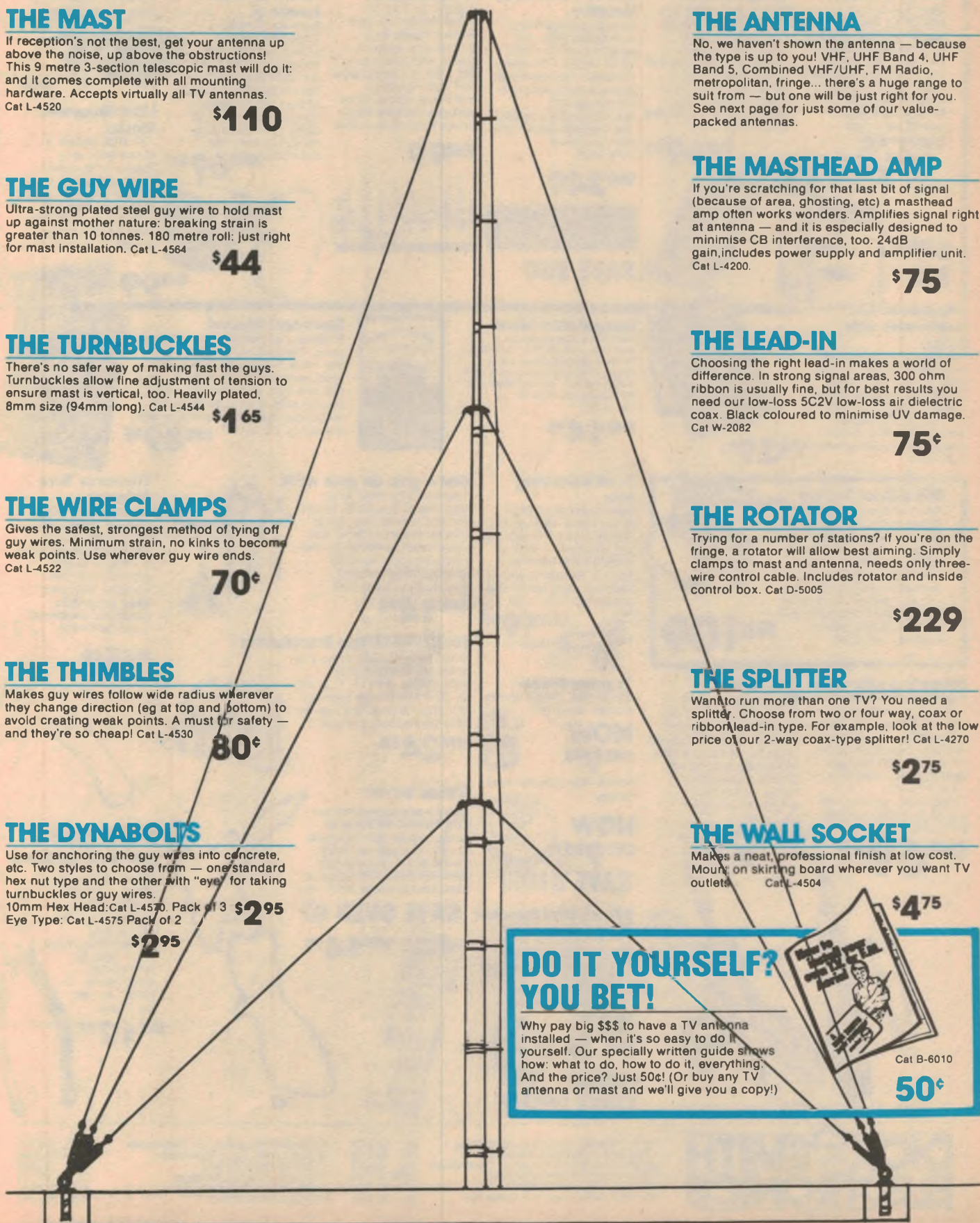

No. 1 For Kits — And Getting Better!

Security Saver!

Save \$24 on our fantastic 8 Sector Home Alarm Kit! If this were a commercial unit you'd pay hundreds of \$\$\$ more. Features 2 instant and 6 delay sectors, security key, inbuilt battery backup and more!! Cat K-3424

\$NZ275



SAVE \$24

Budget Alarm

Where else could you get a quality 4 Sector Alarm at this LOW price? It's the bare-bones sure, but you can build a complete system for the home or office around it! And nothing gives you better value. Cat K-3254

\$NZ69⁹⁵



\$50 off Frequency Counter

Easy to put together — and at this price, it's easy to own! The DSE 1GHz Digital Frequency Counter. A professional unit at a hobbyist price. Kit comes with everything that's needed and features even more than you need. Cat K-3437

\$NZ249



SAVE \$50

4 Input Mixer

A great preamp for small bands, etc! Use all four inputs for guitars or a mixture — guitar, mic, line inputs, etc. Lets you select gain and impedance on individual inputs. More features than the local movie house! Cat K-3036

\$NZ99



Takes a lot of beating!

Save on our Beat Triggered Strobe! Makes a great party, dance, etc. Use it as a conventional strobe or have it flash to the beat of the music. Fantastic for photography — kit comes complete and ready to assemble. Cat K-3153

\$NZ69⁹⁵



\$NZ99

Negative Ion Generator

You can't be positive about anything — but they say these things help you feel better. Cat K-3333



\$NZ39⁵⁰

VCR Simulated Stereo

The DSE Dynamic Noise Reduction System is the ideal, inexpensive way to reduce hiss AND add simulated stereo to your mono VCR! Easy to build and set up. K-3423



Multimeter with Buzzer

The hobbyist's workmate! Amazing value Multimeter with Audible Continuity Tester. Has battery checker, 10A DC range and high sensitivity (20K ohms), mirrored scale and that famous DSE LOW price! Cat Q-1022

\$NZ29⁹⁵



Budget Mini Meter

Here's one Multimeter no workshop can afford to be without. For well under \$20 you get an 11 range, 2000 ohm/volt pocket sized tester. Ideal for general work and it's rugged and reliable! Cat Q-1010

\$NZ14⁹⁵



Electronic Marvel

Professional quality at a hobbyists price. The multimeter which gives you more. Few multimeters can read peak-to-peak and RMS — but this one can. You can even adjust the pointer to zero for nulling! With a single range switch, there's no lead swapping. Cat Q-1143

\$NZ89⁹⁵



DSE Solder Station

Yes, the incredible DSE Workstation with adjustable temperature control is now the best value yet! Puts an end to all those soldering hassles for a truly professional finish. Comes with lightweight iron holder, sponge and comprehensive instruction and service manual. Cat T-2000



\$NZ109

1/3 off Soldering Iron

Save nearly \$10! Our super value, high quality 'Antex' brand iron will get the job done — with 25 watts it's hot when you need it. Reliability with stainless steel barrel and copper tip. Cat T-1300

\$NZ19⁹⁵



Get a grip on your work

The mini vice from Arlec attaches to any table, bench etc and leaves your hands free for the job! 50mm jaws open to about 60mm for the really big jobs. Ideal for cutting, filling and test applications. Cat T-4748

\$NZ14⁹⁵

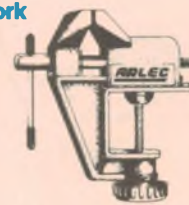

Economy Wire Stripper

We've stripped over 25% off the price of our Economy Wire Strippers. Save heaps of time on those projects with this versatile tool. With large adjustable range and hardened jaws! Cat T-3630

\$NZ5⁹⁵

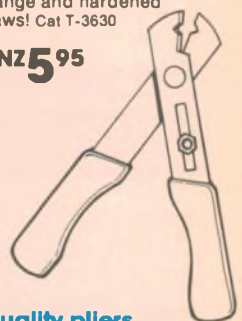

Soldering with Gas

Totally portable soldering — and it even fits in your pocket! Works just like a cigarette lighter — uses refillable butane. Provides an amazing 60 minutes heat at an equivalent of 10 to 60 watts. Detachable cap features a built-in ignition system. Cat T-1370

\$NZ69⁹⁵



Desolder de Savings!

A must for any tool kit. Desolders cleanly and professionally in seconds. Huge 30 watt rating, fully self contained 240 volt. Ideal for workshop, home, technicians... anywhere, anytime! Cat T-1340

\$NZ99



1/2 price Solder

50mm Roll 200g 1.25mm Solder Cat N-1619

NOW \$NZ9⁹⁵



50mm Roll 200g 0.71mm Solder

NOW \$NZ9⁹⁵



SAVE \$10!!!

57mm Mini Speaker

The only thing smaller than this speaker is the price! It performs better than a lot of 75mm jobs. 8 ohm impedance make it suitable for many purposes. Cat C-2222

WAS \$4.25

NOW ONLY \$NZ2⁹⁵



15-30 volt M/Tap Transformer

Great for a thousand and one projects! The DSE 2155 transformer with 15, 17.5, 20, 24, 27.5 and 30 volt tappings at 1 amp. With solder lugs for easy connection. Cat M-6672

\$NZ24⁵⁰

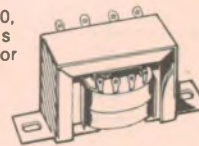

Circuit Saver

There's real savings on our PCB Marker Kit! Ideal for those quickie boards where there's no photo facilities available. Comes with two coloured pens and eraser in hand plastic wallet. Cat T-5175

SAVE OVER \$7

\$NZ14⁹⁵

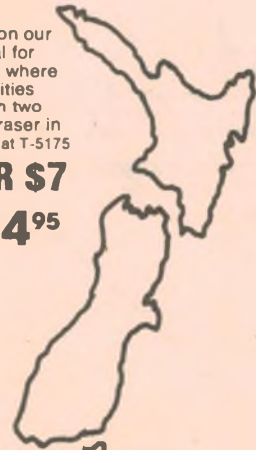

Quality pliers with cutting blade

Quality Side Cutting Pliers — \$7 off normal price! Insulated handles and quality construction make them ideal for servicemen, electricians, hobbyists, etc. Cat T-3270

\$NZ12⁹⁵

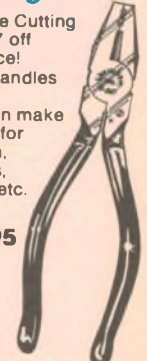

DICK SMITH ELECTRONICS

PTY LTD

Fort & Commerce Streets, Auckland City
1795 Great North Road, Avondale
Victoria Road & Bealey Avenue, Christchurch
Manse & Stafford Streets, Dunedin
450 Anglesea Street, Hamilton
440 Cuba Street, Alicetown, Lower Hutt

(07) 38 9974
(09) 88 6696
(03) 50 405
(024) 74 1096
(071) 39 4490
(04) 66 2022

Cnr Khyber Pass & Park Rds, Newmarket
26 East Tamaki Road, Papatoetoe
16 Lydney Place, Porirua
289 Cameron Road, Tauranga
154 Featherston Street, Wellington
DSX ORDER PHONE LINE

(09) 393 192
(09) 278 2355
(09) 37 6654
(075) 87 071
(04) 73 9858
(09) 392 997

IBM Compatible Under \$1000!

Yes! It's a price breakthrough. A top quality, IBM PC compatible computer for less than \$1000. Unbelievable... but true!

DSE Multitech

Who else could do it but Dick Smith Electronics? With the world-famous Multitech PC500 computer — from one of the largest manufacturers in the world — you get the perfect computer for business, for home, for studies. All the power and performance PLUS the world's leading software range is now within your reach.

Here's what you get:

- 256K memory — fully expandable to meet future needs
- Built-in 360K floppy disk drive (with room for a second!)
- Built-in parallel, serial and joystick ports (the ones others charge you extra for!)
- The very latest MS-DOS 3.2 Operating System (not yesterday's 2.11 system!) compatible with the world's best software range for business, education and games.

Yes, all this under \$1000!

Sensational Saving...

\$995



Monitor not included

And one for the kids: VZ-300 Family Pack



\$169

It's the VZ-300 Colour Computer Family Pack — the best start to home computing. Everything you need for an immediate start is included:

- VZ-300 Colour Computer
- Data cassette for running software and storing your own programs
- 2 game and 2 educational programs. Cat X-7307

Bargain priced quality disks!



Just what the computer buff wants. Premium double density disks starting from only \$2.75 each!

Single sided
Cat X-3500

Double sided
Cat X-3501

\$27⁵⁰
box of 10

\$29⁵⁰
box of 10

Faster Printer!

When speed is important our DSE-130 Dot Matrix Printer gets the job done quickly; ideal for letters, memos and reports. Prints up to 130cps: normal, enlarged and condensed styles, plus graphics. Cat X-3230

\$549

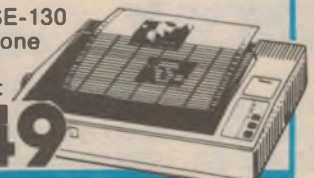

**DICK SMITH
ELECTRONICS**
COMPUTERSTOP

• NSW • Albury 21 8399 • Bankstown Square 707 4888 • Blacktown 671 7722 • Blakehurst 546 7444 • Bondi Junction 387 1444 • Brookvale (Warringah Mall) 93 0441 • Campbelltown 27 2199 • Chatswood Chase 411 1955 • Chulora 642 8922 • Gore Hill 439 5311 • Gosford 25 0235 • Hornsby 477 6633 • Liverpool 800 9888 • Maitland 33 7866 • Miranda 525 2722 • Newcastle 61 1896 • North Ryde 88 3855 • Parramatta 689 2188 • Penrith 32 3400 • Railway Square 211 3777 • Sydney City 267 9111 • Tamworth 66 1711 • Wollongong 28 3800 • ACT • Fyshwick 80 4944 • VIC • Ballarat 31 5433 • Bendigo 43 0388 • Box Hill 890 0699 • East Brighton 582 2388 • Coburg 383 4455 • Essendon 379 7444 • Frankston 547 0522 • GLD • Brisbane City 229 9377 • Buranda 391 6233 • Cherridside 359 6255 • Redbank 288 5599 • Rockhampton 27 9644 • Southport 32 9863 • Toowoomba 38 4300 • Townsville 72 5722 • Underwood 341 0844 • SA • Adelaide City 232 1200 • Darlington 298 8977 • Enfield 260 6088 • Salisbury 281 1593 • WA • Cannington 451 8666 • Fremantle 335 9733 • North Perth 328 6944 • Perth City 481 3261 • TAS • Hobart 31 0800 • NT • Stuart Park 81 1977 B.389/RB

Local Area VHF/UHF



\$39⁹⁵

Reasonably close to the station? You don't need a big antenna. This economy VHF model will give you a great picture on VHF or UHF band 4 — and look at the low, low price! Cat L-4027

Band 4 UHF

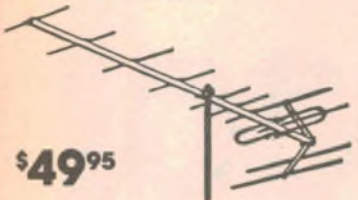

\$49⁹⁵

Already have a good VHF antenna up? Why replace it if all you want to do is watch SBS or local area translators on band 4. Fold-out reflector for maximum performance. Cat L-4040

Ghost Buster

Who ya gonna call? DSE, of course — for this superb ghost buster antenna. High front to back and side ratio means minimum ghosting — great for problem reception areas. Suits VHF and band 4 UHF. Cat L-4023



\$99

Band 5 UHF

Similar to the Band 4 model, but cut with shorter elements to suit Band 5 (channels 39 to 69). A lot of local translators are being put into this band — check with stations to find the band in your area. Cat L-4035



\$44⁹⁵

Phased Array: the big guns!

For long distance (deep fringe) reception this phased array is a beauty. For high band VHF (channels 6 and up), perfect for country viewers watching city channels — or city viewers watching the footy! Cat L-4025

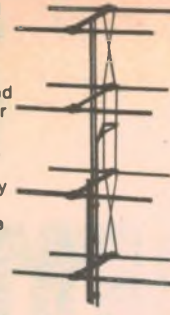

\$99

Super Band 5 UHF

For long distance UHF reception — deep fringe UHF can be dramatically improved with this one. 16 elements and 15 element reflector gives you the edge in picking up that elusive signal. Cat L-4045

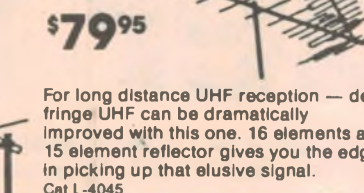

\$79⁹⁵

Fantastic Music Antenna

FM is great — but for best results, you need an outside antenna. This 3 element model is ideal — and it suits economy 300 ohm ribbon. Cat L-4064



\$34⁹⁵

Go-Anywhere Mini TV/FM

Folds up for transportation — so it suits the caravan and camper just as much as the flat dweller. Folded dipole design suits all VHF channels, can be horizontal or vertical polarised and comes with 300 ohm ribbon. Cat L-4026



\$49⁹⁵

STORE LOCATIONS

NSW Swift & Young Sts 755 Terrace Level Shop 1, 65-75 Main St 613 Princess Hwy Oxford & Adelaide Sts Shop 2, 1B Cross St, Warringham Mall Campbelltown Mall Queen St Shop 235, Archer St Entrance 147 Hume Hwy 164 Pacific Hwy 315 Mann St 4 Florence St Elizabeth Dr & Bathurst St 450 High Street 621-627 The Kingsway 173 Maitland Rd, Tighes Hill Lane Cove & Waterloo Rds George & Smith Sts The Gateway High & Henry Sts 818 George St 125 York St Trelor's Bldg, Brisbane St 263 Keira St	Albury Bankstown Bq Blacktown Blakehurst Bondi Junction Brookvale Campbelltown Chateau Wood Chase Chullora Gore Hill Gosford Hornsby Liverpool Maitland Miranda Newcastle North Ryde Parramatta Penrith Railway Square Sydney City Tamworth Wollongong	(000)21 8399 (02)707 4888 (02)871 7722 (02)546 7744 (02)387 1444 (02)83 0441 (048)27 2199 (02)411 1955 (02)842 8922 (02)438 5311 (043)25 0235 (02)477 8633 (02)800 9888 (048)33 7866 (02)525 2722 (048)81 1896 (02)88 3855 (02)889 2188 (047)32 3400 (02)11 3777 (02)267 8111 (087)86 1711 (042)28 3800	ACT 96 Gladstone St VIC Creswick Rd & Webster St 145 McCrae St Shop 46, Box Hill Central, Main St Hawthorn Rd & Nepean Hwy 280 Sydney Rd 1150 Mt Alexander Rd Nepean Hwy & Ross Smith Ave Shop 9 110, High St 291-293 Elizabeth St Bridge Rd & The Boulevard Shop 2, 141 Maroonah Hwy Springvale & Dandenong Rds QLD 157-159 Elizabeth St 166 Logan Rd Gympie & Hamilton Rds Queen Elizabeth Dr & Bernard St 2nd Level Western Entrance Redbank Shopping Plaza Gold Coast Hwy & Welch St Bowen & Ruthven Sts Kings Rd & Woolcock St	Fyshwick Ballarat Bendigo Box Hill East Brighton Coburg Essendon Frankston Geelong Melbourne City Richmond Ringwood Springvale Brisbane City Buranda Chermside Rockhampton Redbank Southport Toowoomba Townsville	(082)80 4944 (053)31 5433 (054)43 0388 (03)890 0899 (03)592 2388 (03)383 4455 (03)378 7444 (03)783 9144 (052)43 8804 (03)87 8634 (03)428 1814 (03)879 5338 (03)547 0522 (07)228 8377 (07)381 8233 (07)358 8255 (07)27 9844 (07)288 5599 (07)532 8863 (078)38 4300 (07)772 5722	Cnr Pacific Hwy & Kingston Rd SA 77 Grenfell St Main South & Flagstaff Rds Shop T25, Elizabeth City Centre Main North Rd & Darlington St 24 Park Terrace WA Wharf St & Albany Hwy 66 Adelaide St William St & Robinson Ave Raine Square, 125 William St TAS Shop 40A, Lower Level Cat & Fiddle Arcade NT 17 Stuart Hwy	Underwood Adelaide Darlington Elizabeth Enfield Ballsblury Cannington Fremantle North Perth Perth City Hobart Stuart Park	(07)341 0844 (08)232 1200 (08)288 8877 (08)255 8099 (08)280 6088 (08)281 1593 (08)451 8888 (08)335 8733 (08)328 8844 (08)481 3281 (002)31 0800 (088)81 1977
---------------------------------------------------------------------------------------------------------------------------------------------------------------------------------------------------------------------------------------------------------------------------------------------------------------------------------------------------------------------------------------------------------------------------------------------------------------------------------------------------------------------------------------------------------------------------------	-----------------------------------------------------------------------------------------------------------------------------------------------------------------------------------------------------------------------------------------------------------------------------------------------------------------------------------------------------------------------------------------------------------	------------------------------------------------------------------------------------------------------------------------------------------------------------------------------------------------------------------------------------------------------------------------------------------------------------------------------------------------------------------------------------------------------------------------------------------------------------------------------------------------------------------------------------------------	----------------------------------------------------------------------------------------------------------------------------------------------------------------------------------------------------------------------------------------------------------------------------------------------------------------------------------------------------------------------------------------------------------------------------------------------------------------------------------------------------------------------------------------------------------------------------------------------------------------------------------	----------------------------------------------------------------------------------------------------------------------------------------------------------------------------------------------------------------------------------------------------------------------------------------------------------------------------------------------------------------------------------------------------------------------------------------------	-----------------------------------------------------------------------------------------------------------------------------------------------------------------------------------------------------------------------------------------------------------------------------------------------------------------------------------------------------------------------------------------------------------------------------------------------------------------------------------------------------------	---------------------------------------------------------------------------------------------------------------------------------------------------------------------------------------------------------------------------------------------------------------------------------------------------------------------------------------------------------------------------------------------------------------	----------------------------------------------------------------------------------------------------------------------------------------------------------------------------------------------------------------------------------------------------------------	--------------------------------------------------------------------------------------------------------------------------------------------------------------------------------------------------------------------------------------------------------------------------------------------------

Visit our new Elizabeth (SA) store
— now open at
Shop T25, Elizabeth City Centre
Ph: 255 6099

Dear Customers,

Quite often, the products we advertise are so popular they run out within a few days, or unforeseen circumstances might hold up shipments so that advertised lines are not in the stores by the time the advert appears. And very occasionally, an error might slip through our checks and appear in the advert (after all, we're human too!) Please don't blame the store manager or staff; they cannot solve a dock strike on the other side of the world, nor fix an error that's appeared in print. If you're about to drive across town to pick up an advertised line, why not play it safe and give them a call first... just in case! Thanks. Dick Smith Electronics.

MAJOR DICK SMITH ELECTRONICS AUTHORISED RESELLERS

NSW: Ballina: A. Cummings & Co. 91-93 River St. 86 2284 • Bowral: F.R.H. Electrical, 28 Station St. 81 1000 • Broken Hill: Hobbies & Electronics, 31 Oxide St. 88 4088 • Charlestown: Newtronics, 131 Pacific Hwy. 43 9800 • Coff's Harbour: Coff's Harbour Electronics, Shop 3, Coff's Harbour Mall, Park Ave. 52 5684 • Danby: Dani Electronics, 220 Crossy St. 81 3872 • Dubbo: Mavina Electronics, 35 Talbragar St. 82 8500 • Geelong: Tomorrow's Electronics & HIFI, 88 William St. 24 7246 • Inverell: Lyn Willing Electronics, 32 Lawrence St. 22 1821 • Lismore: Lenton Record Centre, 121 Pine Ave. 53 2081 • Lightning Ridge: Lightning Ridge Newsagency, 40A Morilla St. 29 0579 • Lismore: Dingo, 3A/5-18 Carrington St. 21 4137 • Port Macquarie: Hail of Electronics, Horton Centre, 124 Horton St. 83 7440 • Orange: Fyfe Electronics, 173 Summer St. 62 6491 • Springwood: Wellington's Electrical Discounts, 115 Macquarie Rd. 51 4888 • Tamworth: Tamworth Electronics Shop 8, Civic Cinema Centre, Pullenby St. 52 8603 • Tamworth: Tamworth Electronics, Wynyard St. 47 1631 • Tweed Heads: Stuart Street Electronic Sales, Stuart St. 36 5744 • Ulladulla: Paula Electronics, 10 Wason Street, 55 3989 • Wagga: Phillip Electronics, 80 Forsyth St. 21 6558 • Windaiga: M & E Electronics, Shop 7, McEwans Arcade, 208 George St. 77 5935 • Young: Keith Douglas Electronics, 186 Boorowa St. 82 1278 • **VIC:** • Echuca: Webster Electronics, 220 Puckham St. 82 2956 • Mildura: McWilliams Electronics 110A Langtree Ave. 25 6410 • Morwell: Morwell Electronics, 95 George St. 34 6133 • Rosedale: Penronics, 1243A Nepean Hwy. 86 7688 • Shepparton: GV Electronics Centre, 84 High St. 21 8886 • **QLD:** • Brisbane: Bob Elkin Electronics, 81 Bourong St. 72 1785 • Cairns: Electronic World, Shop 27, K-mart Westcott Plaza, Shop 2, Sunshine Beach Rd. 47 4444 • Rockhampton: Access Supertronics, 9 Tank St. 72 4321 • Mackay: Stevens Electronics, 42 Victoria St. 51 1723 • Maryborough: Keller Electronics, 218 Adelaide St. 21 4559 • Mooloolaba: Mal's Electronics, Shop 4, 128 Brisbane Rd. 44 6588 • Mt Isa: Outback Electronics, 15 East St. 21 056 • Townsville: Tropical T.V., Vincent Village, 79 1421 • **SA:** • Mt Gambier: Hutchisons Communication Centre, 5 Elizabeth St. 25 0400 • Whyalla: Eyre Electronics, Shop 2, Forsyth St. 45 4784 • **WA:** • Albany: Micro Electronics, 133 Lockyer Ave. 41 3432 • **TAS:** • Launceston: Wills Electronics, 5A The Quadrant, 31 5688

EDS PRESS ORDER SERVICE

ORDERS OVER \$75
FREE DELIVER

	Order Value	Charge	Order Value	Charge
POST & PACKING CHARGES	\$5.00 — \$9.99	\$2.00	\$50.00 — \$75.00	\$6.50
	\$10.00 — \$24.99	\$3.50	\$75.00 or more	N.A.
	\$25.00 — \$49.99	\$4.50		



Terms available to approved applicants

SA Customers: Credit facilities available through AGC: 10 Pulteney St, Adelaide



PTY LTD

P.O. Box 321, North Ryde N.S.W. 2113
Tel: 888 3200

Offer concludes 30/6/87 or until stocks last. Prices can be increased without notice due to fluctuations in currency, high interest rates, government and imports.

50 and 25 years ago..



June 1962

"Electronics Australia" is one of the longest running technical publications in the world. We started as "Wireless Weekly" in August 1922 and became "Radio and Hobbies in Australia" in April 1939. The title was changed to "Radio, Television and Hobbies" in February 1955 and finally, to "Electronics Australia" in April 1965. Below we feature some items from past issues.



June 1937

625-Foot Mast: The General Electric Company has announced that it will erect an ultra-modern 625-foot vertical antenna for its station, WGY in Schenectady, and by doing so will increase the effective signal strength of this 50,000 watt transmitter at least three times. The plans to give this pioneer broadcasting station one of the tallest antenna systems in the country have

been approved by the Federal Communications Commission and work will start at once.

Radio equipment for the Army: Wireless is playing an increasingly important part today in the army and is especially suitable for the training of troops. Special apparatus has been developed for the purpose, the requirements of this type of appliance being durability and mobility. Transmitters and receiving sets are mounted on motor vehicles so that they can be transported readily from place to place. They are designed to transmit both speech and Morse. Amplifying facilities are also required so that a number of men can hear instructional comment.

Flight to the Moon: President Kennedy has set a manned landing on the Moon as a United States goal. The known and unknown problems of such a mission make Columbus' search for a new route to the East, by comparison, about as risky as betting that the postman will come.

No need to refuel: Throw-away cigarette lighters costing the equivalent of about 5/6 each are now on sale in France.

Cylindrical in shape and about 3-inches long, they are of the gas-filled type and are ignited by means of the usual milled wheel and flint. The wheel extinguishes the flame when it is pushed slightly forward by the thumb.

A red line on the transparent base of the lighter acts as a guide to the level of the gas and the user can readily see whether it is time to buy another. The lighters will last an average smoker three months.

JUNE CROSSWORD

ACROSS

1. Device triggered by microwaves. (5,8)
8. Phenomenon affecting radio reception. (7)
10. Said of a number with a radix of three. (7)

11. Useful place for a magnetic plug. (4)
12. Type of wing used on F/A18. (5)
13. Applied to a pinball machine. (4)
16. Effect of troposphere on radio beams. (7)

17. Type of diode. (6)
20. Symbol used for wavelength. (6)
22. Accurate measuring instrument. (7)
26. Hyperbolic function. (4)
27. What EFTS can do to your account. (5)
28. Sixth letter of Greek alphabet. (4)
31. Part of automotive traffic indicator circuit. (7)
32. Type of potentiometer. (7)
33. Male-to-female D-type adaptor. (6,7)

DOWN

1. Substance used to prevent etching in PCB manufacture. (6)
2. Said of non-static characteristic. (7)
3. Twisted cable of natural fibres. (4)
4. Elevate retracted antenna. (6)
5. Doughnut-shaped rings. (4)
6. Adjust relative position. (7)
7. Used in CB radios. (8)

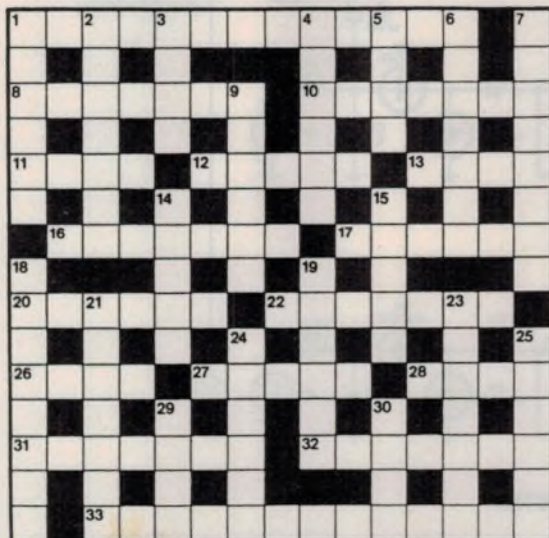

SOLUTION FOR MAY

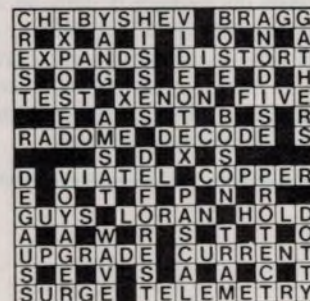

9. Inventor of maser and proponent of the laser. (6)
14. Etude. (5)
15. Possible results of severe electric shock. (5)
18. Electronic device with unknown contents. (5,3)
19. Sequential connection of components. (6)
21. Pattern substrate etching. (7)
23. End of the day. (7)
24. Unit of phase difference. (6)
25. Possible indication of a siren. (6)
29. Conductors at high frequencies exhibit a — effect. (4)
30. Type style for a printer. (4)

Monitor signal levels with this

Low-cost stereo VU meter

Here we present a general purpose stereo VU meter which features easy construction and installation. It's sensitivity can be adjusted down to 3mV so it can be driven by any audio signal source, including a low impedance dynamic microphone.

by BRANCO JUSTIC

This versatile stereo VU meter may be added to the Mini Mixer described in our May 1987 issue, or to any other item of audio equipment. The unit is based on a single IC and, in addition to functioning as a VU meter, could also be used as a simple stereo preamplifier. It is based on a low cost meter movement and all the parts are mounted on a small printed circuit board.

Mechanical meters

The use of mechanical meter movements in consumer electronic equipment is rapidly diminishing. The reason for this becomes very apparent when their prices are compared to the various electronic displays currently available. Mechanical meter movements are expensive!

But while LED and LCD displays

perform better in most applications, many people still prefer mechanical meter movements for use as VU meters. The current availability of some very inexpensive stereo meter movements on the disposal market has prompted the presentation of this project.

How it works

We will discuss the operation of the left channel only; the right channel circuitry is identical.

The input signal is first applied to variable attenuator VR1 and then AC coupled via C1 and R1 to pin 6 of IC1a. IC1a functions as a sensitivity control and allows the sensitivity of the VU meter to be adjusted to suit different levels of input voltage (from 3mV to several volts).

The required gain is produced by cascaded op amp stages IC1a and IC1b.

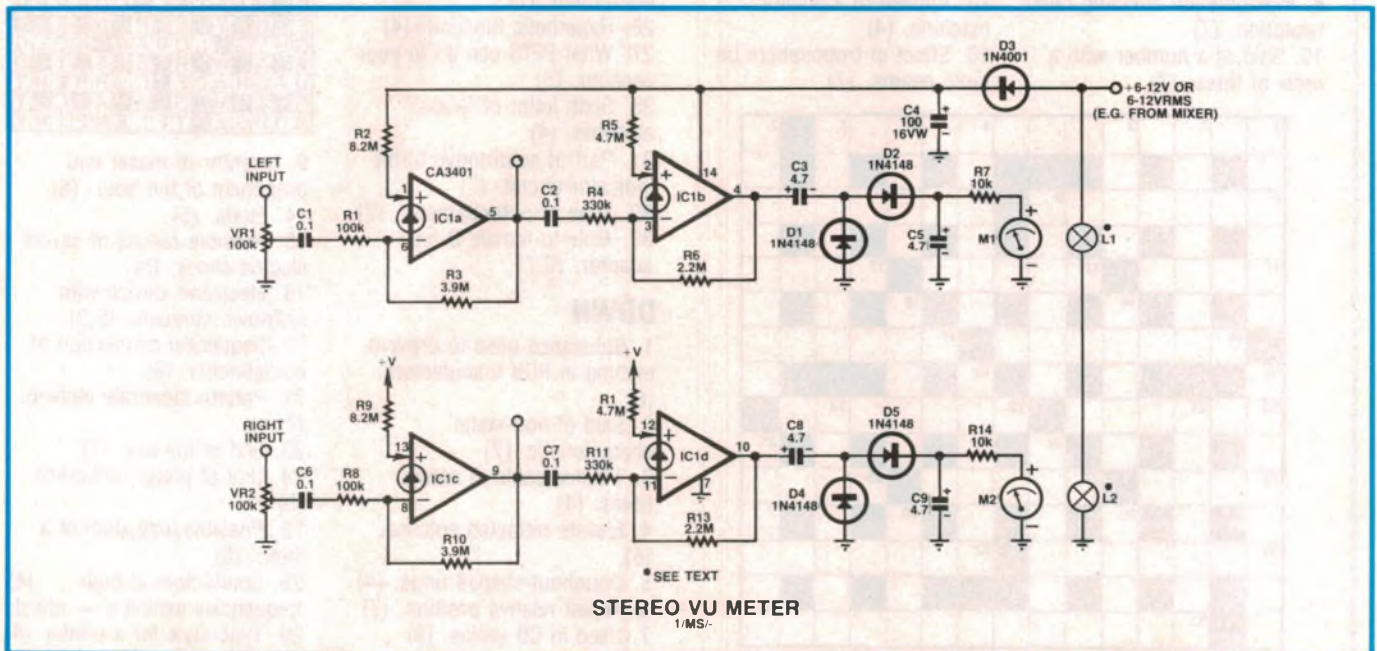

The left and right channel inputs are amplified by the op amp stages, rectified and applied to the meter movements.



The prototype was housed in a small plastic case. Backlighting for the meter scales is provided by two small 6V lamps mounted on the PCB.

These produce voltage gains of approximately -39 and -7 respectively, giving an overall gain of 273 . The amplified signal at the output of IC1b is rectified by diodes D1 and D2 and the resultant fluctuating DC current applied to the meter movement (M1).

The input supply voltage is applied via diode D3 to filter capacitor C4 and the operational amplifier IC. D3 serves to isolate the op amp circuitry from the

two lamps which draw relatively high current (approx. 200mA).

Construction

All the components, including the meter movement, are assembled onto a PCB coded 87vu5 ($96 \times 53\text{mm}$).

Start construction by assembling all the parts onto the PCB as shown in Fig.2. Watch the orientation of the integrated circuit, electrolytic capacitors and

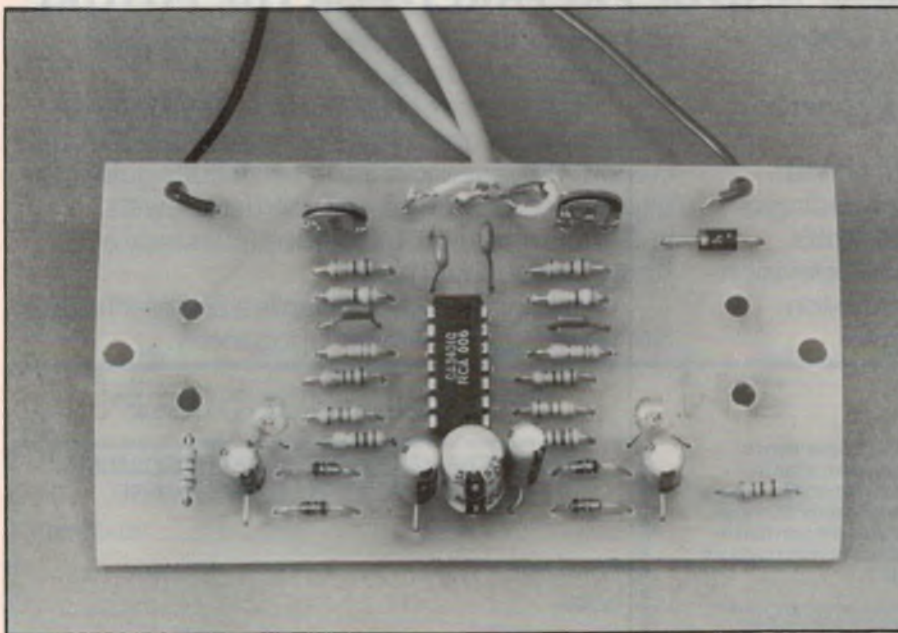

This view shows the assembled PCB, prior to installation of the meter.

MicroGram COMPUTERS

IEEE 488 INTERFACE CARD

Designed for IBM/PC/XT/AT and compatible computers.

More than just a GPIB Controller. INCLUDES GPIB Controller, Talker and Listener with software included in onboard ROM.

PLUS GPIB Bus analyser with four separate analysing modes.

PLUS 16 bit TTL digital Input/Output.

PLUS Breadboard area for custom I/O circuits.

PLUS 68 page manual.

\$590 incl. Sales Tax

Excluding digital I/O and breadboard area **\$540**

DEALER ENQUIRIES WELCOME

043 328651

17 Barry St, Bateau Bay, NSW, 2261

DON'T GET WOUND UP OVER YOUR WINDING PROBLEMS



We custom design and manufacture in volume, transformers and coils for any application.



**Selectronic
Components**
PTY. LTD.

25 Holloway Drive, Bayswater,
Vic., 3153. Telephone: (03) 762 4822.

ELECTRONICS

EXCITING JOBS WITH A FUTURE



GET YOUR TRAINING NOW AND BE PREPARED FOR THE FUTURE

If you're interested in electronics, a Stott's Home Study Course can make it even more interesting. It could lead to an exciting career in the fast growing field of electronics.

You can start with Stott's Introduction to Electronics which gives you an understanding of the basic principles, then choose from Stott's range of electronics courses. Radio and Television Servicing, Radio Receivers, Colour Television, Introduction to Micro Computers, Digital

Electronics for Technicians & Servicemen or Industrial Electronics.

Stott's electronics courses offer plenty of practical work and 'hands on' experience through custom designed kits. You'll be skilfully guided by experienced, professional instructors, with individual attention and advice. You study at home, at your own pace.

Make your move towards a brighter future. But do it now. Send the coupon today.

WITH STOTT'S YOU CAN START ANY COURSE ANY TIME OF THE YEAR AND PROGRESS AT YOUR OWN PACE.

PLEASE SEND ME FREE, AND WITHOUT OBLIGATION, FULL DETAILS OF THE FOLLOWING COURSE:

(PLEASE PRINT)

MR MRS MISS

(AGE)

ADDRESS

POSTCODE

Stott's undertake that no sales counsellor will visit you

ALA/ST 5949/EA 687



Athol H. Kelly
B Com (Hons) A.A.S.A. F.C.I.S.
PRINCIPAL

"Stott's Correspondence College is Australian in origin and ownership, with a tradition of nearly 80 years fine educational service to men and women throughout Australia."

Melbourne, 140 Flinders Street, 3000. Tel: 654 6211
Sydney, 383 George Street, 2000. Tel: 29 2445
Brisbane, 65 Mary Street, 4000. Tel: 221 3972
Adelaide, 225 Pulteney Street, 5000. Tel: 223 3700
W. Perth, 25 Richardson Street, 6005. Tel: 322 5481
Hobart, 150 Collins Street, 7000. Tel: 34 2399
New Zealand, Box 30-990, Lower Hutt. Tel: 67 6592

Stotts
CORRESPONDENCE COLLEGE
The name to trust in correspondence education

the diodes, and leave the meter movement till last.

Note that an insulated wire link (shown dotted) is run on the copper side of the PCB to connect the two 6.3V 200mA lamps in series. This arrangement consumes approximately 200mA from a 12V supply. Alternatively, the lamps could be wired in parallel in which case they would require 6V at 400mA.

If the required voltages or currents are not available, the two lamps could be omitted. Alternatively, two high intensity LEDs with a suitable series resistor could be used to backlight the VU meter.

The prototype was built into a small plastic zippy case measuring 116 x 34 x 65mm (W x D x H). For those readers who wish to follow suit, it will be necessary to cut a hole measuring 46 x 36mm in the base of the case to provide clearance for the meter. The meter-cum-PCB assembly is then secured by means of two 4mm-long screws (see photo).

PARTS LIST

- 1 PCB, code 87vu5, 96 x 53mm
- 1 stereo VU meter movement
- 2 6V 200mA lamps
- 2 5mm 100k Ω trimpots

Semiconductors

- 1 CA3401, LM3900 quad op amp
- 1 1N4001 silicon diode
- 4 1N4148 silicon diodes

Capacitors

- 4 0.1 μ F monolithics
- 4 4.7 μ F 16V electrolytics
- 1 100 μ F 16V electrolytics

Resistors (0.25W 5%)

- 2 x 8.2M Ω , 2 x 4.7M Ω , 2 x 3.9M Ω , 2 x 2.2M Ω , 2 x 330k Ω , 2 x 100k Ω , 2 x 10k Ω

Where to buy the parts: a kit of parts for this project is available for \$17.95 from Oatley Electronics, 5 Lansdowne Pde (PO Box 89), Oatley, NSW 2223. Phone: (02) 579 4985. Price includes pack and post; add \$2.60 for the plastic case. Note: copyright of the PC artwork for this project is owned by Oatley Electronics.

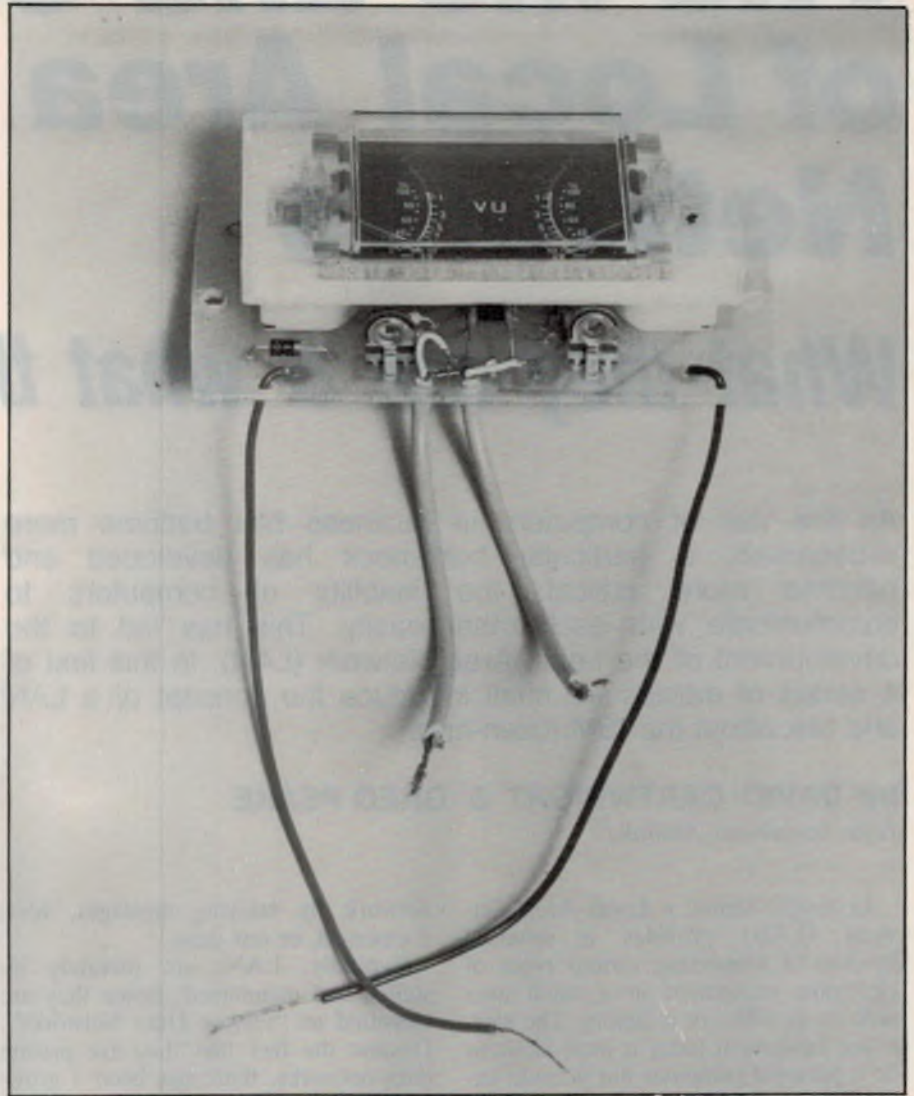

Here's what the fully assembled unit looks like with the meter in position. Note the use of shielded cable for the left and right channel signal inputs.

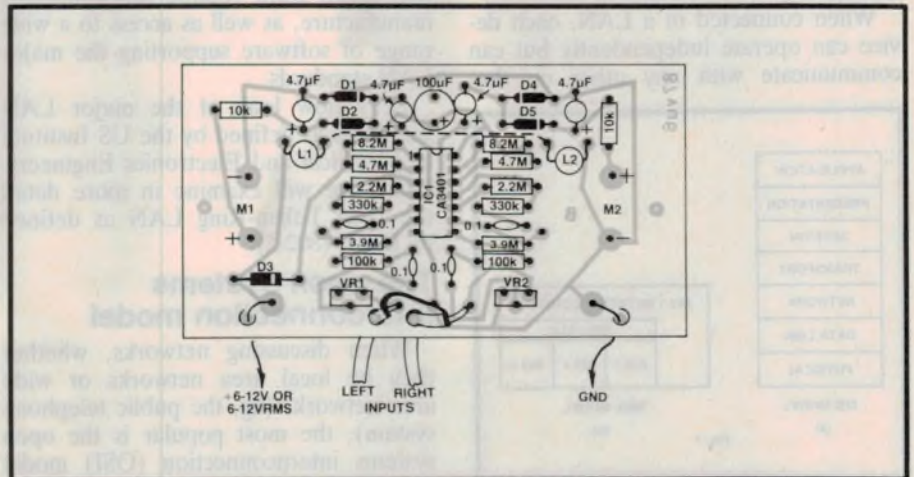

Follow this layout diagram carefully when assembling the PCB and make sure that you install the IC the right way round. The unit can be powered from any 6-12V AC or DC supply.

The ins and outs of Local Area Networks

What they are & what they do

As the use of computers in business has become more widespread, a particular bottleneck has developed and become more critical: the inability of computers to communicate with each other easily. This has led to the development of the Local Area Network (LAN). In this first of a series of articles we shall introduce the concept of a LAN and talk about the IBM token-ring.

by **DAVID CARTWRIGHT & GREG PEAKE**

Texas Instruments Australia

In simple terms, a Local Area Network (LAN) provides a standard method of connecting various types of electronic equipment in a small area such as an office or a factory. The electronic equipment today is most likely to be a personal computer but it could extend in the future to a whole range of equipment such as facsimile and photocopier machines to process controllers in a factory.

When connected in a LAN, each device can operate independently but can communicate with any other on that

network by relaying messages, files, documents, or raw data.

Typically, LANs are privately installed and maintained, hence they are classified as "Private Data Networks". Despite the fact that they are private data networks, there has been a growing trend in the past few years towards international standards. The pressures for setting standards include lower costs that result from volume semiconductor manufacture, as well as access to a wide range of software supporting the major LAN standards.

Let's now look at the major LAN standards as defined by the US Institute of Electrical and Electronics Engineers. Later, we will examine in more detail the IBM Token-Ring LAN as defined by IEEE (802.5).

The open systems interconnection model

When discussing networks, whether they be local area networks or wide area networks (eg, the public telephone system), the most popular is the open systems interconnection (OSI) model developed by the International Standards Organisation. This seven-layered model (see Fig.1(a)) is designed to stan-

dardise data communications between networking equipment.

By comparison, a conventional personal computer has three layers of software and hardware. The first layer is for applications programs which may be anything from wordprocessors to spreadsheets. The second software layer is the disk operating system (DOS) while the third layer is BIOS or Basic Input/Output System which is the operating system of the hardware and, in the case of computers like the IBM PC, is accommodated mainly in a read only memory (ROM).

Let's briefly examine the functions performed by each of the seven layers of the OSI model.

Application layer

The application layer is the same as for the conventional PC described above. It allows a user to perform functions such as data entry, file transfer and electronic mail. At the application level, a user might use a word processor, a spreadsheet such as Lotus 1-2-3, or a database such as dBase III.

For example, imagine that in an accounting department there are ten users of disk-less personal computers (PCs). These disk-less PCs are connected via a LAN to a larger PC which has a 40 megabyte hard disk.

Due to the ability of the network, users of the disk-less PCs are able to store and retrieve their data or programs via the hard disk of the larger PC. These transactions can be totally transparent to the user to the extent that, as far as he or she is concerned, the data is stored in their own PC.

For this type of transparency, the software and hardware of the lower layers of the OSI model have to effi-

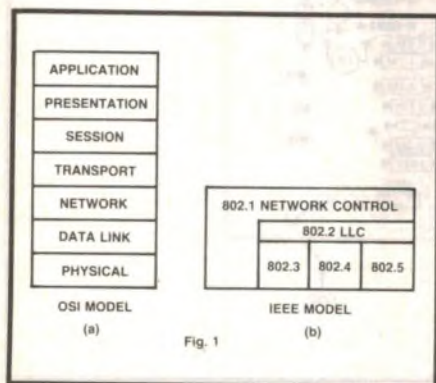

Fig. 1

This diagram shows the seven layers of the open systems interconnection (OSI) model.

ciently move the data from the disk-less PC to the PC with the hard disk. This communication path should be fast and error-free.

There is however no reason why one has to be restricted to a large PC for data and program storage. For example, a larger LAN could involve an office of 200 users using stand-alone or disk-less PCs and all served by a mainframe computer.

The advantage of a LAN in this situation is that instead of each PC having its own hard disk and data base, accessible via that machine alone, users can now share a larger common data base. This resource sharing capability is equivalent to that offered by a multi-user mini-computer or mainframe computing system. However, for the example of the accounting department, the LAN system cost can be far lower than that of a mini-computer.

Presentation & Session Layers

Let's now look briefly at the lower layers of the OSI model. The communication path can be defined in terms of different elements supported by each of the layers.

In the Presentation layer, data is transferred into a format suitable for the Session layer. For example, it might be necessary to compress or expand the data, perform encryption or decryption, or generally convert the data format to one recognised by the succeeding layers.

The Session layer then manages and synchronises the conversations between the application layers while the Transport layer multiplexes and segments the data for efficient transmission. The Transport layer also ensures that data is sent and arrives correctly at the destination.

Network, data and physical layers

Routing of communications through the network, particularly applicable when the LAN is connected to another LAN or a Wide Area Network, is provided by the Network layer. Some error correction is also performed within this layer.

The Data Link layer provides the transmission format of data and control on the network for the information to be transmitted over the physical link.

Finally, the Physical layer provides the mechanical and electrical aspects of the network.

An example of the flow of information between two users is illustrated in Fig.2.

IBM TOKEN-RING NETWORK

STAR-WIRED TOKEN PASSING RING

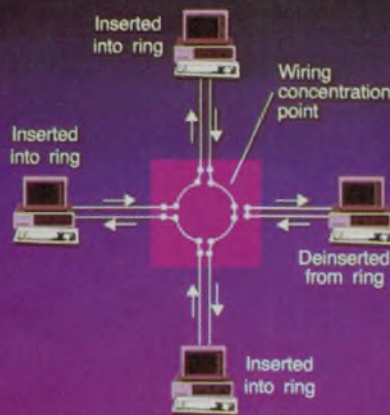

- Logical ring – physical star
- Compatible with IEEE 802.5 standard(4 Mbps)
- Information transmitted via "Token"
- Strengths
 - Collision free
 - Good under heavy loads
 - Ease of reconfiguration
 - Uses twisted pair (telephone or shielded) or fiber optic cabling

Fig.6: the IBM token-ring network depends on the transmission of a unique bit pattern before each terminal or station is given access.

TYPICAL USES OF A LOCAL AREA NETWORK

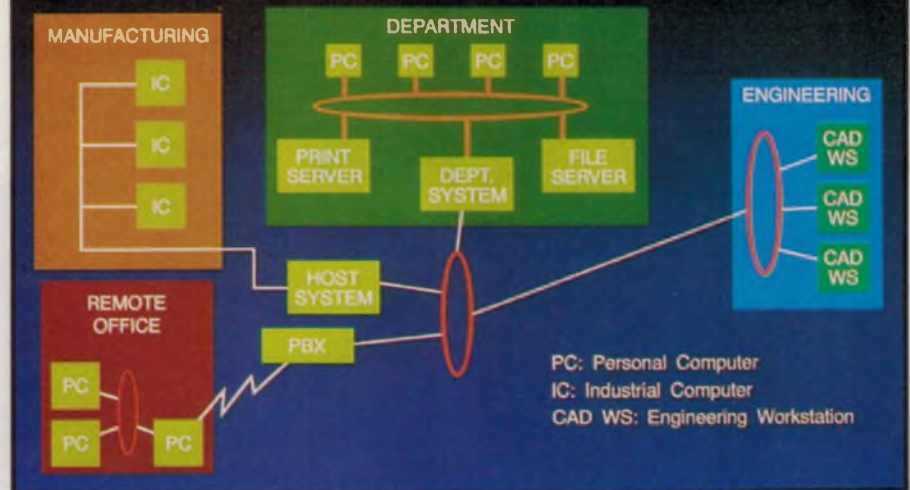

While local area networks often apply to just a few users they can embrace very large numbers of users and applications.

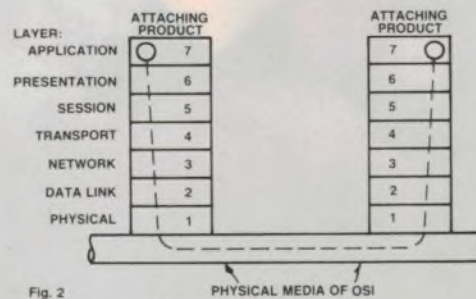

Fig. 2

Data has to be passed up and down all the layers of the network to be transmitted between users.

Design in TI's new

The new IBM® Token-Ring Network promises to become the industry standard. And if you are wondering about the best and quickest way to tie your product into this new 4-Mb/sec LAN, here's your solution: The TMS380 chip set from Texas Instruments.

TI's TMS380 is the *only* commercial chip set tested — and system-verified — by IBM. It's the silicon standard for this new high-speed office-system LAN.

And for a sure, fast entry into this exciting new market, you can begin with TI's TMS380 *Design-in Accelerator Kit*.

Q. What kinds of products can communicate through the new LAN?

A. With the TMS380 chip set, almost any.

TI's new TMS380 chip set was developed jointly with IBM. Its general-purpose system interface allows many kinds of equipment from various manufacturers to communicate through the IBM Token-Ring Network. And since this is an open network, any product in which you use the TMS380 can communicate with any other, when common languages are used.

Q. Is expensive cabling required?

A. No.

Your customers have the option of using telephone twisted pair or shielded twisted pair. And the point-to-point topology of the token ring makes it ideal for fiber optics, since the taps that are necessary with bus topologies are not required.

Q. Where does TI's TMS380 chip set fit in?

A. It's the heart of your LAN adapter card or subsystem.

The TMS380 chip set is a complete solution for the physical interface and media-access control. Its integrated LAN-adapter architecture provides for efficient, transparent handling of the IEEE 802.5 protocols. TI's TMS380 in your product will give your customers freedom to choose the cabling system that best suits their needs. And the flexibility to interface with any of the popular logical-link-control and higher-layer protocols.

◀ Everything you need to begin designing your own IBM Token-Ring Network LAN adapter is included in your TI *Design-in Accelerator Kit*: Three TMS380 chip sets, comprehensive literature, and debug software.

®Registered trademark of International Business Machines Corp.

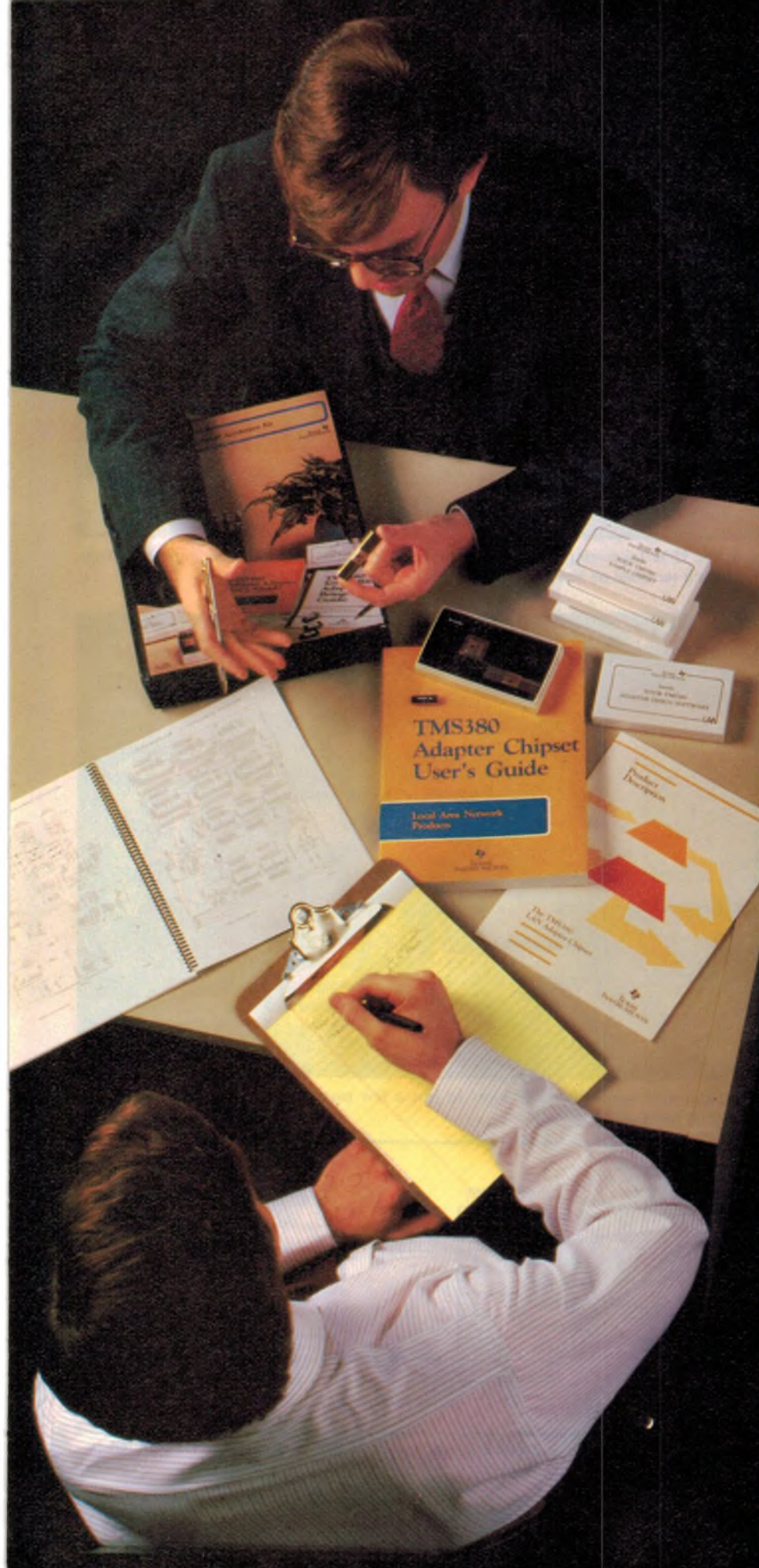

IBM compatibility with token-ring-LAN chip set.

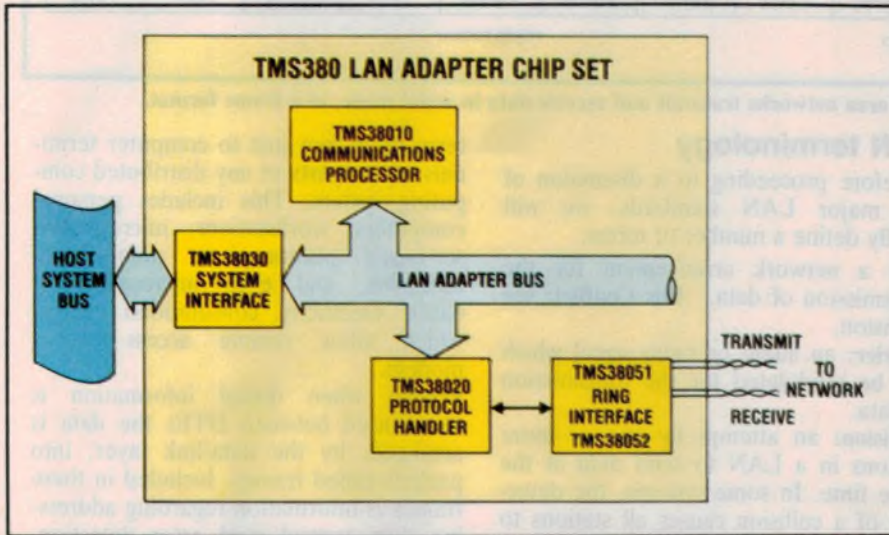

Five TMS380 chips form the heart of your LAN adapter. The TMS38030 automatically manages the interface between system memory and the adapter. The TMS38010 processes and buffers data. The TMS38020 contains RAS and LAN-management software and handles data in accordance with IEEE 802.5 protocols. And the TMS38051 and TMS38052 monitor cabling integrity, control network insertion, and perform clocking and signal conditioning.

Q. What about network management?

A. Every service your system needs is built in.

TI's new TMS380 chip set includes "self-healing" features that ensure the reliability, availability, and serviceability (RAS) of the network. And only the TMS380 chip set has them.

Among these special features are fault isolation of cable-system failures, error reporting, self-test diagnostics, and LAN-management services. So you're relieved of the risk, time, and expense of developing custom hardware and software for these essential functions.

Q. Can it grow with my needs and my customers'?

A. Yes.

On-chip RAS and LAN-management software make TI's TMS380 chip set completely compatible with the IBM Token-Ring LAN and give it a stable foundation to meet the need for future network expansion. As higher performance standards develop, the TMS380 chip set will accommodate them.

Q. What's this about an Accelerator Kit?

A. It's your head start to IBM token-ring compatibility.

TI's Design-in Accelerator Kit will give you a head start on designing IBM Token-

Ring Network compatibility into your products. It includes three chip sets, the TMS380 User's Guide, and the Token Ring Adapter Bring-Up Guide with debug software.

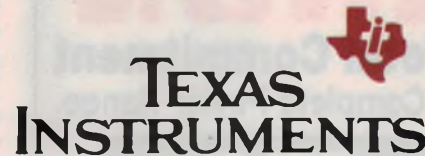

Creating useful products and services for you.

**TEXAS INSTRUMENTS
FIELD SALES OFFICES**

Melbourne: (03) 267-4677
Sydney: (02) 887-1122

**TEXAS INSTRUMENTS
DISTRIBUTORS**

ADELAIDE:

EC & E: (08) 232-0001
VSI: (08) 267-4848

BRISBANE:

Rifa: (07) 832-3700
VSI: (07) 52-5022

MELBOURNE:

Rifa: (03) 480-1211
VSI: (03) 543-6445

PERTH:

VSI: (09) 328-8499

SYDNEY:

Rifa: (02) 858-5966
VSI: (02) 439-8622

To: Texas Instruments Australia
6 Talavera Rd.,
North Ryde 2113

- Please rush me a TMS380 Data Package.
- Place my name on the TMS380 Mail List.

Company

Name

Address

..... Suburb State

Postcode Ph: ()

IEEE LAN standards

Currently there are three major LAN standards defined by the IEEE, each of which have different topologies and accessing procedures. These are as follows:

- IEEE 802.3 — A bus topology implementing Carrier Sense Multiple Access with Collision Detection (CSMA/CD).
- IEEE 802.4 — Bus topology using a token-passing access method.
- IEEE 802.5 — Star-wired ring topology using a token-passing access method.

Fig.1(b) illustrates how these three LAN standards compare with the OSI model of Fig.1(a).

As will be seen later, these standards only relate to the Physical layer and the Medium Access Control (MAC) which is used in the Data Link layer. The MAC defines the method of access used by the particular LAN standard. The three networks all use the IEEE 802.2 standard for the Logical Link Control (LLC) level of the Data link layer.

And while it is not obvious from Fig. 3, it is possible to run the same upper layer protocol software over the three different LAN topologies. We will look at an example of this in the next article.

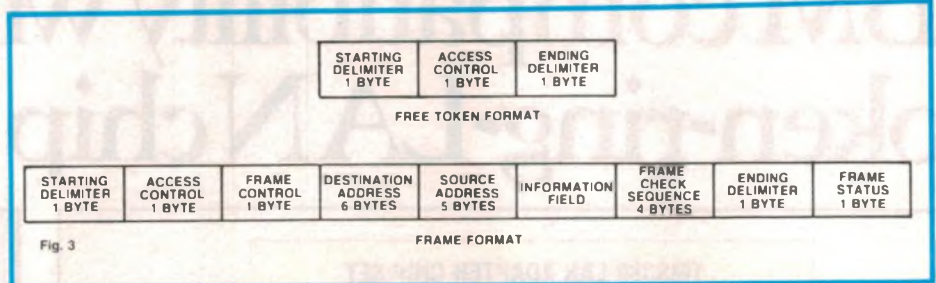

Local area networks transmit and receive data in serial mode, in a frame format.

LAN terminology

Before proceeding to a discussion of the major LAN standards, we will briefly define a number of terms.

Bus: a network arrangement for the transmission of data. **Bus Conflict:** see Collision.

Carrier: an audio or radio signal which can be modulated for the transmission of data.

Collision: an attempt by one or more stations in a LAN to send data at the same time. In some systems, the detection of a collision causes all stations to stop transmissions.

CSMA/CD: Carrier sense multiple access with collision detection; a method of regulating LAN transmissions to avoid collisions.

DTE (Data Terminal Equipment): this

term refers not just to computer terminals but to parts of any distributed computing system. This includes personal computers, workstations, microprocessor-based photocopiers, point-of-sale terminals, and even microprocessor-based electricity consumption meters which allow remote access via a modem.

Frame: when digital information is transmitted between DTEs the data is arranged, by the data-link layer, into packets called frames. Included in these frames is information regarding addressing, bus control, and error detection. An example of the frame formats used in the Token-Ring LAN is given in Fig.3.

Node: a connection or switching point in a LAN.

Protocol: a set of rules ensuring that information exchanged within a network can be received and interpreted correctly by both the transmitting DTE and the receiving DTE.

Token: a unique bit pattern used to tell stations in a LAN when they can transmit data.

Topology: the arrangement of transmission paths in a LAN. The most common are rings (where data is presented to each station in turn), stars (where data passes through a central node), and bus (where data is presented to all stations).

IEEE 802.3: CSMA/CD bus topology

Currently the most popular network of this type is Ethernet which was a joint development of Digital Equipment Corporation (DEC), Intel and Xerox. Ethernet has a theoretical maximum speed of 10 megabits per second (Mbps), although due to bus conflicts actual performance is generally between 1 and 3 Mbps.

(For a further discussion on LAN performances we recommend an article by AT&T's Bell Labs researcher Bart Stuck. His article, "Calculating the Maximum Mean Data Rate in Local Area Networks" appeared in the IEEE publication "Computer", May 1983 edi-

SEMIKRON

innovation + service = Total Commitment
Thyristors, Transistors, Diodes. Complete Power Range.



Stud, Transi or Discretely. We Can Turn You On.
Try Us.

SEMIKRON: P.O. Box 182, Springvale, 3171 (03) 561 3044



TEXAS
INSTRUMENTS

THIS

LOCAL AREA NETWORK DEVELOPMENT SYSTEM

could be yours!!!

WIN
\$10,000
TOTAL VALUE

**GRAND
PRIZE!**

TOTAL VALUE
\$10,000



Includes: Texas Instruments Professional Computer

- TMS 380 LDK Design -in Accelerator Kit with complete chip set
- for token ring network
- TMD5 PCF LAN interface card
- TND 380 TWC Test wiring concentrator with debug software

ENTRIES CLOSE 15th SEPTEMBER, 1987

**ENTER
NOW!**

HOW TO WIN

Simply explain in less than 500 words why you deserve to win this Local Area Network Development System.

Entries will be judged on originality and presentation.

Entries should include details of at least one LAN application for which the system will be used.

Send your entry to
The Editor,
Electronics Australia,
PO Box 227,
Waterloo 2017

The winner will be notified by mail and the result announced in the November 1987 issue of *Electronics Australia*

tion. Most university libraries would have a copy of this publication).

In a typical Ethernet network, all DTE's are connected to a single bus — see Fig.4(a). The bus is accessed by means of "tapping" circuitry which monitors the bus status as well as enabling data transfer to and from the bus. The "tapping" circuitry or Medium Access (MA) unit contains a transceiver unit for data transfer to and from the bus, and a Medium Access Control (MAC) unit for frame handling and error detection — see Fig.4(b).

Before transmitting a frame, the MAC unit monitors the bus to determine if a carrier signal is present. If another frame is already present on the bus, the DTE (or DTEs) trying to send a frame will defer transmission for a certain time interval, after which it attempts again. Once access is gained to the bus, the frame is sent.

While sending a frame, the bus signals are constantly monitored for collision detection. A frame is not regarded as fully despatched until a Frame Check Sequence (FCS) has been transmitted.

However, because of propagation delays within the network, collisions from other transmitting DTEs can still occur. When a collision is detected, a "jam" signal is sent by the originating DTE to reinforce the collision to all other DTEs on the bus. After a short randomly selected time interval, the

transmission of the original frame is attempted again. In the event of continuous collisions a limit is set for the maximum number of re-transmissions of a single frame.

Any frame that is transmitted is received by all MA units connected to the bus, but not necessarily all DTEs. When the MA unit receives a frame, following clock synchronisation, the destination address is checked to determine if frame processing should continue. If so, then error checks using the Frame Check Sequence (FCS) and the frame length indicator are made. If any of these tests fail, the frame is discarded. Assuming a valid frame, the frame is stripped and the information field passed to the DTE.

IEEE 802.4: Token-passing bus topology

The MAP (Manufacturing Automated Protocol) standard is the most popular system using a token-passing bus topology. The history of MAP revolves around General Motors, who have specified MAP for all their factory networking equipment, such as robots and programmable controllers.

Under error-free conditions, the token-passing bus is similar to the token-ring network, except that the bus method "broadcasts" (see Fig.5(a)) while the ring method is "sequential". With the token-passing method, the

transmission of data onto the bus can only be accomplished when a DTE is in possession of the token. In passing the token to the next DTE (successor), the originating DTE listens to the bus to see if the successor is active.

If active, the successor sends a valid frame, which may be the token or an information frame, to its successor (see Fig.5(b)). If no frame is heard in a specified time slot, the token is sent again. When a frame sent by the successor is corrupted, then the token sent is assumed to have been corrupted and is sent again. A lack of response from the successor after a second token is sent causes the network to reconfigure and a new successor is established.

The token-passing bus has a priority system similar to the token-ring whereby a DTE with high priority frames can send a specified number of frames before frames with lower priority can be sent. If there is still allocated time available after all high priority frames have been transmitted, lower priority frames can be sent. The token is then passed on to another DTE.

IEEE 802.5: Token-passing ring topology

The most popular implementation of the 802.5 token-passing ring topology is that used by IBM (International Business Machines Corporation). This network is generally referred to as the IBM Token-Ring Network. Research in a

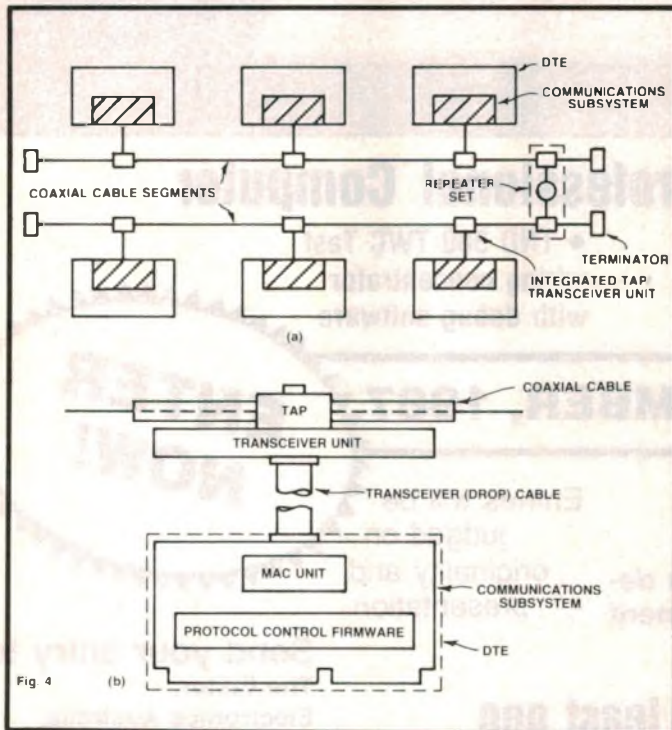

The Ethernet LAN uses taps which monitor the status of the network.

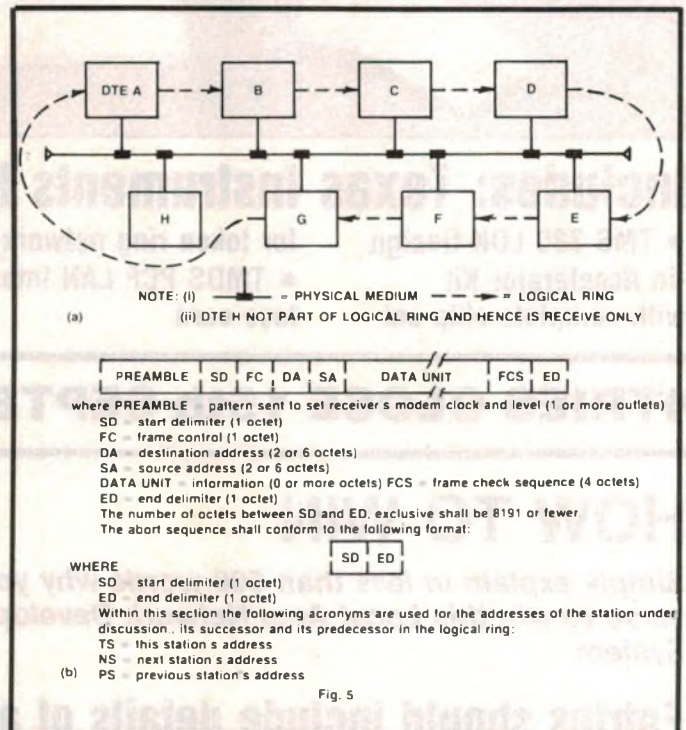

Token-passing bus topology is similar to the token ring.

ring LAN began at IBM's Zurich Research Laboratory in 1979.

In 1982 IBM and Texas Instruments signed an agreement whereby Texas Instruments would develop a chip-set compatible with IBM's token-ring LAN standard. On October 15, 1985 IBM announced its token-ring LAN while on the same day Texas Instruments announced availability of its TMS380 chip-set which implements the IBM standard.

Since October 1985 IBM has announced a variety of token-ring LAN products which enable LAN links to DTE's ranging from PCs to mainframes. In addition to IBM, essentially all major computer and LAN manufacturers are committed to developing products for the token-ring LAN. Clearly, the IBM token-ring LAN looks set to become the industry standard for office environment.

In the second of these articles we will examine software for the network, essentially layers three to seven of the OSI model, while in the final article we will study the bottom two layers. For the moment, we will provide an overview of the topology and compare the Token-Ring LAN with Ethernet and MAP.

IBM token-ring topology

The token-ring network resembles a star-wired ring (see Fig.6). Each DTE, or "station" as they are generally called in IBM literature, is connected via switching relays to the ring.

The relays are located in a central unit called a Wiring Concentrator to which all DTE's on the network are connected. If a fault develops in the Token-Ring LAN, either with a DTE or the cable between a DTE and the Wiring Concentrator, that DTE is automatically disconnected with the rest being able to continue normal operation.

In Ethernet by comparison, a fault occurring in a cable repeater can seriously handicap the network. This can be critical in an office environment such as a bank, insurance company, or airline where hundreds of users may be depending on a LAN for their data processing needs.

On the Token-Ring LAN, data and control is transferred using two different frame formats, as illustrated in Fig.3.

There are eight levels of priorities which affect the ability of a DTE to transmit its frames. For example, once a DTE receives the token it checks the current priority level against the priority

level of its frames. If the priority is equal or less than that of the frames, the DTE can readily transmit. If the priority level is higher than the frames awaiting transmission, the token is passed on.

Before being passed, a priority request can be initiated in the token if the existing priority level is lower than the required level. Assuming no higher level requests are made, the requesting DTE can transmit its frames on the next possession of the token. The number of frames that can be transmitted by a DTE depends on the maximum time allowed for holding the token and the priority of the frames to be transmitted.

Having a priority system offers advantages for real time applications since it allows a set of frames to be sent concurrently by setting a high priority.

By comparison, Ethernet's bus access is probabilistic (it cannot be assured). Thus, real time applications such as voice are not possible. As the speed of the token-ring LAN standard increases, voice and data integration could become more prominent.

A summary of the various features of Ethernet, MAP and the IBM token-ring is outlined in Table 1.

To be continued.

Do you want to... MAKE MORE MONEY?

... of course, we all do ...
then you need to work *smarter* not *harder*.

Specialised training will enable you to get a better job with more money so you can further enjoy your leisure time and do the things you want to do.

No need to take time from your family or hobbies! No need to change your way of life! Simply by spending an hour or so a day with an ICS course you can be on your way to a great new future.

Experts guide you every step of the way!

We show you what to do and how to do it - explain it all in easy-to-understand language - plus we provide all the necessary books, materials, tools and equipment, at no additional cost.

Don't let this opportunity pass you by!

Take a moment now to review the variety of courses available. The choice is yours - an opportunity to get the kind of training you need to further your career, expand on your hobby or start a whole new way of life. All you have to do is complete and mail the coupon, you are under no obligation, so what have you got to lose - absolutely nothing - so do it - TODAY!

TRAIN AT HOME IN SPARE TIME NO PREVIOUS EXPERIENCE NECESSARY



ICS
Since 1890

International Correspondence Schools
398 Pacific Highway, Lane Cove, N.S.W. 2066. 2124
45 Courtenay Place, Wellington 1, New Zealand.

TICK ONE BOX ONLY

- | | | |
|-------------------------------------------------|----------------------------------------------------|-----------------------------------------------------------|
| <input type="checkbox"/> Computer Programming | <input type="checkbox"/> Small Business Management | <input type="checkbox"/> Carpentry & Joinery |
| <input type="checkbox"/> Personal Computing | <input type="checkbox"/> Marketing Management | <input type="checkbox"/> Commercial Art |
| <input type="checkbox"/> Electronics Technician | <input type="checkbox"/> Public Relations | <input type="checkbox"/> Dressmaking & Pattern Cutting |
| <input type="checkbox"/> Fitness & Nutrition | <input type="checkbox"/> Bookkeeping | <input type="checkbox"/> Pharmacy Assistant |
| <input type="checkbox"/> Interior Design | <input type="checkbox"/> Auto Mechanics | <input type="checkbox"/> Secretarial Practice |
| <input type="checkbox"/> Hotel/Motel Management | <input type="checkbox"/> Diesel Mechanics | <input type="checkbox"/> Refrigeration & Air Conditioning |
| | <input type="checkbox"/> Motor Cycle Maintenance | <input type="checkbox"/> Practical Photography |

Mr/Mrs/Ms _____ Age _____
(Please print clearly)
Address _____

_____ P/code _____

☎ (all hours) Sydney: 427 2700 or Phone (Home) _____
Austwide (TOLL FREE): (008) 22 6903 (Optional) 2214

Part 2: how to use the simple Op Amp Tester

Last month we described the circuit and construction of the Op Amp Tester. In this article we detail the various parameters which can be tested and show how to check out typical op amps.

by JOHN CLARKE

Although there are many parameters that the Op Amp Tester can measure, the basic technique for each measurement relies upon only a few simple operations. These involve adjusting the potentiometers, taking readings from a multimeter and then using a calculator to find the result.

Last month we gave a list of specifications for some typical op amps and most of those parameters mentioned can be measured by the Op Amp tester. Before describing how to do each test, let us define the relevant parameters.

Definition of terms

• **Input Offset Voltage** is the voltage which must be applied between the inverting and non-inverting inputs of an

op amp through two equal resistances to give a zero output voltage.

An ideal op amp would not require any input offset voltage for a zero output and most op amps have a typical offset of only a few millivolts. Many op amps provide terminals for offset adjustment using a trim potentiometer. This adjustment can reduce the offset to very close to zero.

• **Input Bias Current** is the average of the currents to the inverting and non-inverting inputs of an amplifier.

The current into each input is measured, added together and divided by two. Some op amps such as those with Fet input stages have an extremely low input current ranging from a few picoamps up to a few nanoamps. An input current of a few picoamps ap-

proaches the ideal.

• **Input Offset Current** is the difference between the two currents when the output is zero.

This is due to the inevitable differences between the differential input transistors in the first stage of the op amp.

• **Input Resistance** is defined as the change in input voltage versus the change in input current, with one input grounded. This is the differential mode input impedance.

• **Large Signal Voltage Gain** is the ratio of the change in output voltage for a change in input voltage.

• **Common Mode Rejection Ratio** is the ratio of the common mode input (both inputs together) voltage range to the change in input offset voltage over this range. It is equal to the gain with a signal applied to only one input, divided by the gain with the signal applied to both inputs. It is normally expressed in decibels.

• **Power Supply Rejection Ratio** is the ratio of the change in input offset voltage to the change in power supply voltage. It can be measured by noting the change in output voltage for a given change in supply voltage and comparing the result with the equivalent change in input offset voltage.

• **Supply Current** is the current required from the power supply to operate the amplifier, with no load connected to the output.

• **Common Mode Input Voltage Range** is the range of input voltage with both inputs together over which the amplifier operates. Depending on the manufacturer, the op amp may or may not operate within specifications for the whole common mode input range.

Exceeding the common mode input range may cause the op amp to "latch up" (ie, the output may go high or low), or may cause damage to the device.

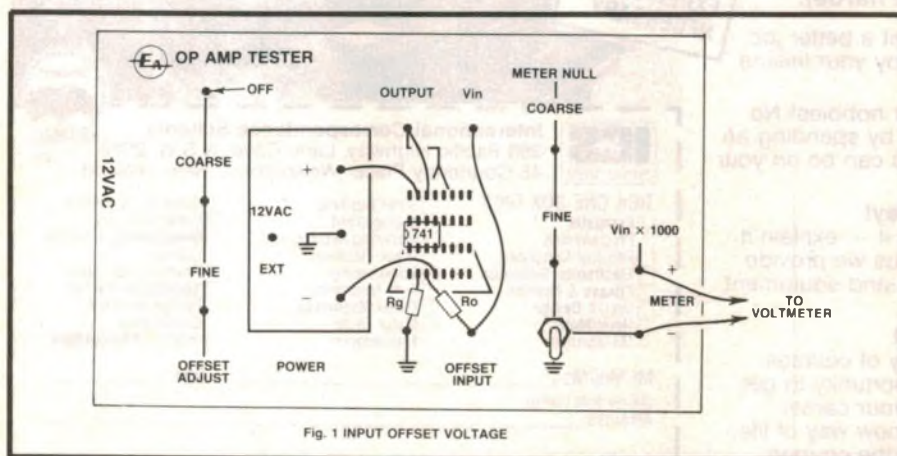
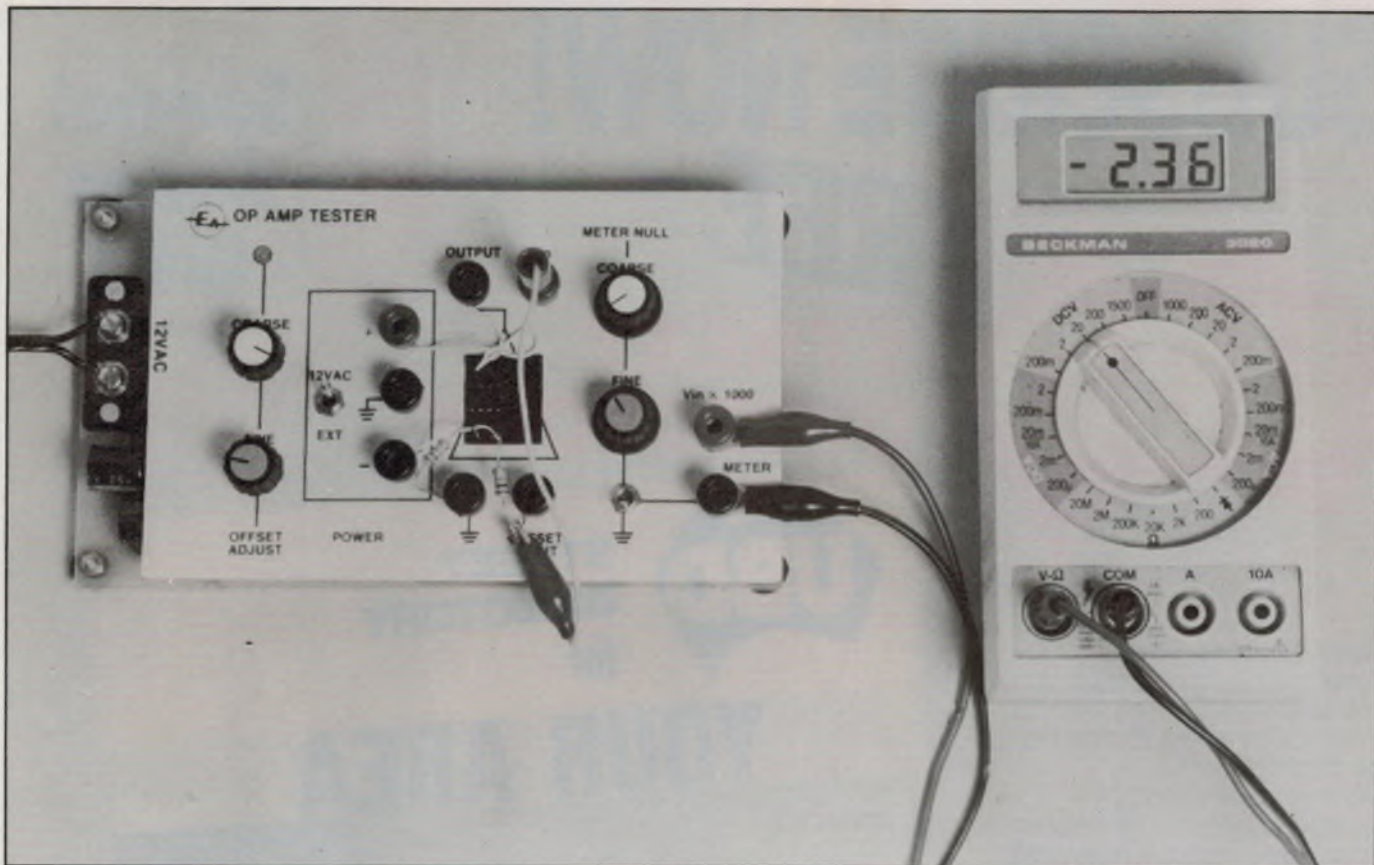

Fig.1: use this setup to measure the input offset voltage



This photograph shows a typical test setup. The op amp is plugged into the socket and wires used to make the circuit connections.

- **Output Voltage Swing** is the peak-to-peak voltage swing which the op amp can deliver without clipping.
- **Bandwidth** is the frequency where the open-loop voltage gain (ie, without any applied negative feedback) is reduced by 3dB from the DC gain value.
- **Unity Gain Bandwidth** is the frequency at which the open-loop gain of the amplifier is reduced to one. This can be measured using a frequency generator and an oscilloscope.

Measurement

Any op amp which can be powered from a $\pm 12V$ supply can be safely tested in the Op Amp Tester. For op amps which are rated for higher supply voltages, (eg, $\pm 15V$), it is possible to power the tester using an external supply. This supply voltage is connected to the positive, negative and ground power terminals on the Op Amp Tester. The power switch is set to the EXT position for external supply use and in the 12VAC position when powering from a plugpack.

Insert the op amp package into the middle row of the test socket. The outer row of the sockets is used for connecting between the tester terminals and the op amp pins using single strand insulated copper wire. Fig.2 on page 55 of

last month's issue shows the pin-outs for some single, dual and quad op amps. Use this information when connecting up the op amp.

Figs.1 to 5 show typical test set-ups for an 8-pin Minidip version of a 741 op amp. The accompanying photo portrays the test set-up of Fig.1.

Power supply connections should be made to the op amp from the + and - power terminals of the tester. Single supply op amps such as the CA3130 which can only be operated up to 16V total should be powered by connecting ground to the negative supply pin of the op amp and the plus power terminal to the positive supply pin of the op amp.

Only one op amp can be tested at a time so that a quad or dual packaged op amp will require testing of each op amp separately.

Initially, connect the inverting or non-inverting terminal of the op amp to the ground terminal via a $10k\Omega$ resistor. We will call this resistor R_g . The offset terminal connects via a $10k\Omega$ resistor, called R_o , to the remaining input terminal of the op amp. Connect the output of the op amp to the output terminal of the tester and finally connect a multimeter across the meter terminals of the tester.

Measurement of the op amp DC pa-

rameters involves using of the $V_{in} \times 1000$ amplifier, watching the output indicator LED, adjusting the offset and null controls, and measuring voltages at the meter terminals, op amp output terminal and supply rails. Note that if an analog meter is used, the connecting leads may need to be reversed depending upon the polarity of the output voltage. A digital multimeter will not require reversal due to its automatic polarity indication.

As its name suggests, the $\times 1000$ amplifier multiplies voltages measured at the V_{in} input terminal by 1000. This is very useful for obtaining greater resolution from your multimeter and also for minimising loading effects (particularly at the input terminals) during measurement.

Let's now detail how some of the more important op amp parameters can be measured.

Input Offset Voltage

To measure Input Offset Voltage, connect the V_{in} terminal to the Offset Input terminal and set the meter null switch to the ground position. Set the Offset Adjust fine control to the centre of its rotation and apply power (see Fig.1).

At this stage, the output indicator

SUBSCRIBE NOW!



FREE STREET DIRECTORY

**Special
Bonus
Gift!**

Need another Street Directory — to replace your old out-of-date edition? to have as an extra in the house or second car?

Here is your chance! Simply subscribe or renew your subscription now and receive FREE the current edition of the most up-to-date, widely used Street Directory in Australia.

UBD Street Directories — used by Ambulance, Police, Fire Brigade, MWS & DB, Dept. of Main Roads, Taxi Co-ops, Couriers, Government Agencies and Fleet Owners.

CAPITAL CITY OR COUNTRY DIRECTORY

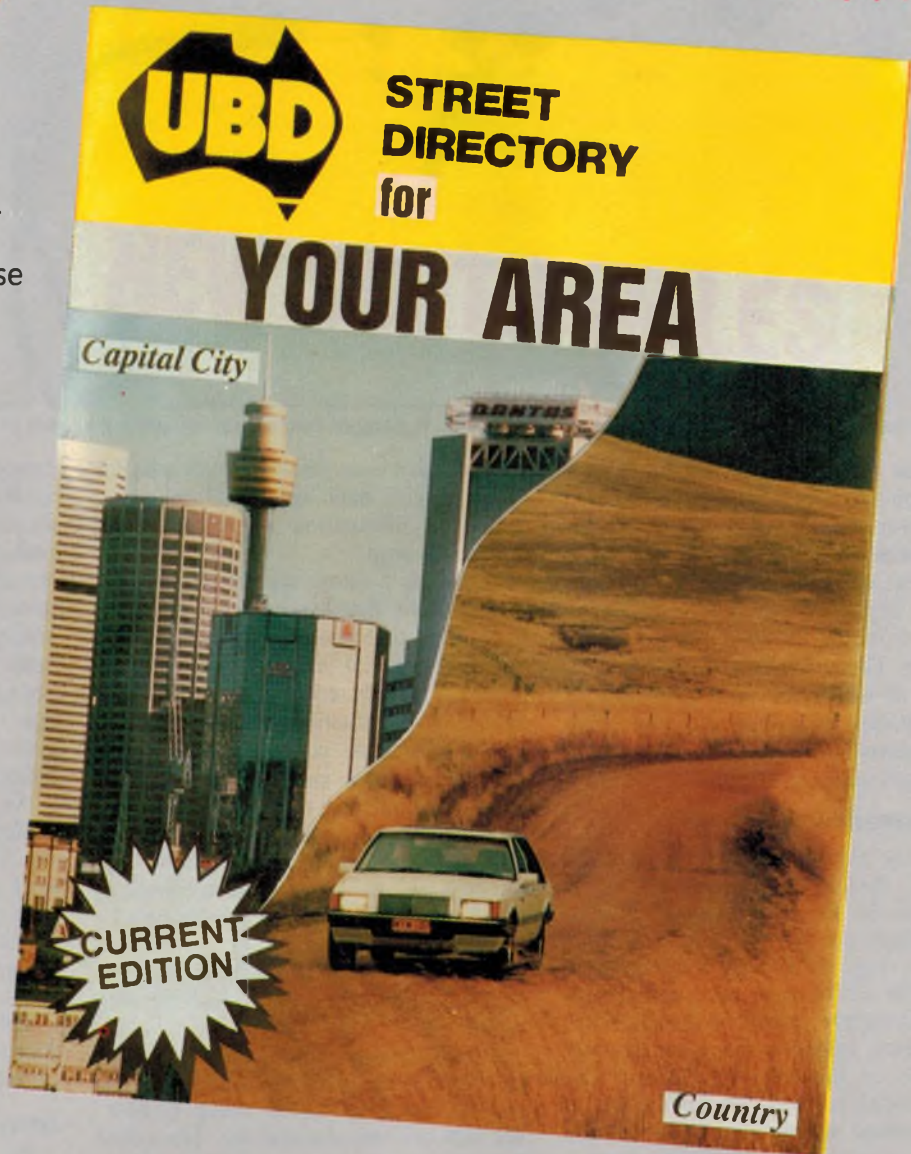

See Subscription Coupon

If coupon/card missing, please phone (02) 693-6666 and ask for the Subscription Department.

NT: will receive Touring Guide and Local Map.
SA: will receive an Adelaide Street Directory and State Touring Guide.
TAS: will receive State Directory
NSW, VIC, QLD, WA: Indicate Capital City or State Directory

Note: Free gift is forwarded under separate cover. Please allow 3-4 weeks.

Offer closes last mail June 30, 1987.

LED should be showing red (the op amp output is low) or Green (the op amp output is high). Adjust the Offset Adjust coarse control until it is set very close to the point where the output LED turns off. Now adjust the fine control until the output LED goes out.

The adjustment of the fine offset adjust control may be very critical. In particular it is difficult to set very high gain op amps to zero output but quite easy with lower gain types such as the TL061.

In practice, it is only necessary to set the offset control to the switch-over point where the output swings from one level to the another to obtain a reliable result. Putting it another way, since the open-loop gain of op amps is so high, it is only necessary to adjust the input offset voltage to bring the op amp output voltage to approximately zero. Making it spot-on zero does little to increase the overall accuracy of the measurement.

The voltage measured by the multimeter is the input offset voltage multiplied by 1000. For example, supposing we get a reading of 2.18V on the multimeter. Since this has been multiplied by 1000 then the actual input offset voltage is 2.18mV.

Note that readings above about 7.7V at the "Vin x 1000" terminal" are not accurate since the output of op amp IC2 will not swing much beyond this. In cases like these, the measurement will need to be made directly from the offset input rather than through the x1000 meter circuit.

Input Bias Current

Input Bias Current for each input is calculated by measuring the voltage across each of the 10kΩ input resistors to the op amp.

Fig. 2. shows the connections to measure the input bias current for both inputs. The procedure is to first measure the current at the Rg resistor input — connect Vin to the op amp side of the Rg resistor and ensure that the Meter Null switch is down. Make sure that the offset controls are set so that the op amp output is close to zero and make a note of the voltage measured on the meter. The current is simply the voltage at the op amp input (voltage at the meter/1000) divided by 10kΩ.

For our example 741 op amp we measured 384mV on the meter which gives an actual voltage of 384 microvolts across the 10kΩ resistor. The input current is therefore 38.4 nanoamps.

Next, measurements are made to find the voltage across Ro. The input offset current is then calculated as before.

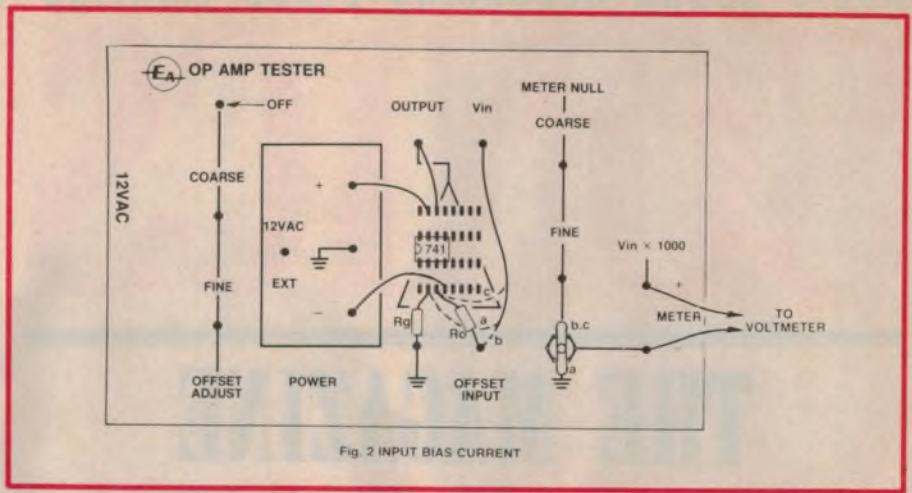

Fig.2: this diagram shows how to check the input bias current.

Firstly, the Meter Null is placed in the up position and Vin is connected to the Offset input (dotted line "b"). Make sure that the Offset Adjustment is set so that the op amp output is close to zero. Now adjust the coarse and fine controls of the meter null for a zero reading on the meter.

This nulls out the offset voltage so that a direct reading at the op amp side of Ro can be the basis of current calculation.

Connect Vin to the op amp side of Ro (dotted line "c") and read the voltage indicated on meter.

We measured 440mV across Ro for our sample 741 op amp which corresponds to 440μV across the 10kΩ resistor. Thus the current is 44.0nA.

The input bias current specification is then half the sum of the two bias currents for each op amp input.

For our test op amp the input bias current is $(38.4\text{nA} + 44.0\text{nA})/2 = 41.2\text{nA}$.

Note that the measurement is only accurate for op amps with bias currents

greater than about 10nA since the loading of the Vin terminal can affect the current flowing when connected directly at the op amp inputs.

Input Offset Current

Input Offset Current is the difference between the input current at the inverting input and input current at the non-inverting input.

For our test op amp, the Input Offset Current is $44.0\text{nA} - 38.4\text{nA} = 5.6\text{nA}$.

Large Signal Voltage Gain

Large Signal Voltage Gain is calculated by measuring the offset voltage required to set the output of the test op amp to about 2V less than the positive supply voltage. The reason for only setting the output within 2V of the supply is to ensure that the output of the op amp is not clipping.

The measurement is easily done using two meters, although a single one can be used by quickly changing the meter probes as shown in Fig.3.

Connect the op amp as shown in Fig.3 with the meter connected to the

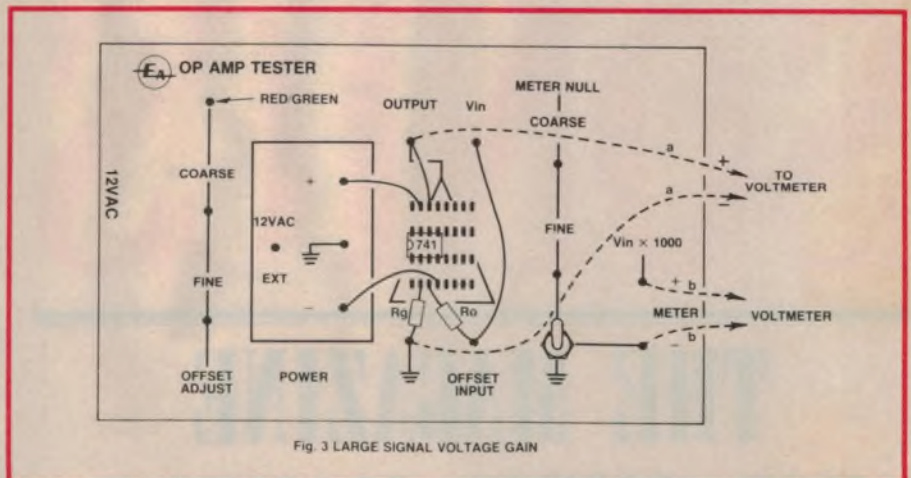

Fig.3: the large signal voltage gain can be measured using the setup shown here.

MUSIC SOUND RECORDING STAGE LIGHTING

SONICS

THE MAGAZINE
FOR MUSIC-MAKERS

Musicians
Home Studio Fanatics
Road Crews
Recording Engineers
Lighting People
Managers
Promoters
Producers

MUSIC SOUND RECORDING STAGE LIGHTING

SONICS

THE MAGAZINE
FOR MUSIC-MAKERS

MUSIC SOUND RECORDING STAGE LIGHTING

SONICS

THE MAGAZINE
FOR MUSIC-MAKERS

Taking
you behind
the scenes of the
exciting world of
today's music
making.

The
latest
instruments,
the latest
techniques,
reviews,
news...

Sonics is published by
the Federal Publishing Company
(02)693-6666

op amp output (dotted lines "a"). Adjust the Offset controls so that the op amp swings positive to some convenient voltage at least 2V below the positive supply rail. We set the output to +6V on our test 741.

Now transfer the meter to measure the offset voltage by connecting it across the "Vin x 1000" output terminals (dotted lines "b"). Make sure that the meter null switch is up. Adjust the meter null knobs for a zero reading.

Now measure the offset voltage. We measured 15mV on the meter which corresponds to $15\text{mV}/1000 = 15\mu\text{V}$ for the op amp.

The large signal voltage gain is then calculated by dividing the op amp voltage output swing by the measured offset voltage. For our 741 op amp example, dividing 6V by 0.015 gives a result of 400V/mV.

Power Supply Rejection Ratio

The PSRR is measured using an external power supply which can be adjusted from $\pm 12\text{V}$ to $\pm 15\text{V}$ or greater. The setup is shown in Fig.4.

Set the power supply to $\pm 15\text{V}$ and set the offset controls for a zero op amp output with the LED off. Now set the meter null controls so the meter reads 0V.

Adjust the power supply to $\pm 12\text{V}$ and adjust the offset controls for a zero output on the op amp. Note the reading shown on the meter.

The change in offset voltage in microvolts (which is simply the offset reading just taken) divided by the change in power supply volts (6V) gives the PSRR in $\mu\text{V}/\text{V}$.

For our test 741 op amp, we obtained 25mV on the meter or $25\mu\text{V}$ for the change in offset voltage. Thus the PSRR is $25/6$ or $4\mu\text{V}/\text{V}$.

Supply Current

The supply current is simply measured by connecting a multimeter in series with one of the supply connections to the op amp and disconnecting the output so that the op amp does not drive the LED. The "per op amp current" is the measured current divided by the number of op amps in the package.

We measured 1.1mA for the test 741 op amp.

Input Resistance

This parameter can only be measured for op amps with input resistance less than several megohms. Op amps with Giga or Tera ohm input resistance can-

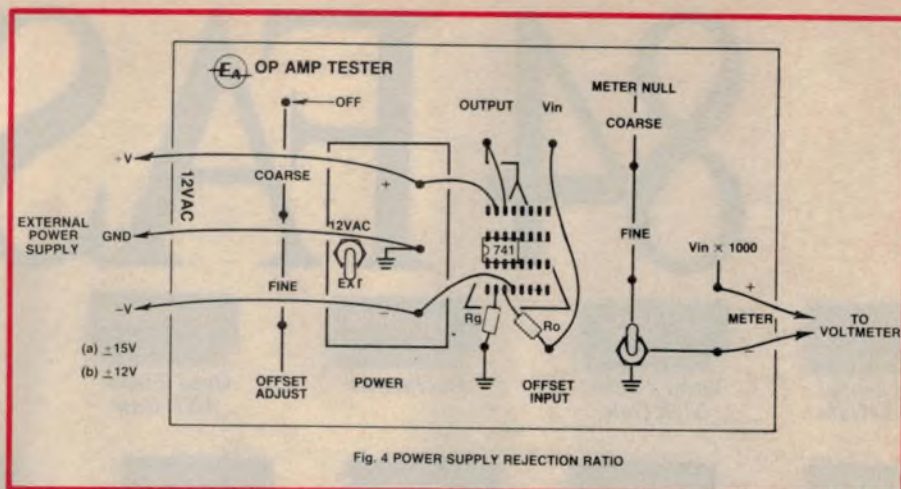

Fig.4: here's how to check the power supply rejection ratio.

not be measured in this set up. Of course an op amp which claims a very high input resistance and measures a very low value can be considered faulty.

Connect the tester as shown in Fig.5 (dotted line "a") with the meter null switch in the upward position and Vin connected to the offset input. Adjust the offset controls so that the output LED shows green. Adjust the meter null control for zero reading on the meter.

Now connect Vin to the op amp input (dotted line "b") and take the reading. The current is the (voltmeter reading/1000) divided by $10\text{k}\Omega$.

For our test 741 op amp, we measured $440\mu\text{V}$ across the $10\text{k}\Omega$ resistor. The current was therefore 44nA.

Next, reconnect the Vin to the offset input terminal (dotted line "a") and adjust the offset controls so that the output LED indicates red. Make a note of the offset voltage on the meter. For the test op amp, we obtained $640\text{mV}/1000$ or $640\mu\text{V}$ at the offset input.

Null this reading on the meter using

the meter null controls and measure the voltage across the $10\text{k}\Omega$ resistor by connecting the Vin terminal to the op amp side of the $10\text{k}\Omega$ resistor (dotted line "b"). Calculate the current.

For our test op amp, we obtained 425mV or $425\mu\text{V}$ across the $10\text{k}\Omega$ resistor. This gives $425/10\text{k}$ or 42.5nA .

Input resistance is the change in the applied input voltage divided by the change in input current.

So for our test op amp we changed the input voltage by $640\mu\text{V}$ and had a change in input current of $(44 - 42.5)\text{nA} = 1.5\text{nA}$. The input resistance is therefore $640\mu\text{V}/1.5\text{nA} = 427\text{k}\Omega$.

This completes our outline of procedures for the Op Amp Tester although it can doubtless be used to measure other parameters such as Common Mode Rejection Ratio, Output Impedance, Short Circuit Output Current and so on.

Incidentally, all parameters measured for the test op amp were within specifications for the 741 as published in Fig.2 last month.

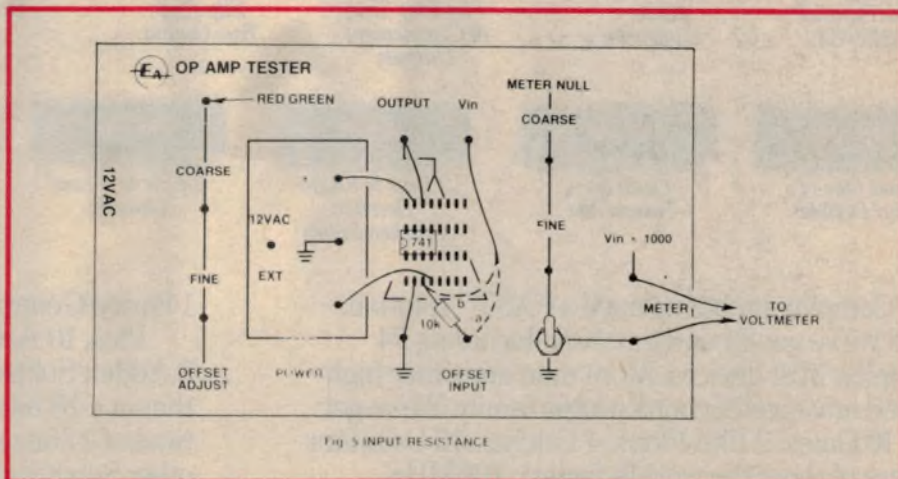
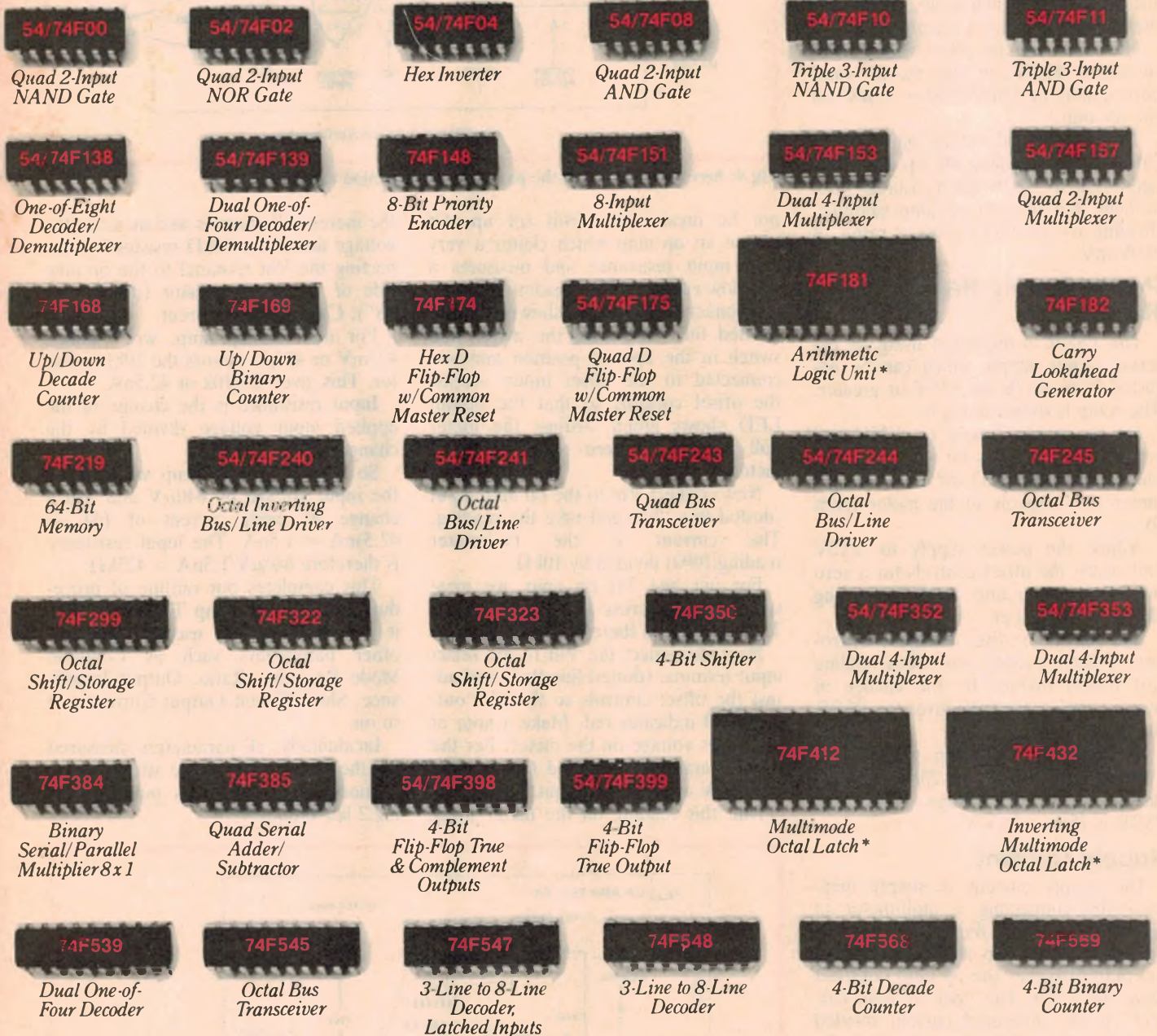

Fig.5: wiring diagram for checking the input resistance.

84 FAST



Complex problems need a FAST™ solution. And we've got 84 of them. Now. Including 74 complex MSI devices. More than any other high-speed advanced Schottky logic family. We've got:

- 10 Gates. 9 Flip-Flops. 4 Latches. 12 Counters (some of them the world's fastest: 100MHz guaranteed).
- 4 Transceivers. 2 Memories. 2 Comparators. 3 Buffer/Line Drivers. 7 Shift Registers. 7 Decoder/Demultiplexers. 12 Multiplexers.

- 1 Parity/Generator Checker. 1 Encoder.
- Plus, 10 Arithmetic functions: 2 Multipliers. 3 Adder/Subtractors. 5 ALUs (including our F181 that in a 16-bit configuration has a maximum add time of 27.5ns at a fraction of the power of all other Schottky equivalents).
- 84 FAST answers. All compatible with existing standard Schottky and Low Power Schottky devices for easy upgrading.

ANSWERS.

54/74F20 Dual 4-Input NAND Gate	54/74F32 Quad 2-Input OR Gate	54/74F64 4-2-3-2 Input AND-NOR Gate	54/74F74 Dual D-Type Flip-Flop	54/74F86 Quad 2-Input Exclusive-OR Gate	54/74F109 Dual JK Flip-Flop
54/74F158 Quad 2-Input Multiplexer	54/74F160A BCD Decade Counter Asyn. Reset	54/74F161A 4-Bit Binary Counter Asyn. Reset	54/74F162A BCD Decade Counter Synch. Reset	54/74F163A 4-Bit Binary Counter Synch. Reset	54/74F164 Serial-In/ Parallel-Out Shift Register
74F189 64-Bit Memory	74F190 Up/Down Decade Counter	74F191 Up/Down Binary Counter	54/74F192 Up/Down Decade Counter	54/74F193 Up/Down Binary Counter	54/74F194 4-Bit Bidirectional Universal Shift Register
54/74F251 8-Input Multiplexer	54/74F253 Dual 4-Input Multiplexer	54/74F257 Quad 2-Input Multiplexer	54/74F258 Quad 2-Input Multiplexer	54/74F280 9-Bit Parity Generator/ Checker	54/74F283 4-Bit Full Adder
54/74F373 Octal D Flip-Flop	54/74F374 Octal D Flip-Flop	74F378 Hex D Flip-Flop with Enable	74F379 Quad D Flip-Flop with Enable	74F381 Arithmetic Logic Unit	74F382 Arithmetic Logic Unit
74F521 Octal Comparator	74F524 8-Bit Register Comparator	54/74F533 Inverting Octal D Latch	54/74F534 Inverting Octal D Flip-Flop	74F537 One-of-Ten Decoder	74F538 One-of-Eight Decoder
74F582 4-Bit BCD Arithmetic Logic Unit	74F583 4-Bit BCD Adder	74F588 GPIB Compatible Octal Transceiver	74F675 16-Bit Serial-In/ Serial-Parallel-Out Shift Register*	54/74F676 16-Bit Serial- Parallel-In/ Serial-Out Shift Register*	74F784 8-Bit Serial Multiplier with Adder/ Subtractor

FAST (Fairchild Advanced Schottky TTL) from Fairchild. Now you have 84 high-speed and low-power choices in an MSI-intensive Micrologic* family.

**For further information contact:
Fairchild Australia Pty. Limited
366 Whitehorse Road, Nunawading, 3131
Tel: (03) 877 5444 Fax: 878 4904**

FASTTM

PRODUCTS MANUFACTURED BY

FAIRCHILD

A Schlumberger Company
ONE OF THE WORLD'S LEADING
SEMICONDUCTOR MANUFACTURERS

An introduction to hifi, Pt.14

FM radio tuners — 2

Antennas; survey of receivers; demodulation

Having examined the basic principles of high quality FM sound broadcasting, it now remains to explain how the incoming signal is processed in typical FM tuners to recover the original left and right-channel stereo information. The explanation covers both valve and solid state design practice.

by NEVILLE WILLIAMS

Perhaps the logical place to begin is with the radiated signal and the receiving antenna.

Without going into a lot of detail, it can be stated that the energy in a radio wave, as it travels through space, is evident as an electric field and a magnetic field at right angles to each other and to the direction of propagation — as illustrated in Fig.1.

The attitude of the respective fields, relative to the ground, is referred to as the "polarisation" of the wave, standard practice being to equate it to the electric component. Thus, if the electric field, as it leaves the transmitting antenna, is (1) at right angles, or (2) parallel to the surface of the earth, the transmission is said to be (1) vertically or (2) horizontally polarised.

Polarisation is determined principally by the configuration of the transmitting antenna (see station list, EA March 1986, p.71) but it can be modified, en route, by local topography, street cables and large metal structures.

For best reception on the FM broadcast band (88-108MHz) the transmitting and receiving antennas should have the same polarisation but herein lies a problem:

For portable and automotive FM receivers, the receiving antenna normally has to be a near vertical whip — which means that, ideally, transmissions also to be vertically polarised. But this conflicts with the interests of the majority of listeners who may wish to use the

one antenna for FM and TV, because most TV services in Australia call for horizontal polarisation.

As a compromise, most FM broadcast stations in this country have settled for so-called "mixed" polarisation which, in effect, tilts the vectors (of Fig.1) with the purpose of sharing the radiated energy deliberately, rather than randomly, between vertical and horizontal receiving antennas.

Owners of portable and automotive FM receivers have little choice but to use them with the associated telescopic whip, wherever they happen to be. For-

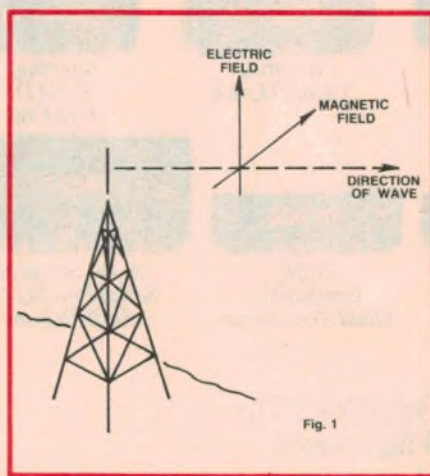

Fig.1: diagram depicting the relationship between the electric and magnetic fields in a VHF radio wave. Vertical polarisation is shown but it could be otherwise, as explained in the text.

unately, within the main service area of FM transmitters, the signal strength is normally adequate for casual listening. (Ferrite rod or small frame antennas, commonly used on the MW broadcast band, are not a proposition at VHF).

For domestic hifi installations, listeners are usually more demanding, particularly in respect to signal/noise ratio, and this commonly calls for a more ambitious antenna system, capable of providing a stronger input signal.

Where cost and space permit, the ideal provision is a separate, directional outdoor antenna for the FM tuner. FM antennas are superficially similar to TV antennas and are commonly available through the same suppliers, but their dimensions are optimised for the FM band.

Where the FM and TV stations lie in the same general direction, an FM tuner or receiver can usually be connected to an existing outdoor TV antenna — but it needs to be done properly. First check the antenna and its present TV cabling to ensure that it is in good condition and then use a commercial "signal splitter" to interconnect the new (FM) cable with the old.

These days, most outdoor TV antennas use 75-ohm coaxial cable to connect to the TV receiver and the logical course is to use a 75-ohm splitter and similar cable, terminated by a standard antenna plug, to feed the FM tuner. The chances are that the tuner (or receiver) will have a matching antenna socket or terminals at the rear marked "75 ohms".

Some tuners may, however, have a pair of terminals marked "300 ohms". No hassle: most electronic parts suppliers stock 75/300 ohm balun adaptors and can explain how they are fitted.

In high signal strength areas, an inexpensive indoor FM antenna can be con-

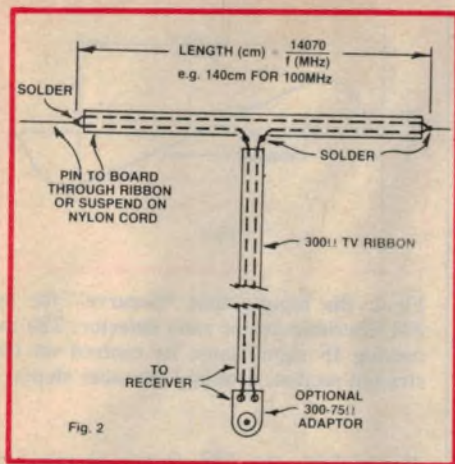

Fig.2: an inexpensive FM antenna system can be contrived from a few metres of 300-ohm TV twin "ribbon". For indoor use, the white translucent variety is less obtrusive.

trived from a few metres of 300-ohm TV twin lead, as shown in Fig.2. This should be supported horizontally, at approximate right angles to the direction from which the FM signals are coming. It can be strung out-of-sight between rafters under a tile roof, or pinned to a wooden picture rail. By using the formula shown, the antenna can be cut to resonate at — or favour — the frequency of a particular station but, otherwise, 147cm (approx.) is a suitable mean figure.

Where the local FM stations are known to be using vertical polarisation, the antenna should be supported vertically, with the connecting lead taken away at right angles for a metre or so, before running down to the FM tuner.

Basic FM receiver

FM tuners and receivers are — and always have been — based on the superheterodyne principle, as outlined in

the earlier chapter on AM-stereo receivers. There are important differences though, as will become apparent from the block diagram, Fig.3. We will take an initial look at the various stages, by way of orientation!

Consistent with the foregoing remarks, the antenna input is shown as providing for either or both a 75-ohm unbalanced (coaxial) cable and a 300-ohm balanced twin lead.

The incoming signal is fed first to one (sometimes two) RF amplifier stages with input and output circuits tuneable to the desired station carrier. The RF amplifier section has four main functions, namely to:

1. Pre-select the wanted carrier and attenuate other signals which might cause "image" or other interference problems;
2. Amplify the incoming signal before it encounters the somewhat noise-prone frequency changing stage.
3. Isolate the antenna from the receiver's internal oscillator;
4. Provide a means by which the AGC (automatic gain control) system can attenuate unduly strong input signals.

A prerequisite of the RF amplifier section is that it should exhibit an overall bandpass of around 250kHz, in order not to attenuate the essential signal sidebands. Whereas, in an AM system, loss of the outer sidebands causes loss of treble response, the effect on an FM system is to compress the modulation peaks, resulting in harmonic distortion of louder sounds.

From the RF amplifier section, the signal passes to a frequency changing (or "mixer") stage where it is heterodyned or mixed with the output from the in-built tuneable oscillator, mentioned above, to produce a "difference" resultant, the so-called intermediate frequency or "IF".

A figure of 455kHz, as used in AM receivers, is totally unsuitable in a circuit where the required bandpass is itself about half that figure. For FM tuners and receivers, the IF has been standardised worldwide at 10.7MHz — a frequency that is kept free for that purpose.

Assuming that the local oscillator operates above the incoming signal frequency by that figure, it needs to be tuneable from $88+10.7$ to $108+10.7$ or from 98.7 to 118.7MHz.

Even though operating at 10.7MHz, considerable care is still necessary in the design and/or adjustment of the IF amplifier system to ensure that the selectivity curve is not unduly "peaky" and that the overall bandpass is, again, wide enough to accommodate what we referred to in the last article as the "sidebands that matter".

While the bandpass is important in an FM tuner, the linearity in terms of signal overloading is not. In fact, the "limiter" stage (or stages) included in most FM tuners are essentially IF amplifier stages which are deliberately set up and over-driven so that they will overload, even when handling what were originally very weak signals. In so doing, they have the "clipping" effect, illustrated in Fig.3 of the previous article, virtually eliminating redundant AM (noise) components but retaining the FM information.

The AGC voltage must be derived from the IF signal before clipping, while it is still subject to variations in amplitude. For this reason, it is shown as being picked up part way along the IF amplifier.

The FM demodulator, which follows the IF section, is equivalent to the detector in an AM tuner, although functioning in a quite different manner. It

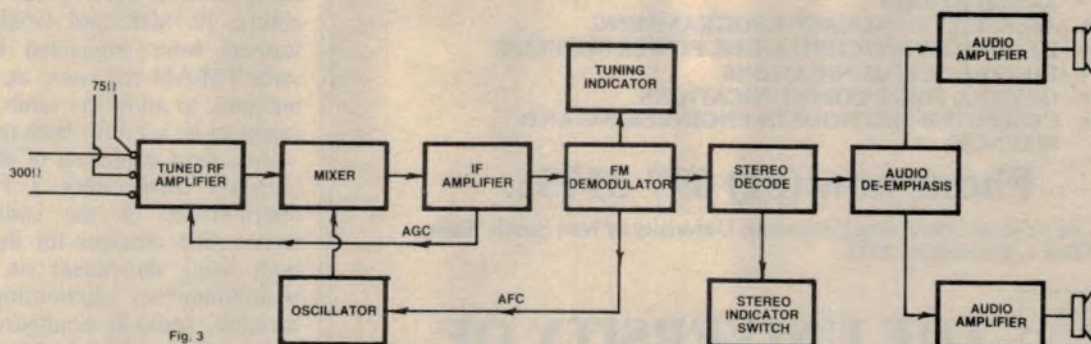

Fig.3: the basic circuit functions in an FM superhet tuner/receiver, valid for both valve and solid-state technology. Modern designs contain extra modules for digital control and readout, which has taken over from analog tuning and dials.

DAVID TILBROOK DOES IT AGAIN!



\$799
PAIR

vifa

AEM-6102
KIT SPEAKERS.

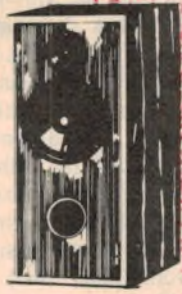

We're talking about the exciting David Tilbrook designed speaker kit which uses VIFA's high performance drivers from Denmark, his 2-way, digital-ready 100 Watt capable masterpiece. The name Tilbrook is synonymous with brilliant design and performance characteristics and this system keeps the legend alive and well. When you compare the price of this kit with similar, fully imported loudspeakers, you will be saving from 55% to 60%!

The performance of the speakers is outstanding. **Australian Hi-Fi Magazine** recently acclaimed: "Well, Mr Tilbrook and Scan have certainly done their homework. **The AEM-6102 is simply superb.** A very accurate design and exhibits remarkable low levels of colouration and distortion - across the board."

Such performance can only be achieved when every component is just right and the drivers are of advanced construction. Which is why VIFA drivers are chosen for such fine speakers as MISSION, DALI, ROGERS, JAMO, VANDERSTEEN, HEYBROOK, BANG & OLUFSEN, D.C.M. and MAGNAT just

to mention a few

Nearly a thousand of the AEM 6102 speakers have already been built in Australia with superb results. For only \$799 a pair including drivers, pre-built cross overs and flatpack cabinets you can be the owner of one of these sonic masterpieces.

For more information, please write to:
Australian Sole Distributor:
SCAN AUDIO Pty. Ltd.,
52 Crown Street, Richmond, 3121.
Telephone (03) 429 2199. Telex 39201.
Genuine O.E.M. enquiries welcome.

Stocked and demonstrated by:
NSW: All Jaycar Stores (02) 267 1614
QLD: Jaycar, Buranda (07) 393 0777
Old Stereo/Visual (07) 37 7433
VIC: Radio Parts (03) 211 8122
Rod Irving Electrs. (03) 663 6151
TAS: NWS Hi Fi, Burnie. (004) 31 5633
Quantum, Hobart. (002) 31 0088
SA: Eagle Electronics (08) 271 2885
International Sound (08) 212 5006
Miltronics (08) 42 3781
WA: Alberts Hi Fi, Perth (09) 322 4409
NT: Sound Spectrum, Darwin (089) 81 5060

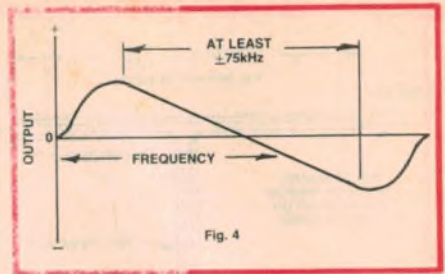

Fig.4: the input/output "S-curve" for an FM discriminator or ratio detector. The incoming IF signal must be centred on the straight section, avoiding the outer slopes.

demodulates the FM carrier to recover the audio signals imposed upon it and performs other supplementary tasks such as providing an AFC (automatic frequency control) voltage to stabilise the oscillator, and the drive signal for a tuning indicator.

In the case of a mono tuner, the audio signal from the demodulator would pass through a top-cut filter network, to provide the necessary de-emphasis (Fig.5, previous chapter) and then on to the audio amplifier. In a stereo tuner, however, the demodulated multiplexed signal is fed to a stereo decoder stage and is de-emphasised only after having been resolved into the left and right-channel audio components.

Early receiver problems

In the era of valves and their associated technology, early model FM tuners were finicky to design, adjust and use and as often as not, were better suited to enthusiasts than to ordinary listeners. Tuning, for example, tended to drift noticeably as the local oscillator and other circuitry warmed up after switch-on.

In the longer term, IF transformers often drifted out of adjustment because of temperature, vibration and ageing problems, thereby affecting the shape of the passband. Adding to their vulnerability, 10.7MHz and 455kHz IF transformers were connected in series in some FM/AM receivers, as an economy measure, to allow the same IF amplifier valves to be used for both modes.

But, most confusing of all, early FM receivers used either a Foster-Seeley discriminator or the commonly preferred ratio detector for demodulation, both being dependent on the critical phase/frequency relationships in an associated, specially configured IF transformer. The design objective was a symmetrical input/output "S-curve", as depicted in Fig.4.

The midpoint of the "S" would ideally coincide with the centre of the

THIS ISN'T COMMON KNOWLEDGE

Never before has the University of New South Wales offered a range of vocational courses such as those embodied in the forthcoming Winter Professional School. If you're an ambitious Engineering Professional and you want to update your knowledge in key areas, then find out more about these courses:

- DRY ETCHING FOR MICRO-ELECTRONIC APPLICATIONS
- ASSEMBLY LANGUAGE PROGRAMMING
- DESIGN OF SWITCHED-MODE POWER SUPPLIES
- DIGITAL COMMUNICATIONS
- OPTICAL FIBRE COMMUNICATIONS
- COMPUTER METHODS IN ENGINEERING AND SCIENCE

Phone now (02) 697 3175...

... or write to Continuing Education, University of New South Wales, PO Box 1, Kensington 2033.



THE UNIVERSITY OF
NEW SOUTH WALES

AK04281

overall IF bandpass characteristic (ie, 10.7MHz). As the carrier deviated by up to 75kHz either way, displacement along the "straight" centre portion of the "S" would result in a plus or minus output voltage, representing the recovered audio signal.

Unfortunately, inadequate design, maladjustment or drift relative to the IF passband could all too easily result in an S-curve which was effectively far less symmetrical and less linear than the ideal, resulting in perceptible distortion during modulation peaks.

Tuning could also be confusing for the uninitiated because, with a conventional manual system, the correct tuning position was flanked by two spurious — and distorted — settings where the signal could be partially demodulated by one or other of the outer ends of the S-curve.

No less disconcerting, many early FM tuners generated a high level of noise when tuning between stations. This came about because, with no input signal, there was nothing to drive the limiter stages into overload; so, instead of clipping residual noise, they amplified it!

Towards the end of the valve era, more refined design and AFC largely overcame the drift problems, automatic muting silenced the inter-station noise, and development of the 6BN6 quadrature detector signalled a less tedious approach to FM demodulation. Improved valves and more ambitious circuit techniques boosted overall performance, such that the last generation of predominantly valve AM/FM stereo receivers were quite impressive pieces of equipment, even if rather massive.

Sansui's Model 1000A receiver, for example, offered all of the facilities available in its present-day solid-state equivalents, even to wide/narrow AM. Rated power output was 40+40W RMS at around 1% distortion — but at an all-up weight of something over 20kg.

The solid state era

In the early and mid-70's, transistors and first generation ICs, along with matching small components, changed the scene dramatically. While the new wave of solid-state FM tuners and receivers still relied on manual tuning with composite 4 or 5-gang variable capacitors, the orderly layout of miniature components on PC boards was a far cry from the congested interior of conventional hard-wired valve equipment.

Typical of the new look was JVC's model 5515X AM/FM stereo receiver, reviewed in the July 1975 issue of EA.

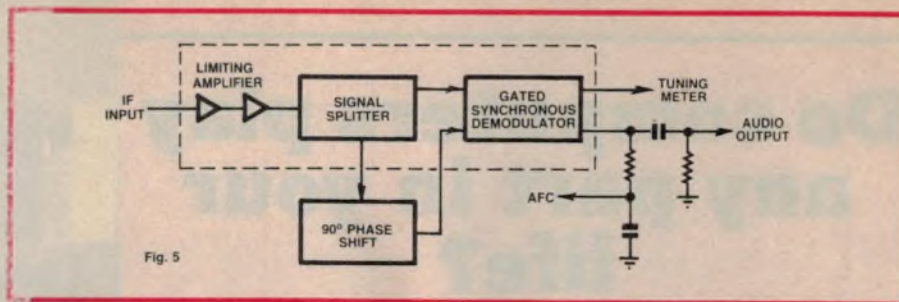

Fig.5: much simplified, this diagram gives some idea of the operation of a quadrature FM demodulator, providing audio output, AFC voltage and drive for tuning meters of one kind or another.

Although somewhat less pretentious than the Sansui 1000A, with a measured power output of 25+25W RMS at 0.3% distortion, it weighed in at a much more manageable 9kg.

Around the same time (Nov. 1974), EA described an AM/FM stereo tuner for home construction based on a Heathkit pre-packaged kit (Model AJ-1214). This, too, used a conventional tuning dial and 5-gang tuning capacitor but the rest of the circuitry was indicative of the shape of things to come.

The tuner was housed in a case measuring 330 x 280 x 90mm (W x D x H) and weighed a mere 3.5kg. Inside, the two tuners shared a common PC board, as pictured, measuring about 180 x 170mm and occupying less than half the available area. While conservative by present standards, it represented a quantum leap compared with the valve technology that preceded it.

Referring back to the various functions depicted in Fig.3, the Heathkit AJ-1214 used a single FET (field effect transistor) as a tuned RF amplifier, with AGC voltage applied to its gate electrode.

High frequency NPN transistors served as mixer and local oscillator stages, with the oscillator tuning subject to automatic correction by means of a "varicap" (or "varactor") diode — signifying variable capacitance or variable reactance — connected in parallel with the main tuning capacitor and controlled by an AFC voltage from the quadrature detector. The AFC system counteracts initial tuning errors and/or frequency drift by nudging the oscillator frequency up or down, as necessary, to maintain the IF signal at the intended intermediate frequency — nominally 10.7MHz.

Varicap diodes are basically similar to the normal silicon rectifier type, except that the junction impurity concentration is manipulated so as to:

1. Optimise the change in capacitance across the junction when it is subjected to a varying reverse voltage, and

2. Minimise series resistance losses and therefore maximise the "Q" of the junction capacitance.

IF amplifier section

In place of one or more valves or transistors, interconnected by double-tuned IF transformers, the IF amplifier system in the Heathkit tuner was concentrated around a single multi-purpose Motorola MC1357P IC and two matched 10.7MHz ceramic filters, one at its input, the other at its output. Such filters greatly reduce dependence on conventional IF transformers and, if correctly chosen, ensure the required bandpass characteristic, with commendable phase linearity.

Ceramic filters (or ceramic resonators) are piezo-electric devices which, like the traditional quartz crystal, exhibit a mechanical resonance reminiscent of a high-Q electrical tuned circuit. They are processed from selected ceramics (eg. lead-zirconate-titanate) and factory calibrated for filter service. Along with varicaps, they have revolutionised tuner and receiver design.

The MC1357P IC provided the necessary IF gain, along with two separate outputs; one suitable for buffering and rectification to generate an AGC voltage for the RF amplifier; the other, limited to remove the AM noise and ready to feed to the FM demodulator stage.

Quadrature demodulator

A second MC1357P was interconnected to function as a quadrature demodulator — a role in which it processes two versions of the incoming IF signal "in quadrature", signifying a phase difference of 90 degrees.

In this role, as illustrated in Fig.5, the basic feed from the IF system passes through a section of the IC, operating as a high-gain wideband limiting (or clipping) amplifier, which transforms the incoming signal into a train of essentially rectangular pulses, of uniform amplitude but retaining the frequency modulation characteristics of the signal.

Do computers play any part in your life?

If they do — or if you just want to find out about them — don't miss each month's issue of

your computer

MAGAZINE FOR BUSINESS AND PLEASURE



A magazine for all computer users and enthusiasts, *Your Computer* has something for everyone — topical features on all aspects of the computing world, expert reviews of the latest software and hardware, up-to-the-minute information for business people, and even games and advice for hobbyists.

NEWS

Your Computer brings you all that's interesting, innovative and inventive in the microcomputing world — news of products, plans and politics to keep you up-to-the-date with what's going on in this fast-moving industry.

REVIEWS

The latest machines and software from all the computer manufacturers are reviewed each month in *Your Computer*. Keep informed about what's available, and use our reviews to help you assess which products are right for you.

TUTORIALS

Your Computer's tutorials include regular series on such popular subjects as the BASIC programming language and dBase II, probably the biggest-selling database program of them all. Written by such well-known industry experts as Les Bell, they're an invaluable aid to learning how to make computers work for you.

PROGRAMS

Your Computer regularly publishes all kinds of programs written by both professional programmers and readers, and ranging from games to business uses, utilities to additions and alterations to well-known programs.

All *Your Computer's* articles are written in everyday English, not computer jargon, so even if you're a beginner there's something for you in every issue. And our regular columns on all the popular brands of microcomputers are packed with enough information to get any newcomer straight into the exciting world of computing. At \$2.95 — less if you take out a subscription — *Your Computer* is going to cost you a lot less than its overseas rivals — and provide you with the latest information on the computer scene in Australia at the same time. Look for it every month at your newsagent.

A portion of the pulsed signal is made available to be passed through an external LCR resonant network and fed back into the IC, now shifted in phase by a nominal 90-degrees. A synchronous demodulator combines the two pulse trains to produce a resultant output voltage that is dependent on their relative phase relationship.

In practice, the system is set up so that, with a signal centred in the IF passband, the output has a certain median value. However, if the incoming signal deviates in frequency, the phase angle between the respective inputs varies and, with it, the resultant output voltage.

If the frequency of the incoming signal varies rapidly, as with audio (or supersonic) modulation, so also does the output voltage — constituting, in fact, the demodulated signal.

If, simultaneously, there is a tendency for the average resultant voltage to creep above or below the median value, an overall shift in the incoming frequency would be indicated. By diverting some of the output signal through a long time-constant RC filter, the audio content can be eliminated and a DC component isolated to serve as an AFC voltage to control the local oscillator, as already mentioned. If desired, the same DC voltage can be used to operate a centre-reading tuning indicator.

Multiplex decoding

And that brings us to the matter of stereo decoding. This can be achieved

by effectively reversing the encoding procedures described in the last article. It requires that the composite signal from the FM demodulator be processed through filters to once again isolate the main L+R audio signal, the 19kHz pilot tone and the two sets of L-R sidebands.

This done, the 19kHz pilot tone is used to create or phase lock a locally generated 38kHz carrier, which is duly combined with the sidebands and demodulated to recover the L-R audio signal. Resistive matrixing of the sum and difference signals can then isolate the original L and R components for normal stereo amplification.

While this is a legitimate method, it is heavily dependent on resonant filters and is not a very attractive proposition for modern mass production.

The preferred approach is not to separate the L+R audio and L-R sideband components but to process them in combination. Accordingly, the 19kHz tone is separated out from the audio information — a relatively simple procedure — leaving the latter as a seemingly random mix of an audio (sum) signal and the two sets of supersonic sidebands relating to the difference signal.

But the mixture of signals is not as random as it might appear — a point that emerges when a phase locked 38kHz signal is added to the mix. In fact, the positive and negative peaks of the 38kHz wave add selectively to the supersonic sideband excursions of the composite signal, to produce what looks like an oddly modulated carrier with

one side having the contour of the L signal and other of the R signal.

Resorting to graphics, Fig. 6 has been adapted from the "Stereo FM Handbook" by P. Harvey and K.J. Bohlman, both (at the time) lecturers at the Lincoln College of Technology, UK. Diagrams (a) to (f) suggest how the original L and R signals add to produce the composite resultant of L+R and a twin-sideband version of L-R. Diagrams (g) to (i) illustrate what happens when a reconstituted 38kHz signal is added to the mix, as described above.

The contours can be resolved separately by envelope (AM) detection of one kind or another as, for example, by twin diodes, so polarised as to sense the positive-going and negative-going peaks.

At this level, the process can be regarded as essentially analog "synchronous" detection. Alternatively, the diodes may be thought of as switches, turned on by alternate half-cycles of the 38kHz signal and steering the left and right components into the appropriate output channel.

Taking the switching concept further, the 19kHz pilot tone can be processed into 38kHz and 76kHz rectangular pulses for more precise timing and the use of sample and hold techniques offering, in particular, better L-R channel separation.

Stereo decoding in the Heathkit tuner was performed by a Motorola MC1310P IC, based on the above switching technology. An internal voltage controlled oscillator generates a 76kHz square wave, which is divided down to 38kHz and 19kHz, the latter being compared with the incoming pilot tone and used to phase lock the entire sampling and switching system.

Because L and R samples are diverted alternately to the respective output circuits, as described above, in effect, they constitute sampled signals, with a pulse rate of 38kHz (compared with 44.1kHz for compact discs). As such, they must undergo not only deemphasis but also low-pass filtering to remove all frequency components above 15kHz, in particular artefacts of the pilot tone and the switching process.

(For a further discussion of the MC1310P, see the description of an FM Stereo Decoder by Jamieson Rowe and David Edwards, EA April 1975).

In the next chapter, we will bring this background material right up to date by relating it to the recently described Playmaster AM/FM Stereo Tuner. The principles of pushbutton "digital" tuning will also be covered.

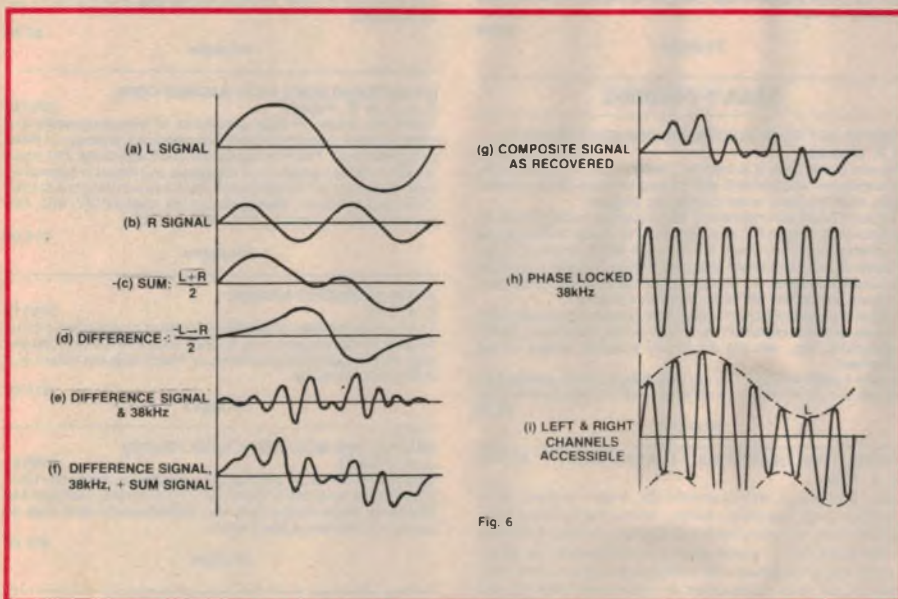

Fig. 6

Fig.6: (a) to (d) are the left, right, sum and difference signals; (e) is the double sideband, suppressed carrier version of (d); and in (f), L+R has been added to form the composite audio signal. Diagrams (g) to (i) show how adding the 38kHz carrier to the composite signal separates the L and R components for easy recovery.

Back by Popular Demand

DATA & REFERENCE

DIGITAL IC EQUIVALENTS AND PIN CONNECTIONS
A. Michaels BP0140
 Shows equivalents and pin connections of a popular user-orientated selection of European, American and Japanese digital ICs. Also includes details of packaging, families, functions, manufacturer and country of origin

256 pages (Large Format) \$18.00

LINEAR IC EQUIVALENTS AND PIN CONNECTIONS
A. Michaels BP0141
 Shows equivalents and pin connections of a popular user-orientated selection of European, American and Japanese linear ICs. Also includes details of functions, manufacturer, and country of origin.

320 pages (Large Format) \$18.00

INTERNATIONAL TRANSISTOR EQUIVALENTS GUIDE
A. Michaels BP0085
 Helps the reader to find possible substitutes for a popular user-orientated selection of European, American and Japanese transistors. Also shows material type, polarity, manufacturer and use.

320 pages \$12.00

CHART OF RADIO, ELECTRONIC, SEMICONDUCTOR AND LOGIC SYMBOLS
M. H. Babani, B.Sc.(Eng) BP0027
 Illustrates the common, and many of the not-so-common, radio, electronic, semiconductor and logic symbols that are used in books, magazines and instruction manuals, etc., in most countries throughout the world.

Chart \$4.00

RADIO AND ELECTRONIC COLOUR CODES AND DATA CHART
B. B. Babani BP0007
 Covers many colour codes in use throughout the world, for most radio and electronic components. Includes resistors, capacitors, transformers, field coils, fuses, battery leads, speakers, etc.

Chart \$4.00

AUDIO AND HI-FI

BUILD YOUR OWN SOLID STATE HI-FI AND AUDIO ACCESSORIES
M. H. Babani BP0220
 An essential addition to the library of any keen hi-fi and audio enthusiast. The design and construction of many useful projects are covered including: stereo decoder, three-channel stereo mixer, FET pre-amplifier for ceramic PUs, microphone pre-amp with adjustable bass response, stereo dynamic noise filter, loud-speaker protector, voice-operated relay, etc.

96 pages \$6.00

AUDIO PROJECTS
F. G. Rayer BP0090
 This book covers in detail the construction of a wide range of audio projects. The text has been divided into the following main sections: Pre-amplifiers and Mixers, Power Amplifiers, Tone Controls and Matching, Miscellaneous Projects. All the projects are fairly simple to build and have been designed around inexpensive and readily available components. Also, to assist the newcomer to the hobby, the author has included a number of board layouts and wiring diagrams.

96 pages \$6.50

COMPONENT SPECIFIC

MODERN OP-AMP PROJECTS
R. A. Penfold BP0106
 Includes a wide range of constructional projects which make use of the specialised operational amplifiers that are available today, including low noise, low distortion, ultra-high input impedance, low slew rate and high output current types. Circuits using transconductance types are also included. All of the projects are fairly easy to construct and a stripboard layout is provided for most of them so that even constructors of limited experience should be able to build any of the projects with the minimum of difficulty.

112 pages \$8.50

MODEL RAILWAY PROJECTS
R. A. Penfold BP0095
 The aim of this book is to provide a number of useful but reasonably simple projects for the model railway enthusiast to build, based on inexpensive and easily obtainable components. The projects covered include such things as controllers, signal and sound effects units, and to help simplify construction, stripboard layouts are provided for each project.

112 pages \$8.50

AERIALS

AERIAL PROJECTS
R. A. Penfold BP0105
 The subject of aerials is vast but in this book the author has considered practical aerial designs, including active, loop and ferrite aerials which give good performances and are relatively simple and inexpensive to build. The complex theory and mathematics of aerial design have been avoided. Also included are constructional details of a number of aerial accessories including a pre-selector, attenuator, filters and tuning unit.

96 pages \$6.50

25 SIMPLE AMATEUR BAND AERIALS
E. M. Noll BP0125
 This concise book describes how to build 25 amateur band aerials that are simple and inexpensive to construct and perform well. The designs start with the simple dipole and proceed to beam, triangle and even a mini-rhombic made from four TV masts and about 400 feet of wire. You will find a complete set of dimension tables that will help you spot an aerial on a particular frequency. Dimensions are given for various style aerials and other data needed for spacing and cutting phasing lengths. Also included are dimensions for the new WARC bands.

80 pages \$6.50

25 SIMPLE SHORTWAVE BROADCAST BAND AERIALS
E. M. Noll BP0132
 Fortunately good aerials can be erected at low cost, and for a small fractional part of the cost of your receiving equipment. This book tells the story. A series of 25 aerials of many different types are covered, ranging from a simple dipole through helical designs to a multi-band umbrella.

80 pages \$6.50

25 SIMPLE INDOOR AND WINDOW AERIALS
E. M. Noll BP0136
 Written for those people who live in flats or have no gardens or other space-limiting restrictions which prevent them from constructing a conventional aerial system. The 25 aerials included in this book have been especially designed, built and tested by Mr. Noll to be sure performers and give surprisingly good results considering their limited dimensions.

64 pages \$6.00

25 SIMPLE TROPICAL AND MW BAND AERIALS
E. M. Noll BP0145
 Shows you how to build 25 simple and inexpensive aerials for operation on the medium wave broadcast band and on 60, 75, 90 and 120 metre tropical bands. Designs for the 49 metre band are included as well.

64 pages \$6.00

FAULT-FINDING

HOW TO GET YOUR ELECTRONIC PROJECTS WORKING
R. A. Penfold BP0110
 The aim of this book is to help the reader overcome problems by indicating how and where to start looking for many of the common faults that can occur when building up projects. Chapter 1 deals with mechanical faults such as tracing dry joints, short-circuits, broken P.C.B. tracks, etc. The construction and use of a tristate continuity tester, to help in the above, is also covered. Chapter 2 deals with linear analogue circuits and also covers the use and construction of a signal injector/tracer which can be used to locate and isolate the faulty areas in a project. Chapter 3 considers ways of testing the more common components such as resistors, capacitors, op amps, diodes, transistors, SCRs, unijunctions, etc., with the aid of only a limited amount of test equipment. Chapter 4 deals with both TTL and CMOS logic circuits and includes the use and construction of a pulse generator to help fault-finding.

96 pages \$8.50

TRANSISTOR RADIO FAULT-FINDING CHART BP070
C. E. Miller

Used properly, it should enable the reader to trace most common faults reasonably quickly. Across the top of the chart will be found four rectangles containing brief descriptions of these faults, vs — sound weak but undistorted, set dead sound low or distorted and background noises. One then selects the most appropriate of these and following the arrows carries out the suggested checks in sequence until the fault is cleared.

Chart \$4.00

ELECTRONIC & COMPUTER MUSIC

ELECTRONIC MUSIC PROJECTS
R. A. Penfold BP0074
 Provides the constructor with a number of practical circuits for the less complex items of electronic music equipment, including such things as fuzz box, waa-waa pedal, sustain unit, reverb/beat and phaser units, tremolo generator, etc. The text is divided into four chapters as follows:

Chapter 1, Guitar Effects Units, Chapter 2, General Effects Units, Chapter 3, Sound General Projects, Chapter 4, Accessories.

112 pages \$9.50

ELECTRONIC SYNTHESISER CONSTRUCTION
R. A. Penfold BP0185
 Should enable a relative beginner to build, with the minimum of difficulty and at reasonably low cost a worthwhile monophonic synthesiser, and also learn a great deal about electronic music synthesis in the process. This is achieved by considering and building the various individual parts of the circuit that comprise the whole instrument as separate units, which can then be combined together to form the final synthesiser. Printed circuit designs are provided for these main modules. Later chapters deal with sequencing and some effects units.

112 pages \$11.00

MIDI PROJECTS
R. A. Penfold BP0182
 Provides practical details of how to interface many popular home computers with MIDI systems. Also covers interfacing MIDI equipment to analogue and percussion synthesisers.

112 pages \$11.00

MORE ADVANCED ELECTRONIC MUSIC PROJECTS
R. A. Penfold BP0174
 Intended to complement the first book (BP74) by carrying on where it left off and providing a range of slightly more advanced and complex projects. Included are popular effects units such as flanger, phaser, mini-chorus and ring-modulator units. Some useful percussion synthesisers are also described and together these provide a comprehensive range of effects including drum, cymbal and gong-type sounds.

96 pages \$6.50

COMPUTER MUSIC PROJECTS
R. A. Penfold BP0173
 Shows some of the ways a home computer can be used to good effect in the production of electronic music. Topics covered include sequencing and control via analogue and MIDI interfaces, computers as digital delay lines and sound generators for computer control.

112 pages \$11.00

MISCELLANEOUS

COIL DESIGN AND CONSTRUCTION MANUAL
B. B. Babani BP0160
 A complete book for the home constructor on "how to make" RF, IF, audio and power coils, chokes and transformers. Practically every possible type is discussed and calculations necessary are given and explained in detail. All mathematical data is simplified for use by everyone.

96 pages \$9.50

AN INTRODUCTION TO Z80 MACHINE CODE
R. A. & J. W. Penfold BP0152
 Takes the reader through the basics of microprocessors and machine code programming with no previous knowledge of these being assumed. The microprocessor dealt with is the Z80 which is used in many popular home computers and simple programming examples are given for Z80-based machines including the Sinclair ZX-81 and Spectrum, Memotech and the Amstrad CPC 464. Also applicable to the Amstrad CPC 664 and 6128.

144 pages \$10.00

A Z-80 WORKSHOP MANUAL
E. A. Parr BP0112
 This book is intended for people who wish to progress beyond the stage of BASIC programming to topics such as machine code and assembly language programming, or need hardware details of a Z-80 based computer.

192 pages \$12.00

GETTING THE MOST FROM YOUR PRINTER
J. W. Penfold BP0181
 Details how to use all the features provided on most dot-matrix printers from programs and popular word processor packages like Wordwise, Visawrite and Quill, etc. Shows exactly what must be typed in to achieve a given effect.

96 pages \$11.00

CIRCUITS & CONSTRUCTIONAL PROJECTS

BEGINNERS GUIDE TO BUILDING ELECTRONIC PROJECTS
R. A. Penfold BP0227
 Shows the complete beginner how to tackle the practical side of electronics, so that he or she can confidently build the electronic projects that are regularly featured in the popular magazines and books. Also includes examples in the form of simple projects that you can build.

112 pages \$6.50

and... Babani Books!

50 PROJECTS USING RELAYS, SCRs AND TRIACS

F. G. Rayer **BP0037**
 This book gives tried and practical working circuits which should present the minimum of difficulty for the enthusiast to construct. In most of the circuits there is a wide latitude in component values and types, allowing easy modification of circuits or ready adaption of them to individual needs
\$8.50
 112 pages

POPULAR ELECTRONIC PROJECTS

R. A. Penfold **BP0049**
 Provides a collection of the most popular types of circuits and projects covering a very wide range of interests including Radio, Audio, Household and Test Equipment projects
\$9.50
 144 pages

ELECTRONIC TEST EQUIPMENT CONSTRUCTION

F. G. Rayer **BP0075**
 This book covers in detail, the construction of a wide range of test equipment for both the electronics hobbyist and radio amateur. Included are projects ranging from a FET amplified voltmeter and resistance bridge to a field-strength indicator and heterodyne frequency meter. Not only can the home constructor enjoy building the equipment but the finished product can also be usefully utilised in the furtherance of his hobby.
\$8.00
 96 pages

HOW TO USE OP-AMPS

E. A. Parr **BP0088**
 This book has been written as a designer's guide covering many operational amplifiers, serving both as a source book of circuits and a reference book for design calculations. The approach has been made as non-mathematical as possible and it is hoped, easily understandable by most readers, be they engineers or hobbyists.
\$11.00
 160 pages

ELECTRONIC GAMES

R. A. Penfold **BP0089**
 Contains a number of interesting electronic games projects using modern integrated circuits. The text is divided into two sections: the first dealing with simple games and the latter dealing with more complex circuits thus making the book ideal for both beginner and more advanced enthusiasts alike.
\$8.00
 96 pages

IC 555 PROJECTS

E. A. Parr **BP0044**
 Every so often a device appears that is so useful that one wonders how life went on before without it. The 555 timer is such a device. Included in this book are basic and general circuits, motorcar and model railway circuits, alarms and noise-makers as well as a section on the 558, 568 and 569 timers.
\$8.50
 176 pages (Available February 1987)

HOW TO DESIGN AND MAKE YOUR OWN P.C.B.s

R. A. Penfold **BP0121**
 Chapter 1 deals with the simple methods of copying printed circuit board designs from magazines and books and covers all aspects of simple P.C.B. construction as comprehensively as possible. Chapter 2 covers photographic methods of producing p.c.b.s and Chapter 3 deals with most aspects of designing your own printed circuit board layouts.
\$8.50
 80 pages

POWER SUPPLY PROJECTS

R. A. Penfold **BP0078**
 The purpose of this book is to give a number of power supply designs, including simple unregulated types, fixed-voltage regulated types, and variable-voltage stabilised designs, the latter being primarily intended for use as bench supplies for the electronics workshop. The designs provided are all low-voltage types for semi-conductor circuits. This book should also help the reader to design his own power supplies.
\$7.50
 96 pages

HOW TO DESIGN ELECTRONIC PROJECTS

R. A. Penfold **BP0127**
 The aim of this book is to help the reader to put together projects from standard circuit blocks with a minimum of trial and error, but without resorting to any advanced mathematics. Hints on designing circuit blocks to meet your special requirements where no 'stock' design is available are also provided.
\$8.00
 128 pages

ELECTRONIC SECURITY DEVICES

R. A. Penfold **BP0056**
 Many people associate the term "security device" with only burglar alarms of various types, but in fact, any piece of equipment which helps to protect people and property against any form of danger could be termed a "security device". Therefore this book, besides including both simple and more sophisticated burglar alarm circuits using light, infra-red and ultrasonics, also includes many other types of circuits as well, such as gas and smoke detectors, flood alarms, doorphone and baby alarms, etc.
\$9.50
 112 pages

FURTHER PRACTICAL ELECTRONICS CALCULATIONS AND FORMULAE

F. A. Wilson **BP0144**
 Written in the same style as the first book (BP53) and with the same objectives in mind, this book is divided into the

COMMUNICATION

(Elements of Electronics — Book 5)
 F. A. Wilson **BP0089**
 A look at the electronic fundamentals over the whole of the communication scene. This book aims to teach the important elements of each branch of the subject. Most of the modern transmissions system techniques are examined including line, microwave, submarine, satellite and digital multiplex systems, radio and telegraphy. To assist in understanding these more thoroughly chapters on signal processing, the electromagnetic wave, networks and transmission assessment are included, finally a short chapter on optical transmission.
\$11.00
 256 pages

50 SIMPLE LED CIRCUITS

R. N. Soar **BP0042**
 Contains 50 interesting and useful circuits and applications, covering many different branches of electronics, using one of the most inexpensive and freely available components — the light-emitting diode (LED). Also includes circuits for the 707 common anode display.
\$6.00
 64 pages

IC PROJECTS FOR BEGINNERS

F. G. Rayer **BP0097**
 Offers a range of simple projects based around a number of popular and inexpensive linear and digital integrated circuits. With most projects, complete layout and/or point-to-point wiring diagrams are included to help simplify construction.
\$8.50
 112 pages

ELECTRONIC PROJECTS USING SOLAR CELLS

O. Bishop **BP0082**
 This is a book of simple circuits which have applications in and around the home and that are designed to be powered by the energy of the sun. Although, if the reader wishes, they could alternatively be powered by the ordinary button cells or small dry batteries.
\$8.50
 128 pages

following fourteen sections: Electricity, Electrostatics, Electromagnetism, Complex numbers, Amplifiers, Signal Generation and Processing, Communication, Statistics, Reliability, Audio, Radio, Transmission Lines, Digital Logic and Power Supplies **512 pages \$16.00**

NEW RELEASES!

A TV-DXERS HANDBOOK

R. Bunney **BP0176**
 Completely revised and updated by Roger Bunney who is probably one of the leading authorities in this country on the subject. Includes many units and devices which have been designed and used by active enthusiasts, and often, considerable ingenuity and thought have gone into the development of such units to overcome individual problems. A practical and authoritative reference to this unusual aspect of electronics. (Large Format)
\$18.00

AN INTRODUCTION TO CP/M

R. A. Penfold **BP0183**
 CP/M is more than just a program to give a common set of standards and hence software compatibility between various computers. It includes a range of commands that help with such things as file copying and editing, the directing of data to the appropriate device etc. In order to get the best from CP/M and the programs running under it, a basic understanding of the system is highly desirable, and this book tells the story.
 96 pages **\$11.00**

ELECTRONIC CIRCUITS FOR THE COMPUTER CONTROL OF ROBOTS

R. A. Penfold **BP0179**
 Provides information and circuits on computer control of electric motors (including stepper types), plus a range of useful sensors including visible light, infra-red, and ultrasonic types.
 96 pages **\$11.00**

USING YOUR AMSTRAD CPC DISC DRIVES

J. W. Penfold **BP0189**
 Covers such things as tracks, sectors and formatting; AMDOS and CP/M operating systems including rules and regulations; filing from BASIC, file copying and transfer; program development including MERGE and CHAIN MERGE; CP/M turnkey discs etc.
 96 pages **\$11.00**

ELECTRONICS BOOKS ORDER COUPON

(If insufficient space enclose separate list)

For airmail outside Australia add \$5.00 to these charges.

BOOK TITLE	BOOK NUMBER	QTY	PRICE

Send to: **Freeport No.4 Federal Publishing PO Box 227 Waterloo 2017** (no stamp required)

Total Price of Books\$
 Plus post & handling\$ **2.75**
 (flat rate up to 10 books)
TOTAL\$

Name: Telephone:

Address: Postcode:

Please tick box to indicate method of payment: **Cheque** * / **Money Order**
 * **Mastercard** **American Express** **Bankcard** **Visa**

Credit Card No:

Signature Expiry Date

(Unsigned orders cannot be accepted As these books are imported, unavoidable delays may occur.)

EA JUN '87

Understanding colour television

By far the most complicated part of a modern colour TV receiver is the colour decoder. Here we examine how the decoder circuit works and discuss how the various signals are derived.

by DAVID BOTTO

In part 3 of this series we saw that the transmitted TV signal contains: (a) the monochrome signal carrying the fine detail of the picture; (b) the colour information consisting of "U" and PAL switched "V" suppressed carrier signals; (c) the "swinging burst" colour synchronisation signal; (d) the line and field synchronising pulses needed to keep the receiver's raster in step with the camera scan; and (f) the frequency modulated sound signal.

Since all the colour information is encoded before transmission, it must be

decoded after demodulation by the receiver's video detector so that these various signals can be applied to the correct sections of the receiver.

The colour bar signal

A standard colour bar signal produces a pattern of vertical bars on the screen of a colour television receiver. Viewed from left to right, the bars are white, yellow, cyan, green, magenta, red and blue (Fig.1). Notice that yellow, cyan and magenta are produced by additive colour mixing.

This colour bar signal may be transmitted by the TV station or produced by a colour bar generator and fed into the receiver antenna socket. When an oscilloscope is connected to various points in the colour receiver, the various waveforms can be easily identified. This makes the colour bar signal very useful in the study (and servicing) of a colour TV receiver.

Fig.2 shows one line of a monochrome television picture, while Fig.3(a) shows a complete colour bar waveform where the signal is at 100% amplitude and with 100% colour saturation. Fig.3(b) shows the colour bar signal as transmitted by the British Broadcasting Corporation at 100% amplitude and 95% colour saturation. Fig.3(c) is the colour bar signal as defined by EBU standards for Europe with 75% amplitude and 100% colour saturation.

Notice how the ten-cycle colour burst signal sits on the "back porch" of the line synchronizing pulse.

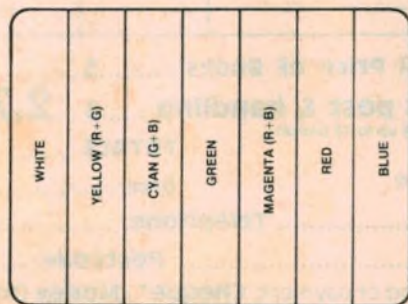

Fig. 1

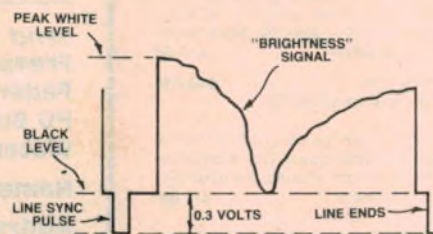

Fig. 2

Fig.1 shows the standard colour bar signal as displayed on the TV screen, while Fig.2 shows one line of a monochrome video signal.

To prevent the colour subcarrier interfering with the luminance signal and producing objectionable patterning on the received colour picture, suppressed carrier modulation is used at the TV transmitter. The colour information of the transmitted program is then sent in the form of sidebands only (see part 3). Thus, in the colour TV receiver, it is necessary to replace the missing carrier so that the original amplitude modulated colour signals can be recovered.

The colour decoder

Fig.4 shows a block diagram of a typical colour decoder. The decoder circuitry separates the various parts of the complete signal and demodulates the "U" and "V" colour signals. You will remember that the "U" signal contains the (B-Y) colour information, and the "V" signal the (R-Y) information.

In Fig.4, point "A" is where the signal from the video detector enters the decoder. If we tuned the TV receiver to a colour bar transmission, an oscilloscope connected to "A" via a 10:1 isolating probe would display the complete colour bar signal.

From point "A", the signal travels through a bandpass filter which removes the luminance signal, allowing only the chrominance information and burst signal to pass. At point "B", the signal appears as in Fig.5(a). The following chrominance amplifier supplies the signal to a burst blanking circuit, which is controlled by pulses from the line time-base circuitry. This removes the "swinging burst" signal so that the signal at point "C" appears as in Fig.5(b).

Because of the way it looks, this signal is often referred to as a "cotton reel" waveform. Two detector circuits are needed, one to demodulate the "V" signal while the other demodulates the "U" signal.

From point "C", the signal is fed to the PAL delay line and to the adder and subtractor circuits. The output from the adder circuit is the "U" signal, while the output from the subtractor is the "V" signal.

Fig.6 shows the basics of the PAL glass delay line. The incoming electronic signal is first fed to a transducer which converts it to an ultrasonic wave. This wave is then detected by a second transducer and converted back to electronic form. Because ultrasonic signals take time to travel through the glass, this gives rise to a delay time. In a PAL colour TV receiver, the delay line is manufactured to extremely tight tolerances to give a delay time of 63.943 microseconds.

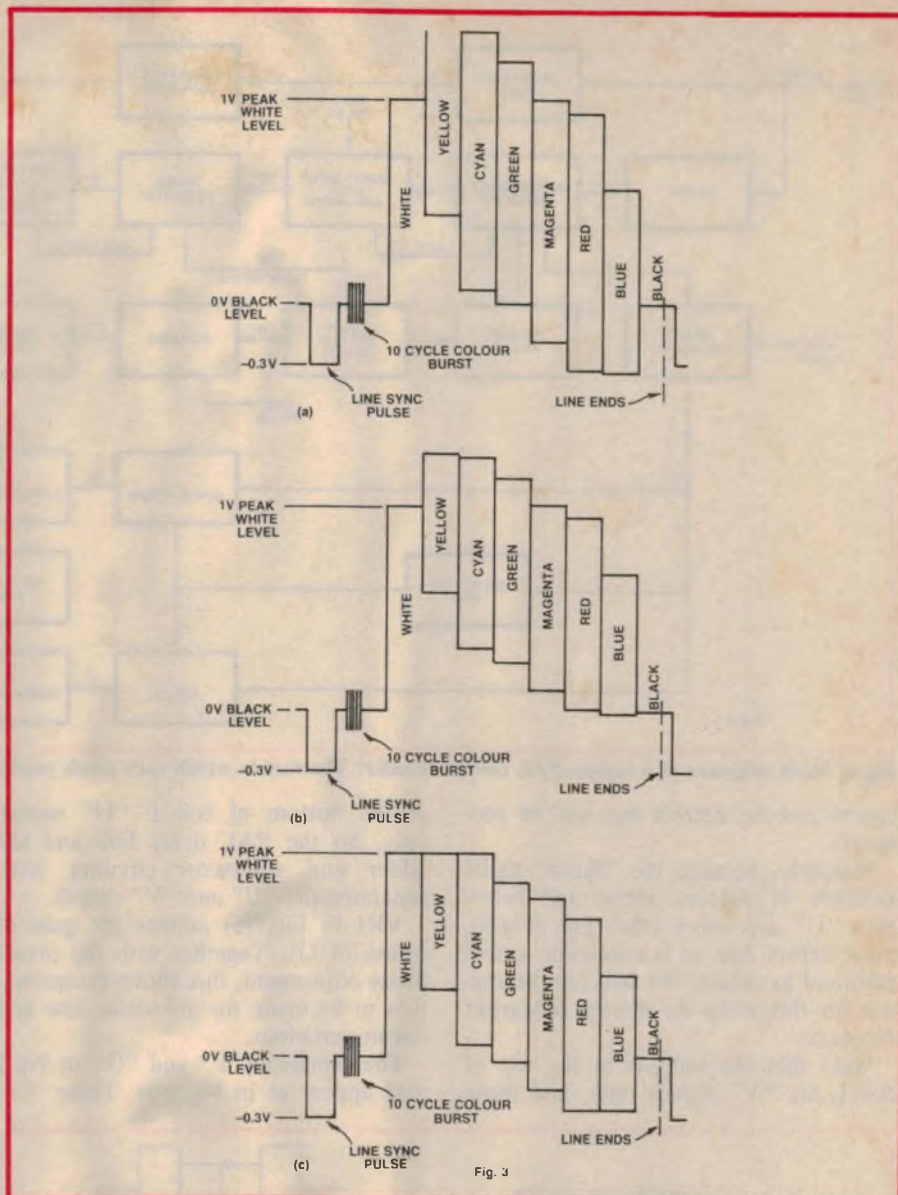

Fig.3: these diagrams show complete colour bar waveforms for varying amounts of amplitude and colour saturation (see text). Note the 10-cycle colour burst signal on the back porch of the line synchronising pulse.

Fig.7(a) shows the delay line and adder and subtractor circuitry of a typical commercial colour TV set.

Suppose that two lines of chroma information arrive at "C" (Fig.4), each line possessing the same hue and saturation. The first line, which we'll call F1, is amplified by transistor Q1 and goes through the delay line and emerges 64 microseconds later across coil L. This means that the signals at points x and y will be of equal voltage but of opposite phase. The next line of chroma information, which we will refer to as F2, arrives directly at point z at exactly the same time as line F1. Thus, lines F1 and F2 arrive together at coil L.

At point x on L, the + and - "U" signals will cancel out and the two -"V"

signals will add together to produce a signal voltage of -2"V" (Fig.7(b)). At the bottom of coil L, the + and - "V" signals will cancel out, and the two "U" signals added to produce a voltage of +2"U".

When the next line of signal arrives (line F3), line two will have passed through the delay line, and line F3 will arrive direct. The result will be as in Fig.7(c).

The "U" voltages will again cancel out, and the "V" voltages will add to give +2"V". At the bottom of coil L, the "V" voltages will cancel and +2"U" will be produced. In any two lines, hue errors will occur in opposite phase directions. Because chroma errors will be a product of two lines, the errors will

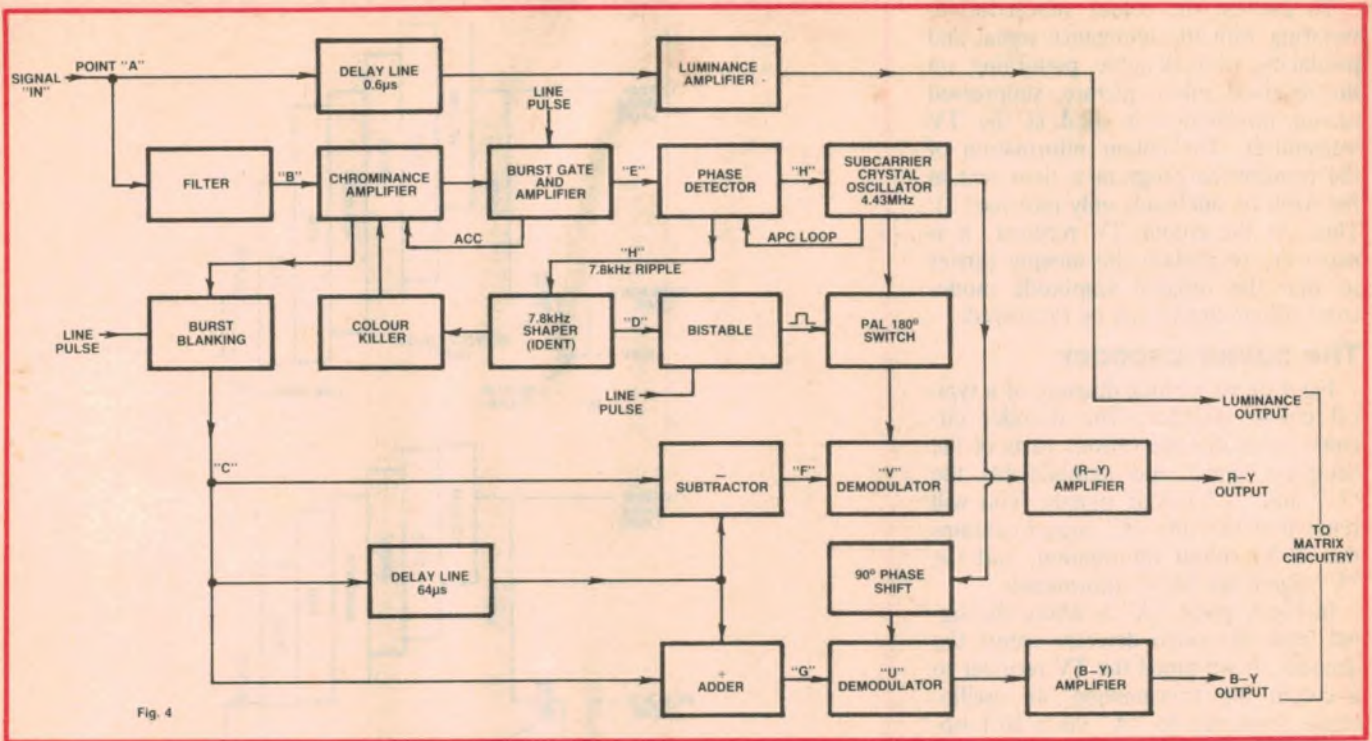

Fig. 4

Fig.4: block diagram of a typical PAL colour decoder. The way in which each block works is explained in the text.

cancel and the correct hue will be produced.

Similarly, because the "burst" signal switches 45 degrees above and below the -"U" axis every other line (Fig.8), burst errors due to transmission errors will tend to cancel. We will see the reason for this when we discuss subcarrier recovery.

Note that the outputs at the top of coil L are "V" signals only, and those

at the bottom of coil L "U" signals only. So the PAL delay line and the adder and subtractor circuitry have separated the "U" and "V" signals.

VR1 in Fig.7(a) adjusts the gain of transistor Q1. Together with the preset phase adjustment, this allows compensation to be made for any delay line and circuit variations.

The signals at "F" and "G" in Fig.4 now appear as in Fig.5(d). These "U"

and "V" chroma subcarriers, have a 90 degree phase difference between them and must be separately demodulated. However, before discussing how this is done we first need to know how the colour burst signal is used.

Separating the burst signal

The output of the chrominance amplifier, consisting of the chroma signal and the colour burst, is also applied to the burst gate and amplifier circuitry (Fig.4). A pulse from the line timebase circuitry controls (or gates) this amplifier, allowing it to operate only for the duration of the ten-cycle colour burst signal.

The amplified burst signal emerges at "E". It is then applied to the following phase detector stage, where it is compared in phase with the TV receiver 4.43MHz subcarrier oscillator.

This 4.43MHz crystal controlled oscillator is used to replace the missing subcarrier. While some texts refer to this as "re-inserting" the carrier, it is more accurate to say that the output generated by the receiver subcarrier oscillator is modulated by the "U" and "V" colour sidebands. The resulting signals are then demodulated to reproduce the required colour signals.

As shown in Fig.4, an automatic phase control (APC) loop signal is fed back to the phase detector. Fig.10(a) shows the basic circuit.

The colour burst signal is applied to

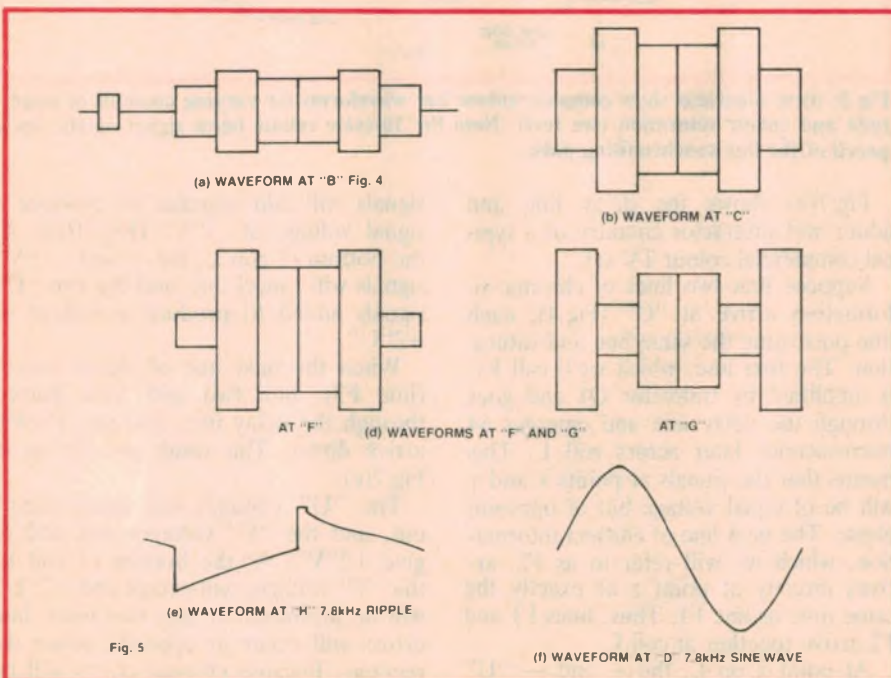

Fig. 5

Fig.5: these diagrams show the waveforms at various points on Fig.4 (see text).

connections "1" and "2" of transformer T. The signals on the secondary winding at points "3" and "4" are 180 degrees out of phase with each other. Thus, current will flow through the diodes only during positive half-cycles at position "3" and negative half-cycles at position "4". The output from the local 4.43MHz oscillator is applied to point "5".

You will see from Fig.10(b) that the local oscillator sine wave output passes through its zero position at the peaks of the burst signal. This can only happen when the phase of the oscillator "lags" exactly 90 degrees behind the burst signal. It then follows that, because the diodes are centre connected anode to cathode, there will be no DC output voltage at "H".

We know that the colour burst signal swings 45 degrees above and below the -"U" axis during every other line of picture signal (Fig.8). Thus, the "mean" or average of the phase of the colour burst signal is on the -"U" axis. The circuit is so designed that the subcarrier oscillator responds only to this mean value.

The subcarrier oscillator is thus "locked" to the same frequency and phase as the + "V" chroma signal. When the local oscillator "lags" behind the mean of the burst signal by 90 degrees there will be no DC voltage output at the wiper of preset resistor R1 (point "H"), as stated previously. However, if the frequency or phase of the local oscillator changes, the currents flowing through diodes D1 and D2 will no longer be equal, and a positive or negative DC output voltage will be produced at "H". This voltage is then applied to the subcarrier oscillator to correct its frequency and phase.

The phase detector produces another useful signal. As the burst signal swings above and below the -"U" axis, a half line frequency (7812.5kHz) pulse is produced. This pulse is amplified and shaped to synchronise the PAL switch (see Figs.4, 5e and 5f).

Some early model colour TV receivers did not contain a 4.43MHz crystal oscillator. Instead, the colour burst signal was amplified and used to energise a "ringing coil" circuit. The resulting 4.43MHz signal was then used instead of a conventional crystal oscillator, but the decoder adjustments were quite critical in such sets.

You'll find that many of the latest PAL receivers contain subcarrier oscillators controlled by an 8.867MHz crystal. This arrangement is becoming increasingly popular with manufacturers. Why

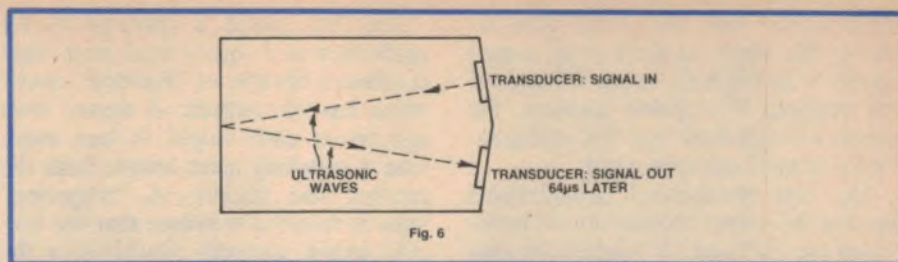

Fig.6: basic scheme for a PAL glass delay line. The output signal emerges 64µs after the input signal.

and how the 8.8MHz oscillator is used will be discussed in a later article.

Demodulating the "U" and "V" signals

Fig.9(a) shows the circuit of a popular type of synchronous demodulator. The signal from the TV's 4.43MHz subcarrier oscillator passes through R1 and R2 to points "X" and "Y". The values of the components are selected so that when "X" approaches its positive peak and "Y" its negative peak, the diodes conduct. It is only during this period of time that there is a path for the chrominance signal between point "P" and the output.

In Fig.9(b), the dotted line represents the waveform of the transmitted signal, and the solid line as it actually appears at point "P". The subcarrier frequency is of course 4.43MHz, but for simplicity is shown as just a few cycles.

Fig.9(c) shows the locally generated subcarrier, the solid portions of the line

representing the periods when the diodes conduct. Look carefully at the diagrams and you will see that, during period "A", the positive peaks of the subcarrier occur at exactly the same time as the positive peaks of the chroma signal.

However, during period "B" the phase of the incoming chroma signal changes by 180 degrees. Now the negative peaks of the chroma signal occur at the same time as the positive peaks of the local subcarrier. The result is that, during period "A", the positive half-cycles of the chroma signal are demodulated. Similarly, during period "B", the negative half-cycles are demodulated.

Fig.9(d) depicts the resulting output waveform at "Q". The solid line across the signal peaks shows the output signal after filtering by choke L1 and capacitors C1 and C2.

If the local oscillator signal is not in correct phase with the chroma carrier, the signal output at "Q" will only be a

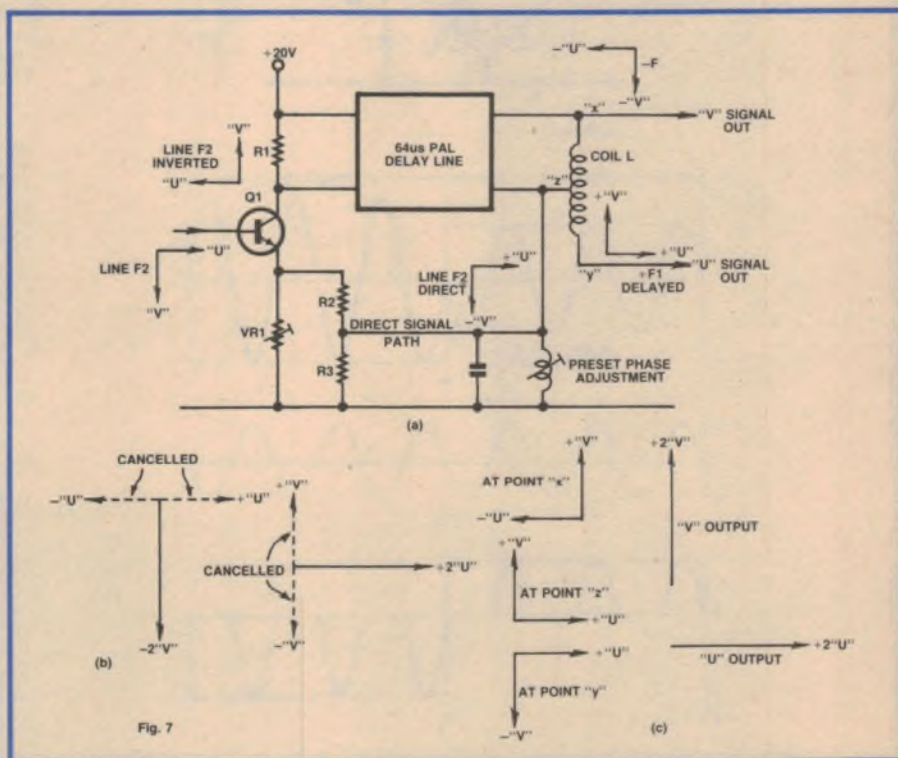

Fig.7: the delay line and adder and subtractor circuitry of a PAL colour TV set.

slight ripple. The filter stage then removes this ripple so there is no output signal. If, in Fig.9(a), diodes D2 and D3 are replaced by suitable resistors, the circuit will still work and this configuration is in fact commonly used.

The two synchronous demodulators used in the colour receiver for demodulation the "U" and "V" signals are usually identical.

Synchronising the PAL switch

There is a phase difference of 90 degrees between the transmitted "V" and "U" colour signals. For this reason, the output from the crystal controlled oscillator is phase shifted by 90 degrees before it is fed to the "U" synchronous demodulator (Fig.4).

In addition, a signal is also fed from the subcarrier oscillator to the "V" synchronous demodulator via the 180 degree PAL switch. The PAL switch must be properly synchronised to ensure that the subcarrier fed to the "V" detector is correctly "in step" with the transmitted "V" signal. You'll remember that the "V" signal is switched 180 degrees every other line at the TV station.

The PAL switch is operated by the application of a square wave from what is called a bistable or "flip-flop" circuit which has two outputs. A square wave appears at each output in turn every time a switching pulse arrives from the receiver line circuitry. A "triggering" pulse is required to ensure that the bistable circuit correctly synchronises the receiver PAL switch.

Without this triggering pulse the bistable circuit would still work. However, if the PAL switch is not correctly "in step" with the switched "V" signal as received from the TV station, incorrect colours appear in the picture. For example, if you look at the relative phase angle diagram shown in part 2 of this series, you will see that green colours would show as red.

You will see from Fig.4 that the 7.8kHz (7.8125kHz) half line frequency ripple pulse produced in the phase detector is applied to a 7.8kHz shaper circuit. Here it amplified and shaped so that a 7.8kHz sine wave signal is produced. This signal synchronises the bistable circuit, ensuring that the TV receiver PAL switch is correctly in phase with the transmitted "V+" and "V-" on each line of the chroma signal. Because

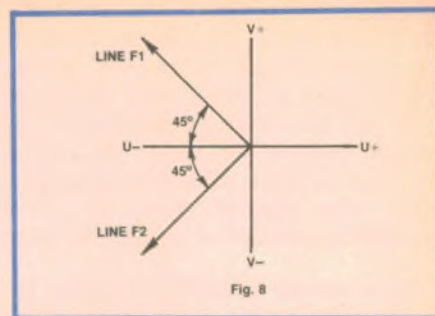

Fig.8: the colour burst signal swings 45 degrees above and below the -"U" axis on alternate lines.

the 7.8kHz sine wave correctly identifies these lines, it is referred to as the "ident" signal.

The 7.8kHz ident signal is also used to control the colour killer circuitry. As you can see from Fig.2, during a monochrome transmission the colour burst signal is not transmitted. This means that the burst signal, the 7.8kHz pulse from the phase detector, and therefore the ident signal will not be produced.

The result is that the signal from the colour killer to the chrominance amplifier is absent and thus the chrominance amplifier is biased off. The reason for doing this is very simple — if the chrominance amplifier continued to work during a black and white transmission, colour patterns and splashes would be visible on the picture.

The ACC (automatic colour control) signal from the burst gate and amplifier is fed back to the chrominance amplifier. The voltage of this signal depends on the amplitude of the received colour burst and controls the gain of the chrominance amplifier. This keeps the level of the colour saturation of the picture constant if the received signal should vary in strength.

When the PAL switch is correctly synchronised to the signal, the local 4.43MHz carrier will be in the correct phase and frequency to be fed to the "V" demodulator. As stated above, the 90-degree phase shifted oscillator signal is fed to the "U" demodulator. Following demodulation, the resulting (R-Y) and (B-Y) signals are amplified and fed to the matrix circuitry.

The NTSC decoder

An NTSC colour transmission, as you'll recall, uses "I" and "Q" signals instead of "V" and "U" signals. The "I" signal is 33 degrees from the PAL "V" signal and the "Q" signal 33 degrees from the "U" signal (see part 2 in this series). The "I" signal is not switched every other line as is the "V" signal. A block diagram of an NTSC

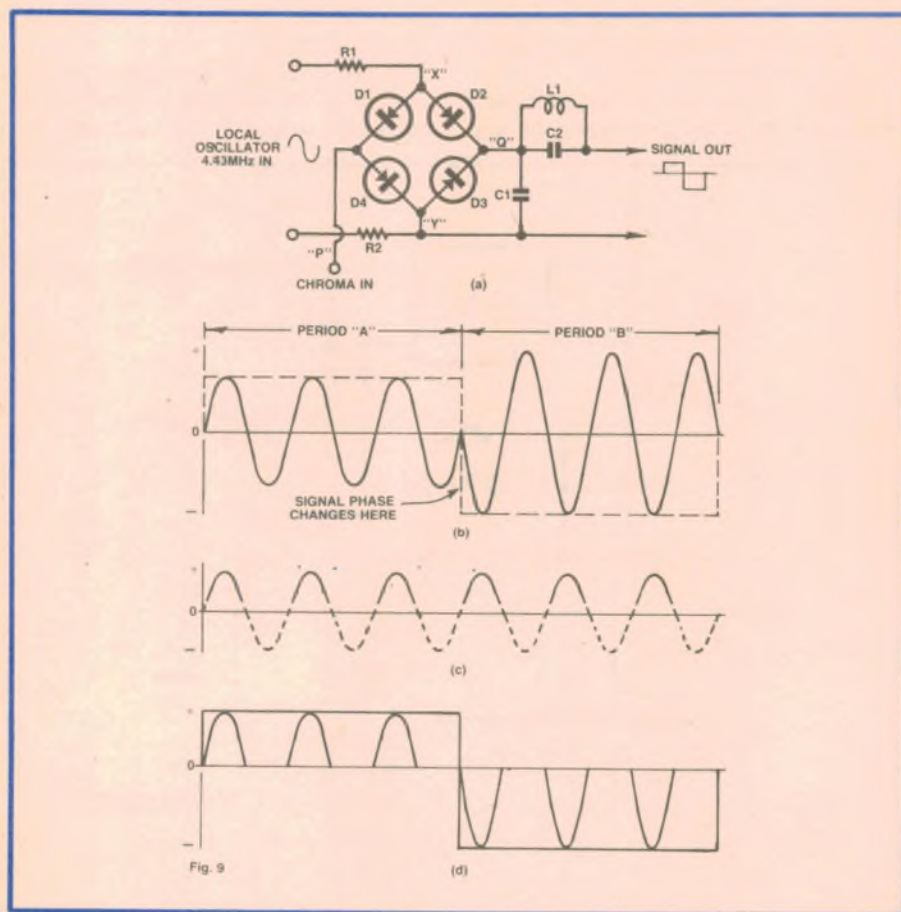

Fig.9: circuit diagram for a popular type of synchronous demodulator.

decoder resembles Fig.4 but the bistable and PAL switch circuitry would be absent.

The signal from the TV receiver's subcarrier oscillator (3.579545MHz for the USA) is sent directly to the "I" demodulator which replaces the "V" demodulator in our block diagram.

PAL-S and PAL-D

Some early PAL colour TV receivers used Pal-S circuitry. In a PAL-S (PAL-Simple) receiver, the PAL delay line and adder and subtractor circuitry is omitted. In any two lines, hue errors of the same colour occur in opposite phase directions. When this happens, the PAL-S receiver relies on the eye to average out any differences in hue.

However, if there are large colour phase errors between two close lines of picture, bar patterns, known as "Han-over" blinds, will appear on the picture. To overcome this problem, a phase control was fitted between the subcarrier oscillator and the two synchronous demodulators. The viewer then adjusted this control for maximum reduction of the blind effect.

The PAL-D (PAL-deluxe or PAL-delay) decoder, as shown in Fig.4, thus

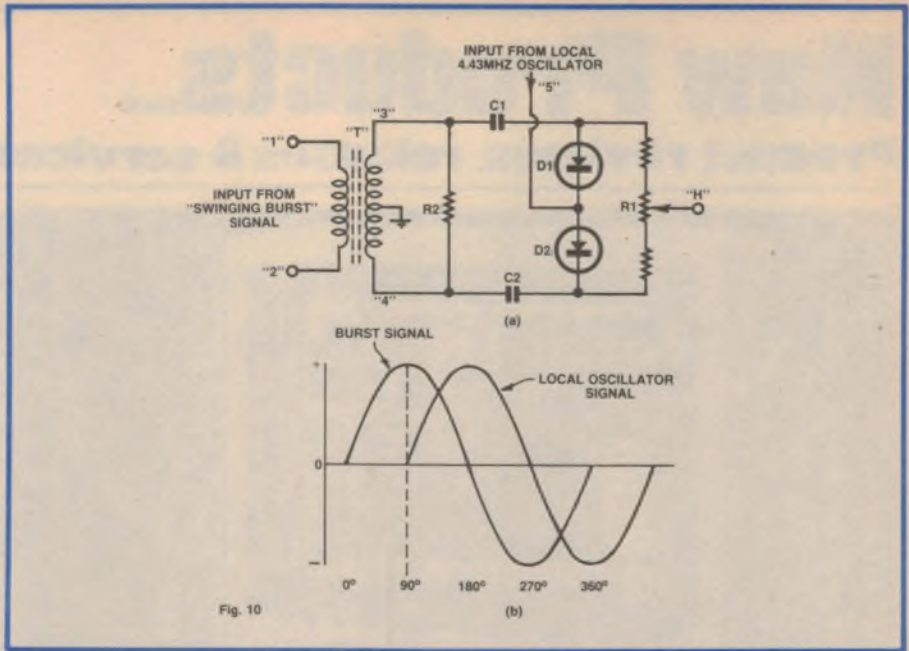

Fig.10: typical phase detector circuit.

displays a superior colour picture when compared to the simpler PAL-S receiver. For this reason, all modern sets use PAL-D colour decoders. In fact, in the very latest designs, most of the decoder circuitry is taken care of by a single large scale integrated circuit.

In part 6, we'll examine the luminance signal and describe how the signals are combined in the matrix circuitry. We'll also take a look at the signals passing through the colour difference amplifiers and discuss how the G-Y signal is recovered.

RADIO/TELEPHONE SIMPLEX INTERCONNECT

RADIO COMPATIBLE DTMF DIALLER

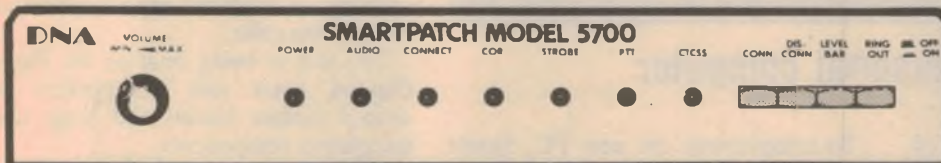

STANDARD FEATURES

- Electronic voice delay stores phone audio until transmitter is fully on.
- Single or multi-digit access code.
- Call limit and mobile activity timers.
- DTMF or regenerated pulse dialling.
- Mobile alert signalling ring detect.
- Prom programmed CW ID.
- Microprocessor controlled.

TELECOM AUST AUTHORISED

OTHER PRODUCTS:

- Australia's largest range of DTMF acoustic diallers from \$14 + S/tax.
- IQD DTMF microphones — the industry standard.
- DTMF alarm and remote control modules including phone control — remote control via telephone with voice synthesiser.
- Telephone quality keypads 3 x 3 or 3 x 4 from \$4 + S/tax.

DNA SMARTDIAL

- Auto redial feature.
- Microprocessor controlled dialler allows for TX rise times and decoder times regardless of user dial speed.
- Also available to your specs with ANI and LCD number display.

DNA COMMUNICATIONS

P.O. BOX 47, ALSTONVILLE, N.S.W. AUSTRALIA 2477
TELEPHONE: (066) 28 3454 FAX: (066) 28 3841

OR

JADE SYSTEMS INTERNATIONAL
P.O. BOX 131
WHANGAPARAO, NEW ZEALAND
TELEPHONE: (09) 424 5984

New Products...

Product reviews, releases & services



Tandy's new 1000SX personal computer

Tandy has announced the release of their new business oriented computer, the 1000SX.

The Tandy 1000SX features an Intel 8088 microprocessor which has a clock speed of 7.16 or 4.77MHz. It has five user-accessible IBM PC compatible card slots, raising the 1000SX's standard RAM complement of 384K to 640K.

To complement the new PC, Tandy has included an improved edition of the Deskmate Software. Deskmate II features six applications on one disk, and it also allows the user to exit Deskmate II to enter a program and then easily return to Deskmate.

For further information contact your local Tandy Electronics store.

Mobile telephone from Philips



Philips has developed a new cellular radio telephone for use with Telecom's MobileNet system.

Called the "Traveller", the new phone will work with telephone systems in the US and Canada as well as those in Australia and New Zealand, thus opening up potential export opportunities for Australia.

The unit is being built at the Philips Clayton plant and incorporates advanced surface mount and large scale integration components.

Telecom has exclusive Australian rights for the 'Traveller'. However, Philips also plans to release a new radio of a similar type to be sold directly by Philips in Australia and overseas.

For further information contact Philips, 15 Blue St, North Sydney, NSW 2060. Phone (02) 925 3333.

1.1GHz frequency counter from Philips

Philips has released the PM6669 frequency counter. The unit incorporates a MTCXO (mathematically temperature-compensated crystal oscillator), making the PM6669 a low-cost instrument.

In the MTCXO principle, the time-base crystal oscillator is individually calibrated by factory measurement of its temperature vs. frequency curve, which is then permanently stored in a non-volatile memory. The correction factor

for any temperature is then automatically applied to the measurement before it is displayed.

Other features of the PM6669 are: a full 9-digit display, a measuring range from 0.1Hz up to 120MHz (optionally up to 1.1GHz), high-sensitivity wide-band input circuitry with automatic, error-free triggering on all input waveforms, continuously variable attenuation, and a switchable low-pass filter for



noise suppression.

For further information contact Philips Scientific and Industrial, 25-27 Paul St, North Ryde, NSW 2133.



Icom's new M-700 marine transceiver

Icom has released a new addition to their marine transceiver range.

The M-700 is a 48-channel high frequency SSB/AM marine transceiver which is able to transmit and receive on any authorised marine channel from 2 to 23MHz with up to 150 watts output.

Allocation of frequencies to the 48 simplex and semi-duplex memory channels can be made according to individual requirements.

Frequency selection is controlled by

two rotary channel switches. The first controls channel group selection, with three channel groups (A, B and C) in logical order according to purpose and a fourth position providing instant emergency access to the 2182kHz International Safety and Calling Frequency. The second controls selection of 16 frequencies within each logical channel group.

The M-700 is fitted with a signal "clarifier" to adjust the pitch of received SSB signals, making off-frequency signals easier to understand.

For further information contact Icom Australia, 7 Duke Street, Windsor, Vic. 3181. Phone (03) 529 7582.

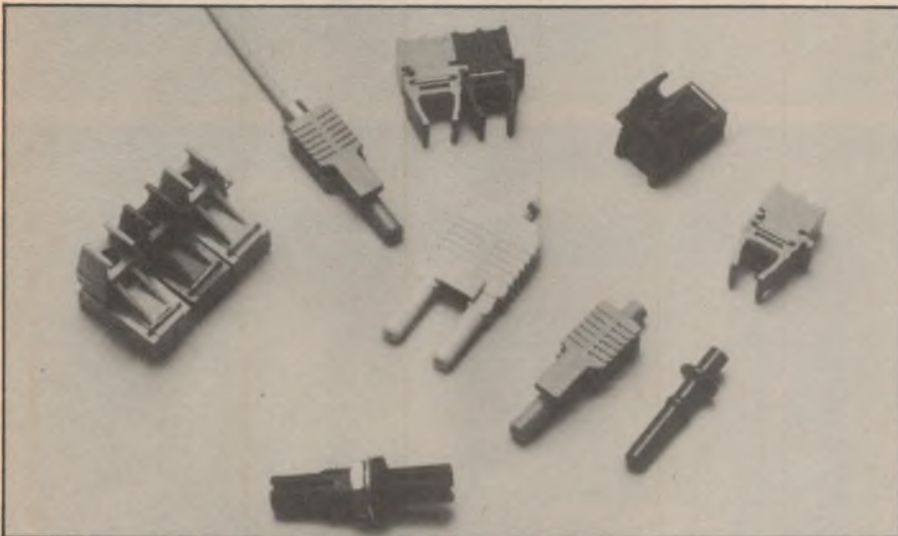

HP's new link fibre-optic components

Hewlett-Packard has released the new Versatile Link fibre-optic components which are designed to be used in plastic fibre-optic applications.

Three categories of performance are offered: standard at 1Mbd up to 5 metres; high performance at 1Mbd up to 40 metres; and high performance at 5Mbd up to 25 metres.

The new link features a choice of package, connector, cable and optoelectronic performance. The three types of connectors offered include: simplex, simplex latching and duplex.

For further information contact VSI Electronics (Australia) Pty Ltd, 16 Dickson Avenue, Artarmon, NSW 2064. Phone (02) 439 4655.

Compact lab supply from Amtex

Amtex Electronics has released the MS-200 four output laboratory power supply.

The MS-200 is modular and allows the customer to select any four modules to suit their requirements from the following voltage ranges: 4.4 to 5.6V at 5 to 10A output; 11 to 17V at 2 to 3.5A; 21 to 28V at 1 to 2A; and 42 to 55V at 0.5 to 1A.

The unit has red LED readouts for voltage indication and green readouts for current indication. Maximum output voltage ripple is 50mV p-p and load regulation is within 1%.

For further information contact Amtex Electronics, 36 Lisbon Street, Fairfield, NSW 2165. Phone (02) 727 5444.

IBM PC compatible motherboard

For those needing a new motherboard for their IBM PC, Electronic Solutions is now selling a high-quality 10MHz no-wait-state motherboard.

The board is a direct drop-in replacement for the IBM PC board but runs at around four times the speed. It has complete IBM compatibility, uses a 8088-1 processor and comes complete with 640K of memory, using the latest high speed 41256 chips.

For further information contact Electronic Solutions, PO Box 426, Gladesville NSW, 2111. Phone (02) 427 4422.

"C" Compilers for Single-chip micros

"C" Cross compilers for PC/XT/AT and VAX hosts by IAR for:

- ★ 8051
- ★ 68HC11
- ★ 6301/6801/6803
- ★ 64180

FEATURES:

- ★ ANSI "C" standard
- ★ IEEE 32 bit floating point
- ★ Trig. exp. and log. functions
- ★ Easy interface to assembler
- ★ Produces compact, romable code

Package includes compiler, assembler, universal linker, librarian and run-time library.

MACRO DYNAMICS LTD
The Development System Specialists

80 Lewis Rd., Wantirna South 3153.
Tel: (03) 220 7260 Fax: (03) 220 7263

New Products...

Portable microwave spectrum analysers

Hewlett-Packard has announced the release of two new portable, programmable microwave spectrum analysers for

laboratory, field and production-line use.

Features of the HP 8562A and 8562B spectrum analysers include meeting MIL-T-28800C, Type III, Class 3, Style C requirements for ruggedness; five-minute warm-up time; synthesized tuning; AM/FM demodulators and speaker; continuously self-adjusting IF section; and a plug-in test and adjustment module that speeds trouble-shoot-

ing and adjustments.

The new units are suitable for applications such as the manufacture and maintenance of terrestrial and satellite microwave links, radar systems, telecom equipment, CATV and LAN systems, mobile and cellular radios, AM/FM/TV broadcast equipment and avionics.

For further information contact Hewlett-Packard Australia Limited, PO Box 221, Blackburn, Vic. 3120.

Non-contact measuring system

Ultrasonic Arrays has released a new ultrasonic distance measuring system, the DMS-1000.

The new unit measures distance, position and thickness to an accuracy of ± 0.001 inches. Measurements can be obtained from most materials, solid, soft or liquid.

Included in the system is a 33mm ultrasonic transducer connected by cable to a microprocessor based system controller in a NEMA 13 enclosure.

The DMS-1000 can be used as a stand-alone gauging system or in a closed-loop process control system. The controller comes standard with RS-232, 422 and 16-bit parallel outputs for interfacing to host computers, programmable controllers, recorders, printers or other system components.

For further information contact Elmeasco, 15 McDonald St, Mortlake, NSW 2137. Phone (02) 736 2888.

New digital oscilloscope from Tektronix

Tektronix has announced the release of their new model 2430A digital oscilloscope which is claimed to be much easier to set up for complex measurements.

The 2430A's new built-in interface greatly expands the scope's capabilities. Features included are Auto Setup which sets up the scope for unknown signals; Waveform Parameter Extraction which allows the user to select and make complex measurements with the push of a button; AutoStep which builds, stores and runs test procedures; and Save on Delta which checks signals against user defined limits.

For further information contact Tektronix Australia Pty Ltd, 80 Waterloo Rd, North Ryde, NSW 2113. Phone (02) 888 7066.

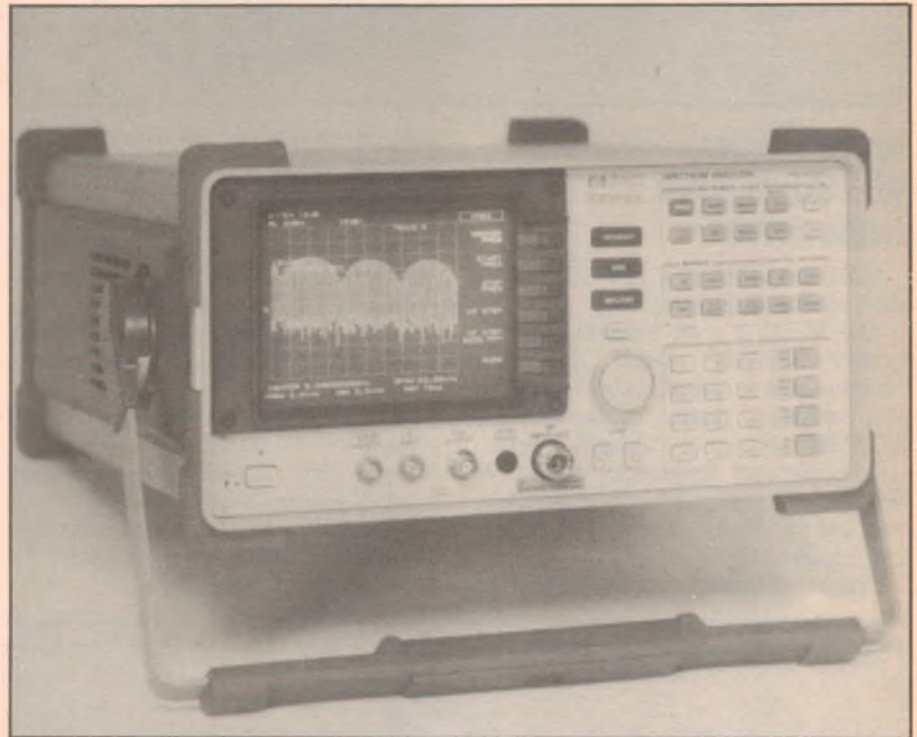

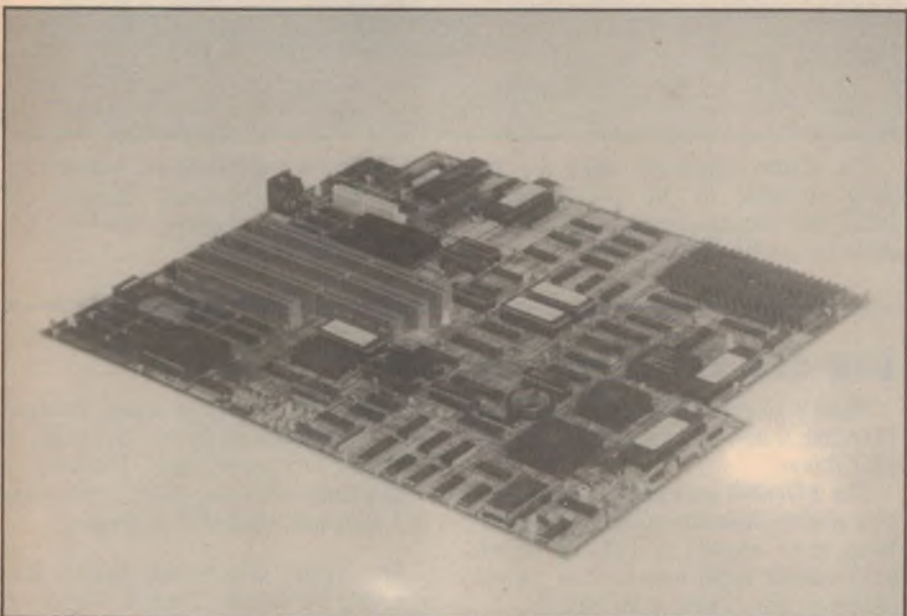
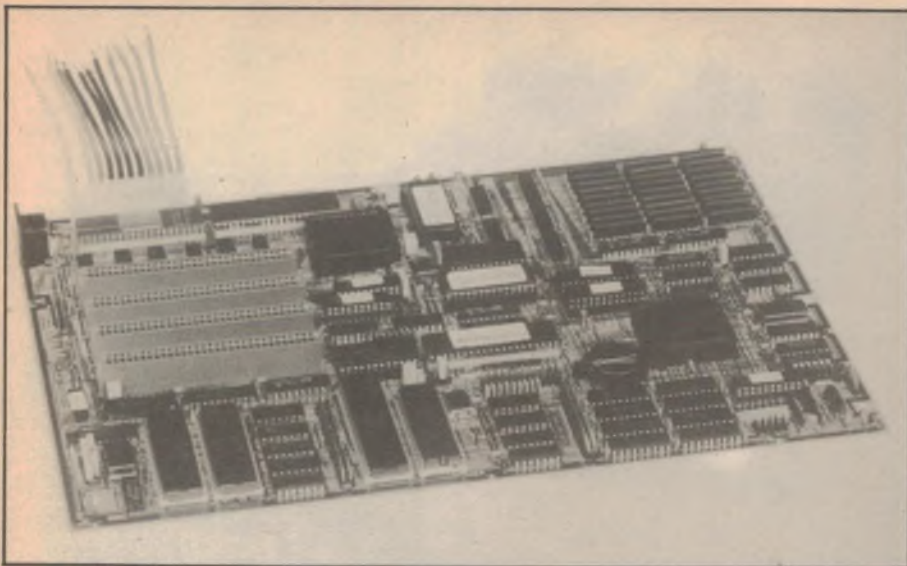

Pulsar's new PC XT/AT compatible motherboards

Pulsar Electronics has released two PC-compatible motherboards. The PC/XT and PC/AT motherboards have high on-board functionality and flexibility. Both have been designed for low power consumption and high speed operation, and to eliminate the need for additional function cards.

Each motherboard has EGA Monochrome text and graphics, Hercules, CGA, EGA and Plantronics video standards on board, software selectable between modes, auto-detection of connected monitor types, 256K-bytes Dual Port Graphics RAM on board, and flicker-free scrolling in all modes.

Also featured are twin RS232 ports, one parallel Centronics port, one floppy controller port capable of reading disk formats from 360K to 2M-bytes, a

games port for dual joy sticks and a keyboard port.

The Pulsar PC/AT has an Intel 80286 processor running at software selectable speeds of 10MHz or 5MHz, and 1M-byte of 100ns dynamic RAM on board with no wait states. A socket is provided for a 10MHz 80287 maths co-processor.

The Pulsar PC/XT has an Intel 8088-1 processor, with software selectable speeds of 4.77MHz, 7.15MHz and 9.45MHz and a socket for the 10MHz 8087-1 co-processor. On board memory is 786K of dynamic RAM (100ns) with no-wait states.

For further information contact Pulsar Electronics, Lot 21 Catalina Drive, Tullamarine, Vic. 3043. Phone (03) 330 2555.

Programmiers



EP232

◆ The EP232 has proved itself to be a reliable low cost programmer. It combines simplicity of use with the convenience of a self contained RS232 device.

FLEXEPROM

◆ A versatile new programmer able to program just about any EPROM, CMOS EPROM or EEPROM as well as single chip micros. No personality plugs are required; device pin details and programming parameters are contained in a user editable configuration file.

◆ Intelligent & Normal Programming

◆ Intelligent Identifier

◆ Easy to use menu driven S/W

◆ Screen based editor

◆ Standard RS232 interface



TTL PROM ADAPTERS

◆ Convert the EP232 or FLEXEPROM into a FUSIBLE LINK programmer able to program a wide range of TTL PROMS.

ALL AUSTRALIAN

◆ Designed and manufactured by

Diamond Systems

Call for details (03) 714 8269
P.O. Box 105, Hurstbridge 3099

New Products...

New recombination electrolyte battery

Pacific Dunlop's Industrial Divison has released a new Australian-made battery which uses recombination electrolyte (RE) technology to provide low cost standby power in industrial systems.

The Exide Safeguard suits float/recharge applications, including emergency lighting, alarm and security systems, switchgear control, uninterruptable power supplies, standby engine/generator starting and communications.

By using the RE principle, Pacific Dunlop has been able to produce a battery which is light in weight and offers a low watt-hour cost. Oxygen generated in recharging is immediately recombined internally, eliminating gassing or any other form of emission or exudation.

The design allows the battery casing to be sealed completely against interference, pollution and the risk of explosion from external ignition.



The Exide Safeguard units are initially available in the 2-Volt Model 2v220 and the range will soon also include the 12-Volt Model 12v38.

For further information contact Pacific Dunlop Industrial Divison, 55 Bryant Street, Padstow, NSW 2211. Phone (02) 774 0500.

Comair Rotron announces new brushless fan

Comair Rotron have introduced a new brushless DC fan technology: ThermoPro-V. This incorporates voltage regulated circuitry which allows internal adjustment of fan performance. Many components on the fan's printed circuit board have been replaced with a custom bipolar chip, enabling a second chip to be added which offers three new control capabilities: Thermal Speed Control, Programmability and Voltage Regulation.

The Thermal speed control is designed to control fan airflow as a function of temperature. It maintains required cooling levels, while keeping

Low-cost FET driver from Theta

Theta-J Corporation has released the FDA200, a new optically-isolated MOS-FET driver.

The FDA200 incorporates a proprietary photovoltaic integrated circuit enabling it to convert a TTL or CMOS level current input into a 12 or 14 volt output to drive discrete MOSFETs.

The FDA200's two optically-isolated

outputs may be used in series, in parallel, or independently to drive MOS-FETs for DC or AC loads. The unit operates from -40°C to $+85^{\circ}\text{C}$ and comes in a standard 8-pin DIP package.

For further information contact Rifa Pty Ltd, 202 Bell St, Preston, Vic. 3072. Phone (03) 480 1211.

noise and power consumption to a minimum.

The programmable voltage regulator allows a single fan to be customised to meet different airflow applications. The fan can be designed for minimum airflow performance while remaining

within the regulated voltage range. If airflow and performance remain constant, noise and power consumption will be minimised.

For further information, contact Total Electronics, 9 Harker Street, Burwood, Vic. 3125. Phone (03) 288 4044.



GET THE PICTURE

FOR THE RIGHT SATELLITE TV EQUIPMENT AT THE RIGHT PRICE...

Dial VIDEOSAT'S TOLL FREE NUMBER

(008) 22-6865



Dealers in all areas
Trade Enquiries welcome



CATCH OUR BUS & SEE THE WORLD THROUGH THE EYES OF AUSSAT



83 Alexandria Parade (Postal: P O Box 427)
Wahroonga, NSW, 2076
Telephone (02) 489 5474

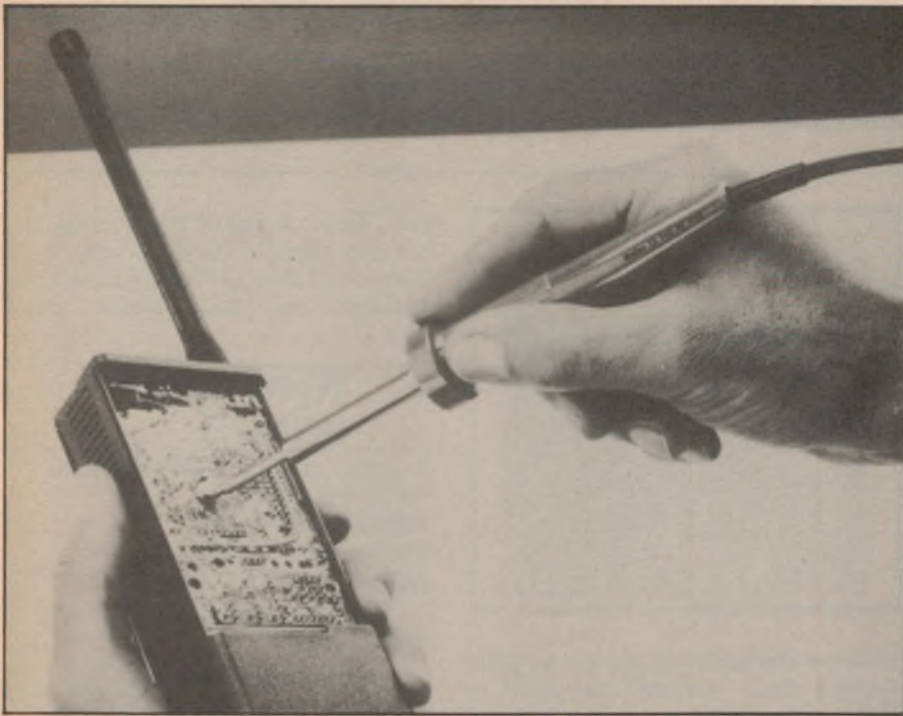

New soldering iron from Weller

Cooper Tools has released the Weller SP30 portable 12 Volt soldering iron rated at 30 Watts.

The new iron is supplied with non-polarised battery clips and a 4.5 metre long lead, allowing use some distance from the battery power source.

A range of 4mm wide tips is available, in cone, screwdriver, chisel and spade types.

For further information contact Cooper Tools Pty Ltd, PO Box 366, Albury, NSW 2640. Phone (060) 21 5511.

Long life aluminium electrolytic capacitors

Elna Co. Ltd has begun production of the RKA series of Telecom/Commercial aluminium electrolytic capacitors. The main feature of the new capacitors is their minimum guaranteed life span of 4,000 hours at 130°C or 20 years at 75°C.

A major factor in the longer life span of the new series is the use of a new electrolyte fluid which is highly stable at very high temperatures.

Other features include a static capacitance of 2.2µF to 2,200µF; voltage rating of 10V to 250V; and operating temperature range of minus 55°C to 130°C.

The main applications for the RKA Series are expected to be in telecommunications, automotive and test equipment, and in switchmode power supplies.

For further information contact Soanar Pty Ltd, 32 Lexton Road, Box Hill, Vic. 3128. Phone (03) 895 0222.

New operational amplifier from Precision Monolithics

Precision Monolithics Inc has announced the release of the OP-42; a new high-speed, fast-settling precision operational amplifier. The OP-42 features unity-gain stability and a minimum symmetrical slew-rate of 50V/µs. Its gain-bandwidth product is typically 10MHz and it offers a guaranteed settling-time of 1µs to 0.01%.

The new op amp has a minimum open-loop gain of 500,000 into a 10kΩ load. Common-mode rejection is 88dB minimum and it has a low offset voltage of 750µV.

The OP-42 is available in an 8-lead TO-99 metal can or ceramic mini-dip, or in a 20-lead ceramic leadless chip-carrier for operation over the military and industrial temperature ranges.

For further information contact VSI Electronics (Australia) Pty Ltd, 16 Dickson Avenue, Artarmon, NSW 2064. Phone (02) 439 4655.

KALEX

UV MATERIALS

3M Scotchcal Photosensitive

		Pack Price	
		250 x 300 mm	300 x 600 mm
8001	Red/Aluminium	\$70.15	\$80.75
8005	Black/Aluminium	\$70.15	\$80.75
8007	Reversal film	\$38.20	\$51.40
8009	Blue/Aluminium	\$70.15	\$80.75
8011	Red/White	\$63.20	\$72.70
8013	Black/Yellow	\$63.20	\$72.70
8015	Black/White	\$63.20	\$72.70
8016	Blue/White	\$63.20	\$72.70
8018	Green/White	\$63.20	\$72.70
8030	Black/Gold	\$88.90	\$108.00
8060	Black/Silver	\$63.20	\$72.70

UV PROCESSING EQUIPMENT

KALEX LIGHT BOX

- Autoreset Timer
- 2 Level Exposure
- Timing Light
- Instant Light Up
- Safety Micro Switch
- Exposure to 22in x 11in

\$599.00 + ST

KALEX "PORTU-VEE"

- UV Light Box
- Fully Portable
- Exposure to 10in x 6in

\$199.00 + ST

PCB PROCESSING

KALEX ETCH TANK

- Two Compartment
- Heater
- Recirculation (by Magnetic Pump)
- Two Level Rack • Lid

\$595.00 + ST

RISTON 3400 PCB MATERIAL

SIZE INCHES	SINGLE SIDED	DOUBLE SIDED
36 x 24	\$90.00	\$117.00
24 x 18	\$45.00	\$ 58.50
18 x 12	\$22.50	\$ 29.25
12 x 12	\$15.00	\$ 19.50
12 x 6	\$ 8.00	\$ 10.00

All prices plus sales tax if applicable

KALEX 40 Wallis Ave.
East Ivanhoe 3079
(03) 497 3422
497 3034
Telex AA 37678



ELECTRONIC COMPONENTS & ACCESSORIES
• SPECIALIST SCHOOL SUPPLIERS

Compact Disc Reviews

by RON COOPER

HARY JANOS SUITE

Kodaly

Arpad Joo

Budapest Philharmonic Orchestra (Nos. 1 & 3)

Hungarian State Concert Orchestra (No. 2)

Hungarian Radio Choir (No.3)

Hary Janos Suite; Concerto; Summer Evening. Sefel Records SE-CD5515.

Playing time: 58 min 26 sec

PERFORMANCE

1 2 3 4 5 6 7 8 9 10

SOUND QUALITY

1 2 3 4 5 6 7 8 9 10



Viennese musical clock but it is all quite exciting music, modern (composed in 1926), colourful and a contrast to the baroque and romantic music I am always raving about.

The second work on this disc, the Concerto, was written in 1939 for the 50th anniversary of the Chicago Symphony Orchestra. It is a charming one movement work. The third and last work, Summer Evening, is an idyllic piece for a chamber orchestra.

The sound on this disc is somewhat subdued at times yet overall very good. It is miked a little further away than say Decca and at times there is slight background hiss. The balance is fine but not spectacular. For best results this disc should not be played too loud as it is not recorded front row, rather one third

back. Hence a slightly lower sound level is more natural. On the whole, I can recommend this disc for its superb performance and fine overall sound. (R.L.C.)

Water Music — HANDEL

Academy of St. Martin-in-the-Fields

Sir Neville Marriner

Philips 416 447-2 ADD

Playing time: 52 min 16 sec

PERFORMANCE

1 2 3 4 5 6 7 8 9 10

SOUND QUALITY

1 2 3 4 5 6 7 8 9 10

Written in the summer of 1717 for a Royal party on the river Thames, the Water Music was an immediate success which was reported in the "Daily Courant" some two days later.

There are three suites and this disc contains all of them in their complete form. They have striking orchestration and the main body of strings is complemented by a large and varied wind section with frequent use of oboes and bassoons. Trumpets are added with french horns in the D & F suites. In addition, there are some very colourful movements featuring recorders to great effect.

The playing by the Academy here could be described as very crisp with a

"Hoots, mon! Let Angus Mac Westinghouse show you how to save your computer money."



Westinghouse Systems

COMPUTER PROTECTOR

'After three years, still the most cost effective'

... protects your computer memory against spikes, glitches, lightning, on-off switches, electric motors etc. Max. peak surge current up to 4500 amps; transient energy absorption up to 75 joules.

PIF3-1A 1AMP 2STAGE +E.L.C.
PIF3-3A 3AMPS 2STAGE +E.L.C.
PIF3-6A 6AMPS 2STAGE +E.L.C.
PIF3-10A 10AMPS 2STAGE +E.L.C.

Engineered and manufactured in Australia for Australian conditions.

80-86 Douglas Pde., Williamstown, Vic. 3016. Tel: (03) 397 1033. Tlx: 37477.

N.S.W.: Bryan Catt Industries P/L. Tel: (02) 526 2222.

QLD: Colourview Wholesale. Tel: (07) 275 3188. S.A.: F.R. Mayfield P/L. Tel: (08) 212 3161.

W.A.: Geo. Moss P/L. Tel: (09) 446 8844.



WS31/1



Information centre

Problem with AM/FM stereo tuner

I am writing to request information on the operating conditions for the AM local oscillator in the AM/FM stereo tuner described in December 1985 to March 1986.

I achieved an acceptable performance from the oscillator by reducing VR1 to give a reading of about 0.6V on the emitter of Q4. At this setting, VR1 is about 50Ω and the emitter current about 12mA. This value of emitter current is much greater than the 1-3mA used in most AM oscillator circuits I have seen. It concerns me that the oscillator is not operating in the way intended.

Consider the operating conditions with VR1 adjusted to give the recommended reading of 1.6V on the emitter of Q4. The base of Q4 will be at about 2.1V (allowing for some conversion of signal to bias at the base-emitter junction) and the top of the biasing potential divider at about 5.1V (assuming the base current to be negligible in comparison with the current through the divider). The current through the 560Ω decoupling resistor will be 12.3mA and the collector/emitter current about 11.7mA. Thus, VR1 will be about 140Ω.

This analysis seems to confirm the high emitter current, but why is VR1 specified as a 4.7kΩ trimpot when a 470Ω unit (say) would greatly facilitate adjustment? Alternatively, if VR1 is presumed to be about 2kΩ (half setting) when adjusted to give 1.6V at the emitter of Q4, then the emitter current will be about 1mA, but the supply voltage would have to be about 6V to give the correct bias conditions.

Could you please provide the design operating conditions for the AM oscillator; in particular, the emitter current (which determines the collector voltage and influences the signal amplitude) and the signal voltage at the secondary of the oscillator coil?

To investigate the problem further I cobbled together an oscillator on a scrap of Veroboard. This used a coil wound on a plastic former with the number of turns for all windings scaled

up (by a factor of about 1.5) to account for the lower permeability of the coil former, fixed capacitors for tuning rather than a varicap, and a BF185 transistor which I had in the junk box.

This transistor had an h_{fe} of 90 (measured on a DMM) compared to 85 which I measured for the BF494 in my tuner. Despite the different components, the two oscillators performed in virtually identical fashion. In particular, both delivered too much output (about 12V p-p at the secondary of the oscillator coil) with VR1 set for a reading of 1.6V at the emitter of Q4, and both displayed a tendency to "squegging" when VR1 was increased beyond about 250Ω. When the transistor was replaced by a lower gain type (BF167 with $h_{fe} = 47$) the output was reduced significantly and the tendency to "squegging" virtually eliminated.

At about the same time, I noticed in the photographs of the prototype AM/FM tuner that the oscillator transistor has a metal can encapsulation, while the BF494 has a plastic encapsulation. What transistor type was used in the prototype? My own observations suggest that the oscillator works far better with low gain transistors. (J.S.T., Elermore Vale, NSW).

- The Q4 transistor used in the prototype was a BF115. However, the recommended BF494 was also tested in the circuit.

A 4.7kΩ trimpot was used for VR1 since it allows a greater range of adjustment for minimum noise of the AM tuner. After testing a completed tuner kit we found that the voltage across VR1 could be set to 3.2V with VR1 at about 1.5kΩ. On that particular tuner this gave minimum noise.

The signal voltage for the oscillator is the maximum that will give the total AM frequency range as detailed in the alignment procedure. A greater signal level will restrict the local oscillator low frequency range while a smaller signal will give more noise for AM reception.

Tunable whip antenna

I have invested considerable time and money in construction the tunable whip project described in *Electronics Australia*

July 1986, but have run into serious problems with its operation. The unit performed well enough on the short-wave bands from 1.5 to 30MHz, and when linked with my FRG-7 receiver. However, when tuned to broadcast band frequencies I get nothing except background noise.

So I went to work at the bench with multimeter, RF oscillators and oscilloscope. To cut a long story short, I cannot transfer signals in the 0.5 — 1.5MHz range from the whip "input" to the DC side of C3, using either current or voltage feed (they don't even get to the DC side of C1). Furthermore, the performance over the higher SW frequencies bears no relation to what would be expected from the graphs in Fig.2, page 52.

I have checked the varicaps, the inductances etc and duplicated the whole thing on breadboard to facilitate trouble-shooting — all without success.

Could you therefore help me on what to look for at various points throughout the masthead circuitry, or alternatively put me in touch with the author of the article for further assistance. (R.D.F., Forest Hill, Vic).

- As far as your broadcast band reception is concerned, all we can suggest is that you check the L1 winding and the type of ferrite or iron powder core used.

We have sent the letter on to the author hoping that he may have further suggestions.

Metric clock oversight

Having read your April 1987 issue, my attention was drawn to A. Layabout's design for a Metric Clock. However, I believe I have found a fallacy in his circuit description: surely, if the length of a metric second is only 0.864 olde seconds, and a "Hertz" is defined as one "cycle per second", then the metric mains frequency (assuming that the energy authorities are not about to change their power systems) will now be known as 43.2Hz.

I hope A. Layabout is able to respond to this letter before April 1st next year. (C.W., Applecross, WA).

- Unfortunately, you have uncovered a

serious oversight in the preparation of the article on Metric Time and the people responsible for preparing this article have been severely reprimanded. In fact, the Metric second requires a new unit for frequency. Instead of Hertz which relates to the olde second, we propose the new unit of frequency as Herring, abbreviated to Hr. The mains power frequency would then be 43.2 Herrings. Understand?

Herring has a German ring to it, so it provides some continuity with Hertz. Herring also has the possibility of colour being applied to it. For example, you could have blue Herrings to describe events which occur with depressing regularity and red Herrings for events which don't need to be measured.

Parking lights reminder false triggers

I built the parking lights reminder project described in *Electronics Australia* July 1986 and installed it in the car, a current model Ford Laser.

All worked as specified until I turned on the ventilating fan. The reminder made slight scratching noises rather like a mouse under the dash. Then, when the turning indicators were used, the noise was a bit more pronounced. Then when the rear window wiper was used, it made half hearted chiming noises.

Finally, when the air conditioner, which has a fan, was turned on, it almost made the full chime sound. The air conditioner cycles on and off about every two minutes so the chimes were going most of the time.

When you stop the engine with the air conditioner going, the chimes do not sound because they have already gone through the chime cycle and stopped.

Have you had any other complaints of the same sort and do you know the cause of the problem and how to fix it? (R.G., Croydon, Vic).

• The problem you have described is probably due to large voltage spikes on the supply lines switching transistor Q1 on and thus providing power to the remaining circuit.

Depending on where these voltage spikes are coming from, there are two possible solutions. If there are positive spikes on the line from the headlight switch, the solution would be to connect a 10 Ω resistor in series with the line. Together with the 100 μ F input capacitor, this will act as a short time-constant filter.

Alternatively, if there are negative voltage spikes on the line from the igni-

tion switch, the solution would be to bypass the 1k Ω resistor associated with D1 and D2 with a 10 μ F 16VW electrolytic capacitor.

Steering for a remote control car

I am in the process of making a remote control car out of a lawn mower motor. I have a problem though. I need something stronger than a servo to steer it, as it will be quite heavy when it is finished. My idea is to somehow take the wires going to the servo motor and re-route them to a bigger motor; eg. a windscreen wiper motor.

One problem is that the motor draws a lot of current from the servo, so I need to amplify the current. Another problem is that the polarity changes. For example, right turn has two polarity changes: (1) from centre to right, and (2) from right back to centre. The same situation applies for left hand turns.

I hope you understand and can help me out. (D.D., Deer Park, Vic).

• We understand your problem although we are not able to offer a ready solution. We suggest you refer to the article entitled "Cruise Control for Cars" published in the June 1984 issue of *Electronics Australia*. This used a servo amplifier to drive a wiper motor, so it may be of use in your application.

Remote control for gates

I am converting our front gates to remote control, using a pair of 12V motors to operate them.

However, I have been unable to get a suitable control unit. I need a transmitter with a range of about 35m and the ability to provide for forward and reverse operation of the motors.

One of the staff of the Dick Smith shop in Brisbane suggested that you might have a design which would be suitable. I note that in the April issue of *Electronics Australia* you refer to a remote control switch described in the January issue. I have not seen this article but assume it is only for on-off switching — not reversible.

Alternatively you may be able to suggest possible suppliers of suitable made-up units or kits. (R.D.J., Newrybar, NSW).

• According to the designer of the UHF remote switch described in the January 1987 issue of EA, the transmitter has a range of up to 50 metres in open space. The receiver could also be adapted to alternately turn on two

relays, one for forward, one for reverse, by using the second section of the 4013 dual flipflop, IC3.

Playmaster 60/60 blows output transistors

I would appreciate any help you could give me regarding a problem I have had with the Playmaster 60/60 amplifier.

In the past fifteen years I have serviced (as a hobby) many amplifiers and have built twelve complete stereos. The Playmaster 60/60 is the first kit set I have built, the previous ones being completely from scratch. In other words, I am not inexperienced but this problem with the Playmaster has me beat.

I bought the kit from Altronics in August of last year. Construction went smoothly and the pre-operational check went according to the magazine article. After two hours of use one pair of MJ55003/MJ5004 transistors blew. Everything was checked and the transistors replaced but the same thing happened again, this time in the opposite channel.

I read the errata about changing to the MJ340 transistor for improved thermal tracking. After doing this the exact problem recurred two more times. At one stage, four of the 1 Ω 1W resistors stopped working.

As a last resort I mounted the four power output transistors on the bottom of the chassis for maximum heatsinking but this time the MJ5003/MJ5004 pair blew after only ten minutes. As before, everything had been checked prior to switch-on, especially using the 100 Ω resistors to set the quiescent current.

As you can see this is starting to cost me a lot of money so I don't want to work on it anymore unless you have some idea as to what the problem could be. At all times, the voltages have been exactly as specified in the circuit diagram. After each "blow-up" the heat-sink has been too hot to touch. (R.W. Lake Grace, WA).

• The problem with thermal runaway appears to be caused by instability. First, check the value of the 68pF compensation capacitors between base and collector of Q11 in both channels. This should read 68p. At least one kit supplier has incorrectly supplied 0.68pF capacitors which read p68. The transistor heatsink should also be earthed. Both these problems were covered in the article entitled "Feedback on the Playmaster 60/60 stereo amplifier" published in the May 1987 issue of EA. E

EA marketplace EA marketplace

ADVERTISING RATES FOR THIS PAGE

SMALL ADS: The minimum acceptable size of 2 centimetres x one column costs only \$40. Other sizes up to a maximum of 10 centimetres are rated at \$20 a centimetre. CLASSIFIEDS: \$4 for 40 letters. Just count the letters divide by 40 and multiply by \$4, ROUND UP TO NEAREST WHOLE NUMBER. CLOSING DATE: Ads may be accepted up to the 18th of the month two months prior to issue date. PAYMENT: Please enclose payment with your advertisement. Address your letter to THE ADVERTISING MANAGER, ELECTRONICS AUSTRALIA, PO BOX 227, WATERLOO, NSW 2017.

FOR SALE

SELL ANTIQUE: Radios, valves, books & parts. MAX, 41 Willmington St., Newmarket 4051.

INVERTERS!: Convert 12V DC to 240V AC. Available in 40 Watt — \$125, 300 Watt — \$300, 600 Watt — \$400. Ph: (02) 728-1674.

SOLAR PANEL!: 18V 7 Watt. Ideal for trickle charging batteries or running 12V equipment. \$130. Ph: (02) 728-1674.

NEW RADIO VALVES: For entertainment or industrial use. Waltham Dan, 96 Oxford St., Darlinghurst, Sydney, Phone (02) 331-3360.

EX-ABC AUDIO TAPES: 1/4" wide on 10 1/2" Standard metal spool \$6.85. Robust metal spool \$12.85 7" spool \$2.25. 5" spool \$1.25. Post extra. Also in stock 1/2", 1" and 2" tapes. Waltham Dan, 96 Oxford St., Darlinghurst, Sydney. Phone (02) 331-3360.

PRINTED CIRCUIT BOARDS

Minimum postage & packaging on all EA & ETI Project PCBs
Catalogue 1976-85 (inc components) \$1.50
PCBs made to order — 48 hr prototype service
Bankcard/Mastercard
Acetronics PCBs
112 Robertson Rd, Bass Hill 2197
(02) 645 1241

MICRO-EDUCATIONAL P/L
8/ 235 Darby St NEWCASTLE 2300
Australia's largest computer mail order company.

FREE

OUR LATEST LIBRARY DISK FOR YOUR **APPLE, IBM, or MACINTOSH**
(Add \$10 for Mac 3.5" disks)
These disks contain the best in public domain software.
Send 6 x 36c stamps for post.

Ask for your **FREE CATALOG**

Dear George,

Please rush me a free library disk for my **IBM/ APPLE/ MACINTOSH**
(Add \$10 for Mac disks)
Enclosed Please find 6 x 36c stamps.

NAME: _____

ADDRESS: _____

P/CODE: _____

ELECTRONICS AUSTRALIA BACK-COPIES: 1976-1985 & American Scientific 1976-1986. Any offer: Tel (02) 398 5005

VINTAGE B & W TV: Bush Simpson 3-17" & 2-21" plus service manual, \$50. 557 6692.

INTO RS232/DB-25 INTERFACING? Save money and make your own mini-testers, break out boxes, 2 way gender benders, etc. Plated through boards \$4 each, 4 way gender bender boards \$14, 256K printer buffer short form kits from \$39, computer & printer switches \$12, serial board for buffer \$18. For more info. Send SAE to Don McKenzie, 29 Ellesmere Cres., Tullamarine 3043.

AMIDON FERROMAGNETIC CORES: Large range for all receiver and transmitter applications. For data and price list and 105X220 SASE to: R. J. & U. S. Imports, P.O. Box 157, Mortdale, N.S.W. 2223. Close during June. N.S.W.: Geoff Wood Electronics, Lane Cove. Webb Electronics, Albury. A.C.T.: Electronic Components, Fyshwick Plaza. Vic.: Truscott Electronics, Croydon. W.A.: Willis Trading Co., Perth.

DO YOU WANT TO BE A RADIO AMATEUR?

The Wireless Institute of Australia, established in 1910 to further the interests of Amateur Radio, conducts a Correspondence Course for the A.O.C.P. and L.A.O.C.P. Examinations conducted by the Department of Communications. Throughout the Course, your papers are checked and commented upon to lead you to a successful conclusion. For further information, write to:

THE COURSE SUPERVISOR
W.I.A. (N.S.W. DIVISION)

P.O. Box 1066
PARRAMATTA, N.S.W. 2150.

RCS. RADIO PTY. LTD.

Established 1933
IS THE ONLY COMPANY
WHICH MANUFACTURES AND
SELLS EVERY PCB & FRONT PANEL
published in EA and ETI
651 Forest Road Bexley 2207
AUSTRALIA
RING (02) 587 3491 FOR INSTANT PRICES
24 HOUR TURNAROUND SERVICE

ELECTRONIC ASSEMBLY

Quality hand assembly of PCBs
Component sourcing & Production consultation
Complete manufacturing service
Economic rates — Let us give you a quote

M.B.M. ENTERPRISES
25 Abbott St. Mendooran 2842
(068) 48 8140

MUSIC SOUND RECORDING STAGE LIGHTING
SONICS
MAGAZINE

For Musicians, Road Crews,
Recording Engineers, Lighting People,
Managers, Promoters and anybody
interested in what goes into
today's music-making.

THE ALL AUSTRALIAN
MUSIC MAKERS'
MAGAZINE

GENERATE ELECTRICITY FROM THE SUN ARCO PV PANELS

M55B 53 WATTS 12V
M75B 47 WATTS 12V

Provide power for pumping, lighting and refrigeration. Now only \$8/WATT.

ELANTE PTY LTD

382 CANTERBURY RD.
SURREY HILLS, 3127
Ph: (03) 836-9966

ACE RADIO (02) 949 4871

Manufacturers & Enthusiasts
Do you have problems sourcing semiconductor devices at reasonable prices?

If so contact us regarding your requirements

**10B/3 Kenneth Rd,
Manly Vale 2093**

A NEW CONCEPT FOR LOW VOLTAGE PROJECTS

COPPER FOIL TAPE: thin pure copper tape backed by special hi-tack adhesive. Current carrying capacity, 5 amps. FULLY TESTED at 24V 5A. Not recommended for mains voltage.

4mm RRP \$8.03 6mm RRP \$9.84 33 metre roll
GIFFORD PRODUCTIONS
PO Box 62, St Kilda, Vic 3182. (02) 534 3462

Letters to the Editor - ctd from page 5

the unbroken power supply.

Solid state logic continuously checks the voltage and frequency of the mains, switching over instantly the moment any anomaly is detected. The result is a continuous sinusoid of constant frequency and amplitude, making the Exide Powerguard a true "no-break UPS".

We hope that by publishing this you will correct any mistaken impression that any of your readers might have formed from your feature.

The fact is, the Exide Powerguard represents a successful departure from off-line UPS performance, providing a

low cost source of conditioned and standby power tailored to the realities of computer and similar systems.

B. Donaldson,
National Marketing Manager,
Pacific Dunlop Batteries — Industri-
al.

(Previously Chloride Batteries Aus-
tralia Ltd).

Congratulations on metric time

I heartily congratulate the Australian Government on introducing Metric Time. I believe that it is well overdue.

Almost everything has gone metric except time — up 'till now! Once the rest of Australia converts to metric

time, Sir Joh will feel that he has made the wrong decision and then Queensland will convert as well.

The Government has kept the secret very well, thereby stopping the community revolt, although the timing of the announcement wasn't the best (April 1st).

Congratulations are also in order to you and Dick Smith for the design of the first Digital Metric Clock. Converting to metric time may take a while, but with your helpful article and the metric clock project, it will take no time at all (pun pun!).

Good on you EA for producing yet another useful (useless?) project.

S. Schulz,
Bayswater, Vic.

PS: Happy April Fools' Day!

Car Burglar Alarm ... ctd from page 63

tioned 10-15cm apart and facing towards each other.

Whatever arrangement you use, make sure that the environment in the vicinity of the transducers is perfectly still. This is to ensure that the signal picked up by the receiver remains constant.

Initially, the sensitivity control (VR1) should be set to minimum; ie, fully anti-clockwise (not clockwise as incorrectly stated in the April issue). It's then a matter of carefully adjusting VR2 for maximum waveform amplitude at pin 9 of IC1b as shown on a CRO.

If you don't have a CRO, adjust VR2 for maximum DC voltage across C6.

One problem that's likely to be encountered here is that the metal adjustment tab of the trimpot makes the unit sensitive to the presence of the screw-

driver. For this reason, it's best to use a plastic tool to adjust VR2.

Once VR2 has been correctly adjusted, it's simply a matter of adjusting VR1 to give the required sensitivity.

Note that twin core shielded cable must be used to connect the transmitter if it is wired in maximum drive configuration (ie, connected between pins 2 and 4 of IC2). The braid of the cable should be connected to the earth pad on the PCB between the two transmitter terminals. Fig.3a shows the details.

Note: the wiring diagram in the April issue incorrectly shows the use of single core shielded cable for the maximum drive configuration. This results in greatly reduced sensitivity.

Single core cable should only be used when the transmitter is wired in mini-

mum drive configuration as shown in Fig.3b. This should provide adequate sensitivity for most situations, including car burglar alarms.

Another problem with the ultrasonic alarm can occur if the transducers are soldered directly to PC pins on the PCB. In this case, mechanical noise generated when the relay turns off can cause repeated false triggering, particularly at high sensitivity settings.

This problem can easily be solved by isolating the transducers from the PCB. Alternatively, the relay can be quietened by sticking a small piece of tape to the end of the relay armature and by bending the two outer relay contacts towards each other to reduce the travel of the changeover contact.

Finally, readers should note that the C and N/C terminals were shown transposed on the wiring diagram on page 47 of the April issue.

AVAILABLE NOW IN AUSTRALIA

★ AUDIO-DRIVE BELTS ★ TURNTABLE BELTS ★ PINCHROLLERS ★ VIDEO BELTS



TURNTABLES

Turntable belts are available in 5 mm & 6 mm with diameters commencing from 122 mm up to 292 mm.

TRADE & WHOLESALE ENQUIRIES WELCOME

Imported & Distributed by WES COMPONENTS PTY. LTD.
For a comprehensive catalogue send your company or
business details to: PO. Box 451 Ashfield NSW 2131 Aust.,
Phone: (02) 797 9866 Fax: (02) 799 7051

VIDEO

Over 60 Video Belt Kits in stock to suit most popular video machines. Other video parts also available ie: pinchrollers, heads, etc.

AUDIO CASSETTE

A range of belts is available in 1.2 mm square & 1.4 mm square, from the 19 mm diameter up to 136 mm diameter. These will suit most audio products. If a flat belt is required our range includes 3 mm, 4 mm, 5 mm & 6 mm belts in an assortment of lengths. An assortment of pinchrollers is also available.

Please call for a stocklist or bring in your sample belt and we will match it.

WAGNER ELECTRONIC SERVICES PTY. LTD.,
305 Liverpool Rd., Ashfield, N.S.W. 2131. Aust.,
Phone: (02) 798-9233



Next month in

Electronics Australia

Headphone amplifier and phase corrector for CD players

CD players which have only one D-A converter inevitably have a phase difference between channels. This unit corrects that error and also provides two headphone outputs with adjustable level. The very high quality circuit does not degrade the CD signal quality.

The romance of railways

We begin a new series of articles on railways, starting with steam locomotives and progressing to electric and diesel-electric locos. Written by the author of "Op amps explained", it is certain to be an erudite overview.

X-wing helicopters

Read about the development of high speed helicopters which will have rigid rotors and which will even include an emergency exit system.

**Note: although these articles have been prepared for publication, circumstances may change the final content.*

Electronics Australia Reader Service

"Electronics Australia" provides the following services:

BACK ISSUES: available only until stocks are exhausted. Price: \$4.00

PHOTOSTAT COPIES: when back issues are exhausted, photocopies of articles can be supplied. Price: \$4 per project or \$8 where a project spreads over several issues.

PCB PATTERNS: high contrast, actual size transparencies for printed circuit boards and front panels are available. Price: \$5 for boards up to 100 square centimetres; \$10 for larger boards. Please specify positive or negative.

PROJECT QUERIES: advice on projects is limited to postal correspondence only, and to projects less than five years old. Price: \$5. Please note that we cannot undertake special research or advise on project modifications. Members of our technical staff are not available to discuss technical

problems by telephone.

OTHER QUERIES: technical queries outside the scope of "Replies by Post", or submitted without fee, may be answered in the "Information Centre" pages at the discretion of the Editor.

PAYMENT: must be negotiable in Australia and made payable to "Electronics Australia". Send cheque, money order or credit card number (American Express, Bankcard, or Mastercard), name and address (see form). All prices include postage within Australia and to New Zealand.

ADDRESS: send all correspondence to The Secretary, "Electronics Australia", PO Box 227, Waterloo, NSW 2017. Please note that we are unable to supply back issues, photocopies or PCB artwork material over the counter.

Back Issues

Photostat copies

Total price of magazines/photocopies, including postage and handling.

No off issues reg x \$4 = \$.....

Cheque Money Order Please tick box to indicate method of payment.

*Please make payable to the Federal Publishing Company Pty Ltd.

Mastercard American Express Visa Bankcard Tick

Card Expiry Date

Credit Card No

Signature

(Unsigned Orders cannot be accepted)

NAME

ADDRESS

POSTCODE

ADVERTISING INDEX

Ace Radio	128
Acetronics	128
Adeal	50
Allen Bradley	50
Altronics	54-59
Amtex	73
Aust Govt. Recruiting	42,43,73
Chapman LE	125
Control Data	18
Crusader	18
David Reid	37
Diamond Systems	121
Dick Smith Electronics	9,75-82
DNA Communications	117
Elante	128
Ellistronics	70
Elmeasco	IBC
Emtronics	62
Fairchild	14,15
Federal Publishing	98,108,110,111
Geoff Wood	40
Gifford Productions	128
ICS	95
Jaycar	30-35
Kalextronics	123
Macro Dynamics	119
MBM Enterprises	128
Microbee	102,103
Micro Education	128
Philips	IFC
RCS Radio	128
Rifa	OBC
Ritronics	20-25
Scan Audio	107
Selectronic Components	85
Semikron	92
Sermac	29
Sheridan Electronics	66,67
Stotts	86
Texas Instruments	90,91
University of NSW	107
Vam Test	85
Videosat	122
VSI	49
WES	128
Westinghouse Systems	124
WIA	128

How to beat the high cost of cheap meters.



You get what you pay for.
So get the Fluke 70 Series.

You'll get more meter for your money, whether you choose the affordable 73, the feature-packed 75 or the deluxe 77.

All of them will give you years of performance, long after cheaper meters have pegged their fishhook needles for the last time.

That's because they're built to last, inside and out. So they're tough to break. They don't blow fuses all the time. You don't even have to replace batteries as often.

And they're backed by a 3-year warranty. Not the usual 1-year.

Of course, you may only care that the world-champion 70 Series combines digital and analog displays with more automatic features, greater accuracy and easier operation than any other meters in their class.

You may not care that they have a lower overall cost of ownership than all the other "bargain" meters out there.

But just in case, now you know.

FROM THE WORLD LEADER
 IN DIGITAL MULTIMETERS.



FLUKE 73	FLUKE 75	FLUKE 77
Analog/digital display	Analog/digital display	Analog/digital display
Volts ohms 10A diode test	Volts ohms 10A mA diode test	Volts ohms 10A mA diode test
Autorange	Audible continuity	Audible continuity
0.7% basic dc accuracy	Autorange/range hold	"Touch Hold" function
2000+ hour battery life	0.5% basic dc accuracy	Autorange/range hold
3-year warranty	2000+ hour battery life	0.3% basic dc accuracy
	3-year warranty	2000+ hour battery life
		3-year warranty

ELMEASCO **Instruments Pty. Ltd.**

Talk to your local Elmeasco distributor about Fluke —

- **A.C.T.** John Pope Electrical (062) 80 6576 • J Blackwood & Sons (062) 80 5235 • George Brown (062) 80 4355
- **N.S.W.** Ames Agency 699 4524 • J Blackwood & Sons • George Brown 519 5855 Newcastle 69 6399 • Bryan Catt Industries 526 2222 • D G E Systems (049) 69 1625
- Petro-Ject 550 1388 • David Reid 267 1385 • W F Dixon (049) 61 5628 • Macelec (042) 29 1455 • Ebson 707 2111 • Selectroparts 708 3244 • Geoff Wood 427 1676
- **N. TERRITORY** J Blackwood & Son (089) 84 4255, 52 1788 • Thew & McCann (089) 84 4999
- **QUEENSLAND** Auslec • Petro-Ject (075) 91 4199 • St Lucia Electronics 52 7466 • Cliff Electronics 341 4655 • L E Boughen 369 1277 • Fred Hoe & Sons 277 4311
- The Electronic Shop (075) 32 3632 • Thompson Instruments (Cairns) (070) 51 2404
- **S. AUSTRALIA** Protronics 212 3111 • Trio Electrix 212 6235 • Industrial Pyrometers 352 3688 • J Blackwood & Son 46 0391 • Petro-Ject 363 1353
- **TASMANIA** George Harvey (003) 31 6533 (002) 34 2233
- **VICTORIA** Radio Parts 329 7888 • George Brown Electronics Group 878 8111 • G B Telespars 328 4301 • A W M Electrical Wholesalers • Petro-Ject 419 9377
- J Blackwood & Sons 542 4321 • R.K.B. Agency 29 7336 • Sirs Sales (052) 78 1251 • Mektronics Co 690 4593 • Truscott Electronics 723 3094
- **W. AUSTRALIA** Atkins Carlyle 481 1233 • Dobbie Instruments 276 8888 • Protronics 362 1044

CMOS PRODUCTS LIST							
■ SRAM							
PRODUCT	TOTAL BIT	ORGANIZATION (WORD x BIT)	ACCESS TIME(ns)	POWER STANDBY TYP. (mA)	POWER OPERATING TYP. (mA)	DATA RETENTION CURRENT	
AKM6256P	64k	8k x 8	100 120 150	100µW (12mW)	200mW (400mW)	—	
AKM6256LP LFP		8k x 8	100 120 150	10µW (500µW)	200mW (400mW)	50µA	
AKM6256LP-L LFP-L		8k x 8	100 120 150	10µW * (250µW)	200mW (400mW)	25µA	
AKM6256LP-SL		8k x 8	100 120 150	10µW (100µW)	200mW (400mW)	10µA	
AKM6256ASP		8k x 8	120 150	100µW (15mW)	15mW (25mW)	—	
AKM6256ALSP ALFP		8k x 8	120 150	10µW (500µW)	15mW (25mW)	50µA	
AKM6287P CQ		64k x 1	45 55 70	100µW (10mW)	300mW (600mW)	—	
AKM6287LP		64k x 1	45 55 70	10µW (500µW)	300mW (500mW)	—	
AKM62256P		256k	32k x 8	85 100 120 150	200µW (10mW)	40mW (75mW)	—
AKM62256LP LFP			32k x 8	85 100 120 150	10µW (500µW)	40mW (75mW)	50µA
AKM62256LP-S LFP-S			32k x 8	100 120 150	10µW (500µW)	40mW (75mW)	10µA

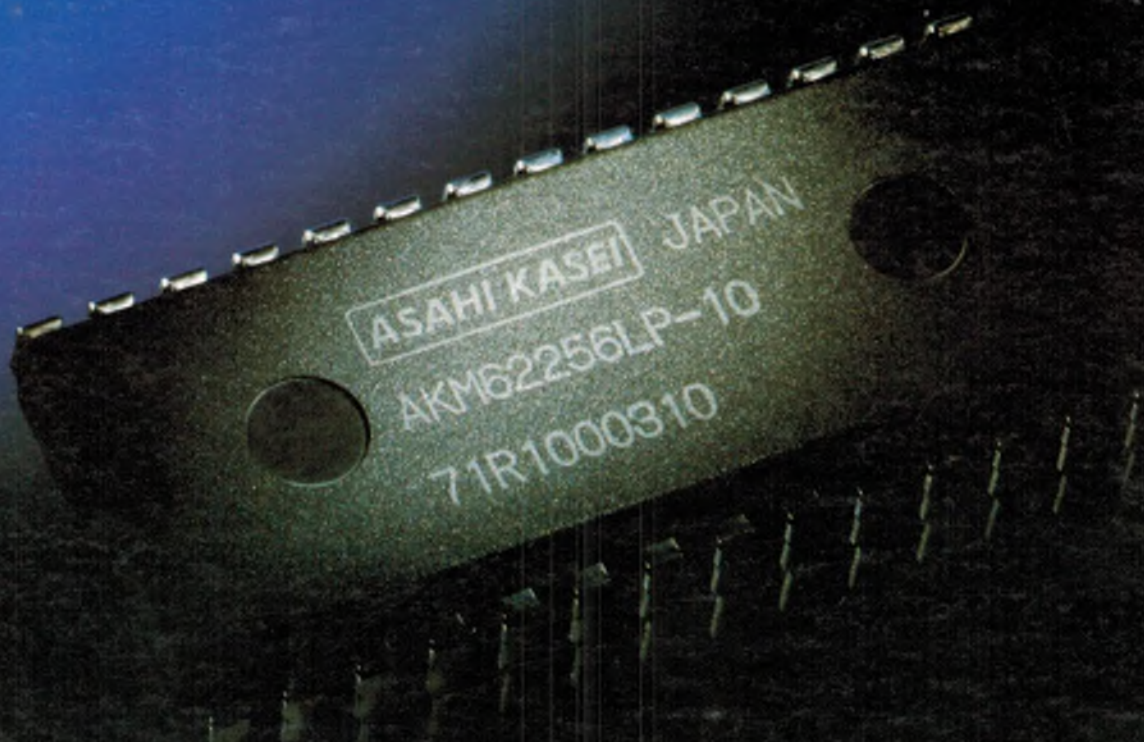

RIFA

MELBOURNE (03) 487 3333
SYDNEY (02) 858 5966
ADELAIDE (08) 232 0001
BRISBANE (07) 277 4311
PERTH (09) 367 6330
HOBART (002) 342 233
LAUNCESTON (003) 316 533

ASAHI KASEI®

Asahi Kasei Microsystems was formed from a joint venture between AMI of the United States and Asahi Chemical of Japan. A design centre was opened for design and marketing of custom and application specific LSI's based on AMI technology. Asahi Kasei Microsystems has entered a co-operative relationship with Hitachi Ltd. for the acquisition of its advanced CMOS process technology.