

# amateur TAPE RECORDING

VOL. 2. No. 2

PRICE 2/-

SEPTEMBER 1960



Furniture by Uniflex

For full details of the "Winston"  
range of Tape Recorders write to



**WINSTON ELECTRONICS LTD**

**GOVETT AVENUE SHEPPERTON MIDDLESEX**

Telephone : Walton-on-Thames 26321

[www.americanradiohistory.com](http://www.americanradiohistory.com)



# PHILIPS TAPES

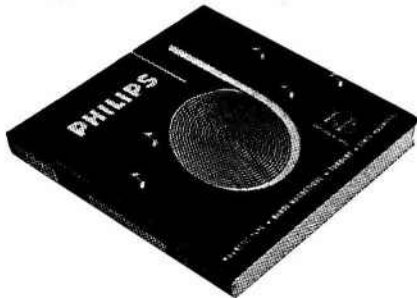

- *Strong pvc base.*
- *Resistant to stretch, snapping and tearing.*
- *Powerful adhesion of magnetic coating.*
- *Unvarying high-quality performance.*
- *Standard, long-play, and double-play tapes available.*

**...better for all  
tape recorders!**

On any tape recorder, Philips Tape gives you better results. It has great sensitivity, a very wide frequency range, and extremely low noise level. This superlative tape is equally good for music or voice recording. Available in all reel sizes from 3", 5", 5 $\frac{3}{4}$ " and 7". For those building up a tape library, Philips 5", 5 $\frac{3}{4}$ " and 7" reels are specially packed in durable books designed for convenient storage, and quick easy reference.

PHILIPS ELECTRICAL LIMITED • CENTURY HOUSE • SHAFTESBURY AVENUE • LONDON • WC2



# Get it TAPED

— to perfection

SIZES	STANDARD			LONG PLAY			SIZES	DOUBLE PLAY		
	FEET	WIDE. INCHES (M.M.)	PRICE £ S. D.	FEET	WIDE. INCHES (M.M.)	PRICE £ S. D.		FEET	WIDE. INCHES (M.M.)	PRICE £ S. D.
3'	150	16 mm	5 6	225	24 mm	8 6	3'	300	32 mm	10 6
4'	300	32 ..	10 6	450	50 ..	14 6	5'	1200	2.. 8 ..	2 5 0
5'	600	1.. 4 mm	1 0 0	850	1.. 31 mm	1 8 0	5½'	1700	3.. 0 ..	2 17 6
5½'	850	1.. 31 ..	1 7 6	1200	2.. 8 ..	1 15 0	7'	2400	4.. 16 ..	4 0 0
7'	1200	2.. 8 ..	1 15 0	1800	3.. 12 ..	2 10 0	SUPERGRADE			
8½'	1750	3.. 6 ..	2 10 0	2400	4.. 16 ..	3 10 0	7'	1200	2.. 8 mm	2 18 6

— naturally



A MEMBER OF THE  
**BBCC**  
GROUP OF COMPANIES

on

# Mss Mastertape

155 RECORDING COMPANY LIMITED, COLNBROOK, BUCKS. TEL. COLNBROOK 2431

# DON'T CROSS THE CHANNELS

Stereo tape recording has come to stay. If you want first-rate stereo sound in the end, you must have a first-rate stereo microphone from the start. This microphone must have the same balanced, wide-frequency response as a mono mike, and in addition achieve separation of all sound into two separate channels. Acos microphones have long been amongst the best in the world; Acos are the leading pioneers in stereo. No wonder, therefore, that the new ACOStereo microphone is strictly in the champion class for performance, separation, good looks and good value.



## MIC 44

The new ACOStereo MIC 44 is a fully stereophonic microphone, operating on the coincident phase principle. It contains two inserts with figure-eight characteristics, at 90° to each other, giving overall clover-leaf response with first-rate channel separation. Output -68 dB ref 1V/dyne/cm<sup>2</sup>; frequency response 50-8,000 c/s; separation better than 12 dB at 1 kc/s. UK retail price £6.6.0.

## GET SET FOR STEREO WITH AN ACOSTEREO MICROPHONE



*also* ARE DOING THINGS IN STYLE

See you at the Audio Fair, Demonstration Room 211, Stand 20

COSMOCORD LTD WALTHAM CROSS HERTS · TEL: WALTHAM CROSS 27331 (London subscribers please dial WS27331)

# Who reads Ferrograph Advertising?



Some have bought their Tape Recorders because they liked the look of them. Others because their price was attractively low. Still more because they didn't know much about Tape Recorders anyway and sought the advice of their friends. All these are good and valid reasons and, we hasten to add, most will probably be quite satisfied with their purchases. But the purchase of a Ferrograph falls into rather a different category. Being almost always in short supply—invariably with a high precision instrument requiring so much individual supervision during manufacture—only a relatively small number of Dealers can be permitted to distribute it. Our advertising, therefore, seeks to overcome this handicap by appealing to those thoughtful and discerning people who are more influenced by reputation and performance than by any other consideration. That is why there are no sensational claims or grandiose statements in Ferrograph advertising. It is sober, restrained and free from exaggeration. We believe that the purchase of a Ferrograph is a serious business—that almost invariably it is bought by those who, like the B.B.C. and other broadcasting organisations and leading personalities in the world of music and drama, are capable of assessing its great qualities at their true worth.

#### **Stereo 808**

Two speeds  $3\frac{3}{4}/7\frac{1}{2}$  i.p.s. For use with external Hi Fi amplifiers and Loud Speakers. The all-purpose machine for Monaural and Stereo Recording/Playback.  
105 Gns.

#### **Series 4A**

4A/N Two speeds  $3\frac{3}{4}/7\frac{1}{2}$  i.p.s. Monaural Recording/Playback.  
81 Gns.

*Three Independent Motors · Synchronous Capstan Motor · Recording Level Meter · Brief Stop · Interchangeable Plug-in-Heads  
Switched Speed Change with Compensated Correction Network · Separate Tone Controls · High Fidelity  $2\frac{1}{2}$  Watts Output Stage  
Uses  $8\frac{1}{2}$ " Tape Spools · Gear-Driven Turns Counter · Automatic Switch Cuts Motors at End of Spool · Endless Loop Cassette (Optional Extra)*

*The Incomparable* **Ferrograph**

**BRITISH FERROGRAPH RECORDER CO. LTD.**

*(A subsidiary of the Ferrograph Company Ltd.)*

131 SLOANE STREET, LONDON, S.W.1 · Tel: SLOane 1510, 2214 and 2215

AMATEUR TAPE RECORDING

★ **TAPE RECORDERS**  
 ★ **HI-FI EQUIPMENT &**  
 ★ **ALL PHOTOGRAPHIC**  
 ★ **CAMERAS**  
 ★ **CINE**

*Plus a Unique Long Playing Gramophone*

**THE  
 AUDIO REPRODUCTION  
 CENTRE**

*A comprehensive range of Equipment  
 always on display including:—*

**Tape Recorders**

Grundig  
 Ferrograph  
 Vortexion  
 Walter  
 Brenell  
 Reflectograph  
 Simon  
 Harting  
 Telefunken  
 Philips  
 Spectone  
 Verdik  
 Veritone

Stuzzi-Magnette  
 Fi-Cord  
 Truvox  
 Kurland  
 Revox  
 Wyndson  
 Regentone  
 Perth-Saja  
 Elektron  
 Minivox  
 Korting

**Hi-Fi Equipment, Microphones,**

Leak  
 Quad  
 Rogers  
 Armstrong  
 Jason  
 Dulci  
 Pamphonic  
 Stentorian  
 Avantic  
 Pilot  
 Collaro  
 Elpico  
 Decca

**Speakers, etc.**

Philips  
 Wright & Weaire  
 G.E.C.  
 Goodmans  
 C.Q.  
 Wharfedale  
 Elac  
 B.J.  
 Garrard  
 Connoisseur  
 Goldring  
 T.S.L.  
 Stirling Tuners

**Tape**

Emitape  
 Scotch Boy  
 B.A.S.F.  
 Grundig  
 Telefunken  
 Elpico  
 Soundrite  
 Gevaert  
 Philips  
 Agfa

**ALL EQUIPMENT  
 EXCEPT TAPE CAN  
 BE ACQUIRED ON  
 FAVOURABLE H.P. TERMS**

**NEW EQUIPMENT**

**WHICH YOU MUST SEE**



**THE  
 "VICTOR"  
 GRAMOPHONE**

The only portable Gramophone specially designed for use as an accessory to a Tape Recorder, supplied complete with mains lead and tape recorder connecting lead.

**Salient features:—**

Four-Speed motor, B.S.R. Gramophone Deck. Strongly constructed portable case, finished in Rexine. Special plug connection for direct linking with Tape Recorders. Provision made for the addition of a mixer to be made available shortly.

**Cash Price: 12 Gns., or £2.12.0 Deposit  
 and 11 monthly payments of £1**

**THE  
 TAPE  
 MIXING  
 ADE**

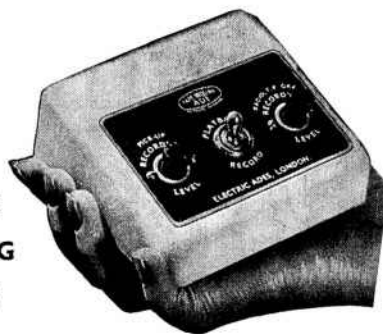

Record and hear your own voice with top line bands, or orchestras. Operates with any make of Tape Recorder, Radio, Television, Radiogram or Microphone. Intermix your tape recordings with: Radio, Television, Radiogram or a combination of any. Anyone can fit the Tape Mixing Ade in a few minutes.

**Price complete 5 Gns. (no extras whatsoever)**

*Full information and illustrated leaflet from*

**AUDIO REPRODUCTION CENTRE  
 134 UXBRIDGE Rd. SHEPHERDS BUSH W.12  
 Telephone: SHEPHERDS Bush 2234**

**OF  
 SPECIAL  
 INTEREST**

**Amateur Tape Recording**

★ **TAPE RECORDERS**  
 ★ **HI-FI EQUIPMENT &**  
 ★ **ALL PHOTOGRAPHIC**  
 ★ **CAMERAS**  
 ★ **CINE**

**EQUIPMENT AND ACCESSORIES**

*Record Library — All available from*

**134 UXBRIDGE ROAD  
 SHEPHERDS BUSH  
 W.12.**

Telephone: SHEPHERDS BUSH 2234

The **WINSTON  
 THOROUGHbred  
 TAPE RECORDER**

Cash Price  
**59 Gns.**



OR **£12.8.0** DEPOSIT  
 AND 12 MONTHLY  
 PAYMENTS OF  
**£4.9.3**

**LONG PLAYING GRAMOPHONE RECORDS FOR HIRE**

10-inch L.Ps. 3/-

12-inch L.Ps. 4/-

Orders over 10/- post free

To mention but a few :—

DRUMMER MAN	Gene Krupa	12-inch	CLP 1087
BING SINGS, BREGMAN SWINGS		"	CLP 1088
THURSDAY'S CHILD	Eartha Kitt	"	CLP 1104
NEW MOON & ROSE MARIE	Andy Cole, E. Larnar	"	CLP 1148
LIKE SOMEONE IN LOVE		"	CLP 1166
GERMAN BEER DRINKING MUSIC		"	CLP 1191
FOLKSONG JUBILEE		"	CLP 1220
DIANGO REINHARDT		10-inch	DLP 1045
BY THE FIRESIDE	Ronnie Hilton	"	DLP 1109
HIS SWINGING GUITAR	Slim Whitman	12-inch	HA-P3 1015
JULIE IS HER NAME	Julie London	"	HA-U 2005
IT'S A BLUE WORLD	Mel Torme	"	HA-N 2016
FAT'S ROCKIN' & ROLLIN'	Fats Domino	"	HA-D 2030
HOWDY!	Pat Boone	"	HA-D 2030
ROCK THE JOINT	Bill Haley	"	HA-F 2037
CALENDAR GIRL	Julie London	"	HA-U 2030
ROGERS & HART SONG BOOK	Ella Fitzgerald, L. Armstrong	"	CLP 1116/7
LOVERS IN THE DARK	Tony Osborne	"	CLP 1151
SING A SONG OF BASIE	Dave Lambert, Annie Rose	"	CLP 1203
ELLA SWINGS LIGHTLY	Ella Fitzgerald	"	CLP 1267
DOWN TO EARTHA	Eartha Kitt	10-inch	DLP 1089
PICK YOURSELF UP	Anita O'Day	"	DLP 1169
SASSY	Sarah Vaughan	12-inch	EJL 1258
SWINGING WITH THE STARR	Kay Starr	"	HA-U 2039
HERE'S LITTLE RICHARD		"	HA-C 2055
ANDY WILLIAM SINGS	Steve Allen	"	HA-A 2054
TOPS IN POPS		"	HA-D 2071
THIS IS FATS DOMINO		"	HA-D 2073
SINGS IRVING BERLIN	Pat Boone	"	HA-D 2082
PAT'S BIG HITS	Pat Boone	"	HA-D 2098
SONGS OF THE FABULOUS THIRTIES	David Rose	"	HA-R 2085
RICKY NELSON		"	HA-P 2119
LITTLE RICHARD & HIS BAND		"	HA-U 2126
GO CHAMPS GO		"	HA-H 2152
RICKY SWINGS AGAIN	Ricky Nelson	"	HA-P 2159
HIS TWANGY GUITAR	Duane Eddy	"	HA-W 2160
YES INDEED	Ray Coniff	"	HA-E 2168
THAT'S ALL	Bobby Darin	"	HA-E 2172
ROCKIN' THE BLUE	Joe Turner	"	HA-E 2173
JOHNNY CASH		"	HA-S 2179
A SINGIN' WING DING		"	HA-R 2182
HIS SINGING GUITAR	Slim Whitman	"	HA-APB 1015
JOLSON SINGS AGAIN	Al Jolson	10-inch	LA 8502
EVERYBODY DANCE	Russ Morgan	"	LA 8564
JUST FOR YOU		"	LA 8563

SEND 6d. STAMP FOR COMPLETE LIST

# amateur TAPE RECORDING

THE OFFICIAL MAGAZINE OF THE BRITISH RECORDING CLUB  
(INCORPORATING THE BRITISH TAPE RECORDING SOCIETY)

*for the tape enthusiast*

**VOL. 2 No. 2 SEPTEMBER, 1960**

Club, Editorial and Advertisement Offices:  
145 Fleet Street, London, E.C.4.

Telephones:  
Club and Editorial: Ludgate Circus 7918  
Advertisements: Fleet Street 7732/2110

Editor  
ROBINSON P. RIGG, M.B.K.S.

Deputy Editor  
K. W. PETERS

Technical Editor  
F. C. JUDD, A.Inst.E.

Technical Adviser  
F. WINSTON REYNOLDS,  
A.M.Brit.I.R.E., M.I.W.M., M.Inst.P.

Club News Editor  
T. NURSE

Advertisement Manager  
J. A. PEARCE

## CONTENTS

World Tape News	8
Commentator at Work (Wynford Vaughan Thomas)	10
Tape View Continental (Jan Phillips)	13
In Camera (Lorna Gulston)	17
Tape Recorder Maintenance, Part II (John E. Little)	20
Tete-a-Tape (David Lazell)	23
Tape Club News	25
Inter-Tape Directory	27
"Dear Sir . . ."	32
Club Pictorial	33
Tape and Disc Review	34
Africa Calling	37
Radio Show, 1960	38
What Are . . . ? (Fredericks)	43
Home View . . .	
1. Uher Stereo III	50
2. Spectone 171	51

## . . . . Lend Me Your Ears

ARE YOU INTERESTED in listening? That's easy — we don't know a Tape Recorder enthusiast who isn't.

Never before have so many people enjoyed listening to recorded sound, but we are convinced that this is only the beginning. The British Recording Club was formed, and later published *Amateur Tape Recording* especially for you whose hobby it is to record sound.

Now we are about to launch a brand new monthly magazine for all who enjoy listening — **Popular Hi-Fi**, out in September.

**Popular Hi-Fi** is Britain's only magazine to cater for all listening tastes, high, low and medium brow, pop, opera, jazz. And it doesn't stop at sounds recorded on disc and tape, it caters for all who enjoy radio and television programmes; and for all who demand the best equipment for their money.

**Popular Hi-Fi** is a personal magazine — the only one to have its own radio request programme — commencing September 9th on Radio Luxembourg — and readers will have the opportunity to choose their own recordings for transmission.

**Popular Hi-Fi** is first in the field with a regular supplement for radio and T.V. audiences, "Radio and Television News", with behind the scenes news of programmes and artists and, for the first time outside the specialist and Trade papers — frank and unbiased reports on radio and television receivers.

Here is a preview of the contents of the first issue of **Popular Hi-Fi**

- a famous stage personality discusses his taste in music
- the furnishing specialist of a foremost women's magazine discusses the vexed problem of fitting hi-fi equipment into the home
- a well known music critic shows how the classics can be fun
- how to recapture the magic of that continental holiday — in sound
- the latest hi-fi releases.
- the latest equipment
- just enough technical gen to make listening more interesting and enjoyable
- a comprehensive directory of the latest records and a host of other features for all listening tastes.

So, if you are interested in listening, buy a copy of **Popular Hi-Fi** on September 9th. By the way, it is edited by the same team that brings A.T.R. to you each month, so we are confident you will enjoy reading **Popular Hi-Fi**.

The title *Amateur Tape Recording* is registered at Stationers' Hall, London. The contents are copyright and may only be reproduced by permission of the Proprietors. Signed articles represent the views of the authors and are not necessarily those of the editor.



# IS HALF YOUR TAPE RECORDER

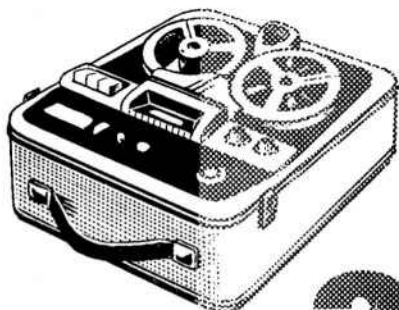

## WASTED?

The performance of a portable tape recorder is severely limited by the space available for its internal loudspeaker.

The connection of a high quality external speaker will reveal hidden detail in your recordings, and the Wharfedale PST/8 is an ideal choice.

This unique, patented enclosure design gives optimum results with Wharfedale 8" foam surround units which are available in a range of impedances to suit all machines.

*Descriptive literature sent free on request*

### WHARFEDALE PST/8

PRICE cabinet only  
£7 10 0 in whitewood  
£10 10 0 finished in  
walnut, oak or  
mahogany veneers.

Recommended units 8" Bronze/FS/AL £4 6 7 inc. P.T.

Super 8/FS/AL £6 19 11 inc. P.T.

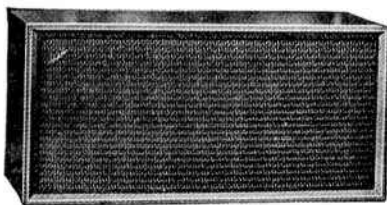

Tel.: Idle 1235/6

Grams :  
"Wharfedel" Idle  
Bradford

**Wharfedale**  
WIRELESS WORKS LTD  
IDLE BRADFORD YORKS

## WORLD TAPE NEWS

### HAUNTED HOUSES

Ulster Tape Recording Society have been chasing spooks with loaded mikes recently, and have taped some very strange sounds. Their investigations were made at a three hundred year old mansion near Dromore, Co. Down, which has a ghostly legend attached to it about a Lord Tyrone who visited his childhood friend, Lady Beresford, there the night after he died. This was over 150 years ago. There is also another tale of a young Irish maiden burning to death in the building.

So it was that this intrepid band of recordists approached this gloomy derelict old mansion one evening recently, and proceeded to set up microphones at strategic points throughout the building, all leading to a monitoring loudspeaker and tape recorder in the main ground floor room.

Just before midnight the first crash was heard, then one of the candles started flickering for no apparent reason and suddenly the second crash came. This seemed to signal the awakening of the spirits for in the next hour a great variety of sounds were recorded—squawks, rumbles, thuds, crashes, metallic tapping, scraping, a cough and more crashes. In fact it appears to have been a ghost's version of a command performance. But the sounds are all there on the tape for the doubters to marvel at, and the experts to analyse.

As the investigating team left the house shortly before dawn, they paused to look back at it—and there was the last phenomenon . . . phantom lights dancing in the windows.

### TAPE GHOSTING

A ghost of more flesh and substance is the one who writes for someone else. The Duke of Bedford has revealed that his autobiography "A Silver Plated Spoon" was a ghosted work really written by the B.B.C. and Television writer Brian Connell. The Duke said that after a number of tape-recorded conversations between them, Brian ended up knowing more about him than he did himself. Brian Connell then wrote the book drawing upon the tape recordings for his information.

### TONY TAPES

Princess Margaret must have very happy memories of her honeymoon stop at Trinidad, for she was obviously delighted by the calypsoes she heard and by the performance of the Dixieland Panbeaters. She discovered from the Dixielanders that they had not made a long-playing record, but received a promise from them that they would soon. However, in the meantime Princess Margaret can listen to the tapes Mr. Armstrong-Jones made there. We are glad to see that an interest in photography does not result in aural matters being neglected. Wonder what machine he uses . . . ?

### GRUNDIG'S NEW FACTORY

Grundig's new tape recorder factory at Dunmurry, on the outskirts of Belfast, in Northern Ireland is expected to commence production this month, concentrating at first on one model, but with provision for expansion in the future. Eventually an increasingly large range of tape recorders will be made at Dunmurry, and future activities will also include the manufacture of all types of electronic apparatus.

### TALKING NEWSPAPER BROADCAST

Extracts from What Goes On Here, Ilford's talking newspaper for the Blind, have been broadcast in a special programme on Blind Welfare in the European Service of the B.B.C.

A recording made by Walter Gillings Sound Features, presenting the idea of the talking newspaper and outlining its possible future development was heard by members of the Ilford and District Tape Recording Society at a recent Society meeting.

### STORM DRAGON

One man's rock is another man's racket—and vice versa of course. Most people on hearing a storm in the middle of the night would sink deeper into their beds, and pull the bedclothes over their heads. Not so, the celebrated musician, Carmen Dragon. He was awakened, he listened, he acted. Straight out of bed, out with the tape recorder, and into a recording session of a rather exceptionally pyrotechnic storm that hit Brighton recently. To quote Mr. Dragon: "I've got a very acute ear for sounds, but I've never heard anything like that before". As one of the conductors of the Hollywood Bowl Symphony Orchestra, he may perhaps be planning a new beginning to that Polka by Johann Strauss!



The celebrated musician Carmen Dragon, with the dragon presented to him by the B.B.C. Concert Orchestra on his arrival in this country recently.

### HALF-A-RECORDER

The Church of the Holy Family, Langley, Bucks., held a fete recently and the prize in one of the competitions was half the cost of an electrical appliance of the winner's own choice. The winner chose half a tape recorder, but as he looked as though he would not be able to afford the other half, he was given that as well. No, he was not dressed in rags—he was seven years old!

### INTER-INTERVIEWS

We mentioned in the July AMATEUR TAPE RECORDING, Dundee Society's remote-control interview scheme for their hospital broadcasts, in which celebrities record answers to a list of questions received through the post. On return the Society splices in the questions to make the complete tape. However, the tape sent to Cliff Michelmore came back complete with questions and answers. The questions were put by a lady, and the lady in question sounded very much like the announcer Jean Metcalfe (alias Mrs. Michelmore).—Dundee have certainly got a scoop for their hospitals, and may even have set off a new trend—spouse interviews!

The finest  
kit-sets



in the  
World

When adding to your  
**HI-FI EQUIPMENT**  
(TAPE, RECORD or RADIO)

you cannot afford to miss  
considering models in the  
world-famous  
**HEATHKIT range.**

**YOU WILL ENJOY  
BUILDING THEM!**

*Absolutely no previous  
electronic or soldering ex-  
perience necessary. Just  
follow the simple step-at-  
a-time well illustrated  
Instruction Manual  
provided.*

Kits include :—  
**TAPE AMPLIFIERS** (playback & recording)  
**HI-FI AUDIO AMPLIFIERS**  
**SPEAKER SYSTEMS**  
**F.M. TUNERS**  
**EQUIPMENT CABINETS**  
as well as  
**TAPE DECKS, RECORD PLAYERS,**  
**PORTABLE RADIOS, 'HAM' GEAR**  
**AND TEST EQUIPMENT.**

**SEE THEM ALL AT OUR  
STAND 112, RADIO SHOW**

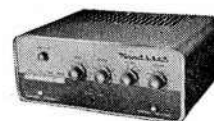

**AMPLIFIERS**  
6W Stereo £11. 8.0  
16W Stereo £25. 5.6  
12W Mono £ 9.19.6

**TAPE (RECORDING &  
PLAYBACK)**  
Stereo ..... £22.4.0  
Mono ..... £16.4.0



**SSU-1 SPEAKER  
SYSTEM**  
Pedestal ..... £11.12.6  
Bookcase ..... £10. 5.6

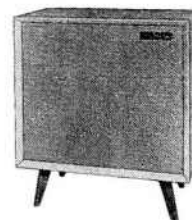

**THE 'COTSWOLD'**  
(£19.18.6)



'CHEPSTOW' (£10.10.0)

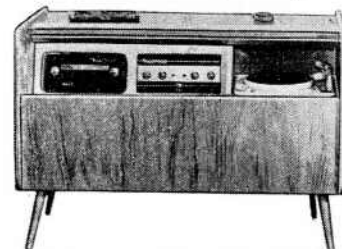

'GLOUCESTER' (£15.18.6)

All models free delivery U.K. Deferred Terms over £10

**\* POST THIS COUPON NOW FOR  
FURTHER INFORMATION**

**DAYSTROM LTD.**

DEPT. AT9  
GLOUCESTER

Please send me, **FREE** and without obligation :

(a) **FULL BRITISH HEATHKIT CATALOGUE** and

(b) Full details of models .....

(Block capitals please) .....

NAME .....

ADDRESS .....



## Commentator at Work

*Wynford Vaughan Thomas*

*Wherever there's news the B.B.C. team of commentators is on the spot recording the sights and sounds for listeners and T.V. viewers all over the world.*

*In this article Wynford Vaughan Thomas offers some practical advice on how to get the best out of people who are being interviewed.*

THE COMMENTATOR faces many trials and dangers in the course of his adventurous career. A slip of the tongue can land him, in a few seconds, into anguish, chaos and disaster.

I shall never forget the Australian commentator who was describing the entry of *s.s. Gothic* with the Queen and the Duke of Edinburgh on board, entering the harbour at Hobart in 1954. He seized his microphone, and with a voice vibrant with emotion electrified a Continent with the announcement: "Ladies and Gentlemen, at last here is the moment we have all been waiting for. Here comes THE ROYAL CLOT YOTHIC".

But all trials pale before the supreme trial of all — interviewing people, unrehearsed, in the street. Once you take the microphone out of the safety of the studio anything can happen, and it usually does. My first attempt at a street interview in London taught me a lesson: be prepared for danger as soon as you open your mouth.



I went out with that old master of Radio rough riding Stewart Macpherson. He was then at the beginning of his career, and professed fine contempt for the traditional polite methods of B.B.C. street interviewing. He told me: "Boy, you want to leap out at your victim, and shake the interview out of him". I said to Macpherson: "All right you go first, and show me how to do it". Nothing daunted, the bold Macpherson sallied forth and collared the nearest passer-by. He was an immaculately dressed city man, complete with bowler, pin-striped trousers, umbrella and black brief case. Macpherson grabbed his arm, thrust the microphone before him and hissed: "Brother, I have got a surprise for you. You're on the air". The city man gave him the sweetest smile, and then in gentle tones, replied: "And brother—if after so short a period of acquaintance, I may use so familiar a term—I have a surprise for you—you can go to hell". He politely lifted his bowler and walked on. I now came out of hiding, and luck was with me, I spotted a gentleman with a charming lady on his arm, who was most communicative. He poured out his views on the questions of the day with magnificent fluency. Then I made my mistake. I turned to the lady at his side, and said: "And now may I have a word with your wife". My victim turned pale, and murmured hurriedly, unaware that he was speaking in to the microphone: "Hush, it is not my wife, it is my secretary. When I get home there will be the devil to pay about this". There and then I learned the big lesson a radio interviewer must master. Always have a quick cut-out ready in case of emergency.

There are many other tricks of the trade which must become second nature to you, if you are to be a successful interviewer on a portable recorder. Make certain that you have a neat introduction ready in your mind before you start to speak, and an equally effective closing sentence. Whatever happens in between you will have at least wrapped up your interview tidily. Ask your questions in such a way that your victim is comfortable. Commentator on the ground:—Brian Johnston reports a Test Match at Lords for T.V. viewers; in the foreground is Roy Webber, chief scorer for all televised cricket matches.



Commentator in the air :—Wynford Vaughan Thomas is taken aloft by helicopter for a radio programme in the series "This is Britain". Note the E.M.I. portable recorder on his lap.

pelled to talk. An interviewer who begins with a question of: "You must enjoy your work, Mr. Jones," type, deserves to get the usual short answer: "Yes," and the interview comes to a standstill. Always record without rehearsal. People are seldom as fluent or self-revealing a second time. In any case you can always re-record if your first attempt was unsatisfactory, and you may have got exactly what you were after on the first go. Avoid those irritating clichés "Tell me, Mr. Smith . . ." or "That must be very interesting". Let the interviewee speak for himself or herself. And do not be ashamed of taking such elementary precautions as watching to see if the tape is running or checking your recording immediately you have done it.

I remember interviewing Sir Thomas Beecham in Paris last year.

The Master received us with his air of old-world politeness, and was in dazzling form as he spoke into the mike. He poured out his wit and his epigrams with reckless generosity, his revelations about the private lives of his contemporaries were delightfully indiscreet, and I felt that I had a first class "scoop" in the bag, until I looked at the machine. The tape had stuck. Not a word had been recorded. I turned in anxiety to explain to Sir Thomas. He was chuckling to himself with the greatest good humour: "My dear fellow," he said. "I saw your wretched appliance had stopped the moment I began to talk, so I knew I could really let myself go". Remember all the best talks are always "off the record".

He was right, interviewing is like fishing, the biggest and best ones are always the ones that get away.

#### A.T.R.'s Roving Reporter

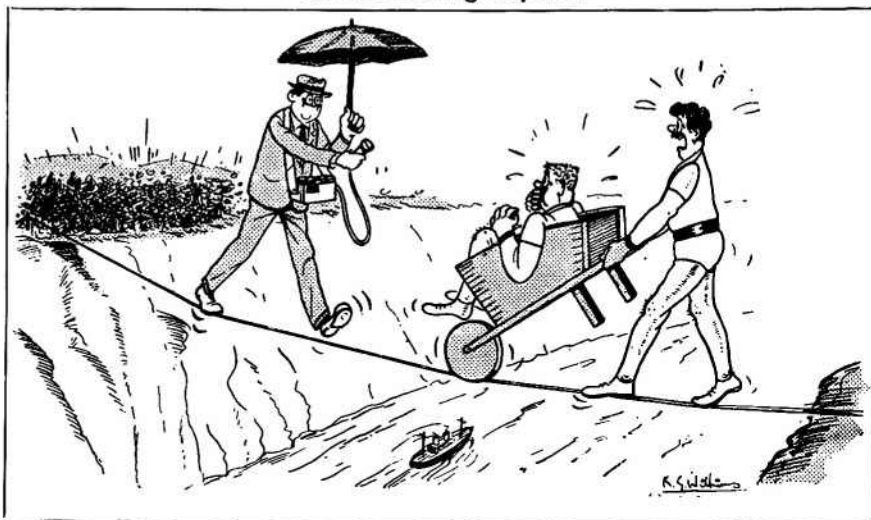

# BRENELL BULLETIN

## NEW HYSTERESIS SYNCHRONOUS MAIN MOTOR

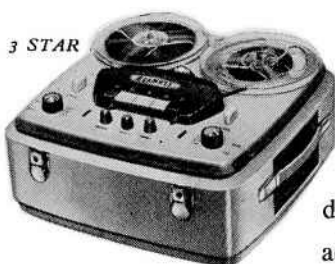

3 STAR

When equipment enjoys a very high reputation among enthusiasts and professional users (as Brenell's does) the manufacturers are rightly expected to provide developments in keeping with that status. Sometimes the advance must even outdate existing standards.

Here is a development of that kind.

As of now, every Brenell tape deck and complete recorder will incorporate a new type of extremely high quality main motor. An HYSTERESIS SYNCHRONOUS MOTOR with a balanced outer rotor and a heavy, statically and dynamically balanced flywheel. This brings 'wow and flutter' down to below 0.1% at  $7\frac{1}{2}$  i.p.s. and adds to the already superlative qualities of Brenell equipment.

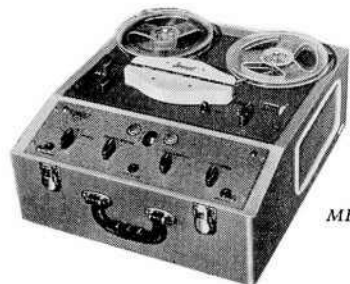

MK5



3 STAR  
R/P STEREO

At the recent British Exhibition in New York, this feature aroused special interest. We demonstrated also, a piano recording at  $1\frac{7}{8}$  i.p.s. We do not suggest that this should be indicative of standard practice, but its quality showed the remarkable extent of our products' capabilities. Similar demonstrations will be given at the Radio Show.

Visit the BRENELL DEMONSTRATION ROOM NO. 311, in the Audio Section, and see and hear for yourself just how good tape recording and reproduction can be.

3 Star : 58GNS/Mk.5 : 64GNS/3 Star R/P Stereo : 89GNS

**Brenell**

Sole Manufacturers

**BRENELL  
ENGINEERING CO. LTD**

1A DOUGHTY STREET, LONDON WCI CHANCERY 5809 and HOLBORN 7358

GD 352

VICTORIA STATION was bustling with true holiday fervour as I arrived to meet A.T.R.'s photographer and Fred, our guide and magic wand waver extraordinary, for a day in la belle France.

London contains many famous meeting points—under the clock at Charing Cross, outside Swan and Edgar's at Piccadilly . . . and in front of Platform Eight at Victoria, the entrance for the Golden Arrow—cupid's dart to the continent! The appointed time found us all assembled there, and we were able to board our train without the usual parcel dropping, suitcase popping scurry that tells one a Briton is going abroad. Pub clocks are clearly to blame for this phenomenon.

We chased through Kent chatting and viewing (two channel reception: left and right hand windows), and before you could say "Monsieur Hulot est mon oncle" we were at Folkestone. Here we got our first glimpse of British Railways afloat, the *s.s. Canterbury*. She has a fine record of service, including two moments of history that always stir emotions, Dunkirk and D-Day.

We were conducted on board by Mr. Wilkins, Traffic Assistant, Folkestone Harbour, who told us some hair-raising tales about the previous day's storm, and of ships heaving over at fantastic angles as they tried to dock; their noses in the air one minute, and their propellers thrashing the breeze the next; waves leaping into the sky and thundering down on all beneath them. "But it's much calmer to-day," he added reassuringly! Luckily for me and my peace of mind it was calm and sunny as the ship steamed out of Folkestone Harbour on to Channel Three.

There weren't any vocal sea-gulls about for me to get my desert island tapings, but I was lucky, for Fred gave a special wave with his wand and I was up on the bridge

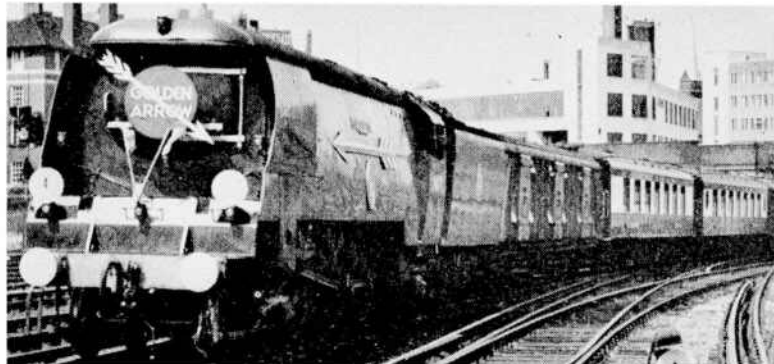

## Tape View

# CONTINENTAL

Ma'mselle Jan Phillips reporting

*British Railway's newest and biggest ship, the Maid of Kent. (inset) The Ship's Radio Room.*



## A.T.R. at the Wheel

Then as a special privilege I was allowed to take over the wheel, and all those unsuspecting passengers came under AMATEUR TAPE RECORDING control—and they never knew, because the crew soon got the ship back on course again.

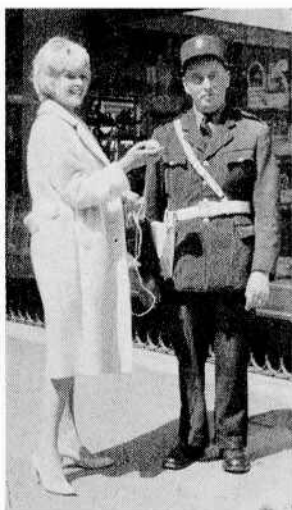

(above) Jan at the helm.

(left) This Gendarme refused to tell the press what he thought of day trippers. Perhaps he didn't understand the question!

(below) Captain Adams gives Jan the gen on navigating the Channel, while the s.s. Canterbury surges along at Full Speed.



It is a surprisingly short crossing, and Boulogne seemed to pop up in mid-channel. I made a dramatic entrance on to French soil, mainly due to the fact that I hadn't noticed the cobble-stones, and began my tour of Boulogne.

The first surprising discovery was that there were as many English as French walking around. This brought home to me more than all the figures I had heard, how popular N.P.D.T's are nowadays. (N.P.D.T.= No Passport Day Trip). School parties swirled around like clouds of gnats and the comments I overheard made me think that times are changing very rapidly, for I am sure that when I was twelve or thirteen I would not have called out to a passing Frenchman: "Hello my darling". As always, that was the one moment the recorder was switched off.

We went into a little cafe for lunch, and gave our order in the native tongue, but still managed to get what we wanted. There was a huge chromium record chaser in one corner that the proprietor kept feeding with francs. The volume from this was . . . but I expect you heard it as well. I had a peep at the selection of records in it. Half of them were French but not a single French record was played while we were there. It seems that the French preference is all British and American, man, with Lonnie and the Platters well to the fore.

We weren't allowed to leave the cafe until the proprietress had shaken hands with us all, with such enthusiasm that I suspect we had just paid their mortgage.

## The Maid of Kent

A visit to the ramparts is a must in Boulogne, for these old town defences give one a fine view of the town and harbour. But we were soon chasing back to the dock to catch our return ship, pausing only to discover that "we regret madame that these are the smallest bottles of perfume we stock", before walking up the gangplank on to British Railways' newest and biggest ship, the *Maid of Kent*. This is the fabulous car-ferry ship that can swallow dozens of cars and coaches and hundreds of passengers and ask for more. It is a most impressive sight to see those large luxury coaches driving straight off the dockside into her. Another eye-catcher is the ultra modern bar into which we accidentally wandered, and from which we were only removed by the call of duty.

Once again, I was lucky enough to be allowed on to the bridge where I met Captain Brown. It had been a gloriously sunny day until then but we were heading towards a very black sky, and I said to the Captain that it looked as though we had seen the last of the sun for the day. "We can soon tell," he replied and showed me the ship's radar set on which he pointed out this cloud. "We'll be in clear skies again by the time we reach Dover," and sure enough we were. But in the meantime I had been taken into the Radio Room, where the Radio Officer, Mr. Sayer, had explained his fabulous array of equipment. There was one piece of equipment on which he was able to pick up the Russian Sputnik's signals, and a radio telephone by which passengers could make calls to anywhere in Britain and to other European countries as well. In fact, on a recent trip one passenger had phoned Vienna from there. All equipment including the automatic alarm and distress signals is duplicated for additional safety. Nothing is left to chance.

Dover is the main car-ferry port and has a smooth Customs set-up that passed us all through with the minimum of delay. On the other side of this we parted company with most of the passengers, who drove away under their own steam, while we made our way to the station and the Flèche d'Or (Arrow of Gold) waiting to speed us home, which it did comfortably, swiftly and punctually, to round off a day to remember. Thank you B.R.



number

1

**PRIORITY**

YOU MAY HAVE MISSED THE FIRST

ISSUE OF

**POPULAR HI-FI**

Place your order

**NOW**

FOR NOVEMBER'S

**Popular Hi-Fi, the magazine for everyone who enjoys listening, which will be on sale at newsagents and bookstalls on **October 14th, 1960.****

Amateur Tape Recording



## YOU TELL THE MANUFACTURERS

Who will be the first British manufacturer to introduce a built-in time-switch in his tape recorders? Is it required by the recording enthusiast?

Readers are invited to suggest improvements and additional facilities they would like to see on tape recorders. Write to "Suggestions", Amateur Tape Recording, 145 Fleet Street, London, E.C.4, to arrive before 20th September. The first three letters opened on this date will be published and the writers awarded a reel of tape each. Even if you don't win a prize, your remarks will be passed on to the manufacturers, so be sure to let us know what YOU want in the future.

### OUR SLIP IS SHOWING—GRUNDIG TK.24

The description given on page 14 of the August edition of A.T.R., of Grundig's new four track recorder, the TK.24, should have read as follows:

It is a single speed machine (3½ i.p.s.) with provision for track selection for monaural off either track or *monaurally* from stereo pre-recorded tapes. Price 62 guineas, including microphone, tape and extra leads.

### TAPE BANK TRAIL

We have passed St. Michael's Mount jutting out of the sea on our right, and are nearing the north coast of Cornwall. Two and Six is still the figure, lest you forget.

Our thanks to A. Non and to the Friern Barnet Tape Recording Club for their generous donations to the Tape Bank.

**YOU WILL NEVER KNOW HOW GOOD YOUR RECORDER CAN BE UNTIL YOU CHANGE OVER TO A**



## BRITISH-MADE MICROPHONE

*There's a model for every requirement*

"I would place it as one of the best microphones I have used during many years of work in this field," writes J.G. in "The Gramophone", August 1960, reviewing the Lustraphone VR/65 Dual Ribbon Stereo Microphone.

You can buy a LUSTRAPHONE DYNAMIC MICROPHONE from as little as 67/6. Literature on request.

● AT THE RADIO SHOW—STAND 309, AUDIO HALL

**LUSTRAPHONE LTD.** ST. GEORGE'S WORKS,  
REGENTS PARK RD., LONDON, N.W.1  
Phone: PRImrose 8844

# Chitnis 4 TRACK STEREOPHONIC RECORDER 9/S4K



### *truest to the original*

There is no doubt which recorder you will buy when you see and hear this 4-track Stereophonic Model, for it has so much to offer both to professional and domestic users alike. The incorporation of world-famous Bogen heads with an advanced powerful twin amplifier system provide sensationally brilliant standards of reproduction at a tape speed of only 3½ inches per second. Mechanically, too, the Chitnis 9/S4K is a masterpiece of efficiency and dependability. Response to all controls is instantaneous; a self-locking arrangement prevents accidental erasure of wanted material. **YOU CAN USE THIS RECORDER FOR STEREO OR MONO AS REQUIRED.** Four track facilities double the playing time of each reel and halve tape costs. Controls are very well positioned, and the complete instrument (with its own built-in loudspeaker for monitoring, etc.) is housed within a case of remarkable compactness and elegant modernity.

- ★ **RESPONSE** 30-16,000 c/s  
±3 dB at 3½ i.p.s.
- ★ **INPUTS** Radio (2) Pick-up  
(2) Microphone (2)
- ★ **OUTPUTS** 2 at 15 ohms;  
two low level
- ★ **SIGNAL-NOISE RATIO**  
Better than 55dB

★ *Pause, superimpose, monitor, etc. Size 13" x 10½" x 6"*

*From good stockists Leaflet on request*

**62  
GNS**

● **FOR STEREO  
AND MONO**  
● **BOGEN HEADS**  
● **PAPST MOTOR**  
3½ i.p.s.  
15-ohm **OUTLETS**

**CHITNIS ELECTRONICS LTD.**

**1 Long Acre, London, W.C.2**

Telephone COVent Garden 1918/9

# IN CAMERA



by Lorna Gulston

IT SHOOK ME rigid the morning the letter arrived. Work nagged and the day crippled along towards 8 p.m. when I should reach the Camp and break the news to the rest of the "Prairie Weeds".

The "Prairie Weeds" began right back in 1951, the day I went into a music shop to buy a mouth-organ, encountered a Svengali of an assistant, and lumbered out clutching a guitar. That, as fellow-squares will remember, was in the antediluvian era before long-haired short-brained youths squawked to the accompaniment of loose strings, tight pants and the howls of the "sent", and one didn't bark one's shins on guitars in every corner of every room of every house which boasted a teenager from fourteen to forty. Like all pioneers, I learned the hard way, sweating it out in solitude in the drawing-room until, quite by accident, I discovered the Three Chord Trick, and then, you will appreciate, I was a maestro overnight. A few months later, when Private Gulston was detailed into a Territorial Army camp concert, from the limbo of one guitar and five female voices, the "Prairie Weeds" burst on a shuddering public. Over the years there were changes, as marriage gobbled up a larynx here and there, but the group lived on and even acquired a second guitar.

Our stamping-ground was Army concerts and charity shows — in short, any place where the audience daren't fly screaming from the hall. We once performed at a mental hospital where inmates also contributed a few items to the entertainment, and afterwards we overheard a lady Committee Member hissing to a crony behind the tea-urn



"Dreadfully sad, don't you think, dear? And they look so normal, poor girls."

However, we pressed on, and when Northern Ireland gained its own Television Service and everybody seemed to be getting into the picture, in a fit of what-the-heck we resolved to storm the bastions of Ulster TV. So the poor

Grundig journeyed to the T.A. every Tuesday and Thursday evening, and after training we rehearsed with more optimism than skill, while the TK5 faithfully reproduced all our the wow, dear Brutus, was not in our tapes but in ourselves. imperfections. I tested the machine for wow, and found that

"We daren't go for an audition," we mourned. "They'll throw us out."

But too many people had elbowed their way into the secret, so to save our faces we had to make a gesture, and now, fantastically, we were pledged to present ourselves at 2 p.m. on the afternoon of Tuesday 26th April at the Studios. In short, we were ON TV!

It was a beautiful afternoon. The sun shone as the sun has a habit of doing when you are already hot and sticky with haste and fright. By the time the five of us plus guitars met in the studio foyer we were red-faced, winded, and feeling as photogenic as a sow having a mud-bath.

A charming poised creature in a white overall coat was waiting to pounce on us.

"Ah, the Prairie Weeds, I presume?" she smiled, in true Stanley style. "Just come along to the dressing room. You've fifteen minutes before you're wanted in the Studio."

We toiled up flights and flights of gleaming linoleumed stairs to a plush little den all mirrored and carpety and h. & c., and there we hurried into our togs — checked cowboy shirts, neckerchiefs and slacks. We were used to quick changes, groping in the dark in cubby-holes behind stages, so we found ourselves with minutes to spare and had a run through our repertoire of "Hand Me Down My Walking Cane" and "Four-Legged Friend".

"It didn't sound as bad as that the last time we recorded," observed Audrey, and four pairs of eyes turned on me with accusation, as if I had done a technical fiddle on the Grundig to flatter us up.

"Bigger room," I defended. "You haven't got the acoustics here."

"Oh goodness," quavered Rosemary. "And there'll be so many people watching us."

That was the trouble. Between one thing and another, the half of Belfast threatened to be agog by their screens at 6.5 p.m. It was a horrid, horrid thought, but we hadn't much time to dwell on it, for our white-coated mentor was back and off we straggled to the ground floor and the doom of Studio 1.

Frankly, Studio 1 was a disappointment. It was tiny and cluttered and suffocating, with disheartened carpets and waspish contemporary stools all tangled up in camera flex, and everyone appeared to be in shirt-sleeves, looking altogether too relaxed for the popular conception of screaming hysteria, flashing lights and cameras whizzing about with demented maniacs at the controls. Lily managed a dramatic

entrance, tripping on a cable and falling into the arms of the plainest, baldest cameraman in the room. She made a good thing out of it, though, because he was thrilled to bits and everybody said later how many close-ups she had!



Rehearsals weren't funny. We stood under batteries of arc lights slowly roasting like barbecued chickens while the producer's voice boomed instructions through a loudspeaker and figures strolled around saying, "A fraction more to the right, Charlie."—"Can you get it O.K. from that angle?"—"A lee-tle closer, I think, Ron". There were two other victims as well as ourselves; a young housewife on holiday from Ghana and an authority on birds. The programme was to open with the housewife, then us, then the naturalist, and we were supposed to start our first song when the assistant producer dropped his hand. "Remember, girls, BIG smiles," he warned, as we stared at him frozen with terror and glum to the point of despair, wondering what brainstorm had caused us to stick ourselves in this public pillory. Anyhow, we did our best. I showed every tooth in my head and swayed so energetically that a button at the waist of my shirt popped off and almost put the nearest cameraman's eye out. Meanwhile, the assistant producer was making weird signals, so we stopped, and he said with the patience born of much amateur talent, "Sorry, dear, but you're looking at the wrong camera, yours is over here!" So the button had died in vain. Still, after the third run through things were better and we had a break to drink fizzy lemonade in the canteen and stroll in nearby cricket grounds, indulging in jube-jubes and rising panic, till it was time to present ourselves at the make-up department. The make-up department was a teenager's paradise. Pots upon pots of mascara, and cream, boxes of powder, strange scented liquids, eyebrow pencils, tweezers and scissors. These were arrayed before a monster mirror which was a veritable hi-fi stereophonic reproducer of facial defects in which the smoothest skin

could be revealed pocked with tiny craters and mountains, a sort of dermatic lunar-landscape. Jill, the make-up queen, installed us one after the other in a chair just like a dentist's and set about making us decent for the viewers. She was vexed because my eyebrows ended too soon.

"Tch, tch," she clucked, juggling with black pencils. "MUCH too short, not symmetrical, if you know what I mean."

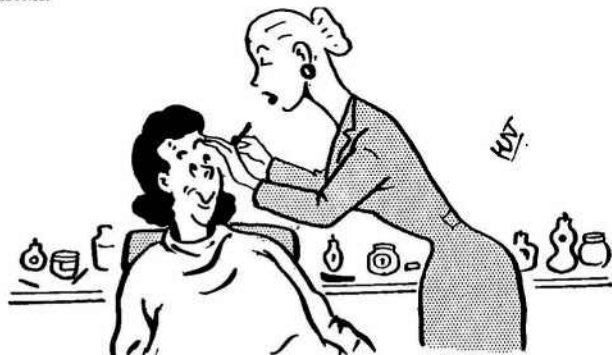

I said I was awfully sorry. I felt quite churlish to have come with abbreviated eyebrows, but she was very good about it and forgave me, probably because she enjoyed helping Nature out.

With stiff masks of faces we walked downstairs and shivered outside the studio doors till the programme then transmitting finished. It was five minutes to six. The hour was nigh. The red light which said "ON THE AIR" went out, and we went in, and the doors closed behind us with a final sort of grunt. "Right, girls, to your places," ordered the assistant producer. "If you want to cough or sneeze or blow your nose, get it over with now, and stay where you are when your turn is finished and don't move a muscle. Don't worry, you'll be fine. The best of luck." Everything clicked into gear, and the studio clock showed 6.4. "One minute," said the producer casually. "O.K., I'm starting to count—50, 40, 30, 20, 10—RIGHT."

The Ghana housewife took a fevered breath, the interviewer sat back more comfortably, then we were off. The interview ticked away and the big saw drew nearer and nearer, so that there was nothing in the world but the assistant producer's upraised hand.

Then it was falling, and I was launching into my introductory whistle. We were on the air, and the Lord have mercy on our souls.

Afterwards we collected our cheque and trooped towards the free sunshine, all babbling at once with relief and speculation. Thank goodness it was all over and done with! How had we sounded? What would everybody say?

A small group was congregated just outside the door—six little girls from about five to nine chewing gum and wobbling on roller skates. The biggest skated up to us and thrust a mangled scrap of paper into my hand.

"Please, Miss, can we have your ortergraf?" she mumbled, bursting a balloon of bubble-gum in my face. "We seen youse and youse was great."



It was a tremendous moment. What every artist dreams of had come to pass—the fans were upon us. The Prairie Weeds had Arrived!

With a flourish I took the paper, trying hard not to look too smug. "Why certainly, dear," I beamed. "You may have our autograph, with the greatest of pleasure."

You know, I have never stopped feeling cheated because when it came to the bit, we didn't have a single pencil among the lot of us, and nobody has asked us since and probably never will!

**ROMAGNA EDITING BLOCK**

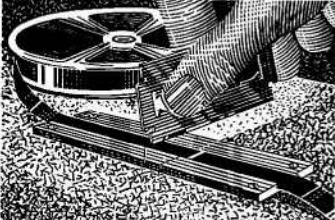
*designed by Stanley Kelly*

**ROMAGNA REPRODUCERS**

The simplest quality design in the world. Completely efficient with equal simplicity of operation.

**7/6**  
post free

Enquiries to **K. H. Williman & Co., Ltd.**  
11 Blackford House, Sutton, Surrey.

Melville 1491  
Vigilant 3700



Only with **FI-CORD** can you have it both ways—really HI-FI and really portable

Don't be misled by the compact size. The **FI-CORD** is a high fidelity instrument of advanced scientific design—assuring true-to-life recordings.

Frequency 50-12,000 c.p.s.  $\pm$  3db. Tape speeds  $7\frac{1}{2}$  i.p.s. and  $1\frac{1}{2}$  i.p.s. Twin track record/playback, using standard  $3\frac{1}{4}$ " spools.

Wherever you go, you can take your **FI-CORD** with you, it is ideal for adding

the realism of sound to movie films.

The **FI-CORD** weighs only  $4\frac{1}{2}$  lbs., measures  $9\frac{3}{8}$ " x 5" x  $2\frac{3}{4}$ ", operates in any position (lid open or shut) and requires no power point. It runs on 4 batteries, rechargeable from the automatic charger supplied.

Built-in speaker. Full playback volume. Extension speaker socket. Dynamic microphone with stop/start switch.

**CATCH IT—  
AND KEEP IT—WITH**

**FI-CORD**

Complete with  
Microphone, Tape,  
Batteries and Charger **59** GNS  
or with Grampian DP4/M  
Microphone **66** GNS

Write for name and address of your nearest stockist to:—  
**FI-CORD** Ltd · 40a Dover St · London · W1  
Tel: HYDE PARK 3448

Our contributor John E. Little describes simple precautions to ensure that your tape recorder will function efficiently. In this article he deals with electronics.

# Tape Recorder Maintenance

by John E. Little.

A KNOWLEDGE OF electronics is not essential to operate a tape recorder; anyone can get good results by simply following the manufacturer's instructions. But to get the best requires a little knowledge of the basic principles of magnetic recording. It is proposed therefore to outline the general principles before proceeding with maintenance and fault tracing.

## Amplifier and Equalizer

The amplifier consists essentially of a voltage amplifier, used both for recording and playback, followed by an equalizer stage.

The problems involved in tape recording are that the record and playback head or heads suffer certain losses. If an acceptable performance is to be achieved, some form of equalization or correction must be introduced. The treble response suffers mostly during recording whereas the bass suffers on playback. Correcting networks designed to give the necessary equalization during recording and playback for each tape speed are selected by means of a switch. Thus by this process the tape is more or less evenly loaded.

## Oscillator and Output

Moving on, we come to that part of the amplifier which in most domestic models provides, during recording, a high frequency oscillator circuit. The output of this is used for erasing unwanted material on the tape, and provides bias to the record head to give a low percentage harmonic distortion, a better signal level, and a low background noise behind the signal. To

understand more fully the theory of alternating current biasing, recourse should be made to textbooks on the subject. The high frequency oscillator generates a frequency of 45,000 to 60,000 cycles per second, and when applied to a moving tape via the erase head, subjects it to a strong magnetic field. Since the distributed flux in the head gap is not uniform the tape passes through increasing and decreasing

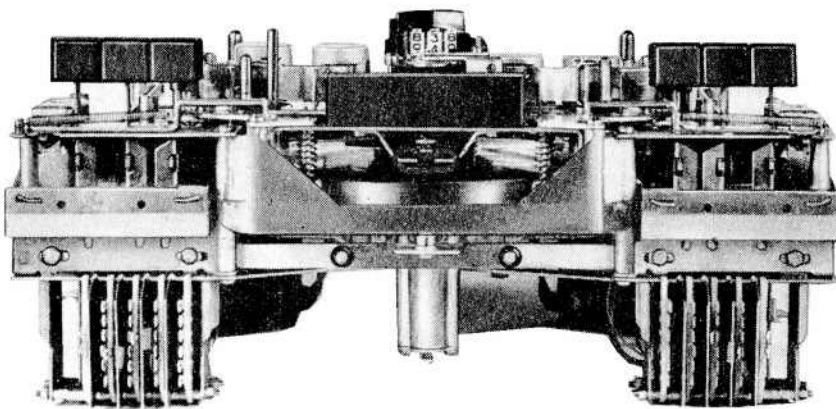
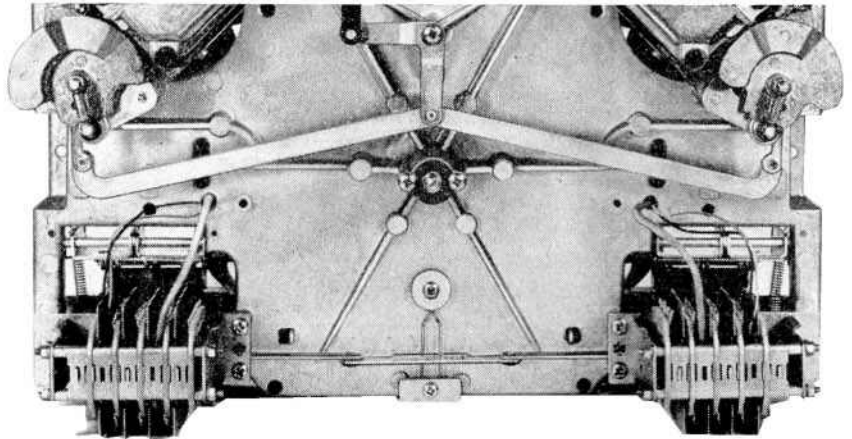

Two views of the underside of the Collaro Mk. 4 deck as fitted to many British made tape recorders.

(above) Note the layout and wiring of the Yaxley switch assemblies at bottom left and right;

(left) The same deck is seen from the side to illustrate the linkage between the press button switches and the contact points.

John Little recommends periodic examination of the buttons, spring sets and contact points to ensure silent and positive switching at all times.

cycles of magnetization so that finally it is left in a clean state.

On playback the oscillator plays no part in the reproducing process, but the valve employed in generating this high frequency now forms part of the output amplifier to drive the loud-speaker.

The more professional machines employ a separate oscillator and output stage.

### Recording Level Indicator

In order to obtain a recording reasonably free from distortion an indicator in the shape of a 'magic eye', neon tube or meter is provided. These serve to indicate the amount of power reaching the record head. The manufacturer usually provides instruction as to how far the eye should close, or the needle of the meter move. In all cases this instruction should be strictly adhered to.

## MAINTENANCE AND FAULT TESTING

### Cleaning

Having removed the amplifier and deck from its case, remove with the aid of a small brush all surplus dust, being careful not to disturb the wiring.

For neatness and simplicity a large number of tape recorders use press buttons. These need to be examined periodically and the spring sets checked to see that the contacts are not unduly worn. If it is necessary to clean these, do not use an abrasive instrument such as a nail file; running the blade of a small screwdriver between the contacts is quite sufficient and effective.

**Yaxley Switches** are used quite extensively. The method of cleaning these is to use one of the many proprietary switch cleaning fluids, following the instructions very carefully.

**NOTE:** Carbon Tetrachloride is not recommended because it leaves a deposit after evaporation which will give rise to excessive noise.

### Fault Tracing

The average person does not possess much in the way of test equipment. If, however, the amateur is to carry out his own servicing, then some form of universal voltmeter is essential. The B.B.C. conveniently provides a test tone of 440 cycles and 1,000 cycles on the Light and Home Service programmes, just prior to the start of transmission, and there are also suitable frequency test tapes available, at a reasonable cost.

### Valves

As a first step the valves should be tested. Certain noises can be traced to these, such as thermal agitation (hiss) or microphony. If a valve rings when tapped, it points to a loose electrode. Change only if troublesome.

### Hum

This can be most annoying and very difficult to locate. First see that the

recorder is properly earthed; examine the connections to the three pin mains plug. Ensure that the metal screens on the record, playback, and erase heads are secure. A faulty valve (low insulation between heater and cathode), in the early stage of the amplifier, or a faulty smoothing capacitor in the power supply unit can give rise to hum.

### Wow and Flutter

This is best detected by using a test tape or recording a fixed tone from the B.B.C. and reproducing to see whether there is any variation in pitch. A more precise test is to record a tone at the higher speed and reproduce at the lower.

If after careful listening you can detect a variation or change in the pitch of the recorded tone, then examine the capstan and pressure wheel to see that they are thoroughly clean. Having satisfied yourself, run the machine again, and if the variations still persist more drastic action is required.

Since the transmission of the tape past the heads is controlled by a number of circular parts, any one of which may be the cause of the trouble, try and associate the variation with the movement of the various rotating parts. Short changes in pitch point to out-of-circle parts whereas long changes suggest bent tape spools, uneven feed, due to the tape bearing on the flange of the spool as it unwinds.

### High Background Noise

The noise behind the signal should be very low. The principal causes of high background noise are:

- (a) Dirty Heads.
- (b) Bad Contact between tape and heads.
- (c) Magnetized Heads.
- (d) Valves.
- (e) Distortion in the high frequency oscillator.
- (f) Worn Heads.
- (g) Components (resistors and capacitors).

### Azimuth Adjustment

You may have noticed that when reproducing a friend's tape on your machine the quality does not compare with your own tapes. This may be due to the difference in the alignment of the reproducing head on your machine, and the record head on your friend's machine.

Most tape recorders have a means of aligning the record and playback heads. The most satisfactory method is to use a test tape with a fairly high frequency recorded upon it. Reproduce and align the head by means of the azimuth adjustment for maximum output.

### Head Cleaning

Apart from using methylated spirit, there is available a cleaning fluid under the name of **KLENZATAPE**. This is supplied in a kit containing two spools, cleaning tape and fluid. The method of application is simple: the tape with fluid applied to it is played through the

machine as normal tape at fast speed (not re-wind). It is most efficient and has the advantage that it is not necessary to remove the head caps. Supplied on an attractive card with full instructions, it is thoroughly recommended.

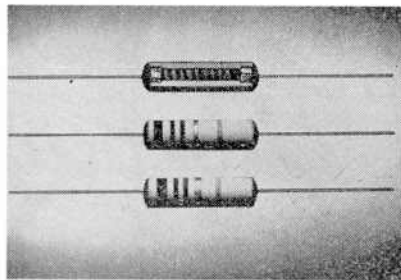

A selection of Eric resistors

### Components

When it becomes necessary to change defective components, ensure that a direct replacement is made, particularly for resistors. High stability resistors are used quite extensively in circuit design to reduce noise in the early stages of the amplifier. They are easily identified by the spiral cut round the length of the resistor, or by a coloured band.

When removing components from printed circuits, do not apply too much heat to the connection, otherwise the circuit will be destroyed. Always ensure that you make good clean soldered connections; bad ones are often the source of noise.

## A.T.R. READER ENQUIRY SERVICE

IF YOU WOULD LIKE PARTICULARS OF ANY OF THE FOLLOWING ITEMS, PLACE A CROSS IN THE BOX PROVIDED AND RETURN THIS COUPON TO A.T.R., 145, FLEET STREET, LONDON, E.C.4.

Tape Recorders (mains)

Tape Recorders (battery)

Microphones

Record Players

Recording Tape

Pre-recorded Tapes

Tape Splicers

Accessories

Name .....

Address .....

The  
**WINSTON**  
*'Thoroughbred'*  
*wins on all*  
*points!*

Forget, for a moment, its moderate cost. Consider only the acknowledged technical advantages of the Winston 'Thoroughbred'—its many exclusive features and refinements. No wonder this most dramatic achievement in better-value Tape Recorders leads the field!



\* *Three speeds: 15, 7½, 3½ inches/sec.—gives 3 hrs. 12 mins. playing time.*

\* *Twin track recording.*

\* *Three loudspeakers ensure live, natural tone for speech or music.*

\* *1,800 ft. spool of long-playing tape supplied —plus high sensitivity microphone.*

\* *Built-in mixer unit enables you to record your voice with standard disc recordings, radio or live music.*

\* *Built-in public address system.*



**FREE**

This practical, informative booklet tells you how to make the most of your 'Thoroughbred'—suggests various uses, gives expert information on recording techniques. Send for it NOW.

**SEE AND HEAR THE WINSTON 'THOROUGH'BRED' AT YOUR DEALERS**

**ALL THIS FOR ONLY 59 GNS**

or £12-8-0 deposit and 12 monthly payments of £4-9-3

NO EXTRAS

**WINSTON ELECTRONICS LTD.**  
**GOVETT AVENUE, SHEPPERTON, MIDDX.**

Tel: Walton-on-Thames 26321.

Cables: "Winston" Shepperton.

*Enquiries from the Retail Trade are welcomed.*

# TETE-A-TAPE

Further deliberations on frustrations imposed, and opportunities offered, by tape recording,

by David Lazell



JUST A FEW weeks ago, I received through the post a very interesting little booklet which described a well-known home psycho-therapy service. I was invited to send details of my personal troubles, to the gentleman concerned, and, in turn, he would send me a tape recording which would help me to overcome the difficulties afore-mentioned. Thoughtfully, the introductory letter suggested that the more intelligent members of society are those who most need the service. A variety of pre-recorded tapes was also advertised, and these appeared useful enough. The list included tapes on better public speaking, overcoming an inferiority complex and gaining self-assurance—and good dieting, too! I do not know why I was selected as a potential purchaser, but as a veteran of some eight or nine encounters with psychiatrists, I appreciate the suggestion that, as one of Britain's 'top people', I may be slightly unbalanced.

The truth of the matter is, of course, that everyone is neurotic these days—even the psychiatrists. I remember visiting an army psychiatrist in Oxford, a nervous captain whose hands shook so vigorously that he found it difficult to steer a cigarette into his mouth. His moustache was deep-stained with nicotine as a result. I remember that interview well—how I wish that I had recorded it. The psychiatrist asked whether I liked the army, and then confessed that he didn't, either. Then he attempted to light a cigarette, a hit-or-miss affair that interested me greatly. He didn't appear to know what to talk about after that, so I asked him what he thought about Freud.

"Very good chap," he replied, smoke billowing from the nervous cigarette. The conversation went on with the usual questions about unhappy childhood, but I soon came to the conclusion that I was the very epitome of mental and spiritual stability and well-being compared to that unfortunate officer. I saluted him at the end of the interview. This took him aback, and he blushed that salutes were not at all necessary. The only result of that visit was that I was subsequently excused boots and marching.

Serious mental illness requires extensive psychiatric treatment, of course. Our minds work in such a way that the true cause of our neuroses may be concealed from us and hidden in our subconscious mind. Thus, if we were asked to describe our troubles it would be extremely unlikely that we would admit the cause of the mischief. The psychiatrist has to work, first, to build a relationship between himself and his patient, and, from there, probe to find as much as he can about his patient's background.

Very often, the patient's condition may be improved simply because he has an attentive listener to the catalogue of his trials and tribulations. It might be an interesting experiment to find out whether just telling your woes to your long-suffering tape recorder might make you feel better.

Anyway, it would appear that this new method of psycho-therapy by post has a lot to commend it, as long as its limitations are accepted.

## Sad Stereo!

THE BATTLE continues to rage, with the advocates of stereo sound trumpeting the virtues of their equipment so loudly, that we humble monophonic morons get further inferiority complexes. I decided to visit an audio exhibition in Leicester, there to obtain a true impression of the much-heralded blessings of stereo. In fact, I wore a clean shirt for the occasion, and it was with great anticipation that I trod the well worn steps to the demonstration being given on the first floor of the building concerned. It was rather like entering Aladdin's cave (without, alas, a magic lamp) since a wonderful variety of equipment splendidly lined the room itself. The stereo equipment being used could hardly have been bought by anyone with an income of less than £2,000 p.a. It was magnificent. I positioned myself halfway between the two loudspeakers (each as tall as a Welsh dresser). Then the bright young man at the controls (which looked something like the main signal box at St. Pancras), put on a record.

At once, I wished that I had stood at a safer distance. I have nothing against rock 'n roll, but it did seem rather a waste in stereo. The recording itself was of a somewhat unintelligible group consisting of tuneless sax., burping bass, rumbling piano and hoarse 'singer'. As far as I could make out, the bass came out of the left hand loudspeaker, the saxophone from the right. I heard the record through, and reflected that it was rather like buying a Stradivarius violin in order that you could hit your small brother over the head with it. I could have stayed and heard some classical works; the stereo '1812' was handy, I think, but those cannons and church bells would have been rather too much. So I left.



## Happy Background

WHENEVER I make a tape recording, I draw the curtains, close the doors and windows and wait 'til all is silent. However, the telephone rings or there is a knock at the door or I drop the lid of the tape recorder, and always at the



intellectual summit(?) of my discourse. After giving myself no few headaches in the attempt to get peace and quiet for my recordings, a friend in Israel suggests that it is all unnecessary. The background noises, he says, make the tape recording much more interesting. So I am now making a list of useful background noises — tea cups clattering on saucers (for the American 'market'); birds singing in the garden (I wait very patiently for these); traffic noisy in the road outside (always with us, I'm afraid); wife using the vacuum cleaner; church bell chiming; Mr. Lazell dropping the lid of his tape recorder on the floor, etc. I wonder if these background noises may not sometimes be more interesting than the speaker.

### Useful Booklet from 'Irish' tape

I HAD my first spool of 'Irish' tape recently, and have been well pleased with it. I note that a useful little booklet, 'How to make Better Tape Recordings' by Warde Adams, Jr., is made available free by the makers of 'Irish' tape. It includes a guide to microphone placement, arranging recording sessions, different types of tape, splicing and recording speeds. Indeed, this is the kind of booklet that is invaluable to all new owners of recorders, who can also make up for any lack of knowledge by obtaining back numbers of AMATEUR TAPE RECORDING.

### Tales on Tape

MR. FRANK WARREN of Watford sent me a tape on which he read one of his short stories, 'Cathedral Chimes'. It was a very accomplished work, well written and well read. Mr. Warren gave me the difficult task of criticism. Anyway, he has started a circle of tape tale-tellers, each member recording a piece of original work and sending it around the circle for comments and criticism. Interested folk should drop a line to Mr. Frank Warren at 7 Princes Street, Watford, Herts.

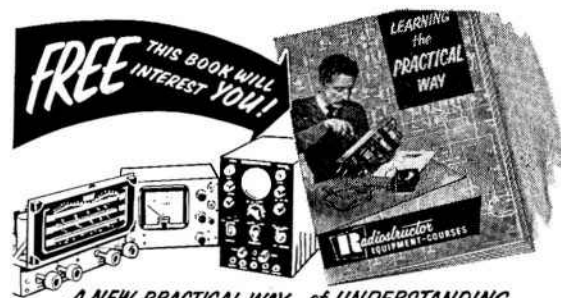

A NEW-PRACTICAL WAY of UNDERSTANDING

## RADIO · TELEVISION · ELECTRONICS

Including: Transistors; VHF/FM; Hi-Fi equipment; Computers; Servo-mechs; Test Instruments; Photo-electrics; Nucleonics; etc.

FOR . . . Your Career . . . Your Own Business . . .  
An Absorbing Hobby . . .

Radiostrucor - An Organisation specialising in electronic training systems - offers a new self-instructional method using specially designed equipment on a "do-it-yourself" basis. You learn by building actual equipment with the big kits of components which we send you. You advance by simple steps, performing a whole series of interesting and instructive experiments—with no complicated mathematics. Instructional manuals employ the latest techniques for showing the full story of electronics in a practical and interesting way—in fact, you really have fun whilst learning! Fill in coupon below, for full particulars—

**POST NOW** To RADIOSTRUCOR (Dept. G85)  
READING, BERKS.

Please send brochure, without obligation, to:

Name: ..... } **BLOCK CAPS PLEASE**  
Address: .....

(We do not employ representatives)

**RADIOSTRUCOR** LEADS THE WORLD  
IN ELECTRONICS TRAINING

# 'SOUND' TERMS FROM SOUTH WEST LONDON'S NEW HI-FI CENTRE



### JUST LOOK AT THESE ADVANTAGES . . .

LOWEST DEPOSITS — UP TO TWO YEARS TO PAY — NO INTEREST CHARGES WHATSOEVER — FREE INSURANCE — YOUR PAYMENTS ARE CANCELLED NOT JUST DEFERRED IF YOU FALL ILL OR BECOME UNEMPLOYED.

HERE ARE JUST TWO EXAMPLES . . .

**BRENELL MARK V** £13.10.0 DOWN  
and 24 monthly payments of 44/9. Cash Price 64 gns.

**PHILIPS STEREO** £19.12.0 DOWN  
and 24 monthly payments of 64/2 Cash Price 92 gns.

DETAILS OF ANY MODEL SENT ON REQUEST

**TAPE  
COPYING  
& TAPE  
TO-DISC  
SERVICE**

**SANDS HUNTER** and Co. Limited

DEPT. A.T.R.

**85 THE BROADWAY, WIMBLEDON, S.W.19**

**CHE 4393**

also at

43 MITCHAM ROAD, TOOTING, S.W.17 | 37 BEDFORD STREET, STRAND, W.C.2 | 19 LUDGATE HILL, ST. PAULS, E.C.4  
BAL 2880 TEM 8858 CIT 7479

## ANNOUNCEMENT

Will Club Secretaries continue to send news to:—

**TERRY NURSE,**  
161 Stuart's Road,  
Birmingham 33,

not later than the 20th of the month. Send plenty of news in because **THIS IS YOUR JOURNAL.** Interesting photographs are also invited.

## SOUND HUNTING



ONE OR two tape clubs pack up for the Summer and close their doors: the rest pack up too—but only so that their recorders, rotary converters, microphones, and other gear can be transported safely to a suitable location point. Then everything is unpacked (whilst those with battery-portables watch and smile) and off the members go sound hunting!

North Lincs S.R.S. proceeded to Waltham Aerodrome for an outdoor meeting recently, to catch the sounds of the Grimsby Aero-Kart Club. They took along a Grundig TK20

powered from an Elpico Vibrator pack, a Fi-Cord, and a Clarion Transi-tape. But it was a blustery day and the wind could be clearly heard on playback, even with shielding on the condenser microphone. Despite this many interesting sounds were taped and valuable experience gained in interview technique.

At another meeting of this active club, members recorded a local musical group called the "Night Hawks", and experimented with recording the guitar amplifiers direct. IN THE "old and new" competition held by West Hertfordshire T.R.S., judge *John Grainger* awarded top-place to Jack Hill, whose tape consisted of a comparison between old and new domestic equipment. Later during the evening, Secretary *Pete Holloway* played his winning entry in the British Recording Club's Historical Events Contest, an interview with William Shakespeare (on horseback).



In the latest "Sound Hunt" which features each month two outdoor teams recording sounds on location, and a third team hectically faking the sounds back in the clubroom, the "home" crew won hands down. Their concoctions included a jukebox, "Down The Hole" (an interview with a gas-main repair man), "In The Cooler" (with member *Vera Jackson* being put there after a struggle in sound with *Sid Attwood* and *Dennis Millard*), a two-way radio conversation (amateur radio fanatics talking through a barrage of atmospherics and Morse), a Commercial radio broadcast (Jingle going: "Buy a tape, Buy a tape, only 12/6 a reel"), an interview with a tramp, with a fireman, and with a man-in-blue.

THE *Urmston* T.R.C. has visited the Daily Mail and also the North Western Gas Board's showplace "Partington Gas Works". Battery portables went with the members on both visits.

At the last meeting members heard "The Big Steal" a story of crime with a difference—each member taking part in the recording, continuing the narration from where the last member left off. The object, of course, was to leave the next narrator in a spot trying to get out of a semi-impossible cliffhanger. "The Big Steal" was a great success and it was agreed to hold a similar do-it-yourself story, this time with a space-fiction theme which is to include home-produced sound effects.

AT A LIGHTHEARTED meeting of the South West London T.R.S. two scenes were recorded from a specially written "pantomime". This was followed by a discussion on whether the joint authors, *Richard King* and *Denys Killick*, derived most pleasure from deliberately miscasting the actors, or the actors from reading their parts.

A NEW SERIES of competitions has been introduced by the Weymouth T.R.C. for recordings made using sound effects in the compilation of short stories. In the first of these



Edited by Terry Nurse

HV

contests, *Terry Hughes* and *David Herridge* won first prize with their tape "Muggings—a Weymouth Cop".

IN COLLABORATION with the Old Hamp-tonians Dramatic Society, West Middlesex T.R.C. produced a play called "The Tinkling Bell" (a "natural" for tape recording). A team of four members went over to make the recording during the final rehearsal, and other members acted as audience and supplied the audience reaction at the appropriate places.



MEMBERS of the Nottingham A.T.R.C. produced a programme of their own with pre-recorded interviews, linking narration, sound-effects and announcements. The programme, produced in the studio, was on the lines of a "review" of what happens on a typical Saturday. Opening at Covent Garden early in the morning, members went shopping at the greengrocers, prepared lunch, visited a jumble-sale in the afternoon, and went to the movies at night. One of the early morning shots was of a milkman. From two ash trays and an obliging member who can whinny very well we got the horse, and by judiciously clanking a milkcrate the picture was complete!

AT Coventry T.R.C.'s meeting *Henry Hopfinger* played over some of his popular actuality recordings. He explained the difficulties encountered by him in recording the Bryan Bailey memorial service in the New Cathedral, stressing especially the trouble with microphone positioning. Also heard was Henry's recording of the Mayor-making ceremony in St. Mary's Hall when Alderman Harry Stanley was installed as the new Lord Mayor of Coventry.

A TEAM of members from Rugby A.T.R.S. under the leadership of *George Dawson* spent some 131½ hours between them recording and editing the tape they made at Elmdon Airport, Birmingham, a while ago.

A TAPE CLUB that can virtually "sound hunt" its own self because it is also a Drama Group, is the newly-formed Phoenix D.& T.R.S. of Windsor, Berks. The Society will take the place of the Windsor Youth Theatre Group which has had three years of fluctuating fortunes. It is hoped the wider scope of the new club will bring in a stream of tape recording enthusiasts and amateur dramatists and foster closer

links between them. The club also hopes to produce tapes of high technical and acting standard for ultimate offer to the B.B.C., and will see that at least one stage play a year is produced. Most tape equipment dealers in the district have pledged support for the club, the first of its kind in the world. IN A COMPETITION held by Bridgwater T.R.C. for the best short interview, Miss Jill Sharman won with an interview with a teacher just back from a visit to China and India.

## GOODWILL SERVICES

MANY creative workers in the clubs, seeking satisfaction from their efforts and a sense of purpose and achievement, are turning to the production of tapes for use in hospitals, at old people's homes, and by the blind. They are discovering that nowhere else can one find such truly appreciative audiences, and the joy that they are bringing to their less fortunate fellows is spurring them on to produce better and better tapes.

John Grainger of the West Herts. T.R.S. has given another programme to the local Blind Club which includes a description of a flower show, the Hertfordshire Modern Ballroom Championships, and wild birds heard in the countryside at this time of year. The Blind greatly enjoy listening to these programmes.

In conjunction with the Rotary Club at Hemel Hempstead, Sid Attwood presented a request programme of "Favourites" for the patients at St. Paul's Hospital. The Rotary Club provided the music and commentary.

SOCIAL evenings for the Blind are also being provided by Barnsley T.R.C. The programme in current use consists of film music and songs from the latest Frank Sinatra Film "Can-Can", along with a quiz of songs from the 1930 decade, entitled "Do You Remember?"



AT A MEETING of the Grantham & District T.R.C. members discussed ways and means of helping the local blind club, and their guest for the evening was the organiser of the club herself. A tie-up between the clubs has been arranged for the not too distant future.

THE Hillingdon Hospital has been approached by West Middlesex T.R.C. with an offer of assistance, and the Hospital Secretary is to put the proposal before the Management Committee shortly.

THE Winchester T.&C.C. are joining the Tape Reading Circle for the Blind and should soon be fully participating. Nottingham A.T.R.S. are at present making plans to run a hospital service and hope to have the scheme running by the autumn.

ALREADY under way with their hospital service are the Hazells T.R.S., Aylesbury, Bucks., and they would like to thank all the people who have sent tapes for copying and use in the service. As part of their hospital programme, the club is providing the Children's wards with taped entertainment in the form of fairy stories and fables, for example "Peter Pan" and Grimms'. These are played over to the children on their admittance days, and help to turn their minds from worry.

If you would like to help the club and this service by recording a fairy-story or a fable, your help would be greatly appreciated, and after dubbings had been made from your tape(s) they would be returned. Please do contact L. W. Powell, Hazell Watson & Viney Ltd., The Printing Works, Aylesbury, Bucks., if you can help.

Friern Barnet & District T.R.C. recently held a temporary hospital service with a difference, the patients being in this case two "sick" tape recorders. Jim Fulton performed the difficult operations with surgeons dexterity, and the patients were soon discharged and sent back to work.



## CLUB TAPESPONDENCE

SEVEN Tape Recording Clubs in the Midlands area are taking part in an experimental scheme for the interchange of ideas, recordings, news, gossip, and so on. They are the clubs in Stafford, Nottingham, Northampton, Warwick & Leamington, Coventry, Leicester, and Kettering. The British Recording Club has agreed to organise the scheme on the clubs' behalf, and your Club News Editor is personally responsible. The scheme, which is already under way, operates on a round-robin basis with each club contributing about 10 minutes of material. The aim of the Midlands Clubspendence Convention will be to foster the spirit of friendship between Midland clubs and to create a closely knit regional unit within the B.R.C. Association of clubs. I should be interested to hear, by the way, if clubs in other regions would be interested in similar Conventions in their area.

A TAPESPONDENCE club with a difference, one that is exclusively for people interested in, of all things, Cheese, has been launched by Bill Richardson of "C" Flat, Avonmore Mansions, Avonmore Road, Olympia, London, W.14.

The "Cheese World Tape Network" to give it its full and correct title will draw its strength from the Cheese World Fromologists Circle—a "fromologist" being a person who studies the science of cheese, and who collects cheese-box labels. Round-robin tapes include items of "fromological interest" and if you wish you can contribute to these by recording on 3in. spools at 3½ or 1½ i.p.s.

TAPEORAMA, the bi-monthly recorded programme distributed by Mike Renshaw of Cambridge, is progressing very well and audience figures continue to rise. With effect from the third edition the tapes have been circulating round-robin style ensuring that the programme gets to participants with the minimum delay. An omnibus edition of the first six "Tapeoramas" is to be released towards the end of the year. Clubs in Blackpool, Birmingham, Huddersfield, Nottingham, Sydenham, and Ipswich regularly receive the programme.

Continued on page 31

## ONLY 2 LEFT!

E.M.I. L2A Battery Recorder 5" spool 3½" per sec., single track, separate record and playback amplifier, no erase, monitoring by headphone, replay through plug-in speaker (not supplied), metering of all facilities. As used by B.B.C., etc. Was £102, Now only 45 gns. As new (2 only).

FERROGRAPH 1144 (YD) Industrial model. 1½", 3½", 7½" per sec., 8½" spools, recording level meter, metal cased. In excellent condition. 42 gns. (2 only).

### ATTENTION CLARION USERS !

The new Clarion "TWIN-SET" will amazingly improve the tonal quality and volume of your Clarion Recorder making it equal to the average Mains Recorder. Consists of transistor amplifier and larger speaker with plug-in connection. Housed in portable lightweight case with leather strap and compartment for your Clarion. A really compact unit for only 8 gns.

### FROM STOCK ON NO INTEREST TERMS !

PHILIPS 4-track Recorder. 7" spools, 3½" per sec. Complete with mike and tape. 34 gns. or £1 deposit and 35 weekly payments of £1. PHILIPS 4-track Recorder. 7" spools, 3 speeds. Including M/C MIKE and L.P. tape. 59 gns. or £2 deposit and 30 weekly payments of £2.

KORTING Stereo and 4-track Mono Recorder. 3½" per sec. 7" spools. 68 gns. or £2 deposit and 35 weekly payments of £2. We stock all makes of new Recorders all available on our famous No Interest H.P. or Credit Sale Terms.

IF you desire a good Recorder at a Bargain Price our list (S.A.E.) of Shop-sold and mint second-hand Recorders will save you £££'S!

WE ARE FAMOUS FOR LOW PRICED RECORDING TAPES and have the largest sales at home or abroad. S.A.E. for list.

## E. C. KINGSLEY & CO.,

132, Tottenham Court Road, London, W.1. (Corner of Warren St.)  
Telephone: EUSton 6500

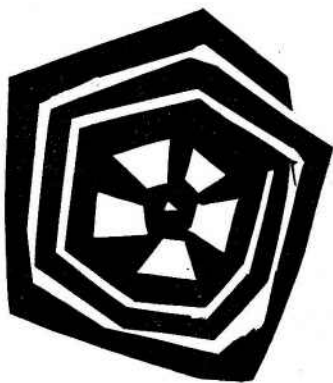

For ease of reading, particulars of Tapespondents are printed in the following order—name, occupation, address, interests, taste in music, type of machine and area of Tapesponding.

**H. B. WATKINS**, Musician, Soldier, Student (Bassoon player), R.E. Staff Band, Gibraltar Bks., Aldershot, Hants. Music, Engineering, history, all art, most sciences. Wind Instruments, folk music (pre Bach and post 1900 in particular), all music. Ferrograph 808, 8 in. 7½, 3½. Any in English, or slow schoolboy French.

**GEORGE ERNEST MCINTOSH**, Tailoring Salesman, age 16, 27 Arthur Road, Rainham, Kent. Amateur Tape Recording. Modern jazz, popular and orchestral. Elizabethan Princess 7 in. 7½, 3½, 1½. Walter 101, 5 in. 3½. U.S.A. or Commonwealth.

**RAY GOODMAN**, Engineering Estimator, 25 Tower Road, Rugby, Warwickshire. Humour, S.F., cycling, foreign life and customs. Trad., swing and some modern jazz, grand opera and romantic classical. Repts R20, 7 in. 3½, 1½, 7½. Home and abroad, especially the Americas. No letter necessary, all tapes answered. Wife would like to join in "Family to Family" tapespondence.

**JOHN PHILIP MEYER**, Draughtsman, 15 Ravensbourne Drive, Chelmsford, Essex. Methodist Church, youth work, electronics, motorcycling. Serious and light (mainly Latin, Latin-American). Truvox Mk. IV, 7 in. 7½, 3½. France, Germany, Africa, Asia and America. Anywhere generally. Languages spoken fluently: English, French and German.

**IRVINE F. SWIFT**, Teacher of the Blind, 74 Golborne Avenue, Withington, Manchester, 20. Photography, gardening, travel, social. All worthwhile music—Bach to Wagner. Ferrograph 4A/N 3 to 8½ in. 3½, 7½. International or National in English.

**R. O. WILLIAMS**, Retired Commercial Rep., Westgate Stores, Abergavenny, Mon. Travel, tape, speech. Church, light, organ. Philips, 5 in. 3½.

**DEREK FRANKLIN**, Sales Manager (medical), Chelmswood, 35 Great Leylands, Harlow, Essex. Air Training Corps, Round Table, 35 mm. photo-

## Inter-tape directory

graphy, philosophy, motoring, people. Symphonic, modern jazz, good pop. Wyndors Victor, up to 7 in. 1½, 3½, 7½. Any.

**ALAN HARPER**, Checker, 12 Bal-lakermeen Avenue, Douglas, Isle of Man. Philately, fishing, most sports, general. Anything except classical. Fidelity Argyll, 3 in. to 5 in. 3½. Anywhere.

**ROBERT FISHWICK**, Independent Retail Grocer, 90 Haig Avenue, Southport, Lancashire. Modern methods food retailing, positive thought, homeopathic and biochemic therapeutics, parapsychology—occult, modern literature, 35 mm. (colour—b. x w.) photography, radiesthesia, international friendship. Folk and trad. jazz, small combo swing. Grundig TK.35, 7½ in. 1½, 3½, 7½. Anywhere in the world (all tapes answered).

**KEN FULSTOW**, Commercial Traveller (and wife Audrey), 53 Legard Drive, Anlaby, Hull, East Yorks. Local government, civil defence, motoring, aviation and space, reading, people and places, taping, tape club, hospital tape service. All music except jazz and rock 'n' roll, mainly classical. Philips EL 3515, up to 7 in. 3½ only. U.S.A., Commonwealth, Europe and Britain. I have a little French and even less German but would like to improve both.

**DENNIS ALAN RUSHEN**, Telephone Engineer, 44 Paston Lane, Walton, Peterborough, Northants. Motoring, fly fishing, outdoor life, meeting people, making friends. Jazz (trad. and Dixieland), brass bands, military marches, etc. Elizabethan Essex, up to 7 in. 3½, 7½, 15. Anywhere—British Isles to Bombay.

**BRYAN SMITH**, Retail Butcher, 31 Priory Avenue, N. Cheam, Surrey. Motoring, practical hobbies. Light entertainment, pops, some trad. jazz. Philips Hi-Fi, up to 7 in. 1½, 3½, 7½. Also Clarion Portable. Any English speaking.

**F. R. OXFORD** (Electrician), Oil-firing Service Engineer, 36 Arkwrights, Harlow, Essex. Photography and hi-fi. Show and film music and light classical. Stern (Collaro), 7 in. 3½, 7½, 15. All parts English speaking.

**JOHN HARNEY**, Civil Servant, 53

Woodyear Road, Bromborough, Wirral, Cheshire. General. Light classical. Clarion Transitate, 3 in. 3½. Anywhere.

**ROY SMITH**, Cinema Projectionist, 64 Princess Road, Kilburn, London, N.W.6. Films, youth clubs, music. Classical, pops, some jazz, light music. Grundig, 5½ in. 3½. Anywhere English is spoken.

**B. S. SHADRAKE**, Works Clerk, 87 Handley Road, New Whittington, Chesterfield. Psychology, travel and tennis. Good music and from shows. Grundig TK 20, 5½ in. 3½. Germany and England. Male or female 20/30.

**DON DIETZ**, Paint Salesman, 1571 Pauline Drive, Sunnyvale, California, U.S.A. T.V. shows. Mechanical organs, street organs, carousel organs. Voice of Music ½ track, 7 in. 7½ music, 3½ speech. Great Britain.

**J. A. SHEPHERD**, Apprentice Carpenter, age 18½, 53 South Road, Erith, Kent. Camping and hiking. Popular music. Grundig TK 20, up to 5½ in. 3½. U.K. and Australia.

**RICHARD LLOYD JONES**, Engineer Operator, 71 Penrhos Avenue, Llandudno Junction, N. Wales. 8 mm. home movies, sport. Light music, pop and rock 'n' roll. Grundig TK 25, 5½ in. 3½, 1½. Anywhere.

**HARRY SHARKEY**, Engineer, 135 Sloan Street, Lurgan, Co. Armagh, N. Ireland. Radio and television, plays and variety. Pop and western, no jazz or classical. Philips EL 3542 and Clarion Transitate, 3 in. to 7 in., twin or 4-track, 1½, 3½, 7½. Anywhere (only English spoken). No need to write first.

**PHILIP WALTON HOLDEN**, Chain-store Department Manager, 5 Belle Street, Kingaroy, Queensland, Australia. Photography (black and white, colour, 8 mm.). Anything from gum leaves to grand opera. Telefunken KL 65, up to 5 in. 1½, 3½. Anywhere with anyone speaking English. No need to write first.

**KEITH REYNOLDS**, Instrument Dept., London Hospital, 117 Coleman Road, Southampton Way, London, S.E.5. Motoring, model making. All music, but not classic. Grundig TK 55, up to 7 in. 7½, 3½, 1½. Any part, not England.

The Club suggests that in all instances it is advisable to first contact a prospective tapespondent by letter on the following lines:—

Dear Mr. X,

I am a member of the British Recording Club and I would like to tapespond with you. I own a X machine and use X in. spools playing at X i.p.s.

My interests are as follows:—

NOTE: Enclosing a s.a.e. usually ensures a prompt reply.

Yours sincerely,

K. M. CUMARU, Engineering Student, Witcombe Hostel, Brockworth, Gloucester. Pen-friendship, travelling to study other countries, making international friendship, exchanging ideas, learning different languages, cinematography, coins, stamps, collecting, recording big peoples thoughts, important events and good music. West and East, good music Philips EL 3542, up to 7 in. 1½, 3½, ½ Any part of the world (including Communist countries).

RAYMOND ERNEST SHORE, Butcher, 10 Second Avenue, Farlington, Portsmouth, Hants. Photography, anything of interest. Opera, classical, folk. Alba Duchess, 5½ in. 3½. Anywhere, especially Italy, Rome, Cassino, Napoli, Salerno. (Little Italian spoken.)

GEOFF MILOW, Production Superintendent (Automatic Transmission Factory), 49 Chilvers Bank, Baldock, Herts. Industrial psychology and management, labour relations, motoring, hi-fi, old time dancing. Symphonic, opera, ballet. Ferrograph 4A/M, up to 8½ in. 3½, 7½. U.K. and U.S.A.

PETER SLADE, Schoolboy, age 15, 15 Wentworth Road, Oxford. Motorcycles, boxing, comedy, motor racing, cycling. Rock 'n roll, jazz, mainly trad. Philips EL 3515, up to 7 in. 3½. G.B., U.S.A., Italy.

VINCENT T. RICHARDS, Fireman British Railways, 14, Pendre Avenue, Rhyl, Flints., N. Wales. People, photography, classical music. Light classical, vocal gems. Fidelity Argvll, 7 in. 3½. America.

LANCE BLACKLOCK, Public Service, 19 Hollick Crescent, Gun Hill, nr. Coventry. 35 mm. colour photographs. Anything—I have large collection to pass on tape. Philips, 8 in., 1½, 3½, 7½. Anywhere.

K. S. ALLDERIDGE (Ken), Water Engineer, Broad Meadows, Abberton Reservoir, Colchester. Motoring, caravans, fishing, shooting, tape recording. Anything prior to Elvis Presley. Standard Twintrack, up to 7 in. 3½, 7½. Anywhere in English.

MICHAEL DAVID JUDD, Student, age 18, 4 Wellingore Road, Erning Estate, Lincoln. Cycling, sport, modelling. Jazz (trad.), some classical. Fidelity Argvll, up to 5½. 3½. Anywhere.

BILL FERNIHOUGH, Student, age 18, 200 Burris Street, Hamilton Ontario, Canada. F.M. radio, photography, fishing, school. Jazz, pop, light classical. Webcor Regent, up to 7 in. 1½, 3½, 7½. Any English speaking person, anywhere.

A. J. STUDMAN, Bricklayer, 184 Napier Road, Gillingham, Kent. Photography. Modern. Philips, 3½ in. to 7 in. 1½, 3½, 15. Anywhere.

TREVOR B. MATTHEWS, Electronic App., age 17, 31 Marina Gardens, Weymouth, Dorset. Cine, stereo, youth club. Classical. 7 in. 3½, 7½. English speaking countries.

VANCE R. VAN DEUSEN, Aircraft Modification Mechanic, 5709 N. Oak, Spokane 16, Washington, U.S.A. Recording, photography, general subjects. Popular, dancing and light classic.

Webcor-Royal Coronet, 3 in., 4 in., 5 in., 7 in. 3½, 7½. Anywhere.

HAROLD G. CLAYDON, Dem. Salesman Radio, 68 Plumer Road, High Wycombe. Photography, dramatics and music. Pop and light classics. Telefunken, 5 in. 3½. Anywhere.

F. W. VON HORSTEN, Box 69, Lusaka, North Rhodesia. Mostly games and outside. Butoba, 5 in., 7 in. 1½, 3½. U.K.

D. I. WILLIAMSON, Company Director, The Bungalow, Occupation Lane, Exley Head, Keighley, Yorks. Peace, dance music, speedway. Dance. Ferrograph, 8½ in. 1½, 3½, 7½, 15.

JACK SIMPSON, Photographer, 31 College Avenue. Bird song recording. Ferrograph, 8½ in. 3½, 7½.

AMRIT P. DEVESAR, Civil Service (High Commission of India), 30 Brookside Road, Golders Green, London, N.W.11. Indian music and pops. Elizabethan Essex, up to 7 in. 3½, 7½, 15. U.S.A., Germany and Commonwealth countries. Persons interested to know about India.

PERCY R. LIMB (Bachelor), Accountant, 3 Astley House, Gipsey Road, West Norwood, London, S.E.27. Welfare of children, music, books. Classical and popular. Elizabethan and Grundig Cub, up to 7 in. 1½, 3½, 7½. Outside Great Britain.

ROBERT J. W. BRITIN, Metallurgical Assistant, age 21, 43 Arthur Road, Rainham, Kent. Music, photography, Christianity, poetry, almost anything. Other peoples interests and ways of living—World Peace. Pops, classical and folk. Tutor De Luxe/Clarion Transisape, 7 in. 3½, 7½, 15. Anywhere, but English only spoken.

E. WEBSTER, Projectionist, c/o Leal Holme, 114 Clifton, York. Sounds of birds, trains, etc. Music boxes. Organ, dance old and modern. Clarion, 3 in. 3½. America or any place.

KENNETH BAKER, Handicraft Teacher, 14 Lodge Lane, Hyde, Cheshire. Cine, photography, stage lighting, yachting. Classical (all types), light

opera. Stellaphone, 7 in. 1½, 3½, 7½. Australia or Canada.

BRUCE J. HOTTER, Merchant Navy Officer, Lloyds Bank House, Hertford, Herts. Photography. Light classics to trad. jazz. Grundig TK 5, 5½ in. 3½. North America, West Indies and Europe.

JOHN R. LOMAX, Schoolboy, age 15, 1 Birkdale Drive, Bury, Lancashire. Making crystal sets, outdoor recording. All types of jazz (particularly Benny Goodman). Perth-Saja M 40 and Clarion, 3 in. to 5½ in. 3½ only. Anywhere in England.

MALCOLM LEGGETT, Apprentice Ironmonger, age 19, 38 Milner Mount, Penrith, Cumberland. Trad. jazz, radio. Folk. Regentone RT 50, up to 7 in. 1½, 3½, 7½. U.S.A., Southern England.

B. J. ARMITAGE, Research Chemist, 173 Townsend Avenue, Liverpool, 11. General, science, chess, taping, musical shows. Popular, musical shows, trad. jazz. Philips AG 8109, up to 5 in. 3½. Anywhere and everywhere. All tapes and letters answered.

JOE T. GRAY, Public Accountant, Box 184 Eastland, Texas. Accounting, church work, travel, music. Semi classical, pops, brass bands, choral, church. Pentron 3/3/4, up to 7 in. 3½, 7½. Anyone who converses in English.

MICHAEL MCCOY, Schoolboy, age 15, 9 Wyke Road, Weymouth, Dorset. Biology, general science, politics. Pops and modern. Geloso, 3 in. 1½. America, China, Russia.

PETER TONNER, Electrician, age 20, 9 Cherwell Terrace, Brambles Farm, Middlesbrough, Yorks. Motorcycles, reading, watching scrambles. Pops. Philips AG 81089, 7 in. 1½, 3½, 7½. Anywhere.

PETER KERSHAW, Student Male Nurse, age 19, Hackney General Hospital, London, E.9. Christian Evangelism, Bible study and allied subjects. Church and choral music and sacred songs in harmony. Simon SP/2, up to 8½ in. 7½, 3½. U.S.A., Europe, particularly Belgium and France.

DESMOND DOOLEY, Cinema Projectionist, age 16, 28 Duke Street, Wallasey, Cheshire. Cycling, music, reading. Pops, folk songs. Gramdeck, 5 in. 7½, 3.20, 4.33, 1.60. U.K. and U.S.A. Would prefer 3 in. spool.

PETER JOHNSON, Schoolboy, age 16, 8 West View Crescent, Highroad Well, Halifax, Yorks. Electronics, tape recording, hiking, music. Anything except modern jazz and chamber music. Home built, Collaro Mk. IV and Mullard Type A, 7 in. 3½, 7½, 15. U.S.A., Canada, Australia, New Zealand.

GORDON R. POWELL, R.A.F., c/o Sgts' Mess, R.A.F. Khormaksar, Aden, B.F.P.O., 69. Motoring, colour photography. Light, military and pops. Uher 195, 5½ in. 7½, 3½. Anywhere.

D. T. ROSE, 63 Morant Road, Colchester, Essex. Hi-Fi equipment, gram amplifiers, radio (V.H.F.), motorcycling, with 35 mm. Camera work, shotgun and rifle shooting, places and objects of historical and geographical interest. Philips EL 3527, 5 in. 3½. Would be



"Well you didn't look as pleased as that when you carried ME over the Threshold."

happy to assist anybody locally with problems via person to person messages for hospital patients and relatives.

**L. G. YOUNG**, Uniform Clothiers Cutter, 7 Salisbury Street, Swindon, Wiltshire. General. Anything except chamber, mod. jazz, madrigals. Grundig TK 25, 5½ in. 1½, 3½. Switzerland and England, Great Britain.

**LESLIE WILLIAM WHITE**, Storeman (hospital), 28 Thrums, Watford, Herts. Photography and recording. Semi classical, light and pops. Grundig TK 820/3D and Clarion (Battery), 3 in. to 7 in. 3½, 7½. United Kingdom.

**MICHAEL JOHN HOLLAND**, Fireman R.A.F., 95 Trenchard Avenue, Stafford, Staffs. Construction kits in plastic and balsa wood, films. Pops record. Walter 101, 5 in. 3½. U.S.A. or Canada, Switzerland.

**IAN BRAMWELL SCOTT**, Sales Representative, P.O. Box 183 Queens-town, South Africa. Aviation, swimming, travel. Edmundo Ross to Beethoven. Philips, 3 in. to 7 in. 1½, 3½, 7½. Anywhere.

**HAROLD CARLTON MOYLAN**, Civil Service (Clerk), 9 Jackson Place, Port of Spain, Trinidad, W. Indies. Tape recording, hi-fi, films, reading, everything. All types, some modern jazz. Truvox, up to 7 in. 3½, 7½. Anywhere English is spoken. Not necessary to write, all tapes will be answered.

**S./Sgt. R. J. PARKINSON** (19038526), Regular Soldier, Trucial Oman Scouts, B.F.P.O. 64. Photography, records. Military and pipe bands, popular, not rock 'n roll. Home—Philips EL 3536, 7 in. Saja Standard, 5½ in. 3½. Commonwealth, Far East, Africa.

**JEFFREY MARTIN STIBBARDS**, Photographer, age 20, 25 Northfield Avenue, N.S. Blackpool, Lancs. Motor-cycling, photography. Modern jazz, modern classics. Verdik S1, 7 in. 3½, 7½. Scandinavia, U.S.A., Canada.



**WILLIAM A. WHITE**, Conductor on Railroad, 1215 Weeks Avenue, Superior, Wisconsin, U.S.A. 8 mm. home movies, boating, etc. Folk, organ, music of foreign lands, etc. Knight (2), 7 in. 3½, 7½. Far East, Middle East.

**MICHAEL WOLSTENCROFT**, Grammar School Student, age 15, 7 Regent Street, Eccles, Manchester, Lancs. Ballroom dancing, recording technique and hi-fi methods. Traditional jazz, popular records. Grundig TK 12, 5½ in. 3½, 7½. America or any part of U.K.

**M. MENZIES**, Photographer/Manager, 54 Church Road, Northenden, Manchester, 22. Varied. Light operatic, show and film and general popular music. Philips EL 3542, up to 7 in. 1½, 3½, 7½. Anywhere.

**Dr. E. M. ROSSER**, Medical Practitioner, 6 Drummond Road, London, S.E.16. Classical. Willcox Gay, dual-track and speed, 7 in. 3½, 7½.

**ERIC WRIGHT**, Production Engineer, 22 Bartlett Close, Coventry, Warwick. Music, gardening, food. Light classical. Sound 444, up to 7 in. 3½, 7½, 15. Germany or U.S.S.R.

**CHARLES DERRICK BUSHNELL**, Shoe Shop Manager, 19 Harps Avenue, Minster-in-Sheppey, Kent. Sport (football, cricket). Popular, trad. jazz, classical (some). Telefunken 75.K.15, up to 5½ in. 1½, 3½. Any English speaking and British Isles.

**JOHN HOUGHTON**, Wiredrawer, 217 Newbridge Lane, Stockport, Cheshire. Motoring, angling, records, films. Pop, film musical shows, jazz, swing. Gainsborough Studio, 7 in. 1½, 3½, 7½. Anywhere, home and abroad.

**J. R. MORTON**, Theatre Management, 17 Alfred Road, Acton, W.3. Music, travel, films, etc. Popular, light classic, dialogue (films and plays). Simon SP4, 7 in. 3½, 7½. Anywhere warm!

**Miss JUNE P. WRIGHTON**, Sweets and Tobacco Manageress, 84 Easson Road, Darlington, Co. Durham, England. Drawing and painting, wildlife, television, scootering, tennis, reading, general. Interested in other countries. Folk, opera, musical, anything but jazz and rock 'n roll. Fidelity Argyll, 5½ in. 3½. British Commonwealth, Scandinavia, African Continent, The Americas.

**GEORGE TUCKER**, Cinema Projectionist, 12 Galesbury Road, Wandsworth, London, S.W.18. 8 mm. cine, tape, effects. Popular, piano. Magnafon, 3 in., 5 in., 5½ in., 7 in. 3½, 7½. Anywhere. All tapes answered.

**GRAHAM WHIBLEY**, Window Dresser, age 21, 7 Warren Avenue, Selsdon, South Croydon, Surrey. Racing cycling, beer mats, science, youth hosting. Modern, trad., light serious, some pops. Walter 303 De Luxe, up to 7 in. 3½, 7½. U.S.A., Canada, Australia, Germany. In English.

## STARTING CLUBS

**THANET** Anyone in Thanet area interested in joining a T.R. Club, please contact P. Foster, 81 Norfolk Road, Cliftonville, Kent.

**PERTH** Perth recordists interested in forming a local Club should contact A. B. McNaughton, 15 Scott Street, Perth.

**BATH** Will anyone in the Bath area wishing to form or join a tape recording club kindly write to John Fishlock, at 1 Dafford's Buildings, Larkhall, Bath:

**WALSALL** R. C. Medford of 21 Longmeadow Road, Orchard Hills, Walsall, Staffs. is trying to form a tape club in Walsall and would be glad to hear from anyone interested.

**HULL** The Hull and District Tape Recording Club officially came into being on July 13th. They already have a dozen enthusiastic members so if you live thataway write for details of the Club to Ken Fulstow, 53 Legard Drive, Anlaby, Hull, E. Yorks.

**ERITH** J. A. Shepherd of 53 South Road, Erith, Kent, would like to start a club to cover the Erith & District area. Mr. Shepherd points out that cine enthusiasts are also welcome to contact him.

**SOUTHWICK & SHOREHAM** R. Powell of 108 Manor Hall Road, Southwick, Sussex, is interested in forming a club in the Southwick & Shoreham area.

## CLUB AFFILIATION TO THE B.R.C.

AMATEUR TAPE RECORDING Magazine extends a cordial welcome to the Clubs listed below, who have recently become affiliated to the British Recording Club: The Secretaries of these Clubs will be delighted to forward details of their activities to local residents who are interested.

**Wakefield & District Tape Recording Club,**

Secretary: I. Chidwick,  
13 New Street, Kinsley, Nr. Pontefract, Yorks.

**Brighton Tape Recording Club,**

Secretary: R. Vivian,  
37, Ditchling Road, Brighton, Sussex.

**Doncaster & District Tape Recording Club,**

Hon. Secretary: Charles E. Young,  
28 Chelmsford Drive, Doncaster, Yorks.

**Ware & District Tape Recording Club,**

Secretary: Mrs. Sheila Wakely,  
3 Chadwell, Ware, Herts.

**Coventry Tape Recording Club,**

Secretary: Roy V. Reynolds,  
1 Thurlstone Road, Radford, Coventry.

**Surrey Tape Recording Club,**

Secretary: S. J. Howett,  
"Pinjarra", Pinewood Grove, Weybridge, Surrey.

**Crawley & Sussex Tape Recording Club,**

Secretary: R. C. Watson,  
32 Southgate Drive, Crawley, Sussex.

# Fings ain't what they used t'be

Flick through the magazines these days and you could be excused for imagining that everyone is manufacturing a tape recorder. Fings ain't what they used to be. They're certainly not what they were when Grundig had to spend the greater part of its advertising just explaining what a tape recorder was!

Of course, most people know what a tape recorder is now—although they rarely call it a tape recorder. More generally it's "a Grundig" or, often as not, "my Grundig". And this

really means something in a country in which there are more tape recorder owners per head of population than in any other country in the world.

It makes you realise how strongly established the Grundig reputation must be—and how well deserved.

So although some things aren't what they used to be, one thing still is—Grundig remains the wisest choice for everyone who wants quality, reliability and genuinely rated performance in a tape recorder.

**GRUNDIG**

**(Great Britain) LTD.**

*the largest manufacturers of tape recorders in the world.*

*Advertising & Showrooms: 39/41 NEW OXFORD STREET, LONDON, W.C.1*

*Trade enquiries to: NEWLANDS PARK, SYDENHAM, LONDON, S.E.26.*

*(Electronics Division, Gas Purification & Chemical Co. Limited)*

GS244

Continued from page 26

CONTACT has been made between the **Bridgwater T.R.C.** and **Bill Watson** of the **Crawley & Sussex T.R.C.** The third party in these tripartite tape exchanges is **Bob Brunson** of Oklahoma City, U.S.A.

## TAPE & CINE

A DEMONSTRATION of the Paillard-Bolex Sonorizer was presented at a meeting of **Leicester T.R. & H.F.C.** Members showed considerable interest in the possibilities of magnetic recording in amateur cine work, and many searching questions were answered by **Mr. Perks** of the **Midland Camera Co. Ltd.**, Leicester.

**CARMYLE** Cine Club, which was formed two years ago and has made several films, is having difficulty in obtaining suitable background music for sound-tracks. They would like to contact some amateur musicians, and perhaps a tape recording club in the Glasgow area, who would help them out. Any and all persons interested please contact Secretary **David McFadyen**, 57 Lanbar Crescent, Glasgow, E.3.

THE monthly meetings of the **Barnsley Cine Club** have created a new interest for the tape society who are now preparing a ten-minute sound-track for one of their films.

SEVERAL interesting meetings have been held recently by **Rochdale & District C.S.** (Tape Section), with demonstrations and talks about tape-cine techniques featured. The Society has been very active on its special publicity film, and the club-room has often resembled a T.V. studio littered with spot lamps, cables, tripods, and cameras, not to mention "over-heated" technicians! But this practical experience is teaching the club just what can and what cannot be done with tape and cine together. Within a few weeks from now the club hopes to have a finished production of sufficiently high standard to put before the public.

MEMBERS of the **Birmingham T.R. & A.C.** were taken to Cornwall and the Scilly Isles via tape-and-cine-synch, last month. The film "Cornish Holiday" was produced in 8 mm. colour by **Monti Kneen**, and the sound-track added by **Monti and Fred Wilkinson**. In all seven months went into the editing of the film, which whilst intended essentially to be a personal family movie, had a much wider appeal and held "B" Trac members' close attention throughout.

## TALKS AND DEMONSTRATIONS

**L. W. Saunders** continued his visits to tape clubs last month talking about EMItape, whilst **B. Wilson**, with a film-can under his arm, also got around to talk about B.A.S.F. tape. **Grantham T.R.C.** will remember **Mr. Saunders'** visit to their club to give his well-known talk. For after he had finished his story of how EMItape is made, a general discussion took place over the state of the club's finances, and it turned out that, in common with 90% of the other clubs, **Grantham** had a lot of bills outstanding. **Mr. Saunders** promptly came to the rescue by auctioning three "E.M.I." initialled propelling pencils. The handsome proceeds made went into club funds, and transformed the Treasurer into a "Most Happy Fella".

**Mr. Wilson** was meanwhile over at **West Middlesex T.R.C.** where the unusual treatment of the material in "The Magic Tape" film was particularly appreciated. **Mr. Wilson** generously gave the club a 1,200 foot spool of professional-grade B.A.S.F. tape, a leader strip kit, and a large handful of those most useful "tape clips" with which to anchor the outer end of tape on to its spool. **Mr. Wilson** also visited **Wakefield & District T.R.C.** during the month.

We hear that **J. F. Parrington** is on his second tour of the clubs now, with two new Walter products which should appeal to members of many societies, the battery-mains machine, and the 404. He has visited **Eastbourne T.R.C.**, and **West Middlesex T.R.C.**, and we hear is scheduled to pay a return visit to **Coventry T.R.C.** shortly. At his West Middlesex visit the battery-mains recorder gave a good account of itself not only with pre-recorded tapes but also from "live" recordings made during the evening in the street outside the clubroom.

**Les Skingley** of **Coventry T.R.C.** paid a return visit to **Rugby A.T.R.S.** to speak on interviewing technique. During

the evening **George Dawson** interviewed Station Officer **Mann** of **Warwick County Fire Brigade**.

**P. E. G. Allen** of **Grundig** demonstrated his firm's **TK60** Stereo model to members of the **South-West London T.R.S.** The evening ended with a live stereo recording using the **TK60** in a session at which **Mr. Allen** was "quizzed" by members.

AN OPEN MEETING specifically designed to display and demonstrate the latest tape and cine equipment to local cultural organisations, was held recently by **Crawley & Sussex T.R.C.** Technical "guides" were in attendance to answer any queries regarding models on view.

**F. Wood** of **F. Woods (Grimsby) Ltd.** gave a demonstration of microphone technique using six microphones at a meeting of the **North Lincs. S.R.C.** The models ranged from a moderate crystal to a **Standard Telephone Co's.** microphone, value £75. A local group of musicians played for this demonstration and they did an admirable job under adverse conditions. (Please telephone **Grimsby 58049** for details of this club.)

**Ralph West, B.Sc., A.M. Brit. I.R.E.**, gave an instructive talk on the construction and working of different microphones, to the **Friern Barnet & District T.R.C.** At his next visit he will talk about the problems of wow and flutter.

## FORTHCOMING EVENTS

On Thursday, September 1st **Nottingham A.T.R.S.** celebrates its first birthday with a Special Anniversary Programme. On September 15th the meeting will deal with "Tape in the Theatre".



HELP WANTED—by **Crawley and Sussex Tape Recording Club**, from local Tape Recorder owners, for their display in the forthcoming exhibition (7th—10th September inclusive), called "Leisure & Pleasure", organised by **Crawley Council of Social Service**. Write to **R. C. Watson (Secretary)**, 32 Southgate Drive, **Crawley, Sussex**.

## LANE'S SERVE THE SOUTH

The largest Hi-Fi Specialist Stockists serving Sussex and the S. Coast

● FREE DELIVERY WITHIN 25 MILES

● EQUIPMENT BY LEADING MAKERS

● COMPONENTS, BOOKS, ETC.

● SHOWROOM WITH DEM CONTROL PANEL

### Selection of items

### IN STOCK NOW

AMPLIFIERS, TUNERS	£	s.	d.
Jason ITV/2	25	7	3
Jason J2-10/Mk. III			
Stereo Amp.	40	19	0
Jason FMT/4	22	15	8
Jason FMT/3 Kit (less valves)	9	19	0
Jason Mercury II (kit)	10	10	0
Quad II Amplifier	22	10	0
Quad 22 Unit	25	0	0
Leak Point One Stereo Pre-amp.	21	0	0
Dynatron TC.16CS Stereo Control Unit	27	0	0
Dynatron LF.16CS Stereo Amplifier	17	10	0
Armstrong ST.3	27	6	0
Also Dulci, Armstrong, B.T.H., Etc. Jason Kits as Advertised.			

SPEAKERS, MOTORS	£	s.	d.
Dynatron CLS.15	35	5	0
Quad Electrostatic	52	0	0
Goodmans AL/12	29	10	0
Wharfedale Coaxial 12	25	0	0
Wharfedale SFB.3	39	10	0

Wharfedale Golden 10FSB	8	7	3
Tannoy Dual 12in.	30	15	0
W.B. 1016	7	12	3
Collaro 4TR200	13	18	3
Garrard 301	22	7	3
Garrard 4HF	18	17	8
Lenco GL.60	28	19	8
Goldring 700	9	14	9

Also Stereo Pick-ups, Cartridges, Stylis, etc.

### TAPE RECORDERS

Grundig TK.20	52	gns.
Grundig TK.24	62	gns.
Grundig TK.60 Stereo	128	gns.
Telefunken 75-15	52	gns.
Telefunken 85 KL	79	gns.
Brenell 3 Star	58	gns.
Elizabethan 'Avon'	27	gns.
Elizabethan Major	59	gns.
Stuzzi Magnette	69	gns.
Geloso	26½	gns.
Elpico TR.400	26	gns.

Philips 4 Track Recorders as advertised.

Microphones by **Acos, Grampian, Reslo, Lustrophone, Simon**, etc., etc.

Tapes in all sizes and types by leading makers.

Callers welcome or write for service by return

**LANE'S (RADIO) LTD.** 11 GARDNER ST., BRIGHTON (Between North St. and North Rd.) Half-day Weds. Phone: BRIGHTON 20773



# Dear Sir . . . . .

H. S. COWIN of Douglas, I.O.M., writes :

I would be very glad if you will help me with the following problem :

I have just purchased a Philips Four Track Tape Recorder Model No. EL.3542/15, and find it satisfactory, but I have a large number of tapes that I had previously recorded on a Ferrograph Two Track model, and I find that even when erased on the Philips I still get a fairly loud background. I realise that this is due to the space between the four tracks not being erased, so I erased all the tapes on the Ferrograph that they were recorded on, and I still heard a faint background at full volume. In an attempt to remove this background, I tried to erase the tapes with a strong permanent magnet. This left a strong background noise which when erased on the Philips seemed quite good, but when playing anything which shows up poor recording, such as when a piano is recorded, I notice a vibration in the note, and the recording is only at about half the normal volume.

Is this due to the fairly strong permanent magnetism not being fully erased ?

I feel that the solution is to have the taped demagnetised by a strong high-frequency A.C. field. I have read that entire reels can be completely demagnetised by this means. Could you let me know if this could be done and the address of any firm that could do it for me.

*ANSWER.—You were unwise to erase with a strong magnet as this method will leave excessive noise on the tape and is likely to cause magnetization of the tape heads which in turn will put noise on to your recordings.*

*You should get a de-fluxer and first demagnetize the heads. You can bulk erase tape with a suitable bulk-eraser such as the WAL or LEERASER. The WAL is made by Wellington Acoustic Laboratories of Farnham, Surrey and the LEERASER by Leavers Rich Limited, Euston Road, London.*

R. O. CORDELL of Lewisham, London, is thinking of modernising his radiogram, and wonders :

Does the speaker have to be separate from the radiogram cabinet in order to achieve hi-fi ?

*ANSWER.—We know of no reason why the loudspeaker should not be used in a Radiogram cabinet for hi-fi reproduction, providing of course the cabinet is of suitable design and built from substantial material.*

*Many of the more expensive R/G's are quite capable of fidelity reproduction. We would emphasise that correct acoustical design of any loudspeaker cabinet is important to reproduction and most of the cabinets available comply with hi-fi requirements.*

Mr. S. ABNETT of Epsom, Surrey, poses the following questions :

My Brenell Mark 5 Recorder is fitted to record and replay stereo and monaural. Is it possible for me to make stereo recordings from Radio or Records ? If so how do I do it, and what do I need ?

I would also like to ask what can be done to cut out or reduce electrical interference on radio ? My last question is can you tell me the name and address of the firm who made the shortwave receiver NC.60 Special ?

*ANSWER.—To record in stereo from disc, you will need a stereo pick-up and each channel from this will then be fed into the left and right hand channels on the recorder. You will only be able to make stereo recordings on tape from stereo disc records.*

*With regard to recording in stereo from the radio, you will only be able to record in stereo when the B.B.C.*

*transmit with compatible stereo system, unless of course you make use of the experimental transmissions by recording from radio (one channel) and television (the other channel).*

*If the Radio interference you complain of upsets reception of your local B.B.C. station you should make application to the Post Office Radio Branch for engineers to investigate. You may obtain a special form from any Post Office.*

*Sorry we can furnish no information on the shortwave receiver you mention. Perhaps a reader will be able to help here.*

Mr. F. MEEK of Edinburgh, writes to us :

I am an apprentice projectionist and purchaser of your magazine since the first issue. I am a very keen Tape Recorder enthusiast, and have managed to save to get a Ferrograph 4A. A little experiment I tried the other week may be of interest to you. We received in the projection room a copy of a film in which the leader of one of the prints was clear film with magnetic sound track on it. I cut this track off for about 14 feet or so, and threaded it through the record head of my Ferrograph and then plugged in my V.H.F. Radio and set the recorder going at Record. I was astonished on trying it at playback to find that I had recorded the music of the V.H.F. and it had come through very well, especially so as sound on film is recorded on at a very much greater strength than my recorder could manage. I thought it was quite an interesting discovery as a film magnetic track will probably be made in quite a different way to the usual magnetic tape.

*ANSWER.—This was indeed an interesting experiment. The result you obtained was possible because the Magnetic Sound Track on film is more or less identical with the conventional magnetic tape used for recorders. It records and erases in exactly the same way, and has generally similar characteristics.*

Mr. D. CLAYTON of Prestwich, Manchester wants to know :

What a 'public address' system is on a tape recorder. Also would you explain what 'mixing' is and what is meant by 'monitoring', monitor 'on' 'off' switch.

*ANSWER.—The reference to 'Public Address' facility, applied to tape recorders is a rather misleading one and should not really be used. It simply means that the internal amplifier can be connected to the loudspeaker and microphone simultaneously, thus permitting speech to be directly amplified. The available power output from the small amplifier and speaker of a tape recorder may be sufficient for a very small hall or large room, but hardly warrants the title 'Public Address'.*

*Mixing simply means that two or more signal sources, viz : microphone and gramophone pick-up may be 'mixed' together, during recording. This is a useful facility although few tape recorders have arrangement for it.*

*Monitoring means either directly listening to material being recorded or listening to the recording a fraction of a second after it has been made. The first system entails a pair of headphones or a loudspeaker connected to the recording amplifier, the second system involves the use of an additional recording head to pick up the signal from the tape immediately it has been recorded. (See article by F. C. Judd—July issue of AMATEUR TAPE RECORDING.)*

Let the British Recording Club panel of experts answer your technical queries. Answers of general interest will be published.

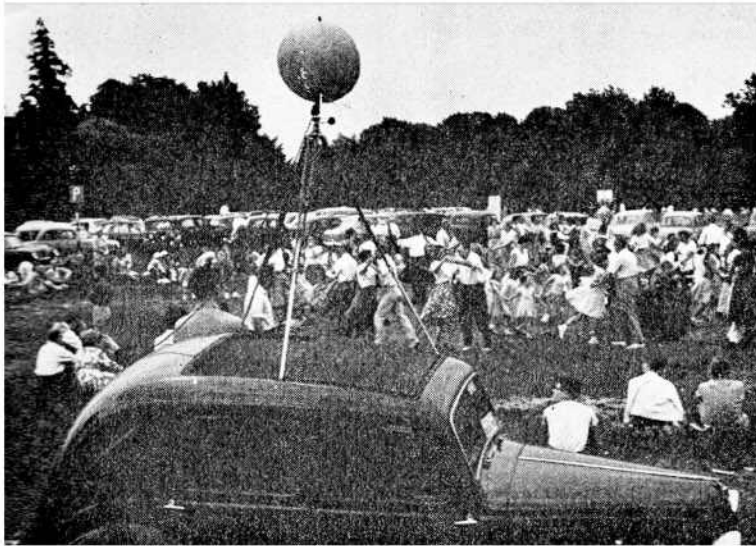

## CLUB PICTORIAL

by  
Albert Greenway

(above) John Grainger of the West Herts Tape Recording Club uses car and parabolic reflector for recording country dancing on Chipperfield Common.

(right) J. M. Davis, Secretary of the Luton Tape Recording Society is seen taping with a friend on board the Shell Super Tanker, s.t.s. "Achatina".

(below) Club Member Enid Long, aged 12 years, who at the moment is encased in plaster after a serious spinal operation. The presentation of an Elpico tape recorder has relieved many hours of idleness by providing a wonderful new source of entertainment for Enid and other teenagers in the same Ward at the Royal National Orthopaedic Hospital, Stanmore. Enid would like to hear from tape-spondents of similar age, especially from those who are long term patients in Hospital.

She has been encased in plaster for nearly six months but hopes to be out of her suit of 'white armour' any day now.

(below, right) Members of the Rochdale and District Cine Society Tape Recording Section make a recording. The equipment on view is a Ferrograph recorder, twin mixer turntables and Reslo Ribbon Mic. The people present are (l. to r.) D. Boggett (Programme Secretary), D. Woolfenden (Secretary), G. Wild (Electrician), P. Alston (Chairman), E. Wallwork (Electronics Advisor), Miss Fulton (Commentator), and A. Ashworth (Assistant Programme Secretary).

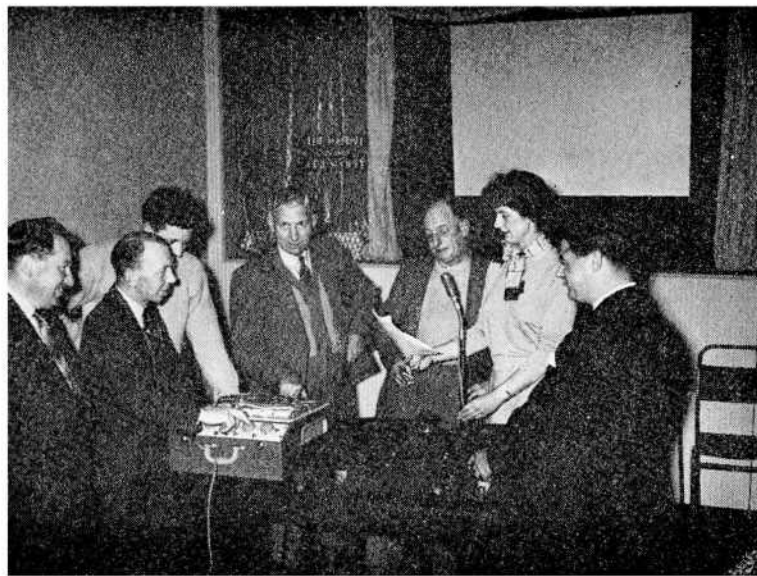
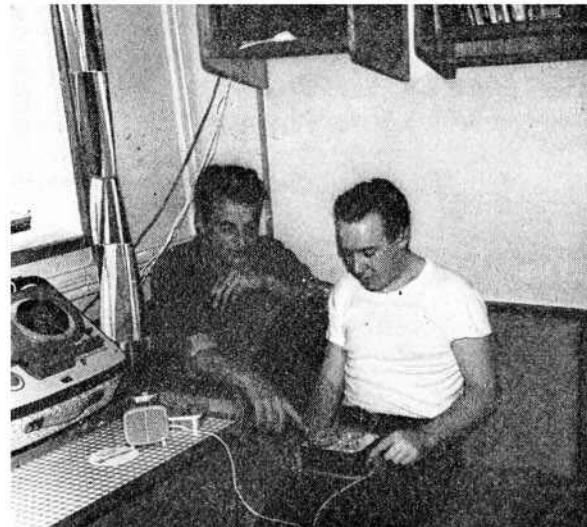



ALL YOUR RECORDINGS CAN BE FOUND QUICKLY AND EASILY BY USING —

## METRO-TABS

3/11 per set

A new and scientific device designed to clean the record and erase heads of your tape recorder, and to reduce faults caused by oxide deposits.

Price 12/6



Write for illustrated leaflets to:

### METRO-SOUND MFG., CO., LTD.

19a BUCKINGHAM ROAD  
LONDON - N.1  
Telephone: CLIssold 8506/7

## NEW FORMULA

# Sound machine + Psycho-tapes or Discs = SUCCESS

SEND NOW for interesting 16 page FREE BOOKLET which will show you how to:-

- ★ DEVELOP PERSONALITY
- ★ GAIN SELF-CONFIDENCE
- ★ TRAIN YOUR MEMORY
- ★ LEARN SELF-HYPNOSIS
- ★ SPEAK IN PUBLIC, etc.

To EDUCATIONAL RECORDINGS, Dept. AN,  
27 York Road, Ilford, Essex.

Please send 16 page free booklet in plain package

Name.....

Address.....

.....

## TAPE AND DISC REVIEW

by Stanley R. White

"Marching With The Organ"

Reginald Dixon.

Columbia ESG 7800.

"Ballet Egyptien"

Reginald Dixon.

Columbia ESG 7809.

Both of the above extended play discs which feature Reginald Dixon at the 3 manual 14 rank Wurlitzer Organ in the Tower Ballroom, Blackpool, are excellent value for



Reginald Dixon at the Wurlitzer Organ

your money. The recordings mark another high spot in Dixon's long recording career; he made his first record 28 years ago, and these are his first stereo releases, and this is really good stereo. Special care was taken to ensure that the fullest possible stereo sound was obtained from the organ. To do this, the two organ chambers were fully divided by altering the pistons before recording commenced. The sound in stereo really is superb.

"Ballet Egyptien" is very welcome, for a modern recording of this piece by Luigini has long been called for. Reginald Dixon gives one of his best recorded performances, playing the slower movements of the piece almost as a straight organ solo, with a grand organ sound. The fast movements are given a more light-hearted treatment as called for, and he makes good use of the effects which are on his organ. The stereo on this disc is delightful.

"Marching With The Organ" is more in keeping with the type of music one expects from Reginald Dixon. It comprises a selection of well known marching tunes played in the usual Dixon style, no better or worse than numerous other marching tune discs he has recorded over the years. I find the record lively and entertaining with plenty of Dixon March tempo. The whole thing is rounded off by the good stereo reproduction, which allows the proud sound of the Wurlitzer to convey its message to the listener with all the glory of these famous Marches. The titles include "The Dambusters", "Le Reve Passe", "Under The Double Eagle", "Old Comrades", "Sons Of The Brave", etc.

## THEY LOOK SO GOOD

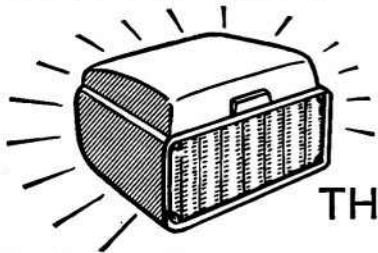

The moment you see the styling of a Truvox Tape Recorder, you know it is the machine for you. Foolproof and simple in operation with professional facilities, a Truvox Recorder will be the centre of your home enjoyment of speech and music. See them at your dealers.

## THEY SOUND SO GOOD

You'll enjoy 'listening' more than ever before. All the technical know-how of a decade of specialisation, to give perfect sound enjoyment, is embodied in the Truvox R6 and R7 . . . the original sound *truly* recorded and *truly* re-played through *large* loudspeakers. Hear them at your dealers.

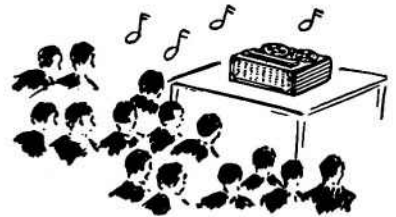

## THEY ARE SO GOOD



That you'll never be satisfied with any other Recorder . . . once you've seen and heard them, you'll decide for yourself . . .

## THEY MUST BE

# TRUVOX

### R.7

7" spools. 10 watts output.  
Records/Replays both  
directions. Two speakers  
(Tweeter and Woofer).  
Response 30-17,000 c/s.

**Retail Price 82 gns.**



H.P. Facilities available.

### R.6

7" spools. 4 watts output  
2 speeds. 8" x 6" speaker.  
Response 30-15,000 c/s.

**Retail Price 55 gns.**



Ask your local dealer for a demonstration  
or full details from :-

**TRUVOX LTD. Neasden Lane, London, N.W.10. (Dollis Hill 8011).**



## B. R. C. Badges

2/9d each, post free

OVERSEAS: 3/- (50 cents, U.S.)

PLEASE SPECIFY BUTTONHOLE  
OR BROOCH FITTING

BACK NUMBERS AND BADGES

obtainable from

145 FLEET STREET, LONDON, E.C.4

**BACK NUMBERS of A.T.R. ARE  
AVAILABLE at 2s. EACH (Post Free)**

**Binders for 12 Editions 12/6 post free or Volume 1 Complete with Binder 31/6 post free**

# FRANCIS OF STREATHAM

● *The Centre for Personal Attention and respect for your Pocket*

## NO EXTRA FOR CREDIT

Minimum deposit and no interest or charges on HP up to 18 months.

FREE service whilst under Guarantee

HIRE SERVICE TAPE RECORDERS AVAILABLE

on hire from 45/- per week.

### MICROPHONES AND MIXERS

	£	s.	d.		£	s.	d.
Lustraphone VR/65 NS Stereo Ribbon	15	15	0				
Lustraphone LD/66	4	2	6				
Lustraphone "Lustrette" M/C	3	7	6				
Lustraphone VR/64 Ribbon	7	17	6				
Lustraphone LFV/59 Dynamic	8	18	6				
Simon "Cadenza" Ribbon	10	10	0				
Simon Cadenza Crystal	3	13	6				
Reslo Ribbon	8	15	0				
AKG Stereo Dynamic D.88	19	19	0				
Grundig Mixer	16	16	0				

Also by Ronette, Acos, etc. We will gladly advise on the type best suited to your requirements.

### HI-FI AND ASSOCIATED EQUIPMENT (at 181 Streatham High Rd.)

	£	s.	d.		£	s.	d.
Decca ffs P.U.	21	0	0	Collaro 4T200	18	13	0
Rogers Junior FM Tuner	24	13	5	Lenco GL/58	19	17	6
Armstrong ST.3	27	6	0	Garrard 4HF	18	17	8
Dulci AM/FM	25	15	2	Garrard 301	22	7	3
Jason J-2.10/MK3	40	19	0	Garrard 301/Strob.	23	18	4
Jason FM	22	15	8	Leak Stereo 20	30	9	0
Jason JTV	25	7	3	Loudspeakers by—			
Quad 11 Control Unit	25	0	0	Export, W.B., Pye, Wharfedale, Goodman's, etc.			

PRE-RECORDED TAPES ● TAPE TO DISC & TAPE COPY SERVICE

- ★ COMPLETE TAPE RECORDER SPECIALISTS
- ★ LARGEST SELECTION OF LATEST MODELS
- ★ SEPARATE HI-FI DEPARTMENT

*Brenell Mk. V	64 gns.	*Reflectograph 'A'	1-tr	95 gns.
Brenell 3 Star	58 gns.	*Reflectograph 'B'	1-tr	105 gns.
Brenell 3 Star Stereo	89 gns.	*Saba		79 gns.
Cossor 4-TR	37 gns.	*Simon SP4		95 gns.
Elizabethan Avon	27 gns.	Simon Minstrelle		39 gns.
Elizabethan "Princess"	39 gns.	Spectone 171		39 gns.
Elizabethan Major	65 gns.	Spectone 161		49 gns.
*Ferroglyph 4AN	81 gns.	*Telefunken 85KL		79 gns.
*Ferroglyph 4A/H	86 gns.	*Telefunken 76		62 gns.
*Ferroglyph 4AN/S	88 gns.	*Telefunken 75/15		54 gns.
Ferroglyph 808	105 gns.	Uher Universal		79 gns.
Ferroglyph Stereo-Ad.	30 gns.	*Uher 4-tr Stereo		102 gns.
Fidelity Argyll	29 gns.	*Vortexion WVA		£93 13 0
Gainsborough	39 gns.	*Vortexion W.V.B.		£110 3 0
Grundig TK20	52 gns.	Wyndson, Victor		45 gns.
Grundig TK24	62 gns.			
*Grundig TK25	62 gns.			
*Grundig TK30	72 gns.			
*Grundig TK35	82 gns.			
*Grundig TK55 Stereo	92 gns.			
*Grundig TK60 Stereo	128 gns.			
*Harting HM8 Stereo	86 gns.			
H.M.V.	£50			
Magnafon	49 gns.			
Philips 4 Tr. 3541	34 gns.			
Philips 4 Tr. 3542	59 gns.			
Philips 4 Tr. stereo 3536	92 gns.			

### BATTERY PORTABLES

*Butoba	69 gns.
Grundig "Cub"	26 gns.
Clarion	25 gns.
Clarion Twin Set	8 gns.
Minivox	37 gns.
Minivox 2 speed	42 gns.
Fi-Cord	59 gns.
Stuzzi "Magnetite"	69 gns.
Steelman	55 gns.
Trav-Ler	29 gns.

\* Microphone extra

Tapes of every size and type by leading makers ready for prompt dispatch. Also Pre-recorded Tapes.

Please mention "Amateur Tape Recording" when writing.

**169-171 STREATHAM HIGH RD., LONDON, S.W.16**

Between St Leonard's Church and  
Streatham Station

STreatham 0466/0192

Hi-Fi Dept., 181 Streatham High Road, S.W.16

Amateur Tape Recording

# AFRICA CALLING



## Bob Rowley reports from Livingstone, Rhodesia

RUNNING A RADIO and Electrical business in Africa, particularly with a Service Department, can be a headache, a more than full time job (no 40 hour week here!) and also . . . great fun! If the old saying "Variety is the spice of life" is true, then there's no shortage of spice in MY life!

In these days of continual progress in Science, with new products appearing almost daily, together with man's great love for holding on to his favourite piece of equipment, there's always plenty of variety!

On many occasions in the past two years a real "ancient" has been brought in for repair, usually long past its day. The proud owner is almost shocked to hear it condemned as being beyond economic repair and begs for it to be fixed at any price. This usually results in a frantic search for an obsolete valve or possibly a substitute, with no "surplus" market to call on in Africa, or, worse, trying to find the value of that burnt-out resistor, with no hope of finding a circuit diagram.

One of my African customers brought in a radio the other week, a mains set in very bad shape. Electrolytic condensers were hanging by one wire, rubber insulation had perished on the wiring, and so on. It was fixed for him, to his great joy, and I must say that when repaired, the performance was very good. I make this point because I finally tracked down the year of manufacture . . . 1937!

On the other hand, the customer may decide that, after all, it may be better to buy one of these new sets. Then, almost invariably, he asks, "What will you allow me on *this* one?" Ah well, it's one way of collecting obsolete parts!

Luckily, Tape Recorders have not really been in circulation long enough to produce many "oldies" of this nature, and the few that do appear on the second hand market are soon snapped up here in Livingstone.

As a matter of fact, to-day I had a customer who was looking for a cheap used Recorder. Casual enquiry produced the answer that all he really wanted was the record/playback head! He already had a tape recorder, and he thought that, with a second head, he could have his 8mm. film sound striped, then mount the second head on the projector so that it ran on the track of the film. Then he would connect this head to the one on his tape recorder, and, presto, he would have sound on film! I gently told him that such a scheme would be rather difficult to put into practice!

Tape is becoming more and more popular here in Africa. Here are two examples of the less normal uses, which may be new to you. A popular restaurant on the banks of the river Zambesi, in sight of the Victoria Falls, now uses a recorder to entertain its patrons. The proprietor uses a 7in. double play reel on his machine, recorded at 1½in./sec. One tape is all he needs to provide music for the evening. A far cry from the days of putting on a 78 r.p.m. record every three or four minutes!

Another use here in Livingstone is the "one man band". Armed with a tape recorder, hi-fi amplifier and speakers and, usually, a set of drums, these individuals supply the needs of some of the hotels for routine dances, receptions, etc. I would have thought the proprietors of the hotels could do just as well by buying the equipment themselves, and running their own music, but I suppose the "personal touch" of the drummer adds some semblance of a "live" show.

However, it's good for business, as I am very careful to point out the need for regular maintenance of the equipment used for these shows. After all, it does have use far in excess of normal, and in temperatures of more than 90 degrees at times in this part of the world. A quarterly check up; cleaning, demagnetising and lubrication where necessary not only prolongs the life of the machine and tapes, but also enables any developing fault to be spotted and corrected before it's too late. In this way, the chances of an annoying breakdown in the middle of a "performance" are greatly reduced.

Regular servicing is a point which I feel cannot be too strongly stressed to all tape users. This applies even more to countries such as Rhodesia, where, during the dry season, there is so much dust in the air. After all, a car, given regular attention, will repay the cost in prolonged life, and, with all its moving parts and precision working, a tape recorder will do the same.

After pointing this out to one of my customers, one of the "one man band" brigade, he almost insisted in bringing his equipment in for service after each performance!

In direct contrast to this was the case of another customer, the manager of another local restaurant. He runs his recorder non-stop from about 7 a.m. to midnight, seven days a week! After six months of this, during which time my suggestions about a spot of maintenance fell on stony ground, the machine developed a squeak. Still it played on and wasn't brought in until, one Saturday morning, the owner came into the shop in great distress and panic.

"This thing won't play at all now," he said; "and I've got a big party on to-night. Can you fix it for me?"

He put the machine down on the counter and I took off the lid. To my dismay I saw patches of oil on the cover plate. "You haven't put oil on this, have you?" I asked. "Oh, yes," he replied; "I was tired of that squeak, so I thought I would give it a drop of oil to stop it."

To cure it, he had taken his oil can and poured oil wherever he could see a hole in the top cover!

He used his machine again that night, but only after I had spent much time in removing oil from drive belts, drive wheels and other rubber covered parts, and mopped it up from all the rest of the works.

Moral, unless you know how and where: DON'T do it yourself.

# Radio Show 1960

Earls Court London - August 23rd to September 3rd, 1960

TAPE RECORDERS will be a big feature at this year's National Radio Show and many new manufacturers will be showing for the first time. We can expect new models with new ideas, smaller decks with cassette loading, small recorders, cheaper recorders for 29, 26, 25½, 24 and even as low as 23 guineas.

Because of better tape head response, slower speeds are becoming the standard for quality reproduction and more programme time, leaving 7½ i.p.s. as the hi-fi speed and in fact, capable of up to professional quality. The usual features such as safety interlock controls, pause controls, superimposing buttons, tape position indicators, magic eye recording level indicators, etc., are being provided, even on cheap machines, and look like remaining as part of the deck furniture on all new recorders.

Newer and much more useful facilities are: immediate mixing of microphone and radio and/or pickup inputs; direct monitoring of recording and pre-record monitoring ("instant audio check" as one firm puts it), and detachable loudspeakers that allow the recorder to be placed in a more comfortable operating position as distinct from a good listening position.

Popular portables will be smaller this year and with decor that is both attractive and serviceable. The styling underlines teenage appeal, one finish is described as 'Italian' style with 'summer blue' leatherette case, two tone blue deck with white controls and silver trim, for example.

How are the British makers keeping up with the Continentals? Still second place, but catching up. Elizabethan claim the first 'All British' four track quality machine. This is to be shown at Earls Court, although the 'Crown',

another 'All British' four track machine (not at the Radio Show), will be available at the same time.

New design features are: better recording heads, slower speeds, im-

proved frequency response, less hum and distortion, except in the cheapest of recorders and some rather close copies of Continental style and finish.

It would appear that the four track



(top left) Elizabethan FT1 (four-track).

(top right) Truvox R.6.

(bottom left) Alba 'Duchess', model R.59.

(bottom right) Murphy TR.1 (cassette-loading).

**YOU have a Stand at this year's Radio Show !!!**

**Call at the British Recording Club Stand No. 412**

will eventually replace two track, but it seems unlikely that 6 or 8 track recorders will become available, 'domestically' at least, since this would certainly call for wider tapes. Four tracks with  $\frac{1}{4}$  in. tape is about optimum. It has taken root in the U.S.A. and on the Continent so it seems likely to remain here.

## STEREO

Two track stereo machines are prominent and most of the larger British manufacturers will be displaying stereo models at the Show. Some are providing space on their decks for fitting either two or four track heads; some recorders are supplied already fitted so that only one external amplifier and speaker will be required for full stereo (two channel). For those with expensive tastes in stereo recording, one model will be displayed that provides full stereo recording and playback, variable speed deck, two loudspeakers, four amplifiers, all for 149 guineas.

One or two machines are fitting V.H.F. tuners and some are providing space for building in a tuner.

A new line is a tape playing unit that can be plugged into the normal pickup sockets of a radio receiver. There will of course, be a selection of tape amplifiers and hi-fi units that cater for tape playback, many of which will be found in the Audio Hall.

## ACCESSORIES

Many new microphones with improved frequency response and lower price will be available about Radio Show time. Cosmocord Ltd. will introduce (at the Show) a low priced crystal stereo microphone with a sufficiently wide frequency response to make low cost stereo recording worthwhile. I have listened to recordings made with this microphone and they were excellent. Three and four channel microphone mixers, stereo balancers, transistor pre-amplifiers, double cut tape splicers, bulk erasers, tape spool containers, special tapes and flexible spools for tapesponding will be highlights of the vast new range of accessories at Earls Court.

Pre-recorded tapes, monaural and stereo are being introduced by 'first time' exhibitors.

Just a mention of hi-fi—the close ally of tape, for amongst the hi-fi equipment in the Audio Hall will be found many new amplifiers, super quality loudspeakers and record transcription units for monaural and stereo. Acos for example are introducing a new type of monaural pickup and arm that tracks at only 3 grammes. Record wear with this will be almost non-existent.

## A FEW OF THE "STARS" AT RADIO SHOW 1960

### RECORDERS

- ★ **BRENELL** New Three Star Stereo. A recorder for the connoisseur and critical recordist. Full details not yet to hand but will be appearing later in AMATEUR TAPE RECORDING. This model was Star of the recent British Exhibition in New York.
- ★ **SPECTONE SPECTO 171**. A new cassette loaded model reviewed in this issue. Popular appeal, nice appearance and excellent performance. 39 guineas.
- ★ **H.M.V.** The new D.S.R.1. A quality recorder with provision for direct monitoring of recording with extra head. Twin amplifier—full facilities.
- ★ **ALBA** The 'DUCHESS' Model R.59. One of the latest low priced recorders. Deck by Garrard. Record monitoring facility and attractive finish. 27 guineas.
- ★ **ELIZABETHAN** One of the first All British four track recorders. Through monitoring. Adaptable for stereo. Complete with microphone and tape. Excellent styling and performance. 39 guineas.
- ★ **TRUVOX** Two new models by Truvox. The R.7, highlight of the New York Exhibition. Full 10 watts of audio power. Wide frequency response and hi-fi performance. A recorder for those who want quality, plus unique styling. 75 guineas.  
The R.6. A high grade popular model, with four watts of audio, full response and contemporary finish. 55 guineas. The enthusiast's recorder.
- ★ **MURPHY** The new T.R.1. Cassette loading. A popular model at £29.18.6.

### DECKS

- ★ **COLLARO** The now well known Studio Deck will be on show again this year. It has become popular with manufacturers and enthusiasts alike. £17.10.0
- ★ **TRUVOX** A new deck—Mark VI, adaptable for stereo, will be on view at the Truvox stand. 25 guineas (stereo 35 guineas). For the discriminating constructor.

### RECORDING AMPLIFIERS

- ★ **TRUVOX** Type M record/playback amplifier, complete with bias oscillator. Full frequency response. Multiple inputs. (Stereo version available soon). High quality amplifier for manufacturers and home constructors.

### ACCESSORIES

If you are looking for accessories such as microphones, telephone attachments, microphone mixers, recording heads, etc., then Acos, Lustraphone and Truvox are exhibiting new designs. Look out for the new Acos Stereo Microphone, the Lustraphone four channel transistorized mixer, and the new Truvox range of record/playback heads including one for ' $\frac{1}{4}$  track'. Another interest point will be the Northern Radio Services' Stand where they will be featuring the 'Symphony' Sterophoner, and a time switch for tape recorders.



## RECORDERS TO LOOK OUT FOR

If you are going to the Radio Show and contemplate choosing your new recorder there, you may experience difficulty in making your choice, even from a short list. Here are a few notes about choosing and buying a recorder and after the Show we will review two, or even three, of the new recorders each month. Do not be hasty in your choice, study the reviews in this or any other magazine. The time will be well spent and may save you disappointment later.

Consider very carefully how you will want to use your new recorder, choose accordingly and choose deliberately.

These are the three general categories under which it is possible to place the many types and makes of recorders, viz: the *inexpensive domestic instrument*, the *quality domestic instrument* and the *semi-professional instrument*. Prices are as variable as performance, but as a guide, recorders from 25 guineas (or less) to about 30 guineas must be considered in the first category. Performance and facilities are variable. Above 30 to 35 guineas the domestic instruments have a variety of extra facilities that make recording more interesting: mixing, superimposing and the like, and are in the main, capable of high fidelity reproduction especially when used with an external high fidelity amplifier and loudspeaker. The semi-professional machine is flexible in use and has a performance that should be regarded as the best available. Such recorders cost around £100 and would be wasted on the person who only wants to record 'pop' music and parties.



**Marconiphone Model MTR/1** has microphone and radio input, low level high fidelity output controlled by volume control and magic eye level indicator. Three speed deck with  $\frac{1}{2}$  track monaural head and 7in. x 4in. elliptical loudspeaker. 2½ watts output. Weight 28lbs. Further details from The Gramophone Company Ltd., Hayes, Middlesex.

## HI-FI LOUDSPEAKERS

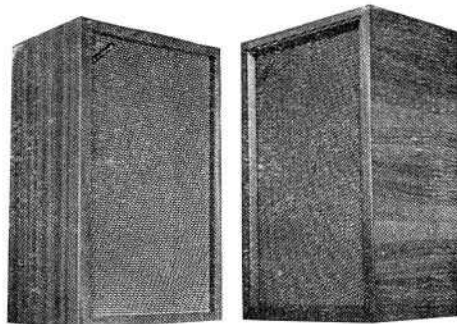

AL 100 and AL 120 Enclosures.

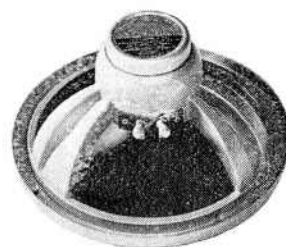

Axiom 112 (10in. dia.), 40-15,000 c.p.s. Power handling, 12 watts, impedance, 15 ohms.

★ **GOODMANS** This famous manufacturer is introducing the new AL.100 12 watt high fidelity loudspeaker system and will be demonstrating the Axiom 110 and 112 speaker units, as well as the Triaxiette Corner Enclosure for home constructors. Tape recordists with an ear for quality should look out for these new Goodmans.

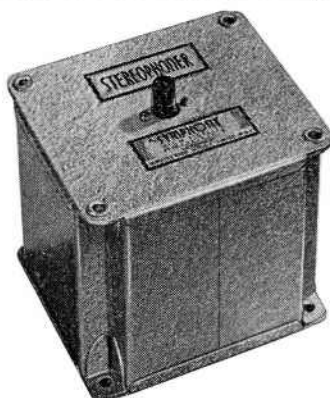

Northern Radio Services' stereo device, The Sterophoner.



The latest 3 Star Brenell Stereo Machine.

These are just a few items selected from the many that are being featured and demonstrated in the Audio Hall and about the Earls Court Show. May we add just once more: choose carefully and deliberately if you are looking for a new recorder or some accessory for your present equipment and do not forget we are on Stand No. 412.

**The C.Q. Conquest** is one of the first all British 4-track machines. It has two inputs for radio and high impedance microphone, provided by means of standard jack sockets, and capable of simultaneous use. Separate gain controls are provided for record and replay which enables monitoring during recording to be carried out at any desired level without interfering with the signal level being fed on to the tape. Other facilities include separate bass and treble tone controls, superimpose switch, external speaker and high fidelity outlets.

Frequency response at 7½ i.p.s. is 40-16,000 c.p.s.  $\pm 2$ dB, supplied complete with 5in. spool of tape, spare 7in. reel, high quality crystal mic. Price 55 gns.



# FOR SUPERB REALISM—**UHER**

## RECORDING AND PLAYBACK *both stereophonic*



The UHER Stereo Record III revolutionises the art of tape recording. In the one instrument UHER has provided for the recording and playback of full, life-like stereophonic sound. Employing the  $\frac{1}{4}$ -track system the UHER gives not only twice the playing time, but permits a wide range of special effects.

- ★  $\frac{1}{4}$ -track recording heads.
- ★ Stereo recording and playback.
- ★ 3 speeds.
- ★ 7" spools.
- ★ Signal-to-noise ratio av-45 dB.
- ★ 4 inputs for each, mono or stereo.

**103 GNS.** Full range of accessories available.

Demonstrations and detailed leaflets of these two models and particulars of the full UHER range, from your usual supplier or write to:  
**TEDELEX (LONDON) LTD.,**  
Valric House, 2-4 Great Eastern Street, London, E.C.2.

UHER UNIVERSAL Europe's finest multi-purpose tape recorder. Five inputs plus provision for dictating, 3-speed recording and playback at studio quality, Full range of extras available, including Akustomat for Automatic control for **79 GNS.** slide-projectors.

### 2 FREE BOOKLETS !

"How To Make BETTER Tape Recordings" (Irish Tape) and Our SENSATIONAL CATALOGUE with Details of 140 DIFFERENT MODELS !

### ! R. B. TAPES DO IT AGAIN !

Brand-new FAMOUS FOREIGN TAPE RECORDERS offered at the Fantastic Price of **35 GNS.** Dep. £7-5-0 Balance 24 mths.

including TAPE, MIC, AUTOMATIC TAPE STOP, FULL MIXING, FREQU. 50-16,000 c.p.s. 2½ watts undisturbed output !

### LOOK! EASIEST TERMS EVER!!

CASIAN Trav-ler	.....	29 gns. dep. £ 6. 9.0
FANFARE 60	.....	23 gns. dep. £ 5. 3.0
GRUNDIG TK24	.....	62 gns. dep. £13. 2.0
ELIZABETHAN Major	.....	65 gns. dep. £13.15.0
WYNDSOR Victor	.....	45 gns. dep. £ 9.15.0

**OPEN ALL  
SATURDAY**

FREE AFTER-SALES SERVICE WITH 12-24 MONTHS GUARANTEE

**R.B.TAPES**  
THE SIGHT AND SOUND CENTRE

179 STOKES NEWINGTON HIGH ST  
LONDON N16 CLISSOLD 9477  
also at 89-91 Gt. Ancoats St. Manchester 4

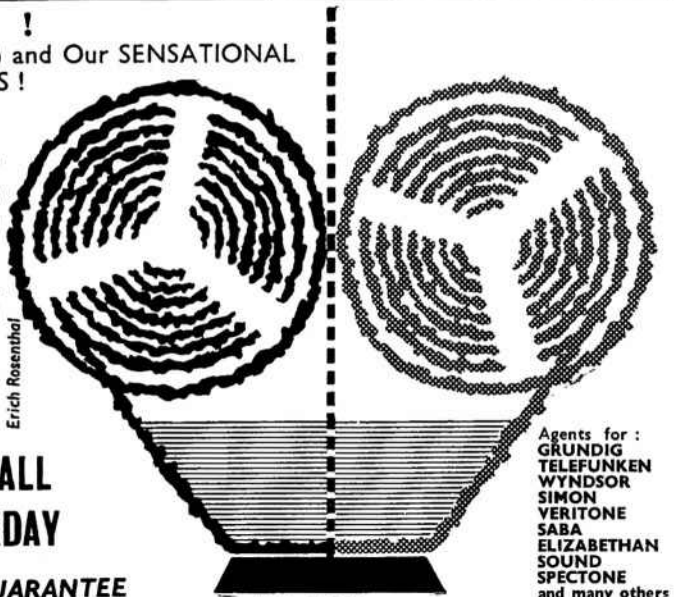

Erich Rosenthal

Agents for :  
GRUNDIG  
TELEFUNKEN  
WYNDSOR  
SIMON  
VERITONE  
SABA  
ELIZABETHAN  
SOUND  
SPECTONE  
and many others

Write NOW  
for All Your FREE Literature.

NAME .....

ADDRESS .....

.....

here



the **FANTABULOUS**  
**SPECTO**

**171**

Coin a word! that's the only way to describe the spectacular new SPECTONE 171 tape recorder — a new high in quality for a new low in cost! Fitted with the famous GARRARD deck and a new concept in recording — the tape cassette. Just drop in and away you go—no complicated threading! Plus! loads of fun giving features including:—

- \* Easy operating via two simple operating controls.
- \* Monitoring mixing and superimposition facilities.
- \* Provision for separate amplifiers and speakers.
- \* Can be used as a straight amplifier.
- \* Modern, compact, neat and with super sound reproduction.

**39 gns.**

Ask for a demonstration at your local dealer or write for colour folder NOW.

**Specto**  
LIMITED

**VALE ROAD, WINDSOR, BERKS. Windsor 1241**

Amateur Tape Recording

IN THIS ARTICLE we will consider various types of Radio Tuners and their aerial systems, but before going further let us consider what is a radio tuner. It is that part of a radio set starting at the aerial input, then through the circuit to the output of the detector. The Tuner can be designed to receive signals from the medium wave band, V.H.F. (very high frequency) or both. Medium waves, which are also known as A.M. (amplitude modulation) operate between 190 and 550 meters (approximately 550 to 1,600 kilocycles); V.H.F., also known as F.M. (frequency modulation), operates between 88 and 100 megacycles (88 million cycles to 100 million cycles every second).

As some of the terms which we shall use may be unknown to you, we will give a brief explanation of them.

- (a) A Detector Stage is that part of a Radio Receiver which separates the Audio-Frequency signal from the Radio-frequency Carrier Signal or CARRIER WAVE.
- (b) A Carrier Wave is an Electromagnetic Signal which actually 'carries' the Audio Signal from the Radio Station Transmitting Aerial to your own Radio Receiving Aerial.

We measure radio wave length in meters. This is the distance the radio wave travels during one complete cycle. There is nothing mysterious about this statement; a Cycle is represented thus:

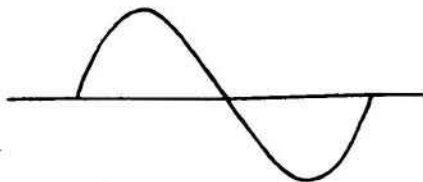

as we know from previous articles.

Wave Length however, is the distance between the peaks of successive cycles of the same polarity or, shown diagrammatically

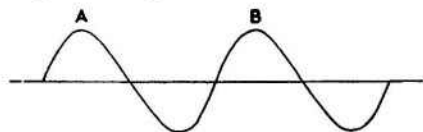

DIAGRAM 'XX'

the distance between A and B.

If you lived 330 meters from the Transmitting Aerial of the B.B.C. and you were listening on your Radio to the Home programme, your aerial would be exactly one wave length away from the transmitter or **ONE COMPLETE CYCLE**.

The V.H.F. frequencies are less than a meter in length so we refer to them by the number of cycles or alternations per second, which enables us to identify the frequency so that we can 'Tune In' to the desired station without any

# What are . . .

## TUNERS and AERIALS

by Fredericks

trouble as V.H.F. Tuning Dials are usually calibrated in frequency.

Amplitude Modulation is a method of placing the audio frequencies on a radio frequency carrier wave by varying the amplitude or strength of the carrier frequency.

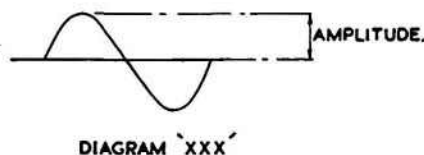

As previously explained the carrier frequency is used to transport the audio frequencies from the transmitter aerial to the radio at your home. Frequency Modulation uses a change in the carrier frequency above and below the assigned frequency to carry the audio signals from the transmitter to the home radio. These methods of modulation will be explained in more detail when the detector circuit is discussed.

### MEDIUM WAVE TUNER

The Medium Wave Tuner normally consists of a pentagrid converter, one or two I.F. stages (intermediate frequency), a detector and a cathode follower output. The V.H.F. Tuner normally consists of a R.F. (radio frequency) amplifier, a mixer and oscillator stage, two or three I.F. stages and a discriminator or detector stage. Figure 1 shows block diagrams of a Medium Wave Tuner and a V.H.F. Tuner. The Limiter stage is used for one type of F.M. (frequency modulation) detector and not with the other type. This will be discussed later in this article.

Do not let the names of the different circuits discourage you as they will be fully explained as we go through the different tuners. Let us now examine Medium Wave Tuners.

The Medium Wave Tuner receives carrier frequencies using amplitude modulation. The first section is the pentagrid converter stage. This section uses a valve with five grids and converts the carrier frequency to a new frequency called an I.F. frequency

FIG. 1.

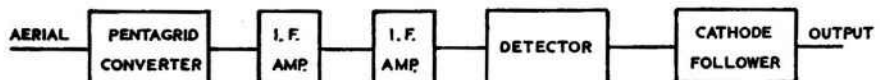

A. MEDIUM WAVE TUNER (AMPLITUDE MODULATION.)

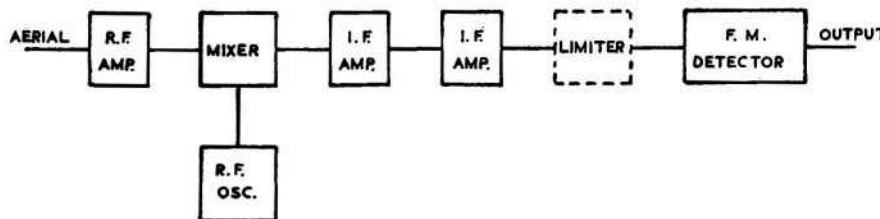

B. V.H.F. TUNER (FREQUENCY MODULATION.)

(intermediate frequency). Figure 2 shows a typical pentagrid converter section. The carrier frequency is picked up by your aerial and coil L.1 receives the signal from the aerial, capacitor C.1 tunes the input circuit consisting of coil L.1 and capacitors C.1 and C.2 which accepts the desired frequency and rejects all other frequencies. The carrier frequency is then connected to grid number 3 of the valve which is the signal input grid.

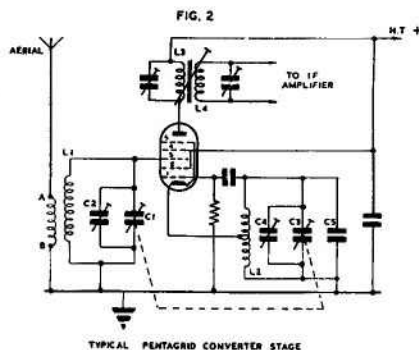

Grids 2 and 4 are connected together inside the valve and are used as the anode for a R.F. (radio frequency) Oscillator circuit. Grid 1 is used as the control grid of the oscillator and the tuned circuit consisting of Coil L.2 and capacitors C.3, C.4 and C.5, determines the frequency at which the circuit will oscillate; capacitor C.1 of the signal input tuned circuit and capacitor C.3 of the oscillator tuned circuit are mechanically linked so that both circuits are tuned together over the desired frequency range when we rotate the Tuning Dial Control. Capacitors C.2 and C.4 are trimmer capacitors and are used to adjust the tuned circuits so that they both tune electrically 'in step'. Capacitor C.5 is used to make the oscillator frequency 465 kilocycles above the carrier frequency which is the I.F. frequency normally used for Medium Wave Tuners. Grid 5 is the suppressor. The combination of several grids in the valve enables us to combine the input signal frequency and the oscillator frequency so that on the anode of the valve we have two signal frequencies which are: The sum of the two frequencies and The difference between the two frequencies.

The transformer, consisting of Windings L.3 and L.4 with a capacitor across each winding, is a tuned transformer with the input winding L.3 and the output winding L.4 each tuned to the two different frequencies present at the anode of the valve. If you desire more detailed information on oscillators and tuned circuits we suggest you obtain any authoritative book on radio fundamentals as a full explanation is too lengthy to include in this article. The valve not only combines the input frequency with the oscillator frequency to produce the I.F. frequency but also provides some amplification.

The carrier frequency is often very weak when it is picked up by your aerial and must be amplified many thousands of times before it is heard in your loudspeaker. The I.F. amplifier circuit is used for this purpose and is similar in many respects to the audio amplifier as its duty, amongst others, is to make the weak input signal stronger. As it operates at R.F. frequencies, I.F. transformers are used to pass the signal frequency from one stage or valve to the next. Figure 3 shows a typical I.F. Amplifier stage.

The valve used is a R.F. Pentode. The input signal from the I.F. transformer is connected to the control grid and the anode connects to the output I.F. transformer. The input and output winding of these transformers are tuned to the I.F. frequency of 465 kilocycles. Two or more of these I.F. Amplifier stages are normally used to provide the required amplification. Each stage amplifies the signal by a factor of approximately 100. Two stages would give an amplification factor of 10,000 (100 x 100) and three stages a factor of 1 million (100 x 100 x 100).

The output of the last I.F. Amplifier is connected to the Detector Stage.

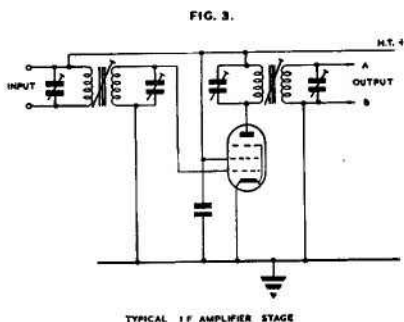

### AMPLITUDE MODULATED SIGNAL

Now let us look at an Amplitude Modulated signal. See Figure 4.

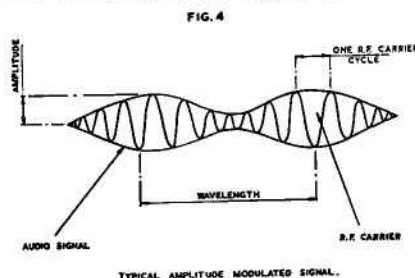

The Amplitude or strength of the R.F. carrier is made to vary with the audio signal frequency alternations. The carrier frequency can be converted to another frequency as we have already seen by the pentagrid converter section of the valve without affecting the audio frequency. Therefore we can use the I.F. frequency method of amplification.

We now have to separate the audio signal frequency from the I.F. frequency. This is accomplished by the use of a detector circuit. See Figure 5.

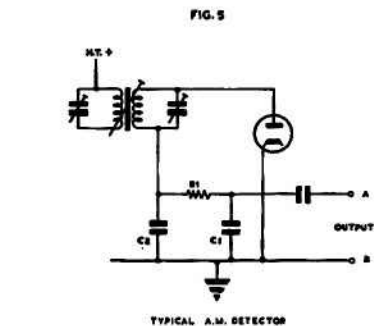

A diode (two electrode) valve is often used for the detector. The output from the I.F. transformer is fed to the anode of the diode valve. The diode only allows the positive half of the signal to pass, which results in a signal being developed across resistor R.1 and consists of the positive half of the input signal. See Figure 6A. Capacitors C.1 and C.2 filter out the R.F. part of the signal so that only the audio signal appears at the output. Figure 6B shows the resulting audio output signal.

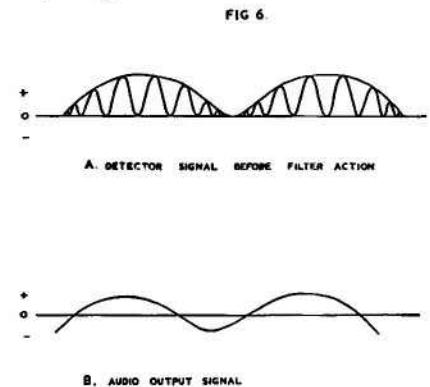

The cathode follower is basically an audio amplifier with a modification to place the load resistor in the cathode circuit instead of the anode circuit. See Figure 7.

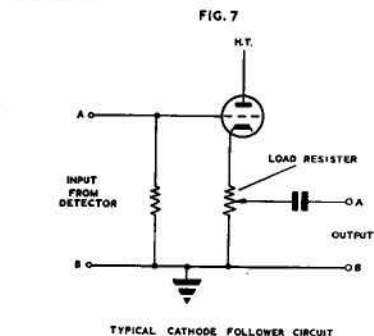

The load resistor consists of a variable resistor or potentiometer and functions as a volume control for the radio tuner.

The V.H.F. tuner has to operate on very high frequencies which reduces the size of some components, e.g., the coils are wound with only a few turns of

# FREE H.P!

WE HAVE THE LARGEST SALES  
OF TAPE RECORDERS IN THE COUNTRY!  
WHY! BECAUSE WE GIVE YOU THE BEST  
TERMS —

THEY INCLUDE:—

- ★ 2 YEARS TO PAY ★
- ★ NO INTEREST CHARGES ★
- ★ DEPOSITS FROM 10% ★



- ★ FREE SERVICING FOR 12 MONTHS — NO CHARGES
- ★ FREE DELIVERY ANYWHERE IN U.K.
- ★ NO PURCHASE TAX
- ★ PART EXCHANGES
- ★ CHEAP SECOND-HAND MACHINES
- ★ SPECIAL FREE TAPE & COMMISSION OFFERS
- ★ 10% INTEREST PAID ON YOUR DEPOSIT
- ★ and lots more besides

WE CAN SUPPLY ALL GOOD EQUIPMENT ADVERTISED IN THIS MAGAZINE ON BETTER TERMS THAN YOU CAN GET ANYWHERE ELSE.

400 machines in stock — £20,000 worth of over 80 different new and second-hand models on permanent demonstration in our showrooms ★ Main Agents for all the best makes ★ Open all day Saturdays ★ Our Mail Order Department covers the whole of England, Wales, Scotland and Northern Ireland—order from us wherever you live for speedy delivery, better service and better terms than you can get locally.

Write, Phone or Call at once for Free Brochures & full details of our Terms—it saves you money if you buy from us.

30 mins. from Central London

# HOWARD

## TAPE RECORDERS

218 HIGH ST. BROMLEY, KENT. RA.V. 4477

cut off here and post this coupon to us today

PLEASE RUSH ME FULL DETAILS OF YOUR TERMS AND BROCHURES:

ATR/APR

Name ..... Address .....

NAME BELOW ANY MODELS YOU ARE PARTICULARLY INTERESTED IN:

# When you buy a Recorder MONO OR STEREO

Look for  
the name  
**BOGEN**  
on the heads

IT GUARANTEES QUALITY

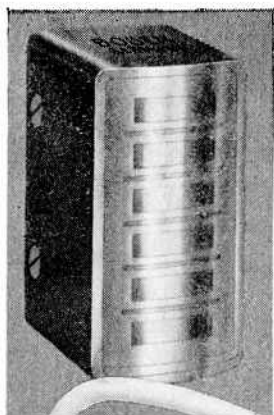
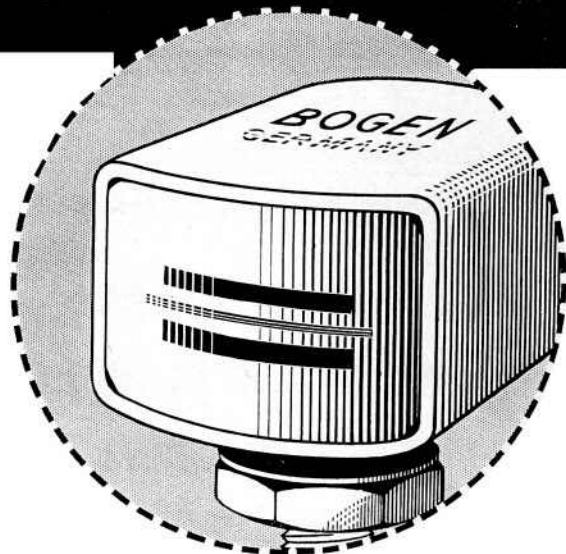

**BOGEN Tape Heads** are found in the finest recording equipment throughout the world. *They are also to be found in more and more of today's best known British and Continental domestic recorders* Made in West Germany by Bogen, who specialise exclusively in the design and manufacture of magnetic heads to extraordinary high standards. Heads for electronic computers, for audio and visual (TV) recording are available. Various types are in use by leading broadcast authorities, laboratories, industry etc. Through **BOGEN**, four track domestic stereo and/or mono recorders are made possible, doubling playing time and providing at  $3\frac{3}{4}$  i.p.s. standards better than those

often associated with twice or four times that speed.\* That is why it pays to see that the recorder you buy is fitted with Bogen Heads in the same way that you want to know what type of lens is fitted to the camera you buy. With **BOGEN** you are assured of finest possible recording and reproduction, long working life, and true dependability. Bogen Heads are also available separately through good stockists for those wishing to fit Bogen to existing equipment.

\*These are the same as the heads used by some commercial producers of pre-recorded stereo tapes.

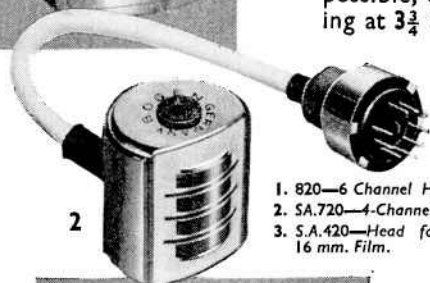

1. 820—6 Channel Head 108 gns.
2. SA.720—4-Channel Head 72 gns.
3. S.A.420—Head for sound on 16 mm. Film. 11 gns.

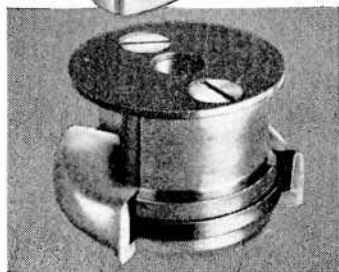

## ★ 4 TRACK HEADS FOR STEREO AND MONO

For Record/Replay and Erase. These heads are easily fitted to existing decks for stereo or mono quarter track operation They are characterised by the same precision standards of manufacture as Bogen heads costing over £100 per piece.

- **FREQUENCY RESPONSE** 30—16,000 c/s at  $3\frac{3}{4}$  i.p.s.; 30—10,000 c/s at  $1\frac{1}{4}$  i.p.s. using high quality tape and amplifier systems.
- **MAGNETS**—Of special laminated steel, finished to micro-precision standards of accuracy.
- **GAP**—3.5 microns (0.0001375 in.) per channel ground and lapped (twice as good as normally accepted standards).
- **SCREENING**—Fully mu-metal screened. Colour coded screened leads.
- **CONSTRUCTION**—To very small size. Mirror smooth face to tape.
- **WORKING LIFE**—10,000 working hours. Equal to 10 years normal use in a domestic recorder.

**PRICE**—Set comprising 4-track record/replay head and erase head, retail—15gns

# BOGEN

MAGNETIC RECORDING HEADS

GOPALCO LTD. | LONG ACRE, LONDON W.C.2 Tel: COVent Garden 2052

wire and the capacitors are small. The signal frequencies are weaker than the medium wave band so we must use a R.F. Amplifier in order to provide enough selectivity to enable us to reject all other unwanted signals. Figure 8 illustrates a typical R.F. Amplifier.

FIG. 8.

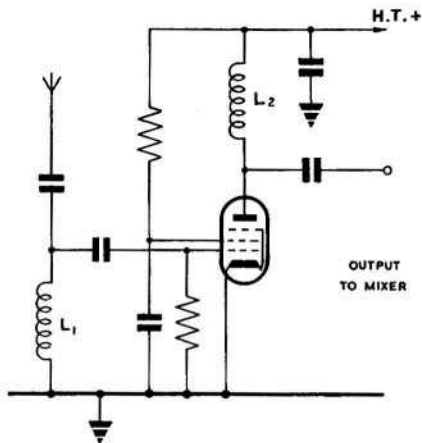

TYPICAL R.F. AMPLIFIER CIRCUIT

Coil L.1 forms an untuned circuit that will allow the desired band of frequencies to be amplified. Coil L.2 is also untuned to pass the desired band of frequencies. These two coils could be tuned however, but this would increase the cost and require precision variable capacitors, so, as we still need further tuned circuits in the section following the R.F. stage for purposes of economy, we leave the R.F. stage untuned and feed directly into the next stage in the tuner, which is known as the mixer circuit.

The mixer circuit together with a R.F. Oscillator circuit accomplishes the same function as the pentagrid converter in the A.M. Medium Wave Tuner. Since we are operating on a much higher frequency two valves are required to accomplish the desired result. Figure 9 illustrates a typical mixer and R.F. Oscillator circuit.

FIG. 9.

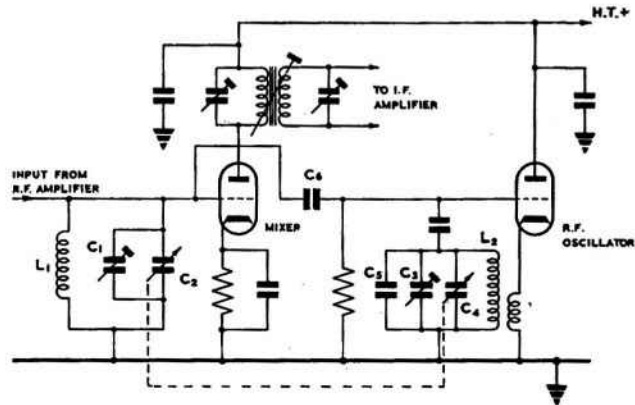

TYPICAL MIXER AND R.F. OSCILLATOR CIRCUIT.

The tuned circuit of the mixer consists of coil L.1 and capacitors C.1 and C.2 and tune to the desired station frequency (88 to 100 megacycles). The tuned circuit consisting of Coil L.2 and capacitors C.3, C.4 and C.5 tunes the R.F. Oscillator to a frequency of 10.7 megacycles below the incoming station frequency. Capacitor C.6 connects the R.F. Oscillator frequency to the control grid of the mixer valve.

Capacitors C.2 and C.4 are connected (ganged) together so that both will tune when the dial is rotated, hence the two tuned circuits are always in step and 10.7 megacycles apart in frequency. The mixer valve combines the two frequencies which are, as you will see, connected to the control grid to produce the I.F. frequency which is the difference frequency, viz: 10.7 megacycles

From the above it will be seen that the I.F. Amplifier valves perform the same function as those in the medium wave tuner except that the I.F. transformers are tuned to 10.7 megacycles.

If required a limiter stage is used. Its function is to remove any amplitude variations in the carrier frequency after it has been amplified. Some F.M. detector circuits require a limiter stage to prevent distortion in the audio output of the detector. Figure 10 illustrates a typical limiter stage.

The resistor R.1 and Capacitor C.1 provide a bias on the control grid of the valve that varies with the signal input. This results in the amplification factor of the valve being varied with changes in the input signal. Resistors R.2 and R.3 reduce the anode and screen grid voltages to provide a greater range of control over the amplification of the valve by the control grid.

### BASIC DETECTORS

There are two basic detectors used in V.H.F. F.M. tuners. They are the FOSTER-SEELEY discriminator and the RATIO-Detector. The Foster-Seeley discriminator requires a limiter stage as shown in Figure 10; however, the ratio detector does not. A typical Foster-

Seeley discriminator circuit is given in Figure 11. Resistor R.1 is the load resistor for diode valve V.1 and Resistor R.2 is the load resistor for diode valve V.2.

When point 'A' is positive, diode V.1 conducts and the audio output is developed across resistor R.1; diode V.2 does not conduct since the anode is negative. When point 'B' is positive, diode V.2 conducts and the audio output is developed across resistor R.2. During this time diode V.1 does not conduct since the anode is negative. The connection to the centre tap of the output

FIG. 11.

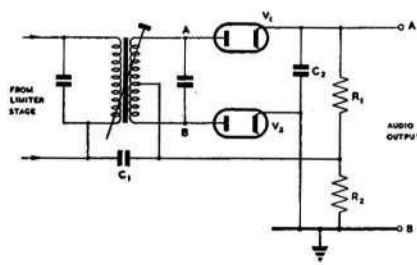

TYPICAL FOSTER-SEELEY DISCRIMINATOR CIRCUIT.

winding of the I.F. transformer completes the circuit to resistor R.2 electrically for proper polarity of the output signal. Capacitor C.2 filters out the R.F. part of the signal and the two signals across Resistors R.1 and R.2 combine to provide the audio output signal.

Before we discuss the Ratio Detector let us consider what is an F.M. Modulated Signal. Figure 12 will help in this respect.

The frequency of the carrier is made to vary with the audio frequency. During the positive half of the audio cycle the carrier frequency increases and during the negative half cycle the carrier frequency decreases. The 'O' voltage reference of the audio signal frequency is the assigned carrier frequency.

Referring back to Figure 11, Capacitor C.1 connects the top of the input side of the I.F. transformer to the

FIG. 10.

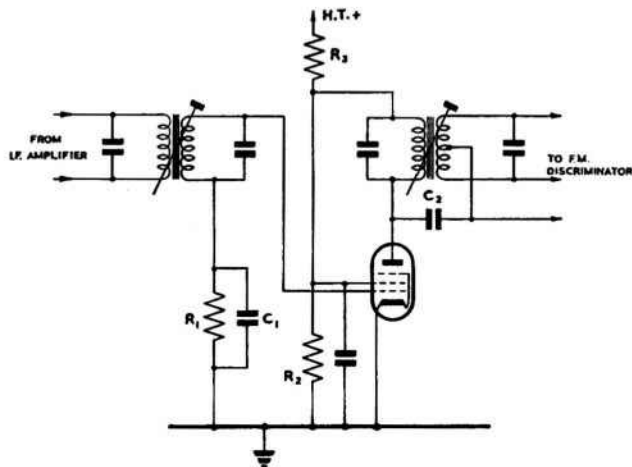



centre of the output side of the I.F. transformer; the signal through the capacitor C.1 combines with the signal on the output side of the I.F. transformer to provide a voltage on the anodes of the two diodes that varies at the audio rate of the audio signal. When the carrier frequency is above or below the assigned frequency, Capacitor C.1 causes a signal voltage to appear on the anodes of the diode valves. When the signal frequency is 10.7 megacycles, the signal through capacitor C.1 will reduce the signal voltages on the anodes of the diodes to '0' resulting in no audio output. This action is the result of the frequencies above or below 10.7 megacycles not being amplified as much as the 10.7 megacycle frequency by the I.F. transformer. The signal through capacitor C.1 remains constant and the signal in the output side of the I.F. transformer varies with the change in frequency. The greater difference between 10.7 megacycles and the signal, the greater the voltage applied to the anodes of the diode valves.

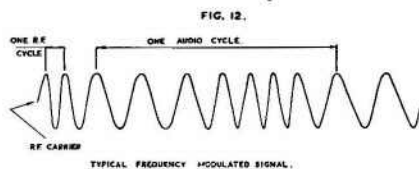

### RATIO DETECTOR

Now let us consider the Ratio Detector. Figure 13 shows such a circuit. You will notice that we have an extra winding L.1 on the output side of the I.F. Transformer.

Also notice that the connections to one of the diodes have been reversed. Capacitor C.1 has a large value compared to capacitor C.2 of Figure 11. This capacitor C.1 acts as a stabilizer and eliminates the need for a limiter stage. When a signal is applied to the I.F. transformer, current will flow through the diodes as follows:

From point 'A' through diode V.1, through resistor R.1 to earth, then up through capacitor C.2, resistor R.2, winding L.1 and back to point 'A'. Current also flows from point 'B' through winding L.1, resistor R.2, down through capacitor C.2 to earth, then

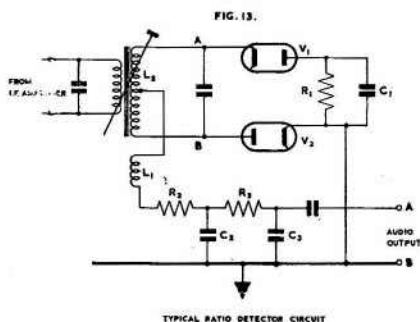

from earth through diode V.2 and back to point 'B'. Note that current through diode V.1 flows through capacitor C.2, and, current for diode V.2 flows through capacitor C.2. It is the ratio of these two opposing currents that results in the output audio voltage. When the carrier frequency is 10.7 megacycles the current through both diodes is equal and the resulting output voltage is zero. When the carrier frequency is above 10.7 megacycles more current will flow through diode V.2 than diode V.1 because the voltage across winding L.1 will add to the signal voltages at points 'A' and 'B' resulting in the anode of diode V.2 becoming more positive than the anode of diode V.1. Below 10.7 megacycles diode V.1 conducts more than diode V.2 because the resulting signal voltages from windings L.1 and L.2 cause the anode of diode V.1 to be more positive than the anode of diode V.2. Resistor R.3 and Capacitor C.3 act as a filter to keep the carrier frequency out of the audio circuits. A cathode follower may then be used; however, for this type of detector circuit it is not necessary.

### AERIALS

The aerial required for the two types of tuners differs because of the frequency of the carrier wave. The medium wave aerial can be a long length of wire or the tuner can have the aerial built into a loop consisting of many turns of wire. Normally an outside aerial is not required for a medium wave tuner.

The V.H.F. tuner however, requires an aerial and can be one of several types. The most basic type consists of

a length of 300 ohm. twin lead with about three feet of it split and spread out as drawn in Figure 14A. A variation of this is also shown in Figure 14B. Figure 14C illustrates an indoor aerial often referred to as 'rabbits ears', whilst Figure 14D shows an outside aerial that can be mounted in the attic or on the roof of the house when the other types do not provide satisfactory reception.

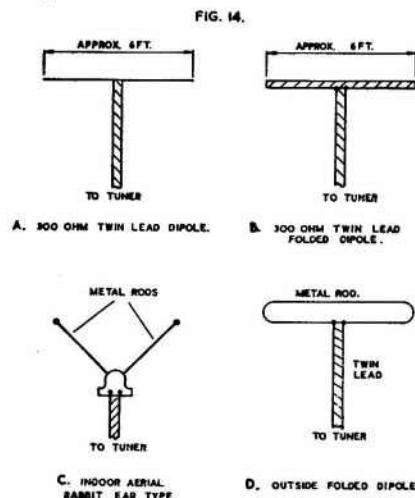

The aerials in Figure 14A and 14B would have to be made from suitable twin lead. The types in figure 14C and 14D are available from radio suppliers as complete units and only require installation in the home.

For the best reception the side and not the ends of the aerial must be facing the transmitting station.

In the next article which will be the last in this series we shall discuss how to obtain the best results from your microphone(s).

**WHEN REPLYING TO  
ADVERTISEMENTS PLEASE  
MENTION AMATEUR TAPE  
RECORDING MAGAZINE**

## SHEEN TAPE RECORDER

CENTRE LTD.

*Specialists in Tape Recorders and Accessories  
Serving London and Home Counties  
Your Centre for Friendly Help—Sales—Service*

**FREE Home Demonstration—Day or Evening  
- To Show Any Model You Require  
- Advice on All Makes from 19 gns.  
Details—With Pleasure—Call—Phone—Write**

8 Station Parade  
Sheen Lane  
Sheen, London, S.W.14  
(Next to Mortlake Station S.R.)

Open 10 a.m. until 7 p.m.  
Early Closing, Wed., 1 p.m.  
Showrooms: PROspect 0985  
Office: CHIswick 5487

### DOUBLE PLAY TAPE

**Return of Post Service** *All post free*  
**B.A.S.F.** 300ft. (3") 14/-; 600ft. (4") 25/-; 1,200ft. (5") 42/-; 1,600ft. (5½") 52/6; 2,400 ft. (7") 77/6  
**M.S.S.** 300ft. (3") 14/-; 1,200ft. (5") 45/-; 2,400ft. (7") 80/-  
**EMITAPE 100.** 100/3N 400ft. (3¼") 17/-; 100/12H 1,200ft. (5") 45/-; 100/24H 2,400ft. (7") 80/-  
**SCOTCH BOY 200.** 400ft. (3¼") 17/-; 1,200ft. (5") 45/-; 2,400ft. (7") 80/-  
**TELEFUNKEN.** 1,200ft. (5") in plastic container, 40/-; 1,800ft. (5½") in plastic container, 50/-; 2,400ft. (7") 75/-  
 Full list of Standard and L.P. Tapes and accessories available free.

**WATTS RADIO (Mail Order) Ltd.**

54 CHURCH STREET, WEYBRIDGE, SURREY  
NOTE.—Post orders only to this address

# CITY SALE & EXCHANGE LTD

**93-94  
FLEET ST EC4**

PHONE: FLEet Street 9391-2

## PEDIGREE STOCK

THESE RECORDERS ARE AVAILABLE FROM STOCK  
AND ARE AVAILABLE ON HIRE PURCHASE

Ferrograph 4A	81 gns.	<b>AMPLIFIERS &amp; SPEAKERS</b>	
Simon SP4	95 gns.	Quad 22 and Amplifiers	£70. 0.0
Reflectograph	95 gns.	Leak Varislope Stereo	£55. 9.0
Grundig TK35	82 gns.	Rogers HG88	£37.10.0
Brenell Mk. V	64 gns.	Wharfedale W2	£29.10.0
Specto 161	49 gns.	Wharfedale SFB3	£39.10.0
		Tannoy Chatsworth	£49.15.0

PART EXCHANGES WELCOMED

POST COUPON NOW!

Please quote for the enclosed

in part exchange for:—\*/Please send details on:—\* (\* Cross out inapplicable.)

Name  
Address

## EXCITING NEWS! HERE IS THE NEW METRO-SPLICER

Look at these unique features . . .

- \* Splices Recording Tape and 8 mm. Cine Film.
- \* Interchangeable channels.
- \* Calibrated in inches and millimetres.
- \* Non-Magnetic Stainless Steel Blade cuts at any angle.
- \* Transparent cutter unit for accurate cutting.
- \* Replacement cutter unit supplied with splicer and spares obtainable from your dealer.
- \* Moulded in High Tensile Nylon.
- \* Impervious to jointing compounds.
- \* Spring-loaded clips.
- \* Countersunk fixing holes.
- \* Scraper tool for film emulsion removal.

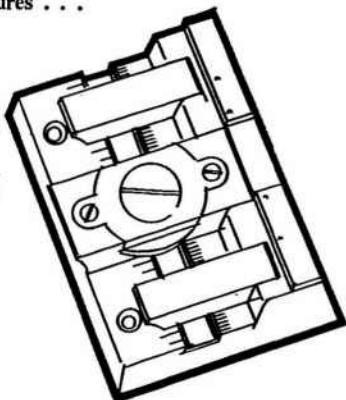

Tape Splicer Kit complete with Scraping Tool and spare cutting Unit 15/-  
Spare Cutting Units 2/6 each  
Spare Scraping Tools 1/- each  
Patents Pending

**IT'S THE SPLICER OF A LIFETIME!**

For illustrated leaflet write to Sole Manufacturers:—

**The METRO-SOUND Mfg. Co. Ltd.**  
19a, Buckingham Road, London, N.1. (CLIssold 8506/7)

## ANNOUNCING THE KURLAND 'KONSOLLETTE'

'konsollette'  
38 GNS. (incl.)

Fitted with the revolutionary Collaro Studio deck. 3 speeds: 1½", 3½", 7½" i.p.s. Digital counter. 3 motors. Will take up

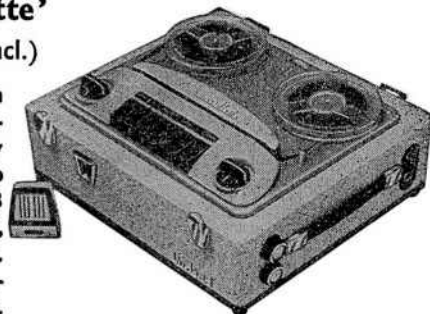

to 7" spools. Very fast rewind. Pause control. Space for third head. The amplifier has been laid out in two printed circuits allowing for easy servicing through base. The 6 valve amplifier monitors through the loudspeaker and can be used as straight through amplifier. Super imposing facilities available. Two tone attractive case approx. weight 24 lbs. Sold including tape, Acos microphone and extension lead.

Available from leading stores — Write for free pamphlet to:  
**KURLAND RECORDING SYSTEMS LTD.**  
TILLY'S LANE, HIGH STREET, STAINES, MIDDX.  
Telephone: STAINES 52788

## NUSOUND RECORDING CO.

# Ferrograph

(Appointed Dealer)

Tape Recorder & Hi-Fi Specialists

Showrooms: First Floor  
3-8 BRIGSTOCK PARADE,  
LONDON ROAD,  
THORNTON HEATH,  
SURREY.

(Opposite Thornton Heath L.T. Bus Depot)  
TELEPHONE: THO 7609

London Showroom  
35 CRAVEN STREET,  
TRAFALGAR SQUARE,  
LONDON,  
W.C.2.

TEL: TRA 2080

## SPECIAL ANNOUNCEMENT

"Advertising Pays", so we are told, but we often wonder exactly how to convey to readers of **AMATEUR TAPE RECORDING** the facilities we can offer to those seriously considering the question: where shall I buy, and where shall I find a Firm willing and interested in MY requirements. One such Firm is **NUSOUND RECORDING COMPANY**, in the heart of London, and **THORNTON HEATH (Croydon) Surrey**, where we are really enthusiastic about Tape Recorders and Audio equipment. **WHY NOT WRITE TO US, OR PAY US A VISIT.**



*Geoffrey V. Smith*  
(SOLE PROP.  
NUSOUND REC. CO.)



# HOME VIEW

I

## UHER STEREO III

THE UHER STEREO III is a four track stereo recorder in the semi-professional class; and rightly so for 103 guineas. Full stereo recordings and playback facilities are provided. The new four track system allows two hours of stereo playing with 1,200ft. of tape as against 60min. twin track. Mono recordings are made by using two of the four tracks simultaneously so that playing time is the same as for a normal two track machine as there is no provision for individual quarter track monaural recording.

The recorder is housed in a grey leatherette covered case with removable lid, with grey deck and white control knobs. Input and output sockets are readily accessible at the side, although I should point out that the plug entries are the continental type for three, four and five pins.

Full provision is made for monitoring during monaural recording and with the aid of the somewhat complex switching system, it is possible to make a second recording synchronised with, and whilst monitoring, the first. For example, I was able to make a recording of a guitar chord accompaniment on one pair of tracks and then add the melody on the other pair of tracks. A final recording of this nature can be played in 'stereo' over two separate loudspeaker channels, i.e., one instrument on the left and the other on the right, both played by a single artist.

The Uher Stereo III was given a non-stop running test for heat, etc., and whilst a certain amount is generated internally from valves, etc., the recorder ran efficiently without the motor over-heating. Listening tests were carried out with an E.M.I. 'Stereosonic' tape and from a professional stereo recording of music selections: both quality of reproduction and the stereophonic effect are excellent. I should at this point add that no microphone, tape or other accessories are provided, although several types of microphone for both monaural and stereo recording are available as well as extra loudspeakers in matching cases. The Uher records and plays back at the three standard speeds of  $1\frac{1}{2}$ ,  $3\frac{1}{2}$  and  $7\frac{1}{2}$  i.p.s. and provides a total playing time of eight hours monaural at  $1\frac{1}{2}$  i.p.s. down to two hours stereo at  $7\frac{1}{2}$  i.p.s. The track arrangements are to international standards as given in the August issue of AMATEUR TAPE RECORDING (page 13).

Provision is made for full stereo recording from a stereo microphone and inputs are provided for radio or pick-up

together with outlets for external amplifier and loudspeakers. Inputs and outputs are for two channels, thus permitting direct recording from stereo discs. A 'fading' control is provided between microphone and gram inputs so that music in stereo from a disc can be faded out to bring up voices or other sounds, in stereo, from the microphone.

### Performance Tests :

Initial tests included the correct functioning of all controls. I could find no fault with these except occasional sticking on the re-wind control after operation of the stop button. Re-wind time is 1.75 minutes for either direction and on both re-wind and playback the tape is nicely tensioned and winds evenly and centrally. The braking system brings the spools quickly to a standstill, without over-tensioning the tape which moves evenly and noiselessly through the guides and pressure pads.

The frequency response of each channel may be controlled on playback by a dual tone control which reduces the h.f. response by about 10dB at 10 Kc/s. The curve of Figure 1 shows that a level response from 60 to 20,000 c.p.s. is possible with slight adjustment of these tone controls. It also shows that the response from one channel is close to that of the other.

Crosstalk is way below -50dB because of the wide separation between the head section and tracks. Signal to noise ratio was found to be a little higher on one channel than on the other but since this was checked from a special tape it also included tape and head noise and I suspect that the head section for one channel was slightly magnetized. Hum,

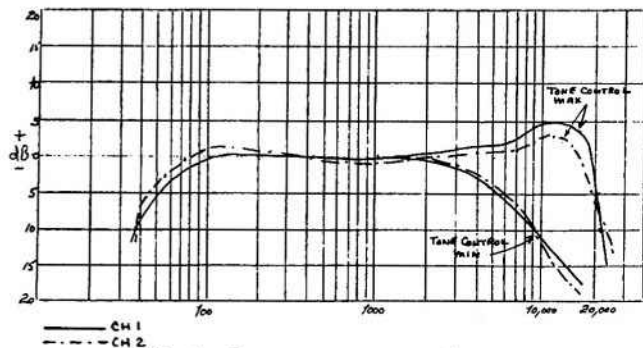

Fig. 1. Frequency response at  $7\frac{1}{2}$  i.p.s.

by F. C. JUDD, A.Inst.E.

2

## SPECTONE 171



although included in the signal to noise figure of  $-45\text{dB}$  is very low. Wow and flutter are quoted in the maker's specification as 0.1% but no indication is given as to whether this is r.m.s. or peak. A test showed it to be approximately 0.15% r.m.s. at 3,000 c.p.s. No full frequency response tests were made for  $3\frac{1}{2}$  i.p.s. or  $1\frac{1}{2}$  i.p.s. The specification quotes 40–16,000 c.p.s. and 40–9,000 c.p.s. respectively. Output power is 2.5 watts per channel which provides a total of 5 watts output on monaural playback as the two channels and twin internal loudspeakers are used together.

The Uher Stereo III chassis is massively constructed, all mechanical components and the drive motor being mounted within a cast frame. The tape drive system employs a mechanically switched idler and a single motor which also takes care of tape take-up by turning the spool hubs via flexible belts. Printed circuits are used throughout and nine working valves are employed for the twin channel record/playback amplifiers. The recording indicator is a novel feature of this machine for it provides two separate indications of record level, one for each recording amplifier channel. The indicator is a conventional 'bar' type but one which employs a split deflection system and separate triode amplifier for each channel. Other than the EMM.801 as this indicator is called, the rest of the valves have British equivalents so that valve replacements present no problem.

My only criticism of electrical performance is the rather high rate of pre-emphasis during recording which gives rise to some distortion at the high frequencies, mainly in the form of audible hiss but which is only really noticeable on a continuous sine-wave recording. On mechanical performance I have no axe to grind but would like to add that anyone considering buying this machine should remember that its full facilities can only be realised with the 'extras', which together, form a very versatile outfit. The Uher Stereo III should be considered as a recorder for the connoisseur.

The Uher Stereo III four track recorder is of German manufacture and is distributed in the United Kingdom by Tedalex (London) Limited, 2-4 Great Eastern Street, London, E.C.2.

### THE SPECTONE PORTABLE TAPE RECORDER —MODEL 171

THIS IS THE FIRST magazine deck recorder I have reviewed and whilst I was impressed with the excellent electric performance of the Spectone 171, my impression of the cassette system is not so favourable. True, the cassette makes for easy storage and complete protection of the tape, and is undoubtedly a good idea from the recorded music collector's

point of view. But I found the cassette rather trying since it had to be opened twice to re-anchor the tape after full re-wind. The spools travel fast and exert sufficient tension to break the anchoring loop when the tape comes to the end. If the cassette is removed, similar size spools may be used but then the braking system is inoperable.

The Spectone 171 is an attractively shaped machine, similar to some of the popular continental makes. A two tone grey case, detachable lid and strong plastic carrying strap provide the external features, whilst a Garrard magazine deck and well designed amplifier chassis are essential items of internal interest.

The frequency response for the single speed of  $3\frac{1}{2}$  i.p.s. is well up to an acceptable domestic standard being, substantially level from 100 to 9,000 c.p.s. *Note this is the overall response from record to playback* and may be regarded as very favourable indeed. From a pre-recorded test tape, the playback only response is right up to the manufacturer's claim within  $\pm 3\text{dB}$  from 50 to 10,000 c.p.s. Hum and noise levels are low and a test using maximum gain on recording (from a microphone) and with maximum gain on playback, showed that much has been done with the circuit to keep hum pick-up to a minimum. Wow and flutter are almost nil as far as music is concerned and barely detectable from a recorded sine-wave of 3,000 c.p.s. Various inputs and outputs are provided viz: microphone, radio, and for extension speaker. The crystal microphone supplied with the recorder is quite capable of passable music recordings and excellent for speech.

The output valve, being an EL.84, provides ample power for the  $7\text{in.} \times 3\text{in.}$  elliptical speaker and for a large extension speaker if one should be used. Controls are provided for tone, microphone and radio (with mixing facility) through monitoring, plus of course, the usual magic eye level indicator.

The electrical performance of the Spectone 171 more than satisfied the array of test equipment used in our laboratory and although we have given no detailed account of the performance, readers may rest assured that the instrument has been thoroughly tested on all points.

The Spectone 171 is a neat inexpensive recorder with a fine electrical performance that does full justice to the Garrard Cassette deck. It is manufactured by Specto Ltd., Vale Road, Windsor, Berks. and priced at 39 guineas.

## B.R.C. APPROVED DEALERS

Visit the Showrooms & Gramophone Record Library at  
**AUDIO REPRODUCTION CENTRE**

134 UXBRIDGE ROAD  
SHEPHERDS BUSH, W.12  
SHE 2234

**RECORDING MACHINES LIMITED**  
119 VICTORIA STREET  
LONDON, S.W.1

**DICKINSONS OF PALL MALL LTD.**  
11 Royal Opera Arcade, Pall Mall, S.W.1  
Behind her Majesty's Theatre in the Haymarket. TRA 2881

**NUSOUND RECORDING CO.**  
3/8 Brigstock Parade, London  
Rd., Thornton Heath, Surrey  
Opposite T/Heath & T. Bus Depot. THO 7609  
London Showroom: 35 Craven Street, Trafalgar  
Square, London W.C.2. Telephone TRA 2080

**ESSEX TAPE RECORDER CENTRES**  
2 MARYLAND POINT STATION,  
LONDON, E.15 (Head Office)  
Telephone: MARYland 5879  
205 HIGH STREET, EAST HAM, E.6  
(Opposite East Ham Station)  
Telephone: GRA 6543

**H. C. ENGERT CO. LTD.**  
8-9 GRAND BUILDINGS  
TRAFALGAR SQUARE, W.C.2  
Telephone—TRAFALGAR 2581

**R.E.W. EARLSFIELD LTD.**  
545 GARRATT LANE  
S.W.18. WIM 0709

**THE TAPE RECORDER CENTRE**  
(Proprietor: C. BRADDOCK)  
266 Waterloo Road, Blackpool, Lancs.

**R. B. TAPES CO. LTD.**  
179 Stoke Newington High Street, N.16  
Telephone: CLIssold 9477  
Also at 89/91 Great Ancoot Street, Manchester

### RAPID RECORDING SERVICE

78s and LPs from your own tapes—  
Master discs and pressings  
Recording Studio equipped with Bechstein Grand  
Mobile Recording Van. "Off the Air" Service  
21 Bishops Close, Church Lane, E.17 COP 3889

### FISHER ELECTRONICS CO. LTD.

60-66 WARDOUR STREET  
Telephone: REGent 7597

### SHEEN TAPE RECORDER CENTRE LTD.

Personal Sales and Service by L. G. Francis  
8 STATION PARADE, SHEEN LANE, SHEEN,  
LONDON, S.W.14. Showrooms: PROspect 0985  
Home: CHIswick 5487  
(Next to Mortlake Station S.R.)

### UNIQUE RADIO SERVICE

The Facade, High Rd., Goodmayes, Essex  
Telephone: Seven Kings 8277



## the **FINEST TAPE RECORDERS** on **INTEREST FREE TERMS . . . .**

Write, Phone or Call today.

You can buy by post with perfect confidence

*DEPOSITS FROM 20% 12 MONTHS TO PAY*

I know how difficult it is to choose the Tape Recorder. That is why more and more people come to the Royal Opera Arcade, because my advice, personal attention and help are freely given. Full demonstrations at any time, and you can always examine and hear the latest and most interesting machines. Remember—I am here to help you.

*Leaflets gladly sent if you are unable to call.*

LAURENCE DICKINSON



**NEW!** 4-Track Monaural Recorders  
PHILIPS 59 gns. TELEFUNKEN 64 gns.  
4-Track STEREO/MONAUROAL RECORDERS  
PHILIPS 92 gns. HARTING 86 gns.  
KORTING 68 gns. ELEKTRON 77 gns.

**CAMERAS.** By Zeiss, Agfa, Eumig, Voigtlander, etc. Send for lists.

**READ THE ALL IN ONE** Tape Recorder Book, 12/6d. Packed with information.

**TELEFUNKEN DA CAPO RADIO.**

39 gns. Call and Hear this fine instrument.

**TELEFUNKEN TAPE DECK,** 63 gns.

Use it with your amplifier or with the Telefunken Radio.

Model	Gns
Philips 3515	32
Sagatone	38
Elizabethan Princess	39
Simon Minstrelle	39
Perth Saja	45
Wyndson Victor	45
Elektron	47 1/2
Magnafon	49
Spectone Ex Tape	49
H.M.V.	£50
Grundig TK20	52
Telefunken 75 with mic.	56
Perth Saja De Luxe	56
Brenell 3 Star	58
Veritone	58
Mobile	58
Ficord	59
Grundig TK25*	62
Telefunken Deck*	63
Korting Stereo*	68
Telefunken 4-track with Mic.	68
Stuzzi Mag-Nette	69
Brenell Mk V with Mic.	69
Grundig TK30*	72
Brenell M.V. with meter. Mic.	74
Elektron Stereo*	77
Telefunken 85KL*	79
Sabafon Automatic*	79
Harting Stereo*	86
Timbra*	89
Simon SP4*	95

\* Excluding Microphone

**ACCESSORIES.** We carry a wide range of microphones, earphones, leads, telephone adaptors, etc., etc.

**SERVICING.** We undertake Rapid and Efficient Servicing of all Tape Recorders.

**TAPES.** Audio, Agfa, B.A.S.F., E.M.I., GELOSO, Scotch Boy, Telefunken, etc. Send for lists.

## Dickinsons of Pall Mall Ltd

11 Royal Opera Arcade, Pall Mall, S.W.1. TRA 2881

*The Royal Opera Arcade lies behind Her Majesty's Theatre in the Haymarket  
(one minute from Piccadilly Circus or Trafalgar Square)*

# hi-fi perfection with enough volume to fill a small hall on BATTERY or MAINS

# Walter

METROPOLITAN

**BIG OUTPUT!**

BIG 2 WATTS  
UNDISTORTED

**BIG REELS!**

5 $\frac{3}{4}$ " TO GIVE 3  
HOURS PLAYING TIME

The only **BIG** recorder  
with **BIG** performance  
on **MAINS** or **BATTERY**

Note these other features;—

Revolution counter • Transistorised  
Mixing facilities • Superimposing facilities  
40/15000 cycles amplifier response  
Signal/Noise ratio better than -40db.



**55**  
GUINEAS  
(Batteries extra)

The **WALTER** records or plays **Outdoors**  
or **Indoors** . . . anywhere . . . everywhere

Double your fun with this revolutionary tape  
recorder. It makes you independent of mains  
electricity supplies; yet it's full size (takes 5 $\frac{3}{4}$ "  
reels) and gives you **BIG** 2 watt output and faith-  
ful reproduction on batteries or on mains.

WALTER INSTRUMENTS LIMITED, GARTH ROAD, MORDEN, SURREY. Tel: DERwent 4421

# Sensational Success of audiotape

**T**APE Recording experts and enthusiasts all over the country are changing to AUDIOTAPE for its flawless perfection of sound reproduction over the entire audio range and its *consistent, uniform quality* from reel to reel.

Available on all standard reel sizes, there are eight different types to meet every recording requirement. AUDIOTAPE, manufactured in the U.S.A., by Audio Devices Inc., gives you the truest sound your recording equipment can produce—try AUDIOTAPE . . . it speaks for itself.

## Sensational C-SLOT REEL!

All 5" and 7" reels of AUDIOTAPE are supplied on the exclusive C-Slot Reel—the fastest-threading tape reel ever developed. The tape end, dropped into a slot in the hub, anchors itself automatically at the first turn of the reel.

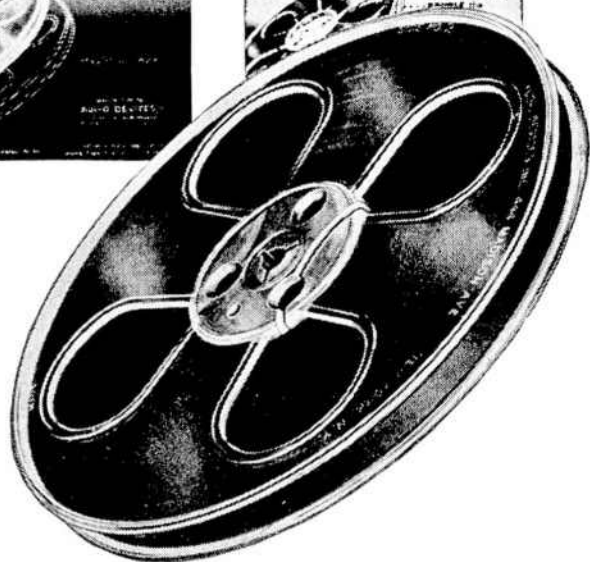

**ELPICO**

A NAME FOR BETTER PERFORMANCE

*Concessionaires to the United Kingdom and Eire*

**LEE PRODUCTS (Gt. Britain) LIMITED**

**"ELPICO HOUSE", . LONGFORD STREET . LONDON . N.W.1**

Telephone: EUSon 5754 (all lines)

Telegrams: Leprod, London

# The 'Studio' Tape Transcriptor

AN OUTSTANDING ACHIEVEMENT IN DESIGN AND PERFORMANCE



**COLLARO** LTD.  
SYNONYMOUS WITH QUALITY.

The result of years of manufacturing experience—THE "STUDIO"—a brilliant new design.

- \* Fast rewind—1,200 feet in 65 seconds.
- \* Space provided for monitor or stereo playback head.
- \* Light piano-type keys.
- \* Three speeds — 1½, 3¼ and 7½ i.p.s.
- \* Twin track single direction, using two magnetic heads.
- \* Three digit counter.
- \* Three motors.
- \* Very low "Wow"—less than 15% at 7½ i.p.s.
- \* Pause control.

Size 12½" x 10½"; Height 1½"; Depth 3½"

**ON VIEW  
AT THE  
Radio  
Show  
STAND 38**

Where quality is the first consideration, the world's leading manufacturers fit Collaro equipment.

**RIPPLE WORKS, BY-PASS ROAD, BARKING, ESSEX**

Telephone: RIPPLEWAY 5533. Telex: 28748

Telegrams: KORLLARO-TELEX-BARKING

Makers of Record Changers, Gramophone Units, Pick-Ups, Electric Motors, etc.

## HIGH QUALITY TAPE RECORDER SPECIALISTS!

# BEST PART EXCHANGE

OFFICIALLY APPOINTED AGENTS FOR:

- |              |                 |
|--------------|-----------------|
| ★ FERROGRAPH | ★ REFLECTOGRAPH |
| ★ SIMON      | ★ GRUNDIG       |
| ★ REPS       | ★ BRENNELL      |
| ★ VORTEXION  | ★ WYNDSOR       |

ALLOWANCE ON YOUR PRESENT TAPE RECORDER—HI-FI EQUIPMENT

### MONO RECORDERS

Verdik .....	45 gns.
Geloso .....	26 gns.
Stuzzi-Mambo .....	39 gns.
Kurland Hi-Fi .....	56 gns.
Brenell 3 Star .....	58 gns.
Wyndsor Victor .....	45 gns.
Walter 101 .....	29 gns.
Walter De Luxe .....	42 gns.
Walter 505 .....	57 gns.
Perth Saja .....	45 gns.
Perth Saja De Luxe .....	56 gns.
Telefunken 75 KL-15 .....	52 gns.
Telefunken 85 KL .....	79 gns.
Grundig TK 20 .....	52 gns.
Grundig TK 25 .....	62 gns.
Grundig TK 30 .....	72 gns.

Specto 161 .....	49 gns.
Specto 171 .....	39 gns.
Veritone Venus .....	58 gns.
Philips .....	38 gns.
Philips EL 3542 .....	59 gns.
Simon Minstrelle .....	39 gns.
Simon SP4 .....	95 gns.
Saba Hi-Fi .....	79 gns.
Vortexion WVA .....	89 gns.
Ferrograph 4 AN .....	81 gns.
Ferrograph 4 SN .....	88 gns.

STEREO	
Korting .....	68 gns.
Harting HM8 .....	86 gns.
Brenell Mk. ....	92 gns.
Ferrograph 808 .....	105 gns.

Ferrograph Stereo Add. 30 gns.

### TRANSISTOR—BATTERY

Grundig Cub .....	26 gns.
Clarion .....	25 gns.
Fi-Cord .....	59 gns.
Butoba .....	69 gns.
Minivox .....	37 gns.
Stuzzi-Magnette .....	69 gns.
Steelman .....	55 gns.

### MICROPHONES

Reslo .....	
Lustraphone .....	
Cadenza .....	
T.S.L. ....	
A.K.G. ....	

Grundig, Etc.

PRE-RECORDED TAPES  
ACCESSORIES  
TUNERS  
AMPLIFIERS  
SPEAKERS  
PICK-UPS  
MOTORS  
CONVERTERS

**THE BEST TERMS NO INTEREST** 18-24 Months Terms Available  
20% DEPOSIT UP TO 12 MONTHS

FREE SERVICING—FREE DELIVERY—FREE TAPE OFFERS—150 MACHINES ON DISPLAY—OUR MAIL ORDER DEPARTMENT WILL DEAL WITH YOUR ENQUIRY BY RETURN. WRITE—PHONE—CALL FOR A QUOTATION ON YOUR MACHINE. A LARGE SELECTION OF USED TAPE RECORDERS. **Tel.: WIM 0709**

**REW EARLSFIELD LTD. 545 GARRATT LANE, LONDON S.W.18**  
10 minutes by bus from Tooting Broadway underground station. 100 yards from Earlsfield Station.



**CLASSIFIED ADVERTISEMENTS**

6d. per word. Minimum 7/6. Box Nos. 1/6 extra

**AMERICAN HI-LO RECORDING TAPE.** 1,800ft. Long Play 35/-, 1,200ft. 24/6, 7in. spool. Guaranteed perfect. **ZODIAC RECORDS LTD., 32 SHAFTESBURY AVENUE, W.1. REGENT 3030.**

**DONATE 2s. 6d.** (100ft. of Tape) to the **BRITISH RECORDING CLUB TAPE BANK** for the use of the Hospital Broadcasting Service and the Tape Reading Circle for the Blind. 145 Fleet Street, London, E.C.4.

**EASYSPLICE TAPE SPLICER SPECIAL OFFER** 3/9d. plus 6d. P. and P. guaranteed for easy accurate tape splicing. **Easysplice Co., 30 Lawrence Road, Ealing.**

**FERROGRAPH and VORTEXION RECORDERS** from our comprehensive range of tape recorders. Telephone **Trafalgar 2080** or **THO 7609.** **NUSOUND Recording Company, 35, Craven Street, Trafalgar Square, London, W.C.2.**

**FERROGRAPH 808,** latest stereo model, unused, perfect, guaranteed, must sell, **£90. BOX ATR/100.**

**FOREIGN LANGUAGES ON TAPE.** The famous **INTERPRET** language courses are now available on tape (3½ i.p.s.). Italian, French, Spanish, German. **£4.6.0** post free. **FREE TRIAL—NO DEPOSIT. VISAPHONE CO. LTD. (DEPT. ATRC), 10 Bayley Street, London, W.C.1.**

**Friendly Folk Association, Torquay (Est. 1943),** Members everywhere, Hobby Exchanges, Stamps, Photography, Viewcards, Tapesponding, Pen-Friends (100 countries).

**GELOSO model G255S Tape Recorder** with all accessories and **Grundig Stenorette** office dictating machine with extras, offers for quick disposal. **Hunt & Colleys Ltd., Hucknall Road, Nottingham.**

**New and Unused Recording Tape** 7in. reels 1,200ft. 27/6 each (usual price 35/-); Ordinary tape 7in. reels 16/6, 5½in. 13/3, 5in. 12/-; Super quality 7in. reels 19/3, 5½in. 15/3; 5in. 13/9. P. and P. 1/- per reel. Empty plastic reels 7in. 2/10, 5½in. 2/8 P. and P. paid. Guaranteed on a money refunded if not satisfied basis. **A. Marshall and Son Ltd., 18 Cricklewood Broadway, London, N.W.2. GLA 0161-2.**

**One only,** New guaranteed Clarion Twinset with mains unit and two leads—used for demonstration only. **£25** Spectone 3 channel self-powered electronic mixer. **£8. Wood, The Studio, 117, Ringwood Road, Highcliffe-on-Sea, Hants.**

**Professional recording tape** (joined) 1,200 feet 7 inch spools at 20/- inc. box P. and P. 1/6d. per reel extra. **Olympic Sound Studios, Carton Street, W.1. Telephone : Hunter 1635.**

**RECORDING ACCESSORIES — Finest Quality Recording Tape** by first class **British Manufacturers.** All Brand New and individually boxed. 3" Long Play 225 ft. 7/6 each. Three for £1. P.P. 1/- 5" Long Play 850 ft. 18/- each. 5½" Long Play 1,150 ft. 24/- each. 7" Long Play 1,800 ft. 29/- each. P & P 1/- per reel. Crystal microphones. For hand or desk use. Finished in cream plastic with gold metal grille, supplied with screened lead 23/6 each post free. Microphone cable dispenser, with wind in handle and plug, will hold over 150 yds. cable 45/- P & P 2/- Microphone cable Twin Braided 79/- per 100 yds, cut lengths supplied. Igranic standard size Jack Plugs 1/11 each. All goods guaranteed, Money refunded if not satisfied. Please send for free lists. Assistance given with recording problems. Post orders only to: **RELAY RECORDINGS, Mott Street, High Beech, Loughton, Essex.**

**SIMON SP4,** latest model, as new, perfect, guaranteed, sacrifice, **72 GNS. BOX No. AT 101.**

**STEREO TAPE LIBRARY** specialists in the sale and hire of **STEREO TAPES.** Hire charge 1/- per tape. Send s.a.e. for particulars to **STEREO TAPE LIBRARY, 'Linden' St. John's Road, BRECON, S. WALES.**

**TAPESPONDENTS LABELS** 4½ x 3 inches, 200—12/- from **SHIRLEY ANN'S PRINTING/DUPLICATING,** Castle Street, EYE, Suffolk. Samples on request. Telephone 219.

**Tape Recorder enthusiast** required by Tape Recorder Specialists for Saturday Sales Staff. Sales ability, good appearance essential. Interesting well paid day's work **Maryland 5879.**

**TAPE TO DISC—ALL SPEEDS** s.a.e. for details **OMEGA RECORDING COMPANY, 112 Sunnybank Road, Potters Bar, Mddx. Telephone 6428.** (Evenings only).

**TAPE TO DISC SERVICE.** Send your recorded tapes to us and be sure of good service. 10% reduction allowed off initial Order. Figures in brackets denotes playing time in minutes. 78 rpm—Single sided discs, (2) 12/-; (3) 13/-; (4) 15/6; or Double Sided 78s—(4) 14/6; (6) 15/6; (9) 18/- 45 EP—(10) 19/- L.Ps Single Sided discs—(9) 21/6; (15) 26/6; (20) 31/6; or Double sided L.Ps—(18) 26/-; (30) 33/-; (40) 37/6. 2/6 extra per parcel for Packing & Postage. SAE for leaflet:- **Sunderland Sound Services, 28 Viewforth Terrace, Sunderland 57032.**

**TAPE TO DISC RECORDING.—** Microgroove L.P. from 27/6. 78 r.p.m. from 11/- 48-hour service. S.a.e. for comprehensive leaflet to: **A. D. Marsh, "Deroy" Sound Service, Little Place, Moss Delph Lane, Aughton, Ormskirck, Lancs.**

**2 Minifon Recorders,** loudspeaker and sundry equipment in first class order, Cost over £190. What offers? Telephone **Wimbledon 7344.**

**Ferrograph 3AN.** Immaculate, factory maintained, complete with unused Ferrotape. **Simon Cadenza Ribbon Microphone.** Best offer secures. **S. R. Church, Vigilant 5488.**

**Bib RECORDING TAPE SPLICER**  
**FOR EASIER AND ECONOMICAL TAPE EDITING**



The easy-to-lift clamps on the new Mark II Bib Recording Tape Splicer are both hinged on the same side of the splicer, making the jointed tapes easy to remove. Precise, rapid tape jointing is ensured, and because you can use all the odd lengths of tape, you soon save the cost of the splicer.

Everyone who uses a tape recorder will need this little tool. It is indispensable. P. Wilson, "The Gramophone". Send a stamped, addressed envelope for a helpful leaflet on tape editing.

**18/6d each (subject)**

**MULTICORE SOLDERS LTD.,**  
**MULTICORE WORKS, HEMEL HEMPSTEAD, HERTS. TEL: BOXMOOR 3636**

-to- TAPE - TO - DISC - TO - TAPE - TO - DISC - TO - TAPE - TO - DISC -

**IF QUALITY AND DURABILITY MATTER** (especially with LP-s from your precious tapes) consult Britain's most experienced transfer service. (6 in. LP-s from 16/-). Delivery 3-4 days.

**SAVE 25-30% ON BRANDED AMERICAN TAPES** 1800 ft. from 35/-, 2400 ft. from 60/- Post Free

**COMPREHENSIVE MAINTENANCE POLICY** (covering free servicing at your home anywhere in Britain and guaranteed by the E.M.I. organisation) supplied free with new equipment.

Specify requirements to :

**SOUND NEWS PRODUCTIONS**  
**10 Clifford Street, London, W.1. REGent 2745**

-to- TAPE - TO - DISC - TO - TAPE - TO - DISC - TO - TAPE - TO - DISC -

YOU GET *Vivid* REALISM...

...with the  
wonderful



# HMV TAPE RECORDER

Speech, music, sound effects . . . you get VIVID REALISM every time with this fine tape recorder. This isn't surprising when you consider its many 'professional' features. What is surprising is that such a quality machine should be so modestly priced. Hear it at your dealer's and you'll realize that "His Master's Voice" offers TODAY'S FINEST TAPE RECORDER VALUE!

- \* Two speeds:  $7\frac{1}{2}$  i/s and  $3\frac{3}{4}$  i/s
- \* Frequency response: 50-10,000 c/s at  $7\frac{1}{2}$  i/s  $\pm$  3dB
- \* Takes 7" spools
- \* Half-track operation
- \* Three-motor drive
- \* Separate record and playback amplifiers
- \* Three head system for instantaneous playback
- \* Pause control for instantaneous stop/start



**ONLY £50**

Complete with 1,200' Emitape, spare spool and crystal microphone.



THE GRAMOPHONE COMPANY LIMITED · HAYES · MIDDLESEX

# THE British Recording Club

Secretary: A. Alexander

Chairman: E. Yates

## DEPARTMENTS

Hospital Services: A. Lovell

Braille Transcription Service: J. F. Adams

Religious Programmes: R. Mayor

Educational Division: Dr. Smith

Joint Programmes Organiser: F. Willemson

## MEMBERSHIP FORM

<b>FULL MEMBERSHIP</b> <b>21/- PER ANNUM</b>	<b>ASSOCIATE MEMBERSHIP</b> <b>5/- PER ANNUM</b>
<p><b>To: THE SECRETARY,</b>  <b>THE BRITISH RECORDING CLUB,</b>  <b>145 FLEET STREET,</b>  <b>LONDON, E.C.4.</b></p> <p>Dear Sir,            I wish to become a member of The British Recording Club. I enclose my membership fee of one guinea (21/-), which includes my annual subscription to the "Amateur Tape Recording" magazine.</p> <p>Name .....</p> <p>Address .....</p> <p style="text-align: right;">Date.....</p> <p>Type of Recorder used.....</p>	<p><b>To: THE SECRETARY,</b>  <b>THE BRITISH RECORDING CLUB,</b>  <b>145 FLEET STREET,</b>  <b>LONDON, E.C.4.</b></p> <p>Dear Sir,            I wish to become an associate member of The British Recording Club. I enclose my annual subscription fee of five shillings (5/-).</p> <p>Name .....</p> <p>Address .....</p> <p style="text-align: right;">Date.....</p> <p>Type of Recorder used.....</p> <p><small>Associate Members DO NOT receive "Amateur Tape Recording" magazine, but are entitled to participate in the Club's Tapesponding activities and any other services which become available.</small></p>

### MEMBERS WISHING TO

# "TAPESPOND"

ARE REQUESTED TO COMPLETE THE FORM BELOW

*I would like to Tapespond and agree to my name and address being published.*

Name..... Age if under 21.....

Address .....

BLOCK LETTERS PLEASE

Interests..... Club Number.....

Taste in Music.....

Type of Machine Used..... Size of Spool.....

Tape speed(s)..... Occupation.....

With what part of the world do you wish to Tapespond?.....

### THE AIMS OF THE

#### BRITISH RECORDING CLUB

- (1) To act as a central organisation for enthusiasts wishing to Tapespond throughout the world.
- (2) To assist in every way possible the advancement and enjoyment of Tape Recording and its many facets.
- (3) To act as a liaison link between Manufacturers, Dealers and enthusiasts.
- (4) To advise and answer member's queries.
- (5) To keep readers abreast of the times with new ideas and equipment in the fields of Tape Recording, Hi-Fi, Stereo and Recordings.

AMATEUR TAPE RECORDING

only

## Authentic Sound

will  
pass  
this  
test

Every day on the farm BASF tape is passing the most critical of all tests for authenticity. As part of an intensive rearing programme, piglets are removed from the sow soon after birth, fed on special foods and given that 'at home' feeling by tape recordings of their mother's grunts. To convince a piglet the recording has to sound authentic. There are three reasons why BASF tape provides the sound that never fails to do so.

The first is its Luvitherm base which permanently holds the magnetic oxide in the tightest bond. The second is the oxide itself, made by a special BASF process to ensure magnetic stability no matter how long the tape is stored. The third is—'know-how'. BASF is the original magnetic recording tape. Today a vast reserve of more than 25 years experience and continued development keeps it ahead for authenticity. Whatever your recorder you can always be sure of registering its complete range of frequencies on BASF tape . . . always reproducing them . . . always obtaining Authentic Sound whatever and wherever you record.



**Magnetic Recording Tape**

**Standard · Long Play**

**Double Play · Editing Sound**

**BASF** CHEMICALS LIMITED, 5a GILLESPIE ROAD, LONDON, N5.