

AMATEUR

TAPE RECORDING

VOL. 5 NO. 4 NOVEMBER 1963 Price 2/-



**WITH TELCAN --
TAPE YOUR
SOUND AND
ACTION -----**



**---- SEE IT ON
YOUR OWN
TV SCREEN
see page -- 8**

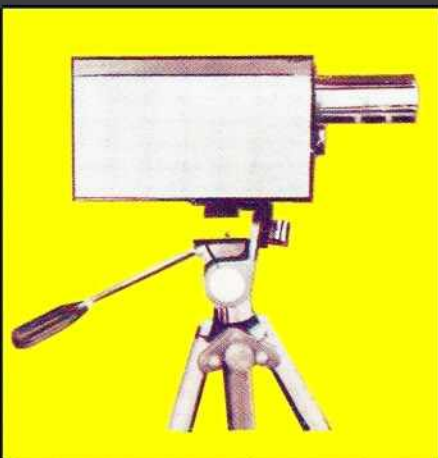

**ALSO EXTRA
1st OF 2 PART
16 PAGE
BOOKLET
DICTIONARY
OF TAPE TERMS**



WHATEVER YOUR ASSIGNMENT—GET THE **FI-CORD 202** PORTABLE BATTERY/MAINS RECORDER— *so much in so little space*

Another assignment for Fi-Cord Fred, safely stowed under his belt, thanks to the compact versatility of the Fi-Cord 202. The Fi-Cord 202 caters for the most exacting professional and for the enthusiastic amateur. Whether you are in a sound-proof studio or perched on a rocky ledge, the Fi-Cord 202 gives you high-fidelity recording at your fingertips. And with this wonderful, lightweight machine you have all the practical advantages of a full-size recorder.

The Fi-Cord 202 offers all these features:

2 speeds— $7\frac{1}{2}$ and $3\frac{1}{2}$ · Standard 4" spools
Vu-meter · Fast forward wind · Fast rewind
Resettable counter · Manual volume control

Built-in loudspeaker · Sockets for microphone, extension speaker and remote control · Safety record switch · Easy-load battery cassettes · Battery warning lamp · Mains input optional.

ACCESSORIES INCLUDE: Carrying case, choice of microphones, power packs for mains and car.

There is a full range of Beyer microphones, from general purpose to ultra-studio quality, to cover every use of the Fi-Cord 202.

Price: 66 guineas, including long life mercury batteries and tape.

Write for fully illustrated brochure and address of nearest stockist to:



FI-CORD INTERNATIONAL 40A, DOVER STREET, LONDON, W.1. HYDe Park 3448



COMPLETE
AUDIO
REALISM

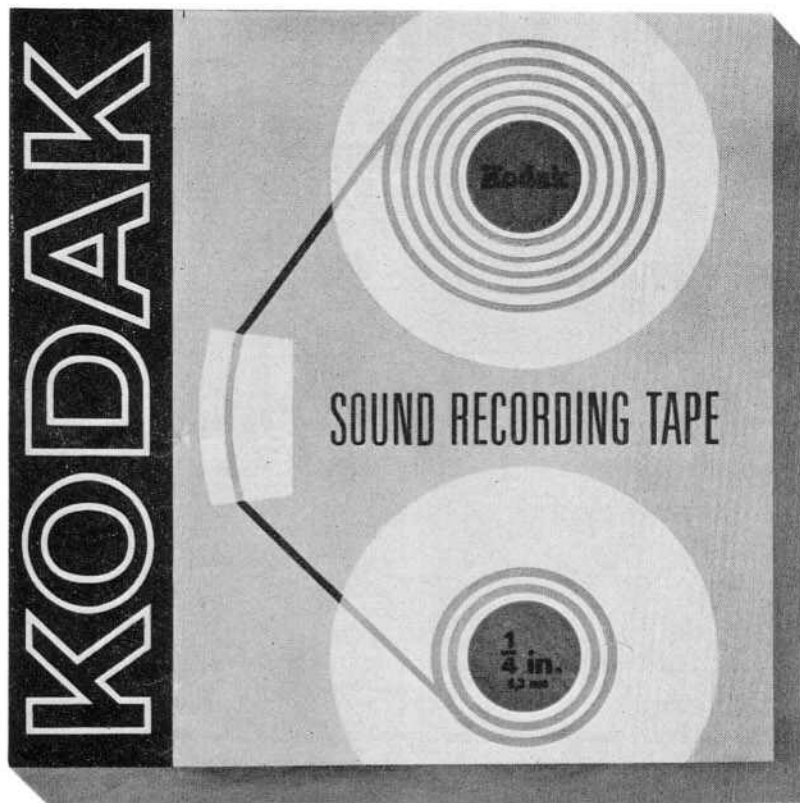

—from new Kodak Sound Recording Tape

There's never been a tape so sensitive as new Kodak Sound Recording Tape. For the first time you can capture complete audio realism. Sound so true you'll hardly believe it's recorded.

- ▶ High output sensitivity
- ▶ Low noise performance
- ▶ Full audio frequency range response
- ▶ Double-lubricated for smooth transport
- ▶ Low bias adjustment

New Kodak Sound Recording Tape is manufactured to the same super-critical standards as Kodak film. Standards that have never been excelled in any coating process. Standards that give a coating uniformity that never varies more than plus or minus 20 millionths of an inch.

There are four types of new Kodak Sound Recording Tape to suit all requirements: standard, long play, double play and triple play—the extra strong tape with the extra long playing time.

Each reel is wrapped in a polythene bag and packed in a sturdy box. A form for recording data is printed on the back of the box. Each reel incorporates a special clip which eliminates tape spillage.

Write for further details of this new tape, to Dept. T2, Kodak Ltd., Kodak House, Kingsway, London, W.C.2.

KODAK LTD.

Kodak

DEPT. T2, KODAK HOUSE, KINGSWAY, LONDON, W.C.2.

WORLD RECORD CLUB OFFERS YOU THE CHOICE OF ANY 3 PRE-RECORDED TAPES

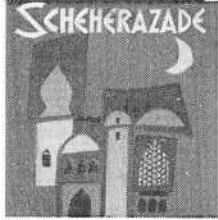

31. Rimsky-Korsakov: Scheherazade. Sir Eugene Goossens conducts the LSO in a breathtaking performance of this rich and exotic masterpiece. **Also on disc: mono/stereo**



32. Star cast and orchestra stare all the famous songs: Getting to Know You, Hello Young Lovers, I Whistle a Happy Tune, Shall We Dance, etc. **Also on disc: mono/stereo**



53. These two suites, containing some of Bizet's most thrilling music, are given magnificent performances by the Sinfonia di London under Muir Mathieson. **Also on disc: mono/stereo**



63 Cuban Carnival, Yesterday, Blues in My Heart, and eight more great numbers played by George Shearing with vocals by Dakota Staton. **Also on disc: mono only**



60 Chabrier's colourful Espana, with Suite Pastorale, Joyeuse Marche and Bourree Fantastique. Paul Bonneau conducts Champs Elysees Theatre Orchestra. **Also on disc: mono stereo**



33. Beethoven 5th, plus Egmont, Josef Krips and LSO in a titanic interpretation which matches the tremendous power of this celebrated music. **Also on disc: mono/stereo**

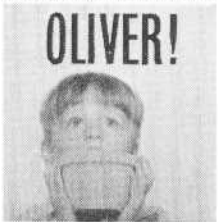

30. Ian Carmichael, Joyce Blair, star cast/orchestra. As Long as He Needs Me, Consider Yourself, all the hit numbers from Lionel Bart's great show. **Also on disc: mono/stereo**



39. Great ballet conductor John Hollingsworth and the Sinfonia di London in a sparklingly fresh interpretation of Tchaikovsky's famous Ballet. **Also on disc: mono/stereo**



59 The silken voice of Nat King Cole in Walkin', Because You're Mine, You'll Never Grow Old, Baby Won't You Say You Love Me and 8 more. **Also on disc: mono only**



40. Superb singing by Bruna Rizzoli and Giuseppe Savio with the chorus of the Teatro Nuovo di Milano and orchestra conducted by Napoleone Annovazzi. **Also on disc: mono only**



52 Gracie Fields sings her favourite songs for you, including In My Little Bottom Drawer, Sally, Song of the Mountain and ten others. **Also on disc: mono only**



25. Ian Wallace, Joyce Blair and chorus. Some Enchanted Evening, I'm In Love With a Wonderful Guy, and all the unforgettable songs from this great musical. **Also on disc: mono/stereo**

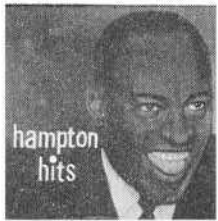

34. Stardust, How High the Moon, Nearer of You, Round Midnight, King David—eight numbers by the vibraphone genius, Lionel Hampton. **Also on disc: mono/stereo**



48. Deep in My Heart, Drinking Song, Serenade—all the old favourites—fresher than ever with Marion Grimaldi, Linden Singers and Orchestra. **Also on disc: mono/stereo**



10 Tchaikovsky Violin Concerto, Tossy Spivakovsky with Walter Goehr and London Symphony Orchestra in a superb performance of this melodious work. **Also on disc: mono stereo**



58 The fabulous dynamic Duke Ellington himself in eight great numbers including Stomping at the Savoy, In the Mood and Honey-suckle Rose. **Also on disc: mono only**



2. Grieg Piano Concerto, Alexander Jenner in an electrifying performance with the Bavarian State Radio Orchestra—conducted by Odd Gruner-Hegge. **Also on disc: mono only**

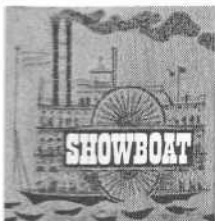

35. Ol' Man River, Bill, Make Believe, many more well-loved numbers from this famous musical memorably sung and played by full star cast. **Also on disc: mono/stereo**



44. Leopold Ludwig and LSO combine brilliantly in an exciting 'double': two of the world's greatest symphonies receive vivid new interpretations. **Also on disc: mono/stereo**



62 The best of Irving Berlin, Easter Parade, The Girl that I Marry, How Deep is the Ocean, What'll I do, 8 more. Raoul Poliak, his orchestra and chorale. **Also on disc: mono/stereo**



38. Hervey Alan, Ian Wallace, Marion Grimaldi and chorus sing the immortal favourites: Cobbler's Song, Robbers' Chorus, Chu Chin Chow, etc. **Also on disc: mono/stereo**

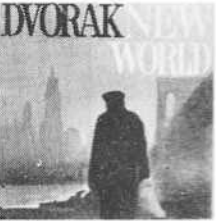

11 Dvorak Symphony No. 5—From the New World. Leopold Ludwig conducts the London Symphony Orchestra in a dramatic and moving performance. **Also on disc: mono stereo**



71 The smooth sound of the Nelson Riddle Orchestra in Touch of Your Lips, Body and Soul, The Tender Touch, As You Desire Me—11 favourites in all. **Also on disc: mono only**



64 The unmistakable sound of the Billy May Band in a tremendous selection — It Happened in Monterey, Bye Bye Blackbird, Be Honest with Me, 9 more. **Also on disc: mono only**

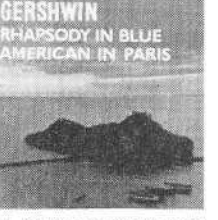

13 Gershwin's Rhapsody in Blue and American in Paris. Pittsburgh Symphony Orchestra conducted by William Steinberg. Jesus Maria Santoro, piano. **Also on disc: mono/stereo**



65. Our Love is Here to Stay, The Nearness of You, Guilty and nine more great hits, all with America's top vocal group, the fabulous Four Freshmen. **Also on disc: mono only**



61 The world's 3 greatest sonatas—Beethoven's Moonlight, Pathetique and Appassionata — superbly played by famous T.V. pianist Joseph Cooper. **Also on disc: mono only**

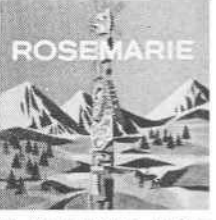

50. David Hushes, Barbara Leigh, Andy Cole and chorus sing Indian Love Call, Rose Marie, and all the other tunes from Friml's well-loved musical. **Also on disc: mono stereo**



54 Tchaikovsky's last and greatest symphony, is here given a splendidly moving rendering by the Sinfonia di London conducted by Muir Mathieson. **Also on disc: mono/stereo**



6 Full-cast production. Brand new arrangements. Star artists sing Stranger in Paradise, Baubles, Bangles and Beads, This is My Beloved, etc. **Also on disc: mono only**

FOR ONLY 30/-

THE GREATEST BREAKTHROUGH SINCE TAPE RECORDING!

Here is the greatest World Record Club introductory offer ever made . . . a unique offer never before matched by any record club or company anywhere in the world!

EVERY ONE OF WORLD RECORD CLUB'S UNRIVALLED RELEASES AS 12" LPs IS NOW AVAILABLE ON 3½ ips TAPE!

Now you have the opportunity to play any WRC release on your tape recorder. Each of these 'tape records' runs at 3½ ips, mono, on 5" spools and can be played on either 2 or 4 track recorders. New electronic techniques of tape-to-tape transfer give these 3½ ips WRC pre-recorded tapes a standard of reproduction unattainable previously at less than 7½ ips.

WORLD RECORD CLUB 7-POINT PLAN MEANS BETTER LISTENING FOR YOU!

1. AN UNPARALLELED INTRODUCTORY OFFER.

Choose now, any three of the superb 3½ ips pre-recorded tapes shown here, for only 10/- each and number them on the attached coupon. (If you wish, of course, you can choose 12" LPs instead. Both disc and tape are the same price.) Please send no money until after you have received, played and approved them. We want you to prove to yourself, before paying, that our tapes are equal to the world's best.

2. THE OPPORTUNITY TO BUILD A UNIQUE TAPE COLLECTION.

The WRC programme, which you will receive with your 3 introductory tapes, offers you an exciting and varied annual repertoire of more than 60 selected releases, covering classics, jazz, shows, ballet music, light music and 'pops'. Every one is a superlatively recorded 3½ ips mono tape (or 12" LP—mono and stereo). Each is offered to you at the

Don't miss this great opportunity. Send off the coupon today, for your 3 introductory selections for only 30/-

privilege club price of 29/- (plus a small charge for post and packing)—much less than you would pay elsewhere for recordings of anything like this quality.

Your only obligation, as a Club member, is to agree to buy four more tapes (or 12" LPs) over the year. Beyond this, there is no subscription or membership fee.

3. A PLANNED PROGRAMME.

Every World Record Club release is hand-picked by an independent panel of Britain's top musical authorities. The Countess of Harewood, Lord Montagu of Beaulieu, Sir Arthur Bliss, Richard Attenborough, Cyril Ornadel, Ray Ellington, Leon Goossens, Malcolm Arnold, Steve Race, John Hollingsworth, Antony Hopkins—and, as special adviser on tape, Miles Henslow.

4. FREE MONTHLY MAGAZINE.

A monthly magazine, packed with fascinating musical articles, reviews, news and pictures, is issued free to all members.

5. SPECIAL CONCERT PRICE CONCESSIONS.

Many concert halls and theatres throughout the country (including the Royal Festival Hall) allow special concession rates to club members for many performances.

6. FREE BONUS TAPES.

The more you buy, the more you save! After fulfilling the minimum membership obligations, you earn another tape of your own choice free for every extra three you buy!

7. EXCLUSIVE EXTRA RELEASES.

In addition to the regular monthly selections, the club offers members exclusive extra tapes at the standard Club price.

World Record Club is unique—the first and greatest Record and Tape Club in Britain, with the largest show catalogue (on tape and mono/stereo disc) in the world. No other method of tape—or record—buying offers you so many additional benefits, so much freedom and variety of choice, with no 'high-pressure' selling. And, of course, there are no subscriptions or membership fees of any kind—only a small deposit of £1 (later refundable) when you become a tape member.

... AND IF YOU OWN A
STEREO TAPE RECORDER
hear the fantastic reproduction of
STEREO 21
THE NEWEST,
TRUEST SOUND
ON TAPE TODAY!

Revolutionary new STEREO 21 pre-recorded tapes (7½ ips twin-track) are issued exclusively by World Record Club. But they are offered without membership commitments of any kind. The first list of all new STEREO 21 releases is now available. It features 30 superb stereophonic tapes ranging from Beethoven's *Eroica* with Josef Krips conducting the LSO, to a lavish full-cast production of *Oklahoma*.

As always, WRC prices present unparalleled value—all STEREO 21 releases cost either 50/- or 60/- depending on playing time (up to 50 minutes). STEREO 21 tapes are now obtainable through leading retailers or direct by post from World Record Club. Send for full catalogue now—STEREO 21 must be heard to be believed!

7-DAY FREE TRIAL OFFER—POST TODAY!

STEREO 21 FREE BROCHURE

To WORLD RECORD CLUB (Dept. ATR4) Box 11
PARKBRIDGE HOUSE, RICHMOND, SURREY.

SEND NO MONEY NOW

3½ ips pre-recorded tapes	12" LPs
---------------------------------	---------

Tick which you want

Please send me, without obligation, on 7-day free trial, the three selections indicated. (Your 3 selections must be either all tape or all disc.) If satisfied, I will pay you 30/- plus 3/- postage, packing and insurance. Only at that stage may you enrol me as a full member of World Record Club, entitled to all the benefits described. My only obligation as a member would be to agree to purchase 4 more top quality 3½ ips tapes (or 12" LPs) over a 12-month period at the special club price of 29/- each. If I am not completely satisfied with my 3 selections, I will return them to you within 7 days, in good condition, and owe you nothing.

NOTE I understand I will be asked to pay £1 deposit when I become a tape member (this does not apply to disc members). This deposit is refundable.

Signed.....
this offer applies in Gt. Britain and N. Ireland only.

MY 3-SELECTION 'PACKAGE' COMPRISES

Choice No. 1 Choice No. 2 Choice No. 3



(place tape/disc key numbers only in the circles)

Tick here if stereo 12" LPs are required where available

Mr/Mrs/Miss
(BLOCK CAPITALS PLEASE)

ADDRESS

To WORLD RECORD CLUB (Dept ATR4)
Box 11 PARKBRIDGE HOUSE, RICHMOND, SURREY.

Please send me your free colour brochure, showing the full range of your new STEREO 21 releases.

NAME

ADDRESS

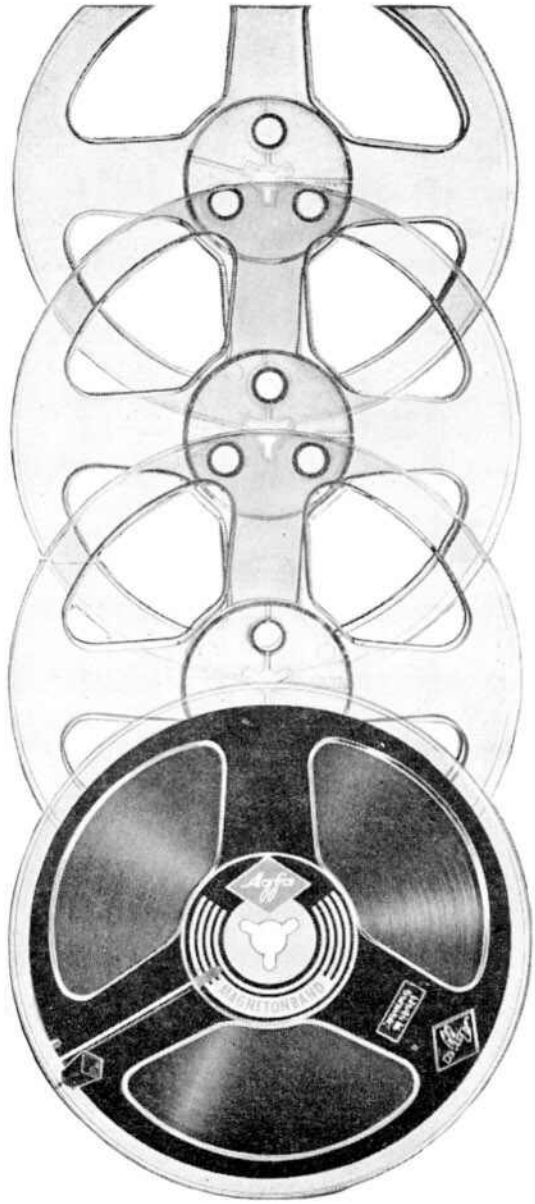

**three
into
one**

TRIPLE PLAY PE 65 TAPE

- * That lengthy opera can be recorded on a single spool without change of track.
- * Your battery recorder will play for three times as long.
- * Agfa triple play tape will not stretch, or break because it is pre-stressed during manufacture.



PE65 tape available on 3 · 4 · 4 $\frac{1}{4}$ · 5 · 5 $\frac{3}{4}$ & 7 inch spools
27 REGENT STREET LONDON SW1 · REGENT 8581

AMATEUR TAPE RECORDING & HI-FI

*Gives the
amateur the
professional
touch . . .*

In this issue :

Latest Tape Recorder— Sound and Sight	8
Russ Allen—Hi-Fi Discs	11
Stereophonic Sound	13
Your Recording Dens	17
Val Parker's Tape Parade	19
PULL-OUT BOOKLET— 110 TAPE TERMS	21
Tape Club News	32
The Sound Scene	35
Electronics Without Tears	37
The Things You Say	39
The Tape Directory	41
News Page	42
Approved Dealers	45
Classified Advertisements	46

Editorial Office:

Room 532, Ulster Chambers,
168 Regent Street, London, W.1.
REGent 4833/5

Advertisement Office:

145 Fleet Street, London, E.C.4.
FLEet Street 7732/2110

Editor: F. C. Judd, A.Inst.E.

Advertisement Manager: H. V. Gould

ON THE COVER

A sparkling design illustrating some of the equipment by Telcan Ltd., the video-recording firm that has taken a tremendous step forward in making a reasonable priced video recorder. See page 8.

Vol. 5, No. 4

November, 1963

THE PROGRESS— —CHASERS

by the Editor

TWO years ago, ATR's technical staff took a long look at video recording. At that time it consisted of highly expensive equipment used professionally by TV companies but complete programmes could be 'canned' ready for screening at later dates. Video recording had become a commercial challenge to film, the only other method of storing newsreels, documentaries and other programmes for future TV screening.

ATR research proved that video recording was fascinating and could be developed to a tremendous degree, but would it ever become available for home use and for the keen amateur? Commerce was thinking that way too. Our rounds in the field of manufacturing told us that not a few were having a look at the possibilities; but the looks at the final objective were through high-powered glasses. Mass-market vision recording seemed a long way off.

Two months ago ATR was pleased to publish the Astonishing Sony Story. This month we are proud to tell you more about Telcan—the amazing all-British video tape equipment brilliantly developed and refined to bring it within the pocket and experience of the enthusiast.

Here is another British first. Like our commercial jet planes we gave the world the lead. Like our commercial jets, let us hope our methods of industrial development and sales exploitation do not let down the brilliance of our researchers. For we know that our competitors in Europe, Japan and the U.S.A., are making every effort to capture this new market. At the moment we are first. Let's keep it that way.

Meantime, ATR will keep its readers advised of all developments which hinge on tape recording, whether sound or vision.

That is why we say that ATR is the Sound and Vision monthly.

The title Amateur Tape Recording & Hi-Fi is registered at Stationers' Hall, London. Contents are copyright and may only be reproduced by permission of the Proprietors. Signed articles represent the views of the authors and are not necessarily those of the Editor.



The 'Telcan' video recorder which can be used the way the tape recording enthusiast uses his sound tape recorder today.

UNTIL recently, television picture recording on magnetic tape appeared to have settled on highly-complex systems by Ampex, R.C.A., and others in the professional field, and it looked as though the cost of a video recorder might never come out of the four- and five-figure price bracket. For instance, the R.C.A. TR 22 professional video recorder costs in the region of £22,000. Portable recording machines for around £4,000 to £5,000 have recently become available, of course. **But what of vision recording equipment for home use?**

In the August issue of *ATR*, we announced the Telcan vision recorder, produced by the Nottingham Electronic Valve Co. Ltd., as the first breakthrough in TV recording and playback for home use. Television recording for everyone is therefore no longer an enthusiast's dream or a laboratory 'hook up', and what a vast new field to explore, with new techniques, new technical jargon (note the use of 'video' instead of vision), and here we have a creative medium that as yet can scarcely be visualised.

What will video recording and editing be like; will the amateur be able to achieve the same professional finish that he does now with magnetic tape sound recording? Will such things as a TV camera mixer become as commonplace as the sound microphone mixer; what problems will there be with the sound channel, because the audio and visual are now more closely linked than ever before?

TECHNICAL REQUIREMENTS OF VIDEO RECORDING

It would be as well to understand something about video recording and its technical problems, how it differs from sound recording, and to know what sort of picture quality — and sound reproduction, too — we can expect. How much will it cost; what programme time will be available for a given

VIDEO TAPE RECORDING!

SOUND AND SIGHT

by F. C. JUDD, A.Inst.E.

A look at the biggest advancement in tape recording in recent years!

footage of tape? Many of these questions cannot as yet be answered fully, but I will at least try to cover as many as possible and outline for you some of the technical aspects of video recording.

Television — or video — recording on magnetic tape, requires an operating frequency range extending far beyond that used for sound recording, and this is, and probably will be for some time, a major technical problem in designing equipment for domestic use. The minimum frequency range required for even adequate domestic picture quality is from D.C. (zero cycles) to at least 2,000,000 c/s. (2 Mc/s.). This means a tape speed of up to, perhaps, 200 inches per second, and even with specially designed recording heads and electronics, may not be much less than 120 inches per second, at least for the present.

VIDEO RECORDING METHODS

When the B.B.C. first began experiments with video recording, they adopted a tape speed of 200 i.p.s., which was used for the Vision Electronic Recording Apparatus (V.E.R.A.) shown at the top of page 9. This was a 'linear' recording system, as opposed to the more recent development of rotary head recording by Ampex and others, although the B.B.C. finally abandoned the V.E.R.A. recorder in favour of rotary head machines. I should explain here, 'linear' recording means that the tape runs across the recording head in the same way as on the more familiar sound recorder, but at high speed.

In the Ampex and similar recorders, the tape runs across a rotating head, as shown at the bottom of page 9, and although the head rotates at 15,000 r.p.m., the two-inch wide tape only moves at 15 i.p.s. The video recording is therefore **across** the tape, in a series of bands, each accounting for about 16 television lines. The rotary head consists of four separate recording heads mounted on the periphery of a 2" diameter drum, and the **effective video recording speed** is in the region of 100 m.p.h., or approximately 1,260 i.p.s. The high speed is necessary for the tremendously high frequency response required for professional use — in this case, around 5,000,000 c/s., or 5 megacycles. The maximum frequency response of the Ampex equipment is in the region of 6.8 Mc/s.

Another method of 'scanning' the tape was introduced recently by a Japanese company, and although this employed a rotating head and a tape speed of 15 i.p.s., a helical guide arrangement permitted a diagonal tape scan, as shown at the bottom of page 9, and a recording speed of about 1,600 i.p.s. I

VIDEO TAPE RECORDING!

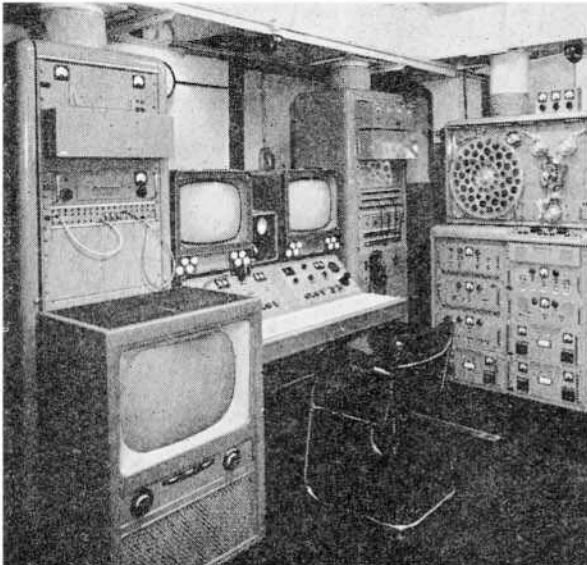

TOP: The Vision Electronic Recording Apparatus (V.E.R.A.), developed in 1958 by the British Broadcasting Corporation. (Photo by courtesy of the B.B.C.)

BOTTOM RIGHT: The Helical scanning method by the Shibaura Electric Co. of Tokyo.

BOTTOM LEFT: The rotating head system for video recording.

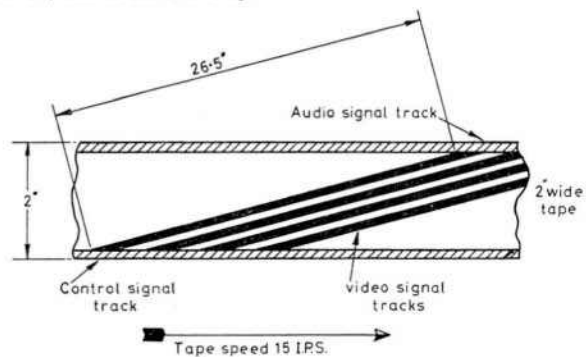
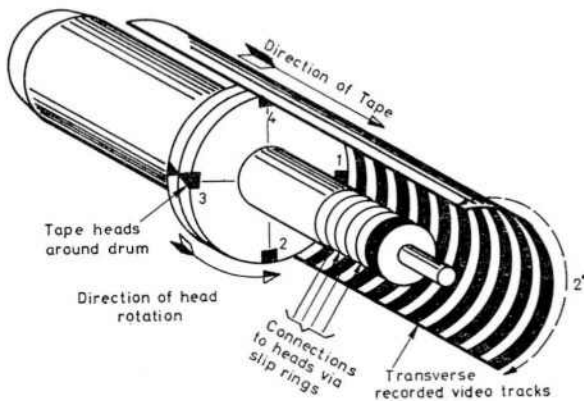

should mention, too, that the tape is kept in contact with the rotating heads by an air suction system.

These special recording heads for professional video recording are highly expensive items: a replacement rotating head assembly for the R.C.A. TR 22 recorder, for example, costs around £1,500. The electronics employed for the video amplifiers, synchronising and servo control equipment, etc., all add to the complexity and cost of professional video recording.

A CONVINCING DEMONSTRATION

The Nottingham Electronic Valve Company have already solved many of the technical problems that have, up to now, held back the design and production of domestic video recorders. Their 'Telcan' (see photographs) was demonstrated for me to my complete satisfaction in the N.E.V. laboratories and factory at East Bridgford.

Aside from the inherent low frequency noise of standard magnetic tape when it is used down to D.C., or zero cycles, the picture quality was almost identical to the original and perfectly acceptable. (Note: In simple terms, the quality of a picture displayed by a TV screen can only be described as being acceptable or unacceptable).

There are still many obstacles to overcome; for example, standard grade magnetic recording tape is not quite good enough, and a specially developed tape is needed. But the Nottingham Electronic Valve Company hope to market a complete outfit, comprising the video recorder, a standard TV set for direct viewing or for displaying the recorded pictures (or a combined recorder and display) and a video camera (page 8) for less than £150!

Finally, I will try to answer some of the questions I raised earlier in this article. Tape editing, for instance, will be similar to the method employed for sound, because the vision and sound tracks are contained on the same tape. Video mixing of more than one camera opens up wonderfully new creative possibilities in the production of one's own TV programmes. Interesting B.B.C. and I.T.A. programmes can be recorded — and remember that a video recording on magnetic tape can be erased and the tape used again. The personal contact of taping, too, becomes even more exciting, with the thought of moving pictures, complete with sound, from friends and relatives. Here I must make it quite clear that one **should not** compare video recording time per spool of tape with sound recording time per spool of tape. Consider, however, that with equipment like the Telcan, a 9" spool of special tape will provide some 30 to 35 minutes of programme time.

In due course, I shall be writing more about this subject, for I am not the only one to be firmly convinced that television recording on magnetic tape for home and amateur use has arrived, and is here to stay.



for the connoisseur

IRISH

You prefer Brittany to Brighton. Höck to highball. Van Gogh to Velasquez. You're choosy as well as selective. Irish is your tape. Irish professional tape has connoisseur advantages precision-engineered into its mirror-smooth surface. The unique Ferrosheen process, by which this microscopically fine surface is obtained, provides exceptional high frequency response due to intimacy of contact between tape and heads . . . head wear is at minimum . . . makes for freedom from head contamination by oxide build-up, considerable reduction in background noise, minimum drop-out. Only Irish tapes have free 'signature binding' kit for authentic library-style filing—simulated Moroccan leather with 23-carat gold foil for simple 'tooling' of title. People like Tandberg recommend Irish. And every Irish tape carries a 100% unconditional guarantee. Your Irish Tape stockist, and other details including technical data, from: A. C. Farnell Ltd., Hereford House, Vicar Lane, Leeds 2. Tel: Leeds 35111.

'IRISH', 'FERROSHEEN' and 'Signature Binding' are registered trade marks of Orradio Industries Inc., Opelika, Alabama.

Get to know
more about...



The Incomparable
Ferrograph

Post this coupon today for full details

NAME

ADDRESS

To: **THE FERROGRAPH COMPANY LTD.**

84, BLACKFRIARS ROAD LONDON S.E.1 Tel: WATerloo 1981

AT.4

Bringing you the
latest Hi-Fi releases . . .

A BAKER'S DOZEN OF BACH!

A FANTASTICALLY exciting disc has come my way and quite against my wishes. Now, I ask you, would you be interested in 'Jazz Sebastian Bach'? It sounds a travesty and particularly when you see it's played by 'Les Swingle Singers'. SWINGLE! I ask you!

But everyone at Philips raved about it and now, having heard it myself, so do I. The Swingle Singers have all the quality of a top choir and they have taken thirteen pieces of Bach, mostly from the Well Tempered Clavier books and without altering a note, have arranged it for voice, string bass and drums, (Pierre Michelot and Gus Wallez), and the results are superb.

The Sinfonia from the Partita No. 2, performed in the main by solo voice and string bass is so wonderful that you'll just have to go and get it and listen for yourself. Bach himself would, I'm sure, have been delighted with these performances. You too will be delighted. It's on Philips BL 7572.

* * *

Still in a dreamy mood, let's turn to 'Moonbeams' Bill Evans Trio. Riverside RLP 428.

The first recording of the trio since the death of their bassist Scott La Faro. His place has been taken by Chuck Israels, a very good man though not in the class of Scott, who I personally miss very much. However we do now hear rather more from Evan's piano and this you may well prefer.

Eight ballads, all deliciously relaxed and beautiful. Moonbeams, sunbeams, every-body beams on Bill Evans.

* * *

Duke Ellington and John Coltrane. HMV CLP 1657. Rec. Sept. 26th, '62.

Another of those wacky seeming pairings but one that has come off extremely well and Trane playing with a warmth I've not found in his playing before. Both the Duke and Trane brought their rhythm sections along and they each bach (Whoops! sorry), back, up on three tracks and on another they mix a little.

A winning double!

* * *

Jazz premiere: Washington. The Paul Winter Sextet. CBS BPG 62165.

This group won an inter-collegiate Jazz Festival at Georgetown University in Washington during 1961 and in that year recorded their first album of track from which is included here. On the 19th November 1962 they made history when Jackie Kennedy presented them at a kids' concert at the White House.

I'm delighted to tell you that the college boys are really great. Winter himself plays a fine modern alto and they all play interesting jazz.

Hear for yourself what the President's wife dug the most.

* * *

'Late Spot at Scott's'. The Tubby Hayes Quintet, Fontana TL 5200.

Recorded live at the Ronnie Scott Club, London, England, May 17th and 18th '62. Tubby, tenor and vibes, Gordon Beck, piano, Freddy Logan, bass, Alan Ganley, drums, Jimmy Deuchar, trumpet.

Tubby has become one of the best known names in British modern jazz. He's a talented lad who can turn his hand to almost any instrument though he sometimes allows his technique to take charge, particularly when playing tenor. Deuchar plays some wonderful stuff and Beck too, but although it is a good album it isn't the most.

For the fans of Tubby.

* * *

'Les Liaisons Dangereuses'. MGM C492. Composed and conducted by Duke Jordan. Music of the original sound track for the motion picture.

This is a very pompous title for Jordan, piano, Charlie Rouse, tenor, Sony Cohn, trumpet, Art Taylor, drums, Eddie Kahn, bass. Recorded at RCA Studios N.Y. City January 12th '62.

I haven't seen the film, and must accept the material here on face value . . . pleasant, swinging, modern jazz, unpretentious and undramatic. Side one consists of three tracks on the same theme. One and three played by the quintet come off O.K. But the middle track by drums and piano could well have been omitted, it's a drag. However, side two is a great deal better and Rouse in particular blows some stormy stuff.

Dangerous company can be interesting!

November, 1963



And this is the LP on which you can find the baker's dozen of Bach compositions. 'Jazz Sebastian Bach'.

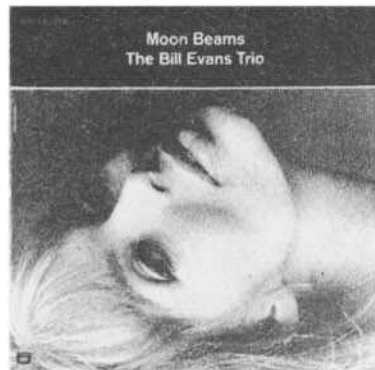

For Hi-Fi music to dream to, try this LP by the Bill Evans Trio.



Russ Allen's Record Review



The coating rooms at Emitape—strictly taboo for dirt, dust and photographers!

We wanted to show you a picture of the clinically clean conditions under which Emitape is made. But we couldn't get a photographer anywhere near the tape. 'Operators Only' is the rule in Emitape's coating rooms.

WHY THE VETO? Unless your tape is free of foreign particles it won't travel smoothly over the recording head of your tape recorder—and sound quality suffers. Eventually the recording head itself will show signs of premature wear. That's why Emitape are so careful about cleanliness.

EVEN THE FILTERED AIR IS FILTERED. The coating rooms themselves are pressurised with filtered air, which is again filtered before being drawn into the coating machines. It's in this rarefied atmosphere that Emitape makes its reputation for cleanliness.

CELLOPHANE WRAP TAKES THE RAP—NOT THE TAPE. And it's a reputation that has nothing to fear from travelling or storage. Each reel of Emitape is cellophane wrapped. A centre tear-strip keeps the wrap intact until it reaches you—*factory fresh*. Always. And sealed against dust. That's why people who care about performance *and* their equipment use Emitape. Why not come clean and join them?

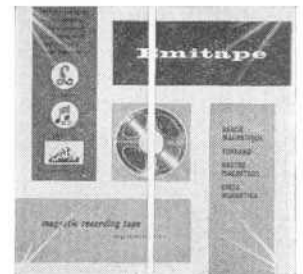

Cellophane wrap keeps dust at bay

Emitape is 'factory fresh'

E.M.I. TAPE LIMITED · HAYES · MIDDLESEX

STEREOPHONIC = SOUND =

John Courtney concludes his series on the fascinating sound that is stereo.

MONITORING AND PHASING

In stereo recording, some form of monitoring is highly essential if proper balance is to be maintained, and this can be done by means of headphones or loudspeakers. The monitoring signals may be taken directly from the recording amplifiers, or from the actual recording if the recorder has separate replay heads. The latter method may entail the use of extra pre-amplifiers, power amplifiers and two loudspeakers. Let me also make it quite clear that stereo recording, playback and monitoring entails two completely separate channels, viz., two microphones, two record/playback amplifiers, and two loudspeakers (or stereo headphones). **There is no compromise method employing a single-channel recorder or amplifier that will provide stereophonic sound with one, or even two, loudspeakers.**

If the tape recorder must be operated in the same room as the microphone, monitoring can only be carried out with headphones, because of the risk of feedback (howling) which would occur if loudspeakers were used. Headphones also provide better directional information, which helps considerably in positioning the sound sources around the microphone. Headphones are also less expensive than extra loudspeakers which may require amplifiers as well.

If the loudspeakers are already incorporated in the tape recorder, and 'through monitoring' is available, the microphones could, of course, be placed in another room, but this may mean extending the microphone cables. This is quite in order if the microphones are low impedance types. Extension

leads attached to high impedance microphones, like the one in Fig. 1, may well impair the high frequency response.

PHASING AND BALANCE

Correct phasing, proper balance of the signal level between the two channels, and full response of the higher frequencies all play an important part in the directive and spatial effect of stereophonic sound. Incorrect phasing, for instance, may cause 'stretching' — and the effect is quite distressing. One may get the impression of a voice ten feet wide!

To achieve accurate directional effect, the phase relationships of the signals through the two channels, right from microphone to loudspeaker, must be such that all signals are 'in phase' over the full frequency range of the equipment. If, for example, one channel is out of phase with the other at the lower frequencies, the bass response may be poor and directivity in general spoiled, i.e., a sound which is supposed to be central may appear to come from all directions at once. This effect is often noticeable on prerecorded stereo tapes when phase changes have occurred during the copying process.

Phasing is not a formidable process, however, and involves nothing more than reversing the connections to one loudspeaker. Play a pre-recorded stereo tape with plenty of bass, or make a stereo recording with some deep sounds, preferably the latter. Whilst the tape is playing, listen and note the strength of the bass. Now reverse the connections to one of the loudspeakers and replay the tape. **If the bass response has DECREASED, the phase was CORRECT.** Restore the connections to the

● Fig. 1. The 'Acostereo' microphone which has aligned elements for direct stereo recording.

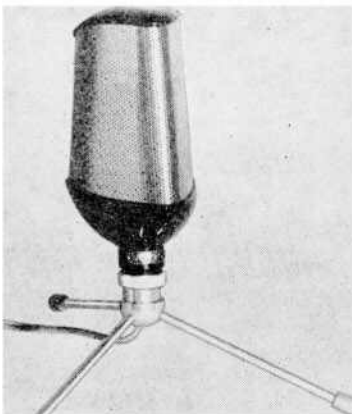

Fig. 2.

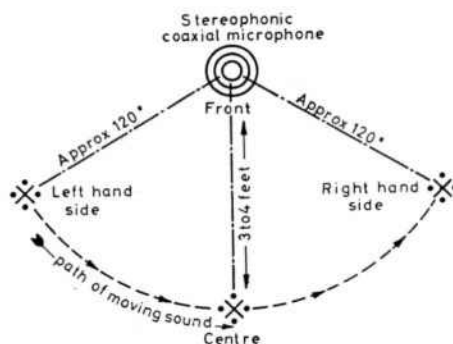

Fig. 2. The approximate path over which 'moving' sound tests may be made to determine directivity and balance. Fixed position tests should be made from the point marked 'X'

Fig. 3.



Fig. 3. Wharfedale loudspeakers set cornerwise for optimum spatial effect. ●

continued — Stereophonic Sound

loudspeaker. If the bass response INCREASED, the phase was INCORRECT. Leave the connections reversed.

BALANCE AND DIRECTIVITY

Inaccurate balance between channels will cause sounds which should be in the centre, to shift to one side or the other. A stereo tape recorder does, or should, have provision for balancing the gain of the two replay channels, and all stereo Hi-Fi amplifiers have this facility as well. Of course, many stereo tape recorders have separate controls for each record and playback channel, so that balance will have to be determined for both.

The most simple way of testing for balance and directivity is to make recordings of sharp transient sounds, such as those produced by a metronome or by tapping a glass bottle with a pencil. Set up the microphone in the centre of the room and produce the clicking or tapping whilst walking slowly from left to right (or vice versa) across the front of the microphone, as shown in Fig. 2. If the overall balance and the speaker phasing is accurate, the 'moving' sound should be 'mirrored' by the loudspeakers. Tests for extreme right hand, centre and left hand positions should also be made, and again the loudspeakers should mirror these positions on playback.

If directivity is blurred, i.e., the sounds appear to have no definite direction, the phasing of the loudspeakers may be wrong. If the sounds are all concentrated to one side or the other, then the balance requires adjustment. Another enlightening test is that of recording the voices of people arranged around the microphone, one to the right, one at the centre and one to the left. The voices should occupy the same position during replay.

LISTENING AREA

The distance between the two loudspeakers determines the overall spatial effect, and the closer the speakers the smaller the 'width' of the sound as a whole. Tape recorders with separate built-in loudspeakers, one for each channel, cannot provide adequate stereo width. The optimum distance between loudspeakers for a reasonably effective spatial effect is about 8 feet to 10 feet, which may be increased up to 12 feet to 15 feet with advantage (see Fig. 3). Distances greater than this give rise to ambiguous spaciousness, unless the phasing and balance of the whole system is very accurate and high-power output is being used.

The angle at which the speakers face the audience is not critical. A slight inward angle is sometimes advantageous to offset reflection from the walls, etc., which can also cause directional confusion. The best stereo effect is usually obtained at the apex of a triangle, with sides of equal length, formed by the listener and the two loudspeakers, as in Fig. 4.

STEREO CAN BE GREAT FUN

The effect of moving sound is very pronounced in stereo reproduction, more so than under natural conditions. For instance, the sound of a moving train is one we accept and regard as nothing unusual. When the same sound is reproduced indoors, over loudspeakers from a stereo recording, the effect is unnatural, and therefore startling. Well, you can try all kinds of 'moving' sounds on your friends — the lawnmower, footsteps, passing cars, etc. — and you will find that recordings made with the microphone outdoors provide better stereo and movement, etc., than those made indoors, where room reflection can mar the full effect. Moving sound is, of course, only a novelty; stereo was designed to provide spatial, and therefore much more lifelike, reproduction of music than could ever be obtained from a single-channel reproducing system with one loudspeaker.

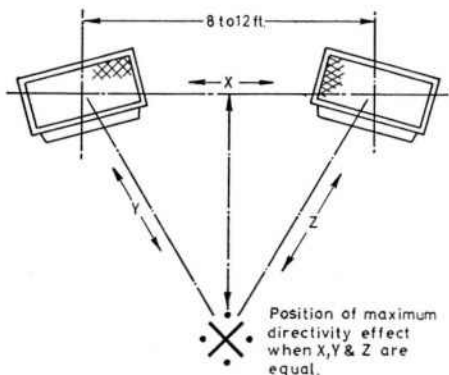

Fig. 4. The optimum listening position for stereo reproduction over two loudspeakers is at the apex of a triangle formed by X Y and Z when both Y and Z equals X.

LOOK OUT FOR THESE INTERESTING FEATURES NEXT MONTH:

Sleep learning with a tape recorder

New techniques with Electronic Sound

Also next month — another of our free 16-page pull-out booklets!



TAPE RECORDER COVERS

Smart, waterproof cover to give complete protection to your tape recorder. Made from rubberised canvas in navy, wine, tan, grey and bottle green with white contrasting pipings, reinforced base, handy zip microphone pocket and name panel.

GRUNDIG TK 1 with pocket	49/6
GRUNDIG TK 5 with pocket	55/-
GRUNDIG TK 8 with pocket	63/-
GRUNDIG TK 14, 23 & 18 ...	59/6
GRUNDIG TK 20 with pocket	52/6
GRUNDIG TK 24 with pocket	55/-
GRUNDIG TK 25 with pocket	55/-
GRUNDIG TK 30 with pocket	60/-
GRUNDIG TK 35 with pocket	63/-
GRUNDIG TK 40 & 41 ...	66/-
GRUNDIG TK 46 with pocket ...	82/-
GRUNDIG TK 60 no pocket	75/-
TELEFUNKEN 85 with pocket	65/-
TELEFUNKEN 75/15 & 76K with pocket ...	55/-
TELEFUNKEN 95 & 96 with pocket ...	69/6
PHILIPS 8108 with pocket	57/6
PHILIPS EL3534 with pocket	87/-
PHILIPS EL3549 with pocket	79/6
PHILIPS EL3538 with pocket	63/-
PHILIPS EL3542 with pocket	63/-
PHILIPS EL3536 with pocket	70/-
PHILIPS EL3515 with pocket	57/6
PHILIPS EL3541/15 with pocket	57/6
PHILIPS 3541H
PHILIPS STARMAKER ...	66/-
COSSOR 1605 with pocket	84/-
COSSOR 1602 with pocket	57/6
COSSOR 1601 with pocket	63/-
STELLA ST455 with pocket	63/-
STELLA ST454 with pocket	57/6
STELLA 459 with pocket	84/-
STUZZI TRICORDER with pocket	58/-
SABA with pocket	63 -
WYNDSOR VICTOR no pocket	60/-
ELIZABETHAN MAJOR with pocket ...	63/-
ELIZABETHAN FT1 with pocket	66/-
ELIZABETHAN TT3 with pocket	75/-
ELIZABETHAN LZ 29 ...	75/-
FI-CORD IA ...	52/6
FIDELITY ARGYLL no pocket	55/-
CLARION (complete with strap)	52/6
BRENELL MK. 5 with pocket	77/-
BRENELL 3 STAR with pocket	69/-
ROBUK RK3 ...	67/6
SONY 521 ...	90/-
FERROGRAPH ...	80/-
REVEX ...	84/-
OPTACORD 412 & 414

CALL, SEND MONEY OR REQUEST C.O.D. WITH YOUR ORDER TO:-

A. BROWN & SONS LTD

24-28 George St., Hull, Tel. 25412/3

CHRISTMAS!



GIVE
Scotch
MAGNETIC TAPE
IN THIS **GAY** WRAPPER

Scotch Magnetic Tape is the perfect present for anyone who owns a tape recorder. And all the 5", 5 $\frac{3}{4}$ " and 7" boxes are packed in colourful seasonal wrappings. **New lower prices, too!**

3M MINNESOTA MINING AND
MANUFACTURING CO., LTD.
3M HOUSE · WIGMORE · STREET · LONDON W1

**SPOKEN CHRISTMAS "CARDS"
FOR FARAWAY FRIENDS**

Why not send truly personal greetings to faraway friends on a Scotch 'One Five Special'? Inexpensive, at only 5/3 per reel. Runs 15 mins. at 3 $\frac{1}{2}$ i.p.s. Packed in a box designed to be sent through the post.





GO
FOR ANY
SOUND
KEEP IT
SAFE
ON



PHILIPS TAPE

GREEN
for standard
RED
for longplay
BLUE
for doubleplay
GREY
for tripleplay

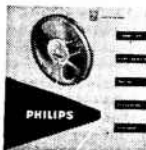

Capture a sound on Philips Tape and it's yours for ever—yours to play back and enjoy whenever you like. Available in all current reel sizes of standard, longplay, doubleplay and tripleplay, Philips Tape gives you all these advantages: great sensitivity, wide frequency range, low noise level, high resistance to stretching or breakage, powerful adhesion of the magnetic coating. And of course, they're colour-packed for easy identification. Whatever tape recorder you own, get the best out of it—with Philips Tape.

FINE PRODUCTS FROM PHILIPS—THE FRIEND OF THE FAMILY

PHILIPS ELECTRICAL LTD., ELECTRO-ACOUSTICS DIVISION, CENTURY HOUSE, SHAFTESBURY AVENUE, LONDON WC2 (PTA4314)

DESIGN for a DEN

. . . So you want to make yourself a den and don't know quite where to start. Like many recording enthusiasts, you have probably collected quite a few pieces of equipment but can't think where to store them, either in or out of use. Not many people are lucky enough to be able to monopolise a whole room, either because their equipment doesn't justify it or because there simply isn't room to spare. So here are three enthusiasts' designs for a den.

MR. B. Whibley, of Gravesend, Kent, is one designer. The photograph — right — is, he says, 'not of my recording den, but our lounge' at **85 Hillside Avenue**. Mrs. Whibley put up with three months of construction chaos while her husband built this console in the window bay. The completed unit now holds (left to right) a Ferrograph 4AN, Collaro 4 TR 200, BJ arm, Super 90 Decca Deram stereo cartridge and Pye stereo amp; two Collaro Studio tape decks, a Linear LT45X recording amp, and a Wal-Gain for playback only from third deck; two ATR mixer units, a Jason Mercury II tuner, Reslo ribbon mic, and various other mics, including some crystal. Speakers for stereo and Hi-Fi listening include two Wharfedale Bronze 10-inch, two Goodmans 8" x 6" elliptical, and four Lorenz tweeters; and finally there is a 78 r.p.m.-only player, and Imperial radio chassis for A.M. short waves, etc. — the whole lot being coupled to a switch-panel for recording in any order! And the use to which this is all put? Mr. Whibley's chief interests are musique concrete and all main scientific advancements and historical events today.



ANOTHER enthusiast who has made use of part of a living room is **George Hills, of Aldern Bridge House, Newbury, Berkshire**. Unlike Mr. Whibley, however, George needs his equipment to be readily movable, as his main interest lies in outdoor recording, particularly country sounds of birds and insects. His equipment consists of a pair of Thoresby bass reflex corner consoles, fitted with Stentorian 10" 1012's and T 359 tweeters (only one of which is shown in his photograph, left), a Grundig TK 1, a Collaro tape transcriber Mk. III (three-speed) and a Sony 2- and 4-track stereo machine. George uses two mics — a crystal Acos and a Sony dynamic, and also has a Magnavox stereo record player, Imperial deck, diamond stylus. The lower record player is a Garrard, model SRP 10, and George himself plays the harmonica and accordion, which he records frequently. He is also a keen tape-spender, with contacts in this country and in America, Germany and Arabia.

MORE fortunate, in that he has a small room to himself, is **Peter Bastin, of 2 Canynge Street, Barbourne, Worcester**. His 7' x 5' den has been built in a link unit between his bungalow and the garage, and is thus fairly well isolated from general household noises. Peter has also lined the ceiling with acoustic PVC tiles and hopes to extend the heavy curtaining to the floor to reduce reverberation. The photograph shows his Brenell and Simon recorders, flanking a Philips record deck. The nine-channel control panel now also incorporates transistorised mixing units, and suspended, out of sight, above is a 10" reflex cabinet speaker. Also out of this photo are a Philips battery portable, records, tapes, catalogues, script board, Grampian DP 4, Cadenza ribbon and other mics, together with de-magnetizer, splicing kit, loops, spare reels, indexes, and 2,173 plugs, knobs, screws and bits!

Peter has obviously gone out of his way to make his den pretty well soundproof, but not everyone can, or even wants to, set up a den this way. How have you solved the problem of storing and setting up equipment into some sort of den? Send us a photograph, with negatives if possible, and describe your den and equipment and what it is used for. Like Mr. Whibley, Mr. Hills and Mr. Bastin, who may win yourself a guinea!

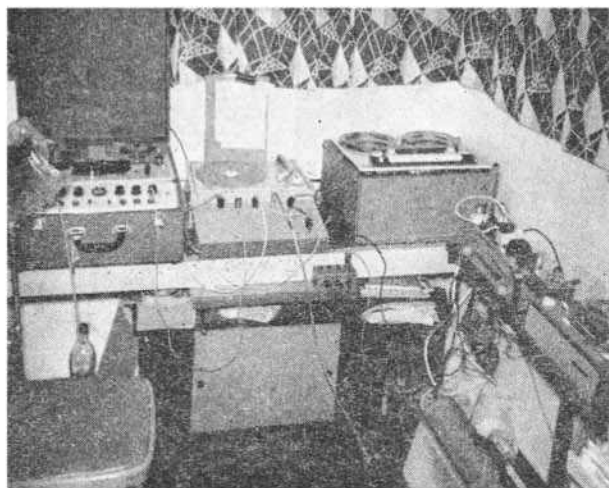



This beats everything !

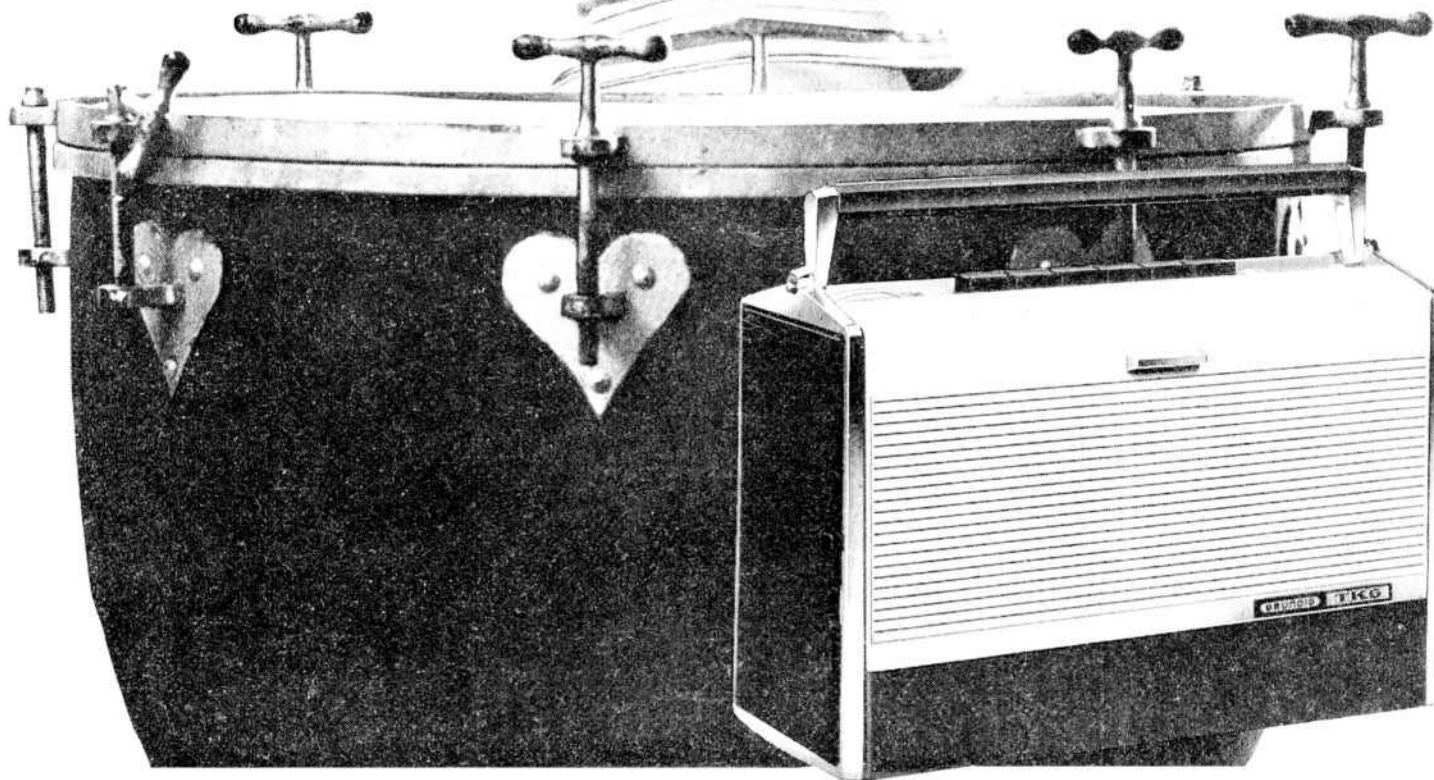

THE SUPERLATIVE **TK6**

A new-era Grundig. No machine like it anywhere. Mains-operated transistorised portable tape recorder. Own built-in battery or car battery operated. Next-century design. Concert hall quality. Two speeds. Four hours play-back. Ask your Grundig Dealer for a demonstration of this brilliant new model. 65 gns. including microphone and triple play tape.

SPECIFICATION

- Speeds $3\frac{1}{2}$ and $1\frac{1}{2}$ i.p.s. • Frequency Response up to 13,000 c/s • 13 Transistors and Diodes
- Revolutionary HF controlled and transistor stabilised motor • Recording Level Meter—Battery indicator
- Tape Canister • Fast forward, rewind, stop, start, temporary stop and recording by press buttons
- Highly sensitive dynamic moving coil microphone • 1,200 feet of triple play tape supplied
- Auto adaptor available • Extra large loudspeaker • Dimensions $12\frac{1}{2}$ " x $5\frac{1}{2}$ " x $9\frac{1}{2}$ " • Separate bass and treble controls.



GRUNDIG (Great Britain) LIMITED

Newlands Park, Sydenham, London S.E.26 SYD 2211

Please send me the exciting TK6 leaflet

NAME

ADDRESS

ATR/10

LOTS OF

Val Parker on his
Tape Parade

VARIETY—BUT OH, WHAT A

WASTE OF TAPE!

The next batch of tapes is now in hand and you just couldn't have a more mixed bag. Its range covers Acker Bilk to the Cantata Choir. We have variety, too, in the recording and quality of these tapes. I find too many of them have a hesitant start and, as they have no leader tape, you wonder if you are damaging the recording handling the tape. By the time the actual recording is finished you are left with an appreciable amount of tape unused. I realise the difficulties of fitting a set piece of music into so many feet of tape but surely it is unfair to the listener who is paying for so many wasted feet.

- **PRAISE MY SOUL . . . The Cantata Choir of St. Martin-in-the-Fields. Saga STG 8099.** ½ track, mono, 3¼ i.p.s. 32/6d.

Technically I thought this tape excellent. It begins with a particularly beautiful rendering of 'Holy, Holy, Holy,' and includes many well-loved hymn tunes including 'Love Divine, All Loves Excelling', 'Lead Us, Heavenly Father' and what I thought was the most moving performance, 'All People That On Earth Do Dwell'.

This was the conclusion of track 1 and after seven competently sung hymns with delightful descants I wondered if the tape could hold my interest during track 2. Then the choir sang the 'Old Hundredth' and here we had light and shade, feeling and emotion which had been sometimes missing before. The tape became a live choir to me, not just a background of well-known church music, but people singing with all their hearts about something that for them held some meaning. Track 2 did not sustain the promise of great choir singing but again it was efficiently performed and efficiently recorded. Jean Trevelyan was at the organ and Edgar Riches, Kevin Hegarty, and Michael Hinton played the trumpets. The conductor was John Churchill.

- **CONTINENTAL HOLIDAY . . . with Pepe de Santa Cruz and his players. Recotape.**

I have just enjoyed a holiday in Spain, soaking up sunshine, and I regarded this particular tape with anticipation. To me, it did not quite succeed in conjuring up warm, balmy nights listening to guitars and flamenco dancing by languid, happy, romantic Spanish artistes.

But if you are still in a holiday mood, this is a pleasant way of reviving the rhythms of Spanish music. May I also ask you to notice the brilliant pianist who, in my opinion, transforms the whole recording into a professional job. He is Tobias Valido and was a student at the Conservatoire of Lisbon.

- **CALL ME MISTER . . . Mr. Acker Bilk and his Paramount Jazz Band. Columbia PA 33SX.** ½ track, mono, 3¼ i.p.s. 35/-.

This is an excellent recording of a universally loved band. What can one say about Acker Bilk that has not already been said? But I can say 'Thank you, MISTER Bilk'. This tape includes many old favourites, some of those with vocals by Acker or Ron McKay. They are the best of their kind. As I cannot go on at great length talking only in superlatives let me list Acker's equally good associates in the band: Mr. Colin Smith (tpt), Mr. John Mortimer (trom), Mr. Stan Greig (piano), Mr. Ron McKay (drums), Mr. Ernie Price (bass) and Mr. Roy James (banjo). Thank you Acker, you are no stranger on my shore!



- The celebrated musician, Acker Bilk, out with a fine tape of purely traditional jazz.



- Not a tape — but a choir! The excellent recording transformed this tape into a stirring concert.



- An appealing tape for those who wish to capture the warmth of Spain while by their own fireside!



"Lawrence of Arabia" recorded on Zonastripe and Zonafilm magnetic tracks awarded 'Oscar' for Best Sound 1963.

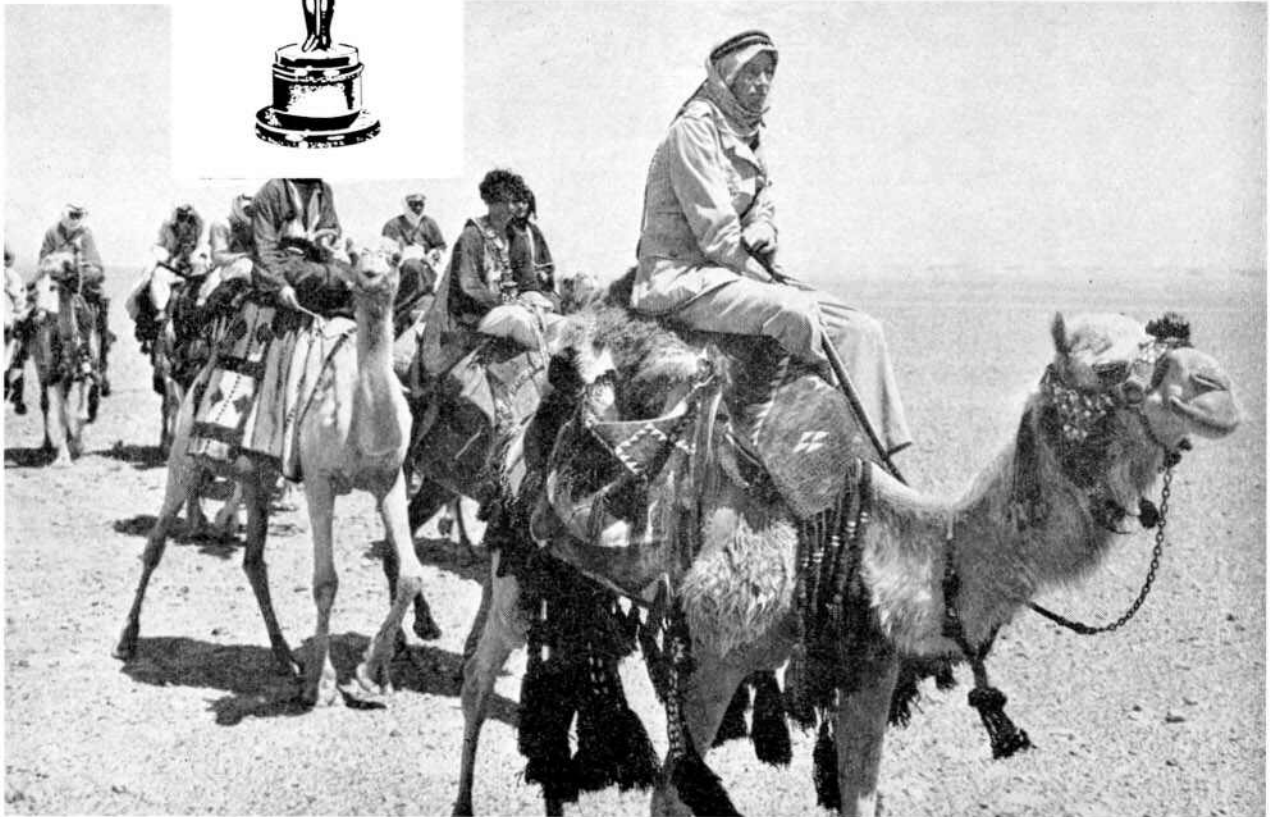

THE TAPE WITH THE OSCAR-WINNING RECORDING QUALITY

Zonatape is available in four grades and four spool sizes. Each is colour coded as follows :

- Clear Spool: **Diacetate Standard Play.**
- Red Spool: **PVC Standard Play.**
- Green Spool: **Polyester Extra Play.**
- Blue Spool: **Polyester Double Play.**

A full range of Zonatape recording accessories includes, printed leader and timing tapes supplied in 5 colours, splicing tapes and metal stop foil.

These professional quality tapes are obtainable from good class dealers but in case of difficulty send to us for name and address of nearest Zonatape stockist.



ZONAL FILM (MAGNETIC COATINGS) LTD, ZONAL HOUSE, WESTFIELDS RD, W.3. ACORN 6841.



**Stand by
for something
special
from
TRUVOX**

*see
next
month's
issue*



introducing the **TRUVOX 90**

A NEW THOROUGHbred SERIES FROM A FAMOUS BRITISH MARQUE

Clinically professional in every line. Crisply precise in operation. Full and faithful in reproducing sound . . . this sums up the new Series 90—the finest yet from Truvox.

No concessions here to mass-market "styling". No fancy plastic moulding; no pretty-pretty cover fabrics. No "cosmetics" at all. Instead—clean, rugged and functionally austere, the new Truvox looks every inch what it is . . . a thoroughbred instrument for the enthusiast.

For the man who wants a *real* tape recorder; not a gilded toy on the one hand, nor a status symbol on the other.

Among the outstanding features of the Series 90 are:

- * "Piano Key" operation.
- * A cathode follower output.
- * Recording level meter.
- * Positive lock reel carriers.
- * 4 digit counter— instant reset button.
- * Hinged editing panel.
- * 'No-tape' autostop.
- * Mixing facilities.
- * Superimposition.
- * Forward facing Rola-Celestion loudspeaker.
- * 3 tape speeds— $7\frac{1}{2}$ $3\frac{3}{4}$ $1\frac{7}{8}$ ips.
- * 3 motor drive— Papst capstan motor.



**PD.93 2-track mono tape unit.
PD.95 4-track mono tape unit.
Each 59 gns. (U.K. only)**



**PD.97 2-track stereo tape unit.
PD.99 4-track stereo tape unit.
Each 79 gns. (U.K. only).**

These handsome self powered tape units, in superb Afrormosia plinths, polyester finished, provide an ideal means of adding tape to the existing Hi-Fidelity system at a very economical price. They can be used with any amplifier at present available and be operated horizontally, vertically or any angle between.

To enable purchasers to make their own personal choice of microphone and tape, we do not supply these items with any tape unit.

CALLING ALL CLUBS!

What Do You Do With Your Time?

How many tape clubs are there in this country? Do you know? We don't either, although our records show vague references to about 200. In fact there are probably many more.

What do all these clubs do with their time and equipment? Through this club news page we try to keep you all informed of each other's activities, but we can't do this as well as we'd like if you don't keep us informed.

At present we have 50 clubs in our league tables, some of whom have contributed only once. We want every club to contribute every month. Not just who said what at the AGM, but a lively, readable report on events and ideas that will be of interest to other clubs. Copies of any written bulletins you may produce, press cuttings and clear photographs are always acceptable. Each month we select the best dozen or so to print, and of these the best ten get points ranging from 10 down to 1. These are the points that, together with competition points, etc., add up to the League Table. So if you'd like to see our Challenge Cup adorning your clubrooms, just make sure that your bulletins reach us by about the 6th or 7th of every month. And we think you'll find that keen competition in this respect sharpens club interest in other fields.

- Young and old alike were fascinated by the displays and discussions given by Southall Tape Recording Society at their local Carnival Show.



CLUB OF THE MONTH

Now for this month's news, and as you may have guessed from the photograph below, our Club of the Month for November is **Southall Tape Recording Society**. We selected this photo from nine they sent us along with plenty of news and lively comment. Their main activity was centred around the Southall Show and Carnival where the club put on a prominent display of recorders and equipment. Naturally they also made recordings for themselves at the show and the photograph shows in the background a boom mic eavesdropping on a keen discussion. Public curiosity was roused by a "hear yourself" feature, and a good turnout of members was on hand to answer questions and generally advise members of the public who showed a surprising degree of interest. Other club members had the job of recording sound FX for the soundtrack of a colour film which was made of the carnival procession. Altogether a much bigger success than even the most optimistic club member hoped for, and discussions are already afoot for the preparation of an even bigger show next year!

DISASTER!

Members of **Rugby Tape Recording Club** will be out in force at the premiere of the new film, 'Disaster', which they helped produce. President Bob Pick being the most active. The film shows an alleged rail accident in the area and depicts the work of doctors, police, hospitals and voluntary workers in coping with the disaster. It is hoped that the film will be shown throughout the country in conjunction with a 'Save a Life' scheme. A very worthwhile project showing a great team spirit we like to see in all your activities.

RIDING THE MARCHES

Another demonstration of team spirit was given by **Ayr Tape Recording Club** recently when they visited Sanquhar to record the 'Riding of the Marches' ceremony. Bedraggled members worked together in the drizzling rain to record the Swearing-in of the Cornet and his Lass and the Ensign in front of the Old Council House, before proceeding to Lochside Farm to witness the drinking of the Stirrup Cup. At this stage strong backs were called upon to push the recording van out of the mud in time to record the crowning of the Sanquhar Queen and the carnival procession through the town.

CALLING ALL CLUBS!

INTER-CLUB INVITATIONS

North London Tape Recording Club has been very busy presenting well organised club evenings with competitions, sound hunts and of course the **ATR Club Recording** contest. (Note — full results and reports in next month's *A.T.R.*) North London also entertained **Bethnal Green Tape Recording Society** when the two clubs completed in a quiz on TR.

Bethnal Green modestly maintain that their win was due to the luck of the draw, just as they modestly claim that a hilarious evening at the 'Festival of Lanterns' gave campers 'a little pleasure'. The club was originally approached by the Camping Club of Great Britain to record the opening music for the festival and ended up producing a whole show for campers to mime to!

Busy Bethnal Green also found time to send their outside recording expert to assist at the **New Circle Tape Recording Club's** recording session with the Michael Ronga Trio and their fretted instruments. As a result the fourteen New Circle members who went along managed to make excellent recordings of some very delightful music. New Circle has also spent a number of evenings discussing sound FX with technical adviser Mr. J. Burchell. As these inter-club invitations have proved both enjoyable and successful, this seems an idea which other clubs might take up if they haven't already done so.

SOUND SCOOP

Hazells Club Tape Recording Section at Aylesbury scored such a success with their documentary on the local fire service that they decided to follow-up with one on the local police. The Chief Constable of Bucks. not only gave the project his blessing but also arranged for a script to be produced by one of his sergeants and a recording of himself to be used as a foreword. The club was even allowed the use of an off-duty patrol car and a police dog for a chase after a fictitious robber, the two villains being played by club members. As everybody knows, the Bucks' police are now rather more occupied with a somewhat less fictitious robbery to the tune of £2½ million. It seems that Hazells got there just in time!

WALTHAMSTOW AT WAR

Walthamstow and District T.R.S. have recently been at war, sound FX wise, while working on the local Red Cross Centenary Pageant. The pageant is to depict the work of the Red Cross since its inception in 1863, and a special script for the story was read by Michael Flanders (of Flanders and Swann — At The Drop of A Hat). The story called for a large number of sound effects, especially for the section dealing with the war years, and trumpets, drums, gunfire, air raids and other warrior noises have been compiled, with a commentary, into an historical sequence. The pageant will also be taped by the club, and an edited disc will be sent to all the countries in which the Red Cross operates.

REQUEST ROSTER

Thornton Heath Club have now got their two hospital request programmes extremely well organised, in spite of the detailed work involved. Apart from the two separate and complete production teams, a roster has to be made for announcers, compères, disc jockeys, etc., and Thornton Heath have now reached the stage where the programmes and personnel are arranged one year in advance. Some organising! The club has also been active in the field of outdoor recording, competitions, **ATR's** one included of course, and a hilarious evening when members were asked to sit in front of the mic and tell a one-minute section of a story to follow on from the previous narrator. It seems that Spike Milligan couldn't have done better!

CINE AND TAPESPONDENCE

A new club with a difference is starting up with its H.Q. in Northampton. Mr. K. Smith, who maintains that tape and cine go together like knife and fork, extends an open invitation to anyone interested in either, or both, of these hobbies. Those who already have tape recorders will, however, be given preference, and membership fee will be 5/- for three months. Anyone interested can get more details from Mr. Smith at 75 Cranford Road, Kingsthorpe, Northampton.

THE LEAGUE TABLE

	Pts.
1. BRIXTON	46
2. THORNTON HEATH	34
2. WALTHAMSTOW	34
4. NORTHAMPTON	30
4. RUGBY	30
6. N. LONDON	28
6. SOUTHALL	28
8. HULL	26
9. BETHNAL GREEN	24
9. BOSTON	24
11. SOLENT	23
12. HUDDERSFIELD	16
13. MIDDLETON	15
14. S. BIRMINGHAM	14
15. LEICESTER	13
15. SOUTH REACH C.Y.C.	13
15. VALENCE	13
18. READING	12
19. AYLESBURY	10
19. COVENTRY	10
21. HAZELLS	9
21. MEDWAY	9
23. BARNSELY	8
23. WOOLWICH	8
25. BROMLEY	7
25. GREAT YARMOUTH	7
25. ST. HELEN'S	7
25. YORK	7
29. SWANSEA	6
29. W. OF SCOTLAND	6
31. CRAWLEY	5
31. NEW CIRCLE	5
31. WARWICK	5
34. WHITSTABLE	4
35. CARDIFF	3
35. GLASGOW	3
35. ILFORD	3
35. ROMFORD	3
35. S.C.F.I.	3
40. AYR	2
40. BIRMINGHAM	2
40. BRITWELL	2
40. LEEDS	2
40. NORWICH	2
40. O'SEAS STUDENTS	2
40. STAMFORD SCHOOL	2
47. BRIGHTON	1
47. CINE & TAPESPOND	1
47. DARTFORD	1
47. HELSBY	1
47. S. DEVON	1

... IN BRIEF

● **Woolwich & District T.R.C.** now meet weekly at New Eltham Public Library on Thursdays at 7.30. New members always welcome.

● **South Reach C.B.C.** has now changed its name to **South Reach County Youth Centre** to cater for young members of the fair sex. The T.R. Group now meets on alternate Tuesdays at the Centre at 7.30. Further information from Erith 37299, 7-10 p.m. any weekday.

● **N.B.**—Please could all Club Secretaries furnish up-to-date information on club membership, meeting places and times, committees and equipment to the Club News Editor at ATR so that we can bring our club files up to date.

TOP TEN CLUBS FOR NOVEMBER

- | | |
|------------------|--------------------------|
| 1. SOUTHALL | 6. NORTH LONDON |
| 2. HAZELLS | 7. NEW CIRCLE |
| 3. RUGBY | 8. THORNTON HEATH |
| 4. WALTHAMSTOW | 9. AYR |
| 5. BETHNAL GREEN | 10. CINE & TAPESPONDENCE |

METRO SOUND TAPE RECORDER ACCESSORIES

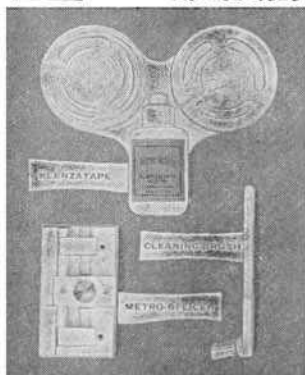

tape accessories set

Tape Accessory sets carded as shown and containing Klenszatape, Metro-Splicer, Metro-Brush, 27/6 each

- KLENSZATAPE** Price per Kit 12/6. Refill fluids 3/11 per bottle.
- METRO-SPLICER** Splicer Kit complete with Film Emulsion Scraper and Spare Cutting Unit — 12/6d. Spare Scrapers 1/3 each. Spare Cutting Units 2/6 each.
- METRO-TABS** 3/11 per set complete with Index.
- METRO-BRUSH** 2/6 each.
- METRO-STOP** 17/6 per set.



METRO-SOUND MFG. CO. LTD.,
19a Buckingham Road, London, N.1.
Telephone CLIssold 8506.

THE HI-FI & TAPE RECORDER SPECIALISTS

MASSEYS CENTRE OF SOUND

Ferrograph Appointed Dealer
SALES AND SERVICE

Equipment to suit All Tastes—Accessories—Repairs
Discs—Pre-Recorded Tapes Mono/Stereo

CHISWICK 121—123 HIGH RD.
W.4. Tel. CH1. 2082.

Daily 10 a.m.—7 p.m. Early Closing Thursday.
(Not closed for lunch)

SHEEN

TAPE RECORDER AND HI-FI CENTRE

Specialists in Tape Recorders—Accessories—Hi-Fi—Stereo

Your Centre for Friendly Help—Sales—Service

B.R.C. Approved Dealer for all Models and Repairs

Pre-recorded Tapes, Mics., Tuners, Amplifiers, Speakers Etc.

Details—With Pleasure—Call—Phone—Write

8 Station Parade

Sheen Lane

Sheen, London, S.W.14 Showrooms: PROspect 0985
(Opposite Mortlake Station S.R.)

Open 10 a.m. until 7 p.m.

Early Closing, Wed., 1 p.m.

New Bigger Showrooms Mean an even Wider Choice from the Mail Order Service run by TAPE SPECIALISTS FOR TAPE ENTHUSIASTS!

A friendly welcome awaits you at our bright new showroom extension. Here you will find a lavish array of equipment at every price level... make your choice for immediate delivery or if you cannot visit us the fast and friendly R.E.W. Mail Order Service makes it easy for you to enjoy the professional results only possible with an advanced Tape Recorder. Get in touch with us now. We have thousands of satisfied customers and a reputation for generous part exchange, reliability and specialist service.

MACHINE OF THE MONTH

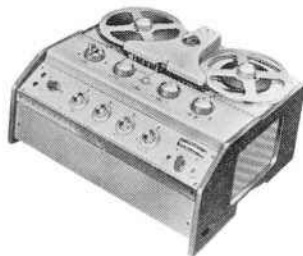

PAMPHONIC REFLECTOGRAPH Type A — 105 gns.

A new machine with a redesigned amplifier giving improved frequency response at all speeds on both record and playback.

2 Speeds: 3 $\frac{1}{2}$, 7 $\frac{1}{2}$ l.p.s. Separate playback amplifier.

V.U.M. Meter. Semi-prof.

No Interest Terms: £11-5-0 deposit and 12 monthly payments of £8-5. Also available on H.P. Terms — 18-24 months to pay.

BARGAIN BASEMENT!

An unrivalled stock of leading makes of new and used machines at unbeatable bargain prices — 30% — 60% reductions on original prices! Make a point of asking for our Special Bargain List.

* CASH FOR YOUR TAPE RECORDER or HI-FI

Highest cash offers for good equipment... get in touch today!

300 MACHINES ON DISPLAY

Call, See, Hear and choose the Tape Recorder you have always wanted from one of the biggest ranges anywhere. Just about every model — for off-the-shelf delivery — including Ferrograph 5AN, 85 gns, Brenell Mk. 5/2, 69 gns, Brenell Mk. V "M", 88 gns, Grundig TK46 99 gns, and hundreds of others.

You're guaranteed maximum satisfaction with the

R.E.W.
"PLUS FIVE" SERVICE

- Generous part exchange allowances.
- No interest terms — lowest deposits.
- Off-the-shelf delivery from the biggest range under one roof.
- Free servicing and free delivery.
- Optional personal insurance.

NO INTEREST TERMS!

Take your pick from our wide range and have any machine you want for 10% deposit, balance twelve months — and no interest charged. (18-24 months H.P. terms also available).

Home demonstrations in the London area gladly arranged. By return enquiry service. Agents for all makes.



R.E.W.

(EARLSFIELD) LTD.

Mail Order Department

266/268 (ATR) Upper Tooting

Road, London, S.W.17.

Telephone: BALham 1710

S S O O U U N N D D

Reviewing the Brenell Mk. 5 Series 2 Tape Deck and the A.K.G. D.77A Stereo Microphone

By
F.C. Judd, A.Inst.E.

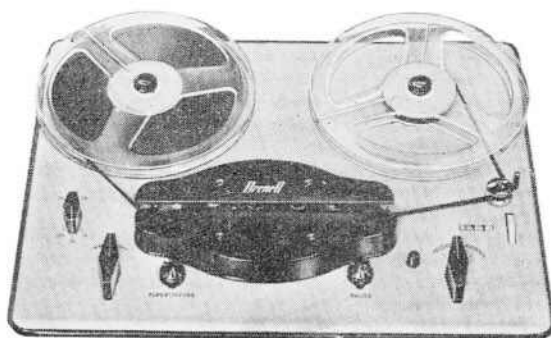

● *The Brenell Mk. 5 Series 2 Tape Deck.*

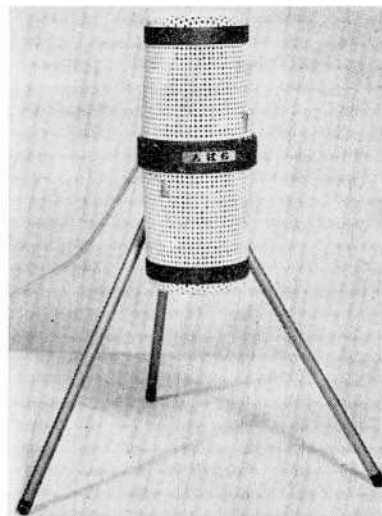

The A.K.G. D.77A Stereo Microphone ●

THE Brenell Mk. 5 Series 2 tape deck is one of the few high class British made decks at present available. It is exactly the same deck as fitted to the Brenell Mk. 5 Series 2 Tape Recorders and providing it is used with well designed recording and replay amplifiers will give an excellent performance.

It is available with various head combinations which do, of course, modify the basic price of 31 guineas. For instance, without heads the deck retails at 27 guineas. With half track stereo erase and record heads the price is 41 guineas. (Further information regarding head combinations and prices can be obtained from the makers.)

The deck submitted for review was fitted with one $\frac{1}{2}$ -track erase head and one $\frac{1}{2}$ -track record head and these are included as standard for the retail price of 31 guineas. There is space for an extra replay head for monitoring, etc., or a combination of two erase and two record heads for staggered twin track recording can be accommodated. The deck therefore, lends itself for a variety of erase/record/playback arrangements.

The Mk. 5 also features an interlocking switch system to prevent accidental erasure and the rewind and record/playback switches are fitted with extended shafts. These enable the user to add extra switch wafers for individual requirements. Other facilities are a pause control, a four figure tape position indicator, removable head covers, speed control switch and a super-imposing button. With the extra capstan sleeve provided the deck will actually operate on four different speeds, namely $1\frac{1}{2}$, $3\frac{1}{2}$, $7\frac{1}{2}$ and 15 i.p.s.

The maximum spool size is $8\frac{1}{4}$ " diameter but I am bound to mention here that a specially modified version of this deck called the Mk. 510 Series 2 is available for an extra 12 guineas. This deck is functionally the same as the Mk. 5 but it will accommodate N.A.B. or standard hub spools up to $10\frac{1}{2}$ " diameter.

PERFORMANCE

The deck sent in for review was tested essentially for mechanical function. The recording/playback performance will depend on the amplifiers, etc., that are coupled to it. However, with suitable circuits such as those issued by the Mullard Research Laboratories or with the Brenell Mk. 5 Series 2 record/replay amplifier, a high standard of electrical performance is possible.

The deck sent for review was subjected to an eight-hour continuous running test and showed no sign of speed variation or overheating at the end of this period. A full spool of tape could be wound and re-wound and stopped anywhere at the high re-wind speed without spilling or snatching.

The Brenell Mk. 5 Series 2 deck is issued with full installation, operating and servicing instructions and is manufactured by The Brenell Engineering Co. Ltd., of 1a Doughty Street, London, W.C.1.

THE D.77A is a new type of microphone which is based on the original A.K.G. D.88. It is a dual microphone instrument which permits co-axial operation of both units over a variable width angle. The two microphones can also be separated for individual mono use or spaced for stereo if

The D.77A has a nominal impedance of 200 ohms and is intended for stereophonic public address systems and stereo tape recording. It has an overall frequency response of 80 to 13,000 c/s., being approximately level between 200 and

The D.77A is supplied complete with 16.5 feet of twin connecting cable and a 5-pin DIN plug. A projection at the rear of the microphone carries a threaded hole for attachment to a stand (The makers can also supply a table stand extra.)

PERFORMANCE TESTS

My tests were concerned mainly with the usual angle of 45° which showed excellent discrimination when used for stereo recording. The microphone has a smooth response and is eminently suitable for music recording.

The D.77A has my personal recommendation and is manufactured by a company who have a name almost second to none for their microphones and headphones. It is distributed in the United Kingdom by Politechna (London) Limited, 3 Percy Street, London, W.1., and retails at £15 10s. 0d. (output impedance 200 ohms) or £17 10s. 0d. complete with matching transformer for 200 ohm to high impedance. The complete specification is given below:—

SPECIFICATION

Frequency Response : 80 - 13,000 c/s.
Sensitivity (open circuit) : 0.18mV/micro-bar.
 (-75dB ref. 1V/dyne/cm²)
Output Impedance : 200 ohms.
Directional characteristic : Crossed cardioids.
Discrimination : Function of unit angle of one microphone to the other.
Dimensions : $5\frac{1}{2}$ " \times $2\frac{1}{4}$ " (without stand).

ELECTRONIC SOUNDS AND MUSIC

Open to all A.T.R. readers is this special effects record of Electronic Music. Space Ship Sounds; sounds for producing your own electronic music; Ring Modulations; White Noise Tones and filtered noises.

ALL FREE COPYRIGHT AND SOUNDS THAT COULD ONLY BE OTHERWISE REPRODUCED IN A FULLY EQUIPPED STUDIO!

Send a 5/- postal order or cheque made payable to "Amateur Tape Recording," also enclosing an unaffixed 6d. stamp for postage, and the coupon below, to:

ATR
DISC No. 6
SEND THIS
COUPON WITH
YOUR ORDER
EFX 1

A.T.R. Dept. 6,
174 Maybank Road,
South Woodford,
London, E.18.

DON'T FORGET YOUR
NAME AND ADDRESS
PLEASE

WAS THIS YOU?

Who sent off for a special effects record and forgot to include your name and address? The following p.o.'s and cheques were received by us without an accompanying address. If yours is one of them please send p.o. counterfoil or cheque signature as proof of identity and state which record you require WITH YOUR ADDRESS, to 174 Maybank Road, South Woodford, E.18.

P.O./ Cheque		P.O./ Cheque	
No.	Postmark	No.	Postmark
088257	Hackney	481682	Brixton
150480	Northants	963595	Stoke
104730	????	791088	Hounslow
989740	Wickam, S.E.2	435439	Dunfermline
894167	Leigh-on-Sea	607636	?? Bucks.
179049	Edgware	061584	Chatteris
711098	Plymouth	850905	Newark

IS HALF YOUR TAPE RECORDER

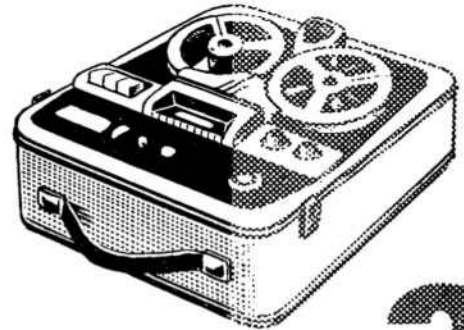

WASTED?

The performance of a portable tape recorder is severely limited by the space available for its internal loudspeaker.

The connection of a high quality external speaker will reveal hidden detail in your recordings, and the Wharfedale PST/8 is an ideal choice.

This unique, patented enclosure design gives optimum results with Wharfedale 8" foam surround units which are available in a range of impedances to suit all machines.

Descriptive literature sent free on request.

WHARFEDALE PST/8

PRICE Cabinet only
£7 10 0 in whitewood
£10 10 0 finished in
walnut, oak or mahogany
veneers.

Recommended units 8" Bronze/FS/AL £4 6 7 inc. P.T.

Super 8/FS/AL £6 19 11 inc. P.T.

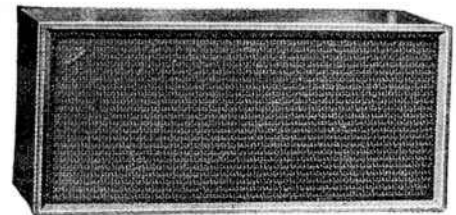

Tel.: Idle 1235/6

Grams:
"Wharfedel" Idle
Bradford

Wharfedale
WIRELESS WORKS LTD
IDLE BRADFORD YORKS

A. LESTER-RANDS tells you all about—

Electronics Without Tears

THE previous articles in this series have dealt with **Resistance, Capacitance, and Inductance**—the three major components used in electronic equipment of all kinds. The valve and transistor are really only aids to generating or amplifying the waveform of a signal which itself can be modified or shaped in various ways by resistance, capacitance and inductance.

The Time Constant

If we apply a D.C. voltage to a capacitor, it will become charged—almost instantaneously—to nearly, but not quite, the same potential as the supply. If we then short circuit the capacitor, i.e., connect its two terminals together, it would be discharged almost instantaneously.

Now when resistance is added to the circuit, as in Fig. 1, the capacitor will take time to charge up, depending on the value of the resistor and the value of the capacitor, and we say that the circuit has a **time constant**. This can be calculated from the simple equation $T=CR$, where T =seconds, C is in Farads, and R is in Ohms. For example, if the values of C and R in Fig. 1 are 1 mFd. and 1 M.ohm, the time for C to become charged will be 1 second, or $(1 \times 10^{-6}) \times (1 \times 10^6)$ (in this case C is in micro-Farads). Note that the equation applies only to the time taken for the charging E.M.F. to reach a little over 60 per cent. of its full value, which covers the most linear part of the charging curve, as shown in Fig. 1.

Now if we discharge a given value of capacitance through a given value of resistance, the equation $T=CR$ can still be used, but must be based on the time taken for the potential to which the capacitor is charged to drop to nearly 40 per cent. of its value. For example, with a capacitor of 4 Mfd. and a resistor of 470 K.ohms, the discharge time would be nearly 2 seconds, or $(4 \times 10^{-6}) \times (0.47 \times 10^6) = 1.88$. This would produce an exponential discharge curve as shown in Fig. 2.

The Time Constant in an Oscillator

If we charged and discharged a simple RC network of this nature continuously, it would produce a repeating waveform as in Fig. 3. This can be done quite easily with the help of valves or transistors. They can be made to operate as high-speed switches by employing a circuit like that shown in Fig. 4. So long as the necessary operating voltages were maintained, the circuit would go on producing a continuous waveform similar to that in Fig. 3.

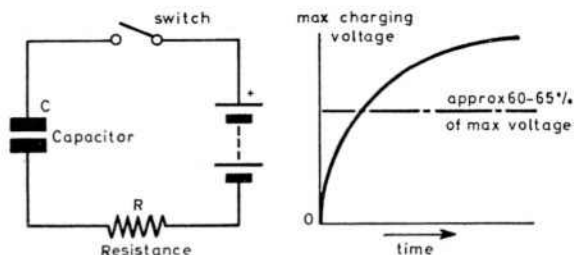
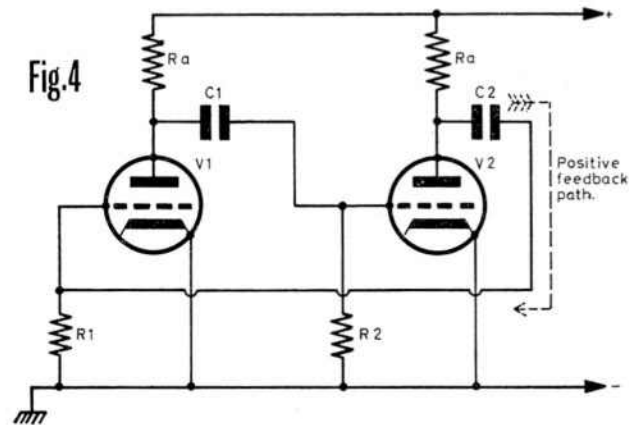

● FIG. 1.—The resistance (R) limits the flow of current and causes the capacitor (C) to charge up slowly.

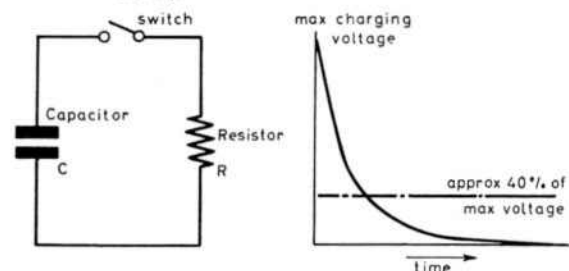

● FIG. 2.—The resistance (R) limits the flow of current and causes the capacitor (C) to discharge slowly.

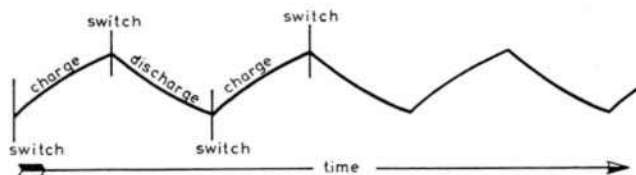

● FIG. 3.—The 'waveform' produced by continuously switching a 'time constant' composed of resistance and capacity.

This circuit is a familiar one in electronics and is called a multi-vibrator. It employs two RC time constants, $C1-R2$ and $C2-R1$, which determine the frequency, or repetition rate, of the waveform, the duration of each cycle of the waveform, and to some extent the 'shape' of the waveform. The capacitor $C2$ also provides what is called a **positive feedback path**, i.e., the signal at the anode of $V2$ is fed back to the grid of $V1$. It is because of this the circuit oscillates continuously; but if $C2$ were removed, the multi-vibrator would become stable and cease to oscillate.

The Time Constant in an Amplifier

The circuit of Fig. 5 is a basic audio amplifier, employing two valves coupled together by $C1$ and $R2$. The time constant formed by these two components must be at least equal to the duration of one cycle of the lowest frequency the amplifier will be required to handle without attenuation.

continued over page

—continued from page 37

● FIG. 5.—A basic audio amplifier circuit. The components C1 and R2 play an important part in the frequency response.

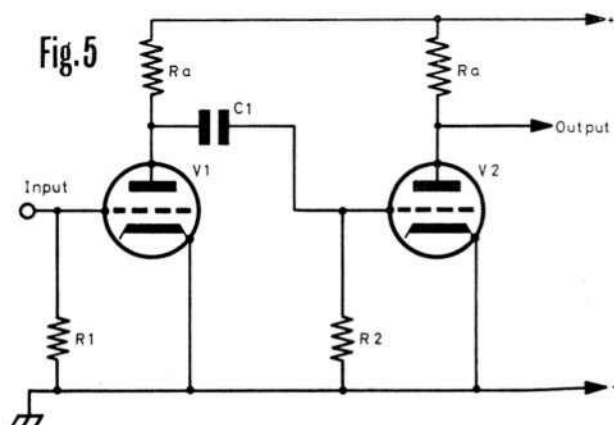

Let's assume this to be 50 c/s., one cycle of which lasts for 1/50th of a second, or 0.02 seconds. In practice, we might choose values of 0.1 mFd. for C1, 470 K.ohms for R2, which provide a time constant of $(0.1 \times 10^{-6}) \times (0.47 \times 10^6)$, or 0.047 seconds (nearly 1/20th second). We could, of course, extend the limit of the low frequency response simply by increasing the value of C1; for example, if this were 0.25 mFd., the time constant, with 470 K.ohms, would be $(0.25 \times 10^{-6}) \times (0.47 \times 10^6)$, or 0.1175 seconds (a little over 1/10th of a second). The low frequency limit would be around 10 c/s.

These examples have been given in the interest of simplicity and do not take into account other components in the circuit, such as the anode load of V1 and the shunt loads provided by the valves themselves.

Next month, I will deal with frequency correction and tone control by means of resistance and capacity. These RC networks play a very important part in tape recorders by providing the necessary recording and replay equalization which must be used to overcome the inherent frequency response losses in tape heads.

THE ATR AUDIO SIGNAL GENERATOR:

Please note: the special dual potentiometer 10K ohms \times 10K ohms Colvern type number 50 – 18/15F is a graded logarithmic type.

When ordering from Colvern Ltd. please quote type 50 – 18/15F graded log.

ELECTRONIC WORLD

is by far the cheapest
HIGH QUALITY TAPE
on the market

- * **Acclaimed by experts**
Reprints of reviews available
- * **Backed by our Guarantee**

If you are not completely satisfied with any purchase, we undertake to refund the full price plus your return postage

POST COUPON NOW!

DE VILLIERS (Electronic World) Ltd.
16c STRUTTON GROUND : LONDON S.W.1

STANDARD PLAY (Acetate Base)

3in.	175ft. 4 for 18/- or 48/- per dozen	<input type="checkbox"/>
4in.	300ft. 4 for 26/-	<input type="checkbox"/>
5in.	600ft. 2 for 26/-	<input type="checkbox"/>
5½in.	850ft. 16/-	<input type="checkbox"/>
7in.	1,200ft. 19/-	<input type="checkbox"/>

ARCHIVISTS GRADE (SP Polyester)

7in.	1,200ft. 22/6	<input type="checkbox"/>
------	---------------	--------------------------

LONG PLAY (Acetate Base)

7in.	1,800ft. 28/-	<input type="checkbox"/>
------	---------------	--------------------------

LONG PLAY (Polyester Base)

3in.	225ft. 4 for 22/- or 60/- per dozen	<input type="checkbox"/>
4in.	450ft. 2 for 21/-	<input type="checkbox"/>
5in.	900ft. 2 or 35/-	<input type="checkbox"/>
5½in.	1,200ft. 24/-	<input type="checkbox"/>
7in.	1,800ft. 31/-	<input type="checkbox"/>

DOUBLE PLAY (Special polyester base)

3in.	375ft. 4 for 40/- or 108/- per dozen	<input type="checkbox"/>
4in.	600ft. 2 for 30/-	<input type="checkbox"/>
5in.	1,150ft. 27/-	<input type="checkbox"/>
5½in.	1,750ft. 35/-	<input type="checkbox"/>
7in.	2,400ft. 45/-	<input type="checkbox"/>

I enclose remittance for £ s. d. Post Free

Name

Address

BLOCK LETTERS PLEASE Cash with order

ARE YOU ONE OF THE WINNERS?

These are the results of our
'Memory Moment' competition

Each one of the names
below wins a tape
recorder

D. V. MATTHEWS,
39 HARTLAND WAY,
off RUTLAND DRIVE,
MORDEN, SURREY.

N. J. ATTWOOD,
15 ORCHARD ST.,
RAINHAM, KENT.

M. BRACE,
23 SMALLEY RD.,
LONDON, N.16.

P. HILDER,
17 DOVEDALE RD.,
WEST BRIDGEFORD,
NOTTINGHAM.

D. M. BARNES,
8 ST. JAMES ST.,
WALTHAMSTOW,
LONDON, E.17.

G. FINCH,
18 NURSERY CLOSE,
SHIRLEY, SURREY.

V. A. MARCH,
37 BOURNEHALL
AVE.,
BUSHEY, HERTS.

The One and Only

FRANCIS OF STREATHAM

Your
dependable
suppliers for all
that's good in

TAPE RECORDERS

including
BRENELL • Truvox • Elizabethan • FERROGRAPH
• Fidelity • GRUNDIG • Cossor • Philips
• Robuk • LOEWE OPTA • Stella • TELE-
FUNKEN • Uher • VORTEXION • Wyndson
• Minivox • Butoba • Stuzzi • Sony • Akia
• TANDBERG.

Microphones, Tapes, Accessories. ALL AT
ADVERTISED PRICES

HI-FI TOO, BY LEADING MAKERS

* No Extra For Credit * GOOD STOCKS
AND SERVICE

Please note our only address

169-173, STREATHAM HIGH RD., LONDON, S.W.16
Between Streatham Stn. and St. Leonard's Church

STReatham 0466/0192

OPEN ALL DAY SATURDAYS

There's room each month for
anything you want to say,
to be said on this page—

THE THINGS YOU SAY

● A CALL FOR YOUTH

PROMPTED by a letter in 'The Things You Say,' September issue, when Thornton Heath refused admission to their Tape Club to a 13-year-old boy, the Walthamstow and District Tape Recording Society has written to us appraising the keenness and interest shown by youngsters on joining their club, and, in fact, are keen to enrol as many interested youngsters as they can. We, in all fairness, can only print however, that after going to press we received a letter from Thornton Heath stating that as their club is held on licensed premises it would be unlawful to have anyone under the age of 18 present.

I sympathise with 13-year-old R. J. Ward, who, because of his age, was barred from joining Thornton Heath Tape Recording Club. We at Walthamstow actually encourage youngsters to join (a special low fee of 5/- per annum provides full membership for them) and, in our experience, the younger members are among the keenest. In fact, one of them has actually built his own tape recorder and all are quite capable of handling our Hospital Programme, and other projects without supervision.

Sorry, Thornton Heath, but you've turned away a lad with initiative. Initiative enough to go ahead and form his own club.

K. J. Perks, Chairman, Walthamstow Club.

Editor's comment: Thornton Heath do seem to have got their facts a little distorted, and possibly other clubs meeting on licensed premises have too. The law is a little complicated on this point, but briefly the position is this. At 14 you are allowed, with the licensee's permission, into any private rooms or dining rooms of a licensed house, but under-16's are prohibited from entering the actual bars, 16-year-olds are allowed into the bars, but may not consume "alcoholic refreshment" until they are 18.

● SUGGESTION PLEAS!

As thoughts turn to the next Audio Fair, here comes a plea to displaying manufacturers from one very interested Hi-Fi enthusiast.

Might I suggest to manufacturers that when the next Audio Fair comes around they might call in Tape Clubs to help them.

I refer to the demonstration rooms where people who are supposedly there to present their firms' products and show them to the public, know little or nothing about the products.

This has been proved to me both at last and this year's Festival.

I was repeatedly told: "Oh! I don't know much about that!" or else they showed complete disinterest in my enquiry.

Now many tape club members own machines by the various manufacturers and also, from the fact that they are tape club members, have access to learn about other machines owned by fellow members, and I am sure that each club could produce a member who could demonstrate on one or other stands at the fair.

The main thing of interest that would arise out of this, is that visiting enthusiasts would at least be asking fellow enthusiasts questions, and not directing enquiries at someone who is doing it as part of his job and has no further interest in the product.

George E. West, Middleton, Lancs.

Well constructed thoughts. Now let's see what the manufacturers, displaying at the next Audio Festival are going to do about it or have to say about it!

BUY A Bib

THE PROFESSIONAL TAPE SPLICER

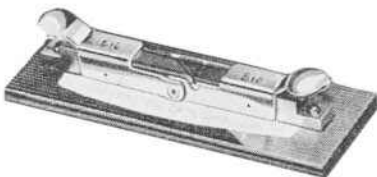

—The most reliable and easy to use.

All metal—beautifully plated—compact in size—mounted on flock covered base. Easily and permanently attached to your tape recorder. Ferrograph, Vortexion, Reflectograph and Wearite decks already have fixing holes for the Bib splicer.

Clamps hold the magnetic or leader tapes in the precision cut channel—no danger of damaging the edges—most important with 4 track recordings. Right angle and oblique cutting slots are provided to facilitate editing to a syllable.

The Bib tape splicer saves tape and makes editing a fascinating hobby.

More Bib splicers have been sold in recent years than any other make. It is incorporated in the "Scotch" Tape Accessory Kit and is used by recording studios and broadcasting organisations.

MULTICORE SOLDERS LTD.

MULTICORE WORKS, HEMEL HEMPSTEAD, HERTFORDSHIRE

Complete with
razor cutter
only 18/6

CHMS 13



The Grampian Ribbon Microphone

Exceptionally wide frequency response—virtually level from 40 c/s to 15 Kc/s—combined with excellent transient response, makes this the ideal instrument for the studio and wherever a high standard of fidelity is essential. Two models are available, each in three impedance sensitivities.

Model GR. 1, having a semi-cardioid response, gives approximately 10 db suppression to high frequencies at the rear face. It is ideal for overcoming problems of feed-back between microphone and speakers.

Model GR. 2, having a bi-directional "figure of eight" sensitivity pattern, discriminates against unwanted side noise both in the vertical and horizontal planes.

Supplied in attractive, padded instrument case, complete with 18 ft. screened lead, swivel holder and connector. **£11.10.0.**

Grampian

30 years' experience in
the manufacture of high-
quality microphones

A full range of accessories is available. Please send for illustrated leaflet. Enquire too for details of the famous Grampian DP4 range of Moving Coil Microphones

GRAMPIAN REPRODUCERS LTD
Hanworth Trading Estate, Feltham, Middlesex. FELtham 2657



TAPE ERASER

HEAD DE-MAGNETISER



PRE-AMPLIFIERS



Three basic essentials for the recording enthusiast

Tape Eraser

Erases both sides of a 7" tape reel in 30 seconds and positively removes even the very low frequency portions of a recording. Use the WAL Tape Eraser, the only way to ensure an *absolutely* clean tape—quicker

and better. Mains operated. Also erases sound from 16 mm. film, 10" aluminium reels. Professionally designed for professional recording engineers. **£6.18.6.**

Head De-magnetiser

De-magnetises tape heads quickly and simply. Also for pin-point erasing on striped film and tape recordings—removes local unwanted noises without detriment. Has nylon-cushioned

twin probes with a concentrated demagnetising field in the 1/8" gap between the arms. Pistol grip. A.C. mains. Professionally designed for professional recording engineers. **£2.10.0.**

Pre-amplifiers

WAL pre-amps are made for every purpose. Fully transistorised, battery-operated, give high gain, completely hum-free. Laboratory built and fully tested. Professionally designed for professional recording eng-

ineers. Ask for details of WAL-GAIN Mono **£5.10.0.** STEREO WAL-GAIN **£7.10.0.** and the superb WAL HI-GAIN with built-in switched equalisation for monitoring, dubbing etc. etc. **£7.16.0.**



Free leaflets available on these professional aids to perfection . . . please write:

ELSTONE ELECTRONICS Ltd
Edward Street, Templar Street, Leeds 2.

AUSTRALIA

ROBERT WHEELER, 58, Security watchman, 5 David Street, Mt. Pritchard, Sydney, New South Wales, Australia. Radio controlled model boats. Organ music, choirs, light classical. Ultratone two track stereo, mono 7in, 1 $\frac{1}{2}$, 3 $\frac{1}{2}$, 7 $\frac{1}{2}$. Anywhere English speaking.

BEDFORDSHIRE

MICHAEL MOSS, 22, Air Ministry Worker, 73 Duchess Road, Bedford. Films, cycling, photography, meteorology, reading. Musical shows, some pop, film sound track and general. Philips EL 3541, 7in., 3 $\frac{1}{2}$. Anywhere English speaking.

BIRMINGHAM

LESLIE KNIGHT, 25, Jeweller, 129 Fentham Road, Aston, Birmingham 6. 8mm photography, physical culture. Sarah Vaughan, modern jazz, Ferguson 441, 53 in., 3 $\frac{1}{2}$. U.K. Male only.

DERBYSHIRE

BUDDY KENDRICK, 20, Fitter, 54 Hawthorn Drive, Cromford, Matlock, Derbyshire. Guitar Playing, electronics. Classics and few pop. Philips EL 3541 4 track, 7in., 3 $\frac{1}{2}$. U.S.A., Australia.

CLOUCESTERSHIRE

PETER PASCOE, 16, Earthenware Packer, 30 Queen Street, Upper Eastville, Bristol 5. Reading, pops and light classical. Civic T 62, 7in, 1 $\frac{1}{2}$, 3 $\frac{1}{2}$, 7 $\frac{1}{2}$. Anywhere, English speaking.

HAMPSHIRE

RICKY LOVELL, 24, Clerk, 4 Albert Grove, Southsea, Hampshire. Films, Italian language, sound effects. Pop, light classic, unusual music. Carousel Hi-Fi, 7in., 1 $\frac{1}{2}$, 3 $\frac{1}{2}$, 7 $\frac{1}{2}$. Italy, Norway, England, English speaking only. Male only.

BRIAN BLAKE, 18, Postal servant, 71 Anns Hill Road, Gosport, Hants. Hi-Fi and audio, photography, Anything good and light, modern jazz, Philips EL 3541 4 track, 7in., 3 $\frac{1}{2}$. U.S.A., Australia, New Zealand.

HERTFORDSHIRE

ALAN SELF, 27, Electrical fitter, 28 Judge Street, North Watford, Hertfordshire. Tape recording/editing; other interests widely varied. Anything except heavy classics. Cossor CR 1604 4 track, 7in., 1 $\frac{1}{2}$, 3 $\frac{1}{2}$. All countries, preferably Scandinavia.

W. HENDRY, 31, Ambulance driver, 21 Masefield Avenue, Borehamwood, Herts. Sound effects, travel. Pop—especially Judy Garland Fidelity Argyl Major, 5 $\frac{1}{2}$ in., 3 $\frac{1}{2}$. Anywhere, especially Tyneside.

Particulars of Tapespondents are given in the following order:— name, age, occupation, address; special interests, taste in music; type of machine, spool sizes, speeds; area of taping required.

THE TAPE DIRECTORY

An ATR service in
the interests of
world-wide friendship

KENT

RICHARD STEVENSON, 36, Civil Servant, 45 Whitehill Road, Crayford, Dartford. Taping, photography, physical culture; anything except grand opera. Argyll Minor, Sound Riviera, 5 $\frac{1}{2}$ in. 3 $\frac{1}{2}$. Anywhere, male only.

LANCASHIRE

ALAN DOBBIE, 24, Radio and TV engineer, 12 Cartmel Road, Ridge, Lancaster. Fishing, photography, radio construction; pop, jazz. Grundig TK 5, 5 $\frac{1}{2}$ in. 3 $\frac{1}{2}$. Anywhere.

JOHN DUXBURY, 25, Postal and Telegraph officer, 42 Walton Lane, Barrow-in-Furness. Tape recording, do-it-yourself, general topics; popular, classical, electronics. Simon SP 5, 7in, 1 $\frac{1}{2}$, 3 $\frac{1}{2}$, 7 $\frac{1}{2}$. Anywhere.

LONDON

ALAN BEDWARD and **BARRIE M. BOX**, 25, Film assistants, TV, 60 Madeley Road, Ealing W.5. Tape productions, rhythm groups; modern jazz, film music. HMV DSR 1, Sound 777, 7in. 3 $\frac{1}{2}$, 7 $\frac{1}{2}$, 15. Anywhere, including U.K.

CHARLES BUSHBY, 47, Electrical fitter, 18 Haycroft Road, Brixton S.W.2. Outdoor sound effects; pop music to light music. Vortexion, Ferrograph, 8 $\frac{1}{2}$ in. 3 $\frac{1}{2}$, 7 $\frac{1}{2}$. England and West Africa.

L. V. HUGHES, 46, Photographic installation engineer, 9 Grosvenor Court, Hale Lane, Mill Hill, N.W.7. Sport macro-photography, cars; classics, Mexican and Spanish folk. Brenell 3 star, 7in, 1 $\frac{1}{2}$, 3 $\frac{1}{2}$, 7 $\frac{1}{2}$. Spain Mexico, S. Americas.

ERIC PETER PHIPPS, 19, Swimming pool attendant, 31st Quentin House, Trinity Road, S.W.18. Swimming, cinema; classic, pop, trad jazz. Cossor 4-track CR 1602 7in. 3 $\frac{1}{2}$. Anywhere, English speaking.

GREG STARBUCK, 17, Apprentice electrician, 40 Pullens Flats, Penton Place, Waltham, S.E.17. Fishing, modern dancing, bikes, girls; guitars, pops, anything 'swinging'. Robuk RK 3, 7in, 1 $\frac{1}{2}$, 3 $\frac{1}{2}$, 7 $\frac{1}{2}$. Anywhere.

JOHN WASHBOURNE, 16, Shop assistant, 38 Upper Walthamstow Road, Walthamstow, E.17. Films, shows, boys clubs, camping, travel; music from films and shows, pops. Philips EL 3549, 7in, 15/16, 1 $\frac{1}{2}$, 3 $\frac{1}{2}$, 7 $\frac{1}{2}$. Australia, U.K., U.S.A. Male contacts only.

MIDDLESEX

EDNA AUSTIN, 20, Secretary, 96 Ealing Road, Brentford. Travel, sport, football, records; pop. Grundig TK 23, 5 $\frac{1}{2}$ in. 3 $\frac{1}{2}$. England, U.S.A., Anywhere.

NORFOLK

MARTIN D. DRAKE, 17, Shop and Mill assistant, 13 Maud Street, Norwich. Cinema, tape recording, drawing; pop, classics. Magnavox TM 840 4-track, 7in, 1 $\frac{1}{2}$, 3 $\frac{1}{2}$, 7 $\frac{1}{2}$. Anywhere, English speaking. Female if possible.

NOTTINGHAMSHIRE

GEORGE W. (BILL) GABBITAS, 27, Driver, 125 Tibbury Rise, Aspley Estate, Nottingham. Recording, making friends; anything and everything. Elpico 2-track TR 400, Philips 4-track EL 3541, 7in. 3 $\frac{1}{2}$. Anyone, anywhere English speaking.

SUFFOLK

JOHN L. BENFIELD, 24, Maintinance to super grid transmission lines, 77 Cliff Lane, Ipswich. Sport, motoring, cinema, photography, philately; the best of everything. Telefunken, 8 $\frac{1}{2}$ in. 3 $\frac{1}{2}$, 7 $\frac{1}{2}$. Germany, English speaking only.

SCOTLAND

BRIAN DEWAR and **NEIL DRYDEN**, 17, Students, 10 Golf Street, Carnoustie, Angus. Birds, Hi Fi, ham radio, motor cycles, stamps; anything except jazz and heavy classical. Ferguson 445 TR, Magnavox TM 840, 7in, 1 $\frac{1}{2}$, 3 $\frac{1}{2}$, 7 $\frac{1}{2}$. Anywhere, especially Europe. No need to write, all tapes answered.

YORKSHIRE

MARGARET CONCHA, 17, Student, 80 Manor Drive, Acomb, York. Films, dancing, sports, travel, animals; pop, jazz, classical, film music, opera, Elvis. Grundig TK 14 2-track, 5 $\frac{1}{2}$ in. 3 $\frac{1}{2}$. Anywhere abroad, English or French speaking.

WILLIAM A. JAMIESON, 33, Laboratory assistant, 486 Leeds Road, Thackley, Bradford. Singing; opera. Tandberg, 7in. 3 $\frac{1}{2}$, 7 $\frac{1}{2}$. Argentina, Austria, Italy, U.S.A.

GORDON SMALLWOOD, 34, Electrician, 5 Bede Avenue, Burton Lane, York. Hi Fi, electronics, radio. TV; trad. jazz, some modern. Ferrograph 4A Twin track, 7in. 3 $\frac{1}{2}$, 7 $\frac{1}{2}$. Anywhere.

WILTSHIRE

WLADMIAR BADZ, 15, Student, 15 Somerset Crescent, Melksham. Radio construction; pop, light classical. Westminster, 5 $\frac{1}{2}$ in. 3 $\frac{1}{2}$. Australia, U.S.A.

News from the Manufacturers

TANDBERG REVIEWS

A unique booklet containing all the technical reviews of **Tandberg** recorders is now available, free of charge, from **Elstone Electronics Ltd. (Tandberg Tape Recorder Information), Edward Street, Templeton Street, Leeds 2.** Prospective purchasers of Tandberg recorders will find these reviews both valuable and informing, for they are unbiased reports by all the well-known technical reviewers.

U.K. AGENT FOR SAJA

The **Tape Recorder Centre, of 266 Waterloo Road, Blackpool, Lancs.,** have been appointed sole U.K. agents for spare parts for all **Saja** tape recorders. Available to private owners and dealers.

PRICE REDUCTION

Due to increased production and greater demand, it has been possible to reduce the price of the **Butoba MT 7** tape recorder from 44 gns. to 38 gns. Details of **Butoba** recorders from **Denham & Morley Ltd., Denmore House, 173-175 Cleveland Street, London, W.1** (Telephone EUSton 3656).

LISTEN AND LEARN

Pre-recorded study tapes for accountancy, secretarial and commercial students are now available. This new method of tuition is based on the use of pre-recorded study tapes which can be operated on all tape recorders, and which have been created and prepared by Chartered Accountants and Chartered Secretaries. The study tapes are suitable either for those studying under correspondence courses or those attending full- or part-time courses at school or college. Send for further details, and the booklet 'Listen and Learn,' to **Rent-a-Tape (Recording) Ltd., Northfield Lane, Brixham, South Devon.**

ATR ANNOUNCEMENTS

SOUND EFFECTS DISCS

We regret that the sound effects record offered in last month's issue was inadvertently referred to as Disc No. 4. This should, of course, have been No. 5, and the latest record is No. 6.

When sending for your sound effects records, please do not forget to state clearly your name and address, and the record which you require. Your cheque or Postal Order should be made out to 'Amateur Tape Recording,' and the 6d. postage fee should NOT be included in your cheque or Postal Order, but should be in the form of an unaffixed 6d. stamp.

Records are still available after the expiry of the special offer, but at the ordinary price of 7/6d., plus an unaffixed 6d. stamp.

INFORMATION, PLEASE

We would very much like to hear from all T.R. Clubs throughout Great Britain, whether or not they have ever contributed to **ATR** in any way before. We frequently receive enquiries from readers enquiring for the address of their nearest club, and we cannot direct them to you if we do not have the address of your current secretary, or do not even know of your existence. It would also help us to know when and where you meet, when you hold your A.G.M., and what sort of equipment you have. So please do drop a line to the Club News Editor giving these and any other details you may think helpful.

STOP PRESS!

Competition winners—Section 1: Thornton Heath. Section 2: Plymouth. Section 5: North London. Section 6: I.V.A.S. Full results and further details in next month's issue.

SWOP COUNTER

F. C. Buchanan, of 12 Pitfour, Glencarse, Perth, Scotland, has a Stuzzi Tape Tuner (9 volt, transistor, with long and medium waves), which he would like to swop for a pocket transistor radio with earphone socket as well as its own internal speaker.



N. Gordon, of 162 South Lodge Drive, Southgate, London, N.14, has a Minox A subminiature camera and exposure meter which he would like to exchange for a two- or three-speed tape recorder.



William D. S. Pithie, of 21 Bonnybank Road, Dundee, Angus, Scotland, would like a Eumig P 8 Phonomatic Projector in exchange for his Stuzzi Magnette, complete with ever-ready carrying case, mic, pickup leads and reel of tape.



D. Franklin, of 9 Grange Road, Tring, Herts., is seeking a loudspeaker enclosure for use with a Telefunken 85 with 4½ ohms output. In return he offers a suitable amount of photographic equipment, including a 35 mm. developing tank, a 35 mm. enlarger with Wray 4.5 lens, timing clock, darkroom safety lamp, large masking frame, focusing box, dishes, and other items of developing and enlarging equipment.



N. E. Lord, Willow Wray Cottage, Lustleigh, Newton Abbot, South Devon would be interested in receiving any offers for a Philips crystal mic (type EL 3573/00), or two H.M.V. 12-in. LP records of Glenn Miller's U.S. Army Band (CLP 1078 and CLP 1080), all in first class condition.



G. Wright, of 8 East Lane, Shipton-by-Beningbrough, York, has an Ilford Densitometer (battery model) which he would like to exchange for one or more of the following:— an FM Tuner; mic for use with a tape recorder; photo-electric exposure meter; or DC to AC converter (12v DC to 250v AC, 200 watts).

COMPLETE "SLEEPOMATIC" UNIT FOR ONLY £20

Comprising transistorised tape machine, auto time-switch, microphone, batteries, and under-pillow speaker.

INTERESTING FREE BOOKLET

and details of our range of tapes, discs, and equipment gladly sent on receipt of postcard. (We are the pioneers of Automated Sleep-learning in Great Britain.)

EDUCATIONAL RECORDINGS LTD. (Dept.)
21 Bishops Cose, Church Lane, London, E.17

GREAT NEW SONY SOUND!



SONY TC. 500

TO THE SERIOUS AMATEUR COME THE LATEST, THE FINEST TECHNICAL ADVANCEMENTS IN STEREOHONIC TAPE RECORDING AND PLAYBACK. THE SOUND IS SONY, THE VERSATILITY IS SONY, THE QUALITY IS SONY. THIS IS FOR THE CONNOISSEUR — THE SONY TC. 500

106 GNS with 2 Sony F87 Cardoid Dynamic microphones and all accessories.

SONY[®]
RESEARCH MAKES THE DIFFERENCE

Detailed specification of this tremendous Sony tape recorder freely available from the Sole U.K. distributors:

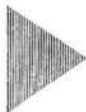

EXTRACTS FROM SPECIFICATION:

Full stereo facilities with independent recording and playback amplifiers, providing professional mixing facilities. Manual cueing, digital tape counter, instant stop, automatic tape lifter. Instantaneous selection of $7\frac{1}{2}/3\frac{3}{4}$ ips. Response — 30-18000 cps at $7\frac{1}{2}$ ips. Harmonic distortion — less than 2% at 3 db below rated output. Detachable speakers for stereo separation.

TELLUX LIMITED
High Fidelity Division
GALLOWS CORNER, ROMFORD, ESSEX

Top 6!

Choose your next tape recorder from this great Philips range

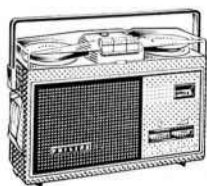

EL 3586
PHILIPS
NEW
BATTERY
TAPE RECORDER

Records and plays back anywhere, any time—even while being carried. All transistor for economical running and lightweight portability.

25 gns. *Carrying case and mains unit available as optional extras*

EL 3514
PHILIPS
STARMAKER
MAINS TAPE
RECORDER



The first mains tape recorder ever to feature the new, space-saving upright styling. Four track recording and playback.

27 gns.



EL 3541
PHILIPS
FAMILY TAPE RECORDER

This truly remarkable four-track tape recorder incorporates many advanced features. An ideal machine for the family man.

36 gns.

PHILIPS **EL 3541/H**
FAMILY DE-LUXE TAPE RECORDER

Has all the features of the EL3541 plus the added advantage of a leathercloth-covered wooden cabinet.

42 gns.

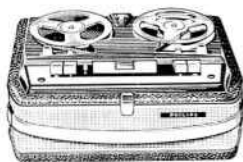

PHILIPS **EL 3549**
4-SPEED HI-FI TAPE RECORDER

This all-transistor, 4-track, 4-speed tape recorder has no equal in the medium price class. Many professional features.

62 gns.



PHILIPS **EL 3534**
4-SPEED HI-FI STEREO TAPE RECORDER
—WITH MULTIPLAY

Impeccable stereo and mono sound plus *multiplay*—the feature that permits the combination of many monitored recordings on one track.

92 gns.



See the complete range at your Philips dealer's

ALL BEAUTIFULLY
MADE BY



PHILIPS

—THE FRIEND OF
THE FAMILY

PHILIPS ELECTRICAL LIMITED, CENTURY HOUSE, SHAFTESBURY AVENUE, LONDON, W.C.2

PTR 4307

LUXOR

A BRILLIANT NEW HI-FI

STEREO TAPE RECORDER

FROM SWEDEN

The first completely self contained 4-track, 3-speed mono-Stereo Recorder on the British Market at a price below anything comparable with it in performance. Built-in stereo speakers and amplifiers as well as all connectors and leads for record and play-back through external equipment.

Also MP 424, in two-tone portable case with carrying strap — 77 gns

BRITIMPEX LTD

U.K. DISTRIBUTORS OF TELEFUNKEN VALVES AND COMPONENTS

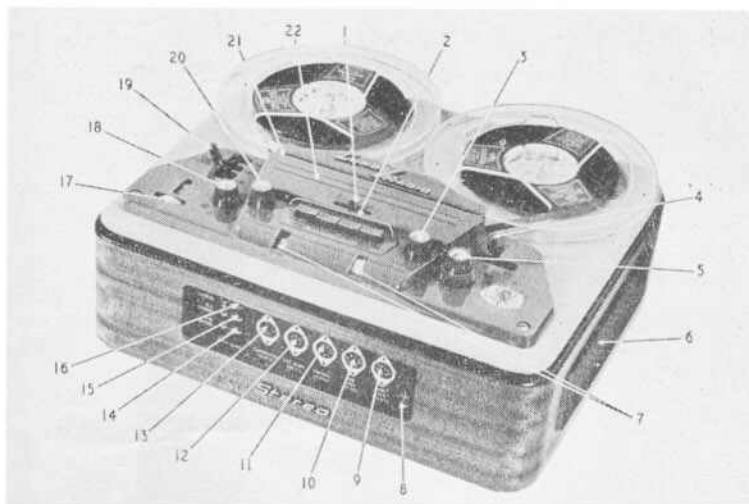

PRICE ONLY

74 GNS

MODEL
M.P. 423

(IN TEAK)

- 1 Track selector
- 2 Pushbutton panel
- 3 Master volume control
- 4 Standby-play-fast forward-fast reverse
- 5 Individual volume controls for stereo balance
- 6 Speaker enclosures (only right visible)
- 7 Recording level indicators (magic eyes)
- 8 Ground
- 9 Microphone (stereo) input
- 10 Microphone (mono) input
- 11 Phonograph input

- 12 Radio input, and external amplifier output
- 13 Earphones
- 14 Socket for external loudspeaker (mono)
- 15 Socket for external stereo loudspeaker
- 16 Socket for external stereo loudspeaker
- 17 Tape-consumption indicator (cuemeter)
- 18 Loudspeaker switch
- 19 Power on/off and speed selector switch
- 20 Tone switch
- 21 Tape guide
- 22 Splicing groove

particulars and address of nearest stockist from sole concessionaires in U.K.
16 - 22 GREAT RUSSELL ST. · LONDON, W.1 · Phone MUSEum 7600

A.T.R. APPROVED DEALERS

MANCHESTER'S SOUND SPECIALISTS

All makes of Tape Recorders and Accessories

Appointed Ferrograph Stockists
Gramophone Record Library—Includes Stereo

LANCASHIRE HI-FI

8 DEANS GATE, MANCHESTER
(Next to Grosvenor Hotel)

* CITY & ESSEX TAPE RECORDER CENTRES

228 BISHOPSGATE, LONDON, E.C.2.
2 MARYLAND POINT STATION,
LONDON, E.15 (Head Office)

Telephone: MARYland 5879

205 HIGH STREET, EAST HAM, E.6
(Opposite East Ham Station)
Telephone: GRA 6543

G. L. MORTON & CO. LTD.

12 OXFORD STREET,
NEWCASTLE-UPON-TYNE

* NUSOUND RECORDING CO.

London Showroom: 35 Craven
Street, Trafalgar Square, London, W.C.2.
Tel. TRA 2080

3/8 Brigstock Parade, London Road,
Thornton Heath, Surrey.
Opposite T/Heath & T. Bus Depot.
THO 7609



THE SERIOUS ENTHUSIAST usually comes to us after finding technical service difficult to obtain elsewhere. WISE PURCHASERS come here first, and are assured of first class technical service at all times. WE SUPPLY All good HI-FI equipment and Tape Recorders. Part Exchange and H.P. welcome. LAMBDA RECORD CO., Dept. ATR, 95, Liverpool Road, Liverpool 23. Telephone GREAT Crosby 4012.

SOUTHERN RECORDER SERVICE

2 ST. GEORGE'S STREET,
WINCHESTER, HANTS

Bath Co-Operative Society Ltd.

TELEVISION CORNER,
SOUTHGATE STREET, BATH

ENGLAND'S BIGGEST SPECIALISTS:

HOWARD

TAPE RECORDERS

218 HIGH ST., BROMLEY, KENT
RAV. 4000 & 4477

R.E.W. EARLSFIELD LTD.

PART EXCHANGE SPECIALISTS

266 UPPER TOOTING RD.,
LONDON, S.W.17.

Telephone: BAL 7710.

* SHEEN TAPE RECORDER CENTRE LTD.

Personal Sales and Service by
L. G. Francis

8 STATION PARADE, SHEEN LANE,
SHEEN, LONDON, S.W.14.

Showrooms: PROspect 0985

(Opposite Mortlake Station S.R.)

Extensive Tape Recorder Show-room. Ferrograph, Grundig, Philips, Brenell, etc. Full

range Mics, Tape, Accessories, Technical Information and Service.

* CUSSINS & LIGHT

KINGS SQUARE, YORK. Tel. 55666

C. SHARP & SON LTD.

4 PREBEND ROW,
DARLINGTON, CO. DURHAM

* VISITED BY "AMATEUR TAPE RECORDING & HI-FI"

**amateur
TAPE RECORDING AND HI-FI**

CLASSIFIED ADVERTISEMENTS

9d. per word, minimum 7/6. Box Nos. 1/6 extra.
Advertisements should be addressed to the Advertisement Manager 'Amateur
Tape Recording & Hi-Fi', 145 Fleet Street, London, E.C.4.

PRE-RECORDED TAPES. Unique complete catalogue listing all makes, Mono, Stereo, 7½ and 3½ i.p.s., including World Record Club tapes. Call for **FREE** copy or send 1/- mailing fee, Dept. TR.2, Teletape Ltd., 33 Edgware Road, W.2. P.A.D. 1942.

Cheap Recording Tape for sale. A. Marshall & Son (Metals) Ltd., 18 Cricklewood Broadway, N.W.2.

Ferrograph 5 A/N, 422 and 424, Revox E36, etc., always in stock — City and Essex Tape Recorder Centres, 2 Maryland Station, London E.15.

Recorder Need Repairing? Then let City and Essex Tape Recorder Centre do it for you expertly and economically.—City and Essex Tape Recorder Centres, 2 Maryland Station, London E.15.

Good cash prices for tape recorders.—Telephone Maryland 5879.

Friendly Folk Association, Torquay (Established 1943). Members everywhere, Hobby Exchanges, Stamps, Photography, View-cards, Tapesponding, Pen-Friends (100 countries).

TAPE/DISC/TAPE transfer, editing, duplicating. If quality and durability matter (especially with LPs from your precious tapes) consult Britain's oldest transfer service. Join Audio Supply Association; considerable saving. 60-page photographically illustrated Hi-Fi Catalogue 4/6d. Sound News, 10 Clifford Street, London, W.1. Regent 2745.

Excellent Quality Discs made from your private tape recordings—Weddings/Choirs etc. LP's from 15/6. (s.a.e.)—S.S.S., Dept. 7, 28 Viewforth Terrace, Sunderland.

HIGHEST CASH PRICES offered for good quality Tape Recorders and Hi-Fi. See our ad. page 34 this issue.—R.E.W., 266/8, Upper Tooting Road, London, S.W.17.

A UNIQUE BUY! Recording tape top brand, 5½in. 1,200 ft. 19/6; 7in. 2,400 ft. D.P. 28/6 P. & P. 1/6 per spool. Bargains in all sizes. S.A.E. for list. E. C. Kingsley & Co., 132 Tottenham Court Road, London, W.1. EUSTON 6500.

RAPID RECORDING SERVICE. 78s. and L.Ps. from your own tapes (48 hour service). Master Discs and Pressings. Recording Studio. Mobile Recording Van. Manufacturers of the Sleep-o-matic Unit. Foreign language courses available for sleep-learning. Brochures and price lists on request from: Dept. ATR, 21 Bishop's Close, London, E.17.

SOUND EFFECTS RECORDS. Did you miss the ATR special offers? MFX-1 14 mixed effects, MFX-2 17 mixed effects, TFX-1 British Railway trains 11 records, AFX-1 Wild Animals. Available at usual retail price of 8/- Each inc. p.t., post and packing from F. C. Judd (Sound Recording) Ltd., 174 Maybank Road, South Woodford, London E.18. List available—3d. Stamp.

MAKE NEW FRIENDS. UK and overseas. V.C.C., 34 Honeywell Road, S.W.11. Established 21 years.

RECORDING TAPE post free. High quality, refund guarantee. 3in 400ft 9/-; 4in 450ft 8/6; 600ft 12/-; 5in 900ft 12/6; 1200ft 20/-; 5½in 1200ft 16/-; 1800ft 28/-; 7in 1800ft 22/6; 2400ft 36/-; M.S. Recording Tapes (Dept. A.T.), 21 Hoyle Street, Radcliffe, Manchester.

SUMMER SALE BARGAINS! Up to 50% price reductions! Every machine brand new, fully guaranteed. Send s.a.e. for complete list. Special sale discount on every order placed during sale period. Quotations on request. Mail Order specialists. — Tape Recorder Services, Library House, Lissieyouth, Morayshire.

OPEN UP YOUR OWN TAPE STATION and speak to the World! Send S.A.E. for particulars. **WORLDWIDE TAPE TALK**, 35 The Gardens, Harrow.

AMATEUR TAPE RECORDING & HI-FI

SUBSCRIPTION FORM

● Make certain you receive your copy of **Amateur Tape Recording and Hi-Fi** by completing this form and sending it, with your annual subscription, to:

AMATEUR TAPE RECORDING & HI-FI,
SUBSCRIPTION DEPT.,
VERNON HOLDING & PARTNERS LTD.,
43/44, SHOE LANE,
LONDON, E.C.4.

Sirs: Please send **Amateur Tape Recording & Hi-Fi** for one year, commencing with the next (.....) issue, to the address below. I enclose the annual subscription of twenty-nine shillings (29s.).

Name

Address

Date

SPECIAL CLUB SUBSCRIPTION

● Tape Club members wishing to avail themselves of the special Club Subscription rate of 21s. per annum should apply to their local Club Secretary. All Club orders must bear the Club Secretary's signature and be sent to the Subscription Department.

ADVERTISERS IN THIS ISSUE

A. Brown & Sons	14
Agfa	6
Associated Howard	47
B.A.S.F.	48
De Villiers	38
Educational Recordings	42
Elstone Electronics	40
E.M.I. Tape	12
Ferrograph	10
Fi-Cord	2
Francis of Streatham	39
Grampian	40
Grundig	18
Irish Tapes	10
Kodak	3
Luxor	45
Massey's Centre of Sound	34
Metro Sound	34
Minnesota Mining and Manufacturing Co.	15
Multicore Solders	40
Philips Tapes	16
Philips Recorders	44
R. E. W. Earlsfield Ltd.	34
Sheen T.R. Centre	34
Sony	43
Truvox	29, 30, 31
Wharfedale	36
World Record Club	4, 5
Zonal	20



MONEY TO BURN? . . .

then you won't want to know about us. Go somewhere else, where they charge you high H.P. rates, charge for delivery, charge for servicing, have little stock and even less knowledge and experience of Tape Recorders. *And the best of luck!*

On the other hand, if you want to save money (or are even downright mean and stingy), HOWARD is for you. Free H.P. ★ Free Delivery anywhere ★ Free servicing ★ Special Cash Terms ★ Special H.P. Insurance ★ 500 machines in stock, 80 different models on show ★ 10 years experience as the biggest Tape Recorder Specialists in the Country ★ In short — *our terms are the best you can get anywhere.*

Cameras, Hi-Fi equipment and Dictating Machines, too!

Write, phone or call in for catalogue, explaining the full mystery of our business (Free, but of course!).

218 HIGH ST.,
BROMLEY,
KENT
RAVensbourne
4000

HOWARD
TAPE RECORDERS • CAMERAS • HI-FI



ON **BASF** LETTER TAPES SPECIALLY PACKED FOR MAILING



BASF LETTER-TAPE enables you to talk to relatives and friends anywhere in the world. **BASF** insistence on highest quality production makes the Letter-Tape extra sensitive to capture every shade of expression. Delight your friends far away—let them *hear* your news on the 150 feet long-play tape specially made for mailing. The lightweight **BASF** Letter-Tape comes complete with mailing carton and reply labels, and costs only 5/6d.



—SYMBOL OF
AUTHENTIC SOUND



BASF CHEMICALS LIMITED, 5a GILLESPIE ROAD, LONDON, N.5. TEL: CANonbury 2011