

J4 LOW LEVEL OUTPUT



R21

AMATEUR

46

SA8

TAPE RECORDING

VOL. 5 No. 9 APRIL 1964 PRICE 21-

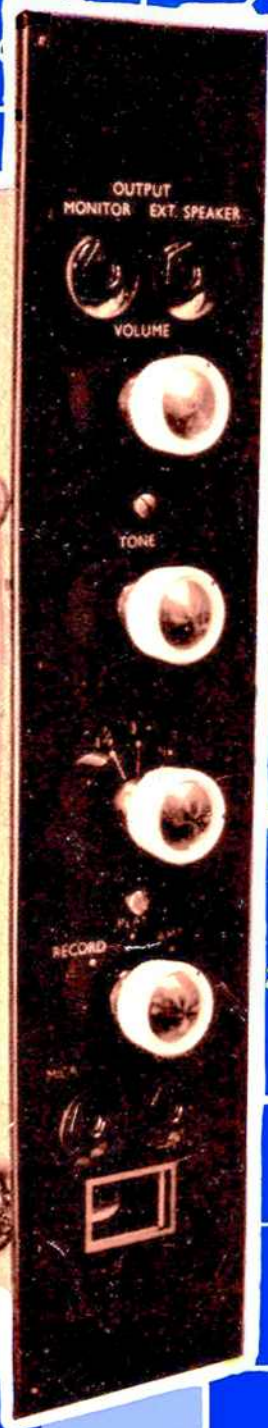
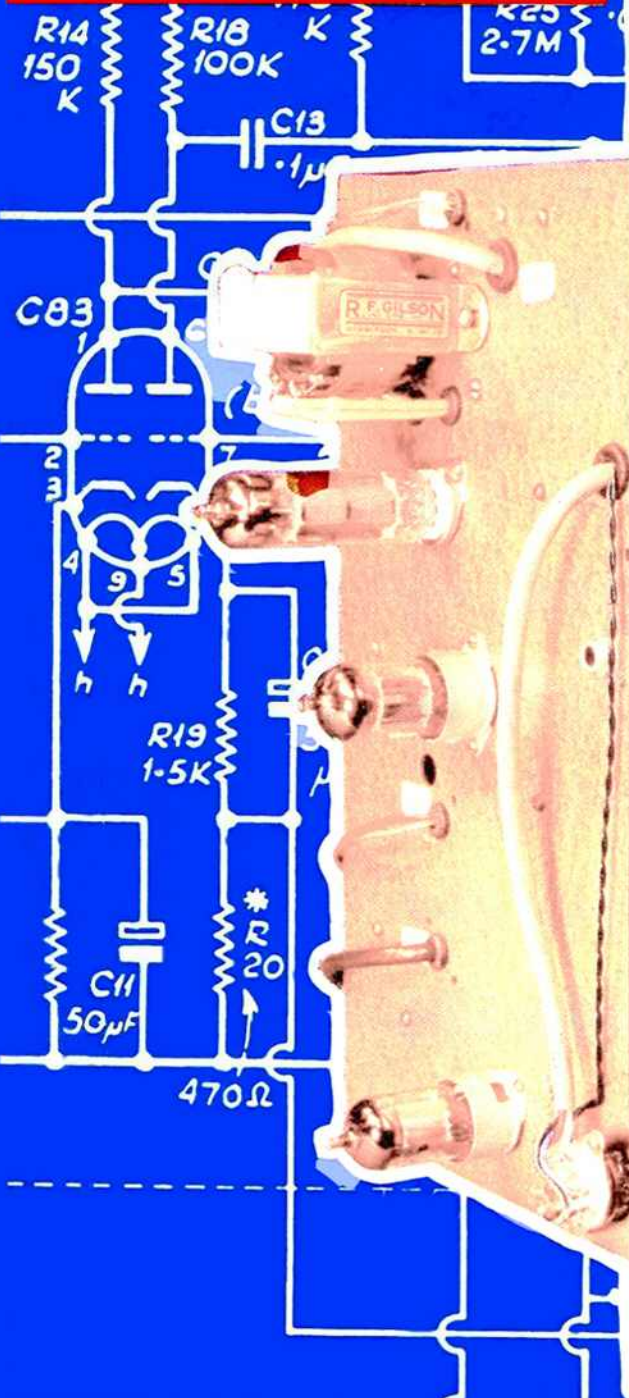

R31 10K
 C21 .01μF
 L1
 L84
FREE BLUEPRINT CIRCUIT FOR YOUR TAPE AMPLIFIER

**SOUNDS FX RECORDS
 LAST IN THE SERIES,
 AND AN EXCLUSIVE
 PREVIEW ON THE
 AUDIO FAIR**

Brilliant

6!



The tape recorder
you're looking for is
in the Philips range

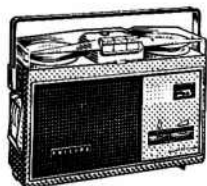

EL 3586
PHILIPS
NEW
BATTERY
TAPE RECORDER

Records and plays back anywhere, any time—even while being carried. All transistor for economical running and lightweight portability.

25 gns. *Carrying case and mains unit available as optional extras*

EL 3514

PHILIPS
STARMAKER
MAINS TAPE
RECORDER

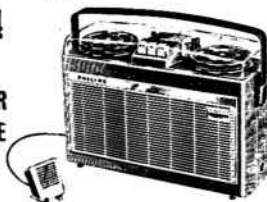

The first mains tape recorder ever to feature the new, space-saving upright styling. Four-track recording and playback.

27 gns.

EL 3541



PHILIPS
FAMILY TAPE RECORDER

This truly remarkable four-track tape recorder incorporates many advanced features. The ideal instrument for the family man.

36 gns.

PHILIPS
EL 3541/H
FAMILY DE-LUXE TAPE RECORDER

Has all the features of the EL3541 plus the important added advantage of a leathercloth-covered wooden cabinet.

42 gns.



PHILIPS
EL 3549
4-SPEED HI-FI TAPE RECORDER

This all-transistor, 4-track, 4-speed tape recorder has no equal in the medium price class. Many professional features.

62 gns.



PHILIPS
EL 3534
4-SPEED HI-FI STEREO TAPE RECORDER
—WITH MULTIPLAY

Impeccable stereo and mono sound plus *multiplay*—the feature that permits the combination of many monitored recordings on one track.

92 gns.



See the complete range at your Philips dealer's

ALL BEAUTIFULLY
MADE BY



PHILIPS

—THE FRIEND OF
THE FAMILY

PHILIPS ELECTRICAL LIMITED, CENTURY HOUSE, SHAFTESBURY AVENUE, LONDON, W.C.2
(PTR 4332)



FREE ideas for party fun with Emitape

Your tape recorder, loaded with Emitape, can make a swinging party.

On tape, you can plan your evening in advance, programming bossa novas and blue beats in any order you like. You can store up hours of entertainment and release it at the press of a button!

FREE EMITAPE LEAFLETS. Emitape have written a new leaflet called

'Emitape for Parties'. It is bursting with ideas on how to have a ball when you have a party. It is absolutely FREE. You can get a copy simply by completing the coupon on the right.

Ask also for the FREE 'Emitape Care' leaflet which helpfully tells you how to get the very best out of your tapes.

To: E.M.I. TAPE LIMITED
HAYES, MIDDLESEX

Please send me free leaflets

'EMITAPE FOR PARTIES'

'EMITAPE CARE'

NAME

ADDRESS

ET 110

ATR 6

VISIT US AT STAND 63 * AUDIO FAIR * APRIL 2-5



WE ARE ONLY A PILLAR-BOX AWAY!

Wherever you live, you are only a 3d. stamp away from the biggest Specialists in the Country! We *guarantee* you our terms—which include **NO INTEREST CHARGES**—cannot be beaten.

Thinking of buying a Tape Recorder? Interested in saving money? Then write or phone us today for Free Brochures on all the good makes and Full Details of our Amazing Terms:

HOWARD

**218 HIGH ST.,
BROMLEY, KENT**
RAVensbourne 4000/4477



GO
FOR ANY
SOUND
KEEP IT
SAFE
ON



PHILIPS TAPE

GREEN
for standard
RED
for longplay
BLUE
for doubleplay
GREY
for tripleplay

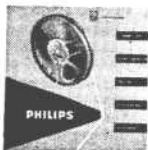

Capture a sound on Philips Tape and it's yours for ever—yours to play back and enjoy whenever you like. Available in all current reel sizes of standard, longplay, doubleplay and tripleplay, Philips Tape gives you all these advantages: great sensitivity, wide frequency range, low noise level, high resistance to stretching or breakage, powerful adhesion of the magnetic coating. And of course, they're colour-packed for easy identification. Whatever tape recorder you own, get the best out of it—with Philips Tape.

FINE PRODUCTS FROM PHILIPS—THE FRIEND OF THE FAMILY

PHILIPS ELECTRICAL LTD., ELECTRO-ACOUSTICS DIVISION, CENTURY HOUSE, SHAFTESBURY AVENUE, LONDON WC2 (PTA4314)

THE WYNSOR TRIDENT TAPE RECORDER

3 speeds: 7½, 3½, 1½
Accommodates up to 7" spools
Quality 7" x 4" speaker
Crystal microphone
Magic-eye record-level indicator
Output: 4 watts
Tone control
Pause control
Tape position indicator with reset
Mains supply: AC only.
200/250v 50 c/s



Please send me descriptive leaflet and name and address of nearest stockist.

NAME.....

ADDRESS.....

ATR/1/64

WYNSOR RECORDING COMPANY LIMITED
WYNSOR WORKS · BELLEVUE RD · FRIERN BARNET · LONDON N.11
Telephone: ENTerprise 2226/7 Telegrams: Wyndreco, London

33 GNS two track
35 GNS four track

AMATEUR TAPE RECORDING

VIDEO & HI-FI

*Gives the
amateur the
professional
touch . . .*

In this issue :

Velocity of Sound	8
Acoustics Without Tears	10
Pictures on Tape	12
How Magnetic Tape is Made	14
Sound Scene	21
ATR'S INVITATION TO THE 1964 INTERNATIONAL AUDIO FAIR	23-30
Under Review	33
Circuits For Home Constructions	36
Tape Directory	38
Val Parker's Tape Parade	40
Tape Club News	42
Strictly Feminine	45
The Things You Say	47
Approved Dealers	49
Classified Advertisements	50

Editorial Office:

Room 538, Ulster Chambers,
168 Regent Street, London, W.1.

REGent 4833/5

Advertisement Office:

Room 532, Ulster Chambers,
168 Regent Street, London, W.1.

REGent 4833/5

Editor: F. C. Judd, A.Inst.E.

Advertisement Manager: E. McKeown

ON THE COVER

- Our cover photo this month shows a complete tape recording and playback amplifier, details of which are in our free circuit plan.

Vol. 5, No. 9

April, 1964

It's coming..... The Audio Fair, of course!

Early this month will see a constant stream of people passing through Russell Square, or, to be more precise, the Hotel Russell. The reason for this is obvious—it's Audio Fair time. And time for anyone and everyone the least bit interested in the world of audio to increase their knowledge in this sphere. And for those who are already well acquainted with this life, to bring themselves right up to the minute with the latest news about it.

Amplifiers, tape recorders, loudspeakers, discs and tapes are but a few of the many products which will be exploited in their full glory on this occasion.

This month A.T.R. invites you to kindle your interest in the Fair by giving you a preview of some of the objects which will be displayed, and on the centre pages we have a plan of the stands for your own personal guide.

Don't forget that we, too, have a stand. It's number 34 and we shall be delighted to renew old acquaintances and meet new readers of A.T.R.

So don't miss the Audio Fair—and more important—don't miss us!

The title *Amateur Tape Recording & Hi-Fi* is registered at Stationers' Hall, London. Contents are copyright and may only be reproduced by permission of the Proprietors. Signed articles represent the views of the authors and are not necessarily those of the Editor.

April, 1964

7

THE • VELOCITY • OF • SOUND

THE measurement of the Velocity of Sound through air and other media is an interesting problem, and the variety of methods outlined in various text books indicate quite clearly the difficulties involved. For example, temperature, humidity, the density of the air and the distance over which the measurement is made, all have some effect on the actual velocity. Newton, for instance, obtained a figure of 979 feet per second, which he later modified to 1,142 feet per second because he had not taken the structure of the air into account or the amount of water vapour it contained.

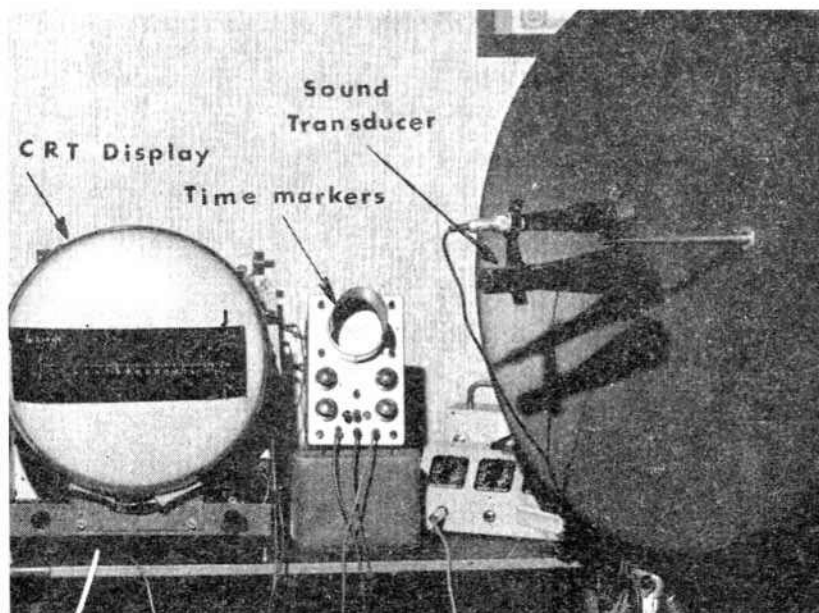

FIG. 1 — Equipment used for measuring the velocity of sound.

METHODS EMPLOYED BY EARLY SCIENTISTS

The most simple method for experimentally determining the velocity of sound is to time its passage over a given distance. This method was used in the 17th century by noting the difference in time of arrival of the flash from a gun and its report. This produced a velocity of 316 metres/second or 1,016.88 feet/second, but from a series of canon-firing experiments in 1660 a figure of 361 metres/second or 1,161.698 feet/second was obtained.

In 1704, an experiment was made over a measured mile which yielded a velocity of 348 metres/second or 1,142 feet/second. Not content with such wide variations, our canon-firing experts made further tests in 1738 over a range of 17

to 18 miles and obtained yet another reading, this time of 332 metres/second or 1,069.476 feet/second. It was eventually decided that these inaccuracies might be due to 'personal errors', so further tests over a distance of 2,850 metres were made. The method used is not given, but was presumably gunfire of some kind, from which yet another figure was obtained, namely, 330.7 metres/second.

MORE ACCURATE METHODS

Still not satisfied, scientists turned their attention to the use of what might be described as a microphone, but which consisted of a stretched membrane coupled to a sensitive indicator, the idea being to avoid the personal error. This, however, was suspect because of the inertia of the membrane, and to overcome this a 'hot wire' microphone was

used. This device consisted of a thin resistance wire heated by an electric current and inserted in one arm of a Wheatstone bridge.

When the wire cooled by the presence of the compressed air from a sound wave, the balance of the bridge was instantaneously (not by modern reckoning) upset and indicated so by a galvanometer. From this perhaps more scientific approach figures of 330.9 and 337.4 were obtained, but still objections were raised to the methods employed.

MORE RECENT EXPERIMENTS

Around 1921, a completely new method was tried, using 'stationary waves'. The principle involves measuring the distance between successive nodes in a stationary sound wave formation in free air and from this calculating the wavelength. Six sets of observations gave a final figure of 331.44 metres/second.

From here we progress to measuring the velocity of sound in 'enclosed pipes', to overcome the effects of open air and where temperature and humidity can be controlled. From this method a value of 338.74 metres/second was obtained, but corrected later to 330.331 metres/second. This was because of temperature and humidity, etc., but later yet another correction was made, this time to a more probable value of 333.1 ± 0.1 metres.

Further experiments entailing the measurement of wavelength within an enclosed tube produced yet more values, namely 343.4 metres/second through dry air at 18° C. and 387.3 metres/second through dry air at 100° C.

IS THERE A TRUE VELOCITY ?

The apparent answer to this is no, at least there is no constant velocity, but it would certainly appear that the true velocity can only be that actually measured under a given set of conditions. Most of the general references to the speed of sound quote 1,129 feet/second in dry air at 20° C. If the formula:

$\text{Velocity} = \text{frequency} \times \text{wavelength}$
is used we get a value of 1,130 feet/second, and one assumes that a correction for temperature and/or pressure and or elasticity of the air has been applied. ($\sqrt{E/P}$). (Newton).

THE VELOCITY OF SOUND OVER SHORT DISTANCES

Not being in a position to fire cannons over measured miles, I decided that a more modern technique might be interesting to apply, and accordingly employed a cathode ray tube as a time measuring device, together with equipment that could be set up within the confines of a small laboratory. Most of

THE VELOCITY OF SOUND

by F. C. JUDD, A.Inst.E.

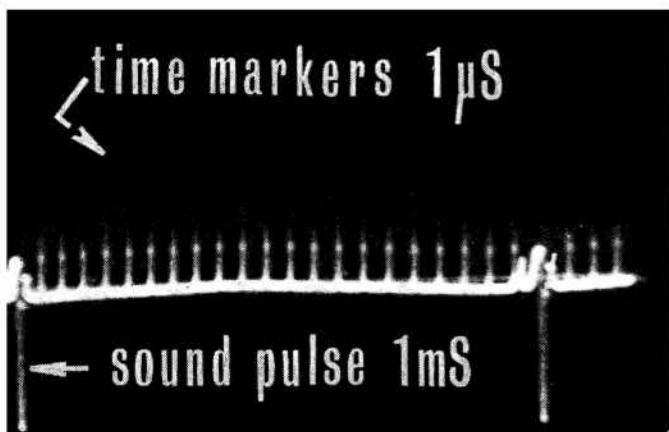

FIG. 2—Oscilloscope display of the sound pulse and time markers. The sound pulse frequency is 50 c/s. Marker recurrence frequency is 1,150 c/s.

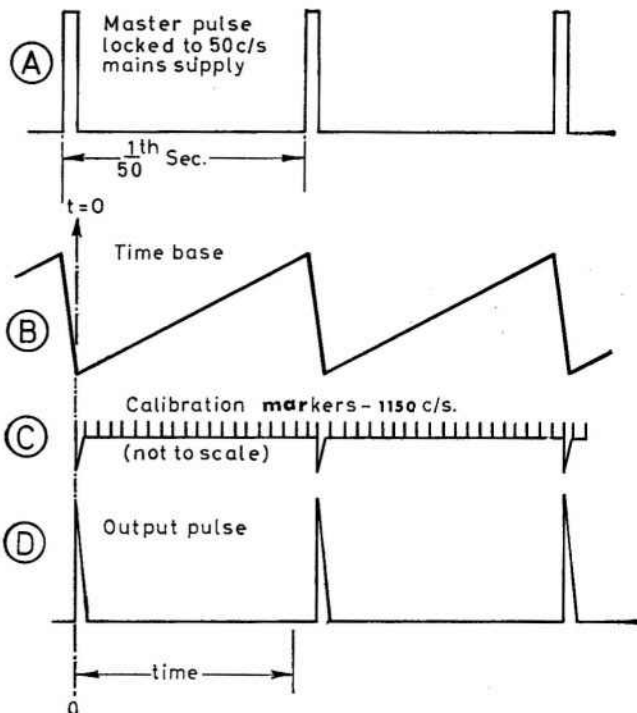

FIG. 3—Relationship of sound pulse, time base and time markers. A—Master pulse; B—Timebase waveform; C—Time markers; D—Output pulse to sound transducer.

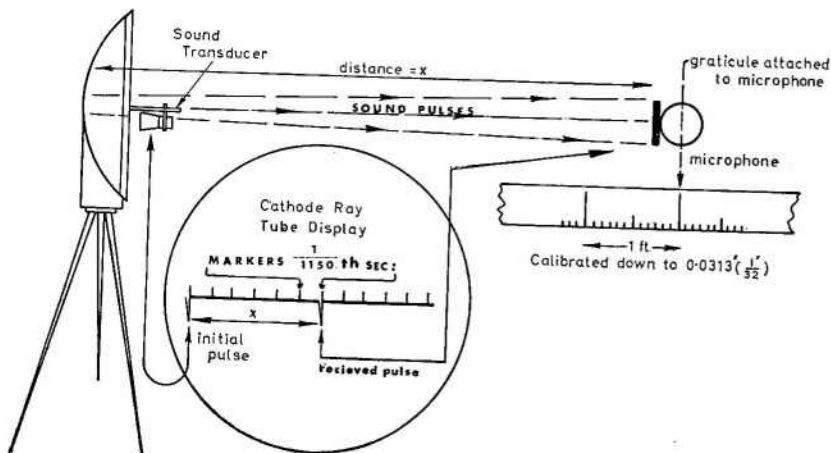

FIG. 4—System for measuring distance and comparing with time markers having a precise interval of $1/1150$ th of a second

this is shown in the photograph, Fig. 1, and the principle is simple enough.

By this method, part of the distance over which the sound pulse was made to travel could be set against time markers of accurately known frequency. The frequency chosen for the markers was 1,150 cycles per second, each marker lasting for only one-millionth of a second (Fig. 2). This overcame the problem of microphone and loudspeaker diaphragm inertia, since the distance could be set against any part of the leading edge of a transmitted and received sound pulse (see

Fig. 3).

Assuming the velocity to lie between a given maximum and minimum, say, 1,000 and 1,200 feet/second, the microphone was arranged to move over a distance of up to 14 inches or so. Using a closely graduated rule and a fine graticule (attached to the microphone as in Fig. 4) it became possible to measure the movement of the microphone to an accuracy of better than $1/32$ nd of an inch. An example reading might be $12 \frac{1}{16}$ th inches, or 1.0052 feet. The velocity would therefore be $1,150 \times 1.0052$ or 1,155.98 feet/second.

All kinds of experiments were carried out with this equipment, even to using it as a 'sound radar' system and measuring the time taken for an echo to return from a given distance. The travelling microphone gave the most accurate results, but like many others who have tried to fix the velocity of sound, I, too, found this impossible. For instance, the velocity of sound close to its source, irrespective of the condition of the air, is higher than the nominal velocity. This experiment was repeated several times with the same results, which are as follows:—

Microphone distance from sound source	Measured velocity in feet per second
3 feet	1,191.86
5 feet	1,173.92
6 feet	1,161.96
7 feet	1,155.98

(Room temperature approximately 70°F — Air: very dry).

Finally, a measurement was made at 9 feet, and although repeated several times, gave a figure of 1,159.54 feet/second. In this instance, however, the room temperature was lower and the air slightly moist.

Although there may be small inaccuracies due to personal error, in observation of the cathode ray tube, etc., the figures quoted above are in themselves sufficiently accurate to show that the velocity of sound is not a constant and is greatly influenced by various other factors.

ACOUSTICS WITHOUT TEARS

A regular feature by A. Lester Rands that explains in the simplest forms, acoustics to the beginner.

Resonance and Vibration

RESONANCE generally means the response of an object capable of mechanical vibration to a tone produced by some other means such as a musical instrument. We are all familiar with the stories of violinists who can shatter wine glasses when a note played on the violin is exactly in pitch with the natural pitch of the glass. We say that the wine glass has *resonance*. The term applies equally to tuned electrical circuits such as those in a radio receiver which can be made to respond or resonate at the frequency of the transmitting station to which they are tuned.

Vibration is the actual movement of that which is set in motion, for example in the plucked string of a violin. This is called *free vibration* but it is also possible to subject a vibrating system to another periodic force, for instance if you take an empty bottle and blow across the top it will emit a note of 'free vibration'. The bottle is now tuned to produce a note about a semitone higher by adding a small quantity of water. Now strike a tuning fork of the same pitch as the original 'free vibration' of the bottle and hold the fork to the neck of the bottle. The air in the bottle will be set in motion and emit a sound having the *same pitch* as the tuning

fork and not that of the bottle. This is 'forced vibration,' and yet another example is when marching soldiers are instructed to 'break step' when crossing a bridge. There is the danger that the rhythm or frequency of the steps should coincide with a mode of vibration natural to the bridge.

An Experiment in Resonance

If you have not thrown away your Christmas tree decorations you may find among them some small coloured glass spheres with an

opening at one end that carries a metal cap and hook. These spheres vary in size from about $1\frac{1}{2}$ " to around 3" in diameter (see *Fig. 1*).

When the metal cap is removed it leaves a short neck with an opening and the sphere becomes a perfect 'Helmholtz' resonator. When a tone of the same natural frequency of the sphere is played the sphere will itself emit a tone of equal pitch. Those who possess an audio signal generator can carry out this experiment quite easily.

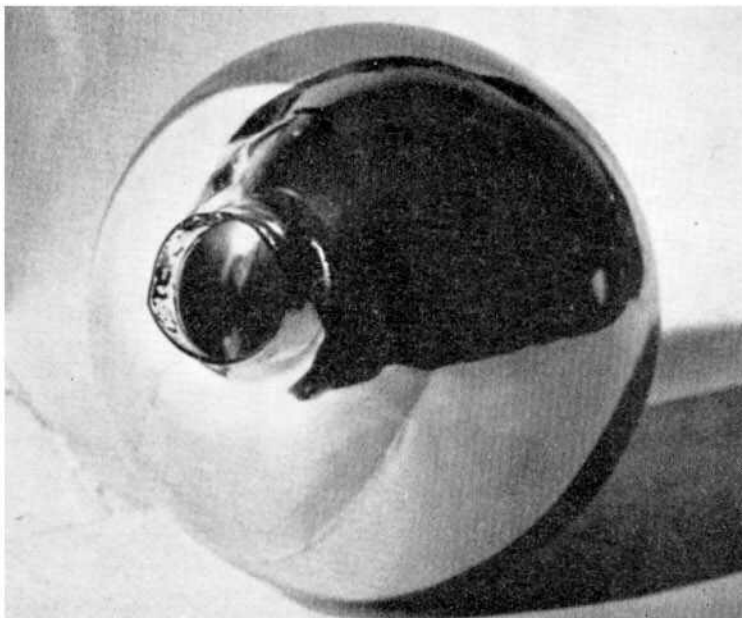

● Fig. 1. A glass Christmas tree decoration makes a perfect Helmholtz resonator.

ACOUSTICS WITHOUT TEARS—continued

Sound has Energy

Helmholtz (1821-1895) made use of these glass resonators for his analysis of musical sounds but the same kind of sphere can also be used to demonstrate that sound has energy. The model shown in Fig. 2 consists of a small glass resonator (Christmas tree type) attached to a freely rotating support suitably counterbalanced with a small weight. The rotating support is set upon a vertical needle point. When a tone of the same frequency as the natural pitch of the glass sphere is sounded, the assembly will rotate. In my original experiment the tone from an audio signal generator was fed into a 10 watt amplifier and the sphere was placed close to the loud-speaker. The 'energy' comes from air pressure set up by the loud-speaker cone associated with the un-

balanced pressure on the interior wall of the resonator, opposite to its open end. The effect is called 'acoustic repulsion' and a quite rapid continuous rotation can be obtained if two or four resonators of the same size are mounted on a four arm mill.

Another phenomenon due to the energy of sound is that of an apparent change of pitch when a tone is intensified with a generator and amplifier this can be demonstrated quite easily. Feed a tone of about 400 c/s. into the amplifier but reproduce at low level. Now turn up the volume until the level is some 10 times greater. Intent listening will reveal that the pitch of

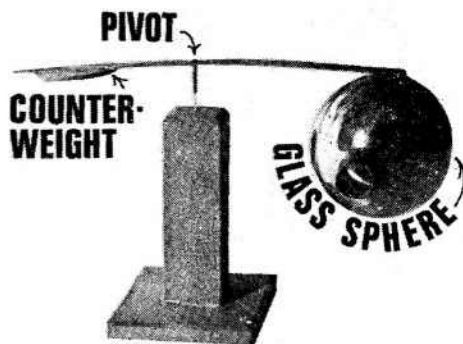

● Fig. 2. Experiment to demonstrate acoustic repulsion.

the tone has increased. The reason may be due to the higher initial velocity of an intensely loud sound. The experiments by F. C. Judd described in his article this month may well bear out the above phenomena.

Professional Performance

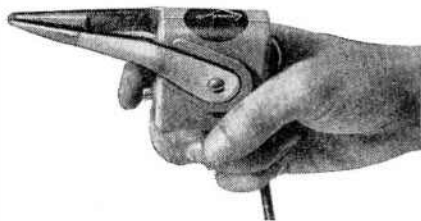

Head De-magnetiser

De-magnetises tape heads quickly and simply. Also for pin-point erasing on striped film and tape recordings—removes local unwanted noises

without detriment. Has nylon-cushioned twin probes with a concentrated demagnetising field in the 1/8" gap between the arms. Pistol grip. A.C. mains. Professionally designed for professional recording engineers. £2.10.0.



Tape Eraser

Erases both sides of a 7" tape reel in 30 seconds and positively removes even the very low frequency portions of

a recording. Use the WAL Tape Eraser, the only way to ensure an *absolutely* clean tape—quicker and better. Mains operated. Also erases sound from 16 mm. film, 10" aluminium reels. Professionally designed for professional recording engineers. £6.18.6.



Pre-amplifiers

WAL pre-amps are made for every purpose. Fully transistorised, battery-operated, give high gain, completely hum-free. Laboratory built and fully tested. Professionally designed for

professional recording engineers. Ask for details of WAL-GAIN Mono £5.10.0. STEREO WAL-GAIN £7.10.0. and the superb WAL HI-GAIN with built-in switched equalisation for monitoring, dubbing etc. etc. £7.16.0.

Free leaflets available on these professional aids to perfection . . . please write:

ELSTONE ELECTRONICS LIMITED
Edward Street, Templar Street, Leeds 2.



The last in our present VIDEO series by GORDON KING, Assoc.Brit. I.R.E. The video articles that will give you a glimpse into the future of tape and video recording.

THE vivid display of a technical breakthrough lies not only in taking full advantage of modern electronic techniques but in marrying this advantage to the needs of the time. Moreover, the right time is often when a number of technical developments reach fruition together.

In the context under discussion, for example, the development of tape, of tape heads, video circuits and applied mechanics must all meet to make video tape recording a feasible proposition.

If one is lacking, then the project cannot be concluded. It is often the small development unit which is most sensitive in

ordinary television signal to display the pictures on the domestic receiver. This idea is now really catching on, and it would seem only a small step from this to putting a picture on-tape for display at some other time.

Some of the problems involved were considered last month, such as "capturing" the high frequency components of the picture signals so that a picture of good definition can be obtained, and of tape speed.

Nevertheless, we have readily available for amateur use a vision signal from the output of a television camera, corresponding to the sound signals that one gets from the output of a microphone. The step into the future, then, is to arrange some device for the recording of the vision signal on magnetic

PICTURES

determining when the time is ripe to strike, for such a unit is trained to think beyond the existing stage of development along a specialised channel.

The project equation is always fully visible to the unit as a whole, and as soon as the missing factor becomes available the project can be switched on without delay. So it has been with the recent developments in the field of domestic video tape recording.

TV CAMERA

Of recent months there has been considerable interest in closed-circuit television from the amateur's point of view. Vidicon camera tubes have dropped from about £60 to the £10 mark, the latter being highly suitable for experimentation, though slight shortcomings may exist on the target area.

The design of television cameras has been for plugging into the aerial socket of a television set. The video signal from the camera, as we saw last month, is modulated upon a carrier wave generated by the camera circuits at a frequency corresponding to one of the television channels. It is thus possible to use the output of the television camera as an

tape—in a similar way to the recording of the sound signal. Last month the differences between the vision and sound signals were highlighted.

DISPLAY ARRANGEMENTS

Let us assume for the time being that we have been successful in recording the vision signal of a scene picked up by our inexpensive camera system. How, then, can we arrange for its display? One very convenient way is, again, to use the domestic TV set as the display medium.

Let us look—non technically—into a TV set for a moment. We have the vision detector from which is produced the vision signal with a characteristic similar to that present at the output of the television camera. This signal is applied to what is called the 'video amplifier'. Vision-wise, this is comparable to an AF amplifier. It magnifies the weak picture signals to a level which is suitable for working the picture tube in the set. The video amplifier is similar to the amplifiers in an ordinary sound tape recorder, but the response of the latter rises only to 12/15 kc/s while that of the former is up to 3 Mc/s or more. While the amplifiers of a sound channel are designed ultimately to operate a loudspeaker, those of the vision channel are designed to operate the picture tube.

It is easily possible to disconnect the feed from the vision detector to the video amplifier in the TV set and apply to the amplifier the **replayed video signal**. In that way we could secure a display on the picture tube of the domestic set of the scene at which the camera was 'looking' when the recording was made.

There would be no great difficulty in fitting a simple change-over switch in the set to change from one signal source to the other, and this would be akin to the 'radio/gram' changeover switch fitted to some radio sets. In the 'radio' position the signal from the detector is directed to the audio stages while in the 'gram' position the audio input is connected across a pair of sockets into which is fed the pickup signal.

Clearly, then, TV sets of the future will almost certainly incorporate a 'TV/video tape' switch so that the output of a video recorder can be connected to a coaxial socket in rather

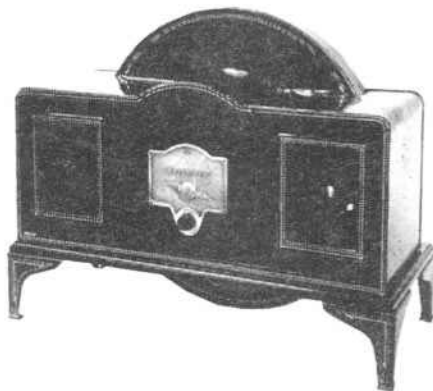

LEFT: The early Baird disc scanning televisor (circa 1930). Video (?) signals for this could be recorded on any present day standard domestic tape recorder.

the same way as a pickup can be connected to a radio set. Fig. 1 shows the basic circuit arrangements and Fig. 2 compares the video channel to a sound channel.

VIDEO-MODULATED RF OUTPUT

It will be understood, of course, that the video signal output from a video tape record would not be suitable for connecting direct to the aerial socket of a TV set. A signal suitable for this application is obtained only by the modulation of the video signal upon an RF carrier at the frequency of an unused TV channel.

While this technique is employed in amateur type closed-circuit TV systems successfully there is nothing to prevent its use in video tape replay systems. The idea then would be to remove the ordinary aerial lead and in place connect the RF output from the video tape recorder. This would be extremely convenient to start with, since there are no existing sets or current models with a video input socket and switch (that is, of the domestic variety).

One big application of video tape recording will be the recording of both the sound and vision of a television programme for future replay. The sound will be recorded by extracting suitable audio signals from across the sound detector in the normally accepted manner. The vision signal likewise would be extracted from across the vision detector load and fed to the video circuits of the recorder through compensating circuits. Eventually, therefore, domestic TV sets could

have two signal output sockets, one for vision and the other for sound.

At the moment video recording is somewhat more complicated than merely picking up a composite video signal from across the detector load of a TV set, amplifying this and then applying it to a record head (as with sound). These complications demand the integration of the recording mechanism with the vision (or TV) receiver.

The problems are highly technical but we will be dealing with them in subsequent articles. Several patents of the Telcan, for instance, relate to the signal part of the system.

Our first video tape recorders will almost certainly use 1/4 in. tape of the triple play variety, probably of a somewhat more advanced nature than that used for audio work. The tape speed will also be well above that expected audio-wise. The Telcan, for example, runs at 120 in. per second for maximum definition. This gives a playing time of 15 minutes on triple play tape and 20 minutes on quadruple play tape. On two tracks the time is doubled in each case, of course, and we shall first see domestic video recorders using the dual track principle.

SOUND PLUS VISION

Remembering that sound is needed as well as vision, there will probably be two pairs of dual tracks (e.g., quarter track principle), giving sound with vision in each case.

In past articles in these pages we have seen that commercial video tape recorders use some method of 'scanning' the tape with the head across its width, thereby accelerating the speed

ON TAPE

by
Gordon J. King

of the tape past the head while retaining a reasonably linear tape speed from spool to spool. This method has very much to commend it, but is extremely costly and at present far outside the range of the domestic market. However, the price of this sort of machine is falling, for a Japanese model was recently developed (by Sony) and costs about £4,300 (compared with £25,000 of the previous studio instruments).

The Sony model is relatively portable and can be carried by one man (weight 75 pounds), and thus falls in a category between the studio models (which are rack and console versions) and the domestic machine, such as the Telcan. It uses 2 in. tape as distinct from standard 1/4 in. variety. Wide tape is needed because of the scanning system, and that adopted by Sony incorporates two heads which rotate so that the width of the tape is scanned in the time of one television field (frame). The head thus works at 3,600 r.p.m. and the life is 1,000 hours. This sort of machine should not be more difficult to operate than any good hi-fi sound recorder. This is mainly because the speed of the tape is 5 1/2 in. per second (linear). An hour's recording can thus be accommodated on a 7 in. spool, and the technique allows for 'butt splicing'.

There is every reason to believe that the scanning technique may eventually be simplified, but because the rotation of the heads has to be synchronised to the field frequency of the television system and that microseconds of tolerance are involved, it seems as though some time will have to elapse before the technique will be a part of domestic models.

For a start, therefore, we shall have to be content with very high tape speeds and some limitation in picture definition and stability.

LEFT: Top picture is Fig. 1. A basic circuit showing how a TV/Video tape switch may be wired between the vision detector and the video amplifier. A co-axial socket is used to inject the video input from the tape recorder replay channel to the video amplifier. In practice, the circuit needs to be considerably more advanced than the basic arrangements shown, in order to process the video signal properly.

BOTTOM picture is Fig. 2. The comparison of a video channel at (a) with an audio channel at (b).

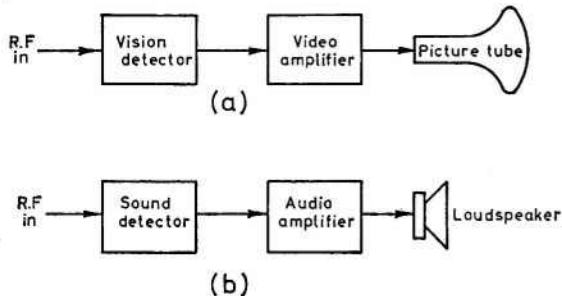
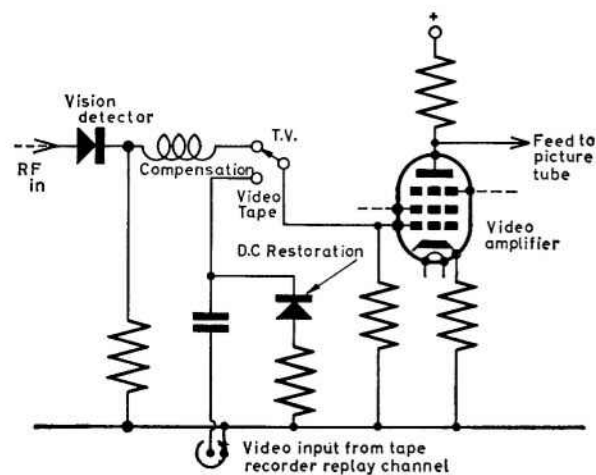

HOW MAGNETIC TAPE IS MADE

A VISIT TO THE KODAK FACTORY WITH

JOHN COURTNEY

WE take magnetic tape pretty much for granted these days, but little realise the tremendous amount of research and development that has been carried out to achieve the high standard of present day magnetic tape. The highly critical processes involved in manufacturing are quite staggering; for instance, more than 100 quality control tests are made on every batch of tapes: tolerances are measured in millionths of an inch and many operations have to be carried out in a 'surgically' dust-free atmosphere. Before we begin our tour of the factory, however, let me explain very briefly the major stages in the manufacture of magnetic tape.

In a basic sense, making tape consists simply of applying a coat of magnetic iron oxide to an acetate, PVC or polyester base. The manufacture of tape is very similar to that of photographic film. In photography, silver halides are applied to a flexible base and used to record a visible image composed of light and shade. With magnetic tape the iron oxides are applied to a similar base and record sound as a series of 'magnetic patterns'. The measurable factors associated with film, such as speed, fineness of grain, latitude and uniformity have their counterparts in tape terminology, and on these are based the many searching tests that a tape will undergo before it is despatched to the user.

There are four major steps in the manufacture of tape: (1) Making the iron oxide emulsion; (2) Coating it onto the base; (3) Slitting and winding the finished tape; (4) Testing and certifying the finished product.

MAKING THE EMULSION

The iron oxide particles may be compared with the 'grain' of a photographic film. If the particles are not uniform in size or are clumped together, the quality of the recording will be adversely affected. On the other hand, if the particles are small and evenly dispersed throughout the coating, we have the 'musical equivalent' of a fine grain film negative.

To ensure this, all raw materials going into the iron oxide emulsion are first run through a gamut of chemical, physical and magnetic tests. The iron oxide is checked for size, distribution and chemical purity and after conversion to the proper magnetic 'form' is again checked and evaluated for magnetic properties. In the same way, binder resins, lubricants, special additives and solvents must also pass strict chemical and physical analysis before being released for production. Once these carefully 'finger-printed' components match the formula specifications, they are placed in a 'ball-mill', a large cylinder containing more than two million steel balls — where they will be made into the super-fine emulsion which will be applied to the tape base. (Fig. 1).

← Fig. 1—Before a batch of iron oxide is released for production a sample is ground in a laboratory-sized ball-mill. If the iron oxide emulsion comes up to standard in this and other tests, the batch is released for milling in a production size ball-mill.

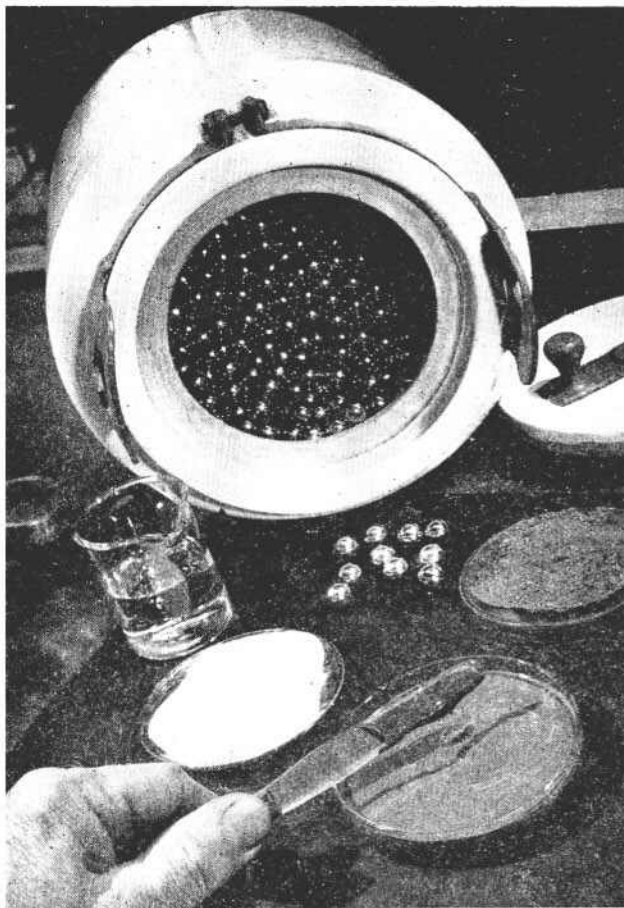

Fig. 3—Equipment for pulse testing of tapes: → one of the many 'electronic' tests that tape undergoes during processing.

As the ball-mill revolves, the ingredients are blended into a homogeneous emulsion and, just as important, the individual microscopic particles are separated and coated with a protective layer of resin binder to ensure a 'fine-grain' highly-sensitive recording.

COATING

From here we go to the coating operation, where a roll of triacetate PVC or polyester base is cleaned and maybe given a special pre-coat to facilitate adhesion. A lubricant backing is also supplied which works in conjunction with the lubricants in the magnetic layer and finally, the base is ready for the application of the iron oxide emulsion.

This is applied with special equipment having critically close mechanical tolerances so that when the tape is ultimately used, the number and distribution of magnetic particles passing the record/playback head remains absolutely constant. The tape heads scan the magnetic particles as one would view a picket fence when passing in a motor car or train. Any variation in width, spacing or height would immediately become apparent. With tape, only absolute uniformity is acceptable.

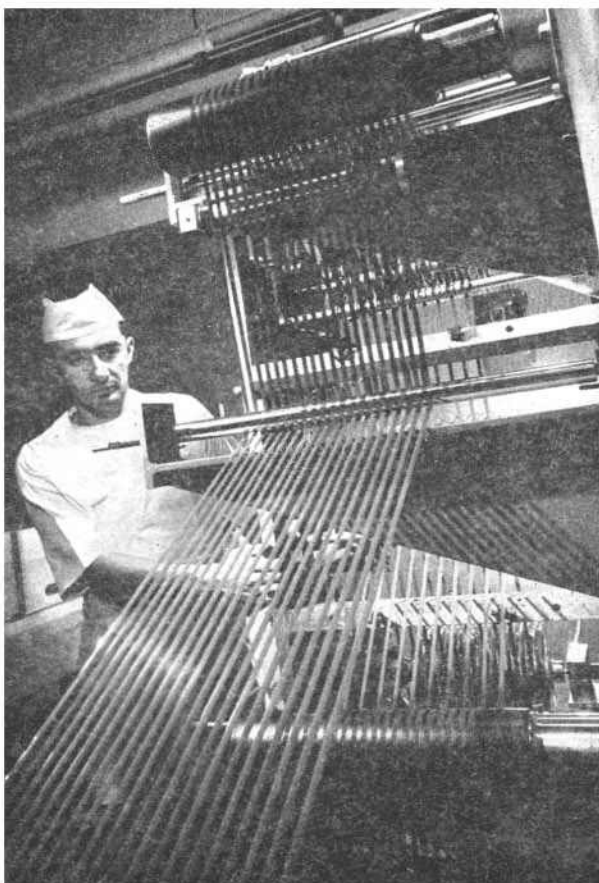

After the base has been coated, but before the emulsion is completely dry, the tape is passed through a strong magnetic field to orientate the iron oxide particles. Each particle then becomes an individual 'magnet' and the orientation tends to align each one north pole to south pole, like a long goods train. Once the tape dries, these particles can no longer move physically, but when a recording is made the impulses from the recording head will change the direction and strength of magnetism so as to form patterns corresponding to the frequency and strength of the impulses from the head. When the tape is replayed, these variations in magnetism reproduce the impulses as minute currents in the replay head which are in turn amplified.

SLITTING AND WINDING

Next comes the stage where the tape is slit into the familiar $\frac{1}{4}$ " wide strips cut to length and wound on to spools (Fig. 2). Although the finesse and uniformity of the emulsion determines the best performance that any tape can give, it is the extreme care in these last stages that assures the user of high recording quality, mechanical strength and smooth running on the tape recorder.

TESTING

As much a part of manufacturing, perhaps even the most important part, is the continuous testing throughout the processing to ensure absolute uniformity. As we have seen, all the raw materials are analysed before they are combined to produce the finished tape. For example, whilst the magnetic emulsion is being made, a succession of tests are conducted to make sure it is up to standard.

← Fig. 2—After the iron oxide coating has been applied to the base, the master roll is slit in $\frac{1}{4}$ " lengths and wound onto spools.

During the coating process, samples are checked frequently for uniformity of thickness, surface quality, and all of the physical properties. A series of 'electronic' tests provides further control data during this process, and in all nearly 100 'quality' tests are carried out before the master rolls are slit into 4" lengths.

After the tape is made, sample cuts are run through specially-designed electronic test equipment that can measure and evaluate sensitivity at several audio frequencies, check output and third harmonic distortion, modulated noise level, signal to noise ratio, saturation point and uniformity. Needless to say, this equipment, some of which may be seen in the photograph (Fig. 3) is far more critical than the tape recorders on which the tape will ultimately be used.

Sample reels of tape are also given microscopic examination to check edge smoothness, uniformity of width, absence of dust or dirt, and evenness of winding. Every spool of Kodak magnetic tape is also examined individually by reflected light to check on general appearance, the winding, cleanliness and the reliability of test samples.

WHY THIS EXTENSIVE TESTING ?

This may be more apparent when we consider that the iron oxide layer — on which the quality of a recording depends — is only 0.0004 inches thick: about one-quarter of the thickness of a human hair. Even this is a pretty rough figure in the microscopic world of tape manufacture, because this thickness must be maintained to within less than 20 millionths of an inch, a measurement about equal to the diameter of a common bacterium.

It should be remembered, however, that quality photographic film manufacturers like Kodak have been working to these tolerances for years. Kodachrome, for instance, has three combined layers equal in thickness to a single layer of iron oxide, and to make a very exotic comparison, a colour inter-negative has fourteen layers that together are only twice as thick as one magnetic recording tape layer! It is because of this experience in critical coating processes that Kodak are able to manufacture magnetic recording tape with such precision and high quality. So, finally, let me explain something of the features of a high quality tape and what they mean to the user.

SENSITIVITY

This is similar to the rated speed of photographic film and is of particular importance to the amateur whose tape recorder has only a constant maximum input to the tape. With a tape of high sensitivity the amateur will obtain an improved signal to noise ratio, better high frequency response, and a higher output.

FULL FREQUENCY RESPONSE

The frequency range that can be recorded on magnetic tape is similar to the range of colour sensitivity of film. The demand for tape with a good high frequency response in both professional and amateur fields has been increased very considerably due to improved design in record and playback heads and of tape recorders generally. Kodak tape satisfies this demand by careful choice of oxides, smoothness of the coating and the concentration of as much oxide as possible in the coated layer of the tape.

LOW NOISE LEVEL

No one wants extraneous noise from a recorded tape. Indeed, the noise level of a tape is one factor by which the quality of a tape is finally judged, for if anything goes wrong during the processing it will invariably show up as an unwanted signal or noise in the final tape. The answer to this problem is, of course, strict quality control at every stage during manufacture.

HIGH OUTPUT

The higher the output from tape the less susceptible it is to noise, but the objective must be to increase output without introducing distortion. This is done by packing as much effective magnetic material into the tape layers as possible, by careful blending of the emulsion, its dispersal and precise control in coating.

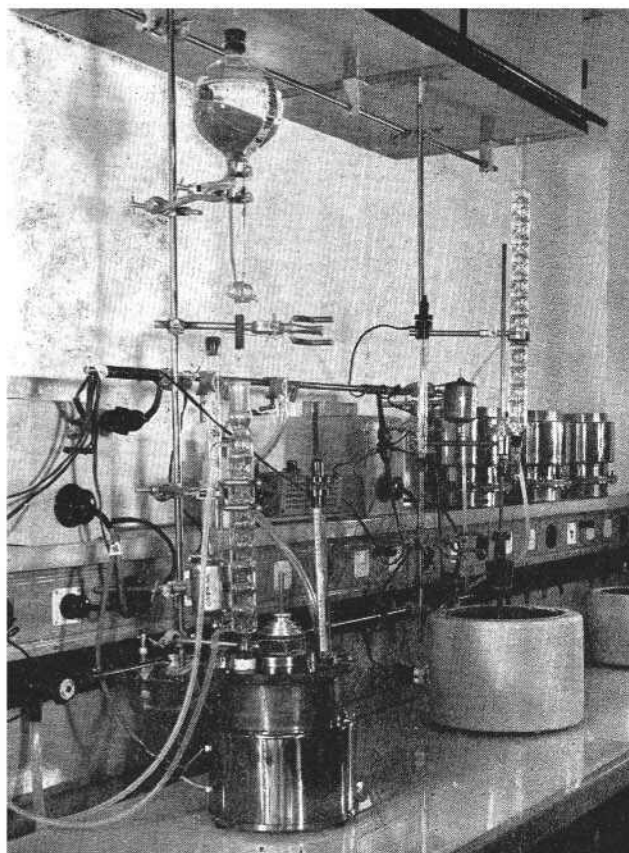

↑ Fig. 4 — Laboratory preparation of iron oxide.

HIGH SIGNAL TO NOISE RATIO

This is a scientific measurement of dynamic range — the spread between the loudest useful recording (without distortion) and the quietest level that can be achieved before the inherent noise of recording and playback amplifiers, etc., becomes predominant. This is achieved by increasing the effective output of the tape as described above and by decreasing the magnetic noise of the tape itself.

LOW PRINT-THROUGH

The problem of print-through arises when a spool of recording tape is stored for a long period and a transfer of recording occurs between adjacent layers of tape. Fortunately, the amateur has little need to worry about this because the print-through factor of a modern quality tape is lower than the inherent noise level of the recording or playback equipment. A little care in storing recording tapes in a cool place and occasionally re-winding or playing them will obviate print-through altogether.

BIAS CONTROL

All tape recorders employ a high frequency bias signal to effect a clear and distortionless recording. The frequency of the bias signal is usually about five times higher than that of the highest frequency in the audio range and is in any case filtered out during playback. Very few domestic recorders have provision for adjusting the bias level, but professional and some semi-professional recorders do have a control for setting the bias for optimum performance.

COMPLETE AUDIO REALISM

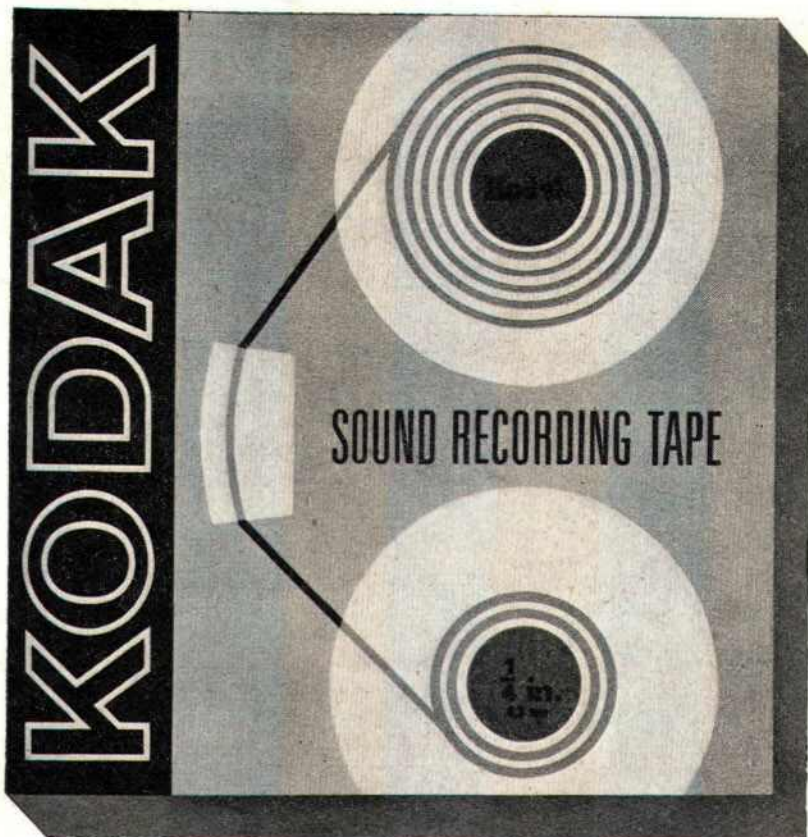

—from new Kodak Sound Recording Tape

There's never been a tape so sensitive as new Kodak Sound Recording Tape. For the first time you can capture complete audio realism. Sound so true you'll hardly believe it's recorded.

- ▶ High output sensitivity
- ▶ Low noise performance
- ▶ Full audio frequency range response
- ▶ Double-lubricated for smooth transport
- ▶ Low bias adjustment

New Kodak Sound Recording Tape is manufactured to the same super-critical standards as Kodak film. Standards that have never been excelled in any coating process. Standards that give a coating uniformity that never varies more than plus or minus 20 millionths of an inch.

There are four types of new Kodak Sound Recording Tape to suit all requirements: standard, long play, double play and triple play—the extra strong tape with the extra long playing time.

Each reel is wrapped in a polythene bag and packed in a sturdy box. A form for recording data is printed on the back of the box. Each reel incorporates a special clip which eliminates tape spillage.

Write for further details of this new tape, to Dept. T2, Kodak Ltd., Kodak House, Kingsway, London, W.C.2.

KODAK LTD.

Kodak

DEPT. T2, KODAK HOUSE, KINGSWAY, LONDON, W.C.2

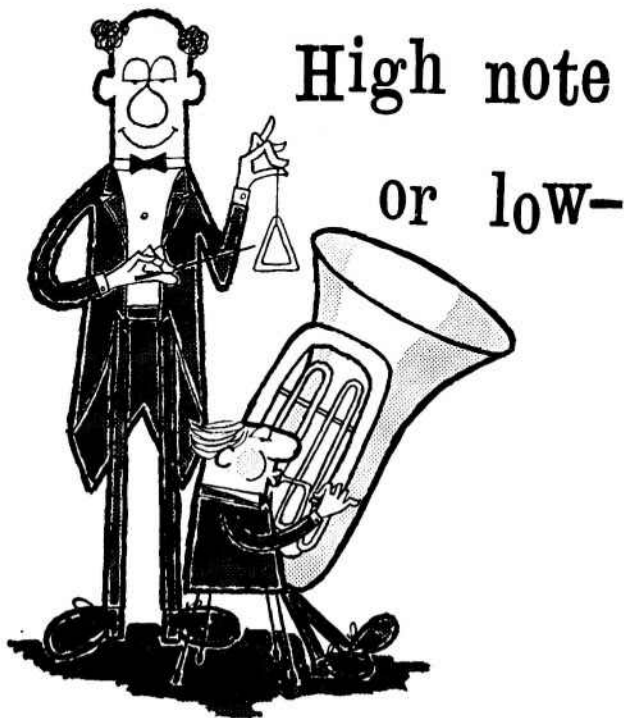

Grampian DP4

is equally sensitive to both

Here's a microphone that responds accurately to the tinkle of the triangle, the boom of the tuba and every other sound between 50 and 15,000 c/s. Uniform frequency response over such a wide range means that the reliable, medium-priced DP4 makes an essential contribution to high quality recordings.

Also for broadcasting, public address and call systems.

Low impedance microphone, complete with connector and 18 ft. screened lead £8.0.0
 Medium and high impedance models £9.0.0

A complete range of stands, swivel holders, reflectors and other accessories is available.

Write or 'phone for illustrated literature:

GRAMPIAN REPRODUCERS LTD

Harworth Trading Estate, Feltham, Middlesex. Feltham 2457



LISTEN

This is the new exciting complete 4 track stereophonic and monophonic tape recording and playback system having 2 entirely independent electrical channels in a compact carrying case beautifully styled in black and ivory. The case lid, when opened, separates into 2 complete full range speaker systems that may be placed apart for optimum stereo performance effect.

Other remarkable features include: Sound on sound recording; 2 VU meters with 2-way illumination; transistorized pre-amplifiers; individual level controls for each channel; tape counter; automatic tape lifter; pre-amp outputs; individual track selection; variable tone control; and smartly designed sensitive SONY F-96 dynamic microphones. Compact, lightweight, the TC.200 is a new hit from SONY that will surely meet the most exacting demands of discerning listeners.

MODEL T.C. 200

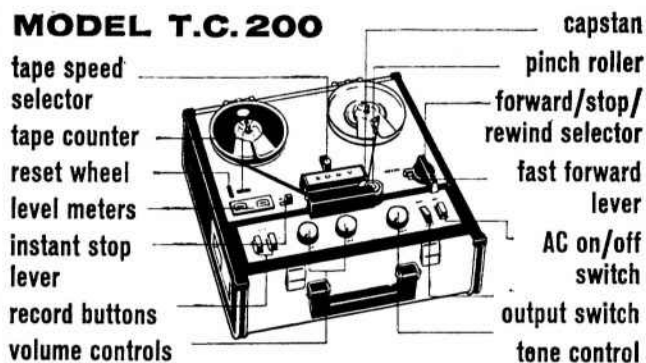

All this at **79 GNS**
 complete with every accessory

For a detailed specification write to sole U.K. concessionaires

TELLUX LTD

HIGH FIDELITY DIVISION · DEPARTMENT A.T.R. · GALLOW'S CORNER · ROMFORD · ESSEX

Amateur Tape Recording Video & Hi-Fi

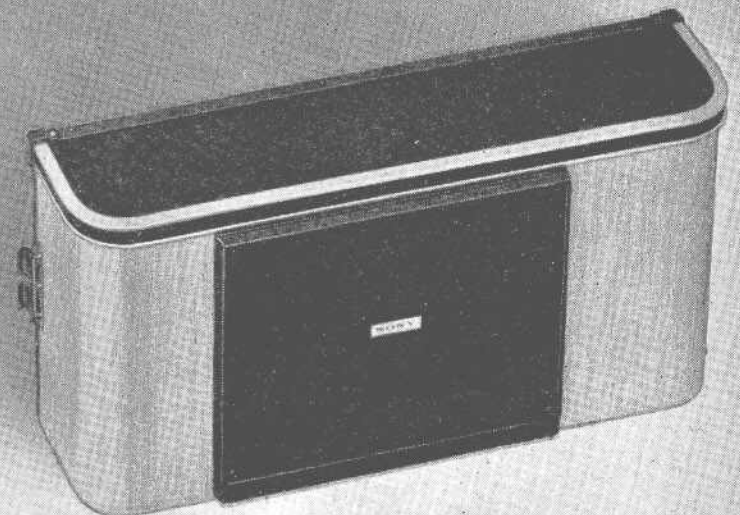
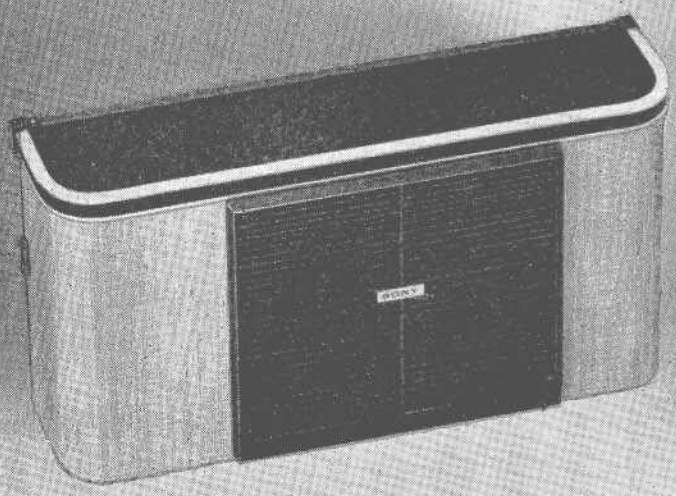

... this is the sound of

SONY® MODEL TC 200

RESEARCH MAKES THE DIFFERENCE

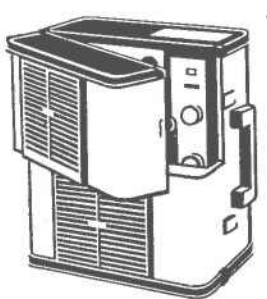
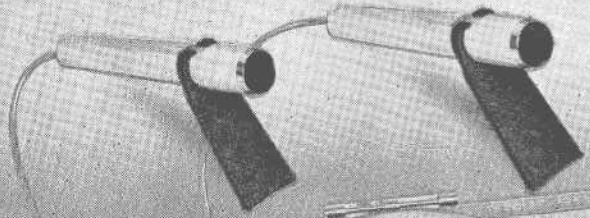

Two high fidelity speakers together form the sturdy case lid.

REVOX 736



the recorder you will eventually own . . .

Write for details and Local Stockist to :

C. E. HAMMOND & CO., LTD.

80, High Street, Eton, Windsor, Berks. Tel. Windsor 63388



SCENE . . . SOUND SCENE . . . SOU

THE page with the latest tit-bits of information on what's going on in the tape recording world.

The main news this month is, of course, the Audio Fair at the Hotel Russell on April 2nd, 3rd, 4th and 5th, but aside from a reminder this column will say no more. You'll find the main news of this in the centre section of the magazine, which has been specially devoted to this. 'Nuf said!

Bound to be of interest to all of you who run round in circles looking for the right plug to match the right lead and vice versa, is this latest pre-packaged range of lead combinations.

The leads are simply divided into two groups, input and output, a selection of which are illustrated. Any output lead can link into any input lead via a phono lead connector, giving no less than 100 different combinations from 10 input and 10 output leads.

Leads can be purchased individually and vary in price according to plug combinations. A complete set of twenty leads costs £6 6s. 6d., and the 6ft. extension lead retails at 10s. All from Tape Recorder Maintenance Ltd., 323 Kennington Road, London, S.E.11, and branches.

CLOCKWORKS

Doubtless most of you will recognise the second illustration below as the famous Guinness Clock in Piccadilly Circus, not more than a stone's throw from our offices here in Regent Street. But how many of you know that the chimes of this clock are recorded on long-play magnetic tape? As the clock chimes every quarter, theoretically the tape is subjected to over 35,000 operations a year. In practice however, with rigorous weekly testing by the manufacturers of the mechanism, this is bumped to the astounding total of 50,000 operations. E.M.I., who supply the tape, are happy to report that when the tape was renewed at the end of the year, no trace of wear or deterioration in quality was detected!

NEW MICS FROM AMPEX

A new line of professional microphones which includes two low impedance models and one high impedance model for use with Ampex audio recorders has been introduced by Ampex International Operations Inc. Model 801 is an omnidirectional microphone and is designed for use with recorders having high impedance input requirements. Models 802 and 803 are low impedance type and allow long cable facilities without loss

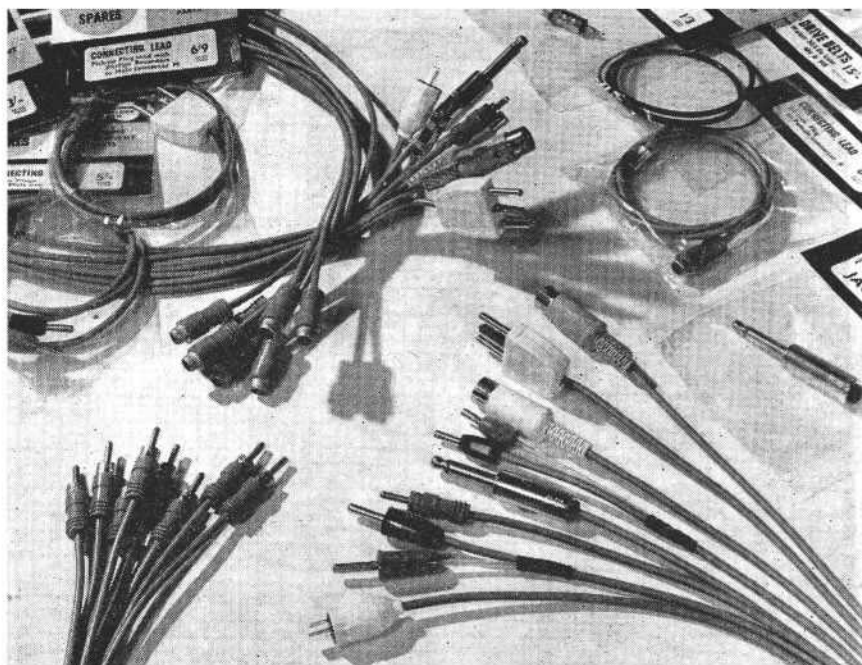

● A selection of the versatile new range of connecting plugs.

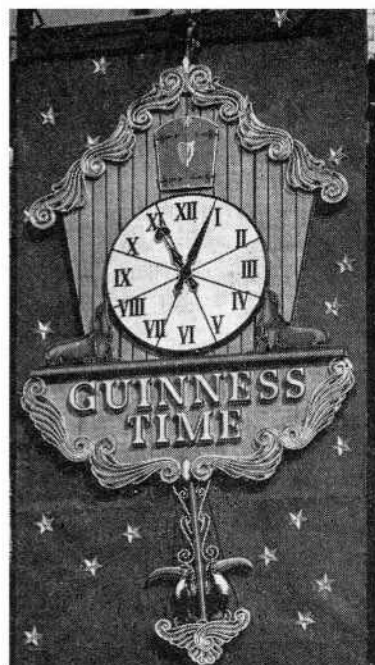

● The Guinness Clock — of course.

FREE SAMPLE OFFER

One hundred thousand reels of triple play tape are being given away free through the trade by Synchronotape. This method of bringing a product to public notice will doubtless be popular to those of us who have a budget to watch! Manufactured on a specially processed P.V.C. base, each 3-inch reel of tape has double leaders while the 4-inch tapes have both double leaders and double metallic stop-foils. Suggested retail prices are 13s. 9d. per 400ft. reel (3 inches), and 27s. per 900ft. reel (4 inches).

Synchronotape are also reducing prices of their double play tapes. A 5-inch reel (1,200ft.) will now cost 29s., 5½-inch (1,800ft.) comes down to 36s. and the 7-inch (2,400ft.) to 48s.

of high frequencies. Model 802 is omnidirectional for recording groups etc., while the 803 is a cardioid type recommended for use where external noise may otherwise creep in. Diaphragms on all three mics are made to be specially resistant to shock, blast, temperature extremes, severe momentary deformations and corrosive fumes.

B.A.T.R. CONTEST

The British Amateur Tape Recording Contest has acquired a new set of sponsors. These include Agfa, B.A.S.F., E.M.I., Kodak, M.S.S., 3 M's, Philips and Zonal, who will serve on the organising committee with Rex Hassan, Douglas Brown and Roger Aslin. The offices of the committee are c/o Audio Information Service, 42 Manchester Street, London, W.1.

The BRENELL Mark 5, Type M, tape recorder

This model has already earned a well-deserved reputation for top quality performance, versatility and reliability. It has all the renowned Brenell features plus many refinements and a quality of finish both internally and externally of the very highest order.

Spotlight on features...

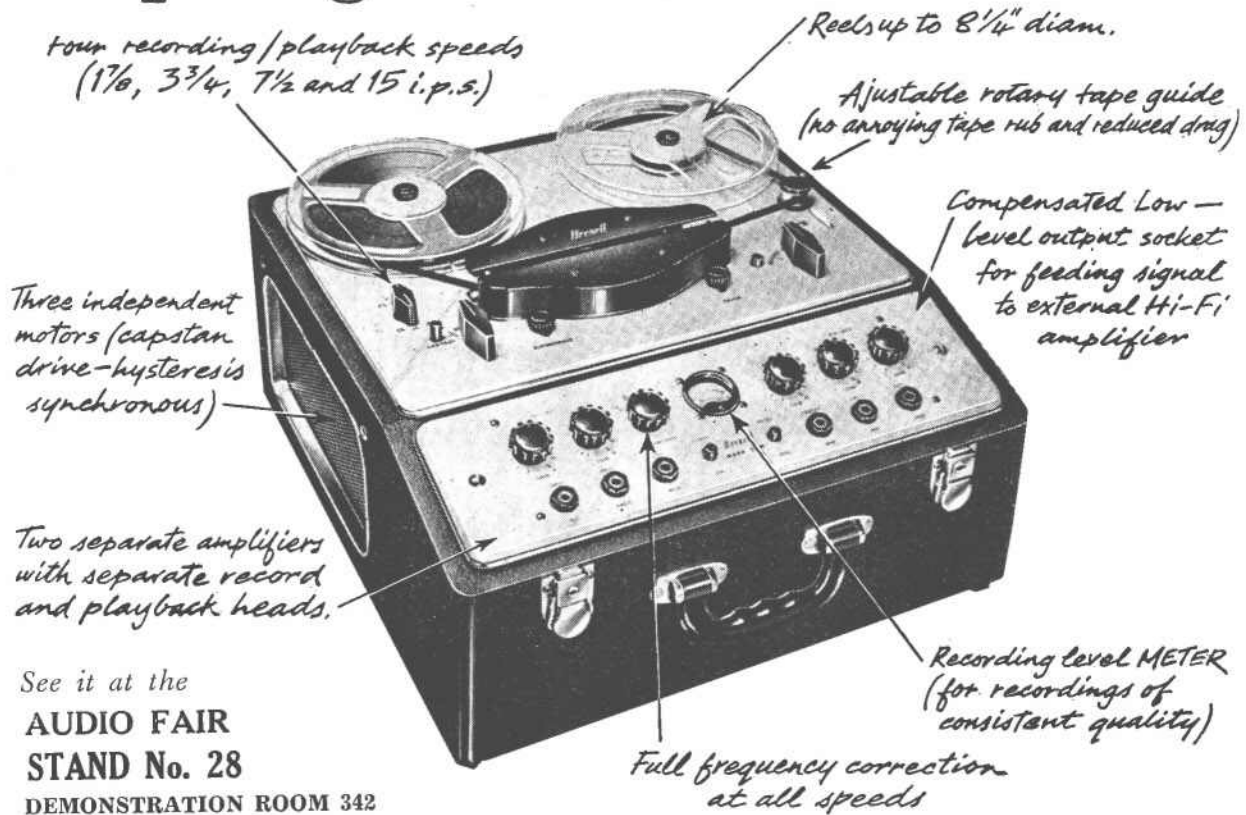

See it at the
AUDIO FAIR
STAND No. 28
DEMONSTRATION ROOM 342

plus...

For full details of the Brenell range
write to the sole manufacturers:—

Superimpose control · pause control · mixing
facilities · fast rewind (1200' in 45 secs) · Low wow
and flutter performance · Controls mechanically
interlocked · 15 ohm speaker output.

Brenell

BRENNELL ENGINEERING CO., LTD
1a DOUGHTY STREET, LONDON W.C.1.
Telephone: HOLborn 7356 (3 Lines)

A.T.R.'s INVITATION TO THE 1964 INTERNATIONAL AUDIO FAIR

*A chance for all ATR readers to get 100% with—it
in the world of Audio*

A VISIT to the 1964 Audio Fair at the Hotel Russell, Russell Square, London, W.C.I., will enable you to hear the newest and best in tape recording and hi-fi. Here you can compare amplifiers, tape recorders and accessories, loudspeakers, discs, tapes and the hundred-and-one other things in the world of audio.

The A.T.R. guide to the stands and demonstration rooms are set out here for your convenience and in addition we take you to a pre-view of some of the products that will be featured at the fair.

AROUND THE STANDS

We suggest you make a bee-line for *A.T.R. at Stand 34 on the ground floor*, for if you haven't already sent off for the last of the A.T.R. special offer sound effects records, as announced in this issue, you can purchase it directly from the Stand. *If you've missed any or all of the original offers which, incidentally, started at last year's Audio Fair, you can order these too, at the Stand where leaflets will be available.* Our Editorial staff will, of course, be in attendance and look forward to meeting you.

LEAK PRESENT THE LATEST IN HI-FI (Stand 64)

For 30 years H. J. Leak & Co. Ltd. have been engaged exclusively on research, development and the manufacture of audio frequency equipment of the highest quality. Leak gave the world the first very low distortion amplifier in 1945, and the amazingly low dis-

ortion content of the first Point One amplifier, one tenth of one per cent., is still an accepted world-wide standard. Of special interest to stereo enthusiasts should be the 'Leak Stereo 30' amplifier which caters for 'tape head' input, mono or stereo as well as pick-up, radio, etc. This is an *all-transistor equipment* with provision for N.A.R.T.B. and C.C.I.R. response for tape replay. (Fig. 1)



● Fig. 1. Fully transistorized "Stereo 30" pre-amplifier by H. J. Leak.

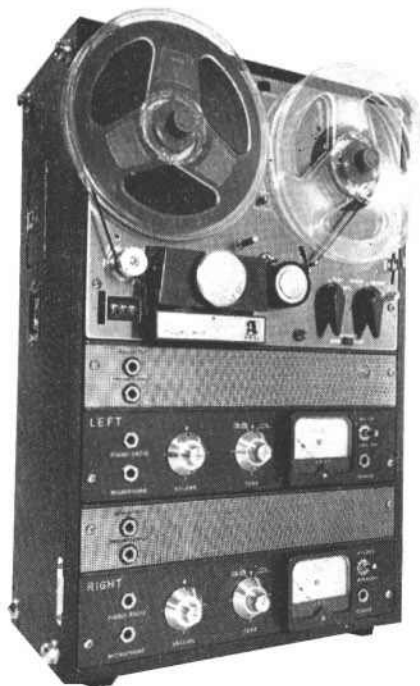

● Fig. 2. The AKAI Model M7 Stereo Tape Recorder.

ATR'S INVITATION TO THE 1964 INTERNATIONAL AUDIO FAIR

AKAI (Stand 47)

Looking for something near professional in stereo recorders? Have a look at the latest from Japan; the AKAI M7 or the model 345 should fill the bill for the highest of 'fi' in stereo. The M7 is as shown in *Fig. 2*, and costs 133 guineas.

CONNOISSEUR (A. R. Sugden) (Stand 25)

Now for loudspeakers. The 'Major' and 'Minor Mk. 2' by Connoisseur will be worth listening to (dem. room 242). Both these loudspeakers employ high efficiency foam surround speakers, the 'Major' handling 5 watts, the 'Minor' 4 watts. These are just the speakers for bringing out the best in any tape recorder. The Connoisseur 'Craftsman' transcription turntable and the SAU-1 pick-up arm might be given serious consideration by the disc enthusiasts for A. R. Sugden are of international repute when it comes to 'disc'.

LOEWE OPTA (Stand No. 10)

Highgate Acoustics will be presenting their full range of high fidelity radiograms as well as the Loewe Opta Model 414 tape recorder, as reviewed in this issue of *A.T.R.* The Loewe Opta transistor radio receivers will also be on show.

KODAK LTD. (Stand 49)

A cordial welcome awaits all visitors to the Kodak demonstration rooms, where they can hear for themselves the remarkable new 'Kodak' Sound Recording Tape. This high fidelity high quality quarter-inch-wide tape is now available in four types to meet the needs of both amateur and professional users. These new tapes have high output sensitivity, low noise performance, full audio frequency range response and double lubrication for smooth transport. They resist scratching, tearing and stretching and are made to exactly the same high standards that have always been associated with 'Kodak' films.

'Kodak' Sound Recording Tape Standard Play, designed for the amateur tape recording enthusiast is a low cost general purpose recording tape. John Courtney takes you on a tour of Kodak to see how this tape is made. (See page 14.)

FERROGRAPH (Stand 67)

The full range of Ferrograph tape recorders and accessories will be on show and for demonstration in room 337. The Model 5AN (*Fig. 3*) is the first of a new series of Ferrograph instruments having a modified capstan/flywheel assembly system providing a notably low wow and flutter content. Four-track enthusiasts demanding high quality might take a look at the Ferrograph 420 for mono or stereo recording and playback, crosstrack recording in fact everything for the ultra discriminate recordist.

GRAMPIAN (Stand 32)

A name famous for its microphones, the Grampian reflector and transistorised mixer which will be on show and for demonstration in room 237, but don't miss the Grampian 'Reverberation Unit' (*Fig. 4*), an instru-

ment intended for amateur and professional use. This is a mechanical spring line device that takes care of dead acoustic conditions and greatly improves the quality of recorded music and vocals.

VORTEXION (Stand 74)

Aside from their semi-professional type C.B.L. tape recorder, Vortexion will also be demonstrating their Electronic Mixers for 4 and 3 channels, the 30/50 amplifier, a twelve-way electronic mixer and the CP.20A portable amplifier. Microphones, stands, and public address equipment are also a feature of Vortexion demonstrations in room 202.

STANDARD TELEPHONES & CABLES (Stand 3)

The latest in S.T.C. microphones will be on show for the first time and these include the Model 4113, a new directional microphone with a low response to mechanical noise, etc. The Model 4114 is a new omnidirectional microphone at an extremely moderate price for tape recording and public address work. The full range of S.T.C. studio microphones will also be on the stand.

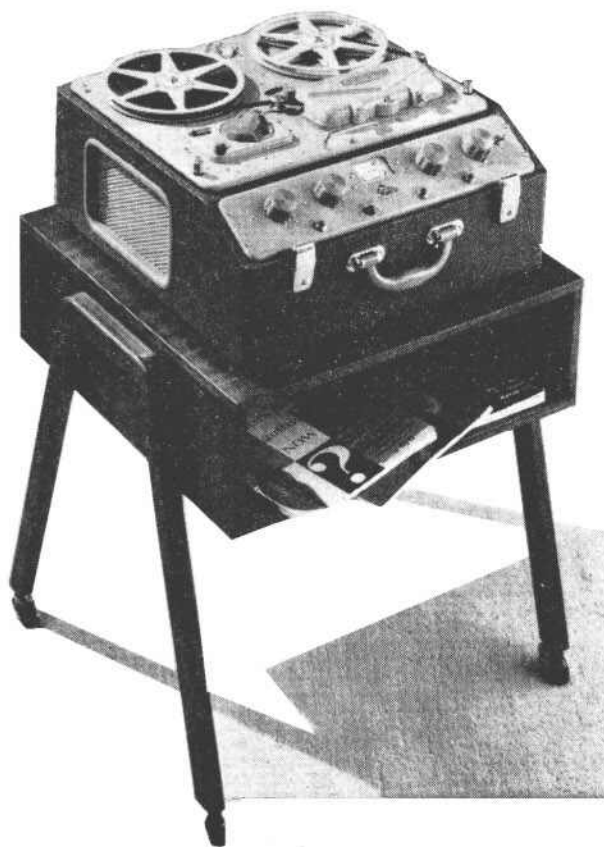
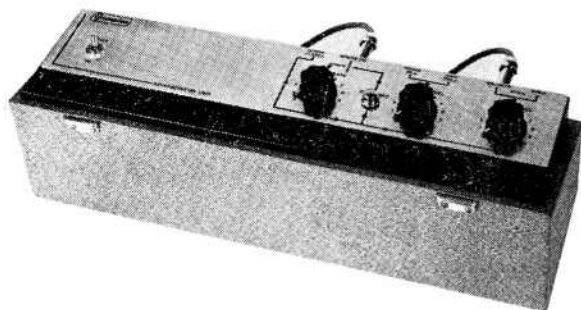
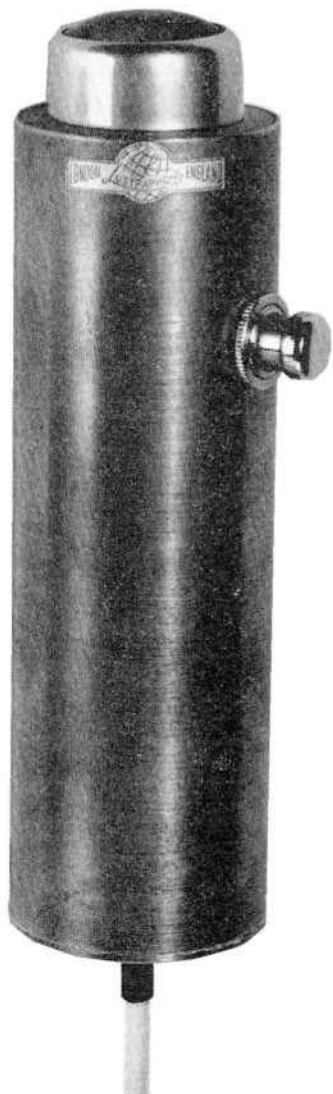

Fig. 3. The Ferrograph Model 5 AN Tape Recorder.

ATR'S INVITATION TO THE 1964 INTERNATIONAL AUDIO FAIR



● Fig. 4. The Grampian Reverberation Unit.



● Fig. 5. The Model D 59 "Radio Mic" by Lustraphone Ltd.

LUSTRAPHONE (Stand 4)

Lustraphone exhibits at the Audio Festival will be grouped to show the numerous microphones, 'Radiomic' systems, transistor amplifiers, mixer units, matching transformers, floor and table stands, microphone booms, as well as many convenient accessories available for: educational services, public address, broadcasting, recording studios, tape recorder users and social services. The 'Radiomic' stem should be of particular interest to professional users; particularly the compact D59 combined microphone and miniature transistorized radio transmitter.. (Fig. 5).

TRUVOX LTD. (Stand 41)

Another well known name in the tape recording world who produce a range of high quality machines such as their latest '90 series' which will be demonstrated for you on request in room 442. The 90 series of recorders cater for mono and stereo requirements in half-track and quarter-track. For example the R.92 is a half-track recorder with full playback facilities and a built-in speaker. Another model, the PD.95 is a tape unit for quarter-track mono for those who already have suitable Hi-Fi amplifiers and speakers. The PD.99 is a quarter-track stereo version of this.

M.S.S. RECORDING CO. LTD. (Stand 51)

Don't miss a 'Journey Into Tape' in M.S.S. demonstration room 217! You will be taken right through the processes involved in the manufacture of magnetic tape by a film in colour. Experts on tape will be there to answer your queries on the best way to ensure maximum performance from your tapes.

B.A.S.F. (Stand 22)

B.A.S.F. always come up with a novel demonstration. This year some pre-recorded talks have been expertly prepared on a number of topics designed to be of interest and assistance to tape recording enthusiasts. You can choose the subject in which you are interested, and whilst you are listening to the talk a copy tape will be automatically prepared and will be ready for you to take away free of charge.

The talks cover the following topics:—

1. Recordings of Historical Interest.
2. Sound Exploration.
3. Sound Effects.
4. Slide Synchronisation.

Details and prices of the full range of B.A.S.F. tapes, library boxes and accessories will be available and B.A.S.F.'s recording experts will be pleased to assist you and answer any queries which you may care to discuss with them in demonstration room 320.

QUAD (Stand 58)

Otherwise known as the Acoustical Manufacturing Co. Ltd., Quad are displaying their full range of hi-fi amplifiers and electrostatic loudspeakers. The Quad A.M. and F.M. tuners will also be demonstrated in room 422. We suggest the Electrostatic loudspeaker demonstrations will be worth listening to, for this comparatively new approach to high fidelity reproduction has much to offer.

THE AUDIO FAIR

List of Exhibitors

Trade Name	Name	Booth	Trade Name	Name	Booth
Allan	Richard Allan Radio Ltd.	39	Leak	H. J. Leak & Co. Ltd.	64
Akai	Akai Electrical Co. Ltd.	47	Luxor	Luxor Industri Aktiebolag	30
Ampex	Ampex Great Britain Ltd.	17	Scotch	Minnesota Mining & Manufacturing Co.	55
A.K.G.	Akustische und Kino-Geräte G.M.B.H.	46	M.S.S.	M.S.S. Recording Co. Ltd.	51
Armstrong	Armstrong Audio Ltd.	19	Metrosound	Metrosound Ltd.	4a
Agfa	Agfa Ltd	2	Mullard	Mullard Ltd.	50
A.T.R.	Amateur Tape Recording Magazine	34	Ortofon	Ortofon A/S	2a
Quad	The Acoustical Manufacturing Co. Ltd.	58	Philips	Philips Electrical Ltd.	54
B.A.S.F.	B.A.S.F. Chemicals Ltd.	22	Pye	Pye Ltd.	13
Jordan-Watts	Boosey & Hawkes (Sales) Ltd.	56	Pioneer	Pioneer Electronic Corporation	16
Breall	Brenell Engineering Co. Ltd.	28	Planet	Planet Projects Ltd.	57
Braun	Braun Electric International	9	Celestion	Rola-Celestion Ltd.	8
Brown	S. G. Brown Ltd.	27	Radford	Radford Electronics Ltd.	11
Butoba	Butoba Schwarzwälder	68	Record Housing	Record Housing	52
Beyer	Beyer Electrotechnische Fabrik	36	Reslosound	Reslosound Ltd.	71
Clarke & Smith	Clarke & Smith Manufacturing Ltd.	24	Rogers	Rogers Developments Ltd.	43
Chapman	Chapman Ultrasonics Ltd.	70	Revox	Revox-Studer	15
Clairtone	Clairtone Sound Corporation of Canada	7	Shure	Shure Electronics Ltd.	48
Connoisseur	A. R. Sugden & Co. Ltd.	25	S.T.C.	Standard Telephones & Cables Ltd.	3
Decca	The Decca Record Co. Ltd.	65	S.M.E.	S.M.E. Ltd.	44
Decca	Decca Radio & TV Co. Ltd.	66	Sherwood	Sherwood Electronic Laboratories	42
Design Furniture	Design Furniture Ltd.	59	Stuzzi	Stuzzi Radiotechnischer Betrieb	14
E.M.I.	E.M.I. Tape Ltd.	63	Sony	Sony Corporation of Tokyo	73
Elcom	Elcom (Northampton) Ltd.	60	Tannoy	Tannoy Products Ltd.	23
Electroimpex	Electroimpex of Hungary	61	Tandberg	Tandbergs Radiofabrikk A/S	69
Fane	Fane Acoustics Ltd.	19a	Trio	Trio Corporation of Japan	62
Fi-Cord	Fi-Cord International Ltd.	37	Truvox	Truvox Ltd.	41
Ferroglyph	The Ferroglyph Co. Ltd.	67	Telefunken	Telefunken G.M.B.H.	5
Grampian	Grampian Reproducers Ltd.	32	Thorens	Thorens S.A.	3a
G.K.D.	G.K.D. Ltd.	45	Vitavox	Vitavox Ltd.	18
Goldring	The Goldring Mfg. Co. Ltd.	20	Vortexion	Vortexion Ltd.	74
Garrard	Garrard Engineering Co. Ltd.	29	Whiteley	Whiteley Electrical Radio Co.	26
Gevaert	Gevaert Photo-Production N.V.	6	Wharfedale	Wharfedale Wireless Works Ltd.	53
Goodmans	Goodmans Industries Ltd.	31	Zonal	Zonal Film Ltd.	40
Grundig	Grundig (G.B.) Ltd.	35			
Records and Recording	Hansom Books Ltd.	1a			
Hi-Fi News	Miles Henslow Publications Ltd.	72			
Wireless and Electrical Trader.	Wireless World — Iliffe				
	Electrical Publications Ltd.	1			
Instrumatic	Instrumatic Ltd.	33			
Kodak	Kodak Ltd.	49			
KEF	K.E.F. Electronics Ltd.	38			
Loewe-Opta	Loewe-Opta A.G.	10			
Lansing	J. B. Lansing Sound Inc.	21			
Lowther	The Lowther Mfg. Co. Ltd.	12			
Lustraphone	Lustraphone Ltd.	4			

This is the complete guide to exhibitors on the ground floor. Many concerns also have demonstration rooms, lounges and offices upstairs.

Those not already exhibiting downstairs are: Federation of British Tape Recording Clubs; General Gramophone Publications; Hanover Press Ltd.; Kelly Acoustics Ltd.; The Long Playing Record Library; Peto Scott Electrical Company; Tape Recording Magazine; K. H. Williman & Co. Ltd.; The Wilson Stereo Library Ltd.; Worden Audio Developments Ltd.

ATR STAND-34

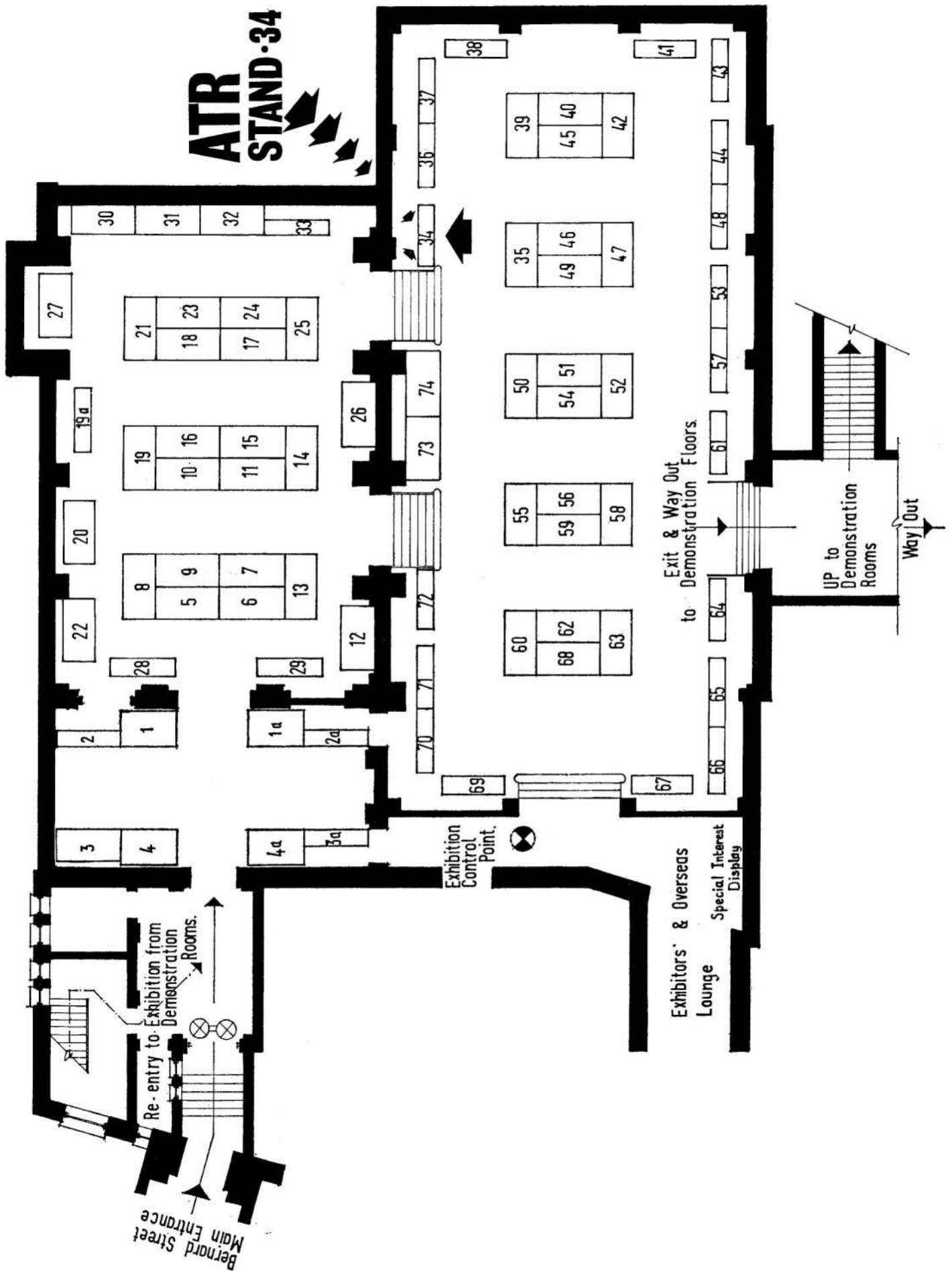

ATR'S INVITATION TO THE 1964 INTERNATIONAL AUDIO FAIR

E.M.I. (Stand 63)

E.M.I. Tape Limited will exhibit its standard range of magnetic recording tapes, Emitape 100 (double play), 99 (long play), 88 (standard play) and 44 (acetate standard play).

Completing the E.M.I. display will be Emidiscs (lacquer recording discs) tape accessories and aids to better recording — notably Emiguides (six pre-recorded instructional tapes); 'Emitape Guide to Better Recording' a 64-page booklet by John Borwick — will also be featured and will be sold from the booth at price 2s. 6d. per copy.

SONY (Tellux Ltd.) (Stand 73)

Sony are presenting a whole new range of tape recorders this year which includes the 263D/SR2L a stereophonic tape deck and amplifier for the constructional enthusiast. It is complete in every detail and has a 3-head system. Price 39½ guineas. For those seeking something more expensive the TC200 at 79 gns. should fill the bill for four-track, two-speed stereo complete with detachable loudspeakers (Fig. 6). If you want professional recording then the TC.777A is the answer at 159 guineas, two-track stereo and a three-head system which provides full recording monitoring.



● Fig. 6. The Sony Model TC 200 Stereo 4-track Tape Recorder.

CLARKE & SMITH LTD. (Stand 24)

Two new additions to the Clark & Smith range are a self-powered AM/FM tuner — Model 658 Mk. 2 with a much improved specification over its predecessor, the Mk. 1 version and a compact loudspeaker system Model

619 remarkably free from colouration and matt finished in walnut veneers. Also being shown, are the integrated stereo amplifier (Model 655), stereo control centre (Model 656) and Stereo Power Amplifier (Model 657). All will be demonstrated together with the E.M.I. pick-up (EPU/100) and the Clarke & Smith transistorized tape recorders TR.634 and 635 in room 317. Designed for education, industrial and commercial users, in addition to their obvious domestic application, these recorders show a refreshing departure from conventional design in both performance and appearance.

FI-CORD INTERNATIONAL LTD. (Stand 37)

A new accessory being shown by Fi-Cord will be a re-chargeable battery unit, which will enable the Fi-Cord 202 to be used from the following power sources: 105-240 volts A.C. mains, 12-volt D.C. car battery, re-chargeable accumulators and mercury batteries.

Also on display will be two recent Fi-Cord releases — a portable battery-powered amplifier speaker and a transistorised mixer unit with high and low impedance outputs (see Fig. 7). Live demonstrations of the Fi-Cord 202 system will be given in demonstration room number 414.



● Fig. 7. The Fi-Cord TM II portable transistorized mixer for use with the Fi-Cord 202 Recorder. BUTOBA (Stand 68)

The Butoba battery-operated tape recorders made in Western Germany are known for excellence of tone and purity of reproduction, and economical purchase price. The Butoba MT7 is no exception and it is ideal for recording music, lectures, birdsong, etc., or for the whole family's constant pleasure. The MT7R model can also be used for dictating at the office or in the car. Recording baby's first cries and all the fun of your Christmas parties can be taped for future enjoyment.

BRENELL ENGINEERING CO. LTD. (Stand 28)

Such has been the success of the Brenell STB 1 stereo unit (first introduced at the 1963 Audio Fair) that this will again be the focus of attention at the Brenell stand (see Fig. 8).

ATR'S INVITATION TO THE 1964 INTERNATIONAL AUDIO FAIR

This excellent stereo unit incorporates separate record and playback pre-amplifiers, and caters for a variety of track designations. 1/4, 2/4, 1/2 and 2/2 track tapes can all be played back, and 1/2 and 2/2 track tapes can be recorded. Variable bias and mixing of input signals are two more of the facilities that have made this recorder popular all over the world.

Also on the Brenell stand you can of course see the complete range of machines incorporating the famous Mark 5 deck, including the Brenell Mk.510, which has been specially designed to take tape reels up to 10½ inches in diameter.

It is anticipated that half-hourly demonstrations will continue throughout the four days of the fair, ably conducted by Mr. J. W. Raine in Room 342.



● Fig. 8. The Brenell STB 1 Stereo unit.

REVOX (C. E. Hammond & Co. Ltd.) (Stand 15)

Making its first public appearance at the Audio Fair is the latest addition to the Revox range of recorders. The Model 376 contains many new and important features, including two V.U. meters calibrated from +3 to -20 V.u.'s, accommodation for 10½-inch diameter spools (not NAB fitting), and a reel size selector switch for large or small spools.

Both twin-track and four-track models have recording speeds of 3¾ and 7½ i.p.s., and the record/replay characteristic is accurate to the latest C.C.I.R. standard of 70 and 140 u/seconds.

A 6-watt monitoring amplifier is fitted, which can be switched to the incoming signal on either channel, the recorded signal on either channel through separate replay heads and amplifiers, or a combined tape signal. Cathode follower outputs are provided for further amplification or transcription purposes.

This new Swiss recorder is being demonstrated in both mono and stereo models, using original orchestral materials, in room 315.

J. B. LANSING SOUND INC. (Stand 21)

From America for the first time come a wide variety of JBL precision transducers, employing highly sophisticated magnetic structures of large diameter edgewound ribbon voice coils. The unique JBL-Ranger Paragon is an advanced stereo reproducer using the principle of radial refraction to integrate the sound from two sets of theatre loudspeaker components into a broad three-dimensional sound source. See this impressive unit, together with the new Graphic Controller, demonstrated in room 112.

GRUNDIG (Grundig (G.B.) Ltd.) (Stand 35)

This firm needs no introduction, for Grundig is to tape recorders as Hoover is to vacuum cleaners. They have two new and exciting ventures in hi-fi this year as well as the full range of tape recorders, including the TK.6 mains/battery model we shall be reviewing next month. These two new items of importance from the Grundig stable are both hi-fi units, the first being the SV 50 stereo power and control amplifier. This is fully transistorised, employing 27 transistors and 2 rectifiers. The built-in microphone pre-amplifier feeds 7 audio amplifiers and correction stages to load the driver stage and the push-pull transformerless output stage. A full complement of filters and tone controls provide wide compensation of the input signal and printed circuits are used throughout.

The new RT 50 hi-fi tuner matches the SV 50 stereo amplifier in every respect. Equipped to receive VHF and medium wave stations, this instrument provides excellent reproduction in any condition. Star features are the switchable automatic frequency control on FM, switchable FM noise suppression and stereo decoder stage for stereo FM reception. The AM stage is provided with a switchable ferrite aerial and switchable band width selection, with FM and AM sections separated through the unit. Demonstrations can be seen in room 147.

PIONEER ELECTRONIC CORP. (Stand 16)

A completely new range of high quality radio tuner units and audio amplifiers are being exhibited for the first time, manufactured in Japan by the Pioneer Electronic Corporation.

Model SM-G 205 is an integrated stereophonic tuner and amplifier, containing its own FM multiplex circuit for receiving B.B.C. stereophonic broadcasts.

Model SM-Q 300B is a general purpose integrated tuner-amplifier with three AM bands, short, medium, and long, and an FM tuner. No multiplex is incorporated but sockets are fitted for an external adaptor. The audio section is fully stereophonic, and contains scratch, rumble, and whistle filters.

All the Pioneer units are being demonstrated, using original orchestral tape recordings and B.B.C. Stereo transmissions were possible, in room 314.

ATR'S INVITATION TO THE 1964 INTERNATIONAL AUDIO FAIR

ARMSTRONG (Stand 19)

Armstrong Radio will be showing their varied range of tape recording equipment, including the new AM-FM tuner illustrated here (see Fig. 9). It can be made suitable for the reception of FM stereo radio broadcasts, and covers the full FM and medium wavebands. On the assumption that the B.B.C. will follow the present experimental stereo transmission with a regular stereo service at some time in the near future, complete provision has been made for an Armstrong Stereo Multiplex Decoder to be added. This will be available as soon as regular transmissions begin and will only require to be plugged in to the tuner and fixed in the appointed space.

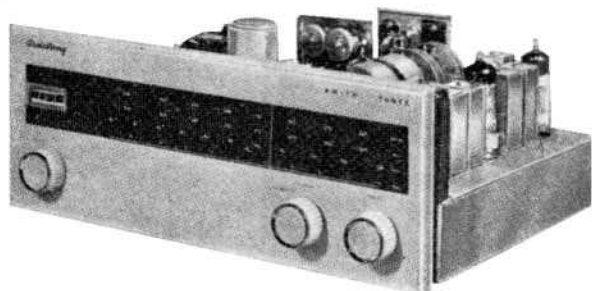

● Fig. 9. The New Armstrong AM-FM tuner.

STUZZI (Recording Devices Ltd.) (Stand 14)

At this year's Audio Fair, Stuzzi will be showing a number of very interesting novel items in tape recording.

One completely new machine is the Disc-Corder, a battery-operated portable with H.F. controlled motor speed regulator and a row of push buttons selecting an amazing range of facilities. It can be used as an ordinary battery-operated tape recorder weighing only 8½ lbs., and in its very smartly designed contemporary housing is a truly 'take anywhere' machine. At a recording speed of 1½ i.p.s. the frequency response is up to 9,000 cycles and the playing time on the 4¼-inch spool is over



● Fig. 10. Stuzzi's new Disc-Corder — tape recorder, record player and radio, in one.

2 hours on each track. At the touch of a button a built-in radio unit comes into operation and you can select from the medium wave band in the same way as on any other high grade transistor portable. Turn the machine over and a record player is exposed that will play 45 r.p.m. records at the touch of yet another button. It is possible to make tape recordings from the radio or from the record player and there are of course separate monitoring facilities.

The Stuzzi Model 802 FM combined tape recorder and F.M. radio will also be on show and for demonstration in room 115. (See Fig. 9.)

TELEFUNKEN (Welmecc Corp. Ltd.) (Stand 5)

Highlight of the Telefunken Stand at the Audio Fair is the introduction of the 'Magnetophone 300' battery/mains tape recorder. Advance information from the Continent has aroused tremendous interest in this sleek model and the specification matches its good looks. High quality recording (40 - 13,000 cycles/sec. at 3½ i.p.s.) puts it in the same class as standard table model mains-only recorders. In fact, this is a good deal better than many mains machines from other stables.

Hope you enjoy looking around the Fair with us. We look forward to seeing you there.

A.T.R. SOUND EFFECTS SPECIAL OFFER

E.P. RECORD

This month's special FX record offer is a key record, the last of this series. It contains special long-running tracks of ambient background sounds viz: sea, wind, thunder, rain, factory, traffic.

This record will enable you to make composite sound tracks with the aid of the whole series produced by CASTLE records.

Don't miss this last and key record for only 6s.

Send your postal order or cheque for 6s. made payable to Amateur Tape Recording Magazine, plus a separate 6d. stamp for return postage to:

A.T.R. Dept. 11, 174 Maybank Road,
South Woodford, London, E.18.

Don't forget to include your name and address, and the coupon on Page 47. This record will also be on sale on the A.T.R. stand at the Audio Fair.

MASTERTAPE

THE CHOICE OF THE CONNOISSEUR

Make Mastertape your choice and be certain of obtaining the best results every time. Whatever type of recorder you own there is a Mastertape to suit your requirements—standard play, long play or double play you will find that British Mastertape is the best tape value.

See us at the Audio Fair
STAND NO. 51
DEMONSTRATION ROOM
NO. 217

M.S.S. RECORDING CO. LTD.
Colnbrook, Slough, Bucks.
Tel: Colnbrook 2431 (8 lines)

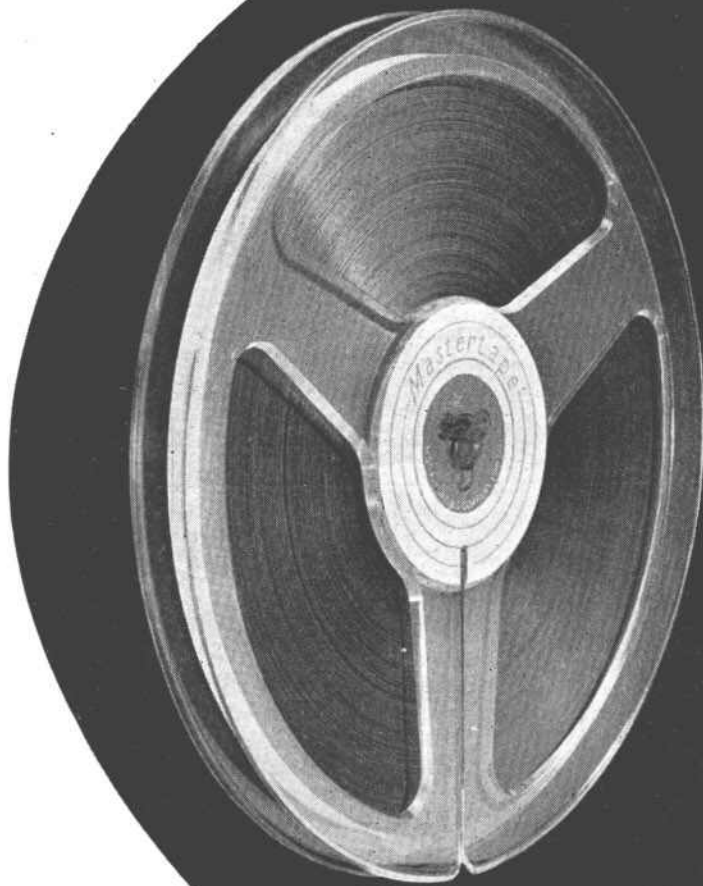

ms

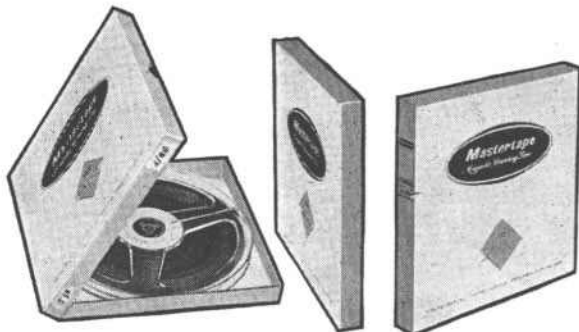



LOEWE OPTA

Hi-Fi Tape Recorders

FOR PERFECTION IN SOUND

OPTACORD 414

With the first-ever high frequency motor ensuring long life and constant speeds. Unsurpassed for a portable tape recorder. Single speed 3 1/2 i.p.s. Twin Track. For use on mains, batteries and car batteries.

47 Gns.

OPTACORD 414 DIA

As the OPTACORD 414, with built-in Synchronisation with Automatic Slide Projector.

57 Gns.

THREE - IN - ONE

MAINS - BATTERIES - CAR BATTERIES

See the complete range in our Showrooms, or write for fully descriptive and illustrated leaflets.

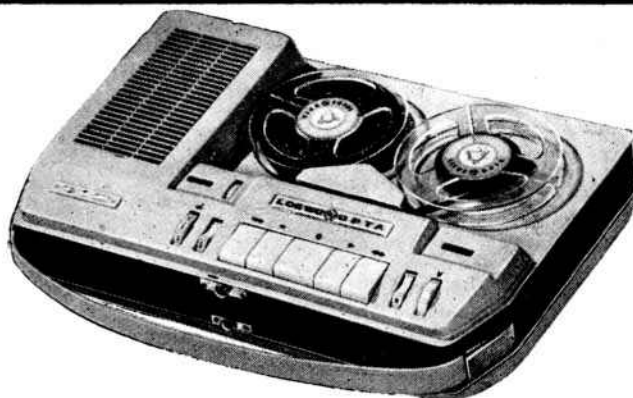

HIGHGATE ACOUSTICS

71/73, Great Portland Street, London W.1. Telephone: MUSEum 2901/6

Everything in Tape - from TeleTape of London!

Now there are two Teletapes in the heart of London! The Marble Arch store known to all tape enthusiasts, has been joined by brand new premises in Shaftesbury Avenue. At these two focal parts of London we can offer you the most comprehensive range of equipment and service. Come in and look at your leisure or get in touch with us by post.

MACHINES: The biggest selection of tape recorders and service in the West End awaits you. Philips, Telefunken, Grundig, Ferrograph, Tandberg and many more — Teletape staff will

advise you impartially and expertly.

PRE-RECORDED TAPES: Teletape's unique tape Bar make choosing tapes easy. And what a choice! Pops, classics, show music, language courses, mono and stereo — you'll find it all here plus the opportunity to hear it before buying. →

ACCESSORIES: Virgin tapes, microphones — all the equipment the tape enthusiast needs and all the advice he'll want on how to use them. ↓



OUT OF TOWN? Not to worry. You're as close as the nearest pillar-box to Teletape. We will gladly include you in our regular mailing list and send you the famous 48 p.p. Teletape catalogue of pre-recorded tapes for just 1/6 to cover post and packing. Why not drop us a line now?

TELETAPE OF MARBLE ARCH
33, EDGWARE ROAD,
LONDON,
W.2.

TeleTape of Marble Arch

33 Edgware Road, W.2. 84/88 Shaftesbury Avenue, W.1

UNDER REVIEW

SLIM, handy and portable is how the manufacturers describe the Optacord 414, transistorised tape recorder, that will run not only from internal batteries but from standard mains supplies as well. This means it is self-contained in every respect and suitable for outdoor use as well as general recording at home.

It has a single operating speed of $3\frac{1}{2}$ i.p.s. and will accommodate spools of up to $4\frac{1}{2}$ " diameter.

The entire operation of the 414 is comparatively simple for it has 'piano key' control for the deck functions, i.e., record, play and rewind. Other controls are for volume and tone, etc., and the makers have incorporated a recording level meter which also shows the condition of the internal battery supply.

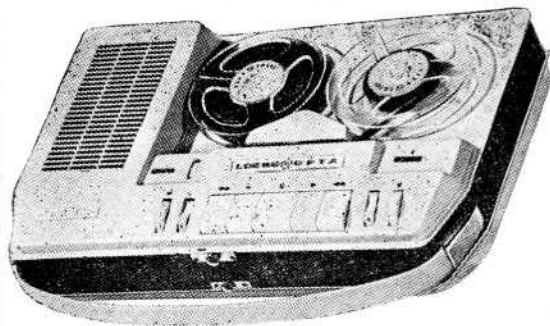

Other features are a three-figure tape position indicator and outputs for an external amplifier or loudspeaker. Input sockets are provided for microphone or radio signals. The clear and concise instruction book reveals the full versatility of this recorder. For instance the 414 can also be operated from a 6 or 12 volt car battery and one can record from a special telephone pick-up which the manufacturers can supply. Track designation is standard half track and by using long-play or double-play tape, long playing (or recording) times are possible. With triple play tape a total play or record time of two hours becomes possible with a full $4\frac{1}{2}$ " spool of tape.

The Optacord 414 operates from five $1\frac{1}{2}$ -volt D.E.A.C. re-chargeable cells type R.S.-3.5 for approximately 15 hours or from 110-220v, 50 to 60 c/s. mains supplies, or of course

A. LESTER RANDS REVIEWS THE LOEWE-OPTA OPTACORD 414 PORTABLE TAPE RECORDER.

from car batteries as mentioned above. For 12v operation a special series voltage dropping resistor is required. Other points from the technical specification are as follows:—

Frequency Response — 50 c/s. to 12,000 c/s.

Dynamic Range — 45 dB.

Power Output — Maximum 1 watt.

Erase and Bias — With h.f. voltage at 55 Kc/s.

Built-in Speaker — Elliptical cone type.

Weight — Approximately 20 lb.

The Optacord 414 is supplied complete with a good quality

whole the 414 can make a clear acceptable recording. Providing one is prepared to accept the limitation set by low power output and small loudspeaker, the reproduction is shall we say, satisfying.

However, the 414 can be used with an external amplifier or loudspeaker either of which can do much toward providing that extra bass and/or greater volume without distortion.

The general mechanical performance was found to be quite satisfactory although recordings of steady tones reveal a slight amount of periodic speed variation perhaps a lot higher than usual these days.

The Optacord 414 Recorder

dynamic microphone, a $4\frac{1}{2}$ " spool of tape and spare spool and connecting leads. It employs a printed circuit chassis and seven transistors and the mechanical features and general layout are well designed. The battery compartment, etc., is easily accessible and the recorder as a whole is of quite attractive finish. It is most certainly portable in every sense.

Performance

Although the makers quote a frequency response of 50 to 12,000 c/s. they give no reference frequency or level. Tests showed, however, that this response is maintained up to the higher frequency limit but falls away rapidly below 70-80 c/s. There is a lift of about 5 dB around 100 c/s. which tends to emphasise the bass response, but I would deem this necessary in view of the small internal loudspeaker. Erasure is clean and free from noise and on the

The nominal speed of $3\frac{1}{2}$ i.p.s. is well maintained throughout a whole spool of tape.

It is fair to report that the Optacord 414 is not only versatile but has a perfectly adequate performance for its retail price of £49 7s. 0d. It lends itself for outdoor recording without resource to A.C. mains supplies but at home can be used with extra equipment if so desired. There is another version of the 414 which has a similar specification but intended for use with a slide projector. This is priced at £59 17s. 0d. and should be of interest to slide enthusiasts.

The Optacord 414 is manufactured in Germany by Loewe Opta Limited and distributed in the U.K. by Highgate Acoustics Limited, 71/73 Great Portland Street, London, W.1., to whom all enquiries and requests for leaflets should be addressed.

Another BRILLIANT RECORDING on

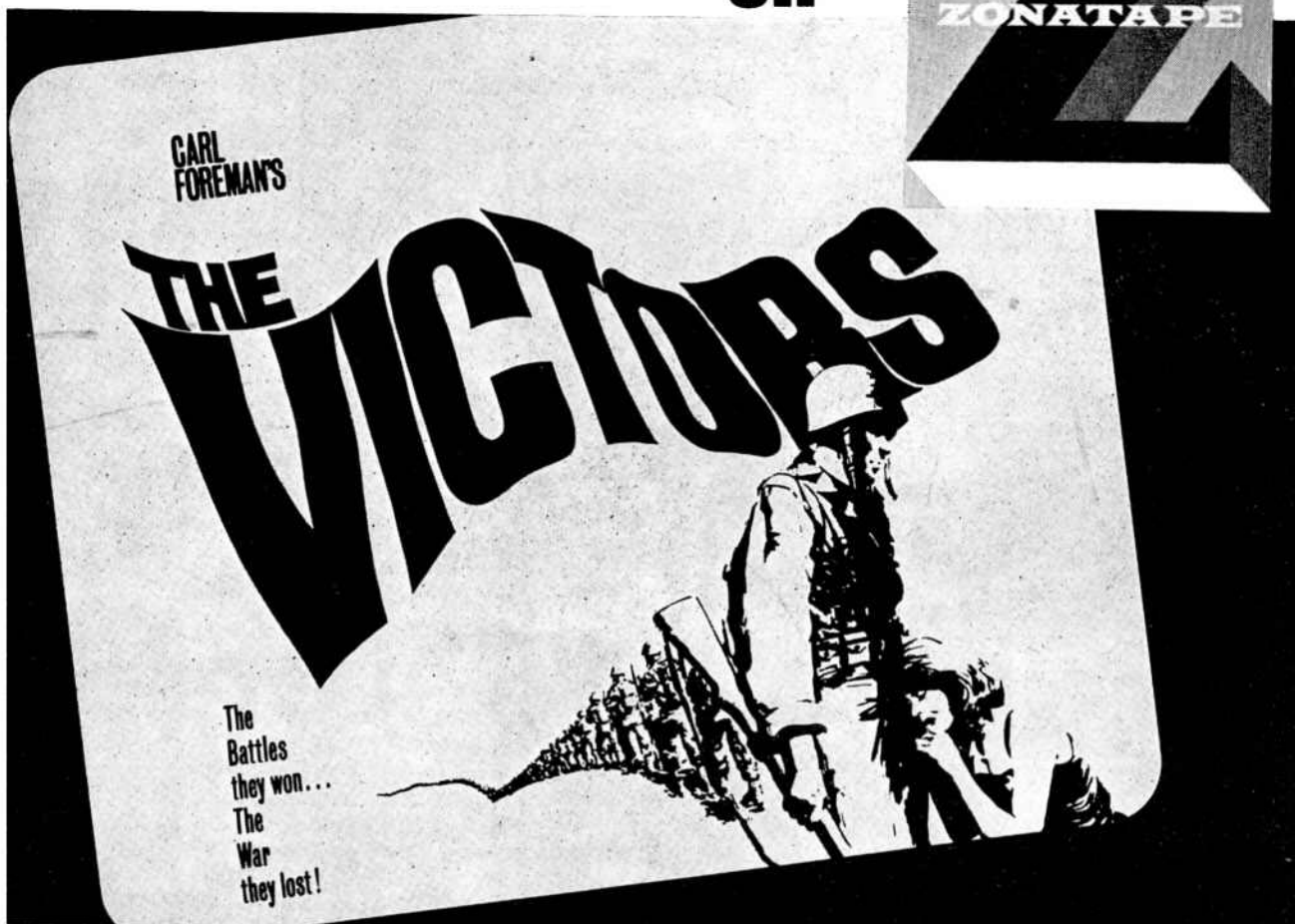

The same quality tape used for the magnificent sound recording of "THE VICTORS" is available to you . . . offers you a fidelity in recording limited only by the capability of your tape recorder. Choose from 4 types: Diacetate or PVC Standard Play, Polyester Extra Play and — just released — Polyester Double Play. Wound on distinctive coloured spools, clear, red, green and blue for easier identification. Supplied in attractive, durable book-type containers. Stocked by all the best hi-fi and radio shops.

BRIEF SPECIFICATION OF ZONATAPE TYPE 700 POLYESTER EXTRA PLAY

Intrinsic coercivity Hci.	310 Oersteds (high)
Retentivity Br.	1200 Gauss
Bias	6.3 milliamps
Peak signal to basic noise ratio	-71 dB
Reel to reel variations	± 1dB at 1000 cycles
Ultimate tensile stress	8 lb.

ZONATAPE

CLEARLY THE BEST FOR RECORDING SOUND

ZONAL FILM (MAGNETIC COATINGS) LTD

ZONAL HOUSE, WESTFIELDS ROAD, ACTON, W.3. ACORN 6841





let the experts guide your selection

Top sound-studios everywhere use Telefunken recording equipment exclusively. Reason why? Telefunken made the world's first tape recorder, and with that head start they've been way ahead in research and development for years. Telefunken's wide range gives you a superb choice of equipment that integrates perfectly with your set-up, yet sounds great on its own. Whatever model you buy you'll know you bought the best . . . Telefunken, the machine the professionals use at home! Telefunken has sound quality taped.

(all prices except for Magnetophon 55, and Magnetophon 300 exclude microphone)

Magnetophon Stereo 97 and 98 Stereo from Telefunken! These recorders were news when first released and live up to their great promises. The 97 and 98 are the same price, but the 97 is a quarter-track recorder. Both have a high signal to noise ratio, wide frequency range and three speeds. **95 gns.**

Magnetophon 85 De-luxe. Two-speed half-track with excellent frequency response: new-styled case and plenty of exciting new features and refinements including built-in splicing groove, remote control connection, new-style magic-eye recording level indicator. **83 gns.**

Magnetophon 96 Quarter-track perfected! Wide frequency range, three speeds. Full inter-track transcription offering ideal effects for cine-enthusiasts. No limit to trick effects that can be achieved with this machine. Can be used for stereo playback utilising stereo amplifier or radio. **62 gns.**



AND NOW... A PORTABLE BATTERY TELEFUNKEN, THE BRAND-NEW MAGNETOPHON 300...

The new 300 on show for the first time in this country. It operates in any position powered by five 1.5 volt batteries (or a rechargeable battery can be supplied if preferred), and uses 5" spools at 3½ ips. There is a pause button and combined

Magnetophon 55 The recent addition to the famous family bringing high-quality tape-recording into a lower-priced field. Elegantly styled, the smart wooden case ensures good sound reproduction. Two-speed half-track performance gives amazing frequency range for a machine in this class. **43 gns.** including TD7 microphone.

recording level/playback volume control built into the handle. The machine is completely push-button operated and introduces high-quality Telefunken electronics into the fully-portable field. **59 gns.** including TD7 microphone.

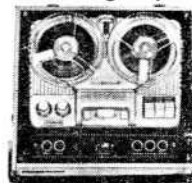

See us at the
Audio Fair
BOOTH NO. 5
Demonstration
room 402



TELEFUNKEN

For further details and illustrated catalogue giving details of Telefunken tape-recorders and accessories write to
WELMEC CORPORATION LTD 27 Chancery Lane London WC2

● Special new ATR feature

CIRCUITS FOR HOME CONSTRUCTORS

Interesting and useful circuits for home constructors and experimenters.

IN this new A.T.R. feature we shall be publishing interesting and useful circuits for home constructors and experimenters. The circuits will in the main include all component values and will be of amplifiers and other equipment for audio application.

The first circuit (Fig. 1) is for a 3-watt stereo amplifier developed by Mullard Limited and reproduced with their kind permission.

NOTE: Neither A.T.R. or Mullard Limited can supply complete equipment or components but further details concerning layout and construction will be found in 'Mullard Circuits for Audio Amplifiers' published by Mullard Limited, price 8s. 6d.

The 3-watt stereo amplifier circuit shows only one channel. The second channel is a duplicate except for SC2 the loudspeaker phasing switch and the power supply.

The sensitivity of the amplifier is 400mV for 3-watts output with negative feedback. Provision is made for treble and bass control which is to -13 dB at 10 K/cs.

and +12 dB at 70 c/s. (relative to 1000 c/s.) Hum and noise level is better than 65 dB for a level response and 3 watts output.

Readers deciding to construct this amplifier are strongly recommended to follow the layout and constructional details in the 'Mullard Circuits for Audio Amplifiers' book mentioned above. This circuit has been especially designed for Mullard valve types ECL86 and EZ81.

RIGHT: CIRCUIT FOR A THREE WATT STEREO AMPLIFIER

(by courtesy of the
Mullard Valve Co. Ltd.)

BUY A Bib

THE PROFESSIONAL TAPE SPLICER

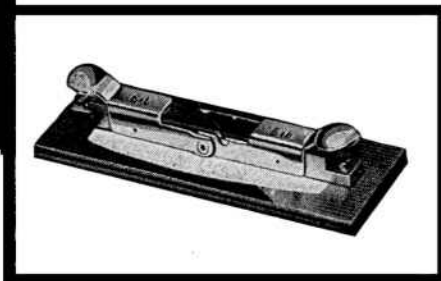

—The most reliable and easy to use. All metal—beautifully plated—compact in size—mounted on flock covered base. Easily and permanently attached to your tape recorder. Ferrograph, Vortexion, Reflectograph and Wearite decks already have fixing holes for the Bib splicer.

Clamps hold the magnetic or leader tapes in the precision cut channel—no danger of damaging the edges—most important with 4 track recordings. Right angle and oblique cutting slots are provided to facilitate editing to a syllable.

The Bib tape splicer saves tape and makes editing a fascinating hobby.

More Bib splicers have been sold in recent years than any other make. It is incorporated in the "Scotch" Tape Accessory Kit and is used by recording studios and broadcasting organisations.

MULTICORE SOLDERS LTD.

MULTICORE WORKS, HEMEL HEMPSTEAD, HERTFORDSHIRE

Complete with
razor cutter
only 18/6

Massey's Centre of Sound

Your Specialist for Tape Recording

"Have pleasure in announcing they have greatly increased facilities for servicing your Tape Recorder — on the spot estimating and trouble shooting"

**Comprehensive Stock of all the Best
Machines — Expert Advice freely given**

Part Exchanges

Terms: 3-6-9-12-18-24 months

121-123 CHISWICK HIGH ROAD, W.4

9.30 a.m. — 6.30 p.m. NOT CLOSED FOR LUNCH

CHISWICK 2082

THE TAPE DIRECTORY

An ATR service to promote friendships through tape correspondence

Particulars of Tapespondents are given in the following order:— name, age, occupation, address; special interests, taste in music; type of machine, spool sizes, speeds; area of taping required.

AUSTRALIA

DOUGLAS BOOKER, 17, Apprentice elec-mech 31, Vermont Street, Sutherland, Sydney, N.S.W., Australia. Dancing, ice-skating; pop and modern music.

ROGER DOYLE, 19, Ex. Public Address Tec. 3, Kenney Road, Pagewood, Sydney, Australia. Commercial recording P.A. and Photograph. Classical, etc. Revox F36 Pyrox 10in., 3 $\frac{1}{2}$, 7 $\frac{1}{2}$, latter preferred. England, U.S.A. Anywhere.

GEORGE FLETCHER, 23, Accountant, 65, Kurraba Road, Neutral Bay, Sydney, N.S.W., Australia. Ten-pin, bowling, 8 mm. and 35 mm. photo; pop, trad., jazz, light orchestral. National 2-track, 7 in., 1 $\frac{1}{2}$, 3 $\frac{1}{2}$, 7 $\frac{1}{2}$. Europe or anywhere English speaking.

FRANK E. LLOYD, 38, Welder, 30 Keevil Street, Elizabeth North, South Aus., Australia. Tape recording, overseas correspondence; semi-classics and organ music. Royal A.Y.C., 7in., 1 $\frac{1}{2}$, 3 $\frac{1}{2}$. America and Europe.

CEYLON

KITHSIRI DE ALWIS, 27, Teacher, S. Thomas' College, Gurutalawa (UVA) Ceylon. Dramatics, sound effects, folk songs; popular and folk. Grundig TK 20, 5 $\frac{1}{2}$ in., 3 $\frac{1}{2}$. Ireland, U.S.A., U.K. and any other Commonwealth country.

NEW ZEALAND

ANTHONY E. KING, 24, Airline sales supervisor, G.P.O. Box 3160 Wellington, New Zealand. Radio, travel, aviation, writing, listening and learning about other countries; all types, Latin American, Conniff, Philips, Ferrograph, 7in., 1 $\frac{1}{2}$, 3 $\frac{1}{2}$, 7 $\frac{1}{2}$. Switzerland, Sweden, U.K., West Indies or anywhere English speaking male or female. Any young ladies interested?

SOUTH AFRICA

DON SHAW, 22, Shipping clerk, 35, Cook Road, Claremont, Cape Town, South Africa. Drums, humour, discussion; modern jazz. Sony 464 cs 4-track stereo. 7in., 3 $\frac{1}{2}$, 7 $\frac{1}{2}$. U.S.A., anywhere.

DAVID A. WILLS, 32, Cinema projectionist, 34 Hammond Road, South Riding, Johannesburg, South Africa. Short story writing, photography, classics, film music. National Stereo 4-track, 7in., 1 $\frac{1}{2}$, 3 $\frac{1}{2}$, 7 $\frac{1}{2}$. U.K., Japan, U.S.A., Worldwide.

SWEDEN

KJELL ANDERSSON, 28, Wages clerk, Stenstry, Kareg 6, Ystad, Sweden. Coin and stamp collection, stereo music, radio electronics; light classic, pop. Philips EL 3541, 7in., 3 $\frac{1}{2}$ only. All countries.

U.S.A.

JEFFREY FEINMAN, 20, Student—New York University, 354 New York Avenue, Brooklyn 13, New York, U.S.A. Comedy, disc-jock shows, general chatter, sound effects, experimental recordings; Rock n' Roll, Pop; VM, 7in., 3 $\frac{1}{2}$, 7 $\frac{1}{2}$. Guys and gals anywhere.

JIM PLUMMER, 18, Student, 2726-162nd Place, Hammond, Indiana, U.S.A.; 8mm., movies, radio-T.V., current events; pop, jazz, folk. Knight, 7in., 3 $\frac{1}{2}$, 7 $\frac{1}{2}$. Anywhere English spoken.

H.M. FORCES

ROY BOSWELL, 22, E & I Section, Royal Air Force, Odiham, Hants. H.M.F.; Hi-fi and radio construction; classical, modern jazz, instrumental. Elizabethan LZ29 4-track, 7in., 1 $\frac{1}{2}$, 3 $\frac{1}{2}$, 7 $\frac{1}{2}$. Holland, Sweden, English speaking.

SGT. J. W. HORNE, 29, Regular soldier, Sgt. Mess, School of Signals, Catterick Camp, Yorks. Golf, reading, telecoms; jazz, pop, folk. Grundig T.K.14, 5 $\frac{1}{2}$ in., 3 $\frac{1}{2}$. New Zealand, all America.

L/C BOB McKAY (23516994), 23, Radio operator 1st Troop "A" Squadron, 10th Royal Hussar, B.F.P.O. 16, Hi-fi, si-fi, shortwave; folk of all kinds (esp. Spanish). Loewe Opta 402, 5 $\frac{1}{2}$ in., 3 $\frac{1}{2}$, 7 $\frac{1}{2}$. Pacific Islands/Australasia, English speaking.

NIGEL POWERS, 15, Schoolboy, W/O Powers, Families Office R.A.F. Steamer Point, Aden, B.F.P.O. 69. Photography, shipping (merchant), scouting; military, pop comedy; Philips EL3542 4-track, 7in., 1 $\frac{1}{2}$, 3 $\frac{1}{2}$, 7 $\frac{1}{2}$. Anywhere English speaking.

CUMBERLAND

MALCOLM LEGGETT, 22, Shop assistant, 11 Friars Road, Scaws Estate, Penrith, Cumberland. Cine 8 mm., recording member M.S.Y.C.; almost all (no classics/mod. jazz). Regentone RT50, 7in., 1 $\frac{1}{2}$, 3 $\frac{1}{2}$, 7 $\frac{1}{2}$. Southern U.K. (male 20-23 preferred).

RONALD ALEXANDER RAE, 15, Student, 81 Dunmail Drive, Carlisle, Cumberland. Camping, reading; pop, jazz (mod & trad), C & W, light classical. Cossor C.R. 1602 4-track, 7in., 3 $\frac{1}{2}$. Any English speaking boy or girl outside U.K.

DORSET

DAVID WILLIAM SHORTO, 18, TV engineer, 88 St. Georges Road, Fordington, Dorchester, Dorset. Sailing, gliding, motor racing, art; pops, trad, light classics. Elizabethan LZ/29 4-track, 7in., 1 $\frac{1}{2}$, 3 $\frac{1}{2}$, 7 $\frac{1}{2}$. U.K., anywhere English speaking.

ESSEX

S. W. BAKER, 36, Qualified male nurse, 7, Northumberland Avenue, Linford, Stanford-Le-Hope, Essex. Brass bands, cine 8mm, photography; all types. Reps 10 and Grundig Cub, 7in., 1 $\frac{1}{2}$, 3 $\frac{1}{2}$, 7 $\frac{1}{2}$. Anywhere (male only).

HANTS.

SHEILA RYAN, 18, 50 Cottage Grove, Southsea, Portsmouth, Hants. Films, record collecting; ballads, pops, Philips EL 3534, 7in., 15/16, 1 $\frac{1}{2}$, 3 $\frac{1}{2}$, 7 $\frac{1}{2}$. Anywhere English speaking.

KENT

STAN & ELSIE MARTIN, 30, Car salesman, 38 Park Road, Bromley, Kent. Family do-it-yourself cars; pop, Civic studio 2-track, 7in., 1 $\frac{1}{2}$, 3 $\frac{1}{2}$, 7 $\frac{1}{2}$. Anywhere English speaking.

LANCS.

REX BERRIE, 42, Sub Postmaster, 28 Whinney Heys Road, Blackpool, Lancs. Photography cine 8 mm.; light classics, Grundig, 7 $\frac{1}{2}$ in., 3 $\frac{1}{2}$ -7 $\frac{1}{2}$. Anywhere opp. sex.

JUDITH GRAY, 18, Student, 21 Rose Avenue, Ashton-on-Ribble, Preston, Lancs. Riding and horses, reading, foreign countries; pops, discovering classics; Fidelity Argyll 4-track, 5 $\frac{1}{2}$ ins. 3 $\frac{1}{2}$. Anywhere.

JOAN HOLGATE, 23, 121 Chesnut Grove, Bootle 20, Lancs. Sport; pop, show, Hawaiian, C & W, Philips EL3536, Cossor 1602 2-track Alba, Grundig TK1, 7in., 1 $\frac{1}{2}$, 3 $\frac{1}{2}$, 7 $\frac{1}{2}$. Eire, Germany, Russia and Hawaii.

QUEENIE LEE, 34, Sales assistant, 3 Banville Street, Gorton, Manchester 18. Theatre, reading, braille; light music, Gilbert and Sullivan opera. Grundig T.K.1. portable, 3in., 3 $\frac{1}{2}$. Anywhere.

DAVID MYERS, 26, Radio & TV salesman, 9 Braemar Grove, Heywood, Lancs. Reading; jazz and light music. Philips EL 3527, 5in., 3 $\frac{1}{2}$. Any countries, male or female.

TOM RILEY, 30, Cotton worker, 10 Vale Street, Haslingden, Rossendale, Lancs. Church lads brigade, photography; pops, jazz, sound effect records, all types of bands. Simon S.P.5, 7in., 3 $\frac{1}{2}$, 7 $\frac{1}{2}$. Anywhere.

PETER THOMPSON, 24, Chauffeur, 3a Warrington Road, Prescott, Lancashire. Goonery, humour, motoring; good pops. Philips EL3542 4-track, 7in., 3 $\frac{1}{2}$, 7 $\frac{1}{2}$. Anywhere English speaking.

LEICESTER

MR. & MRS. FRANK BATHO, 24, Coal miner, 9 St. Saviours Road, Coalville, Leicestershire. Good sound Hawaiian music; exotic percussion, some classical. Philips stereo, model EL3536, 7in., 7 $\frac{1}{2}$, 3 $\frac{1}{2}$, 7 $\frac{1}{2}$. Anywhere English speaking; some people about same age.

ROGER KING, 22, Decorator, 27 Willow Street, St. Mathew's Estate, Leicester. Films, dancing; pop, c/w, Carousel, Radio Tape 2-track 7in., 1 $\frac{1}{2}$, 3 $\frac{1}{2}$, 7 $\frac{1}{2}$. Anywhere English speaking.

GEOFFREY WILLIAMSON, 29, Telephone engineer, 24 Jermyn Street, Melton Road, Leicester. Films, reading, speedway, current affairs; classics, operas, ballet. Grundig T.K.20 5 $\frac{1}{2}$ in., mono 3 $\frac{1}{2}$. U.S.A., U.K., N.Z., Europe, Australia, females only need reply.

LINCS.

TREVOR BRIGHT, 20, Glenside, West Pinchbeck, Nr. Spalding, Lincs. Horticulture; wild life of the world; pop music. Grundig TK 25, 5 $\frac{1}{2}$ in., 3 $\frac{1}{2}$, 1 $\frac{1}{2}$. Africa.

GRAHAM LEAK, 15 $\frac{1}{2}$, Apprentice TV engineer, Frithville, Boston, Lincs. S.W. listening, history; modern pop. Ferguson 3202 4-track, 5 $\frac{1}{2}$ in., 1 $\frac{1}{2}$, 3 $\frac{1}{2}$. North America, Australia, Canada.

THE TAPE DIRECTORY—continued

LONDON

R. BREMER, 38, Electrical engineer; 15, Crescent Road, Hornsey, London, N.8. Photographs; motoring; light music. Philips EL3542. 7in., 1½, 3½, 7½. Anywhere English and French. Females preferred.

WARREN CHONG, 27, 39 Katherine Road, East Ham, London E.6. Storekeeper; hi-fi, music, Radio, TV and Electronics; all types. Philips EL3541 4-track, 5½in., 3½. Germany, Scandinavia etc. Anywhere English speaking.

TONY DUFFY, 21, Brewery worker; 16 Allison Road, Acton, London, W.3. Swimming, dancing, photography; pops, show music, Elvis. Philips EL3541 4-track, 5½in., 3½. Germany, Scandinavia etc.

W. GIBSON, 38, Despatch clerk; 38 Fitzroy Road, Regents Park, London, N.W.1. Photography theatre; general. Sound Riviera, 5in., 3½. U.K. male only.

NOTTS.

VICTOR H. SWANWICK, 19, Trainee quantity surveyor, 24 Hampton Road, West Bridgford, Nottm. Tape recording and dancing; jazz, pops and folk music. GEC, 5½in., 3½. U.K. U.S.A., Australia.

NORFOLK

DAVID BUTTON, 20, Granary worker, 91 Brandon Road, Watton, Thetford, Norfolk. Dancing, pops, guitar music. Ferrograph 5 AN. 7in., 3½, 7½. Anywhere, any age.

NORTHANTS

P. DAVIES, 18, Printer, 14 Saxby Crescent, Wellingborough, Northants. Rally driving, philately, travel, cars, ten-pin bowling; pop to light classics. Grundig TK.14. 5½in., 3½. U.S.A., Canada, Hawaii.

WARWICKS

BRIAN G. SPENCER, 28, Pharmacist, 112 Thornhill Park, Streetly, Nr. Sutton Coldfield. Round table, sport, music, French language, philately; nearly all types. Colaro studio, 7in., 1½, 3½. Anywhere abroad, don't write all tapes answered.

STAFFS.

DENIS J. GRIFFITHS, 41, Non-destructive testing engineer, 10 Woodland Crescent, Merry Hill, Wolverhampton. Colour photography, fiction-writing, reading, the way other people live; show music, Hawaiian guitar, pops, dixieland jazz. Robuk RK 3 Elizabethan F.T.3. 7in., 1½, 3½, 7½. Anywhere abroad, Denmark, Sweden, India, Norway, South America—anywhere.

SOMERSET

MARK DREW, 17, Student, Caspian Villa, Heywood Road, Pill, Bristol. Underwater swimming, debating; modern jazz, general listening. Vogue 2-track, 7in., 1½, 3½, 7½. Sweden, Continent. U.S.A. Same age group, female preferred; letter first please.

YORKS.

DOROTHY BRAILSFORD, 23, Laboratory assistant, 32 Upper Hanover Street, Sheffield 3. Photography, reading, piano; all kinds. Philips 4-track, 7in., 7½, 3½, 1½. Anywhere.

S. H. COX, 33, Night telephonist, 67 Elford Grove, Leeds 8. Films, books, swimming, body building; films, Conniff, Sinatra, Shore, Heath, any kind really. Grundig T.K.20, Philips EL 3545 5½, 4, 1½, 3½. U.K., U.S.A., Australia, Canada, anywhere English speaking.

ERNEST FILNEE, 30, Guard (B.R.), Baptist Chapel House, High Street, Normanton, Yorks. Photography, chess; pops, modern jazz. Stellaphone S.T.450, 2-track, 7in., 1½, 3½, 7½. Japan, South America, South Africa, English speaking.

IRVINE HISCOCK, 32, Capstan Lathe Operator, 42 Wellclose Mount, Leeds 7, Yorks. Films, reading; dance, pops, musicals. Grundig TK 23, 5½in., 3½. Anywhere English speaking, preferably Australia, N.Z., Norway or Sweden.

HUBERT HORSLEY, 24, Driver, 17 Carlton Terrace, Brighouse, Yorkshire. Chess, hi-fi, general light classical reading; classical and pop. Philips 3541, 7in., 3½. U.S.A., Spain, English speaking.

KEVIN J. MCSORLEY, 19, Steel mill operator, 8 Bradhope Road, Berwick Hill, Middlesbrough, Yorks. Football, table tennis; jazz, pops, light classic. Fidelity minor, 5½in., 3½ only. America, Canada.

KEITH MOORE, 15, Student, 37 Bywell Close, Dewsbury, Yorks. Judo, local history; light, musicals, pop. Elizabethan 4-track, 5½in., 3½. Anywhere English speaking.

STANLEY MORRIS, 44, N.C.B., surface, 38 Bawtry Road, Harworth, Nr. Doncaster, Yorks. Theatre organ, tape recording, Methodist church; all but not jazz. Grundig TK 25, 5½in., 1½, 3½. Anywhere English speaking.

GERALD RHODES, 28, Bank Security, 1 Brixton Street, Beeston, Leeds 11, Yorks. Short wave radio, motor-cycling; jazz, mainstream, swing, Chicago. Linear LTR 23 2-track, 7in., 1½, 3½, 7½. Anywhere English speaking.

ALAN RIDDIOUGH, 20, Chemist, 19 Carmona Gardens, Shipley, Yorks. Photography; all except classical. Fidelity 4-track, Grundig TK 1, 5½in., 3½. Anywhere.

STEPHEN ROBERTS, 18, Student, 20 Chatsworth Road, Pudsey, Yorks. Music, reading, geology; jazz, folk music. 5½in., 3½. Anywhere English speaking, preferably outside British Isles.

RUSTY R. TEATHER, 23, Timber worker, 101 Rotherview Road, Canklow, Rotherham, Yorks. Tapesponding, radio, photography, hi-fi, stamps, coins, science fiction; Jazz, C & W., organ, guitar and brass to Bach. TK25, H.M.V., 2202, Alba, Princess. 5½in., 1½, 3½. Europe, U.S.A., Far East. (Secretary of International Tape Pals Inc.)

IRELAND

PETER GOODALL, 16, Schoolboy, 15 Farmlay Gardens, Glengormley, Newtownabbey, Co. Antrim, Northern Ireland. Stamps, 8mm, films, playing the recorder; pop (especially Cliff and the Shadows). Grundig TK.14. 5½in., 3½ only. Anywhere English speaking.

THOMAS KELLY, 29, Labourer, 2 Coronation Park, Ballybeal, Dundonald, Belfast, N.I. Reading, travel; Pop, country and Western. Elizabethan, 7in., 1½, 3½, 7½. Anywhere.

DESMOND McCHEANE, 31, Printer, Wellbrook Freshford, Co. Kilkenny, Ireland. Sport, folk dancing, birds, trick tapes; Ceili music and folk music of all lands. Philips 3542 and Ecco RT 366, 7in., 1½, 3½, 7½. Anywhere—but Scotland especially.

HUGH ROBINSON, 21, Joiner, 30 Robert Street, Newtownards, N.I. Reading, sport, radio, films, pop, TV.; C & W., good pop, Frankie Lane, Jolson, oldies, etc. Cossor 2/4-track, 7½ins, 3½. U.K., France, U.S., Sweden. Anyone who wants a laugh and a chat!

ISLE OF WIGHT

ALAN R. HUNT, 36, Salesman; member of the Royal Observer Corps, 89a, Royal Exchange, Newport, Isle of Wight. Tape recording, Aviation matters; anything except rock and roll. Philips Starmaker, Civic T62, 7in., 1½, 3½, 7½. If you're in the R.O.C. just tape! anywhere.

JOHN CHARLES AYERS, 24, Theatre electrician, c/o Galety Theatre, Carrick Street, Ayr. Live theatre, tape recording; pops to classics, not jazz. Stella 455, Truvox PD 84, Elizabethan Escort, 7in., 1½, 3½, 7½. Anywhere English speaking, twin track only for tapesponding.

JAMES CLELLAND, 30, Shunter, British Railways, Dean Bank Lodge, Dean Bank Lane, Stockbridge, Edinburgh 3. Tape Recording, photography cycling, walking, interior decorating, reading; non-classical. Philips EL 3541 4-track, 7in., 3½. Anywhere.

FRANK H. HERBERTSON, 36, Administrator, 42 Cecil Street, Glasgow, W.2., Scotland. Photography, travel, collecting old swords; anything but classical. Sound Riviera, 7in., 1½, 3½, 7½. Canada, U.S.A., England. Male contacts only.

R. J. Y. McLEOD, 19, Student, The Gowans, Gowan Street, Arbroath, Angus, Scotland. General; everything except heavy classical. Grundig TK 20, 5½in., 3½. Anywhere.

JOHN J. PARK, 21 Parkview Crescent, Newmains, Wishaw, Lanarkshire, Scotland. TV., 8mm cine with sound, sound effects; pop, jazz (trad and modern), light classical. Grundig TK 5, 5½in., 3½. U.S.A., Canada, anywhere English speaking. No need to write first, all tapes answered.

WILLIAM STEPHEN, 32, Cinema projectionist, 15, Bute Crescent, Dunfermline, Fife. 8 mm. cine, record collecting, theatre; instrumental, pop, no jazz. Stella ST454. Philips (portable), 7in., 3½, 1½. Anywhere.

WALES

JEAN HUGHES, 24, Housewife; Windy Ridge, Denbigh Circle, Kinnel Bay, Rhyl, North Wales. Reading chit-chat, swimming; pop no jazz. Sound Riviera, 7in., 1½, 3½, 7½. U.S.A., Canada, Anywhere English speaking.

GARETH AVERY, 19, G.P.O. telephone engineer, Kildare Guest House, Conway Road, Llandudno, North Wales. Hi-fi, art, electronics, travel, humour, reading, driving and TW 31; Pops, C & W., modern jazz, organs, all classical. Philips EL 3541 4-track, 7in., 3½. Anywhere, young lady preferred.

JOHN J. PARRY, 36, Clerk, B.R., 8 Sneyd Street, Cardiff. Reading, rambling, science; Big band jazz, modern jazz. AG 8108, 7in., 1½, 3½, 7½. Anywhere.

SCHOOL

WALTON LODGE SCHOOL, pupils aged eight and nine, Walton-by-Clevedon, Clevedon, Somerset. Hobbies, school news, education, geography, local industries. Grundig TK 14, 7in., 3½. America, Canada, Australia or N.Z., any English speaking school.

Val Parker's Tape Parade — A REVIEW OF THE

AN EVENING IN VIENNA
... Vienna State Opera Or-
chestra.

Here is a feast for all Strauss fans. The Vienna State Opera Orchestra recaptures the gaiety of life in the day of the waltz, the Vienna of yesterday, far removed from wars and enemy occupation. No one listening to the 'Radetsky March' or the 'Thunder and Lightning Polka' can fail to tap his feet or want to dance to the swinging lilt of such waltzes as 'Wine, Women and Song', 'Artists Life' or 'Vienna Blood'. I can recommend to you seventy minutes of the finest music that was so much a part of old Vienna.

A FIRESIDE MUSIC FESTIVAL . . . Vienna State Opera Orchestra.

Whether you sit by the fire or not,



The Vienna State Opera Orchestra will enchant you with this recording of selections from some of the great composers. A collection like this is ideal as background music for the classical fan. No great thought is needed to analyse the

music as each piece is short and well known. At the beginning of Track 1 we are stimulated by the 'Zampa Overture' and Wagner's thrilling 'Ride of the Valkyries'. Then we can listen to the charming 'Entracte' from Schubert's 'Rosamunde' and the pageantry of Verdi's 'Grand March' from 'Aida', Handel's immortal 'Largo', the 'Invitation to the Dance' and the well-loved 'William Tell Overture'.

AN EVENING AT THE BALLET . . . Vienna State Opera Orchestra.

This is the third tape this month in which the Vienna State Opera Orchestra delights us. Sometimes I find it unrewarding, with some of

LUXOR A BRILLIANT NEW HI-FI STEREO TAPE RECORDER

FROM SWEDEN

We are Exhibiting at the
AUDIO BOOTH No. 30
FAIR DEMONSTRATION ROOM No. 218

The first completely self contained 4-track, 3-speed mono-Stereo Recorder on the British Market at a price below anything comparable with it in performance. Built-in stereo speakers and amplifiers as well as all connectors and leads for record and play-back through external equipment.

Also MP 424, in two-tone portable case with carrying strap — 77 gns

BRITIMPEX LTD

U.K. DISTRIBUTORS OF TELEFUNKEN VALVES AND COMPONENTS

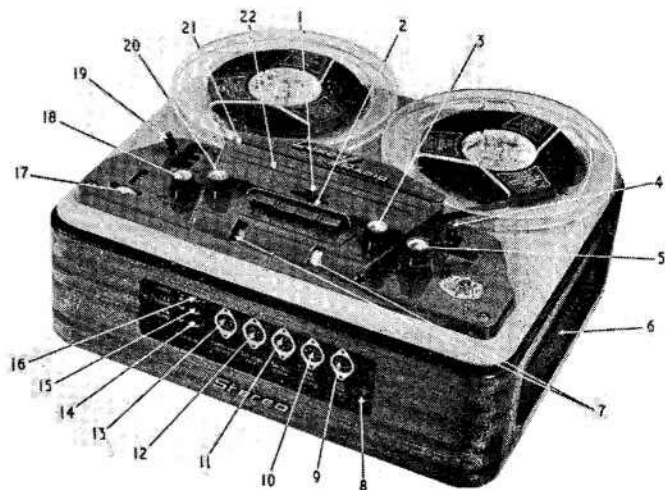

PRICE ONLY

74 GNS

MODEL
M P. 423
(IN TEAK)

- | | |
|---|---|
| 1 Track selector | 12 Radio input, and external amplifier output |
| 2 Pushbutton panel | 13 Earphones |
| 3 Master volume control | 14 Socket for external loudspeaker (mono) |
| 4 Standby-play-fast forward-fast reverse | 15 Socket for external stereo loudspeaker |
| 5 Individual volume controls for stereo balance | 16 Socket for external stereo loudspeaker |
| 6 Speaker enclosures (only right visible) | 17 Tape-consumption indicator (cuemeter) |
| 7 Recording level indicators (magic eyes) | 18 Loudspeaker switch |
| 8 Ground | 19 Power on/off and speed selector switch |
| 9 Microphone (stereo) input | 20 Tone switch |
| 10 Microphone (mono) input | 21 Tape guide |
| 11 Phonograph input | 22 Splicing groove |

particulars and address of nearest stockist from sole concessionaires in U.K.
16 - 22 GREAT RUSSELL ST. · LONDON, W.1 · Phone MUSEum 7600

LATEST PRE-RECORDED TAPES



Lake' must be known to most people whether balletomanes or not. The ballet from 'Faust' is seldom seen outside a performances of the opera but still is well known.

These three tapes I can recommend to you for recording clarity and musicianship but why, oh why, have they been issued to the public with so many careless spelling or printing errors on the publicity sheet.

CELLO AND PIANO SON-ATAS .. Brahms .. played by Janos Starker and Gyorgy Sebok.

Sometimes I feel that a duo of piano and cello can be heavy and clumsy, but I found these two artistes

were completely in tune with the music. Occasionally I felt the piano too dominant or perhaps it was the fault of the recording that the cello was in the background. This is just a little quibble and should not put off your enjoyment of two excellent artistes.



the less popular ballets, to listen only to the music without the spectacle of the dance. Here are four extracts from ballet music that are probably the most well-loved of all. 'Coppelia', 'Sylvia' and 'Swan

INSPECT THIS
BRILLIANT NEW

LUXOR

MADE IN SWEDEN

STEREO TAPE RECORDER



★ SEE AND HEAR IT AT

The New Luxor STEREO Tape Recorder can be tested and tried at L.E.C. ELECTRICAL LTD. It is the finest value 4-track, 3-speed mono-stereo Recorder on the British Market at a price far below anything comparable in performance. In addition to built-in stereo speakers and amplifiers it has all the necessary connectors and leads for record and play-back through external equipment.

It is also available in two-tone portable case with carrying strap Model MP424 at 77 gns. Try this wonderful set today at:

Price Only 74 Gns.

Model M.P. 423 (IN TEAK)

L.E.C. (LEYTON)

ELECTRICAL

120 HIGH RD.

LEYTON, LONDON E.15 Telephone LEY: 6814

COMPANY

Clubs must not let petty arguments ride.

MANY of you will be as surprised and dismayed as I was to learn that the Bethnal Green Tape Recording Society has closed its books and now exists in name only. I can't help feeling that although the rather perfectionist attitude of the committee may be partly to blame, the underlying cause goes back to the rift in the club which led to the formation of the New Circle group. Although the club has apparently continued successfully since the breakaway group left, it has obviously been hard work for those who were left behind. I am not condemning anyone concerned in this rift — I know too little of the events that led up to it — but I do feel that these sort of conflicts should not be allowed to build up in the tape recording world. The essential key to the whole concept of tape recording clubs is surely friendliness. I appreciate that from time to time misunderstandings do arise between clubs and among individual members, but usually these differences can be settled amicably. If this doesn't work out, clubs can always bring their differences to me, as a kind of independent arbitrator — I shall be only too pleased to do anything possible to keep the club movement thriving on a friendly basis. Federations, too, can help in this respect; but, club officials, please don't ride the high horse immediately a tiff blows up. Don't forget, the committee is there to serve the club, not to subordinate it. And don't just let the situation ride — it'll be harder to mend later. A little tolerance goes a long way.

CLUB OF THE MONTH

Now I hand over to the clubs, and top of the table this month are **Hull and District T.R.C.** A lively bulletin from press secretary Brian Saunders tells me that after a mass exodus of the committee before the A.G.M., there was a mass entrance — of exactly the same people! So no change there. This was followed by the annual dinner and dance at one of the city's best wining and dining houses, amidst oak beams, pewter tankards and Gibson guitars! The young rock group who entertained them, none over sixteen years old, so impressed, that the club has made several recordings of them and hopes to send at least one to the E.M.I. recording studios for audition. Hospital service programmes continue apace, with requests coming from as far afield as Butzweiderhof in Germany. Also on the agenda are arrangements for the club visit to the Audio Fair — of course!

B-TRAC REVELS

Birmingham club had a hilarious evening recently when two members prepared a simple pantomime script and assembled suitable costumes. Various members were co-opted on the spot to act in the show and then given five minutes to read their scripts before the reels started turning. Sound effects and background music had been prepared, and the playback afterwards was uproarious. Not only were the missed cues, poached lines, and jumps from page three to page five very much in evidence, but the sound effects had somehow got out of synchronisation with the script, and the clock struck twelve after Cinderella had fled from her prince! A very enjoyable and unusual evening. Another unusual sphere of activity has proved to be in local industry. The

Works Manager of a large Birmingham factory recently complained that he could not read his foremen's reports. On the advice of a B-TRAC member, the manager bought tape recorders, and now the foremen make their reports while doing their rounds!

FAIR IN MINIATURE

As a prelude to the Audio Fair and a means of arousing local interest in it, members of **Thornton Heath T.R.C.** staged a fair of their own in miniature. Originally intended as a one-firm demonstration, the occasion aroused so much interest among other manufacturers that the whole concept was enlarged. Companies represented included Agfa, B.A.S.F., E.M.I., Fi-Cord, Grundig, and of course A.T.R., and about ten other concerns sent publicity and display material. The club found the co-operation of all the manufacturers and the tape recording press most encouraging, and felt that it augured well for any similar activity in the future.

RUGBY REVIEW

The Ministry of Housing and Local Government New Towns' Research Group (what a mouthful!) is preparing a study of the type and number of meeting places to be provided in the new towns for groups like tape recording clubs. The study will also include a re-

port on an old established town which has developed its social life under more normal circumstances. Rugby is the 'normal' town which has been chosen for this, and members of the **Rugby A.T.R.S.**, have been asked to participate in an enquiry, which included details of membership, activities, meetings and facilities. It might be interesting to make a survey of this sort purely among T.R. clubs. Do the London area clubs have any real advantage over provincial ones? Either way, Rugby are rather proud of the fact that although they were only fifth in the League Championship last year, they were the top provincial club.

LIBERTY ARMS

One of those successful London clubs was **Walthamstow and District**, and they recently had the chance to sample the fruits, not of their success, but of the hops. Members were conducted around the 26-acre site of the Ind Coope brewery in the centre of Romford where one of the world's largest bottling plants stands. The highlight of the visit was the sampling of the finished product in the Liberty Arms, the visitors 'local' in the brewery grounds. The magnificent Associated Redifusion studios at Wembley were hosts to the society too. With a forward eye on video, members paid great attention to the subject and gained many professional hints and tips for possible future application.

WALLS OF JERICO ?

Although there is a close link between audio and video, especially in relation to tape recording and cine, there has not, as yet, been any great success in attempts to weld the two fields a little closer together. **Southall T.R.S.** feel they have blown down the walls of Jericho, so to speak, by managing to stage an evening with their local camera club. In doing so, the tape club demonstrated its own concept of the marriage of sound and vision by providing its own slides synchronised with commentary and music. So successful was this evening that similar ones have been planned for the future, including a scheme where photographers throw in a motley of unrelated slides and challenge the recordists to marry a sound track to it, and vice versa. Should prove interesting and instructive.

CHAMPIONS AT WORK

Anyone interested in seeing last year's League Champions at work can find them just a reel of tape away from Stockwell Station, in South West London. Now officially known as the

TOP TEN FOR APRIL

- 1 — Hull
- 2 — Thornton Heath
- 3 — Birmingham
- 4 — Walthamstow
- 5 — Southall
- 6 — London
- 7 — Rugby
- 8 — South Devon
- 9 — Thanet
- 10 — Reading

BRING DISASTER

Lambeth Tape Recording Club, they are now happily settled in their 'nice little room and kitchen' over the Jeffreys Library in Jeffreys Road. In keeping with their new name and with the help of the Lambethans Society, the club is to embark on a history of the Borough of Lambeth. Documentary/actuality and simulation are the favourite T.R. topics of this club, so that mocking up and acting historical events, street cries, etc., should prove almost a busman's holiday for them.

TO WALK ALONE

South Devon T.R.C. and the Torbay Amateur Cine Society are now discussing the joint project of making a sound film. After several scripts had been discussed it was unanimously agreed that a story put forward by Philip Linder should be adopted. With the provisional title 'To Walk Alone', the film will take the form of a short thriller lasting about 15-20 minutes. 16 mm black and white film will be used with magnetic sound stripe track. In it, honorary club member Joe Pengelly has agreed to play the part of a T.V. announcer. In real life Joe is—a T.V. announcer for the B.B.C. West Region, and the club hopes to be allowed to shoot part of the film in the B.B.C. studios.

THANET CHANGE

The **New Thanet Tape Recording Club** has already had a change of organiser — P. Foster moved to Brighton—and the new co-organisers are Chas. A. Brown of Studio One, Woodlands Avenue, Birchington, Kent, and Geo. Watson, of 3 Wentworth Avenue, Westbrook, Kent. Club H.Q. is to be in Margate, where prospective members will find people falling over backwards to help them. Anyone owning a tape recorder is invited to join, even if they don't live in Thanet.

MYSTERY FILM

Reading Cine and Tape Recording Society finds that otherwise reasonably sane club occasions are disrupted by the production of that epic film 'The Great Escape'. The rushes for this film were screened at what amounted to a midnight matinee. Mystery surrounds the enterprise and the plot is still a secret, except to the director!

BACK TO JOE

Our B.B.C. announcer Joe Pengelly (see above) has turned up again, this time as new president of the **Plymouth Tape Recording Club**. As you might guess, Plymouth and South Devon clubs have been getting together, and at one recent joint evening they both enjoyed a demonstration of home chromasonics. Plymouth are also stag-

ing a show at the Scott Lecture Theatre in the Plymouth Central Library to show the public what equipment the club has and uses. It is hoped that new members will be attracted by this.

TAPING THE TUNNEL

Members of the **Dartford T.R.S.** were very much in evidence at the new Dartford Tunnel recently. Loaded with equipment, club members were shown round the eight toll booths, control room administration block, and the tunnel itself. The tunnel trip was accomplished with a landrover escort at front and rear, and a recording made under the ventilation shaft, where the air rushes at the rate of about 20 tons a minute, gave a unique impression of power.

MILLOM STUDIO

Millom and District members have been busily scrounging furniture and carpeting for their new studio/club room (as reported in February). The project is now proceeding apace, and we hope to tell the whole story of the project in a future issue of A.T.R.

DISC PRESSING

Coventry club recently enjoyed a visit from the founder of the Midland Association of Tape Recording Clubs, of which they are members. He compelled the attention of all members with a very interesting illustrated talk on records from the early days to the present long-players, showing grooves, stylus vibration and the way to look after all discs.

LEISURE AND LEARNING

Ilford Tape Recording Society have now earned themselves an entry in the local council's 'Ilford Handbook', and a further mention in the Civil Service Council's booklet 'Leisure and Learning'. It seems that a sure way to bring a club to the public notice is to first make friends with the local council. Keep in touch with them, offer them assistance whenever possible and try to participate in all borough activities. Let their people see what an asset you are, and they'll do your local publicity for you!

PROVING THEIR WORTH

The girls of **South Reach County Youth Club** really had a chance to prove their worth recently. While the record request programme was being relayed over the Tannoy system the girls went round to those patients who didn't have any visitors and made a good job of cheering them all up. Club Warden Mr. Butler agreed that the whole evening had been most satisfying all round.

STUDIO SEARCH

Boston Soundhunters are eagerly searching for permanent premises suitable for conversion to a studio and

THE LEAGUE TABLE

	Pts.
1 — Thornton Heath	35
2 — Walthamstow	24
3 — Coventry	24
3 — Southall	23
5 — Birmingham	21
6 — Millom	19
7 — Bethnal Green	17
8 — Hull	15
8 — North London	15
8 — Rugby	15
11 — Bath	14
11 — Boston	14
13 — Reading	13
14 — Epsom	12
14 — Lambeth	12

workshop, but fear that finance, or rather lack of it, will preclude any action until next season. Anyone know of an attic or a cellar going cheap in Boston? I understand that Boston secretary Philip Towell has been awarded the World Tapes for Education Certificate of Excellence for his outstanding tape production of the Freedom of the Borough of Boston. W.T.E. (sponsor of World Tape Pals) will thus be presenting him with one of their coveted 'Lance Awards.' Congratulations!

OVERSEAS STUDENTS

This rather unique club continues to thrive under the guidance of Derek Chatterton and now has members from about fifteen different countries. Recent activities have included a series of lectures on 'Tape in Education', a series of visits to the Truvox factory, where, eight at a time, they have been shown the making of a tape recorder from start to finish.

FALSE IMPRESSION

Although in their January report, Uxbridge Club gave the impression that it was in fact the old Acton Club with a new name, this is not the case. I have been reassured by the secretary of the Acton Club that his group is still in existence and thriving happily. I hope this will correct any false impression that the Uxbridge report may have given.

AUDIO FAIR TICKETS

Finally a word to all club secretaries. We have here at A.T.R. a number of free tickets for the Audio Fair. Each ticket will admit two people, so clubs coming down in parties, you can obtain your tickets by writing to me, your Club News Editor, at the address below:
Miss Celia T. Kimmins,
Room 538 Ulster Chambers,
168 Regent Street,
London, W.1.

Mark your letters Audio Fair Tickets, and I'll allot them as fairly as possible. See you all there!

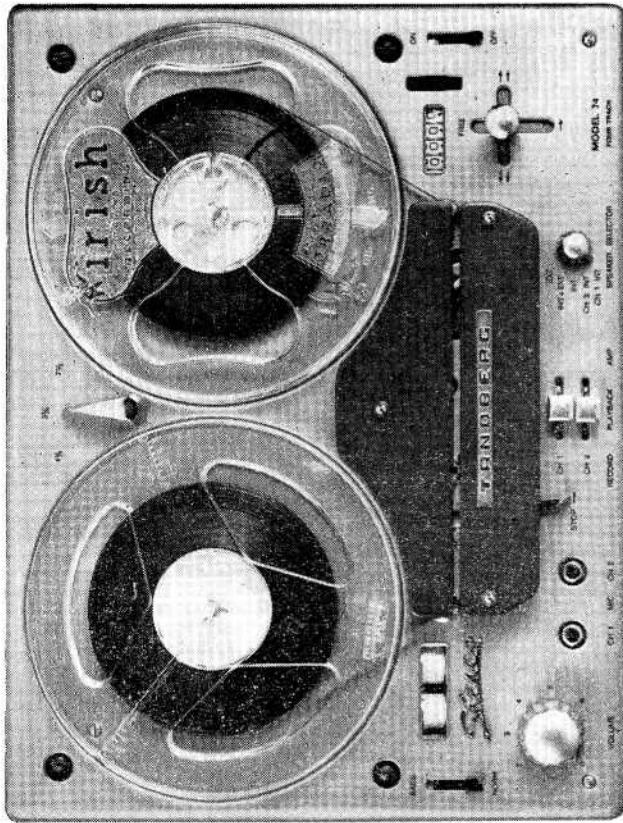

Turn to precise technical excellence that cannot be bettered. Turn to truly professional performance that you can be proud of. Turn to *Tandberg* for a new way of life in stereo recording. The Tandberg Series 7 stereo tape recorder has three speeds, two heads and two power amplifiers. Two indicators, two monitor speakers, two outputs for additional speakers or hi-fi. Four-track or two-track models. The finest portable tape recorder of its size in the world. Illustrated leaflet and Booklet of Technical Reviews on request.

TANDBERG SERIES 7 STEREO TAPE RECORDER 93 gms
 Model 74 (4 track)—Model 72 (2 track) (Illustrated: plan view of top plate—15 $\frac{3}{8}$ " x 11 $\frac{1}{2}$ ")

ELSTONE
 ELECTRONICS
 LIMITED
 EDWARD STREET
 TEMPLAR STREET
 LEEDS 2

Tel: Leeds 35111 (7 lines)

TURN TO Tandberg

The Incomparable *Ferrograph*

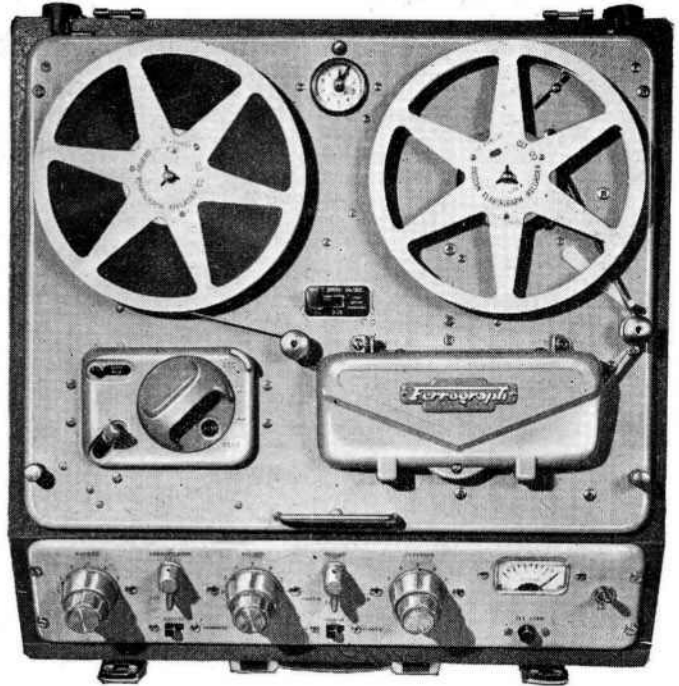

The Ferrograph is much more than a tape recorder; it is a carefully designed instrument for sound recording – the product of 15 years experience and specialisation.

We believe – and Ferrograph owners endorse – that the Ferrograph sets a standard in accord with the highest traditions of British engineering skill. Write today for descriptive literature and name of your nearest stockist.

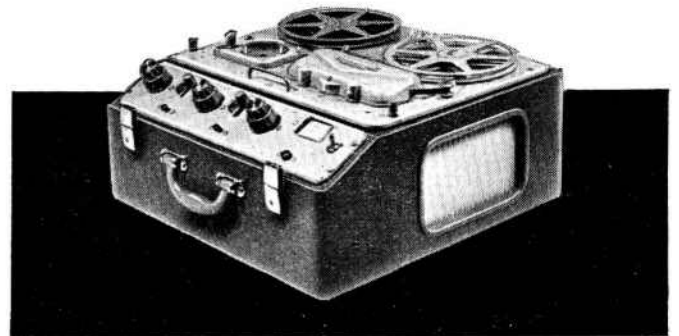

Please send me full details of the Ferrograph range

NAME

ADDRESS

THE FERROGRAPH COMPANY LTD

84 BLACKFRIARS ROAD · LONDON S·E·1

Telephone: WATerloo 1981

AT/10,

TAPE RECORDING DOWN UNDER

By Bell Emmett

Strictly Feminine . . .

TAPE recording is popular in New Zealand and regarded as a wonderfully creative medium by those like Ben and Bell Emmett who live in Dargaville on the North Island. Ben and Bell have their own accordion band and teach music and accordion playing. With tape recording they have become the local centre of all things musical.—Ed.

AS teachers of music, and naturally keen on all good music, we have always wished to hear how we, too, sounded when playing. Many friends had tape recorders, but none gave much better than a rough idea, they all seemed to lack 'presence' and also failed to cover the whole concert platform. Any soloist who moved about whilst singing caused weird effects, and pianos and violins — well, least said, soonest mended.

Eventually, my husband bought a Ferrograph (and that means £175 in New Zealand) and a Reslo ribbon microphone; we then began to get results. Next came the great advantage of a microphone mixer and two microphones. My husband constructed the *ATR* mixer, with the aid of the local radio man, and straightaway taped the local music festival concert; piano and violin recitals, singing, choirs, accordions, bands, speech — everything, in fact, and not one bad recording. The tapes were played back to the festival contest committee and to members of the public, and next day the local newspaper had a heading, 'Concert — Excellent Recording.' We had arrived!

People began asking for dubbings of their different items, and now we record their concerts annually, and also many others, including organists, choirs, and even complete performances of *Messiah*, Gilbert and Sullivan operas, etc. At least, those who have heard the play-backs at my studio say they can 'hear all the parts.' Replay is on the studio Hi-Fi system, using both circuits of a stereo tape recorder together.

By this time we are also keeping records on tape of all concerts in which our local groups and our two daughters or the family group had played. Over a period of five years this has grown to a library of eighteen reels of tape (all indexed, of course) and continually astounds us. Musical progress is obvious (or otherwise) and no argument is possible! Our rehearsals are analysed afterwards at leisure, and for a long time no one has said to us, 'Oh, but of course we sound different to that really,' for tapes once had a name for 'altering things.' Even breathing by the singers and phrasing by musicians can be critically examined, and balance, that bugbear of taping, is now no worry to us.

We also visit churches to record wedding services and find that one microphone beside the altar and one over the aisle above the front of the congregation provides the best results. These recordings have been so effective that one vicar has fixed a permanent thin steel cable across the aisle on which to hang the microphone. The church has bought its own tape, too, and L.P. records made from our tapes have delighted all those who have them.

TAPESPONDING

Tapespondents have also materialised with no effort on our part, and all tapes exchanged usually have introductions and intervals of music and comments, superimposed on, or faded in. Tapes are sent to England and our eldest daughter is being coached in music by tape correspondence with one of the greatest names in the accordion music world.

Our studio is also our lounge, and contains the 'sound cabinet,' with all the necessary equipment for stereo and mono reproduction. All the components are separate and instantly detachable from the wall or cabinets. Recent recordings include a Scottish Dancing competition and a recorded broadcast in our local church of a service from Canterbury Cathedral, with a sermon by the new Archbishop.

The studio is often used for taping radio programmes from overseas. On tape we keep in touch with music matters in London and receive recordings of various British contest concerts each year from the Festival Hall. Also the staff and principal of the British College of Accordionists comment on our musical and orchestral efforts and send us examples of English performances—all on tape. Tape keeps us in touch with the world—and 12,000 miles is a mere week's airmail away for taped messages or music. Truly, tapes are a most vital link in the world of music and friendship. Last, but not least, with the *ATR* sound effects records we are beginning some sketches on tape and plays, and another new field for tape recording opens in New Zealand.

WHATEVER YOUR ASSIGNMENT—GET THE **FI-CORD 202** PORTABLE BATTERY/MAINS RECORDER— *so much in so little space*

Another assignment for Fi-Cord Fred, safely stowed under his belt, thanks to the compact versatility of the Fi-Cord 202. The Fi-Cord 202 caters for the most exacting professional and for the enthusiastic amateur. Whether you are in a sound-proof studio or perched on a rocky ledge, the Fi-Cord 202 gives you high-fidelity recording at your fingertips. And with this wonderful, lightweight machine you have all the practical advantages of a full-size recorder.

The Fi-Cord 202 offers all these features:

2 speeds— $7\frac{1}{2}$ and $3\frac{3}{4}$ · Standard 4" spools
Vu-meter · Fast forward wind · Fast rewind
Resettable counter · Manual volume control

Built-in loudspeaker · Sockets for microphone, extension speaker and remote control · Safety record switch · Easy-load battery cassettes · Battery warning lamp · Mains input optional.

ACCESSORIES INCLUDE: Carrying case, choice of microphones, power packs for mains and car.

There is a full range of Beyer microphones, from general purpose to ultra-studio quality, to cover every use of the Fi-Cord 202.

Price: 66 guineas, including long life mercury batteries and tape.

Write for fully illustrated brochure and address of nearest stockist to:



FI-CORD INTERNATIONAL 40A, DOVER STREET, LONDON, W.1. HYDe Park 3448



The Things You Say . . .

A selection of letters from the A.T.R. postbag. If there's something you would like said on this page, then write to Room 532, 168 Regent Street, London, W.1.

SQUARE DEAL

Firstly may I say thanks for many months of enjoyable reading obtained from your magazine 'Amateur Tape Recording'. Secondly I would like everyone to know that I have had the squarest deal anyone could ask from a dealer and manufacturer of excellent repute and fairness. The dealer is a gentleman by the good name of Lee Radio Service and the manufacturers are Messrs. Truvox & Co. Ltd. The trouble was minor in nature, concerning my Truvox R 94, but the service I received was excellent. Thanks to both parties.

RONALD HIGNETT, London, S.E.13.

This is the kind of letter we always like receiving, and Mr. Hignett is the grateful customer everyone would like to have.

ENGLISHMEN AND POLITICIANS

I feel that Les Baines' letter from South Africa should not go unanswered, if only to let our friends in S.A. know that their views have received expression in this country.

No, Englishmen have not changed—and I hope they never will—in spite of whatever the world's politicians may thrust down our throats pro tem. This thought is the result of an experience of my own when I had established a most interesting contact with a group of four tape enthusiasts in South Africa, one of whom was a Minister of the Church. By air mail letter only we seemed to have a great deal in common, then hey presto, the storm broke over the affairs in that country and contact abruptly ceased without explanation. I have often wondered if this was entirely voluntary.

W. J. TOMLINSON, London, E.17.

HEREFORD AND BORDER FOLK SONGS

The response to the letter you so kindly published for me in February's A.T.R. has been so overwhelming that I have had more than my work cut out to cope with it all.

The first thing I would like to make plain is this. Will you kindly let the good readers of A.T.R. know two things. One, that it isn't necessary to send a contribution to the blind, direct to me. They can send it to their local contact. Their word is good enough for me. Secondly, the empty spool of tape needn't be more than three inches, as there is only twelve minutes of play. Of course, if they want the recording at a speed other than 3½ i.p.s. then they must send the appropriate amount of extra tape.

Finally, out of all the tapes sent, or rather enquiries, 60 per cent. sent a letter first, 30 per cent. sent a tape, with a stamped addressed envelope and a donation, and the remaining 10 per cent. sent empty spools. One comedian even sent an 8½-inch empty spool!

But the results have been very encouraging, and I am grateful to these columns for making it possible.

J. S. GRIFFITHS, Kidderminster.

For any readers who missed the first letter in the February issue, Mr. Griffiths is offering free copies of three Hereford folk songs which were recently accepted by the Vaughan Williams Memorial Library. Copies may be obtained from 'Hillcroft' 29 Sion Hill, Kidderminster, Worcs.

TAPED PICTURES —

by Gordon J. King

Continued from Page 13

CRYSTAL GAZING

Nevertheless, looking about five years into the future should show the establishment of home video recording. We shall have television sets incorporating their own video and sound tape decks, with a switch to record a programme with or without its display on the ordinary screen. Replay will give both sound and vision with quality almost up to the standard of the original programme.

We will have video tape recorders as a separate unit incorporating a picture tube as well as a loudspeaker. We shall be able to use these as we already use sound-only recorders, but in addition to the microphone we will have a small transistorised television camera dealing with the vision side of the recording.

Ultimately, as an extra item to the video/sound replay system, we shall have transistorised sound and video recorders which will almost certainly take the place of the home cine. Tapes cost nothing to process, can be used over and over again, and the television screen is already existing in almost all homes upon which the day's recording can be shown—and the speaker for sound.

Video tape records will be available, as sound tape records are today. Indeed, we are on the fringe of a very exciting era of amateur tape recording. . . .

SHEEN

TAPE RECORDER AND HI-FI CENTRE

Specialists in Tape Recorders—Accessories—Hi-Fi—Stereo
Your Centre for Friendly Help—Sales—Service

B.R.C. Approved Dealer for all Models and Repairs
Pre-recorded Tapes, Mics., Tuners, Amplifiers, Speakers Etc.

Details—With Pleasure—Call—Phone—Write

8 Station Parade

Sheen Lane

Sheen, London, S.W.14 Showrooms: PROspect 0985

(Opposite Mortlake Station S.R.)

Open 10 a.m. until 7 p.m.

Early Closing, Wed., 1 p.m.

SOUND EFFECTS RECORD

Send this coupon with your order,
or bring it to us at Stand 34 at the
Audio Fair.

BGX-1 Price 6/-

A.T.R.
Dept. 11
No.
BGX-1

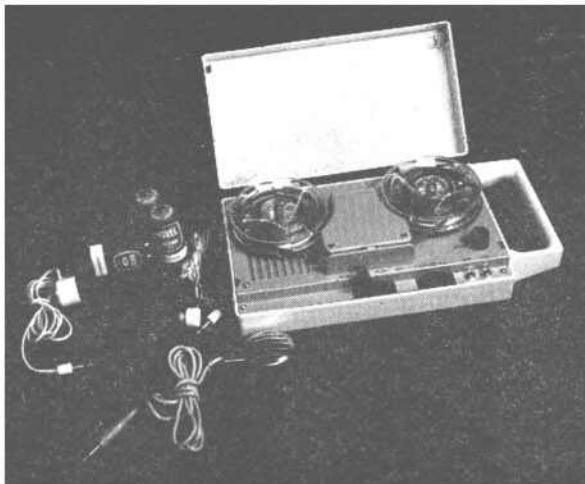

Cheques to: G.S.D. & Co. Ltd.,
Address: General Storage & Distributions
Co. Ltd., 208/209 Upper Street, London, N.1.
Please send Senior Corder HIL-4.

I enclose cash, cheque, P/O, M/O value £6.
(Block letters please)

Name

Address

.....

ONLY £6 COMPLETE

including postage and packing

COMPLETE with all accessories, batteries, and 6 months' guarantee

THE NEW SENIOR CORDER HIL-4

4-transistor tape recorder with variable speed control and telephone pick-up for recording telephone conversations.

Don't let the fantastically low price put you off!

The new Senior Corder Hil-4 is a beautiful little tool for the amateur or professional who wants a really reliable pocket-sized portable recorder, complete with all accessories, and fully guaranteed. Ideal for interviewing, business purposes or home and general recording.

Transistorized, twin-track portable complete with crystal microphone, magnetic earphone, 100 ft. recording tape, empty 3" reel, 2 batteries for motor, 1 battery for amplifier. Telephone pick-up.

- 4 transistors
- 100mW power output
- 2½" dynamic speaker
- DC bias dual-track recording system
- Measures 8½" x 5" x 2½" (excluding handle)
- Weight 2½ lbs.
- Ivory-coloured case
- Guaranteed for 6 months

Only available at this special introductory price while current stocks last.

The One and Only

FRANCIS OF STREATHAM

*Your
dependable
suppliers for all
that's good in*

TAPE RECORDERS

including
BRENELL • TRUVOX • ELIZABETHAN • FERROGRAPH
• FIDELITY • GRUNDIG • COSSOR • PHILIPS
• B. & O. • LOEWE OPTA • STELLA • TELEFUNKEN
• UHER • VORTEXION • WYNDSOR • BUTOBA
• STUZZI • SONY • TANDBERG.

Microphones, Tapes, Accessories. ALL AT
ADVERTISED PRICES

HI-FI TOO, BY LEADING MAKERS

*** No Extra For Credit * GOOD STOCKS
AND SERVICE**

Please note our only address

169-173, STREATHAM HIGH RD., LONDON, S.W.16
Between Streatham Stn. and St. Leonard's Church

STReatham 0466/0192

OPEN ALL DAY SATURDAYS



TAPE RECORDER COVERS

Smart, waterproof cover to give complete protection to your tape recorder. Made from rubberised canvas in navy, wine, tan, grey and bottle green with white contrasting pipings, reinforced base, handy zip microphone pocket and name panel.

GRUNDIG TK 1 with pocket	49/6	STELLA 459 with pocket	84/-
GRUNDIG TK 5 with pocket	55/-	STELLA 458	79/-
GRUNDIG TK 6	67/6	STUZZI TRICORDER with pocket	58/-
GRUNDIG TK 8 with pocket	63/-	SABA with pocket	63/-
GRUNDIG TK 14, 23 & 18	59/6	WYNDSOR VICTOR no pocket	60/-
GRUNDIG TK 20 with pocket	52/6	ELIZABETHAN FTI with pocket	66/-
GRUNDIG TK 24 with pocket	55/-	ELIZABETHAN LZ 29	75/-
GRUNDIG TK 25 with pocket	55/-	FI-CORD 1A	52/6
GRUNDIG TK 30 with pocket	60/-	FIDELITY ARGYLL no pocket	55/-
GRUNDIG TK 35 with pocket	63/-	CLARION (complete with strap)	52/6
GRUNDIG TK 40 & 41	66/-	BRENELL MK. 5 with pocket	77/-
GRUNDIG TK 46 with pocket	82/-	BRENELL 3 STAR with pocket	69/-
GRUNDIG TK 60 no pocket	75/-	ROBUK RK3	67/6
TELEFUNKEN 85 with pocket	65/-	SONY 521	90/-
TELEFUNKEN 75/15 & 76K with pocket	55/-	FERROGRAPH	80/-
TELEFUNKEN 95 & 96 with pocket	69/6	REVEX	84/-
PHILIPS 8108 with pocket	57/6	OPTACORD 412 & 414	63/-
PHILIPS EL3534 with pocket	87/-	FIDELITY PLAYMASTER	...
PHILIPS EL3549 with pocket	79/6		
PHILIPS EL3538 with pocket	63/-		
PHILIPS EL3542 with pocket	63/-		
PHILIPS EL3536 with pocket	70/-		
PHILIPS EL3515 with pocket	57/6		
PHILIPS EL3541/15 with pocket	57/6		
PHILIPS 3541H	72/-		
PHILIPS STARMAKER	66/-		
COSSOR 1605 with pocket	84/-		
COSSOR 1602 with pocket	57/6		
COSSOR 1601 with pocket	63/-		
COSSOR 1604	79/-		
STELLA ST455 with pocket	63/-		
STELLA ST454 with pocket	57/6		

CALL, SEND MONEY OR REQUEST C.O.D.
WITH YOUR ORDER TO:-

A. BROWN & SONS LTD

24-28 George St., Hull, Tel. 25412/3

A.T.R. APPROVED DEALERS

*** L.E.C. (Leyton) Electrical Co.**
120 HIGH ROAD, LEYTON, E.15.
LEYTONSTONE 6814.

Stockists of: Ferrograph, Vortexion, Brenell, Revox, Rogers, Armstrong, Leak, Goodmans, KEF, Record Housing Furniture etc. TAPES by BASF, AGFA, ZONAL 3" to 10". Demonstrations in the Home.

*** CITY & ESSEX TAPE RECORDER CENTRES**

228 BISHOPSGATE, LONDON, E.C.2.
2 MARYLAND POINT STATION,
LONDON, E.15 (Head Office)
Telephone: MARYland 5879
205 HIGH STREET, EAST HAM, E.5
(Opposite East Ham Station)
Telephone: GRA 6543

G. L. MORTON & CO. LTD.
12 OXFORD STREET,
NEWCASTLE-UPON-TYNE

*** NUSOUND RECORDING Co.**

Tape Recorder Specialists
93 Mortimer Street,
Oxford Circus
London, W.1.
Tel.: MUS 1219



THE SERIOUS ENTHUSIAST usually comes to us after finding technical service difficult to obtain elsewhere. WISE PURCHASERS come here first, and are assured of first class technical service at all times. WE SUPPLY All good Hi-Fi equipment and Tape Recorders. Part Exchange and H.P. welcome. LAMBDA RECORD CO., Dept. ATR. 95, Liverpool Road, Liverpool 23. Telephone GREAt Crosby 4012.

SOUTHERN RECORDER SERVICE

2 ST. GEORGE'S STREET,
WINCHESTER, HANTS

Bath Co-Operative Society Ltd.
TELEVISION CORNER,
SOUTHGATE STREET, BATH

WORTHING TAPE RECORDER CENTRE

22 New Broadway, Tarring Road,
W. Worthing, Sussex.
TAPE AND HI-FI SPECIALISTS
Agents for Vortexion, Ferrograph, Fi-Cord, Truvox, Phillips, Revox, Butoba, Wyndor, Elizabethan, Brenell, Loewe-Opta, Grundig, Leak, Quad, Armstrong, S.T.C., Reslo. Repairs, Terms. Exchanges.
Telephone: WORTHING 9260

R.E.W. EARLSFIELD LTD.
PART EXCHANGE SPECIALISTS
266 UPPER TOOTING RD.,
LONDON, S.W.17.
Telephone: BAL 7710.

*** SHEEN TAPE RECORDER CENTRE LTD.**

Personal Sales and Service by
L. G. Francis
8 STATION PARADE, SHEEN LANE,
SHEEN, LONDON, S.W.14.
Showrooms: PROspect 0985
(Opposite Mortlake Station S.R.)

Extensive Tape Recorder Show-room. Ferrograph, Grundig, Philips, Brenell, etc. Full range Mics, Tape, Accessories, Technical Information and Service.

*** CUSSINS & LIGHT**

KINGS SQUARE, YORK. Tel. 55666

C. SHARP & SON LTD.
4 PREBEND ROW,
DARLINGTON, CO. DURHAM

* VISITED BY "AMATEUR TAPE RECORDING & HI-FI"

LUSTRAPHONE

the foremost name in microphones



RIBBONETTE MICROPHONE

A pencil ribbon microphone giving the highest standard of monaural or stereophonic reproduction, the Ribbonette by Lustraphone is a really high quality product.



LAVALIER MICROPHONE

With an adjustable halter neck to leave the hands free, the Lavalier by Lustraphone is a most efficient dynamic microphone, equally effective indoors or outdoors.

Send for fully illustrated literature
LUSTRAPHONE LIMITED
(Dept. A.T.3), St. George's Works,
Regents Park Road, London, N.W.1.
PRImrose 8844/5/6



A Complete Guide to Tape-Recording and Hi-Fi for the Non-Technical Enthusiast

Modern Tape Recording and Hi-fi

KEN PETERS

An excellent and very practical book . . . which covers just about every possible approach to these two subjects. In fact, I searched in vain to find some point which he had not covered'—AMATEUR TAPE RECORDING. With 50 photographs and 50 drawings. 30/-

FABER & FABER LTD,
24 RUSSELL SQUARE, W.C.1.

Amateur

TAPE RECORDING VIDEO & HI-FI

TAPE/DISC/TAPE transfer, editing, duplicating. If quality and durability matter (especially with LPs from your precious tapes), consult Britain's oldest transfer service. Sound News, 10 Clifford Street, London, W.1.

Ferrograph 5 A/N, 422 and 424, Revox E36, etc., always in stock — City and Essex Tape Recorder Centres, 2 Maryland Station, London E.15.

Cheap Recording Tape for sale. A. Marshall & Son (Metals) Ltd., 18 Cricklewood Broadway, N.W.2.

RAPID RECORDING SERVICE. 78s. and L.Ps. from your own tapes (48 hour service). Master Discs and Pressings. Recording Studio. Mobile Recording Van. Manufacturers of the Sleep-o-matic Unit. Foreign language courses available for sleep-learning. Brochures and price lists on request from: Dept. ATR, 21 Bishop's Close, London, E.17.

MAKE FRIENDS anywhere by tapesponding or correspondence. Interesting free details from: The Friendly Bureau (Registered), 43, Clifford Road, Wallasey, Cheshire.

Good cash prices for tape recorders.—Telephone Maryland 5879.

YOU WILL SOON LOSE YOUR "MIKE FRIGHT" if you join Britain's largest and friendliest Tape Exchange:—WORLD-WIDE TAPETALK, 35 The Gardens, Harrow. S.A.E. for particulars.

CLASSIFIED ADVERTISEMENTS

9d. per word, minimum 7/6. Box Nos. 1/6 extra. Advertisements should be addressed to Advertisement Manager, 'Amateur Tape Recording Video & Hi-Fi', Room 538, Ulster Chambers, 168 Regent Street, London, W.1.

A UNIQUE BUY! Recording tape top brand, 5 1/2 in. 1,200 ft. 19/6; 7 in. 2,400 ft. D.P. 28/6 P. & P. 1/6 per spool. Bargains in all sizes. S.A.E. for list. E. C. Kingsley & Co., 132 Tottenham Court Road, London, W.1. EUSTON 6500.

Recorder Need Repairing? Then let City and Essex Tape Recorder Centre do it for you expertly and economically.—City and Essex Tape Recorder Centres, 2 Maryland Station, London E.15.

TAPE TO DISC RECORDING. Finest professional quality, 10 in. L.P. 35/-; 12 in. L.P. 40/-; 7 in. E.P. 17/6; 48-hour postal return service. Any speed tapes. S.a.e. for leaflet.—Deroy Sound Service, 52 Hest Bank Lane, Hest Bank, Lancaster.

Tape Recorder Cleaning and Oiling Kit. Special cleaning kit comprising of hypodermic oiler (for motors etc.), special oil, cleaning fluid for rubber belts, neoprene, idlers, etc. Cleaning cloth, head cleaning brush etc. Attractively packaged £1 post free.—Nusound Recording Co., 93, Mortimer Street, Oxford Circus, W.1. Telephone: Museum 1219.

PRE-RECORDED TAPES. Unique complete catalogue listing all makes, Mono, Stereo, 7 1/2 and 3 1/2 i.p.s., including World Record Club tapes. Call for FREE copy or send 1/- mailing fee. Dept. TR.2, Teletape Ltd., 33 Edgware Road, W.2. PAD. 1942.

JOIN SOUND NEWS AUDIO SUPPLY for better terms on Hi-Fi equipment. 60-page photographically illustrated (non-advertising) Hi-Fi Catalogue 4/6. 10 Clifford Street, London, W.1.

LEE ELECTRONICS, the Tape Recorder and H-F specialists, can now undertake Wow and Flutter Tests with their latest "Gaumont Kalee" Wow and Flutter Meter. Test Report supplied. 24-hour Service. Price 25/-.—400 Edgware Road, Paddington, W.2. PADDINGTON 5521.

World Friendship Society. Members all ages, England and everywhere! Pen friends opposite sex. Details VC74, Amhurst Park, London, N.16.

DON'T BUY A TAPE RECORDER until you have visited the Barden/Grundig Centre opposite Dalston Junction Station. All Grundig models are available on easy terms with generous part-exchange allowances.—The Grundig Centre, 21 Dalston Lane, E.8. CLISSOLD 8811.

FRIENDSHIP INTRODUCTIONS Pen friends Exchange Tape Recordings, all ages, write for free details DUKERIES, 113 Netherton Road, Worksop.

PRE-SLEEP STUDY. Learn difficult lessons or parts or improve your mental powers while you sleep! Send now for Price List of materials: including the perfect Tape Machine, Time Switch, Pillow Speaker, Endless Tape Cassettes, Pre-recorded Tapes for Learning or Therapy, Language Courses etc.—Psychology Tapes Ltd. (ATR) 16, Kings College Road, London, N.W.3. FRI 3314

NEW CATALOGUE of Tape, Hi-Fi Accessories and Equipment. RECORDING TAPE, TAPESPONDENCE LABELS etc. Prepared Especially for CLUBS and ENTHUSIASTS. Send 6d. stamps to "SHIRLEY ANN'S" 7, Manor Road, Felixstowe.

AMATEUR TAPE RECORDING VIDEO & HI-FI

SUBSCRIPTION FORM

● Make certain you receive your copy of Amateur Tape Recording Video and Hi-Fi by completing this form and sending it, with your annual subscription to:

AMATEUR TAPE RECORDING VIDEO & HI-FI,
SUBSCRIPTION DEPT.,
VERNON HOLDING & PARTNERS LTD.,
43/44, SHOE LANE,
LONDON, E.C.4.

Sirs: Please send Amateur Tape Recording Video & Hi-Fi for one year, commencing with the next (.....) issue, to the address below. I enclose the annual subscription of twenty-nine shillings (29s.).

Name

Address

Date



●Tape Club members wishing to avail themselves of the special Club Subscription rate of 21s. per annum should apply to their local Club Secretary. All Club orders must bear the Club Secretary's signature and be sent to the Subscription Department.

ADVERTISERS IN THIS ISSUE

	Page
Agfa Limited	51
B.A.S.F. Chemicals Limited	52
Brenell Engineering Company Limited	22
Britimpex Limited	40
A. Brown & Sons Limited	48
Elstone Electronics Limited	11, 44
E.M.I. Tape Limited	3
Faber & Faber Limited	49
Ferrograph Company Limited	44
Fi-Cord International	46
Francis of Streatham	48
General Storage & Distributions Co. Limited	48
Gramplan Reproducers Limited	18
C. E. Hammond & Co. Limited (Revox)	20
Highgate Acoustics	32
Howard	4
Kodak	17
L.E.C. Electrical Company	41
Lustraphone Limited	49
Massey's Centre of Sound	36
M.S.S. Recording Co. Limited	31
Multicore Solders Limited	36
Philips Electrical Limited	2, 5
Sheen Tape Recorder Centre	47
Sony	18, 19
Stern-Clyne Limited	Inset
Telefunken	35
Teletape	32
Wyndson Tape Recorders Limited	6
Zonal Film Limited	34

Published by Plant News Ltd., and distributed by Vernon Holding & Partners, 43/44 Shoe Lane, London, E.C.4. All editorial communications to: Amateur Tape Recording Video & Hi-Fi, Room 532, Ulster Chambers, 168 Regent Street, London, W.1. Printed by Athol Press, Douglas, Isle of Man.



high definition RECORDING TAPES

are now available in
beautiful, permanent, easy-access
LIBRARY CASSETTES*

*(5", 5 $\frac{3}{4}$ ", and 7" spools: P.E. 31 Long play,
P.E. 41 Double play and P.E. 65 Triple play)*

**If not obtainable from your
local dealer, please write to
AGFA LTD Deer Park Road Wimbledon SW19
giving his name and address.*

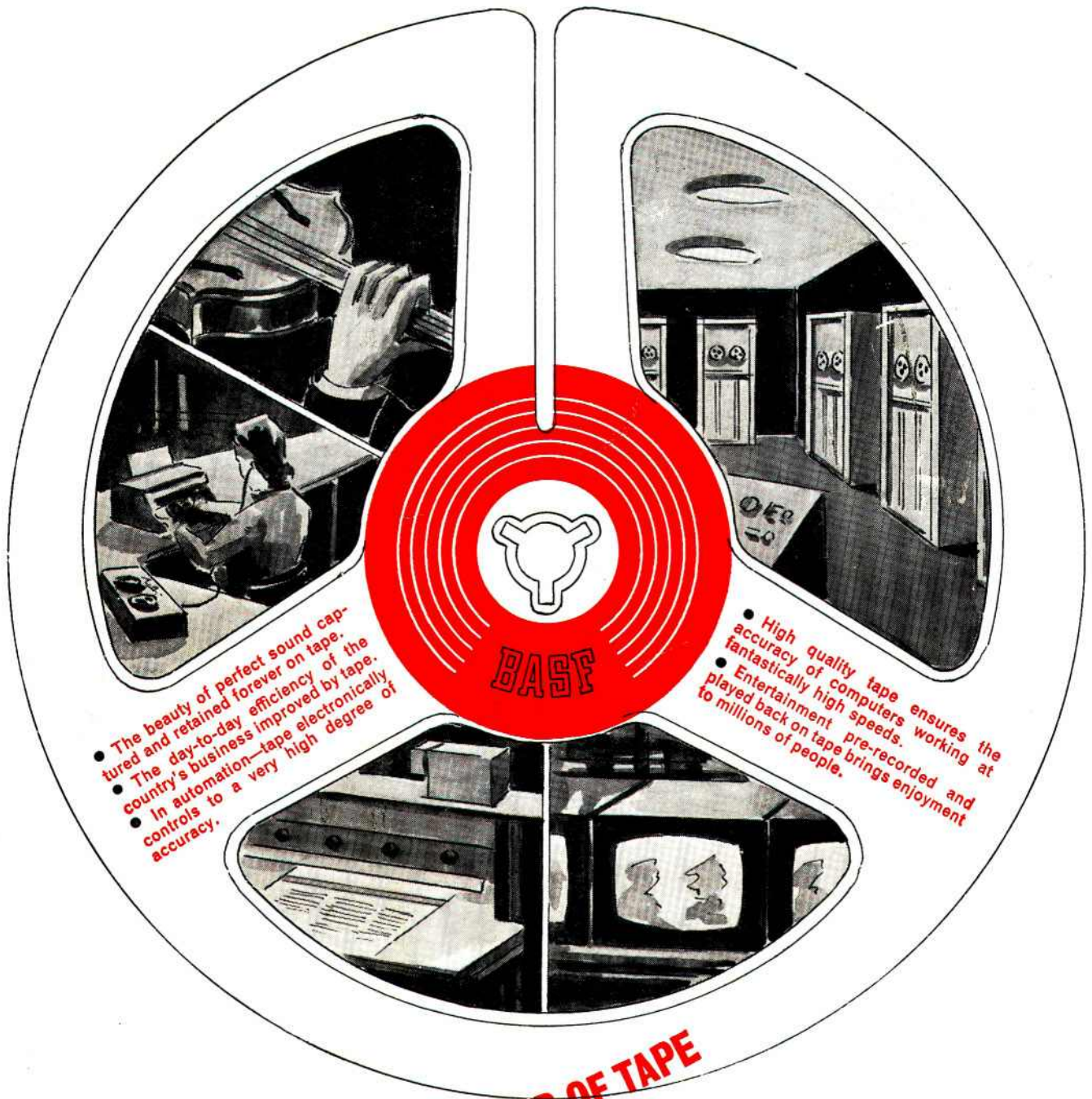

- The beauty of perfect sound captured and retained forever on tape.
- The day-to-day efficiency of the country's business improved by tape.
- In automation—tape electronically controls to a very high degree of accuracy.

- High quality tape ensures the accuracy of computers working at fantastically high speeds.
- Entertainment pre-recorded and played back on tape brings enjoyment to millions of people.

THE WONDERFUL WORLD OF TAPE

BASF—first to produce magnetic recording tape, so opening up channels which affect every one of us. Today, the imagination, initiative and craftsmanship which made this possible are invested in maintaining BASF tapes at a standard of technical perfection unequalled throughout the world.

BASF magnetic recording tapes are recognized for qualities of dimensional and magnetic stability, full frequency response, negligible print through and mirror finish surface. The wide range ensures that there's a BASF tape for every type of machine and every possible requirement—INCLUDING YOURS.



SYMBOL OF AUTHENTIC SOUND

BASF CHEMICALS LIMITED

5a Gillespie Road, London N.5. TEL: CANonbury 2011