

# Understanding High Fidelity

A comprehensive guide to getting the most out of your high fidelity equipment and featuring a complete discussion of the 'quadraphonic' systems.

Martin Clifford

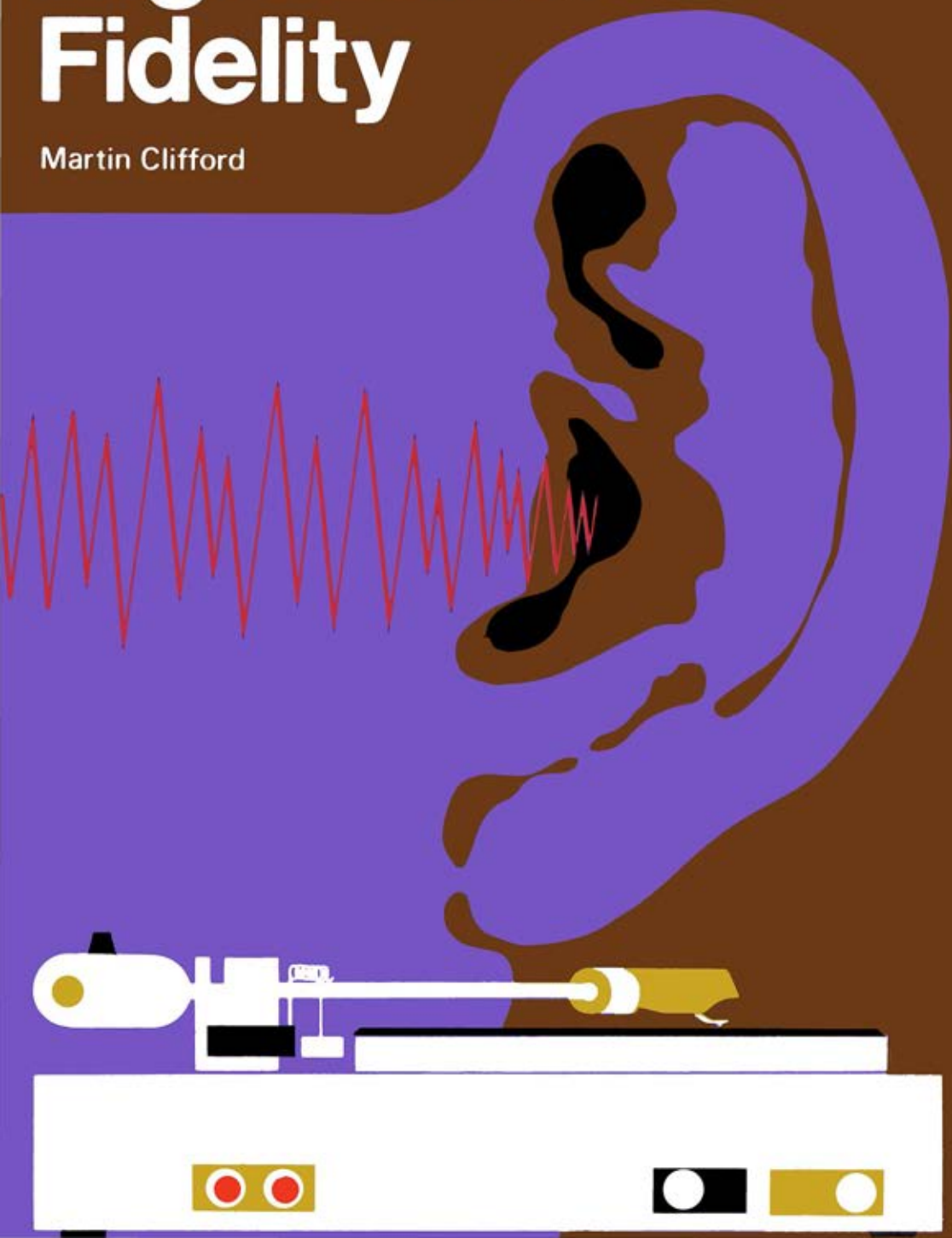

With numerous photos and diagrams, the author, Martin Clifford, tells you how you can get the most out of your high fidelity system. He describes all the various audio components, explains how they work, and lets you know what they are expected to do.

Of special interest is an entire section devoted to all the latest information on four-channel "quadraphonic" systems. Complete discussions of both discrete and matrix systems are included.

Mr. Clifford covers all the major aspects of home audio equipment: open reel and cassette tape recorders and decks, loudspeakers and headphones, AM and FM receivers, turntables, tonearms, multi-amplifier systems, and much, much more.

Also included are a hi-fi "do's and don'ts" guide and a glossary of audio terms.

To put it briefly, UNDERSTANDING HIGH FIDELITY is the ideal book for any hi-fi owner who wants to understand his equipment.

UNDERSTANDING HIGH FIDELITY has been designed for musicians, music lovers, and hi-fi hobbyists: The book is written with such clarity that even the beginner can comprehend the material. However, the author delves into sufficient detail so that even the experienced hi-fi aficionado will find much to both interest and enlighten him.

ISBN 0 - 572 - 00879 - 1

**UNDERSTANDING  
HIGH  
FIDELITY**

by  
Martin Clifford

LONDON  
W. FOULSHAM & CO. LTD.  
New York Toronto Cape Town Sydney

*W. FOULSHAM & CO. LTD.,  
Yeovil Road, Slough, Bucks., England.*

**ISBN 0-572-00879-1**  
**LCCN 72-11748**

Copyright © 1972 by Drake Publishers, Inc.  
All rights reserved. No part of this publication  
may be reproduced, stored in a retrieval system,  
or transmitted, in any form or by any means,  
electronic, mechanical, photocopying, record-  
ing, or otherwise, without the prior permission  
of the publisher.

Printed in Great Britain by  
Redwood Press Limited  
Trowbridge, Wiltshire

# CONTENTS

INTRODUCTION — THE HI-FI IDEA	
Hi-Fi and stereo. Hi-fi and live sound. Hearing errors.	
CHAPTER 1 — THE HI-FI CHAIN OF EVENTS	6
Single and double channels. Audio sources. Amplifier. Loudspeakers. The hi-fi stereo system. Room acoustics. Installing a hi-fi system.	
CHAPTER 2 — THE TURNTABLE	13
Motor and drive system. Turntable platter. Pick-up system. The brushless DC servo Hall motor. The servo control system. Phono car- tridge. Equalization. Stylus. Demands upon phono cartridges. Tonearm. Compliance. Stylus pressure. Channel separation. Auto- return tonearm. Automatic record changer. Anti-skating device. Hum. Buzz. Howling. Maintenance. How to connect your record player. Setting up a stereo system. How to read turntable specifications.	
CHAPTER 3 — THE TUNER	37
AM and FM. Functions of the FM tuner. The FM antenna. The AM antenna. Ground. FM MPX (stereo). Tuner controls. How to read tuner specifications. Conditions frequently mistaken for malfunction. Troubleshooting chart for tuners.	
CHAPTER 4 — TAPE EQUIPMENT	52
Recording and playback process. Tracks. Tape speeds. Tape quality. Low-noise high- output tape. Tape deck, recorder, player? Open reel, cassette, cartridge? Cassette tapes. Chromium-dioxide tape. Frequency vs oxide particle size. Recorder/cassette compatibility. Environmental compatibility. Drive mechanism. Cartridge tapes. Open-reel tape.	

Noise reduction. 2 and 3 motor systems. Recording and playback heads. 3-head decks. Amplifiers, equalization. Automatic stop, auto-reverse. How to connect your tape recorder. Using a bulk eraser. Tape splicing. Microphones. Types of microphones. Microphone frequency response. Microphone impedance. Stereo microphones. Directional characteristics. Tape recorder troubles and their remedies. Troubleshooting chart for open-reel tape decks. Troubleshooting chart for eight-track cartridge units. Troubleshooting chart for cassette units. Tape and recorder precautions. How to read tape deck specifications.

89

#### CHAPTER 5 — THE AMPLIFIER

Pre-amplifier, power amplifier, integrated amplifier, receiver. Preamplifier functions. Phono equalization. Inputs. Tape monitoring. Volume, balance, tone controls. Filters, loudness contour. Headphone jack. Power amplifier function. Criteria of quality. Protector circuits. Speaker terminals. How to read amplifier specifications. Four-channel operation. Reverbification amplifier.

105

#### CHAPTER 6 — LOUDSPEAKERS AND HEADPHONES

Structure and functions. Double cone and coaxial speakers. Two-way, three-way, four-way systems. Directionality. Speaker enclosures. How to choose speakers. Crossover network level controls. Speaker design features. Speaker efficiency. Electrostatic speakers. How to read loudspeaker specifications. Headphones.

115

#### CHAPTER 7 — MULTI-AMPLIFIER SYSTEMS

Reasons for multi-amplifier systems. Electronic crossover network. Features and drawbacks. Hints concerning multi-amplifier

systems. Conversion to multi-amp operation.  
Speaker systems for multi-amp use.

CHAPTER 8 — FOUR-CHANNEL STEREO	124
Speaker placement. Mono goes stereo. The enjoyment of sound. The limitations of two-channel stereo. Four-channel stereo. Ping pong effect. Four-channel systems. The discrete system. Discrete four-channel disc. The Quadradisc. Quadraphonic systems. The 2-2-4 system. Matrix. Regular matrix. SQ matrix. Differences between regular and SQ matrix. The SQ decoder. How to get the most from four-channel stereo. Ambience arrangements. Rear speaker power.	
CHAPTER 9 — OF DOLLARS AND DECIBELS	143
Percentage cost of hi-fi components.	
CHAPTER 10 — DO'S AND DON'TS	145
CHAPTER 11 — A GLOSSARY OF AUDIO TERMS	147

# INTRODUCTION

Ever since the first phonographs began squeaking their scratchy messages into the ears of a surprised world around the turn of the century, there has been an uninterrupted search for better, clearer and finer methods of recording and playing back sound. Yet all the major breakthroughs have been made in recent decades — the first LP records, the invention of stereophonic recording and reproduction, the beginning of FM and FM stereo broadcasting, the development of noise-free amplifiers, the introduction of solid state engineering into audio equipment and, more recently, the adventure of four-channel stereo sound.

## HI-FI AND STEREO

Here we must make a distinction between two terms that are often confused: high fidelity and stereo. High fidelity or hi-fi makes very much the same demands as an oath sworn in a court of law: “. . . the truth, the whole truth, and nothing but the truth”. The goal of hi-fi is to record, preserve and reproduce sound, chiefly music, exactly the way it was played by the performers, without adding anything, without leaving anything out.

Stereo, on the other hand, means that sound is recorded and reproduced via two channels in order to add a directional, spatial sensation. Stereo creates the same effect to the ear that 3-D photography offers to the eye. To continue the visual analogy: 3-D demands sharp, clear, undistorted pictures; stereo creates an illusion of space, width, and location.

Unfortunately, the two don't always go together. There are stereo sets on the market which do not deserve the name “hi-fi” because



their sound quality is inferior. Conversely, there are hi-fi systems with only one channel (“mono-  
phonic”).

The ideal hi-fi system has never and will never be built, simply because the demand to speak the whole truth and nothing but the truth cannot be realized. Between the performers in the recording studio and the listener in his living room, there is a long and complicated chain of equipment and transformations, tearing off something from the original sound here, adding something there. These unwanted fiddlings and diddlings can be reduced to a minimum — and this is what hi-fi technology is all about — but they can never be totally eliminated.

#### HI-FI AND LIVE SOUND

On the other hand, hi-fi has things to offer that no live performance can match. Freedom. You, the listener, choose what you want to hear, when you want to hear it, with whom, and how many times. From this point of view, hi-fi isn't a substitute for live concert performances; it's an alternative.

This brings us to another common misconception, one you will find repeated in too many advertisements: that a good hi-fi system will bring the concert hall into your home. It's simply not true, and it would be bad if it were. First, much of the world's great music, both past and present, wasn't composed to be played in that 19th century invention, the concert hall. Chamber music, first of all the string quartet, calls for the intimacy of small rooms. Bach wrote his organ works as an integral part of church liturgy. Brass bands are for outdoors, and much modern music is composed especially for the recording studio and electronic reproduction. But even those works which were intended for concert hall performance, such as the classical and romantic symphonies, can't and

shouldn't be played over a living-room hi-fi system with concert hall volume. The cannon in Tchaikovsky's 1812 overture would shatter the window panes. No, hi-fi isn't supposed to put the concert hall in your living-room; it's supposed to put the music in your living-room, and it does that remarkably well.

#### HEARING ERRORS

While we're dealing with the subject of misconceptions: there's another one that says "when choosing hi-fi equipment, trust your ears rather than the manufacturer's specifications". Several reservations must be voiced against this advice. The most important is that a person who buys a hi-fi system for the first time in his life is in most cases ill-equipped to judge the quality of musical sound reproduction. Subjected from morning to night to the ceaseless trickle of non-hi-fi sounds — the traffic din, the bass-heavy bellowing of jukeboxes, the babble and squall of cheap transistor radios and TV sets — the hi-fi novice hasn't had opportunity to train and hone his sense of hearing. Experience shows that, left to his own resources, he will usually choose an "impressive sounding" system, mostly with exaggerated bass response and poor brilliance. As his hearing becomes sharper, as he gets used to the possibilities of his system and compares it with his friends' hi-fi installations, he will gradually outgrow his original purchase and will eventually upgrade his system. But since every replacement costs money, he will finally end up with a good system that has cost him much more than if he had bought it in the first place. We feel that our — and every conscientious hi-fi salesman's — advice to the hi-fi novice should be to trust a reputable manufacturer more than his own as yet underdeveloped hearing. Even so, his first encounter with hi-fi sound may not be pleasant at all, simply because he is unac-

customed to hearing musical sounds as they actually are.

If you are planning to invest in a hi-fi system it will help if you learn something of what hi-fi is all about. You should learn some of the language used in hi-fi and you should be able to read a manufacturer's spec sheet with some comprehension. This doesn't mean you are expected to become an electronics technician or an audio engineer. If you know what each hi-fi component is supposed to do, if you have a general understanding of what to expect from equipment, then you will have greater confidence in and appreciation of your hi-fi system. Moreover, you will understand the various controls and will be able to adjust them so you can get the greatest musical satisfaction. And that, after all, is your objective.

Two highly respected manufacturers were of considerable assistance in the preparation of this book: U.S. Pioneer Electronics Corp., noted for their high-quality, high-fidelity component line, and TDK Electronics Corp., manufacturers of Extra-Dynamic, Super Dynamic, Chromium Dioxide (Krom-O<sub>2</sub>), DeLuxe Low-Noise and Maverick tape products. I acknowledge with thanks their permission to use selected material which they supplied.

Martin Clifford

## Chapter 1

### THE HI-FI CHAIN OF EVENTS

What happens to the sound between the recording studio and the listener's living-room? A brief explanation of the "musical flow chart" may be helpful since it creates an awareness of the many transformations — and accompanying difficulties — that the sound has to go through.

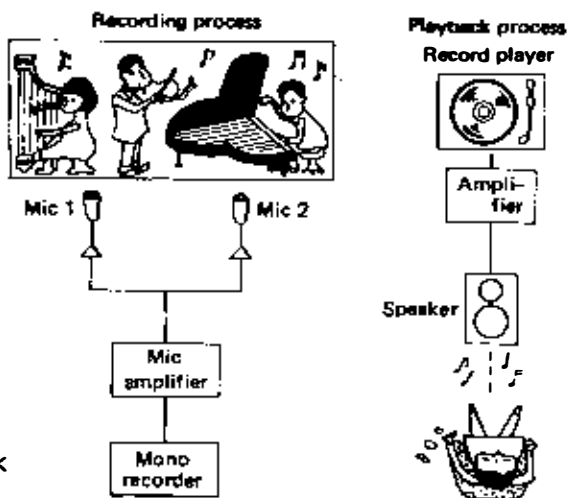

Fig. 1-1  
RECORDING AND PLAYBACK  
IN A MONOPHONIC SYSTEM

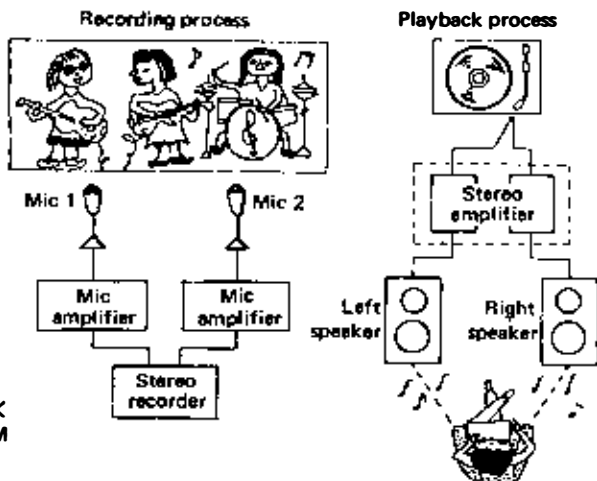

Fig. 1-2  
RECORDING AND PLAYBACK  
IN A STEREO SYSTEM

Fig. 1-1 illustrates recording and playback in a monophonic system, popularly known as mono. After the mono record or disc has been cut, it can be played back on a transcription-type turntable, followed by an amplifier and a speaker.

Recording and playback in a stereophonic system, abbreviated as stereo, isn't more complex, but does call for more components. For optimum sound reproduction, the record should be played on a record player — that is, a player which will handle only one record at a time rather than an automatic type which stacks records — followed by a stereo amplifier. At the output of the stereo amplifier, sound is fed into a left speaker — a speaker placed to the left of the listener — and a right speaker. See Fig. 1-2.

## SINGLE AND DOUBLE CHANNELS

Although Fig. 1-1 shows two microphones being used for sound pickup, more than just two can be used. However, the electrical signal outputs of these microphones are joined, and all of the combined sound then moves in a single channel. The reproduction process for mono is also single channel. The sound source, such as a record player, feeds into a single amplifier and then into a single speaker or a single speaker system. The stereo setup of Fig. 1-2, however, shows that sound reproduction and also sound playback utilizes two channels, generally known as the left or L channel and the right or R channel.

## AUDIO SOURCES

At the recording studio, the sound waves emitted by the voices or instruments are caught

by, in a stereo recording, two or more microphones and converted into electrical signals. These signals are recorded on a master tape in the form of magnetically charged particles. Recording engineers control the conditions and later edit the tapes to obtain the desired sound effects and to eliminate background noise, etc. The finished master tape now becomes the starting point of any of three "delivery" systems. Copies can be made on other tapes — open reel, cassette or cartridge — and sold. A copy of the master tape can be broadcast via radio waves. Or, and this is still the most common method, the signal can be converted into mechanical vibrations which are engraved into a rotating disc. From this master disc, the record companies press records.

The listener then has a choice between the same three systems: he can play pre-recorded tapes on a stereo tape deck; he can receive AM, FM mono or FM stereo broadcasts via a tuner; or he can play records on a turntable. (The name "record changer" often denotes low-priced equipment without claim to hi-fi performance). In a stereo system, tape deck, tuner and turntable are commonly referred to as "sound sources" although they are, of course, not the original sources of sound.

## AMPLIFIER

The signal supplied by tuner, tape deck or turntable is, however, too weak to be converted into audible sound. Therefore, an amplifier is required to augment the signals and supply them to the loudspeakers. The amplifier also provides a convenient opportunity to control the volume, tone quality and other characteristics of the sound.

Very commonly, amplifier and tuner are com-

bined into one unit which is then called a tuner/amplifier or "receiver", a word that must not be confused with a standard radio or TV receiver.

### LOUDSPEAKERS

The loudspeakers (or, for private listening, the headphones) are the final link in the chain of sound reproduction. What sound finally comes out of the loudspeakers is the acid test of the entire system, and they must be chosen with equal care as all other components.

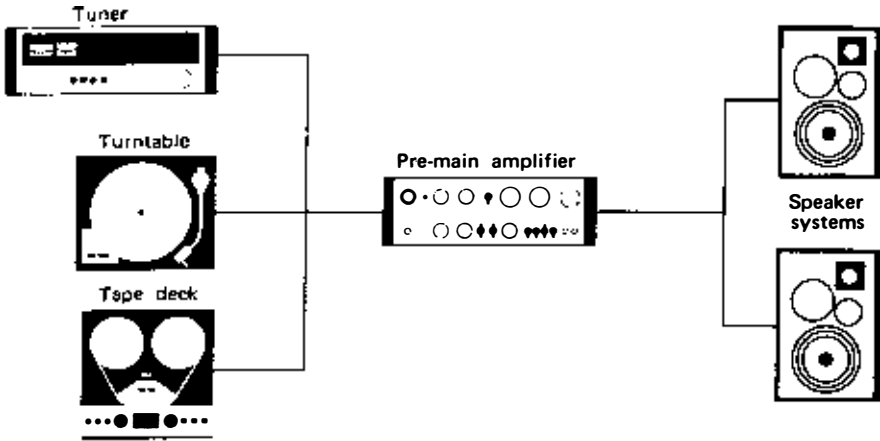

Fig. 1-3 Hi-Fi STEREO SYSTEM

### THE HI-FI STEREO SYSTEM

Fig. 1-3 shows one arrangement (a number of different setups are possible) of a hi-fi stereo system. Although it is beginning to appear more complex, it is the same system shown earlier in Fig. 1-2, with a few components added. Instead of having just a turntable as a sound source, there is also a tuner and a tape deck. Each of these, the tuner, turntable and tape deck, are

capable of supplying a sound signal (also called an audio signal) to the following amplifier unit. The amplifier, shown in Fig. 1-3 as a pre-main amplifier actually consists of two amplifiers: a pre-amplifier or voltage amplifier, and a power amplifier. In some hi-fi systems the pre-amplifier (or pre-amp) and the power amplifier (or power amp) exist as separate components. The pre-main amplifier is also the hi-fi system's control center, for it is on the amplifier you will find the various knobs, levers, or pushbuttons that will enable you to control volume, left-right sound level, tone, and mode. (The mode selector is a switch to permit you to select the sound source input — giving you your choice of tuner, turntable or tape operation.) Note that none of the sound source input devices, the tuner, turntable, or tape deck, can operate a speaker directly. All require an amplifier since their sound output is much too weak for direct speaker operation.

Following the pre-main amplifier, as in Fig. 1-2 and in Fig. 1-3, the sound is channeled to ~~speakers~~ speakers which are positioned to the left and right of the listener.

## ROOM ACOUSTICS

The quality of reproduced sound varies according to the size and shape of the room; the materials of walls, floor and ceiling; and the amount and arrangement of furniture (Fig. 1-4). Harsh or "bright" sound usually results from too many hard reflecting surfaces plus a ceiling that may be too low. This condition is improved by having ample carpet area or covering the wall, especially that facing the speakers, with a thick curtain.

On the other hand, too many absorbing surfaces will tend to 'soak up' the sound, resulting in a certain 'deadness'. Furniture can be



rearranged to provide irregular reflection of the sound. In any event, the true stereo effect is lost if the two speaker systems are placed too far apart. This can be corrected by angling them toward each other or reducing the distance between them.

The kind of sound you are looking for depends on your own taste and the extent of your musical sophistication. For some people, reproduction of treble tones is not an enjoyable experience; for others, a deficiency in the treble range is intolerable. Some people prefer brilliant, hard music; others favor an approach to softness and a lack of reflectivity. And for some, the reproduction of an entire frequency range by a high fidelity system would have to be an acquired taste.

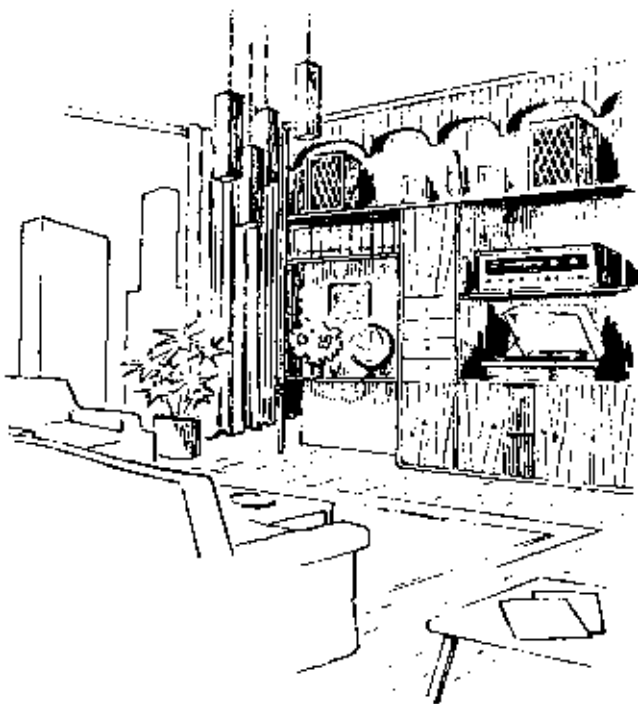

Fig. 1—4  
FOR STEREO, SPEAKERS ARE POSITIONED TO THE LEFT  
AND RIGHT OF THE LISTENER.

## INSTALLING A HI-FI SYSTEM

One of the advantages of using separate components in a high-fidelity system is that they lend themselves to greater flexibility of arrangement. Separate components can also be spaced for maximum freedom from electrical or mechanical interference between units.

When possible, mount motorized components, such as record players, cassette decks, reel-to-reel decks, so they are not affected by possible vibration from outside sources, such as trucks or trains, and so that they, in turn, do not transmit vibrations to other components. Since the record player will have a plastic dust cover, probably hinged on back, allow enough room for the upward movement of this cover. Make sure that components that require frequent adjustment, such as tuner or amplifier, are easily accessible. Patch cords for interconnecting components should be sufficiently long so you can turn components around to get at back panels without too much difficulty. The record player should be absolutely horizontal, something you can easily check with a bubble glass. Inexpensive units are available in hardware and department stores. Reel-to-reel decks can frequently be mounted vertically or horizontally.

## Chapter 2

### THE TURNTABLE

On a stereo phonograph record, the sound information is contained in the microscopic grooves or rather, to be exact, in the undulations of the two walls of the groove. One (the inner) wall bears the information for the left stereo channel, the other (outer) wall that for the right channel. The two are at an angle of 90 degrees. (Fig. 2-2)

Fig. 2-1  
RECORD PLAYER  
① SPEED SELECTOR  
PUSH-BUTTONS  
② ARM ELEVATOR  
③ ARM REST  
④ FUNCTION LEVER  
⑤ DUST COVER

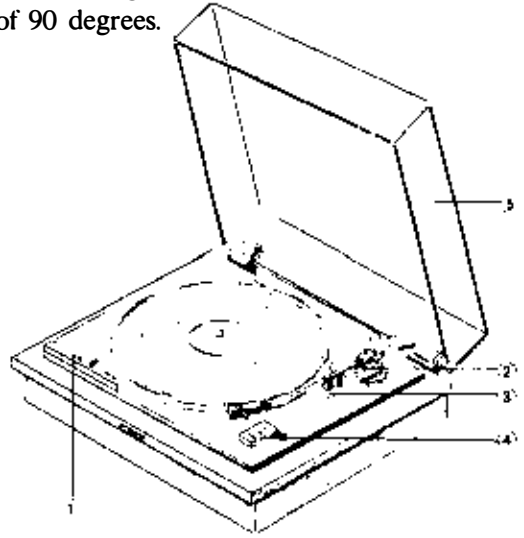

### MOTOR AND DRIVE SYSTEM

The task of the turntable drive system seems simple at first glance: to do nothing but rotate the disc at a specified, constant speed. Any mechanical system with moving parts, however, generates vibrations, inconsistencies and wobble, and in a turntable these would cause noise, unevenness of pitch (“wow”) and rumble. Let us examine what is being done by turntable designers to counteract these troubles.

First, the phono motor in a hi-fi turntable has

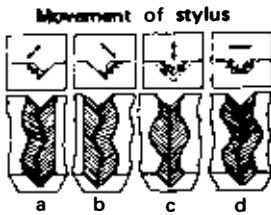

- a: Left signal only
- b: Right signal only
- c: Left and right signal of anti phase
- d: Left and right signal of same phase

Fig. 2—2  
THE GROOVE OF STEREO DISC AND STYLUS MOVEMENT

to meet six conditions: (a) it must revolve at a specified, constant rotational speed; (b) its speed must remain constant even if the supply voltage fluctuates; (c) it must operate almost without vibration; (d) it must have powerful torque (rotational force) to overcome changes in its load and to bring the turntable quickly up to the specified speed; (e) it must not produce any magnetic flux leakage as this would induce noise (“hum”) in the pickup system; and (f) it must be able to operate continuously for many hours.

Only two types of AC motors can fulfill all these conditions — the induction motor and the synchronous motor. Of the two, the induction motor is used mainly for low-priced turntables because its speed is liable to fluctuate with load variations and it would need a regulatory mechanism. This leaves the synchronous motor. Its speed is locked to the AC line frequency and is therefore very constant even if the power voltage fluctuates. A special — and rather expensive — variety is the hysteresis synchronous motor whose features include freedom from vibration and noise-free operation. Most top class turntables are equipped with hysteresis motors although other designs (servo-controlled DC and AC motors etc.) have been tried with good results.

As induction and synchronous motors run at higher rpm's than the 33-1/3 and 45 rpm required for turning the record, they must be coupled to the turntable platter via a speed reducing linkage. This is usually done in one of two ways.

In the rim drive system, one or more idler wheels transfer the power from the motor pulley to the turntable platter by way of friction of their rubber rims. Advantages are relatively low cost, easy speed changes and the possibility of using motors of comparatively low torque. On the other hand, as the rubber rims wear out, a cer-

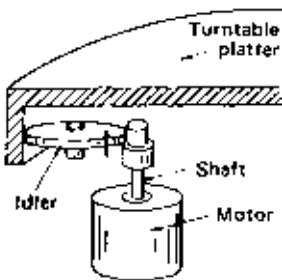

Fig. 2—3  
RIM OR IDLER DRIVE SYSTEM

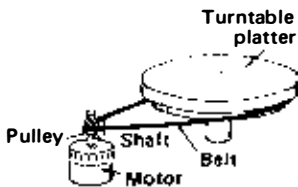

Fig. 2—4  
BELT DRIVE SYSTEM

tain amount of slippage is bound to occur. (Fig. 2-3)

The other common drive system employs a rubber or plastic belt to convey the motor power to the turntable. Speed changes are made by guiding the belt around either of two motor pulley sections with different diameters. The belt prevents motor vibrations from reaching the turntable, thus reducing noise and rumble. In precision engineered hi-fi turntables, the belt is often made of polyurethane because of its resistance to heat, humidity and oil, plus its low elasticity. (Fig. 2-4)

Recently, a few turntables have appeared on the market which have their extremely slow running motors coupled directly to the turntable platter — the motor shaft is also the turntable axle. Speeds are controlled by electronic servo mechanisms. (Fig. 2-5)

Among the many demands made upon phono motors for high-quality turntables, the most important three concern vibration: wow, flutter, and electrical noise. Unfortunately, the turntable designer is faced with a dilemma: freedom from vibrations is easier to obtain with a slow-moving motor (because only a simple or no speed reduction mechanism, the worst source of vibration, is required), but wow and flutter increase (because of the lack of flywheel effect) at slow motor speeds. This problem is solved, i.e., constant speed is obtained with a slow moving motor, by the servo control system outlined below.

## PICK-UP SYSTEM

Most efforts in the design of hi-fi record playing equipment have been concentrated on the pick-up system, i.e. tonearms and phono cartridges. (Fig. 2-6) The difficulties are caused by the great number of — often conflicting — fac-

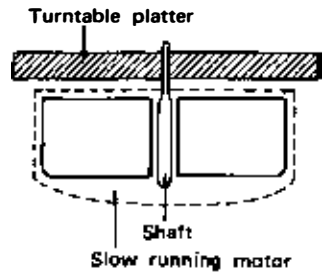

Fig. 2-5  
DIRECT DRIVE SYSTEM

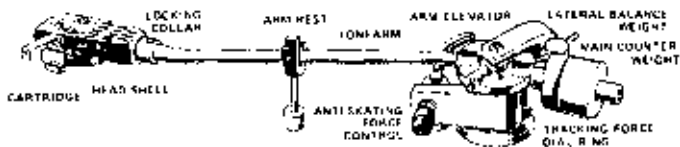

Fig. 2—6  
PICK-UP SYSTEM

tors that have to be taken into consideration. The theory of phono pick-up systems alone could fill a book.

## THE HALL ELEMENT

The Hall element, named after its inventor, is basically a transducer which “translates” changes in magnetic flux into corresponding voltage fluctuations.

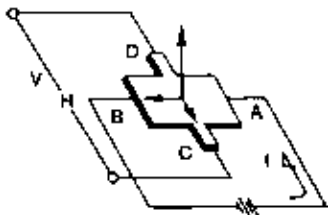

Fig. 2—7  
HALL ELEMENTS ARE USED IN  
MORE ADVANCED TYPES OF  
TURNTABLE MOTORS.

Hall elements, shown in Fig. 2-7, comprise four terminals attached to a cross-shaped base, then coated with a thin membrane of indium antimony. The terminals are divided into two inputs and two outputs. When electric current is supplied to the input terminals, and magnetic power is applied from a vertical direction, voltage appears at the output terminals. The voltage changes according to the magnetic strength. This phenomenon is called the “Hall effect.” To understand its function in this phono motor, the basic principle of electric motors must be examined first.

Every motor operates on the principle that magnetic N and S poles attract and repel each other, and rotational movement can be obtained by switching these N and S polarities in a certain sequence. In AC motors, this switching is done by the (alternating) current itself. The motor speed is determined by the AC frequency (50 or 60 Hz) and the number of poles. Very slow speed AC motors cannot easily be built.

In the DC motor (powered by direct current), the switching must be done by some device external to the motor, usually a combination of

brushes and commutator. These, however, create undesirable electrical noise. This is where the Hall element comes in. Without direct electrical contact, and without generating any electrical noise, this semiconductor device produces a voltage signal when a magnet — in this case the magnetic rotor — moves past it. This signal can be amplified and used to switch the DC current on and off with the correct timing.

In the past, Hall elements were not frequently used because of difficulties in their production and their considerable size.

### THE SERVO CONTROL SYSTEM

The need for a servo system controlling the motor speed is especially evident in slow-speed motors (without much flywheel effect). It operates, briefly, as follows.

A copper film is attached to a stationary plate mounted on the motor's stator in a pattern as shown in Fig. 2-8a, and a pattern as in Fig. 2-8b on a rotating plate fixed to the rotor. The two copper films, with a gap of less than 1 mm between them, act as a capacitor, and the capacitive value changes as one plate rotates.

This cycle of capacitive change which corresponds to the actual motor speed is used, via a field effect transistor, to generate a control signal. After converting this signal into a square wave, it is compared with the calibrated DC



(a)



(b)

Fig. 2—8  
PAIR OF COPPER FILMS ACT AS  
CAPACITIVE MOTOR  
CONTROL DEVICE.

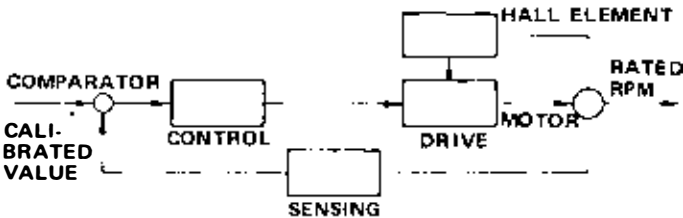

Fig. 2—9  
BLOCK DIAGRAM OF SERVO SYSTEM.

voltage that drives the motor, and subtly changes this voltage to return the motor to constant speed if it has deviated. This principle is illustrated in the block diagram (Fig. 2-9).

Example:

Motor speed drops below rated value → Control signal frequency drops → Equivalent DC voltage drops → Comparison with calibrated value shows gap → Driving circuit increases motor current → Motor returns to rated speed.

## TURNTABLE PLATTER

The turntable platter must be large enough to accommodate the largest diameter records. But there's another reason for making it as large and heavy as the motor torque will permit. A large, heavy platter, once in motion, serves as a flywheel and keeps the speed constant by its own inertia. Turntable platters are made of pressed steel plate or die-cast aluminum alloys. The latter is preferable for high quality systems because of its better electrical properties (anti-magnetism) and greater machining precision. To work as an efficient flywheel, the turntable platter must be balanced just like an automobile wheel.

## PHONO CARTRIDGE

The stylus, mounted in a cartridge at the tip of the tonearm, has the task of tracking the record grooves and transforming mechanical vibrations into electric signals. As the stylus ("needle") rests in the rotating record groove, it is deflected laterally and vertically in accordance with the undulations in the groove walls. This function already explains one of the greatest problems: the stylus must follow ("track") the complicated



meanderings of the groove instantly, but without losing contact with the walls or jumping out of the groove. To be able to do this, the mass of the stylus and all moving parts must be kept as small as possible because the greater the moving mass, the higher its inertia, i.e. resistance to quick changes in movement.

Other conditions for good tracking are: a sufficient downward force called "tracking force" must be applied to the stylus to keep it in the groove. If this is too great, it will cause stylus and records to wear out more quickly than necessary. However, the stylus assembly must have freedom of movement, technically called "compliance" or sometimes "trackability".

The mechanical vibrations picked up by the stylus are converted into an electrical signal by any of a number of systems. Let us briefly explain their functions and weigh their advantages and disadvantages.

The crystal pickup uses a crystalline material, such as Rochelle salts, to act as a transducer. This is a device which converts energy from one form to another, in this case mechanical energy to electrical energy.

Phono cartridges using crystals have too many limitations to be used in high-fidelity equipment. Crystal pickups have poor compliance, a factor that means greater record wear. They also do not have a sufficiently wide frequency response.

Crystal pickups have rather high signal output voltages, about a half volt, or possibly more, substantially higher than the few thousandths of a volt supplied by magnetic pickups. These pickups require no equalization for playback of RIAA equalized records.

Ceramic cartridges (Fig. 2-10) utilize the so-called "piezo-electric effect". Movements of the cantilever (which is affixed to the stylus) apply varying forces — twists and pressures — on a special crystalline material which generates an

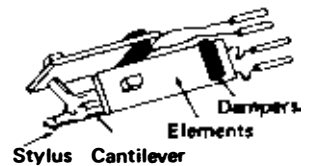

Fig. 2—10  
SCHEMATIC VIEW OF  
A CERAMIC CARTRIDGE

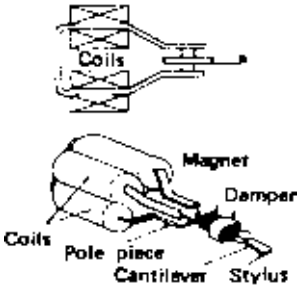

Fig. 2-11  
SCHEMATIC VIEW OF  
A MOVING MAGNET  
CARTRIDGE

electrical voltage in accordance with the stylus movement. The rigid armatures required to exert this twisting force naturally increase the moving mass, and the ceramic elements are sometimes affected by heat and moisture. Although commonly used in low priced record players, they do not fulfill the discriminating demands of real hi-fi.

Moving magnet (MM) cartridges (Fig. 2-11) have a tiny permanent magnet attached to the cantilever which, by moving freely between an assembly of coils, induces a voltage in these coils. Moving magnet cartridges are among the most commonly used hi-fi cartridges, offering the benefits of small moving mass and relatively high output voltage, i.e. efficiency.

The reverse principle is applied in moving coil (MC) cartridges. Here, the magnet is fixed and the coils — one for each channel — move in the magnetic field, thereby receiving an induction voltage. The moving mass of MC cartridges is even smaller than that of MM types, but their output voltage is so low that the amplifier must have special inputs of very high sensitivity.

In addition to low moving mass, MM and MC cartridges offer substantial frequency response and channel separation, factors which explain their great popularity in hi-fi applications.

Induced Magnet (IM) cartridges (Fig. 2-12) have fixed magnet and coil assemblies. Two minute iron plates move in the magnetic field, causing variations in the magnetic flux and, thereby, in the coils' induction voltage.

The output of a cartridge of any type is an electrical signal that requires amplification before it can be delivered to the speaker system. If the signal output of the cartridge is extremely low, it must generally be fed into a pre-amplifier which is then followed by a main amplifier. All magnetic cartridges, whether MM, MC, or IM

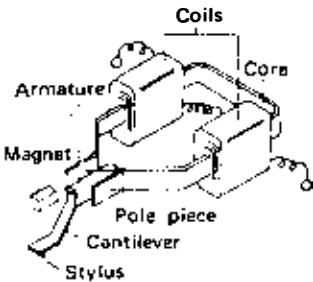

Fig. 2-12  
SCHEMATIC VIEW OF  
AN INDUCED MAGNET  
CARTRIDGE

types, require preamplification. In addition, they also need equalization.

## EQUALIZATION

When records are manufactured, the grooves are produced by a cutter which literally ploughs a path in the record material. The width of the groove depends on the frequency of the tone being "cut in" at the moment. Bass tones are deliberately attenuated to keep the cutter from producing too wide a groove. On the other hand, treble tones do not require as much audio power, and so they must compete with the noise produced by the movement of the cutter through the record. Consequently, treble tones are boosted.

Record manufacturers follow a recording curve recommended by the Record Industry Association of America, or RIAA, but used internationally. Records produced using the RIAA curve have weak bass and strong treble. To compensate for the way records are cut, equalization is required in the preamplifier when magnetic pickups are used. Piezoelectric cartridges, such as crystal or ceramic, do not require equalization since they automatically compensate for the RIAA recording curve. In other words, crystal and ceramic cartridges have a constant amplitude response. The output of such cartridges is equal at all frequencies, so underemphasis of the bass and overemphasis of the treble is compensated for by the cartridge itself.

Magnetic cartridges have a constant velocity response. Thus, when using such a cartridge, the bass must be boosted to the same extent to which it was weakened in the record cutting process. Similarly, there must be a proportional weakening of the treble range. Preamplifiers

contain a circuit which supplies RIAA equalization, usually controlled by a switch on the front panel marked either RIAA or mag phono.

While the magnetic cartridge has several disadvantages compared to crystal or ceramic cartridges — it has less signal output and requires equalization — it is favored for high-fidelity use simply because higher fidelity sound can be obtained.

All the cartridge systems described above generate an electrical signal directly from the mechanical vibrations. There are, however, two types of cartridges which require an outside voltage supply. This is the chief reason why they are not being used widely, although they promise excellent results. One is the semiconductor cartridge (Fig. 2-13) in which mechanical forces created by stylus vibration work upon a silicon semiconductor, changing its electrical resistance in correspondence with stylus movement. The other type is called “photo-electric”. Light from a small bulb in the cartridge falls upon a phototransistor which converts it into an electric voltage. By moving a slotted mask in the path of the light beam, the light intensity can be varied in accordance with stylus vibrations.

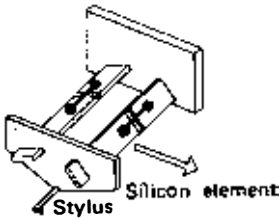

Fig. 2—13  
SCHEMATIC VIEW OF  
A SEMICONDUCTOR  
CARTRIDGE

## STYLUS

The stylus (once known as a needle), in contact with the irregularities in the groove walls of records, follows them more or less faithfully. This movement results in a corresponding electrical voltage produced by a transducer in the cartridge — a device that changes mechanical to electrical energy.

The stylus in a hi-fi cartridge is made either of sapphire or diamond. Diamond is preferable because of its longer service life which averages

400 — 800 hours of operation. Its durability depends largely on the tracking force, i.e. the weight with which the stylus is pushed against the walls of the record groove. The tip of the stylus (Fig. 2-14) is machined to extreme precision. It can be radial (conical) with a tip radius of about 0.5 mil (1 mil - 1/1000 inch) for a stereo cartridge, or elliptical, with its greater width across the record groove. Elliptical styli usually deliver better response to high audio frequencies, i.e. they track high notes better. A modified form of elliptical stylus is the Shibata stylus whose structure permits more contact with the grooves of records. The Shibata stylus was specifically designed to be used with four-channel discs.

Stylus force adjustment for an elliptical stylus is more critical than for the conical type, since you can do more damage more quickly by using too much or too little tracking force with the elliptical stylus. And, since an elliptical stylus is more difficult to manufacture and install correctly, it will cost more than the conical.

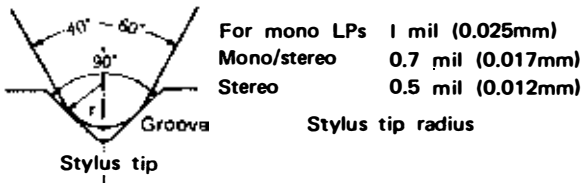

Fig. 2—14  
VARIOUS STYLUS TIPS

The shape of the stylus and the mass of the stylus tip are important factors. Ideally, the mass of the tip should be as low as possible, since the lower the mass, the less force required for tracking loud passages. Other important stylus parameters are compliance and trackability. Tracking is a measure of the velocity of the stylus tip while maintaining good groove contact at a stated tracking force at a stated frequency. It is expressed in terms of cm/sec at a frequency and tracking force. Trackability is a refinement

of the compliance figure, taking into account both stylus tip mass and tracking force.

## DEMANDS UPON PHONO CARTRIDGES

Let us sum up once more the demands made upon a hi-fi cartridge. It must track the record groove with precision, following even abrupt movements such as sudden trumpet blasts with ease. This ability is usually expressed mathematically as "compliance".

The cartridge should track the record even at low force, because too much pressure between stylus and groove causes records and stylus to wear out quickly. Because of the extremely tiny area of contact between stylus and groove walls, seemingly fantastic pressures occur — at a tracking force of a few grams the pressure is several thousand atmospheres, in other words thousand of times higher than the air pressure in an automobile tire.

The cartridge must separate the two stereo channels clearly and at all audible frequencies. And it must deliver an output voltage large enough for the stereo amplifier to work with.

## COMPLIANCE

Compliance is the ease with which a stylus housing will move when it is subjected to a force. As a general rule, the higher the compliance, the better the sound reproduction. In addition, high compliance cartridges produce less record wear.

On spec sheets, manufacturers often specify compliance in terms of the millionths of a centimeter a stylus will move with a force of one dyne. A millionth is frequently written as  $10^{-6}$ , just a shorthand way of writing 1/1,000,000. And so, you will find a representative com-

pliance spec written as  $30 \times 10^{-6}$  cm/dyne. This means that when a force of one dyne is applied to the stylus, it will move a distance of  $30 \times 10^{-6}$  centimeters or 30/1,000,000 centimeter.

Compliance refers to stylus movement, but this movement can be horizontal (lateral) or vertical. Monophonic records require lateral compliance only. Stereo records, however, require both lateral and vertical compliance since the sound signal is recorded in both directions. And so, when buying a pickup, it is essential to consider both lateral and vertical compliance. The ability of a high-fidelity system to supply stereo sound with good separation depends directly on the vertical compliance of the pickup.

There are two ways in which manufacturers measure compliance — static and dynamic. In static tests, compliance of the stylus is measured by machines in a 'non-use' condition — that is, the stylus is not at work during this kind of test. A dynamic compliance test is one in which the stylus is tested under actual working conditions. Since dynamic compliance results are lower than static results, it is helpful to know which is being mentioned in a manufacturer's specification sheet. Dynamic compliance figures for quality styli are about 10 to  $20 \times 10^{-6}$  cm/dyne.

## STYLUS PRESSURE (TRACKING FORCE)

Stylus pressure is the amount of downward force put on a stylus during the time it is playing a record. The ideal stylus force would be zero pressure, but a certain amount of force must be applied for two reasons: 1) to keep the stylus in its groove; and 2) to enable the stylus to make intimate contact with the modulation — the sound signal impressed in the record grooves. With insufficient pressure, the tonearm may go skittering across the face of the record, scratch-

ing it, or may not make adequate contact with the undulations of the groove.

Stylus force, on the average, is somewhere between 1 and 2 grams, with 2 grams as an upper limit. A good rule of thumb is to start at 1 gram and then to try a record that has loud passages. The sound should not break up, but if it does, increase tracking force to 1-1/2 grams. (In some instances, tracking force is less than a gram.)

Compliance and stylus force are related. The greater the compliance, the smaller the tracking pressure required. Thus, if you buy a high compliance stylus, you will need less pressure on it to make it track satisfactorily.

## CHANNEL SEPARATION

Channel separation means exactly what the words imply — the ability of a system to supply two distinct, separate sound channels. However, in a stereo (two-channel) system, or in a quadrasonic (four-channel) system, there can be a tendency for the information of one channel to move into another, thus destroying or minimizing stereo or quadrasonic effect. A quality high-fidelity stereo cartridge should have a channel separation of at least 30 dB, but preferably more.

Channel separation, however, may be measured by the manufacturer at a single spot in the frequency range, possibly 1,000 Hz. But it is more useful to know the amount of channel separation over the entire frequency range of the cartridge, whatever that frequency range may be.

## TONEARM

A cartridge can only deliver its full performance if it is mounted on a tonearm of



equally high quality. The tonearm's main function is to hold the cartridge in its path while it travels across the record, and to apply the necessary tracking force while compensating for other, unwanted forces.

Most high quality tonearms (Fig. 2-15) are made of light metal alloy because of its light weight, stability, and easy machining. By their shape, arms can be grouped into three categories: straight types, J-types, and S-types. In every case, the shell-cartridge assembly is at an angle ( $\alpha$ ) to the arm axis, the line connecting stylus tip to arm pivot. This angle is called offset angle, and its purpose is to minimize the arm's tracking error. (Tracking error is the angle that the cartridge axis deviates from the record tangent at any given point on the record. The smaller the tracking error, the better.) On some economy type equipment, the shell cannot be removed from the tonearm ("integrated arm"). Most modern tonearms, however, have standardized plug-in connections for the cartridge-shell assembly, so that all cartridges following these standards can be freely interchanged.

Since different cartridges require different tracking forces, the tonearm should have a movable balance weight on its rear end, preferably with a graduated scale of tracking forces. The tracking force can then be adjusted by first balancing the arm horizontally, then applying the desired force by moving the balance weight (or a sub-weight) further toward the arm pivot ("static balance"). See Fig. 2-16. On some arms tracking force is applied by the force of a spring ("dynamic balance"). See Fig. 2-17.

On most high quality turntables, the tonearms are equipped with several auxiliary controls to improve their performance and ease of operation.

It requires a certain dexterity to set the stylus down on a record and to lift it off again, and

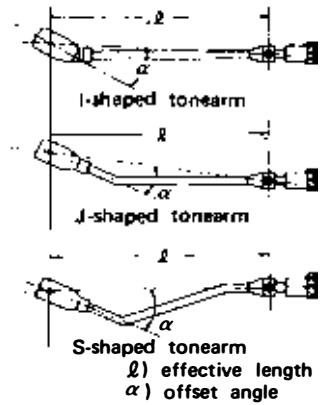

Fig. 2-15  
TONEARMS

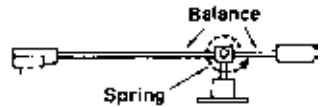

Fig. 2-16  
STATIC BALANCE

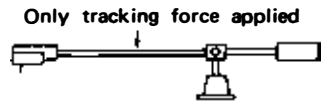

Fig. 2-17  
DYNAMIC BALANCE

countless records and cartridges have been damaged by careless handling. Most hi-fi tonearms are therefore provided with a lifter or cueing device, mostly a hydraulically damped piston which gently floats the tonearm down on the initial record grooves and lifts it up again at the end.

### AUTO-RETURN TONEARM

One step further advanced towards automation is the "auto-return" tonearm. At the end of the record, it lifts off and returns to its rest position automatically. (Fig. 2-18)

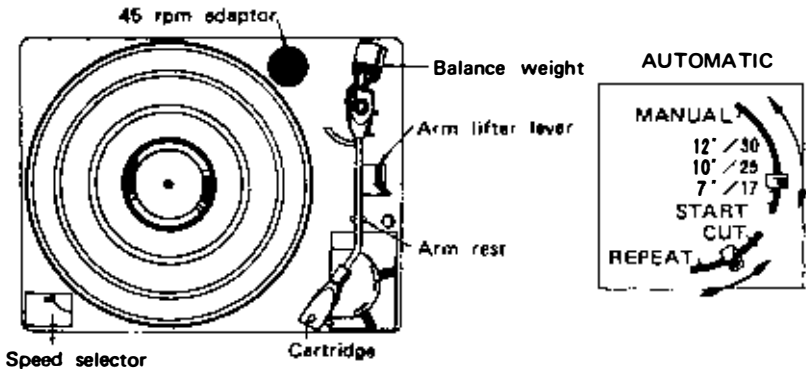

Fig. 2—18  
AUTOMATIC TURNTABLE

The logical extension of this is the fully automatic turntable. A single function lever controls the entire operation. In position start, the tonearm moves over the initial record grooves, the platter begins to revolve, the tonearm comes down, the record is played, and at the end the tonearm lifts off and returns to its rest. There are usually two other controls: a speed selector, and a record size selector which adjusts the tonearm drop point for the three common record diameters, 12", 10" and 7".

## AUTOMATIC RECORD CHANGER

Automatic record changers accept a stack of up to 10 records in one load and then play them automatically. But as each record is dropped on the one below it, without any protective matting in between, a certain degree of slippage is inevitable, and dust particles between the records act as grindstones, shortening record life considerably. For these reasons, automatic changers have never been fully accepted by hi-fi enthusiasts.

However, record changers have been gradually undergoing a hi-fi metamorphosis. Included among the improvements are the change from a lightweight to a heavy turntable platter, a tone arm with mechanical resonances pushed out of the audible range and a cartridge precise offset to provide low tracking error. The counterbalancing system, once a simple spring arrangement highly favored by manufacturers because of its economy, is now an elaborate adjustable weighting device to permit precise balancing for recommended stylus force. Motors now have greater speed accuracy, with a vernier speed control to enable the user to make slight modifications in speed.

A name change has accompanied these upward movements toward the high-fidelity market for record changers are now designated as automatic turntables. The better grade automatic turntables also feature single play, a concession to high-fidelity purists who also want the occasional convenience of automatic operation.

Cartridges made specifically for record changers must tolerate greater abuse, hence are more rugged. This doesn't mean they are better from a high-fidelity viewpoint. They are simply designed for a certain kind of use. A cartridge made for a record player — a machine that will play just one record at a time — can also be

used with a changer, if the changer is operated manually in the single-play mode.

## ANTI-SKATING DEVICE

One other device must be mentioned in this section. An anti-skating device is provided on many high quality tonearms, and may also be called a sidethrust compensator or inside force canceler. To understand its function, we must realize that a tricky combination of forces act upon stylus and tonearm as they track the record. Among these, the most disturbing is a force which tries to pull the tonearm inward, toward the center of the disc, thereby pushing the stylus against the inner wall of the record groove or, in extreme cases, causing the stylus to jump out of the groove. This force is produced by the geometry of the arm. At or near the cartridge, the tonearm is bent, a design intended to help the cartridge eliminate tracking error. Because skating force compels the stylus to engage one wall, the inner wall, much more completely, the result is uneven record wear and its inevitable consequence — distortion. To assure perfect tracking of both groove walls (both stereo channels), this force must be compensated. Usually, a small weight affixed to a string applies a corresponding counterforce on the tonearm. As the skating force varies with the stylus tracking force, the anti-skating device should also be re-adjusted each time the tracking force is changed.

## OPERATING CONSIDERATIONS

### HUM

Hum is a low-pitched droning noise, often 50 or 60 Hz, resulting from a loose connection of

the ground lead. If hum occurs, check the connection of the record player ground lead, generally a black lead with a terminal lug, to your amplifier. If it is loose or not connected, correcting this condition can eliminate the hum problem. Also make sure the signal output wires of the record player are not placed near wires carrying AC, such as a power line cord, or near equipment which may contain a power transformer. Move the signal output wires to various positions while listening to the hum. You may be able to find a position in which hum is completely eliminated.

#### BUZZ

Buzz is a relatively high-pitched noise resulting from induction due to exposure to high intensity TV signals. In this case, the wires in the tonearm may be functioning as a TV antenna picking up TV signals. The solution may be to move your TV receiver further away, or if possible, put the record player in a different location. Sometimes, turning the TV set or the record player to a different angle will help.

#### HOWLING

Howling is acoustic feedback from the speakers to the tonearm or cartridge. Increasing the distance between the speakers or turntable, or laying a soft cushion underneath the turntable base will eliminate howling.

#### MAINTENANCE

Dust collected on the stylus point degrades the quality of reproduced sound. Dust on the stylus point and also in the record grooves can increase record wear because of the abrasive and cutting action of some types of dust particles. Remove record dust with a soft, clean cloth

dampened with a commercially available record cleaner. When cleaning the stylus, use a soft brush, drawing it gently along the stylus in the direction of the tonearm's axis. Don't try to clean the stylus by blowing on it or by rubbing it with your fingers. Don't tap the stylus tip with your finger to see if the amplifier is working.

Provide your turntable with lubricant periodically and follow the manufacturer's recommendations. Some record player producers supply a small amount of lubricant together with the unit. Use either the furnished lubricant or any good quality, light machine oil. Do not overlubricate. For the motor shaft, use one or two drops every three months. For the turntable shaft, five or six drops, once or twice a year will do. However, be careful when using oil. Make sure no oil adheres to the drive belt when oiling the turntable. Oil on the drive belt can cause irregular running of the turntable. If oil does drop on the drive belt or on any rubber surface, wipe it off carefully with a soft cloth saturated with pure alcohol.

## HOW TO CONNECT YOUR RECORD PLAYER

The back of your pre-amp/power-amp takes on the functions of a junction box, for here is where the signal outputs of your various sound sources are connected; the tuner, the record player, the cassette deck, the reel-to-reel deck. The pre-amp/power-amp also has a number of AC outlets. This is not only a convenience, but a necessity, since the average home does not have enough wall or floor outlets to handle all the power cords of the various components in a hi-fi system.

First, connect the power cord of your record player to one of the AC outlets on the pre-amp

power-amp. Make sure that the record player will operate when supplied with AC power.

In addition to the power line cord, your record player has three additional wires: two of these carry the stereo signal, and the remaining one is a ground wire. Connect the ground wire, generally a black lead with a terminal lug on its end, to the ground terminal on the amplifier. This is usually a screw-type connection, so make sure the screw holds the ground wire firmly in place. Omitting the ground wire connection will not harm either your record player or amplifier.

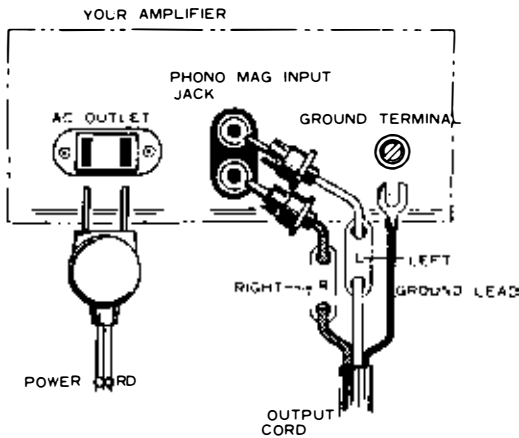

Fig. 2—19  
HOW TO CONNECT A RECORD  
PLAYER TO INPUT  
TERMINALS OF AN AMPLIFIER.

However, a poor connection or no connection can result in hum. Finally, connect the two signal leads to the appropriate signal input on the amplifier. No tools are required since the connections are 'push-in' types. If the cartridge on your record player is a magnetic type, use the terminals on the amplifier marked 'phono mag input'. (See Fig. 2-19.) If your cartridge uses a crystal, connect to the 'aux' (auxiliary) input.

## SETTING UP A STEREO SYSTEM

While a complete stereo system includes more sound sources than a record player, Fig. 2-20

shows the relationship of the record player to the stereo amplifier and the speaker system. With a number of different sound sources connected to the stereo amplifier, the patch cords can make the rear of the amplifier look like a wiring maze. However, if you consider each sound source as an individual unit, as in Fig. 2-20, the hookup technique is simple.

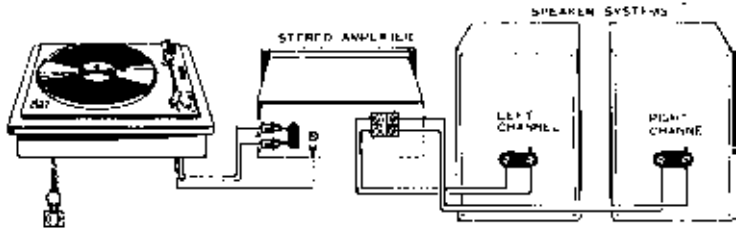

Fig. 2—20  
RELATIONSHIP OF RECORD  
PLAYER TO HI-FI SYSTEM.

A patch cord is simply a wire equipped with push-in terminals at either end. These come in various lengths and are supplied by component manufacturers with their equipment. They are readily obtainable in radio parts stores if more are needed or if longer patch cords are required.

## HOW TO READ TURNTABLE SPECIFICATIONS

When comparing and evaluating turntables on the strength of their catalog specifications, the following items deserve the most attention.

### a) Wow & flutter

Wow is a slowly cycling speed inconsistency causing an up-and-down variation in the playback sound. Flutter is a high-speed quiver especially noticeable in long-held notes. Both are caused by deficiencies in the drive system and expressed as a percentage in the specifications. The smaller the figure, the better. Maximum for hi-fi turntables is around 0.2%.

### b) Signal-to-noise ratio

A measure for the amount of low-pitch “rum-



ble" of a turntable in relation to the desired signal. The larger the figure, the better. Should be above 45 dB.

c) Weight of turntable platter

1.5 kg-2.5 kg is recommended.

d) Tonearm tracking error

Maximum deviation of the tracking angle from the record tangential. The smaller, the better. Should be under 2°-3°.

e) Compliance (of the cartridge)

A measure of the stylus' ability to follow violent undulations in the record groove. Expressed as the amount of deflection (in cm) that a force of 1 dyne upon the stylus will cause. The larger the figure, the better. Depends also upon the tracking force and should be at least  $8 \times 10^{-6}$  cm/dyne.

f) Tracking force

The required downward force that will make a cartridge stay in the record groove and track it. Directly related to compliance: the larger the compliance, the smaller the required tracking force. As light tracking forces save record and stylus wear, smaller figures are preferable. Should not exceed 2 grams.

g) Stereo channel separation

The ability of the cartridge to separate the two channels of a stereo record. Expressed in dB (decibels), should be above 20 dB.

h) Output voltage

The voltage generated by the cartridge at a certain stylus-to-groove velocity and at 1000 Hz. Differs according to cartridge system but should be greater than the sensitivity (in mV) of the amplifier's phono inputs.

i) Frequency response

The lowest and highest audio frequencies that the cartridge will track and deliver. The wider the range, the better. Also, there should be no peaks or dips within this range. Hi-fi cartridges should have at least 20 — 16,000 Hz  $\pm$  3 dB.

#### j) Load impedance

The amplifier's input impedance as seen from the cartridge. For MM and IM pickups, the standard value is about 47,000 to 50,000 ohms, which is what most amplifier phono inputs are designed for. MC cartridges have low load impedances (2-10 ohms), and the amplifier must have special MC phono inputs. Otherwise, a step-up transformer or booster amp will be required between MC cartridge and amplifier.

## Chapter 3

### THE TUNER

Next to the turntable, the tuner is the most common sound source in hi-fi installations. In many cases, tuner and stereo amplifier are combined into one unit, a so-called "receiver." In these instances, the tuner section of the receiver should fulfill the demands outlined below. Whether your hi-fi system uses a tuner-amplifier or a receiver, both must be followed by a speaker system. Ordinary low-cost radio receivers have built-in speakers. This is not the case for hi-fi receivers.

#### AM AND FM

Most hi-fi tuners are AM/FM models which means they receive AM broadcasts as well as FM mono and FM stereo programs. A few exclusive FM models exist, but since there is hardly any difference in cost, the AM/FM tuner with its greater flexibility has advantages.

AM reception in the 535 -1605 kHz band has been with us since the earliest days of radio. Because of its limitations for the reproduction of high-fidelity sound, it is usually relegated to the realm of lo-fi. However, it is useful for supplying news, sports programs, etc. Some radio stations are AM/FM, that is, they broadcast on both the AM and FM bands. However, this does not mean the same program is broadcast on both. Thus, an AM/FM station may simultaneously transmit a musical program on FM while broadcasting news on AM.

AM means amplitude modulation, a transmitting technique in which the sound signal is loaded on a carrier wave by a technique known as modulation. Because the sound signal changes the strength or amplitude of the carrier, it is called amplitude modulation. The carrier frequency remains unchanged. In FM or frequency modulation, the strength of the carrier remains constant, but the frequency is varied by the audio signal. See Fig. 3-1.

When choosing a hi-fi tuner, its FM — and FM stereo — performance is of incomparably greater importance. A good FM tuner will deliver the same degree of hi-fi sound purity as a turntable or tape deck — in many cases its sound will be superior simply because FM stations use top-grade professional reproduction equipment outside the range of the hi-fi amateur. Add to this the fact that the FM radio waves don't cost the listener a cent and that FM music programs can be taped without difficulty, and you will understand why for many budget-minded hi-fi fans the FM tuner has become the chief source of sound.

Carrier amplitude modulated by audio signal.

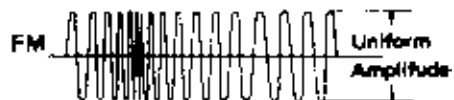
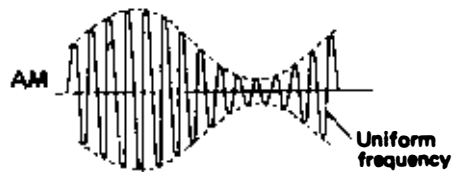

Carrier frequency modulated by audio signal.

Fig. 3-1 AM AND FM

## THE FM ANTENNA

Although the FM antenna is one of the least expensive hi-fi components, it is one of the most important. Manufacturers of quality tuners and receivers often supply an antenna with their units, but this antenna, a dipole made of two-wire transmission line, is intended as a temporary unit to let the anxious hi-fi fan get FM reception immediately.

There are three basic types of FM antennas: the temporary antenna that comes with the receiver or tuner (Fig. 3-2); an indoor type with telescoping arms, sometimes called a 'rabbit ear' antenna; and outdoor antennas. The outdoor antenna is best. A properly installed outdoor FM antenna will increase signal strength, improve the signal-to-noise ratio, and will receive signals that would not ordinarily be obtained (Fig. 3-3).

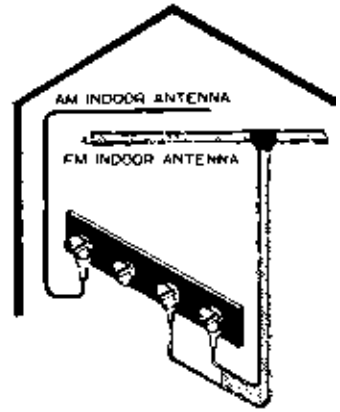

Fig. 3-2  
THE FM ANTENNA SUPPLIED WITH THE RECEIVER OR TUNER SHOULD BE REGARDED AS A TEMPORARY EXPEDIENT.

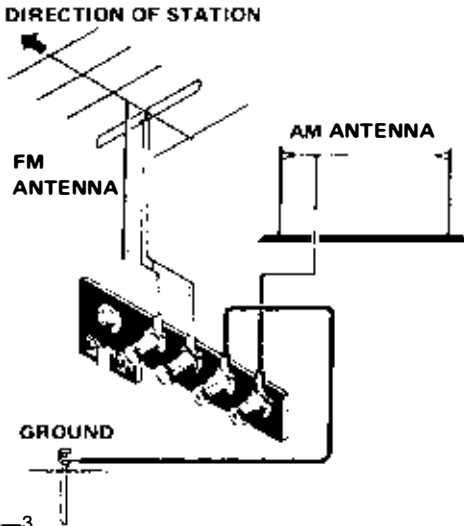

Fig. 3-3  
FOR BEST FM RECEPTION, USE AN OUTDOOR FM ANTENNA.

Many different kinds of outdoor antennas are available, from a simple dipole to an antenna having a number of reflectors and directors, including a rotating device which can be operated

from indoors. In urban areas having a number of FM stations in different locations, an omnidirectional antenna — an antenna that is capable of picking up signals from all directions — can be used. Consistently effective reception range for FM is about 20 miles, but this can be easily extended by using a high gain antenna and a receiver having high input sensitivity.

Some FM antennas, however, have more 'gain' than others. This doesn't mean they amplify the signal, but that they will deliver more of the signal to the receiver or tuner. A high-gain FM antenna, then, would be desirable for areas noted for having poor FM reception.

When installing an FM antenna, mount it so its elements are broadside to the FM station, assuming, of course, that the station or stations are in one general area. If not, then an omnidirectional type or a rotating type should be used.

The FM antenna is connected by a pair of wires, known as transmission line, to the two antenna terminals, located on the back apron of the receiver or tuner. The transmission line is ordinarily the same as that used for television receivers.

## THE AM ANTENNA

Modern FM tuners and receivers come equipped with a built-in ferrite loopstick antenna (Fig. 3-4). On some tuners and receivers, this antenna is adjustable in the sense that it can swing out and away from the tuner or receiver. In others, it is fixed. Generally, in urban locations this is all that is needed, but if the receiver isn't notably sensitive and isn't located within 20 to 30 miles of the station, an outdoor antenna may be required. This can consist of a length of antenna wire, possibly 20 to 50 feet in length, con-

nected by a single lead-in wire to the AM antenna terminal of the receiver or tuner.

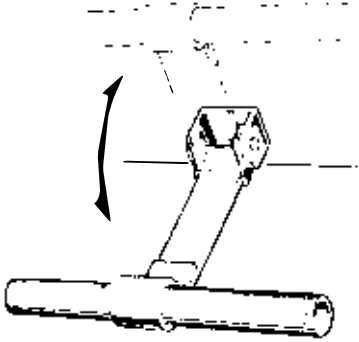

Fig. 3—4

IN SOME FM TUNERS AND RECEIVERS, THE BUILT-IN FERRITE AM ANTENNA CAN BE ADJUSTED, FOR THE BEST AM PICKUP. ITS POSITION WILL NOT AFFECT FM RECEPTION.

## GROUND

At one time in the early days of radio when receivers did not have the sensitivity they have today, a good ground connection was essential for reception. The ground was actually part of the antenna system. Today, a ground connection from a tuner or receiver is a hum reducing or eliminating aid. However, a ground connection is rarely required. If needed, run a wire from the ground terminal on the rear apron of the tuner or receiver to a radiator or cold water pipe.

## FUNCTION OF THE FM TUNER

The demands made upon a hi-fi tuner will become clear if we examine its functions step by step (Fig. 3-5). The FM antenna supplies the radio signal (FM occupies the 88 — 108 MHz band) to the tuner's input, i.e. the radio-frequency (RF) amplifier stage. There, the signal is amplified and, more importantly, separated from those of other FM stations and from random noise signals.

In better-grade FM tuners and receivers, the RF amplifier is a tuned circuit — one of the circuits controlled by the tuning knob on the front panel of the unit. The tuned radio frequency amplifier not only strengthens the signal, but also selects the one desired signal from among all those supplied by the antenna.

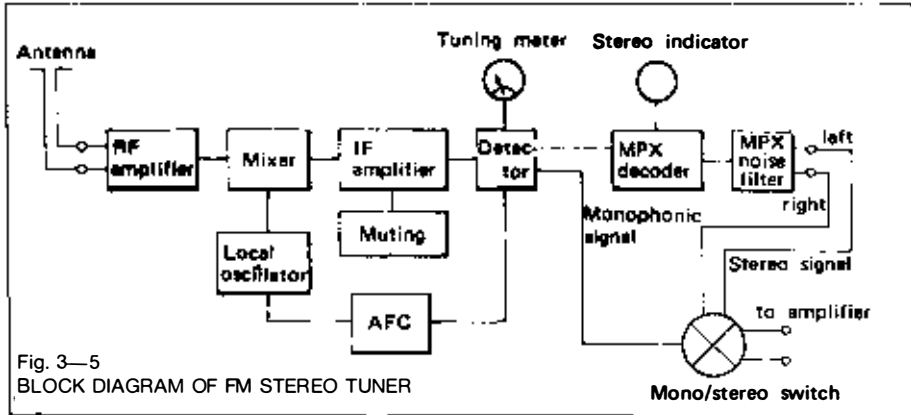

This outlines the first two tasks of an FM hi-fi tuner: sensitivity, i.e. the ability to pick up weak signals; and selectivity, its ability to “slice out” only the desired station while suppressing adjacent signals and noise. Another item found in tuner specifications (Fig. 3-6) and determined at the tuner’s RF stage is cross-modulation resistance which describes a tuner’s ability to prevent the desired signal from being influenced (“modulated”) by strong unwanted stations. In modern tuner designs, cross-modulation resistance has been improved considerably by the use of field effect transistors (FET’s) because of their higher linearity. Since cross-modulation depends largely on the strength of these unwanted signals, it can be further reduced by correct, precise orientation of the antenna towards the wanted station.

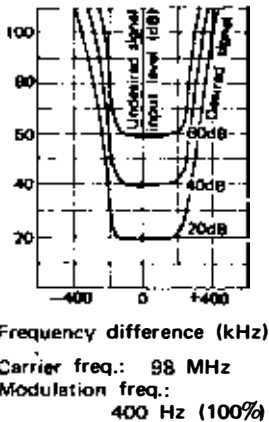

Fig. 3—6  
SELECTIVITY  
CHARACTERISTIC  
CURVE

As the RF stage is followed by an oscillator circuit, it must be designed in such a way that the oscillator frequency does not “leak” from



the tuner, causing interference in nearby TV sets, radios, etc.

The mixer stage delivers an intermediate frequency signal of 10.7 MHz, which is then amplified and again selected in the IF stage. The problem is to amplify only the desired, sharply defined section of the band that contains the wanted sound information. This is done by a series of filters of very precise electrical dimensions, preferably ceramic filters. These are a major factor in determining an FM tuner's selectivity.

The limiting circuit, also part of the IF stage, fulfills one of the most important functions — it suppresses atmospheric noise (Fig. 3-7). This is one of the special features of FM broadcasting and explains the high sound quality attainable. The limiter begins to work only when a signal of sufficient strength is present, and its function is therefore closely related to the tuner's sensitivity and antenna signal strength.

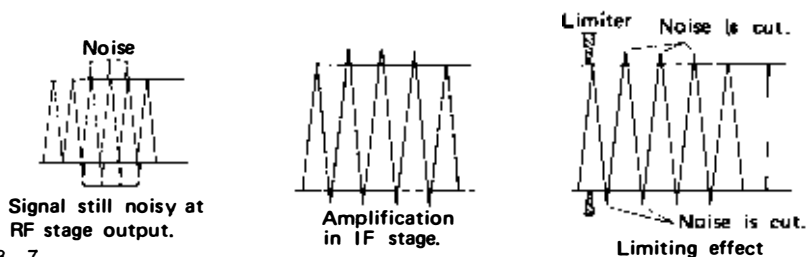

Fig. 3-7  
LIMITING EFFECT

The muting circuit, usually switchable with a control on the tuner's front panel, has a similar purpose — it cancels the noise encountered on unused FM channels, that irritating hiss you hear between stations. The muting control can be either a simple on/off switch or, on expensive models, a continuously adjustable control. As the muting switch cancels weak stations along with the noise, it must be turned off or down when a weak signal is to be received.

After passing through the IF stage, the signal is demodulated, i.e. the audio signal is extracted from it. This signal is still too weak, however, to drive the loudspeakers; it must first be augmented in the amplifier.

### FM MPX (STEREO)

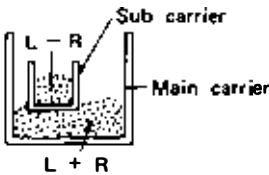

Fig. 3—8  
CARRIER OF FM MPX STEREO  
SIGNAL STRENGTH AND  
TUNING METERS.

The greatest attraction of today's FM tuners lies in the possibility of stereophonic reception. (Of course, this is possible only in areas where FM stereo stations are operating.) When broadcasting a stereophonic or multiplex (MPX) program, the station transmits a sub-carrier wave alongside the main carrier and removed from it by 38 kHz, and a pilot frequency of half the sub-carrier i.e. 19 kHz (Fig. 3-9). A pilot detector circuit in the tuner detects the presence of this pilot signal and activates the so-called FM MPX decoder circuit.

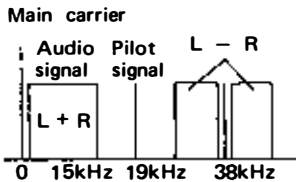

Fig. 3—9  
SPECTRUM OF FM STEREO

Let us call the sound information for the left channel L, that for the right channel R. In a stereophonic FM broadcast, the main carrier contains the sum of both signals, i.e. L + R. A conventional FM radio will receive only this signal and deliver monophonic sound. The sub-carrier transports a difference signal, L - R. In the FM MPX decoder, these two L + R and L - R signals are added and subtracted to regain the signal for each channel:  
 $(L + R) + (L - R) = 2L$  ..... left channel sound  
 $(L + R) - (L - R) = 2R$  ..... right channel sound.

For reasons too complicated to explain here an FM stereo broadcast has only about half the reach of a monophonic program transmitted with the same power. This makes it easy to understand why a good FM outdoor antenna is needed in most cases to assure good stereo reception.

## TUNER CONTROLS

The quality and usefulness of an FM tuner is determined by the precision of the circuits, as well as its operating convenience. Let us take a brief look at the controls, dials and switches found on upper grade AM/FM hi-fi tuners.

The operation mode is determined by a function selector which usually has three positions: AM, FM MONO, and FM AUTO. In FM MONO position, all FM programs are received monophonically, i.e. the MPX decoder is deactivated. In FM AUTO mode, the tuner automatically switches to FM stereo reception when tuned to an FM MPX broadcast.

Tuning is accomplished by turning a large knob and watching one or two meters (Fig. 3-10) as well as the station dial. The signal strength meter deflects to the right when the station is tuned in. The greater its deflection, the stronger the received signal. (It is also helpful in finding the best position and direction for the FM antenna.) The tuning or center zero meter moves into center position to indicate accurate station tuning. Some upper range tuners have a

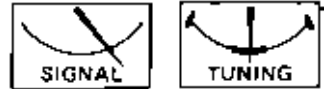
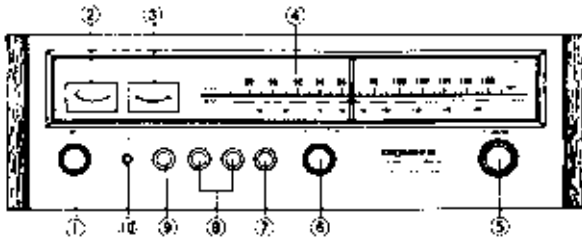

Fig. 3-10  
SIGNAL STRENGTH AND TUNING  
METERS.



- ① POWER SWITCH
- ② SIGNAL METER
- ③ FM TUNING METER
- ④ INDICATOR LAMP
- ⑤ TUNING KNOB
- ⑥ SELECTOR SWITCH
- ⑦ MUTING LEVEL CONTROL
- ⑧ OUTPUT LEVEL CONTROLS
- ⑨ HEADPHONE LEVEL CONTROL
- ⑩ HEADPHONE JACK

dial pointer with a built-in lamp that lights up when a station is tuned in.

A close look at the tuning dials of different tuners will reveal a slight but important difference. On most tuners, the spacing between the frequency markings will become gradually closer toward the right end of the dial. Others have dials with equal distances between all FM frequency markings. These “linear” dials (Fig. 3-11) are of course easier to read and permit quicker, more accurate tuning.

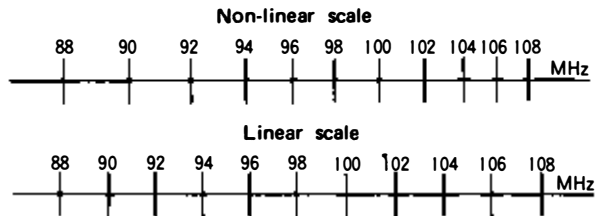

Fig. 3—11  
NON-LINEAR AND LINEAR FM DIAL SCALES.

The muting switch or continuous muting control has already been explained. In addition, top range tuners often are equipped with a switch or control called “MPX NOISE FILTER” or “HI BLEND”. Its function is to eliminate or at least reduce hissing noise which is often present in FM stereo programs of insufficient signal strength. As this circuit operates by blending a certain amount of the high sound frequencies of both channels, its use entails a certain loss in stereo channel separation.

Some tuners or receivers also have low and high filters. Use the low filter to cut out low-frequency interference, such as motor rumbling or hum. Use the high filter to eliminate high-frequency interference, such as that from fluorescent lights.

Another control that may be found on a receiver (or an amplifier) is the loudness control. At low volume levels, the sensitivity of ears to extremely low and high frequencies is reduced.

The loudness control compensates for this by emphasizing these frequencies. The loudness control is often in the form of a switch which can insert or remove a loudness circuit. Keep this switch turned off at normal or high volumes.

Some tuners are equipped with a semi-fixed screw or control for adjusting the MPX decoder's channel separation. This is factory adjusted and re-adjustments should be entrusted to qualified service engineers only.

Other controls found on tuners include output level controls, sometimes separate for AM and FM, which regulate the tuner's output voltage in order to match its sound volume with that of other source equipment (turntable, tape deck). A headphone jack may also be provided, and some tuners have an extra pair of TAPE REC outputs, permitting direct tuner-to-tape recording without going through the amplifier. Last but not least, there may be an AFC switch (although its presence or absence says nothing about the quality of the tuner) whose function is to lock the station to the tuning circuits, in other words to prevent station drift and fluctuations.

## CONDITIONS FREQUENTLY MISTAKEN FOR MALFUNCTION

The presence of noise in a hi-fi system is an aggravating condition. There are a variety of noises relating to the operation of a hi-fi unit. These are generally divided into two types: (1) the unit is faulty (a transistor or some other part has deteriorated) and (2) an external source is adding noise in the form of a signal.

When a hi-fi unit produces an unpleasant noise, it is often assumed the unit is faulty. But statistical records indicate the majority of noises produced in hi-fi acoustic units result from external sources. Due to the inherent high sen-

sitivity and high fidelity in reproduction, the unit amplifies and reproduces extraneous noises, however small, into definite output noise. The original noise source exists in the form of a tiny electrical signal. The hi-fi system, however, treats this unwanted electrical signal as though it were a true signal, amplifying and reproducing it. Table 1 supplies the symptoms, suspected noise sources, diagnosis and remedies, for the most common noise troubles.

## HOW TO READ TUNER SPECIFICATIONS

Compared to a turntable which is chiefly a mechanical device, a tuner's spec sheet presents much greater difficulties to the layman. A rather close familiarity with electronic circuits is required to find one's way through all the ratios, rejections, responses, and factors. Nevertheless, the following brief explanations should be sufficient guidance.

### a) Sensitivity

The minimum antenna signal which the tuner can convert into a satisfactory sound signal. Expressed in  $\mu\text{V}$  (microvolt = 1/1,000,000 of a volt) and defined by the Institute of High Fidelity (IHF) as the signal strength at which the tuner will suppress noise by 30 dB. Values below 2  $\mu\text{V}$  are outstanding. Don't trust figures which do not include a mention of the noise limiting ratio (expressed in dB, usually 30 dB).

### b) Signal-to-noise ratio

The ratio, expressed in dB, between a 400 Hz fully modulated signal and the noise component. 60 dB means that the signal is 1000 times stronger than the noise. The higher the value, the better. 50 dB is about minimum requirement for hi-fi.

### c) Capture ratio

Assume two stations are broadcasting on the

same frequency. "Capture ratio" describes a tuner's ability to suppress the weaker of the two while receiving only the stronger. Also related to the tuner's suppression of random noise. Expressed in dB, smaller values are better. 4.5 dB is usually sufficient.

d) Selectivity

The tuner's ability to slice only the desired station from the hodgepodge of airwaves reaching it from the antenna. Also its ability to receive one of two closely spaced stations. Expressed in dB, higher values are better. 50 dB is usually sufficient.

e) Image rejection

"Image" means a tuner's undesirable reception of the same signal at two or more points on the dial, of which only one is the true station signal. This is caused by interaction of the oscillator frequency and the RF frequency. Image rejection is the tuner's ability to suppress this frequency. Bigger values are better. Good image rejection is particularly essential in areas with several FM stations broadcasting.

f) Spurious response or rejection

An FM tuner's bad habit of creating unwanted, meaningless "lie" signals which it then (a) emits through the antenna, causing interference in a neighbor's TV set or radio, and (b) picks up itself, affecting its own reception. This self-generated lie signal can interfere with the true wanted station signal. Expressed in dB, higher values are preferable.

g) AM suppression

AM in this context has nothing to do with AM broadcasting; AM here means the (amplitude modulated) noise signals emanating from fluorescent lamps, motors, automobile ignition systems, etc. Unless suppressed, they can cause irritating crackle during FM reception. AM suppression is expressed in dB. Higher values are better; 40 dB is about minimum.

h) FM stereo separation

The FM MPX decoder's ability to separate the left and right channel signals of FM stereo broadcasts. For stereo effect, channel separation in the medium audio frequency range (400 — 1,000 Hz) is most important. A good tuner should have 40 dB separation in this range, or 30 dB between 40 Hz and 8 kHz, or 25 dB over the total 20 Hz — 15 kHz range. Be sceptical of specifications that don't mention the frequency range at all.

i) Output level

Usually in the 0.5V range, adjustable on high quality FM tuners. Must match the sensitivity of the amplifier's TUNER or AUX inputs.

TABLE 1 —

	SYMPTOM
WHEN LISTENING TO BROADCAST	Continuous or intermittent noise like jjjjjj or zzzzzz.
	When a station is tuned in, hum is mixed in the program.
	Hissing sound noise in AM (medium wave) reception.
	Static noise (in particular, when automobiles run close to the house).
WHEN PLAYING RECORDS	Reception of FM stereo program contains more noise than FM mono program.
	Hum or buzz. When switched to radio reception, the noise disappears.
	Output tone quality is poor and mixed with noise. Treble is not clear.

WATCH FOR THE FOLLOW

	SYMPTOM
	Power is not turned on although the power switch is set to ON.
	In playing a record, increasing the volume causes howling.



## TROUBLESHOOTING CHART FOR TUNERS.

SUSPECTED SOURCE OF NOISE	DIAGNOSIS AND REMEDY
<ul style="list-style-type: none"> <li>• Static (lightning)</li> <li>• Fluorescent lamp, motor, or thermostat may be in use in house or in the vicinity of the house.</li> </ul>	In many cases, it is very difficult to remove the source of noise. In order to make the radio input larger than the noise level, set up a good outdoor antenna and make a complete grounding.
<ul style="list-style-type: none"> <li>• Poor fluorescent lamp, motor, or electric heater may be in use in house or near the house.</li> </ul>	Reversing the line plug may occasionally alleviate this noise problem. Usually it is very difficult to eliminate the noise.
<ul style="list-style-type: none"> <li>• The frequency of an adjacent station is interfering with that of the station being tuned in (10kHz beat interference).</li> <li>• TV set is on in the same house with the receiver.</li> </ul>	Impossible to remove such interference. If the cause of such noise is in the TV set, increase the distance between the TV set and receiver.
<ul style="list-style-type: none"> <li>• White noise generated from automobile engines.</li> <li>• Radio frequency sewing machine or welding machine being used near your house.</li> </ul>	In an area surrounded by hills or high buildings, the FM input signals are very weak. Thus the noise limiter in the circuit loses its function. Set up an FM outdoor antenna having many director elements.
<ul style="list-style-type: none"> <li>• Note that the service area covered by an FM stereo broadcast is about 50% of that of a regular mono broadcast.</li> </ul>	Increasing FM input signal may alleviate this problem. Use an exclusive FM outdoor antenna instead of the indoor T-type antenna.
<ul style="list-style-type: none"> <li>• Poor connection of shielded wire (a).</li> <li>• Jack connection is loose. (b).</li> <li>• Line cord or fluorescent lamp is near the shielded wire. (c).</li> <li>• Poor grounding. (d).</li> <li>• Ham transmitting station or TV transmitting station is near your house. (e).</li> </ul>	Correct the conditions stated in (a), (b), (c), (d) or (e) Contact amateur radio station and ask operator to install TVI filters Or contact local office of FCC and notify them of existence of signal interference.
<ul style="list-style-type: none"> <li>• Stylus wears out. (a)</li> <li>• Record wears out. (b)</li> <li>• Dust adheres to stylus. (c)</li> <li>• Stylus is improperly mounted. (d)</li> <li>• Stylus pressure is not proper. (e)</li> <li>• The TREBLE level is too high.</li> </ul>	<p>Check (a) through (e) and correct the condition.</p> <p>Lower the TREBLE level.</p>

## NG CONDITIONS; THESE ARE ALSO APT TO BE MISTAKEN FOR MALFUNCTIONS.

SUSPECTED SOURCE OF NOISE	DIAGNOSIS AND REMEDY
<ul style="list-style-type: none"> <li>• Fuse blows. (a)</li> <li>• Line plug is loose. (b)</li> </ul>	Check (a) and (b) and correct the condition.
<ul style="list-style-type: none"> <li>• Distance between the turntable and the speakers is too short.</li> <li>• The place on which the turntable or speakers are set is unstable.</li> </ul>	<p>Change the distance or rearrange the installation. (Installing the turntable on a firm, solid stand may alleviate this problem.)</p> <p>Do not enhance the BASS sound level excessively.</p>

## Chapter 4

### TAPE EQUIPMENT



Turntables and tuners are “passive” sound sources — they can only reproduce commercially recorded or broadcast sound. Tape equipment, with the exception of so-called tape players, lets the listener participate “actively” in the selection and even creation of music programs. This great advantage, together with the operational ease and relatively low price of modern tape equipment, may explain the tremendous tape recorder boom that has been sweeping around the world.

According to the type of magnetic tape used, tape equipment can be grouped into open-reel, cassette and cartridge. The recording tape itself is basically the same for all three types, and so are the essential functions of the machines.

- ① PAUSE LEVER
- ② HEADS HOUSING
- ③ TENSION ARM
- ④ DIGIT PROGRAM INDICATOR
- ⑤ TENSION ARM
- ⑥ LEVEL METER
- ⑦ RECORDING LEVEL CONTROL KNOB (LINE)
- ⑧ RECORDING LEVEL CONTROL KNOB (MIC)
- ⑨ MODE SWITCH
- ⑩ PLAYBACK LEVEL CONTROL KNOB
- ⑪ INPUT SELECTOR SWITCH
- ⑫ MONITOR SWITCH
- ⑬ POWER SWITCH
- ⑭ HEADPHONE JACK
- ⑮ MICROPHONE JACKS
- ⑯ INPUT JACKS
- ⑰ BIAS SELECTOR SWITCH
- ⑱ TRACK INDICATOR
- ⑲ CYCLE (SENSOR) SWITCH
- ⑳ TAPE SPEED SELECTOR SWITCH
- ㉑ FUNCTION BUTTONS

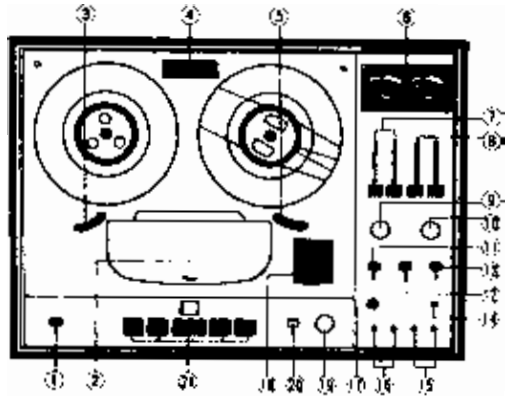

Magnetic recording tape consists of a thin (15 to 35 micron) polyester or acetate film with a layer of fine iron oxide particles imbedded in an adhesive. These iron oxide particles can be magnetized in a magnetic field and will retain this magnetism.

## RECORDING AND PLAYBACK PROCESS

The recording process is, briefly, as follows. Electric signals supplied by a sound source are amplified and then applied to the coil of a small electromagnet called a “recording head” (Fig. 4-1). This causes a magnetic field, alternating in

Fig. 4—1  
SOUND IS CHANGED INTO AN ELECTRICAL SIGNAL, AMPLIFIED, AND THEN DELIVERED TO A RECORDING HEAD. THE ARRANGEMENT OF THE SMALL MAGNETIC PARTICLES ON THE TAPE ARE CHANGED BY THE SIGNALS.

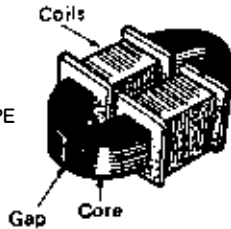

accordance with the sound's rhythm and intensity, in and around a tiny gap between the two poles of the magnet. As the recording tape travels past the recording head, its iron oxide particles are magnetized by the alternating magnetic field (Fig. 4-2). The tape thus stores the sound information in the form of magnetism.

To retrieve this information, the reverse process is used. The tape, transported past the playback head — another small electro-magnet with a similar structure as the recording head — induces a small, alternating current in the magnet's coil (Fig. 4-3). As this current contains the same sound information as the original signal — provided that the tape travels at the same speed at recording and playback — it can be amplified and used to drive a loudspeaker.

## TRACKS

The first tape recorders, built during and after World War II, used the full tape width for a single passage. Later, as tape recorder components, recording tape and techniques became

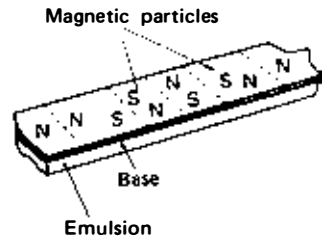

Fig. 4—2  
SCHEMATIC VIEW OF RECORDED TAPE



Fig. 4—3  
STRUCTURE OF TAPE HEAD

more refined, the tape width was split into two and then four "tracks". This provides greater tape economy and, moreover, the possibility to store two (or even four) stereo channels on the tape. Most modern open reel stereo tape recorders for amateur use are four-track models (Fig. 4-4), whereas in cartridge recorders and players the same tape width is divided into eight tracks.

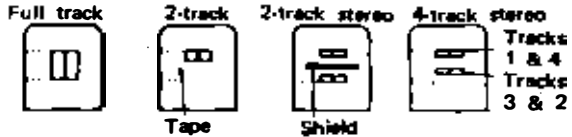

Fig. 4—4  
TRACK LOCATIONS IN TAPE HEADS.

## TAPE SPEEDS

Another tendency in tape recorder design has brought about slower tape speeds. Although professional studio machines transport the tape at 15 or at least 7-1/2 inches per second, most amateur tape recorders offer a choice between 7-1/2 and 3-3/4 ips, and sometimes 1-7/8 ips. (Corresponding decimal values: 19, 9.5 and 4.75 cm/sec.) Cartridge players always run at 3-3/4 ips (9.5 cm/sec) while cassette tape is transported at 1-3/4 ips (4.75 cm/sec). This explains the comparatively long recording time of cassette tapes.

Tape speed is of vital importance for sound quality, especially in the high sound range, because a tape recorder's upper frequency response limit is directly and mathematically related to the tape speed and the gap width of its recording and playback heads (Fig. 4-5). The higher the tape speed, and the narrower the head gap, the better the high-range frequency response. Most hi-fi fans with open-reel tape recorders therefore prefer the highest available speed for recordings they consider important.

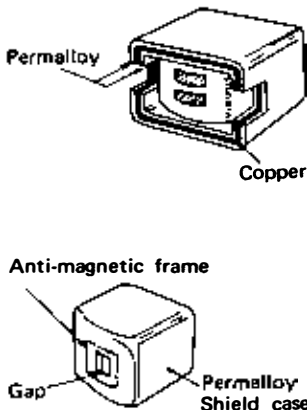

Fig. 4—5  
PERMALLOY SHIELDS  
AGAINST HIGH  
FREQUENCIES

Recent advances in the technology of recording heads have made it possible to manufacture ultra-narrow head gaps so that excellent frequency response up to the limits of the audible sound range can now be obtained even at the slower tape speeds.

Tape speed is of course directly connected with recording time. Table 1 shows recording times (per track and per return trip) for common types of reel tapes at 7-1/2 ips (19 cm/sec) recording speed. 3-3/4 ips provides twice the recording time, 1-7/8 ips four times as much. Table 2 shows the recording time of cassette tape.

TYPE	BASE	THICKNESS ( $\mu$ )	LENGTH		RECORDING TIME (min.)	
			(m)	(ft.)	ONE WAY	BOTH WAYS
Standard 100	Acetate	52	370	1200	32	64
"	Polyester	"	"	"	"	"
Low noise high -output 100	Acetate	"	"	"	"	"
	Polyester	"	"	"	"	"
Long play 150	Acetate	35	550	1800	48	96
"	Polyester	"	"	"	"	"
Double play	"	25	740	2400	64	128
Triple play	"	20	1,100	3600	96	192

TABLE 1 — RECORDING TIME FOR OPEN-REEL TAPE.

TYPE	BASE	THICKNESS ( $\mu$ )	LENGTH		RECORDING TIME (min.)	
			(m)	(ft.)	ONE WAY	BOTH WAYS
C-30	Polyester	18	45	150	15	30
C-60	"	18	90	300	30	60
C-90	"	13	135	450	45	90
C-120	"	9	180	600	60	120

TABLE 2 — RECORDING TIME OF CASSETTE TAPE.

## TAPE QUALITY

The quality of the recording tape is as important as that of the equipment itself. Poor quality tape wears out your tape recorder faster than necessary. Some of the demands on quality tape are obvious: it must not break or stretch easily, its edges must not curl, and its base must retain its strength and flexibility for many years. Also, the emulsion must not separate from the base or wear off because this fouls the heads and tape path and causes "drop-out", i.e. holes in the sound. As the tape constantly rubs against the recording and playback heads, its surface should be as smooth and even as possible to assure long head service life. In addition, there are numerous requirements regarding the tape's electrical characteristics — its dynamic range, frequency response and freedom from noise.

## LOW-NOISE HIGH-OUTPUT TAPE

In recent years, a new variety of recording tape has been put on the market. These "low noise high output" tapes, available on open reels and as compact cassettes, possess higher magnetic particle density and therefore a wider dynamic range — they can record and reproduce a greater span of sound intensities from a whisper to a roar. To make full use of these advantages, however, the tape recorder must have a special provision, an adjustable or

switchable “bias current”.

(Audio frequency signals are never recorded on magnetic tape as it is: the tape develops its optimum characteristics only after it has been “primed” with a rather high frequency bias current. This bias current, usually applied through the recording head together with the audio signal, is different for ordinary tape and for low noise, high output tape.)

Before we talk about the factors that determine the quality of tape equipment, let’s take a brief look at the many types being marketed. We have already made a distinction between reel, cartridge and cassette equipment. Each group is further divided into “tape decks”, “tape recorders” and “tape players”.

## TAPE DECK, RECORDER, PLAYER?

A tape deck, the most common and sensible variety for use in hi-fi installations, consists of the tape transport and the required recording and playback pre-amplifiers but no power amplifiers or loudspeakers. A tape deck can record through microphones or from a tuner or amplifier, and playback is also possible via an external amplifier and speaker system.

A tape recorder is also equipped with its own power amplifier and loudspeaker(s). It can be used as a self-contained unit for recording and playback. In this class we find most portable tape equipment as well as some self-contained home units.

A tape player, finally, is a tape deck minus the recording facilities, i.e. for playback of pre-recorded tapes only. Most cartridge tape equipment falls into this class because stereo tape cartridges are chiefly sold with commercially pre-recorded music. There are, however, a number of cartridge decks equipped for recording as well

as playback and — the latest addition — eight-track four-channel cartridges (“Quadraphonic”) and players which serve as convenient sound sources in a four-channel stereo system.

### OPEN REEL, CASSETTE, CARTRIDGE?

The choice between open reel, cassette and cartridge has become very much a question of personal preferences. Until a few years ago, no status-conscious “elite” hi-fi fan would go near a cassette recorder, branding them as kid stuff for amateurs.

When the cassette recorder was first introduced it was considered little more than a novelty or toy. The slow tape speed used as a standard (1-7/8 inches per second) and the narrow track width made it difficult to record with any sort of quality. Tape hiss was unacceptably high for good music reproduction and frequencies above 6,000 or 7,000 Hz were almost impossible to record as usable levels. One of the many factors that contributed to the ultimate acceptance of the cassette as a high-fidelity component was the change in tape recording material. The coatings on all recording tapes consist of minute particles of magnetic oxide. In its proprietary gamma ferric (SD) oxide, one company, TDK, has succeeded in reducing the average length of these particles to only 4/10 the average length of those on standard tapes — only 0.4 micron. In addition, the shape of gamma ferric oxide particles is better; the width-to-length ratio has been improved.

The latest generation of cassette equipment has made many a “reel snob” eat his words because they deliver, despite their slow tape speed and narrow track width, quite respectable sound in addition to their great snap-in, pop-out convenience. This was made possible by the



development of new precision drive systems (Fig. 4-6), ultra narrow-gap heads and, as mentioned earlier, better recording tape. Cassette decks can be recommended chiefly to hi-fi fans who prefer to get their music the easy, uncomplicated way. A serious drawback of cassette tape however is its shorter service life because the narrow and often extremely thin tape naturally stretches more easily than the wider reel-to-reel tape.

Cartridge equipment for hi-fi installations owes much of its popularity to its great, almost fully automated ease of operation and, to a lesser extent, to the wide-spread use of automobile stereo players which use the same tape cartridges. Most cartridges are recorded with eight tracks. Since one track corresponds to one stereo channel, four stereo programs (or two 4-channel programs) are contained on one cartridge. The tape is wound in an endless, continuous, loop (Fig. 4-7). At one point, a metal switching foil is attached which, when traveling past the head, activates a switching relay. This in turn makes the head move one step down (the width of one track) so that it will scan the next program. In addition to its great convenience, cartridge tape has the advantage of traveling at 3-3/4 ips (9.5 cm/sec), twice the speed of cassettes, and can be expected to deliver better high range frequency response (which is not always true, though). Also, a great deal of music, mostly jazz and popular, is available on commercial pre-recorded cartridges.

With cassette tape, a program is recorded stereophonically on tracks L1 and R1 (Fig. 4-8) and on tracks L2 and R2. A stereo recording can be played back on a mono cassette recorder without loss of quality, although the recording will, of course, only be reproduced in one dimension. Conversely, a recording made on a mono cassette recorder can be played back on a stereo cassette recorder, although again only monophonically.

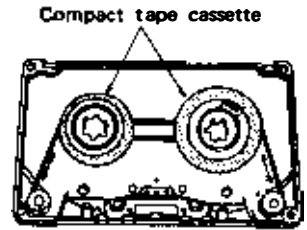

Fig. 4-6  
SCHEMATIC VIEW OF  
CASSETTE TAPE

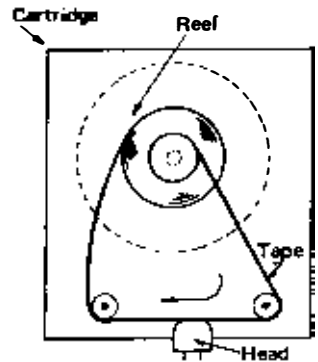

Fig. 4-7  
ENDLESS LOOP TYPE TAPE  
CARTRIDGE

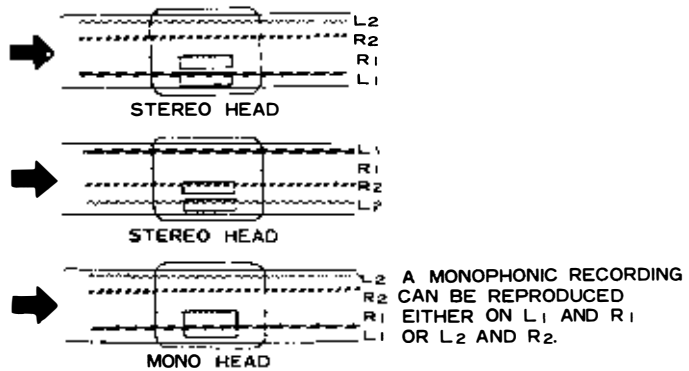

Fig. 4—8  
TWO CHANNELS ARE USED FOR STEREO: ONE CHANNEL FOR MONO RECORDING ON CASSETTE TAPE.

## CHROMIUM-DIOXIDE TAPE

New formulations for cassette tapes have helped extend the frequency response, with substantial reduction in noise. The chromium dioxide tape ( $C_rO_2$ ) does require different bias and equalization, but cassettes are now equipped with a selector control to permit the use of regular and  $C_rO_2$  tapes. There are ferric oxide tapes that are as good as the chromium-dioxide tapes, but you can expect to pay more for both.

There are a number of basic lengths of cassette tape available: C-30, C-40, C-45, C-60, C-90, C-120 and C-180. Two other recording lengths, the C-66 and C-96 versions are also available to ensure complete taping of entire LP records.

All cassettes are the same package size, but the length of the tape they contain can vary. The "C" number specified in the above paragraph (printed on the cassette and the box) indicates the total playing time.

The C-60 tape, for example, runs for 60 minutes (30 minutes on each side) while C-90 tapes run for 90 minutes (45 minutes per side).

The C-180 provides an incredible total of three hours of recording time in a single cassette — an hour and a half per side.

The C-30's may have the highest cost per minute, but they also have the lowest total cost of any cassette. They have the advantage that it's easier to find a specific place on a short tape. This makes them popular for the recording of several miscellaneous short musical numbers.

The C-60 is the most popular cassette length, because its tape is thick enough for maximum durability and long enough for most home recording situations. C-120 and C-180 tapes are very thin and some precautions are needed in using these tapes. If the tape is loosely wound on the cassette, tighten it manually before using. Never touch the tape with your fingers, since this will soil it. If the rubber pinch roller in the recorder is dirty, the tape could easily wind improperly. Keep this rubber roller clean at all times. Try to avoid repeated and excessively fast winding of the tape. When using the tape, use the "stop" button when going from one mode to another; never go from play to fast wind or vice versa. After using a cassette, make sure it is tight and store it in a cool, dry place.

## FREQUENCY VS. OXIDE PARTICLE SIZE

The higher the frequency of any sound, the shorter will be its wavelength on a section of recorded tape. The oxide particles must be shorter than the wavelengths to be recorded for the process to be achieved properly. Thus, standard oxide particles are too large and coarse for recording the upper frequency registers. One manufacturer, TDK, maintains that their SD cassettes have the capability of recording from 30 to 20,000 Hz — more than enough to get the

highest possible performance from cassette recorders. With properly adjusted bias, SD tape is flat to 10,000 Hz, whereas conventional tapes begin to drop off at about 5,000 Hz. But even with so-called standard bias, SD tape helps compensate for the high-frequency deficiencies of older or inexpensive recorders. In a typical case, they will provide about 5 to 10 dB greater output for frequencies above 10,000 Hz.

## RECORDER/CASSETTE COMPATIBILITY

The cassette must be able to work properly in any recorder. Is the recorder old or new? Does it work on AC, battery power or either? Is it a portable or a component deck? Mono or stereo? No two cassette machines act alike, even those that look alike. This is particularly true when it comes to torque, the rotational force which drives the tape.

Ordinary cassettes work well over a limited torque range. When they fall short, the following problems can arise: stalling, jamming, tape pulling and stretching, tape breakage, tape spilling and tangling, and increased wow and flutter.

## ENVIRONMENTAL COMPATIBILITY

Cassettes go everywhere. They're expected to work anywhere under any conditions. Indoors. Outdoors. On the patio. Near radiators. At the beach. In moving automobiles. In the sun. In the rain. Upside down. Sideways. Carried. Swung. Shaken. Dropped. And all this while they are playing.

Can they take such punishment? Most will fail to perform properly while under stress, suffer some permanent impairment or break down entirely.

Consider one factor only — resistance to vibration. Can your cassette play well while it is subjected to rapid vibration? It had better, if it is going to be used in an automobile. Wow and flutter for many cassettes rise intolerably with increasing vibration frequency. Some inferior cassettes will resonate mechanically in the range of 18 to 20 vibrations per second, thus becoming unusable when this range is reached.

## CARTRIDGE TAPES

As shown in Fig. 4-9, it is possible to record two programs with four channels each on 8-track cartridge tape, or, as shown in Fig. 4-10, four programs with two channels each.

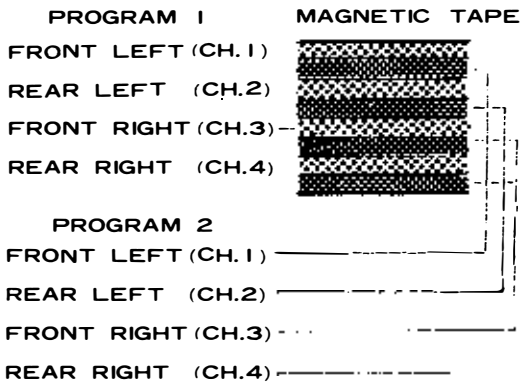

Fig. 4—9  
TWO FOUR-CHANNEL PROGRAMS CAN BE RECORDED ON EIGHT-TRACK CARTRIDGE TAPE.

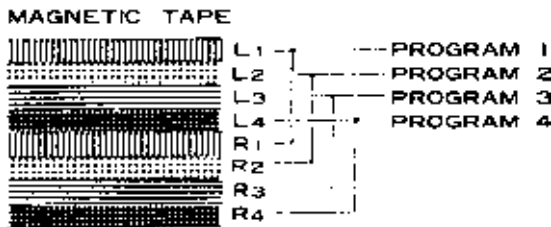

Fig. 4—10  
FOUR STEREO (TWO-CHANNEL) PROGRAMS CAN BE RECORDED ON EIGHT-TRACK CARTRIDGE TAPE.

## OPEN-REEL TAPE

Signal recording on four-channel stereo tape is different from that on a two-channel stereo tape. The difference between tracks used for four-channel and tracks for two-channel are:

four-channel: all tracks are used simultaneously to record one program.

two-channel: conventional stereo: tracks 1 and 3 or 4 and 2 are used for one program. The remaining tracks, 4 and 2 or 1 and 3, for another program. See Fig. 4-11. Table 3 further explains the difference between two- and four-channel tape.

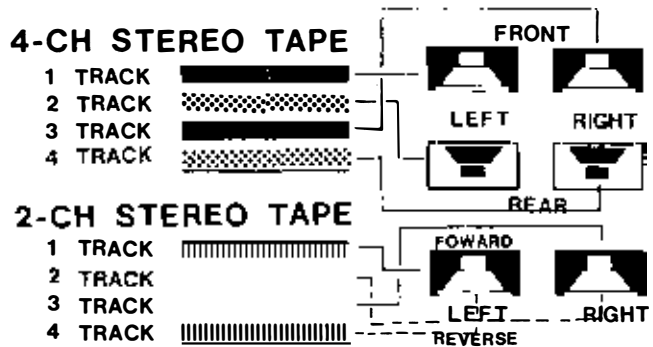

Fig. 4—11  
FOUR-CHANNEL AND TWO-CHANNEL STEREO TAPE.

	4-channel stereo tape	2-channel tape
Track 1	FRONT LEFT	LEFT-channel (Tape travels from left to right)
Track 2	REAR LEFT	RIGHT-channel (Tape travels from right to left)
Track 3	FRONT RIGHT	RIGHT-channel (Tape travels from left to right)
Track 4	REAR RIGHT	LEFT-channel (Tape travel from right to left)

TABLE 3 — CHANNELS FOR OPEN-REEL TAPE.

Despite the inroads made by cassette and cartridge equipment, the open reel tape deck is still the most common, most versatile, most advisable (and most expensive) recording and playback instrument for the serious hi-fi enthusiast. It is the open-reel stereo deck that will be examined in the following paragraphs, although the principles apply to cassette and cartridge equipment as well.

## NOISE REDUCTION

One of the problems of cassettes is tape hiss, and so a number of circuits have been devised for reducing hiss to a much lower, possibly inaudible level. Although a number of manufacturers have introduced their own noise-reduction circuits, the most widely used is the Dolby B system. Dolby is also available as an add-on component for cassette equipment not so equipped.

For the Dolby noise reduction system to be completely effective, it must be used during both recording and playback. At the time of recording, the higher frequencies are boosted if their signal level is low. During playback, of course, these frequencies must be attenuated, and so the overall frequency response isn't changed. However, noise introduced during the recording process is substantially reduced.

A cassette that has had the Dolby treatment can be played back on a cassette deck not equipped with a Dolby noise reduction circuit, with some reduction of tape hiss.

## DRIVE MECHANISM

The mechanical part of a tape deck (Fig. 4-12) has to move the tape past the heads at con-

stant, specified speeds. This is done by a rotating capstan against which the tape is pressed by a pinch roller. In the design of this mechanism, special attention must be paid to avoid tape slippage. The mechanism must perform two other functions: rapid forward winding and rewinding of the tape. All three tasks can of course be carried out by a single motor and a system of belts, pulleys and idlers.

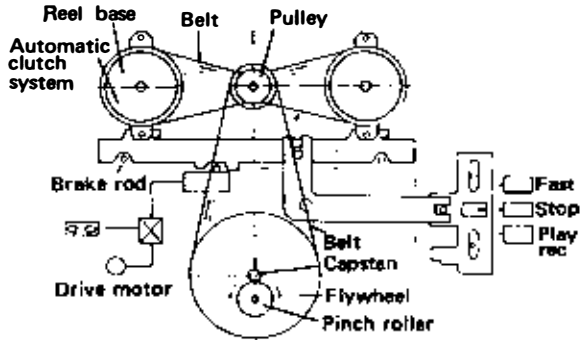

Fig. 4-12  
ONE-MOTOR DRIVE MECHANISM

## 2 AND 3 MOTOR SYSTEMS

Where highest precision and rapid winding speeds are required and cost is a minor consideration, separate motors (Fig. 4-13) can be used to drive the capstan and both reels or three

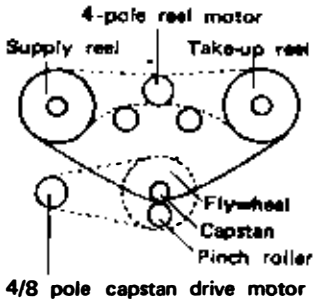

Fig. 4-13  
TWO-MOTOR DRIVE  
MECHANISM

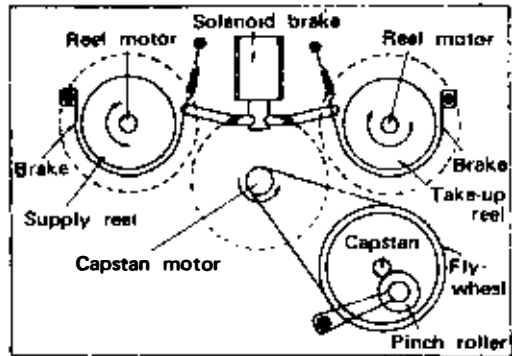

Fig. 4-14  
THREE-MOTOR DRIVE MECHANISM



separate motors for the capstan and each reel. Such top class tape transports are often controlled via electronic relays and pushbuttons and embody tension regulators and other devices to protect the tape from excessive forces. In two and three motor transports (Fig. 4-14) the capstan and reel motors are of radically different design so that each can perform its task with maximum efficiency.

## RECORDING AND PLAYBACK HEADS

A tape deck needs at least two heads (Fig. 4-15). An erasing head which cleans the tape of previous recordings and noise, and a combined recording/playback head. The importance of the head gap has already been mentioned. Other points of interest include the heads' surface polish — the tape must travel over it with as little friction as possible — and its dimensional accuracy and adjustment. (The track locations on the tape are of course determined by an in-

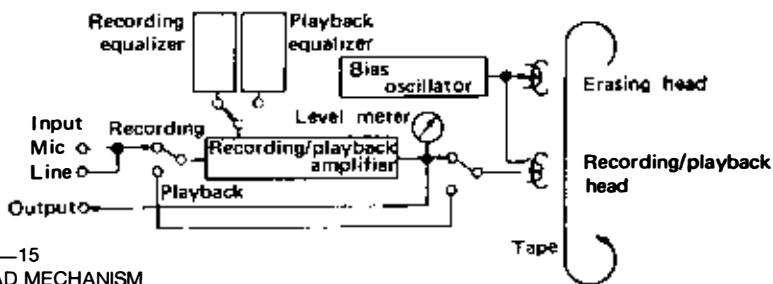

Fig. 4-15  
2-HEAD MECHANISM

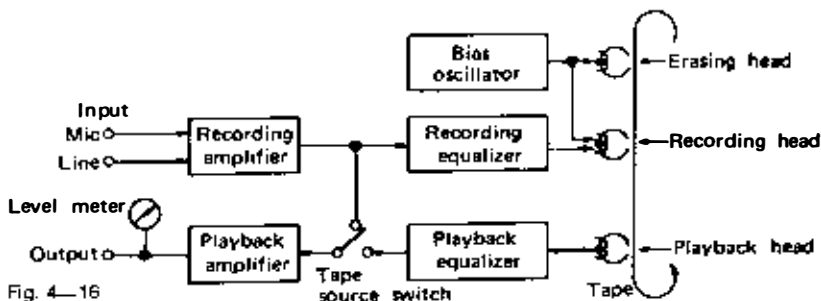

Fig. 4-16  
3-HEAD MECHANISM

ternational standard so that a tape recorded on one machine can be played back on any other provided they use the same two-track or four-track system.)

### 3-HEAD DECKS

Hi-fi enthusiasts who wish to make their own recordings are well advised to bear the extra expense of buying a three-head tape deck, i.e. one with separate recording and playback heads (Fig. 4-16). Not only is each head designed especially for its own purpose, but three-head systems offer the only really accurate recording control possibility: tape monitoring.

As the tape travels past the recording head, it is “impregnated” with the audio signal. This same, original audio signal which comes from the sound source can simultaneously be monitored through loudspeakers (via the amplifier) or headphones. Then, as the tape travels on past the playback head, the just-recorded sound can again be picked up and monitored. Three-head tape decks are equipped with a control to switch back and forth between source monitoring and tape monitoring (Fig. 4-17). Thus, the operator can compare the source sound instantly with the recorded sound and make necessary re-adjustments. Because of the distance from recording to playback head which the tape has to travel, there is of course a short time lag between source and tape monitor sound.

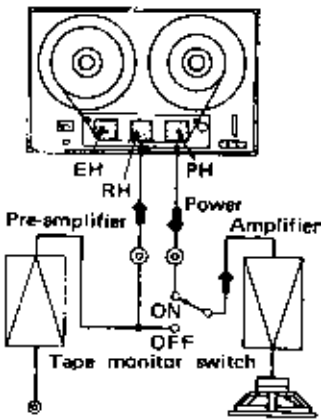

EH: Erasing head  
 PH: Playback head  
 RH: Recording head

Fig. 4-17  
 TAPE MONITORING

### AMPLIFIERS, EQUALIZATION

Although tape decks don't have power amplifiers, they do need electronic circuits that transform the signal into a shape acceptable by

the tape (“recording amplifier, recording equalizer”) and others that augment and again transform the signals picked up by the playback head so that the amplifier can work with them (“playback equalizer, playback pre-amplifier”).

(Technically speaking, an audio signal of flat frequency response, when recorded and played back via tape, would drop off in its very low and very high portions. To compensate for this, the low and high parts of the frequency response curve must be raised. This is done according to an internationally agreed-upon method, the so-called NAB equalization curve (Fig. 4-18). The high portion is boosted in the recording equalizer, the low portion in the playback equalizer so that the tape deck’s outputs again supply a signal with flat response.)

As recording tape has only a limited capacity for storing magnetism, the recording level — the strength of the signal applied to the tape head — must be controlled. This is done with a control knob and usually two VU or level meters. Excessive recording level causes distortion, while an insufficient level results in noisy, hissing tapes.

The need to apply a high-frequency bias to the tape while recording has been mentioned. This frequency, somewhere in the 30 — 100 kHz range, is generated by the “bias oscillator”.

## AUTOMATIC STOP, AUTO-REVERSE

To make the tape deck as convenient to operate as possible, a number of auxiliary devices have been designed. A common feature is an automatic stop mechanism that halts the reels when the tape runs out. Among the several possible methods, the most common one employs a wire lever which, normally held upward by the tape, drops forward and activates a stop

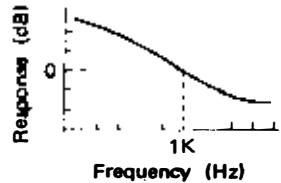
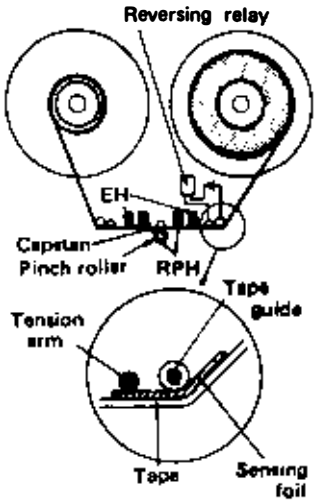

Fig. 4—18  
NAB EQUALIZATION CURVE



RPH: Recording/playback head  
 EH: Erasing head

Fig. 4—19  
 AUTO-REVERSE FUNCTION

switch when the tape runs out.

To get rid of the necessity to remove, turn over and re-thread the tape after each run, various automatic reverse systems have been devised. The most popular — because it is error-proof — is the sensing foil method. The user affixes short pieces of metallic foil near either end of the tape. Tape guide and tension arm (two parts of the tape path) serve as contact points for a relay. When the metal sensing foil reaches these parts it closes an electric circuit, activating the reverse relay which, in turn, makes the tape travel back in the other direction. The length of tape between the two sensing foils thus travels back and forth indefinitely. At each reversing point, tape heads and tracks are switched accordingly. As illustrated in Fig. 4-19, an auto reverse tape deck needs two erase heads and two double-action recording/playback heads.

To have the tape deck reverse automatically, set the auto reverse switch to its “On” position. This permits the tape to run in reverse automatically when the sensing foil attached to the magnetic tape is reached. With a sensing foil attached to one end of the magnetic tape (Fig. 4-20) it makes one complete auto-reverse playback, and then stops at the other end. With sensing foils attached to both ends of the magnetic tape, it makes repeated automatic-

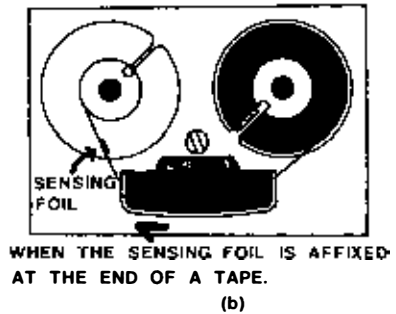
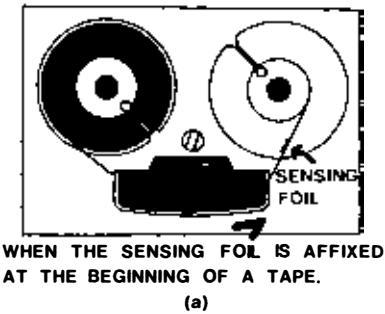
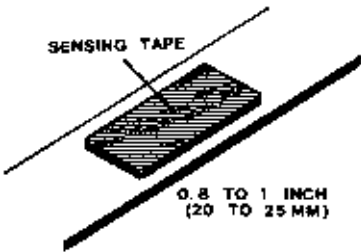

Fig. 4—20  
 THE BACK AND FORTH MOVEMENT OF OPEN REEL TAPE CAN BE CONTROLLED WITH THE HELP OF SENSING FOILS.

reverse playbacks. With a sensing foil attached to any position of the magnetic tape, it reverses the running direction at that position. With sensing foils attached to two positions of the tape, it repeats running between the two positions.

Sensing foil is an adhesive tape of aluminum foil. Cut the sensing tape to a length of about 0.8" to 1" and attach it to the dull side of the tape. Make sure the sensing tape does not extend outside the edges of the magnetic tape.

## HOW TO CONNECT YOUR TAPE RECORDER

Earlier in Chapter 2, Fig. 2-20 showed the relationship of the record player to the stereo amplifier acting as a signal source control center. Fig. 4-21 now shows how other signal sources, the FM tuner and the tape recorder, can also be connected. The tuner and the record player are one way devices — that is, they supply a signal source only and do not receive it. The tape recorder, however, is a two-way device. It can receive a signal for recording purposes

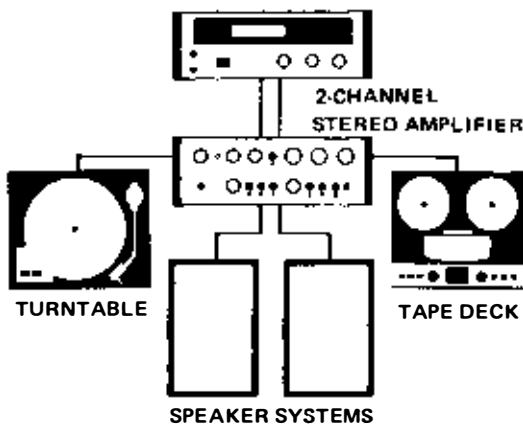
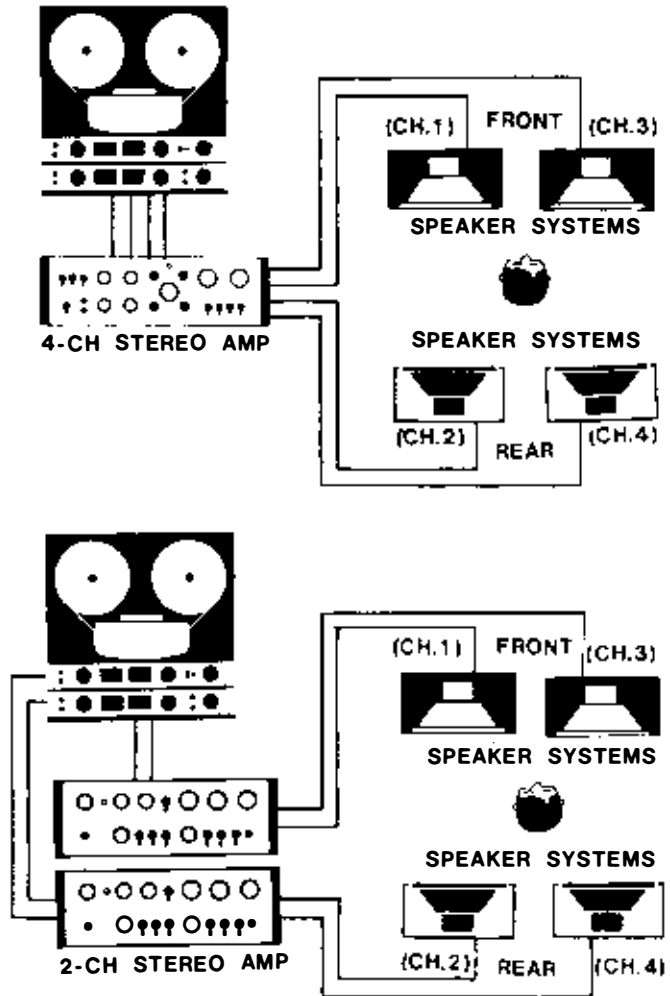

Fig. 4—21  
REAR PANEL OF PRE-AMP, POWER-AMP, OR INTEGRATED  
AMPLIFIER, ACTS AS CONTROL CENTER FOR VARIOUS  
COMPONENTS OF HI-FI SYSTEM.

and it can also delivery a signal. Note that the tape recorder, because of its dual function; has four connecting leads — two in and two out — for stereo operation.



CH. 1..... FRONT LEFT  
 CH. 3..... FRONT RIGHT  
 CH. 2..... REAR LEFT  
 CH. 4..... REAR RIGHT

Fig. 4—22  
 ALTERNATIVE OUTPUT CONNECTIONS FOR A FOUR-  
 CHANNEL OPEN-REEL TAPE RECORDER.

Four channel tape recorders can use either of the arrangements shown in Fig. 4-22. The tape recorder can be connected to a four-channel stereo amplifier or else to a pair of two-channel stereo amplifiers. Although only four connecting leads are shown, there will be a pair of leads for each channel, and so there will be a total of eight speaker connections for four channel operation. The speaker arrangement shown in Fig. 4-22 is just one of many possible ways.

## USING A BULK ERASER

When a recording is made on tape, any previously recorded material is automatically removed as the tape moves past the erase head. There is available, however, a bulk eraser which can be purchased in radio parts stores and which can be used for erasing an entire reel of magnetic tape at one time. The bulk eraser is an electromagnet, receiving its energy from the AC power line.

The reason for using a bulk eraser is that it is possible for some portion of the tape to remain magnetized, particularly if the tape has been used repeatedly. Bulk erasers are efficient and so it is good practice to bulk erase tapes periodically. Some hi-fi enthusiasts bulk erase before recording, even with new tapes, since in this way they are assured of total erasure: once with the bulk eraser and again when the tape moves past the erase head. An advantage of this 'double erase' is that it helps lower the noise level of tapes.

The problem of the bulk eraser, of course, is that it erases an entire tape only, not selected portions. For erasure of part of the tape, the erase head must be used.

## TAPE SPLICING

Editing can be done on cassette tape, but is difficult to do ~~because~~ of the thinness of the tape and the fact that most cassettes are sealed units. Tape splicing, the removal or addition of sections of tape, is ordinarily reserved for open reel tape.

While tape splicing can be done with sharp scissors, it is much better and easier to achieve professional results with a low-cost editing device available in most radio parts stores. If scissors are used, cut the tape on the bias at an angle of about 60 degrees. Butt the two cut ends against each other and join them with special slicing tape. Do *not* use any other type of adhesive such as plastic tape or ordinary adhesive tape. The reason for cutting the tape at a 60° angle is that this helps eliminate the click that can result if the tape is spliced at 90 degrees.

When using an editing device, all that is necessary is to lay the tape in the groove of the editor and cut the tape with a single edge razor blade. A cutting groove at the correct angle is provided. Some tape editors have built-in cutters.

## MICROPHONES

Microphones and tape recorders are a natural combination, but the selection of one or more microphones (some recorders and amplifiers have provision for two mike inputs) requires some planning. The kind of microphone you buy should be determined by what you intend to do with it. If you are considering voice reproduction only, group voices, or single instruments having a limited range, then extreme range of frequency response isn't a requirement. Other questions involve the amount of background noise which



must be suppressed, whether the mike is to be used indoors or out, how the microphone is to be handled, the durability of the unit, etc.

## TYPES OF MICROPHONES

There are four basic types of mikes. Of these, the crystal and ceramic are the lowest cost, with the crystal somewhat less rugged since it can be damaged by excessive heat and humidity. The more inexpensive crystal and ceramic mikes yield results that are barely passable for voice reproduction only. However, higher quality mikes in this category can produce good results.

The dynamic microphone or moving coil type is quite rugged, but there is a relationship between quality and price. Some of these units produce rather poor sound; others excellent.

The ribbon or velocity mike isn't as sturdy as the dynamic mike, but its output is somewhat better, with quality ranging from good to excellent.

Undoubtedly, the best microphone is the capacitor or condenser mike, which is the most expensive.

Generally, either the dynamic or ribbon microphones are good starting types.

## MICROPHONE FREQUENCY RESPONSE

The range of sound which the microphone will convert to equivalent electrical signals is known as its frequency response, specified in Hertz (cycles per second). For voice reproduction only, a microphone having a response of 100 Hz to 5,000 Hz should do. A microphone having a wider response can be used, but it will cost more, and will probably supply increased background noise.

By itself frequency response is meaningless unless the deviation from that response is specified. Generally, a 'flat' response is one that does not vary more than a few decibels, plus or minus. For music reproduction, the ideal arrangement, and also the most costly, is a microphone having the maximum frequency range with the least deviation.

## MICROPHONE IMPEDANCE

Impedance is the electrical opposition to current flowing in the cable connecting the mike to the amplifier. The ohm is the basic unit of electrical resistance or impedance. Cable impedance increases with length and microphones are available in two ranges: high impedance of about 1,000 ohms, and higher, plus low impedance, ranging from about 25 to 600 ohms.

High impedance cables should be kept short — about 10 to 12 feet — as cable impedance must be kept low. As the impedance rises, high frequency losses occur, and line hum increases. All quality and better performing mikes are of the low-impedance type, allowing for long cables, but usually requiring transformers for input to high impedance tape recorders. Crystal and ceramic microphones have extremely high impedances, so they can usually be used only with short cables.

Those microphones which are both high and low impedance have a built-in transformer which can either be used or not used, according to circumstances. The transformer for low impedance microphones, should however, be connected as close to the tape recorder or amplifier as possible to keep cable impedance as low as possible.

## STEREO MICROPHONES

If stereo recordings are to be made, best results are obtained from separate **matched** microphones. A so-called stereo microphone, which is two directional microphones in a single case, while making the recording easier, does not have the flexibility usually required. Rather, use a matched pair of microphones mounted on a bracket that holds them a fixed distance apart. This can give excellent stereo with good center fill, provided the microphones are matched.

## DIRECTIONAL CHARACTERISTICS

All microphones are not equally sensitive to sound arriving from all directions. Some types favor sound coming from certain directions and discriminate against sounds following other paths. We show these microphone characteristics in the form of “polar patterns”. These patterns are extremely important in deciding the correct selection and placement of a microphone.

A polar pattern resembles a view from the top of the world with radiating lines 360° around the chart. The response is plotted at different frequencies for all directions of sounds radiating into the microphone. Three major pickup patterns result.

### OMNIDIRECTIONAL MICROPHONES

Omnidirectional microphones (Fig. 4-23) receive sound equally well from all directions. The polar pattern resembles a circle for all ranges of frequencies. These microphones are suitable for recording groups of people or for sounds radiating from a large auditorium. In using this microphone, its distance from the sound source adjusts the balance between instruments. The ratio of direct sound to recorded sound is a matter of

microphone distance from the performance. Elimination of unwanted sounds is difficult, and sometimes impossible.

#### BIDIRECTIONAL MICROPHONES

Bidirectional microphones (Fig. 4-23) are sensitive to sound from two sides only. Its polar pattern resembles a figure 8 and is suitable for a two-sided conversation of vocal and instrument combinations. These microphones are usually not suitable for recording large instrumental groups. They are the most difficult to use because the area from which sound is accepted is narrower than that of most directional microphones. Positioning must be extremely accurate. Sounds originating from both sides must be considered. Placement is often a matter of trial and error.

#### CARDIOID OR UNIDIRECTIONAL MICROPHONES

Cardioid or unidirectional microphones (Fig. 4-23) accept sound from one direction. The polar pattern looks like a heart. This is an extremely versatile microphone, designed to eliminate sounds and noises by directing the microphone through use of its polar pattern. The cardioid microphone is valuable for street interview recordings, eliminating feedback on public-address systems, recording parts of vocal groups, or instruments in a studio, recording in a noisy room, etc.

The polar pattern of a cardioid microphone should show the pattern at various frequencies, as nearly all microphones tend to be directional at higher frequencies. Proper placement of the microphone and resulting balance will depend upon what frequencies are to be recorded.

In a quality cardioid microphone, a front-to-rear rejection of 20 dB can be achieved, and a 6 db rejection 90° off the center axis. This means 20 dB or more rejection of unwanted sound at

the rear of the microphone or virtual elimination of undesired sound.

Your choice of a microphone will depend on the points discussed and your own specific requirements. The proper placement or positioning of the microphone can be developed by trial and error.

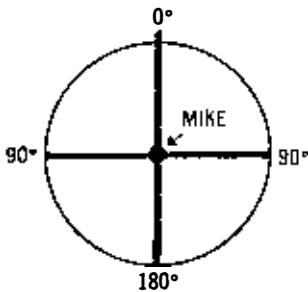

**OMNIDIRECTIONAL**  
One side of diaphragm  
is exposed to air

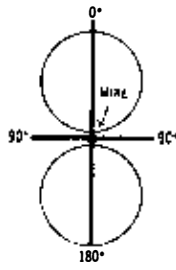

**BI-DIRECTIONAL**  
Both sides of diaphragm  
are exposed to air

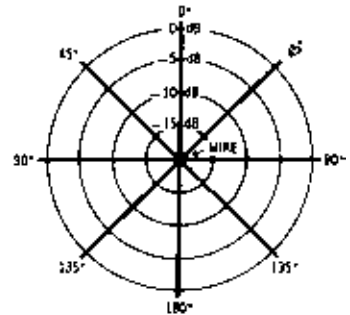

**UNI-DIRECTIONAL**  
One side of diaphragm is  
partially exposed to air;  
Other side fully exposed.

Fig. 4—23  
MICROPHONE DIRECTIONAL CHARACTERISTICS.

## TAPE RECORDER TROUBLES AND THEIR REMEDIES

Since 'bargain basement' cassettes, open reel and cartridge units are made by manufacturers primarily interested in cutting cost, the useful operating life is quite short. In reality these units are not quite the bargain they may have appeared originally. Because cartridge, open reel and cassette components are electromechanical devices, trouble most often appears in the mechanical section, usually in connection with the motor.

Troubles with high-quality units generally stem from two causes: a) failure to follow the manufacturer's installation and operating instructions and b) failure to supply the maintenance recommended by the manufacturer.

Table 4 supplies a list of the most frequently encountered troubles for open-reel units, their probable causes, and suggested remedies. Table 5 is a troubleshooting chart for 8-track cartridge units, while Table 6 is a troubleshooting chart for cassette recorders.

### SOME PRECAUTIONS

Keep your magnetic tapes away from any source that radiates a strong magnetic field. The top of a television set is one such place. So is the top of an amplifier or an air conditioner. Keep tapes away from line power cords that carry heavy currents. These can impress enough hum signal on the tapes to spoil your listening pleasure.

If you plan on storing recorded tape for some time, rewind it at least once every six months. Also, be sure not to leave your tape deck in the record mode.

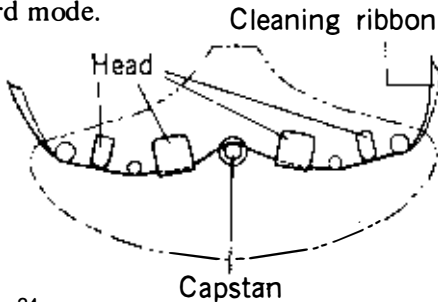

Fig. 4-24  
METHOD OF USING HEAD CLEANING RIBBON.

Dust easily collects on the heads, tape guides, pinch roller, capstan and contact levers. If dust becomes mixed with oil on such parts, it can result in unstable operation, degraded tone quality, unbalanced stereo, etc. Wipe clean any dust with a head cleaning ribbon (Fig. 4-24). If

TABLE 4 — TROUBLESHOOTING CHART FOR OPEN-REEL TAPE DECKS.

Trouble
1) Power is not turned on although the power switch has been turned on.
2) The tape runs improperly though the FUNCTION lever has been set to PLAY.
3) The reel does not rewind the tape.
4) The tape speed can not be changed.
5) Immediately after the tape starts running, reverse running occurs.
6) Although sensing tape is attached to tape, the tape makes no automatic reverse running.
7) Much noise heard.
8) Recorded sound is unstable.
9) Playback sound is abnormal (bad tone quality, distortion, noise, etc.)
10) Although the recording lever is set to REC, the recording will not start. (The needles of level meters will not move.)
11) The recording lever is set to REC, and the needles of level meters move, but the recording is not started.
12) Recorded sound is distorted.

Probable Cause	Remedy
(a) AC power plug is loose. (b) Blown fuse.	(a) Check the Plug or outlet. (b) Replace the fuse.
(a) The FUNCTION lever has been set to PLAY before the tape is loaded, and the pinch roller is in the raised position. (b) The tape is loose and thus the safety switch is turned off. (c) The FUNCTION lever is not fully pulled to the PLAY (REC) position.	(a) Return the FUNCTION lever to the STOP position. (b) Give some tension to the tape and then pull the FUNCTION lever to the PLAY position. (c) Move the FUNCTION lever fully to the PLAY (REC) position.
Reels of different sizes are used.	Use the size of reel as specified
The FUNCTION lever is set to STOP or FAST.	Set the FUNCTION lever to PLAY and then operate the speed selector knob.
In case of the tape with a sensing tape attached, the tape loading may be improper.	Set the tape so that the sensing tape appears between the head housing and the take-up reel.
(a) The sensing tape is too short. (b) The sensing tape is attached to the shiny side of the tape. (c) Contact poles and tape guides are soiled.	(a) Replace with sensing tape of 3/4" to 1" long. (b) Attach the sensing tape to the dull side of the tape. (c) Wipe them clean with absolute alcohol.
(a) Jack connection is loose. (b) A recorded tape produces noise. (c) TV set, amplifier and defective fluorescent lamp may be used in house. (d) Heads are magnetized.	(a) Check the jack. (b) Replace tape. (c) Keep the distance of your deck far from TV set, amplifier, etc. (d) Demagnetize the heads using head eraser.
(a) Heads are soiled. (b) Tape is soiled.	(a) Wipe the front surfaces of the heads clean with alcohol. (b) Replace with a new tape.
(a) Heads are soiled. (b) Tape speed is incorrectly selected. (c) Tape of 4-tracks is not loaded. (d) FUNCTION lever is not fully pulled out to the PLAY (REC) position.	(a) Wipe the front surfaces of the heads clean with alcohol (b) Reset the tape speed appropriately. (c) Reload 4-track tape. (d) Pull the FUNCTION lever fully to the PLAY (REC) position.
Jack connection is loose.	Check the jack.
Heads are soiled.	Wipe the front surfaces of the heads clean with alcohol
Input level is too high.	Set the level control to the middle of the range and while watching the level meter, adjust the output control of TV set or FM tuner,

	SYMPTOM	POSSIBLE CAUSE
	<ul style="list-style-type: none"> <li>● Power is not turned ON if a cartridge has been inserted.</li> </ul>	<ol style="list-style-type: none"> <li>1. Cartridge inserted upside-down.</li> <li>2. Power cord not connected to AC outlet.</li> </ol>
	<ul style="list-style-type: none"> <li>● Playback volume too low.</li> <li>● Channels not balanced.</li> <li>● Highs are not adequate.</li> </ul>	<ol style="list-style-type: none"> <li>1. Dirty tape head.</li> <li>2. Tape is worn out.</li> </ol>
	<ul style="list-style-type: none"> <li>● Playback sound unstable, or dull.</li> </ul>	Cartridge is worn out.
	<ul style="list-style-type: none"> <li>● Wrong pitch of playback sound.</li> </ul>	Unit operating on wrong line frequency.

TABLE 5 — TROUBLESHOOTING CHART FOR EIGHT-TRACK CARTRIDGE UNITS.

dust is difficult to remove, wipe with soft cloth (Fig. 4-25) saturated with alcohol. Make sure the surface of the pinch roller is thoroughly cleaned.

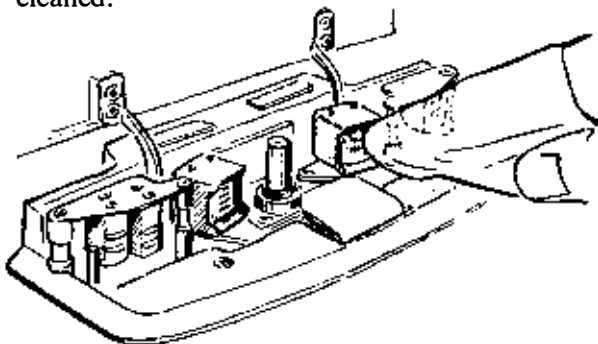

Fig. 4—25  
CLEAN HEADS WITH A SOFT CLOTH.

While cleaning the head-assembly area, be careful not to scratch the head surface. Keep tools, such as screwdrivers, away. It is also a good practice to demagnetize heads used for many hours with a demagnetizer (Fig. 4-26). These are available in radio parts stores. And, when using a demagnetizer, follow the manufacturer's instructions carefully.

It is almost instinctive to rewind open-reel tape after it has been played. It is much better,



<b>REMEDIES</b>
1. Pull the cartridge out, re-insert label side up. 2. Check power cord.
1. Clean 2. Use new cartridge.
Use new cartridge.
Check line frequency.

however, if you plan to put a tape away, to do so after playback, rather than after rewind. The reason for this is that playback puts the tape turns on evenly and with uniform tension. When a tape is rewound, usual practice is to do so at high speed. This puts tension on the tape which can cause it to deform if the tape remains stored for a long time. The same thinking applies to fast forward.

“Print through” is the effect that one layer of magnetic tape has on an adjacent layer. With fast forward or reverse, tape is wound more

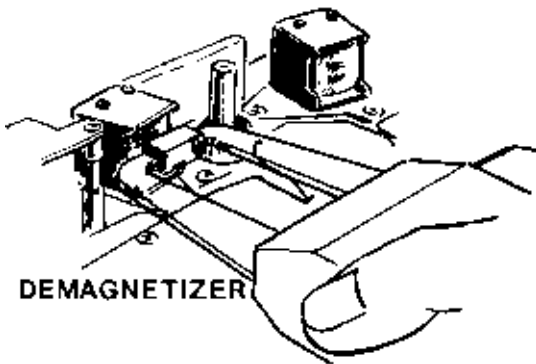

Fig. 4—26  
 DEMAGNETIZE HEADS OF OPEN REEL RECORDERS AT  
 LEAST ONCE A MONTH IF UNIT IS IN REGULAR USE.

tightly, increasing the possibility of print through if the tape is stored immediately afterward for a long period of time.

## HINTS AND TIPS FOR CASSETTE USERS

If a cassette should fail, the best thing to do under ordinary circumstances is simply to discard it. But sometimes it already carries valued recorded material you cannot replace and do not want to lose. Although the salvage job isn't easy, it can often be accomplished.

### SPLICING TORN TAPE

If the tape has broken, you can splice it together. In some cases, you can do this by drawing the two severed ends toward you gently, out of the cassette body, then lining them up carefully. It is best to use a tape splicing block, available anywhere tape supplies and accessories are sold, to keep the tape properly aligned, because misalignment not visible to the naked eye can cause jamming and breakage again.

Special splicing tape, available from the same sources, is also advised and it should be applied to the side of the tape that does *not* make contact with the recorder head during use. This is the more shiny of the two sides of the tape length, and it faces toward the inside of the cassette normally.

Usually, the severed ends of tape are so badly mangled that they cannot be aligned. In this case, the tape ends should be so aligned that they overlap, and a diagonal cut is made through the overlapping portions of both tapes with a razor blade or other clean cutting edge. Again, a splicing block is most useful here. Keep the overlap as small as conveniently possible to

minimize the loss of recorded material. The remaining, matching tape ends, after the trimming, are then carefully aligned and mended with the splicing tape, as described above.

The splice is not completed until the ends of the splicing tape are trimmed off (a pair of scissors will do) so that none of it extends beyond the edges of the recording tape. In fact,

Trouble	Probable cause	Remedy
The tape does not travel.	<ol style="list-style-type: none"> <li>1. The power cord is not connected to the service outlet.</li> <li>2. The fuse has blown.</li> <li>3. The tape is fully wound onto the hub.</li> <li>4. The PAUSE button is locked.</li> </ol>	<ol style="list-style-type: none"> <li>1. Connect the cord to the outlet.</li> <li>2. Replace the fuse.</li> <li>3. Rewind the tape.</li> <li>4. Press the PAUSE button and release it.</li> </ol>
The tone quality in a high frequency range is deteriorated.	The head is dirty.	Wipe the head clean.
Playback sound is distorted.	<ol style="list-style-type: none"> <li>1. The P.B. LEVEL control knobs are set to too high a position.</li> <li>2. The tape is distorted.</li> </ol>	<ol style="list-style-type: none"> <li>1. Lower the playback level.</li> <li>2. Replace the cassette tape.</li> </ol>
The sound indicates wow and flutter.	<ol style="list-style-type: none"> <li>1. The pinch roller is dirty.</li> <li>2. The cassette tape is wound too tightly.</li> </ol>	<ol style="list-style-type: none"> <li>1. Wipe the pinch roller clean.</li> <li>2. Replace the cassette tape.</li> </ol>
The unit will not record.	The knockout flaps are broken out.	Replace the cassette tape, or fill the opening with a piece of paper crumpled in a ball, for instance.
The sound has been over-recorded and is distorted.	<ol style="list-style-type: none"> <li>1. Input level is too high.</li> <li>2. The head is dirty.</li> </ol>	<ol style="list-style-type: none"> <li>1. Lower the recording level.</li> <li>2. Wipe the head clean.</li> </ol>

TABLE 6 — TROUBLESHOOTING CHART FOR CASSETTE UNITS.

to be completely safe, it is wise to narrow down the tape width at the site of the splice, just barely, to make sure that no fouling will occur during tape motion due to excessive thickness. After the repair is completed, the excess of tape protruding from the tape body should be drawn back into the body of the cassette. Winding the hub may be accomplished with a pencil or some such object inserted in the cogged opening of the cassette shell for one of the hubs on which tape is spooled.

## GETTING INSIDE THE CASSETTE

Sometimes the broken ends of the tape do not protrude sufficiently from the body so they can be withdrawn. In a case like this, you can only get at them by opening the cassette — provided, of course, that the cassette is screwed together, not glued or welded. You'll need a miniature Phillips-head screwdriver, tweezers, a steady hand and *lots* of patience — but it can be done.

Even if the cassette is glued or welded together, the situation may be salvageable. In this case, you're going to have to crack the cassette halves apart carefully, to avoid further damage to the tape, and you won't be able to use that cassette housing again — but you *can* manage, with great care and painstaking slowness, to *rewind and transfer* the tape that carries your treasured recorded material into the body of another cassette. The new cassette, of course, would have to be one that is screwed together, rather than glued or welded, so it can be opened without damage and reassembled in useful condition. The recorded contents of the tape would have to be very valuable to justify the undertaking of such demanding surgery, but this sort of repair can be accomplished and indeed has been done.

A repair of exactly this sort can be used, of course, in the event of some breakdown other than tape tearing. Sometimes the internal mechanism of an inferior cassette can become permanently jammed without tape breakage, for example. The taped contents can be transferred to a good cassette.

Preventing such mishaps is easier than correcting them by using high-quality cassettes to begin with.

## PREVENT ACCIDENTAL ERASURES

Once you've made a recording you want to keep, break off the corresponding tab on the back of the cassette to safeguard it. (There's one tab for each side of the tape.) Once the tab is gone, an automatic switch on your recorder will lock out the "record" circuits whenever you load that tape again. (If you change your mind later and want to record the tape over, you can — just cover the tab hole again with cellophane tape, and start recording.)

## HOW TO READ TAPE DECK SPECIFICATIONS

### a) Wow & flutter

Inconsistencies in the tape speed which can cause pitch variations and quivering sound. Expressed as percentages, with different values for each tape speed. Look for the lowest values. 0.25% is about the permissible maximum.

### b) Signal-to-noise ratio

Denotes the tape deck's freedom from self-created noise. Expressed in dB, higher values are better, 50 dB is about minimum.

### c) Frequency response

The lowest and highest audio frequencies that

the tape deck will record and reproduce. Should be as flat as possible and cover at least 50 — 13,000 Hz at 7-1/2 ips or 50 — 10,000 Hz at 3-3/4 ips. See Table 7.

d) Crosstalk

The amount of signal that leaks from one stereo channel into the other and from one tape track into another. Expressed in dB. The higher the value, the better. Channel-to-channel crosstalk should be at least 55 dB, track-to-track crosstalk of a 4-track machine should be above 30 dB.

e) Channel separation

Another word for channel-to-channel crosstalk (above).

f) Maximum reel diameter

The largest reel size that the tape deck will accept. Mostly 7 inches, while a few semi-professional models accept 10-inch reels.

g) Output level

Must match the sensitivity of the amplifier's tape inputs.

Parameter	Excellent	Good	Fair	Unit	
S/N	54-56	50-53	45-50	dB	
Frequency response	7 1/2	30-16,000	50-13,000	50-10,000	Hz
	3 3/4	50-12,000	50-10,000	50-8,000	Hz
	1 7/8	50-8,000	50-7,000	50-5,000	Hz

TABLE 7 — FREQUENCY RESPONSE AND SIGNAL-TO-NOISE RATIO.

## Chapter 5

### THE AMPLIFIER

As the audio signals supplied by the turntable, tuner or tape deck are much too weak to be converted into audible sound directly, they must first be raised to a higher level. This is done by the amplifier which thereby becomes the heart of every hi-fi installation. Before we examine the fundamentals, functions and features of hi-fi amplifiers, we must first clarify a few distinctions in terminology.

#### PRE-AMPLIFIER, POWER AMPLIFIER, INTEGRATED AMPLIFIER, RECEIVER

An amplifier system in a hi-fi installation consists of two parts: the pre-amplifier which includes all the controls for regulating tone, volume and channel balance; and the power amplifier which, as its name implies, supplies a sufficiently powerful signal to drive the loudspeakers. Manufacturers provide the audio enthusiast with a multiple choice: he can purchase separate pre-amplifier and power amplifier units, he can select a combination of both which is commonly called "integrated amplifier", "control amplifier" or just simply "amplifier", or he can opt for a receiver, i.e. a combination of tuner, pre- and power amplifier. (Fig. 5-1)

Since units built to very high performance standards can be found in each group, the question is not so much one of sound quality but rather a question of flexibility versus economy and convenience.

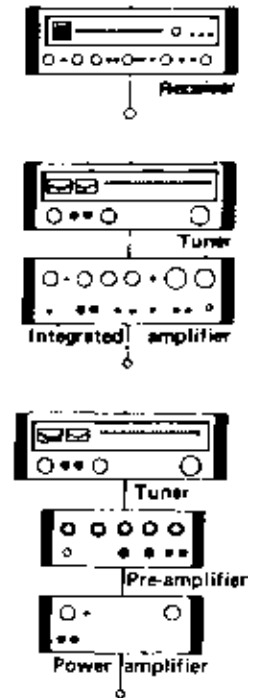

Fig. 5-1  
CLASSIFICATION OF  
AMPLIFIERS

It stands to reason that a combination of two or three functions in one unit should be more economical than separate sets — just think of the cost of chassis and enclosures and power supply units (i.e. the transformer-rectifier assembly in each unit which supplies the needed operating current to the circuits). What's more, an integrated amplifier or receiver saves space and eliminates the need for — sometimes troublesome — cable connections.

On the other hand, the purchaser of a separate tuner plus pre-amplifier plus power amplifier system may gain a little bit in performance and may obtain a more individually “selected” kind of sound, but he definitely gains in flexibility . . . he can replace individual units as technology progresses and new models appear on the market . . . he can easily add an electronic crossover network and one or two more power amplifiers to upgrade his system into a multi-amplifier installation or he can move on to a four-channel system without sacrificing any of his present equipment. And he gets, last but not least, the pride of owning his own custom-assembled, personalized system.

The serious audio enthusiast, when deciding on the purchase of a receiver or integrated amplifier, should, however, insist on one feature (found on most high-quality models anyhow): the possibility of using the pre-amplifier and power amplifier stages separately. This is done by severing a short cable connection on the back panel and by a switch (in the case of some amplifiers) and permits the system to be enlarged into a multi-amplifier configuration at a later date.

The following explanations deal with pre-amplifier and power amplifier functions, in that order, but they apply to integrated amplifiers and receivers, too; only the remarks about connections and matching of components may be disregarded.



## PREAMPLIFIER FUNCTIONS

To the hi-fi novice, the need for and functions of the pre-amplifier are usually more difficult to understand than those of the power amplifier which, after all, clearly produces power. The pre-amplifier can be thought of as a sort of super switchboard — it selects the sound source to be played, it determines the mode of sound (stereo or monophonic), it influences the sound color with its tone controls, it regulates the volume and channel balance, and it brings the signals up to a voltage level which the power amplifier can then work with.

The different sound sources are connected to the preamplifier inputs: the turntable to the phono inputs, the tuner to the tuner inputs, the tape deck to the tape (or sometimes “monitor”) inputs, and an auxiliary source such as a cassette tape deck to the aux inputs. Some amplifiers also have microphone inputs.

## PHONO EQUALIZATION

Let us observe the phono signal on its way through the pre-amplifier. First, it enters a circuit called an equalizer amp. To understand its function, we must be aware of a peculiarity of phonograph records. When the master disc is cut, the high sound ranges are over-emphasized (“boosted”) while the bass range is somewhat suppressed. This must be done to obtain a record groove with sufficient modulation in the high range for the needle to “feel” and, on the other hand, without excessively wild bass undulations (because these would require a wider groove). Technically, cutting of a disc is not “flat” but follows a frequency response curve as shown in Fig. 5-2, called the RIAA curve. Therefore, the audio signal delivered by the pickup cartridge

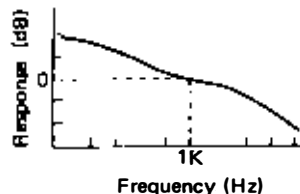

Fig. 5-2  
RIAA EQUALIZATION  
CURVE

would result in equally disfigured sound if it were passed on as it is. The RIAA curve must be “equalized” first to obtain natural sound — and this is the function of the equalizer amp. See Fig. 5-3.

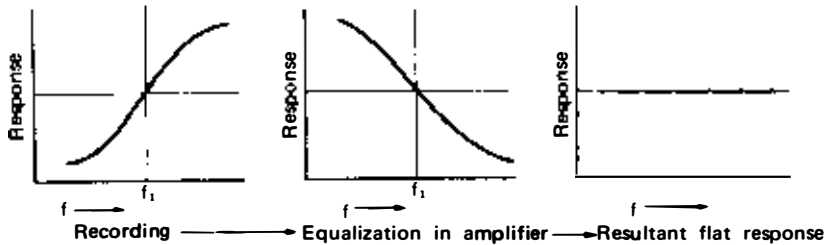

Fig. 5-3 EQUALIZING

## INPUTS



Because the phono inputs have to be equalized, they are called “non-linear” inputs as opposed to “linear inputs” such as those for tape, tuner, microphone or auxiliary signals. Some high grade amplifiers provide two or even three pairs of phono inputs, permitting two or more turntables or cartridges to be connected simultaneously for easy comparison. Also, the input sensitivity and impedance of the phono inputs is sometimes switchable to accommodate cartridges of different characteristics. In this context, another value often found in pre-amplifier specifications is of importance: maximum input voltage of the phono inputs. This describes the highest signal level the amplifier can accept through the phono inputs without overloading, i.e. distorting. It should be at least 10 times higher than the output level of the pickup cartridge.

Tape deck and tuner connections usually do not pose much difficulty because the electrical characteristics are pretty much standardized. With microphones, however, it is important to choose the right type. Mikes must correspond in

their impedance to the amp's mic input impedance, within a tolerance of about plus or minus 20 percent.

## TAPE MONITORING

Switching between the different connected sound sources is usually done with a program selector, mostly a rotary knob with five or more positions. Tape sound, however, is switched on and off with a so-called tape monitor switch with two positions: source and play (or tape). For tape playback, this switch is set in position "play"; for all other program sources it must be in the "source" position. When making a recording on a tape deck with independent recording and playback heads (a 3-head deck), this switch provides two ways of monitoring the recording quality. In position "source", the original before-tape sound is heard from the loudspeakers; in position "play", however, the already recorded after-tape sound is reproduced. By switching back and forth between these positions, the source sound can be easily compared with the taped sound and readjustments made if required.

## VOLUME, BALANCE, TONE CONTROLS

The volume and balance controls of the stereo pre-amplifier are more or less self-explanatory. Note, however, that the balance control, when turned to the right, does not increase the right channel volume but actually reduces the left channel volume. Also, volume and balance controls do not affect the signal supplied to the tape deck for recording.

It is usually not difficult to tell the hi-fi novice from the old pro — just watch him operate the

tone controls of his amplifier. The beginner will show great delight in his ability to turn up the bass and suppressing the treble or vice versa, he will play around endlessly with these knobs and will usually wind up with a setting of heavy, boomy bass accentuation. The more advanced hi-fi listener, however, will use the tone controls sparingly and near the neutral level, except for test purposes. The true purpose of the bass and treble controls on a hi-fi amplifier lies indeed not in the dictatorial power play of the novice, but in the ability to compensate for certain weaknesses in the program material, the listening room and, to some degree, the loudspeakers.

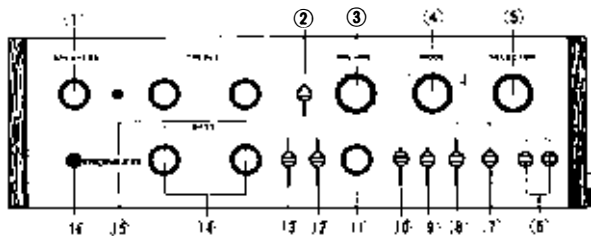

- ① SPEAKER SWITCH
- ② MUTING SWITCH
- ③ VOLUME CONTROL
- ④ MODE SWITCH
- ⑤ SELECTOR SWITCH
- ⑥ MIC JACKS
- ⑦ TAPE DUPLICATE SWITCH
- ⑧ TAPE MONITOR SWITCH
- ⑨ PHONO-2 MM/MC SWITCH
- ⑩ LOUDNESS SWITCH
- ⑪ BALANCE CONTROL
- ⑫ HIGH FILTER SWITCH
- ⑬ LOW FILTER SWITCH
- ⑭ BASS CONTROLS
- ⑮ TREBLE CONTROLS
- ⑯ PHONES JACK

With good, new LP records or tapes played on good equipment in a normal family living room, extreme tone control settings are almost never required.

How do tone controls — and their cousins, the high and low filters and the loudness switch provided on most amplifiers — work?

In its simplest, bargain basement form — as found on portable radios etc. — a tone control is simply a combination of a capacitor with a resistance, and it cuts off the high parts of the sound spectrum. More suitable to hi-fi applications is the passive RC type which boosts or reduces frequencies above and below a "turn-over" point in a way as illustrated in Fig. 5-4. For even more precise, active control, negative feedback techniques (NFB) have to be introduced which require rather elaborate circuits with transistors etc. The obtainable frequency response characteristics are illustrated in Fig. 5-5.

On some amplifiers, the tone controls work on the left and right stereo channels simultaneously, which is quite sufficient for most home applications. On others, there are separate knobs (usually concentric double knobs) for controlling the left and right channel separately, which is useful in difficult listening room conditions.

## FILTERS, LOUDNESS CONTOUR

Low and high filters (also referred to as rumble or bass filters and noise or scratch filters, respectively) have functions as shown in Fig. 5-6. The bass filter is designed to cut off (or, more precisely, to attenuate by so many decibels) the sound spectrum below a certain point, usually somewhere between 100 and 50 Hz. This has the effect of canceling very low hum and rumble generated by turntables. The high filter, on the other hand, attenuates frequencies above 8,000 or 10,000 Hz, as the case may be, to eliminate scratching and hissing noise from records, tapes, FM, etc. It is bad practice, however, to use these filters indiscriminately because together with the noise they also cancel part of the desirable

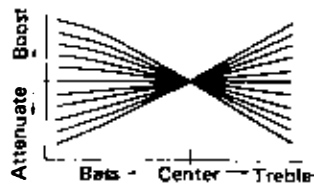

Fig. 5-4  
RC TYPE TONE CONTROL

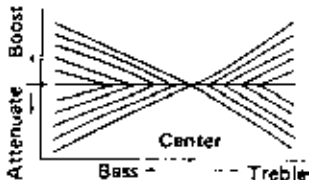

Fig. 5-5  
NFB TYPE TONE CONTROL

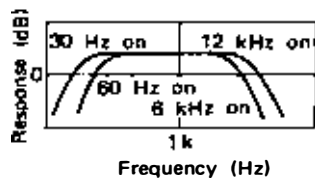

Fig. 5-6  
FILTER CHARACTERISTICS

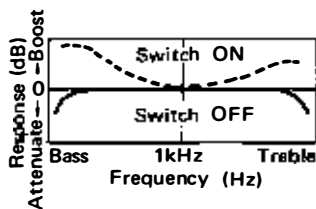
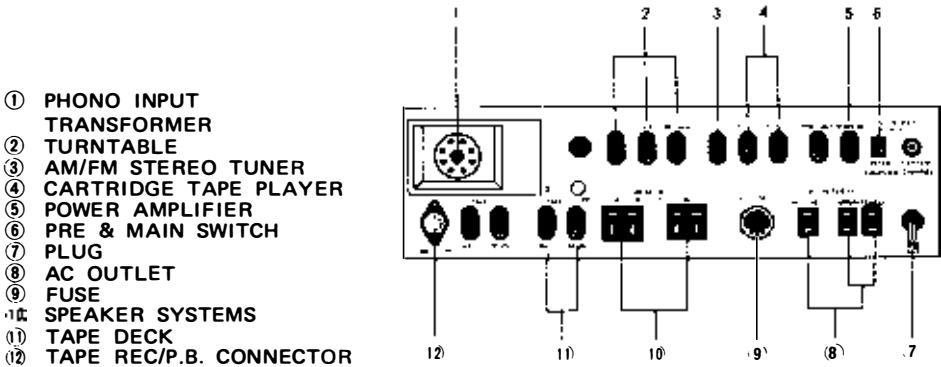

Fig. 5-7  
FUNCTION OF  
LOUDNESS SWITCH

musical spectrum. Use them only when necessary.

The loudness switch on an amplifier must not be confused with the volume control. A more accurate description of its function is found in the name “physiologically correct loudness contour compensation”. This name already hints at a deficiency of the human sense of hearing. Indeed, measurements demonstrate clearly that the human hearing apparatus is, even at its healthy best, far from perfect as far as hi-fi is concerned. One of its shortcomings is that it is rather insensitive to extremely low and very high tones when the overall volume is soft. The loudness switch, a special kind of tone control, overcomes this human error by boosting these extreme sound ranges at low volume settings. It should therefore be turned off at high listening volumes.



### HEADPHONE JACK

In addition to the functions described above, the pre-amplifier does, of course, amplify the signal level to an extent. That is why headphones, which require very little power, can be connected to a headphone jack usually provided on pre-amplifiers.

## POWER AMPLIFIER FUNCTION

From the pre-amplifier, the signal enters the power (or main) amplifier. There, its power is raised several hundred times to a value which can drive (and, if used fully, even destroy) the loudspeakers.

Much concentrated effort has gone into the development of better and better hi-fi power amplifiers. Even the vacuum tube types of years ago — only very few are now on the amateur hi-fi market — produced some excellent results. To this day, hi-fi enthusiasts brought up in that age swear by the vacuum tube amplifier, and in terms of sound quality it does possess a certain mellow charm. Its bad habits — vacuum tube amplifiers guzzle electricity, create tropical heat waves in their vicinity and break down or burn out at all too frequent intervals — made it easy for solid state designs to take over in a hurry. Today, the transistor power amp has emerged as the almost undisputed victor.

## CRITERIA OF QUALITY

Solid state power amplifiers of the latest generation are true marvels of audio engineering, with tremendous power reserves, a remarkable absence of distortion and very high reliability. Design engineers have overcome the many inherent problems by making use of improved components such as silicon transistors, by developing new circuits such as quasi-complementary and pure complementary output stages, and by getting rid of coupling transformers and capacitors.

Conventionally, capacitors were used to couple the individual stages of a power amplifier, and transformers were used to couple the output stage to the loudspeakers. Direct coupling tech-

niques are posing a new challenge to circuit designers. They promise better results not only because they avoid phase shifts between the stages but also, and more importantly, because they use so-called balanced power supplies — i.e. power supply circuits providing matched positive and negative power corresponding to the (+) and (−) sections of the sound signal. Such direct coupled and OCL (“output-capacitorless”) circuits are already being used in some top grade amplifiers.

The purchaser of a stereo power amplifier often chooses a unit mainly on the strength of its output power rating. But as practically all modern amplifiers provide more than a sufficient power reserve, he would be well advised to consider other factors in his choice, such as distortion figures, power bandwidth, etc. which will be explained in the paragraph dealing with amplifier specifications. These give a truer picture of the sound to be expected than the power rating.

## PROTECTOR CIRCUITS

The expensive output stage of a transistor amplifier can be easily damaged by a short circuit in the speaker leads. To prevent this, designers have invented a variety of protector circuits and combinations thereof which shut down the output stage at the first sign of trouble. These can be simple heat fuses or, more elaborately, circuits which detect a drop in output load impedance (in other words, a short circuit). A few top quality amplifiers have protector circuits which detect the presence of DC current at the output stage. As DC current could also lead to loudspeaker damage, these advanced protectors safeguard not only the amplifier but also the loudspeakers.



## SPEAKER TERMINALS

Although one pair of speaker systems is usually quite sufficient for a home stereo installation, some amplifiers have provisions for connecting two or even three pairs of speakers which can then be driven separately or in pairs (Fig. 5-8). One obvious use is to place a second pair of speakers in another room. This feature also permits direct comparisons of different loudspeakers by connecting two or three pairs to the amplifier and switching back and forth.

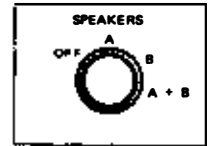

Fig. 5-8  
SPEAKER SWITCH

## FOUR-CHANNEL OPERATION

A two-channel amplifier or a stereo receiver can be used as part of a four-channel hi-fi system by adding a decoding amplifier, as shown in Fig. 5-9. Although a cartridge tape player is shown in the illustration, this can also be a cassette deck. The four-channel amplifier, containing a matrix

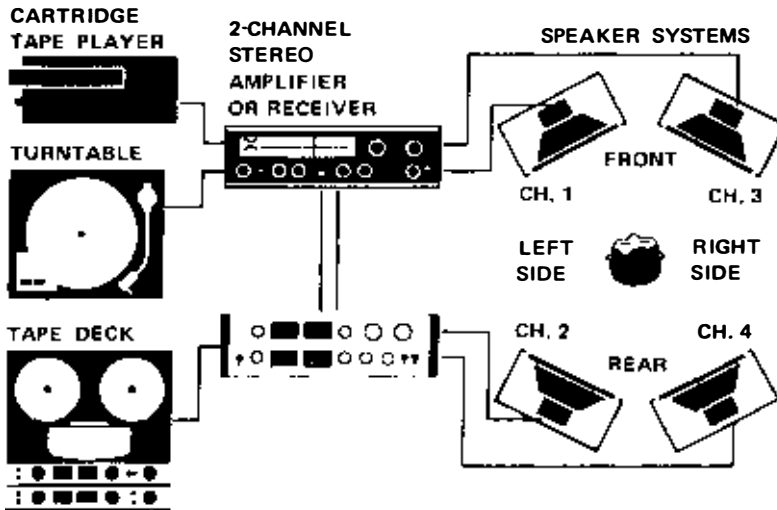

Fig. 5-9  
QUADRALIZER AMPLIFIER CONTAINS MATRIX DECODER AND AMPLIFIER.

decoder, converts any conventional two-channel system into four-channel, without making existing input signal sources obsolete. Two additional speakers are required for the rear channels of sound.

The unit shown in the block diagram is known as a quadralizer amplifier, since it performs a double function in acting as a decoder and also as an amplifier. There are, of course, four-channel preamps and four-channel power amps that work directly with four-channel inputs. A better-quality quadralizer will also have connections for a four-channel stereo tape deck.

In the matrix system operation of the quadralizer, the left and right channel signals are converted into four channel signals by means of the matrix circuit as shown in Fig. 5-10. Signals appearing for each channel are as follows:

- Channel 1 (front, left)       $2L + R$
- Channel 3 (front, right)     $2R + L$
- Channel 2 (rear, left)       $2L - R$
- Channel 4 (rear, right)      $2R - L$

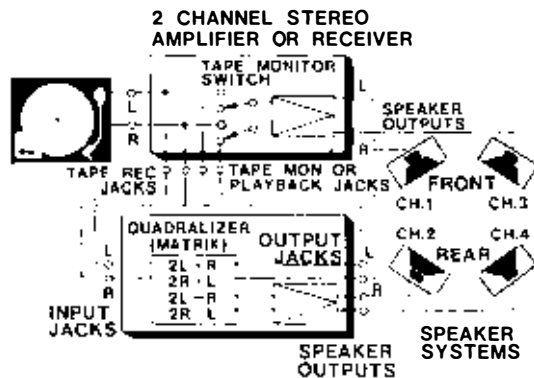

Fig. 5—10  
MATRIXING ARRANGEMENT FOR FOUR-CHANNEL SOUND.

As shown above, the right channel signal component is added to the left channel signal, and the left channel signal component is added to the right channel signal. This feature may sacrifice stereophonic effect and separation

somewhat, but dispersion effect is excellent and vivid stereo presence will be obtained.

## REVERBERATION AMPLIFIER

A reverberation amplifier can be used to add richness to voice, radio, records or tapes, by providing more realistic acoustical effects to an existing hi-fi system. A variety of changes are possible. You can add reverb to the speakers only or to recorded sound only. Or, you can play tapes and add reverberation without altering the sound of the original tape in any way. Fig. 5-11 shows the method of connecting the reverberation amplifier to the main amplifier and a pair of tape recorders. The mode of opera-

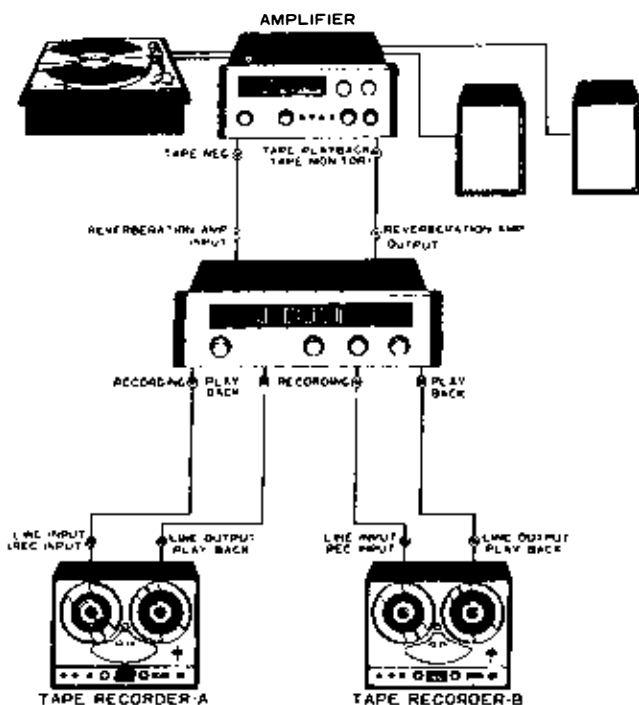

Fig. 5-11  
CONNECTIONS FOR A REVERB AMPLIFIER AND A PAIR OF TAPE  
RECORDERS

tion can be decided by adjustment of a pair of controls on the reverb unit.

## HOW TO READ AMPLIFIER SPECIFICATIONS

### a) Continuous output power

The maximum power (in watts) that the amplifier will deliver from each channel (with both channels operating) without exceeding its rated harmonic distortion. Measured with a 1 kHz signal. Power ratings without clarification of the harmonic distortion are meaningless. Also, the load impedance (4, 8 or 16 ohms) enters into the picture. Responsible manufacturers list output powers as in the following example: Continuous output power 40W/40W (at less than 1% harmonic distortion, into 8-ohm load).

### b) Music power (dynamic power)

Often encountered in advertisements. Of dubious value because measured under conditions other than normal use. Usually given as the sum of both stereo channels, unfortunately often without distortion figures. Judge an amplifier's power chiefly by its continuous power rating (above). The music power rating does, however, provide some information about the power available temporarily from the amplifier when reproducing volume peaks in the music. Good amplifiers have music power ratings not very much removed from their continuous power figures.

### c) Frequency response

The lowest and highest audio frequencies that the amplifier will reproduce from input signals supplied to its AUX input and at 1 watt output power. To be meaningful, the frequency response rating must be accompanied by a  $\pm$  dB figure which indicates by how much the response varies from the standard level (0 dB at 1 kHz) over the given frequency range. Smaller dB

values are better — the same amp may have a frequency response of 20 — 18,000 Hz  $\pm$  1 dB or 18 — 25,000 Hz  $\pm$  3dB. Example of an outstanding amplifier rating:

Frequency response 15 — 40,000 Hz  $\pm$  1 dB  
(through AUX inputs)

d) Power bandwidth (Fig. 5-12)

An important value that puts output power and frequency response in a relationship. Power bandwidth signifies the audio frequency range (in Hz) over which the amplifier will deliver at least half of its rated output power without exceeding its rated harmonic distortion. For example, if the continuous output power of an amp is listed as 20 watts per channel at 1% harmonic distortion, then a power bandwidth rating of 20 — 30,000 Hz means that the amp will deliver 10 watts at 20 Hz and at 30,000 Hz without distorting more than 1%.

e) Signal-to-noise ratio (S/N)

The ratio between (wanted) signal and (unwanted) noise delivered by the amplifier at maximum volume setting and with its treble and bass tone controls set at flat position. The higher the value, the less hum and noise there is. Signal-to-noise ratios should be listed individually for each input; for instance: PHONO (MAG) 65 dB, AUX 70 dB. A 65 dB rating means that only 1/2000 of the signal will be noise, 75 dB means 1/6000.

f) Damping factor

Mathematically, the quotient of the load impedance (i.e. speaker voice coil impedance) and the amplifier's internal resistance. For example, if speaker impedance is 8 ohms and the amplifier's internal resistance is 0.1 ohm, the damping factor is

$$\frac{8 \text{ ohm}}{0.1 \text{ ohm}} = 80.$$

Damping factor is a measure of an amplifier's ability to damp, i.e. control unwanted residual

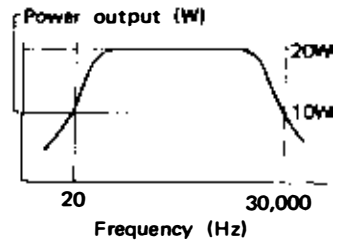

Fig. 5—12  
POWER BANDWIDTH

speaker movements caused by forces other than the audio signal. Higher values are better, but anything over 20 is not really very meaningful. Typical values range from 15 to 100, or more.

g) Input level, input impedance

Input level: the minimum level of the input signal supplied to the power amplifier from which it will deliver its full output power. Should be around 0.1V — 1V and must be close to the pre-amplifier's output level. (Only important if separate pre- and power amps are used.)

Input impedance: The power amplifier's load impedance as seen from the pre-amplifier output. Should be at least 50,000 ohms when using a modern transistorized pre-amplifier.

h) Residual noise

Found in power amplifier specifications. Denotes the amount of noise constantly generated by the amplifier itself, regardless of its volume or gain control setting. Look for the lower values — a good hi-fi amplifier should not exceed 5 millivolts or 3 microwatts.

## Chapter 6

# LOUDSPEAKERS AND HEAD- PHONES

Loudspeakers in a hi-fi system are somewhat like the last pages of a novel. The plot gradually thickens, the parts of the puzzle fall into place, and from them emerges the solution and the revelation of the writer's intent. But, as in some stories, loudspeakers are not always a happy end, sometimes leaving questions unanswered, wishes unfulfilled.

As simple as loudspeakers are in theory, so can they be complex in practice. Let's look at their structure and functions first.

## STRUCTURE AND FUNCTIONS

The signal from the power amplifier passes through a coil (called the "voice coil") which is suspended between the poles and around the center pole of a large, powerful permanent magnet. The interaction between this permanent magnetic field and the alternating magnetic field generated around the coil by the signal makes the coil vibrate in rhythm with the signal. A cone-shaped membrane attached to the voice coil passes these vibrations on to the surrounding air, creating sound waves. A crosssection of such a loudspeaker is shown in Fig. 6-1.

The speaker cone, being a mechanically vibrating mass, has a resonance point, that is a certain sound frequency at which it "likes" to vibrate more than at others and in the vicinity of which it would therefore overemphasize the sound. One major task of loudspeaker designers, therefore, is to eliminate this resonance or at least to bring it under control or lower it be-

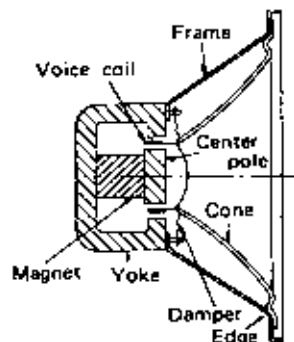

Fig. 6-1  
CUT VIEW OF CONE  
TYPE SPEAKER

neath the lowest audible sound frequency. This is done by means of specially selected cone paper and cone designs.

## DOUBLE CONE AND COAXIAL SPEAKERS



Fig. 6-2  
DOUBLE CONE SPEAKER

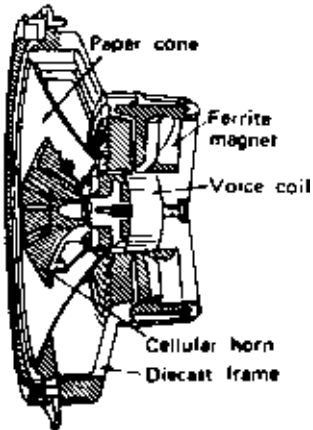

Fig. 6-3 COAXIAL SPEAKER

On the other hand, a loudspeaker can reproduce only a limited sound range — large-diameter loudspeakers are best at delivering the low sound spectrum, small ones are most suitable for the high range. Though most portable and economy class audio equipment has only one full-range loudspeaker, various ways have been conceived to divide the sound spectrum into two or three ranges and feed each portion to a cone of the proper dimensions. One method illustrated in Fig. 6-2 is the double cone speaker which does not really have two cones but a cone made of two different kinds of paper for the low and high ranges. The next logical step is the coaxial speaker shown in Fig. 6-3, which has a larger, outer paper cone for the low range and a smaller horn speaker for the medium and high spectrum. (Designs with three coaxially arranged low, medium and high range speakers are called triaxial.) In the coaxial speaker, there is sometimes a crossover network which divides the signal into the suitable portions, and level controls (attenuators) for each range.

## TWO-WAY, THREE-WAY, FOUR-WAY SYSTEMS

By logical extension of this principle, we arrive at speaker systems with two, three or even four separate speakers mounted in one box. According to the number of sections into which the audio spectrum is divided, such systems are



called 2-way, 3-way or 4-way. The number of speakers in such a box is not always the same as the number of ways, because the high range “tweeters” and mid-range speakers are sometimes doubled, so that we get 3-way, 4-speaker or 3-way, 5-speaker systems.

In such systems, each speaker unit can be designed to reproduce, as ideally as possible, its apportioned sound range. The low-range “woof-er” is usually of large diameter (20, 25 or 30 cm) and considerable weight because of its large, heavy magnet. The mid-range speaker, about 10 cm in diameter, reproduces the sound range from approximately 500 to 2,000 or 3,000 Hz. The top two or three octaves — up to about 20,000 Hz in excellent hi-fi speakers — are the domain of the tweeter, either a small paper cone speaker or, increasingly, a dome-type with a dome-shaped membrane or a horn type with a metal horn instead of a cone. (Horns are more efficient in coupling the sound vibrations to the air, like the bell of a trumpet.) Still another design is the multi-cellular horn (Fig. 6-4) used for mid-range and tweeter applications which is partitioned into a dozen or so cells. The purpose of this is to diffuse the sound more evenly throughout the room.

## DIRECTIONALITY

Speakers have the sometimes desirable, sometimes unwanted, characteristic of radiating their sound in a certain, clearly defined angle which becomes narrower as the sound frequency becomes higher. In this manner, tweeters show a rather strong directionality. As this would affect the sound diffusion in the listening room and limit the usable listening positions, speaker designers have come up with various methods of overcoming this deficiency. One of these is the

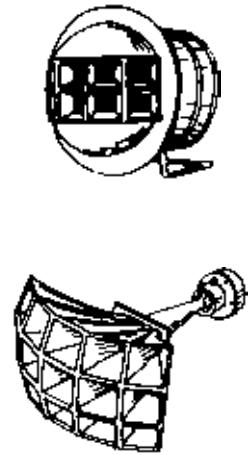

Fig. 5-4  
MULTI-CELLULAR HORN  
SPEAKERS.



Fig. 6-5  
DOME TYPE SPEAKER

multi-cellular horn design, while others include the dome tweeter (Fig. 6-5) or a small "diffuser" reflector mounted before the tweeter.

What complicates matters for the audio amateur is that the speaker box with five speakers does not always sound better than the one with four. A number of other factors enter into the picture, including the quality of each speaker and the way they are matched, the size, shape and weight of the speaker enclosure, and the listening room.

## SPEAKER ENCLOSURES

Enclosures can be roughly divided into two types: closed boxes and bass reflex types. A closed box (Fig. 6-6) is hermetically sealed at the back so that sound emanating from the rear of the speakers is absorbed in the box (which is usually lined with sound absorbent glass wool or plastic foam). Only the sound from the face of the speakers is radiated into the room. Closed boxes usually excel in sound clarity and subtleness, but they require rather voluminous dimensions to obtain satisfactory bass response. A modern variety of the closed box is the air suspension type, often used as compact bookshelf speaker systems, in which the woofer is mounted in a soft baffle suspension so it can perform longer piston movements for better bass response.

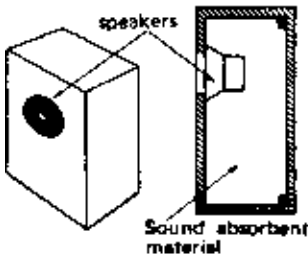

Fig. 6-6 CLOSED BOX

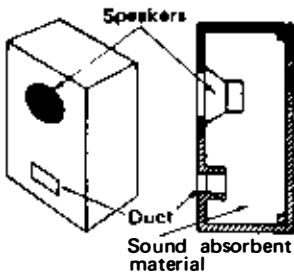

Fig. 6-7  
BASS REFLEX BOX.

The bass reflex type, on the other hand, boosts the bass sound by channeling part of the rear sound back to the front through a duct or port (see Fig. 6-7). In other words, it behaves as if two woofers were installed. The key to successful designs of this type lies in the phase inversion which the box must perform, because otherwise the sound from the speaker and from the duct would be out of phase and might cancel each

other. Bass reflex boxes are being used widely because of their smaller volume in comparison to closed boxes, but their drawback is that the bass range in a poorly designed enclosure sometimes sounds rather boomy.

## HOW TO CHOOSE SPEAKERS

The choice of speaker systems thus becomes rather tricky because the manufacturer's specifications say very little about the character of the sound. The ideal speaker, of course, would reproduce the entire sound range without arbitrarily adding or subtracting anything, but such a loudspeaker has never and will never be designed. All speakers have some individual habits and idiosyncracies which are called "coloration" or "transparancy" or other such abstract words. When purchasing speaker systems, the specifications should be used to determine the general size, type and power range. However, the final choice must be made either after comparative listening tests, preferably with one's own amplifier and in one's own listening room or, if that is impractical, by simply trusting a reputable manufacturer.

## SPEAKER DESIGN FEATURES

Since many speakers are mounted in rectangular-shaped walnut enclosures, with the speakers hidden by a grille, it is just about impossible to determine on the basis of appearance alone whether a speaker is desirable or not. Speaker refinements are generally not accessible to the potential buyer and so he must put considerable reliance on quality associated with the name of a particular manufacturer.

One group of high-grade speakers uses a

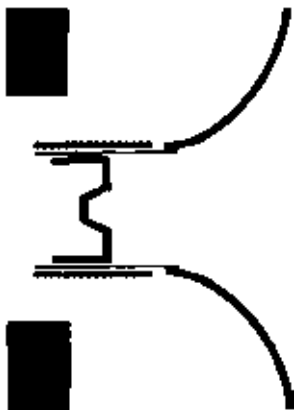

Fig. 6—8  
COPPER CAP AND RING  
COMBINATION HELPS REDUCE  
SPEAKER DISTORTION.

unique concave center pole design and pure copper cap/ring combination. The concave center pole of the drivers' magnetic structure is covered with a pure copper cap (Fig. 6-8). Not only does this reduce the inductance of the voice coil, but it also decreases the voice coil's intermodulation distortion generated by the magnetic field. The result is vastly improved bass and midrange transient responses. Other wanted features would include: long-throw voice coils, providing greater cone movement; acoustically padded enclosures; sound absorbing polyurethane surrounding the woofer; inductance-capacitance crossovers rather than simple capacitor type crossovers; plus specially designed cones that can handle power without breakup.

## SPEAKER EFFICIENCY

Speaker efficiency is the ratio of acoustical power output for electrical power input. There is no relationship between speaker efficiency and speaker quality — that is, a high efficiency speaker isn't necessarily one you should select as a component. Efficiency is simply a measure of the amount of power it takes to drive a speaker. If one speaker is twice as efficient as another, it will require half as much signal driving power for the same amount of sound output.

## ELECTROSTATIC SPEAKERS

Basically, an electrostatic speaker is a capacitor, consisting of a metal plate and a conductive-coated film diaphragm. Sound waves are produced by having the diaphragm move back and forth. A DC bias voltage is put between the two plates, causing partial compression of the diaphragm. The signal voltage then causes the diaphragm to move back and forth with respect

to the metal plate, which is fixed. The spacing between diaphragm and plate is extremely small.

A more costly arrangement uses a diaphragm placed between a pair of perforated metal plates which may be either straight or curved. A DC voltage is applied between the diaphragm and both fixed metal plates. This DC voltage is in series with the signal, simply meaning that the signal adds to the DC voltage or subtracts from it, depending on the polarity of the signal at any moment. As a result the diaphragm moves back and forth between the metal plates. Since the diaphragm is supported between the plates, these must be perforated to let sound come through.

Distortion of electrostatic speakers is very low and transient response is good. Efficiency is also low, and there is a problem of getting adequate bass response. Electrostatic speakers do not use an enclosure, so the problem of coloration of sound due to the box is eliminated.

## CROSSOVER NETWORK, LEVEL CONTROLS

Auxiliary parts in a speaker system include the crossover network and, sometimes, one or more level controls. The crossover network is an electronic circuit which splits the sound spectrum into the required number of ways — low and mid/high range in a 2-way system, low, mid and high in a 3-way. It consists of a combination of coils and capacitors, often equipped with ferrite coil cores which permit better damping and more compact design. The border frequencies between one range and another are called “crossover points”. Unfortunately, they are fixed and inflexible. In such a crossover network they do not always deliver equal response in each sound range. How these difficulties can be mastered will be explained in the next chapter.

The level control (Fig. 6-9) is a simple attenuator which permits the medium or high sound ranges to be suppressed or boosted to an extent — a helpful way of matching the speaker response to the characteristics of the listening room.

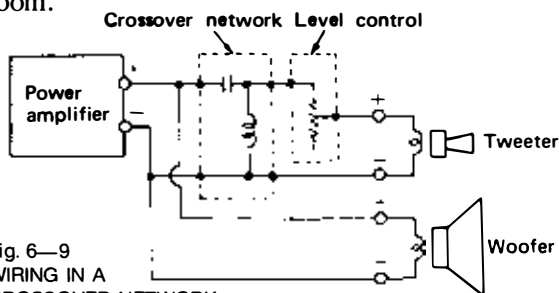

Fig. 6-9  
WIRING IN A  
CROSSOVER NETWORK  
AND LEVEL CONTROL.

## HOW TO READ LOUDSPEAKER SPECIFICATIONS

a) Number of ways, number of speakers

For example: 2-way 2-speaker, 3-way 3-speaker, 3-way 4-speaker, etc. Unfortunately, the number of ways and speakers is not always directly related to the sound quality.

b) Input impedance

The load impedance of the speaker system as seen from the amplifier output. 4, 8 and 16 ohms are the internationally standardized values for speakers to be driven by transistor amplifiers. Not critical.

c) Maximum power handling ability

Also called "maximum input power". The power (in watts) that the speaker system can handle continuously without fear of damage. Sometimes, a higher limit value is also given which describes the maximum input power of short transients and peaks. Power handling ability does not need to equal or exceed the amplifier's output power unless the amplifier is to be operated at top volume — which almost

never happens in home applications.

d) Frequency response

The width of the sound spectrum (in Hz) that the speaker will reproduce. Taking 1000 Hz as the reference level, the lower and upper limits are the points at which the loudspeaker will still deliver 1/3 of the sound pressure level (= -10 dB). Look for wider frequency response ratings. 60 — 15,000 Hz is quite sufficient.

e) Efficiency

(Also variously called “sensitivity” or “sound pressure level”). Measured in dB/W or  $\mu\text{bar}/\text{W}$ . The speaker’s loudness measured in an anechoic chamber with 1 watt input power and at a distance of 1 m (or sometimes 50 cm) from the speaker, directly in front of it. The higher the value, the better the speaker’s efficiency. Note that, with values given in  $\mu\text{bar}$ , measurements at 50 cm distance will result in 4 times higher values than if measured at 1 m.

As larger speaker systems, especially large bass reflex boxes, have higher efficiencies than smaller boxes, a seemingly paradoxical situation arises: smaller speakers require larger amplifier output power than big speaker systems.

f) Crossover frequencies (Fig. 6-10)

The “borderlines” between the low, mid and high ranges in a 3-way speaker system, or between the low and medium/high ranges in a 2-way system. Usually not adjustable. Contain no

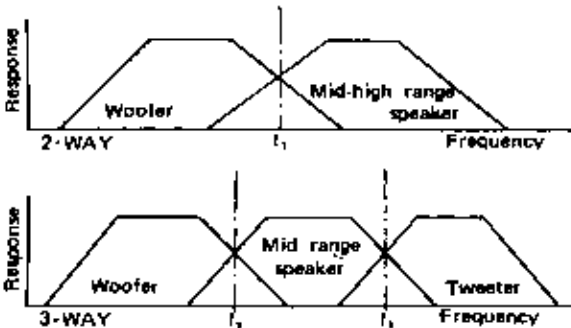

Fig. 6—10 CROSSOVER FREQUENCIES ( $f_1$ ,  $f_2$ ,  $f_3$ )

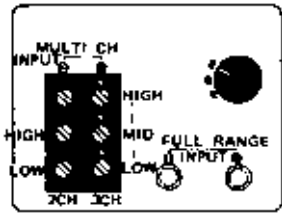

Fig. 6—11  
TERMINALS FOR  
MULTI-AMP SYSTEM

information about the sound quality.

g) Presence (or absence) of separate terminals for use in multi-amplifier installations (Fig. 6-11)

Only of interest to the serious hi-fi fan who plans to enlarge his system into a multi-amplifier configuration. Will be explained in next chapter.

## HEADPHONES

A good pair of stereo headphones is a small worthwhile investment for the serious listener. Headphones serve two main purposes: they permit late-night listening in complete privacy and at full volume levels; and they are indispensable for monitoring tape recordings. Practically all modern stereo amplifiers, tape decks and even some tuners are equipped with standardized headphone jacks. In some instances, the headphone volume can be adjusted with a special control, independently from the master volume setting. Also, most amplifiers are so designed that the loudspeakers are automatically cut off when the headphones are plugged in.

It must be noted that listening through headphones creates a fundamentally different sensation from listening through speakers. As the sound enters directly into the ear, it acquires much stronger "presence". A monophonic program heard through headphones will appear as if the sound source were located right in the center of the head. Stereophonic programs seem to be spread out in "interior space" — an experience that can be startling at first.

Good headphones should be light and comfortable to wear without causing perspiration around the ears. They should also have a wide frequency response — the bass range is very critical — and should sound transparent, not stuffy. Some stereo headphones have built-in volume and tone controls.



## Chapter 7

### MULTI-AMPLIFIER SYSTEMS

In the chapter dealing with loudspeakers we came across the terms 2-way, 3-way or 4-way, meaning the audible sound range is divided into two, three or four portions. This division is usually made by a dividing network in the speaker systems, i.e. between power amplifier and loudspeakers, but it is of course possible — and advantageous, as we will see — to do this at an earlier stage. The reasons are easy to understand.

#### REASONS FOR MULTI-AMPLIFIER SYSTEMS

Assume that two pure sound signals of 100 Hz and 1000 Hz pass through a power amplifier. At the amp output, we will obtain not only the original two signals, but also a number of other frequencies: 1100 Hz, 900 Hz, etc. These undesirable admixtures — sums and differences of the original frequencies — are caused by a bad habit of all amplifiers called “intermodulation distortion”. This can of course be reduced by good amplifier design, but it can never be totally eliminated and can be rather irritating to the listener (Fig. 7-1).

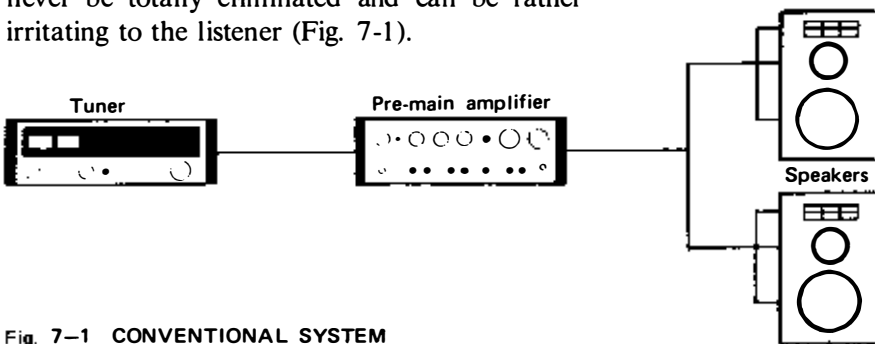

Fig. 7-1 CONVENTIONAL SYSTEM

A few minor problems remained unsolved in regard to the passive dividing networks in loudspeaker systems — dividing is not always even and accurate, DC resistance can degrade damping, and such passive systems are fixed, not flexible. Wouldn't it be nice to get rid of these unwieldy networks altogether?

Also, wouldn't it be lovely to be able to control the intensity of each sound range — bass, medium and high — individually and to obtain tailor-made sound for every record, tape or listening room?

With ordinary systems we are limited in getting reproduced music to fit particular room acoustics, source characteristics and/or personal taste. With the multi-amp system, however, we have a wide choice of components from which to choose, tailoring the entire sound system to our individual taste. Equally important, with a multi-amp system we can reduce intermodulation distortion to a negligible level and achieve a wider dynamic range under all acoustical conditions.

The use of an electronic crossover and more than one power amplifier will definitely improve the sound of the entire system, supplying clearer sound over a wide dynamic range.

## ELECTRONIC CROSSOVER NETWORK

These are the main ideas behind multi-amplifier systems. The signal obtained from the pre-amplifier output is divided into two, three or even four ranges in a so-called “electronic crossover network” sometimes called a “channel divider” or “dividing pre-amplifier”). From there, each partial range enters its own special power amplifier, is raised to the required power level, and then enters directly into one or more loudspeakers of the proper type.

A conventional crossover network uses capacitors and coils, taking advantage of the fact that these electronic parts are frequency sensitive (Fig. 7-2). The difficulty with crossovers of this kind is that the crossover frequency is fixed, and further, depends on the values of the coils and capacitors in the crossover. Finally, such crossover circuits aren't perfect by any means, for they do permit some of the low frequencies to wander into the tweeter, and some of the high frequencies to escape to the woofer. Frequency separation cannot be called decisive.

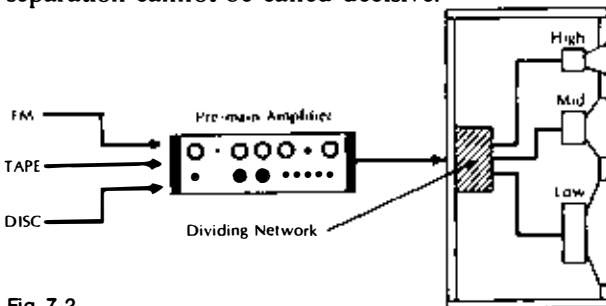

Fig. 7-2  
**SPEAKER SYSTEM USING CONVENTIONAL CAPACITOR-COIL DIVIDING NETWORK.**

An electronic crossover, however, uses tubes or transistors. Further, as each amplifier handles only a small portion of the frequency spectrum, that irksome intermodulation distortion can be easily tamed. No passive dividing network is needed in the loudspeaker systems. And, best of all, crossover frequencies can be switched at will and each sound range can be controlled with accuracy.

The electronic crossover divides the sound frequencies coming out of the pre-amplifier into three ranges: low, mid and high. Its design is more complex than that of ordinary dividing networks using capacitors and coils.

## FEATURES AND DRAWBACKS

If this sounds too good to be true, let us reveal

the one great drawback: money. Two, three, or even four power amplifiers are needed, and the electronic crossover network isn't exactly cheap, either. Therefore, multi-amplifier systems seem to be doomed to remain the privilege of well-heeled enthusiasts or those with extremely understanding wives. To the selected few, however, a multi-amplifier installation can really bring a degree of delicacy and realism in sound that deserves the name "highest fidelity".

(Fortunately, some high-quality pre-main amplifiers and receivers permit their pre and main stages to be used separately so that a multi-amplifier system can be built by adding only one or two more power amps and the electronic crossover network. The speaker systems must of course be equipped with separate input terminals for low, medium and high range.)

## CONVERSION TO MULTI-AMP OPERATION

There are various multi-amp systems, ranging from the basic setup shown in Fig. 7-3 to those

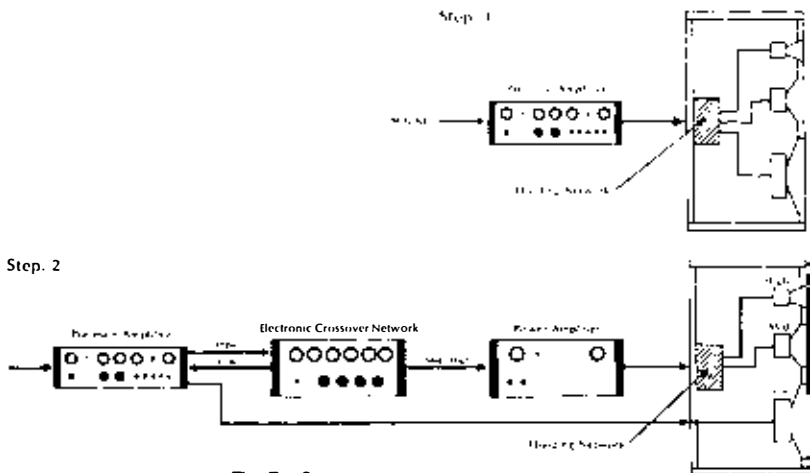

Fig. 7—3  
FUNDAMENTAL MULTI-AMP SYSTEM REQUIRES ELECTRONIC CROSSOVER AND AN ADDITIONAL POWER AMPLIFIER.

that take full advantage of multi-amp techniques. In Fig. 7-3 the original system consists of a combined pre-amp power-amp followed by a coil-capacitor dividing network. To this ordinary system, we can add an electronic crossover and one power amplifier. In this case the power amplifier handles both mid and high frequencies, feeding them to the dividing network in the enclosure. The original power amplifier in the pre-amp power-amp unit is used for handling the low range. In this setup, the dividing network in the enclosure is still used, but its burden is reduced since it is only required to separate highs and mid range tones. The woofer is disconnected from the dividing network and is connected directly to the output of the original power amplifier. The power amplifier feeds all signals into the electronic crossover, while the electronic crossover feeds mid range and treble tones to the new power amplifier. The low-tones are separated by the electronic crossover for amplification by the pre-main amplifier.

The next arrangement shown in Fig. 7-4 is somewhat more elaborate. Known as a three-channel multi-amp system, it provides a wider range of control with two separate power amplifiers in addition to the original power amplifier contained in the pre-main amplifier unit. The receiver should be provided with a switch for separate use of pre- and main amplifiers. In Fig. 7-4 there are three outputs from the electronic crossover. The highs are fed to one power amp, the mid range to another. Each of these added power amplifiers have outputs which connect directly to their respective high and mid-range speakers. Once again, the low range is fed back to the original power amplifier with the low frequencies then traveling from that power amp to the woofer.

The best, and most expensive arrangement, is that shown in Fig. 7-5. Here we use a separate

preamplifier, electronic crossover, and three separate power amplifiers.

The illustrations in Fig. 7-3, 7-4 and 7-5 show single speaker systems. This does not mean to imply that multi-amp is intended for mono, for it would be foolish to waste money doing so. To emphasize that multi-amp is intended for stereo use, examine Fig. 7-6. This shows a two-way multi-amp system. In this arrangement, unlike those shown in Fig. 7-3, 7-4 and 7-5, a pre-amp is used instead of an integrated amplifier. For the two-way system in Fig. 7-6, the extra components are the electronic crossover and the additional power amplifier. For the three-way system in Fig. 7-7, still another power amplifier is required.

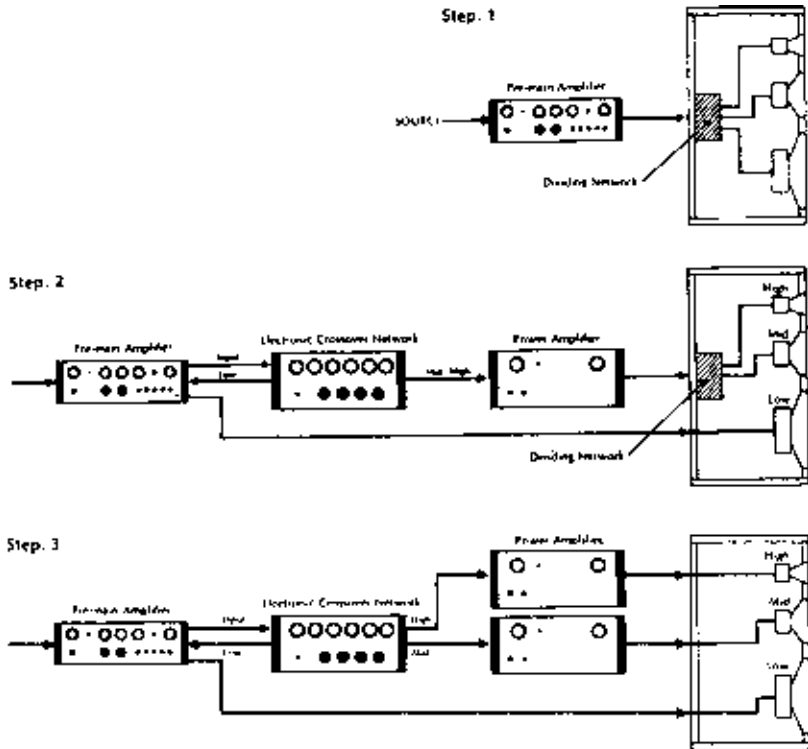

Fig. 7—4  
MORE ELABORATE MULTI-AMP SYSTEM USES ELECTRONIC CROSSOVER AND TWO ADDITIONAL POWER AMPS.

## HINTS CONCERNING MULTI-AMPLIFIER SYSTEMS

Wiring and adjustments in such a system become rather complicated so a few hints may be useful.

In choosing additional power amplifiers it is of course ideal to use the same types for each range. But if different amplifiers are combined, the one with the highest power rating should be used for the bass spectrum. This is because, statistically, most energy in music is found in the low frequency range.

Power handling ability of loudspeakers: If no separate power ratings are given by the speaker manufacturer for the tweeter(s), mid-range

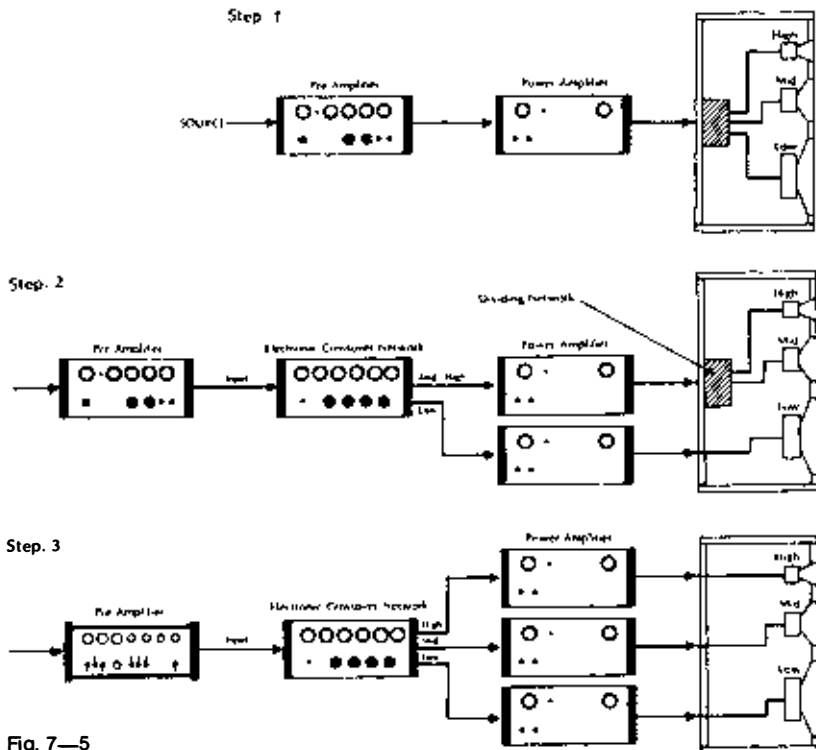

Fig. 7—5  
 IDEAL ARRANGEMENT FOR A MULTI-AMP SYSTEM IS TO USE ELECTRONIC CROSSOVER ONLY, PLUS SEPARATE POWER AMPLIFIERS FOR LOW, MID-RANGE, AND HIGH FREQUENCIES.

speaker and woofer, note that the rating for each segment in a 3-way system becomes approximately 1/9 (not 1/3) of the total. Never turn up the volume control fully or you may blow-out your speakers.

Protection of tweeters against bass pulses: strong, sudden bass pulses may occur when the power amplifiers are turned on and off, and these could damage the tweeters. As a protection, a capacitor of approximately 6 — 12 microfarads should be inserted (in series) between high range amplifier and tweeter.

Setting of crossover frequency controls: start with the settings recommended by the speaker manufacturer or, lacking these, start with 200 Hz for low/medium and 2000 Hz for medium/high. Then play your favorite tape or record and slowly adjust the controls in either direction until the sound becomes most satisfying. (Leave tone controls flat.)

Finally, let us reveal one of the great joys of owning a multi-amplifier system: the advanced

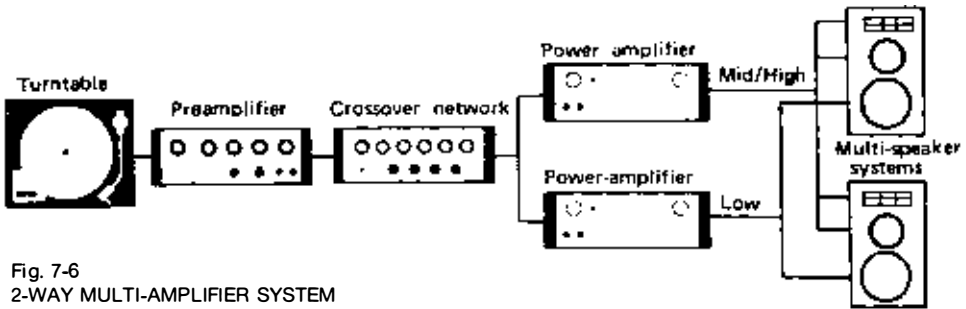

Fig. 7-6  
2-WAY MULTI-AMPLIFIER SYSTEM

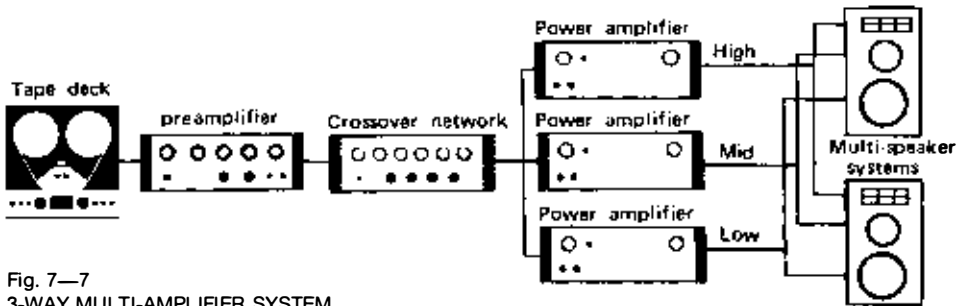

Fig. 7-7  
3-WAY MULTI-AMPLIFIER SYSTEM



amateur or semi-professional can do away with ready speaker systems and can instead buy individual loudspeaker units and have these installed in custom-made enclosures. This provides a new dimension of freedom in sound-engineering one's home.

## SPEAKER SYSTEMS FOR MULTI-AMP USE

There isn't much point in upgrading a hi-fi system to multi-amp only to defeat its purpose by using speakers having a restricted frequency range. For multi-amp hi-fi, choose speakers that provide the widest possible frequency response. The mid-range should be of especially high quality, with a wider than average frequency coverage.

The crossover points should be selected carefully for optimum sound. It is important to adjust the volume level of the high-range (tweeter) midrange and low frequency (woofer) according to the acoustic conditions of the room for maximum fidelity of the reproduced music.

## Chapter 8

### FOUR-CHANNEL STEREO

A two-channel stereo hi-fi system, no matter how high its sound quality, still acts upon a premise which is not true: the idea that sound comes from only one side, i.e. the front of the listener. In reality, sound in any closed room (such as a concert hall) reaches the listener not only from the front, but reflected and reverberated sound waves also come from the sides, rear, floor and ceiling (Fig. 8-1). This reflected sound is what determines a room's or hall's acoustic behavior; having traveled a longer way than the direct frontal sound, the reflected sound reaches the listener a fraction of a second later. If this delay is large, it will give the impression of an echo; if small, it will simply help to blend the instruments together, imparting a feeling of warmth and presence.

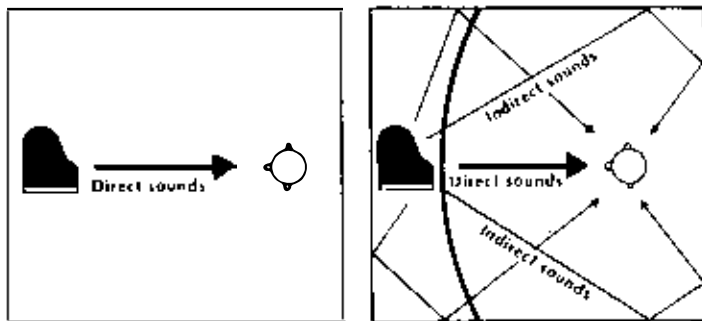

Fig. 8—1  
EVEN WITH A CENTRALLY LOCATED SOLO INSTRUMENT,  
SUCH AS A PIANO, SOUND WILL REACH THE LISTENER  
FROM ALL DIRECTIONS.

### SPEAKER PLACEMENT

4-channel stereo (Fig. 8-2) takes these facts into account, providing the rear sound information through two additional loudspeakers

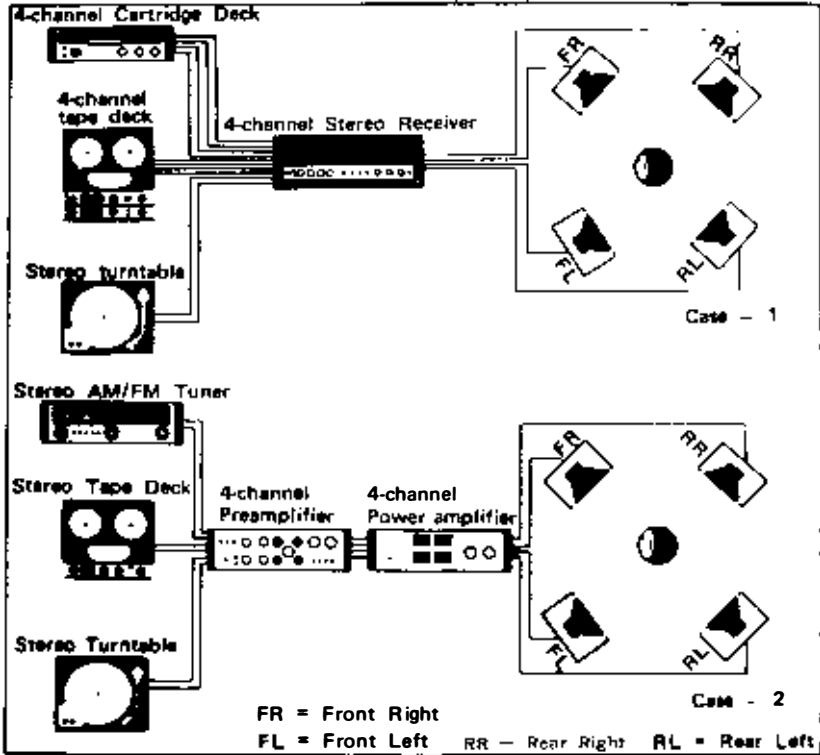

Fig. 8-2 FOUR-CHANNEL STEREO

placed behind the listener (2-2 system). Alternately, three speakers can be placed in front, one behind the listener (3-1 system) or all four in front but at different heights (4-0 system). Of these, the 2-2 arrangement (Fig. 8-3) has

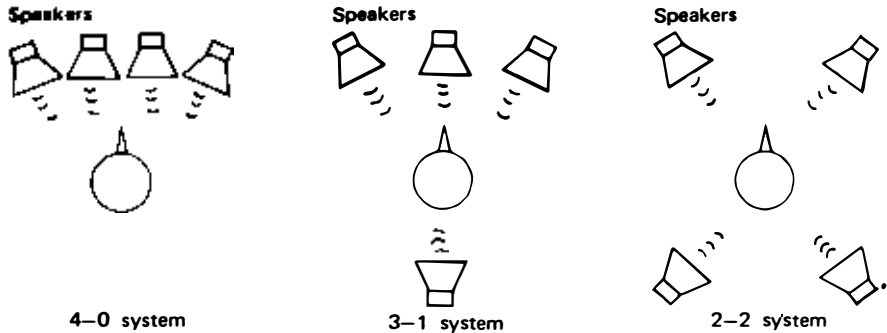

Fig. 8-3 SPEAKER ARRANGEMENTS IN 4-CHANNEL SYSTEM

become most popular because it places the listener in the center of a "sound field" — a novel and startling experience.

## TRUE AND SIMULATED 4-CHANNEL STEREO

### MONO GOES STEREO

It is now approximately two decades since the introduction of two-channel or stereo sound. Stereo broadcasts were inaugurated with the invention of 45/45 stereo discs. Then tube-type receivers and amplifiers practically disappeared and were replaced by solid-state components that gave instant play, without the need for warmup time required by tubes. Tubes also had a much shorter life than transistors and so replacement, if not a serious problem, was often a nuisance. Innovations such as these supplied a strong impetus to the enjoyment of stereo sound, and to the growth of recording companies and companies specializing in the manufacture of high-quality components.

The objective of this development in audio technology was the improvement of reproduced sound quality. Thus, the driving force behind the introduction of two-channel stereo sound was

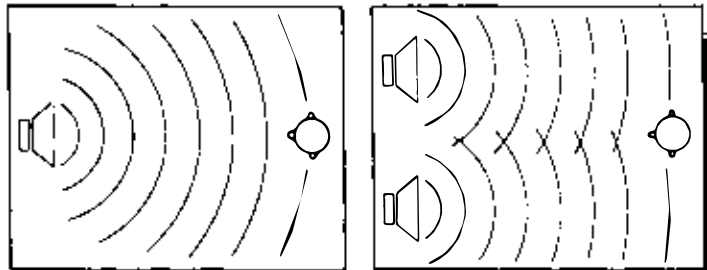

Fig. 8—4  
MONO REPRODUCTION (ILLUSTRATION AT LEFT)  
PRODUCES 'HOLE IN THE WALL' EFFECT, THAT OF SOUND  
COMING FROM A LIMITED, CENTRALLY LOCATED AREA.  
STEREO REPRODUCTION (RIGHT ILLUSTRATION) ENRICHES  
LISTENING PLEASURE BY PROVIDING LEFT-RIGHT SOUND.

dissatisfaction with monophonic sound. This is not to deny that mono sound reached a high level of performance. It did. But with mono it was impossible to re-create the movement and spreading of sound. And so, as shown in Fig. 8-4, a minimum requirement of stereo is the use of two speakers, or two speaker systems, in place of the single speaker or speaker system for mono.

## THE ENJOYMENT OF SOUND

An orchestra playing outdoors will not sound as good as the same orchestra inside a properly designed concert hall. Music played outdoors or in an anechoic chamber where there is virtually no echo effect, doesn't sound complete. Something is missing to give music a certain richness and fullness we associate with concert hall performances. The reason for this is that concert hall music consists of direct sounds from the original sound source — the orchestra — plus a large number of indirect sounds — sounds that are reflected one or more times from the walls and ceiling of the concert hall (see Fig. 8-1 again). It is these indirect sounds, these reverberant sounds, that contribute so much to the total sound field. They not only reach our ears from in front of us, but from above, below, and behind us, coming at us from every conceivable direction.

## THE LIMITATIONS OF TWO-CHANNEL STEREO

Two-channel was such an improvement over mono, that for many years (after the acceptance of stereo) few people challenged stereo reproduction. And yet if you stop to consider the importance of indirect sound waves, the limitations

of two-channel stereo become immediately apparent.

Fig. 8-5 shows the recording and reproduction processes of a two-channel stereo system. If this system is used to make a live recording, the microphones are positioned to pick up sound to the left of center and to the right of center. With these two sound pickups, two separate channels are created, and these require separate amplification. Ultimately, in the reproduction process, the listener, using a stereo system, is able to get the auditory impression of a 'spread' orchestra — that is, the sound does not seem to come from a single sound source located somewhere on stage center. This stereo system does pick up reverberant sound — sound that is bounced off walls, floor and ceiling, but it is incorporated with the two-channel recording, is indistinguishable from it and is not reproduced for what it is — a separate sound entity. What is missing, then, is the beauty and richness of sound contributed by the music hall, an effect enjoyed by those who attend live concerts but lost by those who want the convenience of home listening.

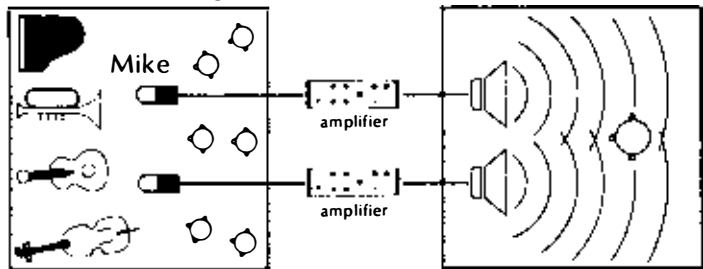

Fig. 8—5  
A STEREO SYSTEM HELPS PRODUCE A SPATIAL EFFECT THROUGH THE USE OF TWO SOUND CHANNELS AND TWO SPEAKERS, OR SPEAKER SYSTEMS.

## FOUR-CHANNEL STEREO

With two-channel stereo, all sounds, direct

and indirect, and of different phases, are heard from the two speakers placed in front. That word 'phase' does need some explaining. In a music hall, sound from the orchestra in front reaches the listener sooner than sound reflected from the walls, ceiling and floor. This time difference, also called phase difference (or more simply, phase) contributes immeasurably to the richness and beauty of sound.

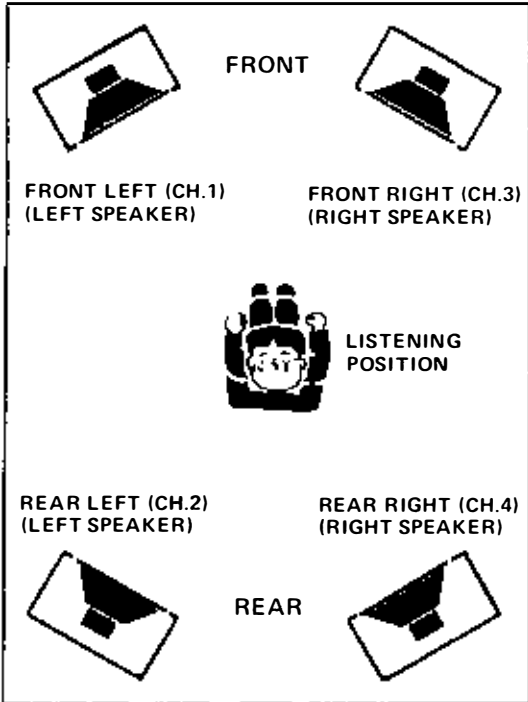

Fig. 8—6  
A COMMONLY USED SPEAKER ARRANGEMENT FOR FOUR-CHANNEL LISTENING. IT IS ALSO POSSIBLE TO POSITION THE SPEAKERS IN A NUMBER OF OTHER WAYS, AS SHOWN EARLIER IN FIG. 8—3.

Four channel stereo uses four speakers (or four speaker systems) quite often two in front and two in the rear of the listener, as shown in Fig. 8-6. Four-channel is used for usual sound reproduction, and also for the creation of new sound effects that can contribute to listening pleasure. Thus, in Fig. 8-7, two orchestras can

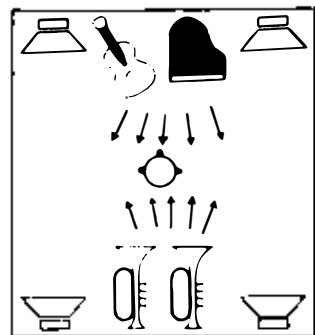

Fig. 8—7  
LISTENER ENJOYS  
UNIQUE SOUNDS OF MUSIC.  
SWITCHING BACK AND FORTH  
BETWEEN TWO ORCHESTRAS.

be arranged, and with four channels the listener not only enjoys the left-right separation supplied by stereo, but the front-back separation supplied by quadrasonic or four-channel stereo.

### PING PONG EFFECT

In the early days of stereo, the new technique was such a contrast to mono, that separation between left and right sound was overemphasized, producing an effect equivalent to sound bouncing back and forth between the left and right sides of the orchestra. Eventually, stereo calmed down and stereo listeners realized that true stereo enjoyment was obtained by correct, but not overemphasized, separation of left right sound. With quadrasonic sound, it is possible to have a solo instrument, such as a trumpet (Fig. 8-8) sound as though it is being played — and marched — around a music hall. Although this seems like a pleasant, but possibly unnecessary innovation, it does show the possibilities inherent in four-channel sound.

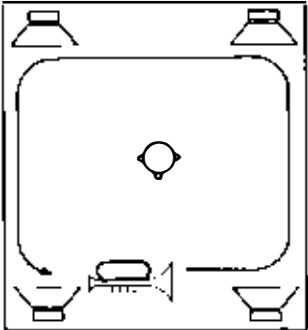

Fig. 8—8  
IN THIS EXPERIMENT  
WITH QUADRAPHONIC SOUND  
AN EFFECT CAN BE PRODUCED  
OF A TRUMPET MOVING  
AROUND A MUSIC HALL.

### FOUR-CHANNEL QUADRAPHONIC SYSTEMS

Four-channel systems can be divided into three distinct types: discrete, 2-2-4, and matrix. Discrete is the most authentic in terms of sound quality and the most expensive.

### THE DISCRETE SYSTEM

The discrete system possesses a number of important advantages for high quality tonal sound, the most important being the fact that independent signals can be recorded on each track, so that the playback supplies the same rich



sound. With this system, unusual effects are possible, such as switching back and forth between sounds of two orchestras, or the movement of a sound field at high speed. Fig. 8-9 shows a diagram of discrete sound using four-channel open-reel tapes. Conventional two-channel stereo tapes use tracks 1 and 3 moving in one direction and tracks 2 and 4 moving in the other direc-

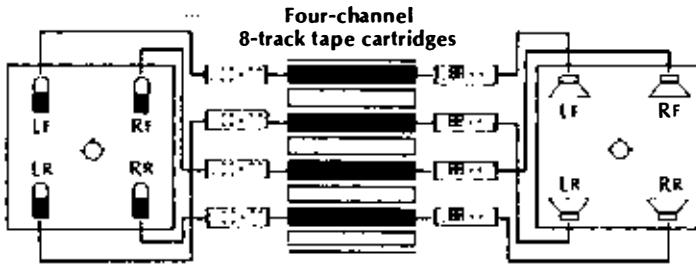

Fig. 8-9  
CONVENTIONAL TWO-CHANNEL STEREO TAPES USE TRACKS 1 AND 3 MOVING IN ONE DIRECTION, AND TRACKS 2 AND 4 MOVING IN THE OTHER DIRECTION. FOUR-CHANNEL STEREO TAPES USE ALL FOUR TRACKS SIMULTANEOUSLY, AND PROVIDE ONLY ONE-WAY OPERATION.

tion. Four-channel stereo tapes use all four tracks simultaneously and so provide only one-way operation. Fig. 8-10 illustrates the use of four-channel eight-track tape cartridges for discrete sound. In this illustration, the blank tracks accommodate another four-channel program.

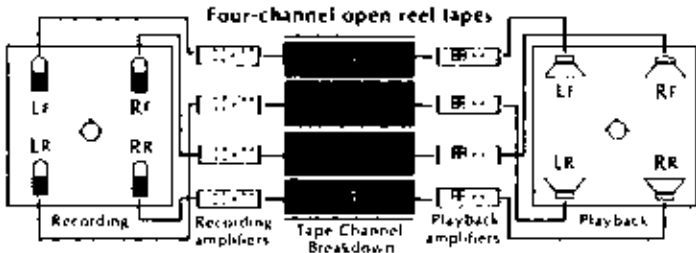

Fig. 8-10  
FOR EIGHT-TRACK TAPE, THERE ARE TWO FOUR-TRACK CHANNELS.

## DISCRETE FOUR-CHANNEL DISC (CD-4)

JVC America, Inc. and RCA have a discrete four-channel disc recording system, plus an associated reproducing system. It is compatible, supplying four-channel sound when played on its associated playback system, or two-channel stereo when played on a conventional stereo unit. The system is named the CD-4: C for compatibility, D for discrete, and 4 (naturally) for four-channel.

The new four-channel record can be used on an ordinary player by attaching a pickup cartridge and a four-channel reproducing unit, corresponding to a pre-amp.

In the four-channel disc, the low frequency range is the same as for stereo (30 Hz to 15,000 Hz), but the modulated carrier system is adapted in the high-frequency range (20 Hz to 45,000 Hz). This is a 45-45 system.

Carrier modulation is centered around 800 Hz and features the application of FM in the low frequency range and phase modulation in the high-frequency range.

Through a matrix circuit, the sum signal is cut in the low-frequency range and the difference signal in the high-frequency range.

## THE QUADRADISC

RCA's four-channel CD-4 disc, labeled by them as a Quadradisc, is a compatible record that can supply four-channel sound when the correct associated equipment is used, or will furnish regular stereo sound. A decoder is required to convert the recording into four discrete channels of sound.

The discrete system uses four channels throughout. With either tape or discs, four channels are used. These four channels are fed

through a four-channel reproducing unit, and then through a four channel amplifier to four speakers. The system is known as 4-4-4.

## THE 2-2-4 SYSTEM

When the original recording for a two-channel stereo disc or stereo tape is made, a large number of microphones are used. These microphones not only pick up the direct sound, but the reverberant sound as well. Thus it is possible to create a four-channel stereo type of sound field, even though the music was not specially recorded as four-channel stereo. The quality of this conversion-type system is usually quite good and often provides an effect that is acceptable in terms of four-channel sound. Its great advantage is that you need not discard your present discs or tape recordings to enjoy four channel reproduction.

This type of quadraphonic sound is called derived or 2-2-4, since it starts with two channels and is handled by two-channel amplifiers.

## QUADRAPHONIC SOUND SYSTEMS

Discrete is the most authentic in terms of sound quality, but it is also the most expensive, since it requires not only a four-channel tape deck but special four-channel tapes. Discrete discs are also more expensive than regular stereo discs.

Matrix systems are a much different story. There are a number of different matrix systems, the most widely accepted being the QS and the SQ. In this book miscellaneous matrix systems, including QS, are lumped into a single category identified as regular.

## MATRIX

There are two types of matrix four-channel systems; regular matrix and SQ matrix. Signal source comes directly from matrix four-channel records or indirectly from FM broadcasts of such records. As these methods are not compatible, two decoders must be added to obtain four-channel reproduction which exhibits the inherent features of each.

The word "matrix" means adding and subtracting. A matrix network is an electronic circuit capable of adding signals to each other, or subtracting one signal from another. The objective of a matrix system is to take apart signals that are 'put together' — that is, recorded in two channel recording, adding some, separating some, then reassembling them into four-channel stereo.

In matrix-type systems, the original four-channel sources are mixed or blended and then converted into two-channel signals. The conversion is called 'encoding'. However, for the home high-fidelity system these encoded signals must be reconverted into four-channel sound, a process known as 'decoding'. Because the matrix systems start with four-channel sound, convert it to two-channel, and then reconvert to four-channel at the receiver, it is often referred to as the 4-2-4 system.

Encoding is a means of packing four channels of information into two channels. The advantage of encoding is its economy. With a discrete tape, the technique involves going from two channels to four. In effect, this halves the total running time of the tape. One solution might be to make the tape tracks narrower, but this requires precision head arrangements in the tape recorder and involves other factors such as signal separation and signal-to-noise ratio.

Matrixing involves combining four signals into two channels in various phase and ampli-

tude relationships. The assumption is that the original four signals can be recovered, but what is not specified is the extent of the recovery. While matrixed material requires a decoder, it can still be played through a usual two-channel stereo system and what will be heard will be stereo, not quadrasonic sound.

### REGULAR MATRIX

As shown in Fig. 8-11, signals  $L_T$  and  $R_T$  from a matrix 4-channel record (or FM broadcast) pass through phase shifters and appear as four separate outputs. This figure also shows that the  $\alpha$  portion of signal  $R_T$  is added to signal  $L_T$  to form front left signal  $L_F$  and that the  $\alpha$  portion of signal  $L_T$  is added to signal  $R_T$  to form front right signal  $R_F$ . The  $\beta$  portion of signal  $R_T$  with phase led  $90^\circ$  ( $+jR_T$ ) is added to signal  $L_T$  with phase lagged  $90^\circ$  ( $-jL_T$ ) to form rear left signal  $L_R$ , while the  $\beta$  portion of the  $-jL_T$  signal is added to the  $+jR_T$  signal to form rear right signal  $R_R$ .

$$L_F \text{ (front left, CH. 1): } L_T + \alpha R_T$$

$$R_F \text{ (front right, CH. 3): } R_T + \alpha L_T$$

$$L_R \text{ (rear left, CH. 2): } -jL_T + j\beta R_T$$

$$R_R \text{ (rear right, CH. 4): } +jR_T - j\beta L_T$$

$L_T$  and  $R_T$  are signals from a record or FM

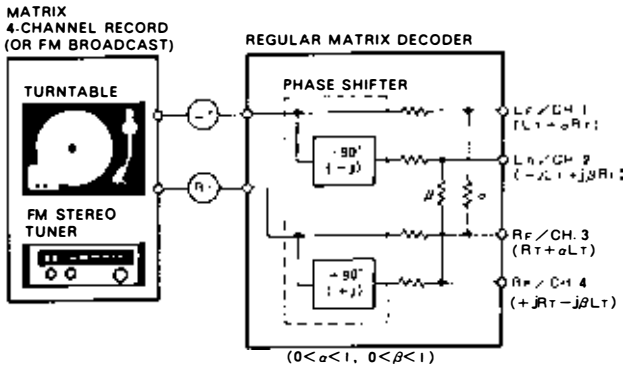

Fig. 8-11  
REGULAR MATRIX DECODER.

broadcast. Term  $-j$  denotes that the phase of the signal has been lagged  $90^\circ$  (with a phase shifter), while term  $+j$  denotes that the phase of the signal has been led  $90^\circ$ .

Using this approach, unnatural images are eliminated and at the same time realism is effected. Even if 2-channel stereo records (FM broadcasts) supply the source material, the resultant effect is an improvement over ordinary 2-channel stereo sound.

### SQ MATRIX

As shown in Fig. 8-12, signals  $L_1$  and  $R_1$  from an SQ matrix record (or FM broadcast) pass through phase shifters and appear as four separate outputs. This figure shows that signal  $L_1$  becomes signal  $L_F$  (CH. 1) and that signal  $R_1$  becomes signal  $R_F$  (CH. 3), without any alteration.

A phase shifter lags the phase of signal  $L_1$  by  $90^\circ$ , after which the lagged signal is added to signal  $R_T$ . Level of the resultant signal is dropped by 0.707 and phase is inverted to form  $L_R$  (CH. 2) signal. In the same manner, signal  $L_T$  is added to signal  $R_T$  with phase lagged  $90^\circ$ . The level is reduced by 0.707 to form signal  $R_R$  (CH. 4).

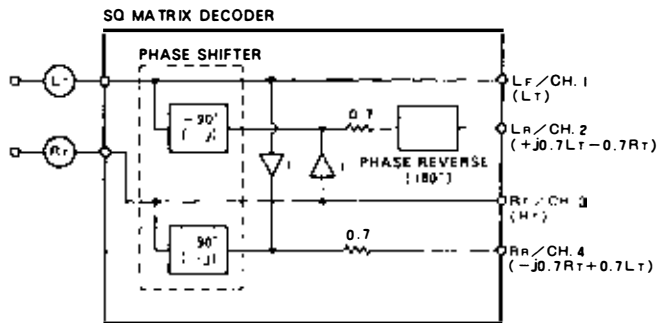

Fig. 8-12  
SQ MATRIX DECODER.

$$\begin{aligned}
L_F \text{ (CH. 1):} & \quad L_T \\
R_F \text{ (CH. 3):} & \quad R_T \\
L_R \text{ (CH. 2):} & \quad +j0.7L_T - 0.7R_T \\
R_R \text{ (CH. 4):} & \quad -j0.7R_T + 0.7L_T
\end{aligned}$$

Thus, separation in the SQ matrix system is better than that in the regular matrix system, that is, separation between  $L_T$  and  $R_T$ . A principal feature of the SQ matrix is the use of logic circuitry, a feature which cancels rear center sound when front center sound exists or vice versa. This arrangement also leads to naturalness in reproduction. For example, with solo instrument reproduction, there can be a problem of phantom signal reproduction in the various channels. With the use of a logic circuit, these signals are either eliminated or considerably attenuated. The effect of logic circuitry is to increase matrix separation. Logic circuitry is sometimes called "gain riding" because of the way the circuit behaves. If a strong signal appears in one channel, it is sensed by the logic circuit, which automatically reduces gain in the other three channels. This helps reduce ghost signals, particularly annoying with solo instrument or voice.

In matrix reproduction of 2-channel records (FM broadcasts), front ( $L_T$ ,  $R_T$ ) separation theoretically becomes infinite. At the same time, rear signals are  $90^\circ$  out of phase to front ( $L_T$ ,  $R_T$ ), resulting in a feeling of depth which corresponds to a large hall.

## DIFFERENCES BETWEEN REGULAR AND SQ MATRIX

The matrix encoding principle of the SQ system and the regular matrix system are quite different. In regular matrix systems, the four-channel signals are recorded from different angles against the  $45^\circ/45^\circ$  conventional record

groove. This inevitably results in crosstalk between the two front speakers. The SQ system, on the other hand, maintains the  $45^\circ/45^\circ$  principle by introducing an additional phase difference of  $90^\circ$ , with the left rear channel information translated into a clockwise circular motion and the right rear channel information translated into a counter-clockwise circular motion of the stylus tip. This principle is called "circular modulation". Thus, as the record rotates, a clockwise helix is produced for the left rear channel, and a counter-clockwise helix for the right rear channel. The two recording techniques, regular and SQ, are illustrated in Fig. 8-13.

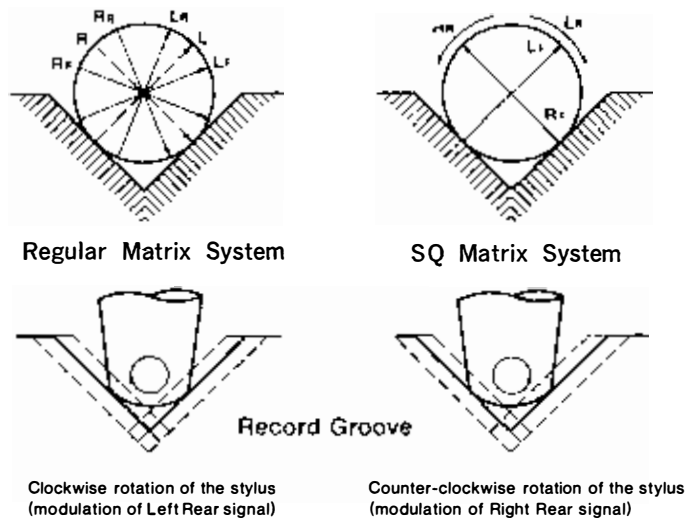

Fig. 8—13  
DISC RECORDING TECHNIQUES FOR REGULAR MATRIX AND SQ MATRIX.

### THE SQ DECODER

How do you convert your present hi-fi system into one that will enable you to listen to SQ encoded four-channel sound? You can do this, without buying all new equipment, by adding an SQ decoder to your existing equipment. The SQ



decoder can be used with either two- or four-channel amplifiers or receivers. Fig. 8-14 shows the connections for a four-channel amplifier or receiver while Fig. 8-15 illustrates how to attach the SQ decoder to a two-channel amplifier or receiver. If your hi-fi system at the present time is strictly two-channel you will need to supply two additional speakers for rear sound reproduction, and a two-channel amplifier for the rear speaker sound. For existing four-channel systems, the inclusion of the SQ decoder is sufficient.

In stereo systems it is possible to maintain about 40 dB of separation between left and right channels. With four-channel operation, this separation must now be maintained in both the front and rear pairs of channels.

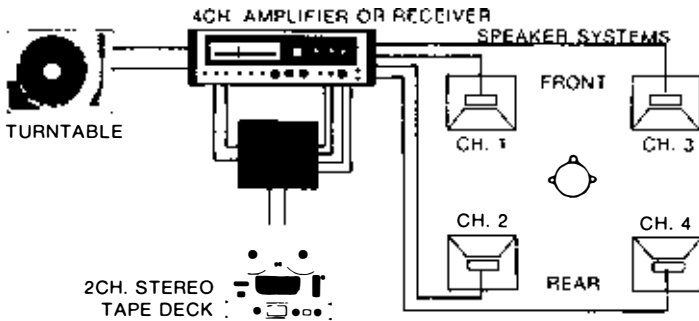

Fig. 8—14  
SQ DECODER CONNECTIONS FOR EXISTING FOUR-CHANNEL SETUP.

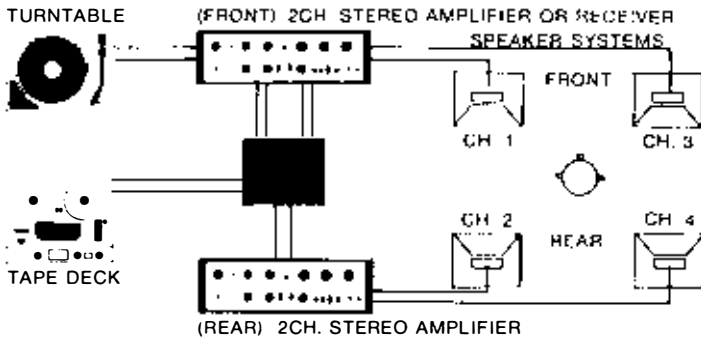

Fig. 8—15  
SQ DECODER SYSTEM FOR USE WITH TWO-CHANNEL SETUP

## HOW TO GET THE MOST FROM FOUR-CHANNEL STEREO

The kind of speakers you select and their position, will definitely affect the four-channel reproduction you will obtain. Ideally, it is best to use identical speakers for front and rear, especially when listening to the interplay between two orchestras whose sounds alternate between the front and rear speakers. However, it isn't absolutely imperative that the rear speakers be full-size models, since all they are required to do is to supply reverberant sound. The wider the sound dispersion of the rear system speakers, the better will be the living presence sound field coming from the speakers being used for ambient sound. It might also be advisable to have the rear speakers placed at a somewhat higher position than the front speaker system.

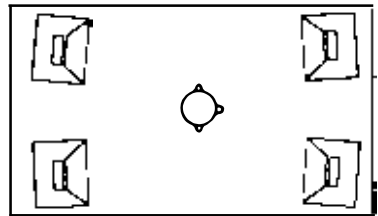

Fig. 8-16  
COMMONLY USED SPEAKER SETUP FOR FOUR-CHANNEL  
SOUND. THE FRONT AND REAR SPEAKERS ARE  
APPROXIMATELY EQUIDISTANT FROM THE LISTENER AND  
ARE POINTED INWARD.

Fig. 8-16 shows the basic placement of speakers for a four-channel stereo system. It is suited for all types of music sources. If this placement is used, the front and rear loudspeaker systems should not face each other squarely across the room, but should be directed slightly towards the center of the room. However, many classical music enthusiasts question the idea of sounds coming at them from the rear. A suitable and effective speaker placement alternative is the one shown in Fig. 8-17. Here the speakers are

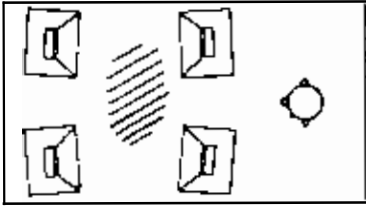

Fig. 8—17  
 IN THIS QUADRAPHONIC SPEAKER ARRANGEMENT, A SOUND FIELD, INDICATED BY THE SLANT LINES, IS CREATED BETWEEN ALL FOUR SPEAKER SYSTEMS. THIS CREATES THE EFFECT OF A "SOUND STAGE" WITH THE LISTENER OUTSIDE IT, AS HE WOULD BE IN A MUSIC HALL.

moved up in front of the listener, to create a sound field as indicated by the shaded area in the center of the speakers. This placement is also tantamount to establishing the stage of the concert hall right in front of the listener, and thus provides exceptional presence quite unattainable with conventional two-channel stereo.

An adaptation of the setup shown in Fig. 8-17 is the placement of speakers illustrated in Fig. 8-18. By bouncing the sounds from the rear speakers off the walls, a soft spread of sound is achieved.

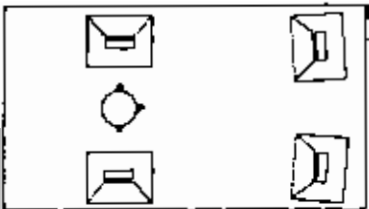

Fig. 8—18  
 IN THIS FOUR-SPEAKER SYSTEM SETUP, THE REAR SPEAKERS BOUNCE THEIR SOUND OUTPUT OFF THE WALLS, RESULTING IN A MORE DISPERSED, SOFTER SOUND.

## AMBIENCE ARRANGEMENTS

A first approach to quadraphonic sound is to attempt to duplicate listening conditions in a music hall. But this is just a first step for there is

no reason for those interested in sound experimentation to keep listening within such confines. Rear ambience is just one way of using four channels. Speakers can be arranged so that the listener obtains an effect of being seated with the musicians. This is applicable to classical and non-classical music. Thus, typical listening to a string quartet is for the listener to face the musical group. It's a strange experience to hear individual instruments coming from the four corners of a room, a technique that will probably exasperate purists, while musically satisfying others.

Possibly one of the reasons hi-fi enthusiasts listen to large sound volumes is an inherent wish to become involved. Quad sound should enable them to achieve their objective, with, hopefully, a return to lower sound output.

#### REAR SPEAKER POWER

Since reflected sound is weaker than direct, an immediate assumption might be made that power for the rear speakers should be less than for front units. However, there are recordings that do require equal power from all four speakers. Having an equal power capability for all four speakers allows for greater flexibility in four-channel experiments with sound. Also, some listeners may prefer greatly enhanced rear channel sound, just for its effect, just as some listeners have a strong predilection for bass response.



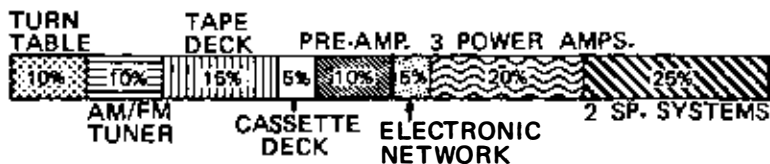
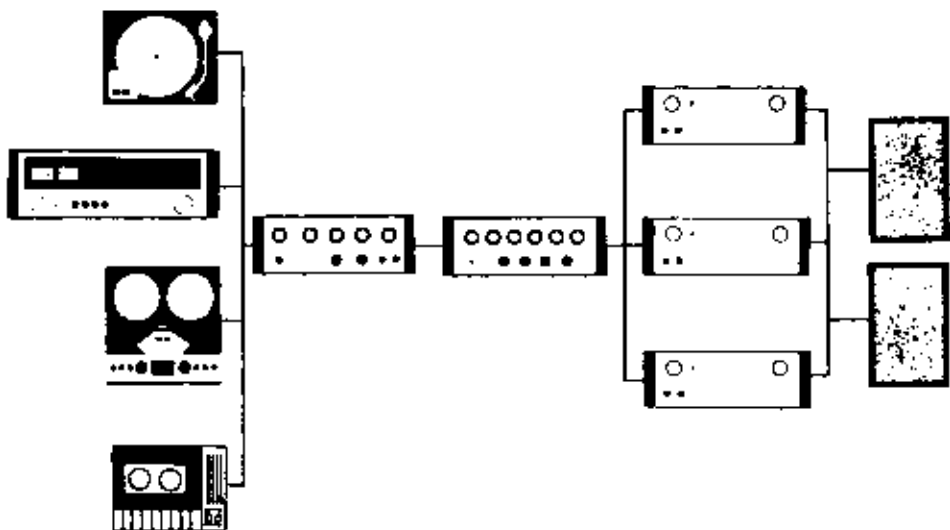
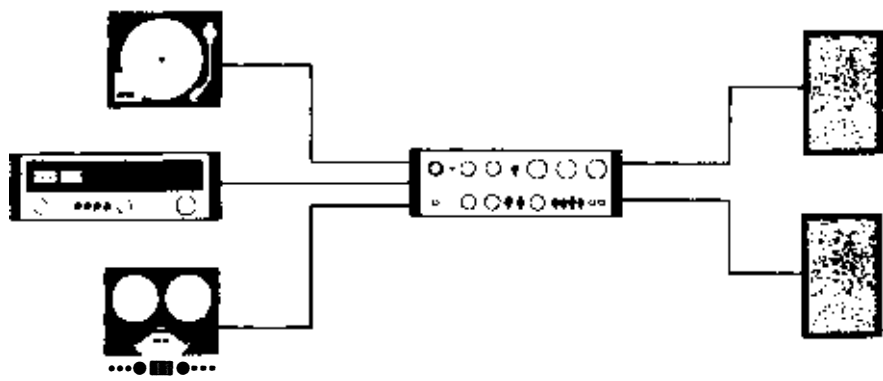

## Chapter 10

### DOS AND DON'TS

- DO read the operating instructions supplied with each unit. Keep referring to the instruction manual when setting up your hi-fi system, and keep the manual handy for future reference.
- DO read and compare the specifications. These contain valuable figures for matching your components correctly. Most items are explained in this guidebook.
- DO fill out and mail the warranty cards, if required, to obtain full warranty protection.
- DO experiment with different speaker positions. No general rules can be given, but often a minor change in the speaker position can bring about a major improvement in sound.
- DO treat your phonograph records with utmost care. Always put them back in their jackets immediately after playing. Store them in an upright position.
- DO store tapes in their boxes and away from motors, TV sets or other electrical appliances. Vertical storage is again recommended.
- DO follow the manufacturer's instructions in regard to proper maintenance of all units — cleaning, lubrication, fuses, etc.
- DON'T install any hi-fi component in a dusty, hot, moist or wobbly place. Avoid direct sunlight.
- DON'T accidentally drop the stylus on the turntable or record when making adjustments of the tracking force, etc. Cartridges are easily damaged.
- DON'T obstruct the movement of a turntable or

tape reel by hand.

**DON'T** ground the system at two or more points. Ground connection should be made only from the amplifier.

**DON'T** run the system at full blast for extended periods. This may damage the speakers and the nerves of your neighbors. Hi-fi is not synonymous with loudness.

**DON'T** call a serviceman immediately when you think your system isn't functioning properly. Refer to the instructions. Very often there is no defect at all, only an operating error.

**DON'T** open or otherwise tamper with a hi-fi unit. This can be dangerous and can invalidate your warranty. Contact qualified service personnel for repairs.



## *Chapter 11*

### A GLOSSARY OF AUDIO TERMS

**A-B TEST:** A method of evaluating the performance of similar high-fidelity components by switching rapidly from one to the other.

**AC:** Alternating current. An electric current with periodically changing polarity. In popular parlance, often used as synonym for electrical house current.

**ACOUSTIC OR MECHANICAL FEEDBACK:** Unwanted low-frequency acoustic interaction between output and input of an audio system, usually between loudspeaker and microphone or turntable cartridge. Can lead to "howl". Separating speakers and record-playing components recommended.

**ACOUSTICS:** The science of sound. Also, the acoustical character of halls and rooms.

**ACTIVE FILTER:** See Filter.

**AERIAL:** Synonym for antenna in British English.

**AF (AUDIO FREQUENCY):** Frequency within the range of human hearing — approximately 20 — 20,000 Hz.

**AFC (AUTOMATIC FREQUENCY CONTROL):** An AFC circuit of an FM tuner corrects for an inaccuracy in tuning by locking in the station being tuned.

**AM (AMPLITUDE MODULATION):** Modulation accomplished by varying the amplitude

(intensity) of the carrier.

**AM SUPPRESSION:** Characteristic of an FM tuner in suppressing changes of amplitude in received signals, thereby improving the signal-to-noise ratio by rejecting noise and interference.

**AMBIENT:** Moving around. Encompassing on all sounds. In quadraphonics, a reference to reverberant as opposed to sound coming directly from musical instruments.

**AMPERE:** Basic unit of current. Submultiples are the milliamperere or thousandth of an ampere and the microampere or millionth of an ampere.

**AMPLIFICATION:** Increase in signal magnitude.

**AMPLIFIER:** Unit providing amplification of signal, from low to higher voltage or current (pre-amplifier) or power (power or main amplifier).

**ANECHOIC CHAMBER (ROOM):** A specially designed room, used for testing microphones and speakers, rendered acoustically "dead" by sound absorbing material.

**ANTENNA:** Assembly of metal bars, wires or loops for picking up radio waves. Dimensions depend largely on the wavelengths to be received.

**ANTENNA DIRECTIONALITY:** The characteristic of certain antenna configurations, including most FM and TV antennas, to receive radio waves reaching it within certain defined angles more strongly than those coming

from other directions.

**ANTENNA GAIN:** An indirect measure of an antenna's output level, i.e. the strength of the signal supplied by the antenna when compared to a standard antenna and at a certain frequency. Expressed in dB.

**ANTI-SKATING DEVICE:** Mechanism exerting a small outward force on a tonearm to compensate for the inward thrust caused by groove/stylus friction and tonearm geometry.

**ANTISTATIC FLUID:** A fluid (or spray) used to prevent phonograph records from becoming electrically charged, as an electrical charge would attract dust.

**AUDIBILITY THRESHOLD:** The minimum sound intensity the average human ear can hear. Approximately 0.0002 microbar at a frequency of 1000 Hz.

**AUTOMATIC LEVEL CONTROL:** A circuit which automatically keeps the level of a signal within a certain range. Examples: automatic gain control in AM radios, ALC in portable tape recorders.

**AUTOMATIC RECORD CHANGER:** Record player which can change from record to record automatically.

**AUX (AUXILIARY) INPUT:** Input on amplifier, etc. Accepts extra signal source such as cassette tape player etc.

**AZIMUTH ALIGNMENT:** Also known as head alignment. The adjustment of the recording and playback heads of a tape unit so they form a right angle with the longitudinal

axis of the tape.

**BAFFLE:** The board on which one or several loudspeakers are mounted. Separates the radiation from the front and back of the speaker.

**BALANCE CONTROL:** Potentiometer used to adjust volume difference of left and right stereo channels.

**BANDPASS FILTER:** A circuit which will pass signals above (high bandpass) or below (low bandpass) a certain frequency while attenuating others.

**BASE:** A thin, strong and somewhat flexible material, usually a polyester or acetate film, on which is deposited a magnetic formulation to make up recording tape.

**BASS:** Low audio frequency range, below approximately 200 Hz.

**BASS REFLEX:** Loudspeaker enclosure with an outlet permitting sound from the rear of the speaker cone to be radiated to the front.

**BEAT:** A pulsation caused by interaction of two waves of different frequencies.

**BIAS:** An electrical signal of relatively high frequency applied to magnetic tape during the recording process, along with the audio signal, to permit the recording of higher (treble) frequencies, ordinarily not possible because of customary magnetic characteristics of all recording tapes. The bias frequency is too high in pitch to be audible, being several times higher than the highest audible frequency the recorder can accept. The bias frequency is

generally in the range of 60 kiloHertz to 120 kiloHertz. In a completely unrelated application, bias is used to describe the side thrust on a tonearm.

**BIAS COMPENSATOR:** See Anti-skating Device.

**BINAURAL:** Two eared. Sometimes used erroneously to mean stereophonic.

**BI-RADIAL STYLUS:** See Elliptical Stylus.

**BLOCK DIAGRAM:** A schematic diagram illustrating the main circuit blocks and signal flow in an electronic device.

**CAPACITOR:** A device which can store an electric charge.

**CAPSTAN:** Drive spindle in a tape deck. The tape is pressed against the capstan by a pinch roller.

**CAPTURE RATIO:** An FM tuner's ability to reject unwanted FM stations and interference occurring on the same frequency as the desired station.

**CARDIOID MICROPHONE:** A microphone with a directional characteristic that resembles the shape of a heart.

**CARRIER:** Main radio signal from a transmitter. Can be modulated in different ways (AM, FM) to convey sound or picture information.

**CARTRIDGE:** (a) phono pickup; (b) endless loop tape in a packaged, standardized container.

**CASSETTE:** Preloaded container with tape and spools for use on cassette tape recorder. A miniature reel-to-reel tape system.

**CENTER CHANNEL:** An output terminal found on some stereo amplifiers which supplies a monophonic mixed L+R signal.

**CHANNEL:** A complete sound path. Monophonic or mono systems are single channel. Stereophonic or stereo has two channels usually identified as L (left) and R (right). A mono system can be played through a two-channel system, with both channels carrying the same sound. The sound from the speakers will be mono even though two channels are used.

**CHANNEL SEPARATION:** Degree to which left and right channel signals are separated in a stereo pickup, FM stereo tuner, amplifier, etc.

**CHARACTERISTIC:** Refers to a characteristic curve which conveys information about an amplifier or other circuit.

**COAXIAL CABLE:** A cable consisting of an inner conductor and an outer screen. Used as antenna leads and for interconnecting audio units.

**COAXIAL SPEAKER:** A loudspeaker consisting of a bass cone with a concentrically mounted tweeter.

**COMPATIBLE:** (a) FM MPX signal receivable as mono by a radio or tuner;  
(b) Stereo record playable with a mono pickup.  
(c) Stereo pickup suitable for playing mono records, too.

**COMPENSATION:** See Equalization.

**COMPLIANCE:** The flexibility of phono cartridge. The unit of compliance is  $10^{-6}$  cm/dyne.

**COMPONENT SYSTEM:** An audio system consisting of separate units: turntable, tuner, amplifier, speakers, etc.

**CONDENSER MICROPHONE:** A microphone utilizing the changes in capacitance caused in a condenser when one of its plates — the microphone membrane — vibrates in rhythm with sound waves.

**CONICAL STYLUS:** A stylus in circular form; one whose crosssectional area at right angles to its longitudinal axis is a circle.

**CONTROL AMPLIFIER:** A preamplifier and amplifier combined in one unit.

**COST-PERFORMANCE RATIO:** A way of evaluating a unit's over-all performance by grading its characteristics with points, and dividing the sum of accrued points by the cost. Naturally highly individualistic.

**COUNTERWEIGHT:** Weight fitted at rear end of tonearm behind the pivot to counter the weight of the arm/head assembly and to permit adjustment of the tracking force.

**CROSSOVER FREQUENCY:** In loudspeaker systems and multi-amplifier audio installations, the borderline frequencies between low/medium range and medium/high range speakers or amplifiers. The point at which two bands of frequencies are separated, such as the frequency at which mid-range and tweeter re-

sponse are divided.

**CROSSTALK:** Leak of right channel signal into left channel, and vice versa. Expressed as level of unwanted signal in relation to wanted signal channel, measured in dB.

**CUEING:** The marking or other identification of particular points on sections of tape, to aid in the location of specific, desired selections or portions of the recording. This can be done with a grease-pencil on the tape or by making a record of readings on a digital index counter, when there is one on the recorder.

**CUTTING:** The process of engraving undulating grooves in a rotating, wax-coated disc. An important step in the manufacture of phonograph records.

**CUTTING STYLUS:** Stylus used for cutting of phonograph records.

**DAMPING:** Reduction of resonant effects by use of resistance or its mechanical and acoustic equivalents.

**DAMPING FACTOR:** Ratio of loudspeaker impedance to amplifier's internal impedance. Denotes amplifier's ability to damp unwanted, residual speaker movement.

**DB (DECIBEL):** A logarithmic unit used to express the ratio between two acoustic or electrical power, voltage or current levels.

Mathematically:

$$\text{dB} = 20 \log_{10} \frac{\text{level}_2}{\text{level}_1}, \text{ or } 10 \log_{10} \frac{\text{power}_2}{\text{power}_1};$$

A unit of relative intensity of sound or an electrical signal, used for comparing the in-



tensities of two different signals (e.g., one may be 20 dB greater than the other), or expressed with reference to some fixed, arbitrary level (e.g., zero dB). A difference of one or two dB is generally considered the smallest that can be differentiated by the human ear.

**DECODER:** In an FM stereo tuner, the circuit that extracts the left and right channel signals from an FM MPX broadcast signal. Also a device that extracts four-channel sound from two-channel encoded sound.

**DE-EMPHASIS:** Attenuation of high sound frequencies in an FM tuner, to counteract the boosting of these frequencies ("pre-emphasis") done at the FM station.

**DEMAGNETIZER:** A component or device for removing unwanted magnetism that builds up with use in the heads of a tape recorder.

**DEMODULATION:** The process of "extracting" from a modulated high or intermediate frequency wave the original audio signal.

**DERIVED CENTER CHANNEL:** See Center Channel.

**DERIVED FOUR-CHANNEL SOUND:** A method of obtaining four-channel sound from two channel sound sources, such as stereo records or tapes. Also known as 2-2-4 system.

**DIN (DEUTSCHE INDUSTRIE NORMEN):** German Industrial Standards. In audio, the German standard of plugs, sockets, etc.

**DISCRETE:** Four-channel sound. Quadraphonic sound handled as such without conversion to two-channel. Also known as a 4-4-4

system. Four independent sound sources on tape or disc played back via two stereo amplifiers into four speakers.

**DISPERSION:** Distribution of sound from a speaker through a room.

**DISTORTION:** Output signals not present in the original input. Distortion may also include noise, hum or dips (exaggerations or depressions) in the frequency response — in short, any departure from the original. See harmonic distortion, IM distortion.

**DRIFT:** Tendency of a tuner to move away from optimum adjustment as its components become warm. Compensated by AFC.

**DROP-OUT:** In tape recording and playback, the “holes” in the sound caused by thin or bare spots on the tape.

**DUAL CONE:** Speaker consisting of separate bass and treble cones mounted concentrically and driven by the same coil. See also Coaxial Speaker.

**DUBBING:** Copying of already recorded material. In tape recording, playing a recorded tape on one machine while recording it on another. The copy is called a dub.

**DYNAMIC MASS:** The effective mass of the moving parts of a pickup cartridge. This is not simply the sum of the masses of each component, but rather the equivalent mass that determines the mechanics of its behavior.

**DYNAMIC RANGE:** In program material, the range of signal amplitudes from highest to lowest; the range (in dB) which a device will

handle.

**ECHO:** A somewhat weaker duplicate of the original sound, following it almost immediately. A condition produced by print through.

**EFFICIENCY:** Ratio of output to input power in a transducer. In loudspeakers, the percentage of electrical input available as acoustic output.

**ELECTROSTATIC SPEAKER:** A loudspeaker utilizing the principle of a membrane vibrating in a strong electric field.

**ELLIPTICAL STYLUS:** A pickup stylus shaped so that its width across the groove is greater than the width of its sides. Claimed to have better high frequency characteristics than round styli.

**ENCLOSURE:** The cabinet which houses one or more speaker units. Has great influence on bass response of speaker.

**ENCODER:** A matrix circuit for combining four sound channels into two.

**EQUALIZATION:** Correction for frequency non-linearity of recordings. Phonograph records are cut with low frequencies attenuated and high frequencies boosted. Equalization compensates for this, producing a flat frequency characteristic. Also known as compensation.

**EQUALIZER AMPLIFIER:** In a pre-amplifier, the circuit which amplifies and "flattens" the phono input signal. Needed because phonograph records are not cut with flat frequency

response but according to a standard "equalization" curve.

**FEEDBACK:** Signal from output of amplifier or electronic network applied to input in anti-phase (hence negative feedback) to reduce distortion and noise, and to flatten or otherwise shape frequency response. Also, unwanted acoustic feedback.

**FERRITE CORE ANTENNA:** An antenna, used chiefly for AM reception, consisting of wire windings around a core of ferrite. Advantages are: compact size, good sensitivity and high directionality.

**FET (FIELD EFFECT TRANSISTOR):** Special kind of transistor consisting of metal oxides. **Amplifies voltage, not current. Used in audio equipment** because of its good linearity and stable impedance.

**FIELD STRENGTH:** The intensity of an electrical or magnetic field.

**FILTER:** A circuit which attenuates signals above, below, or at a particular frequency.

**FLUTTER:** Quick waver of pitch caused by speed fluctuations in the movement of tape or discs.

**FLYWHEEL:** A disk of large mass which, when rotating, has the tendency to maintain its rotational velocity. This effect is utilized in tape equipment and turntables to maintain constant speed.

**FM (FREQUENCY MODULATION):** Type of modulation of radio waves in which the frequency, not the amplitude of the carrier is

modulated by the audio signal. FM broadcasting achieves higher sound quality.

**FOUR-CHANNEL STEREO:** An audio technique using four (instead of two) channels for sound reproduction.

**FREQUENCY:** The number of complete cycles of a wave per second. The basic unit is the Hertz (Hz) equivalent to the cycle per second (cps). Multiples are the kiloHertz (thousand cycles per second) and the megaHertz (million cycles per second). KiloHertz is abbreviated as kHz; megaHertz as MHz.

**FREQUENCY RESPONSE:** The frequency range which a unit will reproduce or respond to.

**FRONT END:** Section of a tuner that selects the wanted station from the radio band and converts the RF signal to IF.

**FUNCTION SELECTOR:** In an amplifier or receiver, the switch or knob which selects the different program sources such as phono, FM, AM, aux. etc.

**GAIN:** Degree of signal amplification achieved in an amplifier circuit. Expressed in dB. Opposite: negative gain or loss.

**GAP:** Vertical slit in a tape-head. In the gap, a magnetic field occurs during recording, and a magnetic signal is induced during replay.

**GHOST:** In TV, the appearance of a secondary picture slightly to the right of the main picture. Similarly, ghost can be used to mean multipath FM reception. Also, the "images" of the true station frequency that an FM tuner

may receive.

**HARMONIC DISTORTION:** The sum of all signals in an output which are multiples of the input signal frequencies ("harmonics"). Their intensities are expressed as a percentage of the total output intensity.

**HEAD:** a) the erasing, recording and playback heads in tape equipment; (b) the shell-cartridge assembly of or attached to a tone-arm.

**HEAD ALIGNMENT:** Adjustment of the heads in a tape recorder so they are at right angles to the longitudinal axis of the tape. Also known as azimuth alignment.

**HEADPHONES:** Small transducers, usually mounted in pairs on a bracket to fit over the head and designed to make intimate contact with the ears. Also known as earphones or headsets.

**HEAD SHELL:** The — often detachable — part of a tonearm which carries the cartridge.

**HEAT SINK:** A device used to remove heat from electronic components such as tubes, transistors, etc.

**HERTZ (HZ):** Unit of frequency, equal to one cycle per second.

**HORN:** Speaker unit using a trumpet-bell shaped, flaring funnel to couple its sound vibrations to the surrounding air.

**HUM:** Unwanted low frequency tone. Usually caused by 50 Hz or 60 Hz AC and its harmonics.

**HYSTERESIS MOTOR:** A motor used in high quality turntables. Characterized by constant speed regardless of power voltage fluctuations.

**IC (INTEGRATED CIRCUIT):** Solid circuit block containing the functions of numerous transistors, diodes, resistors, capacitors, etc.

**IF (INTERMEDIATE FREQUENCY):** The frequency which results in a tuner when the incoming signal from the antenna is mixed with the oscillator frequency.

**IF TRANSFORMER:** Component in tuner or radio receiver used to couple or feed IF signals between successive amplifying transistors or tubes. Windings tuned with capacitors or polyiron slugs to resonate transformer at the fixed IF frequency.

**IHF (INSTITUTE OF HIGH FIDELITY):** Institute founded by American manufacturers of audio equipment, devoted to the improvement of audio technology, standardization of test and measuring methods, etc. "IHF" in audio specifications means that values were obtained in measurements according to IHF standards.

**IHF MUSIC POWER:** The ability of an amplifier to handle power peaks of short duration, as compared to sustained power levels. Example: An amplifier capable of delivering 50 watts of audio power continuously, might be capable of handling 65 watts for short periods of time.

**IMAGE REJECTION:** The ability of a tuner to reject an RF signal which appears to be received, but which is actually a sum or difference frequency of the tuner's oscillator and intermediate frequencies.

**IM DISTORTION:** Intermodulation distortion. (see Distortion). Signals in output caused by interaction of two or more input signals, but not harmonically related to them. Expressed as a percentage of total signal intensity. IM distortion is known to cause listener fatigue.

**IMPEDANCE:** Resistance to the flow of alternating current. Measured in ohms. It may vary with the frequency of the applied alternating current.

**INDUCED MAGNET:** A pickup cartridge in which both magnet and coils are fixed. The moving part is a tiny iron sheet.

**INFINITE BAFFLE:** Type of loudspeaker mounting without an air path between front and rear of speaker cone.

**INTEGRATED AMPLIFIER:** unit combining a preamplifier and power amplifier. Also called pre-main amplifier.

**INTERFERENCE:** Unwanted influences upon desired signal by extraneous signals, for example from electrical appliances, motors, automobiles as well as from undesirable signals generated within the audio equipment.

**IPS:** Inches per second. A term used in connection with the movement of tape.

**KILOHM:** 1,000 ohms. Abbreviation used is letter K.

**LEADER:** A section of plain tape, ordinarily made of plastic, attached to the beginning of recording tape. Known as a trailer when connected to the end of recording tape.



**LIMITER:** Circuits in an FM tuner that reject unwanted amplitude variations caused by atmospheric or ignition noise, producing an FM signal of constant amplitude.

**LINE OUTPUT:** Output terminal of a preamplifier, tape deck, etc., providing a signal for monitoring, tape recording or supplying a signal to a power amplifier.

**LINEARITY:** (a) Amplitude linearity, distortion of which produces harmonic distortion and intermodulation;  
(b) Frequency linearity referring to the straightness of a frequency response curve.

**LOUDNESS CONTROL (CONTOUR):** A circuit which counteracts the reduced sensitivity of the ear to very low and high notes at low volume levels.

**LOW FILTER:** A filter circuit designed to remove low frequency noises (rumble, hum, etc.) from a program.

**MAGNETIC CARTRIDGE:** A cartridge which derives its electrical output signal from changes effected in a magnetic circuit by means of some mechanical device such as a moving coil, moving magnet.

**MAIN AMPLIFIER (POWER AMPLIFIER):** Amplifier unit which produces the output power required for driving speakers.

**MATRIX:** A circuit used for the addition and subtraction of signals. The circuit used for encoding four related sound sources into two channels on tape or disc, requiring a matrix decoder to retrieve the original four channels.

**MICROVOLT:** Millionth of a volt.

**MONAURAL:** One-eared. Sometimes erroneously used to mean monophonic.

**MONITORING:** Listening to sounds, during the recording process, to judge or control the sound quality. Monitoring can be done with input signals prior to recording or playback immediately thereafter. Monitoring also refers to the physical act of making sound adjustments, such as volume, bass, treble or balance.

**MONOPHONIC:** Recording, transmission and reproduction of sound via a single channel.

**MOVING COIL (MC) CARTRIDGE:** Magnetic cartridge in which the coils move and the magnet is fixed.

**MOVING MAGNET (MM) CARTRIDGE:** Magnetic cartridge in which the magnet moves and the coils are fixed.

**MULTIPATH RECEPTION:** Arrival of FM or TV signal via several paths of different length, due to obstructions, reflecting objects, etc.

**MULTIPLEX:** Transmission of two or more channels on a signal carrier so they can be independently recovered by the receiver. In FM stereo: transmission of  $L + R$  (sum) signal and  $L - R$  (difference) signal on main carrier and subcarrier, respectively. Abbreviated as MPX.

**MULTIPLEX DECODER:** See Decoder.

**MUSIC POWER:** The maximum power available temporarily from a power amplifier. Also

called “dynamic-power”.

**NAB:** (National Association of Broadcasters).

Most widely used standard of tape recording techniques.

**NETWORK:** In audio, a frequency dividing network in a speaker system, or an electronic crossover network in a multi-amplifier installation.

**NOISE:** Unwanted signal consisting of a mixture of random electrical agitations. Also, the sum of all unwanted signals such as hum, hiss, rumble, interference, distortion, etc.

**OHM:** Basic unit of resistance or impedance.

**OMNI-DIRECTIONAL:** Equal sensitivity or output in all directions. Said of antennas, microphones and loudspeakers.

**OSCILLATOR:** An electronic circuit which generates an alternating current, e.g. the oscillator in a tuner produces the frequency used to mix with incoming radio signals.

**OUTPUT IMPEDANCE:** Impedance at output terminals of a device as “seen” by the load.

**OUTPUT STAGE:** Final stage of a power amplifier which supplies power to a loudspeaker.

**OUTPUT TRANSFORMER:** Transformer in tube power amplifier to couple output tubes to loudspeaker.

**OVERLOADING:** Feeding in a signal to a system that exceeds the system’s signal-handling capability.

**OVERTONE:** A tone accompanying the fundamental in a musical note. May or may not be harmonic.

**PHASE SHIFT:** As a signal passes through a tuner, amplifier, etc., some frequencies may lag behind others. In a tuner, this phase shift can, in extreme cases, cause loss of channel separation of FM stereo broadcasts. Phase shift in an amplifier results in blurring of stereo spatial localization and, in serious cases, can cause unstable amplifier performance and distortion.

**PHASING:** Connections between power amplifier and speakers in a stereo system must be made in such a way that signals representing a central sound source cause the speakers to move equi-directionally, i.e. in phase.

**POLARITY:** Positive and negative terminals of a battery or power supply, or the north and south poles of a magnet. Sometimes refers to phasing of cartridges and loudspeakers.

**POWER AMPLIFIER:** See Main Amplifier.

**POWER BANDWIDTH:** The frequency range over which a power amplifier will produce at least half of its rated output power (according to IHF standard).

**POWER HANDLING ABILITY:** Maximum amount of power that can be safely fed into a loudspeaker.

**PREAMPLIFIER:** A circuit unit which takes a small signal, e.g. from a tuner or turntable, and amplifies it sufficiently to be fed into the power amplifier for further amplification.

**PRE-MAIN AMPLIFIER.** An integrated audio amplifier consisting of a pre-amp and a power amp.

**PRINT-THROUGH:** The magnetization of a section of tape from a layer of tape immediately above or below it. Can be caused by excessively strong recorded signals. The symptom of print-through is an echo, a weaker sound following the original sound almost immediately.

**QUADRAPHONIC:** Four-channel stereo.

**QS:** A matrixing technique for encoding four-channel sound into two channels. Also known as a 4-2-4 system.

**QUIETING:** Term sometimes used instead of "muting" in FM tuners.

**RATED OUTPUT POWER:** The maximum power that an amplifier will deliver without exceeding its specified distortion rating.

**RATIO DETECTOR:** Circuit in an FM tuner for extracting audio signals from modulated radio or intermediate frequency signals.

**RESISTOR:** Circuit device which offers resistance to the flow of electric current. Resistors may be made from wire, metallic film, carbon and other materials.

**RESONANCE:** The tendency of a mechanical or electrical device to resonate at a particular frequency.

**RESPONSE:** See Frequency Response.

**REVERBERATION:** Reflection of sound from

walls or ceilings. Echo. Can be created artificially by electronic or mechanical devices to imitate the effect of large halls.

**RF (RADIO FREQUENCY):** The frequency of a radio carrier wave. AM covers 535—1605 KHz, FM occupies 88—108 MHz.

**RIAA (RECORD INDUSTRY ASSOCIATION OF AMERICA):** Usually refers to the disc recording and replay frequency response curves established as standards by this association.

**RUMBLE:** Low frequency noise resulting from vibrations in platter and motor of a turntable and from record warp.

**SELECTIVITY:** The ability of a tuner to receive only the desired station while rejecting stations which are not required. Measured in decibels (dB).

**SENSITIVITY:** The input signal level required by a tuner, amplifier, etc., to be able to produce a stated output. The lower the necessary input, the higher the sensitivity.

**SEPARATION:** See Channel Separation.

**SHIBATA STYLUS:** Stylus developed to play multiplexed discs (four-channel records). Resembles an elliptical stylus but has radius of 7 to 8 microns.

**SIGNAL-TO-NOISE RATIO:** Abbreviated as S/N ratio. Ratio of desired signal voltage to unwanted noise and hum voltage. A high S/N ratio is desirable. Expressed in decibels (dB).

**SOLID-STATE:** Circuits using semiconductors, e.g. transistors and integrated circuits (ICs).

**SPEAKER SYSTEM:** Enclosure containing two or more speakers and a crossover network. Speaker box.

**SQ:** A matrixing technique for encoding four-channel sound into two-channel. Also known as 4-2-4 system.

**STEREOPHONIC:** Recording transmission and reproduction of sound via two or more independent channels.

**STYLUS:** A finely machined piece of sapphire or diamond. The part of a phono pickup that traces the record groove.

**SYNCHRONOUS MOTOR:** Type of AC electric motor in which rotor speed is related directly to frequency of power supply.

**TAPE DECK:** Tape equipment comprising complete tape transport system, with motors, drive pulleys, linkage etc., as well as pre-amplifiers for recording and playback, but no power amplifier or speakers.

**THD (TOTAL HARMONIC DISTORTION):**  
See Distortion.

**TONE CONTROL:** Control circuits used to vary the proportion of bass and treble in the sound.

**TRACKABILITY:** Ability of phono cartridge to track record grooves of high amplitude and velocity. Also, see compliance.

**TRACKING ERROR:** Deviation of center-line of phono cartridge from tangential of record at point of stylus contact. Caused by tonearm geometry.

**TRANSDUCER:** Device for converting energy from one form to another; e.g. a loudspeaker converts from electrical energy to acoustic energy, a tape head converts from magnetic energy to electrical energy.

**TRANSIENT:** Abrupt change of state; sudden change in signal amplitude as caused by percussion instruments, "attack" of plucked strings, etc.

**TRANSIENT RESPONSE:** The ability of an amplifier, cartridge or speaker to follow sudden changes in the level of a sound. Also see previous entry.

**TUNER:** The part of a receiver, or a separate unit, which receives radio broadcasts and converts them into audio frequency signals.

**TUNER-AMPLIFIER:** Unit combining the functions of a tuner, preamplifier and power amplifier. Also called "Receiver".

**TWEETER:** A speaker designed to reproduce the high part of the sound spectrum.

**VENT:** Opening or port in a bass reflex loudspeaker enclosure.

**VOICE COIL:** A coil of wire attached to a speaker cone. When placed in the field of a magnet, the coil responds to the alternating signal from the amplifier, moving the speaker cone back and forth in accordance with the frequency and intensity of the signal.

**VOLT:** Basic unit of electrical pressure or electromotive force.



**WOOFER:** A speaker designed to reproduce the low part of the sound spectrum, e.g. organ bass, etc.

**WOW:** Slow variation of pitch caused by speed fluctuation in tape or record movement.

## other books of interest



### **Making and Repairing Transistor Radios**

by W. Oliver

This book covers **practical** radio. Obviously it does take in elementary theory but in the main, its aim is to make available to beginners a wealth of practical advice. Mr. Oliver details many short cuts to successful radio making and repairing.



### **Introduction to Video Recording**

by W. Oliver

This book deals with Video Recording from two angles. For the non-technical reader, it tells in simple terms how video recorders and players work. And for the user who wants more technical information, it gives details of typical equipment. Suppliers and technical advisory services are listed. Auxiliary equipment, closed-circuit television systems, and the practical applications of video recording in domestic, industrial and educational fields are discussed.



### **Transistorised Radio Control for Models**

by D. W. Aldridge

This practical handbook on Radio Control is intended for model makers and experimenters. In it are included "Build-it-Yourself" systems for all levels—some that require little electronic knowledge together with those of a more sophisticated nature. The author explains how to make all of the equipment and progresses from simple steering control to more elaborate systems giving complete control.