

AUDIO ENGINEERING

SEPTEMBER
1952
35c

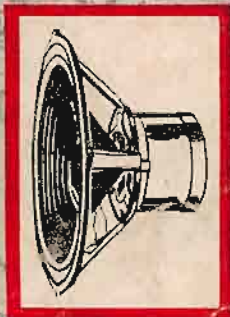

THE WORLD OF SOUND

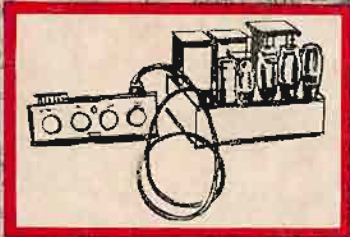
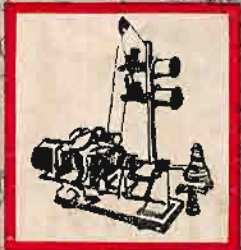

FULL DIMENSIONAL SOUND

Lifts "HI-FI" to a new HIGH

—thanks to the finest in modern sound recording methods and equipment



"FULL DIMENSIONAL SOUND" is an apt description of the tonal perspective that gives these fine records the true balance, depth and full tonal range of the original live performance.

To achieve these outstanding results, Capitol's sound recording methods and equipment include all of the latest technical advances in the audio field. Recording materials — both discs and tape — must measure up to the highest professional standards in every respect. And Capitol — like leading phonograph record manufacturers the country over — has found that Audiodiscs and Audiotape are the ideal combination for meeting these exacting requirements.

Remember — Audiodiscs and Audiotape are made *by* audio engineers, *for* audio engineers. Their consistent uniform quality is the result of more than a decade of experience by the only company in America devoted solely to the manufacture of fine sound recording media — both discs and tape.

AUDIO DEVICES, Inc.

444 MADISON AVE., NEW YORK 22, N. Y.
Export Dept.: 13 East 40th St., New York 16, N. Y., Cables "ARLAB"

...including
audiotape*
for the original sound



...and **audiodiscs***
for the master recording

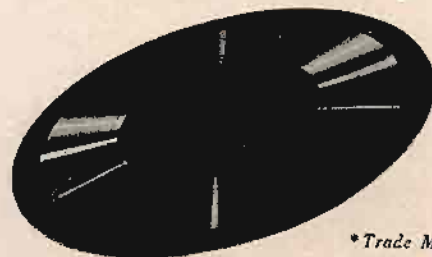

*Trade Mark

Successor to **RADIO** —Established 1917

AUDIO ENGINEERING

INCLUDING



C. G. McProud, Editor and Publisher

Harrie K. Richardson, Associate Editor
Luci Turner, Production Manager
Lucille Carty, Circulation Manager

Edgar M. Villchur, Contributing Editor
S. L. Cahn, Advertising Director
H. N. Reizes, Advertising Manager

Editorial Advisory Board

Howard A. Chinn
John D. Colvin
C. J. LeBel
J. P. Maxfield
George M. Nixon



Representatives

H. Thorpe Covington, Special Representative
677 N. Michigan Ave., Chicago 11, Ill.
Sanford R. Cowan, Mid-West Representative
67 W. 44th St., New York 18, N. Y.
James C. Galloway, Pacific Coast Sales
816 W. 5th St., Los Angeles 17, Calif.
Technical Book & Magazine Co.
297 Swanston St., Melbourne, C. I.
Victoria, Australia

CONTENTS

SEPTEMBER, 1952

Vol. 36, No. 9

Audio Patents— <i>Richard H. Dorf</i>	2
Letters	8
Technicana	12
New Literature	14
Editor's Report	16
Limitations of Magnetic Tape— <i>W. S. Latham</i>	19
A Preamplifier Switching and Equalizing Unit for Critical Listening— <i>M. V. Kiebert, Jr.</i>	21
The Violin— <i>Part 1—Albert Preisman</i>	24
A New Approach in Loudspeaker Enclosures— <i>John E. Karlson</i>	26
Design Considerations of Duplex Loudspeakers— <i>Alexis Badmaieff</i>	28
Planning and Building a Radio Studio— <i>Part 4—Eugene F. Coriell</i>	30
A Proposed Solution to the Loudness Control Problem— <i>John R. Schjelderup</i>	34
Handbook of Sound Reproduction— <i>Chapter 4—Edgar M. Villchur</i>	38
AUDIO engineering society SECTION	
Magnetic Audio Frequency Fundamentals— <i>A. M. Vincent</i>	42
AES Membership Application	66
The Fourth Audio Fair—October 29 to November 1	76
Employment Register	78
Record Revue— <i>Edward Tatnall Canby</i>	48
New Products	56
Book Reviews	68
Price and Product Changes— <i>Radio's Master Reports</i>	77
Industry People	79
Advertising Index	80

COVER

Primarily, our cover this month honors the 19th British National Radio and Television Exhibition—one of the World's major electronic shows. More importantly, however, it is a tribute to the respect and regard which are the heritage of two great and friendly nations. Products sketched are typical of those with which our British cousins are maintaining a stable democracy in a turbulent sea of stress and privation. (*Design and art work, courtesy British Industries Corporation, New York.*)

RADIO MAGAZINES, INC., P. O. BOX 629, MINEOLA, N. Y.

AUDIO ENGINEERING (title registered U. S. Pat. Off.) is published monthly at 10 McGovern Avenue, Lancaster, Pa., by Radio Magazines, Inc., Henry A. Schuber, President; C. G. McProud, Secretary, Executive and Editorial Offices: 204 Front St., Mineola, N. Y. Subscription rates—United States, U. S. Possessions and Canada, \$3.00 for 1 year, \$5.00 for 2 years; elsewhere \$4.00 per year. Single copies 35c. Printed in U. S. A. All rights reserved. Entire contents copyright 1952 by Radio Magazines, Inc. Entered as Second Class Matter February 9, 1950, at the Post Office, Lancaster, Pa. under the Act of March 3, 1879.

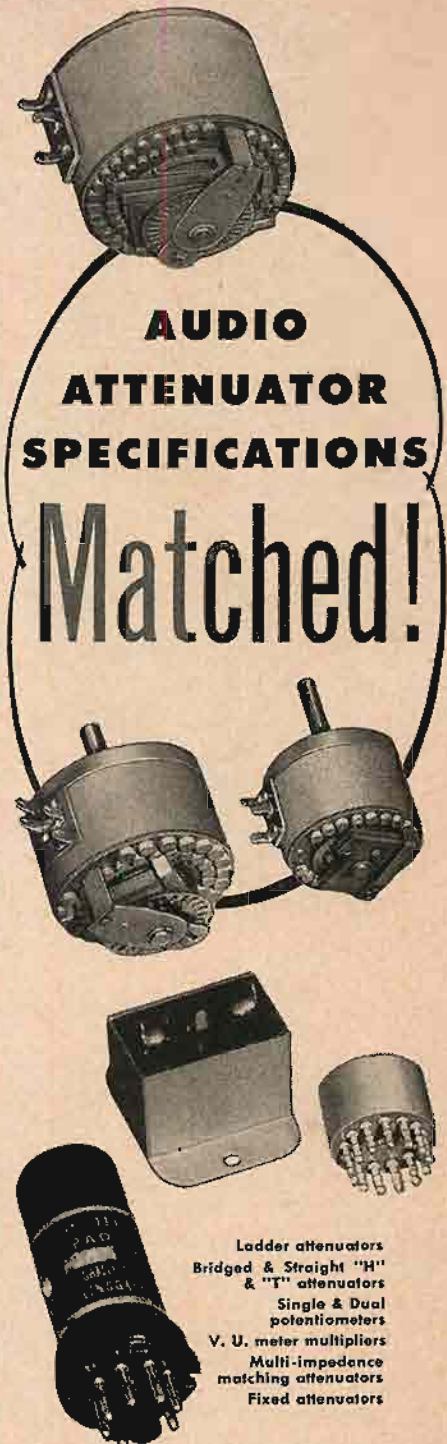

AUDIO ATTENUATOR SPECIFICATIONS Matched!

- Ladder attenuators
- Bridged & Straight "H" & "T" attenuators
- Single & Dual potentiometers
- V. U. meter multipliers
- Multi-impedance matching attenuators
- Fixed attenuators

Shallcross offers a complete line of over 200 standard fixed, rotary-step, and key type attenuators to match practically any audio requirement. Complete facilities are also available for making custom-built units to specifications.

Shallcross

MANUFACTURING COMPANY

Collingdale, Penna.



where precision matters...

THERMADOR

Transformers for Television
... Radar... Aircraft...
Geophysics... Radio

You will find Thermador ready, willing and fully qualified to handle your transformer requirements. Engineering experience and manufacturing know-how, developed over a period of 35 years, form the hard core that makes Thermador today's largest West Coast manufacturer of electrical appliances and transformers. We would like to work with you on your next project involving the design and production of transformers for specific requirements...including joint Army-Navy specifications.

transformers:

- Audio Auto Geophysical
- Driver Filament High-Fidelity Audio
- Input-Output Midget Plug-In
- Plate Power Television
- Tube to Line

...also Chokes and Reactors



THERMADOR ELECTRICAL MANUFACTURING CO.

3-320
5110 District Boulevard • Los Angeles 22, Calif.

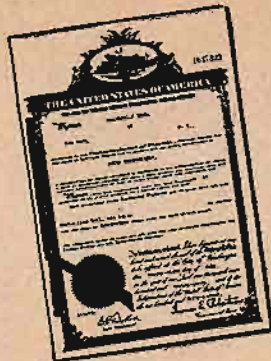

AUDIO PATENTS

RICHARD H. DORF*

FIXED-FREQUENCY audio oscillators find use in a number of applications, most of which require that the oscillator be extremely stable. Paul Jarmotz is the inventor of a circuit whose frequency stability is said to be independent of mechanical shock, variation in supply voltages, and changes in tube characteristics. While it is designed as a fixed-frequency oscillator, in which role it would be suitable for audio-frequency-standards, electronic musical instrument tone generators and radio control circuits, among other uses, there is no reason why it could not be made variable in steps by switching component values. This would be quite useful for quick frequency runs on audio equipment (General Radio has made a step-frequency oscillator for this purpose), tuning musical instruments (a 12-position switch), and the like. The patent, No. 2,589,816, is assigned to the United States Government.

The oscillator is of a type the inventor characterizes as "balanced series loop," and has a low-distortion sine-wave output. The basic circuit is diagrammed in Fig. 1. Two triode stages are provided, each with a plate-load resistor and an unbypassed cathode resistor. The plate of each is connected to the grid of the other in a simple positive feedback arrangement, and both grids are biased somewhat positively.

The circuit looks somewhat like a multivibrator and operates on roughly the same principle. A random disturbance in either tube is transferred to the other, then fed back to set up oscillations as the process continues. Unlike a multivibrator, however, the buildup is severely limited by the presence of the cathode resistors. These are in the circuit, not to provide bias, but to provide degeneration and control the gain. The value of each resistor is such that the gain of the stages is just sufficient to overcome the losses in the feedback loop; as a result, sine-wave oscillations are produced.

The two stages and the feedback paths are symmetrical, the frequency being controlled by the values of C_1 and C_2 , and R_7 and R_8 .

* 255 W. 84th St., New York 24, N. Y.

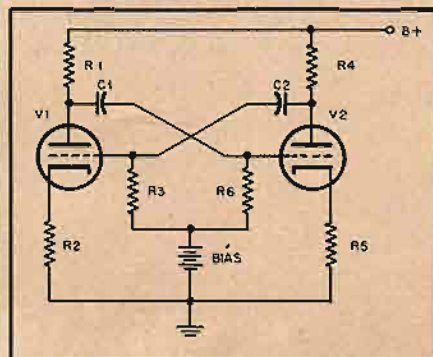

Fig. 1

and R_6 . The patent gives formulas by which the values of the frequency-controlling elements may be approximated, but a little experimentation will give precise results without difficulty. This is preferable because stray capacitance in tube inputs and wiring render the formulas less than exact.

Figure 2 gives a practical circuit (sorry, the inventor gave no values) for a 2000-cps oscillator. The components are coded the same as in Fig. 1, but there are more of them. The positive bias for the grids is obtained from a voltage divider R_{11} - R_{12} across the power supply and R_9 is added between the cathodes for maximum stability adjustment (equalization of cathode voltages, probably). R_3 and R_6 have been added in the feedback paths and C_3 and C_4 have been added in shunt with the grid resistors. C_5 is an output coupling capacitor. The impressive addition is R_{10} , a variable resistor whose function, according to the inventor, is to vary the B-plus voltage as a convenient method of varying oscillation amplitude. A stable oscillator indeed!

A strictly practical approach to designing one of these oscillators ought to work

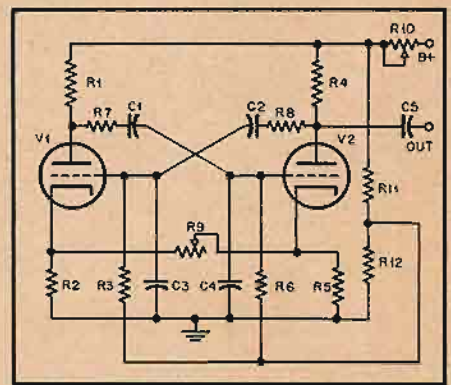

Fig. 2

very well. Beginning with a duo-triode such as the 6SN7-GT and offhand values for plate and cathode resistors—perhaps 0.1 megohms for all four, select random values for R_7 , C_1 , and their opposite numbers. Place variable resistors in the cathode circuits and replace R_{11} and R_{12} with a potentiometer of perhaps 0.1 megohms. A little knob-twiddling should quickly determine final values and frequency can be adjusted later on a ratio basis, starting with the existing values and frequency. C_3 - C_4 and R_3 - R_6 may or may not be necessary, depending on frequency.

Low-Distortion Cathode-Follower

Cathode-followers have found wide use as impedance-transforming circuits because of low frequency distortion, high input impedance, and low cost. They are, however, little less subject to nonlinear distortion than standard stages especially when the

[Continued on page 6]

HEAVY DRIVE SHAFT:

A unique feature! Exclusive with Garrard!

Drive shaft for 33 1/3 rpm and 45 rpm is heavy, thus obtaining more consistent quality at critical low speeds. Wows and wavers eliminated.

TRIPLE SPEED SWITCH:

Speed changes are clearly marked, easily made. The RC-80 plays 33 1/3, 45 and 78 rpm. Records are placed on the player and simple settings made. Action is then completely automatic, including automatic shut-off after last record of any size.

CONVENIENT START-STOP-REJECT LEVER:

Start, stop and reject lever are combined and located conveniently away from tone arm.

PUSHER TYPE PLATFORM:

Adjusts simply to 7"-10"-12" records regardless of diameter or size of spindle hole. No record changing mechanism has been developed to equal the performance of the precision pusher platform. For records with standard center holes, the pusher platform is the only method that gives positive gentle record operation.

PULL-AWAY IDLER WHEEL:

Avoids flattening of drive wheel when changer is not operating.

AUTOMATIC STOP:

Insures positive and unfailing action at end of any type record.

BALANCE-MOUNTED TONE ARM:

Parallel lift tone arm construction guarantees true tangent tracking. Disturbing resonance eliminated.

INTERCHANGEABLE PLUG-IN HEADS:

Carefully engineered to accommodate user's choice of crystal or magnetic cartridges for standard and micro-groove reproduction, such as Astatic, Pickering, Audak and GE twist models.



WEIGHTED TURNTABLE:

RC-80 turntable is heavily weighted to give flywheel action so that any variations in the drive motor are not reflected in record reproduction. No turntable rumble.

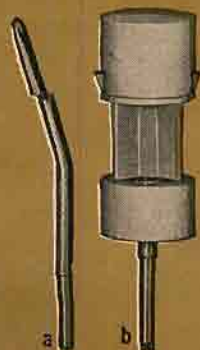

HEAVY DUTY SILENT 4-POLE MOTOR WITH ABSOLUTELY NO RUMBLE:

Speed maintained throughout a wide variation in line voltage. There is no appreciable speed variation operating unit "cold" with a full load or "hot" with one record, regardless of weight, thickness or diameter of records.

IMPORTANT!

Only a 4-pole motor can assure no hum when used with sensitive magnetic pickups.

TWO INTERCHANGEABLE SPINDLES:

Easily inserted, the two Garrard Spindles accommodate all records as they were made to be played. (If user prefers one spindle can be used throughout simply by plugging center hole of 45 rpm records.) a: Typical Garrard spindle for standard center holes. b: Easily inserted wide spindle, for 45 rpm records, remains stationary when record is played. Only a small collar revolves, assuring longer center hole and record wear.

GARRARD

WORLD'S FINEST RECORD CHANGER

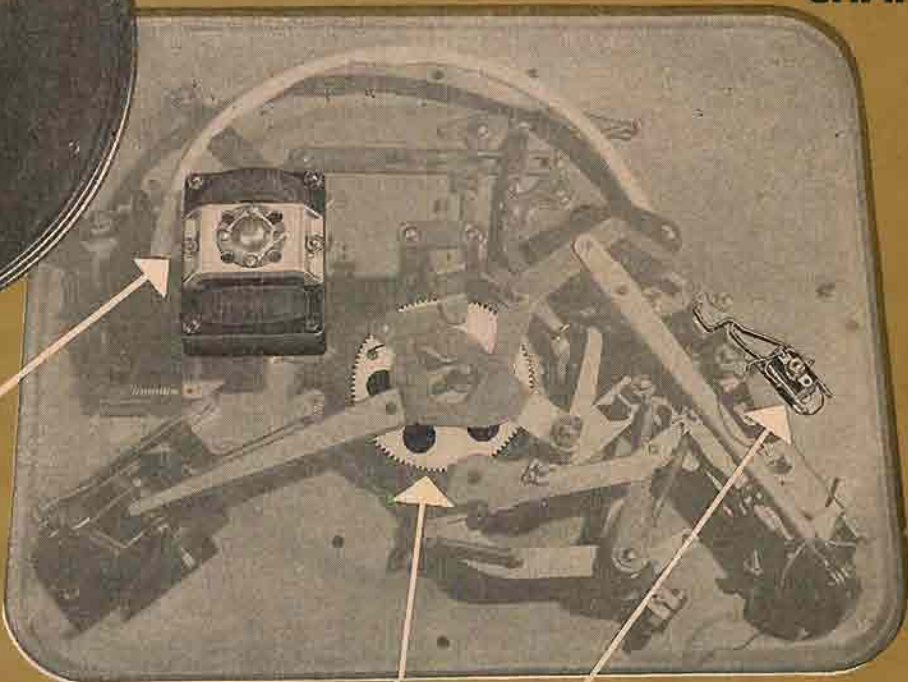

PRECISION GROUND GEARS:

Perfectly meshed to insure constant smooth action and years of service.

MUTING SWITCH:

No sound while changer operates on run-in or run-off grooves. Continuity of music undisturbed by noises.

WATCH-LIKE CONSTRUCTION

All parts are precision made, fastidiously assembled and simple to adjust.

A complete stock of replacement parts is readily available to all Garrard owners.

For an excellent description of what to look for in a record changer, we recommend the section devoted to changers in the new book "High-Fidelity Simplified", published by John F. Rider.

MAIL COUPON TODAY for Garrard Fact Sheet and addresses of dealers, to Garrard Sales Corp., Dept. AE-9, 164 Duane Street, New York 13, N. Y.

Send literature to Name..... Address..... City.....Zone.....State.....

We print this page in order to show you the superb engineering which has caused thousands upon thousands of discriminating people, who enjoy records, to insist upon the Garrard "Triumph", World's Finest 3-Speed Record Changer. Take this advertisement to your favorite sound department, and judge for yourself! \$42.30 net, less cartridges

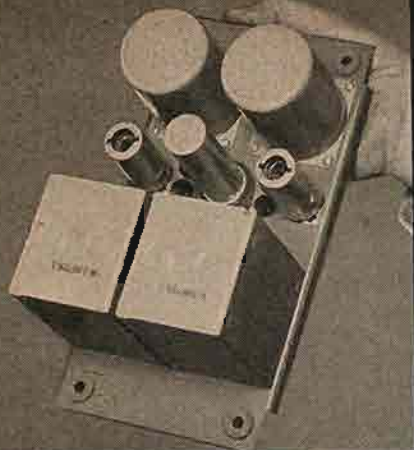

New compact amplifiers—use low-noise, long-life, miniature tubes.

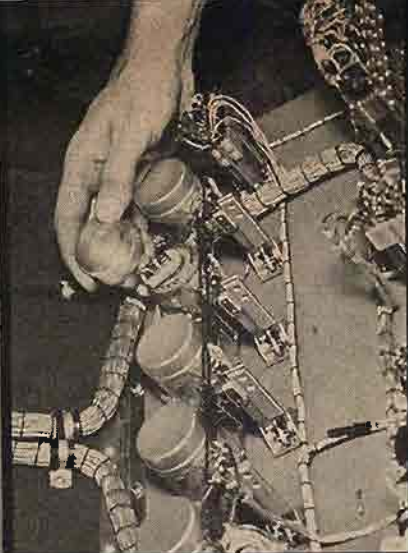

Every component is easy to get at for inspection and maintenance.

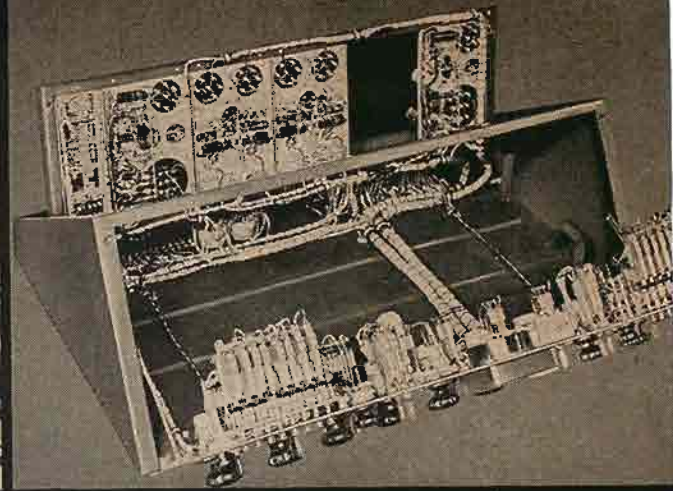

Accessibility, plus! New hinged control panel swings down; amplifier frame swings up.

9 EXTRA FEATURES of the

THE EASY WAY the BC-2B Consolette handles is due in great measure to the careful attention RCA engineers have given to construction details—and to a number of unique operating features (not found in their entirety in any standard consolette). Some of these advantages are pictured on these pages.

For example, see how easy it is to get at

the amplifiers and components. Note how every inch of wiring can be reached without disturbing the installation. See how the consolette fits snugly into the control room—unobtrusively. See how the styling matches other RCA audio and video equipments.

Based on more than 25 years of experience in building studio consolettes, type

BC-2B is in our opinion a high point in consolette design. The instrument includes all essential elements needed by most AM-FM and TV stations. And every feature has been operation-proved—many in RCA deluxe custom-built equipment. *Type BC-2B is available at a "package" price!*

For details, call your RCA Broadcast Sales Representative.

Type BC-2B is styled to match RCA video equipment—like this familiar video console.



... and it's styled to match other RCA audio equipment, too—like this master switcher, for instance.

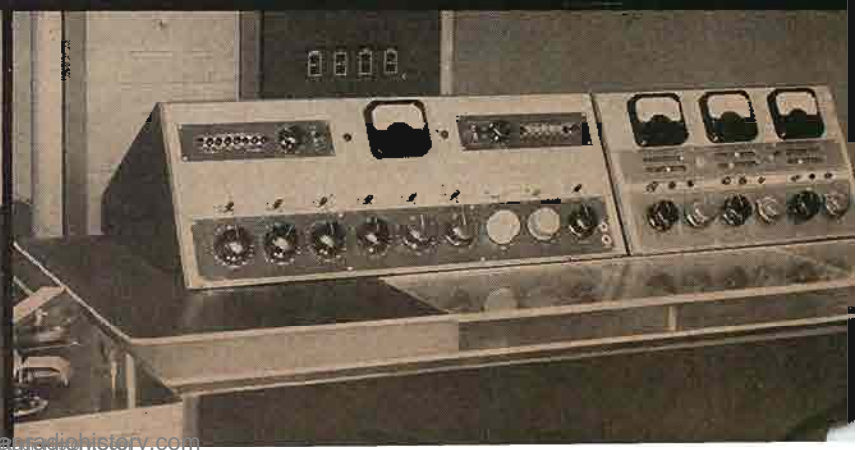

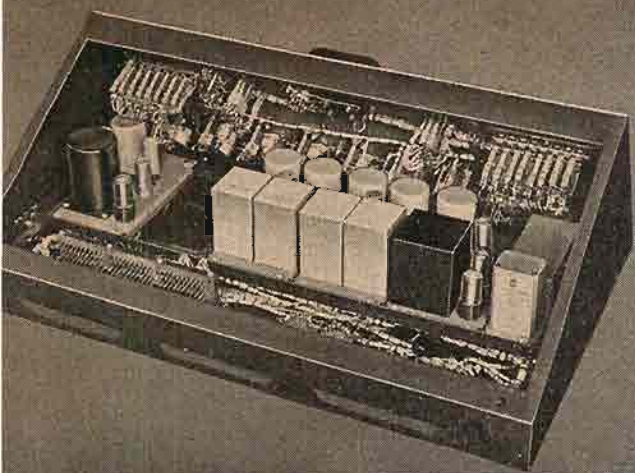

All external connections are made to two terminal blocks. To get at them, just lift the cover.

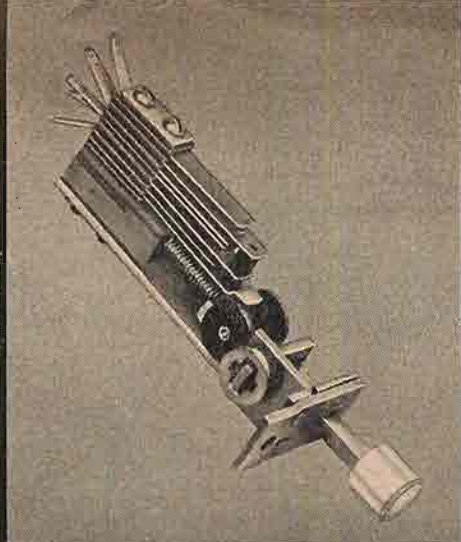

New, reliable interlocking push-button switches are leaf-type and cam-operated.

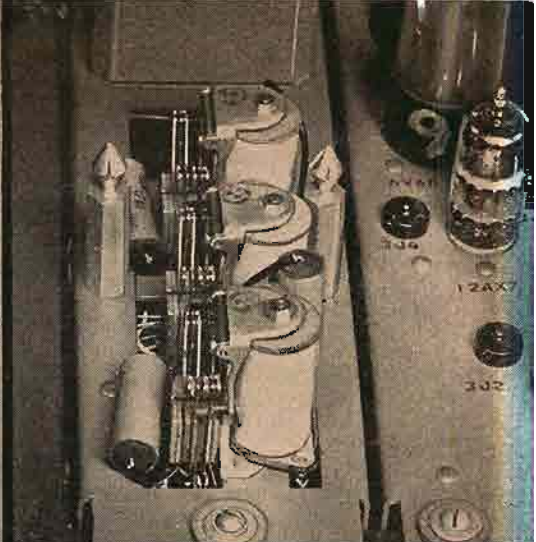

Improved, faster-operating speaker relays eliminate key clicks and audio feedback.

new consolette

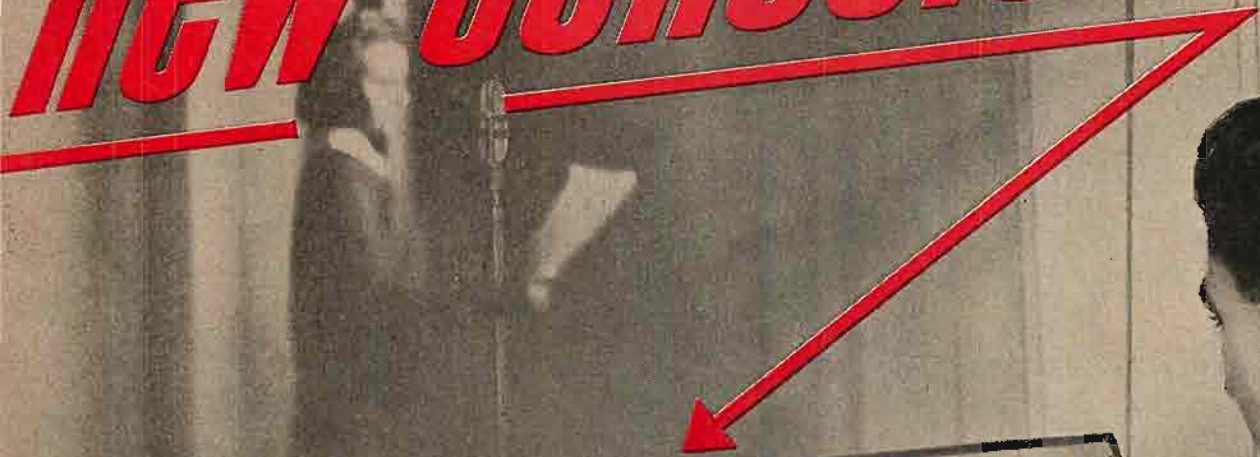

Low height, and 30-degree sloping front and top offer maximum studio visibility. You can install the BC-2B tight up against your studio window. There are no rear connections.



RADIO CORPORATION of AMERICA
ENGINEERING PRODUCTS DEPARTMENT
CAMDEN, N.J.

PLAZA 7-3091



AUDIO & VIDEO PRODUCTS CORP.
730 FIFTH AVENUE • NEW YORK CITY

has been designated manufacturers representative for Metropolitan N.Y.-L.I. and Northern N.J. for the **CINEMA ENGINEERING COMPANY**
MAKERS OF...

• **AMPLIFIERS-COMMUNICATION EQUIPMENT**
Precision-Laboratory-Audio Frequency

• **RESISTORS**
Precision-fixed wirewound

• **EQUALIZERS**
Wave filters, corrective equalizers

• **MAGNETIC RECORDING COMPONENTS**
Recording head, degaussers

• **ATTENUATORS**
Audio frequency types



CINEMA ENGINEERING COMPANY
1510 WEST VERDUGO AVENUE, BURBANK, CALIFORNIA

load impedance is fairly low or the signal level is a trifle too high. A cathode-follower with a microscopically small distortion rating can be very useful in instrumentation—audio signal generators, intermodulation meters, and many other applications in and out of the strictly audio field. Such a circuit has been invented by Norman B. Saunders and assigned to the United States Government. The patent number is 2,592,193.

Distortion in a cathode-follower can be greatly reduced either by keeping the current through it or the voltage between plate and cathode constant. When both are maintained constant, as in this circuit, the error in the output waveform does not exceed .01 per cent.

The circuit is diagrammed in Fig. 3 and utilizes a pentode, a triode, and a gaseous

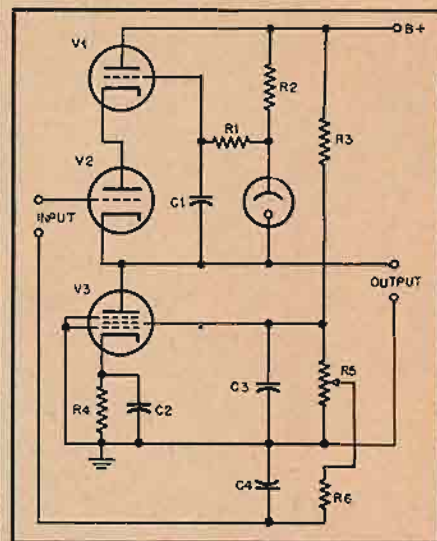

Fig. 3

voltage-regulator tube in addition to the triode amplifier itself, which is V_2 in the figure. The three vacuum tubes are connected in series between the power supply and ground and the input signal is fed to the grid of V_2 , the cathode follower. The "ground" side of the signal connects to the arm of R_3 so that a certain amount of positive bias is connected from voltage divider R_1 - R_2 , through filter resistor R_4 (to remove any audio which may be across R_1 because it is also the pentode screen resistor) and the signal source, to the grid of V_2 . This is a rather awkward bias system for most applications since both sides of the input signal must be above ground for d.c. (C_1 is a bypass to ground for a.c.). However, it seems obvious that a more conventional method would not affect the circuit's operation. The change would merely involve inserting a high-value grid resistor across the input terminals shown and inserting signal between grid and ground.

The pentode V_1 has grounded grid and suppressor. A pentode is essentially a constant current device, its plate current changing very little over fairly wide ranges of plate voltage. Since the current through V_1 is the same as that through V_2 , the pentode fulfills one of the objects of the invention by keeping current in the amplifier tube constant. Its plate resistance is fairly high, placing a high positive voltage on the cathode of V_2 . The positive bias obtained from the arm of R_3 cancels this out and may be adjusted for the correct resultant operating bias for V_2 .

The purpose of V_3 is to fulfill the second

[Continued on page 77.]

CUT CORES
SQUARE
RECTANGULAR
TOROIDAL

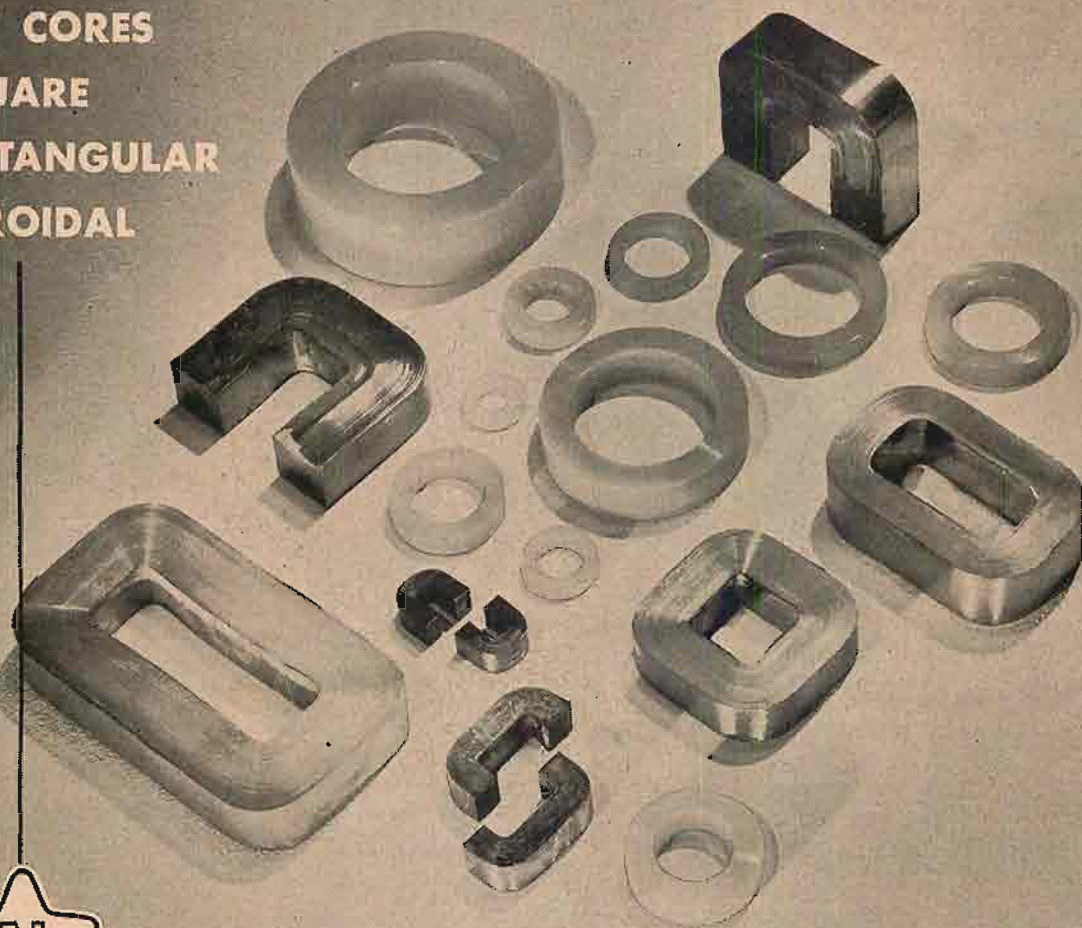

Anything You May Need in **TAPE-WOUND CORES**

RANGE OF MATERIALS

Depending upon the specific properties required by the application, Arnold Tape-Wound Cores are available made of DELTAMAX . . . 4-79 MO-PERMALLOY . . . SUPERMALLOY . . . MUMETAL . . . 4750 ELECTRICAL METAL . . . or SILECTRON (grain-oriented silicon steel).

RANGE OF SIZES

Practically any size Tape-Wound Core can be supplied, from a fraction of a gram to several hundred pounds in weight. Toroidal cores are available in fifteen standard sizes with protective nylon cases. Special sizes of toroidal cores—and all cut cores, square or rectangular

cores—are manufactured to meet your individual requirements.

RANGE OF TYPES

In each of the magnetic materials named, Arnold Tape-Wound Cores are produced in the following standard tape thicknesses: .012", .008", .004", .002", .001", .0005", or .00025", as required.

Applications

MAGNETIC AMPLIFIERS
PULSE TRANSFORMERS
CURRENT TRANSFORMERS
WIDE-BAND TRANSFORMERS
NON-LINEAR RETARD COILS
PEAKING STRIPS . . . REACTORS.

W&D 3963

THE ARNOLD ENGINEERING COMPANY

SUBSIDIARY OF ALLEGHENY LUDLUM STEEL CORPORATION
 General Office & Plant: Marengo, Illinois

here's

absolute reliability

**for heavy duty
audio
amplification**

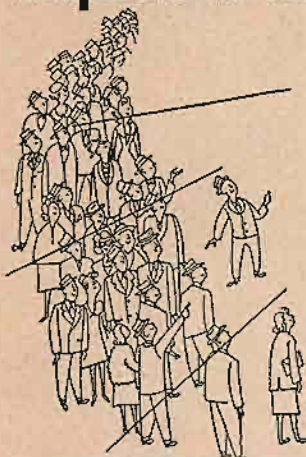

TUNG-SOL



**BEAM
POWER
AMPLIFIER**

If you've been looking for an audio output tube that's stable under the most severe conditions—completely dependable—then this is it! The Tung-Sol 5881 is rugged both mechanically and electrically—and directly interchangeable with the 6L6.

In creating the 5881, Tung-Sol engineers have made lavish use of the design and production techniques which have proved themselves over the past fifteen years—zirconium coating over the carbonized metal plate and pure barium getter to effectively absorb gas for the life of the tube—gold plated wire to minimize grid emission. These are but a few of the major design improvements in the 5881.

Tung-Sol produces the 5881 under laboratory conditions, to assure peak efficiency and maximum uniformity. You'll find this tube has the stuff to take the whole range of audio service requirements from protracted standby periods to repeated heavy overloads. So, if absolute reliability is essential in your audio circuits, the Tung-Sol 5881 is a "must." Order it from your regular supplier.

Write for characteristics and performance data

TUNG-SOL ELECTRIC INC., NEWARK 4, N. J.

Sales Offices: Atlanta • Chicago • Culver City (Calif.)
Dallas • Denver • Detroit • Newark

Tung-Sol makes All-Glass Sealed Beam Lamps, Miniature Lamps, Signal Flashers, Picture Tubes, Radio, TV and Special Purpose Electron Tubes.

LETTERS

Ungilding the Lily

Sir:

In your July issue you make use of the expression "Gilding the Lily." I hope you will not take it amiss if I point out that this is actually a misquotation. I think the original observation about improving the lily was made by Shakespeare, in King John, Act IV, Scene 2, in the following words:

"To gild refined gold, to paint the lily,
To throw a perfume on the violet,
To smooth the ice, or add another hue
Unto the rainbow."*

I am not suggesting that because Shakespeare said something in the 16th century we must forever use the same thing; but I do think that a perusal of these lines shows that the expression "To paint the lily" has some meaning, whereas to talk about "gilding the lily" has none.

G. A. Briggs,
Wharfedale Wireless Works,
Idle, Bradford,
Yorkshire, England.

(* *Italics ours.*—An unguiled lily to Mr. Briggs for his comment. Since the misquotation is better known than the quotation, we followed popular belief. Ed.)

Sir:

We note with interest the article "Gilding the Lily" by Sarser and Sprinkle in the July issue of *Æ*. Since the important portion of the article deals with the Ultra-Linear conversion, a circuit arrangement which we have designed, we feel privileged to comment.

The authors mention that the original Ultra-Linear circuit has a tap at approximately 43 per cent of the primary winding, and that they use a tap at 50 per cent which is "not too far from 43 per cent." What they fail to mention is that in our own circuit arrangement the screen load is 1220 ohms, and in their arrangement it is 2500 ohms. We know that 2500 ohms is too far from 1220 to give comparable results and that the performance of the circuit is degraded through misuse, although there is measureable improvement in their arrangement over the conventional triode connection.

Our patent claims cover the use of any primary tap in this circuit arrangement. However, we have restricted the use of the term *Ultra Linear* to the condition where the dynamic plate characteristic curves are most linear. This occurs with tubes of the 6L6 and the 807 type with a primary impedance of 6600 ohms, screen impedance of 1220 ohms, and a bias equal to 10 per cent of the plate-to-cathode voltage. Only this last condition has been met by Sarser and Sprinkle and it is therefore incorrect to refer to the Gilded Lily as Ultra-Linear.

David Hafler & Herbert I. Keroes,
Acro Products Company,
369 Shurs Lane,
Philadelphia 28, Pa.

Phase Inverter or Phase Splitter?

Sir:

While explaining the audio circuit to an electrical power engineer recently, I pointed out what I called a "phase-inverter" circuit. He examined the diagram carefully and woke me up to a long existing semantic difficulty by asking, "But isn't any amplifier stage a phase inverter?"

Without going into the question of certain circuits which do not invert phase, I had to say yes, and proceed to point out that "phase splitter" might be a better term. With that in mind, he looked at the diagram again and in a few seconds understood it completely.

So there it is, staring us in the face. Electronics, being a branch of a major science (physics), is supposed to encourage a certain amount of precision of expression among its practitioners, at least when a precise term is no more complicated and takes no longer to say than a loose one. Never again, in *AUDIO PATENTS* column or in any other of my writings, will I willingly be guilty of mentioning a phase inverter when I really mean a phase splitter. If someone comes along with a better term, I will use that. Do I hear a chorus of "me-too's"? I hope so.

While we are on the subject of terminology, how about adding the word "electronism" officially to the electronic lexicon? A conglomeration of wheels, levers, brackets, and other parts which constitute a unit that does some kind of a job as a whole is termed a mechanism. But its electronic counterpart defies

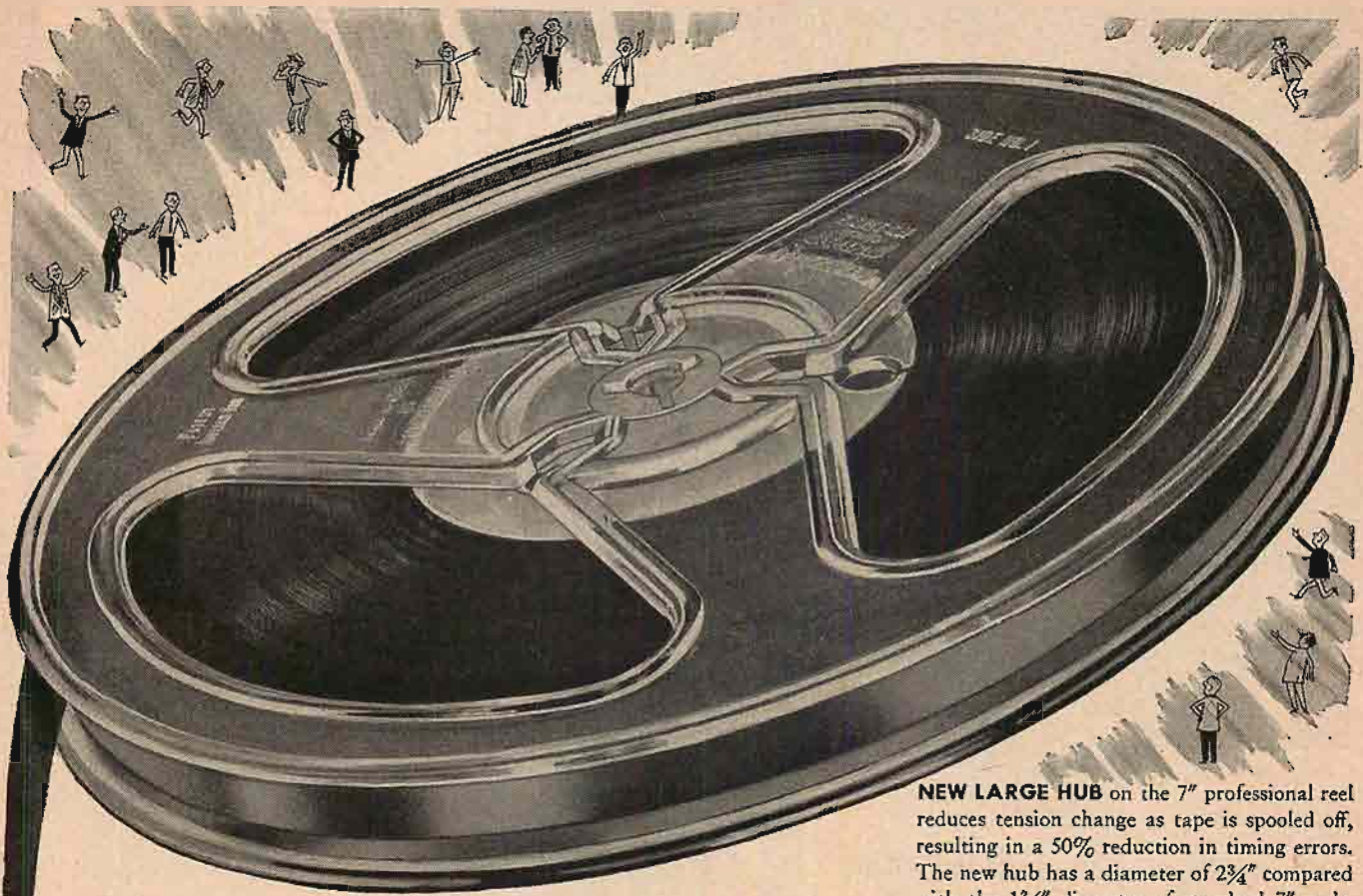

★ Cuts timing errors 50% ★ Reduces pitch changes ★ Splice-free

**It's the new "Scotch" brand dry-
lubricated magnetic tape on
the new 7" professional reel!**

NEW LARGE HUB on the 7" professional reel reduces tension change as tape is spooled off, resulting in a 50% reduction in timing errors. The new hub has a diameter of $2\frac{3}{4}$ " compared with the $1\frac{3}{4}$ " diameter of standard 7" reels. Thus it has approximately the same ratio of outside diameter to hub diameter as the standard NARTB $10\frac{1}{2}$ " metal reel. Another feature of this new reel is the single small threading slot, which minimizes mechanical distortion of the layers of tape nearest the hub.

★ A new, improved tape for this new, improved reel!

★ **"DRY LUBRICATING"** process gives you a tape that practically eliminates sticking, squealing and cupping . . . a completely dependable tape that turns in a flawless performance in almost any condition of heat or humidity!

★ **100% SPLICE-FREE!** Tape supplied on the 7" professional reel is guaranteed to be completely free of splices.

★ **GUARANTEED UNIFORMITY!** Output variation of tape wound on the new 1200-foot reel is guaranteed to be less than plus or minus $\frac{1}{4}$ db at 1000 cps within the reel, and less than plus or minus $\frac{1}{2}$ db from reel to reel.



See your distributor for a supply of 7" professional reels and new dry lubricated tape!



The term "SCOTCH" and the plaid design are registered trademarks for Sound Recording Tape made in U.S.A. by MINNESOTA MINING & MFG. CO., St. Paul 6, Minn.—also makers of "Scotch" Brand Pressure-sensitive Tapes, "Underseal" Rubberized Coating, "Scotchlite" Reflective Sheeting, "Safety-Walk" Non-slip Surfacing, "3M" Abrasives, "3M" Adhesives. General Export: 122 E. 42nd St., New York 17, N. Y. In Canada: London, Ont., Can.

EASY LOW-COST WAY to own a
PROFESSIONAL QUALITY
DUAL SPEED—HIGH FIDELITY
tapeMaster
TAPE RECORDER



**PORTABLE
 MODEL PT-125**

Use with Your Own Audio Amplifier, Radio or Radio-Phono Combination, or with new tapeMaster Model SA-13 Power Amplifier and Speaker.

For the first time, a completely-flexible professional quality tape recorder like this—at such economical cost! Advanced engineering and customized design make the *tapeMaster* a natural choice of recording enthusiasts everywhere. Can be carried anywhere and used with an existing audio amplifier or combined with the SA-13 to make a complete tape recorder and playback assembly far superior to other more costly equipment. Ideal for home, school or commercial use.

Complete with 5" spool of plastic tape and 7" empty take-up spool, in sturdy carrying case covered with waterproof leatherette, less audio amplifier and microphone. Size: 12½" x 12" x 9½" high. **Net Price \$9950**

Built to RTMA Standards • Dual Track—Manual Reversal • Dual Speed—7.5" and 3.75" sec. • Single Knob Instantaneous Speed Change • Fast Forward and Rewind • "A" Wind Tape • Direct Threading of Tape • Push-Pull Supersonic Bias-Erase • Response 50-8000 cps, ± 3 db at 7.5 and 50-5000 cps. at 3.75 • Inputs for Radio, Phono and Mike • Outputs for Audio Amplifier and Headphone • Full Monitoring • Neon Record Level Indicator For 105-125 V 60 cycle AC (Also available for 110-220 V 50 cycle AC) • Operates Vertically or Horizontally.

Send for FREE Bulletin 102-A

tapeMaster inc.
 13 W. HUBBARD ST. • CHICAGO 10, ILL.

Export: Scheel International, Inc.
 Chicago 18, U.S.A. • Cable: Harscheel

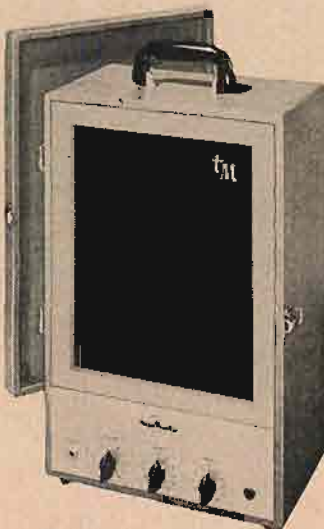

**MODEL SA-13
 POWER AMPLIFIER
 AND SPEAKER**

Portable companion to the PT-125 tape recorder. Combines a special type speaker, new amplifier design, and effective principle of baffling. Amplifier response ± 1 db 30-15,000 cps. Peak output 8 watts. Has separate bass and treble control. 12" x 9½" x 18½" high. **Net Price \$7950**

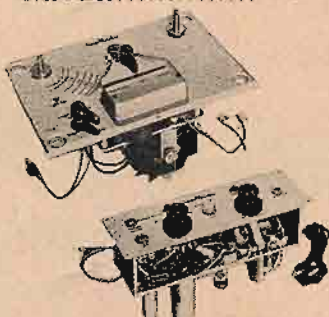

FOR CUSTOM INSTALLATIONS

Model TH-25 Dual Speed Tape Transport Mechanism with Model PA-1 Matching Pre-Amplifier and Push-Pull Supersonic Bias-Erase Oscillator. Fully wired, ready to plug in. Without spool of tape, take-up spool and carrying case. **Net Price \$8850**

Units may also be purchased individually
 (Prices Slightly Higher West and South)

smooth description. It is a chassis, the circuit components (no wiring?), the electrical parts, the electronic assembly—all loose, inconvenient, circumlocutory expressions we use to try to differentiate the electronism from the motor-turntable or tape-transfer parts which we easily call the mechanism.

Who will vote for these two suggestions on a write-in ticket?

Richard H. Dorf,
 255 W. 84th St.,
 New York 24, N. Y.

(We think we agree, and we shall endeavor to revise future manuscripts in accordance with Mr. Dorf's suggestion. Ed.)

O-T-L Amplifiers

Sir:

We have gained experience on two aspects of the series-connected O-T-L amplifier (Æ, June 1952) which may be of general interest.

The matter of optimum speaker impedance is important. In 1948 we selected 150 ohms as a preferred value of speaker impedance. Four years' operating experience has confirmed the choice. Generally speaking, 150 ohms represents the impedance for maximum power transfer from the type 6AS7G twin triode operated from a transformerless voltage-doubler plate supply. Six to ten watts of power is obtained without exceeding tube rating. With proper design, distortion is made exceedingly low. One of our ten-watt designs provides full power output that is flat within 0.1 db from 10 to 200,000 cps. Distortion is below 0.1 per cent from 30 to 15,000 cps.

It has been found that concert-quality 8-in. speakers having 1-in. voice coils—perhaps the smallest units likely to be used for high fidelity—can be wound to 150 ohms without altering gap, efficiency, or response. An early unit supplied by Jensen used #41 wire, which is about as small a gauge as can be handled with commonly used production techniques.

A second preferred value is 500 to 600 ohms, which is feasible on the larger speakers. The Stephens Mfg. Co. is, of course, already marketing 500-ohm speakers. This value matches the standard 500-ohm line of public address systems and is a value into which the single-ended push-pull amplifier can operate with quite high efficiency. We have designed a unit using four 6L6G's which provides a full 50 watts from 10 cps to several hundred kc. Distortion is below 0.1 per cent from 30 to 15,000 cps. Plate dissipation is below 50 per cent of rated value at full output.

It has been our experience that the series blocking capacitor used with the single-ended output need not be very large or expensive for performance at least as good as any amplifier now on the market.

The balanced-to-ground arrangements, although eliminating the output capacitor, suffer from several disadvantages, not the least of which is that for the same number of output tubes the output impedance is four times higher than is the case if the single-ended output is used.

For the record, it should be mentioned that we have both domestic and foreign patent applications covering the balanced single-ended circuit. We are in agreement with the authors that the O-T-L amplifier may well be the high-fidelity amplifier of the future.

W. H. & J. R. Coulter
 Coulter Electronics,
 3023 W. Fulton Blvd.,
 Chicago 12, Ill.

[Continued on page 14]

APRIL 10, 1952

The Los Angeles Times

GUARANTEED QUALITY SPEAKERS

BEVERLY HILLS, Aug. 10—For the first time in the history of the audio industry a manufacturer is guaranteeing the quality of his loudspeakers. The new Altec Lansing "Duplex" loudspeakers, just introduced this week, have an unconditional factory guaranteed frequency range of 30 to 22,000 cycles. Principals at Altec state that no other speakers on the market have this great a frequency range.

These two new loudspeakers, twelve inch 601A and the fifteen inch 602A are improved versions of famous Altec 604 "Duplex" speakers.

Trading throughout the world. The key to steady growth but toward weakened. A few between 1 gave the Most lo tions to

The new Altec **DUPLEX*** LOUDSPEAKERS



602A Net Price with network, \$114.00



601A Net Price with network, \$89.00

TECHNICAL DATA	601A	602A
Diameter:	12"	15"
Power Capacity:	20 watts	20 watts
Impedance:	8 ohms	8 ohms
Weight:	15 lbs.	25 lbs.

FOR YEARS the Altec 604 "Duplex" has represented the highest quality attainable in a loudspeaker. Now two new speakers join the 604 to provide you with an even higher standard for quality sound reproduction. These two new "Duplex" speakers, the twelve-inch 601A and the fifteen-inch 602A, are the finest in the world. Hear and compare these guaranteed quality speakers at your Altec dealer today.

GUARANTEED QUALITY: When you buy an Altec 601A or 602A Loudspeaker, the quality of your purchase is protected with this guarantee. "The Altec Lansing Corporation unconditionally guarantees that, when mounted in an adequate cabinet, this loudspeaker will reproduce all of the tones from 30 cycles to 22,000 cycles."



the Symbol of Quality

*DUPLEX: Mechanically and electrically independent high and low frequency loudspeakers mounted within the physical size of a single frame.

ALTEC LANSING CORPORATION • 9356 SANTA MONICA BLVD., BEVERLY HILLS, CALIF. • 161 SIXTH AVE., NEW YORK 13, NEW YORK

NEW!

The turntable
that you helped
us design!



REK-O-KUT 3-SPEED, 16" Transcription Turntable FOR BROADCAST AND RECORDING STUDIOS

The new B-16H three-speed, 16" transcription turntable is not a modification of a two-speed machine, but a completely new design, with operational controls suggested by leading engineers. Now you can play all three speeds—33 $\frac{1}{3}$, 78 and the popular 45—with equal facility.

The B-16H can be quickly and easily fitted into your present 2-speed transcription consoles or cabinets. The base is drilled and tapped for mounting Audak, Grey or Pickering arms. Maintenance is simple . . . turntable, motor pulley and idlers are easily accessible.

OUTSTANDING FEATURES:

- 45 RPM Adapter . . . disappearing type, built into hub of turntable.
- Aluminum Base . . . square shape, radial ribbed for utmost rigidity.
- Speed Changes . . . instantaneous for all three speeds—controlled by selector.
- Speed Shift . . . Mastermatic, self-locking. A REK-O-KUT exclusive.
- Speed Variation . . . Meets the N.A.B. standard for speed variation and "wow" content.
- Turntable . . . 16" cast aluminum, lathe turned, with extra heavy rim for balanced flywheel action. Sub-mounted in base.
- Motor . . . Hysteresis Synchronous, 60 cycles AC, 115 volts. Available in other frequencies and voltages at extra cost.
- Dimensions . . . 1 $\frac{1}{2}$ " above base, 6" below, 20" wide x 18 $\frac{3}{4}$ " deep. Shipping weight, 30 lbs.

MODEL B-16H \$250.00 net.

Available at Leading Radio Parts Distributors. Write for detailed literature.

REK-O-KUT CO.

38-01 Queens Blvd., Long Island City, N. Y.
EXPORT DIVISION: 458 Broadway, N. Y. C. U.S.A.
Canada: Atlas Radio Corp., Ltd., Toronto 28, Ont.

TECHNICANA

Rugged Tubes

WORK IN GREAT BRITAIN on the design and manufacture of rugged vacuum tubes is the subject of an article by E. G. Rowe in the March 1952 *Wireless World*. In Great Britain, efforts have been directed toward the mechanical improvement of existing electrical designs without changing the characteristics. The aim is to produce "trustworthy" tubes suitable for direct replacement of their existing counterpart. Attention was given to the size, tightness, number, and spacing of the micas. Locking straps in the micas, straps across the micas welded to the anode lugs, and any other available technique of locking the bottom insulator to the stem were methods that helped to reduce failures and noise in operation. Heater failures were minimized by use of the reverse helical heater, having a larger wire size and no sharp bends.

Considerable attention was paid to the glass envelope itself in order to insure against cracking and breakage which may occur if the assembly of the base and envelope are not done with care and accurate operational control.

Relay Calculations

Relay design is the subject of an article by Ch. Guilbert appearing in the March-April 1952 *Toute la Radio* (France). General design calculations are presented and are accompanied by an excellent set of charts relating all the important design parameters. These include turns, resistance, wire size, current, armature size, and force of attraction. With the use of the charts it should be able to shorten the time required to design conventional relays for special purposes, and to obtain the maximum performance from relays available in local stocks.

Design of Studios

Recording Studio Design is the subject of an article by P. A. Shears in the September 1951 *Wireless World*. Basing the design of a studio on the need for balanced acoustics, rather than on economic limitations, requires that the reverberation characteristic be corrected at the low-frequency end of the spectrum, rather than merely cutting the bass in recording. Acoustical materials usually used in studios are not efficient at low frequencies. To balance the absorption, low-frequency resonant absorbers of the open or closed type may be used. In the closed group are panels spaced out from the wall as wainscoting, while in the open absorber group are the various forms of Helmholtz resonator. Lamp recesses and window noise baffles are easily designed open absorbers. Absorption coefficients for curtain and drapery materials are shown in graphical form along with the absorption

of various types of resonant absorbers. Important in the use of the low-frequency absorbers is their high-frequency reflectivity. That is to say, the wainscot absorbers or Helmholtz absorbers should have low coefficients of absorption at the high-frequency end of the spectrum, because all the other items in the room tend to absorb highs.

Maida Vale Studios

The B.B.C. concert studio at Maida Vale has recently been modified and redecorated. The work is described in an article by T. Somerville and H. R. Humphreys appearing in *Wireless World*, April 1952. The studio originally built in 1935 was boomy, having been acoustically treated according to the theories prevalent at that time. Since the war the B.B.C. has conducted numerous researches which led to the redesign plan for the Maida Vale Studio.

Resonant membrane-over-air-space absorbers were designed for four resonant frequencies, 62, 80, 250, and 300 cps. These absorbers were used to provide the required low-frequency absorption curve, and were applied in horizontal lines to the side walls. Diffusion of the sound in the large studio was enhanced by the use of the absorbers and rectangular ceiling ornaments mounted on the surface of the wall, rather than having them flush with the wall surface. Additional low frequency absorption was provided by the liberal use of veneered wood panelling on battens on the studio walls. The air spaces between the battens was filled with an absorbing material. The panelling is both acoustically desirable and aesthetically pleasing. Another important change was the design of choir seats behind the orchestra platform. These seats are absorbent, being made of porous rubber padding covered with a highly porous plastic fabric.

The orchestra platform is made of wood laid over a concrete slab with corrugated board in between to permit the wood to resonate.

Reverberation tests show that a good reverberation condition exists under all types of occupancy, and the glide tone method for reverberation measurement shows a marked improvement in conditions. Listening in the studio and monitoring the program line, gives the final proof of the improvement in the acoustic design of the studio.

German FM

Wireless World for April 1952 carries a report on the use of FM broadcasting in Germany. The report is an abstract from the Bulletin of the *European Broadcasting Union*. It discusses the need for broadcasting in the FM region, the problems of chan-

[Continued on page 67]

Long Life—Low Maintenance
No Comebacks with the

New **300 OHM
TRANSMISSION CABLE**
by **BELDEN**

FOR 50 YEARS
*Wiremaker for
Industry*

To You,
Belden's Golden Anniversary
Means

—product performance that can come only from a "know-how" that has grown through actual service since the inception of Radio.

—an ability to co-operate in pioneering new wires to meet or anticipate industry's growing needs.

In the years that follow

This Belden Program Is—

— TO BE CONTINUED



No. 8230



**COPPER-SHEATHED
20-GAUGE**

STRANDED STEEL WIRE

Brown Polyethylene—Resists Weather and Oxidation

The new Belden Weldohm, 300-ohm Transmission Cable is the greatest advancement in television installation since television began.

Reducing TV lead-in conductor breakage to a minimum is easy. The new Belden Weldohm Cable has overcome the breakage point by 162%, that's 1½ times the strength of pure copper wire.

In actual test, Belden Weldohm Cable will withstand 254% more whipping or severe flexing than the average installation of 300-ohm copper lead-in wire.

There is no difference in the electrical characteristics between an all-copper conductor and the Belden Weldohm copper-coated steel wire. The web is 72 mils of 100% virgin polyethylene.

Replace with Belden Weldohm or make your next new installation with Weldohm and avoid expensive loss of time and labor.

Specify Belden—Weldohm Transmission Cable.

Belden Manufacturing Co., 4689-R W. Van Buren St.
Chicago 44, Illinois



Belden
Radio **WIRE**

LETTERS

[from page 10]

Sir:

It is difficult to resist making comment on the O-T-L article in the June issue. I certainly oppose the manufacture of loudspeakers with voice coils "out of the gap a short distance." One of the greatest sources of distortion is caused by the non-linearity of the suspension system. May I say that any good output transformer produces only a fraction of the distortion as compared to any speaker regardless of price. Perhaps instead of trying to eliminate the output transformer we should seek better methods of transforming electrical energy into acoustical output. Present speakers are certainly the weak link of the entire reproducing system. Let us not make the speakers still worse for the dubious advantage of O-T-L operation.

Louis Bourget
3996 McKinley Blvd.,
Sacramento 16, California

NEW LITERATURE

The Daven Company, 191 Central Ave., Newark 2, N. J. covers the entire field of variable and fixed attenuators in a new 64-page catalog which should be in the hands of every professional audio engineer. Due largely to the completeness of the Daven line and the thoroughness with which items are described, there is little to know about attenuators that will not be found in this book. In addition to description, there are photographs, drawings, and schematics. A highly commendable example of industrial publishing. Requests should be addressed to Department G1.

● **Chicago Transformer Corp.**, 3580 Elston Ave., Chicago, Ill., has placed in the hands of distributors a new, completely revised 24-page catalog and replacement guide. Enlarged considerably over previous editions, the new catalog contains over 500 listings of transformers and related components. Well organized and carefully indexed, the new Stancor catalog is one of the most complete in the transformer industry—a copy should be in the hands of all transformer users.

● **Connecticut Telephone & Electric Corporation**, 70 Britannia St., Meriden, Conn., will mail free on request a unique combination file folder and catalog sheet describing and picturing the accessories. Of primary interest to contractors bidding on government specifications are detailed charts showing part numbers, military designations, circuit arrangements, and electrical characteristics.

● **Parts Division, Sylvania Electric Products Co.**, Warren, Pa., is distributing a 20-page 2-color booklet describing the company's engineering and manufacturing services in the following industries: plastics, formed metal parts, wire, welds, mica, and electronic components. Emphasis is placed on the fact that the Parts Division is supplying various industries with numerous non-electronic products ranging from plastic containers for the cosmetics industry to metal parts for toys.

● **Dimco-Gray Company**, 207 E. Sixth St., Dayton 2, Ohio, has assembled in its new 1952 catalog a complete listing of the company's stock molded plastic parts. Illustrated and described are thirty-six groups of stock plastic knobs, handles, terminal strips, and similar components. All parts listed are available in a variety of thermosetting plastic materials offering special properties as to color, heat resistance, strength, chemical resistance, and electrical properties. Copy of the catalog will be mailed on request.

● **Insulation Manufacturers Corporation**, 565 W. Washington Blvd., Chicago 6, Ill., has included a wealth of helpful information in a new 20-page catalog for users of electrical insulating varnishes. Varnish composition, types, functions, colors, processing, and care are covered by this literature. Data on solvents is also included. Copy will be mailed free on request to Publications Department.

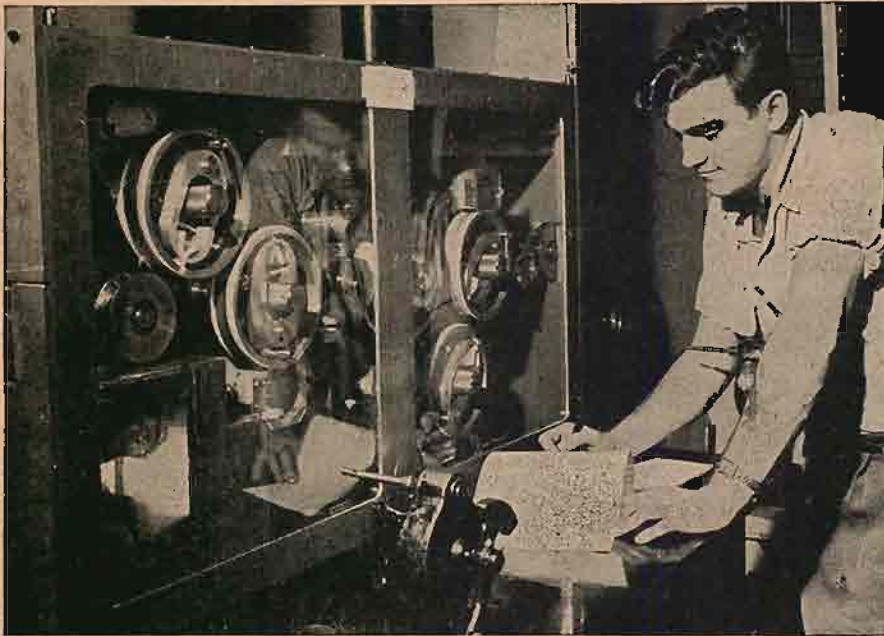

Precision Now Offers Unmatched Facilities For 16mm Processing!

Here at Precision, we are constantly revising our film processing technique; utilizing new engineering principles and new machinery which enable us to offer 16mm producers the finest processing service they will be able to find *anywhere*.

Here are some of the new types of equipment that make Precision a leader among film processing laboratories:

New 16mm Developing Machines automatically operated—Maurer-designed to handle the complete range of 16mm work—negative or positive promptly and efficiently.

Automatic Temperature and Air Control built to a Maurer design. Rigidly maintain every technical condition necessary to the finest 16mm processing.

Electrically Heated and Controlled Drying Cabinets on each new developing machine turn out high quality film, waxed and ready for immediate projection.

Precision Film Laboratories—a division of J. A. Maurer, Inc., has 14 years of specialization in the 16mm field, consistently meets the latest demands for higher quality and speed.

New Electronic Printer: For the reproduction of magnetic sound to 16mm either independently or in combination with picture prints.

New Control Strip Printers operate without notching original—produce fades and dissolves from A & B rolls—incorporate filter changes between scenes.

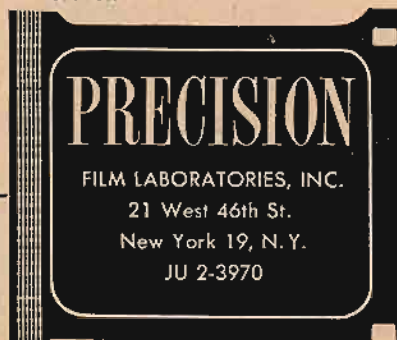

FOR
HIGH FIDELITY
IN
RECORD
REPRODUCTION

Collaro

MODEL 3/522*
THREE SPEED

Fully Automatic

R E C O R D C H A N G E R

FOR 7, 10, AND 12 INCH RECORDS



The COLLARO was engineered to meet the most exacting standards of highest quality audio systems. Superbly constructed, it reveals the painstaking care and attention to the minutest functional details. The result is an instrument of unsurpassed performance.

From the very first to the very last cycle, the COLLARO exhibits an almost uncanny gentleness. As each record-play begins, the remaining stack of records is slowly and safely lowered into position. A weighted, rubbermatted, and dynamically balanced, ball-bearing-mounted turntable provides steady, constant speeds, with no record slippage.

Every worthwhile convenience has been included. An automatic muting switch eliminates disturbing 'thumps' and

'clicks'. Plug-in heads are furnished for all standard cartridges. The tone arm rotates on ball bearings providing maximum lateral compliance. Arm resonance has been kept to an absolute minimum. Stylus pressure is adjustable to as little as 3 grams with good tracking.

A powerful, four pole motor with oilite bearings assures long, trouble-free performance, and virtually no hum pickup. No drive belts are employed, and in 'off' position, all drive couplings are completely disengaged, thus avoiding flat spots.

The COLLARO is absolutely jam-proof. The tone-arm may be lifted, moved, or even locked down during the changing cycles with no danger of damage. When the last record has been played, the COLLARO automatically 'shuts off'.

*Intermixes 10 and 12 inch
Records at All Speeds
List Price.....\$65.00

Model 3/521 Fully Automatic
Non-Intermix Model
List Price.....\$54.50

Base Dimensions: 14 $\frac{3}{4}$ " x 12 $\frac{1}{4}$ "
Depth Below Base: 2 $\frac{1}{4}$ "

At your Distributor or
Write for Details:

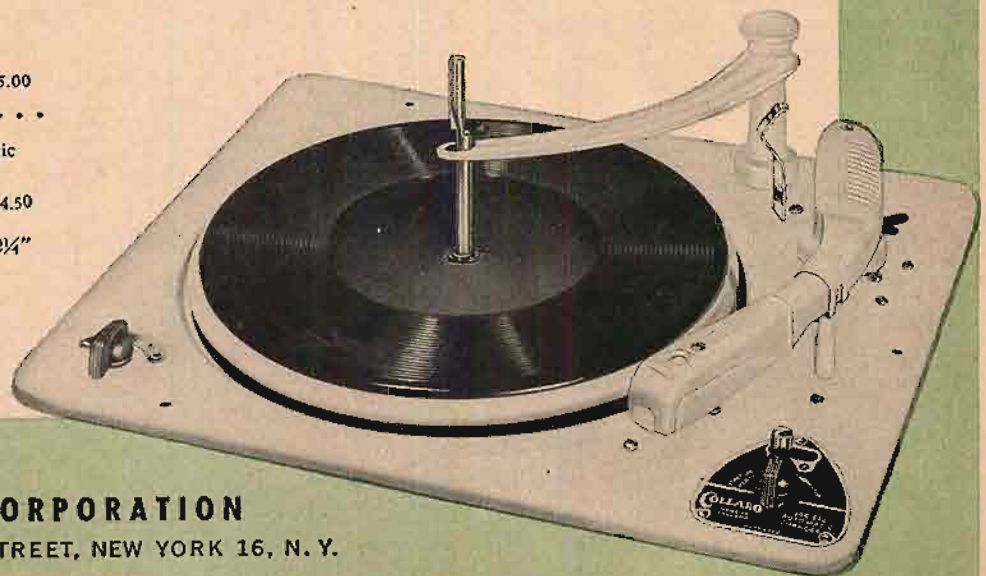

ROCKBAR CORPORATION
211 EAST 37TH STREET, NEW YORK 16, N. Y.

EDITOR'S REPORT

MOVING DAY

THE MOST IMPORTANT news of the month—from our own personal viewpoint—is the exodus from the city and the occupancy of new and larger quarters in Mineola, some twenty miles from the heart of New York. For the information of any who would come to see us, the address of *Æ*'s new office is 204 Front Street, Mineola, New York. If you should come by train—the Long Island Rail Road—you will find the offices just across the street from the station; if you are driving, you will find us where Mineola Boulevard crosses the rail road.

But please—for any communications by mail, *please* remember the post office address—P. O. Box 629, Mineola, New York.

Needless to say, we welcome all visitors—for it is from our contacts with readers, engineers, hobbyists, recordists, and anyone else in the audio business that we learn what goes on in our relatively small "world," and from this knowledge we are able to *try* to give our readers the kind of editorial material they want—interspersed occasionally with some of the tougher-to-follow articles which make up the background of audio engineering.

CONGRATULATIONS, WDET-FM

We have recently been advised of the change in policy and ownership of radio station WDET-FM, Detroit. This station has been acquired by Wayne University, and is now being operated as an educational broadcasting facility on an assigned frequency of 101.3 megacycles, by authority of the Federal Communications Commission.

As the leading exponent of high quality sound reproduction in the home—and elsewhere—*Æ* extends its heartiest congratulations and best wishes. We believe firmly in the ability of FM stations in general to deliver the highest quality signals to the user, and that these stations comprise the backbone of quality signals to many listeners.

Not that AM stations do not deliver good quality, but that relatively few AM receivers are capable of the wide frequency range and low noise which characterizes FM transmission. While it is often said—by those who should know better—that AM transmissions are limited in frequency range to a top of 5000 cps, it can be proven by anyone who cares to take the trouble to assemble a wide-range t-r-f tuner that such is definitely not the

case. A good tuner, designed for wide-range reception, is easily capable of delivering a high-quality signal to the audio system, with a frequency range equal to that of the better phonograph records. The limited frequency range of most AM receivers is due primarily to the sharpness of the intermediate-frequency amplifier stages, and is not a characteristic of the AM transmitter. Without question, most listeners would be satisfied with the frequency range of the AM transmitter if it were reproduced in full at the output of their tuners.

However, FM still has certain undoubted advantages—principally with respect to the lack of noise due to atmospheric static, but to some extent for its lower distortion. The high-budget variety shows appeal to many listeners, and they will still be the basic fare on the big AM stations and the networks. It is probable that this type of entertainment is more universally preferred than the programs made up entirely of music, just as it is becoming obvious that the vast majority of people prefer television to radio for their amusement. But there are still many who would rather have the music, and it is there that the FM station excels. The acquisition of a large library of recorded music can be expensive, but a single FM station can serve thousands upon thousands of listeners with but one copy of each recording.

A few FM stations are supported entirely by contributions from listeners—thus eliminating commercials—and are providing a service which the listeners must consider valuable or else they wouldn't contribute.

For many people, records will always be the mainstay of their home music systems, yet for many others the principal source of program material will always be the radio—so long as it provides the type of material that is desired. Let us hope we are speaking for this last group in expressing the wish that FM services increase, rather than decrease, as time goes on.

SOUND REPRODUCTION COURSE

The Fall course in the High-Fidelity Reproduction of Sound at the Division of General Education of New York University will begin on Friday September 26 and extend until the end of January 1953. This course will consist of material paralleling the articles now running serially in *Æ* under the authorship of Edgar M. Villehur.

Registration for the course begins September 3, and there are no academic prerequisites, so anyone with sufficient interest is invited to attend. Classes will be held on Friday evenings from 7:00 to 9:45.

PICKERING

RECORD PLAYING EQUIPMENT

*For flawless reproduction
of the works of the masters*

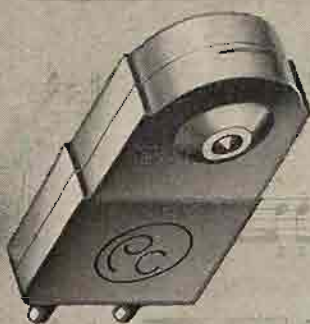

Pickering diamond stylus pickups and related components are the exclusive choice of musicians and lovers of music who insist upon the finest. Engineers acknowledge Pickering audio components as the best available. In every test and performance comparison, they demonstrate their superiority; recreating all the music pressed into modern recordings with the fidelity and realism of a live performance.



Pickering components are created for listening pleasure by Audio Engineers who know music and who know the tastes of discriminating listeners.



Pickering diamond cartridges have no equal. The wear and fracture resistance of the diamond styli in these cartridges is many times greater than that of styli made of sapphire, the next hardest material. Because resistance to wear preserves the precise shape of the stylus point, the life and quality of your valuable record collection is insured.



Don't impair the musical quality of your priceless records.

Use Pickering diamond stylus cartridges... they not only wear longer *but, more important,* they preserve the musical quality and prolong the life of your record library.

By all measures, Pickering diamond stylus cartridges are more economical.

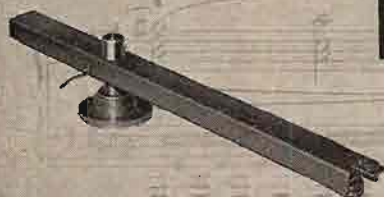

PICKERING & COMPANY, Inc.
Oceanside, L. I., N. Y.



Pickering High Fidelity Components are available through leading jobbers and distributors everywhere; detailed literature sent upon request. Address Department A

Telephone Science Shares Its Knowledge

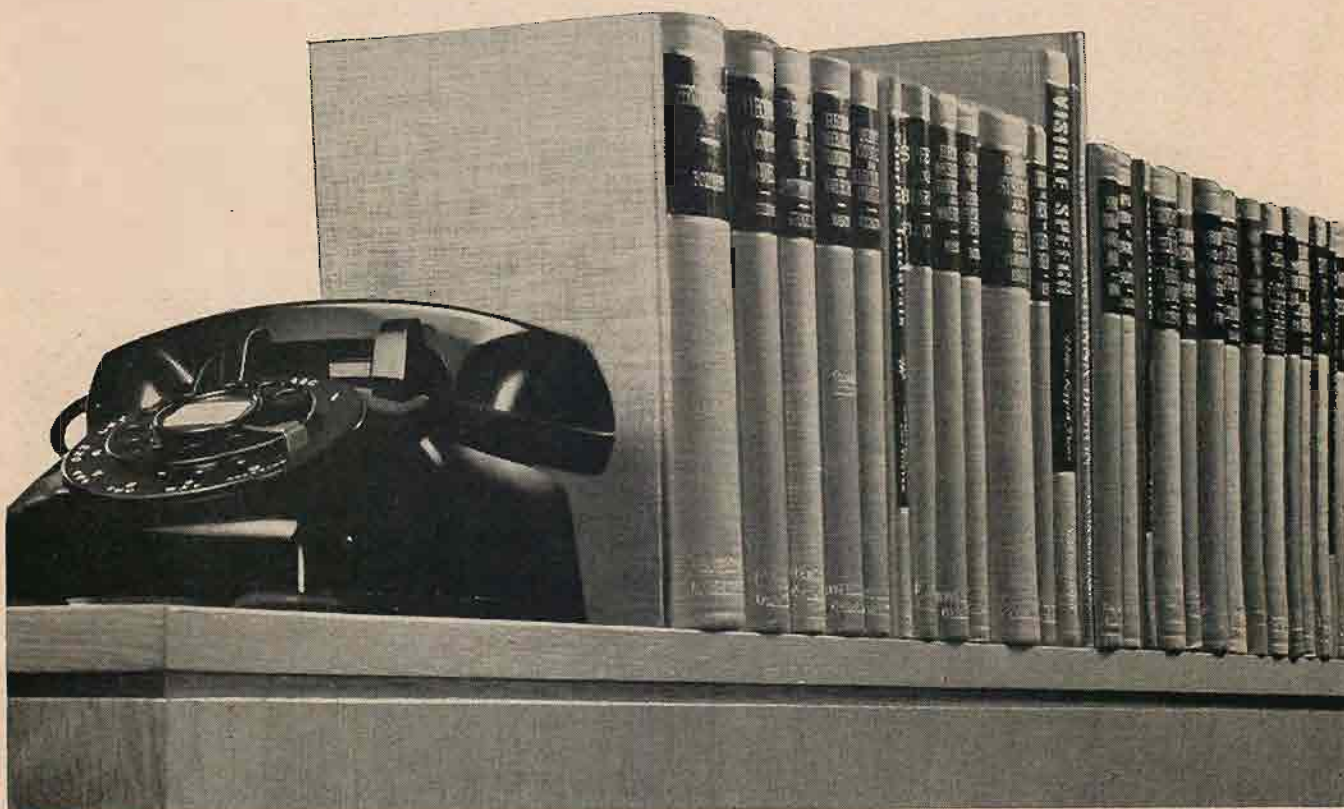

The Bell Telephone Laboratories Series of books is published by D. Van Nostrand Company. Other technical books by Laboratories authors have been published by John Wiley & Sons. Complete list of titles, authors and publishers may be obtained from Publication Dept., Bell Telephone Laboratories, New York 14.

List of Subjects: Speech and hearing, mathematics, transmission and switching circuits, networks and wave filters, quality control, transducers, servomechanisms, quartz crystals, capacitors, visible speech, earth conduction, radar, electron beams, microwaves, waveguides, traveling wave tubes, semiconductors, ferromagnetism.

In their work to improve your telephone service, Bell Laboratories make discoveries in many sciences. Much of this new knowledge is so basic that it contributes naturally to other fields. So Bell scientists and engineers publish their findings in professional magazines, and frequently they write books.

Most of these books are in the *Bell Telephone Laboratories Series*. Since the first volume was brought out in 1926, many of the books have be-

come standards... classics in their fields. Twenty-eight have been published and several more are in the making. They embody the discoveries and experience of one of the world's great research institutions.

Bell scientists and engineers benefit greatly from the published findings of workers elsewhere; in return they make their own knowledge available to scientists and engineers all over the world.



BELL TELEPHONE LABORATORIES

Improving telephone service for America provides challenging opportunities for individual achievement and recognition in scientific and technical fields.

Limitations of Magnetic Tape

W. S. LATHAM*

While thoroughly satisfactory for ordinary musical and program recording, magnetic tape often has minor defects which become apparent when used for certain scientific applications.

THE RAPIDLY EXPANDING use of magnetic tape as a convenient and efficient medium for recording and storing sound energy is familiar to nearly everyone associated with the sound recording industry. Commercial recording organizations, broadcasting companies, and the film industry have recognized the economy, adaptability, and versatility of magnetic tape. Consequently, its development has been accelerated during the past few years in an attempt to keep pace with the growing use of this medium.

Because of the acceptance of their product and the subsequent increased demand, the manufacturers of magnetic recording tape have been faced with several problems. One of these has been the necessity to supply a better product which would be available in sufficient quantity at an acceptable price. The production of a uniform tape capable of high-fidelity recording and reproduction of voice and music has been achieved. Over a very brief period of time, great advances have been made in the development of oxides, binders, and backing materials used in magnetic tape.

From the beginning of its development, the versatility of magnetic tape indicated that its use would not long be confined to strictly commercial applications. Here was a new tool available for scientific applications in fields of research almost completely unrelated to the original purpose of the medium. Soon new requirements were placed on

*Recording Branch, General Engineering Division, U. S. Navy Underwater Sound Laboratory, Fort Trumbull, New London, Conn.

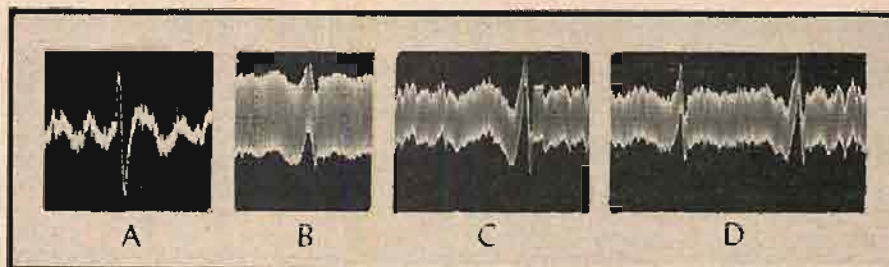

Fig. 2. Oscillograms of transients: (A) Transient as it appeared on erased tape after five plays; (B) effect of this transient on a 15-kc envelope; (C) effect of the same transient on a 2-kc carrier; (D) the transient on the left was produced by a tape hole—the one on the right was the desired signal.

both the physical and magnetic properties of recording tape. These requirements exceeded the capabilities of existing tapes and could only be satisfied by modifications in the manufacturing process. Such modifications would necessitate additional capital expenditures on the part of tape manufacturers, and this capital could be recovered only by increasing the price of an item already acceptable to the majority of users. Quite understandably, the manufacturers have been unwilling to resort to this procedure. Consequently, until the critical users of tape constitute a substantial market for a superior product, they are forced to accept the available tape and cope with the limitations of the medium in its present state of development.

Such limitations confront the Recording Branch of the U. S. Navy Underwater Sound Laboratory whenever it is requested to supply special instrumentation involving the design and development of unique tape recording and

reproducing devices. For economic reasons these devices normally employ commercial magnetic tapes. Because the Laboratory places demands on these tapes in excess of those established by the recording industry generally, the Recording Branch has found it necessary to undertake a continuing investigation of all currently available magnetic tapes in order to determine their performance limitations. Significant phases of the investigation are described in this article.¹

One of the major problems encountered in the use of commercial tapes is the appearance of "holes" or nodules in the envelope of the signal energy recorded on the tape. Although these holes are of no great concern when complex wave structure is being recorded, they become an important factor whenever a carrier-modulated signal is recorded. Contrary to a general belief that such holes are confined to the high-frequency portion of the tape-recorded spectrum, the Laboratory's investigation has proved that the holes are present on the tape regardless of the spectrum content involved. In fact, their presence may be observed by viewing through an oscilloscope the playback of a completely erased tape.

Change of Pin-hole Characteristic

A sample of virgin tape when first transported over the heads of a tape machine was found to exhibit fewer holes than those observed in tape previously used. When the same sample was erased and again passed over the

¹The author acknowledges the competent assistance of Mr. C. R. Turner, of the Recording Branch, in conducting many of the tests described and in compiling the associated data, and the painstaking care exercised by the Laboratory's Photography Laboratory Section in making microphotographs and oscillograms.

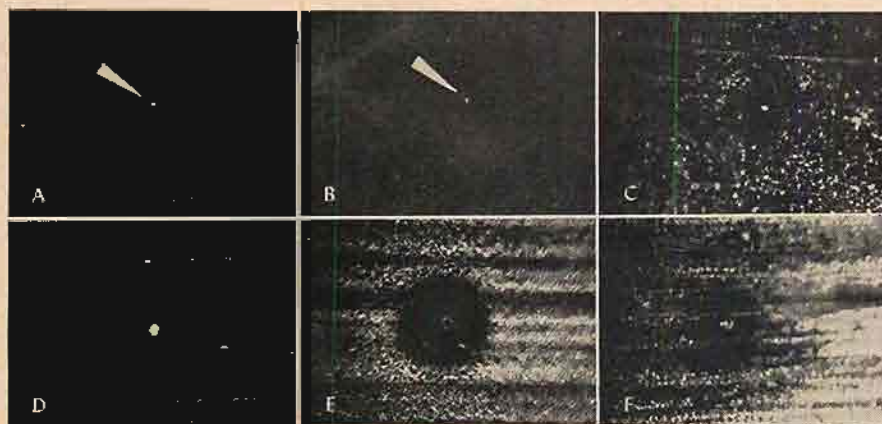

Fig. 1. Microphotographs showing the development of a typical nodule in magnetic tape: (A) Pinhole in virgin tape; (B) tape sample including the hole after one passage over the head assembly; (C) same sample after five passages; (D) after 12 passages; (E) after 1000 passages; and (F) after 1800 passages.

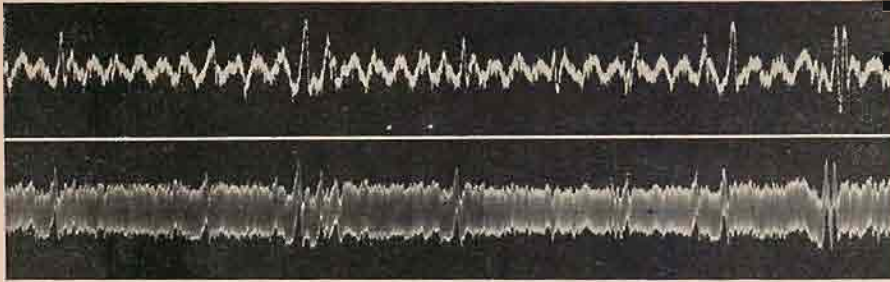

Fig. 3. Effect of tape holes on signal energy: (A) above, inherent noise on erased tape—the high peaks represent holes; (B) below, noise on the same strip of tape modulating a 15-kc carrier.

same heads, an increase in the number of nodules was noted. This brief test indicated the possibility that the supersonic erase and bias energy might have some effect on the phenomenon, but variations in the frequency and amplitude of these energies produced no effect upon the number of holes present in the sample tape. Similarly, variations in the amplitude of the signal energy applied to the medium appeared to be of little consequence in establishing these holes. The possibility that the physical configuration and the surface geometry of a particular recording head might have a bearing on the nodule count of the tape under investigation was eliminated when comparable results were observed on a recorder which used unlaminated head pole-piece construction. Thus, it was apparent that the hole phenomenon is a function of the medium itself. In other words, the holes are present in the virgin tape, but their number increases and their configuration changes with re-use of the tape. This condition is exaggerated so long as the tape remains in motion, frictional contact with a surface, regardless of its state of polish. However, the process reaches a limit beyond which little change is observed in the resulting effect, even though the configuration continues to enlarge.

The development of a nodule is demonstrated in Fig. 1. A reel of virgin tape taken at random from stock was examined under a microscope until an appreciable pinhole was found in the oxide coating. A sample including this hole was cut from the unused tape. The abrasive marks which may be seen at (A) resulted from scoring introduced as the tape passed over rollers, probably during the drying process. At (B) the same tape sample has passed once over the head assembly. Although no apparent change has occurred in the configuration of the hole structure, the presence of more lines on the oxide surface indicates the abrasive effect of tape-head contact. This effect is important in the later stages of development of the hole.

At (C) may be seen the same tape sample after it passed over the head assembly five times. Now, in addition to the presence of increased abrasive action, an accumulation or "clumping" of oxide is noticeable in the area surrounding the original hole in the magnetic coating. After twelve successive passages of the tape over the head assembly, the hole structure developed to the

extent shown at (D). Repeated transport of the tape over the head was continued until, at the conclusion of 1000 passages, the same hole had developed to the extent indicated at (E), which illustrates effectively the progress of the "clumping" process. Excessive abrasion has taken place around the nodule, which now resembles a small crater when viewed from above. The accumulation of the loose oxide particles about

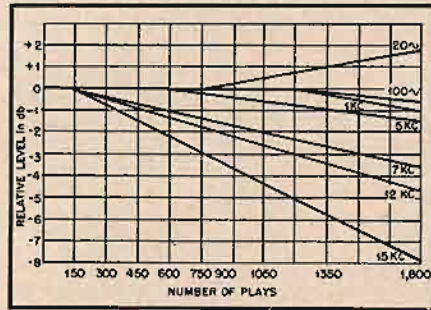

Fig. 4. Behavior of playback level of tape samples containing individual sine-wave components during 1800 replays.

the original irregularity in the oxide surface has reached a point which might be termed saturated. Continuous passage of the tape over the heads beyond this point led to a gradual deterioration of the oxide ring until the condition illustrated at (F) was reached after 1800 successive replays. Although the tape surface exhibits extreme physical wear and the oxide ring has been vastly reduced, the pinhole is still visible. Its presence, moreover, was still apparent through its ability to produce a pronounced transient.

Effect on Playback

An oscillogram of the transient as it appeared on erased tape after the first five plays is shown at (A) in Fig. 2, and the effect of this nodule on a 15-kc envelope is illustrated at (B). It should be noted that the amplitudes of the transient excursions are virtually equal. The irregularities in the unadulterated portions of the carrier envelope resulted from poor head alignment in azimuth on the particular machine used. At (C) is shown a 2-kc carrier being affected by the same tape hole.

It is of interest to consider how the conditions exhibited at (B) and (C) would affect the interpretation of the results if these same carriers were being modulated by strain gauges or by other transient-producing pickup devices. To

distinguish between the desired signal and the undesired pulse, in this case, would be a difficult task, as can be seen from (D). Here, the transient on the left was produced by a tape hole; the disturbance on the right was the desired information in the form of a pulse modulating a 15-kc carrier. Under uncontrolled conditions, recognition would be practically impossible, since both the hole and the signal modulation occur at irregular intervals. The frustrating effect on signal recognition produced by holes in the tape is further illustrated by Fig. 3. Here can be seen the same length of tape first as erased and then as recorded with a signal of 15 kc. Even the minor nodules create an unwanted effect.

A spectrum analysis of the transients created by these holes in the magnetic structure of the tape revealed that the predominant energy was confined to the region of 100 cps. The amplitude of the excursions of these pulses averaged approximately 5 db above the steady-state condition, with occasional peaks approaching 15 db. Under certain conditions, these levels are sufficient to mask the carrier frequencies completely.

All the various types of magnetic recording tapes which are currently available (red and black oxides on plastic and paper) exhibit the hole effect. This also holds true for impregnated tapes as well as coated tapes. Hand selection of tapes does not seem to be the complete answer since, as has been illustrated, holes which are not readily apparent in virgin tape will develop through replay and re-use of the tape.

While the tape tests were being conducted, samples of early as well as current production runs of tape were examined. A tape sample of the type first produced and distributed by one manufacturer displayed noticeably fewer holes per foot than did any of the other samples tested; samples from the same manufacturer's current production were also included. This manufacturer was contacted in an effort to determine the factors which might account for this distinction. A significant factor seemed to be that the oxide for the original tape was in the mixing barrel or bonding process for a period of 10 days prior to application to the base material, while under the present practice this operation was continued for only 24 hours. Also, if the pre-coating and coating processes are not completely enclosed and prevented from absorbing foreign substances from the surrounding atmosphere, minute particles will enter the mixtures. Although these particles may easily be dislodged later, their removal will leave pinholes in the oxide coating. Finer filtering of the oxide coating immediately prior to application should greatly improve the surface uniformity.

Effect of Continued Replays

In connection with the tests conducted to demonstrate the development of a tape hole, the behavior of the playback

[Continued on page 68]

A Preamplifier Switching, and Equalizing Unit for Critical Listening

M. V. KIEBERT, Jr.*

Given a "cleaned-up" output amplifier, as described by the author last month, the next step is to follow the same steps in optimizing the preamplifier and control unit section of the complete system.

FOR THE ENGINEER and/or golden ear who enjoys good music and must live with the distaff side of a family not inclined towards the intricacies of equalizers, equalizer settings, and similar gadgetry, it is necessary to design a high-fidelity system to take into account this point of view and enable tolerable program enjoyment without personal supervision or the teaching of a course in the fundamentals of aural perception and audio circuits.

From this writer's point of view, a typical system is conveniently broken down into four sets of basic elements for the purpose of design consideration. These are, namely, the disc preamplifier and recording characteristic equalizing assembly; the system switching and environmental equalizing facilities; the power amplifier; and the loud speaker and associated acoustical system. These are shown in the block diagram of Fig. 1.

Of these four elements listed above, only the preamplifier and recording characteristic equalizing assembly and the switching and environmental equalizing facilities pose a major audio design engineering job which is ordinarily under the control of the designer. This design problem is exacting due to the low levels involved, and to the fact that the switching controls and equalizing functions are most easily accomplished at relatively high impedance levels with

Fig. 1. Block schematic of the entire system.

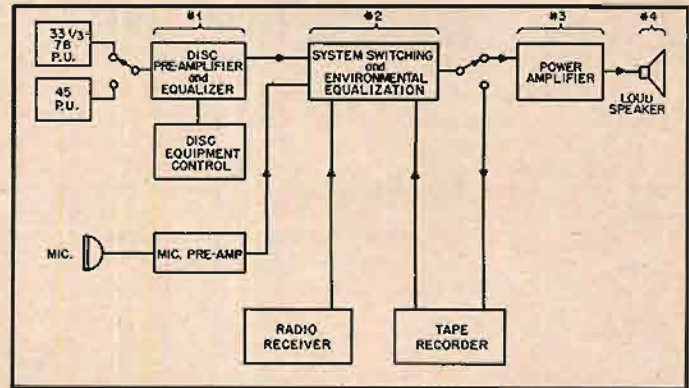

their consequent sensitivity to noise and hum pick-up. Both of these latter functions are logically located in this control unit, "nerve center" position.

The loudspeaker and its associated acoustical systems (which is the subject of Part 3) and the power amplifier (a modified Williamson circuit which was discussed in Part 1) are of essentially straightforward design or may be purchased units of basically linear characteristics and accordingly are assumed to require no additional equalization, nor to require other than an essentially flat frequency characteristic of good transient and intermodulation performance in order to provide satisfactory reproduction of the complex audio signal fed into these two elements of the system.

This article outlines the design, construction and performance character-

istics of a combined preamplifier and recording characteristic equalizing assembly which is combined with switching and environment equalizer facilities. The final unit was engineered for installation in a coffee table, along with the radio receiver and both 33-1/3 and 45 r.p.m. turntables. The power amplifier, microphone preamplifier, and magnetic recording equipment, as well as the loudspeaker assembly, are separately located for convenience.

A separate power supply for this "nerve center" and the use of an output transformer provide for circuit isolation, thus avoiding stray circulating ground currents in the audio system. Residual hum and noise are therefore considerably below the threshold noise level of a quiet room, even when listening within one foot of the speaker.

The final unit more than meets the

*Eclipse-Pioneer Division, Bendix Aviation Corp., Teterboro, N. J.

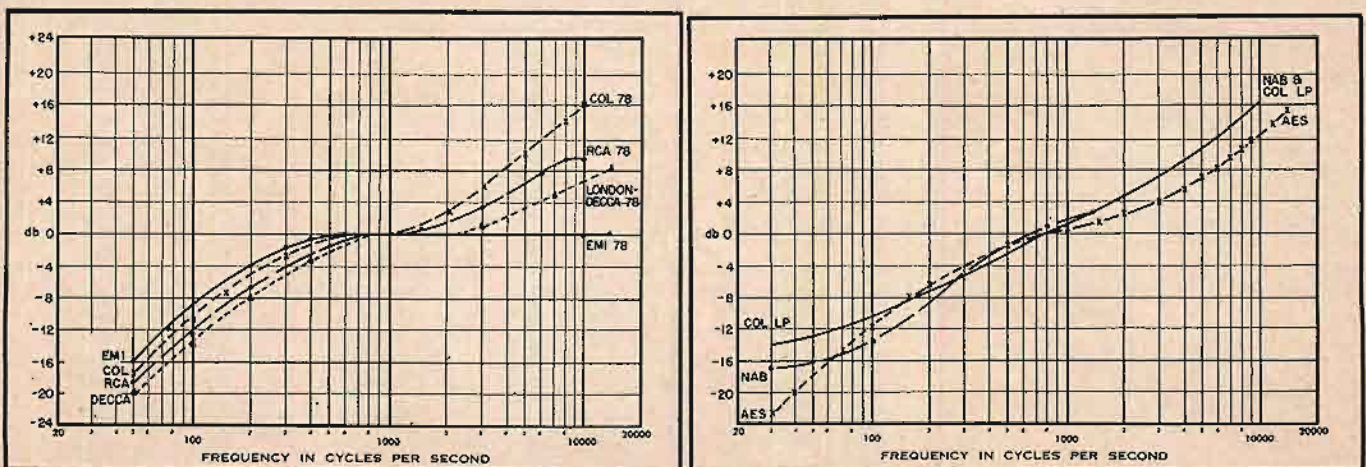

Fig. 2. Recording characteristics for which the preamplifier was designed. (A), left, those used by leading manufacturers of 78-r.p.m. records, and (B), right, those used for transcriptions and LP records, including the AES curve.

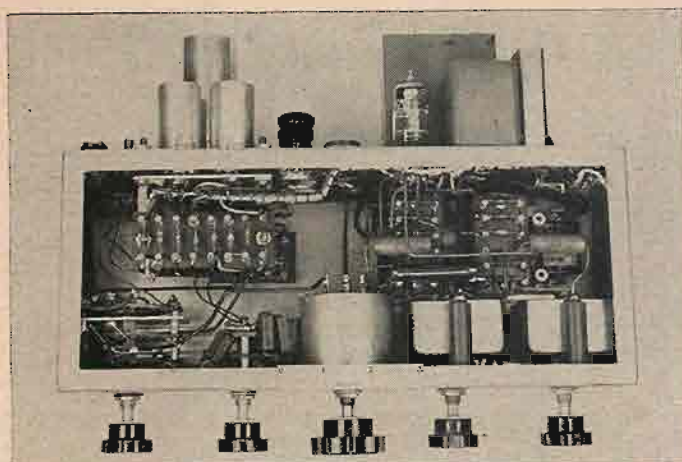

Fig. 3. The complete chassis of the pre-amplifier and equalizer control unit.

original design requirement of a system amenable to technically correct operation by unskilled personnel, while still providing adequate flexibility such that additional and adequate high- and low-frequency environmental equalization was readily available to satisfy individual listener preference and/or to compensate generally for various room acoustic anomalies.

Design Criteria

In considering this system, it was believed to be desirable that only one switch setting should automatically provide the proper and optimum low- and high-frequency compensation required for most discs, and that the midpoint setting of the environmental equalizer controls should provide a system which would have a "flat" over-all frequency characteristic at maximum volume setting with automatic compensation for the Fletcher-Munson curves at lower volume levels. It was desired that the environmental equalization be capable of either boost or attenuation of at least 20 db at both the high and low ends of the audio spectrum in order to provide for personal preference and/or area balance. Due to the fact that most natural phenomena do not change abruptly, and based upon many listening tests of various types and slopes of networks, the environmental equalization was based upon 6 db per octave (single degree of freedom) network swinging around a mid-frequency of approximately 1000 cps and more than critically damped in order to avoid difficulties.

In order to provide the optimum recording characteristic equalization, it was necessary to survey the recording industry both here and abroad, and secure the recording characteristics of each of the most widely used types of records. Accordingly, an investigation was made and reasonably accurate recording curves were made available from the major recording studios as follows:

EMI 78 (British Parlophone, Columbia, Brunswick, HMV, etc.)

Columbia 78 (U. S.)

RCA 78

London, Decca 78

Columbia LP, N.A.B., and the recommended A.E.S. curve

The recording characteristics for each

of these types of discs are shown at (A) and (B) in Fig. 2. It is to be noted that while specifications and much of the literature indicate that the transition from a constant amplitude to a constant velocity curve is a discontinuous function, actual recording characteristics generally indicate coupled systems with only one degree of freedom with the attendant curves as shown at (A). Obvi-



Fig. 4. Power supply used for the preamplifier unit.

ously and fortuitously, such curves are much easier to compensate than those which are discontinuous.

In order to secure optimum signal-to-noise ratios with low-level pickups it was decided to utilize approximately 20 db of gain prior to any recording characteristic equalization. This was done in the first stage which, however, does have an output selector (Sw_1) in order that higher level pickups, such as the Pickering and Clarkstan units, may be used through the same equalizing stages. Use of a pre-preamplifier with a bypassed cathode resistor also helps the hum and noise problems which arise due to heater-cathode coupling. An equalizing preamplifier frequently recommended for this application gives rise to spurious hum and noise due to the unbypassed resistor in the input stage. When using the RPX040, RPX041 or RPX046 pickups, G.E. recommends the use of a 6SC7 with grounded cathodes and work-function bias, with equalization accomplished by means of a RC lossier network between the preamplifier stages. This recommendation was probably based on their findings relative to unbypassed cathode resistors. However, test of the G.E. configuration as compared to the present unit or other units of more conventional design, does show

poorer IM performance, which is probably a result of the greater non-linearity of their bias system.

Construction

Figure 3 shows the completed unit. The controls from left to right are as follows: Input selector Sw_2 (magnetic recorder, radio receiver, 45-r.p.m. record player, and 33-1/3—78 transcription table); record-equalization (record-type) control; Sw_1 , loudness control; low-frequency environment equalization; and high-frequency environmental equalization.

The power supply for this unit, as shown in Fig. 4, has been built on a separate chassis in order to permit its location separate from the other unit.

In assembling components for use in the preamplifier assembly, shown in schematic form in Fig. 5, it was found necessary to utilize a bridge in order to select the correct values of capacitance for the particular value of equalizing feedback resistance utilized. Ordinary, stock type capacitors run approximately ± 20 per cent tolerance, while ± 10 per cent units appear to invariably run right to the limits of the tolerance and accordingly, the importance of utilizing the correct values of capacitance and resistance in the equalizing circuits cannot be too greatly emphasized if reasonably good compensation is to be obtained. Mica units of ± 5 per cent tolerance have, however, been generally found to be very close to the correct value.

The other components of the system are not critical except that special attention should be given to the plate resistors in the first stages to insure that these units are of the "low-noise" type and that the resistors used in the feedback equalizing circuits have a negligible voltage-resistance coefficient.

Relative to low-noise-level and/or low-voltage-coefficient resistors, there are several points all too frequently overlooked by the casual audio experimenter—points which might well be outlined at this time.

For minimum noise, wire-wound units are always quieter than composition units, but before using wire-wound units in feedback circuits, make certain that they are non-inductively wound and in fact have a negligible reactance at frequencies up to 100 or 200 kc—otherwise excessive high-frequency phase shift will cause trouble.

In the present assembly a wire-wound, 1-watt unit used in the plate circuit of the pre-preamplifier improved the signal-to-noise ratio by 18 db when this unit was substituted for a 1/2-watt composition resistor—yet the composition resistor was being operated at only 20 per cent of its rated dissipation.

Composition resistors used in current-carrying loads such as plate circuits or unbypassed cathodes should be carefully suspect of being noise sources in low-level circuits. Where space and miniaturization appear to dictate the use of composition units, use 1- or 2-watt units, even though the dissipation requirement is only 0.1 watt or even

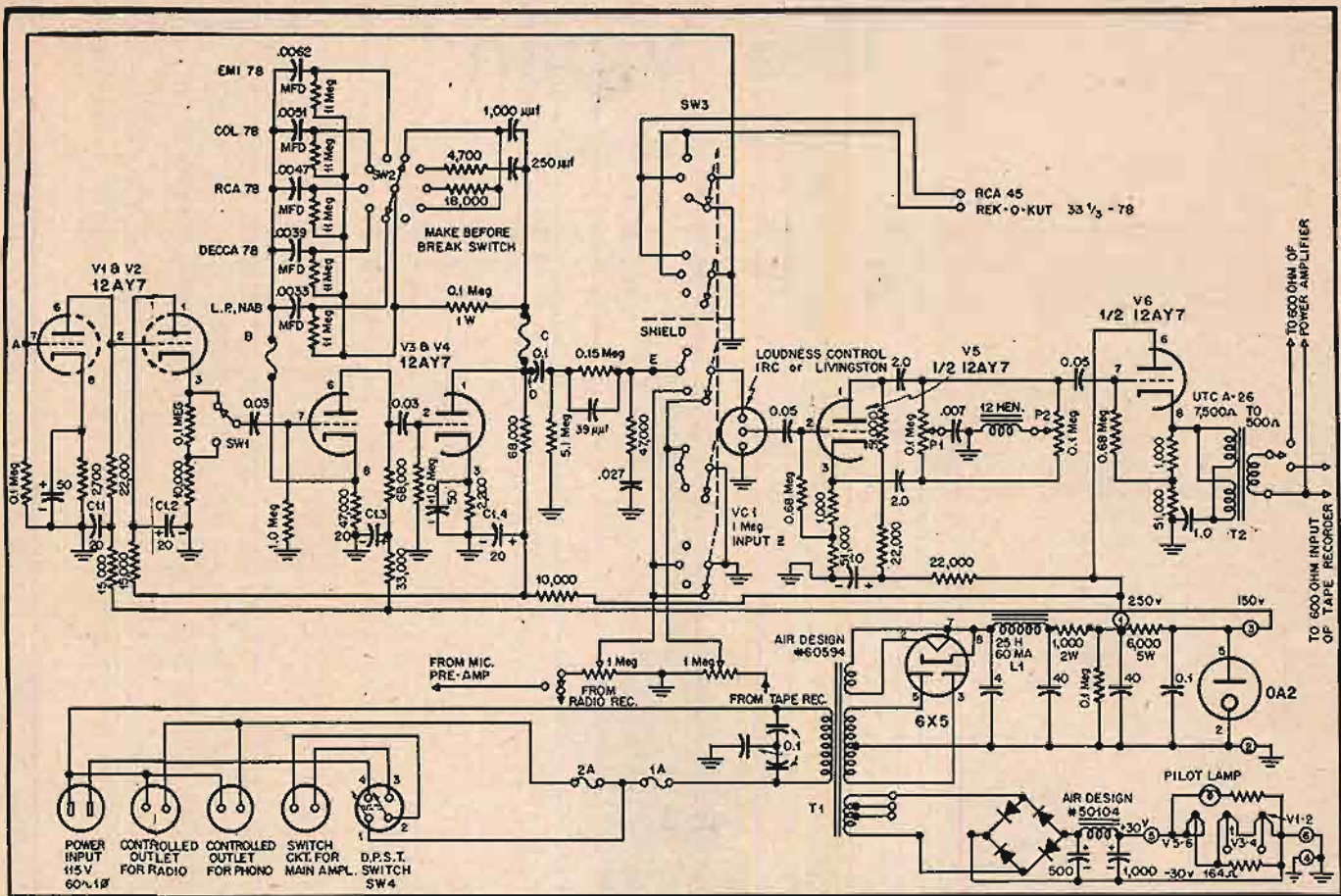

Fig. 5. Over-all schematic of the preamplifier and control unit together with the power supply shown in Fig. 4.

less. With these units used in place of the usual 1/3- or 1/2-watt units, it is frequently possible to pick up an extra 10 to 12 db of signal-to-noise ratio. Where appreciable d.c. currents are not normally present as in the case of the grid resistor and where the a.c. signals are not large, then the smaller 1/2-watt composition units are satisfactory.

In feedback circuits such as that found in the preamplifier recording characteristic equalizing stage, care should be taken to see that the feedback resistor and the associated cathode resistor are of the same type of composition material if space or component availability limits their items to composition elements. Under such a condition the two elements will act as a voltage

dividing potentiometer and while the assembly may not have too good a voltage-coefficient characteristic, no appreciable difficulty will be experienced because they have a relatively high value of minimum bridging impedance—about 105,000 ohms as compared to the approximately 10,000 ohm output impedance (not considering equivalent output impedance due to feedback) of the 12AY7 output stage, across which this divider is placed. Were the 4700-ohm cathode resistor a wire-wound unit and the feedback resistor a composition unit, transient signals would be badly distorted—a point easily established when intermodulation tests are made on such a system.

The low-level coupling capacitors

must likewise be carefully selected. Mica units or other high-quality types should be used. The miniature, metalized paper types are frequently found to be quite noisy when used in low level circuits.

It will be noted that the output of the recording characteristic equalizing amplifier contains an auxiliary low-frequency equalizing network to give a last fine touch to the low end of the recording characteristic compensation curve, a point which is all too often overlooked.

The output cathode follower circuit employs a bridging and isolating transformer in order to avoid the circulating ground currents normally encountered in single-ended outputs which usually give trouble in providing hum-free input to the power amplifier when this unit is located an appreciable distance away from the preamplifier. A bridging type of transformer is used in order that it may be terminated in a 600-ohm load without adversely affecting the distortion characteristics of the cathode follower. It is interesting to note that the 300-ohm output impedance of the cathode follower can deliver 4 volts r.m.s. into a bridging load with the IM kept to below measurable level. When this same stage is loaded by 300 ohms, then the output at 1 volt r.m.s. was found to have over 5 per cent IM distortion.

The pre-preamplifier and recording characteristic equalizer amplifier, along with all associated coupling capacitors and resistors have been mounted in a sub-assembly and this assembly shock-

[Continued on page 50]

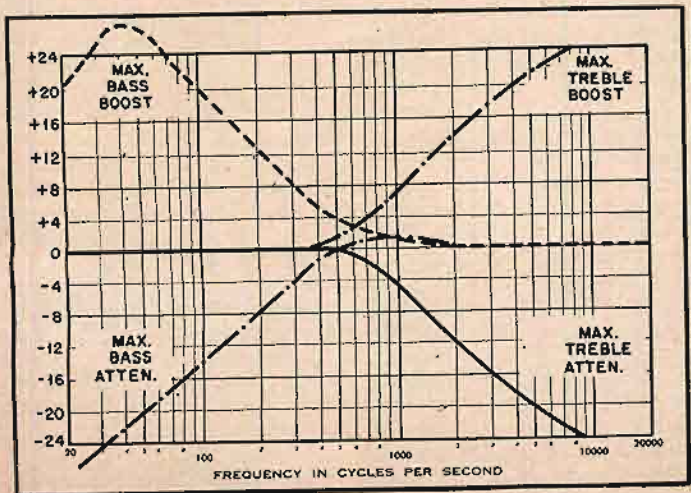

Fig. 6. Curves showing limits of equalization of the bass and treble tone controls.

The Violin

ALBERT PREISMAN*

Part I. A thorough understanding of audio demands a reasonable familiarity with the original sources of sound. One of the most important of musical instruments is the violin, which the author discusses as to its history, its construction, and its musical characteristics.

JUST AS THERE ARE hot rod enthusiasts who install dual mufflers and carburetors on their cars, and chop and channel and relieve and port, etc. etc., so also are there audio enthusiasts who install oversize amplifiers, two- and three-way loudspeakers, etc. etc., on their systems. The one enthusiast is resolved to have no one prune him at a light; aside from that he is bound for no particular destination when he thunders out on the highway. The other enthusiast is resolved that no one shall have a system which is louder than his, that has better flawless highs, less intermodulation distortion, less hangover, and more umpah from his woofer.

It is to the latter that this article is addressed. Follow your enthusiasms as far as you wish, listen with the keenest of hearing to that bit of fuzziness in the reproduction of a certain record, and simultaneously turn a deaf ear to the protests of your better half relative to

* Vice-President in Charge of Engineering, Capitol Radio Engineering Institute, Washington 10, D.C.

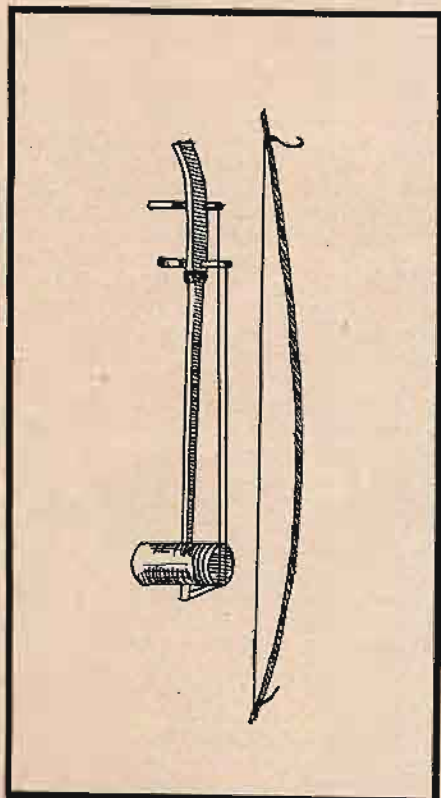

Fig. 1. The Ravanastron—the forerunner of the violin.



Fig. 2. A Stradivarius violin known as "The La Pucelle" dated 1709, from the collection of Rembert Wurlitzer.

the large sums of money you are spending on that new custom-made horn, or turntable, or recorder.

But also stop occasionally to note the quality of the music itself, and the musicianship of the performer. Never mind the cymbal clashes; instead observe the technique and interpretation of the artist. And while you are at it, think for a moment of the musical instrument that is producing the music, and consider how it is constructed and how it is played.

This is admittedly a lengthy introduction to our subject, the violin, but considerable effort is required to wean the average audio engineer away from his hobby into the many ramifications of music. And so, with no further apology, let us turn to the construction and method of playing of the violin.

Brief History

Like many other developments of man, the violin is derived from ancestors whose origins are lost in the mists of antiquity. The idea of a vibrating string as a source of sound is perhaps as old

as the pipes of Pan, but the idea of vibrating the string by means of a bow instead of plucking it is of more recent origin.

The original ancestor is supposed to be the Ravanastron, and is illustrated in Fig. 1. It is shown as having two strings which are vibrated by a bow, and in turn set a resonant chamber into vibration. It is supposed to have originated in Hindustan, but its modern counterpart may be found perhaps even today in China as the Ur-heen, in India as the Omerti, and in Turkey as the Kemangeh a'gouz.

This rude looking instrument developed into a more complicated affair known as the viol, and the viol reached the peak of its development in the 15th century. It resembled the violin in shape and construction, but had as many as seven strings, and in addition was provided with frets along the finger board to guide the fingers of the player, in contrast to the violin, which has a smooth fingerboard.

It was made in various sizes, from the viola d'amore or treble viol to the viola da gamba or bass viol. Many players purchased a "chest of viols," and played on all of them (Mr. Petrillo please note!). However, their sweet but nasal tone must not have been improved by such lack of specialization on the part of the performer, and in any event the viol gave way to the modern violin.

The latter assumed its present form rather suddenly in the 16th Century, when the so-called Brescian school was started. The name of Gaspard de Salo figures prominently in this school, and several fine old violins were made by de Salo and others.

However, following the Brescian school, the greatest school of all was founded at Cremona by Andrew Amati, and his grandson Nicholas. Amati is particularly noted for the quality of his instruments, the most celebrated being known as the Grand Amatis. His most illustrious pupil was Anthony Stradivari, who became the greatest violin maker of all time. His models were patterned after the Grand Amatis, but were more graceful and flatter.

Today the Strad, Fig. 2, is recognized as the top violin, although the quality varies somewhat from one model to another. Its characteristics are beautiful tone, great carrying power, and ability to produce the beautiful tone under the heaviest bow pressure the artist can apply.

There is only one other violin maker

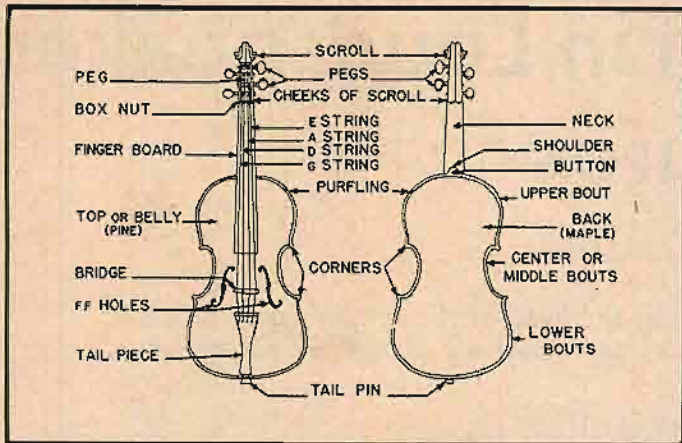

Fig. 3. Diagram of front and back of the violin, showing its essential parts.

or luthier whose product approaches or possibly equals that of Stradivarius, and that is Joseph Anthony Guarnerius, surnamed "del Gesu." Paganini played on a Guarnerius, and Heifetz's favorite violin is a beautiful instrument fashioned by this same maker and known as "The David."

It is true that there have been some very illustrious luthiers during and following the time of Stradivarius and Guarnerius, and that there are some very fine violin makers today, but none seems to surpass or even equal the above two masters. This is in sharp contrast to piano makers, whose product today equals and perhaps even surpasses those made in the past.

That is one of the striking features of the violin family: its sudden rise to peak excellence very early in the history of its present form, and the inability to manufacture it on a quantity production basis, or even on a single hand-made basis to the quality achieved by the Cremona school. Perhaps the next development will have to be of an entirely different form, such as an electronic adaptation of the present acoustic model.

Mechanical Construction

When we look at the violin, we are struck by its seeming simplicity of form, see Fig. 3. Yet actually it consists of seventy separate parts, including the little strips of wood used for ornamentation around its edge and known as purfling. It is this very simplicity of form that baffles the modern violin maker when he seeks to construct a violin equal to or better than a Strad, for it is the gradations in the thicknesses of the wood, as coordinated with the nature of the particular sample of wood, that seem to determine the tone quality. And it is with regard to these matters that the Cremonese masters have been silent.

It is true that age and long playing on the old masters have improved their tone, but there is no doubt that their tone was excellent even when they were new, for they were in great demand even then. And it appears also true that ultimately their tone will begin to worsen with time, for that has been the fate of some old violins, particularly those made of thinner wood. Fortunately the old Cremonese masters still seem to hold

up, although for how long remains to be seen.

The shape of the body has been determined by the playing requirements as well as by acoustical considerations. The C-shaped indentations (center or inner bouts) are to permit the bow to rub on any of the four strings. The rounding of the lower bouts permits the violin to fit better under the chin; the rounding of the upper bouts permits the left hand to finger the strings right up to the end of the finger board, when playing in the so-called upper positions.

The Strings

The source of the sound is the string; there are four of them, tuned in fifths to G, D, A, and E. The reason for the fifths is that aside from the thumb we have four fingers, which are used to "stop" or artificially shorten the strings, thereby raising their pitch. Thus, on the A string, the first finger shortens the string to produce the pitch B; the second finger, C; the third finger, D; and the fourth finger, E.

This, you may note, is the same pitch as the next higher or E string. Hence it would seem more sensible to tune this string to F and thereby extend the range of the instrument. (Similar considerations could seem to apply to the other strings; i.e., they should be tuned in sixths instead of in fifths.) However, the open E string has a tone that is somewhat strident compared to the tone of the A-string stopped by the fourth finger to the pitch of E, and moreover is incapable of a vibrato tone, as is true of the fingered string. There are other features of technique that are facilitated by the tuning of the strings in fifths, although there are probably other features of technique that would be facilitated by tuning the strings in sixths.

However, let us return to the matter of the string as a generator of the tone. The vibrating string has been analyzed mathematically and shown to be capable of vibrating simultaneously at a whole host of harmonically related frequencies. Indeed, Fourier is believed to have developed his idea of the (Fourier) series by noting the complex vibrations of a string.

A string acts as a mechanical transmission line, excited by a generator—the bow or plectrum—somewhere along its length, which sets up standing

waves. Since it is constrained at the end of the fingerboard and at the bridge to very small amplitudes of vibration, it acts at its fundamental frequency like a half-wave line open-circuited at both ends. As such, it vibrates at a fundamental frequency determined by the mass, tension, and length of the string. The greater the tension, the stiffer it is and the greater is the velocity of propagation of a transverse wave along its length, so that it acts as a half-wave line at a higher frequency. The greater the mass, the slower the speed of propagation, and the lower the frequency at which it is a half-wave line. The longer the line, the lower its fundamental frequency.

We can therefore summarize all this by saying that the longer the string and the heavier it is, the lower its pitch, and the more we stretch it, the higher the pitch. Hence, the lowest or G string is made of gut or aluminum wire, on which is wound a tight helix of copper, silver, or even gold wire. The helix adds to the

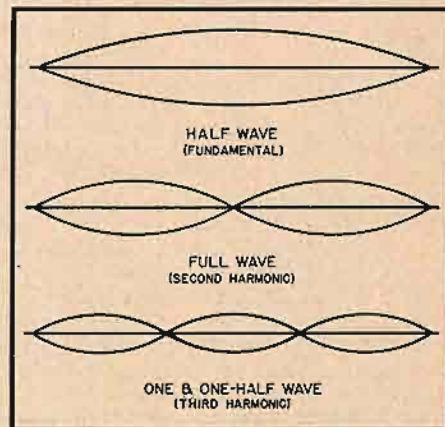

Fig. 4. Various modes of vibration of a string.

mass without increasing the stiffness to lateral vibration for a given tension, so that the pitch is lower, or for a given pitch the tension can be increased. More will be said about this shortly.

The string can vibrate not only as a half-wave line, but as an integral multiple of such a line; i.e., as a full-wave line, one-and-a-half wave line, etc. (see Fig. 4). This means that it produces a Fourier series of vibrations, whose frequencies are therefore harmonically related to one another. The result is a rich source of tone, whose components can then be selected by the bridge and body of the violin in any relative amplitudes so as to produce a variety of tone colors. Indeed, an early electronic musical device (I almost said instrument) could produce tones that sounded even like those of a cornet.

However, in order to produce the higher harmonics, it is necessary that the tension be great enough, otherwise the damping will be excessive over the many wavelengths that the string represents at the higher frequencies. One way to accomplish this is to use the mechanical analogue of electrical loading

[Continued on page 61]

A New Approach in Loudspeaker Enclosures

JOHN E. KARLSON*

New speaker enclosure designs seem to be at the head of the season's crop of ideas. This design is unique, clean in performance, and relatively simple of construction.

IT IS BECOMING increasingly obvious that the weakest link in the high-fidelity chain is the loudspeaker enclosure. By comparison with other units, glaring deficiencies exist which must be overcome before the industry can take real strides forward in meeting the needs of a music loving population. These deficiencies are most apparent in the low-frequency range where the required response is often non-existent or camouflaged by several hundred per cent distortion.

Great emphasis has been placed on this problem in recent years with the result that some progress has been made in this regard. The core of the problem rests in the physical difficulty of obtaining low-frequency resonance in a structure of small dimensions. This can be done in units designed for the reproduction of low-frequencies only, by the use of small slots or holes which have the high inertances necessary for resonance with relatively small volumes. Since these slots or holes act as low-pass filters it becomes necessary to introduce another acoustic path for the high frequencies. As a result, the acoustic path lengths for the high and low frequencies usually become quite different. In addition, the very purpose of the structure

* Karlson Associates, 423 Bedell Terrace, West Hempstead, N. Y.

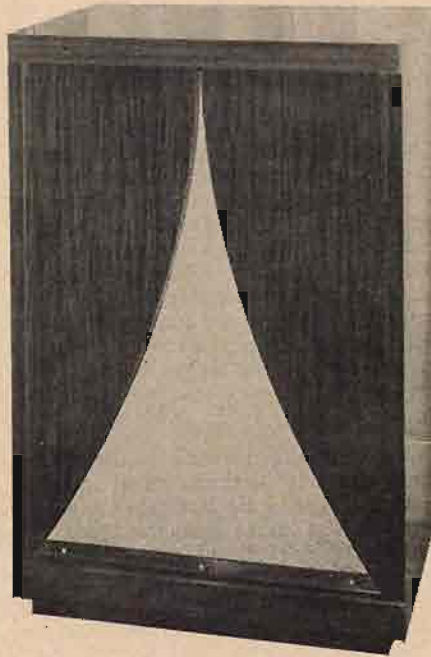

The Karlson "Ultra-Fidelity" speaker enclosure, which employs the principles described herein.

is often defeated during strong passages of music due to the excess pressures developed in these constrictions. The non-linearities thus created give rise to

further harmonic distortion with a resultant loss of the low frequencies.

Coupling

Suppose that we were able to get perfect frequency responses in separate units and it was possible to place these units so that the acoustic path lengths were equal. If we listened to these units individually we would find that they still sounded bad. Why should this be so if the units played in combination are good? The answer can be found by spreading the units apart in a rather dead room and then playing the same combination. Much of the original distortion reappears and the results are unpleasant. Apparently a psycho-acoustic phenomenon occurs when listening to these units which results in making the low-frequency units sound exces-

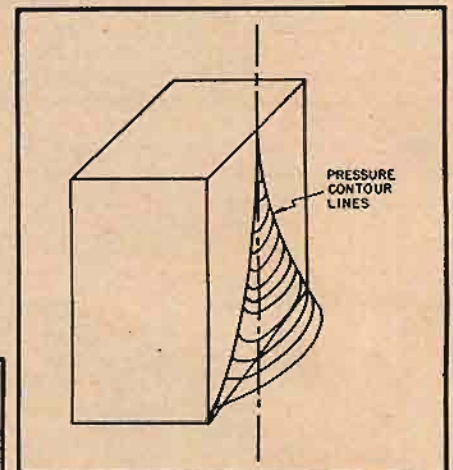

Fig. 2. Sketch of pressure contours from the exponential slot.

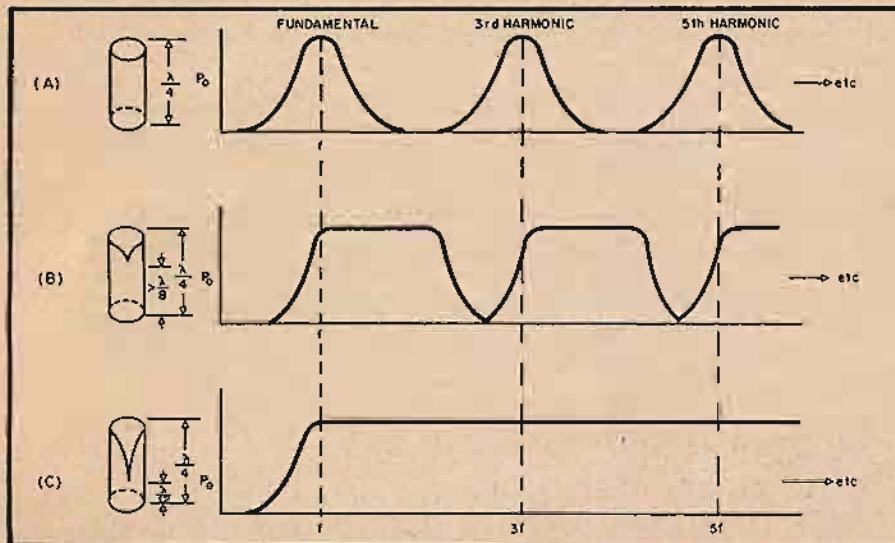

Fig. 1. Frequency response from various types of closed-end pipes: (A) with top open, response is seen to consist of the odd harmonic of the exciting frequency; (B) a notch in one side widens the range of frequencies that are radiated; (C) a long notch gives practically continuous radiation over the frequency range required.

sively boomy and muddy and the high-frequency units harsh and metallic. This difficulty is overcome when all of the units are so closely coupled acoustically that they yield an integral blending of the entire audio spectrum.

Distortion

It seems, however, that every step forward in improved fidelity yields the possibilities for two steps backwards unless extreme care is exercised in overcoming these new objections. With improved coupling between high and low frequency units comes increased intermodulation distortion. This occurs, however, only when non-linearities are present. Since these non-linearities are

undesirable, it appears that the design problem should also include the reduction of these sources of distortion to a bare minimum.

These distortions can occur in the speaker unit, the air load, or the enclosure.

In the loudspeaker unit itself the predominant cause of non-linearity is excessive cone travel either in its entirety or in the individual sections comprising the cone and voice coil. Obviously the solution to this problem rests in heavier air loading which will automatically reduce the cone travel for the same acoustic output and also tend to damp any spurious resonances in the cone structure itself.

Since non-linearities in the air load are caused by forcing large volumes of air through narrow constrictions, it seems that such devices should be avoided. Unfortunately, this requirement seems to eliminate most units used for the production of low frequencies.

The enclosure itself can be the source of considerable distortion. In addition to the more obvious defects of structural resonances and so on, the enclosure can have a profound effect on the over-all frequency response, phasing, and inter-coupling of the loudspeaker units.

The most commonly ignored of these are the latter two because their importance is not generally recognized or understood.

In the reproduction of sound practically all signals are complex combinations of high and low frequencies all be-

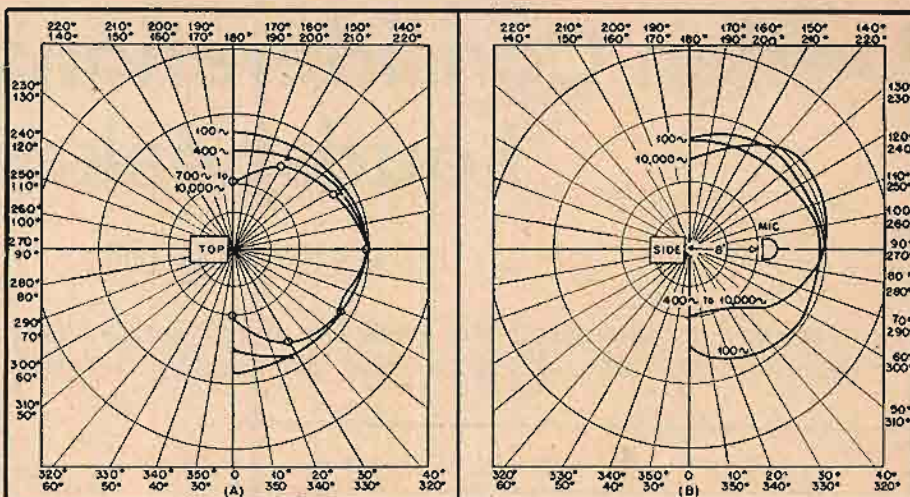

Fig. 3. Polar patterns of sound radiation from exponential slot. (A) horizontal, and (B) vertical.

ing presented to the loudspeaker system in a finite sequence in time. If these component signals should lose their order of presentation to the listener the intelligence thus transmitted is either lost or re-coordinated in the listener's mind, and we have what is called listener fatigue. This condition reduces the enjoyment of the music being reproduced. It may be corrected, however, by designing the enclosure such that its radiation pattern approximates that of a point source, with equal acoustic path lengths for all frequencies.

Another aspect in the maximum transmission of intelligence from our sound

system is involved in our ability to distinguish weak transients in the presence of relatively loud sounds. The ability to hear these pulses of sound varies as a function of the strength of the signal and the length of time the ear is exposed to this signal. If the same signal impinges upon the ear several times a stronger impression will be received and the intelligence more effectively conveyed than if this signal is heard just once. For this reason it has been found that a certain amount of reverberation is essential to the proper appreciation of music. In some instances rooms have been expanded and redecorated just for the purpose of increasing the reverberation time of the room. If it is increased too much the increased perception induced by the repetitive exposure to these signals is confused by the various acoustic paths taken by the many frequency components of the signal. This confusion becomes most apparent when listening to speech; therefore lecture rooms and speech broadcast studios have to be designed with relatively short reverberation times.

In applying these principles to loudspeaker enclosures it is apparent that some reverberation time is desirable, particularly since the enclosure presents possibilities for the retention of the phase relationships during such reverberation. This reverberation must be closely controlled throughout the entire frequency range, however, or else certain frequencies may predominate with the result that enclosure exhibits a certain amount of "core" or hollow sound which is so typical of horns.

Still another factor influencing the proper transmission of intelligence is that of the overall radiation pattern of the system. Trying to maintain an amplifier flat to within a fraction of a db is ridiculous if the radiation characteristics of the speaker system cause variations in excess of 20 db for different positions in front of the speaker.

This problem has had a great deal of attention from acoustic engineers and many solutions have been presented which are more or less effective. None of these are operative over the entire

[Continued on page 58]

Table I

General Requirements for Ultra-Fidelity¹ Speaker Systems

Over-all frequency response	(1) 20-20,000 cps flat within 2 db with gently sloping responses at the edges of the band. (2) Several speakers may be used to obtain this response but all shall be closely coupled acoustically and properly phased to simulate a point source of sound. (3) Reductions of the above bandwidth shall be made simultaneously at both edges of the band to achieve optimum balance. Product of high- and low-frequency responses shall approximate 500,000.
Power output	(4) Average level of acoustic output shall be consistent with application. System shall be able to deliver peak acoustic outputs at 20 db in excess of this rating without cone break up or aurally detectable distortion.
Efficiency	(5) Minimum 5 per cent between 3-db points of over-all bandwidth.
Radiation characteristics	(6) Shall simulate the radiation pattern of a point source in the spatial environment for which the system is designed.
Distortion	(7) Shall be minimized by the elimination or reduction of the principal causes of distortion. Conditions required are contained in the following: a) Provide maximum throat size in horns or other transducers. b) Avoid the use of narrow slots or holes which constrict the flow of acoustic power during strong transients and provide non-linear air loading. c) Provide maximum and uniform air loading consistent with the above for all driver units. d) All motor units shall be closely coupled acoustically. This coupling shall be flat within 2 db for the frequency range required or else provide compensation which will correct the driver-unit response in order to obtain the required over-all response. e) Provide sufficient ring time in enclosure to make weak transients audible in a typical acoustical environment. Control ring time in design to provide compromise between speech and music requirements.
Adaptability	(8) For use in the home it is obvious that it is highly desirable to have a unit which can be placed anywhere in the average room and if necessary readily adapted to custom installations.
Size	(9) Maximum size for use in the home should approximate that of the smaller radio and television consoles.
Cost	(10) The cost of these units should be low to be available to average income families.
Styling	(11) The styling should be distinctive enough to be used in the most affluent surroundings and sufficiently neutral to prevent clashes with furniture of specific styling.

¹ Patent applied for.

Design Considerations of Duplex Loudspeakers

ALEXIS BADMAIEFF*

Development and production of a new line of high-quality loudspeakers requires adequate test facilities—the author describes these, along with the design of the speakers themselves.

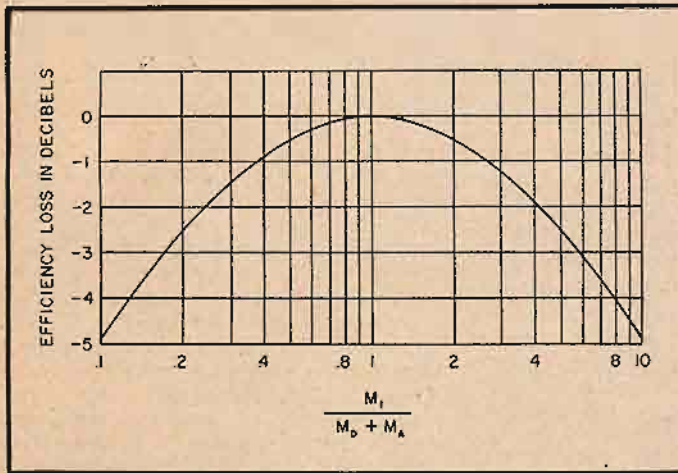

Fig. 1. Ratio of total effective cone mass and voice-coil mass at selected frequency vs. loss in efficiency in db.

DURING RECENT YEARS, the electronics field has been advancing along many fronts. In the field of sound reproduction, amplifiers are designed so that a response of ± 1 db over a frequency range from 20 to 20,000 cps is considered a good average. Likewise, the high-quality microphones almost match the characteristics of the amplifiers, which together comprise an electrical system that is flat within ± 2 db over the full audio spectrum. The mechanical, optical, and magnetic transducers—such as phonograph pickups and cutters, optical film recorders, playbacks and magnetic tape transfer devices—are also engineered to a high degree of accuracy, realizing a response that is held within a range of ± 1 db. But where do the well-engineered voice currents end up? They always end up with a loudspeaker that has the job of translating them to equivalent acoustical reproduction. It is, however, a well known fact that no loudspeaker has been available that can anywhere near match the response characteristics of a good amplifier. The result, then, was a nearly perfect system with an imperfect end result.

In connection with our development work measurements were made on practically all of the available high quality loudspeakers and all were found to have variations of at least ± 8 db in the range from 50 to 15,000 cps. The objective of this development was to remove this bottleneck in the reproduction of high-

quality sound, so that full value of the complementary equipment would be realized. The loudspeaker, then, is the instrument that we are concentrating upon; to try and approach as nearly as possible, with our present-day acoustical knowledge, the characteristics of a good amplifier. Since the most practical and economical wide-range speaker is a two-way or duplex with a crossover network, our development work was concentrated on that general type, with some additional novel features and refinements of prior art.

The most important items in the design of a good speaker are the equipment and method of testing the results achieved. Too many speakers are designed without proper test equipment, which result in an erroneous evaluation of the characteristics that, in most cases, are essential requirements of a loudspeaker. As is generally known, many

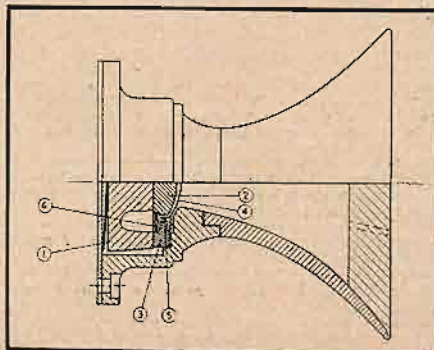

Fig. 2. Cross section of the 3000A high-frequency unit and horn assembly.

tests are conducted involving the response and range of a loudspeaker by merely having several people with "good" ears listen to a sweep frequency and argue as to how many db's up or down a certain frequency band was. A better method used is a "free field" open air space where tests are conducted in an open air field, having the speaker and a calibrated microphone mounted on a pole or tower. This free field, however, is not really free because of reflected interference from the ground producing standing waves and masking the true characteristics. Unless it is a perfectly calm day, which is rare, wind will also greatly interfere with the measurements, and produce results that are unreliable. Tests conducted with a microphone in an ordinary room are, of course, out of the question because the room characteristics will completely mask the eval-



Fig. 3. The high-frequency driver, shown in actual size.

uation of the speaker. The best possible way to conduct acoustical measurements is in an anechoic chamber, better known as a free field room. In our development work, such a chamber is used in all instances and for all tests, such as frequency response, power rating, frequency range, efficiency, and linearity. In such a chamber, it is possible to test acoustical devices over the complete sound pressure range, since outside noises stay out and the high-level sound stays in.

The Altec Lansing anechoic chamber is 15.8 ft. long, 11.7 ft. wide and 13 ft. high on the outside. The interior space measures 10.7 ft. long, 6.8 ft. wide and 8 ft. high. The room is a double-shell structure, well braced along all flat surfaces. The inner shell is resiliently supported in the outer shell by wooden pads and the whole structure is supported by pneumatic cushions. The interior is acoustically treated to absorb sound on all sides, including the floor, by 21-in.

* Consulting Engineer, Altec Lansing Corporation.

wedges of soft Fibreglas absorbers which are attached perpendicularly to all the surfaces, forming an absorbing layer about two feet thick. This chamber is an equivalent of a free field in space absorbing almost all the energy from a sound source and thereby preventing echoes, standing waves, and reverberation. It is particularly stressed that only a free-field response of a speaker represents its true characteristics, because the speaker itself is measured and divorced from all other influencing factors. The acoustical energy is measured by a calibrated microphone, and after proper amplification, its signal is recorded by an automatic pen recorder that records the amplitudes of a continuous sweep frequency from 30 to 20,000 cps.

Design Steps

The approach to a design of a good duplex speaker is, of course, based on known acoustical and electrical facts and good engineering practice. A few of these can be outlined at this time:

- (1) First of all, the two components of the speaker, that is, the LF unit and the HF unit, should be independently designed to have as good a frequency response as possible over their working ranges.
- (2) The high-frequency and the low-frequency

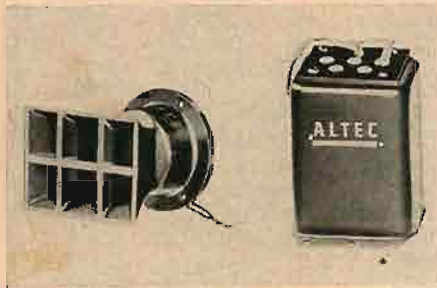

Fig. 4. The high-frequency horn and driver assembly together with its matching crossover network.

frequency diaphragms should be at substantially the same plane to attain good phasing characteristics in the crossover frequency region.

- (3) The two units should be approximately concentrically mounted for proper and constant phasing at the crossover region.
- (4) The size of the LF cone should determine the size of the HF horn.
- (5) The dimensions of the HF horn should determine the crossover frequency.
- (6) The outside surfaces of the HF horn should be so shaped as to have negligible reflections from the LF cone.
- (7) The distribution angle of the HF horn should be at least 90 deg. included angle, but not so wide as to cause interference due to reflections from the cone.
- (8) The resonance of the LF cone should be at about 50 cps or lower to enhance the extreme low-end response and minimize the low-frequency "hangover."
- (9) The efficiency of both units should be as high as normally expected from an efficient single-unit speaker.
- (10) The wattage rating of each unit should be so chosen as to assure linearity over its full rated range.

Fig. 6. The measured frequency characteristic of the crossover network.

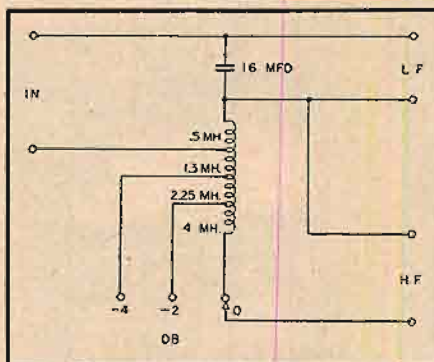
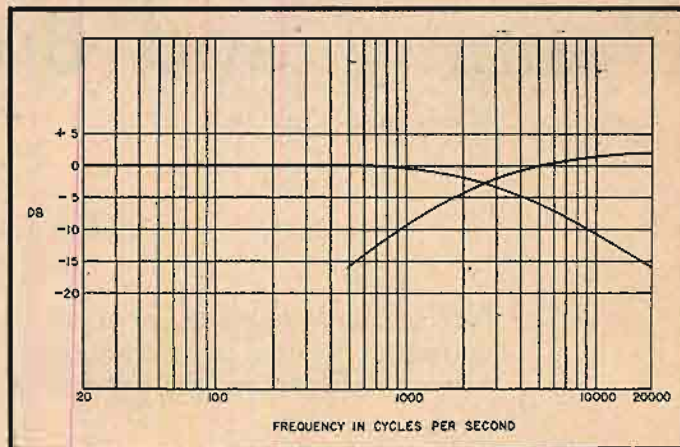

Fig. 5. Schematic of the N-3000A crossover network.

- (11) The crossover network should be simple, economical to manufacture, and should be tailored to the acoustical properties of the units with which it is to be used.
- (12) Mechanically, the speaker should be engineered for easy assembly and protection of the air gap and voice coil against dust and magnetic particles.

All the above factors are essential, but the degree of success in any one or all of these points will determine the quality of the product.

Two speakers were designed: one, a 12-in. duplex which is now known as the 601A, and the other, a 15-in. duplex, now called the 602A. Since both speakers are similar, the 12-in. duplex will be described here in detail.

Our low-frequency unit was designed for one specific job: to reproduce efficiently all frequencies from 30 to 3,000 cps in a properly designed enclosure. This range is most important because it contains the fundamental frequencies of

the majority of sounds. This range, therefore, has to be smooth in response—without peaks or dips that exceed a total of ± 3 db in amplitude variation. The cone designed for this job is a straight-sided 12-in. cone having an included angle of 110 deg. At the rim is a two-step compliance cemented to a frame assembly and painted on each side with two coats of a viscous damping liquid. This preparation, when dried, is a viscous plastic layer which acts as a mechanical damping material for the absorption of mechanical energy generated by the voice coil and transmitted by the cone. The wave motion, as it travels from the center of the cone out to the rim, is substantially absorbed by the mechanical resistance of the damping layer and prevented from reflecting back. This action greatly reduces the standing waves in the cone which would appear as serious irregularities in the response of the cone. The compliance portion of the cone is considerably thinner than the cone proper to reduce stiffness, which together with the total cone assembly mass will resonate at about 50 cps. The apex of the cone is supported and centered by an impregnated cloth spider, which is made very flexible so as not to contribute materially to the total stiffness of the system.

The complete moving system—a damped cone and its supports—is driven by a 3-in. diameter voice coil designed to transform electrical energy to mechanical motion efficiently. The voice coil is wound of aluminum ribbon .004 in. thick and .023 in. wide on a thin stiff paper form. The coil is wound edge-

[Continued on page 74]

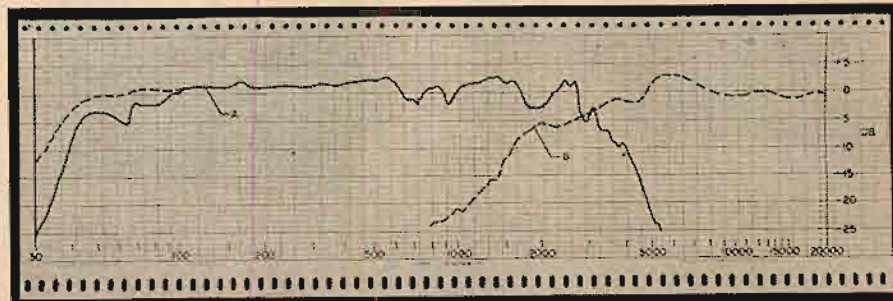

Fig. 7. Frequency response of individual LF (curve A) and HF (curve B) units when assembled and enclosed in the 606A corner cabinet.

Planning and Building a Radio Studio

EUGENE F. CORIELL*

Major, USAF

Part 4. Continuing this series with a discussion of the actual steps required to provide complete control over the installation of the audio cabling between various components of the radio or recording studio.

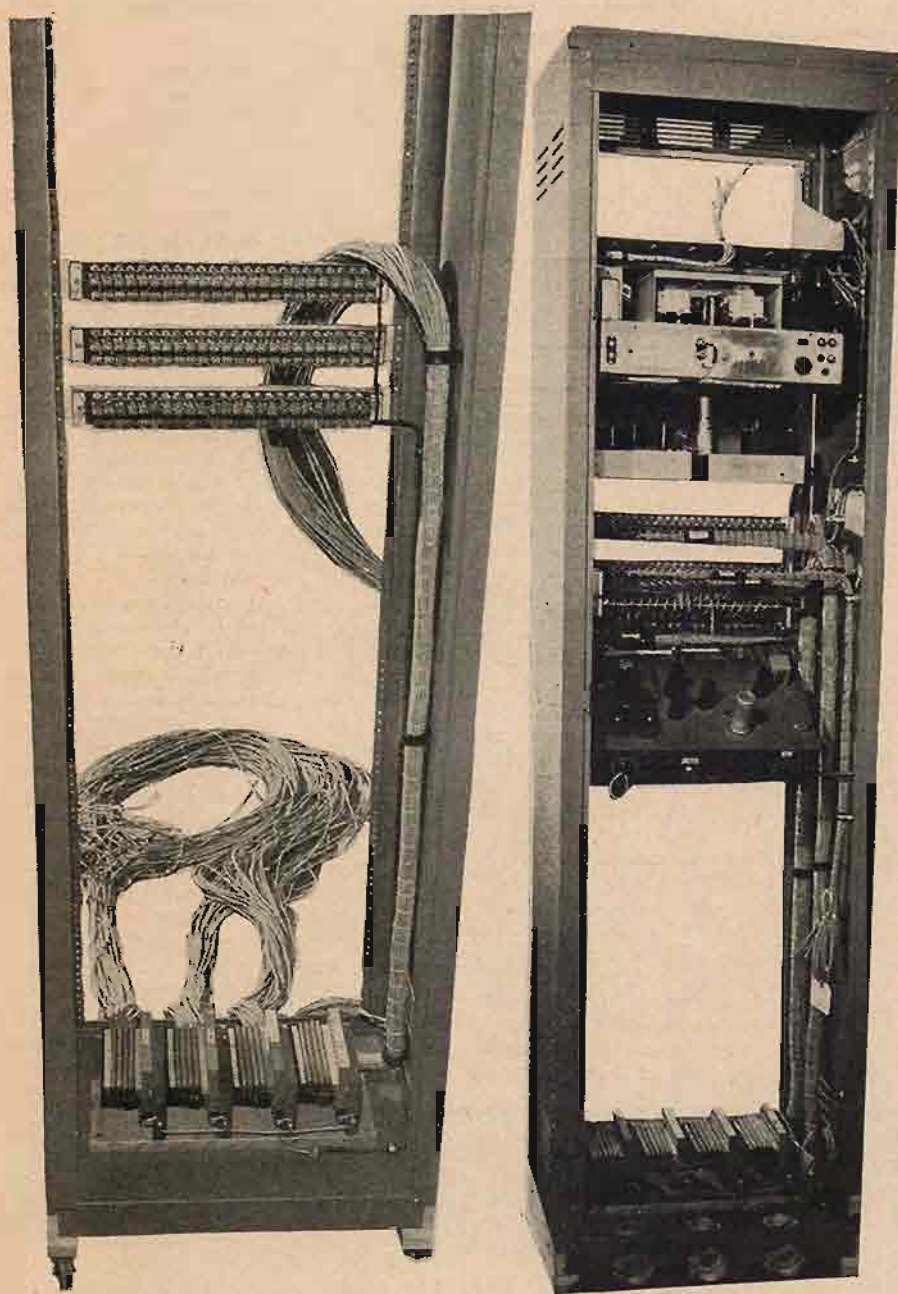

Fig. 1A (left). Rack at beginning of construction, showing jack field and low-level cable wired to underside of W.E. type 100B terminal block. Four blocks are shown mounted on their sides. Disadvantage of this mounting is that it is impossible to get to the underside of the blocks for repairs. Fig. 1B (right). Same rack at a later stage. Note fittings for the interconnection conduits which will take off the rack circuits picked up at the top of the blocks. Note also the talkback amplifier mounted at an angle below the jack field to save rack space. This rack is not the one diagrammed in Fig. 3. Official Defense Dept. Photos.

THE PRECEDING INSTALLMENT began with ways and means of getting along with the contractor during construction of the studio building, and then discussed the planning of the audio facilities. A series of steps was outlined, into which this planning could be broken down. The first three steps were analyzed in detail and included: 1) Decision as to the exact facilities needed, including the choice between stock and custom-built consoles; 2) Preparation of the block diagram; and 3) Jack field layout. The remaining steps will be considered in this and the subsequent installment and include: 4) Rack layout; 5) Relay system wiring diagram; 6) Rack internal cabling pictorial layout; 7) Pictorial layout of interconnection cabling between racks, console, turntables, etc.; 8) Preparation of conduit list and, if necessary, cable make-up sheets; 9) Audio conduit diagram, if any; 10) Complete grounding diagram; 11) Running sheets; 12) Interconnection sheets; and 13) List of construction materials.

With completion of the jack field layout as step three, the physical size of the field, its exact position in the rack, and the positioning of the other rack components can now be determined. These decisions make up step four, rack layout, which could begin with a discussion of the characteristics of standard racks. These come in various overall heights which are usually four to seven inches greater than the amount of useful panel space, to allow for top and bottom trim and for bottom kick-plates. Casters add additional height. The variations in panel space with different rack sizes occur in increments which are even-multiples of $1\frac{3}{4}$ in.

Racks are available as open bolting frames without enclosure of any kind (telephone type) and also as completely-enclosed cabinets. In either case they are designed to take standard rack panels 19 in. wide and varying in height by increments of $1\frac{3}{4}$ in., which also happens to be the height of the smallest standard panel. Racks come ready-drilled-and-tapped on standard spacings, usually alternate spacings of $1\frac{1}{4}$ in. and $\frac{1}{2}$ in., and take either 10-32 or 12-24

*Radio Technical Officer, Armed Forces Information School, Fort Slocum, New York.

rack screws. Rack panels come with screw holes spaced accordingly and it should not be necessary for station personnel to drill racks or panels, except for non-standard rack components. A typical cabinet rack has an over-all height of 83½ in., over-all width of 22 in., 77 in. of panel space, and an over-all depth of 18 in. This latter dimension is sometimes overlooked or misinterpreted. The depth of shelf or amplifier chassis accommodated in the rack depends on the *clear inside depth* which is an inch or two less than the over-all value.

So much for the mechanical details of the rack, which we began to lay out some paragraphs back. In positioning elements in the rack, start with the already-laid-out jack field. Since the heights of some single-row and double-row jack strips are not even-multiples of 1¾ in., the total height of the field may not equal any standard panel height. It may therefore be necessary to add a special make-up panel to the top or bottom of the jack field to bring the field into registration with standard spacing so that the other rack elements which are standard will fit properly. Some jack strips are built to even multiples of 1¾ in., but if these are not available, an alternative plan is to use jack mats. A mat is a decorative frame which fits around one or more double-row jack strips like a windowed panel, and spaces the strips so that the over-all mat height is a standard panel value.

Equipment Location

Ideally, the jack field should be located for maximum convenience in reading the labels and inserting patch-cords. The writer suggests the lowest jack row be no lower than forty inches above the floor, with the top row no higher than sixty inches. This is more leeway than preferred by some engineers but experience shows these extremes are not impractical, and the greater tolerance of location makes it easier to fit the jack field into the rack with minimum conflict with other rules of jack field layout—for example, the rule that locates meters at eye level.

Preamplifiers should be placed at the top of the rack, well away from the

fields of monitor amplifiers and power supplies which should be placed near the bottom of the rack. Amplifiers, tuners, and other equipment having frequently-used controls should not be located directly under jack fields as dangling patch cords may get in the way. Also units with controls should be placed so that they can be reached with minimum stretching and stooping. To save rack panel space, put matching transformers, loss pads and other small items having no controls on narrow shelves behind the more shallow rack components.

Terminal blocks should be placed in the bottom of the rack and provided with covers to prevent debris from falling down among the terminals and shorting them. The space required varies with the type of block and the position in which it is mounted. One of the most popular is the Western Electric type 100B. This is approximately 6 in. long, 3 in. wide, and 3 in. high. It contains four rows of 20 terminals each and can be mounted in a variety of ways. Where space is scarce, blocks can be mounted on their sides as shown in Fig. 1, where they occupy only three and one half inches of rack panel height. The disadvantage of this arrangement is that it is almost impossible to get at the bottom of the block once installed, and any spare terminals must be wired to coiled-up spare pairs during original installation. Another method is to mount the blocks vertically on a bracket extending across the width of the rack. This requires considerably more rack panel space, depending on the cabling arrangement used. The position of all components should be shown on a rack layout sketch.

If there are not too many terminals, the terminal blocks can be replaced by Jones plugs of the recessed type, carried in the rear bottom sill of the rack. If the rack is mounted on casters, pulling out the plugs makes it possible to wheel the rack away for convenient maintenance. This saves the expensive door-swinging space otherwise required behind cabinet racks for maintenance access. Since castered racks are top-heavy in most cases, it's a good idea to chain the top of the rack to an eyebolt in the wall

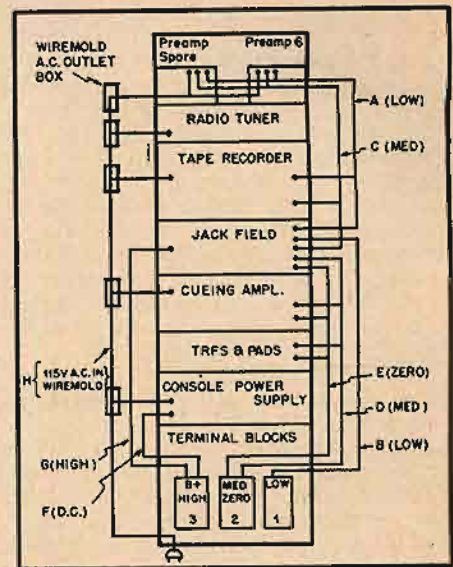

Fig. 3. Rack Cabling Layout. There are relatively few circuits and, if necessary, the low-level pairs as well as the medium- and zero-level circuits could all have been carried on terminal block 2. Note Wiremold distribution system which eliminates a.c. terminal block. Also note that high-level and power circuits are on opposite side of rack from lower levels.

with a detachable clip—but be very careful when moving the rack.

Up to this point, we have covered the following points in the design of the audio facilities: 1) Decision as to exact facilities needed, including type of console; 2) Preparation of the block diagram; 3) Jack field design; and 4) Rack layout. From here on, effective planning requires some organizing to reduce lost motion. Following is a list of things the designer should have on hand before proceeding further with the layout:

1. Complete list of equipment and accessories needed, in exact quantities.
2. Block diagram.
3. Jack assignment chart or list.
4. Instruction books on all equipment and accessories, showing physical dimensions as well as electrical characteristics.
5. Building floor plans or sketches showing equipment layouts.
6. Change register as shown in Fig. 2. Changes come up from time to time and must be entered on several documents such as jack assignment lists, block diagram, individual sketches, etc. By registering the change and checking off all the documents requiring alteration at the time he adopts the change, the engineer provides himself with a complete change reminder against the time when he gets around to altering the records mentioned. Overlooking just one item in making changes can create costly confusion and backtracking.
7. A sketch register on which is noted—even before the sketch is drawn—its number and title, as the need for a given sketch becomes apparent. The usefulness of this register will become apparent during the discussion of running and interconnection sheets.
8. Layout sketches of each rack, showing exactly where each component is located.
9. There should also be an ample supply of forms such as running sheets, interconnection sheets, conduit lists, etc., all of which will be discussed in detail further on.

Now, with everything highly organized—and perhaps thoroughly bound up

DESCRIPTION OF CHANGE	DOCUMENTS AFFECTED											
	BLOCK DIAGRAM	JACK FIELD CHART	RELAY DIAGRAM	CABLE LIST	CABLE LABEL SHEETS	INDIVIDUAL SKETCHES	CONDUIT DIAGRAMS	GROUNDING DIAGRAM	RACK CABLEING LAYOUT	INTERCOM CABLE LAYOUT	RUNNING SHEETS	INTERCONNECTION SHEETS
JACK 9 WAS ANNOUNCER'S BOOTH LOW LEVEL UTILITY #3, NOW SPARE JACK	x	x		x						x	x	
BRIDGING TRF DROPPED	x	x				x				x		
ON-THE-AIR SILENCING RELAY ADDED TO INTERCOM SYSTEM			x	x		x	x					

Fig. 2. Change Register. At the time a change is adopted, indicate hereon all diagrams, layouts, etc. affected. This reduces the likelihood of any document being overlooked when the records are altered.

in red tape—we can go on to the next step in audio planning, the relay system. Relays are used in broadcasting for many purposes: To turn studio speakers off when microphones are live; to select the proper combination of program sources and outgoing lines in master control; to control on-the-air signs and signal lights; to operate talkback speakers; to turn on and off remotely located equipment; to operate monitor dialing systems, etc. In view of the variety of possible relay arrangements, this discussion will be limited to general principles applicable to all relay layouts.

It is good broadcast design to provide the most usual contact condition when the relay coil is de-energized. For example, the most usual studio speaker relay contact condition is **SPEAKER OFF** (and of course, simultaneously **MICROPHONE ON**). When this condition exists with no power in the relay coil, failure of the relay or its power supply will not throw the studio off the air. It is important to keep the supply voltage constant under varying loads, to prevent erratic relay operation, and an emergency relay supply is generally a good investment. Some stock consoles provide d.c. for external relays, in which case these relays are sometimes connected in series with the normal load of the console power supply—perhaps the tube plates. In such instances, it is wise to provide an emergency relay cut-out switch and a compensating load resistor so that relay failure need not disable the console.

The speed of speaker relay operation is often a factor in preventing feedback and can be varied by shunting the coil with a capacitor, or a resistor, or both—or by varying a resistance in series with the coil. Capacitors are also helpful in reducing click pick-up when shunted across the coil-energizing switches. Direct current is best for broadcast relays as they then create no hum fields and do not tend to sing. Locate all relays with a view to ventilation, protection from dust, and maintenance access. Don't hesitate to ask relay manufacturers for advice in relay selection, and buy the best ones available as insurance against the cost and aggravation of faulty opera-

tion. Rugged coils and oversize contacts are prime requisites in broadcast relays.

Draw the complete two-wire diagram of the relay systems with all the care lavished on the audio block diagram—and make sure to identify as such on the relay diagram any relay components appearing on the block diagram. Show the voltages at various points, along with the coil resistances, and describe any non-apparent operational details in notes integral with the diagram. A legend is helpful in identifying the components and symbols.

Level Groups

Before proceeding with the internal cable diagram of the rack or racks, it will be necessary to decide on the circuit audio levels to be included in the various level groups. A level group is one in which the individual pair levels do not differ by more than 30 db approximately. One authority¹ recommends the following criteria for minimum cross-talk: **LOW** (microphones, tape recorder playback heads, turntable pick-ups), -60 to -30 dbm; **MEDIUM** (turntable preamplifier and booster amplifier

WIRE TYPE	No. of Pairs Per Conduit					
	$\frac{1}{2}$	$\frac{3}{4}$	1	$1\frac{1}{2}$	$1\frac{1}{2}$	2
Rubber-Covered Mic Cable	1	3	4	6	8	10
Twisted Pair, Shielded, with Braid over Shield	2	5	8	10	16	32

Fig. 5. Conduit Capacity Table.

outputs), -30 to 0 dbm; **ZERO** (program amplifier outputs, line feeds, etc.) 0 to +30 dbm; and **HIGH** (speakers) above +30 dbm. Separate groups are recommended for control (relays and signal lamps) and power (115 volts a.c.).

There are conditions under which it is possible to depart somewhat from these criteria. For instance, in very

¹ John D. Colvin, "Planning a studio installation," *AUDIO ENGINEERING*, Aug. 1947.

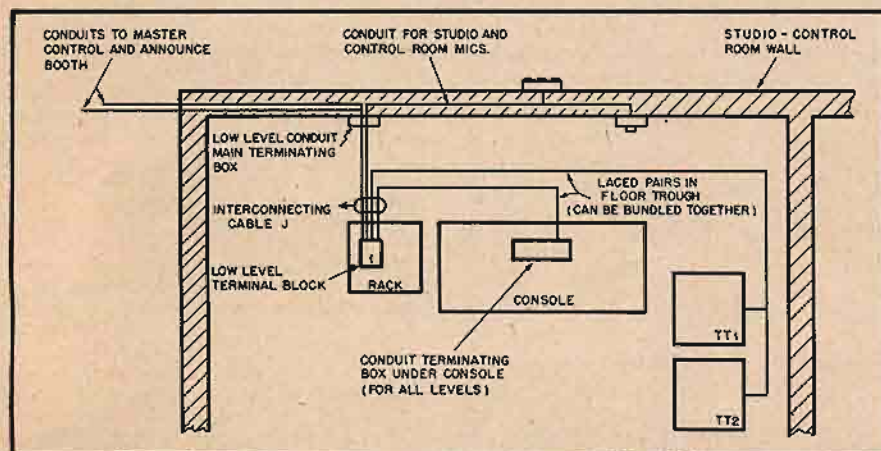

Fig. 4. Interconnection Cabling Layout. To simplify the sketch, only the low-level circuits are shown. This layout is for the studio illustrated throughout this series of articles. Note that the pairs not running in conduit are carried in a trough behind the equipment.

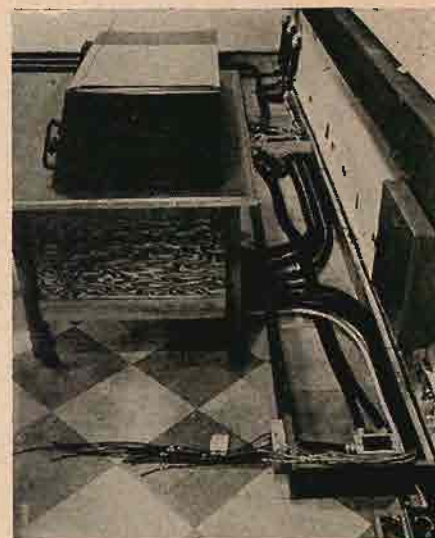

Fig. 6. Interconnection Cable Trough. Racks are to be located at the far end of the console. At top right, cables of three level groups converging on the control room run down the wall to the trough and thence to the racks and console. See Fig. 1 of preceding installment for front view. Most of the floor circuits are run in flexible conduit which is ordinarily not required in trough work. Official Defense Dept. Photo.

short runs, it may be possible to cable medium-level pairs in a zero-level group. In the case of a single amplifier, the input and output pairs can be run together if the bundle contains no pairs from other components. Where space is limited, control d.c. can be run with high level pairs. In general, compromises on level groups are more likely to be successful when all circuits are balanced to ground. However, compromises should not be attempted with low-level lines.

Rack Cabling Layout

The next and sixth chore in our series of planning steps is preparation of the rack cabling layout sketch. This is a pictorial rear view of the rack with its components in place, on which are superimposed the cables which tie the jack field to the rack components and to the terminal blocks. Such a sketch, Fig. 3 for example, is necessary to show the wireman the general plan of the wiring and to enable the designer to visualize the courses of the cables whose make-up he must detail on the running sheets. Our concern here is with the starting and stopping points—and the make-up—of the various cables, and not with their precise physical placement in the rack.

The rack cabling sketch is prepared by picking off from the block diagram the circuits shown as going from the jack field to the various components included on the previously-prepared rack layout sketch. The jack field is usually the most common point for all the circuits in the rack, and the various pairs must go either up or down from the jack field. Some engineers prefer to assign letters to the terminal strips of various amplifiers and show the pairs as running to these strips. Others simply show the pairs as running to the ampli-

[Continued on page 69]

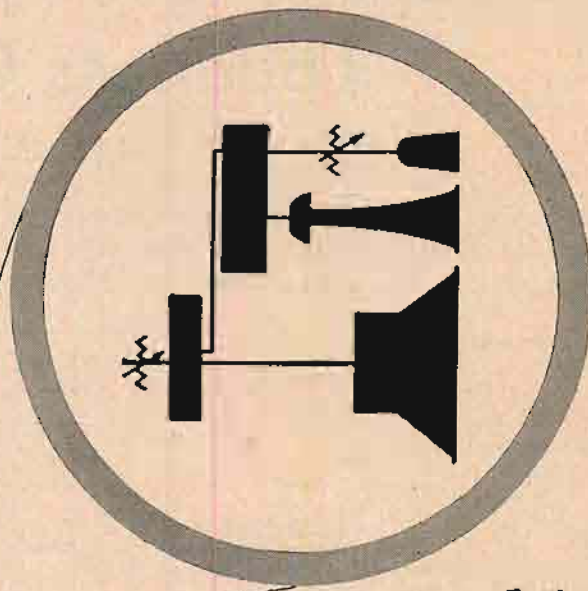

new dimensions in sound

the Jensen TRi-PLEX 3-way reproducer system

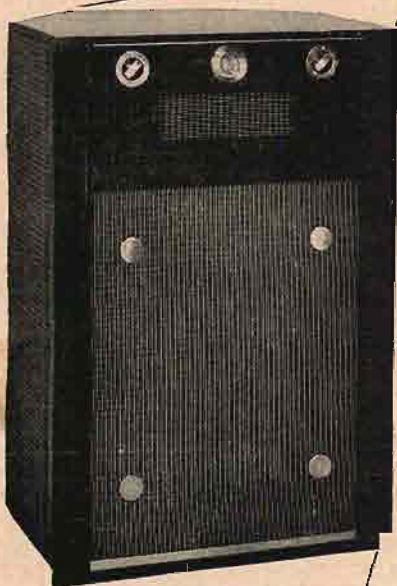

You'll have the feeling a new dimension has been added to sound when you hear the TRi-PLEX, so clean, clear and complete...so utterly realistic...is the reproduction of all the music on the records of today. No obsolescence, either, for performance *now* comprehends the full range of the human ear.

The Jensen TRi-PLEX consists of ultra high, high and low frequency units completely assembled with crossover networks, balance and level controls in a back-loading folded horn cabinet. Completely assembled and laboratory tested. Available in blonde or mahogany.

Jensen Back-Loading Folded-Horn Cabinets for full-dimension bass

Everyone knows a long horn with a large mouth will provide magnificent bass, but space and decor generally forbid. Such performance is available *now* in the new Jensen Back-Loading Folded-Horns...compactly folded into beautiful cabinet designs. No corner is required, but design takes full advantage of corner augmentation if one is available. Models for 12" and 15" speakers in blonde or mahogany.

ASK YOUR DISTRIBUTOR OR WRITE FOR BROCHURE 1020



Jensen

MANUFACTURING COMPANY

Division of The Muter Company 6601 S. Laramie Ave., Chicago 38, Illinois
In Canada: Copper Wire Products, Ltd., Licensee

A Proposed Solution to the Loudness Control Problem

JOHN R. SCHJELDERUP*

The author offers an intelligent solution to the controversy between those who like loudness controls and those who don't. With his approach, correct compensation can be chosen for listening level and program material.

WIDESPREAD CONFUSION seems to exist among audio men over the Fletcher-Munson Ear Characteristic. Several articles have appeared in the technical literature intended to give circuit designs for a suitably compensated volume control which actually were in gross error. This is a serious charge. To be specific, this writer believes it is *not* correct to let the Fletcher-Munson curves be the response curves of the compensated reproducing system. Such a use of the F-M curves results, under many circumstances, in excessive bass boosting and under other circumstances, in insufficient bass boosting. Worse yet, the treble is greatly boosted when actually there should be practically no boost at all!

There are several fallacies contributing to the unsatisfactory circuit designs mentioned above:

1. That the original loudness was always at about 100 db. There is much music that seldom exceeds an absolute level of 70 db and most conversational speech never exceeds 60 db. The error in the case of 60 db speech supposedly reproduced at 60 db would be a 14-db boost at 100 cps.
2. That the F-M curves should be the response of the reproducing system. The error in the case of 70-db-original-loudness music supposedly reproduced at 50 db would be an 8-db boost at 10,000 cps and a 14-db boost at 50 cps.

Rather than make further elaboration

*31 Swan Road, S.E., Washington 20, D.C.

Fig. 1. Effect of reducing volume with normal volume control.

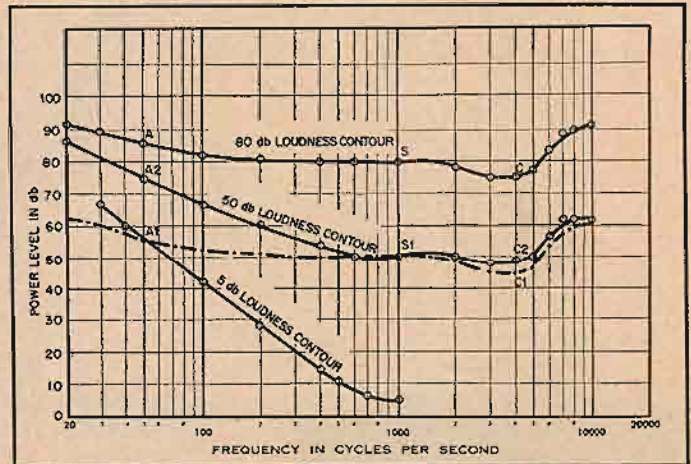

on the results of the above errors, it will be to greater advantage to outline the correct method of deriving the design requirements for a loudness compensator.

Let us take the case wherein we have invited some friends home to dinner and have begun to play a pipe organ record to serve as background music. As we adjust the volume control, the record comes to a part where only three sustained tones are being played—approximately 50, 1000, and 4000 cps. We, knowing our music well, remember that these three tones should sound equally loud and that they were rendered at a fairly high level by the organist (80 db loudness at the recording microphone and organist's ear) and we adjust our

flat reproducing system so that in our living room we hear these tones at a level of 80 db. But wait! This was to be background music; so reluctantly we turn down the gain until the 1000-cps tone is moderately loud—a 50-db level. The 4000-cps tone sounds about as loud as the 1000-cps tone but the 50-cps tone is now inaudible. We go into the dining room and firmly resolve to build a loudness control as soon as the guests have left.

Analysis

Refer now to Fig. 1. Here three of the F-M curves have been reproduced. The top curve indicates the relationship between the acoustic power from a pure-tone generating device and the frequency

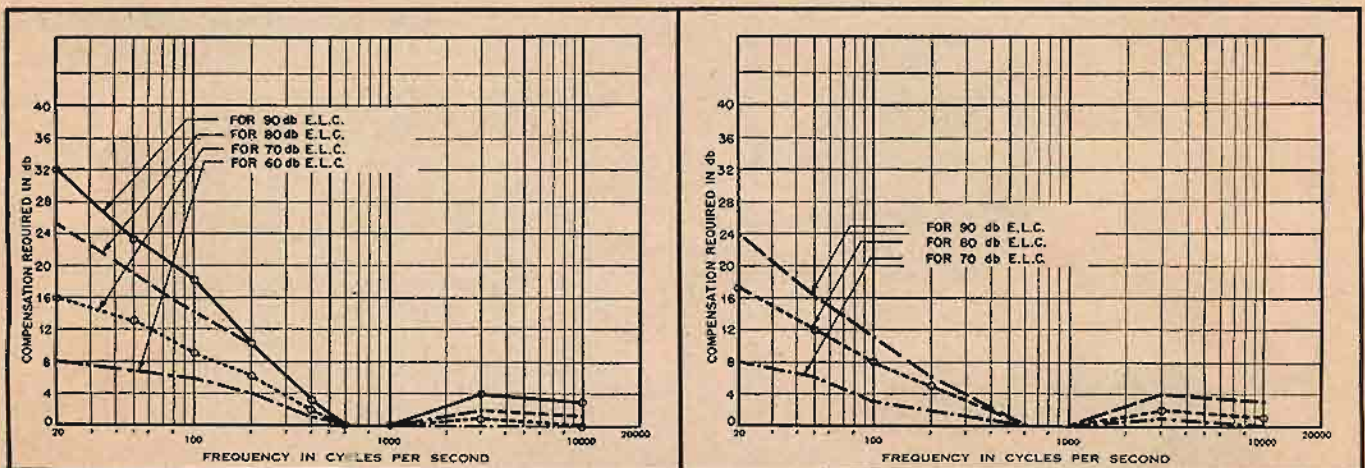
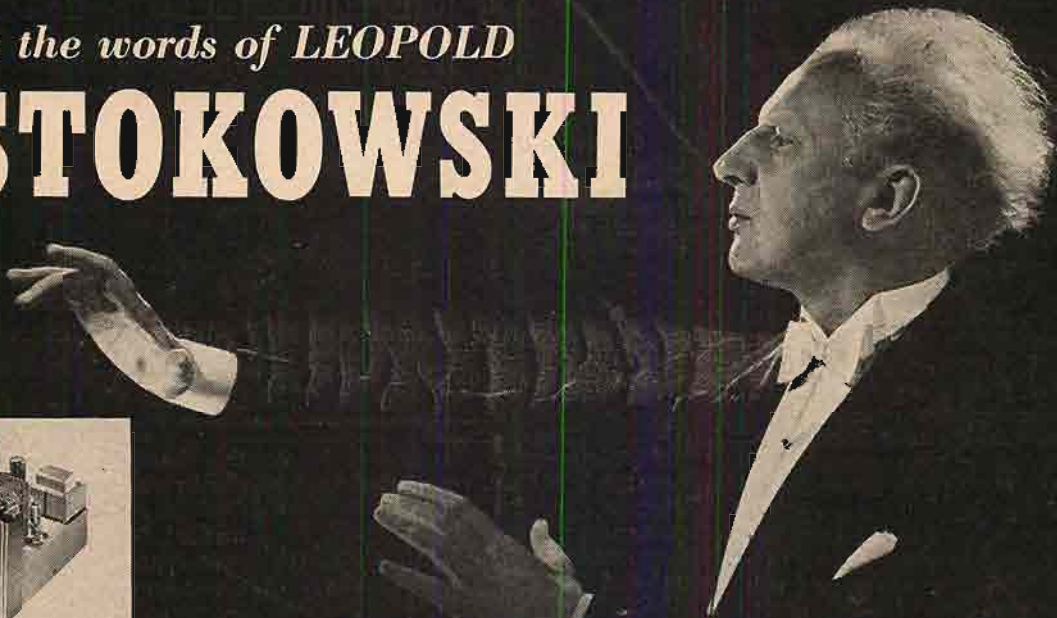

Fig. 2 (left). Compensation required when reproducing the 90, 80, 70, and 60 db equal loudness contours at a level of 50 db. Fig. 3 (right). Compensation required for reproduction at a level of 60 db.

In the words of LEOPOLD

STOKOWSKI



STROMBERG-CARLSON "Custom Four Hundred" HIGH-FIDELITY EQUIPMENT

"gives full musical satisfaction"

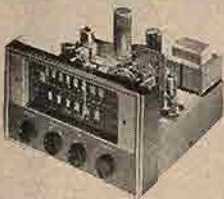

Custom Four Hundred
AM-FM Tuner



Custom Four Hundred Amplifier



Custom Four Hundred
Garrard Changer



Custom Four Hundred Coaxial
Speaker, with exclusive
"Acoustical Labyrinth"

Prior to the introduction of Stromberg-Carlson's new high-fidelity equipment, one of the world's greatest conductors, Leopold Stokowski, was asked to evaluate it. Alone in his own studio, with his library of recordings and his matchless knowledge of music, he tested the equipment. These are his conclusions:

STOKOWSKI STATES:

"For discriminating music lovers who wish to hear great music in its full beauty, I can recommend with confidence the Stromberg-Carlson reproducer, which I have thoroughly tested.

"It has a single stylus with diamond pick-up and

long, light tone arm which reduces distortion to a minimum—a 25-watt amplifier and a pre-amplifier, which incorporates the latest technical knowledge—and a 15" speaker with large enclosure.

"All these features create a reproducer of high quality that will give full musical satisfaction to the discerning music lover."

"Custom Four Hundred" equipment is available in two forms. The high-fidelity enthusiast or music lover will find the matched units all ready to be assembled, or available in complete custom-styled furniture cabinets; with or without radio and television.



Typical Custom Installation, with
AM-FM radio and television

MAIL COUPON FOR FREE BOOKLET

Stromberg-Carlson, Sound Division

1219 Clifford Ave., Rochester 3, N. Y.

Please send the "Custom Four Hundred" booklet and the name of my nearest dealer.

I would do my own installation I am interested in complete cabinets

Name _____

Address _____

City _____ Zone _____ State _____

of the tone when all the tones sound equally loud to a normal, young ear. Thus, in our amplifier at the 80 db loudness, a voltage measurement would have shown 50 cps to be 6 db above the 1000 cps (point A), and the 4000 cps to be 5 db below the 1000 cps (point C), although to the ear these tones sounded equally loud. Now let us observe what happened in the above amplifier when the gain was reduced 30 db. 50, 1000, and 4000 cps fell to points A1, S1, and C1 on the dashed curve. This curve represents the voltage levels in the amplifier after making a 30-db drop in the voltages that corresponded to all tones between 20 and 10,000 cps at the 80-db sensation level. Note that point A1 is on the 5-db loudness contour which fact explains why the 50-cps tone became inaudible since it was then masked by the 30- to 40-db ambient noise in our living room. From the foregoing it is evident that the 50-cps voltage in the amplifier should be boosted to point A2 on the 50-db loudness contour so that it will sound as loud as the 1000-cps tone at S1. Thus the compensation in the amplifier at 50 cps should be the difference between A2 and A1 or 19 db; at 1000 cps the compensation should be zero; and at 4000 cps it should be the difference between C2 and C1 or 3 db. Let it be emphasized that in *no case*—no matter how loud the original tone and no matter how soft the reproduced tones—is it necessary to boost the treble more than 3 to 4 db (and this only at 4000 cps). A glance at the Fletcher-Munson curves will reveal that the curves are essentially parallel above 600 cps and thereby it can be inferred that no substantial compensation is required in the treble range.

Figure 2 shows the compensation needed when various "original" loudness levels are reproduced at a loudness of 50 db. Figure 3 shows the compensation for 60-db loudness reproduction and similarity Figs. 4 and 5 are for 70- and 80-db reproducing levels respectively. A study of Figs. 2 through 5 will show that the compensation for a 90-db original reproduced at a 70-db loudness is practically the same as that for a 70-db original reproduced at 50 db. Similarly, differences in level of 30 db require approximately the same loudness compensation irrespective of the absolute levels. In general, one compensation curve will

Fig. 6. Proposed standard compensation curves for the Fletcher-Munson ear characteristic.

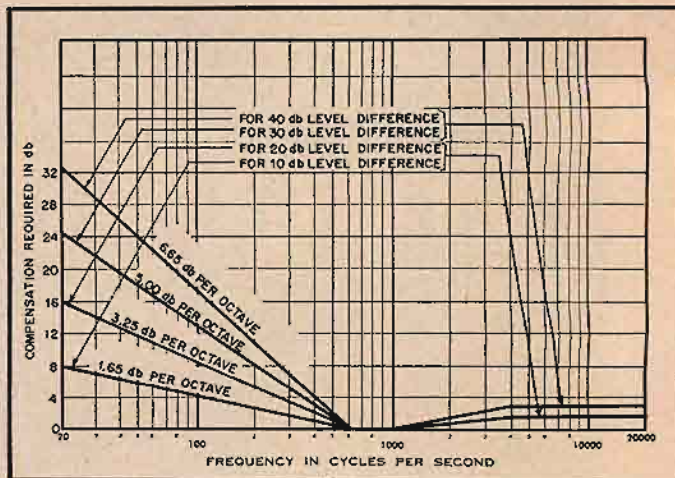

serve for all equal differences in level between original and reproduced tones. Thus a set of approximate compensation curves can be drawn (as in Fig. 6) for differences in level between the original sound and the reproduced sound for 10, 20, 30 and 40 db; the greatest deviation from any theoretical curve is less than 2 db. The writer proposes that Fig. 6 be used as the standard compensation curves for the Fletcher-Munson characteristic. Since the loudness of music generally ranges between the absolute levels of 90 db and 40 db, it is not desirable to reproduce the fortissimo passages of music at a loudness level of less than 50 db, for otherwise about 20 db of the pianissimo passages will be lost as they will then be below the ambient noise level even in the most quiet home (20 db). Hence the curves of Fig. 6 do not indicate the compensation required for reproduction below a loudness level of 50 db for fortissimo passages.

A circuit design is not offered herein as it is felt that any audio man can work one out that will conform closely to the standard curves of Fig. 6. It should be understood that these curves show the compensation in db (based on voltage ratios) to produce the correct audio power in a load of constant resistance.

The Solution

Assume we have built our loudness compensator, we are again entertaining dinner guests. We tune in a "good music station" playing symphonic music whose loudest levels we estimate were originally at an average of 90 db; we decide

that these should be at a 50 db level in our living room and accordingly set our *loudness compensator* to a position marked "40 db" and then adjust our *gain control* until the loudest passages are at an estimated level of 50 db in his living room. After dinner we and our guests settle in easy chairs to hear a newscast. Since we know that the commentator is producing a loudness level of about 60 db in the studio and since we desire to hear the commentator at this level, we set the *loudness compensator* to a position marked "0 db" and then adjust the gain control so that the commentator's voice is at an estimated level of 60 db.

The audio man may utilize such refinements as a VU meter calibrated to indicate the average acoustic loudness level in the place where most listening will be done; a notation on the labels of his records stating the original loudness levels (either estimated or known) of the loudest sustained passages; use of non-standard compensation curves derived from the measured equal loudness contours for the person who is to listen most to the compensated reproducing system.

No doubt the true audio enthusiast would like to reproduce all music at its original loudness level in his home, but he realizes that he must get along with "more normal" people. Thus, when his better half asks sharply, "Does it have to be that loud?", he need merely adjust his *properly* designed loudness controls and effect a happy and satisfying compromise.

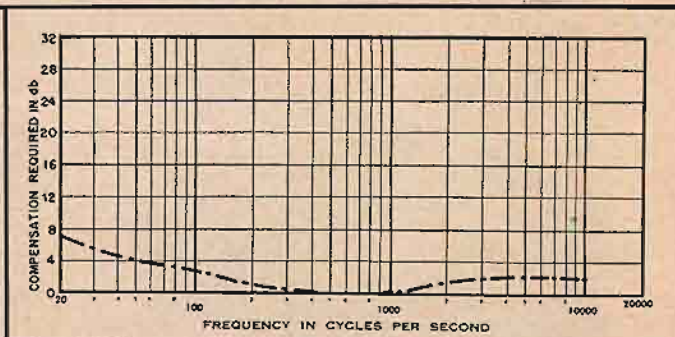
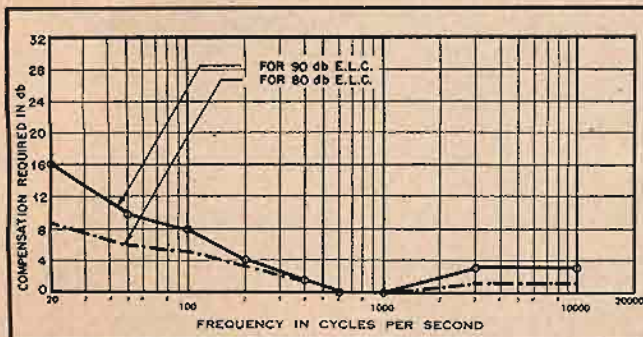

Fig. 4 (left). Compensation required when reproducing the 90, 80, 70, and 60 db equal loudness contours at a level of 70 db. Fig. 5 (right). Compensation required for reproduction at a level of 80 db.

Capitol relies on

AMPEX

to capture the natural color
and true perspective
of original live performances

for

Full Dimensional Sound



Full Dimensional Sound

Capitol
CLASSICS



STUDIO CONTROL ROOM



EDITING ROOM



RECORDING ROOM

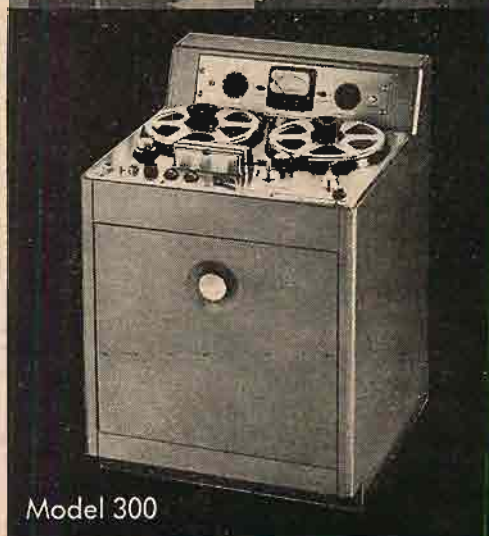

Model 300

... in its superb recording techniques, especially created for its Classical FDS Releases, Capitol Records, Inc. utilize to the highest degree the dynamic fidelity and dependability of Ampex Model 300 Recorders.

AMPEX

Magnetic Tape Recorders

AMPEX ELECTRIC CORPORATION Redwood City, California

AX-108

Handbook of Sound Reproduction

EDGAR M. VILLCHUR*

Chapter 4. Oscillatory Systems.

A discussion of the elements of mechanical, acoustical, and electrical oscillatory systems—one of the basic "circuit" elements in all of audio. The author relates the three similar combinations of components.

A VIBRATING SOURCE of sound such as a tuning fork or stretched string constantly interchanges energy between its elasticity and its mass. At the point of maximum displacement the vibrating unit has come to momentary rest before reversing its motion, and kinetic energy due to inertia of the mass is therefore zero. Potential energy stored in the elastic element, which at this point is strained the most, is at a maximum. When the source returns to its original point of zero displacement there is no tension on the spring at all, but the source has attained its highest velocity, and inertial energy of the mass is at a maximum. The relative values of mass and elasticity determine the frequency of this interchange, just as the relative values of inductance and capacitance in a tuned electrical circuit determine the rate of interchange of energy between the coil and capacitor. Friction limits or "damps" the vibration in the same way that resistance damps electrical oscillation.

The frequency of oscillation of a freely vibrating mechanical system may be expressed by the equation:

$$f = \frac{1}{2\pi\sqrt{MC}}$$

where f = frequency

M = mass of the inertial element

C = compliance of the elastic element

This expression is the same as the equation for electrical circuit resonance, with mechanical units substituted for electrical ones.

If a mechanical system with mass and elasticity is stimulated without being subject to control it will vibrate at its own natural or resonant frequency. This is also true of systems in which the restoring force is supplied by gravity rather than by elasticity, as is the case with a pendulum or with water sloshing around in a bowl. When a system is subjected to forced vibration, however, it must vibrate at the frequency of the oscillatory stimulus. The amplitude of this enforced vibration relative to the force of the stimulus increases as the frequency approaches the resonant

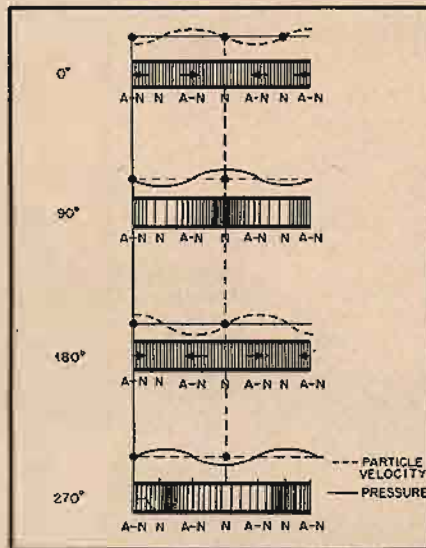

Fig. 4-1. Longitudinal vibration of an air column (after Olson). The nodes and anti-nodes shown refer to particle velocity. Note that the pressure undergoes maximum swing at the velocity nodes and that the velocity loops are pressure nodes.

frequency of the system, with maximum excursion occurring at resonance, where mass and stiffness reactances balance each other out. Friction reduces the excursion at all frequencies, and in addition has the effect of reducing the resonant amplitude peak. We may thus speak of a mechanical system as having a "Q," the value of which varies inversely with friction, in the same way that the Q of an electrical system varies inversely with resistance. These principles may be directly observed by attaching a weight to a few strands of rubber band tied together, suspending the system from one's hand, and bobbing the weight up and down at different frequencies but with the same force. The natural damping may be increased by submerging the weight in water.

Since there is no such thing as a mechanical system with zero mass or perfect rigidity the above characteristics are exhibited by all mechanical systems to some degree. For example, according to one theory of geophysics the formation of the moon depended upon the laws of resonance. The entire surface of the originally molten earth is supposed to

have followed, in various modes, the slow oscillatory patterns of behavior which are now exhibited by large bodies of water and are called the ebb and flow of the tides. These oscillations were induced by the gravitational influence of the sun, which alternately, according to the position of the earth, caused the viscous skin to lag and lead the velocity of its spinning core. The time interval between daily cycles of ebb and flow was determined by the rotational velocity of the earth (which then made a complete revolution in about four hours), a velocity which steadily decreased due to frictional losses incurred by the shifting surface. At some point, it is reasoned, the frequency of skin oscillation became equal to the resonant frequency of the mechanical system or of some section of it; the excursive violence reached its peak, and a great chunk of matter was thrown from the earth to become our satellite.

Acoustical Resonance

It is possible for oscillations, sonic or otherwise, to be induced in enclosures of air. There are two types of enclosure resonance, that of the air column, and that of the Helmholtz resonator. The first is the mode of resonance of the organ pipe and flute, the second that of the ocarina, empty bottle, or bass-reflex cabinet.

The Air Column

Behavior of the resonant air column is dependent on the phenomenon of standing waves. A sound wave travelling along a pipe will be reflected at the end because of the fact that it encounters a medium with changed impedance, whether the end is open or closed. At certain points along the path the pressure front of the reflected cycle will coincide with the pressure front of the oncoming cycle, and reinforcement will occur; at other points of the path a pressure impulse will meet a rarefaction impulse and cancellation will take place. When there is a certain relationship between the length of the pipe and the wave length of the sound travelling back and forth these cancellations and reinforcements always occur at the same points along the pipe. The points are called, respectively, *nodes*, indicating

* Contributing Editor, AUDIO ENGINEERING.

"These 3 for TV"

GATES offers three speech input consoles that fully meet every TV need. Whether you select the ultra complete SA-50 dual channel equipment, the much used SA-40 single channel console, or the very popular 52-CS studioette, you can be certain of top quality through advanced GATES engineering. For 30 years now, GATES has been building fine speech equipment — and for TV there is nothing finer!

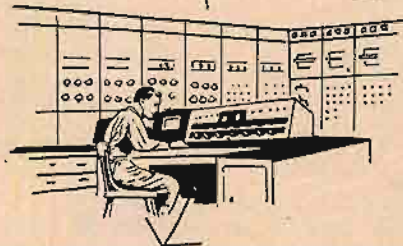

GATES SA-50 Dual Channel Console . . .

Nine mixing channels, dual program amplifiers, dual V. U. meters, 10 watt monitoring amplifier, self-contained cueing amplifier, five preamplifiers with room for two more where required. Complete remote, override, cueing and talk back facilities. Extremely low cross talk combined with high gain. Deluxe equipment all the way!



GATES 52-CS Studioette . . .

All GATES consoles have the same top quality components. This popular, modestly priced console is made possible by combining functions through key control. Many TV stations will prefer to use several 52-CS Studioettes instead of a single larger console. Every progressive TV engineer will find it worth while to investigate the 52-CS Studioette!



GATES SA-40 Single Channel Console . . .

Perhaps the most used speech input console in TV and radio today. Nine mixing channels, wide circuit selection, low cross talk, high gain and extreme ease of servicing are but a few of the SA-40's many features. GATES will gladly send detailed circuit data on request.



GATES Speech Input Catalog — Yours for the asking is a 44-page catalog on GATES speech equipment plus a new 12-page brochure on remote control apparatus. No obligation, of course. Why not write now?

SALES OFFICES

2700 Polk Avenue, Houston, Texas • Warner Building, Washington D. C.
International Division, 13 E. 40th St., New York City • Canadian Marconi
Company, Montreal, Quebec

GATES

GATES RADIO COMPANY

manufacturing engineers since 1922

QUINCY, ILLINOIS, U. S. A.

zero amplitude, and *anti-nodes* or *loops*, indicating maximum amplitude. The nodes of particle velocity and of medium pressure are 90 deg. out of phase, as illustrated in Fig. 4-1. At a velocity node the amplitude of pressure change is at a maximum, while at a pressure node the particle velocity amplitude is maximum. Nodes and loops do not define a static instantaneous condition of the medium; the pressure and velocity at various points go through their normal changes, but the amount of swing occurs as described. When the minimum amplitude at a nodal area is not essentially zero the area is referred to as a *partial node*.

Nodes and anti-nodes created by internal pipe reflections form a *standing wave*, so named because of the fact that the points of maximum or minimum displacement are stationary. It may be seen from Fig. 4-1 that the air column itself is then pulsating longitudinally in addition to the vibration of the individual molecules. The natural frequency of these pulsations is determined by the length of the path of reflection and by the speed of the wave in the medium. Standing waves may be induced in an open-ended enclosure whose length is an integral multiple of a half wave length of the stimulating sound, or in a structure with a closed end whose length is an integral multiple of a quarter wave length of the sound.

If the length of air column is one wave length in relation to a particular frequency it is two wave lengths in relation to the second harmonic of that frequency, three wave lengths in relation to the third harmonic, etc. Therefore an enclosure in which standing waves exist may simultaneously resonate at harmonic frequencies, making air column resonance suitable for application to musical instruments.

The fundamental resonant frequency of an open-ended pipe (assuming the velocity of sound to be 1,100 ft/sec) is:

$$f = \frac{1,100}{2l}$$

where f = the fundamental resonant frequency

l = the effective length of the pipe in feet. (The effective length is slightly greater than the physical length, because of the fact that pressure at the end of the pipe does not become equal to that of the outside air until a short distance past the end. The "end correction" varies with the shape and diameter of the pipe, and to some extent with the order of harmonic.)

Both odd and even harmonics are produced.

When the end of the pipe is closed the fundamental resonant frequency becomes:

$$f = \frac{1,100}{4l}$$

Only odd order harmonics are produced in the closed pipe.

The Helmholtz Resonator

During the late nineteenth century Hermann Helmholtz developed an

acoustical resonator which he employed to isolate a desired harmonic from a complex tone. Helmholtz' device was able to do this by virtue of the fact that it could be forced into oscillation only at its own fundamental natural frequency. If a complex tone with a 200-cps fundamental was sounded before two Helmholtz resonators tuned to 400 and 600 cps each would pick off and vibrate in sympathy with the second and third harmonic components of the tone respectively. The neck or port (in A of Fig. 4-2) served as entrance for the sound, and Helmholtz applied his ear to the small opening, whose effect on the system was negligible.

Understanding the Helmholtz resonator is important, because although its original functions have been taken over by electronic wave analyzers and filters,

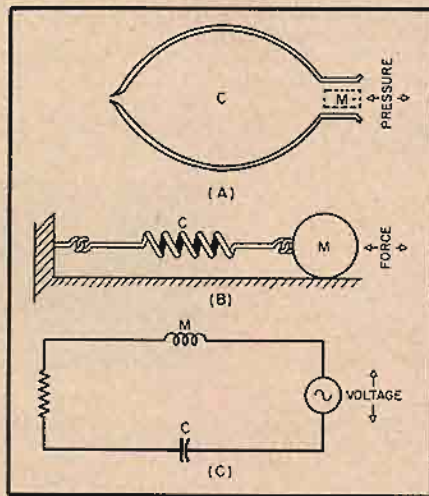

Fig. 4-2. (A) The Helmholtz resonator; M represents the inertial element and C represents the elastic elements. (B) and (C) Mechanical and electrical analogies of the Helmholtz resonator.

the principles involved apply to other modern devices.

In order for the resonator to be set into vibration the wave length of the stimulating sound must be large in comparison with the longest dimension of the enclosure. When the enclosure is excited by sound of such wave length the elastic air inside will be almost uniformly compressed and rarefied at the frequency of the stimulus. It is important to emphasize that at any given instant the compression of the air in the enclosure does not vary significantly from one point to another, and that standing waves are not formed, since the distance from wall to wall is such a small part of the wave length.

The air in the enclosure acts as though a piston, of the shape shown in dotted lines, were moving in and out of the neck. As a matter of fact the air in the neck does exhibit definite inertial behavior of its own which is like that of mass in a mechanical system. We thus have the two requirements of an oscillatory system, inertia and restoring force, and the resonator could be represented symbolically by the spring and weight shown at (B). An even closer



Fig. 4-3. Successive eddies formed by water flowing past an obstacle. (After Sir James Jeans, "Science and Music," The Macmillan Co., 1937.)

analogy may be observed in the kettle drum, whose elastic element is also acoustical (at least in part), but whose inertia is provided by the mass of the stretched membrane.

The Helmholtz resonator will have a natural resonant frequency determined by the relative values of its acoustic compliance and inertance, values which in turn are determined by the volume of the enclosure and by the design of the port. Damping is produced by acoustical friction with the walls of the resonator and with any absorbent material in or across the port.

The natural frequency of a Helmholtz resonator is determined by the same type of relationship that controls the resonant frequency of a mechanical mass-elasticity system:

$$f = \frac{1}{2\pi\sqrt{M_A C_A}}$$

where f = resonant frequency

C_A = acoustical compliance of air in the enclosure

M_A = acoustical mass, or inertance, of air in the port

Decreasing the inertance of a Helmholtz resonator port raises the natural frequency of the resonator. The inertance of air in a pipe, as we have seen, varies directly with the volume of air and inversely as the square of the cross-sectional area to which pressure is applied. Decreasing the length of the port will therefore raise the resonant frequency of the enclosure, but decreasing the port area will have the opposite overall effect, in view of the fact that port inertance is more dependent upon area than upon volume. Because of this fact the neck may be reduced to a simple opening, in which case the port is in the nature of a virtual diaphragm rather than of a piston.

The resonant frequency of the system will be independent of factors which do not affect inertance or springiness, such as the shape of the elastic element. A simple experiment will verify the fact that the natural period of a Helmholtz resonator is independent of relative dimensions once the volume has been fixed. The air in a bottle may be set into oscillation by blowing across the neck opening, a procedure familiar to audio technicians of the younger set. When the bottle is partly full of water the shape of the enclosure can be altered without changing the volume, by tilting the bottle so that the water level is no longer perpendicular to the walls. The pitch of the resonator will remain the same. It is possible, however, for Helmi-

[Continued on page 51]

Revolutionary



CDP

COMPOUND DIFFRACTION PROJECTOR*



Public Address Loudspeaker System for perfect VOICE PENETRATION AND FULL RANGE MUSICASTING

CDP is so advanced in concept... so efficient in performance... that conventional PA reentrant horns are now obsolete by comparison! The CDP COMPOUND DIFFRACTION PROJECTOR* provides a loudspeaker system with peak-free response ± 5 db to 11,000 cps... delivers $2\frac{1}{2}$ octaves more musical range than usual PA units of even larger size. Speech articulation index is at least 20% superior. Polar distribution pattern exceeds 120° at all frequencies up to 10,000 cps. Diffraction principle, high sensitivity and power handling assure much greater sound dispersion, penetration and coverage with fewer units and at far less cost. Greatly improves public address—in all types of applications—indoors and outdoors. *Get the amazing facts about CDP now!*

**WEATHER PROOF
BLAST PROOF
SPLASH PROOF**
Drain holes permit subsequent operation after complete water immersion.

INDESTRUCTIBLE
Molded of glass fibers for extra strength and improved acoustic properties.

*Patent Pending

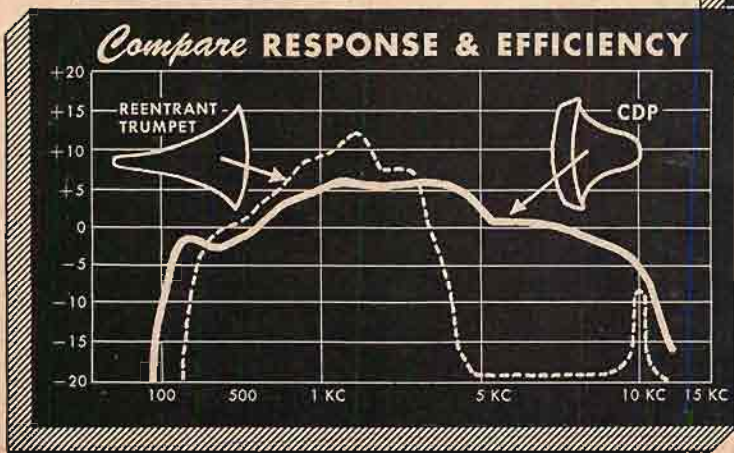
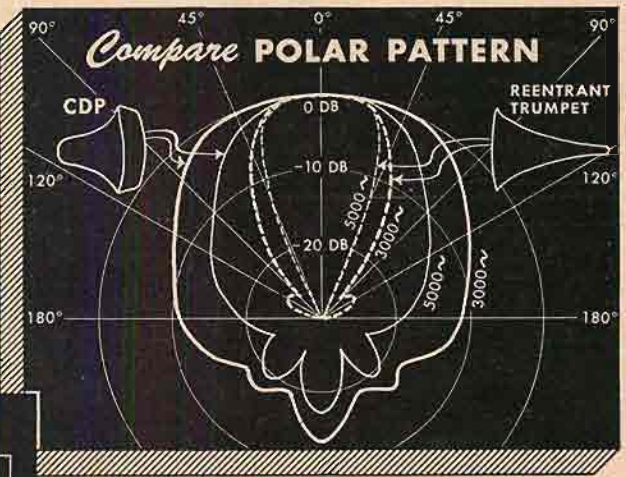
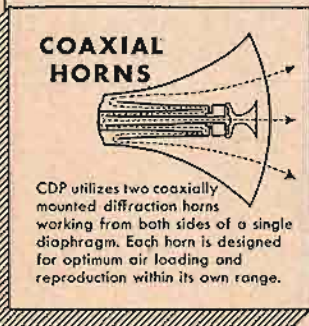
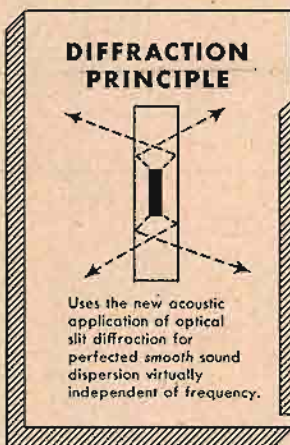

Model 848 Compound Diffraction Projector* Loudspeaker System
Conservatively rated at 25 watts. 16 ohms impedance. Finished in attractive gunmetal gray. Two mounting positions for hang-up bracket. Projectors can be installed horizontally, or vertically for augmented dispersion. Dimensions: $10\frac{1}{2}$ " wide at mouth, $20\frac{1}{2}$ " high at mouth, 20" deep over-all. Weight: Net 12 lbs., Shipping 15 lbs. List Price... **\$59.00**

Send for Free Bulletin 195

Electro-Voice

400 CARROLL STREET • BUCHANAN, MICHIGAN
Export: 13 East 40th Street, New York 16, U.S.A. Cables: Arlab



AUDIO engineering society

Containing the Activities and Papers of the Society, and published monthly as a part of AUDIO ENGINEERING Magazine

OFFICERS

C. G. McProud President Lloyd C. Wingard Central Vice-Pres.
 F. Sumner Hall Executive Vice-Pres. H. M. Tremaine Western Vice-Pres.
 C. J. LeBel Secretary Ralph A. Schlegel Treasurer

P. O. Box 12, Old Chelsea Sta.,
 New York 11, N. Y.

Magnetic Audio Frequency Fundamentals

A. M. VINCENT*

Challenging the electron tube in its well established position as the basic amplifier component, the magnetic principles invoked offer a promising field of new development.

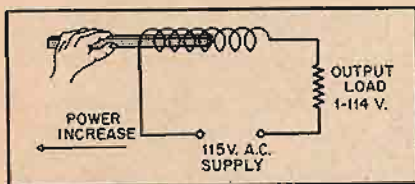

Fig. 1. Basic principle of controlled reactance. The position of the core in the coil is varied.

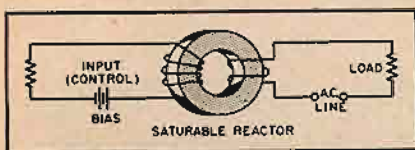

Fig. 2. In the saturable reactor, the core remains stationary, but its permeability is varied by a control circuit in which d.c. flows.

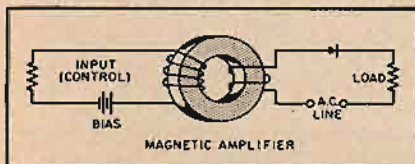

Fig. 3. The addition of a rectifier in the load circuit improves performance by eliminating self-saturation.

Summary: A brief history of magnetic amplifier development is given, with a preliminary description of the operating principles. Comparisons between electron-tube amplifiers and magnetic amplifiers are made, and a number of basic circuits are shown. The advantages and disadvantages with respect to conventional tube amplifiers are listed, with indications of future advances in the art.

* Lieutenant Commander, U. S. Navy.

Responsibility for the contents of this paper rests upon the author, and statements contained herein are not binding upon the Audio Engineering Society.

ELECTRONIC ENGINEERS are beginning to accept the fact that competitors to the electron tube are not only a reality but are here to stay. The Bureau of Ships is interested in these devices primarily because of their reliability and long life compared to that of the electron tube.

The most formidable competitors to these tubes are transistors, magnetic and dielectric amplifiers, and more recently, the promising resistance or crystal amplifier (a semi-conductor responding resistively to magnetic fields).

The transistor has been thoroughly described in numerous publications. Dielectric amplifier fundamental data has recently been assembled and published in the Bureau's monthly periodical "Electron." Material is now being prepared on the resistance or crystal amplifier.

A considerable amount of material has been published on magnetic amplifiers, most of which pertained to servo and other electro-mechanical control applications. Very little data is available on high-speed applications, with the possi-

Presented on November 1st, 1951, at the Third Annual Convention of the Audio Engineering Society.

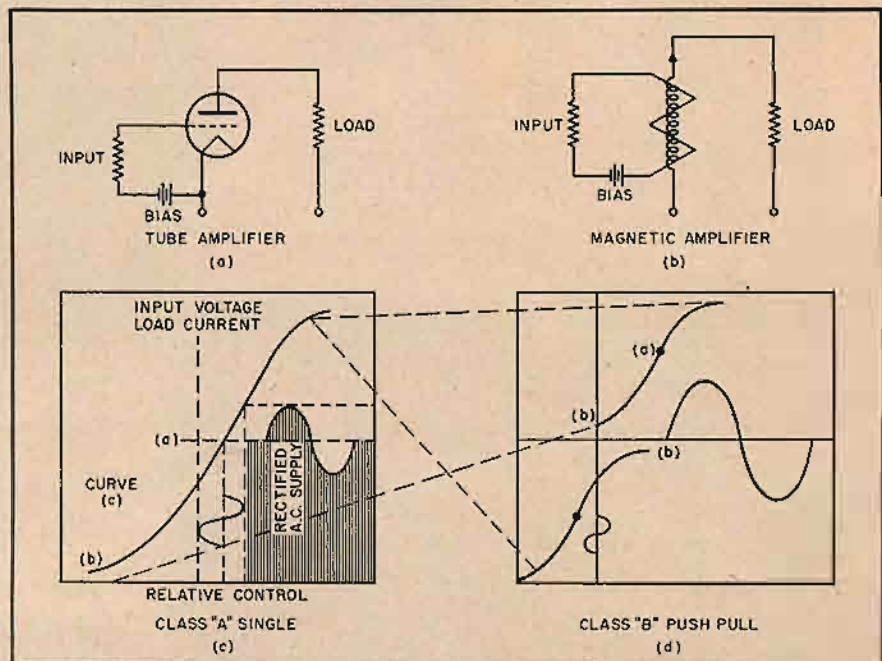
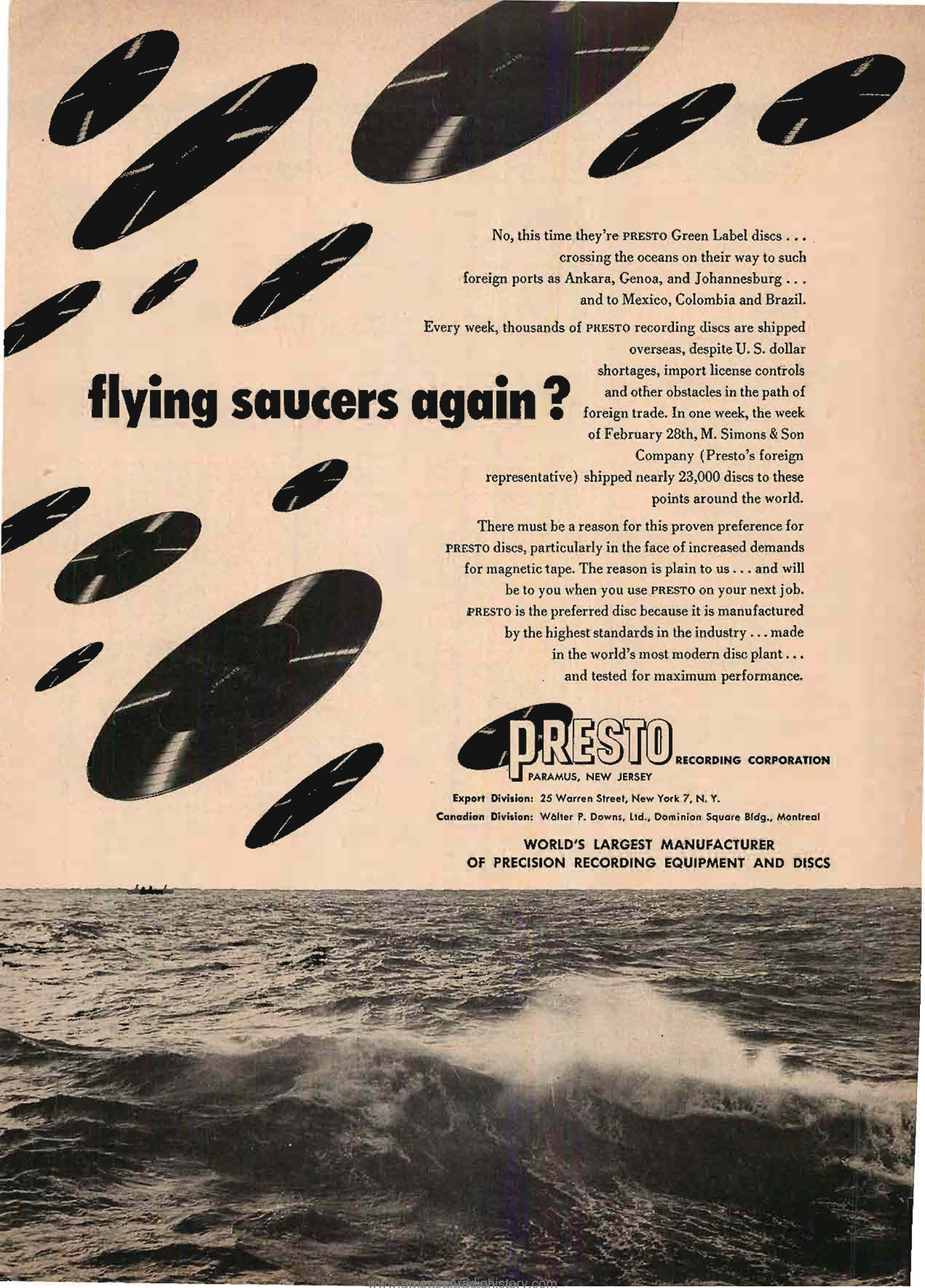

Fig. 4. (a) Simplified tube amplifier, and (b) simplified magnetic amplifier; (c) characteristic, Class A showing operation on linear portion of curve; (d) characteristic converted for push-pull operation.



No, this time they're PRESTO Green Label discs . . .
crossing the oceans on their way to such
foreign ports as Ankara, Genoa, and Johannesburg . . .
and to Mexico, Colombia and Brazil.

Every week, thousands of PRESTO recording discs are shipped
overseas, despite U. S. dollar
shortages, import license controls
and other obstacles in the path of
foreign trade. In one week, the week
of February 28th, M. Simons & Son
Company (Presto's foreign
representative) shipped nearly 23,000 discs to these
points around the world.

flying saucers again?

There must be a reason for this proven preference for
PRESTO discs, particularly in the face of increased demands
for magnetic tape. The reason is plain to us . . . and will
be to you when you use PRESTO on your next job.
PRESTO is the preferred disc because it is manufactured
by the highest standards in the industry . . . made
in the world's most modern disc plant . . .
and tested for maximum performance.

PRESTO RECORDING CORPORATION
PARAMUS, NEW JERSEY

Export Division: 25 Warren Street, New York 7, N. Y.

Canadian Division: Walter P. Downs, Ltd., Dominion Square Bldg., Montreal

**WORLD'S LARGEST MANUFACTURER
OF PRECISION RECORDING EQUIPMENT AND DISCS**

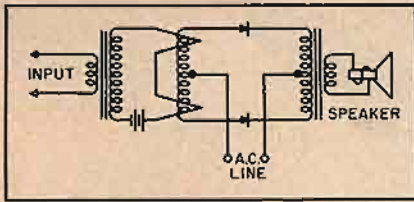

Fig. 5. Simplest form of audio amplifier employing magnetic principles.

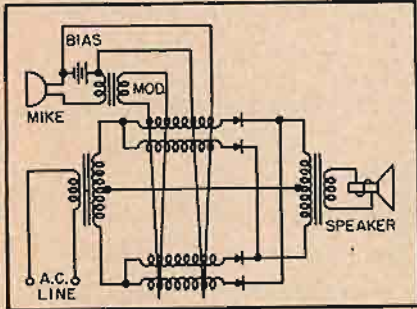

Fig. 6. Single-stage audio amplifier capable of gains up to several hundred.

ble exception of some special magnetic computer circuits, responding to impulses up to 400 kc. Only minor exploratory tests have been made with magnetic circuits at audio and radio frequencies. These tests showed that gains of over 100 per stage can be obtained at audio frequencies and at radio frequencies up to 200 kc. These experiments were made primarily to demonstrate the feasibility of using the device at these frequencies. Reasonable amplification fidelity was obtained, but with low efficiency. Before any attempts were made to improve the efficiency, the developments were terminated in favor of more pressing demands in the computer field. Research in this field was considered more important due to the greater number of tubes involved.

It is believed no further efforts have been made towards developing magnetic audio amplifiers in this country, although it is understood a 500-watt magnetic audio unit was designed for a European airport, showing excellent response up to 7000 cps. The carrier power supply in this instance was 20 kc. This installation, however, required hot-cathode rectifiers.

Recent improvements in core material, rectifiers, and circuitry have elevated the magnetic amplifier, within its limitations, to a reasonably competitive position with the tube amplifier.

Description

For those not familiar with the basic principles of the magnetic amplifier itself, the following description and figures may be helpful.

Figure 1 shows a coil of wire surrounding an iron core. With the core completely within the coil, the reactance to a.c. will be high, restricting the flow of current to the load; with the core removed the impedance drops to about that of the d.c. resistance of the wire; intermediate positions of the core vary the power to the load accordingly. Since it would be difficult to move the core rapidly to follow an audio frequency, a

separate winding is used to control the saturation of a stationary core, as shown in Fig. 2. This would be satisfactory as an amplifier except that the power sensitivity would be relatively low since the control ampere-turns must be equal to the load ampere-turns, plus sufficient ampere-turns to control the core.

In Fig. 3, a rectifier is inserted in series with the load circuit. This eliminates the negative output-winding current pulses that drive the core away from saturation which would require a greater cancelling control-winding current. This is referred to as self-saturation. Self-saturation is not the inclusion of positive feedback, but the elimination of negative feedback whereby the control current for a given output voltage is made independent of the output current. Because of the increased power sensitivity, self-saturation circuits are usually considered for audio applications.

In order to understand the principles involved in audio frequency, a rough analogy between a tube and a magnetic amplifier should be made. Any attempt

low almost precisely that of a tube, a theoretical analysis can be made on the straight portion of the curve.

Analysis of Operation

Figures 4 (a) and (b) are sketches of a tube and magnetic amplifier; (c) is a curve showing magnetic saturation vs. impedance in a magnetic amplifier. Since this curve almost duplicates that of certain type tubes, operating characteristics of both can be plotted on the same curve. For a fair comparison the "plate" supply of both amplifiers must be a.c., for a magnetic amplifier will not control d.c. If this amplifier is to be used to amplify audio frequencies, the supply frequency should be above audibility—at least three times the highest frequency to be controlled. Since both amplifiers are single ended, they must be operated as class A, half way up the slope, as shown in curve (c), point a. The operation analysis then follows along the lines of a class A tube amplifier.

These amplifiers working as class A would not only be inefficient, but provisions would have to be made to separate the carrier from the voice frequencies; consequently they would be normally operated class AB push-pull. With this connection the carrier can be biased out, as indicated by point b in (c). This makes it possible to use coils and rectifiers of lower capacity. (In machinery applications, control is usually effected near the upper end of the saturation curve, near the point of abrupt saturation. This results in greater power sensitivity.) With push-pull connection the "plate" supply rectified pulses are also doubled and smoothed out. Figure 4 (d) shows idealized push-pull transfer curves.

Figures 5 and 6 show further developments of push-pull amplifiers. Figure 6 is a single-stage amplifier capable of gains up to several hundred. Control and bias winding are shown as two single loops; actually they consist of four individual coils wound aiding and opposing to cause an alternate high and low impedance in each pair of load reactors. This results in a rather low efficiency, necessitating relatively large reactors and rectifiers, but does result in improved fidelity when using components not specifically designed for the purpose. Figure 7 shows another circuit developed for audio frequencies, and Fig. 8 outlines the general application as a whole. Although these schematics are

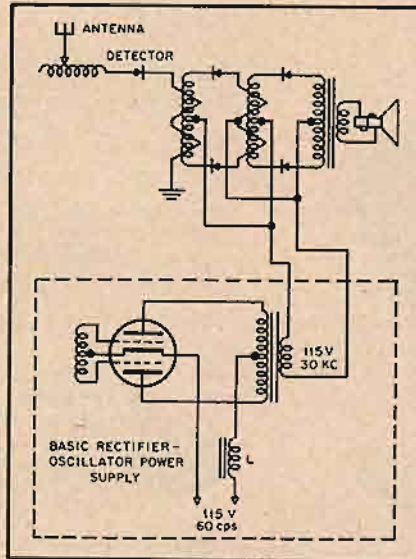

Fig. 8. Typical arrangement for radio receiver use, employing magnetic amplifier circuits throughout.

to analyze the magnetic amplifier in direct relation to a tube requires that certain assumptions be made, as this amplifier differs considerably from those using electron tubes. However, since the input saturation-control voltage vs. load current of an iron core can be made to fol-

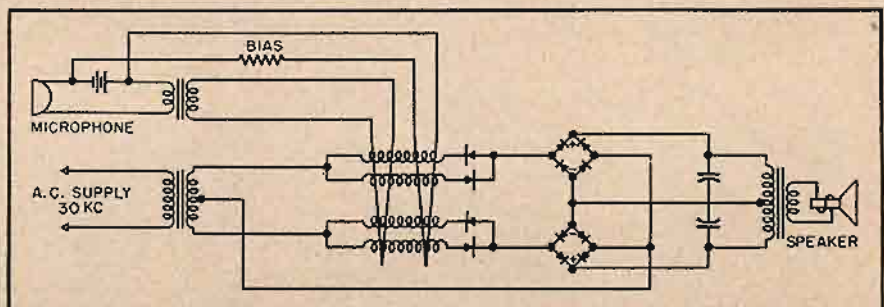

Fig. 7. Further steps in development of suitable circuit for audio applications.

AT HARVEY

You can Hear Them All
and Choose the Finest



THE NEW JENSEN TRI-PLEX 3-Way Reproducer System

The result of exhaustive research to attain the ideal system. The Tri-Plex consists of the P15-LL 'woofer', the A-201 mid-frequency driver and horn, the RP-302 'super-tweeter', and cross-overs, all housed in a handsome, solidly constructed enclosure which provides folded-horn back loading for the 'woofer,' and is designed for either wall or corner placement. Frequency

range: 30-18000 cps. Power Handling: 35 watts. Impedance: 16 ohms. Dimensions: 38 3/4" h. x 25 1/2" w. x 18 3/4" d.

ST-903 — Mahogany\$292.15
ST-902 — Blonde Korina 299.29

McINTOSH

Model C104

PHONO PREAMPLIFIER and EQUALIZER



An extremely flexible unit designed for the most discriminating and acute listener. Provided with five inputs and selector switch, it accommodates crystal pickup, FM-AM tuner, low level microphone, as well as high level and low level magnetic pickups. A 3-position switch selects the correct compensation to match the three recording characteristics most often used. In addition, the C104 features treble and bass boost and attenuation, each with separate controls. Connectors are furnished for obtaining power from the main amplifier. A master power switch and volume control completes the attractive brown hammertone panel. Supplied complete with tubes and connectors.

In Mahogany-finish Cabinet\$57.50
Less Cabinet 49.50

THE ORIGINAL WILLIAMSON HR-15 AMPLIFIER KIT

The famous, original Williamson HR-15 . . . still acclaimed the leader . . . in kit form, with the original Partridge output Transformer.



Assemble this kit, and in 3 hours or less, enjoy the finest sound you ever heard. Operates from a tuner, phono-preamp, crystal pick-up, or other signal source. Absolute gain is 70.8 db with 20 db of feedback. Frequency response: $\pm .5$ db, from 10 to 100,000 cps. Output impedances to match all speakers from 1.7 to 109 ohms. Kit is complete with 5 tubes (1-5V4, 2-6SN7, and 2-5881 (or 807 if requested), 2-Punched Chassis, 2-Resistor Mounting Strips, Sockets, Partridge WWFB Output Transformer, Assembly Instructions, and All Other Necessary Parts for Amplifier and Power Supply.\$76.50

HR-15, as above, but with Partridge CFB Output Transformer (Hermetically Sealed)\$90.00

PARTRIDGE OUTPUT TRANSFORMERS — Available Separately. WWFB.....\$26.00 CFB.....\$40.00

HR-15T WILLIAMSON Kit—Furnished as above, with TRIAD Transformers and Chokes\$69.50

NOTE: HR-15 and HR-15T Kits may be had with British KT-66 Output tubes for \$3.00 additional.

THE STUDIO MIRACLE TELEFUNKEN CONDENSER MICROPHONE

This is the now famous microphone which recently created so much ado in audio engineering circles. It is the instrument which was credited with being responsible for the extraordinary fine quality of several recent commercial recording releases. The Telefunken provides both directional and omnidirectional characteristics and either may be selected by means of a small outside switch. Frequency range is from 30 to 15,000 cps.



Complete with 30 foot low-loss cable, and plugs together with Model U47-N Power Supply\$390.00

Electrical and Acoustical Data on Request



R-J SPEAKER ENCLOSURE BOOKSHELF MODEL FOR 8 INCH SPEAKER

The now famous R-J cabinet developed to new dimensions. Small enough to permit it to be inconspicuously mounted on a bookcase shelf. Reproduces amazingly clean, smooth,

bass fundamentals while permitting direct radiation of high frequencies. An ideal system

where space is at a premium or as an extension reproducer in an extra room. May be finished to match the decor.

Dimensions: 11" h. x 10" d. x 23 1/2" l.

S-8-U — (Single-shelf height)\$24.50

A HARVEY SPECIAL



Dimensions—
Height; 36" Width; 24"
Depth; 19"

BASS REFLEX SPEAKER ENCLOSURES

For 12 and 15 Inch Speakers

Designed acoustically for quality performance, this handsome cabinet is sturdily constructed and reinforced. Attractively finished, it will blend with the decor of most surroundings.

Blonde or Mahogany

SPECIAL \$43.75

VISIT HARVEY'S AUDIO-TORIUM—Come in and visit our new Sound Department . . . all these items and many more on working display at all times.

Telephone **hrc** LUzemburg 2-1500
HARVEY
RADIO COMPANY, INC.
103 West 43rd St., New York 18, N. Y.

NOTE: In view of the rapidly changing price situation in both complete units and components we wish to emphasize that all prices are subject to change without notice, and are Net, F.O.B., N.Y.C.



Fig. 9. Production model of 400-cps, 10-watt control amplifier—approximately same size as that required for a 5-watt audio unit. For audio use a different core material and higher-frequency carrier would be used. Photograph courtesy Magnetic Amplifiers, Inc.

possibly too simplified, they illustrate the operating principles. Design specifications would call for a better oscillator power supply. In addition, the amplifiers would include inverse feedback, bridge rectifiers, padding, filtering, and so on. Figure 9 shows a production model of a 400-cps, 10-watt control amplifier. The manufacturer indicates a 5-watt audio component would be comparable in size and weight.

Performance

Figure 10 is an oscillogram of the output waveform of a 100-watt magnetic amplifier built two years ago to determine the capabilities of the device at audio frequencies. The circuit used was that of Fig. 6; Fig. 11 shows the response curves. A 10-kc motor generator was used as a power supply, and the 10-kc ripple can be noted on the peaks of the signal frequency.

The curves indicate remarkably good

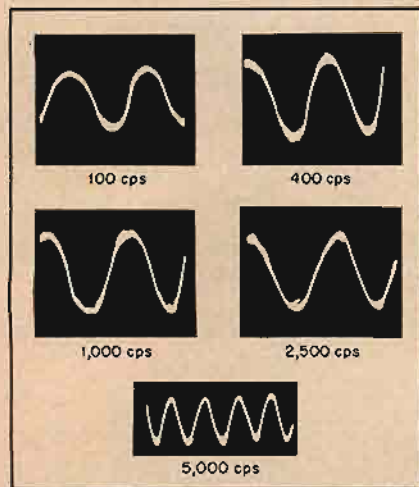

Fig. 10. Output waveforms for various frequencies. These cuts were made from actual oscillograms made from a 100-watt magnetic amplifier.

reproduction, considering the fact that ordinary machinery-type reactors and rectifiers were used in the amplifier.

Oscilloscope patterns indicating the response of magnetic core material triggered by 1-mc pulses are shown in Fig. 12. Although only remotely related to audio applications, they are included to show that the response of a magnetic amplifier is adequate for any radio requirements.

The core material used to obtain the above patterns was 4-79 molybdenum steel tape 1/8-mil thick and 3/32-in. wide; the ratio of inductance from zero to maximum saturation was 4:1; the power supply was 3 mc at 20 volts. Indications are that the response of steel tape core material is superior to the currently available ferrite cores at this frequency.

According to two British investigators, Williams and Noble, it is possible to amplify control signals of 10^{-18} watts at a bandwidth of 10 cps in a special magnetic amplifier having a basic limitation of 4×10^{-20} watts due to thermal noise. Barkhausen effects in the same magnetic amplifier are equivalent to a signal input of 10^{-19} watts for a bandwidth of 1 cps. Drift is the major limiting factor in low-input applications.

From the above investigations it is apparent that the low-level limits of the amplifier are adequate to meet normal requirements. It has already demonstrated its ability to amplify relatively pure sine waves well into the r.f. spectrum.

Indications are that magnetic ampli-

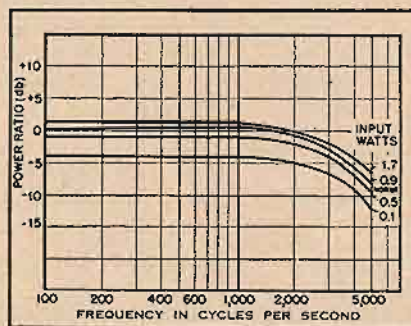

Fig. 11. Response curves for 100-watt amplifier used in making oscillograms of Fig. 10.

fiers have several advantages over equivalent tube amplifiers, namely:

1. Reliability. The rectifier is the life-determining factor. Selenium rectifiers currently in use have a normal life expectancy of around 60,000 hours. Modern crystal rectifiers have a similar life, with a much higher efficiency, but are limited, at the present stage of development, to a forward current of about 500 ma, and an inverse peak voltage of 400.
2. Require no warm up time.
3. Power consumption (with push-pull class B connection) during standby periods is low.
4. Fewer components.
5. Rugged; practically indestructible.
6. Will withstand considerable overloads.
7. Unbalanced effects in balanced circuits, due to cathode emission changes,

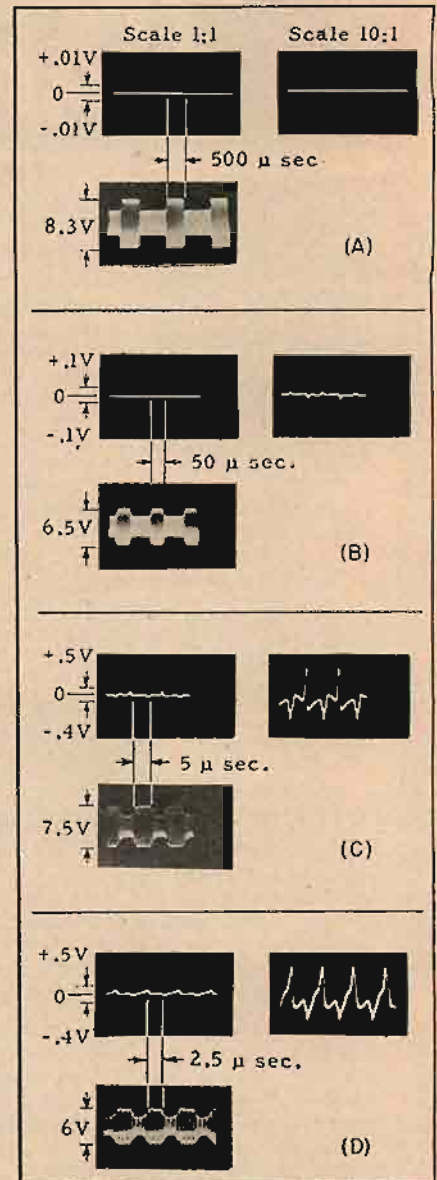

Fig. 12. Magnetic flip flops driven at high rates. Upper pair of photos in each box show input pulses which are, in each case, minimum amplitude required to set flip flop. Increased pulse amplitude is required at higher rates. The lower photos show r.f. envelopes. (A) Pulse repetition rate = 2000 pps. (Time between pulses = 500 μ sec) R.F. envelope = 1.42 mc. (B) Pulse repetition rate = 20,000 pps. (Time between pulses = 50 μ sec) R.F. envelope = 1.32 mc. (C) Pulse repetition rate = 200,000 pps. (Time between pulses = 5 μ sec) R.F. envelope = 1.4 mc. (D) Pulse repetition rate = 400,000 pps. (Time between pulses = 2.5 μ sec) R.F. envelope = 1.5 mc.

are less, because the stability of a rectifier is greater than that of a hot cathode.

8. Relatively unaffected by fungus, moisture, and heat.

The disadvantages are:

1. Currently, until mass production of core material and rectifiers is established, these amplifiers will cost more.
2. No suitable static r.f. power supply is available. This makes it necessary to use a tube oscillator as a power supply. This is not a serious disadvantage, however, when one considers that an electron

[Continued on page 73]

USE OF THE AIR-COUPLER

FAS

Although it is nearly two years since the first announcement of the Fowler-Allison-Sleeper system of bass reinforcement, the number of reports from people who have made such installations, and the enthusiasm for FAS performance has increased steadily.

Heart of the FAS system, of course, is the now famous Dual Air-Coupler, identical with the original design, but with built-in columns which smooth out the bass response to the satisfaction of the most critical music listeners and audiophiles.

As a result, thousands of hi-fi enthusiasts have reported:

1. That the Dual Air-Coupler reproduces lower frequencies than they thought could be recorded on phonograph records or tape,

2. That balance between treble and bass eliminates unnaturally shrill effects, due to the extended bass reproduction provided by the Air-Coupler, and

3. Full, proportional bass response is obtained at any volume level down to audibility, without the use of treble or bass controls.

Now, in the September-October Issue of HIGH-FIDELITY Magazine, information on a new project completed by the same team will be released. This has to do with crossover networks. The original FAS system called for an 8-ohm woofer, an 8-ohm intermediate speaker, and a 25-ohm tweeter, with crossover frequencies at 350 and 1,100 cycles.

However, many hi-fi enthusiasts wanted to use other crossover frequencies, or other speaker impedances, or to operate the Air-Coupler with a single dual speaker. But when they tackled the mathematics of the networks, they ran into trouble. Different formulas gave different values, or came out with designs that did not deliver the performance of which the FAS system is capable.

To do away with all such uncertainties,

a complete set of diagrams and component values has been worked out, from which the correct circuit can be found, as well as the values of standard inductors and capacitors, to use in the network for:

1. Any combination of impedances for a 3-speaker or 2-speaker FAS audio system, and

2. A wide selection of crossover frequencies.

These direct-reading diagrams and tables of values eliminate all mathematics and all guesswork, and make it possible to try different combinations in the FAS system with the assurance that maximum possible performance will be obtained from the selected speakers and crossover frequencies. This information will be found in the September-October Issue of HIGH-FIDELITY Magazine, out September 15.

FAS-2

The suggestion that performance of the FAS system can be improved will come as a surprise to the great number of people who are now using installations of the original design. Nevertheless, further progress has been made which is so basic that the new system is identified as FAS-2.

The same Air-Coupler and the same speakers can be used for the FAS-2, but there are radical changes in the amplifier section of the system, and crossover networks are eliminated entirely. It should be explained that the FAS-2 is more expensive, and to non-critical listeners the extra cost may not seem justified.

However, the super-critical audiophile who wants the very last bit of realism from his system will say: "Here is a system that really does everything!"

And that is literally true of the FAS-2. It is completely versatile not only in its per-

formance on various types of music, but in the freedom of choice it permits as to your particular selection from the various available amplifiers and speakers. There is no uncertainty as to networks, since they are not used. Also, and this point is stressed because it is a basic FAS feature, no tone controls are employed.

Complete information on the FAS-2, together with detailed photographs and diagrams, will appear in the November-December Issue of HIGH-FIDELITY Magazine, out November 1.

Audio Fair

You are cordially invited to see and hear the FAS system at the HIGH-FIDELITY exhibit at the Audio Fair, Hotel New Yorker, New York City, October 29 to November 1. If you would like to play your own test records on the FAS installation, you are welcome to do so. That is the best way to judge FAS performance.

High-Fidelity

This Magazine, now published every other month, is devoted exclusively to wide-range reproduction from FM, records, and tape. Articles by leading authorities describe in non-technical language the operation and use of new equipment, the latest ideas in custom installations, and all the most interesting activities in the hi-fi field. There is also a 24-page section of record reviews and information on recorded music.

HIGH-FIDELITY is a large-size magazine, profusely illustrated, and printed on fine paper. If you are not already a subscriber, by all means order your subscription without delay. When you receive your first issue, if you are not completely satisfied, the entire amount of your remittance will be refunded.

High-Fidelity

MILTON B. SLEEPER, *Publisher*

"THE MAGAZINE FOR AUDIOPHILES"

Charles Fowler, Editor
HIGH-FIDELITY Magazine
1309 Publishing House, Great Barrington, Mass.
Please enter my subscription to HIGH-FIDELITY,
for which I enclose:
 \$5.00 for 1 year (6 issues) SAVE \$1.00
 \$10.00 for 3 years (18 issues) SAVE \$8.00
 Include as part of my subscription issue
No. 3, showing construction of the
Dual Air-Coupler

Name.....

Address.....

Foreign postage: Add \$1.00 per year.

RECORD REVUE

EDWARD TATNALL CANBY*

Records in the Summer "Lull"

WHAT WITH ANOTHER Fair approaching in a few months, audio has taken to its summer lull—merely a slight slackening in the feverish expansion, merely a few sensational announcements—a new tape recorder with everything, for less than \$300, a new super-sound studio to demonstrate everything, at Arrow in New York, a dozen or so new lines of speaker enclosures, and a raft of new amplifiers. . . . Let audio rest for a bit, while records are reviewed like mad; the summer "lull" in records has been even more minute than ever this year and, at last, it seems the old habit of issuing nothing but light opera excerpts and Strauss waltzes for the hot weather has gone—heavyweight stuff of extraordinary interest has come out right through this last summer, heat waves or no. About time, I'd say.

Here's a small taste of it. This month we'll combine the "key" system of technical evaluation with written-out reviews. I suggest you slice the key out of its page (having read the other side carefully first) and mount it where you can refer to it with a glance as you read along. We can't always print it in the most convenient place.

NEW LP RECORDINGS

^aOutstanding recorded sound for the type of music. ^bBig bass—European low turnover point. ^cClose-to, edgy highs. ^dDistortion. ^eFlattish high end; needs boost over normal LP playback.

¹Intimate, close-to recording in good liveness. ²Big, live acoustics. ³From older 78 disc. ⁴piano somewhat in background, off-mike. ⁵Surface noise. ⁶tape flutter and instability; poor transients (piano). ⁷Soloist close-up, loud. ⁸Bass weakish; needs boost over normal LP playback. ⁹Lacking in highs.

Some novel Romantics

^aClara Schumann, *Trio in G Minor, Op. 17. Beethoven, Trio #8 in B flat (posth.)* Mannes-Gimpel-Silva Trio. Decca DL 9555

*279 W. 4th St., New York 14, N. Y.

*Kreutzer, *Grand-Septet in E flat*. Members of Vienna Octet. London LLP 420

^aSpohr, *Grand Nonette; Six Songs for Mezzo, Clarinet & Pf.* Alice Howland, sop.; D. Weber, cl.; and instr. ensemble.

Stradivari STR 609
^aSpohr, *Violin Concerto #8 (In Form of a Vocal Scene)*. K. Stiehler; Leipsic Gewandhaus Orch., Schmitz.

^bSpohr, *Violin Concerto #7*. R. Schulz; Radio Berlin Symphony, Heger.

Urania URLP 7049

A brace of unusual works—sounding much like familiar 19th Century music from Beethoven to Schumann, composed by "unknowns" who at the time were leading musical personalities. You never know about such music; sometimes it is as terrible as it ought to be but sometimes, too, it is unexpectedly fine, if you can open your skeptical ears to it.

The Schumann Trio, by the famous lady pianist, wife of Robert Schumann, will fascinate any Schumann lover. It sounds astonishingly like hubby's music and it's expertly written too; Clara was a thoroughly trained musician in every respect. And yet, after awhile, you begin to feel the weakness of it, the unoriginality, the following-of-formulas, the poor structure.

Kreutzer was a popular Viennese composer of Beethoven's time. His Septet is astonishingly like the jaunty Beethoven Septet in the same key (op. 20)—and astonishingly poor music considering how expert its outward shape is. Off-hand, you couldn't tell it from Beethoven in style.

Spohr was a real composer, too much belittled according to this evidence. (See also Urania's LP of his Quartet Concerto and Clarinet Concerto.) The two violin concerti, Schumann-Weber in style, are every bit as good as many a war horse we hear a thousand times a year; the forms are unusual and original if the harmonies are conventional. Very melodic and good listening. The Nonette, far superior to the Kreutzer, is a fine, colorful piece, a lyric serenade like middle Beethoven with a large dose of Schubert mixed in. The Songs on the reverse side are equally interesting, the clarinet obbligato adding an unusually lovely touch. Unusually good performance throughout all of these.

Mozart series

^aMozart, *Violin Concertos #1, K. 207; #2, K. 211.* Aida Stucki; Ton-Studio Orch., Stuttgart, Lund. Period SPLP 549

^aMozart, *Violin Concerto #7, K. 271a.* Stucki; Ton-Studio Orch., Lund

Mozart, *Rondo in C, Adagio in E, Rondo in*

B flat. Gustav Swárdström; Ton-Studio Orch., Lund. Period SPLP 548

^aMozart, *Symphony #24. March, K. 248 and Divertimento #10, K. 247.* Ton-Studio Orch., Michael, Lund. Period SPLP 545

^aMozart, *Flute and Harp Concerto, K. 299. Horn Concerto #1 in D.* Ton-Studio Orch., Lund. K. F. Mess, fl., Dora Wagner, harp, C. Goermer, horn. Period SPLP 544

An interesting series, cleanly recorded, of seldom heard Mozart works—including a group of substitute movements for the violin concertos that he wrote to please pensive soloists. The job is scholarly, the style good, the orchestra properly small and intimate, the recording balance and acoustics suitable—all in all a series of great interest, were it not for the unimaginative, wooden, metronomic performance of this orchestra under Gustav Lund. Not a subtlety you'll hear right away—the music speaks for itself in spite of this and the sound is as fresh and enjoyable as Mozart can make it. Stucki is a wobbly, uneven soloist; the single movements played by Swárdström show a much better Mozart fiddle. The horn, flute, and harp solos are all good, helping to balance the always slightly wooden playing of the orchestra. A more imaginative conductor could have made this into a stunningly fine series. Well worth a listen even as is.

Mozart, *Violin Concertos #3, K. 216; #4, K. 218.* Szymon Goldberg; Philharmonia Orch., Susskind. . . . Decca DL 9609.

^bMozart, *Violin Concerto #4, K. 218.* Szigeti; London Philharmonic, Beecham.

Columbia ML 4533 (1/2)

(With Prokofieff, *Concerto #1*)

Szymon Goldberg, a celebrated Mozart player (often with Lili Kraus, the pianist) for years, adds the touch of life lacking in the Ton-Studio recordings. These two familiar concertos are done in the "new" style, lightly, with small orchestra, the whole clear, sparkling but not "cute." Good recording, especially of the violin, though not quite as crystalline as the Period recordings. These are tops in present day Mozart.

The Szigeti-Beecham version is evidently a re-issue (as is the Prokofieff) of pre-war 78s—the difference in style (and in recording) is interesting. Beecham's Mozart, once thought of as perfection, now seems overweight, with too big an orchestra, not enough transparency in spite of impeccable playing. Szigeti is too accurate to do a bad job, but one feels a certain false "purity," as though this were some sort of "little gem" of music. The new style, with smaller forces, paradoxically makes the music sound bigger, more communicative.

^aMozart, *Piano Concertos #20 in D*

[Continued on page 54]



In Music, Listening Quality is Everything

"... during the last four years I bought several hundred dollars worth of pickups, purely on high kilocycle claims. Recently I acquired an AUDAX (diamond) CHROMATIC and now I know that Sarser, the violinist (Toscanini's NBC Symphony), is so right ... listening quality IS every-thing ..."

Never before such LISTENING QUALITY, such FAITHFUL REPRÖDUC-

TION, but ... after all the reams are written about kilocycles and other laboratory data—when the chips are down—you and only YOU can decide what sounds best and most pleasing. Therefore ... SEE and HEAR the AUDAX and—You be the judge. Also available to fit record changers. Be sure to ask for a copy of "ELECTRONIC PHONO FACTS" at your distributor's.

AUDAX COMPANY

500 Fifth Avenue

New York 36

Creators of Fine Electro-Acoustical apparatus for over 25 years.

The Standard by Which Others Are Judged and Valued.

PREAMPLIFIER FOR CRITICAL LISTENING

[from page 23]

mounted from the chassis with flexible leads for vibration isolation. This unit will be noted in the upper left corner of Fig. 3.

All the recording characteristic equalizing resistors and condensers have been mounted on S_w_2 with flexible leads at B and C extended to the shock-mounted pre-preamplifier and equalizing amplifier.

The "touch-up" low-frequency equalizing network between points D and E has been placed on the bottom of the chassis under the pre-amplifier sub-assembly.

Care was taken in wiring the unit to insure a single-point ground which would be located at the lowest signal level point. All input circuits were carefully isolated from ground with insulating washers used on the unbalanced input circuits. The actual ground point employed the chassis negative electrolytic bypass capacitor point which was located immediately and conveniently below the pre-preamplifier and recording characteristic equalizer-amplifier sub-assembly.

Care was also taken to insure minimum capacitance to ground of the inter-stage coupling capacitors between sections of V_s and V_e by mounting these two units on insulating stand-off pillars just back of the low- and high-frequency environmental equalization controls.

Performance

Figures 6, 7, 8, and 9 show the actual reproduction characteristics, and confirm the fact that the recording characteristic equalizing circuits provide complementary equalization for the curves of Fig. 2.

Each element of this system was carefully investigated as to signal-to-noise ratios and overload characteristics.

The pre-preamplifier and associated

Fig. 7. Response through equalizer section with controls centered and with loudness control at maximum level position.

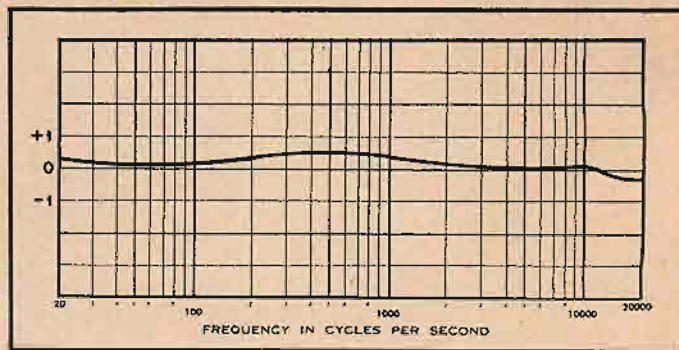

disc-equalizing amplifier, for example, with a 15 millivolt (r.m.s.) input at 1000 cps provides 1.215 volts r.m.s. output to the loudness control with the noise level more than 80 db below this level. The overload point with the pre-preamplifier switch in the maximum gain position was at 80 millivolts r.m.s., which indicates that there is more than an ample overload margin when a G.E. pick-up is used under this condition of operation. The overload point in the minimum gain position, is of course, approximately 0.8 volt r.m.s. under the same conditions of operation.

The environmental equalizer section of the circuit was similarly tested, both at maximum boost and attenuation. Again by careful parts layout it was found that the noise level was more than 80 db below the normal signal level. The specific value was not measurable due to the fact that the vacuum tube voltmeter available for these tests could not read a lower level.

The environmental equalizer section was checked for overload characteristics and output voltage, both under the conditions of a terminating load and a bridging load. In the first case, 15.2 volts r.m.s. input appeared to be the overload point, which gave 5.0 volts r.m.s. into a terminating load, or 6.7 volts r.m.s. into a bridging load. With maximum boost and utilizing a 100 cps signal as a reference, the overload point was 10 volts r.m.s. input, which gave 2.55 volts r.m.s. into a terminating load,

and 4.5 volts r.m.s. into a bridging load.

From the above, it is apparent that there is also ample margin between operating point and the overload point of the environmental equalizer section of this unit when it is noted that the maximum level feed into this section will normally be only 1.215 volts r.m.s.

Under normal conditions of operation, a 15-millivolt input signal as typical of a G.E. pickup, will provide a signal of approximately 0.55 volts r.m.s. across the 600-ohm output of the preamplifier, under which condition of operation a signal-to-noise ratio of better than 80 db is readily obtained. This level appears to be more than adequate as an input for a magnetic recorder and most conventional power amplifiers.

From past experience, it was believed to be essential that the excellent system performance should be obtained regardless of tube selection. Twenty 12AY7's in various combinations and of various previous operating histories were evaluated. Thanks to the type of circuitry, neither the gain, levels, nor frequency response changed more than 0.3 db regardless of their combination.

The writer wishes to acknowledge and credit George Beggs, Jack Shoup, Sherman Fairchild and Paul Landaman for many of the ideas and suggestions embodied in this unit and for suggesting the rather wordy descriptions of several design points often presented in the literature of this new field.

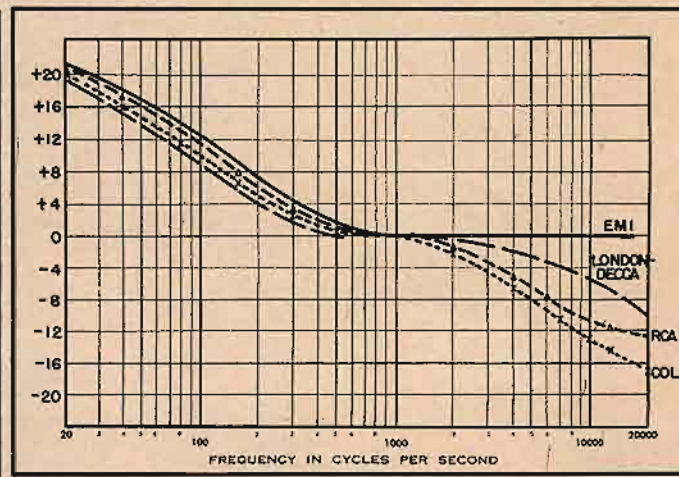
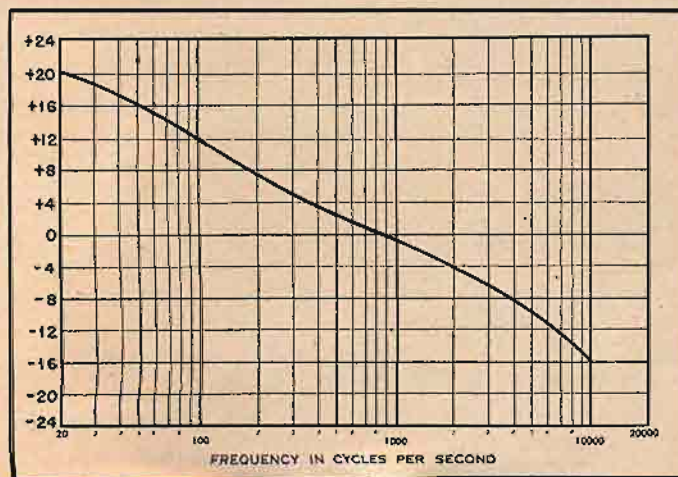

Fig. 8 (left). Measured playback characteristic for LP records. Fig. 9 (right). Measured playback characteristic at various settings of the controls for 78-r.p.m. records.

SOUND REPRODUCTION

[from page 40]

holt resonators with parallel surfaces to have additional modes of resonance caused by the formation of standing waves at higher frequencies. If the enclosure is severely elongated these additional modes may occur near the frequency of Helmholtz resonance, although normally the two resonant modes are widely separated in frequency (witness the deep tone of the usual bottle, whose length as an air column would call for a shrill, fife-like note). Helmholtz prevented standing waves from forming in his resonator by using an enclosure whose curved internal surface did not allow repeated reflections along the same path. Modern Helmholtz-type speaker enclosures usually damp out high-frequency oscillatory reflection with sound absorbent material.

Unlike the air column, which can resonate at harmonic frequencies and produce a rich tone, the Helmholtz enclosure produces no harmonics because it will not vibrate sectionally. This makes the sound of a bottle uninteresting musically, but indicates an advantage from the point of view of using a Helmholtz resonator as part of a reproducing system.

In addition to the resonant systems described above there are other types of mechanical and acoustical sources of sound, which produce vibratory energy by periodic interruption of a steady force. Oscillations are forced, and can only occur if new energy is supplied at every instant. Although individual elements of the systems may possess inertia and restoring force these properties are not fundamental to operation. A device of this nature was used by Galileo in demonstrating the periodic nature of sound, when he passed a knife blade across the serrated edge of a *piastre*, thereby creating a tone of definite pitch. The frequency of the tone depended on the distance between serrations and the velocity of the knife blade, not on the mass and elasticity of the knife or coin.

There are pneumatic as well as mechanical interruption-type sources. The siren, for example, throttles an air stream by means of a rapidly revolving perforated disc. The variation of siren frequency with the velocity of rotation is a familiar effect.

A common interruption phenomenon associated with musical wind instruments is the formation of eddies or whirlwinds when a steady flow of air passes an obstacle of small diameter. These eddies are created one at a time, alternately to the left and to the right of the obstacle. As each small whirlpool moves away it breaks off its connection with the steady stream of air, which flips over to the other side of the obstacle, as shown in *Fig. 4-3*. The same behavior may be observed when an object is drawn through still water, or when a stream of water flows past a rock.

With the formation of each eddy a shock is imparted to the obstacle and to

Speaking of Brand New!

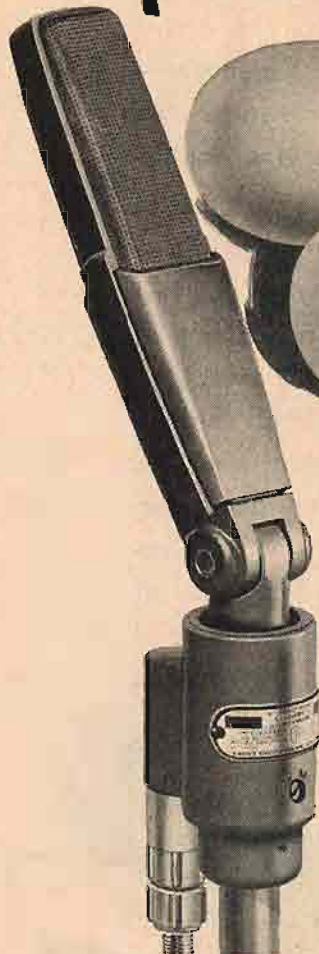

"300"
Broadcast
List Price...\$125.00

"315"
General Purpose
List Price...\$75.00

Here Are the NEW **SHURE**

Hi-Fidelity Slender Series

Bi-Directional Gradient¹ Microphones!

● These microphones outperform all other "slender" microphones—because of their advanced acoustical, electrical and mechanical features. Both models permit greater performer freedom (performers can stand at a 73% greater distance from the microphone!) The "300" and "315" will pick up voice and music from front and back—yet discriminate against unwanted noises from the sides. They reduce reverberation and the pickup of distracting random noises by 66%!

● Model "300" Broadcast is specially designed to meet the exacting requirements of TV, radio broadcasting, and recording. It has a special "Grayje" subdued, non-reflecting finish that blends into the background, gives the spotlight to the performer. Has a "Voice-Music" switch for perfect reproduction of the soloist working at close range, or for the distant instruments of the orchestra. Special vibration-isolation unit eliminates "handling" noises and the pickup of floor vibrations. Model "315" General Purpose is similar in size, design and technical features to the Model "300." It is finished in rich, soft chrome—ideal for those public address applications where its streamlined design and beauty lend prestige to any setting in which it is used.

IMPEDANCE TABLE	OUTPUT LEVEL
L—35-50 ohms	58.7 db below 1 Milliwatt per 10 microbar signal
M—150-250 ohms	59.5 db below 1 Milliwatt per 10 microbar signal
H—High	57.0 db below 1 volt per microbar

Shure Patents Pending

SHURE BROTHERS, Inc. ★ Manufacturers of Microphones and Acoustic Devices
225 West Huron Street, Chicago 10, Illinois ● Cable Address: SHUREMICRO

A unique application of damping brings you smoother, wider range response with Astatic's Model 10L-3 and 11L-3 Turnover Cartridges

Astatic has found the answer—how to get wider-than-ever range and smoother-than-ever response in a double-needle turnover cartridge—with a variation of the damping principle. And a mighty important variation it is, you'll agree, when you test the vastly superior quality of reproduction of these new Astatic 10L3 and 11L3 units. The greater smoothness of response holds through the higher frequencies. High output level and compliance are maintained. Every characteristic of this new cartridge engineering development contributes to a new and finer level of performance, marked especially by absence of listening fatigue. Write for complete details.

SPECIFICATIONS

HOUSINGS
Molded Bakelite.

TERMINALS
Quick disconnect pin type.

TOTAL WEIGHT
5 grams (with Turnover Assembly and Knob, 16 grams).

STYL
Replaceable Type A-1 with 1-mil tip radius on narrow-groove record side. Type A-3 with 3-mil tip radius on standard-groove record side. Precious metal or sapphire.

NEEDLE PRESSURE
8 grams, both needles.

OUTPUT AT 1000 C.P.S.
(Approx.): 1.0 volt, either needle.

FREQUENCY RANGE
50 to 10,000 c.p.s.

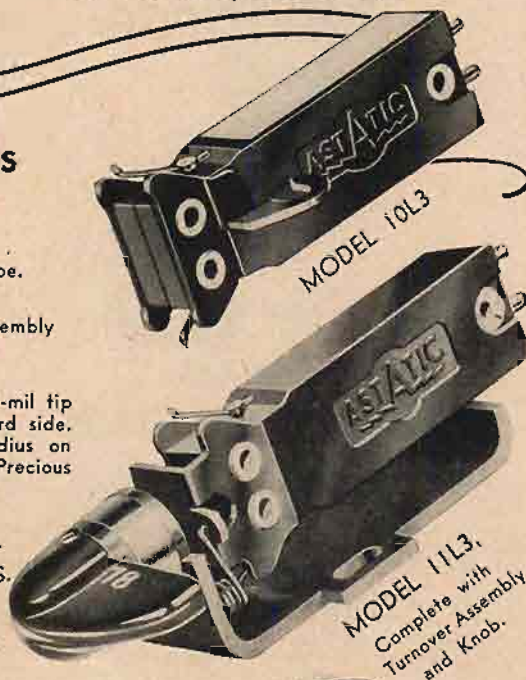

EXPORT DEPT.
401 Broadway,
New York 13, N. Y.
Cable Address:
Astatic, New York

Astatic Special Double-Needle Cartridges
under Brush Development Co. patents



the acoustic medium, and the steady pneumatic pressure is transformed into an acoustical vibration. The interruptions will be perfectly periodic if the flow is steady; the frequency of the shocks is determined by the diameter of the obstacle in relation to the velocity of flow of the medium. This dependence of frequency on the velocity of the air stream is demonstrated by the whistle of the wind (caused by the flow of air past trees and other objects), which becomes a howl when changes in wind velocity cause the pitch to rise and fall.

One eddy is formed each time the air current traverses a distance of 5.4 times the diameter of the obstacle. The frequency of oscillation is therefore:

$$f = \frac{S}{5.4D}$$

where f = frequency of oscillation
 D = diameter of the obstacle
 S = velocity of air flowing past the obstacle

The phenomenon of whirlwind currents is responsible for the primary generation of sounds in wind instruments such as the flute and pipe organ. This primary sound is referred to as the "edge tone."

Analysis of Oscillatory Mechanical or Acoustical Systems by Dynamical Analogies

Since there is a direct correspondence between the impedance elements of mechanical, acoustical and electrical systems, the non-electrical members of this group may be accurately represented by electrical circuit diagrams and analyzed as such. Some years ago electrical phenomena were commonly explained in terms of hydraulic and mechanical analogies. Today the behavior of electrical circuits is well understood, and in general engineers have had much more experience with resonance in electrical circuits than in mechanical systems. The use of electrical units, symbols, and diagrams in connection with mechanical or acoustical systems has therefore been introduced, and dynamical analogies to electrical phenomena serve as a useful analytic tool. The descriptions of this volume will include but not be dependent on such analogies. A perfectly rigorous analysis can be made without them, but dynamical analogies simplify the understanding of complex mechanical systems, and they are used so extensively in audio literature that it is well for enthusiasts as well as design engineers to be familiar with them.

Let us take the acoustical system of the Helmholtz resonator just considered, for which a mechanical analogy has already been presented. Both the acoustical and the mechanical system are analogous (when oscillatory force is applied to the mass element) to the electrical circuit shown at (C) in Fig. 4-2. Certain similarities of the corresponding elements, relative to their own system, should be evident. The application of voltage to a circuit consisting of any or all of the elements of inductance, capacitance, or resistance will result in the flow of a certain amount of current, just as the application of a mechanical force to a device having mass, compliance, and friction will result in a certain velocity of motion. The effect of inertial mass in opposing any change of velocity is like the action of inductance in resisting current change. The impedance of both of

these elements decreases with a decrease in the frequency of change, to become zero if the frequency of changes becomes zero. Thus when d.c. voltage is applied to a coil the inductance has no effect, except during the initial build-up of current, and only the resistance of the winding must be overcome to keep up the same current. When steady mechanical pressure is applied to a body inertia has no effect, except during the initial build-up of velocity, and only friction must be overcome to keep up the same velocity.

The similarities between compliance and capacitance, and between resistance and friction, may be traced in the same way. Only one more principle is required to enable us to construct an analogous electrical circuit; that principle which will differentiate between series and parallel connections in the representation of multielement systems.

The relationship of mechanical elements to their "circuit," in adding or subtracting from the total impedance, is the same as that of electrical elements. Two mass elements whose values must be added to find the total inertial impedance of the system are represented as inductors in series, while two elastic elements, each of which decreases the stiffness impedance of the system, are represented as capacitors in parallel.

It will therefore be seen that all three of the elements in Fig. 4-2 must be shown in series. The accuracy of such representation may be checked by examining different aspects of circuit behavior. For example, if any one of the three mechanical impedances were made infinite—changing the spring into a rigid body would achieve this result—all velocity of motion would be stopped, just as "opening" any one of the three corresponding electrical elements would prevent all current flow. It may also be seen that the inertia-elasticity systems present a minimum impedance to the applied force at resonance, allowing maximum velocity to be induced in them; in the same way the series L-C circuit has minimum impedance at resonance and allows maximum current flow for a given applied voltage. (If one end of the spring is left free and force applied to it rather than to the mass element the analogous circuit becomes a parallel one. The two aspects of circuit behavior referred to above may be checked by the reader.)

On the other hand note the mechanical

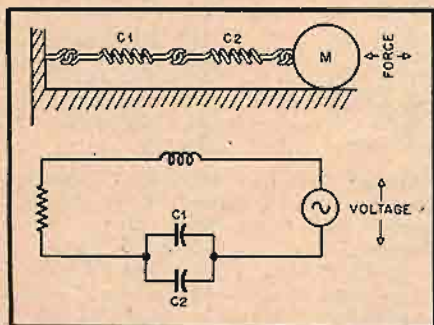

Fig. 4-4. Mechanical system with springs in tandem, and analogous electrical circuit.

system of Fig. 4-4, in which two springs are connected together in a physical configuration that looks like a series circuit. "Freezing" one of the springs will not prevent all motion but will only decrease the total compliance, just as opening one of the parallel capacitors in the analogous circuit will decrease the capaci-



ANNOUNCING THE SENSATIONAL

FISHER

All-Triode Amplifier AND Master Audio Control

■ THE FISHER Laboratory Standard Amplifier is, beyond a shadow of a doubt, *the world's finest all-triode amplifier*—and yet moderately priced. FEATURES IN BRIEF: High output—less than ½% harmonic distortion at 40 watts (.08% at 10 watts). Intermodulation distortion below 3/10% at 30 watts. Uniform response within .1 db, 20-20,000 cycles; 1 db, 5 to 100,000 cycles. Hum and noise better than 92 db below full output. Quality components, beautiful workmanship. ■ THE FISHER Master Audio Control can be used with any amplifier. Intermodulation distortion is virtually unmeasurable; complete, professional phonograph equalization settings and tone controls; genuine F-M loudness control; 5 inputs and 5 independent input level controls; cathode follower outputs. Self-powered.

Write for illustrated brochure and full specifications.

FISHER RADIO CORPORATION · 37 E. 47th ST., N. Y.

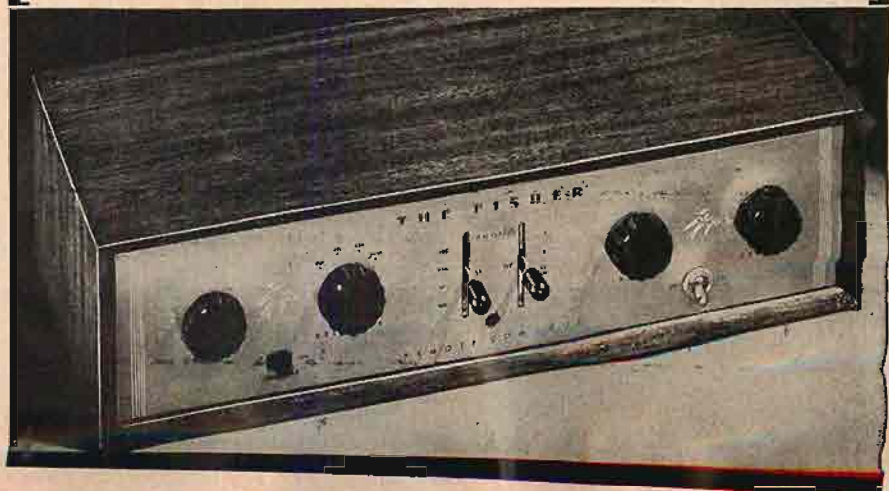

inside this package on your Jobber's shelf...
is the world's **TOUGHEST TRANSFORMER**



H-TYPE

Hermetic sealing meets all MIL-T-27 specs. Steel base cover is deep-seal soldered into case. Terminals hermetically sealed. Ceramic bushings. Stud-mounted unit.

there's nothing tougher than
CHICAGO'S "Sealed-in-Steel" construction



S-TYPE

Steel base cover fitted with phenolic terminal board. Convenient numbered solder lug terminals. Flange-mounted.



C-TYPE

With 10" color-coded leads brought out through fibre board base cover. Lead ends are stripped and tinned for easy soldering. Flange-mounted.

CHICAGO "New Equipment" transformers (available in 3 mountings) feature one-piece drawn-steel cases—the strongest, toughest, best-looking units you can buy. The one-piece seamless design, enclosing an electronically perfect construction, provides the best possible electrostatic and magnetic shielding, with complete protection against adverse atmospheric conditions. For every application: Power, Bias, Filament, Filter Reactor, Audio, MIL-T-27, Stepdown—ask your electronic parts distributor for CHICAGO "Sealed-in-Steel" Transformers—the world's toughest with that extra margin of dependability.

Free "New Equipment" Catalog

Get the full details on CHICAGO'S New Equipment Line—covering "Sealed-in-Steel" transformers for every modern circuit application. Write for your Free copy of this valuable catalog today, or get it from your distributor.



tance of the system but will still allow current to flow. Consider the converse, that is, a system with two springs in parallel mechanically, like the spider and rim suspensions of a loudspeaker. The addition of each spring to the system decreases the total compliance, and if the compliance of either were made zero all motion would have to cease. With a few word changes the above description may be applied to an electrical circuit with series capacitors.

RECORD REVUE

[from page 48]

minor, #24 in C minor. Artur Schnabel; Philharmonia Orch., Susskind.

HMV LHMV-1012

One of RCA's new American LP (& 45) reissues of the British His Master's Voice catalogue, recorded by the Gramophone Co.—a concern that has been musically at the top but technically conservative in recent years. (By which I mean, of course, disc recording at 78, pressed on shellac. No LPs.) These are post-war, pre-1951, with a good sound but not up to present standards. Highs somewhat subdued, especially in the D minor Concerto #20, the piano a bit hard and percussive. I'd guess they're from disc masters. Many HMV reissues will be in this in-between category technically.

Mozart's violin concertos are early works, but the piano concertos continued until his last years these two great works are rightly massive, Beethoven-like in sound as compared with the same orchestra's violin concertos, above. (The Deccas are evidently more recent.) Schnabel, the great Beethoven pianist, adds a further Beethoven touch. The C Minor, #24, is the best technically; both show Schnabel at the top of his intellectual powers, a bit uneven in pianistic details here and there. But this big Mozart alongside your big symphonies and Romantic concertos—Beethoven, Schumann, Brahms and the rest.

*Mozart, Clarinet Quintet, K. 581. Benny Goodman; Amer. Art Quartet.

Columbia ML 4483

*Mozart, Clarinet Quintet, K. 581; Horn Quintet, K. 407. Augustin Duques, clarinet; O. De Rosa, horn. (Members Stradivari Quartet).

Stradivari STR 601

The superb Clarinet Quintet in two more versions. Benny Goodman's is, if my memory is good, an improvement over his pre-war recording of the work, with more flexibility and feeling. But the rival Duques performance has him beat by a good margin—and the Horn Quintet is thrown into the bargain. Duques, an old clarinet hand, achieves that ineffable, other-worldly beauty of tone and phrasing that only a top man can manage in this music. Benny's tone is more metallic (possibly because of too-close recording?), his performance less beautifully sustained.

Stradivari has an impressive standard of performance in its LPs of small instrumental groups; several times before this the label has been a preferable choice over big-company rivalry. The Stradivari surfaces are noisy and tend to be a bit soft. (Level is low—for long playing time—accounting for part of the noise.)

*Mozart, Oboe Quartet, K. 370. Telemann, Oboe Sonata in C minor; Partita #5 in E minor. Harold Gomberg, oboe, Claude Chaisson, harps., F. Galimir, G. Banat, A. Kouguell, strings.

Decca DL 9618

One of the finest records of its sort I've heard—beautiful recording of a first rate oboist in music of two very different kinds. The Mozart, one of his most gracious and lyric pieces, is a perfect illustration here of the new interest that so-called "chamber music" can have when heard close-up and powerful via good recording. You can forget that term, as you listen to the full, high colored sound of this music, recorded superbly! The Telemann works, with harpsichord, are more grave, but still tuneful and dance-like. You'll have a hard time not enjoying this—however much you may distrust chamber music.

Piano

*Liszt, Variations on "Weinen, Klagen";

CHICAGO TRANSFORMER

DIVISION OF ESSEX WIRE CORPORATION

3501 ADDISON STREET • CHICAGO 18, ILLINOIS



Excerpts from "Weihnachtsbaum". Ilona Kabos, pf. **Bartok BRS 910**
 *Liszt, Sonata in B Minor; Funerailles. (Simon Barère Recital). Simon Barère, pf. **Remington 199-85**
 *Liszt, Sonata in B minor. Andor Foldes, pf. **Decca DL 7528**
 *Liszt, Mephisto Waltz; Consolation #3; Spanish Rhapsody. Gyorgy Sandor, pf. **Columbia ML 2209**

Not so long ago this department bewailed the prevalence of inexcusably wobbly, unstable tape-LP piano recording—then, later, noted an improvement. That improvement, with a few striking exceptions, has now carried the best taped piano to unbelievable perfection, in view of what the big companies saw fit to issue a year or so back.

The Bartok Liszt record above is (at the moment) far and away the finest piano record I think I have ever heard. Absolutely steady, percussive only in the natural way, with big bass, natural highs, a startling piano realism. 20,000 cps too, though that is unimportant musically. The playing is equally fine—old Liszt, the fabulous long-haired thunderer of 19th century pianism, must be played like a thunderstorm or not at all and this pianist does it, to match the superb recorded sound.

The B minor sonata, a tremendous long piece of great power, shaking the heavens in its loud parts, singing sweetly, is the arch-example of this kind of power-house music. The Barère recital, taken "live" at Carnegie Hall, competes on LP with Decca's Foldes version and Columbia's earlier Sandor LP.

Here we have two super virtuosi fingerwise, both fantastic in their technique. But Barère takes Liszt in the thunderous way; Foldes, a wizard with contemporary music, modernizes it—the music is sharp, clear, hard, glittering. No doubt about who wins in this case—try the last half inch (side 2) of the Remington-Barère for the most tremendous piano climax you'll ever hear. Moreover, the Remington LP is top piano recording, the Decca-Deutsche Grammophon—is far substandard, with bad flutter and instability, a thin bass, somewhat twangy transients. Not good at all.

It's clear—by the way—that to record piano you must have space—big space. Mike a piano in a big hall and you can hardly go wrong unless you put your mike inside the case. Compare this Barère with the fabulous Rosita Renard set (Gramophone Shop, N. Y.) made in the same place also at a concert. Both are superb.

Sandor, Hungarian like Foldes, falls midway between the others—hard, metallic playing but with a lot of thunder too. Recording is Columbia's typical hardish, close-up sound, good of its type, clean and steady.

*Ravel, Sonatine; Le Tombeau de Couperin. Chabrier, Idyll; Bourrée Fantasque. Kathleen Long, pf. **London LLP 452**
 *Bartok, Three Rondos on Folk Tunes; Roumanian Folk Dances. Lili Kraus, pf. **Decca DL 4011**

The Ravel record, one of the very few Londons that come this department's way (we try. . .) is one of the finest piano performances of the year, a "speaking" kind of playing that makes the piano not merely a kind of sound but a medium for direct thinking, player to you. Astonishing. Recording is excellent, but not top; a bit lacking in presence compared to the superb Bartok job above. Lili Kraus, another of the very great woman pianists, is evidently re-issued here, from older 78s. The contrast in quality is quite striking. Definitely so-so, though the music comes through well enough.

*Griffes, Piano Sonata; Roman Sketches, op. 7. Leonid Hambro, pf. **Walden W-100**

Another odd item, to register the continued technical excellence of small-label material. This is as good as any piano above except perhaps Peter Bartok's own. (It was recorded by Bartok!)

Hambro is a skillful but noisy pianist, his musicianship always just a bit behind his fabulous technique. So here, with this not too interesting American late-Romanticism à la Liszt. Some good sounds, even so.

For a Glorious
BIG TONE
 ON ANY STRINGED INSTRUMENT
specify the Genuine
AMPERITE "KONTAK MIKE"
 THE ONLY NO-DISTORTION "KONTAK MIKE"

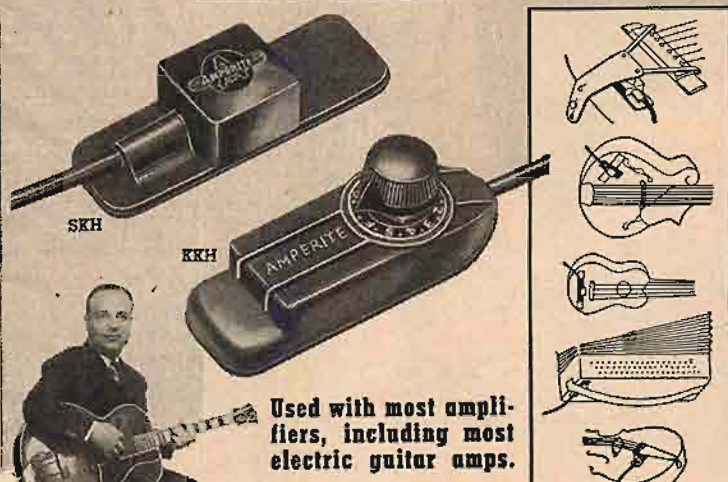

Anthony Antone, widely known as "the most versatile artist of the frets", is an enthusiastic user of Amperite Kontakt Mikes.

Used with most amplifiers, including most electric guitar amps.

No changes in amplifier, instrument, or strings. Attached without tools.

The Amperite "Kontak Mike" improves the tone and volume of any Stringed or Fretted Instrument — also Pianos, Accordions, Harmonicas, etc. It is the only "Kontak Mike" that does not introduce peaks or distortion.

Model SKH, hi-imp. List \$12.00
 Model KKH (with hand volume control) List \$18.00

AMPERITE
STUDIO MICROPHONES
 at P. A. PRICES!
 Ideal for **CLOSE TALKING**
 or **DISTANT PICKUP**

You can shout right into it, or stand away; in either case, the quality will be perfectly natural.
 Model RBLG (200 ohms) List \$42.00
 Model RBHG (hi-imp) List \$42.00



AMPERITE CAROID DYNAMIC MICROPHONE
 Models PGH-PGL List \$32.00



SPECIAL OFFER:
 Write for Introductory Offer, and 4-page Microphone Folder 53-M.

AMPERITE Company, Inc.
 561 Broadway • New York 12, N. Y.
 In Canada: Atlas Radio Corp., Ltd., 560 King St., W., Toronto 28

NEW PRODUCTS

• **New Altec Lansing Speakers.** Two new co-axial speakers, the 12-in. Model 601A and the 15-in. Model 602A (shown), are being introduced this month by Altec Lansing under a guarantee which is unique in the field of audio—both units being unconditionally guaranteed to have a frequency range from 30 to 22,000 cps



when mounted in correctly designed enclosures. Both models are full two-way speakers similar in appearance to the Model 604B. All frequencies up to 3000 cps are handled by a conventional cone using a 3-in. edge-wound aluminum voice coil. Higher frequencies are reproduced by a horn-type tweeter mounted in the center of the LF cone. Crossover is handled by a newly-designed network designated Model N-3000A. Power-handling capacity of both the 601A and 602A is 20 watts. Altec Lansing Corporation, Beverly Hills, Calif., and 100 Sixth Ave., New York City, N. Y.

• **High-Quality Power Amplifier.** Laboratory standards of performance are afforded by the new Model 50-A amplifier recently introduced by Fisher Radio Corporation, 41 E. 47th St., New York City,



N. Y. Harmonic distortion is but 0.25 per cent and intermodulation is below 2 per cent at 40-watt output. Frequency response is uniform within ± 0.1 db from 20 to 20,000 cps and within 1 db from 5 to 100,000 cps. Noise level is 92 db below full output. Internal impedance is 0.53 ohm at the 16-ohm output tap, producing a damping factor of 31. Tube complement comprises 3-12AU7's, 2-6S4's, 2-1614's, 2-5V4G's. A jack is provided to measure plate current of output stage, and a bias control is accessible for adjustment.

• **Binaural Tape Recorder.** The Synchronone, a new tape recorder recently announced by Magnetic Recording Industries, 30 Broad St., New York 4, N. Y., permits synchronous recording of two different audio signals on a single strip of tape without intermixing. The two signals may be recorded simultaneously, or at different times—yet both may be reproduced together in perfect synchronism. Each recorded track may be erased, corrected, altered in relative volume, or dubbed, without affecting the other. Binau-

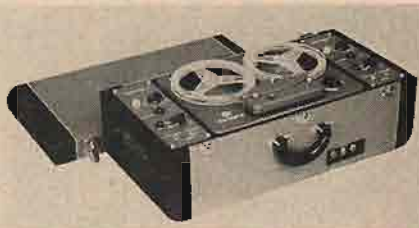

ral reproduction may be achieved by feeding the outputs of the Synchronone into suitable phones or correctly-located speakers. Two models currently in production offer a choice of $7\frac{1}{2}$ or $3\frac{3}{4}$ ins./sec. recording speed with upper frequency limits of 7000 and 5000 cps respectively. Both models have automatic erase heads, fast forward and rewind, separate radio and microphone inputs for each channel, separate output channels, and a dual output for use where mixing of the two channels is desired. Playback output level is sufficiently high for driving conventional power amplifiers.

• **Three-Way Corner Reproducer.** Known as the Transcendent, the new corner speaker assembly built by Brociner Electronics Laboratory, 1546 Second Ave., New York 28, N. Y., is a further development of earlier speakers of this type. Lower frequencies are reproduced by a specially-designed 15-in. speaker driving a large folded exponential horn. Middle and high



frequencies are reproduced by a twin-cone driver unit which contains a magnet producing a flux of 22,000 gauss. This exceptional field strength provides high efficiency and excellent damping. Frequency range of the Transcendent is 30 to 20,000 cps. Power input is 20 watts maximum on program material. Dimensions are 49 1/2 in. high x 33 in. wide, 29 1/2 in. deep from room corner, 23 1/2 in. along wall.

• **Magnetic Tape Recorder.** Many professional features are inherent in the new Tapesonic Model 70 dual-track recorder, recently announced by Premier Electronic



Laboratories, 382 Lafayette St., New York 3, N. Y. Although a portable unit weighing but 54 lbs., it contains three dynamically-balanced motors, handles $10\frac{1}{2}$ -in. NAB reels, and affords recording speeds of

15, $7\frac{1}{2}$, and $3\frac{3}{4}$ ins./sec. Fast forward and rewind permit transfer of a 2500-ft. spool of tape in one minute. Stressed in the manufacturer's announcement is the Tapesonic's frequency range of 40 to 15,000 cps at 15 ins./sec. recording speed. Push-pull 9-tube amplifier has 12-watt audio output into built-in 8-in. monitoring speaker. Flutter and wow are announced as 0.1 per cent at 15 ins./sec. Panel controls include mixing channels for microphone, radio, and phono input, also 4-in. VU meter. Drive mechanism is mounted on a rigid one-piece aluminum casting. Electro-dynamic brake action and tape tension never require adjustment.

• **Equalizer-Preamplifier.** Similar in design and appearance to the well-known Model AE-2A which it supercedes, the new McIntosh Model C-104 remote-control "front end" incorporates greater simplicity of control and an additional turnover



frequency. Although designed primarily for use with McIntosh basic amplifiers, it can be used with effectiveness as the control center for any sound system. Continuously variable tone controls provide exceptional range of boost and droop on both bass and treble. Distortion is under 0.3 per cent at 4 volts output over the 20-to-20,000-cps frequency range. Five input channels are provided, one each for TV, AM-FM, microphone, high-level magnetic pickup, low-level magnetic pickup. The C-104 is equipped with a connector for obtaining power from the basic amplifier, also for feeding signal voltage to the basic amplifier input. The unit may be operated up to 30 feet from the basic amplifier with unimpaired audio performance. McIntosh Laboratories, Binghamton, N. Y.

• **Turns-Indicating Dial.** Precision logging of many multi-turn devices is possible with the new dial announced for September availability by The Helipot Corporation, South Pasadena, Calif. Designed originally for use with helical potentiometers, the unit is suitable for use with similar devices having as many



as 15 turns. Designated the Model RA Precision Duodial, it measures only 1-13/16-in. overall diameter and will be supplied completely assembled. In operation the secondary scale remains stationary until the primary scale completes a revolution, at which point a jump gear turns the secondary to the next digit. Features include a vibration-proof lock, glare-free satin-chrome finish, and a large, easily-gripped Nylon operating knob.

• **High-Quality Radio-Phono Amplifier.** Many desirable features are inherent in the new Bell Model 2200 amplifier for home music systems, introduced recently as a medium-priced addition to the com-



pany's extensive line of audio equipment. Power output of the 2200 is 20 watts with distortion negligible. Frequency range is 20 to 20,000 cps. Included on the control panel is a five-position equalizer switch for all types of domestic and foreign records. Separate bass and treble controls afford both boost and attenuation. Inputs are provided for tuner, high-impedance microphone, two magnetic cartridges, TV, and tape recorder. Bell Sound Systems, Inc., Columbus, Ohio.

• **Decade-Inductor Unit.** Audio design engineers will welcome the new 700 Series Decade Inductors now available from Hycor Company, Inc., 11423 Vanowen St., North Hollywood, Calif. Representing



improved performance over earlier models, the new units also are considerably lower in price. Four models are available in ranges of .001 to .01 H, .01 to 0.1 H, 0.1 to 1.0 H, and 1.0 to 10 H. The units have excellent stability with respect to current and temperature changes. Decade steps are obtained by means of series switching toroid coils. "Q" factor remains essentially constant over all ranges.

• **Line-to-Voice Coil Transformers for 70.7-Volt-Line Audio Distribution Systems.** Though small in size, Stancor's new matching transformers for 70.7-volt-line

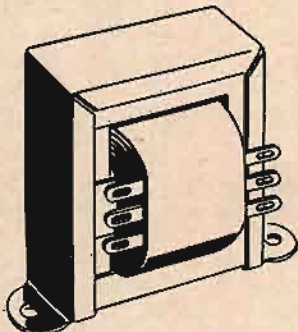

audio distribution systems meet all power and impedance specifications of the RTMA. Designed to operate into load impedances of 4, 8, or 16 ohms, the units are listed as Type Nos. A-8102 and A-8103, differing only in power ratings. Power steps, in watts, for the A-8102 are 8, 4, 2, 1, 0.5; for the A-8103 they are 16, 8, 4, 2, 1, 0.5. Standard Transformer Corporation, 3550 Elston Ave., Chicago 18, Ill.

LOOK
For the New Products at
THE AUDIO FAIR

Memo—For Hi-Fi Value . . . It's Leonard!

**A Professional Type
Tape Recorder**

**PREMIER No. 70
TAPE-SONIC***

Price: \$298.50 net
CASE INCLUDED



23 x 16 x 10 1/2
54 lbs . . . AC only
110 volts, 60 cycles

CHECK THESE FEATURES:

- ✓ 3 speeds: 3 3/4", 7 1/2", 15" per second . . . 2500 ft. per min. rewind and forward
- ✓ Dual track . . . 4 hrs. on one reel; accommodates 10 1/2" NAB . . . 7" . . . 5" reels
- ✓ Three dynamically balanced motors with electro-dynamic braking
- ✓ 9 tube push-pull amplifier . . . 12 watt undistorted output . . . 8 inch extended range speaker
- ✓ 4 inch calibrated V.U. meter
- ✓ Controls: Separate bass & treble; special pad for controlling speaker level while recording; mixer-fader arrangement for external input
- ✓ 2 outputs: 8 ohm for external speaker; Hi impedance for external amplifier
- ✓ 2 inputs: Hi impedance mike w/mixing control; external hi impedance w/separate mixing controls
- ✓ Completely fused for added safety
- ✓ Frequency response: 3 3/4" . . . 40 to 7,000 cps; 7 1/2" . . . 40 to 12,000 cps; 15" . . . 40 to 15,000 cps

**Brociner Pre-Amplifier
& Equalizer A100P**

A self-powered Pre-Amplifier and Equalizer that affords adjustable compensation for the deviations from flat frequency characteristics imposed on phonograph records at the time of their recording. EXACT EQUALIZA-

TION down to 30 cycles. TURNOVER & ROLL-OFF controls operate independently of each other. TURNOVER CHARACTERISTICS: LP 300, 500, 800

cycles. LOW HUM: more than 50 db below signal level. HIGH GAIN: 40 db gain at 2000 cycles. MAXIMUM OUTPUT: 10 volts undistorted. POWER REQUIREMENTS: 110 volts, 50/60 cycles. WEIGHT: 5 pounds. DIMENSIONS: 3" x 8 1/2" x 7 1/2".

A100—Same as A 100 P, but without built-in power supply. Comes with 3-foot power cable and adapter plug. \$49.99 net \$33.00 net

GOLDEN G. E. CARTRIDGE RPX-052 \$22.90
MATCHED KT-66 tubes for Williamson Amplifiers \$11.50 pair
CABINART 12" folded horn kit #61 \$19.95

**Brook 12A3
Amplifier**

A high quality amplifier made for the most discriminating High-Fidelity fan, the Brook 12A3 offers versatility and faithful reproduction with the minimum of distortion. FREQUENCY RANGE: within 0.5 db 20 to 20,000 cps. POWER OUTPUT: 10 watts. THREE INPUT CHANNELS: 1 for TV, 2 for low level magnetic pickups.

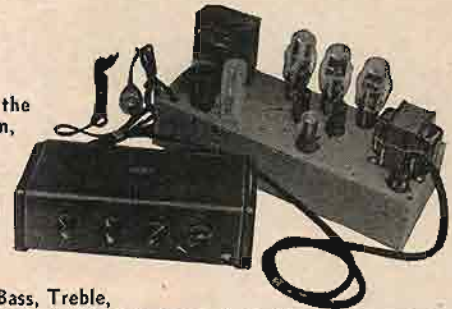

CONTROLS ON PRE-AMP: Volume Bass, Treble, Input Selector, Pilot Light, Power Switch. IMPEDANCES: 2, 4, 8, 16 ohms grounded; 500 ohms ungrounded. HUM LEVEL: more than 75 db below full output. POWER CONSUMPTION: 110 watts at 117 volts, 50/60 cycle. NET WEIGHT: 24 pounds. DIMENSIONS: Basic—17" x 6 3/4" x 8 1/2"; Pre-Amplifier—13" x 6 1/2" x 3 3/4".

\$198.00 COMPLETE

12A Basic Amplifier only . . \$118.50 — 3C Pre-Amplifier only . . \$99.00
Mail & Phone Orders Filled, 25% Deposit, Balance COD.

LEONARD RADIO INC

69 CORTLANDT ST., NEW YORK 7, N.Y.
Cortlandt 7-0315 - 9 Dept AE-9

The House Built On Service
Send for Free Illustrated Hi-Fi Guide

Lafayette

Presents



STROMBERG-CARLSON
Custom Four Hundred
 WIDE RANGE · HIGH FIDELITY

High Fidelity Components for
 Your Custom Installation



Leopold Stokowski Says: "I can recommend with confidence the Stromberg-Carlson reproducer, which I have thoroughly tested. All Stromberg-Carlson features create a reproducer of high quality that will give full musical satisfaction to the discerning music lover."

STROMBERG-CARLSON AM-FM Tuner SR-401. The SR-401 AM-FM Tuner has a sensitivity of 5 microvolts on both bands. AM circuit provides wide and narrow selectivity. Audio frequency response 20 to 20,000 cps $\pm 1\frac{1}{2}$ db. Harmonic distortion less than 1%. 12 tubes including rectifier and tuning eye. AFC on FM can be switched by front panel control. Completely ready to install with all hardware. Silver gray wrinkle finish panel. Size 11 $\frac{1}{4}$ " L x 6 $\frac{1}{2}$ " H x 11" Deep. Shp. Wt. 12 lbs. 139.95

STROMBERG-CARLSON Hi-Fi 10 Watt Amplifier AR-410. The AR-410 Hi Fi Amplifier provides 10 watts from a single chassis. Frequency response 20 to 20,000 cps with less than 1% distortion. Response flat, ± 1 db. Six input connections are provided for front panel selection. Treble control provides 5 db boost and 15 db droop at 10,000 cps; bass control provides 15 db boost or droop at 50 cps. Loudness control follows Fletcher-Munson curves. Gray panel matches tuner. Size 11" W x 7" H x 7" Deep. Shp. Wt. 25 lbs. 79.95

STROMBERG-CARLSON De Luxe Amplifier AR-425. The De Luxe Hi Fi Amplifier AR-425 provides 25 watts. Designed as a dual chassis; controls are located on the pre-amplifier. Frequency response 20 to 20,000 cps, less than 1% harmonic distortion; hum less than 80 db below 20 watts. Tone controls provide 15 db boost and 20 db droop. 5-position brilliance control, 3-section loudness control. Innu selector controls 7 positions; microphone, FFRR, LP, AES, radio, television, tape or crystal phono. Supplied with 6' interconnecting cable. Sizes: Power amplifier 16" W x 8 $\frac{1}{4}$ " H x 7" D; Pre-amp 12 $\frac{1}{2}$ " W x 5" H x 5 $\frac{1}{2}$ " D. Finish English brown mahogany. 189.95

STROMBERG-CARLSON SPEAKERS. The RF-475 15" coaxial speaker provides an exceptionally wide range response of 30 to 16,500 cps, with a distribution angle of 90° vertical and horizontal. Capacity 40 watts of program material. Low frequencies are reproduced by a 15" seamless cone with a 3" voice coil. The 5" high frequency unit is a parametric horn with acoustic lens. Input impedance 16 ohms, 8 lb. Alnico V magnet. Requires 13 $\frac{1}{4}$ " opening with 10 $\frac{1}{2}$ " depth behind panel. Shp. Wt. 50 lbs. 179.95

The RF-471 12" coaxial loud speaker provides exceptional performance due to several unique features. The 3 $\frac{1}{2}$ " seamless tweeter is suspended in Charpinchoe leather to eliminate violent peaks and dips in high frequencies up to 15,000 cps. The tone range down to 30 cps through a 12" seamless low frequency cone with a voice coil of 1 $\frac{1}{2}$ " diameter. Power capacity 32 watts of program material, 8 ohm impedance. Requires 11" opening and 7 $\frac{1}{2}$ " behind panel. Shp. Wt. 15 lbs. 49.95

STROMBERG-CARLSON Labyrinth RL-485. With the RL-485 Exponential Acoustical Labyrinth Kit, any speaker cabinet, of sufficient size, can be converted to the famous Stromberg-Carlson Labyrinth. Will fit any cabinet with the following minimum inside dimensions: 30" H 24" W 20" D. Kit contains all necessary material and installation hardware and instructions. 20.00

STROMBERG-CARLSON Model TV-421 TV Chassis. The TV Tuner Chassis TV-421 features a bright, well-contrasted picture and exceptional performance in fringe areas. Equipped with a 21" picture tube and designed to receive channels 2 through 13 (adaptable to U.H.F. channels). The chassis is supplied with 19 tubes plus 3 rectifiers, plus mask and all mounting hardware. Size 20-11/16" W 23 $\frac{1}{4}$ " D 21 $\frac{1}{2}$ " H (including picture tube). Shp. Wt. approx. 75 lbs. 299.95

Lafayette
 Radio

NEW YORK	100 SIXTH AVE.
BRONX	542 E. Fordham Rd.
NEWARK	24 Central Ave.
BOSTON	110 Federal St.

ENCLOSURES

[from page 27]

audio range and considerable variations occur over even relatively narrow angles of radiation. Obviously a new approach is needed which has a completely uniform radiation pattern over a wide angle for the entire audio spectrum.

Frequency Response

The requirements for the optimum frequency response have been the subject for much controversy, but it is now generally conceded that the broadest possible frequency range is desirable provided that the high- and low-frequency limits are properly balanced and very low distortion exists in the system. It would also appear that the flattest possible response between these limits is also desirable. In this regard the enclosure designer is forced to use the available commercial units which often appear to be peaked at about 1500 cps with sloping responses toward each end of the band. Where flat response is difficult this design procedure gives a relatively good articulation index with seemingly increased efficiency over units having a flat response.

In any event the enclosure must be designed to provide flat coupling over the entire frequency range in which it operates. This is also a rather complicated problem since the frequencies handled vary in wavelengths by ratios up to 1000 to 1.

It can be readily seen from the preceding discussion that the enclosure used with a speaker plays a very important part in its performance. All too often have enthusiasts purchased elaborate systems and mounted a costly speaker in the nearest available box. Naturally the expected results were not obtained. Fortunately, more general recognition is being given to the importance of exacting design in enclosures as well as other units in the high-fidelity chain.

A summary of the points discussed is contained in Table I together with some practical requirements for the optimum ultra-fidelity loudspeaker system. The use of the term ultra-fidelity will become apparent upon reading these specifications. In fact, it is doubted that any other commercial loudspeaker systems are available which can even approach these requirements. Probably the largest theatre speakers using immense folded horns provide the closest approach but obviously these are completely unsuitable for use in the home.

In view of the foregoing, it is significant to report that an enclosure has been developed in which these objectives have been largely fulfilled. It stands 34 $\frac{1}{2}$ inches high, 22 $\frac{1}{2}$ inches wide and 17 inches deep, or about the size of a small bass reflex cabinet and is designed for use with a single 15" coaxial speaker. Excellent results have also been obtained with smaller speakers.

This performance has been made possible through the invention of a com-

pletely new type acoustic transducer which is broadly applicable in the field of acoustics. Technically it can probably be classified as an exponential slot radiator.

As might be inferred from the previous discussion this device is extremely broad banded in its response. This feature is an unique function of the design of the exponential slot relative to its acoustical environment. Its basic action can be readily understood by comparing it with that of a simple pipe closed at one end, as at (A) in Fig. 1. If this pipe is elongated with the length appreciably greater than the width, the resonant wavelength $\lambda_0 = 4L$ where L is the length of the pipe. Also observe that resonance occurs at all of the odd harmonics of this frequency.

These resonances occur because the open and closed ends of the pipe both present abrupt discontinuities in the propagation of sound waves in this pipe. This results in sharp reflections which, when reinforced, lead to resonance and when cancelled yield antiresonance. (A) of Fig. 1 shows a typical resonance curve of this structure.

Now if one of these discontinuities were not as abrupt as that shown at (A) but instead consisted of a short tapered section at the open end, which would release a constant amount of energy for each increment of its length then the resonance curve would take the form of (B). Again note that this pattern is repetitive at all of the odd harmonics.

If we extend this taper so that its length is in excess of two thirds of the length of the pipe we now have a condition which provides a flat response from the lowest fundamental frequency to the upper limits of the audio spectrum. Also by controlling the rate of taper the response over a band of frequencies can be made absolutely flat because equal discontinuities exist for all frequencies within this band.

This latter type of structure yields itself quite naturally to use in loudspeaker enclosures since this is the very type of performance which has been dreamed about but never before realized.

Another factor of considerable importance is that of its radiation pattern. Note that the energy released is being uniformly distributed over a straight line, as shown in Fig. 2. Excess pressures are developed at regular points along the length of the aperture dependent upon whether or not compressions or expansions are occurring in the energy contained within the transducer. When these excess pressures occur, a portion of the energy traveling along the length of the column is released as radiation. The distances between such areas of radiation are governed by the wavelengths of the sounds being propagated.

Under these conditions the tapered aperture becomes, in effect, a straight-line source with equal amounts of energy being released at regular intervals along this line. At the low frequencies only one area of release occurs while at

the highest frequencies several areas occur.

The radiation pattern of this type of energy distribution for the ideal case yields a uniform distribution in a plane normal to the axis of the column while narrowing in beam width in any plane including the axis. At high frequencies the radiation pattern is theoretically an ellipsoid of revolution resembling a flattened balloon.

In actual practice this narrower beam is broadened because the individual areas of energy release are not point sources and that additional dispersion at the high frequencies can be realized through the proper placement of the speaker. Plots of experimental results which confirm these statements are

shown in Fig. 3. Note that the sound distribution in the horizontal plane is virtually constant over an angle of at least 120 deg. irrespective of frequency.

Low-Frequency Response

The low-frequency performance of the exponential slot radiator has been found to be exceptionally good. In tests on the previously mentioned enclosure the frequency response from 25 to 100 cps remained flat within 1½ db. This result is well within the potential accuracy of equipments normally used in such tests. Below 25 cps the reliability of the available test equipment was questionable and made accurate results difficult to obtain. Tests made in this region showed that fundamental coupling was

From Station Break to Feature... the NEW "BALANCED" TV Tripod is doing a whale of a job every day!

WE THREW THE book away and engineered a brand new "BALANCED" Tripod for every photographic and video need. The result—a revelation in effortless operation, super-smooth tilt and 360° pan action.

PERFECT BALANCE prevents mishap if the lock lever is not applied. Quick release pan handle locks into desired position. Mechanism is enclosed, rustproof, needs no lubrication. Tension adjustment for Camera Man's preference. Built-in spirit level. Telescoping extension pan handle. We defy you to get anything but the smoothest, most efficient operation out of this tripod beauty.

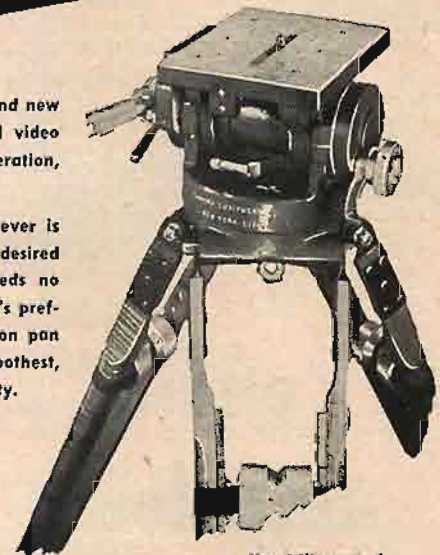

Head illustrated contains adjustable camera tie-down screw for locating center of gravity. This feature is optional.

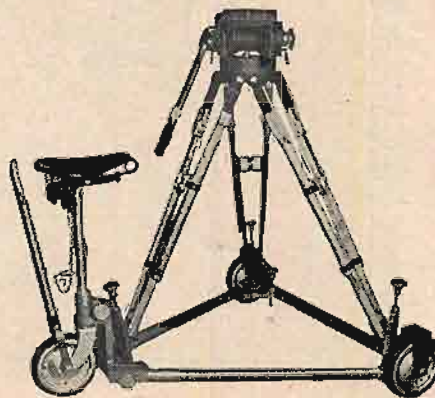

"BALANCED" TV TRIPOD mounted on 3-wheel portable collapsible dolly.

If you work with film... for Studio, News-reel, Commercials, Business, Industrial or Home Movies—it will pay you to get to know us. The country's foremost professionals depend upon our portable, versatile, adaptable equipment.

FRANK C. ZUCKER
CAMERA EQUIPMENT CO.
1600 BROADWAY NEW YORK CITY

We Calibrate Lenses Precision "T" STOP CALIBRATION of all type lenses, any focal length. Our method is approved by Motion Picture Industry and Standard Committee of SMPTE. For proper exposure density, it is important that you have your lens "T" stop calibrated. Lenses coated for photography. Special TV coating. Rapid service.

We Rent and Service
Cameras * Moviolas * Dollies

Complete line of 35mm and 16mm equipment available for rental
MITCHELL: Standard, Hi-Speed, BNC, NC, 16mm
BELL & HOWELL: Standard, Shiftover, Eyemos
MAURER: 16mm Cameras
MOVIOLA: Editing machines, Synchronizers

We Design and manufacture Lens Mounts and camera equipment for 16mm — 35mm and TV cameras.

FREE ALLIED

1953 CATALOG

**COMPLETE 236-PAGE
ELECTRONIC SUPPLY
BUYING GUIDE**



**World's Largest Stocks of ELECTRONIC SUPPLIES
for INDUSTRY and BROADCAST STATIONS**

**ONE COMPLETE
DEPENDABLE SOURCE
FOR EVERYTHING
IN ELECTRONICS**

Simplify your purchasing—send your consolidated orders to ALLIED—the reliable one-supply-source for all your electronic needs.

Depend on ALLIED for the world's largest stocks of special electron tubes, parts, test instruments, audio equipment, accessories—complete lines of quality electronic apparatus. Our expert Industrial supply service saves you time, effort and money. Send today for your FREE copy of the 1953 ALLIED Catalog—the only complete, up-to-date guide to Electronic Supplies for Industrial and Broadcast use.

We specialize in Electronic Equipment for Research, Development, Maintenance and Production Operations

**SEND FOR FREE
1953 CATALOG**

ALLIED RADIO CORP.

833 W. Jackson Blvd., Dept. 17-J-2
Chicago 7, Illinois

audio anthology

Paper cover . . . \$2.00

Distributors write for quantity discount

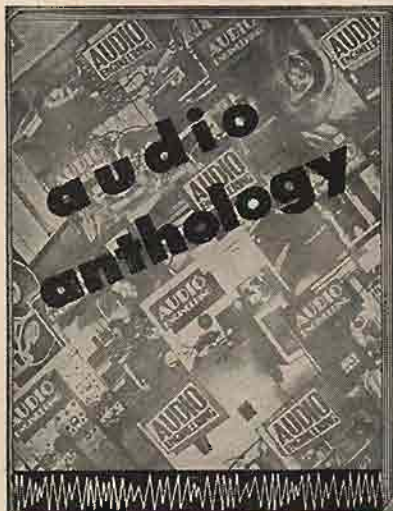

The long awaited compilation of reprints from early issues of AUDIO ENGINEERING, most of which are unobtainable. The ANTHOLOGY contains 37 articles, covering • amplifiers • speakers • noise suppressors • phonograph equipment • tone and loudness controls • dividing networks. Together, they comprise the most authoritative reference work for the audio hobbyist.

---CUT OUT---MAIL TODAY---

Book Division, Dept. A9
Radio Magazines, Inc.
342 Madison Ave., New York 17, N. Y.

Sirs: Enclosed is my check money order for _____ copies of the Audio Anthology.

Name (print carefully)
Address
City Zone State

predominant even as low as 10 cps. The same tests conducted on an identical speaker housed in a bass-reflex cabinet produced so much distortion that they had to be discontinued to protect the speaker cone from destruction.

The reason for this remarkable performance at these extremely low frequencies can be visualized more readily by referring to the equivalent mechanical network of this system shown in Fig. 4. By the proper choice of constants this network can remain flat over

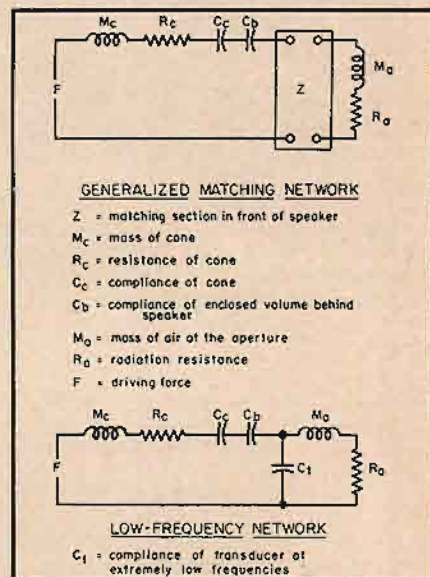

Fig. 4. Equivalent mechanical networks of exponential slot enclosure.

a very broad band and will also provide the step-down impedance-matching network required at these low frequencies. The air load at the aperture is therefore almost perfectly matched to the loudspeaker cone, and thus we have in effect created a virtual expansion in the size of this cone.

In the higher frequency region the distributed constants of this transducer, acting in combination with the exponential slot, provide uniform loading to the upper limits of the audio spectrum. The transition between these two modes of operation is performed smoothly because of the almost perfect matching provided by these two approaches.

Bass response is clean and since it is predominantly fundamental a great deal of bass boost can be applied without audible distortion. This provides an ideal means of compensation for the loss in aural response at these low frequencies.

General

Several experimental models have been built using these inherent principles with excellent results. A production model is now available which has undergone rigorous testing and comparison with competitive units. As a result of these tests it is felt that a new standard of high-fidelity reproduction has been achieved.

An electronic organ installation was made using this new design and the results have been declared by expert or-

ganists to be "out of this world." At the lowest Bourdon note (32 cps) enough intensity can be realized with one forty-watt amplifier to shake the floor, windows, and doors of the church in which this installation was made. The cubic volume of the main auditorium is 48,000 cubic feet. Used in this way the electronic organ really competes with the pipe organ for musical honors.

Additional research is being carried on applying these principles to the entire art. The results of this research will be disclosed as production models are made available.

THE VIOLIN

[from page 25]

of a transmission line.¹ This means the addition of mass; it can be added at discrete points just like Pupin loading coils, or it can be distributed uniformly, like permalloy tape on a submarine cable.

The latter method is employed by winding a helix of thin wire along the center core, as was just mentioned previously. The result is a heavy wire of sufficiently smooth surface to permit the fingers to slide along it for playing "in positions," and the tension can be sufficiently great so that a large number of harmonics are propagated along its length without undue attenuation. The result is a richer tone for the lower strings.

When we come to the higher strings, particularly the E, the tension must be so great (since the pitch varies as the square root of the tension) that no loading is possible, for otherwise even a steel wire would break. Moreover, too many harmonics are apparently not desired by the ear in this range, for the string is usually surrounded by a small cloth tube where it presses on the bridge, in order to bypass and damp out the higher harmonics and make the tone less shrill and "metallic."

It is interesting to note that when metal E and A strings were first introduced, there was a hue and outcry against them by the musicians, but today they are accepted as having practically as good a tone, especially when cloth tubes are employed for the E string, and the annoyance and danger of a string breaking, especially on hot humid days, is greatly reduced by their use. It is also interesting to note that most of the preceding discussion applies just as well to the piano and even the harp.

The Bow

Before we trace the path of the vibrations from the strings to the air, let us see how the bow acts upon the string. The bow is made of Pernambuco wood (from South America). It is cut from a straight piece of wood and heated and bent to its familiar shape. It is then

fitted with white horse hair, splayed out into the form of a flat ribbon and rubbed at suitable intervals with rosin to give it the proper frictional qualities.

The finest bows are those made by Francis Tourte (1747-1835) and can command several thousand dollars today. Unfortunately, bows tend to deteriorate in time and lose their shape and elasticity, but some very fine Tourte bows are still available. Lest the reader question the seemingly fantastic price for so simple a device, let it be known that the more difficult art is that of bowing rather than fingering, and to a virtuoso a good bow is worth all that is asked for it.

The action of the bow is as involved and profound as a nonlinear relaxation

oscillator. It is the nonlinear characteristic of friction that produces the vibration of the string when the bow is drawn across it; the d.c. motion of the bow is converted into a.c. vibration of the string just as the d.c. energy of the plate supply is converted into a.c. energy by an r.f. oscillator or a multivibrator.

Fundamentally, the action depends upon the fact that the coefficient of moving friction is lower than that of static friction, and furthermore decreases as the velocity of rubbing increases. When the bow is first applied to a string and drawn across it, it pulls the string sideways with a strong frictional force. When the string is sufficiently distorted, its tension has built up to such a point

magnecorder

*gives you
all 3*

1. true fidelity

Everything from the ultra-accurate recording of music and voices to the vibration of a mechanical part in a research laboratory — Magnecorder catches all of the sound, and stores it on tape for future reference. Frequency response: Flat from 50-15,000 cps \pm 2 db. at 15"/sec. tape speed. Exceeds 50 db. with less than 2% harmonic distortion.



2. convenient portability

Remote recordings are easy with Magnecorder. Lightweight and rugged, the amplifier is in one case and the mechanical unit in another — balanced for carrying ease.



3. exceptional flexibility

Any portable Magnecorder can be mounted in a standard 19" rack and combined with others for elaborate continuous recording systems. Console mountings are also possible due to Magnecorder's unit construction.



Write!

for descriptive literature or refer to your classified telephone directory under "Recordings" for a demonstration.

Magnecord, INC. DEPT. AE-9

225 W. OHIO ST., CHICAGO 10, ILLINOIS

NAME

ADDRESS

CITYZONE.....

STATE

¹I. Crandall, "Theory of Vibrating Systems and Sound," p. 64, The Loaded String.

You are Invited to Attend the Fourth Annual

AUDIO FAIR

Sponsored by the

AUDIO engineering society

in conjunction with its

Annual Meeting and Convention



AUDIO TODAY and **TOMORROW**

of utmost interest and importance to government and military agencies, Broadcast Engineers, Recordists, Sound-on-Film Men, Public Address Operators, Audio Hobbyists, Dealers and Distributors, and lovers of HIGH-QUALITY and HIGH FIDELITY music reproduction.

YOU WILL SEE and HEAR

industry-wide displays and demonstrations of the latest and BEST AUDIO and HIGH FIDELITY equipment, components, and accessories.

AGAIN UNDER ONE ROOF

Hotel New Yorker, New York City, Oct. 29, 30, 31, Nov. 1, 1952

Fifth and Sixth Floors

REGISTRATION FREE for all Exhibits

EXHIBIT HOURS:

Wed. Oct. 29	11 A.M. to 9 P.M.
Thurs. Oct. 30	10 A.M. to 6 P.M. (AES Banquet at 7:30 P.M.)
Fri. Oct. 31	10 A.M. to 10 P.M.
Sat. Nov. 1	10 A.M. to 5 P.M.



For further information and banquet reservations, write

Harry N. Reizes, Fair Manager, Rm. 510, 67 W. 44th St., New York 36, N. Y.

Murray Hill 7-2880

that the static friction between it and the bow can pull it no farther.

The bow now starts to slide past the string, and immediately the coefficient of friction decreases. The string can no longer be held out in its distorted position, and it begins to slide back in a direction opposite to the motion of the bow. The relative velocity between the two increases, the frictional force decreases still further, and the string begins to move faster and faster toward its equilibrium position.

Its mass now carries it past this position until it is distorted in the opposite direction. The tension, as well as the pull of the bow, now bring it to a stop and then begin to accelerate it in the same direction as the motion of the bow. As it gains in speed and catches up with the bow, the frictional pull of the latter on it increases, thus helping to accelerate it. It can even exceed the bow in velocity and swing to a maximum amplitude momentarily ahead of the bow. Then it starts to swing in the opposite direction, and so on to and fro.

The continued vibration depends upon the fact when the string is moving in the direction of the bow, the relative velocity between the two is low and the aiding frictional force is therefore high, whereas when it is moving opposite to the bow, the velocity is high and the opposing frictional force is low. As a result, more energy is absorbed or stored by the string in the first-mentioned half cycle than is dissipated by it in the form of heat in the next half cycle; for equilibrium, the energy absorbed must balance all that is dissipated, acoustically radiated, or otherwise expended.

If the difference in frictional forces is great enough, the vibration of the string can even be great enough so that its velocity exceeds that of the bow and it can therefore even move ahead of the bow during a part of the half cycle when it is moving in the same direction as the bow. Of course during this brief time the bow is actually acting to decelerate the string, and energy is being in part returned to the bow and in part being dissipated as heat.

But if during the first part of this half cycle, the bow exerts sufficient force on the string to store enough energy in it, the string can overswing the bow and yet continue to oscillate. The significance of all this is that the loudness of the tone is not limited by the speed with which the bow is drawn across the strings. By applying increased pressure, the loudness can be increased even though the string now at times exceeds the bow in forward velocity.

The foregoing discussion, however, helps to explain some other factors in bowing. Often, particularly at the end of a composition, the violinist has to play a long note extending perhaps into several measures and all in one bow. To do so, he must move the bow very slowly across the string to make it last. Although usually the tone is not required to be loud, nevertheless the tone does not have to be very quiet just because the bow velocity is so low. However, in actual practice, the major diffi-

to the **E. E. or PHYSICS GRADUATE**

with experience in

RADAR OR ELECTRONICS

Hughes Research and Development Laboratories, one of the nation's large electronics organizations, is now creating a number of new openings in an important phase of its operation.

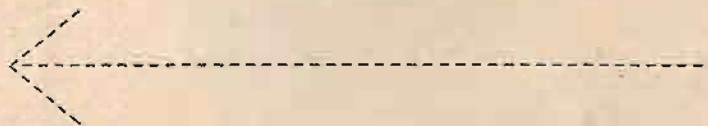

Here is what one of these positions offers you:

1. THE COMPANY

Hughes Research and Development Laboratories is located in Southern California. We are presently engaged in the development of advanced radar devices, electronic computers and guided missiles.

2. THE NEW OPENINGS

The positions are for men who will serve as technical advisors to the companies and government agencies purchasing Hughes equipment. Your specific job would be to help insure the successful operation of our equipment in the field.

3. THE TRAINING

Upon joining our organization,

you will work in our Laboratories for several months until you are thoroughly familiar with the equipment you will later help the Services to understand and properly employ.

4. WHERE YOU WORK

After your period of training (at full pay), you may (1) remain with the company Laboratories in Southern California in an instruction or administrative capacity, (2) become the Hughes representative at a company where our equipment is being installed, or (3) be the Hughes representative at a military base in this country—

or overseas (single men only).

Compensation is made for traveling and for moving household effects, and married men keep their families with them at all times.

5. YOUR FUTURE

You will gain all-around experience that will increase your value to the company as it further expands in the field of electronics. The next few years are certain to see a large-scale commercial employment of electronic systems—and your training in the most advanced electronic techniques now will qualify you for even more important positions then.

HOW TO APPLY

If you are under thirty-five years of age, and if you have an E. E. or Physics degree, with some experience in radar or electronics,

write to:

HUGHES

RESEARCH AND DEVELOPMENT LABORATORIES

Engineering Personnel Department

CULVER CITY, LOS ANGELES COUNTY, CALIFORNIA

Assurance is required that relocation of the applicant will not cause disruption of an urgent military project.

Enjoy Music
 AS THE MASTERS PLAY
 IN YOUR OWN HOME
 WITH A *High Fidelity* CABINET



BEAUTIFUL CORNER CABINET
 IN BLONDE OR MAHOGANY
 IN KIT FORM AND PRICED
 FOR EVERYONE TO ENJOY

8" speaker cabinet size — 18" x 13" x 27"
 THE MISSOURIAN (Mahog.) List Price — \$18.50
 THE GLENDALE (BLONDE) LIST PRICE — \$21.50
 12" speaker cabinet size — 27" x 13" x 25"
 THE MISSOURIAN (Mahog.) List Price — \$21.50
 THE GLENDALE (BLONDE) LIST PRICE — \$24.50

For complete details, see your
 Sound Dealer, or write:

Ozark

WOOD PRODUCTS COMPANY
 311 Park Ave., Glendale, Mo.

Now you can have a quality, high-fidelity folded corner cabinet, at a fraction of the price you'd expect to pay — because you do the assembly work yourself! These kits contain only the best of materials, and include complete, easy-to-follow instructions that will enable you to assemble your unit in less than an hour!

Here's what the kit contains:

Factory pre-cut finest quality mahogany plywood and fir.
 Beautifully designed speaker grille and plastic grille cloth.
 Plastic wood.
 Complete assembly instructions including speaker hardware.
 Wood screws and brads
 Glue

Authoritative and Enlightening . . .



*Acknowledged the Leading Publication
 in the Field of Sound Reproduction*

If you are novice, hobbyist, experimenter, or engineer . . . if you are a lover of music . . . and in pursuit of sound, undistorted . . . Audio Engineering will be your faithful, reliable companion all the way.

"What to Do" and "How to Do" will guide your every move through this thrilling experience we call Audio.

Each new issue brings New Ideas, New Slants, and Latest Developments . . . month in and month out . . . twelve times a year.

BE SURE to get your copies REGULARLY

MAIL this
 Coupon NOW

AUDIO ENGINEERING

P. O. Box 629, Mineola, N. Y.

Enclosed is Check Money Order for \$ _____
 Please send a copy of each new issue of Audio Engineering for the next
 12 months; 24 months to:

Please Print

Name _____

Address _____

City _____

Zone _____ State _____

Subscription Price: U.S.A., Canada and Pan American Union: 1 year . .
 \$3.00 2 years . \$5.00. Other countries: 1 year . \$4.00 2 years . \$7.00.

culty is admittedly that of moving the bow with uniform motion when it is moving so slowly; this is one of the marks of a good player.

Another point is that if the string is bowed near a nodal point, such as the bridge, a small displacement corresponds to a large displacement at the center of the string. It is similar to exciting a resonant line near a nodal point; the impedance here is high, so that the current for a given applied voltage is low. An extreme example is a Zeppelin-fed half-wave dipole, which is "voltage" fed at its end or current node.

In the case of a string, if the bow vibrates it near the bridge rather than at its center, the velocity at this point of excitation can be relatively low compared to that at the center of the string, where the velocity loop occurs, and which can be taken as a reference point. This means that for a given amplitude of vibration at the velocity loop or center of the string, the velocity at the point of bowing can be relatively low and hence not markedly exceed the velocity of the bow.

In short, the bow does not have to be drawn rapidly across the string to produce a loud tone, as would be the case if the string were bowed at the middle.

A further point is that bowing a string near an end or node tends to produce a tone richer in harmonics. This is because the deflection of the string is asymmetrical along its length and hence represents a more complicated shape and therefore a greater number of harmonics than one having a simpler symmetrical form, as when bowed at the center. It is based on the fact that the Fourier series for a complicated wave shape in general has more and stronger harmonic terms than that for a simple wave shape approaching a sinusoid in appearance.

This is also recognized in the case of a piano, where the position of the hammer along the string has an influence on the quality of the tone. A further point is that the hardness of the hammer, or rather the felt material, determines the quality of the tone. A hard felt produces a "brilliant" tone, i.e., one rich in higher harmonics.

In the case of a violin, some control of the tone is possible by bowing the strings closer to the bridge or closer to the finger board. If the string is bowed closer to the bridge, the tone is somewhat harsher, more "martial," more strident, and let us say more brilliant. If it is bowed closer to the finger board, the tone is softer and perhaps "sweeter."

Of course one must not overlook that the most practical reason for bowing the strings close to the bridge rather than at the center is to allow room for the fingers to stop or shorten the strings down to a minimum length. The pitch can be more than quadrupled by stopping the string near the end of the fingerboard, which is quite a range. But it is fortunate that bowing requirements do not conflict with the requirements of fingering and the two are compatible.

(to be continued)

SYLVANIA
PRECISION

FREE!

The following manufacturers' products are cataloged in the 128 page Instrument & Test Equipment Section.



EMICO

JACKSON

Chicago

ELECTRONIC MEASUREMENTS

SUPERIOR

BROWNING

BARKER & WILLIAMSON



SUPREME

marion

STERLING

Industrial Instruments

precise

HICKOK

RADIO CITY PRODUCTS

JAMES MILLEN

Darlington

Weston

FREED

Shurite

BOONTON RADIO

TRIPLET

BEAM



SHALLCROSS

MEASUREMENTS CORPORATION

EICO

JBI

Simpson



128 page
INSTRUMENT and
TEST EQUIPMENT
Catalog



as reprinted from
the 1200 page
RADIO'S MASTER



AUDIO ENGINEERING subscribers can receive, without cost or obligation, a complete 128 page catalog section on Test Equipment and Instruments, as reprinted from the 1200 page RADIO'S MASTER, the Industry's Official Buying Guide.

This section catalogs in detail the products of the leading Instrument and Test Equipment manufacturers — all in 1 handy booklet. It is complete with descriptions, specifications and illustrations as written by each manufacturer. You will find this large catalog section extremely helpful and a handy reference.

This FREE offer is made possible by a special arrangement between AUDIO ENGINEERING MAGAZINE and the publishers of RADIO'S MASTER. Be sure to get your copy . . . just mail coupon NOW.

GET YOUR FREE 128 page CATALOG

AUDIO ENGINEERING MAGAZINE
P. O. BOX 629, MINEOLA, N. Y.

Please send, without cost or obligation, the 128 page Instrument and Test Equipment Catalog as reprinted from Radio's Master.

Name.....

Address.....

City..... Zone..... State.....

These manufacturers do not catalog test equipment in Radio's Master. Separate catalog sheets will accompany each booklet.

Audio Instruments Corp.
Ballantine Laboratories
General Radio Corp.
Heath Company
Hewlett-Packard Corp.

AUDIO engineering society

APPLICATION
FOR
MEMBERSHIP

P. O. Box 12, Old Chelsea Station, New York 11, N. Y.

I desire { admission into } the Audio Engineering Society. Grade desired

Print or Type Name in Full

Born at
City State Country Date Age

Residence
Street City State

Mail Address
Street City State

Occupation
Position Name and Address of Concern

Present Duties
State in Detail (Students give school and course)

Past Experience
Give Companies, Years, and Positions

Member of Other Societies
Give Names or Abbreviations, and Grade of Membership

EDUCATION

SCHOOL ATTENDED	FROM	TO	COURSE	DEGREE

ADMISSION REQUIREMENTS

A Member, according to the constitution, may be any person active in audio engineering who has an academic degree or its equivalent in scientific or professional experience in audio engineering or in a closely related field or art. Such a person shall, upon election, be entitled to all the rights and privileges of the Society.

An Associate Member may be any person interested in the objectives of the Audio Engineering Society and, upon election, shall become entitled to all the rights and privileges of the society except the right to vote or to hold office or chairmanship of standing committees.

A Student Member may be any student interested in audio engineering and enrolled in a recognized school, college or university. A student member is not eligible to vote or to serve on committees except in his own local chapter.

Three references are required with application for the member grade, two for associate membership and one for student membership. References should be familiar with your work; they need not be members. Yearly dues are \$7.50 for member, \$6.00 for associate and \$3.00 for student, each of which is halved if the date of application is between April 1st and September 30th.

Payment must accompany application, and application must be signed to expedite handling.

REFERENCES

Name Company and Address Title or Position

-
-
-

Signature of Applicant

PLEASE DO NOT WRITE IN THIS SPACE

Application Received	Amount Received	Application to Admissions Committee	Dues Payment to Treasurer	Application Approved by	Date Approved	Membership Card	Past Papers

TECHNICANA

[from page 12]

nel allocation, and required transmitter power. Also covered are the design of inexpensive receivers, the required field strength to enable satisfactory reception with these receivers, and the number of transmitters that must be used to provide coverage for all of Western Germany.

Distributed Amplifiers

The design of distributed amplifiers is discussed in an article by A. Cormack in *Electronic Engineering* for April, 1952. In the distributed amplifier the plates and grids of several tubes are connected at appropriate points along an artificial transmission line in which the tube capacitances are included as transmission line parameters. By using four Osram Z77 sharp cutoff pentodes in each of two stages a total gain of 28 db was obtained in a bandwidth greater than 150 mcs. The design equations are presented along with some suggestions for circuit modifications which might be useful for various applications.

The two-stage amplifier was designed to work from a 200-ohm line and feed a 75-ohm line. Photographs have been included and show the circuit layout and construction details. The Osram Z77 is not identical to any tube of American manufacture, but might be replaced by the 6CB6 or the 6AH6 with some sacrifice in bandwidth. All three tubes have reasonably similar characteristics.

Telephone Cable Transmission

Transmission aspects of the telephone cable from Key West to Havana are outlined in the March 1952 *Bell Laboratories Record*. The system uses carriers in the range 12 to 108kc and is a four-wire transmission system with one pair used for each direction. Each cable contains three submerged carrier amplifiers which provide about 65 db gain with 40db feedback over the useful band. Each amplifier has three stages. These amplifiers are designed to operate for many years without service or replacement. As they decrease in performance their condition will be noted by monitor tests in an unused part of the transmission spectrum, and the power-supply voltage can be increased. The power is supplied on the cable along with the signal frequencies. When the amplifiers show still further decrease in activity, the input signal levels may be reduced in order to lessen the modulation products produced. Such a decrease in level will not materially affect the transmission since the amplifiers are designed with a margin of 10 db.

Nomograms

The Swiss publication *Radio Service* for January-February 1952 features an excellent article by Walter Duenbostel on the design and use of nomograms. It covers the transformation of graphical material from linear to logarithmic coordinates and then to the form of a nomogram. The details of nomogram construction are discussed at considerable length.

HARRISON AUDIO SHOP REPORTS . . .
Sensational New ACRO TRANSFORMERS
Sweeping High Fidelity Field in Sales!



FREE!

Write for 12 page ACRO data; Amplifier and conversion schematics.

Using a Williamson??

Double your power output, and reduce distortion by 50%!!

ACRO TO-300

"The World's Finest Transformer"

- Response ± 1 db 10cps to 100,000cps
- Rated to handle 40 Watts
- Resonance-free response
- Unequalled square wave response
- Low phase shift
- Most quality per dollar!

\$2475
net

ACRO TO-310. Same ratings but 20 watts. For converting all popular 10-watt 6V6 amplifiers to the sensational Ultra Linear Operation **\$18.75**

Convert to Ultra Linear Operation by simply changing three resistors and condensers! . . . **KIT \$1.00**

All units fully potted in attractive grey hammertone case. Compact, only 3 1/2" x 3 1/4" x 4 1/4" high.



ACRO TO-290. For the original Williamson Amplifier. Performance equal to the finest, regardless of price. **\$15.75**



HARRISON RADIO CORPORATION

227 GREENWICH ST.
NEW YORK 7, N. Y. • BR 4-7777

If C O D is desired, please enclose 25% Deposit

Do you have any Audio PROBLEMS?
Call or write Ben Pitt, our Audio Specialist, for friendly, helpful advice. No obligation!

Grommes Custom High Fidelity

Triode Amplifier

An all triode basic amplifier based upon the Williamson circuit . . . the last word in ultra high fidelity

Frequency response $\pm .5$ DB 10 to 100,000 CPS at 8 watts. Distortions at 15 watts .1% harmonic; I.M. .25% at 10 watts; 20 DB feedback from 2 loops; damping factor 20; cathode follower driver, 2 direct coupled stages; fixed bias.

The ideal pre-amplifier for the 215BA. Completely variable feedback type equalization for reproducing records exactly as recorded. Frequency response radio input $\pm .5$ DB. 6 to 100,000 CPS. Step type bass and treble controls; 25 DB equalization down to 20 CPS. For magnetic or dynamic pickups.



Model 215BA
\$12500
NET

Model 210PA
\$9950
NET

PRECISION ELECTRONICS, INC.

641-43 MILWAUKEE AVENUE • CHICAGO 22, ILLINOIS

HIGH FIDELITY AT ITS BEST
Money Saving
at HUDSON
 RADIO & TELEVISION CORP.
VALUES!
ALL Famous Makes In Stock!



Natural Reproduction
ALL TRIODE — REMOTE CONTROL
AMPLIFIERS

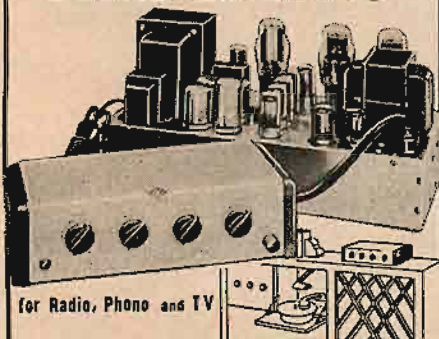

for Radio, Phono and TV

A Treasure in Listening Pleasure is YOURS with BROOK... the "Stradivarius" of Amplifiers. Magnificent instruments that provide the closest possible approach to actual "presence". Range: 20 to 20,000 cps. within 0.5 db. Features the exclusive BROOK 8-position stepped bass and treble control circuits. Harmonic and intermodulation distortion reduced to the vanishing point. In 10 watt or 30 watt models with remote-control.

MODEL 12A3, 10 watt, complete
 List \$330.00 Net **\$198.00**

MODEL 10C3, 30 watt (Ill. above) complete
 List \$525.00 Net **\$315.00**

FREE NEW 1953
HUDSON HI-FI CATALOG

Latest and greatest of all Hudson Catalogs! Complete buying guide... value-packed with the world's finest High-Fidelity and Audio Equipment... Amplifiers, Speakers, FM-AM Tuners, Record Changers, Tape Recorders, Packaged Systems, Custom Furniture, etc. for professional and home installation. Select from the largest stocks of ALL Standard Makes AT LOWEST PRICES!



Send for your free Catalog today! Dept. D9
 VISIT OUR MODERN SOUND STUDIOS

HUDSON
 RADIO & TELEVISION CORP.

48 WEST 48th ST. • 212 FULTON ST.
 New York 36, N. Y. New York 7, N. Y.
 Phone: Circle 6-4060

Book Reviews

Ultrasonics, by P. Vigoureux. New York: John Wiley & Sons, Inc., 163 pp., \$4.00.

The author of this new work presents the physical basis of ultrasonics. It is a fine companion for the earlier book of the same title by Benson Carlin which presented current practice in ultrasonic measurement and industrial application.

In the volume under discussion there are an Introduction and five chapters: Generation, Propagation, Observation, Gases, and Liquids. An appendix contains a derivation of the impedance of a transmitting transducer in an interferometer. This is followed by more than eleven pages of bibliography. An important feature of this bibliography is that it does not include references prior to 1939 because these have been listed in the works by Bergmann and Richards. Numerous tables of the ultrasonic and related properties of various media occupy a large portion of the last two chapters. They form a basis for checking future measurements and the preliminary calibration of new equipments.

Although it may be said that much of the material included may be found in the various scientific journals, it has been collected here in a most useful manner along with a clear exposition of its meaning. Also, such a compilation is most valuable for the majority of engineers who do not

have available the multitude of foreign journals from which the references have been drawn, nor the facility for translating and interpreting these in a different language.

—LSG

Vacuum-tube Voltmeters, 2nd ed., by John F. Rider, revised by John F. Rider and Alfred W. Barber. 432 pages. New York: John F. Rider Publisher, Inc., \$4.50.

This book is an up-to-date and authoritative collection of material on vacuum-tube voltmeters. The first eight chapters are devoted to the fundamentals of VTVM's of various types. Then in order are chapters on probes, design and construction, calibration, and application of the vacuum-tube voltmeter. Chapter Thirteen consists of three sections. The first is a tabulation of the characteristics of almost all the commercially available VTVM's. This is followed by nearly fifty pages of the circuit diagrams of the instruments tabulated. The final section of this chapter consists of frequency correction curves and specification charts for various units for which such curves were available. The last chapter presents a wealth of maintenance material for a number of the instruments listed.

Anyone who has occasion to use a VTVM frequently will find this a valuable addition to his technical library. It can easily help the reader to simplify his measurement problems and speed his work.

—LSG

MAGNETIC TAPE

[from page 20]

level of tape samples containing individual sine-wave components recorded at normal level was observed during the course of 1800 replays of each sample. The results of these observations are

available. For the first 125 replays, no observable deterioration of signal intensity occurred at any frequency. As expected, however, the higher frequencies, which are recorded with a minimum of flux penetration into the oxide, were the first to suffer. This deterioration is a direct result of the continuous abrasive action, which removes surface particles of oxide.

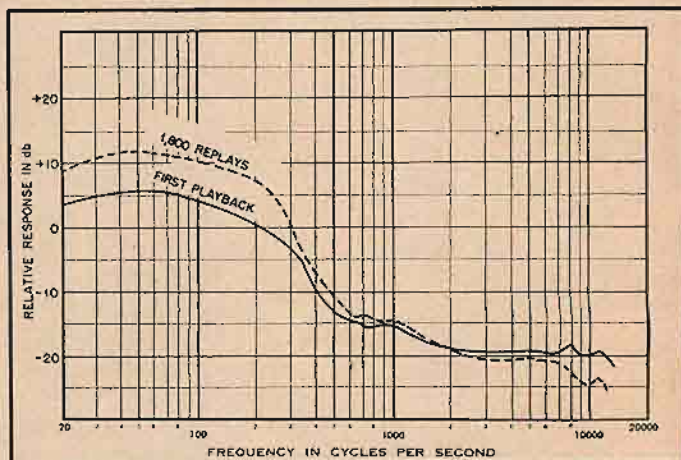

Fig. 5. Frequency analysis of over-all tape noise before and after 1800 replays.

illustrated in Fig. 4. Since certain applications of the magnetic medium in the fields of analysis and autocorrelation subject tape to many passages over the heads, information of this nature is vital. Actual values of the level changes shown are qualitative, inasmuch as slight variations will occur depending upon the tape tension factors involved. Nevertheless, the general trend is indicative of the behavior of the several varieties of commercial tapes currently

All frequencies above 100 cps suffered losses at some period during the 1800 consecutive replays, but frequencies below approximately 50 cps displayed an increase in energy at the conclusion of the tests. This is explained by the fact that the greater remanent flux in the tape at the longer wavelengths influenced the residual oxide particles which were being removed from the surface by the abrasive action between the tape and reproduce head. These particles formed

a gradually accumulating deposit of sludge about the head gap.

The same effect was noted when spectrum analyses of a sample of blank tape were made prior to and at the conclusion of 1800 replays. As indicated in Fig. 5, the low-frequency content of over-all tape noise was enhanced during the 1800 passages over the head, but the upper portion of the spectrum suffered. Because of the physical appearance of the tape samples at the conclusion of 1800 replays, there was some doubt as to whether any coating remained on certain portions of the tape surface. The samples, however, were erased and re-recorded with very satisfactory results.

Conclusions to be drawn from this investigation indicate that certain applications of magnetic tape, in the fields of research and development as well as in industry, are at present restricted by limitations of the medium itself. Although these limitations may appear to be insignificant when considered from the viewpoint of commercial recording concerns and broadcasters, the specialized requirements of scientists and researchers must nevertheless be appreciated and respected by those who control magnetic tape production if the recording of information by means of the magnetic process is to be exploited fully.

RADIO STUDIO

[from page 32]

fier chassis, the specific terminal numbers being shown on the rack running sheets. Ordinarily, all the low-level pairs going up from the jack field are grouped into a single cable, all medium-level up pairs make up another cable, etc. In like manner, the various pairs going down the rack are cabled by level groups. The cables are shown on the sketch as single lines, with turn-offs as the jack field, various amplifiers, etc.

As the make-up of each cable is thus defined, a cable number or letter is assigned to it on the rack cabling sketch, and a line should be assigned to it on the cable list. Entries on this list include cable number or letter, general cable title such as RACK 1, INTERNAL, circuit level, number of pairs, and kind of wire used. If any of the cables are to be encased in conduit, a column should be provided on the cable list for conduit size. The matter of audio conduit is discussed in detail a little later. The sharp-eyed reader here sagely observes that while the cable list was shown in the planning breakdown as step 8, it's being discussed in the same paragraph with an earlier planning phase, namely rack cabling layout. The writer hastily points out that the cable list should be completed as step eight but that its make-up must begin during preparation of the rack cabling layout.

Some of the rack circuits do not go to the jack field—for example, relay d.c. and 115-volt a.c. These are run up the rack from the terminal blocks to their upper destinations, are assigned letters or numbers and are entered on the cable

Comparison proves—

McIntosh

WORLD'S FINEST AMPLIFIER!

- Less than 1% harmonic or inter-modulation distortion even at peak power—reproducing the entire audible range from 20-20,000 cps.

Compare McIntosh 50W-2 with any amplifier—at any price. For it is only by such comparison that you can fully appreciate the truly superior qualities of this unique, patented instrument that has reached the theoretical limit of quality and efficiency! No other amplifier can give you so much power with so little distortion, at such low cost.



50W-2 Amplifier
50 Watts (Peak: 100)

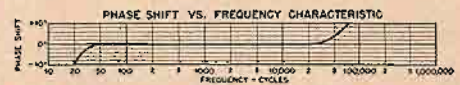

Write today for technical information and name of nearest dealer.

NEW! Model C-104
EQUALIZER
PRE-AMPLIFIER



Controls tone balance simply—and without distortion

McINTOSH LABORATORY, Inc., 321 Water St., Binghamton, N. Y.

Announcing

AUDIO'S FINEST CABINETRY

For
**HOME
MUSIC
SYSTEMS**

The SIBELIUS



Moderately Priced

Although introduced only a few short weeks ago, the distinguished new River Edge enclosures have established themselves as Audio's finest—and most beautiful—cabinetry. Incomparably built to the high standards of cherished furniture, they are made from the original species of wood specified in the finish. Heavily constructed of 13/16" plywood, with corners mitre-locked and reinforced. Available in many authentic styles—both modern and traditional. See them at your favorite sound dealer's.



The BAUME

Acoustically
Engineered

River Edge speaker enclosures are horn-loaded and are equipped with the McProud - designed "Flex - O - Port" — adjustable to match the speaker of your choice.

Write TODAY
for Illustrated
Brochure
HR-3

RIVER EDGE INDUSTRIES

River Edge, New Jersey, ORadell 8-0900
N. Y. Showroom: 192 Lexington Ave., CHickering 4-2120

IT'S IN THE HEADLINES!

NEW LOUDSPEAKER IMPROVES FM SETS

Developed at M. I. T. to Sell at Low Price and Give High Fidelity Tone

Surpassing the performance of sound-reproducing apparatus costing many times as much, a new type, inexpensive loudspeaker system was demonstrated yesterday by two acoustical experts of the Massachusetts Institute of Technology.

Dr. Jordan J. Baruch and Henry C. Lang are the inventors of this device which, at a demonstration, provided high-fidelity reproduction of frequency modulation radio and home phonograph recordings.

AND NOW TERMINAL HAS IT!



MODEL U-25 SPEAKER

This amazing new speaker consists of four special 5-inch cones, mounted in a delta-shaped cabinet with a system of carefully spaced vents in the top, which create a sound illusion of a much larger cabinet without the size usually necessary. One watt input adequate, two watts for best efficiency. Impedance 4 ohms. Response: 60 to 11,000 cps. Speaker is enclosed in either blond or mahogany cabinet (13"H, 19"W, 9 3/4"D).

\$29.75

FREE! Send for "Terminal's Audio Digest"

OPEN THURSDAY EVES. 'TIL 9
AMPLE PARKING AFTER 6 P.M.



Terminal Radio Corp.

New York's Dependable Radio Supply House

85 Cortlandt St., New York 7, N. Y.
WOrth 4-3311

list like the audio circuits. In connection with terminal blocks, try to put all the pairs of a given level group on the same block, or on the same portion of a shared block. When different level groups share the same block, put the low-level pairs at the top, medium-level next, etc. High-level circuits should go on a separate block which can be shared, if necessary with relay d.c. 115-volt a.c. circuits usually have their own block which is of a different, barrier-type design with safety cover, or they can run in a wire-mold distribution system as shown in Fig. 3.

The next (seventh) step is the preparation of the interconnection cable layout. This is a pictorial one-line representation of all the cables that tie together the console, rack, turntables, etc. Referring to the rack cabling sketch, Fig. 3, pick up the rack internal circuits shown terminated at the terminal blocks and trace them to their respective external destinations indicated on the block diagram. For example, the pairs of low-level cable "B" are shown ending at terminal block 1. These pairs must be picked up again on the other side of the block and carried to the various microphone wall receptacles, console microphone inputs, etc.

The grouping of these external pairs into one or more low-level cables is facilitated by a floor plan layout of the control room equipment. This drawing, with cables superimposed upon it, becomes the interconnection cable layout shown in Fig. 4. Reference to this sketch shows that since all the studio microphone receptacles are grouped in a single wall plate, the pairs going to this plate might naturally form one low-level cable. The two pairs going to the turntables might form another, and so on. However, it is also observed from the sketch

that most of the low-level pairs coming out of the rack must run in the same general direction to get to their destinations. For this particular equipment layout, it would appear simpler to consider all the low-level pairs as constituting one (and in this case the only) low-level interconnecting cable. These pairs would therefore be laced up accordingly and each group of circuits would be brought out of the bundle as turn-offs to the console, turntables, etc. The cable would be given an identifying letter or number on the layout, the necessary data would be entered in the cable list, and each pair involved would be checked off on the block diagram. Cables of other level groups are made up in similar manner, and when they have been entered on the floor plan layout, the latter becomes the completed interconnection cable layout.

Conduit Runs

By this time, the cable list should also be complete. Since the occasionally-needed cable make-up sheets will be described along with the interconnection sheets in the next installment, we can now discuss the next (ninth) step in the audio planning—namely, audio conduit. To avoid confusion, note that when a cable runs in conduit for part or all of its length, the conduit should bear the same designation letter or number as the cable. It will be remembered that the cable list includes a column for the conduit size, if any. In this connection, the table in Fig. 5 shows conservatively the number of pairs of different wires that may be pulled in various sizes of conduit. Additional pairs may be accommodated if runs are short, bends are few, pairs do not cross each other at bends, and a pulling lubricant is used.

When should cable be run in rigid conduit? Generally when cable must run

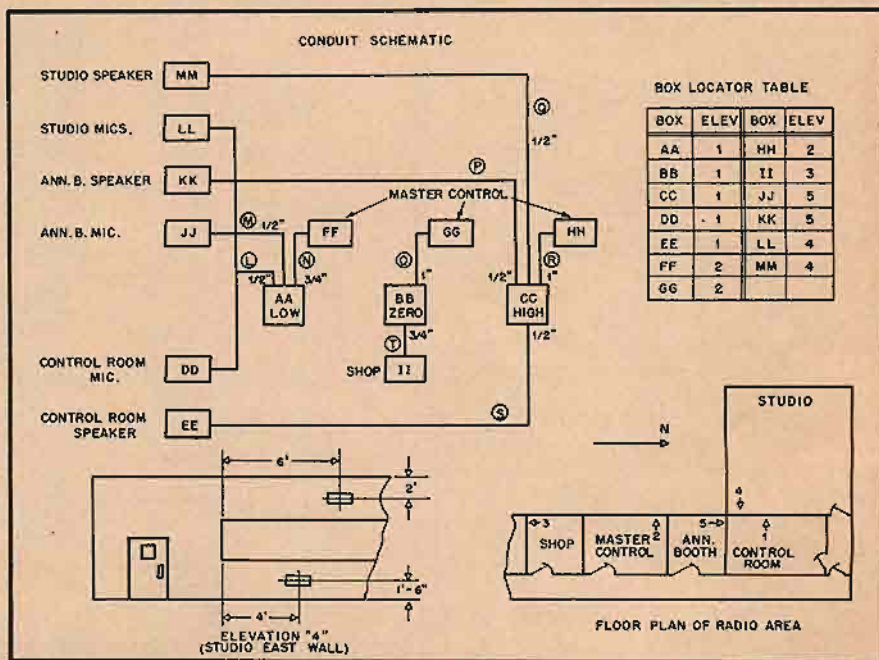

Fig. 7. Audio Conduit Layout. Circled letters are individual conduit designations. No medium-level conduits are shown as no medium-level circuits leave the control room. Boxes are surface mounted, and should be dimensionally located in elevations of their respective walls hereon. Floor plan aids in identifying walls and visualizing conduit runs.

through walls, either to other rooms or to other points in the same room. Conduit is best used during original construction. Cabling for additions to existing installations can readily be run in exposed wiremold or similar metal duct, or in flexible Greenfield conduit, the runs being carried on the chair rails and baseboards. When many pairs must be run between two points, as between rack and console, a trough—generally without conduit—is probably the easiest solution for a raceway. The same is true of three or four points located roughly along the same straight line as in Fig. 4. The trough can be in the floor under the equipment, or upon the floor behind the equipment as shown in Fig. 6. The pairs of a given level group are laced into a cable and placed in the trough at a minimum distance of three inches from the edges of adjacent cables of different level groups.

Getting back to conduit, it is essential to have a conduit layout diagram as shown in Fig. 7. This is one-line sketch showing each conduit, its size, the terminating wall boxes in the various rooms served, and the exact physical location of each box in every wall. Since the control room is the starting point for all the conduits, begin the layout with a large terminating wall box in the control room, to which are run all the low-level conduits from the studio, announce booth, other points in the control room, etc. These conduits terminate at their respective destinations in smaller wall boxes. In like manner, the conduits of each of the other level groups are run from their respective control room terminating boxes.

All conduits should be labelled on the drawing with the conduit letter or number and the size. Information required to make this layout comes from the block diagram, the interconnection cable layout of Fig. 4, and the conduit capacity table in Fig. 5. Remember to size the conduits to accommodate spare pairs and a #14 insulated ground wire—just in case. In the course of pulling, pairs occasionally break, or short, or ground out to the shield; also station growth may require additional circuits in the future, and spares cannot readily be pulled later in the same conduit. At the top of Fig. 6 can be seen three cables of different level groups coming out of their respective terminating wall boxes and running down the control room wall to the trough, and thence to rack and console.

So far, the conduit diagram shows all the conduits and the wall boxes but does not dimensionally locate the boxes. We therefore draw on the conduit layout a partial elevation of each wall involved just enough to locate the box—and label each such wall sketch as ELEVATION 1, ELEVATION 2, etc. Then we draw a floor plan layout of the entire radio area, including master control, shop, and all other places to which conduit is to be run, and label each wall thereon with the latter assigned to its elevation sketch. This permits each wall to be visualized in relation to the others. Finally, a locator table is put on the con-

NEW PERFORMANCE STANDARDS

with the

WEATHERS FM CAPACITANCE CARTRIDGE

20 to 20,000 Cycles Response

W-202 or
W-202-C
Cartridge
Set



DO YOU REALIZE WHAT LOWER STYLUS PRESSURE CAN DO FOR REPRODUCTION FIDELITY AND RECORD LIFE?????

You can operate with stylus pressures down to one gram with the new WEATHERS Cartridge!

Get the NEW W-202-C Cartridge Set for your present record player (automatic or manual to enjoy unexcelled high fidelity reproduction).



For the ultimate in record reproduction, with one gram stylus pressure, combine the standard W-202 Cartridge Set with the new WEATHERS W-12 or W-16 Reproducer Arm.



W-12
Reproducer Arm

Change to the WEATHERS Cartridge NOW and preserve your records for the years to come.

WEATHERS INDUSTRIES

Box 531 66 E. Gloucester Pike
Barrington, N. J.

See your dealer or
write for literature

New WILLIAMSON TYPE

AMPLIFIER Features

- First Williamson Type Amplifier supplied with matching preamplifier.
- Uses Altec Lansing Peerless output transformer.
- Practically distortionless—Harmonic and intermodulation distortion both less than 1/2 of 1% at 5 watts output.
- Frequency response:
 - ± 1 db from 10 cycles to 100 kc.
 - Output impedance 4, 8, or 16 ohms.

The new Heathkit Williamson Type Amplifier kit is the best obtainable in amplifiers today—the choice of the really discerning listener. You can hear the difference and measurements actually bear out the superb performance. Frequency response ± 1 db from 10 cycles to 100 kc allow you to hear the highs and lows with equal crispness and clarity. Harmonic and intermodulation distortion both less than 1/2 of 1% at 5 watts output eliminate the harsh and unpleasant qualities which contribute to listening fatigue.

The circuit is similar to the one published in Audio Engineering Magazine for November, 1949, and is considered by engineers throughout the audio field as one of the best ever developed. The Main Amplifier (which may be purchased separately) consists of a voltage amplifier and phase splitter using a 6SN7, a driver stage using a 6SN7, and a push-pull output stage using a pair of 6B7 tubes. The output transformer is manufactured by the Peerless Division of Altec Lansing and is built to their highest standards. Output impedances of 4, 8, and 16 ohms are available. The power supply uses a separate chassis with husky Chicago Transformer power transformer and choke, and 700V Mallory filters for long burn-free operation. A 5V4G rectifier is used.

The main amplifier and power supply are each on a chassis measuring 7" high by 5 1/2" wide by 11" long.

PREAMPLIFIER AND TONE CONTROL UNIT KIT

The preamplifier kit consists of: a 12AX7 (or 12AY7) dual triode first amplifier stage with a turn-over control for LP or 78 record types, and a 12AU7 amplifier stage with individual bass and treble tone controls which each provide up to 15db of boost or attenuation. A switch on panel selects either magnetic, crystal, or tuner inputs. Preamplifier also is well suited to custom installations—it will operate in either vertical or horizontal position, and special notched shafts of the controls and switches allow a variety of shaft lengths to be selected. Dimensions: 2 3/4" high by 10 1/4" wide by 7 1/4" deep.

WRITE FOR
Free
CATALOG

The
HEATH COMPANY
BENTON HARBOR 25,
MICHIGAN

Heathkit AMPLIFIER KIT



WA-A1 Amplifier kit—Combination 1—(Main Amplifier and Power Supply) complete with WA-P1 Preamplifier Kit. Total Ship. Wgt., 34 lbs. (Shipped Express only) **\$69.50**

WA-A1 Amplifier kit only—Combination 4—(Main Amplifier and Power Supply). Less WA-P1 Preamplifier. Total Ship. Wgt., 29 lbs. (Shipped Express only) **\$49.75**

WA-P1 Preamplifier Kit only, (less power supply) (Tubes included). Total Ship. Wgt., 7 lbs. (Shipped Express or Parcel Post) **\$19.75**

You SAVE BY
ORDERING DIRECT

4 GOOD REASONS WHY The New MAGNEMITES* Are The Perfect Tape Recorders for Portable Use



- 1 **World's Smallest, Lightest Tape Recorders**
Letterhead size, weighing 10 lbs., the Magnemites* offer every desirable feature for field recording, compactly assembled in beautiful, precision recorders.
- 2 **Record Without AC Power**
The Magnemites* are powered by inexpensive dry-cell flashlight-type batteries that last 100 operating hours. No wet cells that require daily recharging.
- 3 **Playback and Monitoring Facilities Built-In**
An output connection which feeds earphones or an auxiliary amplifier and speaker during playback, is also used for monitoring while recording.
- 4 **Exceptional Recording Quality**
4 Magnemite* models are available for any recording need. Designed to record music, interviews, or any type of sound effects with lifelike reproduction.

The Magnemite* series consists of 3 dual-track models (1 7/8, 3 3/4, or 7 1/2 in. per sec.) and 1 single-track model (7 1/2 in. per sec.) designed to NAB standards.

Many exclusive features distinguish Magnemites* as the outstanding portable recorders. Write today for complete literature and direct factory prices.

*Trade Mark Reg.

AMPLIFIER CORP. of AMERICA • 398-4 Broadway • New York 13, N. Y.



Double installation of Gramplan Amplifier with Power Supply

NOW AVAILABLE The GRAMPAN Feedback Disk Recording Cutterhead Unit

Engineers and musicians now realize a perfect transient response of any recording system is of paramount importance—the Gramplan cutterhead with its precision-made true balanced armature and flux correcting feedback loop obtains this ideal.

Used by the BBC and other international broadcast networks where fidelity is of primary importance, you too, can be assured of the highest fidelity disk recording.

Many outstanding recordings, such as the LP Mercury Olympian Series, were recently produced with the Gramplan.

For more information, write to



REEVES EQUIPMENT CORP.
10 EAST 52nd STREET • NEW YORK 22, N. Y., U. S. A.
CABLE: REEVESQUIP, N. Y.

Wide frequency range
30 c/s to 20 kc
Low Distortion
Superior transient response

The Audio's New LABORATORY INSTRUMENTS give you Precision Measurement at Moderate Cost



INTERMODULATION METER — Highest Professional Flexibility at Reasonable Cost.

Model 165 IM Meter is especially suited for laboratories, broadcasters, recording studios, Signal generator, analyzer, voltmeter in single case. Reads % IM, amplifier output directly on meter. Provides for use of scope to analyze & cure IM causes: full graphic instructions supplied. Wide range of low & high test frequencies: 60 cps internally, 40-200 cps externally; standard 2, 7, 12 kc internally, 2-20 kc externally. Voltage ratio choices: for LF testing, 4:1; for more accurate HF testing, 1:1. 8 3/4 x 19" rack-type panel; 8 1/2" deep. Price \$250.00.

Negligible loading with New BRIDGER

In bridging measuring instruments across high-Z circuits, lowest possible circuit loading is vital. Improvements in Model 100B's cathode follower circuit & special double-shielded cable reduce input capacity to only 3 mmf. Input Z: 70 megs, 3 mmf, with 3 ft. cable. Output Z: 200 ohms. Output/input voltage ratio: 0.99. Usable to several hundred kc. Price \$96.50.



Do you have the data on our new GALVANOMETER-PROTECTOR? Write NOW for Catalog A.

The Audio INSTRUMENT COMPANY INC
Dept. T 133 WEST 14th STREET, N.Y. 11, N.Y.

duit diagram for ready reference in determining in which wall a given box is located. This table is almost superfluous on the layout of the small system shown in Fig. 7 but it's a real time saver when there are fifty boxes distributed among twenty walls.

Regarding the types of wire to be used in conduit, low-level circuits should be run with standard rubber-insulated shielded microphone cable. For all other levels, wire such as Whitney Blake type CB-3-22-F, which is understood to have been developed by or for CBS, is ideal. This is a 22-9a twisted shielded pair, stranded, with insulation over the shield and a separate bare ground wire under and in contact with the shield. For extremely long runs of high-level circuits, a somewhat larger gage may be desirable. For cables of all levels within racks and troughs, the Whitney Blake wire mentioned works very well. Try to avoid using solid wire; the slightest nick made in the copper when skinning the ends is a potential cause of wire breakage at soldered joints.

It's a good idea to talk over your conduit problems with an electrician early in the game. He can advise you on many points such as the proper wall boxes to provide adequate depth for audio fittings, use of standard versus thin-wall conduit, location of pull boxes, etc. It is generally advisable to have the contractor's electricians pull the cable in the audio conduit, especially if you have been on the heavy side in assigning pairs to a given size of conduit.

As soon as each conduit has been pulled—or after all have been pulled—every pair should be identified and labeled at both ends with a Brady "Qik-Label" (available from Graybar) showing both the cable and pair designation thus—A-17. Test each pair for continuity of both conductors, shorts between conductors, shorts between conductors and shield, and continuity of the shield. Also check the continuity of the #14 insulated ground wire recommended for most conduits. (This last should be taped up in each destination box until needed, and should be brought out of the control room central wall box and soldered to station ground.) Any defective pairs found should be cut off short at both ends and forgotten, and their pair numbers assigned to the spares that replace them. Don't forget to change the number of pairs shown for that cable in the cable list.

This testing procedure is tedious and expensive, especially in large installations, and the contractor will quite properly want to be paid for it—so make sure it is called for in the contract. Finally, be sure to specify the length of slack to be left at each box. It can't be cut longer if you find it's too short.

Don't Miss It!
THE AUDIO FAIR
Hotel New Yorker
Oct. 29, 30, 31, and Nov. 1

AUDIO FREQUENCY FUNDAMENTALS

[from page 46]

tube amplifier also requires a power supply (rectifier-filter) to convert the 60-cps a.c. to d.c. A similar tube to convert 60-cps to 30 kc would be comparable in size. Tube manufacturers indicate that this oscillator tube can be made with a life expectancy of 10 years, ruggedized for proximity fuse applications if desired.

3. Until more efficient rectifiers and improved circuitry are developed, this amplifier will be less efficient and possibly larger than equivalent tube units.

From the small efforts made toward magnetic audio amplifiers, it appears that there may be tremendous possibilities in this field, especially in high-power applications.

NOTE: Most of the material used in this article was obtained from a Bureau of Ships pamphlet, NAVSHIPS 900, 172, titled "Magnetic Amplifiers, A Rising Star in Naval Electronics," published several months ago to stimulate interest in the magnetic amplifier. This material has not as yet been evaluated by the Bureau Engineers.

Wortman Joins New Fine Sound, Inc.

Two prominent names in the audio industry are associated in a new professional recording company known as Fine Sound, Inc. Formed in February of this year by C. Robert "Bob" Fine, formerly chief engineer of the recording division of Reeves Sound Studios and at one time associated with Majestic Records in the same capacity, the firm will handle all re-recording, mastering, and testing for a number of



Mr. Wortman



Mr. Fine

major record manufacturers. Mr. Fine has been elected president of the new company.

Associated with him as general manager is Leon A. Wortman, who resigned recently as director of advertising and sales promotion for Audio & Video Products Corporation. Prior to his connection with A-V, Mr. Wortman was advertising manager for the Fairchild Recording Equipment Corporation and publicity director for the Audio Engineering Society.

Fine Sound, Inc., is located at Tomkins Cove, N. Y., where complete wide-range controlled-recording facilities have been installed in the company's plant.



MIDGET CONDENSER MICROPHONE

For Precision Sound Measurements and High Quality Sound Recording

Built to give years of service without change in calibration. Even without dessicators, Kellogg Midget Condenser Microphones show no detectable drift in laboratory service. Proven in use for optimum performance for more than 15 years.

- RUGGED CONSTRUCTION
- EXCEPTIONAL CALIBRATION STABILITY
- UNAFFECTED BY VARIATIONS IN HUMIDITY

PRINCIPAL CHARACTERISTICS

	MODEL A	MODEL B
RESPONSE (Referred to 1 volt/dyne/cm ²)	-59 db	-55 db
FLAT TO WITHIN	± 3 db from 20 to 11,000 cps. for closed cavity without grille.	± 4 db from 20 to 15,000 cps with or without grille for perpendicular incidence in free field.

Users Include government laboratories, universities, audio development laboratories, sound studios and industrial plants manufacturing sound equipment.

● SEND FOR FULL SPECIFICATIONS TODAY! WRITE DEPT. 27-C

KELLOGG

AN IGT ASSOCIATE

SWITCHBOARD & SUPPLY COMPANY
Sales Offices:
79 W. Monroe St., Chicago 3, Ill.

MIDGET CONDENSER MICROPHONE
An Associated International Telephone and Telegraph Corporation

FOR THE GREATEST VALUES IN SOUND

... look to Arrow Audio Center

Arrow Audio Center, America's first complete building devoted exclusively to high fidelity and sound equipment, naturally features the very newest and finest in

sound — all at unsurpassed values. For your every sound need you'll always find exactly what you want at Audio Center.



ACROSOUND TO-300 TRANSFORMER

Here's the transformer that brings Williamson amplifier users new heights of high fidelity in the Ultra Linear Circuit. TO-300 actually halves the distortion while doubling the power output. Convert your "old" Williamson for superlative results, or build your new Williamson around this fine transformer and listen to the best.

ACROSOUND TO-300 Transformer

Shpg. wt. 6 lbs.

Complete Acrosound literature on request.

NET \$2475

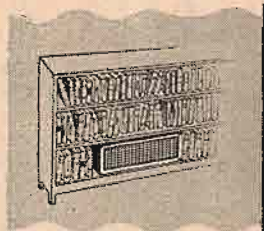

R-J SPEAKER ENCLOSURE

For maximum bass with minimum space thousands of critical listeners have acclaimed the almost unbelievable bass response provided by the R-J speaker enclosure and any good speaker. The single bookshelf model, S-8-U illustrated, offers clean, smooth bass fundamentals as well as unobstructed direct radiation of high frequencies and excellent transients with an 8-inch speaker. 11" high, 10" deep and 23½" long. In sanded finish, unpainted Mahogany or Korina veneer.

Model S-8-U R-J Speaker Enclosure
Shpg. wt. 20 lbs.

NET \$2450

ARROW ELECTRONICS'

Audio Center

BEAUTY IN SOUND

65 CORTLANDT ST., NEW YORK 7, N. Y., DIGBY 9-4714

ORDER BY MAIL
From "WHOLESALE"

America's Finest
HIGH FIDELITY
EQUIPMENT

Get High-Fidelity Music
At Minimum Cost
From "Wholesale Radio"

★ **HI-FI AMPLIFIERS**

GROMMES 50PG	\$ 55.00
CRAFTSMEN C-500	99.50
ALTEC LANSING Power Amp. A333A	111.00
ALTEC LANSING Remote Amp. A433A	
Has operating controls for A333A	75.00
BELL Model 2122A	50.46

High-Fidelity, Magnetic

★ **CARTRIDGES**

GE RPX-050 with dual reversible sapphire stylus	\$ 8.37
GE RPX-051, same as RPX-050 (less stylus) ..	5.28
GE RPX-052 with combination diamond and sapphire stylus	23.37
GE RPX-040 with .003 sapphire	5.97
GE RPX-041 with .001 sapphire	5.97
GE RPX-042 (less stylus)	4.35
GE RPX-046 Professional type (less stylus) ..	6.87
GE RPX-047 Broadcast type (less stylus) ..	9.27
PICKERING S120M Sapphire stylus	9.90
PICKERING D120M Diamond stylus	24.90
PICKERING S140S for microgroove. Sapphire ..	15.00
PICKERING D140S for microgroove. Diamond ..	36.00

★ **GARRARD RC-80**
RECORD CHANGER

Model MB mtg. base—\$2.50
Model WB Wood base—5.95 **\$42.30**

SPECIAL! While They Last

★ **MEISSNER TUNERS**

Reg. \$54.70	8C FM TUNER	\$39.95
Reg. \$70.95	9AJ FM-AM TUNER	\$49.95

REK-O-KUT LP 743 \$54.95
3-speed, 12" turntable

Complete Line of High Fidelity
Equipment by the Famous Makers

- Electro-Voice
- Acro Sound
- Weathers
- Magnecord
- McIntosh
- Browning
- Partridge
- Jensen

A Practical Guide For Assembling
Your Own High Fidelity System

"MAKE MUSIC LIVE"

By Green, Radcliffe & Scharff
First complete hi-fidelity handbook **\$4.50**

For Audio Values Write For Free F.Y.I. Bulletin
Address Orders to Dept. AE-9

WHOLESALE
RADIO PARTS CO., Inc.
311 W. Baltimore St.
BALTIMORE 1, MD.

DUPLEX LOUDSPEAKER

[from page 29]

wise, insulated and cemented by a varnish, and later baked to insure a non-compliant assembly. The impedance of the voice coil is nominally 8 ohms. Aluminum ribbon was chosen, rather than copper, because of the selection of unity ratio between the mass of the generator and the effective mass of the radiator plus its air loading at the upper end of the working frequency spectrum. A ratio of unity at about 1,000 cps produces the highest efficiency and best frequency response. This ratio is graphically illustrated in Fig. 1, which shows the loss of efficiency in db versus the ratio $M_i/(M_d+M_a)$, where M_i is the mass of the voice coil, M_d is the mass of the effective area of the diaphragm, and M_a is the mass of the air load.

The magnet and pole piece assembly uses an Alnico V permanent magnet weighing 1.8 lbs. which supplies 13,000 gauss to the voice-coil air gap. The structure is conventional in design, consisting of a circular steel back plate, an outside steel spacer ring, a steel front plate having a beveled 3-inch diameter hole that forms one of the pole pieces, and a central pole piece and magnet assembly. The frame, which is a steel die-formed part, completes the low frequency assembly and has the sole purpose to support the component parts rigidly to the baffle.

High-Frequency Unit

The design of the high-frequency unit was based on the space available within the 12-in. low-frequency unit. To minimize interference from the cone and raise the efficiency of the driver, a horn-type radiator was chosen. To maintain the proper phase relation at the crossover region, the driver was located at substantially the same plane as the area of radiation from the effective cone area at the crossover point. The horn length was then fixed at the maximum depth of the cone. From the foregoing dimensions, the crossover frequency was chosen to be 3,000 cps. For ease of manufacture, the high-frequency horn and driver were designed as an integral and independent unit to be mounted directly on the face of the inner pole piece, inside the cone of the low frequency unit. The horn designed is an exponential type with deflection baffles at its mouth. For best distribution angle and minimum interference from reflections of the cone, the flare rate of the horn was chosen to cut off at 1,800 cps. The throat coupling to the diaphragm of the driver was designed to have a cutoff, due to cavity-orifice resonance, at 22,000 cps. This resonance occurs in the cavity between the diaphragm and compliance and the diaphragm dome, coupled to an orifice which is the annular entrance to the horn. The efficiency of the horn was measured to be 9 db. The acoustic loading ratio is 3:1.

The cross section of the driver, with its horn and housing, is shown in Fig. 2. It is a dynamic moving coil type consisting of a magnet (1), an inner and an outer pole piece (2), (3), a diaphragm and compliance (4), a voice coil (5) attached to the diaphragm, and an acoustic resistance ring (6). A photograph of the driver alone is shown in Fig. 3 which clearly shows the diaphragm and its compliance. The dimensions of the unit are approximately 1-3/8 in. diameter and 3/4 in. thick.

To achieve a good response and extend the range to 22,000 cps, particular attention must be placed on the design of the diaphragm. Since it is a mass controlled device, the total mass of the diaphragm and voice coil must be kept extremely small. The material used for the diaphragm is .0005-in. aluminum foil dome shaped to attain rigidity. The compliance is a part of the diaphragm consisting of tangential corrugations flattened at the rim for cementing to the pole plate. The voice coil is edgewise-wound aluminum ribbon made self-supporting by means of a baked insulating varnish. The finished coil is then cemented to the diaphragm dome.

Crossover Network

The crossover network was designed especially for the described low- and high-frequency units. Since the input impedance was chosen to be 8 ohms, which is considered standard for two-way speakers, the network not only has to divide the two frequency ranges, but also match the line impedance to the individual units. The crossover frequency is 3,000 cps.

Because of good phasing characteristics of the combined duplex speaker, the network slope was designed to be 6 db per octave. To match the 8-ohm input impedance to the 30-ohm high-frequency unit, the inductance element was designed as an auto transformer, having a step-up ratio of 1 to 4, with three taps for adjustment of the high-end response in 2 db steps. The schematic is shown in Fig. 5 and the measured electrical response is shown in Fig. 6. As will be shown later, the actual acoustical crossover slope is considerably more than 6 db per octave. The attenuation is achieved acoustically.

Performance

The actual frequency response of the high- and low-frequency units when assembled together to form a duplex speaker system is shown in Fig. 7. This final assembly is shown in Fig. 8, which also shows a felt ring cemented between the cone and the base of the high-frequency unit. This felt ring serves two purposes. First, it prevents foreign matter from accumulating in the air gap, which would interfere with the voice-coil motion, and secondly, it acoustically attenuates frequencies above 3,000 cps, which are radiated by the surface of the cone underneath the felt ring. The combined electrical and acoustical attenuation slope above the crossover frequency is 18 db per octave as shown in Fig. 7.

Fully explaining
mathematical
tools of analysis
valuable in
mathematical
phases of
communication
engineering



Here is a book supplying the mathematical and analytical tools needed by communications engineers to deal successfully with problems in such fields as radio, radar, and television. The book not only takes up the Laplace, Fourier, and Taylor analyses but also covers the applications of these analyses to all important phases of electrical communications. Throughout, both the mathematical and engineering viewpoints are considered. To keep pace with demands made by television and radar, sideband theory is fully treated, as well as transient and harmonic analysis.

Just Published

HARMONICS, SIDEBANDS, AND TRANSIENTS IN COMMUNICATION ENGINEERING

As Studied by the Fourier
and Laplace Analyses

By C. Louis Cuccia

Research Engineer, Radio Corporation of
America, RCA Laboratories Division,
Princeton, New Jersey

464 pages, 6 x 9, 273 illustrations, \$9.00

Partial list of
the book's 22
chapters . . .

- Complex Waves in Radio, Television, and Radar
- Linear - network Analysis
- Harmonic Distortion—Amplifier Operation
- Harmonics and Transients in Amplifiers
- Integrating, Differentiating, and Scanning Systems for Television
- Reactance Tubes, Frequency Stabilization, and Phase Synchronization
- Frequency Modulation and Wave Interference
- Spectral Analysis of Finite Wave Trains
- Reception in Electrical Communications

This book fully treats the basic analysis of harmonics, side bands, and transients in communication engineering — using Fourier analysis, Laplace transform analysis, and, to a lesser degree, Taylor series analysis. Starting with the basic harmonic and wave concepts familiar to every communications engineer, it builds up the fundamentals of the Laplace analysis from the Fourier analysis.

Throughout, the book considers the engineering background of the communications problems to which analysis is applied. It includes the analysis of radio and television transmission from the pick-up system . . . through transmission and demodulation . . . to the output; a complete treatment of modulated waves; and the background and harmonic analysis of vacuum tubes, gas tubes, and ultra-high-frequency tubes.

AUDIO ENGINEERING

P. O. Box 629

Mineola, New York

curve A. The resultant acoustical output of the high-frequency unit is represented by curve B. The slope is 12 db per octave below 3,000 cps, which is the result of the electrical network and the acoustical low-frequency cutoff of the horn. As measured, the total curve is flat within +3 db from 40 to 20,000 cps, with the exception of the region between 50 and 65 cps where it is about 5 db down from the average. The above response was measured in the anechoic chamber and represents the actual response of the speaker system enclosed in the 606A corner type cabinet, which was designed for the new speaker. Since the response was recorded without the benefit of rigid corner walls for which the cabinet was designed, the frequency at 30 cps is considerably lower in amplitude than if the corner walls in a normal room were used. The 30-cps response measured in a typical hard walled room is appreciably improved as shown by the dotted portion of curve A in Fig. 7.

As mentioned earlier, the other devel-



Fig. 8. The Altec Lansing 601A 12-inch duplex loudspeaker.

opment is the 602A loudspeaker, which is essentially the same as the 601A, except that a 15-inch cone-and-frame was used. The construction is the same and the performance is superior. The advantage gained in a larger area cone is in the improvement of the extreme low-frequency range. The 602A extends substantially flat to 30 cps and had good efficiency at 20 cps. Since a larger 2.41 pound magnet was used in the 15-in. unit, the over-all efficiency was raised by 2 db. The power handling capacity of both the 601A and 602A is 20 watts, sine wave, continuous radiation. For reproduction of speech and music, however, the peak power rating is 30 watts, at which point non-linearity becomes a limiting factor.

During listening tests, consisting of a variety of material, such as pipe organ selections, speech, percussion, wind and string instruments, vocalists, and full orchestra, exceptional reality and quality are realized. A-B tests were also conducted in competition with various high-quality speaker systems, and the tests confirmed the measurements.

FULL TONAL REALISM

Super Horn
PAT. PEND.
LOUDSPEAKER ENCLOSURES

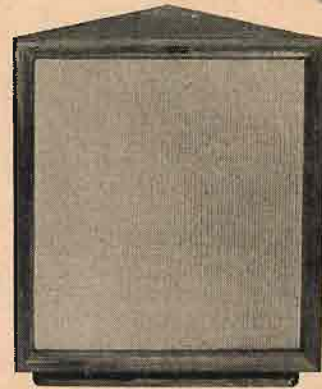

CLEANNES . . . reproduction without resonant peaks or distortion . . . is the keynote of SUPER-HORN engineering. Full bass down to 40 cps. is accurately reproduced by an exponential horn. Clear highs are radiated directly from the front of the speaker with no tuned cavities or ports to produce false bass or "boom".

GRACEFUL RIGIDITY is the keynote of SUPER-HORN construction. Classic beauty of line is combined with rugged durability. All panels are of 3/4 inch and 5/8 inch woods, internally braced to prevent vibration.

BLOND . . . 12" . . . \$80—15" . . . \$85

MAHOGANY 12" . . . \$75—15" . . . \$80

All Prices Net

WRITE FOR TECHNICAL LITERATURE

GATELY

DEVELOPMENT LABORATORY

CLIFTON HEIGHTS, PA.

IF YOU ARE MOVING

Please notify our Circulation Department at least 5 weeks in advance. The Post Office does not forward magazines sent to wrong destinations unless you pay additional postage, and we can NOT duplicate copies sent to you once. To save yourself, us, and the Post Office a headache, won't you please cooperate? When notifying us, please give your old address and your new address.

Circulation Department

RADIO MAGAZINES, INC.

342 Madison Avenue
New York 17, N. Y.

SAVE
33 $\frac{1}{3}$ %



**This is our
GROUP SUBSCRIPTION PLAN**

You and your friends and co-workers can now save up to \$1.00 on each subscription to **AUDIO ENGINEERING**. The more men in a Group, the more each saves. If you send 6 or more subscriptions for the U.S.A. and Canada, they will cost each subscriber \$2.00, 1/3 less than the price of a regular 1-year subscription. Present subscriptions may be renewed or extended as part of a Group.

AUDIO ENGINEERING is still

- The only publication devoted entirely to Audio—
- Recording
- Broadcasting equipment
- Acoustics
- Home reproduction systems
- PA systems
- Psychoacoustics

(Please print)

Name

Address

Position Company

Name

Address

Position Company

Name

Address

Position Company

Name

Address

Position Company

Name

Address

Position Company

Name

Address

Position Company

Add \$.50 to each Foreign subscription ordered

RADIO MAGAZINES, INC.
342 Madison Ave., N. Y. 17, N. Y.

**The Fourth Audio Fair
October 29 to November 1**

AUDIO WILL BE KING, and court will be paid by more than 15,000 sound engineers, music lovers, and commercial buyers of sound equipment, at the 1952 Audio Fair, according to a recent attendance estimate voiced by Harry N. Reizes, Fair manager. If the rate of attendance growth established in previous years is maintained, the 1952 exhibit will firmly establish the Fair as the second largest annual electronic event in the country, exceeded only by the yearly convention of the I. R. E.

In order to better accommodate the increased number of visitors, this year's Fair will last four days instead of the usual three, opening October 29 and continuing through November 1, on the fifth and sixth floors of Manhattan's famous Hotel New Yorker.

Conceived originally as an event of specific interest to audio hobbyists and professional engineers, the Fair has become a principal buying mart for audio equipment on a commercial level. Among this year's record-breaking attendance will be many purchasing agents and buyers representing major jobbers and dealers in all parts of the country, Mr. Reizes said.

Widest Range of Exhibits

Other records will be established by the number of exhibitors participating and in the variety of equipment on display. More than 100 manufacturers already have engaged exhibition space, and items to be shown range from professional recording equipment valued at thousands of dollars to a fifty-cent pocket microscope for examining phono-cartridge styli.

Emphasis in most displays, however, will be placed on medium-priced semi-professional equipment for use in home music systems.

Conducted each year in conjunction with the annual Convention of the Audio Engineering Society, the Fair has paralleled the Society in achieving world-wide recognition. Together, they are regarded internationally as the most prominent of the annual displays and forums devoted to the science of reproduced sound.

Although a number of European manufacturers have taken part in previous fairs, the 1952 event will play host to more than ever before. Among the scientists and engineers who will deliver papers before technical sessions of the Society are G. A. Briggs and Harold Leak, prominent British audio authorities, both of whom are coming to this country solely to attend the Fair and the Convention, according to F. Sumner Hall, Society vice-president and chairman of the convention papers Committee.

The 1952 Fair will emphasize in its exhibits the theme *Audio Today and Tomorrow*. While there is no official contest, exhibitors this year, as in previous years, while preserving an audio *esprit de corps*, are competing actively in the creation of attractive displays based on the Fair's theme.

**CUSTOM-BUILT
RADIO-PHONOGRAPH
INSTALLATIONS**

"Soundcrafters"

**F.M.-A.M. 13 Tube Chassis
HIGH FIDELITY**

Complete, ready to plug in
—including amplifier with
all tubes and 10" or 12"
P.M. Speaker. **\$67⁵⁰**
List \$139.50

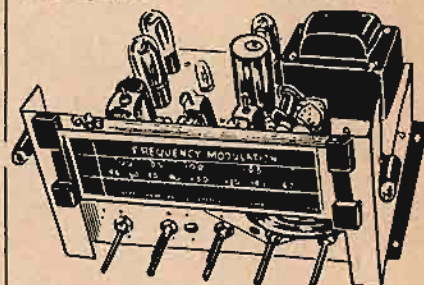

FM tuning range 88 Megacycles—108 Megacycles. AM tuning range 535 Kilocycles—1650 Kilocycles. Individual circuit de-coupling insures minimum circuit drift. Dial, large, easy-to-read multi-color slide rule type. Tone range covers all tones from 30 cycles to 15,000 cycles. Brand new, original factory sealed carton. Built-in pre-amp for reluctance pickup and XTAL input. Push-Pull audio output 14 watts. Volume tone and bass controls. Antenna, folded FM aerial, knobs, plugs, etc. Instructions incl. 12 $\frac{3}{4}$ " x 10 $\frac{1}{4}$ " x 7 $\frac{3}{4}$ " high. Will accommodate 2 speakers. **RCA LICENSED WEBSTER #100 Changer w/GE cart. \$29.95 VM No. 950 WITH GE CARTRIDGE 28.95**

Console Cabinet available to fit Chassis and Record Changer
Immediate Delivery—Fully Guaranteed
Come in or order by mail—
\$10 on C.O.D. orders

MUSIC LOVERS

Full Range Tone is possible
on your phonograph.

A General Electric Reluctance Pickup in place of your present crystal will make all the difference in the world.

**WE DO THE WORK . . .
YOU ENJOY IT**

Disconnect your tone arm and mail it to us. We will install the GE Cartridge for you and furnish you with an easy plug-in preamplifier requiring no tools. WE pay postage.

TOTAL Cost to you only \$14.50
Please tell us types of tubes when ordering.

JAN ELECTRONIC DIST. CO.
222 Fulton St., N. Y. 7 Worth 4-0632

Don't Forget . . .
THE AUDIO FAIR
Oct. 29, 30, 31, and Nov. 1
Hotel New Yorker, N. Y.

**OIL FILLED
Condensers are BEST . . .**

. . . for high-fidelity amplifiers! Highest efficiency, lowest leakage and hysteresis losses, longest life—practically permanent! Normally very expensive, but we have some excellent bargains for those who plan to build (or re-build) their own amplifiers. Send for free list.

E. GARR, P.O. Box 101, Riverdale Station 71, N.Y.C.

ADCOLA

REGISTERED TRADE MARK

SOLDERING INSTRUMENTS

Any Voltage Range Supplied from 6/7 to 230/250 volts. Our instruments for 110 volts are superb in making

SOUND JOINTS

for all

SOUND EQUIPMENT

Supplied to most leading British electrical manufacturers and H.M. and foreign government departments.

These soldering instruments are named instruments as they are such a complete departure in design from the usual solder bolt or iron and are ideal for all modern assembly and maintenance work on telecommunications, radar, television, wireless, etc.

3/16" dia. bit Standard Models
3/16" Detachable Bit Type (Factory Bench Line)

- Heating time: 90 seconds
- Consumption: 25 watts
- Weight: 4 ozs.
- High temperature
- Handle unaffected by element temperature
- Length of instrument: 9"
- Equally suitable for daily or intermittent use
- Prices
Standard 3/16" Bit Model \$3.15
Standard 1/4" Bit Model 3.50
Detachable 3/16" Bit Model 4.20

Catalogue sent free on request.

MADE IN ENGLAND

Registered Design (U.S.A., British, & Foreign Patents)

Write direct to sole manufacturers and suppliers:

ADCOLA PRODUCTS, LTD.
CRANMER COURT
CLAPHAM HIGH STREET
LONDON, S.W. 4, ENGLAND

STOP LOOK LISTEN

Stop at the Hotel New Yorker October 29, 30, 31, November 1.

Look at the greatest collection of Audio Equipment ever assembled.

Listen to the newest developments in everything from pickups to speakers.

THE AUDIO FAIR

You're Invited Admission Free

AUDIO PATENTS

[from page 6]

condition for low distortion—maintain a constant voltage between plate and cathode of V_2 . It operates in this manner:

R_1 , V_1 , and V_2 form a series voltage-divider circuit between B-plus and ground. V_1 is a voltage-regulator tube, so the d.c. voltage between the grid of V_1 and the cathode of V_2 does not change. R_1 - C_1 is a low-pass filter to prevent sudden changes in the cathode voltage of V_2 from varying the regulated voltage.

In operation, the signal voltage on the grid of V_2 tends to be followed by the cathode-ground potential of the tube, producing the output voltage. Since a constant potential difference is maintained by the regulator between the amplifier cathode and the grid of V_1 , the voltage on the latter grid varies in step with the output voltage. If on one alternation, for instance, the grid of V_2 goes positive, the plate resistance of V_2 is reduced. If V_1 did not exist or were a resistor, this would cause a smaller voltage to appear between anode and cathode of V_2 . Instead, since the grid of V_1 also goes positive, the plate resistance of V_1 is also reduced and the voltage remains substantially constant.



A MONTHLY SUMMARY of product developments and price changes of radio electronic-television parts and equipment, supplied by United Catalog Publishers, Inc. 110 Lafayette Street, New York City, publishers of Radio's Master.

These REPORTS will keep you up-to-date in this ever-changing industry. They will also help you to buy and specify to best advantage. A complete description of most products will be found in the Official Buying Guide, Radio's Master—available through local radio parts wholesalers.

Miscellaneous Radio, TV and Electronic Parts

CENTRALAB Added type DD16 v.d.e.w. ceramic disc "buffers."
CORNELL-DUBILIER Added a number of series UP & UPT twist prong base electrolytics.
SCHOTT, WALTER L. Added the new "50" line of hardware. Each item is packaged to sell for \$.30 net.
STANDARD TRANSFORMER Added No. P-4060, vibrator transformer with 6 volt d.c. primary at \$2.57 net.
TRIAD TRANSFORMER Added approximately 117 replacement, amateur, industrial, and geophysical transformers.

Recording Equipment, Speakers, Amplifiers, Needles, Tape, Etc.

ALTEC LANSING CORP. Added No. 730A, driver unit at \$29.50 net . . . 30A and 40A horns at \$29.50 and \$33.75 net respectively . . . M14, microphone system at \$395.00 net . . . 21BR-200, microphone at \$125.00 net. Decreased price on A-322C amplifier to \$338.00 net.
AMERICAN MICROPHONE CO. Withdrew model CH, carbon hand microphone . . . DH & DHT, dynamic hand-held microphone.
BOGEN CO., INC. Added TV booster BB1-A (mahogany & walnut sets) at \$19.50 net and BB1-B (for blonde sets) at \$20.10 net; separate 6J6 triodes operate in independent push-pull circuits to provide maximum gain and bandwidth with measurable superior signal-to-noise characteristics . . . model TWIN, a two-station wireless system employing the power line and ground as the transmitting medium at \$57.00 net . . . CW-1, additional single stations at \$30.00 net . . . models TP17 and TP17X, 3-speed transcription players with crystal and magnetic pickups at \$126.00 and \$138.00

Air-Tone

HEADQUARTERS FOR SOUND EQUIPMENT

"IN PERSON" PERFORMANCE
IN YOUR OWN HOME

NEWCOMB AMPLIFIER



Complete line of High Quality Amplifiers, from small single units to large rack installations

Air-Tone

SOUND AND RECORDING CO.
1527 CHESTNUT ST.
PHILA. 2, PA. • RI-6-8388



have "HIGHS"
got you low?

Directional characteristics of the acoustical lens at 5000 cycles.

The new Jim Lansing acoustical lens gives the highs a smoothness your ear will appreciate instantly! The new lens, a natural development brought about by the inadequacies of the multicellular horn, distributes sound constantly and uniformly over the entire audio spectrum . . . giving the highs a smoothness impossible to match by any other method.
Drop into your high fidelity dealer and ask for the full story today.

JIM LANSING → first in fine sound

JAMES B. LANSING SOUND, INC.
2439 Fletcher Dr., Los Angeles 39, California

Concertone

MAGNETIC TAPE RECORDERS



NETWORK RECORDER
NWR-1

just like being there
THE ONLY low cost high fidelity tape recorders delivering professional performance. Professional users' net prices begin at

\$345.00

Write for Bulletin #101
Manufactured By

Berlant Associates

4917 W. Jefferson Boulevard
Los Angeles 16, California

ALLIED

has them
IN STOCK!

the New
ALTEC DUPLEX
Speakers!

we can supply
from stock
all types of
Altec Lansing
products, including
amplifiers,
tuners and home
music systems, as
well as speakers...



FREE 1953 CATALOG

Complete 236-page Buying Guide to everything in High-Fidelity, Television, Radio, and Industrial Electronics. Write for FREE copy now.



ALLIED RADIO

Dept. 17-JJ-2, 833 W. Jackson Blvd.
Chicago 7, Ill.

net respectively... FM 801, FM tuner with a freq. response of 50-15000 cps ± 1 db at \$69.00 net... AM901, AM tuner with a freq. response of 50-7500 cycles in high-fidelity position and 50-3500 cycles in high selectivity position at \$57.00 net.

DUOTONE CO. INC. Added 45 rpm adaptors, 5 to an envelope at \$1.25 net.

ELECTRO-VOICE Added T-35, super tweeter at \$29.70 net... X-30, crossover for T-35 at \$6.75 net... Peacese equipment console in mahogany at \$78.00 net and blonde at \$84.00 net... Regency speaker, enclosure in mahogany at \$114.00 net and blonde at \$120.00 net.

HALLCRAFTERS CO. Added models ST-83, hi-fidelity AM/FM tuner at \$129.95 net... A-84, amplifier, power output 15 watts maximum, freq. range 3 to 200,000 cps at \$99.50 net and HT-20 at \$449.50 net.

LOWELL MFG. CO. Added rear seat speaker kit model No. R7, at \$2.70 net... long corridor baffles LC8B at \$9.00 net... LC8S at \$10.80 net... LC810 at \$12.60 net... Hi-Fi decorative grille H-24 at \$13.50 net... 6 metal recessed perforated square ceiling grilles... model SUELN, semi-recessed wall type angular baffle at \$13.80 net.

MAGNA ELECTRONICS CO. Added 12 record players... 2 all purpose oscillators, both iron core permeability tuned... 7 all purpose amplifiers.

RECOTON CORP. Added variable reluctance pick-ups, 195X at \$6.60 net; 175X and 155C at \$4.20 net each and 155X at \$11.40 net... acoustic tone arms and reproducers Nos. 40 and 51 at \$9.00 net each; 50 and 61 at \$1.20 net each; 30 at \$1.50 net and 54 at \$1.80 net.

REK-O-KUT Added model R-16H, 3-speed 16 in. transcription table at \$250.00 net.

SIMPSON, MARK Decreased prices on four amplifiers... five portable systems... two phono top amplifiers... MMS-27P, portable mobile system... MMO-27P, outdoor mobile system... ME-36R, amplifier with Webster 190 3-speed record changer.

TURNER CO. Added microphone models 80; sensitivity approx. 58 db below 1 volt/dyne/sq. cm.; response is 80 to 7000 cps at \$9.57 net... model 81 technical specs, as model 80, only smaller at \$8.37 net... model 83, technical specs, as model 80, hand microphone at \$9.57 net... model 82-3H, technical specs, as model 80, with "third hand" that slips over the head and holds the microphone in position at \$13.65 net... model 51D, dynamic microphone, freq. response 60 to 13,000 cps, substantially flat essentially non-directional in any position at \$51.00 net... model 70D, dynamic, freq. response 200 to 5000 cps with slightly rising characteristic for max. speech intelligibility, output level 52 db below 1 volt/dyne/sq. cm. at \$25.50 net and model 70R, carbon, as 70D except with carbon cartridge and output level 42 db below 1 volt/dyne/sq. cm. at \$23.10 net.

WEBSTER-ELECTRIC CO. Decreased price of S835A, room speaker to \$26.00 list (accessory for single-channel sound distribution system model S8344A)... also S8107-2A to \$29.00 list (accessory for console 2-channel distribution system model S8271B).

WILCOX-GAY CORP. Model 3C10 added at \$199.95 retail. A tape-disc Recorder, it contains high-speed wind; forward and reverse; double neon recording volume indicator, one for overload; new controlled reluctance mike; 6 x 9 oval speaker... also model 3AV10 Recorder Pix at \$249.50. Has built-in projector; high fidelity sound on tape; automatic push-button operation.

Test Equipment

HICKOK ELECTRICAL INSTR. CO. Model 670 cathode ray oscilloscope increased in price to \$229.00 net.

R.C.A. Added WR-40A at \$1450.00 net and WR-41A at \$595.00 net, UHF sweep generators.

RADIO CITY PROD. Introduced their TV "do-all" generator model 740 at \$69.50 net which combines a signal generator, an audio generator, a marker generator and a pattern generator... model 808 at \$99.95 net, which combines a tube tester, a CR tube tester, a CR tube reactometer, a vacuum tube voltmeter (a.c. & d.c.) and an ohmmeter... model 533M at \$99.50 net, a miniaturized oscilloscope weighing 9 lbs... TV series 8000 which includes models 740, 808 and 533M, all described above in one portable case at \$279.50 net... series 8010, as 8000, plus 730 signalizer at \$299.50 net.

REINER ELECTRONICS CO. Added model 475 at \$225.00 net, a vacuum tube voltmeter with a.c. voltage range, 0.1 to 120 volts, in full-scale ranges 1.2 v, 3 v, 12 v, 30 v and 120 v... d.c. range 0.02 to 300 volts in full-scale ranges 1.2 v, 3 v, 12 v, 30 v, 120 v and 300 v... + d.c. and - d.c. switch provided... model LB-200, resistance limit bridge with range of 10 ohms to 100 megohms at \$475.00 net.

Tubes—Receiving, Television, Special Purpose, Etc.

R.C.A. Added receiving tubes 6CL6, a power pentode of the 9-pin miniature type designed especially for use in the final video-amplifier stage of TV receivers. Also useful as a wide-band amplifier in lab. equip... 12AX4GT, a half-wave vacuum rectifier tube of the heater-cathode type. It is intended for use as a damper tube in horizontal deflection circuits of TV receivers, utilizing series-heating strings.

RAYTHEON Added 12BY7, a miniature pentode designed to be used as a video amplifier in TV receivers. It is presently used in the new Westinghouse TV receivers... added special purpose tubes BK816, a half wave mercury-vapor rectifier... CK6140, a beam power tube... CK5763, a miniature beam power tube... CK-6110, a heater-cathode type double diode of subminiature construction designed for use as a low current power supply rectifier.

CLASSIFIED

Rates: 10c per word per insertion for noncommercial advertisements; 25c per word for commercial advertisements. Rates are net, and no discounts will be allowed. Copy must be accompanied by remittance in full, and must reach the New York office by the first of the month preceding the date of issue.

THE AUDIO EXCHANGE, INC. buys and sells quality high-fidelity sound systems and components. Guaranteed used and new equipment. Catalogue, Dept. JE, 159-19 Hillside Ave., Jamaica 32, N. Y. Telephone OL 8-0445.

WILLIAMSON AMPLIFIER—flat from 20 to 20,000 cps, essentially distortionless, loudness control, \$56.00. Long Island Sound Co., 19 Bennett Place, Amityville, N. Y.

BRAND NEW Peerless S-265-Q transformer for Williamson output—\$22.50. V. H. Lynch, 174 Tudor Ave., Akron, Ohio.

CUSTOM DUAL-CHASSIS 30-watt Williamson Amplifiers—all Peerless transformers, \$89.50. Dr. Nicely, Kenton, Ohio.

WANTED—16-in. disc recording and playback equipment. State make, model, condition, and price in first letter. Also, FOR SALE—Amplifier Corp. of America Twin-Trax, 74 1/2 p.s., excellent condition. What am I offered? W. C. Moore, 906 Paseo, Kansas City 6, Missouri.

78-r.p.m. Bargains, symphonic, like new. Write for list, Mrohs, Box 2026, Ann Arbor, Michigan.

WANTED—77-D RCA Microphone FOR SALE—Tape recorder, Brush BK-401, \$95. Lester Henninger, 801 Vernon Road, Philadelphia 19, Pa.

FOR SALE—Two rack-mount PT6-A Magnecorders, PT6-M 10-in. reel attachments, custom-built record and playback amplifiers, Carnegie Hall Recording Company, 881 Seventh Ave., Plaza 7-1795.

WANTED—W. E. KS-1027 horn, for cash or will trade 8-cell horn with throat to fit Altec high-frequency unit. Box CS-1, AUDIO ENGINEERING, P. O. Box 629, Mineola, N. Y.



Employment Register

POSITIONS OPEN and AVAILABLE PERSONNEL may be listed here at no charge to industry or to members of the Society. For insertion in this column, brief announcements should be in the hands of the Secretary, Audio Engineering Society, P. O. Box 12, Old Chelsea Station, N. Y. 11, N. Y., before the fifth of the month preceding the date of issue.

★ Positions Open • Positions Wanted
★ Engineer—Development and design of loudspeakers and focus magnets for commercial and government applications. Position requires initiative, ingenuity, and a thorough knowledge of permanent-magnet circuit development. Applicant must have ability and experience in mechanical design. A knowledge of loud-speaker acoustic development is desirable. Salary commensurate with ability. Write or phone Glaser-Steers Corporation, 2 Main Street, Belleville, New Jersey—Belleville 2-4480.

● Audio Technician. Experienced in installation, operation, and maintenance of commercial broadcast audio equipment including disc and tape recording and playback systems. Presently employed in well-known audio laboratory. Single, 25 years old, draft exempt. Prefer N.Y.C., but will travel. Resume available. Box 901, AUDIO ENGINEERING, P. O. Box 629, Mineola, N. Y.

LAST CALL

ULTRASONIC FUNDAMENTALS

By S. YOUNG WHITE

The rapid increase in the use of ultrasonics during the last few years makes it natural that the well-informed sound engineer should want to learn something of the applications and potentialities of this amazing new field. But interest in ultrasonics is not confined to the sound engineer—it is of still greater importance to the industrial engineer for he is the one who will visualize its uses in his own processes.

Elementary in character, ULTRASONIC FUNDAMENTALS was written originally as a series of magazine articles just for the purpose of acquainting the novice in this field with the enormous possibilities of a new tool for industry. It serves the double purpose of introducing ultrasonics to both sound and industrial engineers. The list of chapter headings will indicate how it can help you.

CHAPTER HEADLINES

Too Much Audio. Opportunities in Ultrasonics. Elements of Ultrasonics. Experimental Ultrasonics. Coupling Ultrasonic Energy to a Load. Ultrasonics in Liquids. Ultrasonics in Solids. Testing by Ultrasonics. High-Power Ultrasonics. Notes on Using High-Power Ultrasonics. Applications of Ultrasonics to Biology. Economics of Industrial Ultrasonics.

The applications of ultrasonics have already extended to many industries, and as its possibilities are explored they will increase a hundredfold. To keep abreast of its growth, engineers in all fields must know what they may expect from ultrasonics, how it is used, how the energy is generated, and the techniques of applying ultrasonic treatment to many processes.

ULTRASONIC FUNDAMENTALS

By S. YOUNG WHITE

36 pages, 40 ill., 8½ x 11, paper cover
\$1.75

Book Division, Dept. A
RADIO MAGAZINES, INC.

342 Madison Avenue New York 17, N. Y.

PROFESSIONAL DIRECTORY

Custom-Built Equipment

U. S. Recording Co.

1121 Vermont Ave., Washington 5, D. C.
Lincoln 3-2705

Tape duplicating

Prices per 7" reel, any quantity,
\$1.00 if we use your tape, or \$3.50
if we supply new plastic base
Audiotape.

EMPIRE RECORDING CO.

3221 S. Acoma St., Denver, Colorado

In Southern California it's HOLLYWOOD ELECTRONICS

(in The Audio Mile)

Distributors of Hi Fidelity
Components Exclusively
Webster 3-8208

7460 Melrose Ave. Hollywood 46, Calif.

Industry People...

A. A. Ward, executive vice-president, Altec Lansing Corporation, scored personal as well as commercial triumph in introducing new Altec Lansing speakers to jobbers and press at New York's Hotel Plaza on August 7—was ably aided and abetted by H. S. Morris, Marty Wolfe, Mel Sprinkle, and Doug Netter, all members of company's eastern crew . . . David Sarsser, violinist with the NBC symphony and co-designer of the famous Musician's Amplifier, will receive more than casual mention in a *Toscanini* article now in the works for a prominent national magazine.

Paul Weathers, inventor and manufacturer of the pickup bearing his name, announces opening of a new factory at Barrington, N. J. . . . Kenneth Boothe has been upped to a vice-presidency, and Joseph G. Connolly has been appointed secretary and general counsel, of Audio & Video Products Corporation, New York—announcement made by Charles B. Rynd, A & V president and board chairman . . . Sam Norris, president, Amperex Electronic Corporation, taking pride in new tube manufacturing plant at Hicksville, Long Island, N. Y.

Robert R. Blanchard, formerly associated with Station KJZZ, Denver, is new sales engineer for Gates Radio Company in Rocky Mountain area . . . Robert B. Moon and Dale Samuelson have been appointed sales manager and sales promotion director, respectively, of Hammarlund Manufacturing Company, Inc., New York . . . Jerry Kahn, president, Standard Transformer Corporation, pointing with pride to two new wings which, upon completion, will add 35,000 sq. ft. to huge Stancor plant in Chicago.

Tom J. Cunningham, manager of sound sales, Electronic Wholesalers, Inc., Washington, D. C., officiated recently at opening of new air-conditioned sales and demonstration showroom—company plans extensive sales and merchandising campaign

Robert S. Caruthers has joined Lenkurt Electric Co., San Carlos, Calif., as chief systems engineer—formerly with Bell Telephone Laboratories for 23 years . . . Robert Adelson, tax specialist, has joined legal staff of Sylvania Electric Products, Inc., New York City.

Morton G. Scheraga, formerly development engineer, has been upped to assistant technical sales manager of the Instrument Division, Allen B. Dumont Laboratories, Inc., Clifton, N. J. . . . Dr. C. J. Breitwieser has been promoted to director of engineering by P. R. Mallory & Co., Inc., Indianapolis—previously served as executive assistant to Dr. F. R. Hensel, engineering vice-president . . . Earl Steiker is new general manager of the rectifier division of Galvanic Products Corporation, Valley Stream, N. Y.

Ralph I. Cole, formerly technical director of the Rome Air Development Center, and Vernon C. Weihe, formerly of the Air Transport Association, have joined engineering staff of Melpar, Inc., Alexandria, Va., a subsidiary of Westinghouse Air Brake Company . . . Julian E. Sprague, vice-president, Sprague Electric Company, announces addition of Frank J. Leeming to company's application engineering staff . . . New president of Federal Telecommunications Laboratories, Inc., Nutley, N. J., is Vice Admiral Carl F. Holden, USN (Ret.).

Lincoln Walsh, president, Brook Electronics, Inc., Elizabeth, N. J., is owner-pilot of a brand new Bonanza—now has used Ercoupe for sale (unpaid adv.) . . .

R. A. Brewer, vice-president, MacManus, John & Adams, Inc., advertising agency, using new Concertone to establish among friends the practice of building symphonic libraries via off-the-air tape recordings

Henry A. Schober, president, Radio Magazines, Inc., applying the rod to editorial group to make frequent mention of AE's change of address—OUCH!—Quote: AE's new address is P. O. Box 629, Mineola, N. Y. Unquote.

See You at THE FAIR
HOTEL NEW YORKER
Oct. 29, 30, 31, Nov. 1
BE THERE

For
HIGH FIDELITY
in
MINNEAPOLIS



Call Lincoln 8678
ELECTRONIC CENTER, INC.
107 Third Avenue North

WE FEATURE:

McINTOSH
RADIO CRAFTSMEN
PICKERING
ELECTRO-VOICE
GARRARD
GENERAL ELECTRIC
WEATHERS
GROMMES
REK-O-KUT
R-J ENCLOSURES
PERMOFLUX
And others

SEE US for tape recorders,
tuners, amplifiers and kits.

No other Mike Stands
OFFER SO MUCH AS
ATLAS

the COMPLETE
STUDIO LINE

MAXIMUM STABILITY: Maximum base mass is concentrated at outer periphery. Bases are self-leveling, shock-absorbing, anti-tip, anti-scratch.

MAXIMUM QUIET AND EASE: Special Full-Grip, Velvet-Action clutches, inner-lined with wear-proof locking collars, function smoothly at slight pressure, yet cannot creep, jam, rasp, jolt or jar.

MAXIMUM WEAR: Heavy oversized tube assemblies are super-chrome plated for highest durability.

MAXIMUM VARIETY: Floor or table, boom, orchestra or collapsible types—there's an ATLAS stand for your every studio need.

COMPARE ATLAS at your distributor TODAY. See why more studios specify ATLAS than any other line. Write NOW for FREE latest Catalog 551.

ATLAS also leads in the manufacture of public address loudspeakers and accessories.



ATLAS SOUND CORP.
1448-39th Street, Brooklyn 18, New York
In Canada: Atlas Radio Corp., Ltd., Toronto, Ont.



WE ALSO MAKE GOOD AMPLIFIERS

Our main job in life is making the 215 speaker, and speakers have always been our chief interest. Yet because speakers deserve good amplifiers, we were, quite early in our career, asked to make those good amplifiers. It is just twenty years ago this month since the first high-fidelity amplifier in the world appeared—designed and produced by us. Believe it or not, it was a push-pull amplifier with negative feedback. It had a flat response from 30 to 12,000 cps, and a power output of 10 watts, because even in those early days we believed in having a reserve of undistorted output power.

Today our 20 watt amplifier is still outstanding. With distortion of less than 1% at a power output of 20 watts, it is +1 db at 20 cps, -1 db at 60,000 cps, and dead flat from 30 to 50,000 cps. Hum level is -90 db. (that is, virtually non-existent), and it is absolutely free from incipient motor-boating or rf oscillation. These defects are frequently shown up with a 'scope and square-wave generator, and many amplifiers thought perfect may not pass this extreme test. Our amplifiers have to pass the test before they are sent out. Additionally, all our products are now comprehensively tested with white-noise.

Our tone-control preamplifier has won many friends in the U.S.A., as it has throughout the world. It has continuous control of treble and bass, and was designed to be the perfect corrector for LP records, taking everything else—78's, tape and radio—in its stride. There is no distortion at all in any position of the controls. Used with the 20 watt amplifier, it is as near perfect as you can ever hope to get an audio amplifying system.

BUT LOOK AT THE PRICE.

The 20 watt amplifier complete except for tubes (standard American types used) costs only \$110.00 (plus 12½% import duty) all freight charges paid. The Tone-control preamplifier similarly costs \$25.00. The legendary 215 speaker added to these at a cost of \$48.00 will give you an audio outfit which, to quote the words of our American visitors who have called to see us this summer, ends the search for many years to come, at a price level which on the face of it seems ridiculous. The best is not always the dearest.

★ ★ ★

Illustrated catalogue free on request, AND we shall be with you again at the Audio Fair in New York.

H. A. HARTLEY CO. LTD.
152, Hammersmith Road
London W.6, England

ADVERTISING INDEX

Adcola Products Ltd.	77
Air-Tone Sound & Recording Co.	77
Allied Radio Corp.	60, 78
Altec Lansing Corp.	11
Amperite Co., Inc.	55
Ampex Electric Corp.	37
Amplifier Corp. of America	72
Arnold Engineering Corp., The	7
Arrow Electronics, Inc.	73
Astatic Corp., The	52
Atlas Sound Corp.	79
Audak Co.	49
Audio Devices, Inc.	Cover 2
Audio Instrument Co.	72
Audio Fair, The	62
Belden Manufacturing Co.	13
Bell Telephone Laboratories	18
Berlant Associates	78
Camera Equipment Co.	59
Chicago Transformer Co.	54
Cinema Engineering Co.	6
Classified Ads	78
Electro-Voice	41
Electronic Center, Inc.	79
Empire Recording Co.	79
Fisher Radio Corp.	53
Garr, E.	76
Garrard Sales Corp.	3
Gately Development Laboratory	75
Gates Radio Co.	39
Harrison Radio Corp.	67
Hartley, H. A., Co. Ltd.	80
Harvey Radio Co., Inc.	45
Heath Co., The	71
High Fidelity Magazine	47
Hollywood Electronics	79
Hudson Radio & Television Corp.	68
Hughes Research & Development Laboratories	63
Jan Sound Distributing Co.	76
Jensen Manufacturing Co.	33
Kellogg Switchboard & Supply Co.	73
Kierulff & Co.	80
Lafayette Radio	58
Lansing Sound, James B., Inc.	77
Leonard Radio, Inc.	57
Magnecord, Inc.	61
McIntosh Engineering Laboratories, Inc.	69
Minnesota Mining & Manufacturing Co.	9
Orradio Industries, Inc.	Cover 3
Ozarks Wood Products Co.	64
Partridge Transformers Ltd.	80
Precision Electronics, Inc.	67
Pickering & Co., Inc.	17
Precision Film Laboratories, Inc.	14
Presto Recording Corp.	43
Professional Directory	79
Radio Corp. of America	4, 5
Reeves Equipment Corp.	72
Rek-O-Kut Co.	12
River Edge Industries, Inc.	69
Rockbar Corp.	15
Shallcross Manufacturing Co.	1
Shure Brothers, Inc.	51
Stromberg-Carlson	35
tapeMaster, Inc.	10
Terminal Radio Corp.	70
Thermador Electrical Manufacturing Co.	2
Tung-Sol Electric, Inc.	8
U. S. Recording Co.	79
United Transformer Corp.	Cover 4
Weathers Industries	71
Wholesale Radio Parts Co., Inc.	74

PARTRIDGE WILLIAMSON OUTPUT TRANSFORMER

*Built to the
original specification*

De-luxe model now available from stock from all important Radio Stores throughout the U.S.A. (Price \$26.00 duty paid)

This transformer is now accepted as the most efficient in the world. According to "Audio Engineering" (Nov. 1949), there is no U.S. equivalent. Thousands already sold in the U.S.A.

Partridge P.1292 16 watt Output Transformer now available is intended for use in equipment reproducing the full audio frequency range with the lowest possible distortion.

Series leakage inductance .10 mh.
(Price \$21.00 duty paid.)

The Following Stores are among those now Stocking Partridge Transformers.

Harvey Radio Co. Inc.	Electronic Wholesalers
103 West 43rd Street,	Inc.
New York 18.	2345 Sherman Ave.,
	Washington, D. C.
Sun Radio Corp.,	Gates Radio Company,
938 F Street, N.W.,	2700 Polk Avenue,
Washington, D. C.	Houston, Texas.
Gates Radio Company,	Wholesale Radio Parts
Quincy, Illinois.	Co. Inc.
Terminal Radio Corp.,	311 W. Baltimore St.,
85 Cortlandt Street,	Baltimore 1, Maryland.
New York 7.	

Sole Agents in Canada: Atlas Radio Corporation, 560 King Street West, Toronto 2-B.

If you are unable to purchase Partridge transformers in your city, write to us and mention the name of your dealer.

Full test data, including square-wave tests, distortion curves, etc., together with list of U. S. stockists rushed Air Mail to you.

PARTRIDGE TRANSFORMERS LTD.
TOLWORTH, SURREY, ENGLAND

Hear the New

**Altec
DUPLEX
Speakers**



See the New

"AUDIOPHILE HAVEN"

within our famous

"AUDIO WORKSHOP"

**KIERULFF
SOUND CORP.**

820 W. Olympic Blvd.

Los Angeles 15, Calif. • RI 7-0271

AT LAST!

no more unscheduled program breaks!

irish SOUND-PLATE

AN ENTIRELY NEW MAGNETIC RECORDING TAPE

It's break-proof...just what you've been wanting



(Produced and Sold Under the
IRISH Label as 220RPA Red Band
ORRadio Magnetic Tape)

No Other Tape Matches These Sound-Plate Features:

- SOUND-PLATE** has two times the tensile strength of acetate
- SOUND-PLATE** will not tear or break
- SOUND-PLATE** eliminates timing problems —programs on the nose
- SOUND-PLATE** is unaffected by moisture or temperature change
- SOUND-PLATE** is engineered for high speed operation, 15 to 500" per sec
- SOUND-PLATE** is not affected by static
- SOUND-PLATE** has a greater surface slip

Another Reason WHY SOUND-PLATE is Best For Professional Use!

There are differences in magnetic oxides. ORRadio molecular lubricated oxides are more stable in coating conditions and turn out more uniform dispersions, thus assuring you of the finest recordings possible. SOUND-PLATE is made in the ORRadio tradition.

Here, at last, the sum total of everything you have ever wanted in a professional magnetic recording tape. ORRadio IRISH 220RPA SOUND-PLATE eliminates your physical problems in magnetic tape recordings. It won't tear or break. It has all the excellent qualities that have made ORRadio IRISH 211RPA the most popular tape among professional engineers.

Yes, SOUND-PLATE costs a little more . . . but, in the long run, it will prove to be not only the most satisfactory, but the most economical magnetic recording tape you can use.

Try SOUND-PLATE at our expense! Buy a reel of SOUND-PLATE at your favorite Radio Parts Distributor. If you are not completely satisfied, return it to your distributor who has been authorized to refund your money.

1200 Ft. SOUND-PLATE on Plastic Reel	\$15.50 List	2400 Ft. SOUND-PLATE on Metal Reel	\$33.85
--	--------------	--	---------

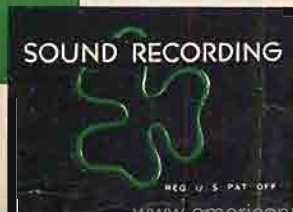

Manufactured in U.S.A. by
ORRadio INDUSTRIES, INC. OPELIKA, ALABAMA
World's Largest Exclusive Magnetic Tape Manufacturer



for Stock Hermetically Sealed Components

For over fifteen years UTC has been the largest supplier of transformer components for military applications, to customer specifications. Listed below are a number of types, to latest military specifications, which are now catalogued as UTC stock items.



RCOF CASE

Length1 25/64
Width1 61/64
Height1 13/32
Mounting1 1/8
Screws4-40 FIL.
Cutout7/8 Dia.
Unit Weight1.5 oz.



RC-50 CASE

Length1 5/8
Width1 5/8
Height2 5/16
Mounting1 5/16
Screws#6-32
Cutout1 1/2 Dia.
Unit Weight8 oz.



SM CASE

Length11/16
Width1/2
Height29/32
Screw4-40 FIL.
Unit Weight8 oz.

The impedance ratings are listed in standard manner. Obviously, a transformer with a 15,000 ohm primary impedance can operate from a tube representing a source impedance of 7700 ohms, etc. In addition, transformers can be used for applications differing considerably from those shown, keeping in mind that impedance ratio is constant. Lower source impedance will improve response and level ratings... higher source impedance will reduce frequency range and level rating.

MINIATURE AUDIO UNITS...RCOF CASE

Type No.	Application	MIL Type	Pri. Imp. Ohms	Sec. Imp. Ohms	DC in Pri., MA	Response \pm 2db. (Cyc.)	Max. level dbm	List Price
H-1	Mike, pickup, line to grid	TF1A10YY	50,200 CT, 500 CT*	50,000	0	50-10,000	+ 5	\$16.50
H-2	Mike to grid	TF1A11YY	82	135,000	50	250-8,000	+21	16.00
H-3	Single plate to single grid	TF1A15YY	15,000	60,000	0	50-10,000	+ 6	13.50
H-4	Single plate to single grid, DC in Pri.	TF1A15YY	15,000	60,000	4	200-10,000	+14	13.50
H-5	Single plate to P.P. grids	TF1A15YY	15,000	95,000 CT	0	50-10,000	+ 5	15.50
H-6	Single plate to P.P. grids, DC in Pri.	TF1A15YY	15,000	95,000 split	4	200-10,000	+11	16.00
H-7	Single or P.P. plates to line	TF1A13YY	20,000 CT	150/600	4	200-10,000	+21	16.50
H-8	Mixing and matching	TF1A16YY	150/600	600 CT	0	50-10,000	+ 8	15.50
H-9	82/41:1 input to grid	TF1A10YY	150/600	1 meg.	0	200-3,000 (4db.)	+10	16.50
H-10	10:1 single plate to single grid	TF1A15YY	10,000	1 meg.	0	200-3,000 (4db.)	+10	15.00
H-11	Reactor	TF1A20YY	300 Henries-0 DC, 50 Henries-3 Ma. DC, 6,000 Ohms.					12.00

COMPACT AUDIO UNITS...RC-50 CASE

Type No.	Application	MIL Type	Pri. Imp. Ohms	Sec. Imp. Ohms	DC in Pri., MA	Response \pm 2db. (Cyc.)	Max. level dbm	List Price
H-20	Single plate to 2 grids, can also be used for P.P. plates	TF1A15YY	15,000 split	80,000 split	0	30-20,000	+12	\$20.00
H-21	Single plate to P.P. grids, DC in Pri.	TF1A15YY	15,000	80,000 split	8	100-20,000	+23	23.00
H-22	Single plate to multiple line	TF1A13YY	15,000	50/200, 125/500**	8	50-20,000	+23	21.00
H-23	P.P. plates to multiple line	TF1A13YY	30,000 split	50/200, 125/500**	8	30-20,000 BAL.	+19	20.00
H-24	Reactor	TF1A20YY	450 Hys.-0 DC, 250 Hys.-5 Ma. DC, 6000 ohms ... 65 Hys.-10 Ma. DC, 1500 ohms.					15.00

SUBMINIATURE AUDIO UNITS...SM CASE

Type No.	Application	MIL Type	Pri. Imp. Ohms	Sec. Imp. Ohms	DC in Pri., MA	Response \pm 2db. (Cyc.)	Max. level dbm	List Price
H-30	input to grid	TF1A10YY	50***	62,500	0	150-10,000	+13	\$13.00
H-31	Single plate to single grid, 3:1	TF1A15YY	10,000	90,000	0	300-10,000	+13	13.00
H-32	Single plate to line	TF1A13YY	10,000****	200	3	300-10,000	+13	13.00
H-33	Single plate to low impedance	TF1A13YY	30,000	50	1	300-10,000	+15	13.00
H-34	Single plate to low impedance	TF1A13YY	100,000	60	.5	300-10,000	+ 6	13.00
H-35	Reactor	TF1A20YY	100 Henries-0 DC, 50 Henries-1 Ma. DC, 4,400 ohms.					11.00

* 200 ohm termination can be used for 150 ohms or 250 ohms, 500 ohm termination can be used for 600 ohms.

** 200 ohm termination can be used for 150 ohms or 250 ohms, 125/500 ohm termination can be used for 150/600 ohms.

*** can be used with higher source impedances, with corresponding reduction in frequency range. With 200 ohm source, secondary impedance becomes 250,000 ohms... loaded response is -4 db. at 300 cycles.

**** can be used for 500 ohm load... 25,000 ohm primary impedance... 1.5 Ma. DC.

United Transformer Corp.

150 VARICK STREET

NEW YORK 13, N. Y.

EXPORT DIVISION: 13 EAST 40th STREET, NEW YORK 16, N. Y.

CABLES: "ARLAB"