

AUDIO

AUGUST / 1964

60¢

...the original magazine about high fidelity!

**ANNUAL
PRODUCT
Preview
ISSUE**

**ANNUAL
PRODUCT
Preview
ISSUE**

**PRODUCT
Preview**

**ANNUAL
PRODUCT
Preview
ISSUE**

NEW SCOTT TRANSISTOR TUNER BRINGS MAJOR IMPROVEMENT TO FM LISTENING

... AND YOU CAN OWN ONE FOR ONLY \$259.95

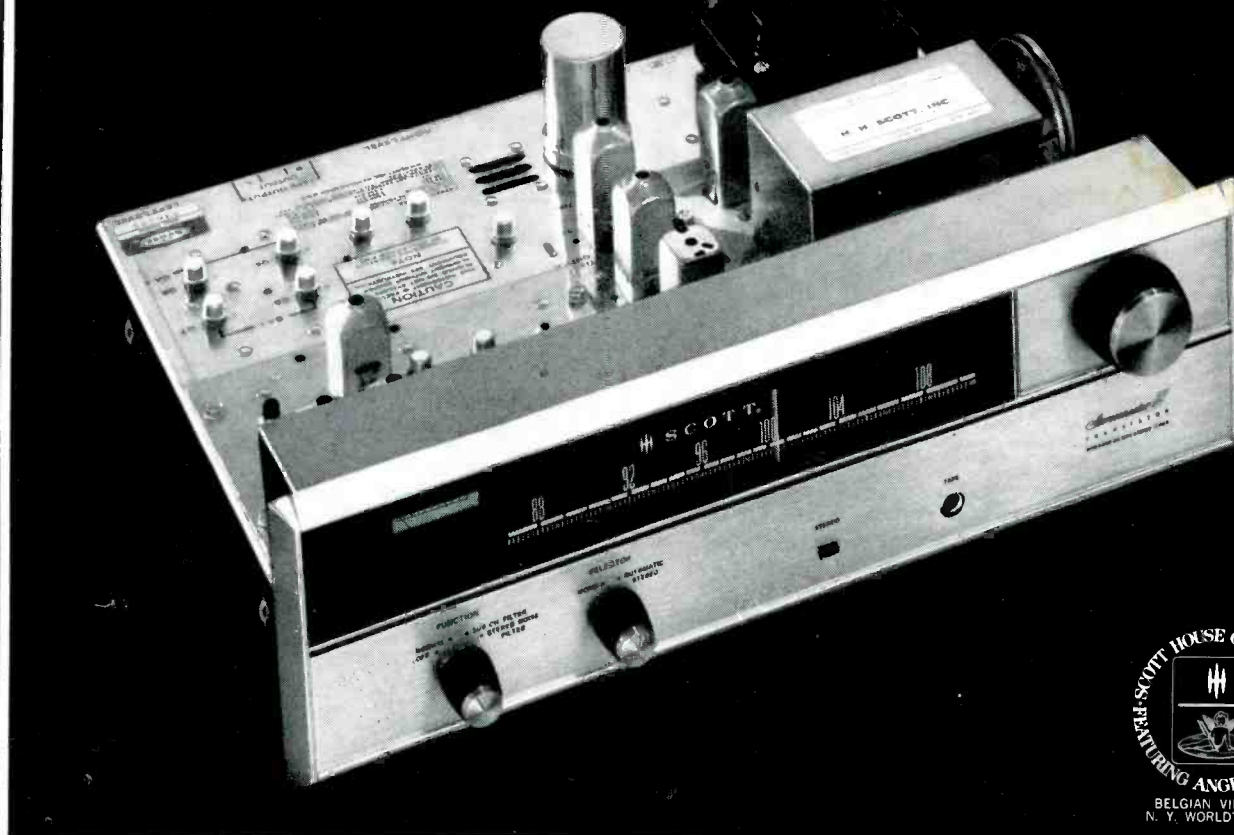

Great news! Scott announces a top-performing solid-state FM stereo tuner at a modest price . . . a no-compromise tuner that exceeds the performance of conventional tube units, and is factory guaranteed for two full years. ■ The superb per-

formance of the new Scott 312 required an entirely new approach to tuner circuit design . . . not just a simple substitution of transistors for tubes . . . it meant not just one, but six major engineering innovations. A few of these are shown below:



Exclusive "Comparatron" provides foolproof silent automatic stereo switching. Momentary changes in signal strength will not cause stereo to switch in and out as do ordinary automatic devices.

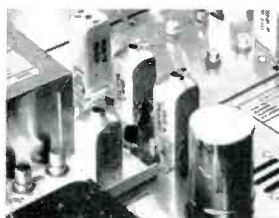

"Flat Line Limiting" circuits assure quiet noise-free FM reception, impervious to pulses caused by automobile ignitions, refrigerators, apartment house elevators, and other electrical noises.



New Scott silver-plated four-nuovistor front end outperforms even the best conventional vacuum tube front ends. Nuovistors provide greater reliability, longer life, and guaranteed stability over years of use.

SPECIFICATIONS: IHFM usable sensitivity (minimum) 2.2 μ v; signal-to-noise ratio: 65 db; distortion: under 0.8%; drift: less than 0.02"; frequency response (in stereo): \pm 1 db, 30-15,000 cycles; capture ratio: 4 db; selectivity: 30 db; cross modulation rejection: 80 db; AM suppression: 55 db; accuracy of calibration: 0.5%; separation: 35 db, an outstanding design accomplishment. Dimensions 15 1/2" w x 5 1/2" h x 13 1/4" d in optional accessory case.

*These are the limits prescribed by the FCC. All Scott tuners will exceed these frequencies.

Export: Scott International, 111 Powdermill Road, Maynard, Massachusetts. Canada: Atlas Radio Corp., 50 Wingold Avenue, Toronto. Cable HIFI

IMPORTANT FREE OFFER FROM SCOTT

• H. H. SCOTT, INC.
• 111 Powdermill Rd.
• Department 35-08
• Maynard, Mass.

• Please rush me your free booklet, "A New Era in FM" explaining how you can get better FM reception with these new solid state circuits, and complete specifications on the Scott 312 solid state FM Stereo tuner.

• Name.....
• Address.....
• City.....
• State..... Zip Code.....



Circle 100 on Reader Service Card

AUDIO

AUGUST, 1964 Vol. 48, No. 8

Successor to **RADIO**, Est. 1917

C. G. McPROUD • *Publisher*

DAVID SASLAW • *Editor*

JANET M. DURGIN
Production Manager

Contributing Editors

EDWARD TATNALL CANBY

JOSEPH GIOVANELLI

HAROLD LAWRENCE

CHESTER SANTON

HERMAN BURSTEIN

BERTRAM STANLEIGH

HENRY A. SCHOBER
Business Manager

SANFORD L. CAHN
Advertising Director

EDGAR E. NEWMAN
Circulation Director

Representatives

Bill Pattis & Associates,
4761 West Touhy Ave.,
Lincolnwood 46, Ill.

James C. Galloway,
6535 Wilshire Blvd.,
Los Angeles 48, Calif.

Warren Birkenhead, Inc.,
No. 25, 2-chome, Shiba Hama-
matsu-cho,
Minato-ku, Tokyo, Japan

AUDIO Articles

A Basic Course in Commercial Sound— Chapter 5	19
Class-D for Efficiency— In Three Parts—Part 3	23

Norman Crowhurst

Peter A. Stark

AUDIO Reviews

Light Listening	6
Record Revue	82
Jazz and All that	93

Chester Santon

Edward Tatnall Canby

Bertram Stanleigh

PRODUCT PREVIEW SECTION 28

A1—Basic Amplifier	30	A15—Loudspeaker Mechanism	45
A2—Basic Amplifier Kit	31	A16—Large Speaker Systems	48
A3—Preamplifier	32	A17—Small Speaker Systems	52
A4—Preamplifier Kit	33	A18—Tape Recorders	58
A5—Integrated Amp	33	A19—Microphones	67
A6—Integrated Amp Kit	35	A20—Headphones	72
A7—Tuner—FM, AM or AM-FM	36	A21—Miscellaneous	74
A8—Tuner Kit—FM, AM or AM-FM	37	Commercial Sound	84
A9—Tuner-Amp (Receiver)	38	CS1—Amplifiers and Controls	84
A10—Tuner-Amp Kit (Receiver)	40	CS2—Receivers	87
A11—Phono Pickup Cartridge	40	CS3—Microphones	87
A12—Phono Pickup Arm (Tonearm)	42	CS4—Speakers	87
A13—Turntable—Without Arm	43	CS5—Miscellaneous	91
A14—Turntable—With Arm (Changer)	44		

AUDIO in General

Audioclinic	2
Letters	8
Audio ETC	10
About Music	14
Editor's Review	16
Industry Notes	97

Joseph Giovanelli

Leo Beranek

Harold Lawrence

Number 12 in a series of discussions
by *Electro-Voice engineers*



The Electro-Voice commitment to outer space technology started with a telephone call shortly after the first sub-orbital space flight. Excessive hum from the 400 cps alternators in the capsule had seriously interfered with communications, and an answer to this problem was desperately needed.

Within four days, the first prototype of the microphone that would eventually be first to enter orbit was delivered for preliminary evaluation. The microphone was a modification of a standard noise cancelling design, no larger than a quarter, then being produced for the U.S. Air Force.

But in order to fully meet the unique demands of space flight, special plating methods had to be developed, and materials had to be specified that would remain inert despite extremely high temperatures and a 100% oxygen atmosphere. In addition the microphone had to remain fully operative under 30G forces. Interestingly, a standard E-V PA speaker and the microphone under test both withstood the full force of a 50G centrifuge during development of the space microphone.

The E-V microphone quickly proved its mettle in testing, and became standard equipment for the Mercury space efforts. Despite its small size, however, a need was expressed for an even less obtrusive unit. To achieve this, the bulk of the microphone element was moved into the astronaut's helmet, leaving a boom no thicker than a pencil extending to his mouth. Full noise canceling was maintained despite the unusual shape, a tribute to the E-V experience that originally developed this vital communications feature.

This new space microphone is currently specified for the Gemini and Apollo space programs now in preparation. Another product, still under study, is a complete headset for use when the astronaut's helmet is removed. This tiny unit folds into a packet smaller than a pack of cigarettes, yet provides full communications capability for the astronaut.

E-V is proud of its ability to respond to the communications needs of our nation's space program. And we anticipate that the developments in this field will eventually find application in equally vital—though earthbound—audio installations.

For technical data on any E-V product, write:
ELECTRO-VOICE, INC., Dept. 843A
Buchanan, Michigan 49107



CIRCLE 103



AUDIO (title registered U. S. Pat. Off.) is published monthly by Radio Magazines, Inc., Henry A. Schober, President; C. G. McProud, Secretary. Executive and Editorial Offices, 204 Front St., Mineola, N. Y. Subscription rates—U. S., Possessions, Canada, and Mexico, 5.00 for one year, \$9.00 for two years; all other countries \$6.00 per year. Single copies 60¢. Printed in U.S.A. at 10 McGovern Ave., Lancaster, Pa. All rights reserved. Entire contents copyrighted 1964 by Radio Magazines, Inc. Second Class postage paid at Lancaster, Pa.



RADIO MAGAZINES, INC., P. O. Box 629, MINEOLA, N. Y.
Postmaster: Send Form 3579 to AUDIO, P. O. Box 629, Mineola, N. Y.

Coming

Testing

- Transient Generators for Audio Testing. John L. Grauer. Circuits are given for simple transient generators which can be inexpensively built to evaluate impulse response of audio equipment.

Construction

- Automatic Speaker Connector. Ronald L. Ives. Automatic method for connecting multiplicity of speakers throughout the house.

Commercial Sound

- Basic Course in Commercial Sound. Chapter VI discussing microphones. Norman Crowhurst.

Profiles

- Magnecord Tape Recorder, Model 1024.
- B & W Sine Wave Generator.

In the Sept. Issue

On the newsstands, at your favorite audio dealer's, or in your own mailbox.

AUDIO CLINIC

Joseph Giovanelli



Send questions to:

Joseph Giovanelli
2819 Newkirk Ave.
Brooklyn 26, N. Y.

Include stamped, self-addressed envelope.

Radio Frequency Interference in Home Music Systems

Q. My neighbor's has a citizen's band two-way radio in his car which is able to transmit on more than one frequency. It has enough power for a radius of at least 15 miles. He intends to install it into his house.

When he is sitting in his car in the driveway and transmitting, I receive his transmissions through my high fidelity system, regardless of the station I am tuned to, and regardless of my volume setting. Even when my FM tuner is turned off, he comes through in the same way. The only way I can shut him out is when I turn my pre-amplifier selector to phono instead of FM.

I have been told that if I had a tape recorder and tried to tape an FM broadcast, his transmission would come through on the tape. Is this true?

I would be interested in knowing about any device which he can use to stop interfering with my reception. If not, is there anything I can do that would solve the problem and not degrade my system in any way?

Also, do you know of any rules of responsibility pertaining to people who transmit this way? S. Neiditch, San Bernardino, California.

A. It is not always possible for the operator of Citizen's Radio Service equipment or, for that matter, the operator of Radio Amateur Service equipment to prevent interference, even when his equipment is in the best possible operating condition. The operator, however, is legally responsible for seeing that his equipment does not cause interference because of improper equipment design, poor maintenance, or poor operating procedure.

If a person is receiving from either of these classes of service, even though the transmitting equipment is operating perfectly, the law assumes that his own equipment is not designed, maintained, or operated correctly. It then becomes his responsibility to correct the condition. (For further information, contact the Federal Communications Commission, Washington, D. C., or the Federal Communications Commission radio inspector nearest you.)

In correcting this condition, good equipment grounding is often very important. (Sometimes grounding contributes nothing, but good installations should always be grounded as a matter of good practice. There are only a few rare instances where grounding high fidelity equipment impairs its performance.) Proper equipment operation demands that both your equipment and that of the interfering radio operator must

be grounded. The discussion that follows deals with the ideal method for obtaining a good ground.

If your home has earth around it, an excellent grounding system can be made by sinking 10-foot long copper rods into the ground to a depth of at least three feet. These rods should radiate outward like the spokes of a wheel and should be connected at the center. Run a heavy wire from this center junction to the equipment. In your case, more than 15 feet of wire will allow standing waves to form which will result in the equipment's being above ground by some r.f. potential. (The length of interconnecting cable is determined by the interfering signal. If lengths of line are used which are less than the critical one, no difficulty will be encountered.) If more than 15 feet of wire must be used to connect your equipment to ground, three separate pieces of interconnecting cable should be used, each cut to a different length. For example, one may be 22-foot long, the second 27-foot and the third 33-foot.

This grounding arrangement is the ideal one, but if it is not possible for you to use it, a waterpipe can serve the purpose. In that event three interconnecting cables of random length should be used even if the distance between your equipment and the water pipe is less than 15 feet.

Let us return to the problem of eliminating the unwanted interference you are experiencing. First, find out just how it is entering your equipment. Because it can be heard whether the FM receiver is on or not, we know for certain that it is not picked up in the tuner. We do not know, however, if it is picked up when the antenna from the tuner is disconnected. It is remotely possible that the signal from the antenna is strong enough to re-radiate the interference directly into the amplifier. Therefore, disconnect the antenna from the tuner and see if the interference persists. If not, a balanced, high-pass filter should be connected to the antenna and tuner or possibly between the antenna and transmission line. Such filters are commercially available.

If the interference still can be detected, possibly it is entering your equipment via the interconnecting cable between your tuner and preamplifier. To determine this, disconnect the cable from the preamplifier while the interfering station is transmitting. If the signal is coming into your system in this way, you can place an r.f. choke of about 750 mh in series with the "hot" lead of the cable. The choke should be mounted in a box which is grounded to the preamplifier. Possibly it can be mounted right on the preamplifier. If it cannot be mounted in this way, use a short wire to make this ground, the heavier the better. Use the shortest possible lengths of interconnecting cable between the box and the preamplifier and tuner. Ground the chassis of the tuner to the preamplifier chassis using as heavy a cable as possible, making the cable as short as possible.

If the interference is now attenuated but

consider this...with other units
now offering counterweighted tone arms,
oversized turntables, precision motors...
what makes the Garrard

so special?

You see before you three parts of the great Type A Automatic Turntable:

1. The counterweight-adjusted, dynamically balanced tone arm (which tracks the cartridge of your choice at the lowest pressure specified by the manufacturer).
2. The exclusive "sandwich" turntable system (a) ribbed rubber mat (b) heavy, cast, non-ferrous outer turntable (c) sound-deadening foam cushion (d) inner drive table...the entire assembly weighted and balanced for rumble-free, fly-wheel action.
3. The Laboratory Series® humless, noiseless, high-torque motor...developed for the Type A, engineered and built by Garrard.

However, these are only parts, and record playing units by other manufacturers offer some features reminiscent of these.

Then what makes the Garrard so special? Simply this...the Garrard is far more than the sum of its parts.

Creative engineering, rigid quality control, and 50 years of experience have joined together to make the Garrard an enduring source of satisfaction and pride to a legion of sophisticated admirers.

You'll find the Garrard a genuine pleasure to own. Over the years, your dealer has found it the same pleasure to recommend. That's why more people continue to buy Garrard than any other high fidelity component. They buy it for precision, for performance and to enjoy the convenience of single and automatic play, both at their fingertips.

But mainly, they buy it because it's a Garrard, and those who really know fine equipment have confirmed that a Garrard is indeed something special.

There is a Garrard Automatic Turntable for every high fidelity system. Type A, \$84.50; AT6, \$59.50; Autosim, \$44.50. For literature, write Dept. GK-14, Garrard, Port Washington, N.Y.



Garrard[®]
World's Finest

Circle 104 on Reader Service Card

DYNAMIC NEWS FROM ALTEC

2 New Microphones Expressly for Professional Use

Two new studio dynamics—Altec 688A Omnidirectional; Altec 689A Cardioid—have been developed by Altec specifically for broadcast, recording, and TV use. Part of the famed Altec Series 680, these microphones offer maximal characteristics to meet and exceed the strictest professional recording and broadcast standards. Each is equipped with the exclusive Altec "Golden Diaphragm" which is not only extremely rugged in use but which also contributes inherent low resonance qualities and peak-free response. These two new microphones plus Altec's famed M20 Omnidirectional Condenser Microphone System and M30 Cardioid Condenser Microphone System now offer the industry superb qualities and characteristics to meet any and all requirements that can be imagined.

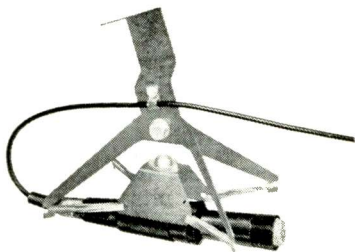

ALTEC 688A OMNIDIRECTIONAL DYNAMIC MICROPHONE—\$90 net. Extremely uniform response from below 35 to over 20,000 cycles. Highly efficient. Low hum pickup. Shown in an Altec 181A Boom Mount. Output Impedance: 30/50, 150/250 and 20,000 ohms (selection by connections in microphone cable plug). Output Level: -55 dbm/10 dynes/cm². Hum: -120 db (Ref.: 10⁻³ Gauss). Dimensions: 1 1/8" diameter at top (1 1/2" largest diameter), 7 1/2" long not including plug. Weight: 8 ozs. (not including cable and plug).

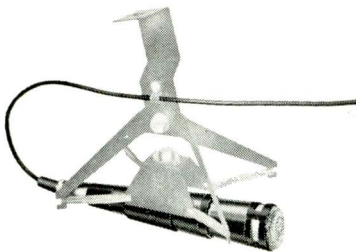

ALTEC 689A CARDIOID DYNAMIC MICROPHONE—\$108 net. High front-to-back discrimination for an average of over 20 db from 40 to over 16,000 cycles. Virtually flat response throughout this frequency range. Output Impedance: 30/50, 150/250 and 20,000 ohms (selection by connections in microphone cable plug). Output Level: -54 dbm/10 dynes/cm². Hum: -120 db (Ref.: 10⁻³ Gauss). Dimensions: 1 1/2" diameter at top, 7 1/4" long not including plug. Weight: 11 ozs. (not including cable and plug).

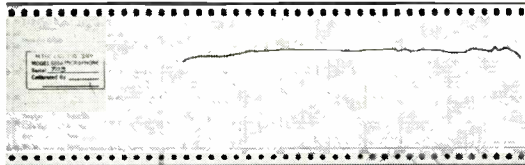

Each 688A and 689A microphone comes with its own individual response curve made by a Bruel & Kjaer servo-driven recorder in conjunction with an Altec anechoic chamber. The curve serves as a permanent record of the unit's response characteristics for immediate reference at any time required.



ALTEC M20 OMNIDIRECTIONAL CONDENSER MICROPHONE SYSTEM—\$233 complete with base, stand attachment, and power supply. This is the famous "Lipstik"—so named for its miniature size—the only American-made condenser on the market. The M20 provides the wide, uniform frequency response of a laboratory standard—an exceptional microphone for broadcast and recording of highest quality.

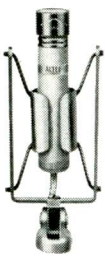

ALTEC M30 CARDIOID CONDENSER MICROPHONE SYSTEM—\$280 complete. This directional microphone offers the superb response characteristics of the condenser with the ruggedness and small size available only from Altec. 20 to 20,000 cycle range with better than 10 db front-to-back discrimination at the extremes, better than 20 db in the mid-range.

ANNOUNCING AN IMPORTANT NEW DIVISION AT ALTEC

The Audio Controls Division was recently organized at Altec Lansing Corp. The new division specializes in design and manufacture of precision attenuators, equalizers, filters, networks and switches, as well as custom consoles and associated products specifically for the recording and broadcast industries. It is headed by Arthur C. Davis, a Fellow of the AES and well-known in this field as a leading design engineer and manufacturer.

For specific engineering details and free demonstration, call your nearest Altec Distributor (see Yellow Pages) or write Dept. AM-8.



ALTEC LANSING CORPORATION
A Subsidiary of Ling-Temco-Vought, Inc.
ANAHEIM, CALIFORNIA

© 1964 ALTEC LANSING CORPORATION

Circle 105 on Reader Service Card

not quite eliminated, it can be eliminated or further attenuated as to be unimportant by using two small capacitors. They are to be mounted in the box along with the r.f. choke. Their value should be about 200 pf each, and one should be connected from each side of the choke to ground. The values are chosen to have reactances which are as low as possible to the interfering signal and as high as possible to audio frequencies.

It sometimes happens that this signal is picked up along the length of the speaker line. It then enters the feedback loop and is detected and amplified. You can determine this by disconnecting your speaker line from the amplifier and connecting the speaker to the amplifier with a line only a few inches long. If the interference disappears or is much attenuated, you will then know that you have found the trouble.

If this should be the method by which the interference is produced, you can bypass the output transformer terminals of your amplifier to ground with a 0.05 μ f capacitor. This capacitor should be a disc ceramic unit. It should not cause any deterioration of the sound produced by your amplifier because its reactance at audio frequencies is much higher than the impedance of the speakers.

It is possible that the interference is entering your equipment via some other interconnecting cable. If you have a television receiver or AM radio connected to your preamplifier, you should use the r.f. choke again, with the metal box and capacitors. In your particular case it is probably not being picked up in the cable connecting your preamplifier to the power amplifier, but sometimes this interference is picked up via that cable. Again, the r.f. choke, should be used. The box should be mounted to the amplifier.

Be sure to ground all chasses to the preamplifier with heavy wire and keep the grounding wires as short as possible. The preamplifier should be grounded to the waterpipe as described earlier.

It is sometimes necessary to bypass circuitry within the preamplifier in order to eliminate the trouble. Keep the values of such capacitors small, 20 pf or less so that the high-frequency characteristics of the preamplifier will not be degraded.

Sometimes interference is introduced into an amplifier via the a.c. line. Filters can easily be made, but are commercially available. They can be installed between the power line and your amplifier. These filters will eliminate r.f. pickup from the power line, but they will not eliminate such pickup via the line cord. Therefore, be sure that both sides of the a.c. line are bypassed to the chassis of your various pieces of equipment. An 0.02 μ f ceramic capacitor should be used for this purpose, 60 v d.c.

Keep all line cords rolled up if their full length is not required. Do not use extension cords if you can avoid them.

While your problem does not involve the phonograph portion of the equipment, this is, nevertheless an important source of r.f. pickup. To eliminate it, be sure that the tone arm is properly grounded to the preamplifier; be sure that the turntable is likewise grounded. Often signal enters the phonograph stage via the terminal strip used by many tonearm manufacturers. This strip should be enclosed in a metal container and the metal container grounded to the preamplifier.

Sometimes, but rarely, nothing can be done to eliminate the interference; the transmitter is just too close and too powerful. About all you can hope for is cooperation from the operator of the transmitter.

(Continued on page 12)

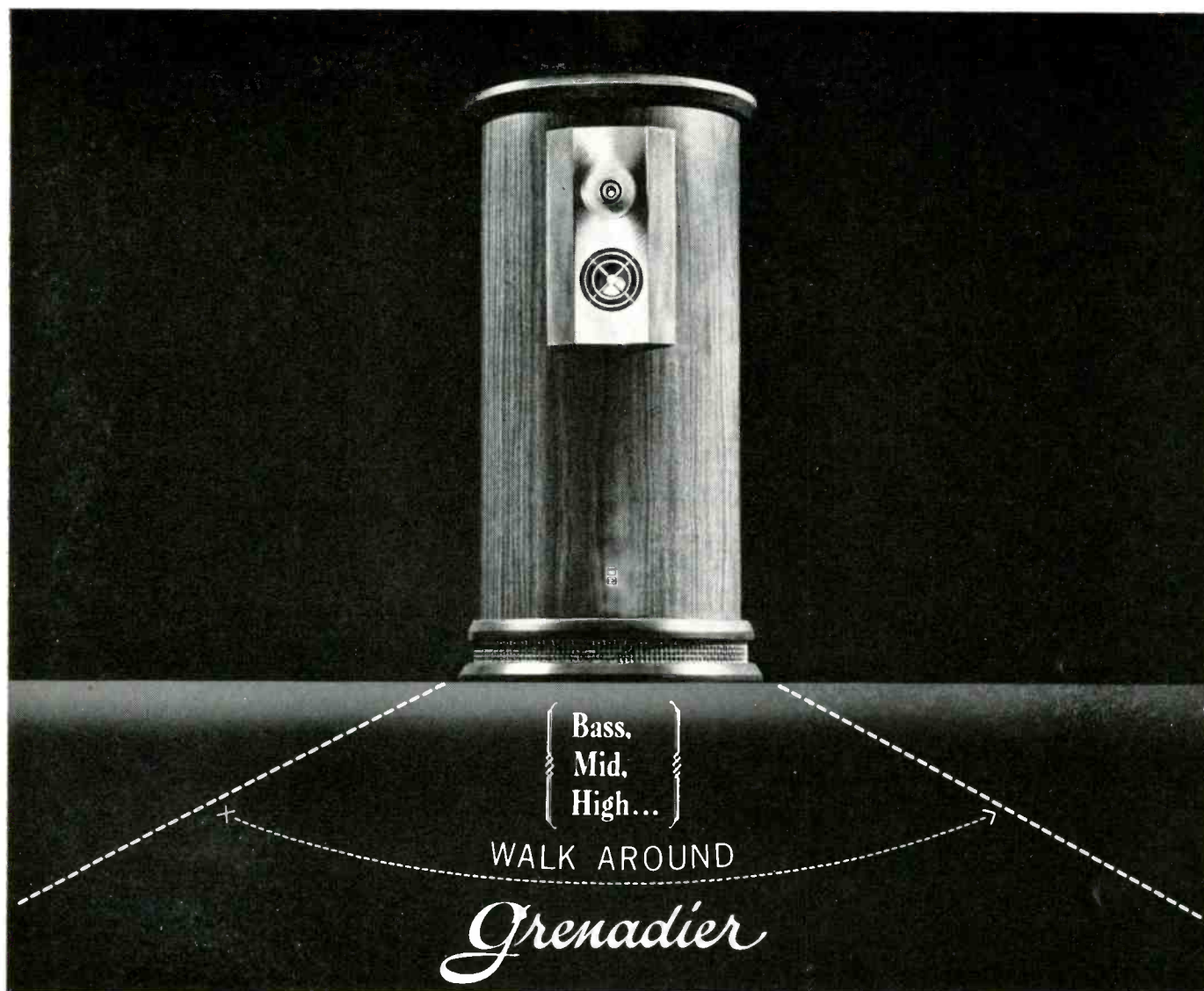

As Featured At The World's Fair Pavillion of American Interiors

If you don't believe all you
 have heard about the new Empire Grenadier...
 we urge you to try this simple test:

Walk around an arc in front of the Empire Grenadier Speaker. There is no change in sound level of bass, mid range and highs. *No matter where you are seated or standing, full frequency & separation is assured by the exclusive Empire divergent lens speaker system.*

No other speaker can make this statement! Some speakers will only have a narrow angle of high frequency sound propagation. Some speakers may have 2 or even 3 bands of high frequency sound. With these or other speakers, slight shifts of position, turning ones' head, or even leaning to one side may cause sharp changes in the listening

tone and level, thus losing the separation. We urge you to make the above comparison and when you're finished, you, too, will fully appreciate the phenomenal separation of the Empire Grenadier . . . the first speaker system designed and engineered for stereo. Lets you sit anywhere—hear everything. Need more? It has a mass loaded woofer with floating suspension and four inch voice coil, world's largest speaker ceramic magnet structure (18 lbs.) and a front loaded horn with 360° aperture throat.

For the complete story see your Hi-Fi dealer, or write

"World's Most Perfect High Fidelity Components" **EMPIRE**

Empire Scientific Corp. — 845 Stewart Ave., Garden City, L. I., N. Y. Export: EMEC, Plainview, L. I., N. Y. — Canada, Empire Scientific Corp., Ltd., 1476 Eglinton West, Toronto
 Circle 106 on Reader Service Card

Don't look at
the price
of this speaker
(until you've heard it)

It's hard to believe that any speaker selling for such a low price can possibly have the quality of the Sonotone "Beverly Hills." Consider: Two 8-inch coax speakers with clear, smooth response over the entire frequency range. New high-frequency cone radiator carries it up to 20,000 cps; acoustically matched enclosure extends it down to 45 cps.

These handsome cabinets are made of rigid warp-free 3/4" (non-resonant) panels with lock-mitered joints. The enclosure has a handsome oil walnut finish. The cabinets are lined with "Tufflex," a material proved most effective in reducing cabinet vibration.

The Sonotone "Beverly Hills" is ideal for budget-priced, high quality stereo systems. Now you can look at the price. It's only \$69.75 — but please hear it first. Also available — the "Scarsdale," single 8" coax in an oil walnut finish enclosure, \$49.75. At high fidelity dealers. Write for brochure (SAH-84).

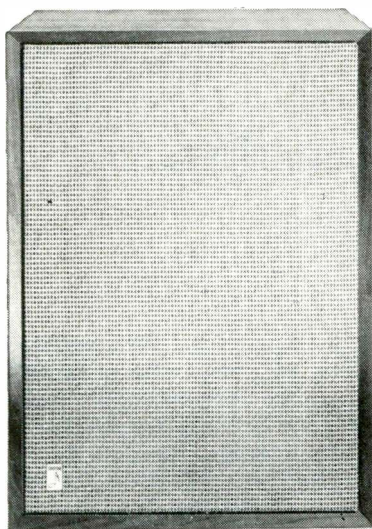

(\$69.75)

SONOTONE
audio products

Sonotone Corp., Electronic Applications Div., Elmsford, N. Y.

Circle 107

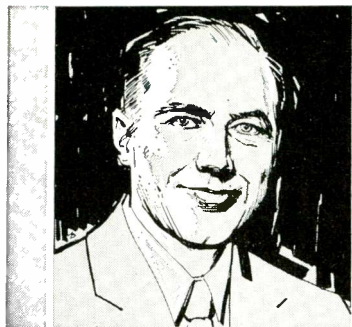

Hugo Montenegro: Russian Grandeur
RCA Victor LSP 2902

At this stage of the game it isn't easy to turn out recordings of light music that will impress the experienced stereophile. After all these years of extensive experiment and general fooling around (ultra distant or stiflingly close placement of microphones and wild side-to-side movement of sound source) there seems to be little left to say in the way of innovation. The fact that RCA is trying to say something new in this recording made in their Hollywood studios can be traced pretty much to the efforts of Al Schmitt, the producer of the album. Before taking over production duties on the RCA Victor staff, Schmitt had garnered considerable renown in the industry as a top-notch recording engineer for that label's West Coast operation. He has some striking arrangements for chorus and orchestra to handle in this release but the truly novel decisions at this recording session were made in the control room. We'll go into them after a brief description of the material being recorded.

Hugo Montenegro has been a high-powered musical attraction on the Time label in recent years. To celebrate his return to the Victor organization, he has put together a fine collection of melodies based on well known themes from Russian symphonies and concertos. A forty-piece orchestra and a mixed chorus have been scattered over a large studio to lend new effects to *Sabre Dance*, *Meadowland*, *Tchaikovsky's Story of a Starry Night* and the famous *Full Moon and Empty Arms* that first appeared as part of a Rachmaninoff piano concerto. The daring feature of the recording, impressive to this listener at any rate, is Al Schmitt's decision not to bring up the gain in these arrangements whenever they call for occasional use of extremely low levels of sound from chorus or orchestra. On the basis of what I hear on this stereo disc, the VU meters must have been virtually immobile at their left side during many of the distant effects Montenegro creates here yet the signal, however faint, comes through with remarkably little background noise in the groove. These passages betray, if nothing else, Al Schmitt's precise knowledge of the type of very low-noise pressing RCA's plants can deliver at this juncture. If you have recently installed an up-to-the-minute stereo cartridge in a top design tone arm, latch on to this disc for a quick check on the noise level of your new combination. A record with so small an amount of monitoring in the low-level passages is quite a rarity these days.

Anyone Can Whistle (Original Broadway Cast)

Columbia KOS 2480

If you purchase your records from a cautious dealer, this show album may not even be in his stock "Anyone Can Whistle" closed on Broadway after only a few performances. Most of the opening night notices were so uncomplimentary it will be a rare dealer indeed who decides to stock this album in depth. Columbia Records, committed to the release of the album months before opening night, decided to put the best possible face on a difficult matter in the hope that the score would find at least a few supporters among home listeners. In so doing the label has placed much stress in its publicity on the success of Leonard Bernstein's "Candide," another musical on Columbia Records that has done quite well in the home after flopping on Broadway. Unfortunately for all concerned, "Anyone Can

LIGHT LISTENING

Chester Santon

"Whistle" is saddled with a score that doesn't come within miles of "Candide." It's easy to see where the backers of the show and Columbia placed considerable faith in the production while it was still in the formative stage. The music and lyrics are by Stephen Sondheim, a distinguished talent who contributed the lyrics of "West Side Story" and "Gypsy" and wrote both music and lyrics for "A Funny Thing Happened on the Way to the Forum." Equally impressive to the persons putting up the money for "Anyone Can Whistle" was the fact that the book for the show was by Arthur Laurents who collaborated in a similar capacity with Sondheim in "Gypsy" and "West Side Story." Neither did the latest Sondheim-Laurents effort suffer from a lack of name power on the theatre marquee. Angela Lansbury, Lee Remick and Harry Guardino appear in the starring roles but they can do very little in pulling together a chaotic plot that attempts a biting commentary on contemporary American values only to chew itself up in the process. The story seems too farfetched to allow the uninspired songs to make any point worth remembering. It would take voices much better than those of Miss Remick or Miss Lansbury to bring out any significant appeal in the songs they handle. The title tune could barely be considered a candidate for an almost average Broadway musical of recent times. The rest of the recording, even if you succeed in figuring out the action of the plot, contains very little that you'd ever wish to hear a second time.

New Christy Minstrels: Today
Columbia CS 8959

Here's movie music with a difference. Metro-Goldwyn-Mayer has introduced several innovations in its production of an off-beat Civil War opus called "Advance to the Rear." As the name of the story indicates, the usual heroics of a war film have been bypassed and the action centers instead on the comic adventures of a group of misfits within the ranks of the Union Army. (Since the North did win the war, it is less apt to raise objections to a reminder of conditions that probably existed on both sides of the lines.) Another groundbreaking element in the picture is the musical score composed by Randy Sparks and sung and played by the New Christy Minstrels under his direction. This is alleged to be the first time a folk group has been used to score an entire motion picture and also the first time that original folk songs have been created for any film. If true, such an event should erase any remaining doubts about the arrival of folk music of the Christy type in big time show business.

The voices of the two girls and seven men comprising this crackerjack group are backed up in this release by much more than their usual compliment of stringed instruments. Responding to the challenge of the film medium, the Minstrels have added half a carload of noise makers for this special project, some of them almost extinct because they go back to the "musical" life of the untutored layman in 19th Century America. A narxophone, auto-harp, okelin, mondo-cello and double bass tiddle are to be found among the supposedly common items of that day. The ballads, marches, novelties and riverboat songs drawn from the music of the era come across with a new freshness when the Christy ensemble applies its enthusiasm to the job. Columbia's sound is heavy with what its promotion department may consider a "vibrant" quality. Most of us, alas, will merely put it down as excessive baking in an echo chamber. **BE**

We don't need to tell you a thing about the Fisher Laboratory Standard amplifier system.

Just read the specifications:

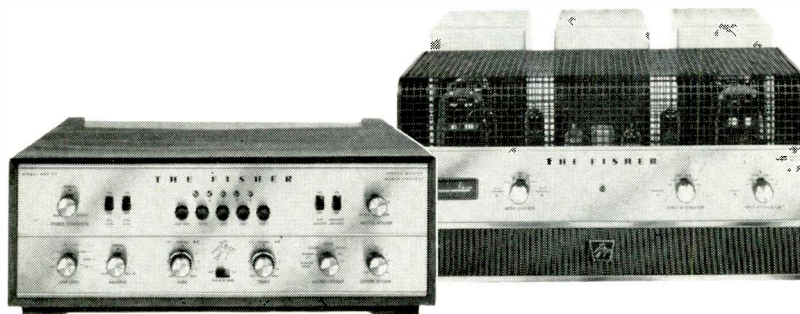

The Fisher 400-CX Stereo Master Control and Preamplifier

- 18 inputs; 22 controls and switches.
- Facilities for up to 8 separate stereo program sources.
- ± 1 db from 20 to 25,000 cps.
- 0.04% harmonic distortion at 2.5 volts output.
- -80 db hum and noise.
- 1.5 mv sensitivity on tape head; 2.8 mv on phono.
- Special stereo dimension control for diminishing or augmenting stereo effect.
- Exclusive Fisher DIRECT TAPE MONITOR.*
- Exclusive *sonic null balancing* for perfect left-right acoustic balance by simple electronic means.
- CONTROLS: Push-Button Selector (Low Level, Tuner, Tape Recorder, Auxiliary 1, Auxiliary 2); Low Level Selector (Microphone, 3 $\frac{3}{4}$ ips, 7 $\frac{1}{2}$ ips, 78 rpm, Col.-1, RIAA-1, RIAA-2, Col.-2); Balance; Stereo Dimension; Left/Right Bass (concentric); Left/Right Treble (concentric); Mono/Stereo (Balance Right, Balance Left, Reverse, Stereo, Mono Phono, A, B); Volume; Center Volume.
- SWITCHES (On/Off): Low Filter; High Filter; Tape Monitor; Loudness Contour; Phase Reverse.
- Size: 15 $\frac{1}{8}$ " wide, 4 $\frac{13}{16}$ " high, 12" deep.
- Weight: 18 lbs.
- Price: \$199.50 (walnut cabinet, \$24.95; metal cabinet, \$15.95). *PATENT PENDING

The Fisher SA-1000 Stereo Power Amplifier

- 150 watts IHF music power output (both channels driven).
 - 65 watts per channel RMS output (conservatively rated).
 - 0.25% harmonic distortion at 1 kc at rated output.
 - 0.5% IM distortion at 80 watts per channel.
 - ± 1 db from 8 to 48,000 cps.
 - -90 db hum and noise at rated output.
 - 0.7 to 2.75 volts input sensitivity, variable via oscilloscope-type attenuator.
 - Switchable subsonic filter.
 - D'Arsonval-type calibration meter.
 - Size: 15 $\frac{1}{8}$ " wide, 7 $\frac{3}{4}$ " high, 12" deep.
 - Weight: 70 lbs.
 - Price: \$329.50.
- (Also available in kit form as K-1000 StrataKit, \$279.50.)

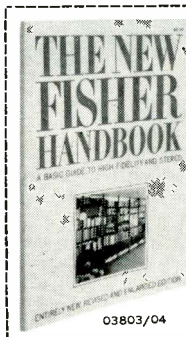

FREE! \$2.00 VALUE! Send for your free copy of *The New Fisher Handbook*. This entirely new, revised and enlarged edition of the famous Fisher high fidelity reference guide is a magnificent 76-page book. Detailed information on all Fisher components is included.

Fisher Radio Corporation
21-40 44th Drive
Long Island City, N. Y. 11101

Name _____

Address _____

City _____ State _____

OVERSEAS RESIDENTS PLEASE WRITE TO FISHER RADIO INTERNATIONAL, INC., LONG ISLAND CITY, N. Y. 11101

CANADIAN RESIDENTS WRITE TO TRI-TEL ASSOCIATES, LTD., WILLOWDALE, ONT.

The Fisher

Circle 108 on Reader Service Card

INTRODUCING AMERICAN'S NEW "DOUBLE DUTY"

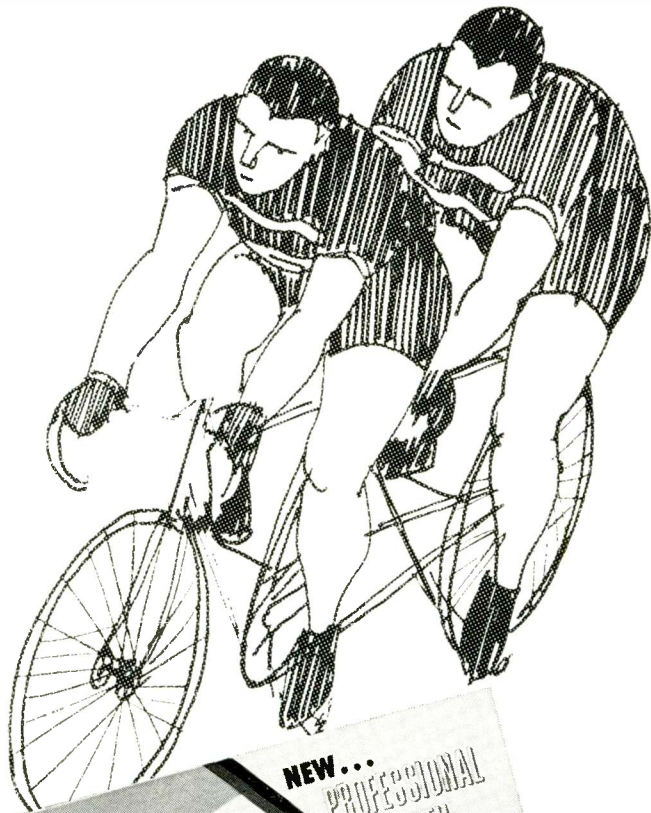

EXTRA STRENGTH PLUS EXTRA LENGTH

Now from the company whose Professional Length Series revolutionized the recording tape industry comes the STRONGEST double-length recording tape in the world, American brand's new DOUBLE DUTY, 2400 feet of 3/4 mil tensilized mylar on the standard seven inch reel.

Designed to eliminate the possibilities of breaking, stretching, and print-through, American's new 3/4 mil DOUBLE DUTY is easier to handle, has 50% more tensile strength than comparable tapes and costs no more.

See your dealer or write to:

GREENTREE  **ELECTRONICS** 291 S. LA CIENEGA BOULEVARD
BEVERLY HILLS, CALIFORNIA

Circle 109 on Reader Service Card

LETTERS

Multiple Speaker Systems

SIR:

It is a pity that the multiple speaker system is still such a controversial subject, or, as Mr. Oakley Jr. so aptly remarked in "An Open Baffle Paralle-series Array," (Dec. 1963) one of which the stock has risen or fallen as different authors voiced their opinions and presented their facts and findings, since this has undoubtedly prevented quite a few experimenters from trying same for themselves.

As one who has experimented a little with the loudspeaker array (one in use since 1960), I actually feel unqualified to make a statement, having had to limit my tests mostly to comparative listening.

May I, however, call your attention to another possible hook-up of the loudspeaker array. As is known, the main difficulty in obtaining good bass response from such a system lies in the rather high fundamental resonance of the average 6-inch loudspeaker of the radio-replacement type, also that most experts recommend the use of models with resonances staggered at least half an octave apart (stating at the same time that this would be quite outside the normal 10 percent manufacturing tolerance). Why not use a system of models with dissimilar sizes? For instance one like I have used since 1960 (see Fig. 1). Having a power distribution which is proportional to the ratings of the respective models, an array like this (or a more elaborate one) will also increase the piston's radiating area and displaced volume, thus lowering the low-frequency cut-off of the system. As regards the necessary housing for such an array? A modification of either the Baruch-Lang model (*Popular Science*) or the one described by Mr. Augspurger in *Electronic World* (double-chambered and triple-ducted) will further improve the bass response.

B. THE
c/o Djl. Lembah 78
Makassar, Indonesia

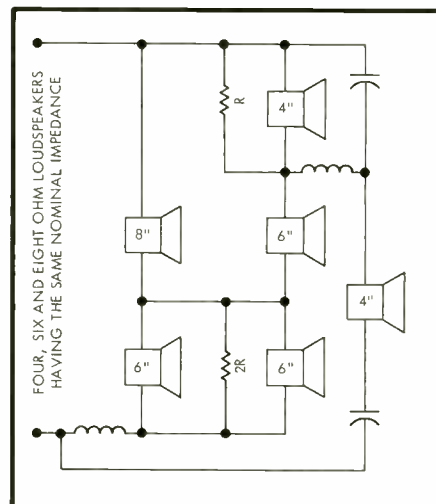

Fig. 1. As an elaboration one could take four 6-inch models for the 8-inch one, an 8-inch one for each of the 6-inch models, and four 4-inch models, thus arriving at a total of twelve loudspeakers. Note: R is a wire-wound resistor whose value is the same as the nominal impedance.

WE DARE TO COMPARE THE CONCERTONE 800



FEATURES:	AMPEX 2070	CONCERTONE 800	CONCORD 884	EICO RP-100 WIRED	FREEMAN 200	NORELCO 401	REVERE M-2	ROBERTS 400D	SONY 500	TANDBERG 64	V-M 740	WEBCOR EP-2360	VIKING 270
6 HEADS	No	Yes	No	No	No	No	No	No	No	No	No	No	No
3 MOTORS	No	Yes	No	Yes	Yes	No	No	Yes	No	No	No	No	Yes
AUTOMATIC REVERSING FOR RECORD & PLAY	No	Yes	No	No	No	No	No	No	No	No	No	No	No
PUSH BUTTON CONTROLS	No	Yes	Yes	Yes	Yes	Yes	Yes	Yes	No	Yes	Yes	No	Yes
REMOTE CONTROLLABLE	No	Yes	No	No	No	No	No	Yes	No	No	No	No	Yes
SOUND ON SCUNO	Yes	Yes	Yes	Yes	Yes	Yes	Yes	Yes	Yes	Yes	Yes	Yes	Yes
BUILT-IN ECHO CONTROL	No	Yes	No	No	No	No	No	No	No	Yes	No	No	No
CENTER CAPSTAN DRIVE	No	Yes	No	No	No	No	No	No	No	No	No	No	No
TRANSISTORS	Yes	Yes	Yes	Yes	Yes	Yes	No	Yes	No	No	No	No	No
TAPE LIFTERS	Yes	Yes	Yes	Yes	Yes	No	No	Yes	Yes	No	No	No	No
OPERATES BOTH HORIZONTAL & VERTICAL	Yes	Yes	No	Yes	Yes	No	No	Yes	Yes	Yes	No	No	Yes
COSTS UNDER \$400	No	Yes	Yes	No	No	Yes	Yes	No	Yes	No	Yes	Yes	No



One look at the chart above should prove to your satisfaction that the Concertone 800 is your best value in stereo recorders!

What the chart does not show you is that Concertone's industry exclusives — double Reverse-o-matic® (automatic reversing at each end of the tape), and six heads — combine to give you continuous music playback and recording with the touch of a button.

And if that is not enough, the Concertone 800

(portable or tape deck) is realistically priced. It starts at \$379.95 (including two dynamic microphones for stereophonic recording). If you are still not convinced we dare you to send for the clincher—our new brochure on the Incomparable Concertone 800, and the name of your nearest dealer. Write to Concertone, Post Office Box 3162, South El Monte, California.

CONCERTONE 

Circle 110 on Reader Service Card

AUDIO ETC.

Edward Tathall Canby

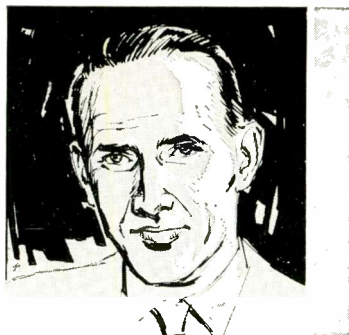

The Electroacoustic Revolution Leo L. Beranek*

Our second guest editorial writer needs no introduction—AUDIO readers certainly respect his accomplishments in the field of acoustics and electroacoustics. In this article Dr. Beranek describes a new development which could completely change the concept of concert halls.

The electroacoustic revolution began quietly after magnetic tape recording was perfected in the early 1950's. It gained force when the Philips company of Eindhoven (The Netherlands) installed a working electronic reverberation system in 1954 in the Arts and Sciences Hall in The Hague. Their system comprised a loop of magnetic tape with multiple recording and playback heads connected to electronic amplifiers and many loudspeakers located throughout the hall. Later, two famous opera houses, La Scala in Milan and Staatsoper in Vienna, installed, with success, an electronic reverberation system for special sound effects. In America, in 1958, Joseph Whiteford of the Aeolian-Skinner Organ Company (Boston) developed an electronic reverberation system for use with the pipe organ in Christ Church, Cambridge, Massachusetts, and later in the Chapel of the Choate School in Wallingford, Connecticut.

These systems were publicized, but the use of artificial reverberation has gone relatively unnoticed by the musical world until recently. In May 1964, the *New York Times* and *The Times*

* Bolt Beranek and Newman, Inc., Cambridge, Massachusetts

Fig. 2. Interior view of the auditorium of the Palace of Conventions in the Kremlin in Moscow.

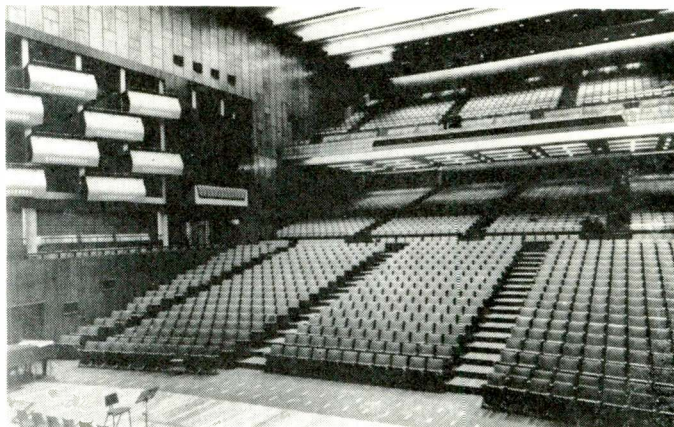

of London carried the news of an experimental installation of loudspeakers and microphones for lengthening the reverberation time in London's Royal Festival Hall (see Fig. 1). This system now works only at frequencies below 300 cps, the region where the tones of cellos and basses derive much of their warmth. According to *The Times*, this system "uses up to 100 channels, each tuned to one frequency and spaced at 3-cps intervals. Only if the present experiment is successful will the extension of the system to cover the whole musical range be investigated."

As exciting as the installations in the Western world have been, the giant step toward total electronic acoustics was taken by the Russians in the Kremlin Palace of Conventions in 1962. (see Fig. 2). This hall essentially has no natural reverberation or natural reinforcement of live events because its walls and ceiling are covered with

thick sound-absorbing materials. For speech reinforcement, individual loudspeakers are located in the backs of the 6,150 seats, so that each member of the audience is surrounded by a "harmonious whispering chorus." For concerts or operas two other sound systems are used.

One of the systems, for music, uses up to 20 microphones in operation on the stage simultaneously. These microphones are divided into five groups and connected to five amplifiers and five large, complex loudspeakers, skillfully hidden above the proscenium, to

project the direct sound of the performers to the audience. Sounds originating on the right-hand side of the stage are projected from the right-hand loudspeakers and sounds originating from each of the four other parts of the stage project from the loudspeaker nearest to it.

The other system for music employs ten large loudspeakers located in the walls and ceiling and provides the reverberation appropriate to the optimum enhancement of the various styles of music performed in the hall. The reverberation is produced by amplifying signals from stage microphones feeding separate loudspeakers in a special large unfurnished room in the basement of the Palace. This sound, augmented by the natural reverberation of the live room, is again picked up by microphones and conducted electrically to a control desk. At the control desk additional reverberation can be introduced electronically by two machines, each with a loop of magnetic tape traveling like an endless belt around a drive system along which are located a series of magnetic recording and reproducing heads. Finally, the sound passes through electronic amplifiers and, thence, to the loudspeakers in the ceiling and walls. Thus the reverberant quality of the sound heard in the hall can be controlled and adjusted to be similar in musical character to that of smaller-sized concert halls, such as the Grosser Musikvereinsaal in

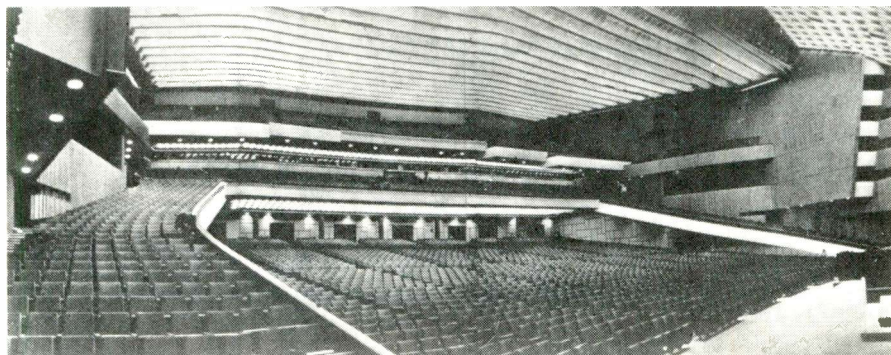

Fig. 1. Interior view of Royal Festival Hall in London.

"...THE FINEST LOW-POWERED AMPLIFIER ON THE MARKET..."*

the Dynakit SCA-35 gives superlative performance at less than \$100



\$99.95 kit
\$139.95 assembled

Now there's a Dynakit for everyone. Long acknowledged as the quality leader of the high fidelity industry, with performance directly comparable to the most extravagant designs, Dynakit now introduces high quality performance concepts at a remarkably low price. ■ Take the time to listen to this latest Dynakit on your

favorite speakers. Compare it to amplifiers at least twice its cost. Even with low efficiency speakers, the SCA-35 sounds like a big, powerful, expensive amplifier. ■ Why does the SCA-35 sound so much better than higher priced designs? As detailed and as fine as its specifications are, they cannot adequately define absolute performance. Dyna's painstaking engineering and consummate concern with quality have evolved unique circuitry which fully utilizes the superior performance characteristics of patented Dynaco output transformers—transformers frequently used in far more expensive equipment than our own. Years of refinement have produced a new design with the stability, low noise, low distortion, full power bandwidth, and excellent overload characteristics usually reserved for much more costly equipment. ■ One look inside the SCA-35 will convince you that this is the easiest of all such amplifiers to build. A clean, uncluttered layout and three factory assembled etched circuit boards speed assembly and assure consistent performance from unit to unit, even in the hands of novices. Detailed pictorial diagrams and step-by-step instructions leave nothing to chance.

*Hi Fi Tape Systems Annual, in their Editor's Choice of Hi Fi Systems, selected the SCA-35 and the FM-3 Dynatuner as offering the "Most Fi per Dollar" (after choosing other Dynakits unanimously for higher priced categories) with the following comments: "The SCA-35 is the finest low powered amplifier on the market, delivers 16 watts (on each channel) from 20 to 20,000 cycles with less than 1% distortion, and below 3 or 4 watts the distortion is unmeasurable."

High Fidelity Magazine (May 1964) reported: "A kit-built version of the SCA-35 proved to be an outstanding performer among low power amplifiers. (It) offers performance that belies its cost, meets or exceeds its specifications, and is in general an excellent high fidelity component."

Audio Magazine (March 1964) concludes: "The SCA-35 . . . is perfect for a small installation where excellent quality, simplicity of construction and operation, and attractive appearance are requisites."

SEE DYNAKITS
at the NEW YORK WORLD'S FAIR

AR-Dyna
Music Room
Better Living Center
Room 224

Dynakits have been
selected for many
individual exhibits
as well!



United States Steel

© 1961 New York World's Fair 1964-1965 Corporation



FM-3
\$109.95 kit
\$169.95 assembled



Stereo 35
\$59.95 kit
\$79.95 assembled



PAS-3
\$69.95 kit
\$109.95 assembled

The FM-3 Stereomatic tuner is the ideal companion to the SCA-35 for flawless mono and stereo FM automatically!

If you prefer the additional flexibility and matchless performance of the renowned PAS-3 Dyna preamplifier, the Stereo 35 offers the same power output as the SCA-35 with the recognized advantages of a separate power amplifier.

Complete specifications and impartial test reports are available on request.

DYNACO INC. 3912 POWELTON AVENUE, PHILADELPHIA 4, PA.

Vienna and Symphony Hall in Boston.

How successful are these latest attempts at replacement of natural by electronic acoustics? Apparently they have proven to be feasible technically and satisfactory from a musical standpoint. Several qualified listeners have spoken favorably of their experiences in the Palace. Harold Schonberg, music critic for the *New York Times*, reports on Festival Hall: "It seems to work. . . . One was conscious of a smoothness, richness and instrumental fusion that definitely puts the Festival Hall into a superior class . . . the ear cannot tell the difference between electronic and mechanical reinforcement."

Obviously philosophical questions about the "morality" of electronic acoustics in concert halls will arise among musicians and critics. Although people have long accepted high fidelity and stereo sound for listening to recorded material they may feel cheated if they learn that a live concert is not completely natural. However, there can be no question that owners of old and new halls the world over will consider the adoption of such systems where the halls either must serve many purposes, or are very large, or both, or where they have defects in their present acoustics that need correction.

One must not be deceived into think-

for the critical recordist...
ANOTHER "FIRST" FROM UNIVERSITY



It's shock-mounted! It's a dynamic!
It's a cardioid! And it's only \$29.95
(It's also guaranteed for 5 years!)

Today...from the laboratories of University...an advanced technology has produced a great new microphone for the critical home recordist. It represents a clean and dramatic break with tradition—with outmoded notions. Considering its moderate price, you would expect it to be an ordinary crystal, carbon—or at the most, dynamic omni-directional. It isn't. The 8000 is a cardioid dynamic typical of the finest professional recording microphones. With its superb directional characteristics, it virtually eliminates background noise. You can work close or far—you will achieve a degree of clarity and definition you never thought possible before. Response: 70-13,000 cps. Sensitivity: -156 db (EIA). Output Level: -59 db/1mw/10 dynes/cm² Includes 15 ft. cable with choice of high or low impedance at the Cannon plug and receptacle! Includes desk stand adaptor.

Mod. 8000: \$29.95—Mod. 8100 with on/off switch: \$31.50.

For complete specifications, write Desk R-8A, LTV/University, 9500 West Reno, Oklahoma City, Oklahoma,

LTV
UNIVERSITY

A DIVISION OF LING-TEMCO-VOUGHT, INC.

Circle 113 on Reader Service Card

U-48R

ing that electronic acoustics is an inexpensive solution to the complex problem of providing good sound for all possible use conditions. The four sound systems in Moscow's 6,150 seat Palace (the fourth sound system is a separate one for motion pictures) would add several hundred thousand dollars to the cost of a large hall. Furthermore, subtle, detailed, electroacoustic design is necessary. The cost of appropriate sound-absorbing finishes needed in a completely "electroacoustics" hall may actually be greater than that of normal finishes for a hall designed for good natural acoustics (or even one which has supplementary electroacoustics). Finally, and of great importance, the operator of a complex electroacoustic system must have the skills of a professional recording engineer—he becomes a key element in a musical performance. And his costs and the maintenance costs of the electronic equipment go on year after year. On the other hand, a reverberation system for the pipe organ in a small church is relatively moderate in cost and a trained operator is not necessary.

Natural acoustics is not about to disappear. The fine acoustics for musical activities achieved in recent halls—Indianapolis' Clowes Auditorium; Dartmouth's Spaulding Auditorium; Seattle's Opera House; Tanglewood's Music Shed; Montreal's Place des Arts; College of Idaho's Jewett Auditorium; Goucher College's Music Auditorium; Nuremberg's Meistersingerhalle; Munich's Bayerische Staatsoper—National Theater; Bristol's Colston Hall; and Jerusalem's Binyanei Ha'Oomah—are clear evidence of successful collaborations among owners, architects, and acousticians. However, even these successful halls for music generally rely on electroacoustic aids for speech events. The decision to go "natural" or "electronic" or some appropriate combination, must be made after full account is taken of the practical factors of size, uses, cost and architectural concept. Æ

AUDIOCLINIC

(from page 4)

If he is a responsible person, he will maintain radio silence during times you wish to make important tape recordings. If he is unwilling to cooperate and if the nature of his transmissions or if his conversation with any other party exceed five minutes, this operator can be reported to the FCC. (This applies only to operators in the Citizen's Radio Service.) However, if a radio amateur operator is uncooperative, he can be ordered to maintain what are known as "quiet hours" during which he is not allowed to transmit.

If proper precautions are taken, if the offending party is cooperative, and if luck is with you, you can eliminate all of the interference from your system. Good luck. Æ

"Only the Music is Present...When the Classics Speak"

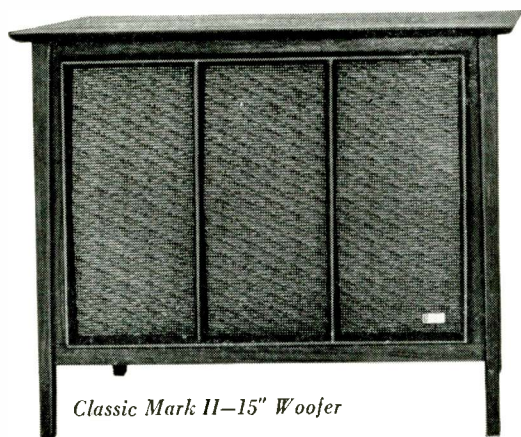

Classic Mark II-15" Woofer



Classic Dual 12-12" Woofer

(they look like this when the music stops)

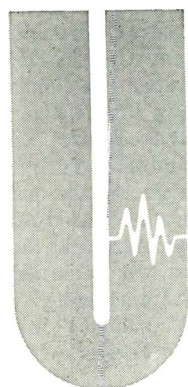

It's a phenomenon of great speakers. Reproduction is so faithful you're totally absorbed in sound . . . unaware of its source. You'll find this particularly true when you hear the University Classic Mark II 3-way system. There is absolutely no distortion, no coloration . . . up to 40,000 cps. According to Julian D. Hirsch, Hirsch-Houck Laboratories, ". . . The University Classic Mark II justifies substantial claims that the manufacturer has made for it. It is one of a limited group of speakers to which I would give an unqualified top notch rating." Cabinetry in oiled walnut, \$295. Classic Dual 12 3-way system, finished in oiled walnut, \$229.50. Write today for your free "Guide to Component High Fidelity": Desk R-8, LTV University, 9500 W. Reno, Oklahoma City, Okla.

LTV UNIVERSITY A DIVISION OF LING-TEMCO-VOUGHT, INC. 9500 West Reno, Oklahoma City, Oklahoma



ABOUT MUSIC

Harold Lawrence

Noise, Gnats and Notes—A Look At Summer Concerts

ASK AN ARTIST or a concert manager about outdoor concerts and he will probably shudder and make a few sharp comments about airplanes, insects, birds and the elements. Under ideal circumstances, a musical performance *al fresco* can be a delightful experience: the fragrance of the Berkshire countryside in full foliage permeating the Music Shed at Tanglewood; the spectacular view of the glimmering lights of Los Alamos seen from the Santa Fe Opera Theatre; or the evocative setting of an ancient Roman amphitheatre in Provence for an opera by Gluck. But the outdoor concert can also make you wish you had remained home to enjoy the program's equivalent on records. And, judging by the primitive sound reinforcement systems now in use in many of our sprawling outdoor musical events, the chances are that your home equipment would give you a better crack at the music.

The loudspeakers at Lewisohn Stadium, for example, were installed to project the sound to the upper reaches of the amphitheatre, and also to overcome the noises of the city. But then the planes came. Mrs. Charles S. Guggenheimer, chairman of the concerts, made arrangements to have the flight paths in and out of La Guardia Airport re-routed during concert hours. But air traffic being what it is, the drone of the engines continued to plague the Stadium. Leopold Stokowski, who had stopped a concert in Philadelphia's Robin Hood Dell when a diesel railroad engine honked by, interrupted a Stadium program five times when planes flew overhead. Jets and propellers are the chief noise-makers at Lewisohn Stadium, but there are other distractions: fire engines, trucks, foreign cars with aggressive mufflers, and so on. At one performance, a band of adolescent merry-makers outside the Stadium tossed lit firecrackers over the wall and onto the audiences.

In a letter to the *New York Times*, an irate music lover described the airplanes over Lewisohn Stadium as "winged pests of the sky." But the smaller variety of

airborne creatures also intrude on outdoor concerts. It was a warm summer night at the Santa Fe Opera, and the work in progress was Johann Strauss's *Die Fledermaus*. Preparing for a high note, Sara Endich took a deep breath. A large fly sailed into her wide-open mouth, effectively silencing the soprano. At another outdoor concert, recorder player Bernard Krainis was about to launch into a long musical phrase. He breathed in deeply and sucked in a pair of mosquitoes. (He saw them coming but it was too late.) Somehow, he managed to enter perfectly in tempo.

At an Esplanade Concert in Boston, confusion broke out in the ranks of the orchestral players, who suddenly began to flick at their pages and play wrong notes. The audience discovered later that swarms of gnats, attracted by the lights on the music stands, had buzzed their way from the Charles River and settled on the music parts. The musicians simply couldn't tell the gnats from the notes.

In preparation for a recording of a Castle Hill Festival concert in Crane's Beach, Gene Bruck set up his two Ampex 300 tape machines in the bushes behind the seats. Shortly after the program had gotten under way, the reels suddenly stopped revolving. Bruck and his engineer searched frantically for the cause of the failure. To their horror, they found that slugs (normally herbivorous insects) had crawled into the works of both recorders and had been ground to slime.

Insects may be troublemakers, but at least they are relatively quiet, crickets excepted. Birds are another matter. At a Tanglewood concert a few years ago, Pierre Monteux was midway through the first movement of Tchaikovsky's Fifth Symphony when, as the *New York Times* reported "a bird fled into the shed, perched on a girder and started to sing. At another sort of summer event this might have been a pleasant rural touch. But because of the [performance] the audience had fallen into so

deep and responsive a silence that the bird was a resentful intruder." Even bird lovers found it hard to appreciate the cheerful twittering.

A better combination of birds and music occurred in London two summers ago during a performance of the "Pastoral" Symphony. This time, the warbling complemented Beethoven's bucolic score. (At a recording session in London that same year, pianist Byron Janis and the London Symphony were somewhat less enchanted by another winged visitor. Janis had just reached the cadenza of the Tchaikovsky Concerto when a bird, which had nestled in the rafters of the Wembley Town Hall where the recording was taking place, began to sing an obbligato. Stagehands were dispatched to the roof to chase away the feathered trespasser, but without success. It was finally decided to bypass the cadenza and proceed to the next movement. The change in strategy worked. For the remainder of the session the bird was silent. The cadenza was recorded later under the cover of night.

Singin' In The Rain

The Bermuda weather bureau had predicted a cloudy day with possible showers during the evening. The outdoor performance of Mozart's *Così fan tutte*, however, was not cancelled. Everything went well until the beginning of Act II when the rains came. Soprano Reri Grist, who was singing the role of Despina, was caught in the middle of her aria. Everyone, it seemed, was prepared for the downpour except Miss Grist. People in the audience remained in their seats; some ladies donned plastic rain gear and others pulled out umbrellas. Dorabella and Fiordiligi, to whom Despina was singing her aria, snapped open their parasols. Backstage, the tenor and baritone shared a flask of gin. But Miss Grist had no choice but to continue singing. At the end of her aria, her drenched wig was plastered to her cheeks and neck and her makeup had run down her face.

The rain that fell on Leonard de Paur and his Infantry Chorus in a Havana outdoor stadium in 1952 may have dampened the costumes of the singers but not their spirits. It was a special rainfall. For weeks, a severe drought had parched the island and Cubans had been praying for rain. When the clouds burst over Havana during the de Paur concert, the audience was ecstatic: all remained in their seats, and let the drops fall on their upturned faces. At the end of the program, de Paur was carried off in triumph on the shoulders of the wildly cheering spectators, who regarded him and his singers as rainmakers.

Despite the charms of summer outdoor concerts, many concertgoers feel that music is for indoors. Æ

UNIMPAIRED FIDELITY TO THE FRONT...

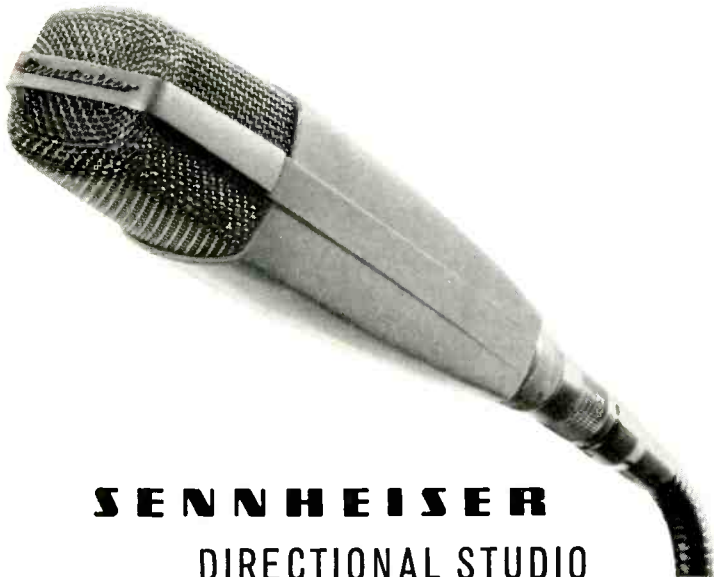

SENNHEISER
DIRECTIONAL STUDIO
MICROPHONE MD 421
A Wide-Range
Moving-Coil Design
Professional Net: \$95.00

Discrimination against interfering background sounds and the effects of a poor acoustic environment is assured by at least 16db rear rejection at any frequency above 250 cps, yet natural reproduction is maintained throughout the area of desired sound. The frequency response curve shown here depicts performance of the MD 421 truthfully because it is not merely representative of on-axis performance. The polar diagram shows why. Polar response is essentially the same for all frequencies of interest, which cannot be said of all directionals. There is no loss of detail and balance, no blurring of sounds, no effective high-frequency roll-off, from off-axis sound sources.

Proof of performance: an individually plotted frequency response curve is supplied for each Model MD 421, and it is guaranteed to be within ± 2.5 db of the average curve shown between 40 and 16,000 cps. Impedance of the standard version is 200 ohms. A cable transformer for high impedance is available. Model MD 421 HN offers high and low impedance. (Professional net: \$98.00.)

The MD 421 and 421 HN include a bass control, calibrated in distance markings as well as for speech and music. Proper setting of this control eliminates the low-frequency emphasis common to directional microphones in close-up use.

ACOUSTIC BARRIER TO THE REAR

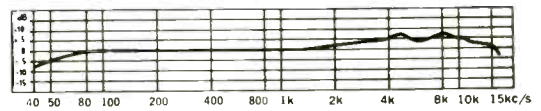

Frequency Response of the MD 421

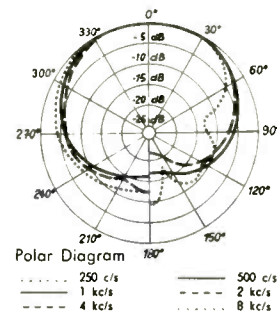

Polar Diagram

..... 250 c/s ——— 500 c/s
——— 1 kc/s - - - - 2 kc/s
- - - - 4 kc/s 8 kc/s

TECHNICAL DATA:

Frequency range:	30 to 17,000 cps
Maximum deviation from nominal curve:	± 2.5 db between 40 and 16,000 cps
Output level:	-53 db re 1mw/10 dynes/cm ²
Impedance:	MD 421: 200 ohms MD 421 HN: 30,000 ohms or 200 ohms
Directional pattern:	Cardioid
Discrimination at rear:	At least 16 db for frequencies above 250 cps
Magnetic field interference factor:	5 μ v/50 milligauss
Speech-music control:	Fitted in MD 421 and MD 421 HN
Dimensions:	6.96" x 1.9" x 1.81"
Weight:	13.4 oz., approx.

For complete technical specifications, call or write Sennheiser Electronic Corporation (N. Y.). For demonstration of this model and the full Sennheiser line, call or write Harvey Radio Co., Inc., franchised distributor for the New York metropolitan area.

HARVEY
RADIO CO., INC.

103 West 43rd Street, New York 36, N. Y. • (212) JUDson 2-1500



SENNHEISER
electronic
CORPORATION (N. Y.)

25 West 43rd Street, New York 36, N. Y. • (212) LONgacre 4-0433
Plant: Bissendorf/Hannover, West Germany

Circle 115 on Reader Service Card

EDITOR'S REVIEW

ANNUAL PRODUCT PREVIEW

Every year, in August, we preview the products manufacturers will feature in the ensuing months 'till next year at this time.

Every year the listing increases in size.

This year, for the first time, we are including a totally new category: commercial sound.

We decided to include the commercial sound category because of the unusually large and favorable response we received to the commercial sound course and articles. Apparently many readers are deriving benefit from these articles, including a surprisingly large number of people *not* engaged in commercial sound professionally. We are not completely sure how to interpret these results as yet but rather suspect that readers are beginning to realize that the principles which apply to commercial installations also apply to home installations, in spite of the seeming differences.

In any case, the commercial sound section is considerably smaller than the consumer section. There are two reasons for this: One reason is that there are far fewer manufacturers and products in this field; and second reason is that this is our first attempt at rounding up commercial sound information and we started somewhat late. Before making plans for next year we would like to hear *your* reaction to this kind of coverage. We would appreciate having the answers to the following questions:

1. Do you want a commercial sound product roundup in the same issue with the consumer product roundup?
2. Should we cover more categories than we did in this issue?
3. Is there a particular time of year when this information would be more useful to you?
4. Would a tear-out section be useful?

When we receive your response to these questions, we will then plan to provide what you want, when you want it. Please answer soon.

By the way, in case you aren't the counting type, note that the Product Preview section is by far the largest we have ever done. Also note that there are some very definite trends indicated. For example, there are three different manufacturers represented with portable phono products, whereas last year there was only one. In addition, there are several more about to be released which couldn't make this issue.

Note also that the trend towards transistor equipment is accelerating rapidly. Finally, note the continuing trend towards all-in-one equipment.

WONDER WHERE THE YELLOW WENT?

Speaking of commercial sound, some readers have taken note of the absence of those special yellow pages we used in the first several chapters of the commercial sound course. In the July issue, and in this one, we were forced to omit the yellow pages because of some particularly difficult production problems. We really intended to continue using them for the entire course, but unfortunate circumstance intervened. However, all is not lost, we will resume using the colored paper with the next chapter.

COPYRIGHTS AND TAPE CLUBS

We noted with great interest an item from England which describes a method for bypassing copyright law difficulties. It seems that the Society charged with protecting musical copyrights has granted a blanket license to members of the Federation of British Tape Recorder Clubs to record copyrighted musical works for use in members' homes, hospitals, national and local charities, club premises, old peoples' clubs and homes, and local, national, and international competitions.

Of course this license covers the music only and does not allow infringing the performers' rights.

This agreement clearly points the way for solution of a rather sticky, and similar, problem in the United States. The only obstacle is that there is no similar American organization to the British Tape Club Federation. In fact it is very unlikely that such an organization will be formed in the United States if we are to judge by the seeming difficulty in forming clubs in this area of interest. Yet, there are so many people desirous of taping musical performances without breaking the law, that there must be some way of getting around this impasse. Can you think of a way?

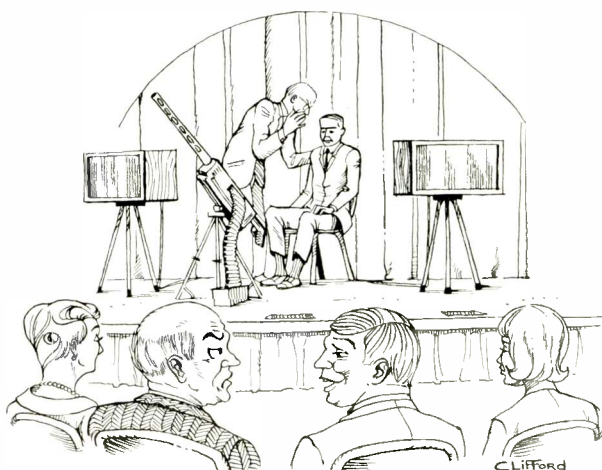

Looks like the "moment of truth"—hey?

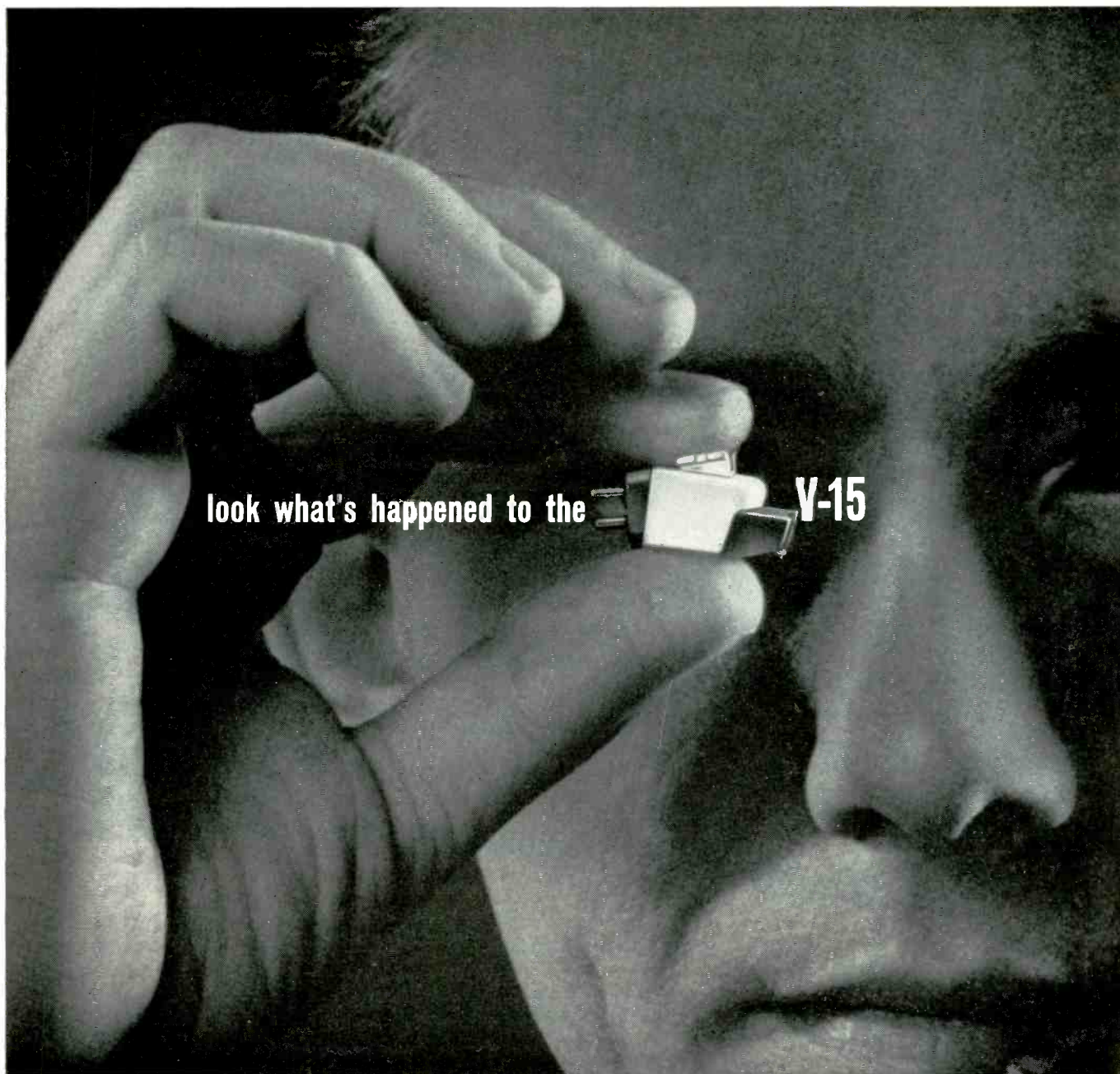

look what's happened to the **V-15**

FOUR MICRO-MAGNETIC* 15° PICKUPS!

Whether you own a record changer, automatic turntable, or a professional type manual turntable Pickering has engineered the RIGHT V-15 pickup for you. If it's RECORD CHANGER application, where high output and heavier tracking forces are required try the **V-15 / AC-1**. Most of you, no doubt are tracking lighter on the late model AUTOMATIC TURNTABLES and will use the **V-15 / AT-1**. Or if a professional type MANUAL TURNTABLE is your choice you'll need the even more compliant **V-15 / AM-1**. And if it's unexcelled tracking ability you're seeking, you will demand the ELLIPTICAL STYLUS PICKUP **V-15 / AME-1**. All four of these pickups are radically different from any other cartridge. You can see the difference. You can hear the difference. Pick up a V-15. Note its light weight—only 5 grams. Perfect for low mass tone arm systems. Now, see how Pickering's exclusive "Floating Stylus" and patented replaceable V-Guard assembly protects your record and diamond as it plays.

*Trade Mark of Pickering and Co., Inc.

FOR THOSE WHO CAN **HEAR** THE DIFFERENCE

PICKERING & CO., INC. PLAINVIEW, N.Y.

Pickering

THE WORLD'S LARGEST AND MOST EXPERIENCED MANUFACTURER OF MAGNETIC PICKUPS

Circle 116 on Reader Service Card

AUDIO • AUGUST, 1964

17

Which one of these
tuner dials lets
you *pre-tune* with
professionally-calibrated
accuracy ?

Sherwood's, of course

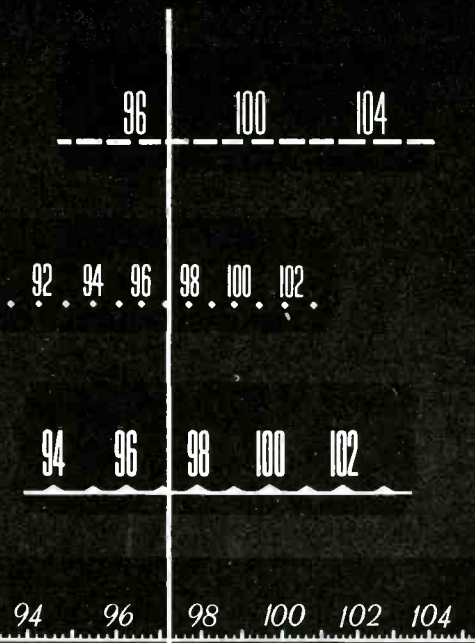

Sherwood's new S-8000IV FM stereo tuner/
amplifier, \$329.50.
Genuine Walnut cabinet optional at \$29.50.

Only Sherwood precisely graduates its FM tuning dial every 200 kilocycles—the minimum spacing between FM station channels. If, for example, the FM broadcast of your choice is being transmitted at 97.3mc., you can visually pre-tune the Sherwood tuner dial to receive it with professionally-calibrated accuracy. Final zeroing-in of the FM station's carrier is merely a matter of referring to Sherwood's D'Arsonval Zero meter.

Precision tuning is but one of many superlative engineering reasons for buying Sherwood's new S-8000IV FM stereo tuner/amplifier. Others include 80-watts of stereo music power 1.8 μ v. IHF sensitivity 2.4db. FM capture effect only 1/3% distortion at 100% modulation new "powered" center channel for a mono speaker—ideal for extension speakers stereo headphone jack and separate speaker disabling switch.

FREE — \$1.00 value Information Kit
at your Sherwood Dealer.

Take this coupon to your Sherwood dealer and receive:

- *Time-Saver Shopping Guide*—detailed comparative specifications on components offered by major manufacturers.
- 64-page book, *An Introduction to Hi-Fi & Stereo* published by the Institute of High Fidelity.
- *FM & FM Stereo Station Finder*—listing current and proposed stations
- *Installation portfolio*—a pictorial review of how many different component systems have been installed.
- Descriptive literature on Sherwood components.

If you prefer, send 25c in coin direct to Sherwood, together with your name and address. Your package will be sent by return mail.

Name _____

Street _____

City _____ State _____ Zip Code _____

Sherwood Electronic Laboratories, Inc., Dept. A-8
4300 North California Avenue, Chicago, Illinois 60618

Sherwood

High Fidelity

STEREO RECEIVERS ■ TUNERS ■ AMPLIFIERS
STEREO INDICATOR LIGHTS ■ SPEAKER SYSTEMS

Circle 117 on Reader Service Card

A Basic Course in Commercial Sound

NORMAN H. CROWHURST

Chapter V

Transformers for Constant-Voltage Lines

Speaker-matching transformers for constant-voltage lines may come with the speakers or as a separate entity, in which case they may have tapings on both primary and secondary (Fig. 5-1). The secondary tapings provide for different voice-coil impedances. The primary taps provide the impedance values to correspond with the wattage ratings required.

Note that the lowest wattage rating uses the whole primary, while the highest wattage rating uses least of it. You may never need to know this fact, if you always use transformers clearly marked in wattage rating but if, for any reason, you start figuring things out for yourself, this fact may confuse you, from a somewhat natural, but incorrect expectation that more turns would result in more power.

Power Matching

Now let's suppose we have a speaker distribution system with a total speaker rating of 100 watts, to be connected to a 50-watt amplifier as effectively as possible. As we showed in the last installment, this requires an impedance change from 100 ohms to 50 ohms, or a voltage change from 70 to 50. Looking at a catalog, or going through available stock, suppose we find a transformer, listed as providing both primary and secondary

125, 250, 333, and 600 ohms. It is rated as having a maximum power of 40 watts, with a frequency response from 10 to 20,000 cps. Can we use it? It seems the nearest thing to what we want, from the available list.

Choice of Tapings

The nearest impedances to those we want are 50 and 125. Now (a) stepping up our actual 50 ohm load, to 125 ohms as amplifier load, would reduce the amplifier output from 50 watts to 40 watts, which (b) happens to be the power rating of the transformer. Is that the best we can do?

The impedance *ratio* we need is 2:1 and the transformer will provide this ratio, between tapings rated at 250 and 125 ohms. The limit to power rating of a transformer is its saturation density—voltage at a frequency. By using a 250-ohm tap for 100 ohms, we use the same maximum voltage at $2\frac{1}{2}$ times the current, which is $2\frac{1}{2}$ times the power, or 100 watts, allowing plenty in reserve. But effi-

ciency will go down. No efficiency rating is given in the listing, but in a transformer of this size it could be about 98 per cent, with 1 per cent loss in each winding. Dropping the working impedance in this way will increase the *percentage* loss $2\frac{1}{2}$ times, making the efficiency 95 per cent.

With the 50/125 ohms taps, the power delivered is likely to be 98 per cent of 40 watts, or 39 watts. With the 125/250 ohms taps, the power delivered is likely to be 95 per cent of 50 watts, or 47.5 watts. Thus for power handling and efficiency, the 125/250 ohms taps are better to use than the 50/125 ohms taps. Low-frequency response will not suffer by the change, but high frequencies may.

According to simple theory, the high-frequency cut-off should be brought down in frequency by a ratio of $2\frac{1}{2}$, which would lower it from 20,000 to 8,000 cps—still good enough for commercial sound. It may be better than this, because nominal response (used in theory) assumes that resistive loads are used, while the actual speaker load is inductive at these frequencies, reducing the effective loss, caused by leakage inductance in the transformer.

But suppose our estimate of efficiency is 'off': suppose the normal figure is 95 per cent. Then using the 50/125 ohms taps will deliver 95 per cent of 40 watts, or 38 watts. Using the 125/250 ohms taps, the losses

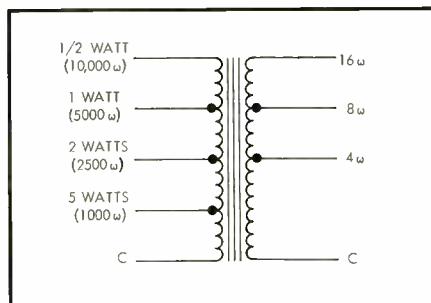

Fig. 5-1. Diagram of typical speaker line transformer with taps.

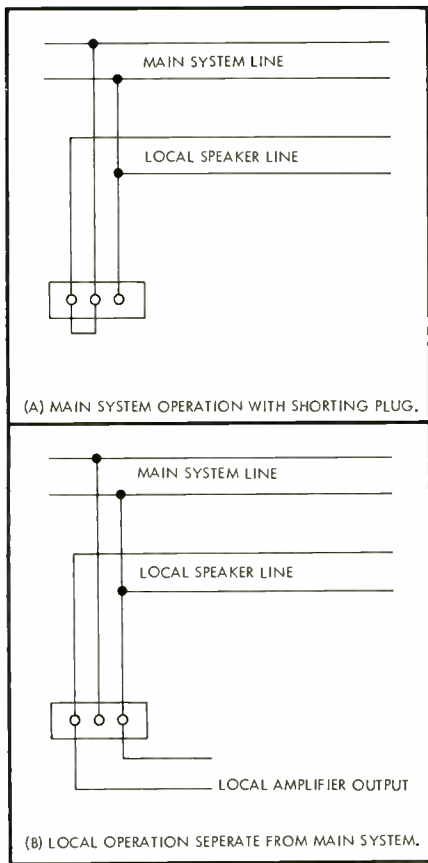

Fig. 5-2. Method of providing local tap-in for speaker system, so installed speakers can be connected, either to the main system, or for local use.

are $2\frac{1}{2}$ times as much, making the efficiency 87.5 per cent, thus delivering 87.5 per cent of 50 watts, or 43.75 watts. This is still better than the 50/125 connection, but not by so big a margin as with the higher efficiency figure. An even less efficient transformer might make it best

to stick with the 50/125 ohms taps.

To determine this, if you have the transformer on hand, you can check its efficiency closely enough with an ohmmeter. Measure the winding resistances at the relevant taps, and express it as a percentage of the rating of the tap measured. A resistance of 1/100th of the tap rating represents 1 per cent loss. Add the percentage losses in both windings and subtract the total from 100, and you have the efficiency in per cent.

So much for using taps whose nominal impedances are higher than those actually connected. What about the other way? Suppose our working impedances had been 200 and 400 respectively, for which the transformer provided tapplings for nominal impedances of 75 and 150. What would be the effect of using these?

First, the power rating would be reduced by the ratio of impedance change, in this case 8:3. A 40-watt transformer would only handle 15 watts; but this at the lowest frequency the transformer is supposed to handle. If this is 20 cps, then the transformer will handle 15 instead of 40 watts at this frequency. If you need more power than 15 watts, the transformer is not necessarily 'out': the capacity goes up in proportion to

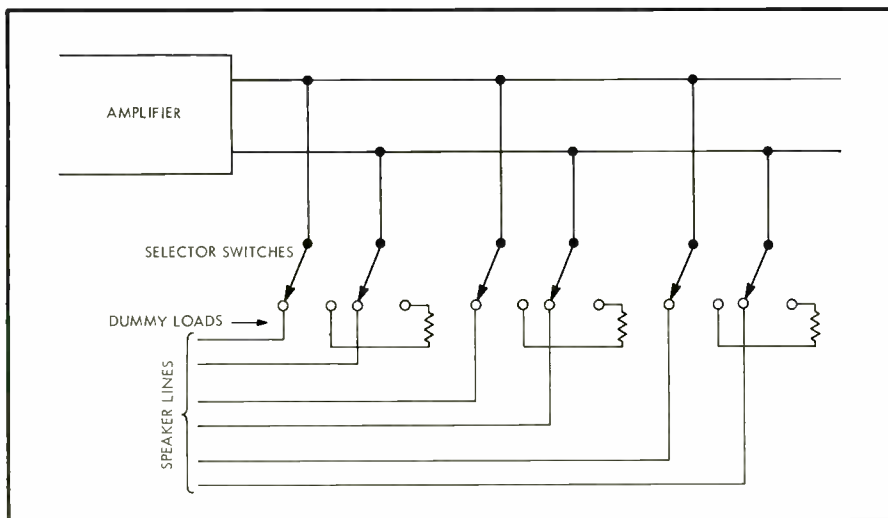

Fig. 5-3. Typical output switching circuit, using dummy loads. Although still used, the need for these is obsolete today.

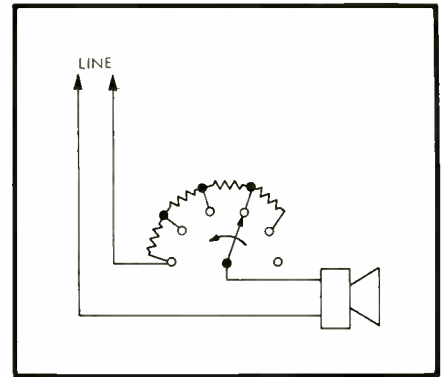

Fig. 5-4. Type of volume control used for local setting in multi-room installations, such as hotels.

the square of the frequency, so the same transformer would handle 60 watts from 40 cps up.

There may also be a low-frequency loss, in the same 8:3 ratio, which would bring the low-frequency point from 20 cps up to $8/3$ times this, or 53 cps—still good for commercial sound. And in this case high-frequency response will be extended so this is no problem.

That's given the outline of the way to figure matching transformers, when the load and amplifier don't happen to fit without some juggling. Now we come to another problem sometimes encountered in big systems:

Providing Flexibility

When surveying a big job that involves any multiple use, it is well to explore carefully all the possible needs of the system. The architect may make provision for flexibility in use of a new building—movable partitions, adjustable acoustics, and so forth. Where this has been provided, the sound system should be no less flexible: it must be able to handle all the possibilities envisaged in the architectural variations, possibly with even more variations.

Even simple installations, such as the local high school gymnasium, may require flexibility, both at the input (microphones and other sources) and audience ends. We shall come to inputs presently, for now let's

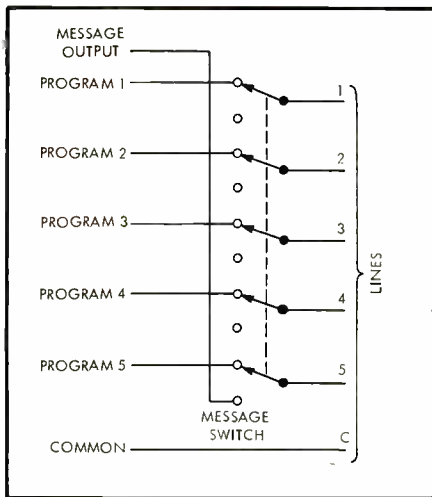

Fig. 5-5. One method of providing paging facilities over a system with program selection choice.

stick with outputs for the moment. Most modern gymnasiums are equipped with retractable seating, so none, some, or all of the available facilities may be used, at different times. Even if the seating consists of old-fashioned movable chairs, these can be arranged in a variety of ways and the sound system should be flexible enough to handle each possibility.

Whether this flexibility is achieved with fixed (installed) speakers which can be connected

or disconnected at well, or by movable (portable) speakers which can be moved around like the chairs, must be determined by individual school (or other customer) needs.

In any installed system, small or large, where the number or grouping of speakers used is liable to change, either switching or some form of patch cord connection must be provided. Where different groups of speakers may be required either all together on a common system, or separately for different sectional programs, it may be worth using sufficient separate amplifiers to provide the maximum individual-group service likely to be needed, rather than using one big amplifier for the whole load.

Another alternative, which allows maximum flexibility in a different way, is the provision of a local socket for plugging a group of speakers from the main system to local use (Fig. 5-2). Removing the shorting plug used for big-system connection, a local amplifier, movie projector output, or whatever, can use the local units of the same

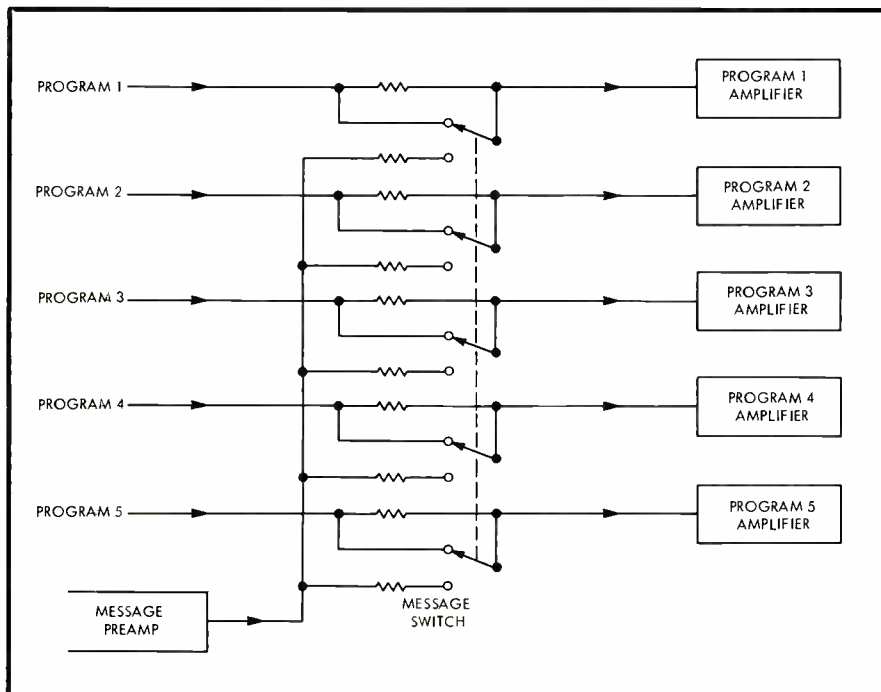

Fig. 5-6. A more sophisticated method, that does not completely interrupt the selected programs, merely attenuates them.

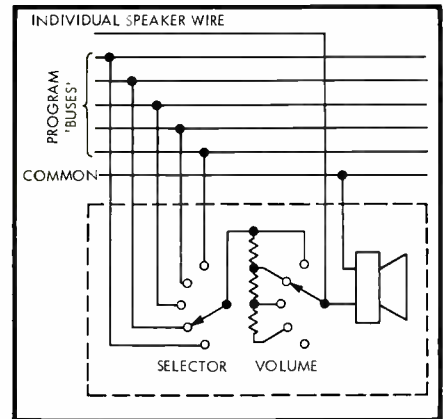

Fig. 5-7. One method of avoiding loss of paging messages due to setting of local volume controls.

speaker system, already installed in the building.

Dummy Loads

Where central switching for such diverse facilities is provided, a common practice, which is really a 'hangover' from earlier days, is to provide the switching arrangements with alternate dummy loads. Whenever a bank of speakers is disconnected from the system, the amplifier to which they are normally connected is provided with an alternative dummy load (Fig. 5-3).

This practice originated in the days when commercial amplifiers used big output tubes—generally transmitting triodes—where dangerous voltages might develop if the load impedance was not held down to a reasonably constant value. This was before the days of feedback. Nowadays this practice is quite unnecessary and often very wasteful of power. Any good commercial amplifier has enough properly designed feedback to hold the output voltage reasonably constant, from completely open circuit operation to a load which draws the maximum power for which the amplifier is designed.

Local Circuit Selection

A variant of the speaker distribution requirement occurs in what we may term the hotel-type

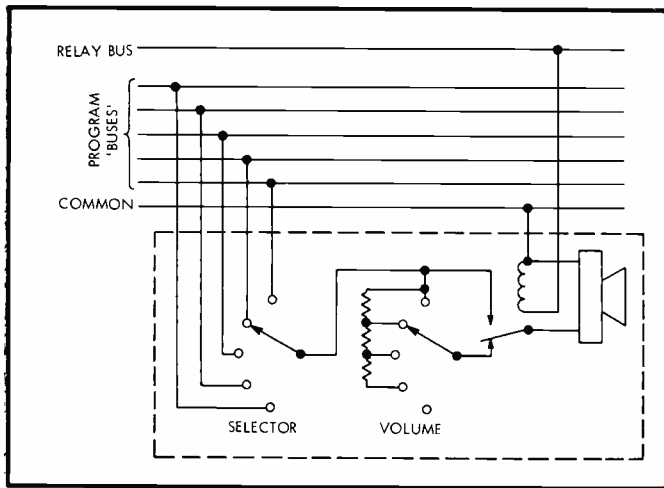

Fig. 5-8. An alternative method of achieving the same result.

installation (although variations of it will be found in many multi-purpose buildings) where speakers are provided in many rooms or apartments, on the same system. Provision is made at each speaker for connecting it to one of several circuits and controlling volume to enable loudness to be suited to the needs of the moment in that room.

To economize on power, the volume control is usually a step switch, inserting series resistance (*Fig. 5-4*), with the last position ('OFF') going open circuit. In such cases each line must be fed with sufficient power to run all the speakers on the system at a satisfactory level, if they should all be connected to that line and turned to full volume at the same time.

Over-all Paging

Some systems like this combine with a call, or paging, function. To achieve this, all speakers must be connected to one circuit when a message has to be sent out. At the control center all lines are paralleled, disconnected from their normal program sources, and fed with the message program (*Fig. 5-5*).

An alternative arrangement switches to a 'mix' arrangement on all channels (*Fig. 5-6*), so that the 'normal' program is not completely interrupted, but is noticeably attenuated, while the message is superimposed at a level that over-rides the nor-

mal program. Note that, to avoid power loss in the attenuation network, this mixing is achieved before the power amplifiers feeding the system.

One more thing may be necessary in such a system: some of the speakers may be turned completely off, or to a level so low that the message is not adequately heard. In this case, the system needs a means of sending the message at full volume, even on those speakers that happen to be turned down or off.

This can be done in one of two ways: (a) each speaker circuit is provided with an individual 'direct' line back to control center, as well as the 'bus' circuits for program selection (*Fig. 5-7*); or (b) each speaker is provided with a relay to make the change, and a d.c. 'bus' control effects the changeover, on command from the control center (*Fig. 5-8*).

The first method may be best in systems where distances are small, so the cable involved for individual returns costs less than the number of inexpensive relays needed for the other method, at one per speaker. Virtually, it's the cost of a relay per speaker versus the cost of a separate wire back to control center from each speaker. This may be affected by the 'geographical' layout of the system.

If the layout is such that each 'bus' line radiating from the control center serves only one or two speakers, then individual

connections back from each speaker will take very little extra wire, and relays are an unnecessary expense. On the other hand, if each 'bus' line serves a number of speakers, then individual connections back would require a considerable number of extra wires, and individual relays can effect a saving.

In the system of *Fig. 5-7*, all the switching is performed at the control center. In the system of *Fig. 5-8*, the control center controls switching that is made at each speaker, remotely. Further variations are possible. We have shown the relay as merely switching the volume control out of circuit, which means the bridging function, of sending the message down all program lines, is performed at the control center. One variation is to provide a separate message line bus, in addition to the relay control bus, and make the relays change speaker connections from volume-controlled program of individual selection, to the message bus, uncontrolled.

We have discussed this kind of installation enough to show that there is considerable flexibility of method. There are companies that specialize in this kind of system. If you buy one of their systems, then the foregoing presentation will serve to introduce you to the possibilities so you can 'shop' intelligently, to get the system best suited to the needs of the job, and then in-

(Continued on page 95)

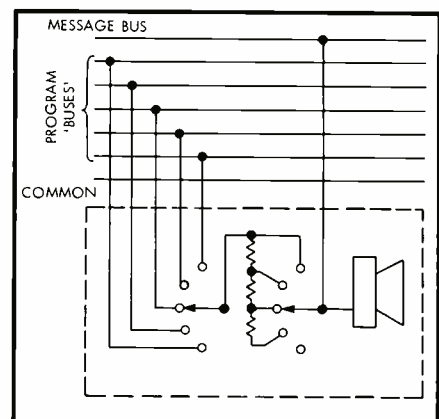

Fig. 5-9. Why wouldn't this circuit work —see text?

Class-D For Efficiency

PETER A. STARK

A summary of the operation and theory of Class-D audio amplifiers using switching techniques, with design information and several working circuits

IN THREE PARTS—PART THREE

Output Stages

The most reasonable choice in semi-conductors for our output stage is still the transistor, despite the advent of all sorts of new devices within the past years. Most of these new devices still have such limited uses that their prices are beyond the reach of the average person. The lower-priced devices, under \$25 for example, are often unsuitable. These include tunnel diodes which make nice switches but are low-power only, four-layer diodes which are also nice switches and could handle a little power, but are hard to control, silicon-controlled rectifiers and gate-controlled silicon rectifiers, which can handle huge amounts of power but not at high frequencies. These latter might be especially suitable if only their frequency range were increased, and this might well occur sometime in the future.

Transistors, on the other hand, are dirt cheap, reliable, and easy to control. And yet, even here, we must make a careful choice if we want reliable operation. And choosing a transistor for pow-

ers of more than a few watts becomes hard. To see why this is so, let's examine some of the possible output circuit configurations of Fig. 20.

Of the three possible circuit configurations for a transistor amplifier, the common base circuit has little appeal for us because it has a current gain less than one. Since one of the requirements is an output current into the speaker, the stage would contribute little of this current. The other two transistor circuit configurations, the common collector and the common emitter, are shown in (A) and (B) of Fig. 20, respectively.

Both of these circuits would be suitable for driving a speaker. The voltage gain of the common collector is less than 1, but getting the required voltage drive into the stage is easy so this is no problem. The common collector has current gain, and the common emitter has both current gain and voltage gain, so that both circuits are suitable to some extent. But resistors R_1 and R_2 introduce problems.

Note that a capacitor and inductor

have been placed in series with the speaker. The capacitor is there to prevent d.c. from getting to the speaker. The inductor L_1 in (A) of Fig. 20, is so chosen that the audio signal gets through with little attenuation, but the high-frequency switching signal does not. In other words, the inductor in series with the speaker acts as a low-pass filter which passes through the audio. The reason for the filter is two-fold. First, keeping the high frequencies out of the speaker prevents speaker heating and results in an integration of the pulse signals to produce an audio signal (see our previous discussion on types of modulation), and second, keeping power out of the speaker reduces the power dissipation of the circuit and keeps power supply drain down, increasing efficiency.

Now let's return to the problem of resistors R_1 and R_2 . In (A) of Fig. 20 when transistor Q_1 is on (saturated), the emitter of Q_1 is almost at -12 volts (actually, it is about -11 volts since some voltage drop exists across the transistor). Some current therefore exists through resistor R_1 , resulting in a power loss. We can reduce this loss by making R_1 very large, so that the current through it is very small. Meanwhile, capacitor C_1 starts to charge, and the current through L_1 sets up some magnetic field about the inductor. Both C_1 and L_1 are therefore storing some energy at this time.

Suppose that transistor Q_1 now switches off. Ideally, the voltage at the emitter of Q_1 should now return to 0 volts. But since C_1 and L_1 are storing some energy, current will still flow through the loop consisting of R_1 , C_1 , L_1 , and the speaker. This current sets up a voltage drop across R_1 , so that the emitter voltage of Q_1 never does really return to zero. This is undesirable, since it limits maximum power. The only way to avoid it is to make R_1 very small, so that the voltage drop is small. And so we are squeezed between two conflicting requirements—making R_1 very small and also making it very small. This is obviously impossible.

The same argument holds for the case of R_2 in (B) of Fig. 20, where again we'd like to make R_2 both very large and very small. The solution to this dilemma is quite simple—let's combine the circuits of (A) and (B) into a single circuit (C), and let's supply two input signals in opposite phases to the two transistors, so that when one transistor

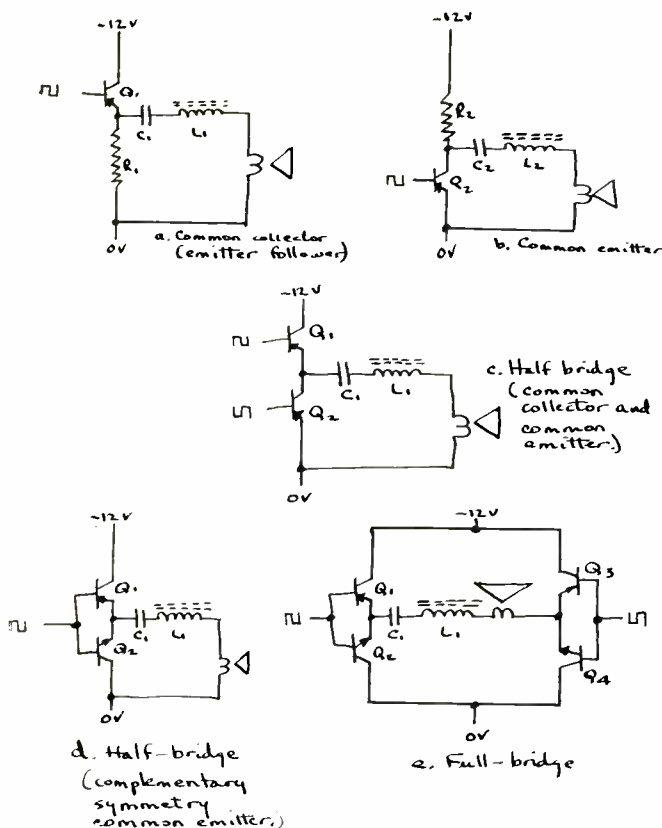

Fig. 20. Possible output stage circuits.

is on, the other is off. What we've really done is replace resistor R_1 in Fig. 20 (A) by transistor Q_2 . When transistor Q_1 is on, we wanted to make R_1 very large. This is the same as turning Q_2 off, which then means that Q_2 acts like an open circuit. On the other hand, when transistor Q_1 is off, we wanted to make R_1 very small. This is equivalent to turning Q_2 on, since Q_2 then acts like a short circuit. The junction of the emitter of Q_1 and the collector of Q_2 therefore varies between -12 volts and zero (disregarding temporarily the slight voltage drops in the transistors).

A slight disadvantage of the circuit of Fig. 20(C) can lead us into trouble. Suppose that one of the two drive signals fails for some reason, so that the corresponding transistor remains on. Each time the other transistor turns on, therefore, we have a direct short circuit from -12 volts to 0 volts. The resulting high current is then likely to destroy both transistors. This can be eliminated by the circuit of 20(D), where we use a pnp and an npn transistor in series. We can then use only one input pulse, since positive pulses will turn on the npn transistor and turn off the pnp transistor, and vice versa. One of the two transistors will therefore always be on and the other will be off. If the drive fails, then the two bases, connected together, will be at some constant d.c. voltage. Depending on exact circuit conditions, this voltage may be either more positive or more negative than the voltage at the two emitters. In either case, one of the two transistors will always be turned off. This sort of a circuit is said to be "fail-safe," for obvious reasons.

You may have wondered why the circuit is called a half-bridge. This becomes quite clear when we look at the circuit of 20(E), which is called a full-bridge since it so much resembles the common Wheatstone bridge. The full-bridge has the advantage of providing more power to the speaker.

Look at (D) of Fig. 20. If the emitters of Q_1 and Q_2 swing between 0 and -12 volts, then the voltage across C_1 , L_1 , and the speaker varies by 12 volts peak-to-peak. In the circuit of 20(E), however, transistors Q_1 and Q_2 receive a drive signal out of phase with the input drive signal to transistors Q_3 and Q_4 , so that Q_1 and Q_4 turn on and off together, and Q_2 and Q_3 turn on and off together.

When Q_1 and Q_4 are on, and Q_2 and Q_3 are off, the voltage across C_1 , L_1 , and the speaker is 12 volts in one direction. On the other hand, if transistors Q_1 and Q_4 are off, and Q_2 and Q_3 are on, the voltage across C_1 , L_1 , and the speaker is 12 volts in the other direction. The voltage therefore varies by 24 volts peak-to-peak. The voltage output is twice as high for the full-bridge as for the half-bridge, thus the maximum power output is four times as high. Since the current is also twice as high, however, we must be sure that the transistors can stand the extra current. (Note that we could eliminate capacitor C_1 if we could only make sure that the waveshape of the modulated pulses is such that the average d.c. value at the emitters of Q_1 and Q_2 is

equal to the average at the emitters of Q_3 and Q_4 . No average d.c. current through the speaker would then occur—we're back at the bridge circuit characteristics—so that no d.c. isolation capacitor is necessary. But it's safer to leave C_1 in.)

We brought up the matter of current in the transistors, and this brings up the question of what kind of transistors we need for a given power output. For this let's consider the circuit of (E) of Fig. 20. We mentioned that the maximum output voltage is 24 volts peak-to-peak. Once we consider a possible voltage drop of as much as 1 volt in each transistor, this reduces to about 22 volts peak-to-peak. If the maximum modulation percentage is about 95 per cent, then the maximum audio output voltage would be about 20 volts peak-to-peak, corresponding to approximately 7 volts rms. The maximum power into a 16-ohm loudspeaker is therefore about $(7)^2/16$, or 3 watts. The maximum power into an 8-ohm loudspeaker is about $(7)^2/8$, or 6 watts. (The corresponding power outputs from the half-bridge are 0.75 and 1.5 watts, respectively.) The speaker current is obtained from Ohm's law; since we are concerned with the peak current rather than just the rms current, we must use the peak voltage of 10 volts in the calculations (half of the peak-to-peak value). The maximum current through a 16-ohm speaker is $10/16$ or 0.63 ampere; the maximum current through an 8-ohm loudspeaker is $10/8$ or 1.25 ampere.

At this point we must realize that there is yet another current through the speaker, and that is the current due to the high-frequency pulse signal which gets through inductor L_1 . Let's assume that the minimum average frequency of this wave is 50 kc, and disregard the higher harmonics starting at 100 kc (the perfect square wave's harmonics will start with the third, at 150 kc, but when we start to modulate we obtain some even harmonics also, so that the next harmonic is at 100 kc instead).

What is the impedance of L_1 and the speaker at the 50 kc frequency? Suppose we pick L_1 so that it forms a low-pass filter with the speaker, starting to act at 10 kc. The response at 10 kc will be 3 db down, and at 15 kc will be about 5 db down. This means that the impedance of the inductor at 10 kc is equal to the nominal speaker impedance, or about 16 ohms for the 16-ohm speaker, 8 ohms for the 8-ohm speaker. At 50 kc the impedance will be five times higher, or 80 and 40 ohms respectively. Now, it happens that the speaker is also not a constant impedance device. Above the audio range a typical speaker impedance starts to rise, and may also be quite high. Most speakers will, in fact, have about the same impedance as the inductor at 50 kc. The total impedance is mostly inductive, so that we may add the two to get about 160 ohms for the 16-ohm speaker, and about 80 ohms for the 8-ohm speaker. The peak current through the 16-ohm speaker due to the switching signal is therefore $10/160$ or about 63 milliamperes. Similarly, the current

through the 8-ohm speaker is $10/80$ or about 125 milliamperes.

These are quite large currents, let's face it, and exist even when no modulation exists. We have simplified the above calculations very much, and neglected practically all transient situations. To do this thing right, we should have considered the Fourier case analysis of the square wave or used other sophisticated methods. But this so much complicates the picture that the above method, though less precise, is preferable. And it quite accurately describes some of the actual measurements taken on some of the circuits which follow later.

Let's reconsider the large currents we obtained. That current of 125 milliamperes in the circuit means a peak loss of 1.5 watts in the circuit, assuming 12 volts from the power supply. This really reduces the efficiency of the amplifier, doesn't it? What can we do? Well, we can adopt two courses of action, both of which try to decrease the amount of high-frequency current in the speaker. One way is to either increase the operating frequency of the circuit or decrease the cut-off frequency of the filter so that the filter absorbs more. The other is to use a different kind of low-pass filter which is more efficient.

Using a different kind of filter brings up difficulties. For one thing, more filter elements means greater loss in the elements. For another, as filter complexity increases, each filter element has to be calculated and adjusted much more closely. If the values of the filter change with time, circuit operation may get much worse.

The first method is by far the easier. We can easily increase the operating frequency from 50 up to some 70 or 80 kc, and can easily increase the size of L_1 so that it starts to act at a lower frequency. This latter change will also mean that L_1 will filter out some of the upper audio frequencies, but this can be compensated by increasing the treble somewhere before the amplifier. If we increase the operating frequency up to 75 kc, for example, and adjust L_1 so that the filter cut-off frequency is only 7 kc, then the amplifier will be about 7-db down at 15 kc, which can easily be compensated. Since the average powers in music and voice at these frequencies are quite low, such compensation should not cause overloading in the amplifier.

When this is done, the maximum current through the 16-ohm speaker due to the switching frequency drops to about 41 milliamperes, and the maximum current through the 8-ohm speaker drops to about 82 milliamperes. Any further reduction is hard to achieve, because it means further raising the frequency. This is hard, as we'll see in a moment.

If we add the actual audio signal currents of 0.63 ampere and 1.25 ampere obtained above for the 16- and 8-ohm speakers respectively, to the high-frequency switching currents, we find that at maximum we get totals of about 0.67 ampere and 1.33 ampere, respectively. Looking back at Fig. 20(E), we see that each transistor must be able to pass this current at least some of the time. These

are peak currents, no average values, but they may extend for a small fraction of a second and each transistor must be rated for at least this current peak.

Moreover, as we mentioned earlier, there exists some voltage drop across each transistor when it is turned on. This voltage drop is typically between 0.5 and 1.0 volts. Assuming worst case conditions of 1.0 volt, this means that the peak power dissipation in the transistor at 0.67 ampere is 0.67 watt, and at 1.33 ampere is 1.33 watt. Since each transistor is conducting over approximately one-half of each pulse, the average power dissipation would be somewhere about half, or 0.33 and 0.67-watt respectively.

So far we have found two required characteristics of our output transistors—the maximum power dissipation and the maximum current. The maximum collector-emitter voltage and maximum base-emitter voltage ratings should also be at least 12 volts, so we may place the full 12 volts across each transistor. This is another limitation on the transistor. A further limitation is the operating frequency. To reproduce a square wave accurately, the cut-off frequency for the transistor must be at least ten times higher than the pulse repetition frequency. For the 70 kc square wave, this would mean that the transistor must be capable of going to at least 700 kc. But as soon as we get modulation, some of the pulses are much shorter than the pulses in the 70 kc square wave, so that we need much greater frequency response.

Let's look at the 70 kc square wave a little longer. At 70 kc, each cycle takes 1/70,000 second, or about 14 microseconds (millionths of a second). Each of the square wave half-cycles is therefore 7 microseconds. Under high modulation levels of perhaps 90 per cent or so, one half of the pulse may lengthen to 13 microseconds. In order to properly reproduce these waves, the output transistor must be able to reproduce such a 1-microsecond (or even shorter) pulse. This means that the output must increase to the level of the pulse in less than a half microsecond, and must then decrease back to zero again in less than a half microsecond, in order to preserve the appearance of the pulse. This requires a frequency response up to about one or two megacycles from the transistor.

Finally, there comes the question of operating gain. If we wish to reduce the drive to the transistor, or make its operation more reliable with a given value of drive, we must choose a transistor with a reasonable value of gain (beta). Since the value of beta for a given type of transistor may easily vary over a two-to-one or even three-to-one range, we must pick a transistor whose beta is sufficiently high that even a low-beta unit will work well.

So far we have decided that we need a transistor which will have a high beta, a high operating frequency, a power dissipation of 0.67 watt for 8-ohm speakers (or 0.33 watt for 16-ohm speakers), and a maximum collector current of 1.33 ampere (or 0.67 amperes for 16 ohm

speakers). Moreover we need both a pnp and an npn unit.

These requirements are hard to meet. The high power dissipation means that a transistor with a bolt-down case is required since a small lead-mounted unit cannot dissipate that much power. But large units tend to have lower betas and, most important, lower maximum operating frequencies. The author has not yet found suitable low priced units which will do the job, although there undoubtedly must be some.

One transistor factor we must consider is thermal runaway. This occurs when the transistor starts to heat up, so that its leakage current (the current between collector and emitter) rises as a result of the temperature rise. This factor is most serious for germanium transistors, where the leakage current doubles for each 8 degrees or so Fahrenheit; silicon transistor leakage current increases more slowly. Increasing leakage current increases the current during transistor operation, so that the power dissipation rises even further and the temperature goes up. This results in even more current and so on, so that if the circuit is not stabilized the transistor may overheat and destroy itself.

One of the common ways of limiting the transistor current and stabilizing the circuit is to insert resistance in series with the emitter or collector, so that a rising current decreases the applied voltage and tends to keep the power dissipation low. Note that the output circuit of Fig 20 (E) is particularly susceptible to thermal runaway, since there is no external resistance in series with the transistors. The transistors will usually be located near each other so chances are that if one heats up the other will also heat up. The danger is that all transistors will get overheated and literally melt. There is no way of compensating the circuit to prevent this without adding resistances or in some other way reducing the performance.

There are two possible ways of avoiding thermal runaway in this circuitry. One way is to choose a transistor (and maybe even a heat sink) which can absorb the extra heat without being affected. This would indicate that a silicon transistor, whose leakage current is less dependent on the temperature, and which can operate at higher temperatures without damage, might be best. The other way is to make sure that the transistor always has enough drive to keep it fully saturated or fully turned off. This condition is tied in with having a high beta, since with a low beta the transistor needs more drive to turn it on and off.

Unfortunately, most silicon transistors are npn units; there are very few silicon pnp transistors. This means that we may often not be able to find a pair of silicon transistors which will satisfy our requirements.

The above discussion describes a very real problem, one which provides great difficulty in designing an amplifier. The amplifiers described in this article sidestep the entire problem by limiting the power output of the amplifier. In this way the output transistors are not called upon to deliver anywhere near the currents and voltages required in the preceding discussion. The transistors used in these amplifiers are the 2N527, a germanium pnp transistor with a beta of 72-121, a typical frequency cut-off of 3.3 mc, maximum collector current of 0.5 amp, maximum dissipation of 225 mw, and collector-emitter breakdown voltage of 30 volts. This transistor costs less than two dollars. Also used is the 2N697, a silicon npn transistor with a beta of 40-120, a maximum collector current of 0.5 ampere, maximum dissipation of 600 mw, and collector-emitter breakdown voltage of 40 volts. The 2N697 is available from several manufacturers at various prices, but in general costs about two dollars. Any of a number of other transistors would also

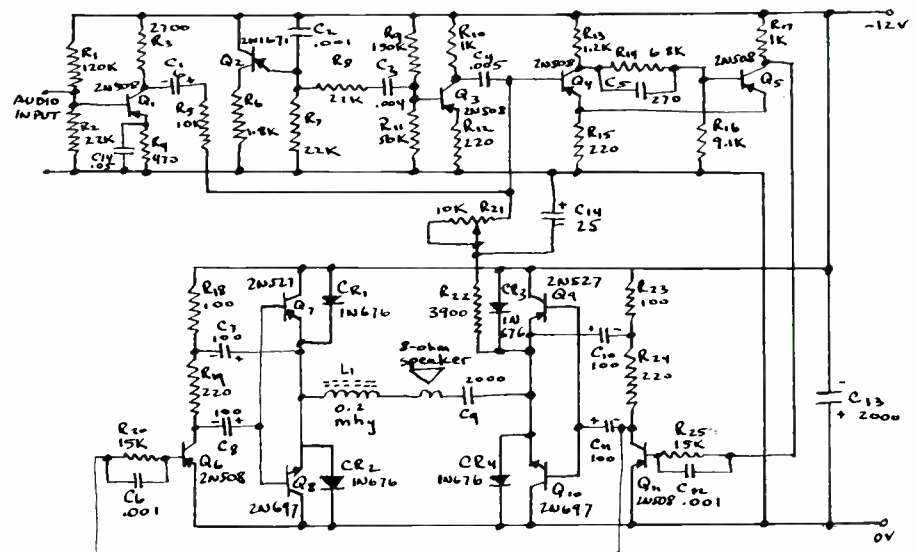

NOTES: 1. ALL CAPACITORS 10 μF.
2. ALL RESISTORS 1/2 WATT, ±5%

Fig. 21. Schmidt-trigger modulator amplifier schematic.

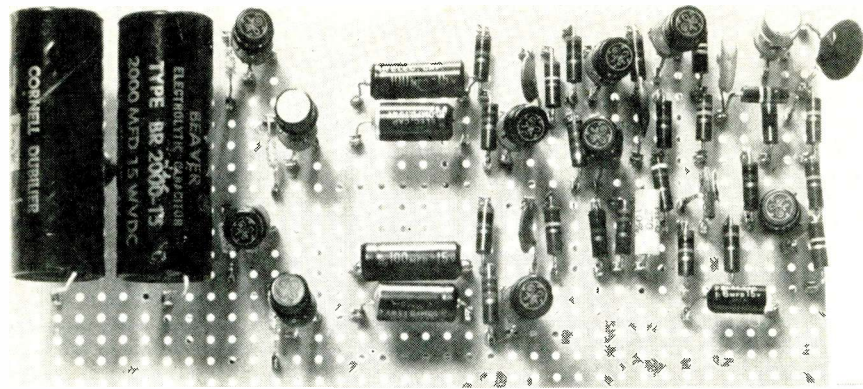

Fig. 22. Schmidt-trigger modulator amplifier.

work in the circuits, with varying degrees of success. The minimum beta is very important, since a low beta may prevent complete switching of the transistor with resultant high power dissipation. If the transistor overheats and passes more current, chances are both transistors of a pair will be destroyed.

After these introductory cautions, let's go to the three working amplifier circuits.

Amplifier with Schmidt Trigger Modulator

Figures 21 and 22 show an amplifier using the Schmidt trigger modulator described earlier. Using an 8-ohm loudspeaker, the amplifier produces an output power of approximately 1 watt.

The audio input signal is amplified by Q_1 and applied to the Schmidt trigger, consisting of transistors Q_4 and Q_5 . Capacitor C_{14} in the emitter circuit of Q_1 provides high-frequency boost, starting at about 7 kc, to compensate for the decrease in high frequencies in the low-pass filter at the speaker. This stage is designed so that it starts to limit just below the point at which the modulator starts to distort.

Transistor Q_2 is a Unijunction transistor which provides a triangular wave as described earlier. This triangular wave is amplified by Q_3 and also applied to the Schmidt trigger. The trigger is similar to the trigger described earlier. The output from the trigger circuit is taken at the collector of Q_5 , and applied to the base of Q_{11} through a network consisting of resistor R_{25} and capacitor C_{12} . The resistor reduces the voltage swing from Q_5 to an acceptable value, and capacitor C_{12} is a speed-up capacitor which provides a larger pulse at the beginning and end of each pulse to assist Q_{11} in switching.

The output of Q_{11} is taken through capacitor C_{11} and applied to the bases of transistors Q_9 and Q_{10} , which provide one half of the full-bridge. This output is also applied to transistor Q_6 , which inverts the pulse and applies it to transistors Q_5 and Q_6 , the other half of the full-bridge. Capacitors C_7 and C_{10} provide a positive feedback path to the collectors of the driver transistors to increase the power driving the output stage. This is to guarantee that enough drive signal is present to completely switch the output transistors. Diodes

CR_1 through CR_4 are connected in reverse across the four output transistors to prevent reverse spikes generated by the inductors in the circuit from damaging the transistors.

The speaker is connected in series with L_1 and C_9 across the two halves of the full-bridge. Inductor L_1 is 0.2 millihenrys, and has an impedance of about 9 ohms at 7 kc. Since this coil must have a resistance of about 1 ohm or less, and must be able to pass up to about one-half ampere without saturation, you will probably find that you must make your own. Providing that it uses a large core, a transistor radio antenna coil works well. Otherwise, obtain a $7\frac{1}{2}$ -inch length of $\frac{1}{2}$ -inch diameter ferrite core material (Lafayette MS-333), and cut it into four equally-long pieces. Tape the four pieces next to each other to make one thick core, and then close-wind 50 turns of number 24 enamel wire over the core.

This amplifier is fairly straightfor-

ward and reliable, except that resistor R_{21} needs to be carefully adjusted. This resistor is in a d.c. feedback path from the output of the amplifier back to the input of the Schmidt trigger. With R_{21} correctly adjusted, the output pulses from the Schmidt trigger with no audio input are symmetrical. Another way of checking is that, with R_{21} properly adjusted, the average d.c. voltage at the collector of Q_{11} is exactly half of the d.c. power supply input. If for any reason the symmetry of the square wave changes, the d.c. feedback path will try to reestablish symmetry.

A somewhat more sophisticated version of the Schmidt trigger was published by K. C. Johnson^{12,1} and is quite interesting.

The K. C. Johnson Schmidt Trigger Amplifier

The K. C. Johnson amplifier is shown in Fig. 23 and 24. Although Johnson has stated that the amplifier will develop about one watt, the circuit is more conservatively rated at about 0.3 watt before distortion sets in. You'll note that the output stage is a half-bridge, almost identical to half of the full-bridge shown in Fig. 21. The power may be somewhat increased by using 0.2 mhy for L_1 and using an 8-ohm speaker.

The Schmidt trigger consists of transistors Q_2 and Q_3 , and is slightly different from the Schmidt trigger described earlier and shown in Fig. 10. Rather than obtaining feedback by connecting the emitters of the Schmidt trigger transistors together, the feedback comes from the two collector-to-base paths consisting of C_3 , R_3 , R_{11} , and C_4 . The output from Q_3 is coupled from the collec-

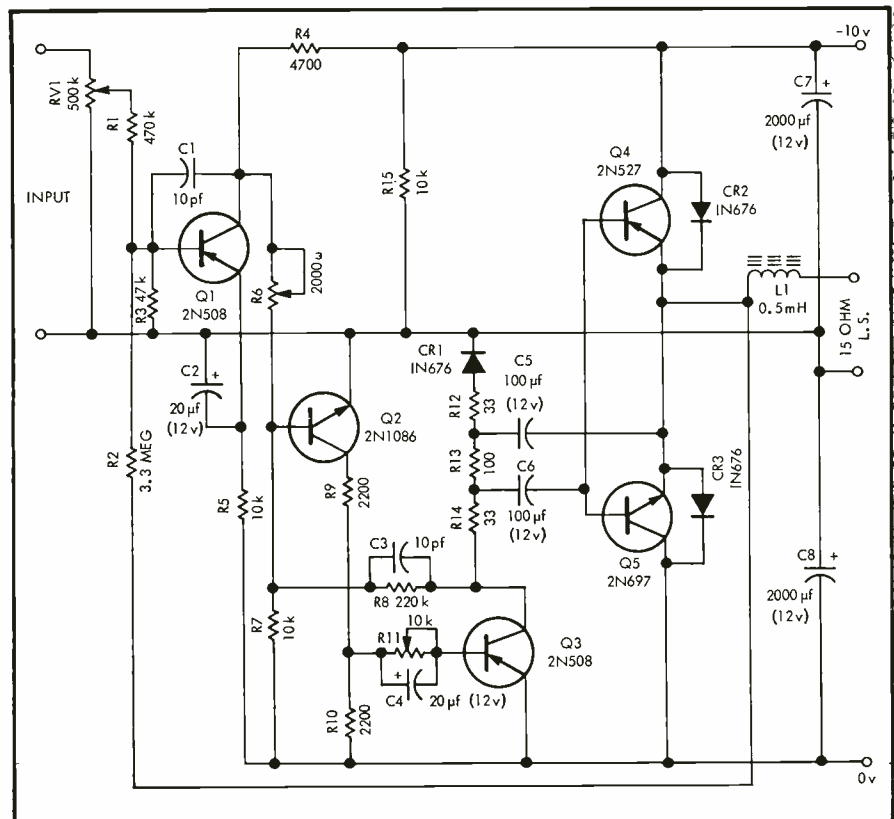

Fig. 23. K. C. Johnson amplifier schematic.

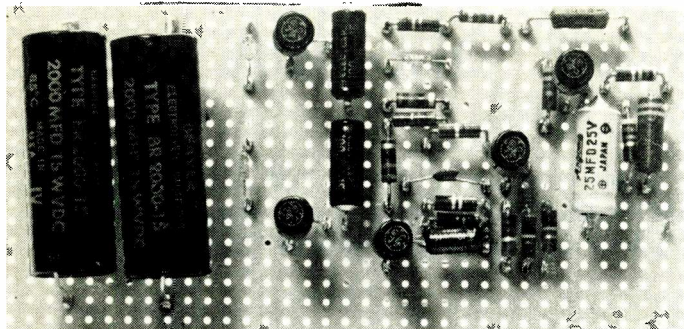

Fig. 24. K. C. Johnson amplifier (see references 1 and 12).

tor into the base of Q_4 and Q_5 through capacitor C_6 . A positive feedback signal comes from the output through capacitor C_5 , and is coupled to the junction of resistors R_{12} and R_{13} .

As the emitters of Q_4 and Q_5 vary between -10 volts and 0 volts, the average d.c. value with no modulation becomes approximately -5 volts, and this potential is impressed across capacitor C_8 , through the speaker. The cathode of CR_1 is therefore at approximately -5 volts. When the emitters of Q_4 and Q_5 are at -10 volts, however, a high current would exist through C_5 and R_{12} ; diode CR_1 prevents this by being reverse biased under these conditions. Since the collector supply for the output driver transistors in the preceding amplifier (see R_{18} and R_{23} in Fig. 21) comes from -12 volts, such a diode is not required there.

The triangular wave and the audio signal are applied to transistor Q_2 from Q_1 , through resistor R_6 . You may at this point be asking, where does the triangular wave come from?

And this is the intriguing point about this amplifier—it comes from the output. You see, transistor Q_1 is a Miller integrator.¹⁴ Capacitor C_1 , in conjunction with the input circuit resistances (such as R_2) acts as a low-pass filter, an integrator. Now, since capacitor C_1 is connected between the base of Q_1 and its collector, the current through the capacitor depends on the voltage differences across it. If the voltage gain of the transistor in this circuit is called A , then if the input voltage to the amplifier changes by -1 volt, the output changes by $+A$ volts (the minus sign denotes the phase reversal). The voltage change across C_1 is therefore equal to $A - (-1) = A + 1$. The current through the capacitor is therefore $A + 1$ times larger than if the capacitor were connected from the base of Q_1 directly to ground. Another way of saying this is that the circuit behaves as though another capacitor, whose value is $A + 1$ times C_1 , were connected between the base of Q_1 and ground. If the gain of the stage is 30 , then we could get the same results by removing C_1 and instead connecting a capacitor equal to $(10 \text{ pf}) (30 + 1) = 310 \text{ pf}$, between the base of Q_1 and ground.

Let's now look at just the portion of the circuit consisting of the Miller integrator and resistor R_2 , and compare this with Fig. 15. If we only feed a square wave into resistor R_2 , then the output from the Miller integrator will be a triangular wave. But don't we have a square wave at the output from the am-

plifier? We merely mix the audio signal with this, and immediately have the kind of signal we need for the Schmidt trigger.

We have a second advantage in this circuit—the square wave fed back from the output of the amplifier has already been modulated once, and now we modulate it again. We can therefore get much larger modulation percentages from this amplifier than if we modulated each triangular wave only once. We note also that a d.c. feedback path exists from the junction of C_7 and C_8 to the base of transistor Q_1 through resistor R_3 ; this feedback path tends to stabilize the unmodulated output to produce equal positive and negative pulses.

This circuit is really ingenious and works quite well, considering the scarcity of components. But it has a few disadvantages. For one thing, it is hard to start working. Until the Schmidt trigger receives a triangular wave input, it won't provide a square wave output to the output stage. On the other hand, until there is an output from the output stage, there can't be any triangular wave.

If there is no output, the voltage across C_8 can be any value between 0 and -10 volts, so that the operating points of the various transistors may be widely off their proper values. Then too, transistor Q_3 depends on the positive feedback path from the output stage to give it enough gain and to establish the

proper operating voltages. But if there is no output, there isn't any feedback.

Finally, the entire amplifier is one big feedback loop, and it won't operate without the feedback. A slight error in a component value at one end of the amplifier can have a large effect on a voltage at some other point in the circuit. This is why R_6 and R_{11} require precise adjustments; these potentiometers will probably have to be readjusted each time you make a change to the circuit or change a transistor.

The amplifier, while being simple and having few components, clearly suffers from this corner-cutting. On the other hand, next comes an amplifier which uses many components (12 transistors alone), but is reliable under all conditions, requiring no adjustments at all:

Astable Multivibrator Amplifier

Figures 25 and 26 show an amplifier using the astable multivibrator to generate length-modulated pulses. This amplifier works as follows:

The audio input is amplified by transistor Q_1 and applied to a phase splitter, Q_2 , and two amplifiers. Note that C_1 is rather large; its purpose is not merely to integrate the feedback signal provided from the output through R_{24} , but to completely remove the square wave and recover the audio. This is therefore part of a negative feedback path which mixes the audio signal from the output of the amplifier with the input. Transistors Q_3 and Q_4 amplify the output of the phase splitter, and are directly coupled to the astable multivibrator, which consists of transistors Q_5 and Q_6 , R_{25} , C_{11} , and R_9 provide a negative feedback for the d.c. average signal from the output of the amplifier. This tends to stabilize the output so that the unmodulated square wave is symmetrical.

The astable multivibrator, transistors Q_5 and Q_6 , works like the circuit of Fig. 16, except that it receives two out-of-

(Continued on page 95)

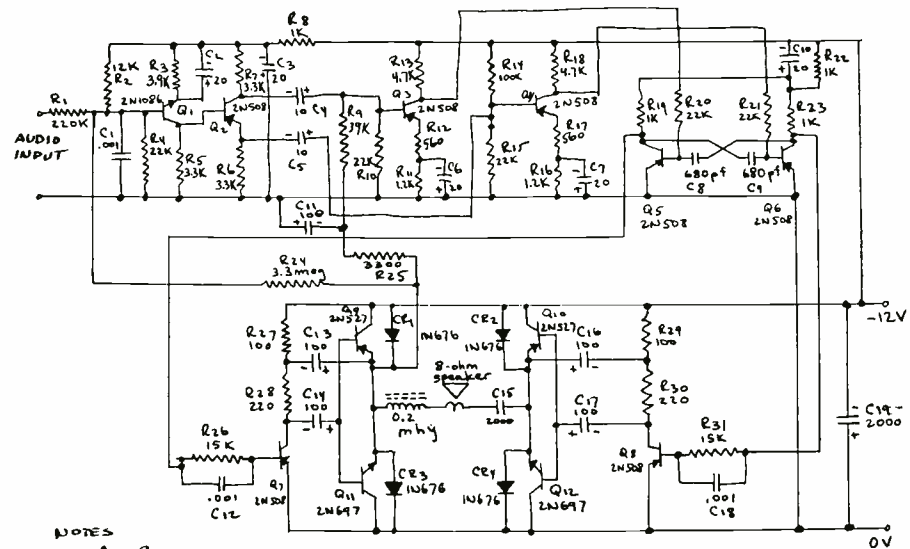

- NOTES
1. All CAPACITORS in μf except if otherwise marked
 2. All RESISTORS $\frac{1}{2}$ WATT, $\pm 5\%$.

Fig. 25. Astable multivibrator amplifier schematic.

PRODUCT PREVIEW SECTION

Presenting the annual compilation of the new—and some of the old standby—products that will be shown by your hi-fi dealer during the coming months, and at the High Fidelity Music Show in September (San Francisco) and October (New York).

WHEN THE HI-FI MANUFACTURERS bring forth their annual crop of new and improved products, they are understandably anxious that everyone should know all about them. We are in full sympathy with this desire to the extent that we employ the August issue as a Product Preview.

In an attempt to arrive at some sort of uniformity in the descriptions of the products shown, each manufacturer was furnished forms for each category of products, with spaces for the information we think is important to the potential purchaser.

We have continued the style of pre-

sentation, allowing a listing of up to five items in addition to the principal one, but without description in detail. Thus we have over 350 main listings plus an average of 2-plus subsidiary listings for each main one—giving us a total listing of almost 1000 products.

The specifications given are those provided by the manufacturer. Prices quoted may vary between East and West, but only one price is shown. In any instance, for further information about any product described or listed, just write to us using the code number at the end of each item (i.e. A1-1, A11-2,

etc.). DO NOT USE THE READER SERVICE CARD.

The Product Preview Section contains 21 consumer categories (A1 through A21) and five commercial sound categories (CS1 through CS5). The commercial sound categories are similar in title to some of the consumer categories, but the products are not at all similar.

Below is a listing of the manufacturers and importers who make the products available in the Preview Section. Note that some names are trade names and not necessarily the name of the manufacturer.

Acoustech, Inc.
139 Main St.
Cambridge 42, Mass.

Acoustic Research, Inc.
24 Thorndike St.
Cambridge 41, Mass.

Acoustica Associates
5331 W. 104 St.
Los Angeles 45, Calif.

Acoustical Manufacturing Co., Ltd.
Huntingdon, England

AKG of America
Div. of North American Philips Co., Inc.
125 Park Avenue
New York, N. Y. 10017

Allan, Richard, Sales Corp.
P. O. Box 95
Jericho, N. Y.

Allied Impex Corp.
300 Park Ave., South
New York 10, N. Y.

Allied Radio Corp.
100 N. Western Ave.
Chicago 80, Ill.

Altec Lansing Corp.
1515 S. Manchester Ave.
Anaheim, Calif.

American Recording Tape (see Greentree)

American Microphone Co.
400 S. Wyman St.
Rockford, Ill.

Ampex Corporation
934 Charter St.
Redwood City, Calif.

Apparatus Development Co.
Wethersfield, Conn.

Argos Products Co.
Genoa, Ill.

Artisan Organs
2476 N. Lake Ave.
Altedena, Calif.

Astatic Corporation
Conneaut, Ohio

Audio Devices, Inc.
235 E. 42 St.
New York, N. Y. 10017

Audio Dynamics Corp.
Pickett District Rd.
New Milford, Conn.

Audio Originals
326 E. St. Joseph
Indianapolis, Ind.

Audio Tech Laboratories
2819 Newkirk Ave.
Brooklyn 26, N. Y.

Barker and Williamson
Bristol, Pa.

Barker Sales Co.
339 Broad Ave.
Ridgefield, N. J.

Barzilay Furniture Mfg. Co., Inc.
17303 S. Western Ave.
Gardena, Calif.

Bell Sound Division (see TRW)

Benjamin Electronic Sound Corp.
80 Swalm St.
Westbury, N. Y.

Beyer (see Rye Sound)

Bogen Communications Div.
Lear Siegler, Inc.
Paramus, N. J.

Bozak Mfg. Co.
Box 1166
Darien, Conn.

Burgess Div. Servel
Freeport, Ill.

Butoba (see Stanford International)

British Industries Corp.
80 Shore Rd.
Port Washington, N. Y.

Cabinart Acoustical Dev. Corp.
34 Geyer St.,
Haledon, N. J.

Castagna (see Scope Electronics)

CBS Laboratories
277 High Ridge Rd.
Stamford, Conn.

Chancellor Electronics, Inc.
457 Chancellor Ave.
Newark, N. J.

Cipher (see Inter-Mark)

Clark, David, Co., Inc.
360 Park Ave.
Worcester, Mass.

Concertone
9730 Factorial Way
South El Monte, Calif.

Concord Electronics Corp.
809 N. Cahuenga Blvd.
Los Angeles 38, Calif.

Craig Panorma
34-12 S. LaCienega Blvd.
Los Angeles, Calif.

Crown International
P. O. Box 261
Elkhart, Indiana

CTS of Paducah
1565 N. 8 St.
Paducah, Ky.

Dual (see United Audio)

Dynaco, Inc.
3916 Powelton Ave.
Philadelphia 4, Pa.

Eastman Kodak Company
Rochester, N. Y.

EICO Electronic Instr. Co.
131-01 39th Ave.
Flushing, N. Y. 11352

Electro-Voice, Inc.
Buchanan, Mich.

Elpa Marketing Industries
New Hyde Park, N. Y.

EMI (see Scope Electronics)

Empire Scientific
845 Stewart Ave.
Garden City, N. Y.

Ercona Corp.
432 Park Ave. South
New York 3, N. Y.

Eric Engineering Co.
1823 Colorado Ave.
Santa Monica, Calif.

Fairchild Recording Equipment Corp.
10-40 45th Ave.
Long Island City 1, N. Y.

Ferroglyph (see Ercona)

Finney Co.
34 W. Interstate St.
Bedford, Ohio

Fisher Radio Corp.
21-29 44 Drive
Long Island City 1, N. Y.

FM/Q (see Apparatus Development)

Frazier (International Electronics)
2649 Brenner Drive
Dallas 20, Texas

Freeman Electronics Corp.
729 N. Highland Ave.
Los Angeles 38, Calif.

Garrard (see British Industries)

General Electric Company
2200 N. 22 St.
Decatur, Ill.

Goodmans (see UTC)

Gotham Audio Corp.
2 W. 46 St.
New York 19, N. Y.

Grado Laboratories, Inc.
4614 Seventh Ave.
Brooklyn 20, N. Y.

Greentree Electronics
1122 S. LaCienega Blvd.
Los Angeles 35, Calif.

Groomes Div. of
Precision Electronics, Inc.
9101 King St.
Franklin Park, Ill.

Harman-Kardon
Plainview, N. Y.

Harned (see Lectronics)

Hartley-Luth
519 E. 162 St.
Bronx, N. Y. 10451

Heath Company
Beuton Harbor, Mich.

International Electroacoustics, Inc.
333 Sixth Ave.
New York 14, N. Y.

International Electronics Corp.
81 Spring St.
New York 12, N. Y.

Itoh, C., Co., Ltd.
C.P.O. Box 117
Osaka, Japan

Jensen Manufacturing Co.
6601 S. Laramie Ave.
Chicago 38, Ill.

Jerrold Electronics Corp.
15th & Lehigh
Philadelphia 32, Pa.

JFD Electronics Corp.
15th Ave. at 62 St.
Brooklyn 19, N. Y.

Karg Laboratories
162 Ely Ave.
S. Norwalk, Conn.

Kenwood Electronics, Inc.
3700 S. Broadway
Los Angeles, Calif. 90007

Kersting Mfg. Co.
504 S. Date St.
Alhambra, Calif.

KLH Research and Development Corp.
30 Cross Street
Cambridge 39, Mass.

Klipsch and Associates
Hope, Arkansas

Knight (see Allied Radio)

Kodak (see Eastman Kodak)

Koss Electronics
2227 N. 31 St.
Milwaukee, Wis.

Lafayette Radio
P. O. Box 10
Syosset, N. Y.

Langevin (see Altec Lansing)

Lansing, James B., Sound, Inc.
3249 Casitas Ave.
Los Angeles 39, Calif.

Leak (see Ercona Corp.)

Lectronics of City Line Center
7644 City Line Ave.
Philadelphia 31, Pa.

Leonhardt Engineering Company
5126 E. State St.
Rockford, Ill.

London (see Lectronics)

Lux (see Itoh)

Magnecord (see Midwestern Instruments)

Marantz Company
25-14 Broadway
Long Island City 1, N. Y.

Martel Electronic Corp.
2356 S. Cotner Ave.
Los Angeles 64, Calif.

McIntosh Laboratory, Inc.
2 Chambers St.
Binghamton, N. Y.

Michigan (see Electro-Voice)

Micro Seiki Co., Ltd.
7-925 Koenji, Suginami-ku
Tokyo, Japan

Midwestern Instruments
Tulsa, Okla.

Miranda (see Allied Impex)

Mullard (see International Electronics)

Multitron Corp.
309 Queen Anne Rd.
Teaneck, N. J.

Neat Onkyo Denki Co., Ltd.
No. 4-1 chome, Kanda Hatago-cho
Chiyoda-ku, Tokyo, Japan

Neshaminy Electronic Corp.
Edison-Furlong Rd.
Furlong, Pa.

Newcomb Products Co.
6824 Lexington Ave.
Hollywood 38, Calif.

Neumann (see Gotham)

Nortronics Co., Inc.
8101 W. 10 Ave. N.
Minneapolis, Minn.

North American Phillips Co.
100 Park Ave.
New York, N. Y.

OKI (see Chancellor Electronics, Inc.)

Ortofon (see Elpa Marketing)

Pickering & Company, Inc.
Plainview, N. Y.

Pilot Radio Corp.
100 Electra Lane
Yonkers, N. Y.

Permoslux Corp.
4111 San Fernando Rd.
Glendale, Calif.

Puresonics
4938 W. North Ave.
Chicago, Ill. 60639

Quad (see Acoustical Mfg.)

R & A (see Ercona Corp.)

RCA Electronic Components and Devices
Harrison, N. J.

Reeves Soundcraft Corp.
Great Pasture Rd.
Danbury, Conn.

Rek-O-Kut Co.
38-19 108 St.
Corona, N. Y.

Roberts Electronics, Inc.
5920 Bowercraft Ave.
Los Angeles 16, Calif.

Rockford Special Furniture Co.
2024 23 Ave.
Rockford, Ill.

Rotron Mfg. Co., Inc.
Woodstock, N. Y.

Rye Sound Corp.
145 Elm St.
Mamaroneck, N. Y.

Sarkes Tarzian, Inc.
East Hillside Drive
Bloomington, Ind.

Schober Organ Corp.
43 W. 61 St.
New York 23, N. Y.

Scope Electronics Corp.
235 E. 42 St.
New York, N. Y. 10017

Scott, H. H., Inc.
111 Powder Mill Road
Maynard, Mass.

Scully Recording Instruments Corp.
480 Bunnell St.
Bridgeport, Conn.

Sennheiser Electronics Corp.
25 W. 43 St.
New York 36, N. Y.

Sharpe (E. J.) Instruments, Inc.
965 Maryvale Drive
Buffalo, N. Y.

Sherwood Electronic Laboratories, Inc.
4300 N. California Ave.
Chicago 18, Ill.

Shure Brothers, Inc.
222 Hartrey Ave.
Evanston, Ill.

Sonotone Corp.
Elmsford, N. Y.

Stanford International
569 Laurel St.
San Carlos, Calif.

Stanton Magnetics
Plainview, N. Y.

Sony Corp of America
580 Fifth Ave.
New York 36, N. Y.

Superscope, Inc.
8520 Tuijunga Ave.
Sun Valley, Calif.

Switchcraft, Inc.
5537 N. Elston Ave.
Chicago 30, Ill.

Tandberg of America, Inc.
P. O. Box 171
Pelham, N. Y.

Tannoy (America) Ltd.
P. O. Box 177
East Norwich, N. Y.

Thorens (see Elpa Marketing)

Telepro Industries
Cherry Hill, N. J.

Transistor Sound Laboratory, Inc.
80 Swalm Rd.
Westbury, N. Y.

TRW Columbus Division
Thompson Ramo Wooldridge, Inc.
6325 Huntley Rd.
Columbus 24, Ohio

United Audio Products
12 W. 18 St.
New York 9, N. Y.

University Loudspeakers
Oklahoma City, Okla.

Utah Electronics
Huntington, Ind.

UTC Sound Division
809 Stewart Ave.
Garden City, N. Y.

Vernon Audio Division
144 E. Kingsbridge Rd.
Mt. Vernon, N. Y.

Viking of Minneapolis, Inc.
9600 Aldrich Ave. South
Minneapolis 20, Minn.

Vitavox (see Ercona)

Jordan Watts (see Lectronics)

Wharfedale (see British Industries)

Wigo (see United Audio)

Winegard Co.
300 Scotten Blvd.
Burlington, Iowa

Wolverine (see Electro-Voice)

YL-Acoustic Co. Ltd.
19 Shiba-Tamura-cho
Minato-ku, Tokyo, Japan

A1. BASIC AMPLIFIER

ACOUSTECH

● **Acoustech 1 Solid-State Stereo Power Amplifier.** A solid-state stereo power amplifier using silicon output stage combined with direct-coupled circuitry. Mil-spec glass-epoxy boards, computer-grade electrolytics, conservative operation of all components.

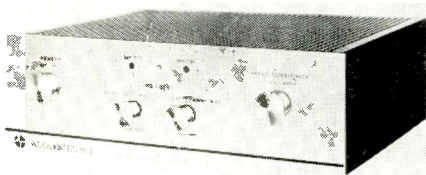

Specifications: Freq. resp. 2.5 to 250k cps ± 3 db at 5 watts output; power bandwidth, 20 to 20k cps; power output, rms, 40 watts per channel; harmonic distortion, 0.95% at 40 watts from 20 to 20k cps; IM distortion, 0.95% at 40 watts; hum and noise, 85 db below 40 watt output; sensitivity, input for rated output, 2.5 volts; damping factor, 50; output impedances, 4, 8, 16 ohms; controls, on-off, input sensitivity; switches, high and low rolloff; convenience outlets, 1; weight, 29 lbs; dimensions, 15 $\frac{3}{4}$ " wide, 5" high, 12" deep; price, \$395.00. A1-1.

ALTEC

● **351B Solid-State Power Amplifier.** Transistor utility amplifier adaptable to a wide variety of applications. Draws only 6 watts from the power line at zero signal. 70-volt output. "Flashguard" circuit gives a visual warning when output transistors become dangerously overloaded.



Specifications: Freq. resp. 20 to 20k ± 1 db; IHF music power output, 50 watts; harmonic distortion, 1.5% at 40 watts from 25 to 10k cps; hum and noise, 90 db below 50-watt output; sensitivity, input for rated output, 0.45 volts; damping factor, 7.5; output impedances, 4, 8, 16, 125 ohms, 70v; controls, level; switches, protective circuit; weight, 15 lbs; dimensions, 9 $\frac{3}{4}$ " wide, 5" high, 9 $\frac{1}{4}$ " deep; price, \$252.00. A1-2.

DYNA

● **Stereo 70/A Stereo Power Amplifier.** Conservatively-operated stereo amplifier. Patented Dyna "Blaset" assures long tube life, and low distortion.

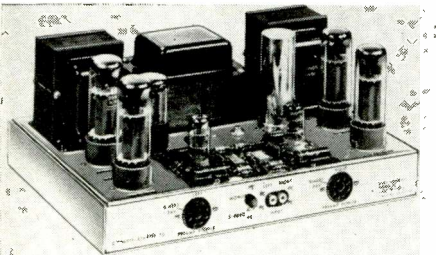

Specifications: Freq. resp. 10 to 40k cps; ± 0.5 db at 1 watt output; power output, rms, 35 watts per channel; harmonic distortion, 1% at 35 watts, ± 1 db from 20 to 20k cps; IM distortion, 1% at 35 watts; hum and noise, 90 db below 35-watt output; sensitivity, input for rated output, 1.3 volts; damping factor, 15; output impedances, 4, 8, 16 ohms; controls, dual bias adjust;

switches stereo-mono power; weight 32 lbs; dimensions, 13" wide, 6 $\frac{1}{2}$ " high, 9 $\frac{1}{2}$ " deep; price, \$129.95. A1-3.

1. Stereo 35/A, 35-w \$79.95
2. Mark 111/A, 60-w \$99.95
3. Mark 1V/A, 40-w \$79.95

FISHER

● **SA-1000 150-Watt Stereo Power Amplifier.** Utilizes newly-developed 8417 cavity-anode beam power output tubes. High percentage of feedback, 780 of filtering and low-impedance silicon-diode power supply. Hinged cover conceals infrequently-used controls.

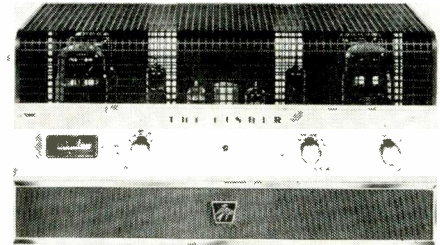

Specifications: Freq. resp. 8 to 50k cps ± 1 db at 2 watts output; power bandwidth, 8 to 40k cps; IHF music power output, 75 watts per channel; power output, rms, 65 watts per channel; harmonic distortion, 0.25% at 130 rms watts at 1 kc; IM distortion, 0.4% at 130 watts rms; hum and noise, 90 db below 130 watt rms output; sensitivity, input for rated output, adjustable 0.5 to 2.0 volts with freq. compensated attenuation; damping factor, 17; output impedances, 4, 8, 16 ohms; controls, a.c. Balance, Bias; switches, input attenuator Subsonic Filter, power; weight, 70 lbs; dimensions 15 $\frac{1}{2}$ " wide, 7 $\frac{1}{4}$ " high, 12" deep; price, \$329.50. A1-4.

GOTHAM

● **PFB-150 WD.** Employs 5 balanced push-pull stages. The output transformer is a specially-designed toroid. It is designed for any high-power low-distortion application. The PFB 150 WA variation is used with the Gramplan head in the Gotham-Gramplan disc-cutting system.

Specifications: Freq. resp. 20 to 40k ± 0.5 db at 10 watts output; power bandwidth, 40 to 15k; harmonic distortion, 0.7% at 150 watts from 40 to 15k cps; IM distortion, 1.0% at 200 watts peak; hum and noise, 100 db below 150-watt output; gain 50 db; damping factor, 40; output impedances, 8, 16, 32, 93 ohms; controls; gain 2-db steps; switches: on-off, metering; weight, 107 lbs; dimensions, 19" wide, 10 $\frac{1}{2}$ " high, 11" deep (2 chassis); price, \$615.00. A1-5.

HARMAN-KARDON

● **Citation B Solid-State 80-watt Stereo Amplifier.** Features: heavy-duty silicon output transistors. All specifications are based on both channels driven simultaneously. Full power is available to 4, 8, 16-ohm loads. Computer-grade electrolytics. Automatically stabilized against extreme heat variations. Fail-safe under direct shorting conditions. B+ fusing. Has idle current adjustments for each output transistor with front panel meter.

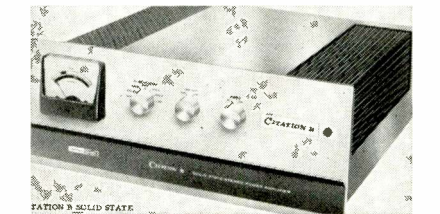

Specifications: Freq. resp. 1 to 100k cps ± 1 db at 1 watt output; power bandwidth, 15 to 60k cps; power output, rms, 40 watts per channel; harmonic distortion, 0.5% at 40 watts from 20 to 20k cps; IM distortion, 0.5% at 40 watts; hum and noise, 90 db below 40 watt output; sensitivity, input for rated output, 1.6 volts; damping factor, 50; output impedances, 4, 8, 16 ohms; controls, individ. idle adjust; switches, meter selector, subsonic filter, power, impedance convenience outlets, 1; weight, 33 lbs; dimensions, 14 $\frac{3}{4}$ " wide, 5 $\frac{3}{8}$ " high, 14" deep; price, \$425.00. A1-6.

LAFAYETTE

● **LA-280 Criterion 200-Watt Solid-State Stereo Amplifier.** Using a total of 30 solid-

state devices, the LA-280 develops 100-watts each stereo channel into a 4-ohm load. All components are conservatively rated. The LA-280 has outputs for electrostatic speakers and stereo headphones.

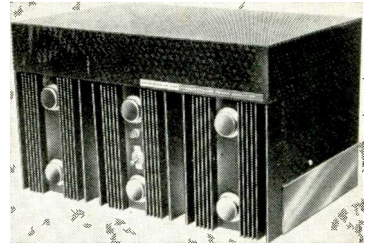

Specifications: Freq. resp. 15 to 20k cps ± 0.1 db at 100 watts output; IHF music power output, 100 watts per channel; power output, rms, 80 watts per channel; harmonic distortion, 0.05% at 75 watts from 100 to 20k cps; IM distortion, 0.2% at 120 watts; hum and noise, 90 db below rated output; sensitivity, input for rated output, 1.5 volts; output impedances, 4, 8, 16 ohms; controls, power on/off; input level; convenience outlets, 2; shpg. weight, 35 lbs; dimensions, 14 $\frac{3}{4}$ " wide, 8" high, 9 $\frac{1}{8}$ " deep; price, \$299.50. A1-7.

JBL

● **Solid-State Energizer.** The Energizer takes the place of a conventional stereo amplifier. It is a solid-state audio power source which becomes an integral part of any JBL loudspeaker enclosure combination. Plug-in circuit board controls damping and makes minor adjustments in frequency contour of specific JBL speaker systems. Installs directly in loudspeaker enclosure back panel.



Specifications: Sensitivity, input for rated output, 3 volts; output impedances, for 8, 16 ohm speaker; controls, Chan A gain, Chan B gain; weight 18 lbs; dimensions, 15 $\frac{1}{2}$ " wide, 4 $\frac{1}{2}$ " high, 5 $\frac{1}{4}$ " deep; price, \$216.00. Available either factory installed, or for addition to existing JBL speaker systems. A1-8.

LEAK

● **Stereo 60.** Two identical power amplifiers, electronically separate but physically combined.

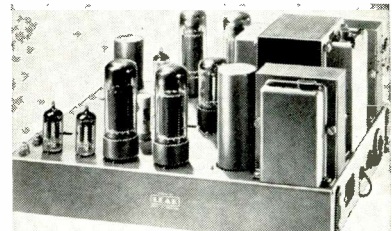

Specifications: Freq. resp. 20 to 20k cps ± 0.5 db at 25 watts rms output; IHF music power output, 50 watts per channel; power output, rms, 30 watts per channel; harmonic distortion, 0.1% at 25 watts at 1000 cps; hum and noise, 80 db below 30 watt output; sensitivity, input for rated output, 0.125 volts; damping factor, 25; output impedances, 4, 8, 16 ohms; convenience outlets, 2; weight, 29 lbs; dimensions, 10 $\frac{3}{4}$ " wide, 6 $\frac{3}{8}$ " high, 13 $\frac{1}{8}$ " deep; price, \$219.00. A1-9.

1. Stereo 20 20-watt stereo \$149.00
2. TL/50 Plus 50-watt mono \$159.00
3. TL/25 Plus 25-watt mono \$119.00

MARANTZ

● **Model 8B Stereo Amplifier.** Built-in metered test and adjust for plate-current ("bias") and dynamic balance. Exceptionally clean, stable circuit. Highest grade workmanship and parts.

Specifications: Freq. resp. 3 to 40k cps ± 1 db at 1 watt output; power bandwidth ± 1 db, 15 to 40k cps; power output, rms, 35 watts per channel; harmonic distortion, 0.5% at 35 watts from 20 to 20k cps; IM distortion, 0.5% at 35 watts; hum and noise, 100 db below 35-watt output; sensitivity, input

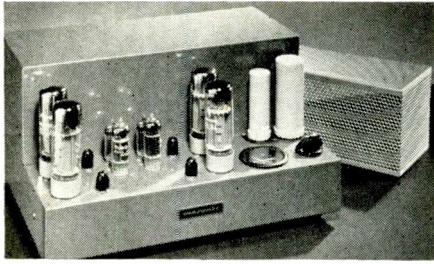

for rated output, 1.3 volts; damping factor, 20; output impedances, 4, 8, 16 ohms; controls; bias, balance; switches; bias test; weight 55 lbs; dimensions 13½" wide, 7¼" high, 10½" deep; price \$285.00. A1-10.

1. Model 9, 70-w mono \$384.00
2. Model 9R, rack panel mount \$414.00
3. Model 970, 70-w 8-ohm, 16-ohm, 70.7V \$384.00
4. Model 970R, rack panel mount \$414.00

McINTOSH

• **MC275 Stereo Amplifier.** Produces 75 watts continuous power, simultaneously, from each channel with harmonic distortion less than 0.5% throughout the audio range.

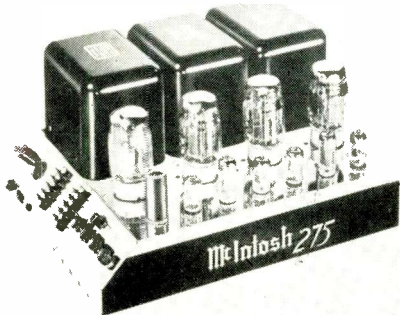

Specifications: Freq. resp. 16 to 60k cps ±0.25 db at 75 watts output; power bandwidth, 16 to 60k cps; IHF music power output, 100 watts per channel; power output, rms, 75 watts per channel; harmonic distortion, 0.5% at 75 watts from 20 to 20k cps; IM distortion, 0.5% at 75 watts; hum and noise, 90 db below 75 watt output; sensitivity, input for rated output, 0.5 volts; damping factor, 10; output impedances, 4, 8, 16, 600 ohms 70 volt, 115 volt; controls, gain balance; switches, stereo/twin/mono; convenience outlets, 1; weight, 67 lbs; dimensions, 12¼" wide, 8" high, 17¼" deep; price, \$414.00. A1-11.

1. MC225 25-Watts/Channel \$198.00
2. MC240 40-Watts/Channel \$288.00
3. MC40 40-Watts mono \$159.00
4. MC75 75-Watts mono \$229.50

PURE-SONICS

• **Quadramatic Amplifier Model 402-C.**

Specifications: Freq. resp. 8 to 50k cps ±1 db at 10 watts output; power bandwidth, 25 to 20k cps; IHF music power output, 80 watts per channel; power output, rms, 40 watts per channel; hum and noise, 80 db below 40 watt output; sensitivity, input for



rated output, 1.5 or 2.5 volts; damping factor, infinite; output impedances, 4, 8, 16 ohms; controls, input level; switches, sensitivity; weight, 35 lbs; dimensions, 17" wide, 5¼" high, 11" deep; price, \$314.00. A1-12.

1. 1180 80-w rms, 160-w IHF mono .. \$249.00

QUAD

• **Quad II Power Amplifier.**

Specifications: Freq. resp. 10 to 60k cps ±1 db at 1 watt output; power output, rms,

15 watts per channel; hum and noise, 80 db below 12 watt output; sensitivity, input for rated output, 1.4 volts; damping factor, 10;

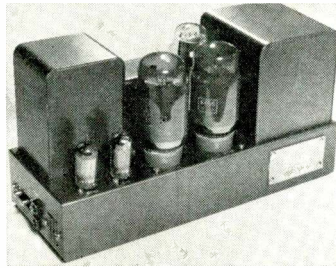

output impedances, 15, 7 ohms; weight, 18 lbs; dimensions, 4¾" wide, 6¾" high, 12½" deep; price, \$100.00. A1-13.

RADFORD

• **ISTA 60 Power Amplifier.** Unconditionally stable—will feed pure capacity loads. Employs patented feedback circuits, with very heavy feedback at all frequencies—instability from transformer phase shift eliminated by a frequency separation system.

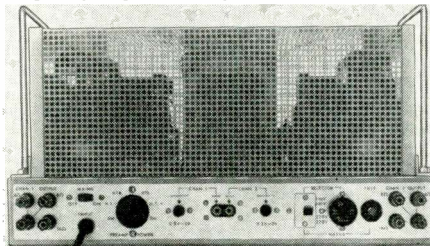

Specifications: Freq. resp. 5 to 200k cps ±1 db; power bandwidth, 10 to 50k cps; IHF music power output, 90 watts per channel; power output, rms, 75 watts per channel; harmonic distortion, 1% at 75 watts from 20 to 20k cps; IM distortion, 2% at 75 watts; hum and noise, 90 db below 1 watt output; sensitivity, input for rated output, 0.5 volts; damping factor, 50; output impedances, 4, 8, 16 ohms; switches, power, voltage; weight, 48 lbs; dimensions, 15" wide, 8¾" high, 12¼" deep; price, \$300.00. A1-14.

1. ISTA 30 40-w-per-chan. \$250.00

A2. BASIC AMP KIT

ACOUSTECH

• **Acoustech 111 Solid-State Stereo Amplifier Kit.** Silicon transistors, direct coupled, glass-epoxy plug-in circuit boards, computer-grade electrolytics, conservative operation of all components.

Specifications: Rise time 1 µs; power bandwidth, 20 to 20k cps; power output, rms, 40 watts per channel; harmonic distortion, 0.25% from 20 to 20k cps; IM distortion, 0.45% at 40 watts; hum and noise, 85 db below 40 watt output; sensitivity, input for rated output, 2.0 volts; damping factor, 70; output impedances, 4, 8, 16 ohms; controls, on-off; convenience outlets, 1; weight, 25 lbs; dimensions, 15¼" wide, 5" high, 8" deep; price, \$199.00. (assembled \$350.00). A2-1.

DYNAKIT

• **Stereo-35 Amplifier Kit.** Utilizes a combination of positive and negative feedback.



High quality output transformers. Builds in 3 hours, no instruments or adjustments. Pre-assembled etched circuit boards. Compact, low profile design.

Specifications: Freq. resp. 20 to 20k cps ±0.25 db at 1 watt output; power bandwidth, 15 to 35k cps; IHF music power output, 23 watts per channel; power output, rms, 17.5 watts per channel; harmonic distortion, 1% at 35 watts (±1 db) from 20 to 20k cps; IM distortion, 1% at 35 watts; hum and noise, 80 db below 35-watt output; sensitivity, input for rated output, 1 volt; damping factor, 10; output impedances, 8, 16 ohms; weight, 16 lbs; dimensions, 13" wide, 4" high, 5½" deep; price \$59.95. A2-2.

1. Stereo 70, 35-w rms ea chan \$99.95
2. Mark 111, 60-w rms mono \$79.95
3. Mark IV, 4-w rms mono \$59.95

EICO

• **HF89A 110-watt Stereo Amplifier Kit.** Cathode-coupled phase-inverter-driven circuit, preceded by a direct-coupled voltage amplifier. Fixed-bias, push-pull EL34's output stage with provision for both bias and d.c.-balance adjustments. Silicon diode rectifiers.



Specifications: Freq. Resp. 5 to 100k cps ±0.5 db at 2 watts output; power bandwidth 15 to 100k cps; power output, rms 50 watts per channel; harmonic distortion 1% at 50 watts from 20 to 20k cps; IM distortion, 0.5% at 100 watts; hum and noise 80 db below 1 watt output; sensitivity, input for rated output, 0.55 volts; damping factor 12; output impedance, 4, 8, 16 ohms; controls, level set, bias, d.c. bal.; switches, on-off; convenience outlets, 2; weight 40 lbs; dimensions, 15" wide, 6" high, 11" deep. Price, \$99.50. A2-3.

1. HF-87A 80-w stereo amp kit \$74.95

FISHER

• **K-1000 Stratakit 150-Watt Stereo Amplifier Kit.** The Fisher K-1000 is the kit version of the SA-1000, and is in all respects the same. It incorporates a system for a.c. balancing the phase-inverter for minimum IM distortion, without need for a distortion analyzer. Metering circuit incorporated for setting bias and balance. Price, \$279.50. A2-4.

HARMAN-KARDON

• **Citation B Solid-State 80 Watt Amplifier Kit.** Unique kit pictorial-instructions make the Citation B simple to assemble. Output transistors and power transformer are pre-assembled into place. A completely laced and cut wiring harness is provided. Features and specifications are exactly the same as the factory-wired version. Price \$335.00. (assembled \$425.00). A2-5.

HEATHKIT

• **Model AA-121 80-Watt Stereo Amplifier Kit.** Fixed bias, front panel controls, extra mixed-channel center speaker output.

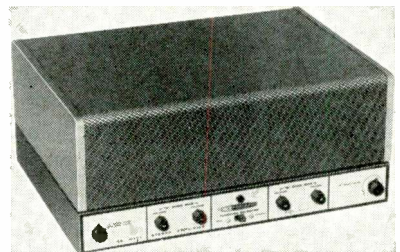

Specifications: Freq. resp. 20 to 20k cps ±0.5 db at 80 watts output; power bandwidth, 20 to 20k cps; IHF music power output, 49 watts per channel; power output, rms, 40 watts per channel; harmonic distortion, 1.5% at 40 watts from 20 to 20k cps; IM distortion, 0.5% at 40 watts; hum and

noise, 85 db below 40 watt output; sensitivity, input for rated output, 0.95 volts; damping factor, 16; output impedances, 4, 8, 16 ohms; controls, level, bias, balance; switches, power; convenience outlets, 2; weight, 40 lbs; dimensions, 15" wide, 7 1/4" high, 11" deep; price, \$79.95. A2-6.

1. AA-111 28-w ster \$44.95

SCHOBER

• **TR-2 Transistor Power Amplifier.** Clips symmetrically at 50 watts with 1 kc sine wave input and with an 8-ohm load. With a 16-ohm load the clipping point is 31 watts; with a 4-ohm load, 48 watts. Built-in fan provides forced air cooling of chassis and interior components. Circuit breaker line protection.

Specifications: Freq. resp. 20 to 25k cps ± 1.0 db at 40 watts output; power bandwidth, 20 to 25k cps; power output, rms, 40 watts per channel; harmonic distortion, 0.75% at 40 watts from 30 to 20k cps; IM distortion, 1.4% at 40 watts; hum and noise, 85 db below 40 watt output; sensitivity, input for rated output, 0.055 volts; output impedances, 4, 8, 16 ohms; controls, coarse gain, fine gain; switches, on-off; weight, 12 1/2 lbs; dimensions, 5 1/2" wide, 11 1/4" high, 7 1/2" deep; price, \$69.95. A2-7.

A3. PREAMPLIFIER

ACOUSTECH

• **Acoustech 11 Solid-State Stereo Control Center.** Stepped-switch tone and level controls, three switched low-level inputs and four high-level inputs. Full tape facilities. Tape, microphone and RIAA equalization on low-level inputs.

Specifications: Inputs: Mag 1, Mag 2, Mag 3, tuner, aux 1, aux 2, tape mon; controls: 2 bass, 2 treble, level, balance mode selector; switches: hi filter, lo filter, loudness, equalization muting, speaker selection; outputs: main, 47 ohms, 2.5 max. volts; recording, 100k ohms, 0.5 volts; freq. resp. 1 to 100k cps ± 0 db at 2.5 volts; harmonic distortion, 0.25% at 2.5 volts from 20 to 20k cps; IM distortion, 0.25% at 2.5 volts; sensitivity, input for 1 volt output, phono, 1 mv, tuner, 0.15 volts; hum and noise, 60 db below 2.5 volt output. Weight, 13 lbs; dimensions, 15 3/4" wide, 5" high, 12" deep. Price, \$348.00. A3-1.

DYNA

• **PAS-3/A Stereo Preamplifier.** A high-feedback stereo preamplifier with full flexibility and exceptional ease of operation.



Specifications: Inputs: Special (low level), phono, tape head, tape FM-AM, monitor FM-MPX, Spare (high level); controls: selector, volume, balance, blend, bass and treble on each channel; switches: power, filter, monitor, loudness compensation; outputs: main 5k ohms, 2 max. volts; recording 0.5 volts; freq. resp. 10 to 40k cps ± 0.5 db at 2 volts; harmonic distortion, 0.05% at 2 volts from 20 to 20k cps; IM distortion, 0.05% at 2 volts; sensitivity, input for 1 volt output, phono, 1 mv, tuner, 0.1 volts; hum and noise, 74 db below 10 mv input. Weight, 12 lbs; dimensions 13" wide, 4" high, 8" deep. Price, \$109.95. A3-2.

1. PAS-2/A ster preamp \$99.95
2. PAM-1/A mono preamp \$59.95

FISHER

• **400-CX Stereo Master Audio Control.** 28 controls and 18 inputs. Stereo dimension control and tape monitoring facilities. Separate high and low input-level controls. Connector for attaching a remote balance and volume control. Jewel indicator system.

Specifications: Inputs: Mag 1 Mag 2 Tape hd., Tape Amp., Aux 1 Aux 2; controls: Volume Center Chan Volume, Balance, Treble (2), Bass (2), Stereo Dimension, Loud-

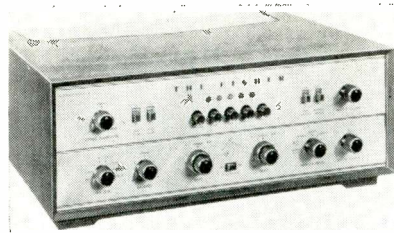

ness Contour Mode; switches: Input Selector, Low Level Equalizer, High & Low Filter, Phase Rev.; outputs: main, 30 ohms, 35 max. volts; recording, 5k ohms; freq. resp. 20 to 20k cps ± 0.5 db at 2.5 volts; harmonic distortion, 0.04% at 2.5 volts at 1 kc; IM distortion, 0.1% at 2.5 volts; sensitivity, input for 2.5 volt output, phono, 1.5 mv, tuner, 0.2 volts; hum and noise, 80 db below 2.5 volt output. Weight, 18 lbs; dimensions, 15 1/4" wide, 4 13/16" high, 12" deep. Price, \$199.50. A3-3. Accessories: 10-UW, UM walnut and mahogany cabinets, \$24.95; MC-2 metal cabinet, \$15.95; RK-1 remote control \$17.95.

HARMAN-KARDON

• **Citation A Solid-State Stereo Control Center.** Seven stages of gain on slide-out glass epoxy boards. Stabilized against extreme temperature variations. Total rise time less than one microsecond. Zener diode regulated power supply. Tone controls out of circuit in "flat" position. Front panel high impedance earphone jack.

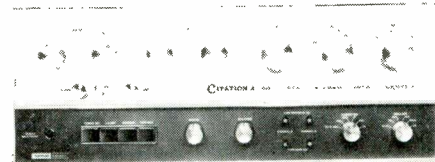

Specifications: Inputs: phono 1, phono 2, tape head, tuner, aux. tape amp; controls: two bass, two treble, loudness mode, function, blend, balance, turnover, rolloff; switches: stereo rev, low cut, contour, tape mon, system on/off, amp on/off; outputs: main, low imp, 6 max. volts; recording, low, 2 volts; freq. resp. 1 to 1 meg ± 0.25 db at 2 volts; harmonic distortion, immeasur. at 2 volts from 20 to 20k cps; IM distortion, 0.05% at 2 volts; sensitivity, input for 1 volt output, phono, 1.5 mv, tuner, 0.25 volts; hum and noise, 85 db below 2 volt output. Weight, 25 lbs; dimensions, 14 1/2" wide, 5 1/2" high, 7" deep. Price \$350.00. WCA walnut enclosure \$20.00. A3-4.

JBL

• **SG520 "Graphic Controller" Stereo Pre-amp.** Illuminated pushbutton selectors and straight-line controls, plus concealed front panel secondary controls.

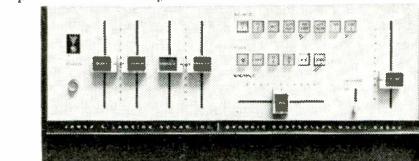

Specifications: Inputs: Phono, tape, tape head mic, tuner, aux; controls: volume, bass A & B, treble A & B, balance, phono balance, phono gain, gain A & B; switches: on-off, loudness, source, mode, tape mon., IIF filter LF filter; outputs: main, less than 50 ohms, 3 max. volts; recording 1 volt; freq. resp. 20 to 20k cps ± 0.25 db at 3 volts; harmonic distortion, 0.15% at 3 volts from 20 to 20k cps; phono, 60 db, tuner, 20 db; hum and noise, one microvolt referred to low level phono. Tuner 90 db below rated out. Dimensions, 15 1/2" wide, 6 1/2" high, 12 1/2" deep. Price, \$450.00. A3-5.

LEAK

• **Varislope 2 Stereo Control Center.** Functions electronically to the performance standards for broadcasting and recording.

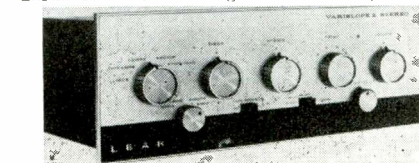

Specifications: Inputs: Phono, Tape Head, Tuner, Microphone, Tape Amp; controls: Bass, Treble, Balance, Volume w/On-Off Switch; switches: Input Selector, Function, Filter (H.F.) Filter Slope Switch & Tape Monitor; outputs: main, 100k ohms, 0.125 max. volts; recording, 100k ohms, 0.125 volts; freq. resp. 20 to 20k cps ± 0.5 db at 0.125 volts; harmonic distortion, 0.01% at 0.125 volts at 1k cps; sensitivity, input for 0.125 volt output, phono, 3.5 mv, tuner, 50 mv volts; hum and noise, 60 db below 0.125 volt output. Weight, 6 lbs; dimensions 10 1/2" wide, 3 1/4" high, 6 1/2" deep. Price, 129.50. A3-6.

1. Point One control center \$119.50

MARANTZ

• **Model 7 Stereo Console.** Built to last, using professional cabling and other quality construction techniques.

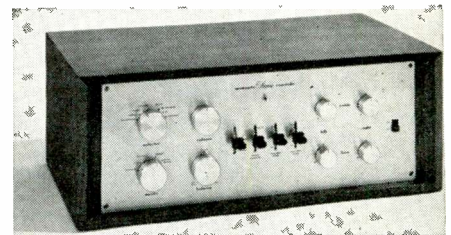

Specifications: Inputs: mike, phono 1 and 2, tape head, FM-AM, FM-mpx, tape TV, aux; controls: mode, selector, vol, balance, treble, bass; switches: on-off, hi and low cut, boost, tape monitor, record equal.; outputs: main, cathode follower, 15 max. volts; freq. resp. 20 to 20k cps ± 0.5 db; IM distortion, 0.15% at 10 volts; sensitivity, input for 1 volt output, phono 0.5 mv, tuner, 0.075 volts; hum and noise, 80 db below 10 mv input. Weight, 15 lbs; dimensions, 15 3/4" wide, 5 3/4" high, 7" deep. Price, \$285.00, wooden cabinet, \$24.00. A3-7.

McINTOSH

• **C24 Solid-State Preamplifier.** Features silicon-planar transistors.

Specifications: Inputs: Tuner, Tape, Aux, Phono 1, Phono 2, Tape Hd; controls: Bass, Treble, Contour, Mode, Volume, Selector; switches: IIF Filter LF Filter RIAA/LP, Tape Mon. Speaker, Phase; outputs: main,



10k ohms, 10 max. volts; recording, 10k ohms, 1.2 volts; freq. resp. 20 to 20k cps ± 0.25 db at 2.5 volts; harmonic distortion, 0.1% at 2.5 volts from 20 to 20k cps; IM distortion, 0.1% at 2.5 volts; sensitivity, input for 1 volt output, phono, 0.7 mv, tuner, 0.1 volts; hum and noise, 110 db below 2.5 volt output. Weight, 17 lbs; dimensions, 16" wide, 5 7/16" high, 11" deep. Price, \$249.00. A3-8.

1. C22 ster preamp \$279.00

PURE-SONICS

• **Stereo Control Center Model 110A.**

Specifications: Inputs: Mike, Phono 1, Phono 2, Tape, Tuner 1, Tuner 2; controls: Volume, Bass (2), Treble (2); switches: Mode, Output, Contour, Rumble, Tape,



Scratch; freq. resp. 8 to 70k cps ± 1 db at 10 volts; harmonic distortion, immeasurable at 2 volts from 20 to 20k cps; IM distortion, immeasurable at 2 volts; sensitivity, input for 1 volt output, phono, 1 mv, tuner, 0.1 volts; hum and noise, 75 db below 2 volt output. Weight, 15 lbs; dimensions, 13" wide, 5 1/4" high, 9" deep. Price, \$269.00. A3-9.

QUAD

● Quad 22 Control Unit.

Specifications: Inputs: Phono, Tuner 1, 2, Tape, Microphone; controls: Volume, Balance, Bass, Treble, Filter slope Filter frequency; switches: on/off, Mono/Stereo/2-Mono and Input selector push-buttons; outputs: main, 1.5 Meg, 1.4 max. volts; recording, 500 k ohms, 0.1 volts; freq. resp. 20 to 20k cps ± 0.5 db at 1.4 volts; harmonic

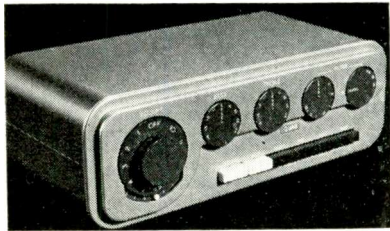

distortion, 0.02% at 1.4 volts at 700 cps; sensitivity, input for 1.4 volt output, phono, 4 mv, tuner, 0.07 volts; hum and noise, 70 db below 1.4 volt output. Weight, 7 lbs; dimensions, 10 1/2" wide, 3 1/2" high, 6" deep. Price, \$107.00. A3-10.

RADFORD

● SC-5 Transistorized Preamplifier. Feedback rumble filter, high signal-to-noise ratio. Styled with aluminum anodized panel, lathe turned aluminum knobs; lifetime finish.

Specifications: Inputs: Phono, tuner, tape, aux., tape mon.; controls: bass, treble, gain, balance; switches: disc, filter, mono, monitor, aux 1, aux 2; outputs: main, 600 ohms, 10.5 max. volts; recording, 600 ohms, 10.5 volts; freq. resp. 30 to 60k cps ± 1 db at 0.5 volts; harmonic distortion, 0.01% at 10.5 volts from 30 to 60k cps; IM distortion, 0.03% at 10.5 volts; sensitivity, input for 1 volt output, phono, 4 mv, tuner, 10.5 volts; hum and noise, 60 db below 0.5 volt output. Weight, 8 lbs; dimensions, 10 1/2" wide, 3 3/4" high, 8 1/2" deep. Price, \$150.00. A3-11.
1. SC-6 3-chan transistor control unit \$175.00

A4. PREAMPLIFIER KIT

ACOUSTECH

● Acoustech IV Solid-State Stereo Control Center Kit. Excellent ability to handle overloads. Two switched high-level inputs, three switched low-level inputs, tape monitoring facilities.

Specifications: Inputs: Mag 1, Mag 2 hi Mag 2 lo tuner aux, tape monitor; controls: 2 bass, 2 treble, level, balance, mode selector; switches: on-off, tape mon, muting, freq. comp.; outputs: main 2k ohms, 2.0 max. volts; recording 100k ohms, 0.5 volts; freq. resp. 1 to 100k cps ± 0 db at 2.0 volts; harmonic distortion, 0.15% at 2 volts from 20 to 20k cps; IM distortion, 0.09% at 2 volts; sensitivity, input for 1 volt output, phono, 1.5 mv, tuner, 0.2 volts; hum and noise, 75 db below 2 volt output. Weight, 10 lbs; dimensions, 15 3/4" wide, 5" high, 8" deep. Price, \$149.00. (Assembled, \$225.00). A4-1.

DYNAKIT

● PAS-2 Stereo Preamplifier Kit. Low-cost, feedback-design control center. Easy construction, simplified circuitry, preassembled etched circuit boards.

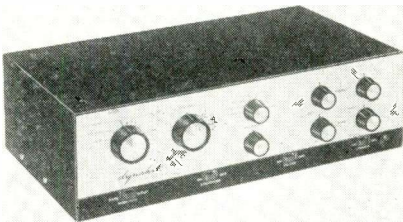

Specifications: Inputs: phono, tape head, FM-AM, special (low level), FM-MPX, Spare (high level); controls: selector, volume, balance, blend, individual left and right bass and treble; switches: power, filter, monitor, loudness compensation; outputs: main, 5000 ohms, 2 max. volts; recording, 0.5 volts; freq. resp. 10 to 40k cps ± 0.5 db at 2 volts; harmonic distortion, 0.05% at 2 volts from 20 to 20k cps; IM distortion, 0.05% at 2

volts; sensitivity, input for 1 volt output, phono, 1 mv, tuner, 0.1 volts; hum and noise, 74 db below 10-mv input. Weight, 11 lbs; dimensions, 13" wide, 4" high, 8" deep. Price, \$59.95. PK-30 panel mount kit, \$13.95. A4-2.
1. PAS-3 stereo preamp kit \$69.95
2. PAM-1 mono preamp kit \$34.95

EICO

● ST 84 Stereo Preamplifier Kit. Distortion down to 0.05% at all levels.

Specifications: Inputs: mag ph, tape hd, mic, tuner, (3) aux; controls: level, balance, bass, treble; switches: input, mode, tape mon, loudness, scratch filter, rumble filter; tape speed equal'n; outputs: main 5k ohms, 4

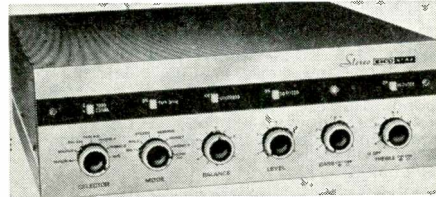

max. volts; recording, 1400 ohms, 4 volts; freq. resp. 5 to 25k cps ± 0.3 db at 2 volts; harmonic distortion, 0.05% at 2 volts from 20 to 20k cps; IM distortion 0.04% at 2 volts; sensitivity, input for 1 volt output, phono 1.6 mv, tuner, 0.17 volts; hum and noise 70 db below 1 volt output. Weight 8 1/2 lbs; dimensions, 15 3/4" wide, 5 1/2" high, 8 3/4" deep. Price \$59.95. A4-3.

HARMAN-KARDON

● Citation A Solid-State Stereo Control Center Kit. Description and specifications same as Citation A preamp. Price, \$279.95 (assembled, \$350.00). A4-4.

HEATHKIT

● Model AA-141A Stereo Preamplifier Kit. Features 8 inputs, cathode follower outputs, self-powered, and Baxandall-type tone controls.

Specifications: Inputs: Mag, Phone, Xtal, Phono, Aux. 1, Aux. 2; controls: Volume, Bass, Treble, Fil. Balance; switches: Source,

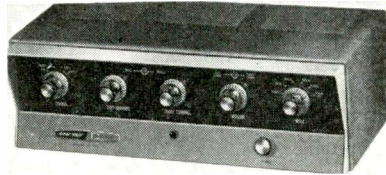

Mode, Power; outputs: main, 1500 ohms, 2.5 max. volts; recording, 1500 ohms, 2.5 volts; freq. resp. 20 to 20k cps ± 1 db at 2.5 volts; harmonic distortion, 0.1% at 2.5 volts from 20 to 20k cps; IM distortion, 0.1% at 2.5 volts; sensitivity, input for 1 volt output, phono, 0.003 mv, tuner, 0.1 volts; hum and noise, 65 db below 2.5 volt output. Weight, 11 lbs; dimensions, 15 3/4" wide, 5 1/2" high, 7 13/16" deep. Price, \$34.95. A4-5.

1. AA-11 stereo preamp kit \$84.95

A5. INTEGRATED AMP (AMP-PREAMP)

ACOUSTECH

● Acoustech V Solid-State Stereo Control Amplifier. Direct-coupled silicon transistor circuit combined with an all silicon transistor preamplifier. Glass-epoxy plug-in circuit boards, computer-grade electrolytics and flexible control functions.

Specifications: Rise Time, 2 μ sec.; power bandwidth, 20 to 20k cps; power output, rms, 30 watts per channel; harmonic distortion, 0.25% at 20 watts from 20 to 20k cps; IM distortion, 0.5% at 30 watts (8 ohms out); hum and noise, 70 db below 30 watt output; sensitivity, input for rated output—phono, 2.5 mv, tuner, 0.5 volts; damping factor 60; output impedances, 4, 8, 16 ohms (no output transformer); inputs—3 phono, 1 tape amp, 1 aux, 1 tuner; weight, 30 lbs. Dimensions, 15 3/4" wide, 5" high, 12" deep. Price, \$299.00. A5-1.

ALTEC

● 360A Amplifier. All solid-state circuit, matrixing network for center-channel voltage output. Automatic reset circuit breakers for overcurrent protection of each channel and a.c. line. Dual microphone inputs for stereo recording. Diffused panel illumination plus daylight power indicator. Both headset and speaker monitoring for tape recording. Front panel dual-range gain switch. Variable-cross-over-type bass tone control.

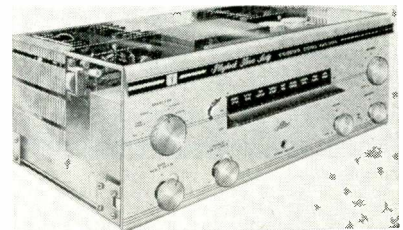

Specifications: Freq. resp. 20 to 20,000 cps ± 1 db; IHF music power output, 35 watts per channel; harmonic distortion, 1.5% at 25 watts from 20 to 10,000 cps; hum and noise, 84 db below 25 watts output; sensitivity, input for 25-watt output—phono, 4 mv, tuner, 400 mv; damping factor greater than 10; output impedances, 4, 8, 16 ohms; input—phono, tape head, tape amp, mic; weight, 24 lbs. Dimensions, 15" wide, 5 1/2" high, 11 3/8" deep. Price \$389.00. A5-2.

BOGEN

● AT600 Solid-State Stereo Amplifier-Preamplifier. 60-watt stereo amplifier, headphone outlet, brushed-gold finish front panel, choice of either wood or vinyl-clad metal enclosure.

Specifications: Freq. resp. 15 to 75,000 cps ± 1 db at 1 watt output; power bandwidth, 20 to 20,000 cps; IHF music power output, 30 watts per channel; power output, rms, 25 watts per channel; harmonic distortion, 0.75% at 25 watts from 20 to 17,000 cps; IM distortion, 0.7% at 25 watts; hum



and noise, 80 db below 25 watt output; sensitivity, input for rated output—phono, 25 mv, tuner, 0.25 volts; damping factor 40; output impedances, 4, 8, 16 ohms; inputs—2 phono, 2 tape head, 2 tape amp, 2 aux, weight, 15 lbs. Dimensions, 15" wide, 4 3/4" high, 10" deep. Price \$224.95. Enclosures: EN11 (metal) \$14.95; WE11 (walnut) \$27.95. A5-3.

1. AP250 50-watt ster amp-preamp .. \$154.95
2. AP35 35-watt ster amp-preamp .. \$ 99.95

DYNA

● SCA-35/A Stereo Control Amplifier. Excellent power response, stability with any load, and overload characteristics. Provision for third-speaker output or connection for headphones on rear panel. Bandpass filter for balanced response even with noisy discs or rumble-prone players.

Specifications: Freq. resp. 20 to 20k cps ± 0.25 db at 1 watt output; power bandwidth, 15 to 35k cps; IHF music power output, 23 watts per channel; power output, rms, 17.5



watts per channel; harmonic distortion, 1% at 35 watts ± 1 db from 20 to 20k cps; IM distortion, 1% at 35 watts; hum and noise, 80 db below 17-watt output; sensitivity, input for rated output—phono, 4 mv, tuner 1 volt; damping factor 10; output impedances 8, 16 ohms; inputs—6 phono, 2 tape head, 2 tape amp, 2 aux, 2 radio; weight, 20 lbs. Dimensions, 13" wide, 4" high, 10" deep. Price \$139.95. Dynaco, Inc. A5-4.

FISHER

● **TX-300 Stereophonic Transistor Master Control-Amplifier.** Tape monitor system permits monitoring and playback with use of tone controls and filters. Features low noise and good transient response. Sixteen inputs, ten outputs, twenty-one controls and switches. A front-panel jack is provided for connection of headphones, and tape recorders can be connected to jacks on both front and rear panels.

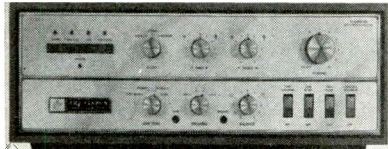

Specifications: Freq. resp. 10 to 25k cps ± 1 db at 2 watts output; power bandwidth, 12 to 50k cps; IHF music power output, 50 watts per channel; power output, rms, 36 watts per channel; harmonic distortion, 0.5% at 72 rms watts at 1 kc; IM distortion, 0.5% at 72 watts; hum and noise, 86db below 72-watt output; sensitivity, input for rated output—phono, 2.8 mv, tuner, 0.2 volts; damping factor 10; output impedances, 4 to 16 ohms; inputs—2 phono, 2 tape head, 2 tape monitor, 2 aux, 2 mic; weight, 24 lbs. Dimensions, 15 1/2" wide, 4 13/16" high, 11 1/2" deep. Price, \$329.50. Accessories: Model 50-U, walnut cabinet, \$24.95. A5-5.

1. X-100-B 50-w ster amp \$169.50
2. X-101-C 60-w ster amp \$199.50
3. X-202-B 80-w ster amp \$249.50

GROMMES

● **A41 40-Watt Stereo Amplifier.** Solid-state with drift-field power transistors and diode bias. Transformer coupled driver, output overload protection with feedback around every stage to ensure long trouble-free operation.

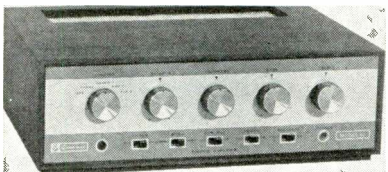

Specifications: Freq. resp. 20 to 20,000 cps ± 0.5 db at 20 watts output; power bandwidth, 20 to 20,000 cps; IHF music power output, 25 watts per channel; power output, rms, 20 watts per channel; harmonic distortion, 0.5% at 20 watts from 30 to 15,000 cps; IM distortion, 0.5% at 20 watts; hum and noise, 85 db below 20-watt output; sensitivity, input for rated output—phono, 2 mv, tuner, 0.15 volts; damping factor 30; output impedances, 4, 8, 16 ohms; inputs—1 phono, 1 tape head, 2 aux, 1 tuner; Dimensions 13 3/4" wide, 4 3/4" high, 11" deep. Tent. Price, \$179.95. Accessories: Walnut cabinet, \$14.95. A5-6.

1. A40 40-w ster-amp \$119.95
2. A25 25-watt ster amp \$ 79.95

HARMAN-KARDON

● **A1000T Solid-State Integrated 70-Watt Stereo Amplifier.** Features: industrial grade silicon transistors, regulated power supply, military-type hinged glass-epoxy boards.

Specifications: Freq. resp. 10 to 100,000 cps $\pm 1/2$ db at 1 watt output; power bandwidth, 10 to 60 k cps; IHF music power output, 40 watts (8 ohms) per channel; power output, rms, 35 watts per channel; harmonic



distortion, 0.5% at rated power from 20 to 20,000 cps; IM distortion, 0.5% at rated output, hum and noise, 85 db below 35-watt output; sensitivity, input for rated output—phono, 2.5 mv, tuner, 0.2 volts; damping factor, 50 at 8 ohms; output impedances, 4, 8, 16 ohms; inputs—6 phono, 2 tape head, 2 tape amp, 2 aux, 2 tuner; weight, 25 lbs. Dimensions, 14 1/16" wide, 3 3/8" high, 10" deep. Price, \$369.95. Accessories: CW10 walnut enclosure, \$19.95. A5-7.

KENWOOD

● **Model TK-400 Transistor Stereo Amplifier.** Front-panel see-saw switches, direct tape-monitor system, front-panel stereo headset jack. New chassis has flexibility of design.

Specifications: Freq. resp. 20 to 20,000 cps ± 1 db at 1 watt output; IHF music power output, 40 watts per channel; power output,

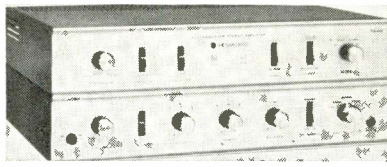

rms, 32 watts per channel; harmonic distortion, 1% at 25 watts from 30 to 25,000 cps; hum and noise, 75 db below 32-watt output; sensitivity, input for rated output—phono, 1.5 mv, tuner, 0.1 volts; damping factor 20; inputs—2 phono, 1 tape head, 1 tape amp, 2 aux, weight, 27 lbs. Dimensions, 15 1/4" wide, 5 3/4" high, 12 1/4" deep. Price, \$199.95. A5-8.

1. Model KM-220 Integrated Stereo Amp \$169.95

KLH

● **Model Sixteen Transistor Integrated Amplifier.** Protective electrical circuit in output stages. Complete shorts across either or both loudspeaker outputs will cause no damage. The protective circuit is designed also to safeguard the amplifier from damage due to operation of the output stages at full power with no load.

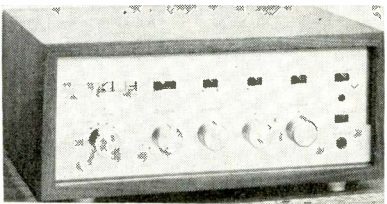

Specifications: Freq. resp. 25 to 20k cps $+0, -1$ db at 70 watts both channels operating; power bandwidth, 25 to 20k cps; IHF music power output, 50 watts per channel; power output, rms, 35 minimum watts per channel; harmonic distortion, less than 2% at 35 watts from 25 to 20k cps with both channels operating into 8-ohm loads; hum and noise, 80 db below 35-watt output; sensitivity, input for rated output—phono, 2 mv, tuner, 0.3 volts; damping factor 4; output impedances, 8 ohms; inputs—2 phono, 2 tape amp, 4 aux, 2 tuner; weight, 12 lbs. Dimensions, 11 3/4" wide, 4 1/2" high, 10 1/2" deep. Price, \$219.95. East coast. Accessories: oiled walnut case, \$19.95. A5-9.

KNIGHT

● **KN-999 100-Watt Stereo Amplifier.** Solid-state circuit.

Specifications: Freq. resp. 20 to 25,000 cps ± 0.5 db at 100 watts output; IHF music power output, 50 watts per channel; power output, rms, 35 watts per channel; harmonic distortion, 1%; hum and noise, 80 db below rated output; sensitivity, input for rated



output—phono, 2 mv, tuner, 0.1 volts; output impedances, 4, 8, 16 ohms; inputs—2 phono, 1 tape head, 1 tape amp, 1 aux, weight, 20 lbs. Dimensions, 13 3/4" wide, 4 1/2" high, 12 3/4" deep. Price, \$179.95. Accessories: Metal case, \$5.95. A5-10.

1. KN-950A solid-state-50-w ster amp \$119.95
2. KN-940A-44-w ster amp \$ 89.95
3. KN-928-28-w ster amp \$ 54.95
4. KN-918-15-w ster amp \$ 39.95

LAFAYETTE

● **LA-250A 50-watt Integrated Stereo Amp.** Full range of controls including separation and volume balance. Third channel output, d.c. on the filaments of preamp and tone-control tubes.



Specifications: Freq. resp. 20 to 50,000 cps ± 1 db at 20 watts output; power bandwidth, 20 to 50,000 cps; IHF music power output, 25 watts per channel; power output, rms, 20 watts per channel; harmonic distortion, 0.25% at 1 watt from 20 to 20,000 cps; IM distortion, 0.5% at 1 watt; hum and noise, 77 db below 20-watt output; sensitivity, input for rated output—phono 3.5 mv, tuner, 0.5 volts; output impedances, 4, 8, 16 ohms; inputs—2 phono, 2 tape head, 2 aux, 2 tuner, weight 28 lbs. Dimensions, 14 1/2" wide, 5 1/2" high, 12 3/4" deep. Price, \$99.50. A5-11.

1. LA-200WX 44-w transistor ster amp \$109.50
2. LA-340WX 40-w transistor ster amp \$ 79.50
3. LA-260WX 40-w integ ster amp ... \$ 79.95
4. LA-224WX 24-w integ ster amp ... \$ 49.95

LEAK

● **Stereo 30.** Solid-state, accepts all sources, i.e. record, tape, tuner, or microphone.

Specifications: Freq. resp. 30 to 20k cps ± 1 db; IHF music power output, 15 watts per channel; harmonic distortion, 0.1% at 8 watts, 1000 cps; hum and noise, 66 db

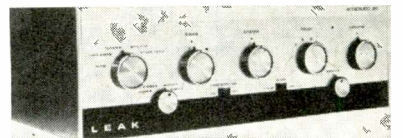

below 15 watt output; sensitivity, input for rated output—phono, 3.5 mv at 47k ohms, 20 mv at 33k ohms, 60 mv at 100k ohms, damping factor, 60 at 1000 cps; output impedances, 4, 8, 15 ohms; inputs—2 phono, 1 tape head, 1 tape amp, 1 aux (tuner), 1 mike; weight, 14 lbs. Dimensions, 13" wide, 4 1/4" high, 9" deep. Price, \$249.50. A5-12.

LUX

● **LUX-S063 Stereo Amplifier.** An integrated amplifier employing the motional-feedback system.

Specifications: Freq. resp. 30 to 30k cps -3 db at 10 watts output; power bandwidth, 30 to 30k cps; IHF music power output, 15 watts per channel; power output, rms, 12 watts per channel; harmonic distortion, 0.7% at 13 watts from 40 to 25k cps; IM distortion, 2% at 13 watts; hum and noise, 60 db below 13-watt output; sensitivity, input for rated output—phono, 4 mv, tuner, 0.2 volts; damping factor 8; output impedances, 8, and 16 ohms; inputs—one phono/and infinitive with MFB, one tape head, one tape amp, one aux, one X'tal; weight, 25.3 lbs. Dimensions, 10" wide, 4" high, 7 1/2" deep. Accessories furnished: a pair of sp. cords fuses and lamps. A5-13.

1. SO 11 10-w trans ster amp
2. SQ 38 10-w ster
3. SQ5B 14-w ster amp
4. SQ 77 10-w ster amp

McINTOSH

● **MA-230 Amplifier-Preamplifier.** 30 watt-per-channel tube power amplifier combined with a solid-state preamplifier.

Specifications: Freq. resp. 20 to 20k cps ± 0.25 db at 30 watts output; power bandwidth, 20 to 20k cps; IHF music power output, 44 watts per channel; power output, rms, 30 watts per channel; harmonic dis-



ortion, 0.5% at 30 watts from 20 to 20k cps; IM distortion, 0.5% at 30 watts; hum and noise, 75 db below 30-watt output; sensitivity, input for rated output—phono, 1.5 mv, tuner, 0.25 volts; damping factor 10; output impedances, 4, 8, 16 ohms; inputs—2 phono, 1 tape head, 1 tape amp, a tuner; weight, 43 lbs. Dimensions, 16" wide, 5 7/16" high, 14 1/2" deep. Price, \$349.00. Accessories: cabinet, \$29.00. A5-14.

PILOT

● **Pilot A-288 80-Watt Integrated Amplifier.** Twelve push buttons, two private listening headphone jacks, styled in black, gold, and white.

Specifications: Freq. resp. 5 to 50k cps ± 1 db at rated watts output; IIF music power output, 80 watts per channel; harmonic distortion, 0.1%; hum and noise, -80 db below rated output; sensitivity, input for rated output—phono, 12+3 mv, tuner, 110 mv; output impedances, 4, 8, 16 ohms; inputs—2 phono, 1 tape head, 1 tape amp, 1 aux, 1 Mic; Dimensions, 15 $\frac{1}{4}$ " wide, 6 $\frac{1}{4}$ " high, 12 $\frac{3}{4}$ " deep. Price, \$289.50. Accessories: walnut enclosure, \$22.50. A5-15.

1. 246 60-w integ ster amp \$199.50
2. 230 24-w integ ster amp \$ 89.50

PURE-SONICS

● **Stereo Amplifier Model 250.** Transistor front end.

Specifications: Freq. resp. 10 to 50k cps ± 1 db at 10 watts output; power bandwidth, 25 to 20k cps; IIF music power output, 40 watts per channel; power output, rms, 25 watts per channel; harmonic distortion, unmeasurable at 25 watts from 25 to 10k cps;



IM distortion, unmeasurable at 25 watts; hum and noise, 80 db below 25 watt output; sensitivity, input for rated output—phono, 5 mv, tuner, 0.5 volts; damping factor infinite, output impedances, 4, 8, 16 ohms; inputs—2 phono, 1 tape head, 1 tape amp, 1 aux, 1 tuner; weight, 35 lbs. Dimensions, 16" wide, 5" high, 11" deep. Price, \$335.00. Accessories: Walnut Case, \$28.50. A5-20.

RADFORD

● **SC4-10 Transistor Integrated Amplifier.** Rated output (English) of 15 watts per channel. Distortion less than 0.1% over range 20 to 20k cps at 15 watts.

Specifications: Freq. resp. 20 to 20k cps ± 0 db at 15 watts output; power bandwidth, 20 to 20k cps; IIF music power output, 20

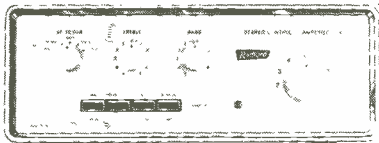

watts per channel; power output, rms, 15 watts per channel; harmonic distortion, 0.1% at 15 watts from 20 to 20k cps; IM distortion, 0.4% at 15 watts; sensitivity, input for rated output—phono 4 mv, tuner, 0.5 volts; damping factor 20; output impedances, 8, 16 ohms; inputs—2 phono, 1 tape amp, 2 aux, 1 tuner, weight, 17 lbs. Dimensions, 10 $\frac{1}{2}$ " wide, 3 $\frac{3}{4}$ " high, 14 $\frac{1}{2}$ " deep. Price, \$250.00. A5-16.

SCOTT

● **299D 70-Watt Stereo Amplifier.** Provides complete tape facilities, including tape-monitor and tape-head inputs. Powered center-channel output for driving center channel or extension speakers, plus a front panel earphone output with speaker switch.

Specifications: Freq. resp. 20 to 20k cps ± 1 db at 30 watts output; power bandwidth, 27 to 20k cps; IIF music power output, 40



watts per channel; power output, rms, 30 watts per channel; harmonic distortion, 0.8% rated output from 20 to 20k cps; hum and noise, -80 db below 1 watt output; sensitivity, input for rated output—phono, 3 mv, tuner, 0.5 volts; output impedances, 4, 8, 16 ohms; inputs—2 phono, 1 tape head, 1 tape amp, 1 aux, 1 tuner, weight, 28 lbs. Dimensions, 15 $\frac{1}{2}$ " wide, 5 $\frac{1}{2}$ " high, 13 $\frac{1}{4}$ " deep. Price; less than \$230.00. Accessories: Cases in wood and metal from \$14.00.

1. 233, 66-w ster amp less than \$190.00.

SHERWOOD

● **S-9000 150-watt Solid-State Integrated Stereo Amplifier.** Special circuit to prevent damage to transistor components due to shorted output or overheating. Uses silicon transistors mounted on glass-epoxy circuit boards throughout. Output circuits are transformerless.



Specifications: Freq. resp. 20 to 20k cps $\pm \frac{1}{2}$ db at 50 watts output; IIF music power output, 75 watts per channel; power output, rms, 50 watts per channel; harmonic distortion, 0.5% at 50 watts from 20 to 20k cps; IM distortion, 1% at 55 watts; hum and noise, 80 db below 50 watt output; sensitivity, input for rated output—phono, 1.2 mv, tuner, 0.25 volts; damping factor 20:1; power output: music power 75 watts per channel at 8 or 4 ohms (50 w. at 16 ohms), 55 watts at 8 or 4 ohms at 1% IM distortion (40W at 16 ohms); inputs—2 phono, 2 tape head, 2 tape mon., 2 aux, 2 tuner; weight, 24 lbs. Dimensions, 14" wide, 4" high, 12 $\frac{1}{2}$ " deep. Price, \$299.50. Accessories: Leatherette case, \$8.50. A5-18.

1. S-5500IV 80-w integ ster amp .. \$199.50
2. S-5000II 80-w integ ster amp ... \$124.50
3. S-1000III 80-w mono amp \$124.50
4. S-1000IIIR 80-w mcno rack panel \$132.00

TRANSWAVE

● **TA 50.** Complete with cover. Front panel earphone output jack.

Specifications: Freq. resp. 10 to 40k cps ± 1 db at 1 watt output; power bandwidth, 30 to 20k cps; IIF music power output,

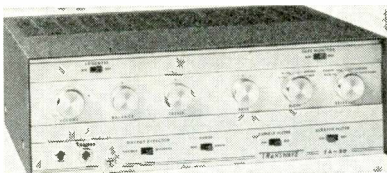

20 watts per channel; power output, rms, 15.2 watts per channel; harmonic distortion, less than 1% at rated output; hum and noise, 80 db below rated output; sensitivity, input for rated output—phono, 2.4 mv, tuner, 300 mv; damping factor 5; output impedances, 8, 16 ohms; inputs—2 phono, 1 tape head per channel, 1 tape amp per channel, 1 aux per channel, tapeout tuner; weight, 32 lbs. Dimensions, 14 $\frac{3}{4}$ " wide, 5 $\frac{1}{4}$ " high, 10 $\frac{1}{2}$ " deep. Price, \$119.50. A5-19.

A6. INTEGRATED AMPLIFIER KIT

DYNAKIT

● **SCA-35 Stereo Control Amplifier.** Etched circuit boards, simple construction, provision for headphone or third speaker output on rear panel.

Specifications: Freq. resp. 20 to 20k cps ± 0.25 db at 1 watt output; power bandwidth, 15 to 35k cps; IIF music power output, 23 watts per channel; power output, rms, 17.5 watts per channel; harmonic distortion, 1% at 35 watts (± 1 db) from 20 to 20k cps; IM distortion, 1% at 35 watts; hum and noise, 80 db below 17-watt output; sensitivity, input for rated output—phono, 4 mv, tuner, 1 volt; damping factor 10; output impedances, 8, 16 ohms; inputs—6 phono, 2 tape head, 2 tape amp, 2 aux, 2 radio; weight 20 lbs. Dimensions, 13" wide, 4" high, 10" deep. Price \$99.95. A6-1.

EICO

● **ST-70 80-watt Stereo Amplifier Kit.** **Specifications:** Tube complement (3) ECC-83/12AX7, (2) 12DW7, (2) 6SN7GTB, (4) 7591, (1) GZ34. Freq. Resp. 10 to 50k cps

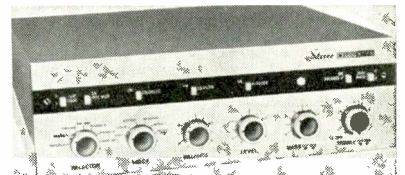

± 0.5 db at 2 watts output; power bandwidth, 15 to 90,000 cps; IIF music power output, 37.5 watts per channel; power output, rms, 35 watts per channel; harmonic distortion 1% at 30 watts from 25 to 20k cps; IM distortion, 1% at 70 watts; hum and noise 63 db below 1 watt output; sensitivity, input for rated output—phono 4 mv, tuner, 0.5 volts; damping factor 11; output impedance, 4, 8, 16 ohms; inputs—4 phono, 2 tape head, 2 tape amp, 4 aux. Dimensions, 15 $\frac{1}{2}$ " wide, 5 $\frac{1}{2}$ " high, 15" deep. Price \$149.95 assembled, \$99.95 kit. A6-2.

1. ST-40 stereo amp kit \$79.95

FISHER

● **KX-200 80-watt Stereo Amplifier.** Styled to match all other Fisher units. Power-derived center-channel output with level control. Equalization switchable on both low-level inputs, enabling connection of two record players, a recorder and record player.



Specifications: Freq. resp. 20 to 20k cps ± 1 db at 2 watts output; power bandwidth, 25 to 20k cps; IIF music power output, 40 watts per channel; power output, rms, 35 watts per channel; harmonic distortion, 0.4% at 70 watts at 1kc; IM distortion, 0.8% at 70 watts; hum and noise, 90 db below 70 watt output; sensitivity, input for rated output—phono, 3.5 mv, tuner, 0.35 volts; damping factor 10; output impedances, 4, 8, 16 ohms; inputs—2 phono, 2 tape head, 2 tape monitor, 4 aux, weight, 26 lbs. Dimensions, 15 $\frac{1}{2}$ " wide, 4 13/16" high, 12 $\frac{1}{2}$ " deep. Price, \$169.50. A6-3.

1. KX-100 Stratakit, 50-w ster amp .. \$129.50

HEATHKIT

● **Model AA-21 70-Watt Stereo Amplifier Kit.** 26-transistor, 10-diode circuit. Encapsulated, epoxy-covered circuit modules for easy assembly.



Specifications: Freq. resp. 13 to 25k cps ± 1 db at 70 watts output; power bandwidth, 13 to 25k cps; IIF music power output, 50 watts per channel; power output, rms, 35 watts per channel; harmonic distortion, 2% at 35 watts from 20 to 20k cps; IM distortion, 1% at 35 watts; hum and noise, 60 db below 35 watt output; sensitivity, input for rated output—phono, 3 mv, tuner, 0.25 volts; unity damping factor; output impedances, 4, 8, 16 ohms; inputs—1 phono, 1 tape head, 1 aux, 1 FM stereo; weight; 29 lbs. Dimensions, 15 $\frac{1}{2}$ wide, 5 $\frac{1}{4}$ " high, 14" deep. Price, \$139.95. A6-5.

1. AA-22 transistor 40-w ster amp kit \$99.95
2. AA-100 50-w ster amp kit \$84.95
3. AA-151 28-w ster amp kit \$59.95
4. AA-32 16-w ster amp kit \$39.95

KNIGHT KIT

● **KG854 54-Watt Stereo Amp Kit.** Transistor stereo amplifier kit.



Specifications: Freq. resp. 20 to 20k cps \pm 1 db at 54 watts output; power bandwidth, 20 to 20k cps; IHF music power output, 27 watts per channel; power output, rms, 15 watts per channel; harmonic distortion, 0.75% at 54 watts from 20 to 20k cps; IM distortion, 0.75% at 54 watts; hum and noise, 77 db below 54 watt output; sensitivity, input for rated output—phono, 3 mv, tuner, 0.5 volts; output impedances, 4, 8, 16 ohms; inputs—1 phono, 1 tape head, 1 tuner, 2 aux; weight, 16 lbs. Dimensions, 13" wide, 2 3/4" high, 11" deep. Price, \$79.95. A6-6.

1. KG 870 70-w ster amp kit \$149.95
2. KG 320 32-w ster amp kit \$ 69.95

SCOTT

● **LK-72B, 80-Watt Stereo Amplifier Kit.** Flexibility, tape monitor facilities, derived and powered center channel outputs, tape head inputs, rumble and scratch filters.



Specifications: Freq. resp. 20 to 20k cps \pm 1 db at 35 watts output; power bandwidth, 20 to 20k cps; IHF music power output, 40 watts per channel; power output, rms, 35 watts per channel; harmonic distortion, 0.8% rated output from 20 to 20k cps; hum and noise, 80 db below 1 watt output; sensitivity, input for rated output—phono, 3 mv, tuner, 0.5 volts; output impedances, 4, 8, 16 ohms; inputs—2 phono, 1 tape head, 1 tape amp, 1 aux, 1 tuner; weight, 30 lbs. Dimensions, 15 1/2" wide, 5 1/2" high, 13 1/4" deep. Price, Less than \$150.00. A6-7.

1. LK-48B 48-w ster amp kit Less Than \$130.00

A7. TUNER — FM, AM, or AM-FM

ALTEC

● **314A Emperor Royale FM-MPX Tuner.** Designed for FM-multiplex network relay and rebroadcast work and for off-the-air stereo monitoring. Automatic mpx all-electronic switching.

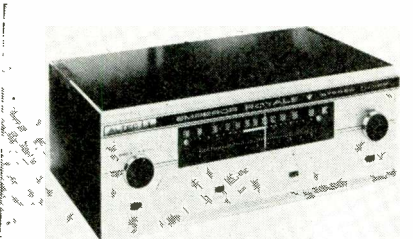

Specifications: 12 tubes; cascode front end; horiz. bar tuning indicator; controls—tuning; switches—power, a.f.c. defeat, muting, mpx noise filter, stereo-mono; freq. resp. \pm 1 db from 20 to 20k cps; sensitivity 1.2 μ v for 20-db quieting with 300-ohm antenna; stereo separation 30 db; time division stereo circuit; dimensions: 15" wide, 5 1/2" high, 11 1/8" deep; weight, 12 1/4 lbs. Price \$359.00. A7-1.

BELL

● **2441-S1 AM-FM Stereo Tuner.** Twin motors for "Visual Tuning" of stations, automatic frequency control, automatic volume control.

Specifications: FM: 9 tubes; neutralized cascode front end; 3 i.f. stages; ratio detector; 1 audio stage; meter tuning indicator; output signal 1 volt; 2 outputs; controls—FM tuning, AM tuning, function selector;

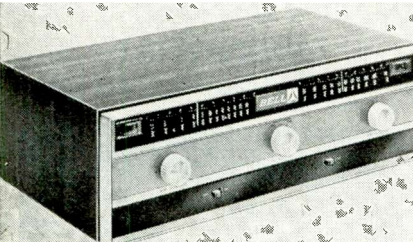

switches, on-off and a.f.c.; crossmodulation index 80 db; freq. resp. \pm 0.5 db from 20 to 20k cps; signal-to-noise ratio 60 db; IHF volume sensitivity 1.2 μ v; capture ratio 4 db; selectivity 6 db at 250 kc; IHF usable sensitivity 2 μ v; AM suppression 32 db; harmonic distortion (100% mod.) to 0.5%; stereo separation 28 db; switching stereo circuit; reactance a.f.c. circuit; drift less than +7 kc. AM: pentagrid mixer w/r.f. pre-amp circuit; 3-gang tuning capacitor; diode detector; 2 i.f. stages; meter tuning indicator; IHF volume sensitivity 3 μ v; freq. resp. \pm 3 db from 20 to 7k cps; Harm. dist. 1%. Price \$174.95. A7-2.

1. 2421-S1 \$144.95

BOGEN

● **FT60 Solid-State FM-Stereo Tuner.** Calibrated meter, a.f.c.



Specifications: FM: 15 transistors; grounded-grid front end; 4 i.f. stages; ratio detector; 2 audio stages; meter tuning indicator; output signal 0.75 volts; 2 outputs; controls—tuning; switches, selector, a.f.c. power; crossmodulation index 70 db; freq. resp. \pm 1 db from 20 to 15k cps; signal-to-noise ratio 60 db; IHF volume sensitivity 1 μ v; capture ratio 3 db; selectivity 40 db; IHF usable sensitivity 2.5 μ v; AM Suppression 55 db; harmonic distortion (100% mod.) 0.5%; stereo separation 35 db; time division stereo circuit; diode capacitor a.f.c. circuit; drift \pm 10 kc; dimensions: 15" wide, 4 3/4" high, 10" deep; weight, 11 1/2 lbs. Price, \$234.95. A7-3.

1. TP35 FM-stereo tuner \$139.95

DYNA

● **FM3/A Multiplex FM Tuner.** Automatic electronic switching from mono to stereo, center-of-channel tuning.

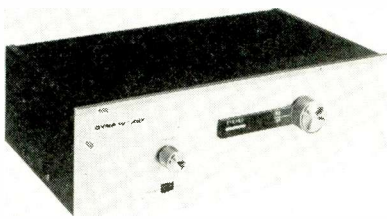

Specifications: 11 tubes, cath. cpd. front end; 4 i.f. stages; bal. bridge detector; 2 audio stages; EMMS01 tuning indicator; output signal 2 volts; 2 outputs; controls—tuning, volume; switches—on-off; freq. resp. \pm 0.5 db from 30 to 15k cps; signal-to-noise ratio 67 db; IHF volume sensitivity 0 μ v; capture ratio 5 db; selectivity 54 db; IHF usable sensitivity 6 μ v (in stereo operation), 4 μ v mono; AM suppression 63 db; harmonic distortion (100% mod.) 0.5%; stereo separation 30 db; env. det. stereo circuit; drift 30 kc max.; dimensions: 13" wide, 4" high, 8" deep; weight, 13 lbs. Price \$169.95. A7-4.

FISHER

● **TFM-300 Transistor FM-Stereo Tuner.** Five short time-constant limiters and wide-band ratio detector. Step-type variable-threshold muting. Automatic stereo switching. Front or rear tape jacks.



Specifications: 4 tubes, 21 transistors, 8 diodes and 2 bridges; golden synchrode front end; 5 i.f. stages; ratio detector; 4 audio stages; meter tuning indicator; output signal 2.0 volts; 5 outputs; controls—tuning, level; switches—power, mode selector, muting; freq. resp. +1 db from 20 to 15k cps; signal-to-noise ratio 70 db; IHF volume sensitivity below noise level; capture ratio 2.0 db; selectivity 55 db; IHF usable sensitivity 1.

8 μ v; AM suppression 60 db; harmonic distortion (100% mod.) 0.4%; stereo separation 40 db; time division stereo circuit; drift 0.01%; dimensions: 15 1/8" wide, 4 13/16" high, 11 1/8" deep; weight, 9 lbs. Price \$299.50. A7-5.

1. FM-100-B FM-MPX tuner \$249.50
2. FM-200-B FM-MPX tuner \$299.50
3. R-200 AM-FM-MPX tuner \$299.50
4. MF-300 remote control FM-MPX tuner \$329.50
5. FM-1000 network relay FM-MPX tuner \$429.50

GROMMES

● **107 AM-FM Tuner.** A solid-state tuner with flywheel tuning and "stereo sentry" lamp.

Specifications: FM: 17 transistors; 3-gang front end; 4 i.f. stages; ratio detector; 2 audio stages; meter tuning indicator; output signal 1 volt; tuning control; switches selector, a.f.c. power; crossmodulation index 75 db; freq. resp. \pm 0.5 db from 20 to 20k cps; signal-to-noise ratio 60 db; capture ratio 5



db; selectivity 30 db; IHF usable sensitivity 2 μ v; AM Suppression 50 db; harmonic distortion (100% mod.) 0.5%; stereo separation 30 db; switching stereo circuit; diode a.f.c. circuit; drift 10 kc; dimensions: 13 3/4" wide, 4 3/4" high, 11" deep; AM: superhet circuit; 3-gang tuning capacitor; diode detector; 1 i.f. stage; meter tuning indicator; IHF usable sensitivity 5 μ v; freq. resp. \pm 3 db from 20 to 6k cps; harm. dist. 1%. Price \$179.95. A7-6.

1. 106 AM-FM stereo tuner \$129.95

HARMAN-KARDON

● **F1000T FM-Stereo Tuner.** Solid-state circuit automatically switches to stereo mode. Threshold control, adjustable muting, Darsomval tuning meter, 3-position range switch.

Specifications: 18 transistors, 8 diodes; quadrature front end; 4 i.f. stages; wide-band detector; 2 audio stages; meter tuning



indicator; output signal 1.75 volts; 4 outputs; controls—stereo logic, muting, tuning; switches—a.f.c. defeat, local-suburban-distant, on/off; crossmod. ind. 85 db; IHF volume sensitivity 0 μ v; capture ratio 4 db; selectivity 3 db; IHF usable sensitivity 2.0 μ v; AM suppression 60 db; harmonic distortion (100% mod.) 0.1%; stereo separation 35 db; switching stereo circuit; solid-state a.f.c. circuit; drift \pm 5 kc; dimensions: 14 1/16" wide, 3 3/8" high, 8" deep; weight, 20 lbs. Price \$299.95. A7-7.

1. CW10 walnut enclosure \$19.95

KARG

● **SXT-1A Stereo Tunematic, Crystal-Controlled FM Tuner.**

Specifications: 8 tubes; crystal controlled front end; 4 i.f. stages; discrim. detector; 2 audio stages; output signal 3 volts; 2 outputs; controls—station selector, volume; switches on-off; freq. resp. \pm 2 db from 15 to

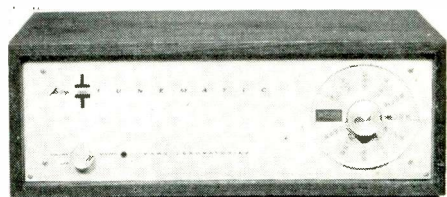

15k cps; signal-to-noise ratio 4 db; capture ratio 2 db; selectivity 33 db; IHF usable sensitivity 2.1 μ v; AM suppression 38 db; harmonic distortion (100% mod.) 0.2%; stereo separation 33 db; time div stereo

circuit; dimensions: 15 1/2" wide, 5" high, 5 1/2" deep; weight, 11 lbs. Price \$329.95. A7-8.

1. FMX-9 stereo FM tuner \$199.95
2. SCT-3A stereo FM tuner \$149.50

KENWOOD

• **TK-500 Transistor FM-Stereo Tuner.** Automatic protection circuit (U.S. Patent pending) automatically guards against wide-spread transistor damage due to short circuits. Indicator shows FM stereo broadcasts with automatic relay switching to proper mode.



Specifications: 22 transistors; cascode front end; 5 i.f. stages; ratio detector; meter tuning indicator; output signal 2 volts; controls—muting, tuning, level; switches—noise filter, a.f.c. power; freq. resp. ± 1 db from 20 to 20k cps; signal-to-noise ratio 60 db; IHF volume sensitivity 1 uv; capture ratio 2 db; IHF usable sensitivity 1.8 uv; harmonic distortion (100% mod.) 0.4%; stereo separation 35 db; switching stereo circuit; variable capacitor a.f.c. circuit; drift 10 kc; dimensions: 15 1/4" wide, 5 3/4" high, 12 1/4" deep; weight, 14 lbs. Price \$199.95. A7-9.

1. KW-550 FM-stereo tuner \$169.95

KNIGHT

• **KN-265 Stereo FM-AM Tuner.** Solid-state circuit.

Specifications: FM: 17 transistors; 4 i.f. limiter stages; ratio detector; light tuning indicator; 4 outputs; freq. resp. ± 0.5 db from 20 to 25k cps; stereo separation 30 db;



dimensions: 14 1/4" wide, 4 1/2" high, 13 3/16" deep; weight, 14 lbs. AM: 3-gang tuning capacitor; tuned rf detector; freq. resp. ± 0.5 db from 20 to 20k cps; harm. dist. 1%. Price \$179.95. A7-10.

1. KN-255A solid-state FM-MPX-AM \$139.95
2. KN-245A FM-MPX-AM \$ 99.95

LEAK

• **Trough-Line 3, FM Tuner.**

Specifications: 7 tubes plus 2 diodes; cascade front end; 3 i.f. stages; Foster-Seeley detector; 1 audio stage; max closure tuning indicator; output signal 1 volt; 2 outputs; controls—tune, volume w/on-off; switches



a.f.c. local-distant; freq. resp. ± 1 db from 20 to 20k cps; IHF usable sensitivity 1.5 uv; reactance tube a.f.c. circuit; drift 3 kc; dimensions: 11 1/2" wide, 4 1/4" high, 8 1/4" deep; weight, 13 lbs. Price \$149.00. A7-11.

1. TW stereo mpx adaptor \$69.95

MARANTZ

• **Model 10 FM-Stereo Tuner.** A no-compromise tuner incorporating an unusual visual-display tuning and multipath indicator. New type i.f. circuit eliminates alignment problems.

Specifications: 22 tubes plus CRT; 6 i.f. stages; Foster-Seeley detector; CRT tuning indicator; controls—scope centering, tuning; switches—stereo test, automatic-mono, muting, power, panel dim; freq. resp. ± 1 db from 20 to 15k cps; signal-to-noise 70 db; 10 db volume sensitivity 0.9 uv; adj. channel rejection, 42 db; alt. channel rej. 150 db; IHF usable sensitivity 2 uv; AM suppression 70 db; harmonic distortion (100% mod.) 0.5%; stereo separation 30 db, 20 to 15,000 cps; dimensions: 15 3/4" wide, 5 3/4" high, 15" deep; weight, 30 lbs. Price \$650.00. A7-12.

McINTOSH

• **MR71 FM-Stereo Tuner.**

Specifications: cascode front end; 5 i.f. stages; 2 audio stages; meter tuning indicator; output signal 2.5 volts; 2 outputs; controls—volume, auto freq. tuning; switches—mode, muting; freq. resp. ± 0.5 db from 20



to 20k cps; signal-to-noise ratio 70 db; capture ratio 1.5 db; IHF usable sensitivity 2.5 uv; harmonic distortion (100% mod.) 0.5%; stereo separation 30 db; peak detecting—self matrixing stereo circuit; dimensions: 16" wide, 5 7/16" high, 13" deep; weight, 27 lbs. Price \$399.00. A7-13.

1. MR67 FM-stereo tuner \$299.00

PILOT

• **T89 AM-FM-Stereo Tuner.**

Specifications: FM: 4 i.f. stages; meter tuning indicator; 2 outputs; controls—tuning, power, muting, selector; freq. resp. ± 1 db from 20 to 20k cps; capture ratio 1 db; selectivity 44 db; IHF usable sensitivity 1.8 uv; harmonic distortion (100% mod.) 0.2%; stereo separation 30 db; dimensions: 15 1/4" wide, 6" high, 13 1/2" deep; AM: meter tuning indicator; IHF usable sensitivity 3 uv; harm. dist. 1%. Price \$249.50. A7-14.

1. T-88 FM-ster tuner \$199.50
2. 280B FM-ster tuner \$ 99.50
3. Mark IV FM tuner \$ 59.95

QUAD

• **FM Tuner with Stereo Decoder.**

Specifications: 7 tubes and 15 transistors; permeability tuned front end; 3 i.f. stages; Foster-Seeley detector; twin neon tuning indicator; output signal 0.1 volt; 1 output;



freq. resp. ± 1 db from 50 to 15k cps; AM suppression 35 db; harmonic distortion (100% mod.) 1%; stereo separation 35 db; switching stereo circuit; reactance tube a.f.c. circuit; drift 15 kc; dimensions: 10 1/2" wide, 3 1/2" high, 8" deep; weight, 9 lbs. Price \$94.00. A7-15.

1. AM11 tuner \$104.00

SCOTT

• **312 Transistor Stereo FM Tuner.** New approach to tuner circuit design—not just simple substitution of transistors for tubes.

Specifications: FM: 13 transistors; 4 nuvistor front end; 4 i.f. stages; ratio detector; 4 audio stages; meter tuning indicator; output signal 1-2 volts; 2 outputs; controls—function selector; switches—filter, on/off;

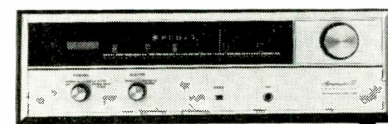

crossmodulation index 80 db; freq. resp. ± 1 db from 50 to 15k cps; signal-to-noise ratio 65 db; capture ratio 4 db; selectivity 35 db; IHF usable sensitivity 2.2 uv; AM suppression 55 db; harmonic distortion (100% mod.) 0.8%; stereo separation 30 db; time switching stereo circuit; a.f.c. circuit; drift 0.02%; dimensions: 15 1/2" wide, 5 1/2" high, 13 1/2" deep; weight, 13 lbs. Price less than \$260.00. A7-16.

1. 350-D auto FM-ster tuner less than \$225.00
2. 333-B AM-FM ster tuner .. less than \$290.00
3. 4312 auto FM-ster tuner \$365.00

SHERWOOD

• **S-2100II FM-Stereo-AM Tuner.** Stereo indicator light, zero center tuning meter, FM

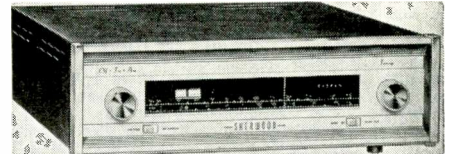

interchannel hush, flywheel tuning, expanded slide rule tuning scale.

Specifications: FM: 12 tubes, 2 silicon rectifiers and 9 diodes; cascode front end; 4 i.f. stages; ratio detector; zero-center tuning meter; output signal 1.2 volts; 2 outputs; controls—tuning, hush, FM-stereo level; switches selector, hush; freq. resp. ± 0.5 db from 20 to 20k cps; signal-to-noise ratio 60 db; capture ratio 2.4 db; selectivity 200 kc at -3 db; IHF usable sensitivity 1.8 uv; harmonic distortion (100% mod.) 0.3%; stereo separation 40 db; phase locked osc. & bal. synch detector stereo circuit; drift 15 kc; dimensions: 14" wide, 4" high, 10 1/2" deep; weight, 121 lbs. AM: superhet circuit; 3-gang tuning capacitor; diode detector; 2 i.f. stages; meter tuning indicator; controls AM level, tuning; switches selector, AM wide—narrow; usable sensitivity 2 uv @ 60% mod. for 0.5v out, gdb s/n; freq. resp. ± 6 db from 20 to 7500 cps; Price \$209.50. A7-17.

1. S-3000V FM-stereo tuner \$165.00
2. S-3000III FM mono tuner \$120.50
3. S-3000IIIR rack mounted (5 1/4" x 19") \$128.00
4. S-2000IV AM-FM mono tuner \$170.50
5. S-2000IV RS (3 1/2" high x 19") .. \$178.00

TRANSWAVE

• **TW 102 FM Multiplex Tuner.** Three nuvistor front end. Extruded aluminum panel with machined control knobs.

Specifications: 10 tubes and transistors; grounded grid front end; 4 i.f. stages; ratio



detector; output signal 1.5 volts; 2 outputs; controls tuning, on/off; switches FM/FM Multiplex noise filter; freq. resp. ± 1 db from 20 to 20k cps; signal-to-noise ratio 60 db; capture ratio 4 db; IHF usable sensitivity 3.2 uv; stereo separation 30 db; switching stereo circuit; diode a.f.c. circuit; drift 20 kc; dimensions: 14 3/4" wide, 5 1/4" high, 10 1/2" deep; weight, 23 lbs. Price \$119.50. A7-18.

A8. TUNER KIT — FM, AM or AM-FM

DYNAKIT

• **FM-3.** Extremely simple operation and automatic indication when tuned to a stereo broadcast. Exact center of channel tuning.

Specifications: 11 tubes; cathode coupled front end; 4 i.f. stages; wide band discriminator detector; 2 audio stages; EMM801 tuning indicator; output signal 2 volts; 2 outputs; controls—volume, tuning; switches—power; freq. resp. ± 0.5 db from 30 to 15k cps; signal-to-noise ratio 67 db; IHF volume sensitivity 0 uv; capture ratio 5 db; selectivity 54 db; IHF usable sensitivity 4 uv; AM suppression 63 db; harmonic distortion (100% mod.) 0.5%; stereo separation 30 db; envelope detection time switching stereo circuit; drift 30 kc; dimensions: 13" wide, 4" high, 8" deep; weight, 12 lbs. Fully automatic mono/stereo switching with indicating "stereocolor." Price, \$109.95. (Assembled, \$169.95). A8-1.

1. FM-1 mono tuner kit \$79.95

EICO

• **ST-97 FM-Stereo Tuner Kit.** Exclusive multiplex circuitry.

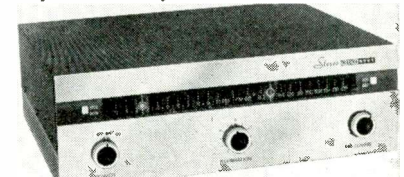

Specifications: 13 tubes; r.f. and self-oscillating mixer; 4 i.f. stages; ratio detector; 1 audio stage; eye tuning indicator; output signal 0.7 volts; 2 outputs; controls—tuning, separation; switches on/off, stereo/mono, afc on/off; freq. resp. ± 1 db from 20 to 1500 cps/signal-to-noise ratio 55 db; IHF usable sensitivity 3 uv; harmonic distortion (100% mod.) 0.5%; stereo separation 30 db; matrix stereo circuit; drift 20 kc; dimensions: 15 $\frac{1}{2}$ " wide, 5 $\frac{1}{4}$ " high, 11 $\frac{3}{4}$ " deep; weight, 17 lbs. Stereo indicator; pre-wired and aligned front end and i.f. strip. Price \$99.55. (Assembled, \$149.95). A8-2.

FISHER

● **KM-60 StrataKit FM-Stereo Tuner.** "Stereo Beam" indicates stereo programs. Critical stages are prealigned at the factory. Final touch-up is accomplished with built-in tuning meter. Level controls and an input attenuator.



Specifications: 11 tubes; Golden Cascade front end; 4 i.f. stages; ratio detector; 2 audio stages; meter tuning indicator; output signal 2.0 volts; 4 outputs; controls—tuning; switches—selector, power, stereo filter; freq. resp. ± 1 db from 20 to 15k cps; signal-to-noise ratio 70 db; IHF volume sensitivity below noise level; capture ratio 2.5 db; selectivity 60 db; IHF usable sensitivity 1.8 uv; AM Suppression better than 50 db; harmonic distortion (100% mod.) 0.5%; stereo separation 35 db; time-division stereo circuit; drift 0.01%; dimensions: 15 $\frac{1}{2}$ " wide, 4 13/16" high, 13" deep; weight, 18 lbs. Price \$169.50. A8-3.

HARMAN-KARDON

● **Citation III Professional FM Stereo Tuner Kit.** Features: all critical and complex stages (if and MX) pre-built and aligned at factory. Two meters aid in final alignment.

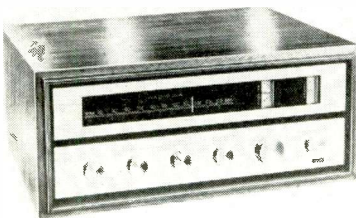

Specifications: 7 tubes, 9 diodes; nuvistor front end; 3 i.f. stages; Foster-Seely detector; 2 audio stages; level and balance meter tuning indicators; output signal 2 volts; 3 outputs; controls afc, loudness, tuning; switches on/off, range, function, muting; crossmod. ind.; freq. resp. ± 0.5 db from 1 to 52k cps; signal-to-noise ratio 75 db; IHF volume sensitivity 0 uv; capture ratio 3.5 db; selectivity 65 db; IHF usable sensitivity 1.65 uv; AM Suppression 70 db; harmonic distortion (100% mod.) 0.1%; stereo separation 30 db; switching stereo circuit; solid-state a.f.c. circuit; drift ± 5 kc; dimensions: 14 $\frac{1}{2}$ " wide, 6" high, 12 $\frac{1}{4}$ " deep; weight, 35 lbs. Price, \$230.00. (Assembled, \$325.00). A8-4.

HEATHKIT

● **Model AJ-43 Solid-State AM-FM Stereo Tuner.** Stereo phase control for maximum separation, minimum distortion. 25 transistor, 9-diode circuit. Automatically switches to stereo. Filtered stereo tape recorder outputs.

Specifications: FM: 25 transistors; 4 i.f. stages; ratio detector; meter tuning indicator; output signal, 0.5 volts; controls:

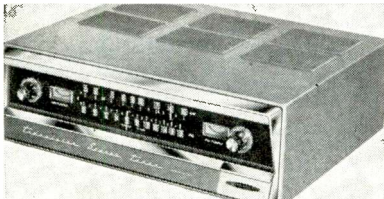

balance, L & R output level, stereo separation, FM stereo phase, FM meter zero, 38-kc oscillator adj.; switches: noise filter, SCA filter, AM-FM selector, local-distance, stereo defeat, afc defeat, on-off; cross-modulation index, 60 db; freq. resp. ± 3 db from 20 to 15k cps; IHF volume sensitivity 1 uv; capture ratio 7.5 db; IHF usable sensitivity 3.5 uv; AM Suppression 30 db; harmonic distortion (100% mod.) less than 1%; stereo separation 40 db; switching stereo circuit; diode a.f.c. circuit; dimensions: 15 $\frac{1}{2}$ " wide, 5 $\frac{1}{4}$ " high, 14 $\frac{1}{4}$ " deep; weight, 14 $\frac{1}{2}$ lbs. AM: Superhet circuit; 3-gang tuning capacitor; diode detector; 1 i.f. stage; meter tuning indicator; controls—output level, meter zero; IHF usable sensitivity 8 uv; IHF volume sensitivity 3 uv; Harm. dist. less than 2%. Price, \$119.95. A8-5.

- | | |
|--------------------------------------|----------|
| 1. AJ-33 transistor AM-FM ster tuner | \$ 99.95 |
| 2. AJ-41 AM-FM-ster tuner | \$119.95 |
| 3. AJ-13 FM-ster tuner | \$ 49.95 |
| 4. AJ-53 AM tuner | \$ 27.95 |
| 5. AJ-63 FM tuner | \$ 39.95 |

KNIGHT-KIT

● **K6-765 AM-FM Transistor Stereo Tuner Kit.**

Specifications: FM: 14 transistors, 18 diodes; 3 i.f. stages; ratio detector; meter tuning indicator; output signal, 1 volt; 2 sets outputs; controls—selector, tuning; switches AFC, power; freq. resp. ± 1 db from 20 to 20k cps; capture ratio 9 db; IHF usable



sensitivity 2 uv; AM Suppression 30 db; harmonic distortion (100% mod.) 1%; stereo separation 30 db; dimensions: 13" wide, 2 $\frac{3}{4}$ " high, 11" deep; weight, 14 lbs. AM: 2 i.f. stages; meter tuning indicator; controls selector; IHF usable sensitivity 3 uv; harm. dist. 1%. Flywheel ballbearing tuning, stereo indicator light. Price, \$99.95. (Assembled, \$149.95). A8-6.

- | | |
|---------------------------|---------|
| 1. K6-50 AM-FM ster tuner | \$69.95 |
|---------------------------|---------|

SCOTT

● **LT-110B FM Multiplex Stereo Tuner Kit.** New styling, refined performance and features. All critical sections are wired and pre-tested at the factory.

Specifications: cascade front end; 3 i.f. stages; ratio detector; 2 audio stages; meter tuning indicator; output signal 1-2 volts; 2 outputs; controls—sonic monitor selector; switches—stereo filter, AGC; crossmodulation index 80 db; freq. resp. ± 1 db from 50



to 15k cps; signal-to-noise ratio 60 db; capture 6 db; selectivity 35 db; IHF usable sensitivity 2.2 uv; AM Suppression 55 db; harmonic distortion (100% mod.) 0.8%; stereo separation 30 db; switching stereo circuit; drift 0.02 kc; dimensions: 15 $\frac{1}{2}$ " wide, 5 $\frac{1}{4}$ " high, 13 $\frac{1}{4}$ " deep; weight, 16 lbs. Price, less than \$140.00. A8-7.

A9. TUNER-AMPLIFIER (RECEIVER)

ALTEC

● **708A Astro, AM-FM Stereo Tuner-Amplifier.** Power transistors in the output stage to pro-



vide transient response as well as 55-watts output with low heat generation.

Specifications: FM: Total of 18 tubes, 12 transistors, 5 diodes; cascade front end; eye tube tuning indicator; IHF usable sensitivity 2 uv; stereo separation 30 db; time division stereo circuit. AM: eye tube tuning indicator; sensitivity 2.9 uv. **AMPLIFIER:** Freq. resp. 20 to 20k cps ± 1 db; IHF music power output 27.5 watts per channel; harmonic distortion, 1% at 20 watts from 25 to 10k cps; sensitivity—phono, 4 mv. aux. 450 mv; damping factor 10; output impedances 4, 8, 16 ohms; dimensions, 15" wide, 5 $\frac{1}{4}$ " high, 14 $\frac{1}{4}$ " deep; weight, 28 lbs. Price \$597.00. A9-1.

BELL

● **Imperial 1000 FM-Stereo Tuner-Amplifier.**

Specifications: FM: 3 nuvistors, 13 transistors; neutralized super-cascade front end; 4 i.f. stages; ratio detector; 7 audio stages; meter tuning indicator; 10 controls—contour, volume, balance, function, tuning, bass & treble each channel, muting; switches, 7, lo-

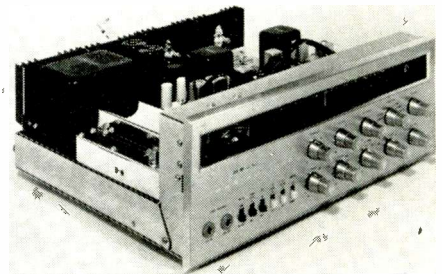

cal-stereo, afc, low filt, distant Filter, high Filter, monitor source; crossmodulation index 80 db; freq. resp. ± 0.25 db from 20 to 53k cps; signal-to-noise ratio 65 db; IHF volume sensitivity 0.8 uv; capture ratio 2 db; IHF usable sensitivity 1.6 uv; AM suppression 40 db; harmonic distortion (100% mod.) 0.5%; stereo separation 30 db; balanced demodulator stereo circuit; reactance diode a.f.c. circuit; dimensions: 17 $\frac{1}{2}$ " wide, 6-3/16" high, 16 $\frac{3}{4}$ " deep; weight, 45 lb. **AMPLIFIER:** Freq. resp. 9 to 85k cps ± 3 db at 1 watt output; IHF music power output 40 watts per channel; harmonic distortion, 0.25% at 40 watts at 1000 cps; IM distortion, 0.7% at 40 watts; hum and noise, 80 db below rated output; sensitivity, input for rated output—phono 1.5 mv, aux. 0.5 volts; output impedances 4, 8, 16 ohms; dimensions, 17 $\frac{1}{2}$ " wide, 6-3/16" high, 16 $\frac{3}{4}$ " deep; weight, 45 lbs. Price \$529.95. A9-2.

- | | |
|---|----------|
| 1. Imperial 900 FM-stereo tuner-Amp, 80-w | \$469.95 |
| 2. 2445-S2 AM-FM-stereo tuner-Amp, 44-w | \$319.95 |
| 3. 2425-S2 AM-FM stereo tuner-Amp, 30-w | \$269.90 |

BOGEN

● **RT1000 Solid-State FM-Stereo and FM-AM Receiver.** Tuning meter, push-pull knob control, light flywheel tuning, automatic FM-stereo (lights indicator when transmission changes from mono to stereo).



Specifications: FM: 13 transistors; grounded-grid front end; 4 i.f. stages; ratio detector; meter tuning indicator; controls: tuning, volume, balance, bass, treble, loudness, high and low filters; switches: selector, afc, mode, output, reverse, power, phase, tape mon; crossmodulation index 70 db; freq. resp. ± 1 db from 20 to 15k cps; signal-to-noise ratio 60 db; IHF volume sensitivity 1 uv; capture ratio 3 db; selectivity 40 db; IHF usable sensitivity 2.5 uv; AM suppression 55 db; harmonic distortion 0.5%; stereo separation 35 db; time division stereo circuit; capacitor diode a.f.c. circuit; drift ± 10 kc. AM: 4 transistors; super-het circuit; 3-gang tuning capacitor; 2 i.f. stages; meter tuning indicator; IHF usable sensitivity 6 uv; IHF volume sensitivity 4 uv; freq. resp. ± 2 db from 20 to 6k cps; harm. dist. 1%. **AMPLIFIER:** Freq. resp. 12 to 85k cps ± 1 db at 1 watt output; power bandwidth, 20 to 20k cps; IHF music power output 50 watts per channel; power output, rms, 40 watts per channel; harmonic

distortion, 0.7% at 40 watts from 20 to 18k cps; IM distortion 0.6% at 40 watts; hum and noise, 85 db below 40-watt output; sensitivity, input for rated output—phono, 25 mv, aux. 0.25 volts; damping factor 40; output impedances 4, 8, 16 ohms; inputs—2 phono, 2 tape head, 2 tape amp, 2 aux., dimensions, 16 3/16" wide, 4 7/8" high, 15 13/16" deep; weight, 40 lb. Price \$549.95. A9-3.

1. RP60 FM-AM & FM-stereo receiver \$314.95
2. RPF60 FM-stereo receiver \$279.95
3. RP230 FM-AM & FM-stereo receiver \$249.95
4. RP100-BM mono receiver \$186.60

ERIC

● Palomar SR-500.

Specifications: FM: 7 transistors; quadrature-tuned front end; 4 i.f. stages; ratio detector; 1 audio stage; meter tuning indicator; output



signal 0.125 volts; 3 outputs; controls, fly-wheel tuning; switches, afc, local-distance; freq. resp. ± 1 db from 15 to 53k cps; IIF usable sensitivity 2.5 uv; harmonic distortion (100% mod) 1.0%; stereo separation 30 db; time division stereo circuit; silicon diode a.f.c. circuit. **AMPLIFIER:** Freq. resp. 10 to 30k cps ± 1 db at 10 watts output; power output, rms, 25 watts per channel; harmonic distortion, 1.0% at 10 watts from 10 to 30k cps; IM distortion 1% at 10 watts; hum and noise, 80 db below 25 watt output; sensitivity, input for rated output—phono, 2 mv, aux. 0.125 volts; output impedances 4, 8, 16 ohms; inputs—2 phono, 2 tape head, 2 tape amp, 4 aux., dimensions, 16" wide, 4 7/8" high, 13" deep; weight, 21 lbs. Price \$399.00. A9-4.

1. 5763 AM-FM receiver 15-w rms per ch \$239.95

FISHER

● **600T Tuner-Amplifier.** The tuner employs 5 wide-band stages and five short time-constant limiters followed by a detector with a one-megacycle bandwidth, and equipped with variable-threshold muting. The multiplex section, indicates and automatically switches to the correct mode of operation. Speaker selector switch enables the selection of one or more pairs of speakers, or headphone-only operation.



Specifications: FM: 4 tubes, 48 transistors, 15 diodes, 2 bridges; synchrode front end; 5 i.f. stages; ratio detector; meter tuning; controls: muting, threshold (tuner sec. only); switches: muting, mode; signal-to-noise ratio 70 db; IIF volume sensitivity below noise level; capture ratio 2.0 db; selectivity 55 db; IIF usable sensitivity 1.8 uv; AM suppression better than 60 db; harmonic distortion (100% mod.) 0.4%; stereo separation 40 db; time switching stereo circuit; drift 0.01%. **AMPLIFIER:** Freq. resp. 20 to 25k cps ± 1 db at 2 watts output; power bandwidth, 12 to 35k cps; IIF music power output 55 watts per channel; power output, rms, 45 watts per channel; harmonic distortion, 0.5% at 90 rms watts; hum and noise, 86 db below 90 rms watt output; sensitivity, input for rated output—2.8 mv, aux. 0.21 volts; damping factor 10; output impedances 4 to 16 ohms; inputs—4 phono 2 tape head, 2 tape monitor aux.; dimensions, 16 1/2" wide, 5 1/4" high, 11 1/2" deep; weight, 31 lbs. Price \$595.00. Accessories Model 100-0 Walnut Cabinet \$24.95. A9-5.

1. 800-C 75-w AM-FM mpx receiver \$449.50
2. 500-C 75-w FM-mpx receiver \$389.50
3. 400 65-w FM-mpx receiver \$329.50

GROMMES

● **5003 30-Watt AM-FM Stereo Receiver.** "Stereo sentry," simplified controls.

AUDIO • AUGUST, 1964

Specifications: FM: 17 tubes, 11 diodes grounded-grid 2-gang front end; 3 i.f. stages; ratio detector; eye tube tuning indicator; controls—tuning, selector, loudness, balance, bass, treble; switches—stereo, contour, afc, power; crossmodulation index 70 db; freq. resp. ± 0.5 db from 20 to 20k cps; signal-to-noise ratio 55 db; capture ratio 6 db; selectivity 30 db; IIF usable sensitivity 4 uv; AM suppression 50 db; harmonic distortion (100% mod.) 0.7%; stereo separation 30 db; switching stereo circuit; reactance tube a.f.c. circuit; drift 15 kc; 14" wide; 5 1/4" high, 13 1/4" deep; AM: Superhet circuit; 2-gang tuning capacitor; 1 i.f. stage; eye tube tuning indicator; IIF usable sensitivity 10 uv; ± 3 db from 20 to 6.5k cps; harm. dist. 1%. **AMPLIFIER:** Freq. resp. 20 to 20k cps ± 1 db at 1 watt output; power bandwidth, 30 to 15k cps; IIF music power output 15 watts per channel; power output, rms, 12 watts per channel; harmonic distortion, 1% at 10 watts from 40 to 15k cps; IM distortion 2% at 15 watts; hum and noise, 72 db below 15 watt output; sensitivity, input for rated output—phono, 3 mv, aux. 0.25 volts; damping factor 4.5; output impedances 4, 8, 16 ohms; inputs—1 phono, 1 tape head, 1 aux. Price \$249.95, walnut cabinet \$24.95. A9-6.

KENWOOD

● **Model KT-10 Transistor AM-FM Stereo Receiver.** Automatic protection circuit guards against transistor damage due to short circuits at output; automatic relay switching to proper mode shows reception of FM stereo; direct tape-monitor system; front-panel stereo headset jack; SCA noise eliminator; illuminated meter.

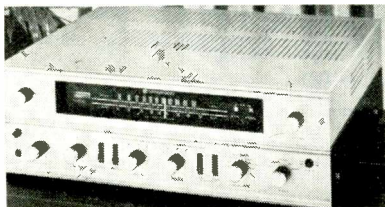

Specifications: FM: 42 transistors; 4 i.f. stages; ratio detector; automatic relay tuning indicator; freq. resp. ± 1 db from 20 to 20k cps; signal-to-noise ratio 72 db; IIF volume sensitivity 1 uv; selectivity 2 db; IIF usable sensitivity 2.5 uv; harmonic distortion (100% mod.) 1%; stereo separation 35 db; switching stereo circuit; variable capacitor a.f.c.; drift 10 kc; meter tuning indicator; IIF usable sensitivity 10 uv; IIF volume sensitivity 26 uv; freq. resp. ± 3 db from 50 to 4k cps; harm. dist. 1.5%. **AMPLIFIER:** Freq. resp. 20 to 20k cps ± 1 db at 1 watt output; power bandwidth, 20 to 18k; IIF music power output 20 watts per channel; power output, rms, 16 watts per channel; harmonic distortion, 1% at 16 watts from 20 to 18k; hum and noise, 72 db below 16 watt output; sensitivity, input for rated output—phono, 1.5 mv, aux. 100 volts; inputs—1 phono, 1 tape head, 1 tape amp, 1 aux.; dimensions 17 1/2" wide, 5 1/2" high, 14" deep; weight, 24 lbs. Price \$299.95. A9-8.

1. KW-55 AM-FM-stereo receiver ... \$239.95
2. KW-33 AM-FM-stereo receiver ... \$189.95

KNIGHT

● **KN-370 70-Watt Receiver.** Automatic stereo switching.

Specifications: magic-eye tuning indicator; freq. resp. 20 to 20k cps; IIF volume sensitivity 2 1/2 uv; harmonic distortion (100% mod.) 0.6%; stereo separation 30 db; dimensions: 16" wide, 5 1/4" high, 15" deep; ship

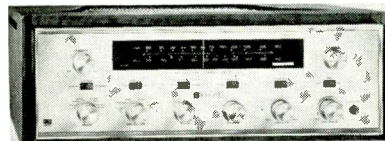

weight, 38 lbs.; magic-eye tuning indicator; IIF volume sensitivity 75 uv. **AMPLIFIER:** Freq. resp. 20 to 20k cps at rated watts output; IIF music power output 35 watts per channel; power output, rms, 32 watts per channel; harmonic distortion, 0.7% output impedances 4, 8, 16 ohms; inputs—2 phono, 1 tape head, 1 tape amp, 1 aux. Price \$279.95. A9-9.

1. KN-330 30-w stereo receiver \$159.95
2. KN-345 44-w stereo receiver \$199.95

LAFAYETTE

● **LA-226C 40-Watt FM-AM Stereo Receiver.** "Pilot Monitor" stereo indicator shows when

set is tuned to FM-stereo broadcast. Two 3-gang tuning capacitors, front panel stereo headphone jack.



Specifications: FM: 20 tubes, 7 diodes; ratio detector; EM 84 tuning indicator; freq. resp. ± 0.5 db from 20 to 20k cps; IIF usable sensitivity 3.5 uv; harmonic distortion (100% mod.) 0.7%; stereo separation 30 db; matrix stereo circuit; reactance a.f.c. circuit; dimensions: 17 1/2" wide, 5 1/4" high, 15" deep; weight, 45 lbs. 3-gang tuning capacitor; EM 84 tuning indicator; controls—concentric bass, treble, volume balance, dimension, hum, balance, FM noise filter, rumble filter, speaker headphone, phase loudness, afc, on/off, spkr. impedance. **AMPLIFIER:** Freq. resp. 20 to 20k cps ± 2 db at 40 watts output; IIF music power output 20 watts per channel; power output, rms, 18 watts per channel; harmonic distortion, 1.5% at 20 watts from 20 to 20k cps; hum and noise, 65 db below 1 watt output; sensitivity, input for rated output—phono, 2 mv, aux. 0.1 volts; damping factor output impedances 8, 16 ohms; inputs—4 phono, 2 tape head. Price \$189.95. A9-10.

1. LA-250 24-w AM-FM stereo receiver \$139.50
2. LA-215 AM-FM stereo receiver ... \$109.50

MARTEL

● **Model 200 FM-AM-Multiplex Tuner-Amplifier.** RIAA compensated phono input for magnetic, crystal, and ceramic cartridges.

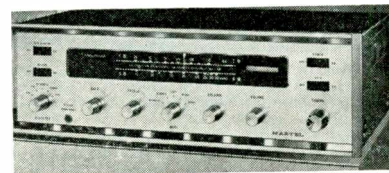

Specifications: FM: 17 tubes, 7 diodes; 3 i.f. stages; Foster-Seeley detector; controls—bass, treble, selector, mode, balance, volume, tuning; switches—power, a.f.c., tape monitor, spkr; sensitivity 1.5 uv for 20 db quieting; stereo separation 30 db; matrix stereo circuit; dimensions: 17 1/2" wide, 5" high, 10 1/2" deep; weight 24.3 lbs. AM: superhet circuit; 1 i.f. stages; tube tuning indicator. **AMPLIFIER:** Freq. resp. 20 to 20k cps ± 2 db; IIF music power output 15 watts per channel; output impedances 8, 16 ohms; inputs—4 phono, 2 tape amp, 2 aux. Price \$179.95. A9-11.

1. "100" AM-FM-multiplex tuner-amp \$139.95
2. "61" AM-FM-multiplex tuner-amp \$109.95

PILOT

● **R1000 110-Watt FM-AM-Stereo Receiver.** Solid state stereo amplifier.

Specifications: FM: 4 i.f. stages; meter tuning indicator, controls—muting, bass comp., tape mon., volume, balance, bass, treble, selector, mode, speaker control, tuning; switches—scratch, rumble, phono selector; freq. resp. ± 1 db from 20 to 20k cps; capture ratio 1 db; selectivity 44 db; IIF usable sensitivity 1.8 uv; harmonic distortion (100% mod.) 0.2%; stereo separation 30 db; dimensions: 17 15/16" wide, 7 1/4" high, 15" deep. AM: meter tuning indicator; IIF usable sensitivity 3 uv; harm. dist. 1%. **AMPLIFIER:** Freq. resp. 10 to 30k cps ± 2 db; IIF music power output 55 watts per channel; harmonic distortion, 1%; hum and noise, 80 db below rated output; sensitivity, input for rated output—phono, 12 + 3 mv; inputs—2 phono, 1 tape head, 1 tape amp. Price \$499.50. Walnut enclosure \$34.50. A9-12.

1. R707 AM-FM-stereo receiver solid-state amp \$349.50
2. R303 AM-FM-stereo receiver \$289.50
3. 746 AM-FM-stereo receiver \$399.50
4. 602 MA/1 FM-stereo receiver \$249.50
5. 610 FM-stereo receiver \$199.50

RCA

● **MX-7 Stereo Receiver.** Separate tuning controls on AM and FM sections permit reception of two programs at the same time, with one of the channels fed to a remote speaker.

Specifications: FM: nuvistor front end; 4 i.f. stages; Foster-Seeley detector; tube tuning indicator; controls—FM tuning, AM tuning,

volume, balance, bass, treble; switches—MX filter, afc, power, mono-stereo, selector, loudness, sensitivity, tape monitor, remote volume/balance; usable sensitivity 2.5 uv for 20-db quieting; AM suppression 55 db. **AMPLIFIER:** Freq. resp. 15 to 30k cps ± 1 db; IIF music power output 20 watts per channel;



power output, rms, 15 watts per channel; harmonic distortion, less than 1% at 30 watts; hum and noise, 60 db below rated output; sensitivity, input for rated output—phono, 2.5 mv, aux. 0.5 volts; output impedances 4, 8, 16 ohms; inputs—2 phono, 2 tape amp, 2 aux, 2 tape monitor; dimensions: 17 3/4" wide, 6 1/2" high, 12 1/2" deep; weight 35 lbs. Price \$349.50. Accessories—walnut cabinet \$26.75; remote control, \$26.75. A9-13.

SCOTT

• **345 64-Watt FM-Stereo Tuner-Amplifier.** Incorporates a new low-impedance symmetrical drive circuit. Series-gate time-switching multiplex. Pulse suppression-limiting for improved suppression impulses from sources like automobile ignition and apartment house elevators.



Specifications: FM: 15 tubes; cascode front end; 3 i.f. stages; ratio detector; 2 audio stages; eye tube tuning indicator; controls—input & stereo selector, bass & treble, loudness, speakers, scratch; switches—tape monitor, compensator; crossmodulation index 80 db; freq. resp. ± 1 db from 50 to 15k cps; signal-to-noise ratio 60 db; capture ratio 6 db; selectivity 35 db; IIF usable sensitivity 2.2 uv; AM suppression 55 db; harmonic distortion (100% mod.) 0.8%; stereo separation 30 db; time switching stereo circuit; drift 0.02%; dimensions: 17 1/2" wide, 6 1/4" high, 13 1/4" deep; **AMPLIFIER:** Freq. resp. 20 to 20k cps ± 1 db at 28 watts output; power bandwidth, 32 to 20k cps; IIF music power output 32 watts per channel; power output, rms, 28 watts per channel; harmonic distortion, 0.8% at rated output from 20 to 20k cps; hum and noise 80 db below 1 watt output; sensitivity, input for rated output—phono, 3 mv, aux. 0.5 volts; output impedances 4, 8, 16 ohms; inputs—2 phono, 1 tape head, 1 tape amp, 1 aux, 1 (other); dimensions, 17 1/2" wide, 6 1/4" high, 16 3/4" deep; weight 34 lbs. Price, less than \$365.00. Accessories: Cases in wood and metal from \$17.95. A9-14.

- 340-B 70-w FM-stereo tuner-amp less than \$400.00
- 380 70-w AM-FM stereo tuner-amp less than \$470.00

SHERWOOD

• **S-8000IV 80-Watt FM-Stereo Receiver.** All the electronics for a complete home music system are contained on a single compact chassis.

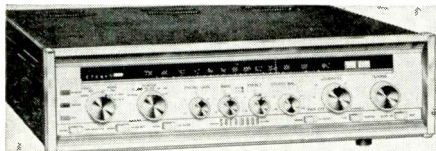

Specifications: FM: 21 tubes, 3 silicon rectifiers, 13 diodes; cascode rf amp, front end; 4 i.f. stages; ratio detector; 2 audio stages; zero-center tuning-meter; output signal 1.5 volts; 2 outputs; controls—tuning, loudness, phono gain, bass, treble, stereo bal, hush; switches—power, selector, function, tape mon, phase, lo filter, hi filter, loudness contour, hush; freq. resp. $\pm 1/2$ db from 20 to 20k cps; signal-to-noise ratio 55 db; capture ratio 2.4 db; IIF usable sensitivity 1.8 uv; harmonic distortion (100% mod.) 1/3%; stereo separation 40 db; phase loaded osc. & bal. synch. detector stereo circuit; drift 15 kc; dimensions: 16 1/4" wide, 4" high, 14" deep; weight 34 lbs. **AMPLIFIER:** Freq. resp. 20 to 20k

cps $\pm 1/2$ db at 36 watts output; IIF music power output 40 watts per channel; power output, rms, 36 watts per channel; harmonic distortion, 0.5% at 36 watts from 20 to 20k cps; IM distortion 1.5% at 36 watts; hum and noise, 75 db below 1 watts output; sensitivity, input for rated output—phono, 1.2 mv, aux. 0.3 volts; damping factor 5:1; output impedances 4, 8, 16 ohms; inputs—2 phono, 2 tape head, 2 tape monitor, 2 aux, 1 AM; dimensions 16 1/4" wide, 4" high, 14" deep; weight, 34 lbs. Price \$329.50. Accessories—walnut-tone leatherette case \$9.50, walnut wood cabinet \$29.50. A9-15.

- S-770011 80-w AM-FM-stereo receiver \$374.50

TRANSWAVE

• **TW75.** An FM multiplex stereo receiver. Speaker director switch enables extension speakers to be used with system.

Specifications: FM: 8 tube, grounded-grid front end; 4 i.f. stages; ratio detector; 6 audio stages; bar eye tuning indicator; controls—bass, treble, volume, balance, function, mode, tape monitor; switches—loudness, scratch, rumble; freq. resp. ± 1 db from 20 to 20k cps; signal-to-noise ratio 75 db; IIF usable sensitivity 3.5 uv; harmonic distortion (100% mod.) 1%; stereo separation 30 db; modified matrix stereo circuit; silicon diode a.f.c. circuit; drift 25 kc; dimensions: 14 3/4" wide, 5 1/2" high, 12 1/2" deep; weight, 40 lbs.

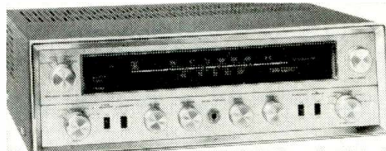

AMPLIFIER: Freq. resp. 10 to 40k cps ± 1 db at 1 watt output; power output 35 watts per channel; power output, rms, 25 watts per channel; harmonic distortion, better than 1% at rated outputs; IM distortion 2% at rated output; hum and noise, 80 db below rated output; sensitivity, input for rated output—phono, 3 mv, aux. 120 mv; damping factor 5; output impedances 4, 8, 16 ohms; inputs—2 phono, 2 tape amp, 2 aux, 2 tape out; dimensions, 14 3/4" wide, 5 1/2" high, 12 1/2" deep; weight, 40 lbs. Price \$249.50. A9-16.

- TW60 AM-FM-stereo receiver \$219.50

A10. TUNER-AMPLIFIER KIT (RECEIVER)

EICO

• **Model 3566 Solid-State FM-MPX Stereo Tuner-Amplifier.** Protected against open or shorted speaker leads. Automatic switching to stereo. Adjustable threshold muting aft. M-derived low-pass SCA filter. Sharp cut-off. 15kc low-pass filter.

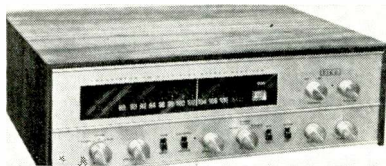

Specifications: FM: 42 transistors; 3 transistor front end; 4 i.f. stages; ratio detector; meter tuning indicator; controls—tuning, vol/ldnss, balance, treble, bass; switches mono-stereo, input sel, tape mon, muting-off, aft-off, pwr on-off; freq. resp. ± 1 db from 20 to 15k cps; signal-to-noise ratio 60 db; IIF usable sensitivity 2.0 uv; AM Suppression 40 db; harmonic distortion (100% mod.) 0.5%; stereo separation 38 db; time-switching stereo circuit. **AMPLIFIER:** Freq. resp. 10 to 60k cps ± 1 db at 10 watts output; power bandwidth, 20 to 20k cps; IIF output 33 watts per channel; power output, rms, 30 watts per channel; harmonic distortion, 0.5% at 25 watts from 20 to 20k cps; IM distortion 1% at 25 watts; hum and noise, 70 db below 30 watt output; sensitivity, input for rated output—phono, 3 mv, aux. 0.180 volts; damping factor 12; output impedances 8 ohms; inputs—1 phono, 1 tape amp, 1 aux; Price \$249.95 (assembled; \$349.95). A10-1.

- 2536 FM ster tuner-amp \$149.95

HEATHKIT

• **AR-13 "Solid-State" AM-FM Stereo Receiver.** 43 transistor, 18 diode circuit. Tuner automatically switches to stereo. Not a beginner's kit.

Specifications: FM: 43 transistors; 3-transistor front end; 3 i.f. stages; ratio detector; meter tuning indicator; controls—phase adj., mp balance, mp separation, FM squelch phase, AFC, local-distant; switches SCA filter noise, filter, speaker; crossmodulation index 60 db; freq. resp. ± 3 db from 20 to 15k cps; signal-to-noise ratio 50 db; IIF volume sensitivity 3 uv; capture ratio 10 db; IIF usable sensitivity 3.5 uv; AM Suppression 20 db; harmonic distortion (100% mod.) 1%; stereo separation 30 db; switching stereo circuit; diode a.f.c. circuit; AM; Superhet circuit; 3-gang tuning capacitor; 2 i.f. stages; meter tuning indicator; IIF usable sensitivity 9 uv; IIF volume sensitivity 3 uv; freq. resp. ± 3 db from 20 to 3k cps; harm. dist. 2%. **AMPLIFIER:** Freq. resp. 15 to 30k cps ± 1 db at 20 watts output per channel; power bandwidth, 10 to 60k cps; IIF power output 33 watts per channel; power output, rms, 20 watts per channel; harmonic distortion, 1% at 20 watts from 20 to 20k cps; IM distortion 1% at 20 watts; hum and noise, 65 db below 20 watt output; sensitivity, input for rated output—phono, 6 mv, aux. 0.25 volts; damping factor 20:1; output impedances 4, 8, 16 ohms; inputs—2 phono, 2 aux. Price \$195.00. A10-2.

A11. PHONO PICKUP CARTRIDGE

ADC

• **Point Four/E Pickup.** Induced magnet principle, elliptical stylus, 15-deg. vertical tracking angle.

Specifications: Freq. response 10 to 20k cps ± 2 db; IM dist 1%; output, 4.3 mv/cm rec. velocity; channel separation, 30 db at 1 kc, 20 db at 10 kc; recommended load, 47 k ohms;

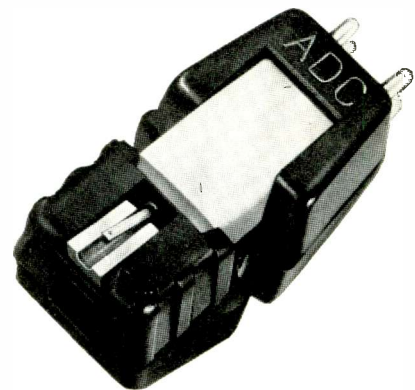

recommended tracking force—professional arms, 0.75–1.5 gms; compliance—lateral, 30 x 10⁻⁶ cm/dyne, vertical, 30 x 10⁻⁶ cm/dyne; inductance, 500 mh; d.c. resistance, 700 ohms; 4 terminals; mounting dimensions, 7/16" or 1/2". Price, diamond, \$60.00; replacement styli, elliptical—\$25.00; regular—\$15.00. A11-1.

- Point Four \$50.00
- 660 for auto, TT \$46.50
- 770 for changers \$29.50

ASTATIC

• **Model 45D "Cantata" Ceramic Stereo Cartridge.**

Specifications: Freq. response ± 2 db from 30 to 12k cps; IM dist 1%; output 2 mv/cm rec. velocity; channel separation, 30 db at 1 kc, 15 db at 10 kc; recommended load, 47k ohms with network supplied; recommended tracking force—professional arms, min. 1 gm, changers, 2–4 gms, effective stylus mass, 1.5 mg; compliance—lateral, 15 x 10⁻⁶ cm/dyne, vertical, 15 x 10⁻⁶ cm/dyne; capacitance, 1000 pf; 4 terminals; mounting dimensions, 7/16" & 1/2"; weight, 5.7 gms. Price, diamond,



\$44.50; replacement styli, N45-7d \$12.95, A11-2.

1. 217D "Magnaflo" ster ceramic \$17.75
2. 153RD "Retractable Needle" ster ceramic \$17.50
3. 233D "Magnaflo" ster ceramic \$15.75
4. 17D ster ceramic \$15.75
5. 133D ster ceramic \$13.75

BENJAMIN—ELAC

• *STS 322*. Moving-magnet, 0.52-mil stylus. *Specifications:* Freq. response 20 to 20k cps ± 2 db; IM dist 2%; output, 0.9 mv/cm rec. velocity; channel separation, 25 db at 1 kc, 20 db at 10 kc; recommended load, 37k ohms; recommended tracking force—profes-

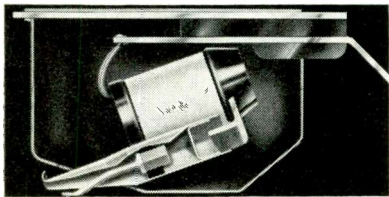

sional arms, 1.5 gms, changers, 3 gms, effective stylus mass, 1.4 mg; compliance—lateral 14×10^{-6} cm/dyne, vertical, 14×10^{-6} cm/dyne; inductance, 650 mh; d.c. resistance, 1000 ohms; 4 terminals; mounting dimensions, Std.; weight, 10 gms. Additional features: New metal shielding—lateral and vertical adjustment of cartridge. Price, diamond, \$49.50; replacement styli, \$25.00, A11-3.

1. STS-222 compatible mono/ster \$39.50

DUAL

• *DMS-900* Magnetic Stereo Cartridge. Constructed so that stylus can be easily replaced—just lift out.

Specifications: Variable reluctance; freq. resp. 20 to 20k cps ± 3 db; output, 1 mv/cm

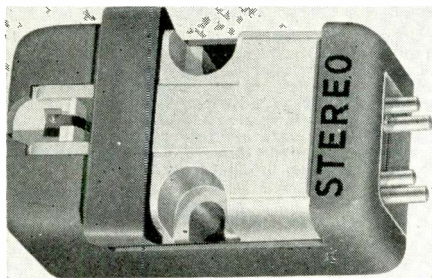

rec. velocity; channel separation, 28 db at 1 kc; recommended load, 12-47k ohms; recommended tracking force—professional arms, 1.5-5 gms, changers 2-5 gms; compliance—lateral 4×10^{-6} cm/dyne, vertical, 3×10^{-6} cm/dyne; inductance, 250 mh, d.c. resistance 800 ohms/channel; no. of terminals, 4; mounting dimensions, std.; weight 14 gms. Price, diamond, \$34.50; replacement styli, \$17.25, A11-4.

DYNACO—B & O

• *Stereodyne III*. Moving iron, 15-deg. stylus angle, high compliance, mumetal shielding fully-retractible stylus.

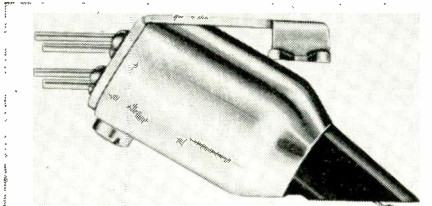

Specifications: Freq. response 20 to 20k cps ± 3 db; 1.5 mv/cm rec. velocity; channel separation, 30 db at 1 kc, 20 db at 10 kc; recommended load, 47k ohms; recommended tracking force—professional arms, 1.5 gms, chang-

ers, 3 gms, effective stylus mass, 1 mg; compliance—lateral, 12×10^{-6} cm/dyne, vertical, 12×10^{-6} cm/dyne; 4 terminals; mounting dimensions, std.; weight 10 gms. Additional features: Thermally stable damping material, quadri-coil push-pull moving iron design. Price, diamond, \$19.95; replacement styli, \$11.95, A11-5.

1. Stereodyne II stereo \$17.95

EMPIRE

• *880 P Stereo-Mono Cartridge*. Tapered stylus lever, 15-deg. tracking angle.

Specifications: Freq. response 10 to 28k cps ± 3 db; IM dist 1%; output, 1.5 mv/cm/sec rec. velocity; channel separation, 35 db at 1 kc, 25 db at 10 kc; recommended load, 47k

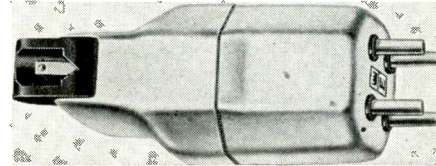

ohms; recommended tracking force—0.5 to 4 gms, either tone arms or changer, effective stylus mass, 1.0 mg; compliance—lateral, 15×10^{-6} cm/dyne, vertical, 15×10^{-6} cm/dyne; inductance, 650 mh; d.c. resistance, 500 ohms; 4 terminals; mounting dimensions, std.; weight, 10 gms. Price, diamond, \$19.95; replacement styli, \$10.95, A11-6.

1. 880 PE elliptical stylus 880 P \$29.95
2. 880 \$17.95

GENERAL ELECTRIC

• *C200 Ceramic Stereo Cartridge*.

Specifications: Freq. response 20 to 17k cps; 300 mv/cm rec. velocity; channel separation 20 db at 1 kc, 15 db at 10 kc; recommended load, 1 meg, 100 pf; recommended tracking force, changers, 5-6 gms; compliance—lateral, 2.5×10^{-6} cm/dyne, vertical, 2×10^{-6} cm/dyne; capacitance, 1000 pf; 4 terminals; mounting dimensions, std.; weight, 6 gms. Price, Sapp/diamond, \$15.90; replacement styli, \$9.95, A11-7.

1. C100A ceramic stereo \$15.90
2. VR 1000-7 magnetic stereo \$24.95
3. VR 227 magnetic stereo \$16.95
4. 4C 050 magnetic mono \$12.95

GRADO

• *Mark III Stereo Cartridge*.

Specifications: Freq. response 15 to 28k cps; output 0.6 mv/cm rec. velocity; channel separation, 25 db at 1 kc; recommended load,

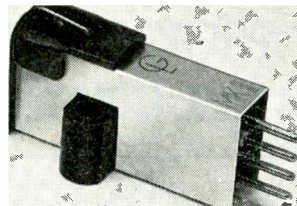

above 5k ohms; recommended tracking force professional arms, 1 gm, changers, 6 gms, effective stylus mass, 0.5 mg; compliance—lateral and vertical 25×10^{-6} cm/dyne; d.c. resistance, 1500 ohms; 4 terminals; mounting dimensions, std.; price, diamond, \$37.50, A11-8.

1. MK-1 \$75.00
2. MK-11 \$44.50
3. MK IV \$27.50

LONDON

• *MK III Pickup*. Elliptical stylus ground from a square shank.

Specifications: Freq. response 20 to 16k cps ± 1 db; IM dist. 2%; output, 1.2 mv/cm rec.

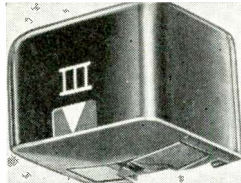

velocity; channel separation, 20 db at 1 kc, 15 db at 10 kc; recommended load, 50k ohms; recommended tracking force—professional arms, 2 gms, effective stylus mass, 1 mg; compliance—lateral, 15×10^{-6} cm/dyne, vertical,

4×10^{-6} cm/dyne; 4 terminals; weight, 12 gms. Impedance, 3000 ohms at 400 cps; for use in London arm only. Stylus replacement and factory overhaul at same time. Price, diamond, \$75.00; replacement styli, \$25.00, A7-9.

1. C.R.A. general purpose version \$65.00
2. MK, II 0.6-mil spherical stylus \$60.00

MICRO

• *M1007G Magnetic Cartridge*.

Specifications: Freq. response 20 to 20k cps ± 2 db; output, 1 mv/cm rec. velocity; channel separation, 25 db at 1 kc, 18 db at 10 kc;

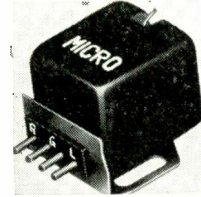

recommended load, 100 ohms; recommended tracking force—professional arms, 1-1.5 gms, changers, 2.5-3 gms; compliance—lateral and vertical 6.0×10^{-6} cm/dyne; d.c. resistance, 800 ohms; 4 terminals; mounting dimensions, EIA; weight, 10 gms, A11-10.

1. M-1007
2. M-1007F
3. SC-201 ceramic
4. SC-202 ceramic

NEAT

• *VS-2000 Moving-Coil Cartridge*. Easily replaceable stylus assembly, output relatively high.

Specifications: Type, moving coil; freq. resp. 10 to 20k cps ± 3 db; output, 5 mv; channel separation, 30 db at 1 kc, 30 db at 10 kc;

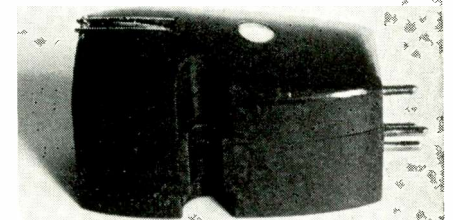

recommended load, 10k-50k ohms; recommended tracking force—professional arms, 2 gm; compliance—lateral and vertical, 15×10^{-6} cm/dyne; d.c. resistance, 80 ohms; no. of terminals, 4; mounting dimensions, EIA; weight 13.5 gms, A11-11.

NEUMANN

• *Neumann DST 62 Dynamic Stereo Cartridge*. No rubber membrane, complete enclosure of cartridge bottom. Torsion bar re-enforced.

Specifications: Freq. response 30 to 15k cps ± 2 db; output, 0.1 mv/cm rec. velocity; channel separation, 25 db at 1 kc, 25 db at 10 kc; recommended load, 50 ohms; recommended tracking force—professional arms, 6 gms, effective stylus mass, 1 mg; compliance—lateral and vertical, 3.6×10^{-6} cm/dyne; d.c. resistance, 18 ohms; capacitance, 0 pf; 5 terminals; mounting dimensions, special; weight, 30 gms. Price, diamond, \$79.50; replacement styli, \$20.00, A11-12.

ORTOFON

• *SPU/t Cartridge*. Electromagnetic elements are wound with pure copper wire into long thin coils. Arm is a special thin light alloy strip. "Prime diamonds" used.

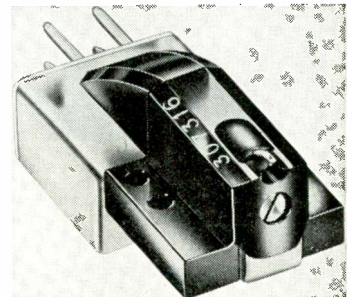

Specifications: Freq. response 20 to 20k cps ± 2 db; 14 mv/cm rec. velocity; channel separation, 25 db at 1 kc, 20 db at 10 kc; recom-

mended load, 50k ohms; recommended tracking force—professional arms, 2 gms, effective stylus mass, 1 mg; compliance—lateral and vertical, 10×10^{-6} cm/dyne; d.c. resistance, 1.8 ohms; 4 terminals; mounting dimensions, std.; weight, 17 gms. Additional features: Minimum 20 db channel separation 20–20k. Price, diamond, \$50.00, replacement styl, \$15.00. A11-13.

1. SPU/GT in shell for Ortofon and SME arms \$50.00
2. SPE/T same as SPU/T, elliptical stylus \$75.00
3. SPE/GT same as SPU/GT, elliptical stylus \$75.00

PICKERING

• **Model GA/38ATG Stereo Fluxvalve.** Model U38/AT cartridge with the D3807ATG "Safe V-Guard" "Floating Stylus" mounted in a plug-in head for the Garrard Type A.

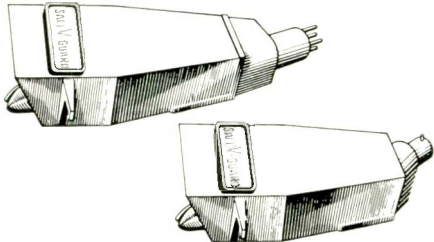

Specifications: Freq. response 20 to 17k cps ± 2 db; output 2 mv; channel separation, 35 db at 1 kc; recommended load, 47k–100k ohms; recommended tracking force—professional arms, 1–3 gms, changers, 3 gms; inductance, 245mh; d.c. resistance, 410 ohms; capacitance, 250 pf; 4 terminals; mounting std.; weight, 14 gms. Price, diamond, \$52.50; replacement styl, \$17.00. A11-14.

1. Model U38/AT D3807AT stylus \$46.50
2. Model G6/38ATG (plug-in shell for Garrard AT6) \$52.50

SHURE

• **M55E Stereo Dynetic Cartridge.** 15-deg. tracking angle.

Specifications: Freq. response 20 to 20k cps output, 1.2 mv/cm rec. velocity; channel separation, 25 db at 1 kc, 20 db at 10 kc; recom-

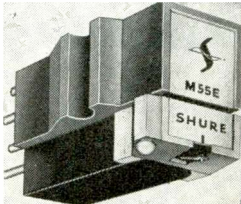

mended load, 47k ohms; recommended tracking force—professional arms, 1.25 gms, changers, 1.5 gms, effective stylus mass, 1.1 mg; compliance—lateral and vertical, 25×10^{-6} cm/dyne; inductance, 680 mh; d.c. resistance, 650 ohms; 4 terminals; mounting dimensions, std.; weight 7 gms. Price, diamond, \$35.00. A11-15.

SONOTONE

• **Velocitone Mark IV.** Ceramic cartridge designed to operate with magnetic or ceramic input.

Specifications: Freq. response 20 to 17k cps ± 2 db; IM dist. 2.5%; output, 2 mv/cm/rec. velocity; channel separation, 30 db at 1 kc, 10 db at 10 kc; recommended load, 47k to 100k ohms; recommended tracking force—professional arms, 1.5–3 gms, changers, 3–4 gms; effective stylus mass, 3.0 mg; compliance

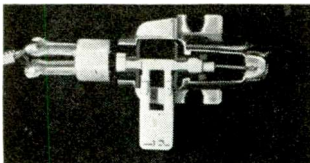

—lateral and vertical, 15×10^{-6} cm/dyne; capacitance, 780 pf; 4 terminals; mounting dimensions std.; weight, 3.0 gms. Additional features: "Sonoflex" non-breakable flexible needle assembly. Price, diamond, \$24.25; sapphire, \$20.25; replacement styl, \$5.00; \$4.00. A11-16.

1. 21T, 21TR (retractable bracket) series \$ 9.70
2. 22T, 23T ceramic replacement \$10.00
3. 141 series (mono crystal repl.) \$ 2.50
4. 20T1 & 20T2 series (stereo crystal repl.) \$ 3.50

STANTON

• **48IEL.** Elliptical stylus.

Specifications: Freq. response 20 to 20k cps ± 2 db; output, 1 mv/cm rec. velocity; channel separation, 35 db at 1 kc; recommended load, 42k ohms; recommended tracking force—professional arms 1 gm, changers, 3 gms, in-

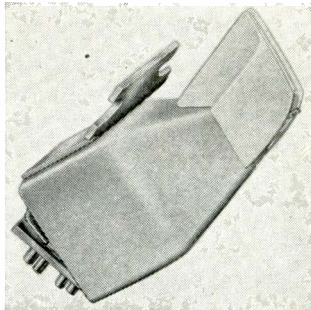

ductance, 640 mh; d.c. resistance, 3200 ohms; capacitance 250 pf; 4 terminals; mounting dimensions, std.; weight, 10 gms. Price, diamond, \$49.50. A11-17.

WEATHERS

• **LDM Cartridge.**

Specifications: Freq. response 20 to 20k cps ± 2 db; output, 1 mv/cm rec. velocity; channel separation, 35 db at 1 kc, 20 db at 12 kc; recommended load, 27k ohms; recommended

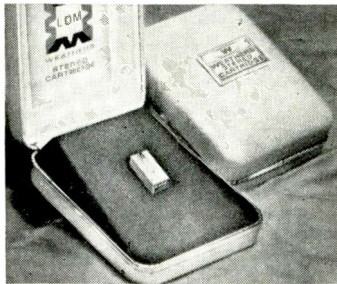

tracking force—professional arms, 1.5 gms, changers, 2 gms, effective stylus mass, 0.3 mg; compliance—lateral 30×10^{-6} cm/dyne at $\frac{1}{4}$ -gram tracking force; mounting dimensions, std.; weight, 4 gms. Price, diamond, \$22.50; replacement styl, \$10.00. A11-18.

A12. PHONO PICKUP ARM (TONEARM)

ADC

• **ADC 40 Pritchard Pickup System.** Low Inertia, side thrust compensator, ball-bearing mount.

Specifications: Over-all length of arm, 10 1/8"; distance from arm axis to turntable

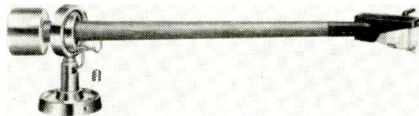

spindle, 9"; type of suspension, gimbal; stylus force $\frac{3}{4}$ gms; type of pickup head, plug-in; arm material, walnut; spacing, std.; overhang, 0.7"; arm resonance—6 cps, vertical or lateral. Price \$99.50. A12-1.

CASTAGNA

• **Model A.** Opposing magnets suspend total weight of arm assembly including cartridge. Sapphire jeweled bearings. Adjustable. 8 to

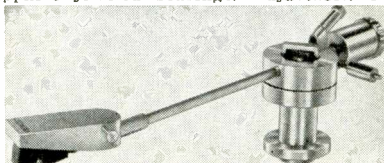

28 deg., tracking angle. Overhang adjustment, calibrated spring adjustment for stylus force.

Specifications: Over-all length of arm, 9 1/4"; distance from arm axis to turntable spindle, 8.45"; height range of turntable, $\frac{1}{4}$ " to 1 3/8"; gimbal suspension; stylus force range, 0 to 5 gms; arm material hard aluminum, pickup mounting, flat board; adjustable screw spacing, $\frac{1}{2}$ "; offset angle, 23°46"; overhang, 0.677"; range of cartridge weights for zero adjustment, 4 to 24 gms; maximum tracking error 1.19-deg; arm resonance 8 cps, lateral or vertical. Price \$125.00. A12-2.

DYNACO-B and O

• **TA-12.** Integrated arm and cartridge, single-hole mounting, stylus azimuth adjustment.

Specifications: Over-all length of arm, 12"; distance from arm axis to turntable spindle,



8 1/4"; height range of turntable, 0" to 2"; gimbal suspension; stylus force range 0 to 4 gms; arm material, aluminum; pickup mounting, plug-in; overhang, $\frac{1}{2}$ "; over-all weight, 1 lb. Price \$49.95. A12-3.

1. TA-16 16" version of above \$59.95

EMPIRE

• **980 Stereo Arm.** Fundamental arm resonance 6 cps, calibrated stylus force adjustment.

Specifications: Over-all length of arm, 12 3/8"; distance from axis to turntable spindle, 9"; over-all height range of turntable, 1 1/8"; ballbearing suspension; stylus force

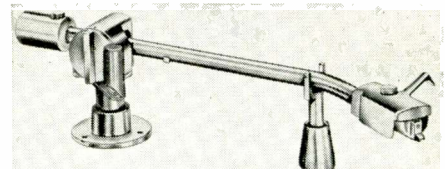

range, 0 to 8 gms; aluminum pickup head; arm material, aluminum; pickup mounting, bracket; screw spacing, std; offset angle, 23.8 deg; overhang, $\frac{3}{4}$ "; range of cartridge weights for zero adjustment, 0 to 25 gms; maximum tracking error, ± 0.65 deg; arm resonance—6 cps, lateral and vertical; mounting template supplied. Price \$50.00; accessories: extra cartridge brackets, \$1.95. A12-4.

GRADO

• **Laboratory Tone Arm.** Incorporates separate balance adjustments for the vertical and lateral planes of arm movement.

Specifications: Over-all length of arm, 10 1/4"; distance from arm axis to turntable spindle, 8 3/16"; type of suspension, balance, with spring; stylus force $\frac{1}{2}$ -gm min.; type of pickup head, slide mounts; arm material, wal-



nut; pickup mounting, standard on slide; overhang, $\frac{3}{4}$ "; maximum tracking error, ± 0.5 deg; additional features, stylus overhang adjustable, interchangeable cartridge slides; arm resonance—11 cps. Price \$45.00; extra cartridge slides, \$2.95. A12-5.

LONDON

• **Stereo Pickup Arm.** Coarse and fine counterweight adjustments, accurate scale calibration, lowering device—mechanical with viscous damping.

Specifications: Over-all length of arm 12"; distance from arm axis to turntable spindle,

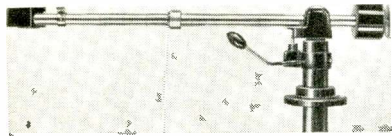

8.375"; height range of turntable, 0.35" to 1.75"; ball race suspension; stylus force range, 0 to 3.5 gms; integral pickup head; arm material, steel; overhang, 9.625"; maximum tracking error ± 2.5 deg; additional features, fast cartridge change; arm resonance 4 cps, lateral; 12 cps, vertical; Price \$60.00. A12-61.

1. MKIV \$60.00

NEAT

● GA-23 Tone Arm. Hydromatic lift and sliding base. Slide-thrust compensator and

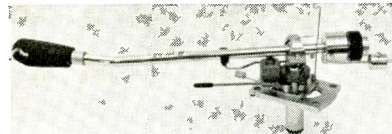

all other adjustments for balance. Head plugs in as does output cable. EIA cartridge mounts. A12-7.

ORTOFON

● RMG-212 Tone Arm. Precision ball bearings, lateral balance by the special shape of the arm tube, counterweight calibrated in grams from 0 to 10.

Specifications: Over-all length of arm, 12"; distance from arm axis to turntable spindle, 9 1/8"; height range of turntable, 2 3/8" to 3 3/8"; gimbal suspension; stylus force range, 0 to 7 gms; plug-in pickup head; arm material, dural; pickup mounting adjustable;



screw spacing, std; offset angle, 22.7 deg; overhang 5/8"; cartridge weight for zero adjustment preset 31 grams; maximum tracking error 1.19 deg; additional features, plug-in audio cables; arm resonance—8 cps, lateral and vertical; over-all weight 1 lb.; mounting dimensions, 3 hole, 1 1/2" centers. Price \$54.95; extra pickup heads, \$5.00. A12-8.

- | | |
|---|---------|
| 1. RMG-212T w. predrilled Thorens arm board | \$60.00 |
| 2. RMG-309 16" arm | \$60.00 |
| 3. SMG-212 12" arm | \$30.00 |
| 4. SKG-0212 12" arm | \$20.00 |

REK-O-KUT

● S-320 12" Arm. Meets the requirements of the new, high-compliance cartridges, can track

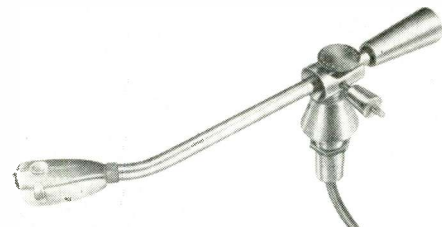

at 1 gram or less. Price \$34.95; accessories: extra pickup heads, \$5.95. A12-9.

- | | |
|-----------------------|---------|
| 1. S-260 16" tone arm | \$36.95 |
| 2. S-340 12" tone arm | \$24.95 |

SHURE-SME

● Model 3009, Series 11. Precision tone arm. Specifications: Distance from arm axis to turntable spindle, 8.43"; height range of turntable, 2 3/8" to 3 1/4"; knife-edge suspension; stylus force range, 0 to 2.5 gms; metal pickup head; arm material, alum. & steel; pickup mounting, 2 screws; screw spacing,

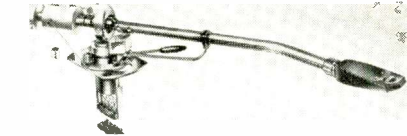

1/2"; range of cartridge weights for zero adjustments, 7 1/2 to 19 1/2 gms; over-all weight 15/16 lbs; mounting template supplied. Price \$92.50. A12-10.

STANTON

● Model 200 Stanton Unipoise Arm. Patented Stanton "Unipoise" single-pivot bearing. Light-weight construction.

Specifications: Over-all length of arm, 11 3/8"; distance from arm axis to turntable, 8 3/16"; height range of turntable, 1 to 2 1/2"; single-pivot bearing suspension; stylus force range, 0 to 3 gms; arm material, aluminum

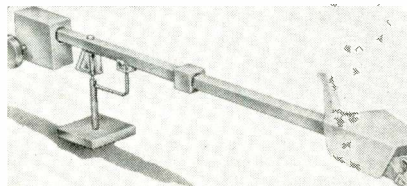

and steel; pickup mounting screw spacing 1/2"; offset angle, 21-deg; overhang, 17/32"; range of cartridge weights for zero adjustment, 7 to 15 gms; maximum tracking error, 1 deg; over-all weight, 7 oz. Price \$24.00. A12-11.

THORENS

● BTD-12S Tone Arm. This tone arm has been built to match the Thorens turntables.

Specifications: Over-all length of arm, 12 5/8"; distance from arm axis to turntable spindle, 7 1/2"; height range of turntable, 2" to 3 1/2"; bearing suspension; stylus force range 0 to 8 gms; plug-in pickup head; arm material, alum.; pickup mounting, adjustable; screw spacing, std; offset angle, 25.15 deg; overhang, 11/16"; range of cartridge weights

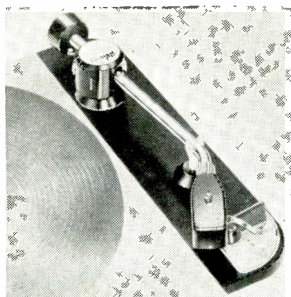

for zero adjustment, 0 to 19 gms; maximum tracking error, 0.5 deg; additional features, stylus remains in vertical plane for any height adjustment; built-in cueing device for remote raising and lowering arm; arm resonance—17 cps, lateral and vertical; over-all weight 1 lb.; mounting dimensions 3-hole, 1 1/2". Price, 40.00; extra pickup heads, \$5.00. A12-12.

A13. TURNTABLE— WITHOUT ARM

EMPIRE

● 208 3-Speed Turntable. Lapped steel shaft, honed bearing well, three-way rumble isolation.

Specifications: Speeds—33 1/3, 45, 78 rpm; belt drive; hysteresis motor; turntable diameter, 12"; turntable weight, 6 lbs; shaft diameter, 5/8"; turntable material, aluminum; rubber mat; total wow and flutter less than 0.05%; dimensions of chassis, 14 11/16" x 16 11/16"; clearance required above mounting board, 2 3/8"; below, 3 1/2"; type of mounting, screw; controls, on-off; provision for arm mounting, available pre-drilled; over-all weight, 20 lbs. Price, \$125.00. Accessories, walnut base, \$14.95. A13-1.

EMT

● 940. For use with any arm and cartridge combination. Strobe-calibrated secondary turntable. Back-up angles are indicated for all speeds. Tonearm lift and lowering device. Electronic remote control of turntable brake. Specifications: Speeds—16 2/3, 45, 33 1/3, 78 rpm; rim drive; synchronous motor; turntable diameter, 13"; turntable weight, 8 lbs.;



shaft diameter, 1/2"; turntable material, cast iron; felt mat; wow and flutter 0.3% peak-to-peak or 0.1% rms; dimensions of chassis, 15 1/2" x 19 3/4"; clearance required above mounting board, 2"; below, 7"; controls on/off, stereo selector; over-all weight, 22 lbs. Price, \$595.00. Accessories, electronic brake, \$89.50. A13-2.

FAIRCHILD

● 750, 16" 3-Speed Turntable. For use in broadcast studios.

Specifications: Speeds—33 1/3, 45, 78 rpm; belt drive; 2-speed hysteresis synch. motor; turntable diameter, 16"; turntable weight,



35 lbs; turntable material, nonferrous; rubber mat; wow and flutter, 0.03% (peak); dimensions of chassis, 24 x 24"; controls, on-off, speed; over-all weight, 50 lbs. A13-3.

GRADO

● Laboratory Series Turntable. Patented turntable designed for playing stereo records. Features large flywheel separate from



platter, belt drive, and unusual bearing system.

Specifications: Speed—33 1/3 rpm; belt drive; hysteresis-synchronous motors; urethane mat. Price, \$115.00 with base. A13-4.

NEAT

● P-83 3-Speed Turntable. Replaceable arm board, heavy cast frame.

Specifications: 33 1/3, 45, 78 rpm; puck



drive; hysteresis motor; turntable diameter, 12"; turntable material, aluminum; neoprene mat; wow and flutter 0.2%; dimensions of chassis, 16.6 x 13.2"; controls—speed, on-off. A13-5.

REK-O-KUT

● *R-34H 2-Speed Turntable Kit*. Easily assembled turntable kit less arm and base.
Specifications: Speeds—33½, 45 rpm; belt drive; hysteresis synchronous motor; turntable diameter, 15" x 14¼" x 5½"; turn-

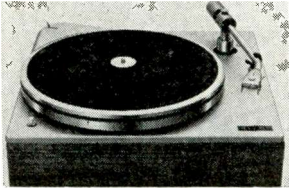

table material, one piece cast aluminum, rubber mat; wow, 0.08% rms. Price, \$69.95. A13-6.

- | | |
|---------------------------------------|----------|
| 1. B-12H 3-speed | \$165.00 |
| 2. B-12GH 3-speed | \$109.95 |
| 3. R-33 single speed | 69.95 |
| 4. K-33H single speed kit | 59.95 |
| 5. K-34 2-speed w. arm and base | \$ 89.95 |

THORENS

● *TD-124, Transcription Turntable*. The main table is made of cast iron, cover table made of aluminum. Speed adjustable ± 3.0 per cent for exact musical pitch. Built-in illuminated



strobe. Levelling by means of built-in level-bubble and easily accessible levelling screws.

Specifications: Speeds—16, 33, 45, 78 rpm; belt and idler wheel drive; induction 4-pole motor; turntable diameter, 12"; turntable weight, 11½ lbs.; shaft diameter, 9/16"; turntable material, cast iron, aluminum cover; mat, rubber; wow and flutter below NAB specs; dimensions of chassis, 15 x 12¼"; clearance required above mounting board, 2½"; below, 3"; type of mounting, rubber grommets; controls, 3; provision for arm mounting, replaceable board; over-all weight, 22 lbs. Price, \$125.00. Accessories: wood bases, \$10.00 to \$40.00. A13-7.

- | | |
|-----------------|---------|
| 1. TD-121 | \$85.00 |
| 2. TD-111 | \$40.00 |

A14. TURNTABLE—WITH ARM (CHANGER)

ACOUSTIC RESEARCH

● *Two-Speed Turntable*. Comes complete with arm, oiled-walnut base, transparent dust cover, cables, overhang adjustment device, and stylus-force gauge. Meets NAB specifications for broadcast equipment on wow, flutter, rumble, and speed accuracy.

Specifications: Speeds 33½ and 45 rpm. belt drive, synchronous motor; turntable diameter, 11 11/16"; turntable weight, 3.3 lbs; shaft diameter ¾"; turntable material aluminum; polyurethane mat; wow, 0.15% flutter,

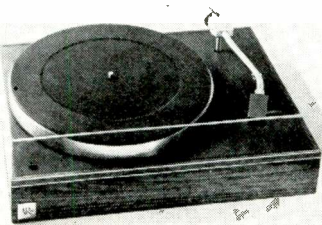

0.05%; dimensions of chassis, 12½ x 16"; clearance required above mounting board, 2 9/32"; below 2¾"; type of mounting, spring; controls, on-off; pickup head, universal; material, Acrylic; mounting dimensions, adjustable; number of leads to head, 4; number of leads to chassis, 5. Price \$78.00. A14-1.

BENJAMIN—MIRACORD

● *PW-10H (Studio H) Automatic Turntable*. Hysteresis synchronous motor, pushbutton operation, can be used automatically or manually at all four speeds, dynamically balanced cast turntable and mass balanced arm, tracks and trips at 1 gram. Also available with four-pole motor.

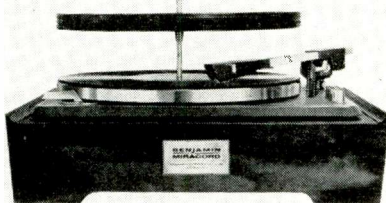

Specifications: Speeds—16½, 33½, 45, 78 rpm; rim drive; hysteresis motor; turntable diameter, 12"; turntable weight, 6.5 lbs; turntable material, Zamak; rubber mat; wow, 0.1% flutter, 0.1%; dimensions of chassis, 14 9/16 x 12 9/16"; clearance required above mounting board, 5½"; below, 3¾"; type of mounting, spring and foam w/rubber bushing; controls—speed, record size; automatic cycling time, 12 sec. at 33½ rpm, 6 sec. at 78 rpm; type of pickup head, plug-in; material, plastic w/metal; mounting dimensions, standard"; number of leads to head, 5; number of leads to chassis, 4; accommodation for different record sizes, 7", 10", 12"; price, \$99.50. Accessories: extra heads, \$5.00; 45 auto spindle, \$5.00. A14-2.

- | | |
|---------------------------------------|---------|
| 1. PW-10 (Studio 10) 4-pole motor ... | \$89.50 |
|---------------------------------------|---------|

BOGEN

● *B61 Turntable*. Complete with tone arm, tracks at 1.5 grams. Precise, automatic cueing and continuously variable speed.

Specifications: Speeds—78, 45, 33½, 16 rpm; rim drive; 4-pole motor; turntable diameter, 12"; turntable weight, 7¾ lbs; turntable material, zinc alloy; rubber mat; wow, 0.2%; flutter, 0.2%; dimensions of chassis,

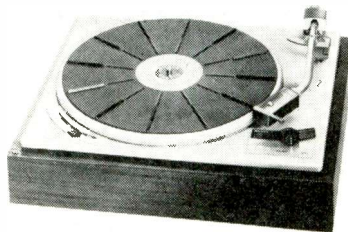

15¼" x 13¼"; clearance required above mounting board, 2½"; below, 2¼"; type of mounting, spring; controls—on/off, play, speed; type of pickup head, plug-in; material, aluminum; number of leads to head, 4; number of leads to chassis, 3; price, \$64.95. Accessories: base, \$5.25; dust cover, \$5.50. A14-3.

- | | |
|--------------|---------|
| 1. B51 | \$49.90 |
|--------------|---------|

DUAL

● *1009 Auto Turntable*. Manual and automatic single play and automatic changer operation with interchangeable spindle; dynamically balanced tonearm tracks under ½ gram; accepts all high compliance cartridges; interchangeable cartridge holder; wired to permit shut-off of amplifier after play.

Specifications: Speeds—16, 33, 45, 78 rpm; rim drive; continuous pole motor; turntable

For information about any of these products send us a card or letter and mention the code number at the end of each item—i.e. A14-4, etc.

diameter, 10½"; turntable weight, 7½ lbs; shaft diameter, ¾"; turntable material, zinc alloy; rubber mat; wow, 0.04%; flutter, 0.03%; dimensions of chassis, 10¼ x 12½"; clearance required above mounting board, 6"; below, 3"; type of mounting, spring/rubber; controls, speed selector, variable speed, manual and auto start; reject, stop; number of leads to head, 4; accommodation for different record sizes, 7", 10", 12". Price, \$99.50. Accessories: extra heads, \$3.00; 45-rpm auto spindle, \$4.80. A14-4.

- | | |
|--|---------|
| 1. 1010 automatic turntable | \$69.50 |
| 2. 1011 automatic turntable (intermix) | \$72.50 |

EMPIRE

● *498 Record Playback System*. Balanced 6 lb. turntable, precision ground belt, compact size. Complete with walnut base and 980 arm.

Specifications: Speeds—33½, 45, 78 rpm; belt drive; hysteresis motor; turntable diameter, 12"; turntable weight, 6 lbs; shaft diameter, ¾"; turntable material, aluminum; rubber mat; total wow and flutter, 0.05%; min. over-all space req. 16" W x 13¼" D x 7½" H; clearance required above mounting

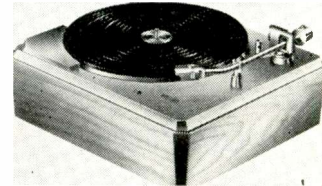

board, 2¾"; below, 3½"; type of mounting, screw; controls—power; type of pickup head, aluminum with removable cartridge bracket; number of leads to chassis, 5; price, \$187.00. Accessories: extra heads, \$1.95; belts, \$1.95. A14-5.

- | | |
|--------------------------------------|----------|
| 1. 488 same less base | \$172.00 |
| 2. 398 208 turntable with 980 arm .. | \$190.00 |

FISHER—LINCOLN

● *70, Automatic Turnover Turntable*. Automatically plays both sides of a record or one side only. Handles 7", 10", and 12" records intermixed.

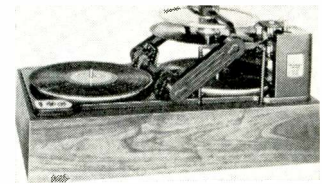

Specifications: Speeds—33½ rpm; belt drive; synchronous induction motor; dimensions, 27 x 15¾ x 19¼"; clearance required above base, 14¾". A14-6.

GARRARD

● *Type A, Automatic Turntable*. Dynamically balanced tone arm, turntable platter cast, weighted, and polished. Tracking force adjusted by calibrated gauge on the side of the arm. Pusher-platform changing mechanism.

Specifications: Speeds—33½, 45, 78, 12½ rpm; rim drive; shaded 4-pole motor; turntable diameter, 10½"; turntable weight, 6 lbs; turntable material, aluminum; rubber-

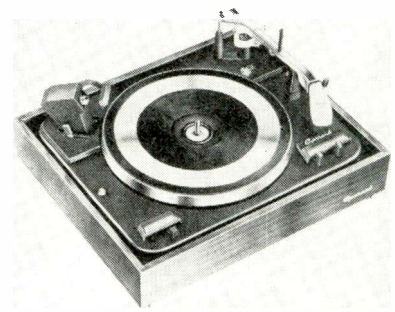

ribbed with chrome insert mat; dimensions of chassis, 16¾" x 14¼"; clearance required above mounting board, 6"; below, 2¾"; type of mounting, barrel springs; controls, manual and auto on/off; automatic cycling time, 10 secs at 33½ rpm, 3½ secs at 78 rps; type of pickup head, plug-in 4 pin; material, plastic;

mounting dimensions, 1/2" number of leads to head, 4; number of leads to chassis, 5; accommodation for different record sizes. Price, \$84.50. Accessories: extra heads, \$1.50; base, walnut, \$4.95. A14-7.

1. AT6 automatic turntable 4-speed ... \$59.50
2. Autoslim/P auto-manual, intermix .. \$44.50

STANTON

● *Model 800B Stereotable*. Gyro-poise action, magnetic suspension, unified arm and platter suspension. Rigidly mounted motor allowing the base to dissipate vibration. Separate arm mounting board. Unique magnetic arm-board mounting.



Specifications: Speeds—33 1/3 rpm; puck drive; synchronous motor; turntable diameter, 11 27/64"; turntable weight, 2 lb. 7 oz.; shaft diameter, 9/32"; turntable material, alum.; rubber mat; wow, 0.04%; flutter, 0.05%; dimensions of chassis, 14 7/8" x 11 7/8"; clearance required above mounting board, 1 5/8"; below, 3"; controls, on-off; Stanton 400A cartridge; mounting dimensions, 1/2"; number of leads to head, 4; number of cables to chassis, 2. Price, \$129.95. A14-8.

THORENS

● *TD-224*. 2-in-1 Swiss instrument that combines turntable with an automatic record changer. More than five years in development, the TD-224 combines the essence of a TD-124 with an automatic changing mechanism of unusual design.



Specifications: Speeds—16, 33 1/3, 45, 78 rpm; belt and idler drive; 4-pole motor; turntable diameter, 12"; turntable weight, 8 lb.; shaft diameter, 3/8"; turntable material, non-ferrous; rubber mat; wow and flutter below NAB; type of mounting, rubber grommet; controls, 4; type of pickup head, plug-in; material, aluminum; std. cartridge; mounting dimensions, std.; number of leads to head, 4; number of leads to chassis, 5; automatic intermix for 7", 10", 12" records. Price, \$250.00. Accessories: extra heads, \$5.00; bases, \$30.45. A14-9.

WEATHERS

● *"The Townsend" Model 82-1*. Universal cartridge mount, adjustable stylus pressure and tracking angle, solid oiled walnut tone arm.



Specifications: Speeds—33 1/3 rpm; direct rim drive; 12-pole synchronous motor; turntable diameter, 12"; turntable weight, 12 oz.; shaft diameter, 1/4"; turntable material, aluminum; foam mat; wow, 0.03%; flutter, 0.04%; dimensions of chassis, 17" x 14"; clearance required above mounting board, 3"; below, 2"; type of mounting, walnut base included; controls, on-off; over-all weight, 12 lbs. Price, \$59.95. A14-10.

1. K-66 w/arm and cartridge \$ 99.50
2. TP-2225 w/arm, transistor preamp, cartridge \$189.50

A15. LOUDSPEAKER MECHANISM

RICHARD ALLAN

● *C G-12 Super 12" Woofer*. Designed for use as bass unit in wide-range, high-power multiple speaker systems. Curved rigid cone, doped cambrie surround, extra-long voice coil and high flux Ferroba magnet system suitable for use in "slim line" enclosures.

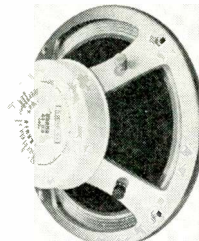

Specifications: cone speaker; power handling capacity 30 watts; impedance 15 ohms; frequency response, ±1 db from 25 to 5k cps; sensitivity (watts input for +85-db level 10 feet on axis) 0.44 watts runs at 1k cps; magnet weight 56 oz.; voice-coil diameter 2 in.; free air resonance frequency 30 cps; recommended enclosure volume 1 cu. ft. Dimensions 12 1/4" dia. 4 1/2" deep; mounting dimensions, (4) 1/4-in. holes on 11 9/16" circle; cutout diameter 10 3/4"; weight, 10 1/4 lbs. Other features 14,000 Gauss ceramic magnet. A15-1.

1. C G 8 8"
2. C G 10 10"
3. C G 12 12"
4. C G 15 15"
5. 812 F 8" mid-range

ALTEC

● *605A Duplex Loudspeaker*. An improved version of the famous 604 series. Provides smooth response in the highs, high linearity, clean transient response in the lows.

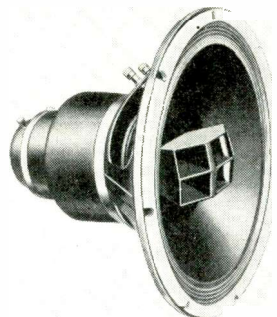

Specifications: Type, duplex; power handling capacity, 35 watts; impedance 16 ohms; frequency response, from 20 to 22k cps; magnet weight, l.f. 40 oz., h.f., 8 oz.; voice-coil diameter, l.f. 3", h.f. 1 3/4"; free air resonance frequency 25 cps. Dimensions: 15 5/16" dia., 10" deep; weight, 37 lbs. with network. Price \$168.00. A15-2.

1. 601C \$108.00
2. 602C \$132.00
3. 415C \$ 67.50
4. 803B \$ 60.00
5. 755C \$ 29.95

BOZAK

● *B-207A Coaxial Speaker*. The B-207A is a 2-way speaker intended for infinite-baffle enclosures and "large" sound. It is capable of handling modern high-powered amplifiers.

Specifications: 2-way; power handling capacity 20-60 watts impedance 8 ohms; frequency response ±3 db from 40 to 20k cps; magnet weight 40 oz.; voice-coil diameter 1 1/2"; free-air resonance frequency 36 cps; recommended enclosure volume 5 cu. ft. minimum. Dimensions—15" diameter, 7" deep; mounting dimensions (8) 1/4-in. holes on 14 1/2" circle; cutout diameter 12 1/4"; weight 13 lbs. Price \$89.50. A15-3.

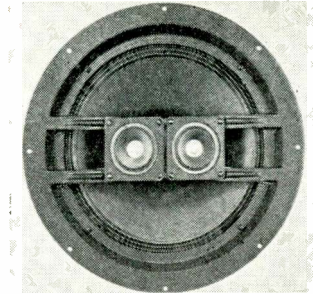

1. B-199A woofer 12" \$52.00
2. B-209B midrange 6 1/2" \$51.00
3. B-200Y dual tweeter \$32.00
4. B-800 8" wide-range speaker \$45.00

CTS

● *152 Loudspeaker*. 40 watts nominal, 80 watts peak. All speakers in this line are styled in platinum and ebony finish.

Specifications: cone speaker; power handling capacity 80 watts peak; impedance 8 ohms; frequency response, ±5 db from 35 to 6k cps; sensitivity (watts input for +85-db level 10 feet on axis) 0.5 watts; magnet weight 24 oz.; voice-coil diameter 1.5 in.; free air resonance frequency 55 cps; recommended enclosure volume 6 cu. ft. Dimensions 15 1/8" dia. 7 3/4" deep; mounting dimensions, (8) 0.375-in. holes on 14" circle; cutout diameter 13 29/32"; weight, 8 lbs. Price \$42.50. A15-4.

1. Model 124 12" \$37.50
2. Model 123 12" \$17.00
3. Model 804 8" \$13.50
4. Model 801 8" \$ 7.50
5. Model 693 6" x 9" \$ 8.00

ELECTRO-VOICE

● *Model 12TRXB*. Three separate radiating elements, built-in electrical crossover, ceramic magnet, cloth suspension, large edge-wound voice coil. Compression driver with diffraction horn for highs. Die-cast frame.

Specifications: 3-way; power handling capacity 60 watts; impedance 16 ohms; frequency response, from 35 to 20k cps; sensitivity (watts input for +85-db level 10 feet

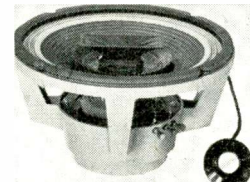

on axis) 0.2 watts; magnet weight—woofer 1 lb. 6 oz.; tweeter 3.16 oz.; voice-coil diameter—woofer 2 1/2", tweeter 1"; free air resonance frequency 50 cps; recommended enclosure volume 3 1/2 cu. ft. min. Dimensions 12 1/4" dia. 7" deep; mounting dimensions, (4) 1/4-in. holes on 11 1/2" circle; cutout diameter 11"; weight, 14 lbs. Price \$70.00. Other features continuously variable high frequency control on 30" cable. A15-5.

1. SP8B Radax coaxial 8" \$33.00
2. SP12B Radax Coaxial 12" \$39.25
3. SP12 Radax Coaxial 12" \$56.00
4. 15TRXB 3-way 15" \$85.00
5. SP15 Radax Coaxial 15" \$72.00

GOODMANS

● *12" Triarion 100C*. Three concentric radiators.

Specifications: 3-way; power handling capacity 20 watts; impedance 16 ohms; fre-

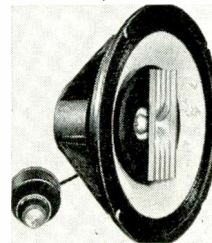

quency response, 20 to 20k cps; magnet weight 16 oz.; price \$34.50. A15-6.

HARTLEY-LUTH

● *Model 218MS Woofer*. Response at 15 cps down 7 db with 6-8% distortion, at 30 cps

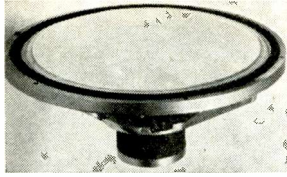

down only 1 db with 4-6% distortion, less than 1% from 100 cps upward. Impervious to humidity and temperature extremes.

Specifications: woofer; power handling capacity 25 watts; impedance 16 ohms; frequency response, ± 3 db from 20 to 3k cps; magnet weight 14 lb.; voice-coil diameter 15 in.; free air resonance frequency 17 cps; recommended enclosure volume 8 cu. ft. minimum. Dimensions 18" dia. 8" deep; mounting dimensions, (6) $\frac{3}{8}$ -in. holes on 17 $\frac{1}{4}$ " circle; cutout diameter 15 $\frac{5}{8}$ "; weight 16 lbs. Price \$195.00. A15-7.

1. 220MS full range 10" \$135.00
2. 312 full range 12" \$ 99.95
3. 310 full range 10" \$ 85.00

HEATHKIT

● **Model AS-183 12" 2-way Speaker.**

Specifications: Coaxial; power handling capacity 30 watts; impedance 8 ohms; frequency response, 20 to 15k cps; magnet weight 28 oz.; voice-coil diameter 1.5 in.; free air resonance frequency 25 cps; recom-

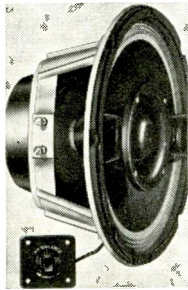

mended enclosure volume 6900 cu. in.; dimensions 12" dia. 6 $\frac{3}{8}$ " deep; mounting dimensions, (4) $\frac{1}{4}$ " holes on 11 $\frac{1}{8}$ " circle; cutout diameter 11"; weight, 10 $\frac{1}{2}$ lbs. Price \$49.95. Other features—die cast frame, high-frequency level control. A15-8.

1. AS-173 12" 3-way \$39.95
2. AS-163 12" 3-way coaxial \$29.95
3. AS-143 12" \$19.95
4. AS-143 12" \$ 9.95
5. AS-133 8" two-way coaxial \$14.95

JENSEN

● **SG-300 12" 3-Way Speaker.** Triax® loudspeaker has three electrically and acoustically independent loudspeakers in one housing; Flexair® woofer, midrange horn using woofer cone as outer section, and horn-loaded compression VHF tweeter on die-cast support bar. Includes new HF balance control adaptable to mounting in smaller enclosures.

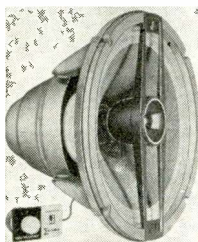

Specifications: 3-way; power handling capacity 40 watts; impedance 8 ohms; frequency response from 20 to 20k cps; sensitivity (watts input for +88-db level 10 feet on axis) 1 watt; woofer magnet weight 16 oz.; voice-coil diameter 1 $\frac{1}{2}$ in.; free air resonance frequency 25 cps; recommended enclosure volume 3 cu. ft. minimum. Dimensions 12 $\frac{3}{8}$ " dia. 8 $\frac{1}{8}$ " deep; mounting dimensions, (4) 0.265" holes on 11 9/16" circle; cutout diameter 10 $\frac{1}{2}$ "; weight, 12 $\frac{1}{2}$ lb. Price \$99.50. Other features HF balance control. A15-9.

1. SG-223 reflex horn 12" Flexair coax \$76.50
2. SG-222 multicell horn 12" coax \$69.50
3. SG-210 3-element 12" coax \$43.50
4. SG-88 comp. tweeter 8" Flexair coax \$42.50
5. SG-80 dual-cone 8" Flexair \$19.75

KNIGHT

● **KN-612HC.** Dynamic integrated 3-way speaker.

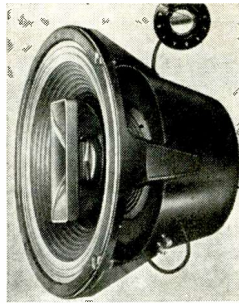

Specifications: magnet weight 4 lb. 10 oz.; voice-coil diameter 2 $\frac{1}{2}$ in.; free air resonance frequency 35-20k cps. A15-10.

LAFAYETTE

● **SK-58A 12-inch 2-Way Speaker.** 12-in. free-edge woofer plus an improved 3-in. cone-type tweeter, with the tweeter mounted on the same axis as the woofer. Built-in LC network. The free edge of the woofer is connected to the speaker basket by a sheepskin surround.

Specifications: Type, coaxial; power handling capacity 20 watts; impedance 8 ohms;

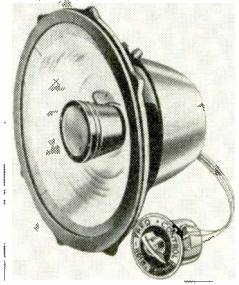

frequency response, from 30 to 15k cps; magnet weight 20 oz.; free air resonance frequency 40 cps; recommended enclosure volume 6 cu. ft. Dimensions: 12 $\frac{1}{2}$ " dia. 6 $\frac{1}{8}$ " deep; cutout diameter 10 $\frac{1}{2}$ "; weight 11 lbs. Price \$29.50. Other features: brilliance level control. A15-11.

1. SK-180 10" 3-way \$32.50
2. SK-215 15" 3-way \$64.50
3. SK-216 12" 3-way \$54.50
4. SK-210W 12" 3-way \$42.50
5. SK-128 8" biaxial \$19.50

JBL

● **LE14C 14-inch Linear Efficiency Composite Transducer.** The LE14C consists of two matched transducers mounted on a common axis, with voice coils lying in the same plane. The effective piston area equals that of many 15-inch speakers, yet the stepped frame permits installation in enclosures which would ordinarily accept only a 12-inch unit. Assembly includes crossover network with adjustable high-frequency attenuation.

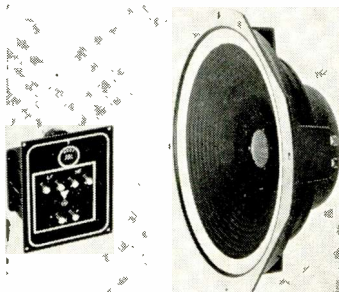

Specifications: 2-way system; power handling capacity 30 watts; impedance 16 ohms; sensitivity (watts input +85-db level 10 feet on axis) 1.64 watts; bass voice-coil diameter 4 in.; bass free air resonance frequency 25 cps; recommended enclosure volume 1.7 cu. ft. or more. Dimensions 13 $\frac{7}{8}$ " dia. 5 $\frac{1}{2}$ " deep; mounting dimensions, (4) $\frac{1}{4}$ -in. holes on 13 $\frac{1}{4}$ " circle; cutout diameter 12 7/16"; weight, 21 lb. Price \$150.00. Other features: Crossover network furnished in separate die-cast aluminum case. A15-12.

1. D130 15" ext. range \$102.00
2. D123 12" ext. range \$ 72.00
3. D216 8" ext. range \$ 36.00

4. LE8T full range 8" "Linear Efficiency" \$ 66.00
5. LE20 direct radiator tweeter \$ 33.00

MICHIGAN

● **Model MC8.** Budget-priced speaker. Features rigid die-cast frame ceramic magnetic structure, dual cone radax design. SLM design.

Specifications: Radax 2-way; power handling capacity 24 watts; impedance 8 ohms; frequency response, 50 to 13k cps; sensitivity

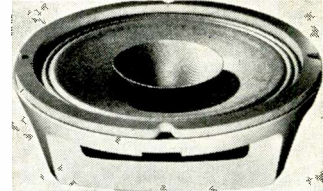

(watts input for +85-db level 10 feet on axis) 0.8 watts; magnet weight 6.0 oz. ceramic; voice-coil diameter 1 in.; free air resonance frequency 75 cps; recommended enclosure volume 1 $\frac{1}{4}$ -cu. ft. min. Dimensions 8 $\frac{1}{4}$ " dia. 3 3/16" deep; mounting dimensions, (4) $\frac{1}{4}$ -in. holes on 7 $\frac{5}{8}$ " circle; cutout diameter 7"; weight, 4 lbs. Price \$15.00. A15-13.

NESHAMINY

● **Model 350 Woofer.** Long-travel dynamic woofer complements mid/high range electrostatic. Light cone with slight apex weighting and specially treated cloth suspension.

Specifications: 11" dynamic woofer; power handling capacity 100 watts; impedance 8

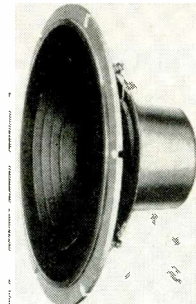

ohms; frequency response, ± 3 db from 30 to 2k cps; magnet weight 18 oz.; voice-coil diameter 1.3 in.; free air resonance frequency 40 cps; recommended enclosure volume 2.2 cu. ft. Dimensions: 11 $\frac{1}{4}$ " dia. 5" deep; mounting dimensions, 6 holes on 10 13/16 circle; cutout diameter 11 5/16"; weight, 10 lbs. Price \$37.00. A15-14.

R & A

● **780 Mark IV Speaker.** Dust and moisture proof, tropicalized, anisotropic magnet system, polarized for stereo.

Specifications: 8" twin cone; power handling capacity 20 watts; impedance 8 ohms; frequency response from 45 to 17k cps; magnet density 12,000 cm²; voice-coil diameter 1

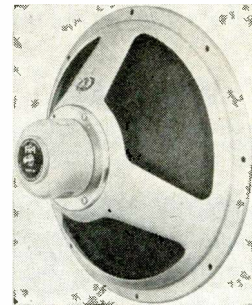

in.; free air resonance frequency 65 cps; recommended enclosure volume 1.5-6 cu. ft. Dimensions: 8" dia. 4" deep; mounting dimensions, 4 holes on RMA std circle; weight 5 lbs. Price \$14.95. A15-15.

1. 750 tweeter \$ 9.95
2. 7100 10" full range \$16.95
3. 7120 12" full range \$18.95
4. Dual 1262 ind. magnet sys., built-in crossover \$39.95

STENTORIAN

● **HF 1012U.** Full range 10" speaker.

Specifications: power handling capacity 10 watts; impedance 4, 8, 16 ohms; frequency

response, ± 2 db from 30 to 14k cps; magnet weight 32 oz.; voice-coil diameter 1 in.; free air resonance frequency 35 cps; recommended enclosure volume 4-6 cu. ft. Dimensions: 11 $\frac{1}{4}$ " dia., 4 $\frac{3}{8}$ " deep; mounting dimensions, (4) 3/16" holes on 10 25/32" circle; cutout diameter 9 $\frac{1}{4}$ "; weight, 6 $\frac{1}{2}$ lb. Price \$18.95. A15-16.

1. H.F. 1214 12" full range \$ 52.50
2. H.F. 812U 8" full range \$ 14.95
3. T359 cone tweeter \$ 14.95
4. 15" concentric duplex \$159.50
5. 12" concentric duplex \$119.00

TANNOY

• **10" Monitor Dual-Concentric Loudspeaker.** This is the smallest and most compact of the "Monitor Dual-Concentric" line of Tannoy speakers. There is, in addition, a 12" and 15" model. The principle incorporates a horn-loaded high-frequency tweeter, closely integrated with the curvilinear LF diaphragm and voice-coil assembly. The units come complete with their individual crossover network system.



Specifications: dual concentric; power handling capacity 20 watts; impedance 16 ohms; frequency response, ± 3 db from 27 to 20k cps; magnet assembly 6 $\frac{1}{4}$ lbs; L.F. voice-coil diameter 2 $\frac{1}{2}$ " (H.F. 2"); free air resonance frequency 27 cps; recommended enclosure volume 1 $\frac{1}{2}$ cu. ft. minimum. Dimensions 11 $\frac{1}{2}$ " dia. 6 $\frac{1}{2}$ " deep; mounting dimensions, (4) $\frac{1}{4}$ -in. holes on 11" circle; cutout diameter 9"; weight, 9 lbs. Price \$112.75. Other features: Crossover weight 2 $\frac{1}{4}$ lbs.; finish, hard enamel. A15-17.

1. 15" monitor dual concentric \$179.00
2. 12" monitor dual concentric \$138.00

LTV UNIVERSITY

• **Model 312, 200 Series 12" 3-Way Speaker.** Die-cast frame, high-compliance woofer. Diffusicone mid-range. Sphericon super tweeter has its own specially constructed reflector baffle to prevent acoustic interaction between tweeter and woofer. It also provides 120-deg. dispersion in all directions. Built-in electrical crossover network and adjustable brilliance control.

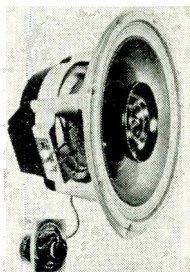

Specifications: 3-way; power handling capacity 35 watts; impedance 8-16 ohms; frequency response, ± 2 db from 28 to 22k cps; Dimensions 13" dia. 6 $\frac{5}{8}$ " deep; mounting dimensions, (4) 1/16-in. holes on 11 9/16" circle; cutout diameter 11"; weight, 10 $\frac{1}{4}$ lbs. Price \$73.00. A15-18.

1. Model 6201 \$ 57.57
2. Model 315-C \$156.00
3. Model C-12-HC \$ 49.50
4. Model C-15-HC \$ 89.50
5. Model Cobreflex \$ 24.15

UTAH

• **C8JC-3 Celesta.** 3-element, 8" speaker, heavy die-cast frame. Internal dust cap protects the voice coil gap from "stray whiskers." Other versions of this speaker include a 12" model with a 20 oz. magnet.

Specifications: 3-way; power handling capacity 30 watts; impedance 8 ohms; fre-

quency response, 35 to 20k cps; magnet weight 10 oz.; voice-coil diameter 1 in. Dimensions 8 3/16" dia. 3 9/16" deep; mounting

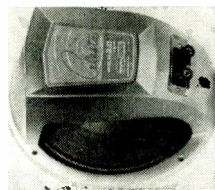

dimensions, 4 holes on 7 11/16" circle; weight, 5 lbs. Price \$17.95. Other features: finger tightening terminals. A15-19.

1. C8JC-1 single cone \$11.95
2. C8JC-2 dual cone \$12.95
3. C12JC-1 single cone \$15.95
4. C12PC-2 dual cone \$18.95
5. C12PC-3 3-way \$24.95

VITAVOX

• **DU120 Coaxial Full Range Speaker.** Designed for use with the finest associated components.

Specifications: direct radiator moving coil cone; power handling capacity 30 watts; impedance 15 ohms; frequency response, 30



to 15k cps; magnet weight—l.f. 3 $\frac{1}{4}$ lb., h.f. 2 $\frac{1}{2}$ oz.; voice-coil diameter—l.f. 1 $\frac{3}{4}$ ". h.f. 3/4"; free air resonance frequency—l.f. 35 cps, h.f. 220 cps; recommended enclosure volume 4-6 cu. ft. Dimensions 12 $\frac{1}{8}$ " dia. 7" deep; mounting dimensions, (4) 5/16-in. holes on 11 $\frac{1}{2}$ " circle; cutout diameter 11"; weight, 14 $\frac{1}{2}$ lb. Price \$95.00. L.f. unit is protected by a dust filter, h.f. section has a polyester diaphragm. A15-20.

1. AK120 12" full range \$ 75.00
2. AK121 12" woofer \$ 85.00
3. K1540 15" woofer \$125.00

JORDAN WATTS

• **Modular Loudspeaker.** Developed from "Jordan's Law," small metal diaphragm, silvered beryllium copper suspension, rectangular chassis, good response from small enclosures; power handling can be increased by using in line source arrays, with phase shift networks, to maintain optimum polar response.

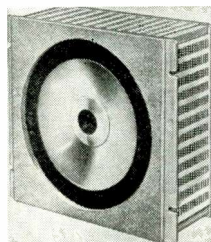

Specifications: metal cone concentric; power handling capacity 12 watts; impedance 16 ohms; frequency response ± 3 db from 30 to 17k cps; magnet weight 40 oz.; voice-coil diameter 1.5 in.; free air resonance frequency 55 cps. Dimensions 4" dia. 2" deep; mounting dimensions, 5 $\frac{1}{2}$ " x 5 $\frac{1}{2}$ " (rectangular); weight, 4 lbs. Price \$60.00. A15-21.

WHARFEDALE

• **Super 12 RS/DD Full-Range 12" Loudspeaker.** A full-range 12" speaker with an unusually powerful magnet system.

Specifications: Full-range; impedance 12-15 ohms; frequency response, 25 to 15k cps; magnet weight 256 oz; voice-coil diameter 1 $\frac{3}{4}$ in.; free-air resonance frequency 28-33 cps; recommended enclosure volume 1 cu. ft. or more. Dimensions 12 $\frac{3}{4}$ " dia. 7" deep;

mounting dimensions, (4) 3/16" holes on 12 $\frac{3}{8}$ " circle; cutout diameter 10 $\frac{7}{8}$ "; weight, 22 lbs. Price \$89.50. Other features 190,000 gauss total flux; density, 17,000 gauss; roll surround for small enclosures, cast basket, aluminum voice coil. A15-22.



1. Super 8/RS/DD 8" full-range \$26.50
2. Super 10/RS/dd 10" full-range \$47.50
3. Super 3 treble \$26.50
4. W12/RS woofer \$52.50
5. W15/RS woofer \$89.50

WIGO

• **Model CX-212 12" Coaxial.** The CX-212 consists of a 12" range woofer, plus a twin-tweeter array with a built-in crossover network.

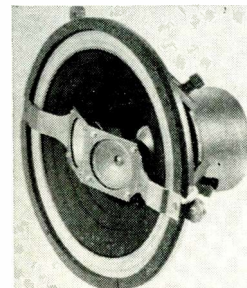

Specifications: Type 2-way; power handling capacity 30 watts; impedance 16 ohms; frequency response from 30 to 15,000 cps; magnet weight 29 oz.; free air resonance frequency 40 cps. Price \$79.50. Other features: flux density 12,500 gauss. A15-23.

1. ERD-2 extended range (12") \$ 59.50
2. CX-2 twin-tweeter array \$ 20.00
3. ER-85 extended-range (8") \$ 21.00
4. TW-400 tweeter (4") \$ 12.50
5. WD-155 super woofer (16") \$169.50

WOLVERINE

• **Model LT8 8-in. Speaker.** Three separate radiating elements, including an 8" woofer, 4" mid-range, and a compression horn VHF driver. Tweeter employs a ring diaphragm. Ceramic magnet, die-cast frame, and edge-wound voice coil.

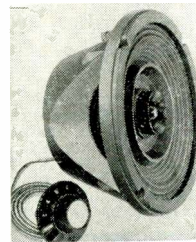

Specifications: 3-way; power handling capacity 40 watts; impedance 8 ohms; frequency response, 45 to 18k cps; sensitivity (watts input for +85-db level 10 feet on axis) 1.6 watts; magnet weight woofer 10 oz. ceramic, tweeter 1.47 oz. Alnico-V; voice-coil diameter woofer 2", tweeter 1"; free air resonance frequency 65 cps; recommended enclosure volume 1 cu. ft. min. Dimensions 8 $\frac{1}{4}$ " dia. 3 15/16" deep; mounting dimensions, (4) $\frac{1}{4}$ -in. holes on 7 $\frac{5}{8}$ " circle; cutout diameter 7"; weight, 6 $\frac{1}{2}$ lbs. Price \$33.00. Other features: Continuously variable high frequency level control on 30" cable. A15-24.

1. Model LT12 \$36.00
2. Model LS8 \$21.00
3. Model LS12 \$22.50
4. Model LS15 \$29.50

A16. LARGE SPEAKER SYSTEMS

ALTEC

● **838A Carmel.** The Altec "Carmel" balances size, appearance, and audio quality. The mid-range or presence region of the Carmel system is particularly fine. The "Carmel" is a two-way, bass reflex system with a frequency range from 30-22k cycles. Power rating: 30 watts. Two high-compliance 414A bass speakers. An Altec 804A driver mounted on an

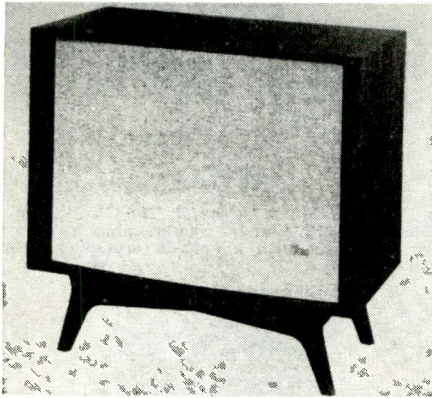

811B horn covers the highs to 22k cps. An N-800E network provides the necessary crossover at 800 cps. Dimensions: 29 3/4" H. x 35" L. x 17 3/4" D. Price: \$333.00. A16-1.

1. 837A Avalon \$280.50
2. 831A Capistrano \$399.00

ADC

● **ADC-18.**
Specifications: speakers—1 l.f., 1 h.f.; power handling capacity 10-65 watts; impedance 8,

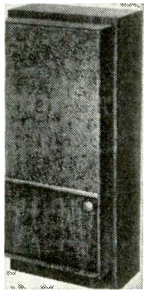

16 ohms; frequency response ± 3 db from 20 to 20k cps; magnet weights: l.f., 9 lb. Dimensions: 17" wide, 40" high, 12 1/2" deep; oiled walnut \$250.00. A16-2.

BOZAK

● **B-410 Concert Grand Speaker System.** Designed for the music connoisseur.
Specifications: infinite baffle enclosure; speakers—4 l.f., 2 m.f., 8 h.f.; power handling capacity 50-200 watts; 3-way L.C., 6 db/octave at 400 and 2500 cps crossover networks; impedance 8 ohms; frequency response ± 3 db from 28 to 20k cps; magnet

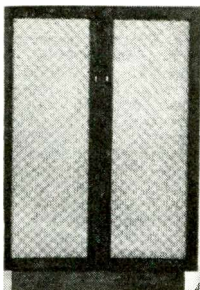

weights: l.f., 24 oz.; m.f., 24 oz.; h.f., 16 oz.; voice coil diameters: l.f., 1 1/2"; m.f., 1 1/2"; h.f., 3/4". Dimensions: 36" wide, 52 1/4" high,

19" deep; weight, 210 lbs.; walnut or mahogany \$790.00. A16-3.

1. B-310A Concert Grand system \$770.00

ELECTRO-VOICE

● **Patrician 800.** The latest in a series of 4-way speaker systems. 30" woofer, controlled mid-bass by use of a 100-cycle first crossover frequency with 12-db-per-octave attenuation on either side. An SP12D mid-bass speaker, liberally-padded enclosure, T250 treble driver, using an 8HD diffraction horn for frequencies above 800 cycles. T350 tweeter 23k cps.

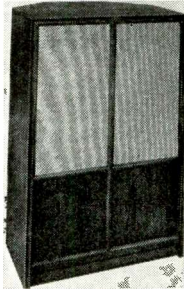

Specifications: infinite baffle enclosure; speakers—30" l.f., 12" m.b. compression horn m.f., compression horn h.f.; power handling capacity 200 watts; 4-way electrical 12 db/octave crossover networks; impedance 16 ohms; frequency response 15 to 23k cps; sensitivity (watts input for +85 db level 10 feet on axis) 0.13 watts; magnet weight: 9 lb. 4 oz. ceramic l.f., 3 lb. Alnico m.b., 3 lb. m.f., Alnico 1 lb. h.f.; voice coil diameters: l.f., 2 1/2"; m.f., 2"; h.f., 1"; other features: three continuously variable mid and high-frequency level controls. Dimensions: 51" wide, 33" high 27 3/4" deep; weight, 315 lbs.; satin walnut \$875.00, mahogany \$875.00, fruitwood \$875.00. A16-4.

1. Georgian 400 \$495.00
2. Stereon 850 \$375.00

EMPIRE

● **Royal Grenadier Model 9000.** Divergent lens speaker system. Total magnetic power more than 1 million lines. Rigid cylindrical enclosure.

Specifications: speakers 15" l.f., direct radiator m.f., domed tweeter h.f.; power handling capacity 100 watts; L-C (12 db) crossover network; impedance 8 ohms; frequency

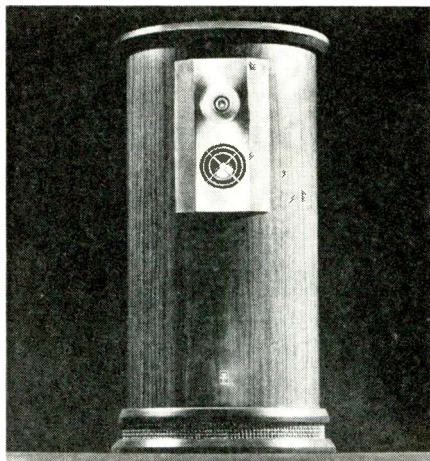

response ± 3 db from 20 to 20k cps; sensitivity (watts input for +85-db level 10 feet on axis) 1.0 watts at 1 kc; magnet weights: l.f., 9 lb.; m.f., 2 1/2 lb.; h.f., 1 lb.; voice-coil diameters: l.f., 4"; m.f., 2 3/4", h.f., 1"; die cast wide angle acoustic lens for mid and high frequency direct radiators. Dimensions: 29" H, 22" diameter; weight 85 lbs.; hand-rubbed satin walnut \$250.00. A16-5.

1. 9000M marble top \$260.00

FISHER

● **XP-10 Consolette.** Three high-compliance transducers with high flux-density magnet assemblies. 15" woofer incorporates frequency-linear eddy-current damping and a butyl-impregnated half-roll surround. 8" mid-range, crossover at 200 cps, sealed in its own sub-enclosure to prevent interaction between the speakers.

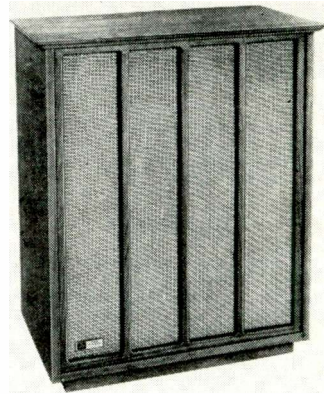

Specifications: infinite baffle enclosure; speakers—15" l.f., 8" m.f., 2" h.f.; power handling capacity 65 watts; L-C, air-core coils crossover network; impedance 8 ohms; frequency response ± 2.5 db from 34 to 18k cps; magnet structure weights: l.f., 96 oz.; m.f., 88 oz.; h.f., 88 oz.; voice coil diameters: l.f., 2"; m.f., 1.5"; h.f., 2"; soft-mass cotton dome tweeter, extremely close speaker matching, hand-made drivers. Dimensions: 24 3/4" wide, 30 1/2" high, 14 3/4" deep; weight, 80 lbs.; Scandinavian walnut \$249.50. A16-6.

FRAZIER

● **Dcl Mar Speaker System.** Economical big speaker system.

Specifications: modified bass reflex enclosure; speakers—1 l.f., 1 h.f.; power handling

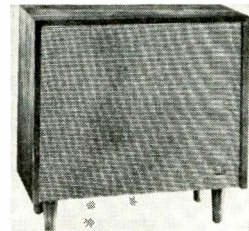

capacity 15 watts; impedance 8 ohms; frequency response 40 to 15k cps; dimensions: 23 3/4" wide, 23 3/4" high, 11 1/2" deep; hand-rubbed oil walnut \$79.50. A16-7.

1. F-8-3X utility version \$57.00
2. F-8-3Y horn tweeter utility \$87.00

HARNED

● **Full-range Electrostatic Loudspeaker.** Built-in treble amplifier makes speaker compatible with any good system. Suitable for use in medium to large rooms.

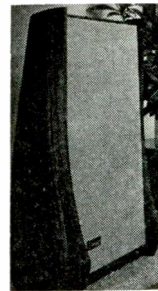

Specifications: free standing enclosure; speakers—1 l.f., 1 h.f.; power handling capacity 60 watts; pure resistive crossover network impedance 16 ohms; frequency response ± 2 db from 35 to 18k cps; dimensions: 26" wide, 43" high, 12" deep; weight, 70 lbs.; walnut, \$500.00. A16-8.

HARTLEY-LUTH

● **Concertmaster III.** Housed in various semi-open back enclosures; utilizes the Hartley-Luth 18" woofer and a 10" unit for mid and high range. Acoustic treatment of cabinet interior with Hartley 'Soundsorbers'.

Specifications: semi-open baffle enclosure; speakers—1 l.f., 6 h.f.; power handling capacity 25 watts; electrical, 300 cycle 12-db-per-octave crossover network; impedance 16 ohms; frequency response ± 3 db from 16 to 20k cps; magnet weights: l.f., 14 lb.; m.f., 6.1 lb.; voice coil diameters: l.f., 1 1/2"; h.f., 1"; other features identical cones except for size,

HOBSON'S CHOICE? NEVER AGAIN!

If, in 1631, you went to rent a horse from Thomas Hobson at Cambridge, England, you took the horse that stood next to the door. And no other. Period. Hence, Hobson's Choice means No Choice.

And, as recently as 1961, if you went to buy a true high fidelity stereo phono cartridge, you bought the Shure M3D Stereo Dynetic. Just as the critics and musicians did. It was acknowledged as the ONLY choice for the critical listener.

Since then, Shure has developed several models of their Stereo Dynetic cartridges—each designed for optimum performance in specific kinds of systems, each designed for a specific kind of *porte-monnaie*.

We trust this brief recitation of the significant features covering the various members of the Shure cartridge family will help guide you to the best choice for you.

THE CARTRIDGE

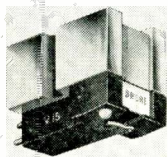

V-15

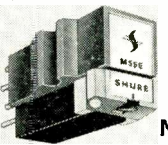

M55E

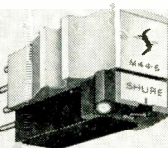

M44

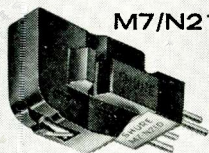

M7/N21D

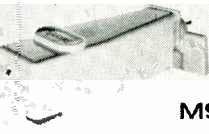

M99



M3D

ITS FUNCTION, ITS FEATURES . . .

The ultimate! 15° tracking and Bi-Radial Elliptical stylus reduces Tracing (pinch effect), IM and Harmonic Distortion to unprecedented lows. Scratch-proof. Extraordinary quality control throughout. Literally handmade and individually tested. In a class by itself for reproducing music from mono as well as stereo discs.

Designed to give professional performance! Elliptical diamond stylus and new 15° vertical tracking angle provide freedom from distortion. Low Mass. Scratch-proof. Similar to V-15, except that it is made under standard quality control conditions.

A premium quality cartridge at a modest price. 15° tracking angle conforms to the 15° RIAA and EIA proposed standard cutting angle recently adopted by most recording companies. IM and Harmonic distortion are remarkably low . . . cross-talk between channels is negated in critical low and mid-frequency ranges.

A top-rated cartridge featuring the highly compliant N21D tubular stylus. Noted for its sweet, "singing" quality throughout the audible spectrum and especially its singular re-creation of clean mid-range sounds (where most of the music really "happens".) Budget-priced, too.

A unique Stereo-Dynetic cartridge head shell assembly for Garrard and Miracord automatic turntable owners. The cartridge "floats" on counterbalancing springs . . . makes the stylus scratch-proof . . . ends tone arm "bounce."

A best-seller with extremely musical and transparent sound at rock-bottom price. Tracks at pressures as high as 6 grams, as low as 3 grams. The original famous Shure Dynetic Cartridge.

IS YOUR BEST SELECTION

If your tone arm tracks at 1½ grams or less (either with manual or automatic turntable)—and if you want the very best, regardless of price, this is without question *your* cartridge. It is designed for the purist . . . the perfectionist whose entire system *must* be composed of the finest equipment in every category. Shure's finest cartridge. \$62.50.

If you seek outstanding performance and your tonearm will track at forces of ¾ to 1½ grams, the M55E will satisfy—beautifully. Will actually improve the sound from your high fidelity system! (Unless you're using the V-15, Shure's finest cartridge.) A special value at \$35.50.

If you track between ¾ and 1½ grams, the M44-5 with .0005" stylus represents a best-buy investment. If you track between 1½ and 3 grams, the M44-7 is for you . . . particularly if you have a great number of older records. Both have "scratch-proof" retractile stylus. Either model under \$25.00.

For 2 to 2½ gram tracking. Especially fine if your present set-up sounds "muddy." At less than \$20.00, it is truly an outstanding buy. (Also, if you own regular M7D, you can upgrade it for higher compliance and lighter tracking by installing an N21D stylus.)

If floor vibration is a problem. Saves your records. Models for Garrard Laboratory Type "A", AT-6, AT-60 and Model 50 automatic turntables and Miracord Model 10 or 10H turntables. Under \$25.00 including head shell, .0007" diamond stylus.

If cost is the dominant factor. Lowest price of any Shure Stereo Dynetic cartridge (about \$16.00) . . . with almost universal application. Can be used with any changer. Very rugged.

SHURE Stereo Dynetic®

HIGH FIDELITY PHONO CARTRIDGES . . . WORLD STANDARD WHEREVER SOUND QUALITY IS PARAMOUNT
Shure Brothers, Inc., 222 Hartrey Ave., Evanston, Illinois

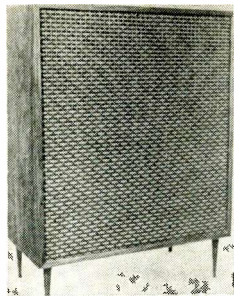

magnetic suspension on both. Dimensions: 29" wide, 36" high, 16" deep; weight, 125 lbs.; oiled rubbed walnut, \$195.00. A16-9.

1. Concertmaster IV \$525.00
2. Holton type A w. 220MS speaker .. \$245.00
3. Holton type A w. 310 speaker \$195.00
4. Holton type B w. 220MS speaker .. \$245.00
5. Holton type B w. 310 speaker \$195.00

HEATHKIT

• *Model AS-21 Legato Compact Speaker System.* 800 cps crossover, completely assembled, can be driven by as little as 3 watts.

Specifications: modified infinite baffle enclosure; speakers—2 l.f., 1 h.f.; power handling

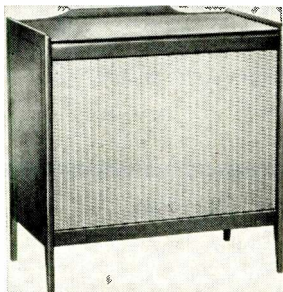

capacity 30 watts; L-C crossover network; impedance 16 ohms; frequency response 30 to 22k cps; magnet weights: l.f., 24 oz.; h.f., 8.48 oz.; voice-coil diameters: l.f., 3"; h.f. 1 3/4"; other features 800 cycle crossover into exponential horn; dimensions: 32" wide, 32 3/4" high, 18" deep; weight 54 lbs.; walnut, \$239.95. A16-10.

JENSEN

• *PR-100 3-Way Console Speaker System.* 15" woofer, new Jensen MH-400 aspheric® midrange, top end radiated by the new E-100 Sono-Dome®



Specifications: Bass-superflex enclosure; speakers—1 l.f., 1 m.f., 1 h.f.; power handling capacity 40 watts; impedance 8 ohms; frequency response 20 cps to beyond audibility; dimensions: 34" wide, 29 1/2" high, 14 9/16" deep; weight, 76 1/2 lbs.; oiled walnut, \$297.50. A16-11.

JBL

• *D50S7 Olympus.* Two-way "Linear Efficiency" loudspeaker system. Distinctive acoustical enclosure with hand-carved wooden fretwork grille. LE15A 15-inch low frequency loudspeaker, above 500 cps crossover, LES5 driver, with cast aluminum exponential horn and slant-plate acoustical lens.

Specifications: non-vented enclosure; speakers—1 l.f., 1 h.f.; power handling capacity 60 watts; two-way, 500 cps, 12 db/octave with step attenuator crossover network; impedance 16 ohms; sensitivity (watts input for +85-db level 10 feet on axis) 0.75 watts; voice coil diameters: l.f., 4"; h.f., 1 3/4"; frequency response and total acoustic power remain uniform through crossover region. Dimensions: 40" wide, 26 3/4" high, 20" deep; weight, 160

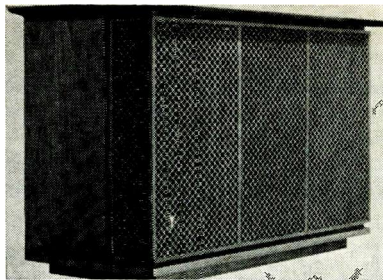

lbs; mahogany, tawny walnut oiled walnut, Danish teak, ebony \$645.00. A16-13.

1. D50MS7 "Studio Monitor" with 57 components \$ 516.00
2. Paragon integrated stereo reproducer \$2250.00
3. Metregon integrated stereo reproducer with S62 components \$1308.00
4. D40001 Lowboy folded horn enclosure with 001 2-way system \$ 468.00
5. D51 LE14C Apollo enclosure with LE14C system \$ 378.00

KLIPSCH

• *Klipschorn, K357.* New midrange, FM distortion below 0.1%.

Specifications: all horn speakers—horn l.f., horn m.f., horn h.f.; power handling capacity 100 watts; three-way balancing crossover network; impedance 16 ohms; frequency response

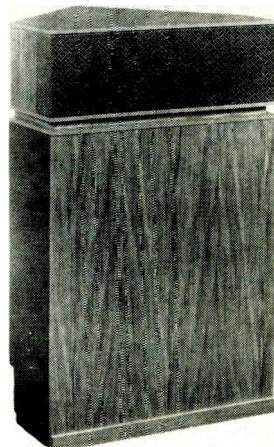

± 5 db from 35 to 18k cps; sensitivity (watts input for +85-db level 10 feet on axis) 0.08 watts; dimensions: 31" wide, 52" high, 28" deep; weight, 195 lbs., oil rubbed walnut \$794.00; piano finish, hand rubbed walnut, mahog. \$852.00; hard rock maple \$794.00; theatre black \$514.00. A16-12.

LEONHARDT

• *LH-500 "Concert Master" Speaker System.* Cylindrical shape with wood trim provides wide sound dispersion from a single light-weight diaphragm.



Specifications: sealed enclosure; power handling capacity 20 watts; impedance 8 ohms; frequency response 25 to 20k cps; other features; fused for protection against accidental overloads. Dimensions: 16" wide, 37" high, 12" deep; weight, 32 lbs.; oiled walnut; \$159.95; any other finish; \$169.95. A16-14.

QUAD

• *Electrostatic Loudspeaker.*

Specifications: power handling capacity 15 watts; frequency response 45 to 18k cps; other features; wide range electrostatic model designed for use with Quad II power ampli-

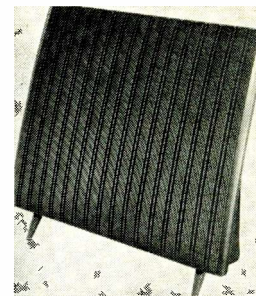

fier. Dimensions: 34 1/2" wide, 31" high, 10 1/2" deep; weight, 35 lbs.; metallic bronze grille, beech end frames & feet; \$260.00. A16-15.

SCHOBER

• *Model LSS-10 Organ Loudspeaker System.* Specifically designed for electronic organ application, suitable for high fidelity reproduction. The LSS-10 is essentially two phase inverters, one for the 12" woofer and another, placed inside the larger one, for the 8" high frequency unit. Acoustic cutoff plus electrical cutoff produces rapid cutoff below 300 cps eliminating acoustic interaction in the crossover region.



Specifications: dual phase inverter enclosure; speakers—12" l.f., 8" h.f.; power handling capacity 40 watts of organ tone; 300 cps 1/4-section crossover network; impedance 8-16 ohms; frequency response ± 5 db from 32 to 13k cps; magnet weights: l.f., 22 oz.; h.f. 12 oz.; voice-coil diameters: l.f., 2"; h.f., 2". Dimensions: 24" wide, 36" high, 19" deep; weight, 80 lb.; standard walnut \$150.00; unfinished birch \$125.00; to specification \$165.00. A16-16.

SHERWOOD

• *Tanglewood Model SR4 4-Way Speaker System.* Features a pair of 10-inch woofers with staggered resonances, 17.5 and 18.5 cps, 2 cu. ft. enclosure. Each speaker is individually chambered. One-in.-thick rosin-filled flake-board speaker baffle and front to back reinforcement. Shallow ring-radiator tweeters.

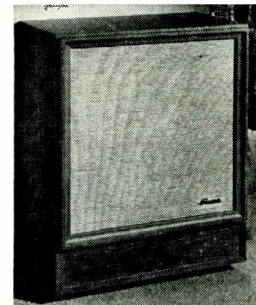

Specifications: sealed enclosure; speakers—(2) 10" l.f., 8" m.l.f., 8" m.f., 3 1/2" h.f.; power handling capacity 75 watts; 12 db/octave at 200 cps, 600 cps, and 3500 cps crossover networks; impedance 8 ohms; frequency response ± 2 1/2 db from 29 to 17.5k cps; magnet weights: l.f., 10 oz.; m.l.f. 6.8 oz.; m.f. 6.8 oz.; h.f., 9.0 oz.; voice coil diameters: l.f., 1.5"; m.f., 1"; h.f., 1". Dimensions: 24" wide, 31" high, 13" deep; weight, 73 lbs.; walnut \$219.50, birch, unfinished w/grille \$209.50, black lac, no/grille \$199.50; kit, 6 speakers and crossover \$109.50. A16-17.

TANNOY

• *GRF Speaker System.* The "GRF" system provides a compound expanding sound source, the effect of this is that the wave front area varies with frequency. The system incorpo-

Some plain talk from Eastman Kodak about tape:

base characteristics, surface smoothness and sound brilliance.

Kodak
TRADEMARK

Visualize a roll of sandpaper $\frac{1}{4}$ -inch wide. Now thread it into your tape recorder and run it awhile. Devastating thought? Sure is. Some poorly made tapes seem just about like that. Here's the story: Iron oxide is actually harder than many types of sand. And each particle of this destructively hard material can exert thousands of pounds of pressure, cutting a recorder head brutally. Luckily, that sort of thing can't happen here.

And for two good reasons. The first is our "R-type" binder. This resinous material has a number of unique advantages. It covers each particle of iron oxide thoroughly. It can be critically controlled, and coated to a glass-like smoothness. No other binder can be handled like our "R-type" binder. This means that Eastman tape gives you a smoother, more friction-free surface to begin with.

We take this super-smooth surface and to make certain that your recorder heads will get tender treatment, we take the extra precaution of lubricating the entire thickness of the binder.

A lubricant must lubricate, but not too well.

Here are the requirements. Tape must slip over heads (and pressure pads if your recorder has them), but there must be no slippage at all over the capstan, otherwise constant speed will suffer. The ideal lubricant has a combination of characteristics that allows it to glide friction-free (relatively, of course) in certain places and hold fast and not slip at all in others. Designing lubricants that give this sort of performance is difficult. After a few thousand tries, we hit it and got some big rewards in terms of performance.

For example: The length of tape from idler to capstan, is not just in forward motion. It is in longitudinal vibration as well. About 3000 CPS in some recorders, maybe 5000 or 6000 CPS in others. This acts as a sort of mechanical

AC ripple superimposed on the DC motion of the tape, if we may be allowed an electronic metaphor. The result is the generation of sidebands that destroy the timbre of the music. Lubrication does effectively control the generation of these sidebands. Trouble with sidebands is that they peak way up. Lubrication also suppresses the peaks while reducing friction.

We incorporate our lubricants into the magnetic coating. And we lubricate the base as well. In that way, all bets are covered. You might have noticed from time to time how some tapes smear their lubricants all over your equipment. Because our lubricants are stable, you'll never get that sort of "gunking" from an Eastman tape.

A dilemma: Polyester or Acetate?

Base materials have their problems too. They must not stretch, or sound distortion will result. They must be strong so that they won't break. But they must be "short" enough to break clean without necking down and losing recorded material. They must be supple enough to be head-clinging but not so floppy they behave like wet spaghetti. Basically, two different materials are used in tape bases. Acetate and polyester. These two materials are so different that they are used for entirely different applications and do give us sufficient versatility to solve most base problems.

Polyester is a really tough material. It is a first choice when it comes to superior strength in thin coatings such as $\frac{1}{2}$ mil materials. Where really long play is needed, polyester is the ticket. Acetate is a different story altogether. Especially our unique type of acetate which we have named Durol. Durol base is outstanding in its yield strength and elasticity characteristics. Under emergency loads it will break clean with virtually no permanent deformation.

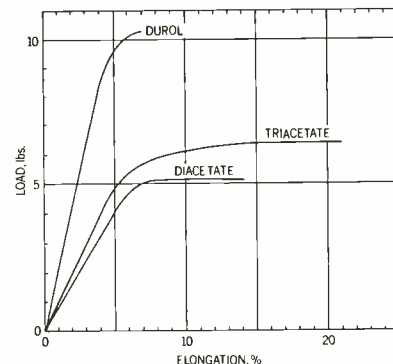

The above chart shows what happens when you simulate tough rewind conditions. Tape was put under sudden stress until it snapped. The end of the curve is the breaking point. Note that the Durol base samples proved out 40% stronger than the conventional acetates. How much permanent stretch remains after breaking is known as residual elongation. With Durol base tape this is less than 2%, while conventional acetates average 8-10%. This means that Durol base tapes can be spliced with virtually no loss in recorded material. Next time let's dig a bit further into general tape technology and a few of the parameter considerations.



Choose EASTMAN Sound Recording Tape, Type A303, for all general-purpose applications. Choose Type A304 wherever high output characteristics are called for. For long-play applications choose new Type P105—so thin you get 3600 feet on a 7-inch reel! EASTMAN Sound Recording Tapes are available at your local electronic dealer's and other tape outlets.

© Eastman Kodak Company, MCMLXI

EASTMAN KODAK COMPANY, Rochester, N.Y.

Circle 119 on Reader Service Card

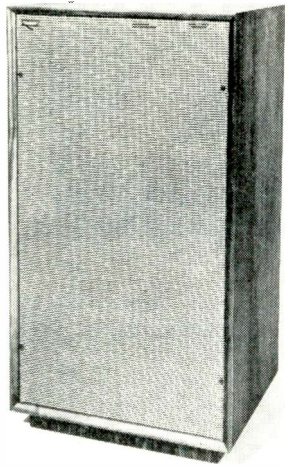

rates the Tannoy 15" Monitor Dual Concentric loudspeaker.

Specifications: horn loaded enclosure; power handling capacity 50 watts; RLC crossover network; impedance 16 ohms; frequency response ± 3 db from 30 to 20k cps; magnet assembly weight: 13 lbs.; voice coil diameters: l.f., 2"; h.f., 2"; other features horn-loaded high-frequency tweeter feeds through curvilinear diaphragm of LF assembly. Dimensions: 23½" wide, 42" high, 17½" deep; weight, 130 lbs.; oiled walnut \$385.00. A16-18.

1. 'Belvedere Senior' with 15" Dual Concentric Monitor \$268.50
2. 'Belvedere Senior' with 12" Dual Concentric Monitor \$231.00
3. 'Dalton' with 12" Dual Concentric Monitor \$215.00
4. 'Berkeley' with 10" Dual Concentric Monitor \$199.75
5. 'Cadet' with 10" Dual Concentric Monitor \$159.75

UNIVERSITY

• Classic Mark II.

Specifications: Ducted-bass-reflex enclosure; speakers—1 l.f., 1 m.f., 1 h.f.; power handling capacity 60 watts; ¼-section filter, 6 db/oct.

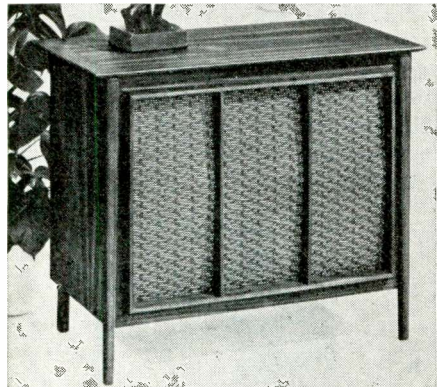

crossover network; impedance 4-8 ohms; frequency response ± 5 db from 20 to 20k cps; dimensions: 35" wide, 28¼" high, 17½" deep; weight, 86 lbs.; oiled walnut \$295.00. A16-19.

1. Classic Dual 12 \$229.50
2. Classic S-95 (unfinished) \$340.00

YL

• **CS-6 Orchestra.** All-horn four-way system covering the middle and high frequency range

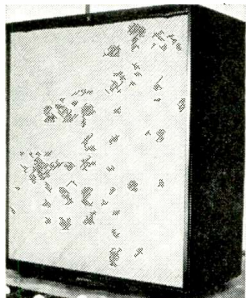

by horn-loaded metal-diaphragm compression drivers and the bass range by a powerful,

hard-cone 15" woofer mounted on a short horn. Designed for home use.

Specifications: multi-horn enclosure; speakers—15" l.f., M-550 & MH-350 compr. drivers, SH-180 driver h.f.; power handling capacity 35 watts; L/C with air-core coils 200, 1000, and 5000 cps crossover networks; impedance 16 ohms; frequency response ± 5 db from 25 to 20k cps; sensitivity (watts input for +85-db level 10 feet on axis) 0.2 watts; assembly magnet/weights: l.f., 230 oz.; m.f., 176 & 54 oz.; h.f., 27 oz.; voice coil diameters: l.f., 2½"; m.f., 2" & 1¾"; h.f., ¾"; other features—the three compression drivers respectively replaceable with higher gap flux density ones. Dimensions: 34¼" wide, 43¾" high, 19½" deep; weight, 172 lbs.; Japanese cherry wood (Sakura) \$895.00. A16-20.

1. CS-5 Concert \$689.00
2. CS-7 Symphonia \$559.00
3. CS-12 Symphonietta \$459.00

A17. SMALL SPEAKER SYSTEMS

ACOUSTIC RESEARCH

• **AR-4.** Similar in design and performance to AR-3 except for limitation of frequency response at extreme ends.

Specifications: Acoustic suspension enclosure; speakers—8" l.f., 3½" h.f.; power handling capacity 50 watts; LC with variable tweeter level control crossover network; impedance 8 ohms; sensitivity (watts input for

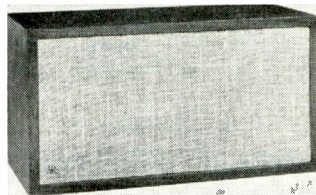

+85-db level 10 feet on axis) 0.75 watts; magnet weights: l.f., 6.8 oz.; h.f., 3.0 oz.; voice coil diameters: l.f., 1½"; h.f., ¾". Dimensions: 19" wide, 10" high, 9" deep; weight, 15 lb. 10 oz.; oiled walnut \$57.00; unfinished pine \$51.00. A17-1.

1. AR-3, mahogany or birch \$216.00
2. AR-2a, mahogany or birch \$122.00
3. AR-2, mahogany or birch \$96.00

ACOUSTICA

• **Table Lamp Speaker.** Electrostatic speaker in form of lamp shade with woofer in base of lamp. Electrostatic speaker, including fabric cover, is less than ¼-in. thick.



Specifications: speakers—1 l.f., 1 h.f.; frequency response 40 to 25k cps; variety of decorator designs \$209.50 up. A17-2.

ALTEC

• **841A "Coronado."** The 841A "Coronado" is styled to match a pair of "Carmels" or "Avalons" when used as the center speaker in a three-channel stereo system, or can be used in pairs, or monophonically. 12" woofer and a 3000 sectoral horn and driver with Mylar diaphragm, 40-22k cps frequency response, 20 watts maximum input power. Measures 30" H x 19" W x 14" D lined with Fiberglas. Walnut, \$204.00 A17-3.

1. 835B "Monterey, Jr." \$88.50
2. 836A "Lido" \$112.50

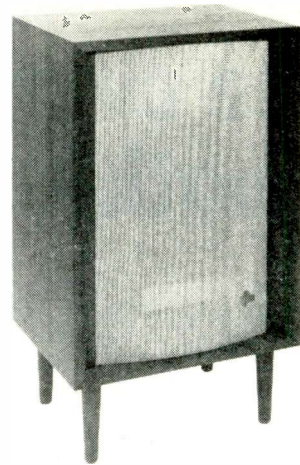

ARGOS

• **TX-12 Three-way Console Speaker System.** Oiled and hand-rubbed ¾" American walnut cabinet, sturdy, gracefully curved metal legs, terminal strip marked for stereo phasing.

Specifications: ducted port enclosure; speakers 12" l.f., 8" m.f., 3½" h.f.; power handling capacity 35 watts; N.P. capacitors crossover



network; impedance 8 ohms; frequency response ± 7 db from 40 to 17k cps; magnet weights: l.f., 10 oz.; m.f., 2 oz.; h.f., 1.47 oz.; voice coil diameters: l.f., 1"; m.f., 1"; h.f., 9/16". Dimensions: 19" wide, 24" high, 5¾" deep; weight, 25 lb.; oiled walnut \$54.95. A17-4.

1. TX-1 2-way system \$29.95
2. TX-2 2-way system \$44.50
3. TX-4 3-way system \$79.95
4. TX-5 2-way system \$32.50
5. PHF-15 2-way system \$29.95

AMPEX

• **2010 Speaker System.** Designed to complement the Ampex 2000 series tape recorders, may also be used separately. Bookshelf (small) sized.

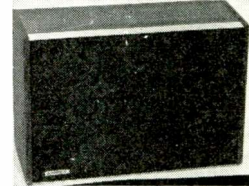

Specifications: speakers—8" l.f., 3" h.f.; 2000 cps crossover network; walnut \$79.00. A17-5.

ADC

• **325 Caprice.** Bookshelf two-way system.

Specifications: sealed enclosure; speakers—6" l.f., 3" h.f.; power handling capacity 10-60 watts; L-C crossover network; impedance 8 ohms; frequency response ± 4 db from 45 to

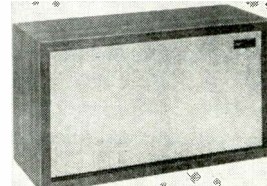

20k cps; Dimensions: 19" wide, 10½" high, 8" deep; weight, 19¾ lb.; oiled walnut \$49.50. A17-6.

1. 303 Brentwood \$85.00

"UNEXCELLED

by any other Tuner!"

Audio, February, 1964



need we say more?



\$30 down and only
\$10 a month
from most dealers!

Send for FREE INFORMATION

MR 67
6 Chambers St.
Binghamton, N. Y.

McINTOSH LABORATORY INC.
6 Chambers St., Binghamton, N. Y.

Please send me MR 67 information

NAME _____

STREET _____

CITY _____ STATE _____

Circle 120 on Reader Service Card

AUDIO-TECH

● **ME-12 Loudspeaker System.** Continuously adjustable tweeter output. Color-coded binding posts for easy stereo connection. Guaranteed for 2 years against defective materials and for workmanship.

Specifications: Type of enclosure, infinite baffle; speakers 12" l.f., 3" h.f.; power handling capacity 30 watts; type of crossover

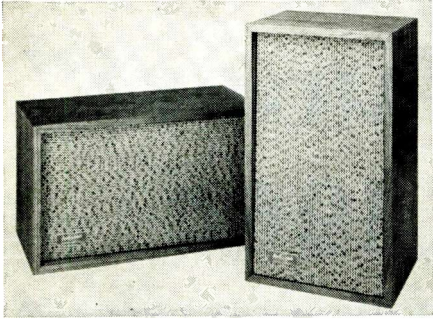

network, capacitor; impedance 16 ohms; frequency response from 40 to 20,000 cps; magnet weights: l.f., 32 oz.; h.f., 1.47 oz.; voice coil diameters: l.f., 2"; h.f., 1/2"; fused to protect against overload. Dimensions: 14" wide, 24" high, 12" deep; weight, 35 lbs.; oiled walnut, \$129.00. A17-7.

1. JA-15 system \$250.00

BOZAK

● **B-302A Urban Speaker System.** Ideal for small listening rooms. Contains one 207A two-way speaker, one B-209B midrange speaker and one 10102 crossover network to provide crossover at 800 cps.

Specifications: infinite baffle; speakers: one l.f., one m.f., two h.f.; power handling capacity, 20-60 watts; crossover network: three-way LC, 6 db/octave at 800 and 2500



cps; impedance 8 ohms; freq. resp. ± 3 db from 40 to 20k cps; magnet weights: l.f., 24 oz.; m.f., 24 oz.; h.f., 16 oz.; voice coil diameters: l.f., 1 1/2"; m.f., 1 1/2"; h.f., 3/4". Dimensions: 24" wide, 30" high, 20" deep; weight, 80 lbs.; walnut, mahogany, \$254.50; French Provincial, cherry \$290.00; Italian Provincial \$278.00; Early American \$257.50. C-305U matching equipment cabinet \$185.00. A17-8.

1. B-305 Urban system \$397.50
2. B-305 Provincial system \$440.00
3. B-4000 system \$495.00

CABINART

● **Mark 3.** An extended range 8" loudspeaker system at low cost.

Specifications: bass reflex-horn enclosure; speakers—8" extended range; power handling capacity 10 watts; impedance 8 ohms; frequency response 50 to 19k cps; sensitivity (watts input for +85-db level 10 feet on axis) 1/4 watt; magnet weight: 6.8 oz., voice coil

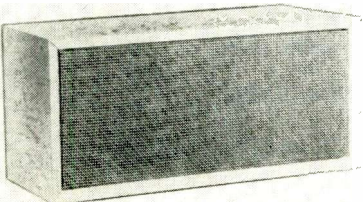

diameter: 1"; 3" whizzer cone, annulus surround, 65 cps resonant freq., free air. Dimensions: 23" wide, 11" high, 9 1/2" deep; weight, 26 lb.; unfinished birch \$19.50, walnut \$27.00. A17-9.

1. Mark 4 \$29.50

EICO

● **HFS-5 2-Way Speaker System.** 8" bellows-suspension woofer and a 3 1/2" closed-back tweeter. The enclosure is constructed of 3/4" stock and is tuned to 45 cps by a tubular ducted port. System Q of 1/2.

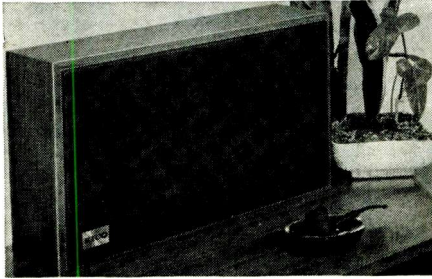

Specifications: ducted-port reflex; speakers 8" l.f., 3 1/2" h.f.; power handling capacity 25 watts; crossover network-bridging capacitor and h.f. level control; impedance 16 ohms; frequency response ± 5 db from 52 to 14k cps; magnet weight: l.f. 10.7 oz.; h.f., 1.47 oz.; voice coil diameters: l.f. 2"; h.f. 1/2"; dimensions: 12 1/2" wide, 24" high, 10" deep; oiled walnut \$59.95 kit, assembled \$89.95. A17-10.

ELECTRO-VOICE

● **E-V Four, 3-Way Acoustic Suspension System.** 12" ceramic-magnet woofer, new compression driver and diffraction horn combination utilizing ring-type diaphragm for mid-range, 5" dynamic cone tweeter, three-way etched circuit board crossover with crossover frequencies at 800 and 3500 cps. Two step-type level controls.

Specifications: sealed enclosure; speakers—12" l.f., compression horn m.f., 5" cone h.f.;

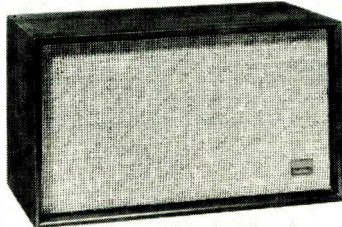

power handling capacity 60 watts; etched circuit, 3-way electrical crossover network; impedance 8 ohms; frequency response—30 to 20k cps; sensitivity (watts input for +85-db level 10 feet on axis) 1 watt; magnet weights: l.f., 1 lb. 6 oz. ceramic; m.f., 3.16 oz. Alnico V; h.f., 6.8 oz. Alnico V; voice coil diameters: l.f., 2"; m.f., 1"; h.f., 1"; enclosure liberally padded with acoustic damping material. Dimensions: 25" wide, 14" high, 13 1/2" deep; weight, 45 lb.; oiled walnut \$145.00; mahogany \$145.00; unfinished \$130.00. A17-11.

1. E-V One \$103.00
2. E-V Two \$115.00
3. E-V Six \$290.00
4. Marquis 300 \$240.00

EMI

● **812 Two-Way System.** 3/4" excursion in woofer, high compliance cloth edge, high-compliance tweeter, double-wound high-efficiency voice coils.



Specifications: infinite baffle enclosure; speakers—6 1/2" l.f., 4" h.f.; power handling capacity 15 watts; L-C crossover network; impedance 8 ohms; frequency response ± 3 db from 50 to 12k cps; magnet weights: l.f., 10 oz.; h.f., 5 oz.; voice coil diameters: l.f. 1"; h.f., 9/16". Dimensions: 10 1/2" wide, 14 1/4" high, 8" deep; weight, 14 lbs.; walnut (oiled) \$49.95. A17-12.

EMPIRE

● **8000 Grenadier Divergent Lens Speaker System.** Combination front and rear loaded low-frequency horn.

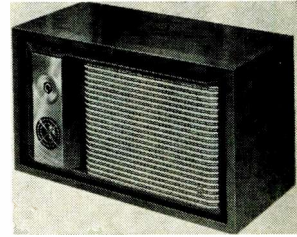

Specifications: Cylindrical enclosure; speakers—12" l.f., direct radiator m.f., dome h.f.; power handling capacity 100 watts; LC (12-db) crossover network; impedance 8 ohms; frequency response ± 3 db from 30 to 30k cps; sensitivity (watts input for +85-db level 10 feet on axis) 1.2 watts at 1 kc; magnet weights: l.f., 9 lbs.; m.f., 2 1/2 lbs.; h.f., 1 lb.; voice coil diameters: l.f., 4"; m.f., 2 3/4"; h.f., 1"; die cast wide angle acoustic lens for mid & hi frequency direct radiators. Dimensions: 15 1/4" dia. 29" high; weight, 65 lbs.; satin walnut \$180.00. A17-13.

1. 8200 Grenadier walnut \$180.00

FISHER

● **XP-4A Speaker System.** Eddy-current damping, no woofer basket (achieved by utilizing the walls of the cabinet as the supporting structure for the speaker).

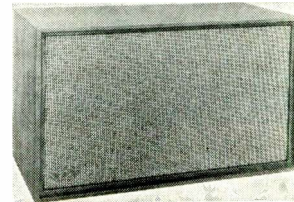

Specifications: infinite baffle enclosure; speakers—12" l.f., (2) 5" m.f., 2" dome h.f.; power handling capacity 60 watts; L-C air-core coils crossover network; impedance 8 ohms; frequency response 28 to 20k cps; voice coil diameter: l.f., 2"; eddy-current damping of woofer, hemispherical tweeter. Dimensions: 24.5" by 14" by 12" deep; weight, 60 lbs.; Scandinavian walnut, mahogany, cherry \$199.50; unstained birch \$189.50. A17-14.

1. XP-5 2-way bookshelf system \$ 54.50
2. XP-1A 3-way bookshelf system ... \$129.50
3. XP-2A 3-way bookshelf system ... \$ 84.50
4. KS-1A 3-way slim-line system \$ 89.50
5. KS-2A 3-way slim-line system \$119.50

FRAZIER

● **Corsair II Two-Way Speaker System.** Free air resonance of 10" woofer is 30 cps.

Specifications: speakers—10" l.f., horn h.f.; power handling capacity 20 watts; L-C 12 db/

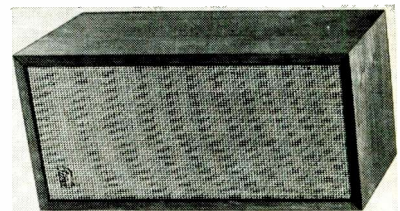

octave crossover network; impedance 8 ohms; frequency response 30 to 17k cps. Dimensions: 11 7/8" wide, 23 7/8" high, 11 7/8" deep; weight, 45 lb.; oil walnut \$129.95. A17-15.

1. Corsair I cone tweeter \$119.95

GOODMANS

● **Maximus III.** Features four woofers and two mid- and high-frequency speakers.

Specifications: speakers—4 l.f., 2 m.f. and h.f.; power handling capacity 60 watts; L-C

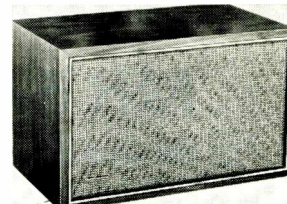

crossover network; impedance 8-16 ohms; frequency response 30 to 20k cps; magnet weight: l.f., 3.5 lb.; distortion less than 0.5%



... brings you equipment of unsurpassed quality

From Switzerland, where craftsmanship and music are traditional.

THORENS TURNTABLES

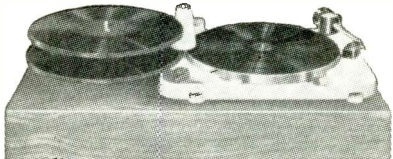

THORENS TD-224 — World's first turntable and automatic record changer. Provides the quality of undistorted, single-play performance with the convenience of automatic record changing. Includes BTD-12S tone arm, illuminated strobe plus many other features never before combined in a single instrumentnet \$250.

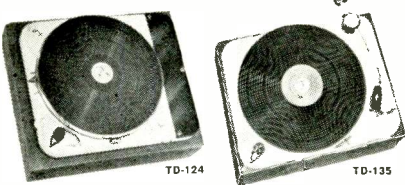

THORENS TD-124 — The recognized standard of quality for transcription turntables, regardless of price. Offers a host of exclusive features for the finest systems. net \$125.00 For single speed performance, convertible as required, see the TD-121 at \$85 net.

THORENS TD-135 — First integrated unit to feature a true transcription arm, the Thorens BTD-12S, plus a "TD" quality turntable. Outstanding adjustment flexibility, precision mounting and other quality features assure perfect performance. No other integrated unit approaches its professional standards. net \$99.75

Send for FREE CATALOG on Elpa's complete line and *sound REcreation** components, Dept. A.

* *sound REcreation* — A Mark of Elpa Marketing Industries, Inc.

Searching everywhere in the world, Elpa selects the finest components from the finest craftsmen and brings them to you with the promise of unsurpassed performance. Let Elpa guide you to the peak of enjoyment in the world of high fidelity.

From England, where high fidelity first earned its reputation.

CECIL E. WATTS Record Cleaning Equipment

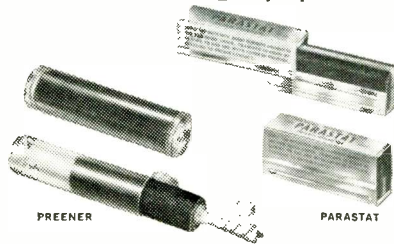

NEW PREENER — Provides the perfect solution for a dust-free record collection. Plush pile penetrates each groove, removes all dust and grit, as well as static \$3.00

NEW PARASTAT — Brings older records back to life, Preens new records and keeps them new. Ideal accessory to restore fidelity to older records \$15.00

(not illustrated)
THE ORIGINAL DUST BUG — Attaches to any turntable in seconds. Carefully designed and pre-balanced for minimum force. Height adjustment screw for maximum cleaning efficiency \$6.00

NEW CHANGER DUST BUG — Fits on any record changer arm without interfering with its performance \$5.00

From Denmark, where fine design is the hallmark of quality.

Ortofon

Tone Arms and Cartridges

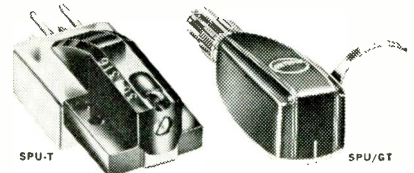

ORTOFON SPU-T — The finest professional quality stereo cartridge available anywhere in the world. Available for any high-quality universal stereo arm. Distortion-free reproduction. Life-long diamond stylus. net \$50.00

SPU/GT — available premounted in plug-in shell for SME & all Ortofon tone arms. **BTD/SPU** available premounted in Thorens plug-in shell net \$50.00
NEW! AVAILABLE in any of the above models equipped with Ortofon's Exclusive **ELLIPTICAL STYLUS** net \$75.00

(not illustrated)
ORTOFON RMG-309 — The ultimate in tone arm efficiency and simplicity. This 16" arm features finest ballbearing pivot gimbal suspension and other professional features. net \$60.00

ORTOFON RMG-212 is highest quality 12-inch professional arm, with all features of the RMG-309 plus lateral balancing. net \$55.00

ORTOFON SMG-212 — A 12-inch tone arm distinguished by both technical excellence and economy. Laterally balanced to provide perfect tracking even up to 30° out of level. net \$30.00

ORTOFON SKG-212 with calibrated counterweight and other fine features, offers greatest economy net \$20.00



ELPA MARKETING INDUSTRIES, Inc. / NEW HYDE PARK, NEW YORK

In Canada: Tri-Tel Associates Ltd., Willowdale, Ont.

Circle 121 on Reader Service Card

from 150-20k cps. Dimensions: 18" wide, 12 3/4" high, 10" deep; walnut \$169.00, A17-16.
 1. Maximus I one woofer \$ 59.50
 2. Maximus II two woofers \$109.00

GRADO

• "Lab-Standard" Speaker System.

Specifications: modified reflex enclosure; power handling capacity 75 watts peak; im-

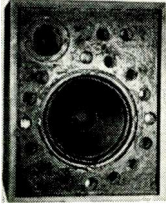

pedance 8 ohms; frequency response 25 to 20k cps; dimensions: 16" wide, 20" high, 10" deep; walnut \$150.00, A17-17.

1. Mini Lab \$49.50

HARTLEY-LUTH

• *Holton Jr. 220MS*. Walnut with cane grille and walnut panel front. Can be used horizontally or vertically. Finished on four sides. Cabinet acoustically treated with Soundorber consisting of 35 square feet of acoustic materials. Cabinet corners splined and all interior joints cleated.

Specifications: infinite baffle enclosure; speakers—one full range; power handling capacity 25 watts; impedance 8 ohms; frequency response ± 3 db from 20 to 20k cps; magnet weight: 6 lbs. 1 oz.; voice coil diameter: 1"; magnetic suspension. Dimensions: 15" wide, 30" high, 13" deep; weight, 40 lbs.; oiled rubbed walnut, \$195.00, A17-18.

1. Holton Jr. w. 312 speaker \$155.00
 2. Holton Jr. w. 310 speaker \$135.00
 3. Capri w. 220MS speaker \$180.00
 4. Capri w. 310 speaker \$130.00

HEATHKIT

• *Model AN-10 Acoustic Suspension Speaker System*. Takes only 10 watts to drive.

Specifications: infinite baffle enclosure; speakers—10" l.f., (2) 3 1/2" h.f.; power handling capacity 40 watts; L-C crossover network; impedance 16 ohms; frequency response ± 5 db from 30 to 15k cps; magnet

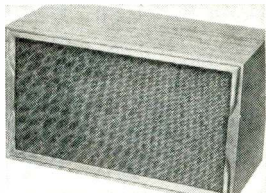

weights: l.f., 16 oz.; h.f., 1.47 oz.; voice coil diameters: l.f., 1 1/2"; h.f., 1". Dimensions: 24" wide, 13 1/2" high, 11 1/2" deep; weight, 28 lbs.; walnut \$64.95; unfinished birch \$59.95, A17-19.

1. AS-2AU & AS-2AW acoustic susp. sys wal \$96.50
 2. AS-51 2-way sys wal \$46.95
 3. AS-22U & AS-22W "Profile" 3-way sys wal \$54.95
 4. AS-193U & AS-193W 2-way sys wal \$24.95
 5. AS-81U & AS-81W 2-way sys wal .. \$19.95

JENSEN

• *PR-150W*. Low-resonance, high-compliance system using acoustic suspension principle and aspheric dome midrange and high-frequency radiator. New type of annulus on 12" woofer permits long, linear excursion.

Specifications: sealed enclosure; speakers—1 l.f., 1 h.f.; power handling capacity 35 watts; LRC with 2 lb. copper coils crossover network; impedance 8 ohms; frequency response ± 5 db from 25 to 20k cps; magnet weights: l.f., 27 oz.; h.f., 16 oz.; voice coil diameters: l.f., 1 1/2"; h.f., 1 1/2"; other features mid-high range covered by MH-400 dome radiator (aspheric). Dimensions: 25" wide, 14" high, 11 1/2" deep; weight, 45 lbs.; walnut \$119.50; unfinished \$99.50, A17-20.

1. PR-50W 2-way system \$ 69.50
 2. TF-3W 3-way system \$109.50
 3. TF-4W 4-way system \$129.50
 4. X-20 compact 2-way system \$ 49.50

KLH

• *Model Seventeen Acoustic Suspension Loud-*

speaker System. Two-way system of medium efficiency that may be used with amplifiers of 10 watts or larger.

Specifications: speakers—10" l.f., 1 1/4" h.f.; power handling capacity 10-60 watts music; R-C-L crossover with adjustable h.f. level; im-

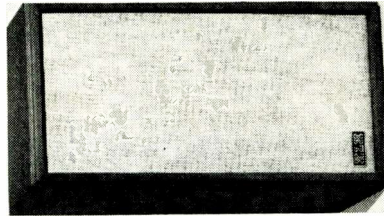

pedance 8 ohms. Dimensions: 11 13/16" wide, 25 1/4" high, 8 3/4" deep; weight, 28 lbs.; oiled walnut \$69.95, A17-21.

1. Model Four acous susp 3-spkr sys \$ 231.00
 2. Model Six acous susp 2-way sys .. \$ 134.00
 3. Model Seven acous susp 3-spkr sys \$ 203.00
 4. Model Nine electrostatic \$1140.00
 5. Model Fourteen compact 2-spkr sys \$ 49.50

KLIPSCH

• *Model H. Hovesp*. Horn loaded from 1 ke upwards. Total enclosure controls bass diaphragm motion for minimal bass distortion.

Specifications: speakers—encl. l.f., horn m.f., horn h.f.; power handling capacity 40 watts; three-way balancing crossover net-

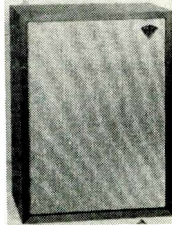

work; impedance 16 ohms; frequency response ± 5 db from 60 to 18k cps; sensitivity (watts input for +85-db level 10 feet on axis) 1.0 watts. Dimensions: 21 1/2" wide, 15 1/2" high, 11 1/8" deep; weight, 45 lbs.; oiled walnut, satin walnut, mahog., maple \$221.00; theatre black \$188.00, A17-22.

KNIGHT

• *KN-2350, Three-Way Bookshelf*.

Specifications: sealed enclosure; speakers—12" l.f., dome m.f., dome h.f.; power handling

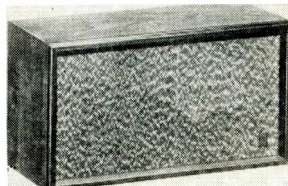

capacity 50 (music) watts; LC with 2 lb. air core coils crossover network; impedance 8 ohms; frequency response 15 to 21k cps; magnet weights: l.f., 27 oz.; m.f., 16 oz.; h.f., 4.6 oz. A17-23.

LAFAYETTE

• *SK-275 "Decor-ette III" Bookshelf System*. Polyfoam woofer, closed back midrange, cane-type sealed-back super tweeter. Tube-type duct.

Specifications: reflex enclosure; speakers—12" l.f., 6" m.f., 3 1/2" h.f.; power handling capacity 25 watts rms; 2000 and 5000 cps

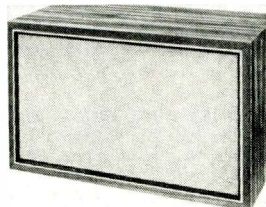

crossover networks; impedance 8 ohms; frequency response 30 to 30k cps; magnet weights: l.f., 16 oz.; finished on 4 sides. Dimensions: 24" wide, 14" high, 12" deep; weight, 30 lbs.; oiled walnut veneer \$79.95, A17-24.

1. SY-382WX "Elipto-Flex" sys \$64.50
 2. SK-270WX 5-spkr, 3-way thinline .. \$59.95

3. SK-300WX "Decor-ette V" 5-spkr thinline \$39.95
 4. SK-236WX 3-way, 3-spkr thinline .. \$29.95
 5. SK-265W 2-way, 2-spkr thinline .. \$19.50

JBL

• *Lancer 99 "Bookshelf" System*. Furnished as self-energized matched stereo pairs, requiring no power amplifier. Features new LE14A 14-inch 'Linear Efficiency' woofer, small direct radiator tweeter, and crossover network with adjustable high-frequency attenuation. Distinctive grille is hand-carved wooden fretwork.

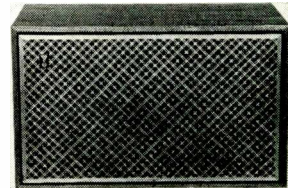

Specifications: ducted port enclosure; speakers—1 l.f., 1 h.f.; two-way with adjustable high-frequency attenuation crossover network; impedance 8 ohms; sensitivity (watts input for +85-db level 10 feet on axis) 1.65 watts; diameters: l.f., 4"; h.f., 3/8". Dimensions: 23 1/2" wide, 14" high, 12" deep; weight, 48 lbs.; fawn walnut, oiled walnut, dark mahogany, cherry A17-25.

1. Trimline 54 slim sys \$117.00
 2. Lancer 33 bookshelf sys \$ 93.00
 3. Lancer 77 bookshelf sys \$147.00
 4. D53LE14C bookshelf \$198.00
 5. D48S5 Madison bookshelf \$198.00

LEAK

• *"Piston Action Sandwich"*. Patented system.

Specifications: sealed enclosure; speakers—1 l.f., 1 h.f.; power handling capacity 50 watts; 6-element half-section crossover net-

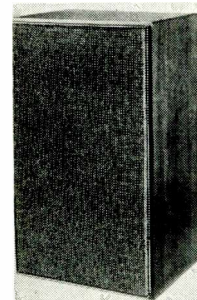

work; impedance 15 ohms; frequency response ± 2 db from 35 to 18.5k cps; sensitivity (watts input for +85-db level 10 feet on axis) 0.5 watts; voice coil diameters: l.f., 2"; h.f., 1". Dimensions: 15" wide, 26" high, 12" deep; weight, 49.5 lbs.; Scandinavian walnut \$199.00, A17-26.

LEONHARDT

• *LH-190 Speaker System*. Cylindrical speaker system.

Specifications: power handling capacity 15 watts; impedance 8 ohms; frequency response



35 to 18k cps; dimensions: 10" dia., 24 1/2" high; weight, 10 lb.; cane, classic, contemporary \$85.00; oiled walnut (no metal trim) \$95.00. Accessories: chain hanger kit for suspending from ceiling \$12.50, A17-27.

1. LH-101 "Micro-Sonic" system \$34.95

NESHAMINY

• *Model Z-600*. Treble reproduced by a pair of Janszen Series 130 electrostatic mid/high range radiators which have been matched to within ± 1 db. Each electrostatic radiator contains 176 push-pull sheathed conductors.

Specifications: sealed enclosure; power handling capacity 100 watts; built-in high-

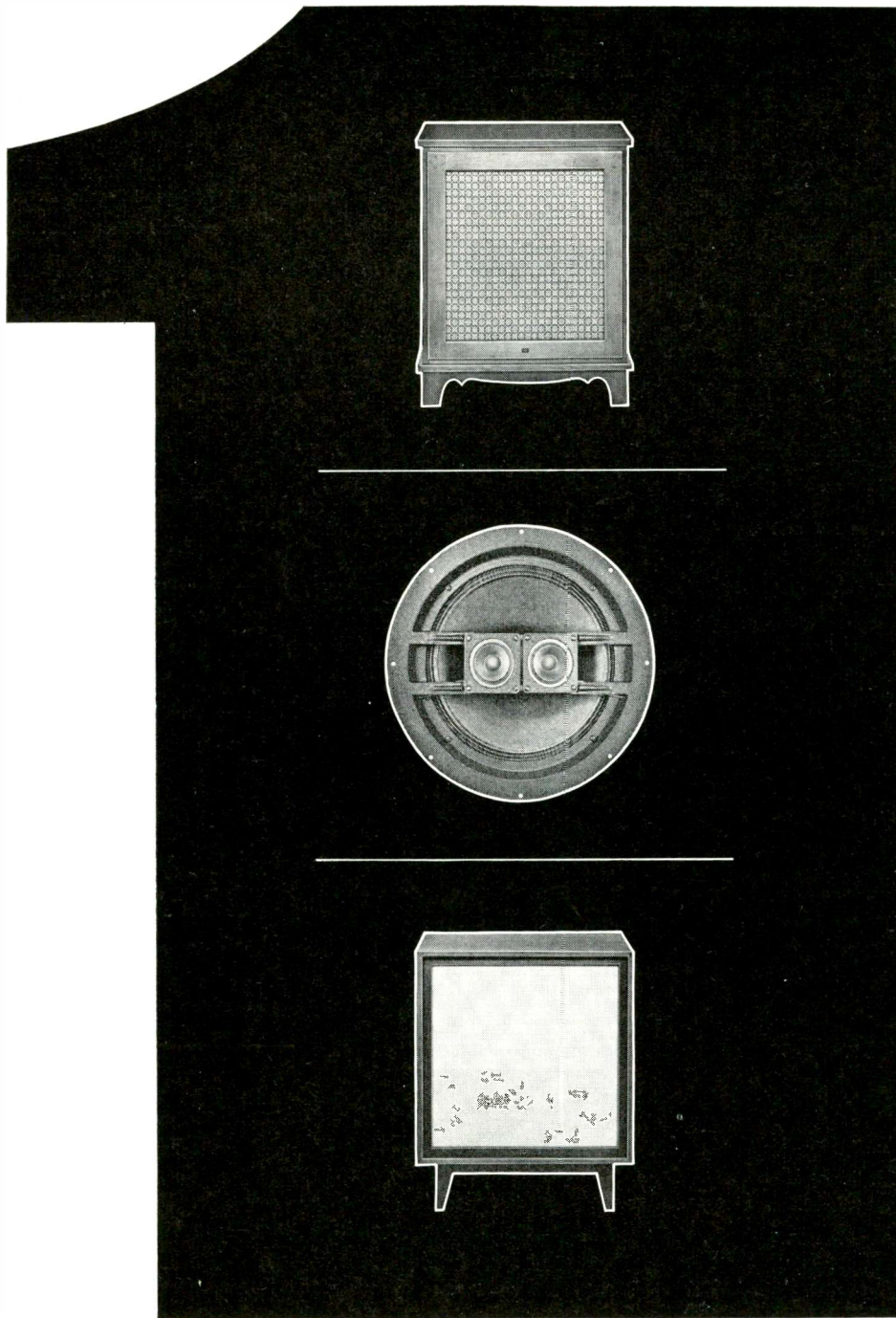

B-300/the one outstanding value in loudspeakers

because it alone offers

GREATER PRECISION in the re-creation of music than any other speaker of comparable size at any price
GREATER VERSATILITY in use, for equally superb performance with infinite-baffle mounting in wall or cabinet
GREATER EXPANDABILITY for easy Systematic Growth from the smallest Bozak into the largest, the world's finest.

"B-300" designates a two-way speaker system comprising the same full-size Bass and Treble speakers used in all Bozaks. B-300 can be the "ultimate" speaker for a small music system, or the starting point for step-by-step growth into The Supreme Achievement in the Re-Creation of Sound—the Bozak CONCERT GRAND. / Give your music system the precision performance TODAY, the possibility of growth TOMORROW, that make the Bozak B-300 the ONE outstanding value in loudspeakers. Hear it, buy it, at your Franchised Bozak Dealer. Catalog on request.

DARIEN / CONN / 06821

Complete kits for URBAN and EARLY AMERICAN speaker cabinets add a handsome setting for superb sound at a sensible saving.

Circle 122 on Reader Service Card

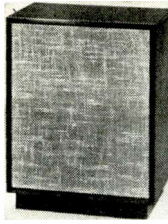

lac. \$119.50. Accessories Model RL console table legs \$19.95. A17-31.

1. SR2W Berkshire 3-way system \$99.50
2. SR1W Newport 2-way system \$84.50

SONOTONE

● *SE-80 "Scarsdale" speaker system.* Non-resonant panels, lock-miter joints, special venting techniques.

Specifications: vented enclosure; speakers—8" wide range; power handling capacity 20 watts; mechanical crossover; impedance 8

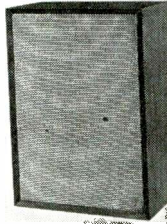

ohms; frequency response 45 to 20k cps sensitivity (watts input for +85-db level 10 feet on axis) 1.1 watts; magnet weights: 8 oz.; voice coil diameter: 1"; other features: carefully-matched coaxially-mounted high-frequency radiator. Dimensions: 17 1/2" wide, 24" high, 11" deep; weight 27 lb.; oiled walnut \$39.75. A17-32.

1. SE-880 "Beverly Hills" dual 8" system \$54.75

TANDBERG

● *CX-266.* Contains an X165B coaxial speaker. Dimensions: 13 1/4" wide, 22" high, 10" deep; teak \$89.50. A17-33.

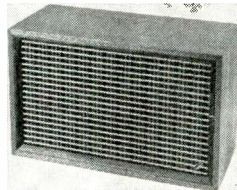

UNIVERSITY

● *Senior 11.* RRL tuned cabinet matched to specially developed University components.

Specifications: ducted bass reflex enclosure; speakers—1 l.f., 1 m.f., 1 h.f.; power handling capacity 30 watts; impedance 8 ohms; frequency response ±2 db from 30 to 22k cps.

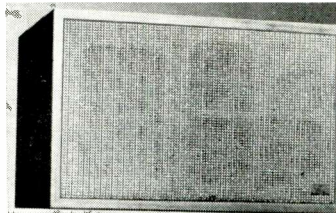

Dimensions: 25" wide, 15 1/2" high, 12 1/8" deep; weight, 44 lbs.; oiled walnut \$99.50; unfinished \$89.50. A17-35.

1. Medallion monitor wal \$129.95
2. Companion wal \$ 79.50
3. Mini-Fles wal \$ 69.95
4. Tri-Planar wal \$ 79.95
5. Companionette wal \$ 69.95

UTAH

● *Heritage III (HS3-W).* Eight speakers in a ducted port enclosure. Reflex port extends across the total width of the cabinet and vents toward the floor. Each mid-range speaker and

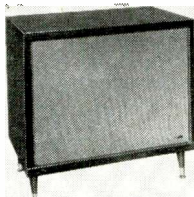

each tweeter is mounted in its own housing to eliminate interaction. The mid-range speakers are separately "tuned" (by use of different voice coil diameters) for complementary response curves. The same technique is used in the tweeter construction.

pass filter; impedance 8 ohms; frequency response ±3 db from 30 to 22k cps; magnet weight: 18 oz l.f.; voice coil diameter: l.f., 1.3"; woofer covers 30 to 2000 cps, electrostatic radiators cover 1500-30k cps. Dimensions: 20" wide, 26 1/4" high, 13" deep; weight, 50 lbs.; oiled walnut \$195.00. A17-28.

1. Z-400 \$159.50
2. Z-500 \$134.95

RADFORD

● *"S. L. S" Studio Loudspeaker.* Utilizes matched acoustic transmission line for deep bass, response characteristic in mid and high frequencies integrated with "white noise" techniques. Cabinets complex, built of kiln dried solid Afrormosia, 1" thick, sealed and coated with polyurethane primer.

Specifications: acoustic trans. line enclosure; speakers—1 l.f., 2 h.f.; power handling capacity 30 watts; half section, adjusted on white noise, crossover network; impedance 16 ohms; frequency response ±2 db from 30 to 17k cps; magnet weights: l.f., 80 oz.; h.f., 20 oz.; voice coil diameters: l.f., 4"; h.f., 1"; other features "line source" high units, for proper stereo effect. Dimensions: 17 1/4" wide, 35" high, 15" deep; weight, 60 lbs.; waxed walnut \$300.00. A17-29.

1. B.L.S. bookshelf speaker \$150.00

SCOTT

● *X-5 Two-Way Miniature Loudspeaker System.* The new S-5 measures only 10 inches by 16 x 6 3/4 inches is a most remarkable speaker system.

Specifications: speakers—1 l.f., 1 h.f.; power handling capacity 25 watts; L-C 6 db/octave

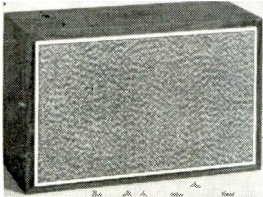

crossover network; impedance 8 ohms; frequency response ±5 db from 60 to 15k cps; magnet weights: l.f., 6.8 oz.; h.f., 2.5 oz.; voice coil diameters: l.f., 3/4"; h.f., 1/2"; tweeter level control. Dimensions: 10" wide, 16" high, 6 3/4" deep; price: less than \$60.00. A17-30.

1. S-2 3-way system
2. S-3 3-way system

SHERWOOD

● *SR3 Ravinia 3-way Speaker System.* One-inch thick rosin-filled flakeboard speaker baffle and front to back reinforcement, shallow ring-radiator tweeters.

Specifications: sealed enclosure; speakers—12" l.f., 8" m.f., 3 1/2" h.f.; power handling capacity 60 watts; 12 db/octave at 600 cps and 3500 cps crossover networks; impedance 8

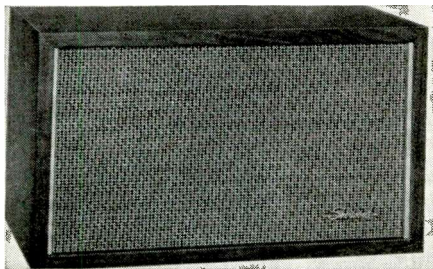

ohms; frequency response ±2.5 db from 48 to 17.5k cps; magnet weights: l.f., 1.66 lb.; m.f., 6.8 oz.; h.f., 9.0 oz.; voice coil diameters: l.f., 1.5"; m.f., 1"; other features: 21 cps free air resonance woofer. Dimensions: 15" wide, 26 1/4" high, 13 1/4" deep; weight, 55 lbs.; walnut \$139.50; birch unfinished \$129.50; blk.

Specifications: ducted port enclosure; speakers—(2) 12" l.f., (2) 8" m.f., (4) 5" h.f.; power handling capacity 80 watts; (2) L-C crossover network; impedance 8 ohms; frequency response 20 to 20k cps; sensitivity (watts input for +85-db level 10 feet on axis) 0.05 watts; magnet weights: l.f., 2 lb.; m.f., 6.8 oz.; h.f., 3.16 oz.; voice coil diameters: l.f., 2"; m.f., 1"; h.f., 3/4". Dimensions: 33" wide, 26" high, 18 3/4" deep; weight 110 lb.; walnut \$199.90. A17-36.

1. HS 1 Heritage I 3-spkr bookshelf .. \$ 79.95
2. HS 2 Heritage II 4-spkr. console .. \$139.90
3. Pro sealed bookshelf \$ 99.50

WHARFEDALE

● *W60 Achromatic Full-Range 2-speaker System and Sand-filled Enclosure.* The original Achromatic unit.

Specifications: Sand-filled ported duct enclosure; speakers—12 1/2" l.f. and h.f.; LC (1500 cps) crossover network; impedance 8 ohms; magnet weights: l.f., 152 oz. (9.5

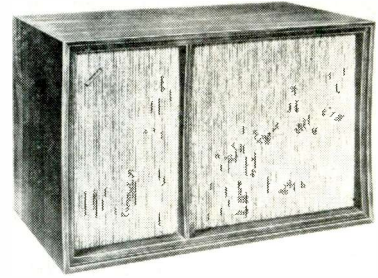

lbs.) m.f. and h.f. 20 oz. (1 1/4 lbs.) voice coil diameters: l.f. 2"; m.f. and h.f. 3/4"; other features—sand filled panel to eliminate cabinet resonance, wire-wound "L" pad to balance high frequencies. Dimensions: 24" wide, 14 1/4" high, 13" deep; weight, 50 lbs.; oiled or polished walnut \$122.50; utility model sanded birch \$106.50. Accessories B67 Universal Mounting Base in oiled or pol. walnut \$10.50; in sanded birch \$9.50. A17-37.

1. W40 2-spkr sys, wal \$ 83.50
2. W70 3-sys, wal \$172.50
3. W90 dual 3-way (6 spkr) sys, wal \$272.50

A18. TAPE RECORDERS

AMPEX

● *2000 Series Tape Recorders.* Automatic threading and reversing mechanism. Cast aluminum chassis, hysteresis-synchronous motor. These models are all similar mechanically but offer different outputs and housed in different cases. Model 2050 is a deck.

Specifications: Speeds—7 1/2, 3 3/4, 1 1/8 ips; heads—(3) 1/4-track; records 4-track stereo, 4-track mono; plays 4-track stereo, full or half

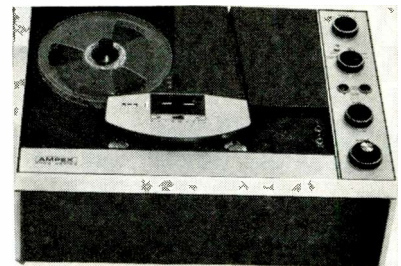

track mono; reel size 7"; 1 motor; timing accuracy 99.97%; freq. resp.—7 1/2 ips, ±2 db from 30 to 18k cps; 3 3/4 ips, ±3 db from 40 to 12k cps; 1 1/8 ips, ±3 db from 40 to 6k cps; signal-to-noise ratio, 52 db; wow and flutter, 0.8% at 7 1/2 ips, 0.12% at 3 3/4 ips; rewind time, 1200-ft. reel, 115 sec. Inputs—2 microphone, 2 high level; amplifier outputs—2, high impedance. Price, less than \$439.00. A18-1.

1. Model 2070, same deck w. 28-w pwr amps, port case, mic \$499.00
2. Model 2080, same as 2050, wal base, dust cover \$469.00
3. Model 1050, same as 2050, manual threading and reversing \$349.00
4. Model 1070, same as 2070, manual threading and reversing \$399.00
5. Model 1080 same as 2080, manual threading and reversing \$369.00

No other solid state stereo tuner/amplifier kit has EICO's \$500-\$600 quality...



and looks it. (for only \$229⁹⁵)

Introducing the new 3566 all transistor F.M. MPX Stereo Tuner/Amplifier. Designed throughout to the quality level of the costliest Tuner/Amplifiers on the market.

SUPERIOR TRANSISTOR SOUND: Perfect deep based fidelity, the clarity and detail of exactly reproduced transients... the sweet, airy quality achieved with extremely low distortion and extended frequency response. Plus plentiful reserve power for orchestral crescendos (even with inefficient speaker systems)—all against a velvet quiet background: This is the new **transistor sound** that is taking over in high fidelity... This is the sound of the superior new EICO 3566.

UNSURPASSED FM STEREO TUNER PERFORMANCE: Entirely new FM "Front End" and 4-Stage IF Strip with wideband ratio detector, developed only after the practical requirements of optimum FM Stereo performance were established by experience with earlier transistor designs in the field... Achieves **Minimum Bandwidth Variation with signal level** for consistently high **quality** reception regardless of signal strength... **Handles even abnormally strong signals without overloading** (a strong local signal won't "blanket" the dial)... **Unsurpassed usable sensitivity** with only slightly more signal required for full 40db quieting. **Time-switching** transistor multiplex circuitry, incorporating separation and balance adjusts, achieves outstanding 38db channel separation... completely effective filtering of all types of interference. Noiseless, purely electronic **Automatic Switching** between FM Stereo and FM Mono (controlled by the pilot frequency in stereo broadcast signal), with defeat. **Stereo Indicator Light** gives instantly visible indication of stereo broadcasts... **D'Arsonval tuning meter** gives exact center-of-channel tuning indication... **Adjustable-threshold interstation noise muting** gives you silence between stations while tuning, and infallible stereo program indication. Convenient Muting-Off Switch for weak station reception... **Exactly right AFC pull-in range** permits you to tune in stereo stations accurately with ease. Convenient AFC-Off switch for tuning in weak stations.

UNSURPASSED STEREO AMPLIFIER/PREAMPLIFIER PERFORMANCE: Entirely new amplifier/preamplifier circuitry, designed with the highest performance objectives. **Phenomenally low noise, low distortion RIAA phono preamplifiers** with maximum overload resistance. **Low distortion, variable inflection feedback tone controls** permit boost or cut at the extremes of the range without affecting mid-range response or the volume level. Isolated from power amplifier by buffer stages to eliminate loading distortion. **Unique, very low distortion drive of power amplifier output stages**, plus 36db of overall feedback to reduce distortion to an inaudible level. **No output transformers**—giving unrestricted bass response and eliminating transient distortions normally occurring due to output transformer characteristics. **Fast-acting instrument fuses** provide full protection against accidental shorting of speaker leads.

SIMPLIFIED KIT ASSEMBLY: You wire only non-critical audio and power supply circuits, mostly on military-style terminal boards for easy check-

out... **FM "Front End," 4-stage FM IF strip, and entire multiplex circuit pre-wired and pre-aligned...** Transistor Sockets eliminate risk of transistor heat damage... **This kit can be recommended to beginners!**

CONTROLS: Input Selector, Mode (incorporates FM stereo defeat), Volume, Balance, Bass, Treble, Loudness Compensation, Muting-off, AFC-off, Power on-off. **INPUTS:** Mag. Phono, tape, auxiliary, 300 Ω antenna. **OUTPUTS:** left and right speaker systems, headphones. **INDICATORS:** Illuminated tuning dial, tuning meter, stereo program indicator light. **FUSES:** Line, Left Speaker, Right Speaker, **SIZE (HWD):** 5 x 16½ x 13¼ inches.

AMPLIFIER/PREAMPLIFIER SPECIFICATIONS: **POWER:** 66 watts total IHF music power output. **IM DISTORTION:** 2% at 30 wpc (watts per channel); 1% at 25 wpc; 0.3% at normal listening level. **IHF POWER BANDWIDTH:** 20-20,000 at 25 wpc, 0.5% harmonic distortion. **HARMONIC DISTORTION:** 0.16% at normal listening level. **FREQUENCY RESPONSE:** ± 1db 10-60,000 cps. **HUM & NOISE:** 70db below 10mV on mag. phono; 70db below rated power on other inputs. **SENSITIVITY:** 3mV on mag. phono, 180mV on other inputs. **SPEAKER CONNECTIONS:** 8-16 ohms.

FM MPX STEREO TUNER SPECIFICATIONS: **SENSITIVITY:** 2 microvolts for 30db quieting (IHF Standard), 2.7 microvolts for 40db quieting. **IHF HARMONIC DISTORTION:** 0.5%. **CHANNEL SEPARATION:** 38db. **FREQUENCY RESPONSE:** ± 1db 20-15,000 cps. **IHF SIGNAL-TO-NOISE RATIO:** 60db. **IHF CAPTURE RATIO:** 4.5db. **IMAGE REJECTION:** 50db. **IF & SPURIOUS REJECTION:** 80db. **SCA REJECTION:** 40db. **38 KC SUPPRESSION:** 55 db. **19 KC SUPPRESSION:** 45db.

EICO 3566 also available factory wired (includes oiled walnut cabinet) \$349.95... optional oiled walnut cabinet for kit \$9.95.

Visit the EICO exhibit in the Pavilion of American Interiors at the World's Fair.

EICO EICO Electronic Instrument Co., Inc.
131-01 39th Avenue, Flushing, N.Y. 11352

Please send 1964 Catalog

Name _____

Address _____

City _____ Zone _____ State _____

BELL

● **RT-366 Stereo Tape Recorder/Duplicator.** Tape duplication feature.

Specifications: Speeds—7½, 3¾ ips; heads—(3) ¼-track; records ¼-track stereo, ¼-track mono; plays ¼-track stereo, ¼-track mono; reel size 7 or 10½ in.; 3 motors; freq. resp.—7½ ips, ±3 db from 40 to 16k cps; 3¾ ips, ±3 db from 40 to 12k cps; signal-to-noise

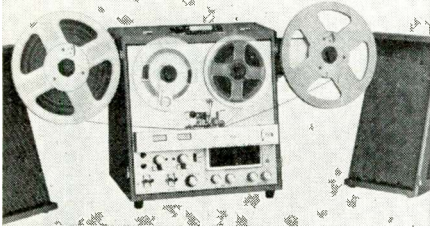

ratio, 50 db; wow and flutter, 0.2% at 7½ ips, 0.25% at 3¾ ips; rewind time, 1200-ft. reel, 45 sec. Inputs—2 microphone, impedance 3 meg; sensitivity 3 mv; 2 high level, impedance 1 meg; sensitivity 3 mv; amplifier outputs—2 preamp, impedance 22k ohms; speaker outputs 2, impedance 8 ohms; output power 8 watts per channel, A18-2.

1. T-367 ster tape deck/duplicator ... \$369.95
2. T-347 ster tape transport/does not have duplicating feature \$319.95

BENJAMIN—TRUVOX

● **PD-100.** Four-track stereo tape deck with built-in record playback and transistor monitor preamps. Three heads, three motors, three speeds. Off-the-tape monitoring.

Specifications: Speeds 7½, 3¾, 1½ ips; heads—(3) ¼-track; records ¼-track stereo, ¼-track mono; plays ¼-track stereo, ¼-track mono; reel size 7 in.; 3 motors; timing accuracy better than 99%; freq. resp.—7½ ips, ±3 db from 30 to 20k cps; 3¾ ips, ±3 db

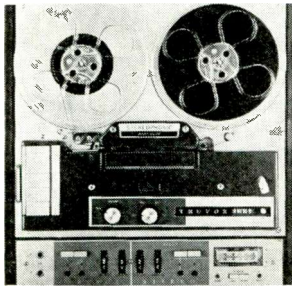

from 30 to 12k cps; signal-to-noise ratio, 50 db; wow and flutter, 0.1% at 7½ ips, 0.15% at 3¾ ips; rewind time, 1200-ft. reel, 55 sec. Inputs—2 microphone, impedance 2 meg, sensitivity 1 mv; 2 high level, impedance 500k ohms, sensitivity 150 mv; preamp outputs—2, cathode follower. Dimensions, 14½" wide, 16½" high, 7¾" deep; weight, 30 lb. Four-digit pushbutton reset counter—built-in splicing plate—automatic shut off. Hubloc spindles. Vertical or horizontal operation. Price, \$399.50. Accessories: Wood Base \$20.00, A18-3.

BUTOBA

● **Battery-Operated Portable Model MT-5.** 6-hr. recording on 5" reels, 2 motors with transistor electronic speed control, 5" x 7" speaker, 40 hrs. on 8 flashlight batteries. Transistor, battery or a.c.

Specifications: Speeds—3¾, 1½ ips; heads—(2) ½-track; records ½-track mono; plays ½-track mono; reel size 5"; 2 motors; freq.

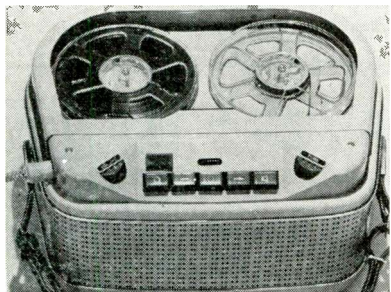

resp.—3¾ ips, ±3 db from 50 to 13k cps; 1½ ips, ±3 db from 60 to 5k cps; signal-to-noise ratio, 40 db; wow and flutter, 0.4% at 3¾ ips, 0.5% at 1½ ips; inputs—1 microphone,

impedance 200 ohms, sensitivity 200 mv; 1 high level, impedance 100k ohms, sensitivity 1 volt; amplifier outputs—1, line, impedance 200 ohms; speaker outputs 1, impedance 8 ohms; output power 1.2 watts. Dimensions, 12" wide, 9" high, 6" deep; weight, 12 lb. Price, \$199.95. Accessories: a.c. converter, \$29.95, A18-4.

CIPHER

● **Model VII Tape Recorder.** Built-in preamp and amplifier, 2 full-range detachable speakers. Play horizontally or vertically. Has digital tape index counter, 2 dynamic microphones 2 VU meters. Instant start and stop of tape. Records sound-on-sound. Automatic reel shut-off.

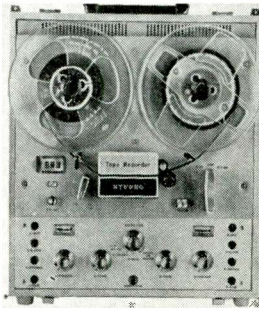

Specifications: Speeds—1½, 3¾, 7½ ips; heads—(2) ¼-track; records 4-track stereo, 4-track mono; plays 4-track stereo, 4-track mono; reel size 7"; 1 motor; freq. resp.—7½ ips, ±2 db from 35 to 15k cps; signal-to-noise ratio, 50 db; wow and flutter, 0.2% at 7½ ips, 0.25% at 3¾ ips; inputs—2 microphone, impedance 8 ohms; 4 high level; amplifier outputs—2, high impedance speaker outputs 2, impedance 8 ohms; output power 10 watts. Dimensions, 15½" wide, 20" high, 7¾" deep; weight, 45½ lbs. Price \$274.95. Accessories included: 2 dynamic microphones, 1-7" reel, 2 patch cards, A18-5.

1. Cipher I \$139.95
2. Cipher V \$ 79.50
3. Cipher VII D \$199.95
4. Cipher 800 \$499.95
5. Cipher VI \$239.95

CONCERTONE

● **Series 800 ¼ Track Stereo Bi-Directional Recorder/Reproducer.** "Reverse-O-Matic" records and plays in both directions continuously. Six heads, three for each direction. Solid-state record and reproduce electronics. Built-in echo and sound-on-sound. Available as a completely self-contained portable unit or as a tape deck. Pushbutton controls and remote controllable.

Specifications: Speeds—7½, 3¾ ips; heads—(6) ¼-track; records ¼-track stereo; plays ¼-track stereo, ¼-track mono; reel size 7"; 3 motors; timing accuracy 99%; freq. resp.—



7.5 ips, ±3 db from 50 to 15k cps; 3.75 ips, ±3 db from 50 to 7.5k cps; signal-to-noise ratio, 50 db; wow and flutter, 0.2% at 7.5 ips, 0.25% at 3.75 ips; rewind time, 1200-ft. reel, 40 sec. Inputs—2 microphones, impedance 1½-Z, sensitivity 1 mv; 2 high level, impedance 1½-Z, sensitivity 0.1 volts; amplifier outputs—2, impedance 200 ohms; speaker outputs 2, impedance 8 ohms; output power 5 watts. Dimensions, 14½" wide, 19½" high, 8¾" deep; weight, 47 lbs. Model 801. Price, \$399.95. Accessories: Satellite speakers \$79.95, A18-6.

1. Model 802 tape deck \$349.95
2. Model 400 Cosmopolitan portable .. \$197.50

CONCORD

● **Model 884 Tape Recorder.** Transistorized tape recorder, four separate preamps, monitor-

ing of recorded signal. Pushbutton transport controls.

Specifications: Speeds—7½, 3¾, 1½ ips; heads—(3) full track, (1) ¼-track; records 4-track stereo, ½-track mono; plays 4-track stereo, ½-track mono; reel size 7"; 1 motor; Freq. resp.—7½ ips, ±1.5 db from 30 to 20k cps; 3¾ ips, ±2 db from 30 to 15k cps; playback signal-to-noise ratio, 60 db; wow and flutter 0.15% at 7½ ips, 0.23% at 3¾ ips; inputs—2 microphone, impedance 20k ohms; 2 high level, impedance 1.2 meg, sensitivity



1 mv; amplifier outputs—2, speaker outputs 2, impedance 8 ohms; output power 2 watts. Dimensions, 15½" wide, 11½" high, 17" deep; weight, 43 lbs. Monitoring switch, sound-on-sound switch. Price: \$449.95. Accessories: 2 mikes w/stands, A18-7.

1. Model 104 \$ 99.95
2. Model 220 \$149.95
3. Model 330 automatic \$199.95
4. Model 440 \$239.95
5. Model 550-4 \$319.95

CROWN

● **Model SSS24 Solid State Tape Recorder.**

Specifications: Speeds—7½, 3¾, 1½ ips; heads—(3) ¼-track; records ¼-track stereo, ¼-track mono; plays ¼-track stereo, ¼-track mono; reel size 10"; 3 motors; timing accuracy 99.8%; freq. resp.—7½ ips, ±2 db from 50 to 30k cps; 3¾ ips, ±2 db from 30 to 20k cps; signal-to-noise ratio, 56 db; wow and flutter, 0.09% at 7½ ips, 0.18% at 3¾ ips; rewind time, 1200-ft. reel, 38 sec. Inputs—4 microphone, impedance 100k ohms, sensitivity 0.3 mv; 6 high level, impedance 5k

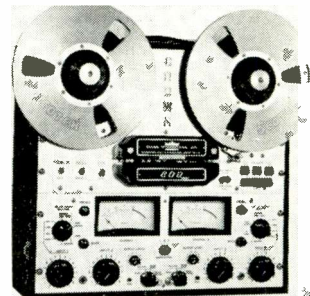

ohms, sensitivity 0.3 volts; amplifier outputs—3, phone, impedance 600 ohms. Dimensions, 19" wide, 17½" high, 8" deep; weight, 56 lbs. Micro-touch electronic control, electrodynamic braking, 5" VU meter, solid-state plug-in circuitry. Price, \$1295.00. Accessories: Carrying case, console, remote control, repeatomatic, A18-9.

1. SSS22 solid-state 2-track ster \$1295.00
2. SSS22-4 rec 2-track, plays 2 and 4-track \$1460.00
3. SSS24-2 rec 1/4-track, plays 2 and 4-track \$1460.00

DUAL

● **TG12 Tape Deck.** Four-track stereo/mono record and playback, smooth and positive tape

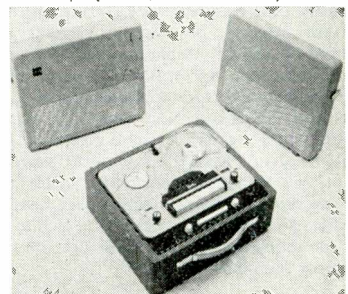

handling, mechanical pushbutton controls. No pressure pads.

Specifications: Speeds—1½, 3¾, 7½ ips;

**“Did you hear Schubert’s 9th
this morning?
I recorded it complete...
in stereo!”**

**“I wasn’t home –
had to go to school
again to record a
long lecture on
anthropogenesis.”**

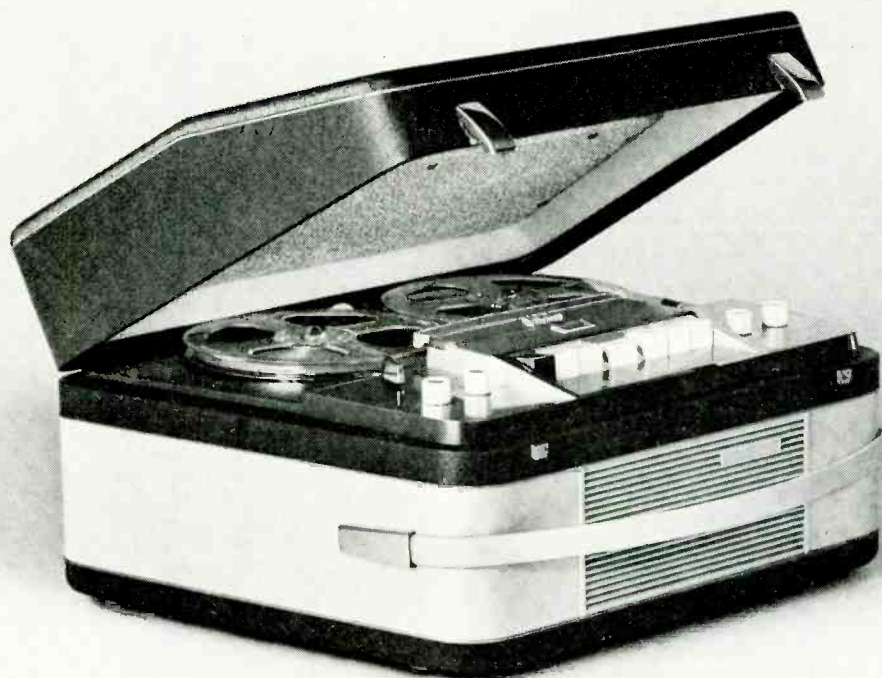

Whether your family’s requirements in a tape recorder reflect the demands of hobby or profession... classroom or business, you will find every one of your special needs fulfilled by either, or both, of the two solid-state Norelco recorders shown above.

The Continental ‘401’ (left), engineered for standby studio use as well as for professional-quality home music systems, is completely self-contained for both stereo and mono recording and playback. Includes dual recording and playback preamps, dual power amplifiers, two stereo-matched loudspeakers and a stereo dynamic microphone. Its four speeds include $7\frac{1}{2}$, $3\frac{3}{4}$, $1\frac{7}{8}$, $15/16$ ips. Response: 50-18000 cps at $7\frac{1}{2}$ ips • Wow and flutter: less than 0.14% at $7\frac{1}{2}$ ips • Signal-to-noise ratio: better than -48 db.

The Continental ‘101’ (right) is a new, professional-quality 7-pound portable that works on ordinary flashlight batteries, providing excellent recording (and playback) of anything, anytime, anywhere. Gives you up to two hours on a 4” reel of tape. Sound is clear as a bell and loud as you want it. Features dynamic microphone and constant-speed motor with capstan drive. Ruggedly built, handsomely styled, surprisingly low-priced. The perfect portable for the entire family—for work or play—at home or away!

Norelco recorders are sold and demonstrated at camera shops, hi-fi dealers and wherever good sound is sold. Write for booklet 20 to: **NORTH AMERICAN PHILIPS COMPANY, INC.**, High Fidelity Products Division, 100 East 42nd Street, New York, N. Y. 10017.

Norelco®

Circle 124 on Reader Service Card

heads—(2) ¼-track; records 4-track stereo, 4-track mono; plays 2- and 4-track stereo, 2- and 4-track mono; reel size 7 in.; 1 motor; freq. resp.—7½ ips, 40 to 20k cps; 3¾ ips, 40 to 16k cps; signal-to-noise ratio, 52 db; wow and flutter, 0.15% at 7½ ips, 0.25% at 3¾ ips; rewind time, 1200-ft. reel, 45 sec. Inputs—2 microphone, impedance 10 meg; sensitivity 2 mv; 1 high level, impedance 22k ohms, sensitivity 2 mv; amplifier outputs—1, impedance 18k ohms; speaker outputs, 1, impedance 8 ohms. Dimensions, 13½" wide, 6" high, 10¼" deep. Price, \$245.00. A18-10.

1. TG12A 4-track stereo recorder with speakers \$349.95

DYNACO—B & O

• *Stercomaster II*. Mixing facilities for three stereo inputs (whose plug-in preamps are interchangeable for mixing up to six identical inputs); monitor facilities; built-in power amps; dual meters; complete facilities for sound-on-sound, synchronizing to existing material, and controllable echo effects; automatic stop at end of tape; provision built in for low impedance microphone; counter with push-button reset; in-line threading of tape. Transistorized.

Specifications: Speeds—7½, 3¾, 1½ ips; heads: (3) ¼-track; records 4-track stereo, 4-track mono; plays 4-track stereo, 4-track mono; reel size 7"; 1 motor; freq. resp.—7½ ips, ±2 db from 40 to 16k cps; signal-to-noise ratio, 50 db rms; wow and flutter, 0.075% at 7½ ips, peak 0.2% at 7½ ips; rewind time, 1200-ft. reel, 90 sec. Inputs—2 microphones, impedance 200 ohms, sensitivity 0.15 mv; 2 phono input RIAA equalized 47k-2mv @ 1000 cps; 2 high-level, impedance 100k ohms, sensitivity 0.5 volts; amplifier outputs—1, NAB equalized 0.75 volt; speaker outputs 2, impedance 4-10 ohms; output power 8 watts. All inputs and outputs in stereo. Dimensions, 18" wide, 7½" high, 14" deep; weight, 33 lbs. Other features: teak cabinet with cover, interchangeable input preamps. Price, \$498.00. A18-11.

1. Portable version with built-in extension monitor speakers in case \$525.00

EICO

• *RP-100 Transistorized 4-Track Stereo Mono Deck*. 3-motor tape transport with electro-dynamic braking. Record and playback equalization on both 7½ and 3¾ ips tape speeds. Mixing mic. and line-level controls. Eye-tube level indicators, no pressure pads and precision tape guidance. Top-of-deck jam-proof speed shift. Digital turns counter. Automatic end-of-tape stop switch.

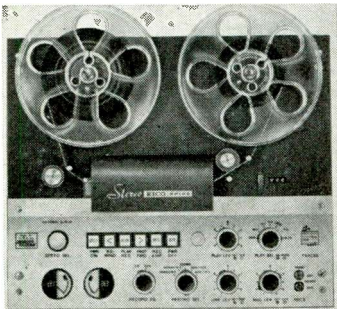

Specifications: Speeds—7½, 3¾ ips; heads—3 ¼-track; records 4-track stereo, 4-track mono; plays 4-track stereo, 4-track mono; reel size 7 in.; 3 motors; freq. resp.—7½ ips, ±3 db from 30 to 17,000 cps; signal-to-noise ratio, 45 db; wow and flutter, 0.2% at 7½ ips, 0.3% at 3¾ ips; rewind time, 1200-ft. reel, 45 sec. Inputs—microphone, impedance 5.6 meg, sensitivity 5 mv; high level, impedance 500k ohms, sensitivity 0.1 volts; amplifier outputs—0.7v, impedance 5k ohms. Dimensions, 12 9/16" wide, 12¾" deep, 6½" high; weight,

Do not use reader service card for information about these products—send card with code number that appears after each listing.

22 lbs. Price, \$349.00 wired, \$299.95 kit. A18-12.

1. 2400 4-track stereo/mono deck \$199.95 kit, \$269.95 wired

FERROGRAPH

• *5¼24*. Designed to laboratory standards. **Specifications:** Speeds—3.75 and 7.5 ips; heads—(2) ¼-track, (1) ¼-track; records twin-track stereo, ½-track mono; plays twin-track and 4-track stereo, and half-track mono; reel size 8¼"; 3 motors; timing accuracy 99.5%; freq. resp.—7.5 ips, ±3 db from 30 to 15k cps; 3.75 ips, ±3 db from 40

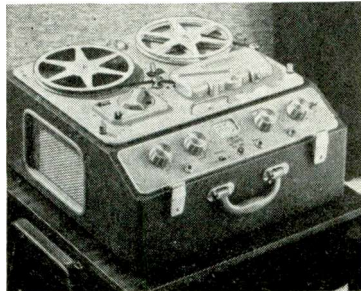

to 10k cps; signal-to-noise ratio, 52 db; wow and flutter, 0.16% at 7.5 ips; rewind time, 1200-ft. reel, 60 sec. Inputs—2 microphone, impedance 1 meg, sensitivity 2 mv; 2 high level, impedance 0.5 meg, sensitivity 50 mv; amplifier outputs—2, low level, impedance 1k ohms. Dimensions, 18½" wide, 9¾" high, 17½" deep; weight, 48 lbs. Provision for monitoring, re-recording from track to track. Price, \$595.00. A18-13.

1. 5AN mono rec, monitor spkr. \$425.00

FREEMAN

• *"800 Automaton"* three stereo jacks for private group listening and educational applications; slant panel console design with recessed carrying handle for easy 'drop-in' into cab.; self contained speakers; all functions controlled by simple 'jockey' lever; power switch design permits use of amplifiers without deck as central music or P.A. system; sound-with-sound and sound-on-sound with individually controllable record function on each channel permits use of either left or right channel as the master. Cathode follower preamp outputs.

Specifications: Speeds—3¾, 7½, 1½ ips; heads—(2) ¼-track; records 4-track stereo,

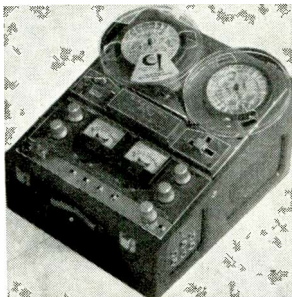

4-track mono; plays 4-track stereo, 4-track mono; reel size 7"; 1 motor; timing accuracy 99.8%; freq. resp.—7½ ips, ±5 db from 40 to 16k cps; 3¾ ips, ±5 db from 40 to 12k cps; signal-to-noise ratio, 40 db; wow and flutter, 0.15% at 7½ ips, 0.25% at 3¾ ips; rewind time, 1200-ft. reel, 120 sec. Inputs—2 microphone, impedance 50k ohms, sensitivity 0.25 mv; 2 high level, impedance 600 ohms, sensitivity 1.5 volts; amplifier outputs—2, std. phone jacks, impedance 600 ohms; speaker outputs 2, impedance 8 ohms; output power 10 watts. Dimensions, 13" wide, 9" high, 15" deep; weight, 26 lb. Speaker monitor switch. Price, \$299.50. Accessories: S-40A portable stereo speaker pair \$69.50. A18-14.

1. "660 Senior" port., ½-tr mono, bat & a.c. \$199.50
2. "550 Senior" port., ½-tr mono, bat & a.c. \$159.50
3. "200 DPA" Stereo Robot, auto. rev & play deck & preamps \$495.00

HEATHKIT

• *Model AD-22 Stereo Tape Recorder*. Semi-kit form, rugged, die-cast tape mechanism comes factory assembled; build only the electronics. Two inputs per channel, mixing controls, two VU meters, concentric clutched level controls.

Specifications: Speeds—7½, 3¾ ips; heads—(2) ¼-track mono; reel size 7"; 1 motor;

timing accuracy 98%; freq. resp.—7½ ips, ±3 db from 40 to 15k cps; 3¾ cps, ±3 db from 40 to 10k cps; signal-to-noise ratio—45 db; wow and flutter, 0.2% at 7½ ips, 0.3% at 3¾ ips; rewind time, 1200-ft. reel, 100 sec. Inputs—2 microphones, impedance 1 meg, sensitivity 5 mv; 2 high level, impedance

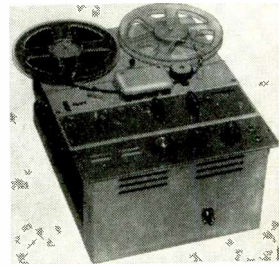

250k ohms, sensitivity 0.160 volts; amplifier outputs—cath. foll., impedance 600 ohms. Dimensions, 12" wide, 8" high, 15" deep; weight, 20 lbs. Price, \$159.95. A18-15.

1. AD-72 port 4-tr ster rec kit (semi) \$179.95

KNIGHT

• *KN-4000A Transport with KN-4003 Solid-State Record/Play Preamp*. Operates horizontally or vertically.

Specifications: Speeds—7½, 3¾ ips; heads—(3) ¼-track; records 4-track stereo, 4-track mono; plays 4-track stereo, 4-track mono; reel size 7"; 3 motors; timing accuracy 98%; freq. resp.—7½ ips, ±3 db from 40 to 17k cps; 3¾ ips, ±3 db from 40 to 12k

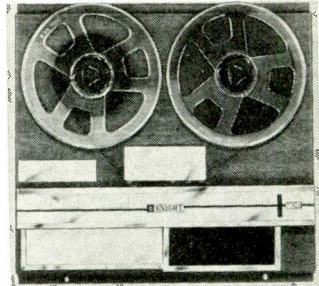

cps; signal-to-noise ratio, 50 db; wow and flutter, 0.2% at 7½ ips, 0.25% at 3¾ ips; rewind time, 1200-ft. reel, 45 sec. Inputs—2 microphone, impedance 250 to 10k ohms, sensitivity 1 mv; 2 high level, impedance 330k ohms, sensitivity 0.1 volts; amplifier outputs—2, phono-jack, impedance 5k ohms, 1.2v. Dimensions, 15½" wide, 13½" high, 7" deep; weight, 25 lbs. Echo and sound-on-sound with provisions for tape monitor during record made. Price, \$129.95. A18-16.

1. KN 4003 solid-state record/play pre-amp \$119.95

LAFAYETTE

• *RK-600A 4-Track Stereo Tape Recorder*. Portable self-contained 2-speed tape recorder. Sound-with-sound recording. High-low tone control, pause control, and monitor output for direct use of headphones.

Specifications: Speeds—3¾, 7½ ips; heads—(2) ¼-track; records 4-track stereo, 4-track mono; plays 4-track stereo, 2- or 4-track mono; reel size 7"; (1) 4-pole motor; freq. resp.—7½ ips, ±5 db from 40 to 15k cps; 3¾ ips, ±5 db from 40 to 9k cps; signal-to-noise ratio, 45 db; wow and flutter, 0.25% at



7½ ips; rewind time, 1200-ft. reel, sec. Inputs—2 microphone, impedance 50k ohms, 2 high level; monitor and speaker outputs, impedance 50k & 4 ohms; output power 1.5 watts. Dimensions, 16½" wide, 7½" high, 11" deep; weight, 27 lbs. Other features: two 4 x 6 oval speakers, vinyl case; complete with 2 dynamic mikes, patch cords, 7" reel. Price, \$129.50. A18-17.

1. RK-675WX pushbutton 4-tr ster rec \$179.50
2. RK-650WX pushbutton 4-tr ster-mono deck \$109.50

**JBL PRESENTS THE
SOLID STATE STEREO
GRAPHIC CONTROLLER**

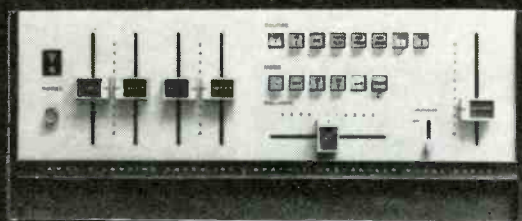
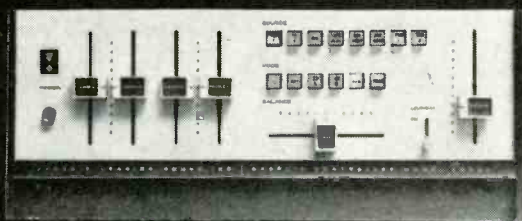

A TOUR DE FORCE OF CREATIVE ENGINEERING

Straightline controls. Pushbutton selectors. Inputs in front as well as back. Take a look and wonder... *Isn't this the way it should have been done in the first place?* The JBL design staff started fresh. Clean slate. No restrictions, prejudices or preconceptions. With cold objectivity they regarded the functions of a preamplifier/control center, re-evaluated its relationship to a human operator, weighed every conceivable feature. Straightline controls give immediate visual indication of setting. Even from a distance. Direction of movement seems intuitive. Up to increase, down to attenuate. Slide to one side or the other to balance channels. Pushbutton selectors permit instant comparison, switching from one source (top bank) or mode (lower bank) to another without passing through intermediate positions. Pushed button lights up. Controls are so arranged that those most frequently used are most accessible. Human engineering. Front-panel inputs permit sampling and comparing components, connection of portable units without disrupting permanent rear-chassis connections. Front jacks are behind a

flip-down door which also conceals occasionally used facilities such as a headphone jack, fuse, filters, system gain, level and balancing controls. The Graphic Controller includes a 1,000 cycle test tone generator to be used for speaker balancing, placement and orientation. An Aural Null Stereo Balancer accessory provides a very precise means for balancing speakers, and also the two signals from your stereo pickup. Performance-wise—in terms of response, distortion, hum—the JBL solid state Graphic Controller is the finest instrument of its kind you can buy. As has been said of other JBL products, "It's the result of doing everything right." In fact the Graphic Controller is so *right* in every respect, so well built, so well engineered that yours might very well become a family heirloom. There's much more to be said about the SG520. You'll find a complete description in Bulletin SL801-2. Write for your free copy and the name of the Authorized JBL Audio Specialist in your community.

The Graphic Controller is designed, engineered and manufactured by:



JAMES B. LANSING SOUND, INC., LOS ANGELES 39, CALIFORNIA

- 3. RK-137AWX 4-tr rec w ster play-back \$ 89.50
- 4. RK-142 WX 2-speed tape rec \$ 59.95

MAGNECORD

• **Model 1024.** Built-in mixer, VU meters, solid-state electronics with regulated power supply. Die cast precision mainframe, three-motor transport, two-speed hysteresis synchronous capstan motor.

Specifications: Speeds—3.75, 7.5 ips; heads—(3) ¼-track; records ¼-track stereo, ¼-track mono; plays ¼-track stereo, ¼-track mono; reel size 8"; 3 motors; timing accuracy 99.8% freq. resp.—7.5 ips, ±2 db from 45 to 18k cps; 3.75 ips, ±2/3 db from 35 to 10k cps; signal-to-noise ratio, 50 db; wow



and flutter 0.2% at 7.5 ips, 0.25% at 3.75 ips; rewind time, 1200-ft. reel 80 sec. Inputs—2 microphone, impedance 50k ohms, sensitivity 2 mv; 2 high level, impedance 100k ohms, sensitivity 0.076 volts; amplifier outputs—2 emitter follower, impedance 2200 ohms. Dimensions, 19" wide, 15¾" high, 12" deep; weight, 47 lbs. Mic. jacks on front panel, mic. & line inputs mix & have master control. Price, \$595.00. Accessories: cases (1 for mechanism & 1 for amplifier) ea. \$30.00. A18-18.

- 1. 1028 \$925.00
- 2. 1048 \$995.00
- 3. 1022 \$739.00
- 4. 1021 \$659.00

MARTEL

• **301 Portable Tape Recorder.** Four speed, lightweight, a.c.-battery. Tape counter, calibrated VU meter.

Specifications: Speeds—15/16, 1½, 3¾, 7½ ips; heads (3) ½-track; records ½-track mono; reel size 5"; 1 motor; freq. resp.—7½



ips, ±5 db from 60 to 14k cps; 5/16 ips, ±5 db from 80 to 4k cps; signal-to-noise ratio, 40 db; wow and flutter, ±3% at 7½ ips, rewind time, 96 sec. Inputs—1 microphone. Dimensions, 12" wide, 10¼" high, 5¼" deep; weight, 12 lbs. Tape counter, pause, built-in power supply. Price \$199.95. Accessories: stop-start foot control \$4.95. A18-19.

MIRANDA



• **"Nocturne" Stereo Tape Recorder.**
Specifications: Speeds—1½, 3¾, 7½ ips; heads (2) ¼-track; records ¼-track stereo, ¼-track mono; plays ¼ and ½-track stereo,

¼-track mono; reel size 7 in.; 1 motor; timing accuracy 98% freq. resp.—7½ ips, ±3 db from 40 to 18k cps; 3¾ ips, ±3 db from 40 to 12k cps; signal-to-noise ratio, 50 db; wow and flutter 0.2% at 7½ ips, 0.25% at 3¾ ips; —2 microphone, impedance 50k ohms, sensitivity 1.5 mv; 2 high level, impedance 50k ohms, sensitivity 0.3 volts; amplifier outputs—2, monitor, impedance 100k ohms; speaker outputs 2, impedance 4 ohms; output power 10 watts. Dimensions, 17" wide, 7¼" high, 12½" deep; weight, 29 lb. Digital counter, 2 VU meters, sound-on-sound, Teakwood cabinet; equipped w/1 microphone. Price \$249.95. Accessories: Additional Microphones \$14.95. A18-20.

- 1. Sorrento ster rec \$399.95
- 2. Mirandette C Portable \$169.95

NEWCOMB

• **T×10 Series tape recorders.** This series comprises a number of models varying in head complement and speed ranges. The T×10-4 is fitted for 4-track operation and speeds of 7½ and 3¾ ips. Tape motion is controlled with a single "joy stick" lever. Differential

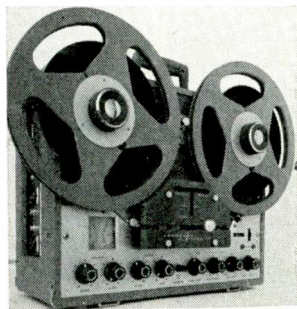

braking provides rapid but smooth stops. No pressure pads. Automatic stop sets automatically. Plug-in transformers accommodate low-impedance microphones.

Specifications: Speeds—7½, 3¾, ips; heads—(3) ¼-track; records 4-track stereo, 4-track mono; plays 4 and 2-track stereo, 4 and 2-track mono; reel size 10½ in.; 1 motor; timing accuracy freq. resp.—7½ ips, ±2 db from 30 to 18k cps; 3¾ ips, ±3 db from 30 to 13k cps; signal-to-noise ratio, 55 db; wow and flutter 0.15% at 7½ ips, 0.2% at 3¾ ips; rewind time, 1200-ft. reel, 45 sec. Inputs—2 microphone, 2 high level, outputs—2, 1 monitor output. Dimensions, 16¾" wide, 12¾" high, 9½" deep; weight, 36½ lbs. Horizontal or vertical operation, accepts NAB hubs; Price \$750.00. Portable case—\$25.00. A18-21.

- 1. T×10-2 ½-track, 3¾ and 7½ ips \$750.00
- 2. T×10-215 ½-track 7½ and 15 ips, special order \$885.00
- 3. T×10-415 ¼-track 7½ and 15 cps, special order \$825.00

NORELCO

• **"Carry-corder" 150.** Pocketable cartridge-loading recorder, battery operated. Turnover cartridge plays 30 minutes on each side, and may be removed without rewinding for later return to same cartridge for continuing recording. Fully transistorized. Operates 20 hours on one set of batteries at 2-hour per day rate. Cartridge holds 300 feet of triple-play tape. Level and battery-condition indicated by meter. Single switch controls functions.

Specifications: Speeds—1½ ips; heads—(2) ½-track; records and plays half-track

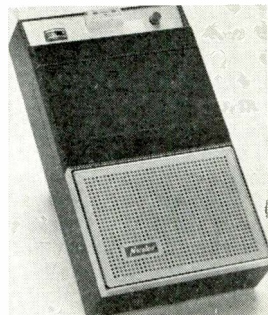

mono; cartridge loading; 1 motor; rewind time, 70 sec. Inputs—1 microphone, 1 high level output for external amplifier. Dimensions, 4½" wide, 7¾" high 2¼" deep; weight with batteries, 3 lbs. Omnidirectional dynamic microphone with start/stop switch; black vinyl carrying case with pocket for microphone; 4 cartridges. A18-22.

OKI

• **Model 555 Transistorized Stereo Recorder.** Separable 2-way slim-line speakers attach to case for carrying. Automatic shut-off, digital index counter, pause control, and sound-on-sound and sound-with-sound facility. Operates vertically or horizontally.

Specifications: Speeds—7½, 3¾ ips; heads—(2) ¼-track; records 4-track stereo, 4-track mono; plays 4-track stereo, 4-track mono; reel size 7 in.; 1 motor; timing accuracy freq. resp. 7½ ips, 20 to 22k cps; 3¾ ips 30 to

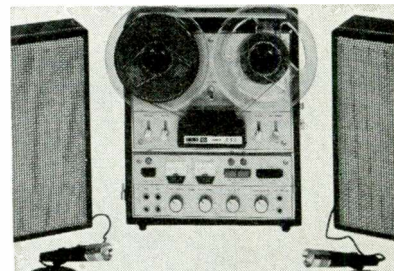

15k cps; signal-to-noise ratio, 50 db; wow and flutter, 0.12% at 7½ ips, rewind time, 1200-ft. reel, inputs—2 microphone, impedance 10k ohms, sensitivity 2 high level, impedance 500k ohms, impedance 3k ohms; speaker outputs 2, impedance 4-16 ohms; output power 3 watts. Dimensions, 11¾" wide, 13" high, 4¾" deep; with speakers 12¾" deep, weight, 24 lb. with spkrs. Price \$370.00. A18-30.

- 1. Model 333, stereo \$300.00
- 2. Model 222, mono record, stereo play \$190.00
- 3. Model 111, Mono \$130.00

ROBERTS ELECTRONICS

• **1650 Stereo ¼-Track Record/Play.** Provision for internal and satellite speakers, two VU meters.

Specifications: Speeds—3¾, 7½ ips; heads—(2) ¼-track; records 4-track stereo, 4-track mono; plays 4 & 2-track stereo, 4-track mono; reel size 7 in.; 1 motor; timing accuracy 99.8%; freq. resp.—7½ ips, ±3 db from 30 to 18k cps; 3¾ ips, ±3 db from 50 to 10k cps; signal-to-noise ratio, 48 db; wow and flutter, 0.2% at 7½ ips, 0.2% at 3¾ ips; rewind time, 1200-ft. reel, 90 sec. Inputs—2

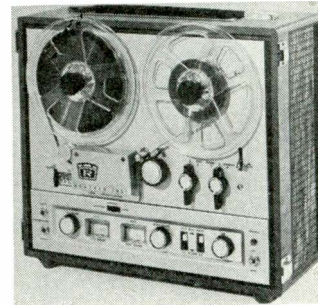

microphone, high impedance, sensitivity 1.5 mv; 2 high-level, high impedance, sensitivity 150 mv; amplifier outputs—2 preamp, high impedance; speaker outputs 4, impedance 8 ohms; output power 6 watts. Dimensions, 16" wide, 13¼" high, 9" deep; weight, 32 lb. Independent channel switching, record monitor switch, tape lifter, auto stop, pause lever, edit guide. Price, \$299.95. A18-23.

- 1. 1600 mono ½-track \$169.95
- 2. 1640 ster ¼-track, 4-speed \$259.95
- 3. 1660-D ster ¼-track, deck and pre-amps, 4-speed \$249.95

SCULLY

• **Model 280.** Solid-state professional recorder/reproducer, three separate plug-in pre-amplifier cards for play and record amplifiers and oscillator. Direct-drive hysteresis synchronous capstan motor, harness wiring, disc brakes, 24v. d.c. control circuit, plug-in relays, separate microphone and line input transformers. Power supply has tapped toroidal transformers and silicon rectifiers for heat reduction. Precision plug-in reel hubs, front panel access to calibration and equalization adjustments.

Specifications: Speeds—3¾, 7½, 15, 30; heads—(3) full track, (3) ½-track, (3) ¼-track; records 2-track stereo, 1 & 2-track mono; plays 2-track stereo, 1 & 2-track mono; reel size 10½ in.; 3 motors; timing accuracy 99.8%; freq. resp.—15 ips, ±2 db from 30 to 18k cps; 7½ ips, ±2 db from 50 to 15k cps; signal-to-noise ratio, 60 db; wow and flutter,

PAY FAR LESS AT ALLIED

STEREO HI-FI & RECORDING EQUIPMENT

see the world's largest selection



490
Value-Packed
Pages

send card today for your

FREE

MAIL
NOW

money-saving

ALLIED
1965 CATALOG

including the complete
knight-kit® CATALOG

see special products and
exclusive values available
only from Allied...

Choose from the world's largest selection of famous-make components and systems at lowest prices anywhere. See latest solid-state Stereo Hi-Fi. Get our unbeatable low price on a complete hi-fi system. Build your own KNIGHT-KIT® hi-fi it's easy and the savings are big. See famous KNIGHT® components equal to the very best in performance, yet far lower in cost. Enjoy the largest selection of complete tape recorders, preamplifiers, and recording tape. Get the most for your money in beautiful hi-fi cabinetry. For everything in Hi-Fi, for everything in Electronics, SEE THE 1965 ALLIED CATALOG—SEND CARD TODAY.

satisfaction guaranteed or your money back

EASY TERMS: Use the convenient Allied Credit Fund Plan

**SEE
OTHER
SIDE**

For your FREE 1965 ALLIED Catalog, fill in card, detach and mail now. (Please give other card to an interested friend.)

**SEND
CARD
TODAY**

MAIL
NOW

Name _____
PLEASE PRINT

Address _____

City _____ Zone _____

State _____

15-H

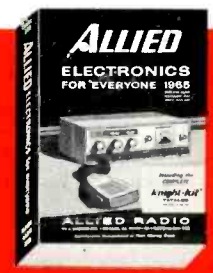

Send card today for

your **FREE**
ALLIED
1965 CATALOG

EVERYTHING IN
STEREO HI-FI & RECORDING
AT LOWEST PRICES ANYWHERE

Name _____
PLEASE PRINT

Address _____

City _____ Zone _____

State _____

15-H

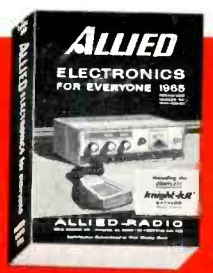

Send card today for

your **FREE**
ALLIED
1965 CATALOG

EVERYTHING IN
STEREO HI-FI & RECORDING
SAVE AS NEVER BEFORE

MAIL
CARD
NOW

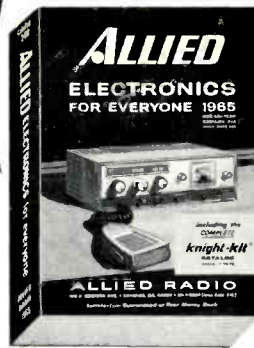

FREE send card today
for your 490-page
money-saving

ALLIED

HI-FI—ELECTRONICS
1965 CATALOG

WORLD'S LARGEST • BIGGEST SELECTION • BIGGEST SAVINGS!

AMERICA'S STEREO HI-FI HEADQUARTERS

SEE THE BIG BUYS • SEE WHAT'S NEW

new knight-kit® build-your-own hi-fi



NEW KG-854
Solid-State 54-Watt
Stereo Hi-Fi
Amplifier—at
amazing low cost



NEW KG-765 Solid-State FM-AM
Stereo Tuner—easy to build, a
money-saving top performer

See many other outstanding do-it-yourself
kits: Hi-Fi, Hobby, Citizens Band, Ama-
teur, Intercom, Test Instrument—wonder-
fully easy to build—savings up to 50%.

money-saving knight® stereo hi-fi



NEW KN-330 Stereo Hi-
Fi Receiver—top perform-
ance at big savings



NEW KN-990A Deluxe Hi-
Fi Record Changer—best
buy anywhere



NEW KN-2350 Speaker
System—acoustic sus-
pension type at lowest
price ever

tape recording values



Top buys in all
makes of recording
tape—big savings
on our own Knight
quality tape

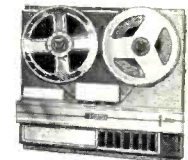

NEW KN-4000A Stereo Tape
Deck—3-motor unit with push-
button controls

more for your money in hi-fi cabinetry: wide selection of period
styles—including money-saving, easy-to-assemble furniture

PLUS EVERYTHING IN ELECTRONICS FOR EVERYONE

- FM-AM & AM Radios
- Phonographs & Accessories
- Citizens Band 2-Way Radios
- Amateur Equipment
- Test & Lab Instruments
- Hi-Fi & Electronics Books
- TV Tubes & Antennas
- PA Systems & Intercoms
- Automotive Electronics Equipment
- Tools and Hardware
- Largest Selection of Electronic Parts, Tubes, Transistors

satisfaction guaranteed or your money back

EASY TERMS: Use the convenient Allied Credit Fund Plan

ALLIED RADIO

100 N. Western Ave., Chicago, Illinois 60680

AMERICA'S STEREO HI-FI HEADQUARTERS

FREE SEND CARD TODAY FOR YOUR
1965 ALLIED CATALOG

and give one card to an interested friend

MAIL
NOW

TO:

ALLIED RADIO

P. O. Box 4398

CHICAGO, ILLINOIS 60680

PLACE
STAMP
HERE

TO:

ALLIED RADIO

P. O. Box 4398

CHICAGO, ILLINOIS 60680

PLACE
STAMP
HERE



0.08% at 15 ips, 0.1% at 7½ ips; rewind time, 1200-ft. reel, 40 sec. Inputs—1 microphone, impedance 150 ohms, sensitivity 0.1 mv; amplifier outputs—1, line, impedance 600 ohms. Dimensions, 19" wide, 15¼" high, 9" deep; weight, 75 lbs. Mono full- or half-track, price, \$1795.00. A18-24.

1..Stereo 2-channel \$2245.00

SONY

● **Model 777S-4 Tape Recorder.** Transistorized; available for either 4- or 2-track stereo recording. Bilateral head accomplishes 4- & 2-track stereo or mono playback with no head shifting, track width or alignment compromise. Sound-on-sound; tape/source comparison monitoring; mike and line mixing; 3 motors, 2-speed hysteresis-synchronous drive motor; pushbutton solenoid-activated operation; remote control for all models; relay operated pause control and military type modular plug-in transistorized electronic circuitry. Complete with portable case and remote control.

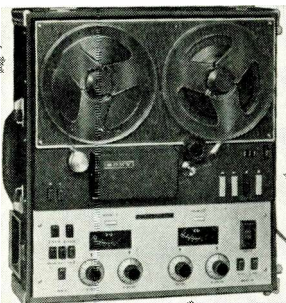

Specifications: Speeds—7½, 3¼ ips; heads—(1) ½-track, (3) ¼-track; records ¼-track stereo, ½-track mono; plays ½-track stereo, ¼ or ½-track mono; reel size 7 in.; 3 motors; timing accuracy 99.8%; freq. resp. 7½ ips, ± 2 db from 50 to 15k cps; signal-to-noise ratio, 50 db; wow and flutter, 0.12% at 7½ ips, 0.18% at 3¼ ips; rewind time, 1200-ft. reel, 60 sec. Inputs—2 microphone, impedance 250 ohms, balanced sensitivity—70 db; 2 high level, impedance 100k ohms, sensitivity—12 db; amplifier outputs—2, line, impedance 600 or 10k ohms; binaural monitor 1, impedance 10k ohms. Dimensions, 16" wide, 17¾" high, 9" deep; weight, 43 lbs. Price, \$695.00. Accessories: SSA-777 amplifier-speaker system, \$175.00. MX-777 stereo mixer, \$175.00. A18-25.

1. 600 \$495.00
2. 500 \$399.50
3. 200 \$239.50
4. 211TS photo sync recorder \$139.50
5. 102 \$129.50

TANDBERG

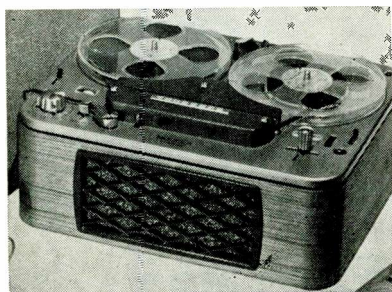

● **Series 8 Mono recorders.** Comprising four models, this series offers a variety of functions and tracks to suit the particular application of the user. Model 821 is fitted for 2-track recording and playback; Model 841 is fitted for 4-track recording and playback.

Models 821F and 841F are identical electrically, but are equipped with built-in solenoids for use with remote-control foot-pedal operation, with foot pedals furnished. Specifications are given for model 821 and are identical with 841 except for head complement.

Specifications: Speeds—3¼, 1½, ips; heads—(2) ½-track, 7 in.; reel size; 1 motor; freq. resp.—3¼ ips, ± 2 db from 40 to 10k cps; 1½ ips, ± 3 db from 40 to 5.5k cps; signal-to-noise ratio, 50 db; wow and flutter, 0.2% at 3¼ ips, 0.3% at 1½ ips; impedance 1 meg, impedance 0.5 meg, speaker outputs 1, impedance 4 ohms; output power 3 watts. Dimensions, 15" wide, 6¾" high 11½" deep; weight, 21 lbs. Price \$219.50. A18-26.

1. 841-4-track \$237.50
2. 821 F with remote control \$294.50
3. 841 F with remote control \$312.50

UHER

● **Royal Stereo 8000.** Lightweight, built-in "echo effect," 4-speeds, colored-light identification of recording or playing position, sound-on-sound, built-in mixer.

Specifications: Speeds—7½, 3¼, 1½, 15/16 ips; heads—3 ¼-track; records 4-track stereo, 4-track mono; plays 4-track stereo, 4-track mono; reel size 7 in.; 1 motor; timing accuracy 99.9%; freq. resp.—7½ ips, ± 3 db from 50 to 20,000 cps; 3¼ ips, ± 3 db from 50 to 16,000 cps; signal-to-noise ratio, 50 db; wow



and flutter, 0.15% at 7½ ips, 0.15% at 3¼ ips; rewind time, 1200-ft. reel, 90 secs. Inputs—3 microphone, impedance 2k ohms, sensitivity 150 mv; 2 high level, impedance 50k ohms, sensitivity 5 mv; speaker outputs 2, impedance 4 ohms; output power 2.2 watts. Dimensions, 14" wide, 13" high, 7" deep; weight, 23½ lbs. Other features: transistorized, may be played with top down and 7" reels, built-in system to synchronize auto. projector with tape. Price, \$499.95. Accessories: sound actuated switch (Akustomat) #817 \$44.95.

1. 4000-Report \$399.95
2. 5000 Universal \$299.95

VERNON

● **47/26 Stereo Tape Recorder.** The name of the recorder comes from its complement of 47 transistors and 26 diodes. Completely self-contained, with dual recording and playback amplifiers and built-in monitoring speakers. Three motors; three heads; all-electronic switching; three controls for each channel (tone, record level, playback level); automatic rewind, replay, and shutoff; three inputs per channel with simultaneous intermix;

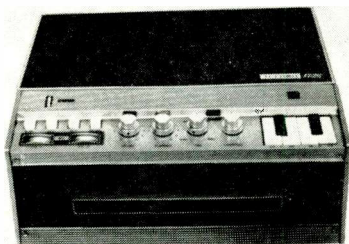

sound-on-sound and echo effects; remote control; pause switch for editing; and monitoring from either the recorded tape or the pre-amplifier input. It can also serve as an audio center for a high fidelity or a PA system.

Specifications: Speeds—7½, 3¼ ips; heads—(3) ¼-track; records 4-track stereo, 4-track mono; plays 4-track stereo, 4-track mono; reel size 7 in.; 3 motors; freq. resp. 7½ ips ± 3 db from 30 to 20k cps; signal-to-noise ratio 50 db; wow and flutter, 0.15% at 7½ ips, 0.25% at 3¼ ips; rewind time 1200-ft. reel, 45 secs. Inputs—microphone; high level; output power 10 watts. Dimensions, 16" wide, 7" high, 13" deep. Price \$600.00 A18-29.

VIKING

● **Retromatic 220** Plays in both directions

automatically, through silence sensor or photo cell reversing or manually with pushbuttons. Built-in preamp and power amp. mixing. Ready for remote control with vertical and horizontal operation. Solenoid-controlled braking.

Specifications: Speeds—7½, 3¼ ips; heads—(4) ¼-track; records 4-track stereo, 4-track mono; plays 4-track stereo, 4-track

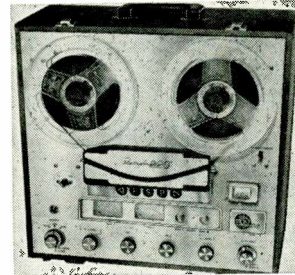

mono; reel size 7 in.; 3 motors; timing accuracy 99.8; freq. resp.—7½ ips, ± 3 db from 20 to 25k cps; 3¼ ips, ± 3 db from 20 to 15k cps; signal-to-noise ratio, 55 db; wow and flutter,—0.2% at 7½ ips, rewind time, 1200-ft. reel, 45 sec. Inputs—2 microphone, high impedance 1 meg., sensitivity 1 mv; impedance 1 meg, sensitivity 100 mv; amplifier outputs—3, speaker outputs 2 impedance 8, 16 ohms; output power 12 watts. Dimensions, 16" wide, 15" high, 7 15/16" deep; weight, 45 lbs. Pushbuttons. Stainless steel front plate. Price, \$860.00. Remote control \$59.95; walnut enclosure \$31.95; portable case \$55.75. Plug-in transformers for low-impedance microphones ea. \$24.95. A18-27.

WOLLENSAK

● **1280 Stereophonic Tape Recorder.** Detachable wing speakers, VU meters, and features vertical or horizontal operation. Tab controls; separate volume and tone controls for each channel; fast forward and rewind with interlocking safety controls; automatic head demagnetization; automatic tape lifters; monitor facility; self-adjusting braking system; built-in reel locks; accessory storage compartment.

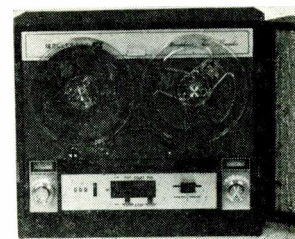

Specifications: Speeds—7½, 3¼ ips; heads—(2) ¼-track; records 4-track stereo, 4-track mono; plays 4-track stereo, 4-track mono; reel size 7 in.; freq. resp.—7½ ips, ± 3 db from 60 to 15k cps; 3¼ ips, ± 3 db from 60 to 7k cps; signal-to-noise ratio, 45 db; wow and flutter, 0.3% at 3¼ ips; Inputs—2 microphone, 2 high level, impedance 1 meg, sensitivity 1 volt; amplifier outputs—2, standard phone jack; speaker outputs 2, impedance 8 ohms; output power 3 watts per channel. Dimensions, 17½" wide, 10 9/16" high, 14" deep; weight, 30 lbs. Price, \$199.00. A18-28.

1. M-2 auto tape cartridge rec \$399.00
2. M-4 automatic tape rec in cabinet \$459.00
3. 1980 ster rec \$379.00
4. 1500 mono tape rec \$179.00
5. 1220 mono tape rec \$129.00

A19. MICROPHONES

AKG



● **D-19E.** A dynamic cardioid microphone provided with a bass attenuation switch for top quality music and speech recording. A five

pin output Cannon connector allows use of 50 ohms, 200 ohms or high-impedance connections.

Specifications: dynamic; cardioid dir. pattern; mylar diaphragm material; metal case; charcoal finish; output impedance 50, 200, hi/ohms; freq. resp. ± 3 db from 40 to 16k cps; length of cable furnished 15 ft.; dimensions—6" long, 1 7/16" dia.; weight 5.7 oz.; swivel adaptor mounting; bass attenuation switch, integral windscreen. Price, \$65.00. Accessories W-24 windscreen, ST-19 table stand, SA-2 clamp adaptor, A19-1.

1. D-19C/60 60-ohm dynamic cardioid \$58.00
1. D-19C/200 200-ohm dynamic cardioid \$58.00

ALTEC

● **683 Cardioid Dynamic Microphone.** The 683A Cardioid Dynamic is a modest-priced version of the 685A. It has the same essential features including the sintered-bronze filter, but does not come with an individually measured Bruel and Kjaer response curve. The 683A is more than adequate for the small broadcast or television station, and for most recording uses.

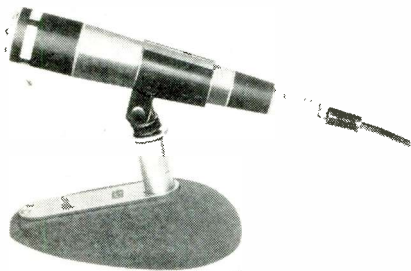

Specifications: dynamic; cardioid dir. pattern; baked enamel finish; output impedance 30/50, 150/250, 20k ohms; freq. resp. 45 to 15,000 cps; length of cable furnished 15 ft.; dimensions—1 1/2" dia., 7 1/4" long; weight 11 oz. Slip-on adapter mounting. Price, \$72.00. A19-2.

1. 682 omni dynamic \$54.00
2. 681 omni dynamic \$42.00

AMPEX

● **Model 200 Microphone.** A high-impedance omni-directional microphone designed for recording applications.

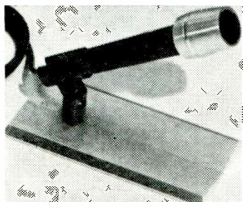

Specifications: dynamic; omni-dir. pattern; freq. resp. 50 to 15k cps; stand mounting; other features: simulated leather carrying case. Price, \$34.95. A19-3.

THE ASTATIC CORPORATION

● **988 "Vogue" Futura-Styled Dynamic Microphone.** The 988 is omnidirectional in a plane perpendicular to the axis of the microphone or with microphone in upright position, and tends to become directional when tilted towards source of sound. "Pop-proof" and "blast-proof" diaphragm. Furnished complete with stand adaptor and lavalier assembly.

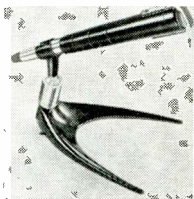

Specifications: Dynamic; omni-directional dir. pattern; mylar diaphragm material; die cast alum. case; satin black finish; output impedance 50, 150 or 250 ohms; freq. resp. 40 to 15k cps; output -57 db; cable connection Cannon XLR-3 lock latch; length of cable furnished 20 ft.; cable end serviced; dimensions—9 11/32" x 1 1/32" dia.; weight 8 3/4 oz.; stand adaptor for 3/8" x 27 thread and lavalier furnished. Price, \$150.00. A19-4.

1. 888 dynamic wide range \$110.00
2. 788 dynamic general purpose \$ 79.50

BEYER

● **M360.** High sensitivity and wide frequency range, immune to humidity or temperature.

Specifications: ribbon; cardioid dir. pattern; output impedance 200 ohms; freq. resp.



± 3 db from 30 to 20k cps; sensitivity—77 db; length of cable furnished 16 ft.; miniature plug. A19-5.

1. M80 dynamic cardioid
2. M610 dynamic cardioid
3. M69 dynamic cardioid
4. M67 dynamic cardioid
5. SM72 wireless microphone

DYNACO—B&O

● **Model 200 Stereo Microphone.** Dual-ribbon stereo microphone designed for broadcast and professional recording applications. The top section (which is rotatable through 90° with respect to the lower section) can be removed for monophonic use. The phase characteristics of the 200 make it unusually well suited to the requirements of multiplex broadcasting, with optimum reproduction and accurate source localization in playback. The 200 is suitable for recording in stereo by either the AB or MS techniques.

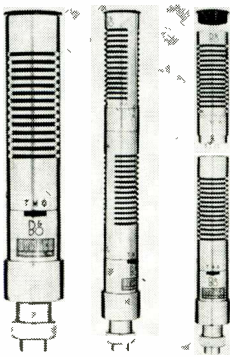

Specifications: ribbon; figure 8 (each element) dir. pattern; duraluminum diaphragm material; steel case; chrome finish; output impedance 200 ohms; freq. resp. ± 2 db from 30 to 13,000 cps; sensitivity (m) = 156 db; 5-pin connector; length of cable furnished 20 feet; dimensions—10 1/2" x 1 3/16"; weight 1 lb.; quick-clip adapter to standard thread mounting; other features: talk-music-off switch, phase switch. Price, \$149.95. Accessories MT-2 stereo matching transformer 2 x 200 to 40k ohms, \$24.95. A19-6.

1. 50 50-ohm mono \$59.95
2. 53 50/250/Hi-Z mono \$69.95
3. 100 200-ohm mono \$89.95
4. 150 makes Model 200 from 100 \$69.95

ELECTRO-VOICE

● **Model 676 Dynamic Cardioid.** Continuously-variable-1) principle for uniform, symmetrical cardioid pattern at all frequencies. High discrimination against feedback and unwanted

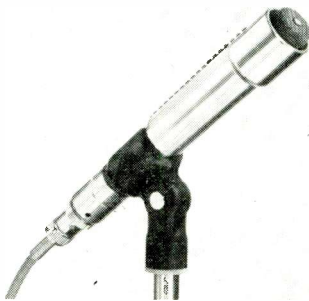

sound. Three-position switch for low-frequency attenuation. Die-cast construction, acoustalloy diaphragm.

Specifications: Dynamic; cardioid dir. pat-

tern; acoustalloy diaphragm material; die-cast case; chrome finish; output impedance 150 or Hi-Z ohms; freq. resp. from 40 to 15k cps; sensitivity—58 db/1 volt/dyne/cm²; cable connection Amphenol MC4; length of cable furnished 16 ft.; Amphenol MC4 plug; dimensions—1 1/4" dia. x 7 3/8"; weight 12 oz.; slip-in clamp mounting; available in matched pairs for stereo recording. Available in satin chrome, gold, or non-reflecting gray finish. Price, \$60.00. Accessories Model 355 windscreen, \$6.60. A19-7.

1. 664 dyn cardioid \$ 51.00
2. 665 broadcast dyn cardioid \$ 90.00
3. 666 broadcast dyn cardioid \$153.00
4. 636 dyn omni \$ 43.50
5. 655C broadcast dyn omni \$120.00

FREEMAN

● **DM-166 Dynamic Omnidirectional Microphone.** Built-in matching transformer, die cast housing, wind screen, furnished in fitted walnut case.



Specifications: Dynamic; omni dir. pattern; mylar diaphragm material; die cast case; gray finish; output impedance 2k ohms; freq. resp. ± 5 db from 35 to 18k cps; sensitivity -55 db; cable connection detachable screw-on standard phone and mini-phone; two lengths of cable furnished each five ft.; chrome slip-on clamp mounting; floor stand coupler also furnished. Price, \$39.95. A19-8.

KNIGHT

● **KN-4550.**

Specifications: Dynamic; cardioid dir. pattern; acoustalloy diaphragm material; die cast case; polished finish; high or low output impedance; freq. resp. ± 5 db from 50 to

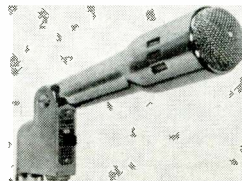

15k cps; sensitivity -56 db; cable connection plug; length of cable furnished 8 ft.; dimensions—7 1/4" x 1 1/4"; weight 2 lb.; threaded mounting. Price, \$34.50. A19-10.

1. KN4500 dynamic \$23.95
2. KN4510 ceramic \$ 7.95
3. KN4520 dynamic lavalier \$11.50
4. KN4515 crystal communications \$12.05
5. KN4506 noise-cancelling ceramic ... \$ 8.95

LAFAYETTE

● **PA-400 Dual-Impedance Unidirectional Dynamic.** Selection of high- or low-impedance outputs by positioning cable connector supplied. May be hand held or used with standard mount desk or floor stand. Equipped with handy on-off switch.

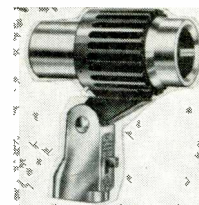

Specifications: Dynamic; cardioid dir. pattern; metal case; black and silver finish; output impedance 50k and 600 ohms; freq. resp. 90 to 10k cps; cable connection 2-conductor shielded; length of cable furnished 10 ft.; weight 2 lb.; standard 3/8"-27 mounting. Price, \$21.50. A19-11.

1. PA-43 omni dyn \$ 6.95
2. PA-409 general purpose dyn \$ 9.95
3. PA-409 dual impedance dyn \$11.95
4. PA-17 omni crystal \$ 4.95

NEUMANN

● **Model U-67 Condenser Microphone.** This newest Neumann condenser microphone was

EXCLUSIVE **Bell** DESIGN

*Start with Amplifier
...plug in Tuner later!*

NEW 80 WATT TRANSISTORIZED Tuner/Amplifier

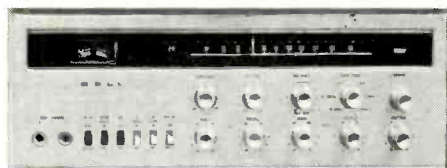
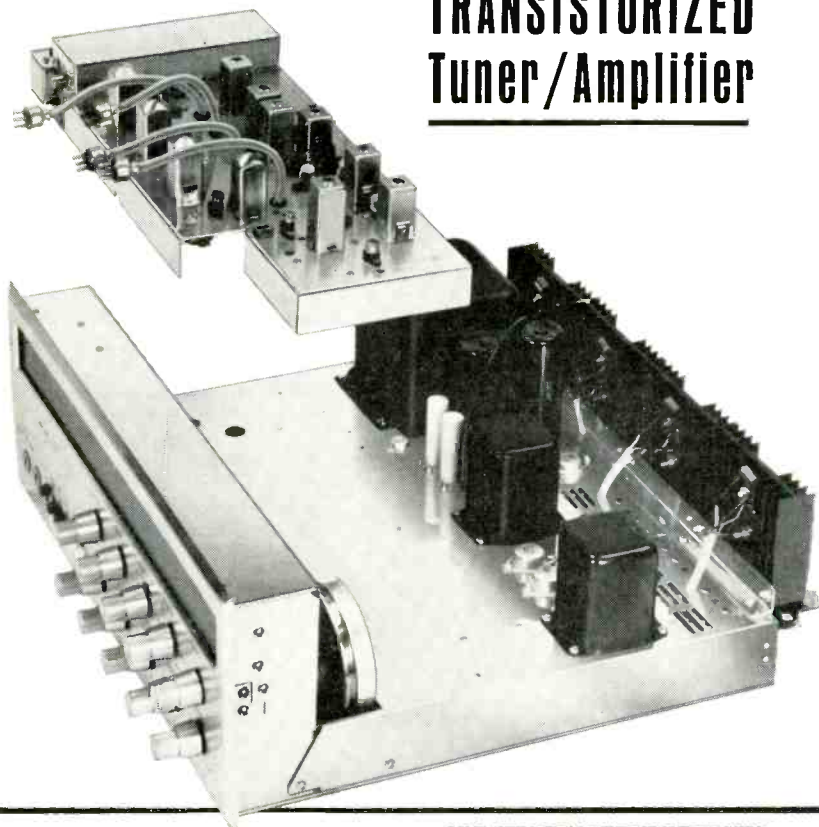

Bell IMPERIAL 1000 FM STEREO TUNER / AMPLIFIER

Unquestionably the ultimate in a stereo component. Transistorized circuitry • Full 80-watt IHFM power output • Frequency response of 9 to 85,000 cycles • Unequaled stereo separation 30 db 20 cps to 15 kc inclusive • Automatic stereo switching • Fully silverplated tuner • Luxurious chrome plated chassis with soft golden panel and striking "cockpit" dial lighting ... \$529.95

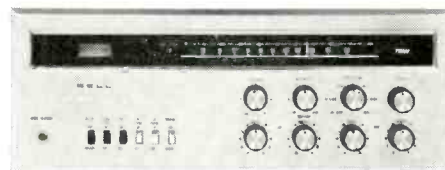

Bell IMPERIAL 900 FM STEREO TUNER / AMPLIFIER

Outstanding technical performance nearly equal to Imperial 1000 • Transistorized • Ultra-high tuner sensitivity • 80-watt power output... 9 to 75,000 cycle amplifier response ... \$469.95

EXCLUSIVE **Bell** DESIGN

*Make tape copies while you
listen to your original tape!*

NEW TAPE DECK TAPE DUPLICATOR

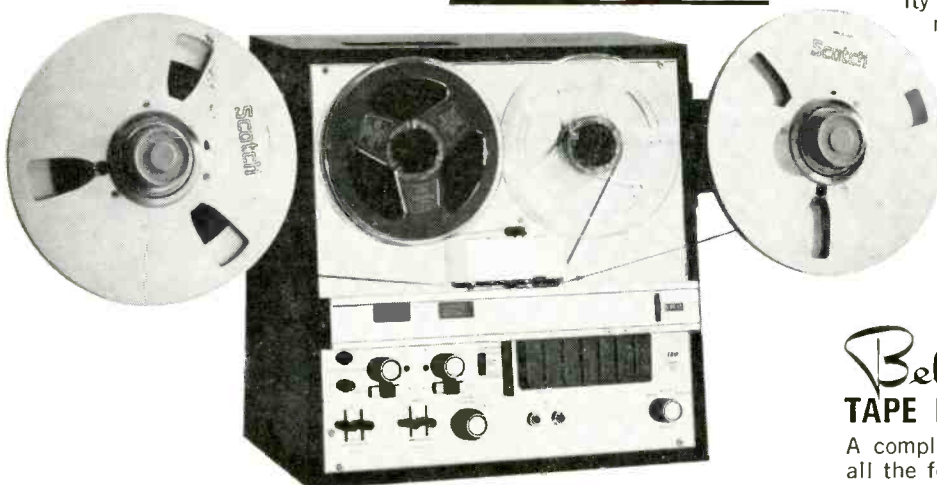

Bell T-367 STEREO TAPE DECK / DUPLICATOR

Now ... a single tape deck that will make copies of pre-recorded tapes... record and playback high fidelity stereo or monaural tapes • Echo and sound-on-sound flexibility • Off-the-tape monitoring • Three-motor drive • Electro-dynamic braking • Attractive polished-chrome deck plate with contrasting black ebony housing... T-367 \$369.95 ... DK-1 Duplicator Motors \$49.95. EB-1 Housing \$24.95

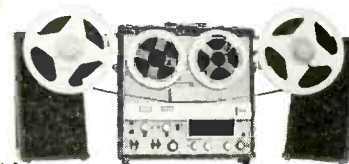

Bell RT-360 STEREO TAPE RECORDER / DUPLICATOR

A complete portable stereo recorder with all the features of the T-367 plus built-in 16-watt stereo amplifier and swing-out speakers ... RT-360 \$449.95 ... DK-1 Duplicator Motors \$49.95

Prices slightly higher in West.

TRW COLUMBUS DIVISION

THOMPSON RAMO WOOLDRIDGE INC.
6325 Huntley Road • Columbus 24, Ohio



Send for New Catalog on the complete Bell line of stereo high fidelity components for your home music center.

especially designed to be a studio recording microphone adaptable to different situations and particularly close microphone pickups. Its "voice-music" switch and overload protection switch make it ideally suitable to multiple mike techniques. It uses an EF86 tube. The Model M 269 is identical to the U-67 except that it offers the possibility of remote control and infinite resolution between patterns.

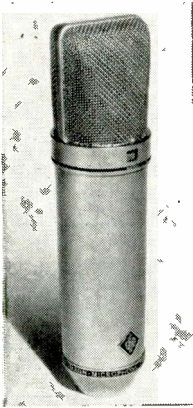

Specifications: condenser; omni, cardioid, figure-8 dir. pattern; Mylar diaphragm material; brass case; chrome sanded finish; output impedance 50/200 ohms; frequency range, 20 to 16k cps; sensitivity 2.2 mv/bar; cable connection 7-pole male Tuchel; length of cable furnished 25 ft.; Cannon XLR 3-32 on output of power supply plug; dimensions—7 7/8" x 2 1/4"; weight 1 lb.; Swivel stand or elastic suspension mounting; other features: fully r.f. protected. Price, \$435.00. Accessories Z 48 full elastic suspension, Z 67 wind and close talking guard, each \$32.50. A19-12.

1. M269 condenser \$495.00
2. SM2 stereo M-S—remote controlled \$795.00
3. KM56 mini 3-pattern condenser .. \$435.00
4. KM54a mini cardioid condenser \$435.00
5. M49b remote controlled pattern ... \$495.00

OMEGA

● **Condenser Microphone.** Individually calibrated, response curve supplied with microphone. Complete with power supply, NuVistor sub-miniature tube used as an impedance matching device.

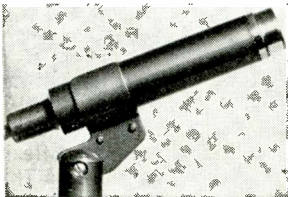

Specifications: condenser; omni dir. pattern; vac. plated alum. alloy diaphragm material; alum. and stainless steel case; enam. finish; output impedance 200 ohms; freq. resp. +3 db from 20 to 20k cps; sensitivity -52 db; cable connection cannon XL; length of cable furnished 20 ft.; cannon plug; dimensions—3/8" x 5"; weight 44 lbs; standard 3/8" swivel mounting. Low Z, price \$150.00. High Z, price, \$130.00. A19-13.

PML

● **EK/EC 61.** One of the smallest condenser microphones available. Choice of 4 impedances. Cardioid EC61 has 85% directivity (15 db rear rejection).

Specifications: Condenser; EK omni, EC cardioid dir. pattern; gold sputtered mylar diaphragm material; metal case; satin chrome

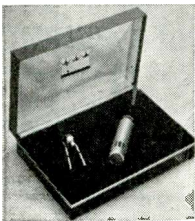

finish; output impedance 50, 600, 200, HI-Z ohms; freq. resp. +3 db from 30 to 18k cps; sensitivity 52 db; cable shielded single co-axial; length of cable furnished 10 ft.; un-terminated; dimensions—length 2 11/16 x 11/16" diameter; weight 1 1/4 oz.; clamp to 3/8" x 27 TPI standard mounting. Requires

power supply. Price \$99.50 (EK); \$109.50 (EC); accessories: power supplies 4315 (AC), \$49.50; 4316 (Battery), \$39.50. A19-14.

1. D-44 dynamic cardioid \$ 49.95
2. C-2 condenser \$259.00
3. ST-6 stereo condenser \$695.00

RCA

● **SK-46 Bi-Directional Ribbon Microphone.**
Specifications: velocity; bi-directional dir. pattern; ribbon diaphragm; metal case; gray and chrome finish; output impedance 200 or 15k ohms; freq. resp. ± 8 db from 40 to 15k



cps; sensitivity -58 dbm; cable connection wired in; length of cable furnished 25 ft.; dimensions—5 1/8" h, 1 29/32" w, 1 3/8" d; weight 13 oz.; swivel; 5/8"-27 thread mounting; price, 49.50. A19-15.

1. 77-DX polydirectional ribbon \$197.00
2. BK-1A non-directional dyn \$ 73.50
3. BK-5B uni-axial ribbon \$146.50
4. BK-6B dynamic lavalier \$ 86.00
5. BK-11A bi-directional ribbon \$131.25

SCHOEPS

● **Professional Condenser Microphone.** The Schoeps CM-66 is designed with a patented multiple pattern single diaphragm made of metal; pattern switching is achieved by altering the acoustical chambers behind the diaphragm. The switching 15-db attenuator between the capsule and the preamplifier prevents overloading and distortion.

Specifications: Type condenser; dir. pattern cardioid, omni, figure 8; diaphragm material solid nickel; case matte satin chrome; output impedance selectable 30/50, 150/250 ohms; output level, -45 dbm/ubar; freq. resp. 30 to 19,000 cps; cable connection Cannon XLR-3; length of cable furnished 33 ft. Price, \$450.00, with A-60 elastic suspension \$470.00. A19-9.

1. M221/26 condenser mic \$460.00
2. CM 640 condenser mic \$415.00
3. M221/24 condenser mic \$440.00

SENNHEISER

● **MD212 Lavalier Microphone.** Freedom from mechanical noise by means of second internal microphone case string-suspended to outer housing; high output level; full sound pickup of persons speaking into the side of the microphone, thus making it applicable for interviewing.

Specifications: omnidirectional dir. pattern; plastic diaphragm material; metal case; non

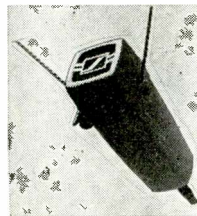

reflecting finish; output impedance 200 ohms; freq. resp. ± 6 db from 80 to 16k cps; sensitivity -59 dbm; cable connection balanced; length of cable furnished 28 ft.; dimensions—3 3/8 x 1 1/8 in.; weight 4.5 oz; without cable neck string mounting. Price, \$110.00. A19-17.

1. MD211 dynamic studio \$115.00
2. MD421 dynamic cardioid studio .. \$ 95.00
3. MKH104 omni transistorized condenser \$195.00
4. MKH404 cardioid transistorized condenser \$230.00
5. MKH804 beam transistorized condenser \$342.00

REMEMBER—do not use reader service card for information—send your own card—use codes.

SHURE

● **Model 550S Omni-Directional Dynamic.**

Specifications: Dynamic; omnidirectional dir. pattern; Shure Duracoustic diaphragm material; metal case; satin chrome finish; output impedance 50, 250, and high; freq. resp. 50 to 15k cps; sensitivity -57.5 db at

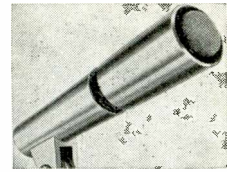

low impedance; cable connection detachable plug; length of cable furnished 18 ft.; Amphenol MC3M plug; dimensions—6 1/16" L x 1 1/2" dia.; weight 2 1/4 lb.; 5/8"-27 stand mounting; "On-Off" switch; 18 ft. cable and plug; integral swivel; convenient impedance change. Price, \$41.40. A19-18.

1. 570S lavalier (with switch) \$69.00
2. 578S omnidyne \$54.00

SONOTONE

● **CM-1050WR.** Low-impedance ceramic microphone. Rugged construction, "floating" armature suspension.

Specifications: ceramic; omnidirectional pattern; hardened aluminum diaphragm material; die-cast case; brushed chrome finish;

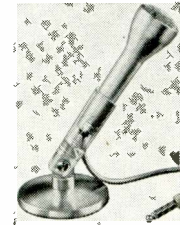

output impedance 250k ohms; freq. resp. 50 to 10k cps; sensitivity -58 db; length of cable furnished 7 ft.; phone plug; dimensions—1 9/16" dia., 5 1/4" long; weight 0.4 lbs; hand held unaffected by heat or moisture. Price, \$18.50. Accessories: CMS-10 stand (die-cast). Price, \$5.00 A19-19.

1. CM-1018 low-imp \$18.50
2. CM-1050SR low-imp voice range .. \$18.50
3. CMC-1050WR above with stand \$23.50
4. CM-3050 low-imp voice range, stand \$15.00
5. CM-3150 3050 less switch \$14.50

SONY

● **C-17B Condenser Microphone.** Unidirectional cardioid pattern making it ideal for stereo recording, as well as TV, night club and public address applications. The frequency response of the C-17B is identical to the well-known Sony C-37A.

Specifications: condenser; cardioid dir. pattern; Mylar diaphragm material; chrome



case; satin finish; output impedance 250 ohms; freq. resp. ± 2 db from 20 to 18k cps; output level -50 db mv/bar at 250 ω; length of cable furnished 30 ft.; dimensions—3/8" dia. x 3 3/4"; other features: Includes power supply, carrying case, and cable. Price, \$275.00. A19-22.

1. C-37A condenser \$295.00
2. F-81 cardioid dynamic \$ 29.50
3. F-32 dynamic omni \$ 27.50
4. F-87 cardioid dynamic \$ 22.50

TANDBERG

● **CM-6. Crystal microphone.**

Specifications: Crystal; freq. resp. 30 to 12,000 cps; length of cable furnished, 12 ft.; Price, \$15.00. A19-20.

3 Ways to Own a Transistor Stereo Amplifier

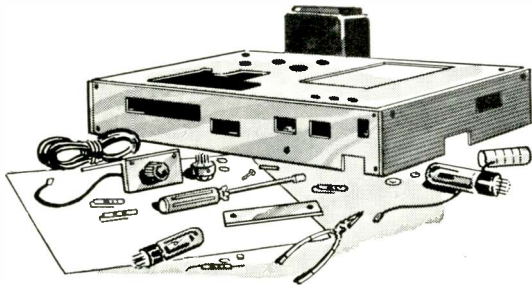

1. The Hard Way

Design It? Buy The Parts...\$170

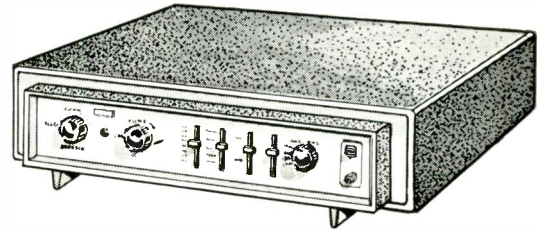

2. The Costly Way

Buy It Assembled...\$204.90 to \$812.00



3. The Best Way

Build The Heathkit AA-21...\$139.95

No Matter How You Look At It, building the Heathkit AA-21 is your best way to own an all-transistor stereo amplifier.

1. Build It From Scratch? This truly is the hard way. You not only have to design it yourself, which is a major, time-consuming task even if you're an audio engineer, but then you also have to find the parts. And you'd have to fashion your own cabinet. If you choose this way, good luck!

2. Buy It Factory Assembled? This is the easiest, but also the most costly way. If you've shopped around, you know that quality factory-assembled stereo components are expensive.

3. The Best Way! Thanks to Heathkit, you can build your own all-transistor stereo amplifier quickly & easily, and *save* up to \$672! Why does a Heathkit cost so little?

First, you buy *direct* from the factory. No dealers...no distributors...no expensive "middleman" profits! Your money goes into *product quality*, not its distribution!

Secondly, since you build it, you save the high cost of labor. And your Heathkit goes together quickly & easily. No special skills or knowledge required! Simple, non-technical, check-by-step instructions take you from parts to performance in a few relaxing leisure-time evenings. Overall result? Better quality at lower cost!

In addition Heathkit provides fast delivery —your order is shipped the same day it's received.

Free technical consultation and performance guaranteed specifications assure you of factory-built results.

Now Take A Close Look At The AA-21! Examine its fresh, modern, designer styling — its handsome, luggage-tan, vinyl-clad all-steel cabinet & sparkling polished trim—attractive enough to enhance the decor of any room! Now push the unique on/off button and listen! Notice the clean undistorted power...70 watts continuous, 100 watts IHFM at ± 1 db from 13 to 25,000 cps! Plenty of "oomph" to produce each sound naturally, realistically! No faltering, no compromising...just pure, unmodified response! This is "transistor sound"...this is the sound of the Heathkit AA-21!

And you enjoy cool, instant, hum-free operation; longer life; and lower power consumption...characteristics unobtainable in tube-types! There are plenty of inputs to handle any program source, and the secondary controls are conveniently located under the hinged lower front panel to prevent any accidental changes.

Assembly is quick & easy with 5 circuit boards plus prewired, encapsulated, circuit modules. A matching transistor AM-FM stereo tuner is also available.

If You Like To Do Things The Best Way, then choose the best way to own an all-transistor stereo amplifier...choose the Heathkit AA-21 *now!*

Kit AA-21, 29 lbs.....\$139.95

FREE 1964 HEATHKIT CATALOG



See this and over 250 other exciting Heathkits available in easy-to-build kit form. Save 50% or more by doing the easy assembly yourself! Send for your free catalog today!



HEATH COMPANY, Dept. 41-8-1
Benton Harbor, Michigan 49023
In Canada: Daystrom, Ltd., Cooksville, Ontario

- Enclosed is \$139.95, plus postage. Please send model AA-21.
 Please send my Free 1964 Heathkit Catalog.

Name _____

Address _____

City _____ State _____ Zip _____

HF-168

Prices & specifications subject to change without notice

Circle 128 on Reader Service Card

UNIVERSITY

● **Model 8000.** Shock-mounted variable-impedance cardioid dynamic designed for the home recordist.

Specifications: Dynamic; cardioid dir. pattern Zamac 3 case; satin, chrome and black finish; output impedance 20k ohms; freq. resp. ± 5 db from 50 to 20k cps; sensitivity -154 db; cable connection Cannon; length

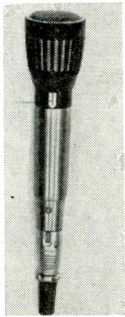

of cable furnished 15 ft.; Cannon plug; dimensions—1 23/32 dia., 6 3/4" length; weight 1 1/4 lbs; hand held or stand (with adapter) mounting. Choice of 2 impedances. Price, \$29.95. Accessories: mic stand and adapter, \$10.37 net. A19-21.

1. 1000	\$81.00
2. 2040	\$30.60
3. 2140	\$45.36
4. 4080	\$52.96
5. 9000	\$24.75

A20. HEADPHONES

ASTATIC

● **2503 Astaticphone.** Mono headset with ceramic boom mike.

Specifications: Ceramic; freq. resp. 30 to 10k cps ± 3 db; impedance 20k ohms at 1000 cps; sensitivity 100 db SPL for 6.5 volts in-put; maximum voltage handling 35 v rms;

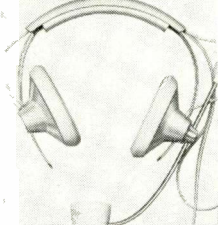

plug cord end serviced; cord 6 ft; net weight 11 oz. Price \$37.75. Accessories: Model BC 1 ear cushions, per pair, \$1.50. A20-1.

1. 2501 ceramic headset	\$25.75
2. 2601 crystal headset	\$22.75
3. 2603 crystal headset with ceramic boom mike	\$35.25

CLARK

● **100 Series.** Polyvinylchloride foam ear cushions provides good coupling with a minimum of discomfort in wearing. Available in three impedances, as noted below, for various applications.

Specifications: freq. resp. 20 to 10k cps ± 3 db; impedance 8 ohms; sensitivity 100 db; maximum power handling 1 watt; Price \$39.50. A20-2.

1. 103 300-ohm	\$39.50
2. 112 1200-ohm	\$44.50

FISHER



● **IIP-50 Headphones.**

Specifications: freq. resp. 30 to 17k cps; impedance 12 ohms; sensitivity 15 mw; maximum power handling 1 watt; plug 3-contact; cord 6 1/2 ft; A20-3.

FREEMAN



● **SEP-100 Stereophones.** Stereo level control adjusts each ear. Stereo-mono switch. Complete with stereo phone plug.

Specifications: freq. resp. 25 to 18k cps ± 5 db; impedance 8 ohms; sensitivity 0.1 mw; maximum power handling 250 mw; plug, standard phone; cord 6 ft; price \$26.95. A20-4.

JENSEN

● **IIS-1 Stereo Headphones.** Lows down to 20 cps without boom. No masking by room noise. No overloading or audible distortion when played at high volume. Complete with jack panel.

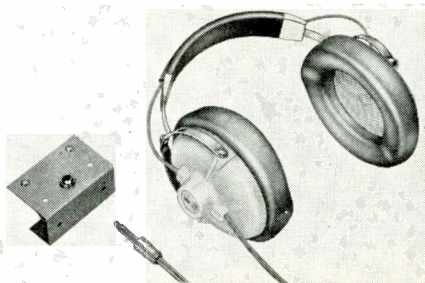

Specifications: Dynamic; freq. resp. 20 to 15k cps; impedance 8 ohms; sensitivity 95 db level for 1 mw; plug 3-contact; cord 8 ft; net weight 10 oz. Price \$29.95. A20-5.

1. HS-1L above w. spade lugs	\$27.15
2. CC-1 stereo headphone control center	\$49.60
3. CFN-1 cross-feed network	\$23.50

KNIGHT

● **KN876 Stereophones.** Individual volume controls on each ear-piece.

Specifications: Dynamic; freq. resp. 15 to 16k cps; impedances 4, 16 ohms; plug 3-cord phone; cord 8 ft; net weight 1 lb. Price \$19.95. Accessories: Replacement ear-cushions. A20-6.

1. KN875 stereo phones	\$14.95
2. KN879 phone control box	\$ 7.95

KOSS

● **SP-3X.** 3 1/2" sound reproducers are mounted in each earpiece, sponge foam ear and head cushions, adjustable headband. Molded of



Implex plastic. Complete with adapter plate that connects to any system. 1 volt at 400 cps will develop 127 db of sound pressure referred to 0.0002 dynes/cm².

Specifications: dynamic; stereo; freq. resp. 10 to 15k cps; impedance 4 ohms; maximum

power handling 10 watts; plug 3 conductor; cord 8 ft; net weight 12 ozs. Price \$24.95. Accessories: T-5 remote control listening station. Price \$8.95. A20-7.

1. PRO-4 headset	\$45.00
2. PRO-600 headset 600-ohms	\$50.00
3. SP-5NS dual mode stereophones	\$24.95
4. SP-5SM stereo/mono phones	\$24.95
5. SP-5VV dual-input stereophones	\$24.95

LAFAYETTE

● **F-767 Stereo Headphones.** Lightweight, air cushioned headband foam rubber earcushions. Supplied with overload junction box for connection to stereo amplifiers without phone jacks. Headband removable for cleaning.

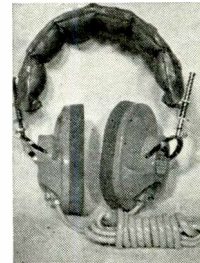

Specifications: dynamic; freq. resp. 30 to 15k cps; impedance 8 ohms; maximum power handling 500 mw; plug standard; cord 6 ft; net weight 11 oz. Price \$11.88. Accessories: F-641 junction box with 2 volume controls. Price \$4.59. A20-8.

1. F-770 stereo headphones	\$19.95
2. F-800 resistor box for F-770	\$ 4.95

PERMOFLUX

● **B-DHS-28 Stereo-Fones.** All units carefully sealed against moisture and dust intrusion. Headband of nickel-plated flexible spring steel, covered with top-grade leather. Earcushion designed for close firm fitting to ears. Molded neoprene cable, with multi-strand cadmium-bronze conductors.



Specifications: freq. resp. 20 to 20k cps; impedance 12/12 ohms; sensitivity 112 db at 1000 cps; plug P1055/3; cord, 5 ft; net wt. 15 oz; Price, \$45.00. Accessories: Stereo-Mono Adapter, 10 ft. cable (AD-250-55/3) \$8.50. A20-9.

1. B-DHS-17 stereo-fones (300/300)	\$52.50
2. B-DHS-600 stereo-fones (600/600)	\$52.50
3. B-DHS-4m stereo-fones (4M/4M)	\$52.50
4. B-DHS-15M stereo-fones (15M/15M)	\$52.50
5. DHS-28 dimensi-fones (25 ohms)	\$42.50

PML

● **D42 Dynamic Headphones.** The impedance, when connected in series is 400 ohms, whereas a parallel connection gives 100 ohms.

Specifications: Dynamic; freq. resp. 30 to 20k cps; impedance 200-ohms per system; maximum handling 5 mw; cable unterminated; cord 6 ft; net weight 180 grams. Price \$24.95. A20-10.

SHARPE

● **Model HA-10 Stereo Headphones.** Liquid-filled, noise attenuating ear seals and dual-



10½" REELS — the Newcomb TX10 takes them . . . and any other size down to 3". Think of the advantages of professional-size reels: You can splice together many pre-recorded tapes to give you *hours* of music without changing reels. You get long playing time from 1.5 mil tape — with all the other advantages of normal thickness: Strong, tough tape. Minimum stretch. Less print-through. Easier splicing and editing. Lower cost per foot. The big-reel feature alone is a compelling reason for choosing the Newcomb TX10. But there's more . . . much, much more . . .

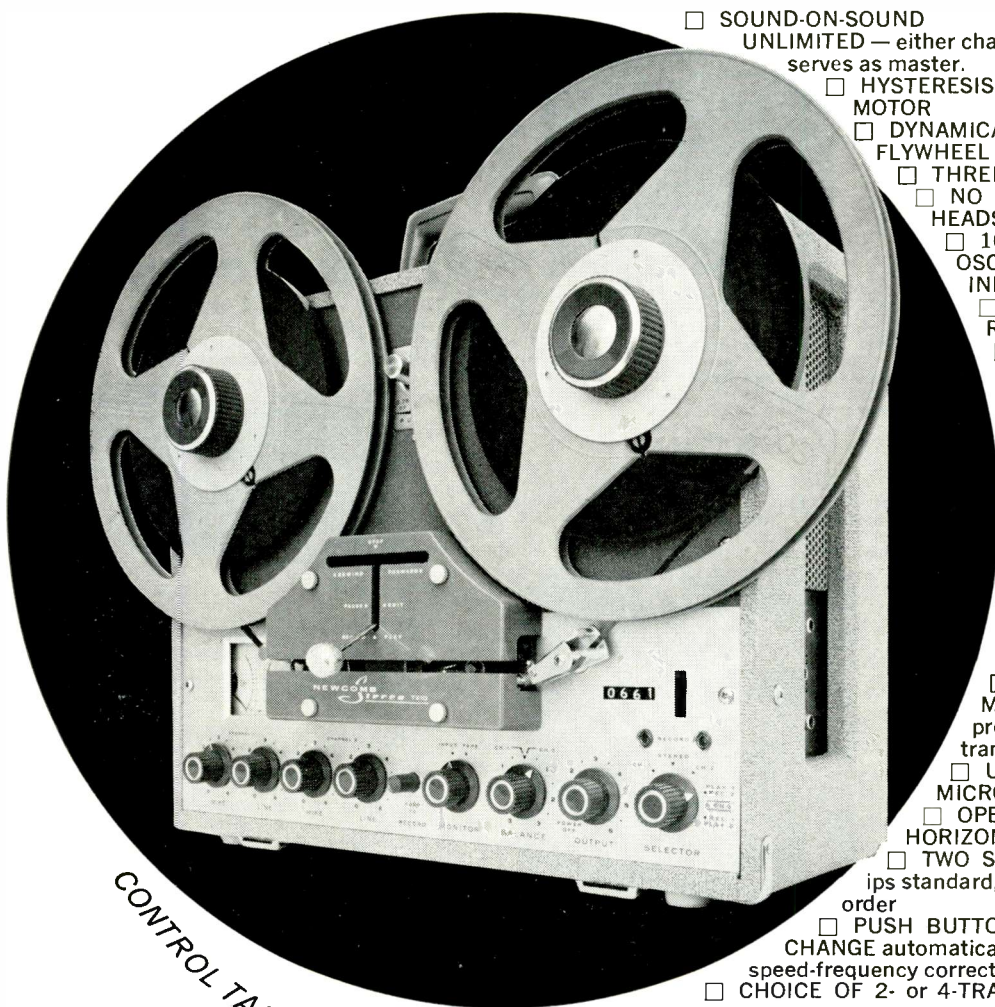

CONTROL TAPE MOVEMENT EASY AS A WISH

- SOUND-ON-SOUND UNLIMITED — either channel serves as master.
- HYSTERESIS SYNCHRONOUS MOTOR
- DYNAMICALLY-BALANCED FLYWHEEL DRIVE
- THREE HEADS
- NO PRESSURE PADS ON HEADS
- 100 KC BIAS AND ERASE OSCILLATORS WITH INDICATOR LIGHTS
- MONITOR BEFORE RECORDING OR OFF THE TAPE
- DIFFERENTIAL BRAKING ON BOTH REELS
- 4-DIGIT COUNTER
- MIXING CONTROLS for "Mike" and "Line" inputs on both channels — four separate, non-concentric knobs.
- AUTOMATIC SHUT-OFF
- PILOT LIGHT
- TWO ILLUMINATED VOLUME LEVEL METERS ARRANGED POINTER-TO-POINTER
- POSITIVE RECORD INTERLOCK prevents accidental erasure.
- HANDLES LONG MICROPHONE LINES; built-in provisions for plug-in input transformers.
- USES CANNON MICROPHONE CONNECTORS.
- OPERATES VERTICALLY OR HORIZONTALLY.
- TWO SPEEDS — 7½ or 3¾ ips standard, 15 & 7½ on special order
- PUSH BUTTON SPEED CHANGE automatically provides speed-frequency correction.
- CHOICE OF 2- or 4-TRACK MODELS

NEWCOMB TX10 STEREO TAPE RECORDER

Easiest to operate; easiest on tape. This is the consensus of Newcomb TX10 owners. All tape movement is integrated in a single, central joystick. Control positions are completely logical; operation is virtually intuitive. Though built for quick reaction to your commands, the Newcomb TX10 provides perhaps the gentlest tape handling available. Even with tape re-winding at 18 miles an hour, Newcomb's differential braking quickly brings a fully-loaded 10½" reel to a smooth, calm, quiet stop. The ingenious automatic tape tension control gyrates tirelessly to protect tape during rapid direction shifts. But only the person who operates one can fully appreciate the clean, natural operation of the TX10. Write for your free copy of Publication TX4.

NEWCOMB AUDIO PRODUCTS CO., DEPT. T-8 HOLLYWOOD, CALIF. 90038
Circle 129 on Reader Service Card

slide headband with padded zip cushion. One-year guarantee, with fixed \$8.00 charge for reconditioning after guarantee period expires.

Specifications: Dynamic; freq. resp. 20 to 20k cps \pm 3 db; impedance 8 ohms; sensitivity 115 db; maximum power handling 2 watts each. A20-12.

1. Model HA-8 stereo headphones \$24.50
2. Model CM-4 stereo headphones \$14.50

SONOTONE

● **"Sono/com" SH-2100 Ceramic Headset.** Low-impedance ceramic headset for learning labs. Immune to temperature and humidity changes. Attractive appearance. Self-adjusting ear cushions. Available in 4 colors (green, coral, suntan, black).

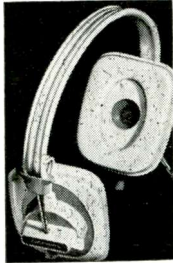

Specifications: ceramic; freq. resp. 80 to 10k cps; impedance 8k ohms; sensitivity 8 dynes/cm²/v.; phone plug; cord 5 ft; net weight 9½ oz. Price \$26.25. Accessories: SB-3100 low-impedance noise-cancelling boom microphone. Price \$20.75. A20-13.

1. SH-2000 hi-impedance headset \$26.25

SUPEREX

● **Model ST-M Stereophones.** Separate dynamic woofer and ceramic tweeter with miniature crossover networks and treble controls, built-in surge protection, soft poly-foam cushions. Fully adjustable headband and separate adjustment centers.

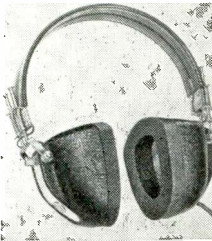

Specifications: freq. resp. 20 to 20k cps \pm 5 db; impedance 8-16 ohms; sensitivity 25 mw; maximum power handling 1.5 watts; plug 3 circuit stereo; cord 7 ft; net weight 16 oz. Price \$29.95. Accessories: Model SC-2, chairside remote control box. Price \$6.95. A20-14.

1. Model ST-MH, same with higher imp. range \$40.00
2. Model ST-S, single element stereo-telephone \$24.95
3. Model SX-800, lightweight stereo-telephone \$21.95
4. Model SX-7MB, with boom microphone \$34.95
5. Model SX-735L "lorgnette" headphone \$14.95

A21. MISCELLANEOUS

AMERICAN

● **Double Duty.** Latest addition to American Professional Length Series of recording tapes. Featuring 2400 feet of ¾-mil tensilized mylar

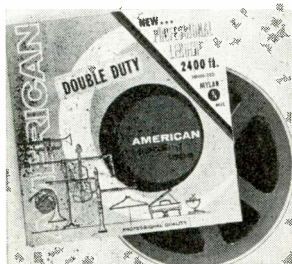

on a standard 7" reel. Extra length plus 50% greater tensile strength. A21-1.

1. D-6 MT 600 ft. mylar 3" reel
2. D-18 MT-5 1800 ft. mylar 5 inch reel
3. D-36 MT 3600 ft. mylar 7 inch reel

AMPEX

● **500 Series Recording Tape.** This is a new line of recording tapes for home audio recorders featuring exterior color-coding in a new package.

Eleven different configurations of thickness and reel size. Mylar is used exclusively

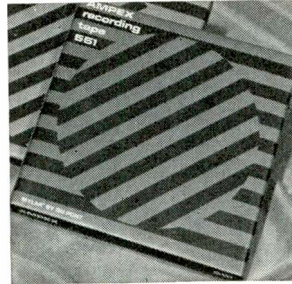

as a base. The new line is packaged in three color combinations that identify the tape by thickness—½ mil, 1 mil, and 1½ mils. The tapes are available in both 5" and 7" reels. A special oxide formulation is used in four tapes in the 500 Series to provide maximum recording quality at speeds of 3¾ and 1½ inches. A21-2.

ARTISAN

● **"Cinema" Model Console.** The newest in Artisan's line of organs. This three-manual console was designed to look and sound like the theater organs of the silent movie era. Only 36" deep, requiring no more space than



a two-manual model. Over 160 independent oscillators are employed along with 18 preamps to produce authentic theater voices. Complete price \$2950. A21-3.

1. "York" kit organ, 2-manual, 25-note pedal from \$1,750.00
2. "Empress" kit organ, 2-manual, 32-note pedal from 2,250.00
3. "Imperial" kit organ, 3-manual, 32-note pedal from \$3,850.00
4. "Chapel" kit organ, 2-manual church type from \$2,750.00
5. "Concert" kit organ, 3-manual church type from \$5,400.00

AUDIO DEVICES

● **Audiotape Magnetic Sound Recording Tape.** Audio Devices also makes blank recording

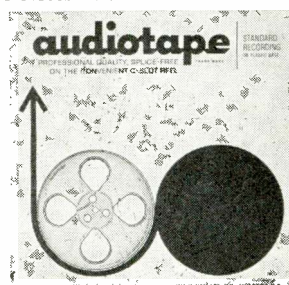

discs, magnetic sound recording film, cutting points for blank discs, continuous-loop magnetic tape cartridge. A21-4.

1. self-timing leader tape
2. head demagnetizer
3. head alignment tape
4. Audiodisc chip chaser

ADC

● **Hush Brush.** Record-cleaning device consisting of 1800 nylon bristles which are spring loaded to exert the correct pressure required



to clean today's fine-cut record grooves. A felt pad releases the correct amount of de-staticizing detergent cleaning fluid to loosen imbedded dirt and to eliminate static. Will not damage records. Price \$11.95. A21-5.

AUDIO ORIGINALS

● **Model 303-D Component Cabinet.** Danish design for shelf speakers featuring space-saving folding doors; pull-out record shelf; adjustable component shelves. Speaker area

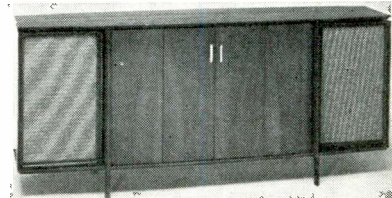

25¼ H x 16½" W. Component shelves, 20¾ W x 5¼" or 7¼" high. Record shelf—17¾" W. Over-all size, 77" W x 32½" H x 17¾" D. Shipped knocked down, easily assembled. Oiled walnut finish. A21-6.

1. 303, similar to above, less doors .. \$109.50
2. 202 B, height 31" \$ 69.50

BARKER & WILLIAMSON

● **Test Instrument Pair.** Model 210 audio oscillator is a source for low-distortion signals from 10 to 100,000 cps. The circuit consists of an RC audio circuit followed by

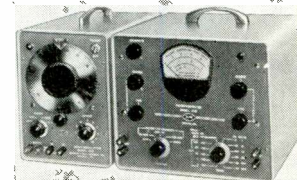

an amplifier of extremely low distortion. The Model 410 distortion meter measures harmonic distortion, noise level, audio gain or loss, and a.f. voltages. The circuit consists of a variable-frequency Wien bridge, followed by a calibrated attenuator and a vacuum-tube voltmeter. A21-7.

1. Model 210 audio oscillator \$165.00
2. Model 410 distortion meter \$189.50

BARZILAY

● **Design One Stereo Ensemble Kit.** The Barzilay Design One stereo furniture three-piece ensemble kit consists of the K61 equipment cabinet kit, and two K62 speaker en-

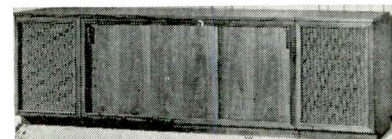

closure kits which may be placed side-by-side or separated. The equipment cabinet and speaker enclosures (in pairs) are available separately. The K61 equipment cabinet features a lift-top for mounting electronics, turntable, and tape recorder, or optional front-mounting of electronics on 3-way control panel which allows the use of one, two or three-piece electronics without wasting space. Almost five feet of record and tape storage is provided behind the three sliding doors.

Specifications: Over-all size—Design One Ensemble: 8'L 18½"D 28¾"H; K61 equip-



Manita de Plata listens to the playback of a stereo master tape which will become "Flamenco Legend" (Connoisseur CS 263). The speakers are AR-3's.

***first playback after the recording:
guitarist Manita de Plata listens to himself
through AR-3's***

Connoisseur Society makes stereo records in 12-inch 45-rpm LP's, of the very highest quality.

Connoisseur engineers recently made a European tour, taking their recording equipment with them. They recorded *Flamenco Legend* (Connoisseur CS 263) with Manita de Plata in Arles, France, where this photo was taken.

Recording engineers make critical decisions on the basis of the playback sound achieved on location. Artificial coloration in the monitor loudspeakers provides false clues to work with, and tends to perpetuate itself inversely in the record. Connoisseur engineers chose AR-3 speakers as producing the sound most faithful to the tape.

The AR-3 (\$203 — \$225, depending on finish) and the lower-cost AR-2a (\$109 — \$128) are often used professionally because of their high quality, but they are primarily designed for the home. AR-3 speakers were selected for the top stereo systems described by three magazines — the September 1963 *Popular Science*, the Fall 1963 *Bravo*, and the 1964 edition of *Hi-Fi/Tape Systems*. A five-year guarantee covers any repair costs, including freight.

ACOUSTIC RESEARCH, INC., 24 Thorndike Street, Cambridge, Massachusetts 02141

Circle 130 on Reader Service Card



KENWOOD solid state stereo

New High Fidelity Stereo Units For Those Who Are Selective

Who's selective? YOU ARE... if you choose the handsome look of KENWOOD with all-new transistorized circuitry. Here are components engineered only for those who expect the big, full sound of quality, demand superior performance and reliability and prefer all those special features.

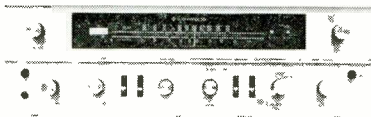

KT-10 ALL TRANSISTOR AM/FM AUTOMATIC STEREO RECEIVER is an all-new transistorized tuner, pre-amplifier and 40 watts main amplifier on a single chassis. Exclusive custom features include an automatic protection circuit that guards against transistor damage, automatic relay switching to proper mode, tape monitor system, front-panel stereo headset jack and so much more. \$299.95



TK-500 TRANSISTORIZED AUTOMATIC FM STEREO TUNER features an automatic protection circuit, automatic relay switching to proper mode, a Nuvistor Cascode Front-end, and tape record outputs. \$199.95



TK-400 ALL TRANSISTOR STEREO AMPLIFIER has a total of 80 watts music power (IHF Standard) or 40 watts per stereo channel, output transformerless circuit, front-panel stereo headset jack and direct tape monitor system. \$199.95

See the complete line of Kenwood receivers, tuners, amplifiers and accessories at your high fidelity dealer, or write direct for descriptive catalogue to:



KENWOOD ELECTRONICS, INC.

New York Office: 212 Fifth Avenue, New York, N.Y. 10010, Murray Hill 6-1590

Los Angeles Office: 3700 South Broadway Place, Los Angeles, Calif. 90007, ADams 2-7217

ment cabinet—57"W 18½"D 28¾"H; K62 speaker enclosures—19"W 18½"D 28¾"H. Interior specifications available on request. Price \$269.50, kit, 8432 assembled, A21-8.

1. K61 equipment cabinet kit, \$161.50
2. K62 speaker enclosure kits (pairs only) \$54.00 (ea.)
3. Design Two stereo console kit \$199.50
4. Design 5 stereo ensemble kit \$249.50

BEYER

• **Model UG-8 Speaker Voltage Divider.** This device enables the user to connect a headphone to any standard amplifier. It is simply

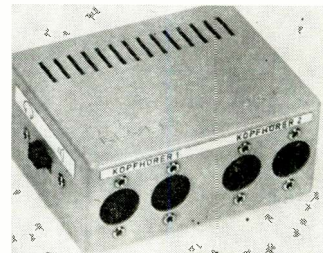

connected between the existing loudspeaker and amplifier and one may listen to either headphones or loudspeaker without disconnecting the set. A21-9.

BURGESS

• **Test Tape.** This "Test Tape" makes it possible for the home tape recordist to check his recorder for maximum recording and playback efficiency without the need for auxiliary test gear. This tape is said to be the first step-by-step explanation that tells the re-



cordist how to check his recorder for fidelity, balance, timing, and frequency response. It will also teach production techniques such as sound-on-sound, splicing, editing, and other ways to use tape and recorder for more home pleasure. Price \$8.00, A21-10.

CLARK

• **Model 830 2-for-1 Adapter.** This is a compact, molded plug adapter for connecting two



stereo headsets to a single jack on an amplifier, tape recorder or stereo receiver. Price, \$5.25, A21-47.

CBS LABORATORIES

• **STR-100 Stereophonic Frequency Test Record.** STR-100 frequency test record tests pickups and systems for sweep and spot-frequency response with voice announcements, channel separation, wavelength loss, stylus wear, compliance, phasing, vertical and lateral tracking, tone arm resonance. \$8.50, A21-11.

1. STR 110 \$10.00
2. STR 111 \$10.00
3. STR 120 \$10.00
4. STR 130 \$10.00
5. STR 140 \$10.00

ELECTRO-VOICE

• **Model NT1 Stereo Mixer Transformer.** Quality one-to-one ratio transformer permits

Circle 131 on Reader Service Card

three-channel stereo reproduction without need for third amplifier. Proper (L+R) signal derived from left and right channels. Also makes possible stereo reproduction with one full range and one limited range speaker system.

Specifications: Impedance: 4, 8 or 16 ohms; response: 20-20,000 cps; dimensions: 4 7/16" W x 3 11/16" D x 4 11/16" H. Price \$17.00. A21-12.



1. AT37 L-pad level control \$ 5.00
2. X36 3500-cps crossover \$13.00
3. X8 800-cps crossover \$42.50
4. X825 800-cps crossover \$24.50
5. X1020 100- or 200-cps crossover .. \$50.00

EMT

• *140 Series Reverberation Units.* A precision manufactured steel plate develops high spectral-energy decay of sound for natural-sounding artificial reverberation. Decay period is variable from 0.5 to 5.0 seconds manually or by optional remote control. Stereo version, EMT 140st. ideal for FM-MX stations and stereo recording. Steel plate in mounting suspension driver and pickup microphone and associated amplifiers. Occupies 8' x 1' x 4' 6". Weight 374 lbs. Operates with 200/600 ohm sources and loads. Price: \$2450.00 mono, \$2690 stereo. A21-13.

1. Remote control conversion kit ... \$ 710.00
2. 140FB mono, remote control \$3250.00
3. 140FBst stereo, remote control .. \$3490.00

FAIRCHILD

• *Model 510 Compressor.* Self-powered automatic sensing device that restores original full range dynamics eliminated due to various recording techniques. The Compressor with automatic gain increase provides dynamic expansion of high levels to compensate for controls placed on original recording of disk, tape, or FM transmission. Not an amplifier; does not introduce distortion. May be switched



for use as compressor for pleasant background music or overload protection in home tape recording and PA systems. A stereo device, may also be used monophonically.

Specifications: 100k ohms to both channels input impedance; output impedance 57k to 470k ohms; power amplifier output needed 40 to 16 ohms; min. control circuit voltage for Compressor action 0.25v a.c.; expansion 6 db per channel; compression 20 db max/channel; attack time 10 m/sec; distortion none; frequency response flat ± 1 db thru entire audio range; a.c. power required, none. Price \$75.00. A21-14.

1. 510K kit version of the Compressor .. \$59.95

FINCO

• *3007 FM Pass Filter.* Installed in the antenna lead line at (or near) the set, this FM filter guarantees complete block-out of interference. Passes *only* FM signals. Is used to eliminate interference to FM reception from TV stations, Citizen Band and amateur transmitters, electric motors, fluorescent lamps, automobile ignition, so on. Price \$6.95. A21-15.

1. FM-4C antenna \$14.64

FISHER

• *Model 50 Portable.* High fidelity system in a "suitcase" featuring transistor electronics. Measuring only 2 3/4" by 1 1/4" by 8", the compact case contains a low-noise preamp with a full complement of audio controls a 30-watt

Who says a professional-grade, ribbon-type mike has to cost a small fortune?

Most audio engineers agree that microphones with ribbon-type generating elements give the best acoustic performance obtainable... the smoothest, most distortion-free response over the broadest frequency range.

Most ribbon-type mikes are therefore quite expensive... up in the hundreds of dollars.

But not the RCA SK-46. It gives you a frequency-response of 40 to 15,000 cps

...and it costs only \$49.50*

What's so special about ribbon-type mikes?

There are 7 basic types of microphone generating elements: ribbon, condenser, magnetic, dynamic, ceramic, crystal and carbon. RCA sells all 7, so we can be relatively impartial about the advantages of the ribbon type.

A typical ribbon element (special aluminum alloy foil 0.0001" thick) weighs only about 0.25 milligram—hundreds of times lighter than generating elements in, say, dynamic and condenser mikes. The ribbon, in fact, is as light as the air mass that moves it, which accounts for its exceptional sensitivity.

In fact, of all 7 types of generating elements, the ribbon-type element is superior in:

- ★ Smoothness of response
- ★ Breadth of frequency range
- ★ Immunity to shock and vibration
- ★ Adaptability to various impedances



- ★ Low hum pickup
 - ★ Immunity to temperature and humidity variations
- That's why most of them cost so much.

But now you can get the remarkable RCA SK-46 bi-directional ribbon-type mike at Your Local Authorized RCA Microphone Distributor — For Only \$49.50*.

For full technical information—or the name and address of your nearest distributor—write: RCA Electronic Components and Devices, Dept. 451, 415 So. 5th St., Harrison, New Jersey.

*Optional Distributor Resale Price

RCA Electronic Components and Devices, Harrison, N. J.



The Most Trusted Name in Electronics

Circle 132 on Reader Service Card

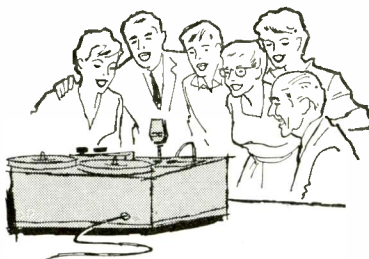
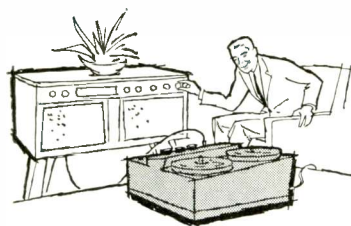

WHY

you should buy and enjoy TARZIAN TAPE

Most of its users say that Tarzian Tape is the finest tape you can buy for the entire range of audio recording purposes, from stereo music to school work. Tape dealers who sell Tarzian Tape do so because they believe it is a very good product for you, the user—not because we give them fancy advertising support and free premiums.

ITEM	Reel Size	Length (Feet)	Code Number
Standard Play	3"	150	1131-01
	5"	600	1131-06
	7"	1200	1131-12
	Reel	2400	1131-24R
Acetate Tape	Hub	2400	1131-24H
Long Play	3"	225	1121-02
	5"	900	1121-09
	7"	1800	1121-18
	Reel	3600	1121-36R
Acetate Tape	Hub	3600	1121-36H
Long Play	3"	225	1321-02
	5"	900	1321-09
	7"	1800	1321-18
	Reel	3600	1321-36R
Mylar Tape	Hub	3600	1321-36H
Extra Long Play 0.5 Mil	3"	300	1411-03
	3 1/4"	.600	1411-06
	5"	1200	1411-12
	7"	2400	1411-24

The package for Tarzian Tape is strictly functional, not ornate. The price is standard: not cheap like "white box," not artificially high because of some "magic ingredient." The quality is professional, not because you run a recording studio or a radio station, but because any good tape recorder deserves it and any discriminating pair of ears appreciates it.

Insist on Tarzian Tape... depend on it for long lasting, professional quality performance whatever your recording assignment.

FREE... Tarzian's "Lower the Cost of Fun With Tape Recording" contains 32 illustrated pages of tape tips. Send for your free copy.



SARKES TARZIAN Inc.

World's Leading Manufacturers of TV and FM Tuners • Closed Circuit TV Systems • Broadcast Equipment • Air Trimmers • FM Radios • Magnetic Recording Tape • Semiconductor Devices
MAGNETIC TAPE DIVISION • BLOOMINGTON, INDIANA
 Export: Ad Auriema, Inc., N.Y. • Canada: E. J. Piggott Enterprises Ltd., Toronto, Ont.

Circle 133 on Reader Service Card

(IHF) power amplifier, a Garrard changer, equipped with Pickering magnetic cartridge, and two detachable, full-range loudspeaker systems, which can be placed up to 20 feet apart. The unit features instant 'warmup' and automatic shutoff. Two additional pairs of inputs are provided for auxiliary sources. Price \$229.50. A21-16.

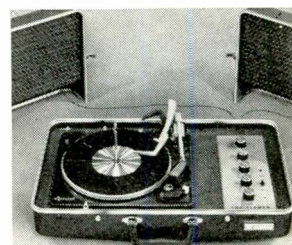

1. Model 75 custom module, identical electronics, larger component-type speakers.

"FM/Q"

• *Dynaplex Broadband FM Antenna*. A quality-made eight-element broadband FM antenna designed especially for stereo multiplex reception. Made of heavy-duty seamless aluminum

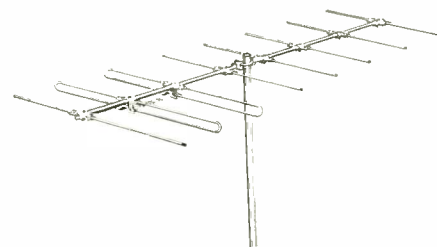

tubing, with burnished anti-corrosive finish. All hardware used is rustproof stainless steel, including the "U" bolt. Price \$32.50. A21-17.

1. Dynaplex two-bay stacked array ... \$ 66.96
2. Super Mark I, 12-element broadband yagi ... \$ 49.96
3. Super Mark II, 2-bay stacked array, mast ... \$149.96
4. Metropolitan 5-element broadband .. \$ 14.95
5. Junior 5-element broadband \$ 19.96

FREEMAN

• *Model 1400 Preamp-Mixer*. Mixes and controls any combination of four microphones, tuners, phonos, radios, and so on for use with any tape recorder or amplified at conferences,



rehearsals. Four high-impedance channels, four independent controls; gain, 6 db; uses single 9-volt battery. Inputs—four standard phone jacks; output, one phono socket. Dimensions: 6" wide, 2 1/4" high, 3 1/2" deep, weight, 1 1/4 lbs. Price \$24.95. A21-18.

GRADO

• *"Dustat" Record Cleaner*. This cleaner substantially reduces the electrostatic charge in records and removes dirt and grit. The Dustat

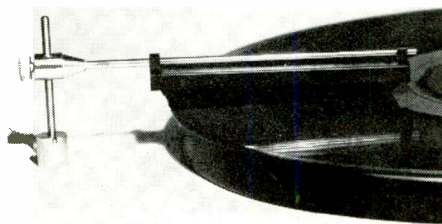

is easy to install and is fully adjustable for any turntable. The device does not contain radioactive materials, nor does it use any fluids. Price, \$6.95. A21-19.

HEATHKIT

● **AE-20 Equipment Center and AE-40 Matching Speaker Cabinet.** Custom designed for Heathkit components; holds most hi-fi components; factory assembled, ready to use; factory finished in beautiful walnut; available for custom finishing.

Specifications: AE-20 cabinet over-all: 36" W x 32 3/8" H x 19" D. Finish: walnut. Changer compartment: 17" W x 15 3/4" H x 17" D. Tape recorder compartment: 14 1/2" H x 17" W x 17" D. Shelf compartments: 17" W x 6" H x 17" D. Power amplifier compartment: 8 3/4" H x 17" W x 15 1/8" D. Tape drawer is optional.



AE-40 matching speaker cabinet handles either 12" or 15" speakers. Price AE-20 \$79.95 (unfn.), \$99.50 (walnut). A21-21.

1. AE-135 Early American \$115.00
2. AE-235 Early American speaker cabinets \$55.00 each

JERROLD

● **FMP-16 "Paralog" FM Antenna.** "Paralog" FM antennas have extremely high front-to-back ratios and negligible minor lobes for the elimination of co-channel interference. Their low V.S.W.R. provides the freedom from

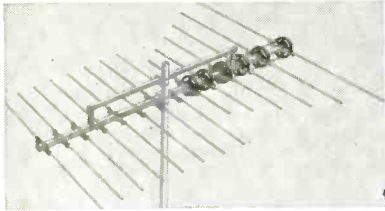

standing waves so necessary to prevent "suck-outs" on particular stations and reflection losses in the antenna system. The exceptionally high gain (up to a realistic 11.6 db on the FMP-16) delivers signals that let the tuner do its best—producing hiss-free, fully limited FM reproduction. Flat response assures good reception on all channels and the high-gain and narrow forward lobe provide the best possible results for the elimination of multi-path problems. Price \$59.95. A21-22.

1. FMP-8 FM antenna \$29.95
2. FMP-10 FM antenna \$39.95

JFD

● **LPL-FM10 Antenna System.** This new series overcomes the power loss and range limitations of multiplexed FM stereo, and delivers up to 58 per cent more gain than 10-element Yagi antennas. Provides flat response over the entire FM band. Constructed of gold-

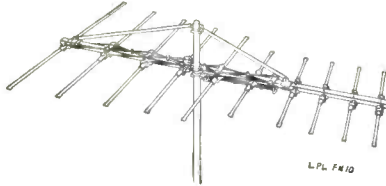

anodized aircraft aluminum with sufficient rigidity for rotor installations. Price \$49.95. A21-23.

1. LPL-FM8 8-cell antenna system .. \$39.95
2. LPL-FM6 6-cell antenna system .. \$29.95
3. LPL-FM4 4-cell antenna system .. \$19.95

KERSTING

● **A-85 Quick-See Album File.** This file gives you a front view, flip through selection of record albums and tapes with adjustable back rest. Albums are nestled in the file which rolls forward on ball bearings, eliminating jacket wear. The Quick-See is all steel, welded, with polished steel ball bearings. Available in 9 different sizes, brass finish. **Specifications:** 13" high, 14 1/2" wide, 14"

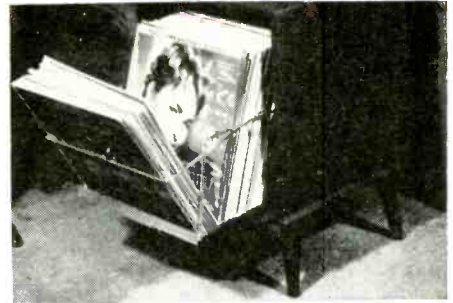

deep; capacity: 85 12" LP's. Price \$12.95. A21-24.

1. 8-13 \$ 7.95
2. A-70 \$11.95
3. A-100 \$13.95
4. A-125 \$16.95

KLH

● **Model 15 Compact Stereo Phono System.** This system is assembled of a carefully matched group of high-quality components, including full-range, small-cone, high-compl-



ance KLH speakers (2 in each enclosure). Solid-state stereophonic amplifier with an output of 15 watts music power and more than 30 watts peak. Other components include a new KLH changer built by Garrard, and a Pickering V-15 magnetic pickup with a diamond stylus. Controls are provided for vol-

AKG... when performance counts most!



CONDENSER • DYNAMIC MICROPHONES

AKG of America • Division of North American Philips Company, Inc. 125 Park Avenue, New York, N. Y. 10017

6-64

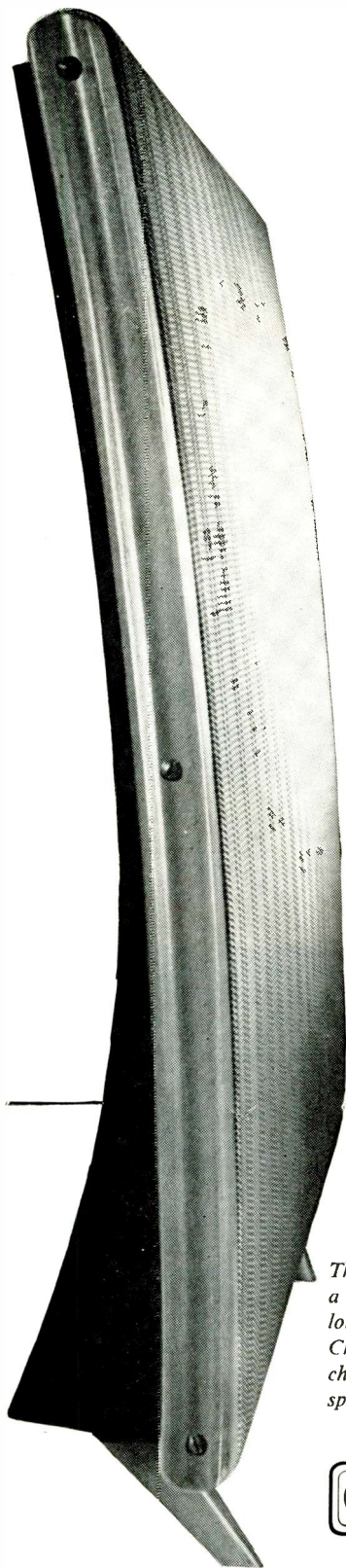

completely lacking in character?



The depth probing Ad-men will shudder at the use of such a title but we can think of no better description for a good loudspeaker.

Character in the music; character in the instruments; character in the artist—yes, but no character in the loudspeaker, please!



for the closest approach to the original sound.

WRITE FOR AN ILLUSTRATED LEAFLET AND THE NAME OF YOUR NEAREST QUAD DEALER TO ACOUSTICAL MANUFACTURING CO. LTD. HUNTINGDON, ENGLAND

Circle 135 on Reader Service Card

ume, balance, bass (15 db cut or boost), treble (15 db cut or boost), mono or stereo mode, and phono or auxiliary program source. Dimensions: control center: 4"H x 18"W x 14"D; Enclosures: 8"H x 14"W x 8 1/4"D. Shipping weight: 50 lbs. Finished in oiled walnut only. Price \$259.95. A21-25.

1. Model Eleven portable stereophonic phonograph \$199.95

KODAK

• *Sound Recording Tape.* Kodak sound recording tape is a general-purpose magnetic tape featuring low noise, high sensitivity, high output, full audio-frequency range, and consistent uniformity, both within each roll and from roll to roll. These properties enhance

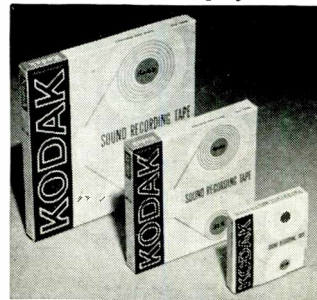

the performance of any tape recorder and permit recordings of highest fidelity with fine recording equipment. Available in five popular sizes: 1.5-mil Triacetate, standard play, in 1200-, 600- and 150-ft. reels of 7-, 5- and 3-in. diameter, respectively, and in 1-mil Triacetate Extra Play in 1800- and 900-ft. reels of 7- and 5-in. diameter. A special "splicing slot" is provided on the face of the Thread-Easy Reel. A21-26.

LAFAYETTE

• *TM-45 Stereo VU Balance Meter.* Helps to balance a stereo system perfectly. Two damped loudness meters calibrated in db and per cent provide a continuous comparison of



speaker levels. Does not load circuit. Individual attenuation controls, calibration switch. Size 6" W x 3 1/4" H x 2 7/8" D. Shpg. wt., 3 lb. Price \$7.95. A21-27.

1. PK-224 "Stylochron" 1000-hour stylus wear timer \$ 3.95
2. PK-223 stylus pressure gauge \$.99
3. MS-785 tone arm lift control \$ 1.95
4. ML-120 bulk tape eraser \$18.95
5. PK-238 tape head demagnetizer \$ 3.95

JBL

• *C58 "Delphi" Equipment Cabinet.* Styled to harmonize with the JBL "Olympus" and "Apollo." Hand-crafted of selected hardwoods, and 3/4" stock throughout. The top is divided into three counter-balanced sections. Two concealed front-opening doors give additional flexibility in installing components. Available in mahogany, tawny walnut, oiled walnut, Danish teak, and ebony. Height 26 1/2", width (top) 64 3/8", depth (top) 20 3/8", price \$396.00. A21-29.

3M

• *Low-Noise Recording Tape.* Signal-to-noise ratio three to five db better than conventional tapes, extremely good high-frequency sensitivity and an ultra-smooth coating for all critical applications. Long wear and low rub-off characteristics help to make most recording machines sound better. Price \$4.50 a roll. A21-30.

1. Low Noise 201, economy \$4.50 a roll
2. Low Noise 202 polyester \$5.10 a roll
3. Low Noise 203 extra strength .. \$7.35 a roll

MICRO

• *MDP-1. Record Cleaner.* The dust pickup device consists of a "Pair Cleaner" system which employs a brush together with a disc cleaner which wipes off the dust dislodged by the brush. The cleaner is saturated with an anti-static liquid which renders the disc sur-

face impervious to static charges so that it no longer attracts dust. A21-31.

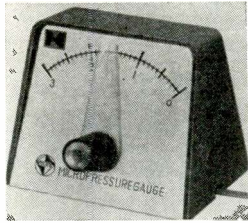

1. MPG-2 stylus pressure gauge
2. MPG-3 stylus pressure gauge
3. MSS-1 stylus scope

MULLARD

● *Matched Pairs.* The widest range of Matched-Pair tube types available. Each pair

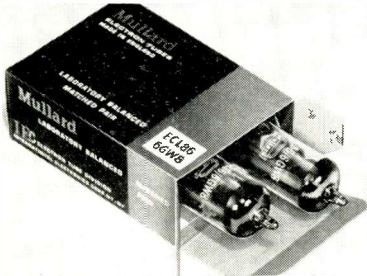

is laboratory-balanced and reflect traditional Mullard quality of construction and performance. A21-32.

MULTITRON

● *MA-44 FM-Stereo Antenna.*

Specifications: Provides at least 20-db gain over standard, reference dipole at any frequency in the FM band. Printed, distributed constants replace conventional components for greater precision and reliability in critical parts of the circuit. Cardioid pattern responds to transmissions from different directions but permits positioning for rejection of unwanted signals. Price \$29.95. A21-33.

NORTRONICS

● *1200 Series Record, Record-Play Heads.* New four-track stereo, laminated-core heads with all-metal, hyperbolic face construction; replaces older TLB, CSQ, ASQ, and 1100 styles. Model 1200, high-Z (L=800 mh) 100

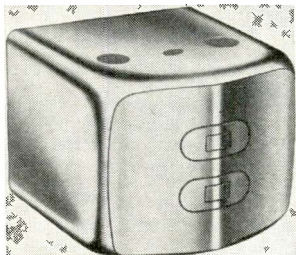

μ-in. gap; for use with tube circuits. Model 1201, medium-Z 400 mh; 100 μ-in. gap; for use with transistor circuits. Model 1203, low-Z record only (L=50 mh) 500 μ-in. gap; for use with tube or transistor circuits. Model 1205, medium-Z (L=200 mh) 500 μ-in. gap; for use with tube circuits. Price \$28.20. A21-34.

RADFORD

● *Low-Distortion Oscillator and Measuring Set.* New techniques permit accurate measurement of total distortion as low as 0.0005%, without auxiliary equipment. Also permits generation of square waves of similar quality. Invaluable for developmental engineer.

Specifications: Oscillator: freq. range. 5 cps to 250 kc in 5 bands. Impedance output —10k pot; or 600-ohm T attenuator; output voltage 10v. rms on pot; +20db on 600 ohms. Distortion: 0.006% max at 600 ohms; 0.003% max. at 10k. Hum—better than minus 100db. Square wave conversion—rise time 0.1 microsecond; no overshoot. Distortion measuring —20–20kc. All components of highest quality; tropicalized. Price \$600.00. A21-35.

ROCKFORD

● *Record Storage Cabinet 520.* Decorator-inspired unit equipped with lift-top lid, tilt-
(Continued on page 83)

"the only automatic... for finest systems

...bids fair to reduce the 'superiority' of manuals from fact to fiction."

The American Record Guide, Jan. 1964

All the experts agree:

"... will function as well as any good separate tonearm... the most compliant cartridges, operating at the lowest forces for which they are designed, can be used..." *HiFi/Stereo Review, January, 1964*

"... fully capable of operating with a tracking force of 0.5 grams, as rated. The trip mechanism operated flawlessly at this force, with no evidence of side thrust on the cartridge..." *Electronics World, March, 1964*

"... tracked perfectly well with the table tilted to almost 90°, with warped records and with eccentric records... means that the arm is balanced in all planes... the ability to vary speed is a real asset." *Audio, November, 1963*

"... variations in line voltage, as well as in the number of records placed on the turntable, had very little effect on the speed, so that speed accuracy and speed constancy (under a wide range of operating conditions) were truly excellent." *High Fidelity, November, 1963*

"... I can drive a pair of AR3 speakers with full bass boost on the amplifier and still not hear objectionable turntable rumble. (When I try this with most record changers, they make a sound like a subway rolling through my living room.)" *Popular Science, February, 1964.*

Complete reprints of these sensational reviews are yours for the asking. Better yet, see the Dual 1009 demonstrated at your audio dealer. An outstanding value at \$99.50

DUAL 1009 Auto/Professional Turntable and its extraordinary tonearm



UNITED AUDIO  DUAL

12 West 18th St. New York, N.Y. 10011

Circle 131 on Reader Service Card

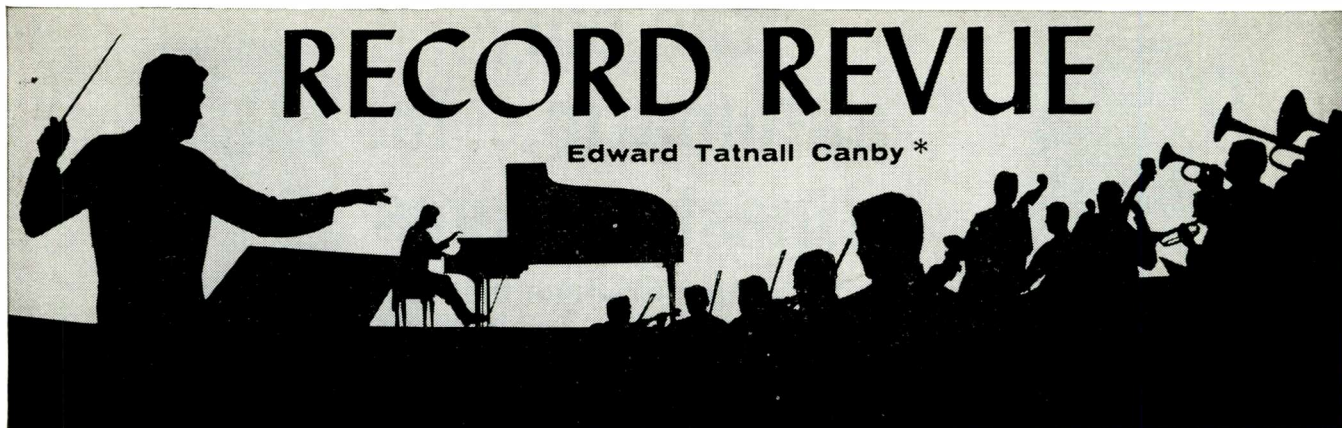

MOZART

A Solemn Requiem Mass in honor of John Fitzgerald Kennedy. (Includes the complete Mozart Requiem, with soloists, massed Boston choirs and the Boston Symphony under Leinsdorf.)

RCA Victor LSC 7030 (2) stereo

Unbelievable. After only a couple of months' sale, this album produced such revenue that RCA Victor presented a check for \$20,000, the gross profits in that short time, to the Kennedy Library! You can figure how fast it was selling and, we can assume, still is. Unprecedented. And Mozart went along with it.

Mozart went along, too, with the complete TV-radio coverage of the actual event on Jan. 19, 1964. He was therefore heard by more people than have heard the famous "Requiem" in all the 170-odd years since its composition. Fantastic.

Well, I'd best report objectively on the music which fills much of the recording, the Mozart itself. Its first interest is that here for the first time the music was incorporated into a complete Requiem service. The musical numbers come in their proper place, with much other material between, most of it chanted by the familiar voice of Cardinal Cushing, occasionally answered by a male choir of seminarians in the responses. An interesting experience for those of us who know the music (and other music of the sort) in the usual concert form.

As to the performance of the "Requiem" itself, it was physically much oversized (five Boston-region choirs and the whole Boston Symphony) but in spite of the grand blur it was a moving performance. It was bound to be. For these were musical people and they expressed their deep feelings directly in the music at hand—which is very well able to carry all the emotion they could put into it.

As for the Cardinal's music, the less said the better. He is a faithful American and he merely reflects standard American practice in singing out of tune. (The earnest young seminarians who did the responses were bound and set to sing Gregorian chant in a real high-minded style but he threw them off pitch.) It is, indeed, strange to hear that familiar and somewhat raucous voice chanting between segments of pure Mozartean art; but it was a sincere sound, too, and thereby a good sound on this occasion.

I was least happy about the dismal musical prelude and postlude on the organ, abjectly faded out on cue. Meaningless, reflecting no credit to anybody as part of such a solemn musical service as this. It's on the record.

Schubert: Mass in G

Mozart: Missa Brevis in B Flat, K. 275. Soloists, Chorus, Orch. Freiburg School of Music, Froitzheim.

Decca DL 710091 stereo

Two lovely short masses, the very early one by Schubert, all song from beginning to end, and one of the short early Mozart masses, joyous and full-blooded in the style that was expected and accepted in the later 18th century church.

The Mozart is a very lovely performance, by an earnest and musical choir of students plus adequate soloists and a nice orchestra. The Schubert, for some reason, is less clear: the words are mumbled and unintelligible and the details are fuzzy. Still—not half bad.

Mozart: "Haffner" Serenade, K. 250. Bavarian Radio Symphony, Kubelik.
D. Grammophon 138869 stereo

A splendid performance of the seldom heard "Haffner" Serenade (not the symphony of the same name but an earlier piece, commissioned for a big Salzburg wedding banquet). Czech-born Kubelik puts drive into it and an occasional overmannered effect, but generally the playing is impeccably accurate and intense at the same time—as it should be. There's much emotional expressiveness here, as so often beneath Mozart's suavely decorative banquet-music style.

This is a big serenade and a long one, meant to carry on through the whole of a pre-wedding banquet evening. It is actually a lively symphony and a violin concerto combined; there are the four movements of the symphonic form plus an interpolated series of movements with violin solo, complete with cadenza—that would have been Mozart himself, playing before the assembled guests. The whole occupies two good LP sides and it'll provide a superb big-stereo accompaniment for your banquet, if you want.

Mozart: Concerto for Flute and Harp, K. 299. Telemann: Suite in A Minor (Flute). Elaine Shaffer, fl., Marilyn Costello, harp; Philharmonia Orch., Menuhin.

Angel 536189 stereo

Here the impresario Menuhin assembles an all-American solo team (harp and solid-gold flute shipped from the U.S. by air) with a crack British orchestra for some felicitous music-making, nicely combining the American virtues of high-class technical precision with the British virtue of informed stylistic understanding, which is Yehudi's too. The Mozart piece, commissioned by a French aristocrat who played flute to his daughter's harp, is often tossed off as a minor work of unimportance; here it gets a sympathetic and musically respectful treatment that shows its real values, most humanly.

The Telemann Suite has been rivalling the Bach B Minor Suite (No. 2), also with solo flute, in recent years. It is a similar piece, but less complex than the Bach, with juicier, more "advanced" harmonies and a more compliant feel to it. The two make an excellent comparison, rather nicely summing up their respective composers' characteristic personalities. The sound here is a bit too big for the music, more on a symphonic level, but the styling is good, with correct continuo accompaniment from the harpsichord.

HAYDN & WIFE

Haydn: Symphonies Nos. 6, 7, 8 ("Le Matin," "Le Midi," "Le Soir"). Chamber Orch. of the Sarre, Ristenpart.

Nonesuch H-71015 stereo

For the first time on stereo disc, these

three wonderful little concerto-symphonies of Haydn are here brought together on a single platter. (They were once issued by the old Haydn Society on mono disc, later reissued on mono tape—all now discontinued.) The Library of Recorded Music series has them too, but on two different discs along with other material.

The Nonesuch recording is the best to date—this Sarre music, now appearing on several U.S. importing labels, is worth watching carefully, especially when the conductor is Karl Ristenpart. These playings are not quite as authentically styled as the ones on the Library label but they are more flexible and polished, avoiding a certain occasional stiffness in the Library versions.

The symphonies were written all at once, as young Haydn's first offering to his new patron, the great Prince Esterhazy. To favor a brace of new players hired along with himself, Haydn tactfully wrote "concertante" solo passages into all three, for violins, cello, bassoon, oboe, flute (not forgetting the older instrumentalists on the staff). Masterful works of this early period, 1761. Haydn was just 29.

Boccherini: Sinfonia Concertante in C with Guitar; Sinfonia in D Minor ("La Casa del Diavolo"). Angelicum Orch. of Milan, Cattini.

Vox STPL 514.130 stereo

Boccherini, poor man, long ago was tagged as "the wife of Haydn" (i.e. a less potent counterpart of that powerful composer) and he hasn't recovered since. Not until now. We know only a few works out of his hundreds—the same old cello concerto over and over, a handful of quartets (he wrote 102) or quintets (113) and that is that.

So here we go, straight into a pair of big works for orchestra. A good deal more interesting than you might have expected, too. The man did, after all, have a big reputation in a day when music listeners knew their stuff very well.

The "Sinfonia Concertante" from around 1799 (the time of the big early Beethoven works) is of a Mozartish persuasion—Mozart wrote two similar pieces—and it is very nicely assembled, if without any great tension. It ambles along comfortably. The guitar is faintly audible now and then; more important are the wind instruments and two solo violins that play much of the time as joint soloists, giving the music its "concertante" aspect. This multiple-solo music was then much in demand and today it makes an excellent sonic effect via records, especially in stereo.

The symphony about the "Devil's habitation" (hell) is more serious-minded, its final movement an interesting reflection of other more familiar music in the same vein, the music of the Furies in Hades from Gluck's "Orpheus" or the chilling music that accompanies Mozart's Don Giovanni when he is taken off into the nether regions by the great stone statue. Remarkable similarity—this was the way hell music was supposed to sound in those days.

PRODUCT REVIEW

(from page 81)

down door, record storage space for over 200 records. Holds up to a 12" speaker. Available in oil walnut, hand-rubbed mahogany, blonde, and ebony. Price \$86.00. A21-37.

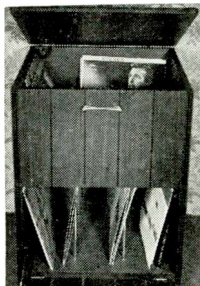

1. 500L center equipment cabinet \$163.50
2. 510H record storage cabinet, wall mounting \$ 71.00
3. 720 All-in-one console cabinet \$249.90
4. 810 Early American equipment cabinet \$151.50
5. 600 Italian Provincial equipment cabinet \$136.50

ROTRON

• *Whisper Fan Kit.* Delivers air at 60 cu. ft./min. to provide adequate heat dissipation in amplifiers, tuners, tape decks, or similar components housed in cabinets restricting ventilation. Improves performance by minimizing component drift due to temperature changes within the enclosure; fan is unusually quiet. May be mounted in virtually any position necessary. Kit includes accessories for three different mounting methods. Single-phase motor draws 7 watts. Bearings are pre-lubricated, never needs attention under normal operating conditions. Measures less than 5"

square by 1½" deep. May be used with or without ventilating ports. Price for complete kit: \$14.95. A21-38.

SCHOBER

• *Recital Organ Kit.* Full-size AGO-specification organ designed to give theatre and church pipe sounds, and all facilities found on pipe organs. Special feature: "Library of Stops," consisting of plug-in voices so that any or all stops may be interchanged for others by plugging in small printed-circuit cards. The "Library of Stops" kit includes materials and instructions enabling constructor to design and make any voices he wishes to have in addition to the 32 standard stops. Optional 2-channel operation (by changing one resistor connection) gives each manual through separate amplifier and speaker system. 100% transistor operation.

Specifications: 2 manuals, 32 pedals, 32 stops, 6 couplers, all gold-on-gold switch con-

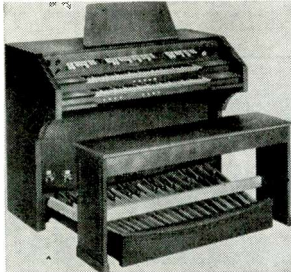

tacts. Approx. 300 transistors. 5 pitch registers on each manual (including mutation) and 4 on pedals. Separate manual vibrators, no pedal vibrato. Available accessories: percussion, reverberation, 13-piston combination action, chimes. Can be used with any good amplifier and speaker (stereo or mono); Schober transistor amplifier and organ speaker system available. Console 55" wide, 46½" deep including standard full-length pedals, 43½" high plus 10" music rack. Consoles available in standard walnut, or in any other wood or finish at extra cost. Price, \$1500.00. A21-40.

1. Console IT Organ \$850.00
2. Spinet Organ \$550.00

SHURE

• *Model M100L & M100W Phono Systems.* The M100 has been designed for the perfectionist. It will be available only in limited quantities. The M100 is possibly the costliest



unit of its type and consists of a luggage unit (100L) and a library unit (100W). The library unit is made of solid walnut. Each unit utilizes the Shure V-15 stereo 15 deg. Dynetic cartridge; a Shure designed and produced solid-state preamplifier-amplifier; the precision Dual automatic turntable, and Shure-designed loudspeakers. Price 100L, \$400.00; 100W, \$450.00. A21-41.

SOUNDCRAFT

• *Magnetic Recording Tape and Accessories.* Complete line of recording tapes, each of which is color coded to identify type of base,



Don't let a "STEREO-DEAF" FM Stereo Enjoyment Antenna Spoil Your FM Stereo Enjoyment

Install the New
Stereo-Engineered

JFD LPL-FM

LOG PERIODIC ANTENNA

- features full-wave log-periodic L-dipole system.
- derived from the powerful logarithmic periodic array used to track America's missiles and satellites through space—discovered by the Antenna Research Laboratories of the University of Illinois.

The all-new JFD LPL-FM antenna is log-periodic engineered to give you the clean gain, directional selectivity, and wideband response your system needs for fidelity FM stereo or mono performance.

The secret is in the full-wave log periodic L-dipole cells that work with amazing frequency-independent efficiency and directivity over the entire 88-108 mc. FM/FM stereo range. Result: the purest FM sound your system has ever reproduced—on every station—up to 175 miles away!

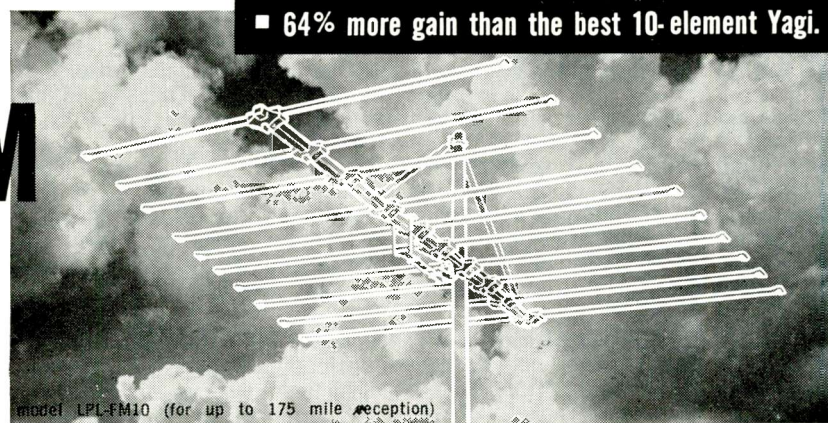

■ 64% more gain than the best 10-element Yagi.

model LPL-FM10 (for up to 175 mile reception)

—AND FOR THE ULTIMATE IN MULTI-FM SYSTEM LISTENING . . .

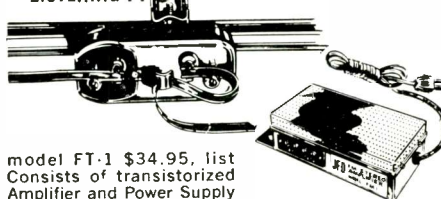

model FT-1 \$34.95, list
Consists of transistorized
Amplifier and Power Supply

Install the new JFD FM Antenna Distribution Amplifier, FT-1, and feed two stereo or mono receivers with sparkling FM. Space-age all-transistor circuitry gives you up to 18 db. of amplification without overloading. No controls or adjustments. Uses standard 117 V.A.C.

Write for the technical specs, charts, patterns and data that tell all.

Circle 137 on Reader Service Card

FOUR LPL-FM ANTENNAS TO CHOOSE FROM

model	range (up to)	list
LPL-FM10 (illustrated)	to 175 miles	\$49.95
LPL-FM8	to 150 miles	\$39.95
LPL-FM6	to 125 miles	\$29.95
LPL-FM4	to 75 miles	\$19.95

HAVE YOU HEARD ABOUT THE NEW JFD TV/FM SIGNAL SEPARATOR MODEL SS-TVFM?

It electronically combines your present TV antenna lead-in with the JFD FM Log Periodic lead-in—so only one down-lead is needed. Also—it separates the TV/FM signal of the new combination TV/FM antennas for input to TV set and FM system.

only \$5.95, list

JFD ELECTRONICS CORPORATION
15th Avenue at 62nd Street, Brooklyn, N. Y. 11219

and ranging from 1½-mil Mylar tape through "Plus-50" and "Plus-100X" to triple-play types in Mylar, and in Standard and Standard-50 acetate bases, and ranging from 3" to 10½" reels. Also available are empty boxes, empty reels, and leader and timing tapes in 5 colors. Soundcraft tape is also available in RCA-type cartridges. Tape prices depend on type of tape and on reel size. A21-42.

1. Magna-see kit for visually observing recording patterns \$12.00

SWITCHCRAFT

• **330 G Stereo Adapter Cable.** Converts sockets on European-type tape recorders and radios for use with American made microphones, headphones, and extension speakers. Plug directly into European-type 5-hole sockets found on Norelco, Korting, Grundig, Sony, Elber tape recorders, Grundig radios. Other features: Can also be used to interconnect preamplifiers and crystal or ceramic high impedance photograph cartridges to many foreign built tape recorders. Price \$5.50. A21-43.

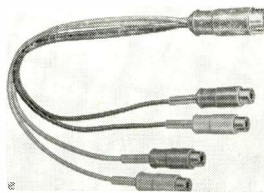

1. 330H same as 330G, except 3 pins .. \$3.30
2. 353, permits use of 2 stereo headphones \$4.25
3. 05H81 adapts 3-cond phone plug to stereo \$4.35
4. 82AB86 adapts speaker terminals to phono plug \$1.10
5. 374 converts phone plug to "Tini-plug" \$1.70

What makes the FAIRCHILD 688 the world's finest Power Amplifier?

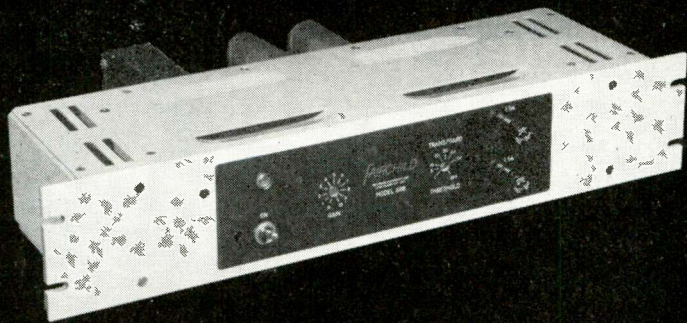

Just this!

Only the FAIRCHILD 688 Power Amplifier delivers a true and continuous 50 Watts (not music power) at any frequency from 10 cycles to 50,000 cycles, and with a low, low distortion under 1% with full 50-Watt output! Only the FAIRCHILD 688 Power Amplifier produces clean, and reliable 50 Watts into 16 ohms! Only the FAIRCHILD 688 Power Amplifier is stable enough to keep on producing 50 Watts at any frequency up to 50KC - not for a second, or 5 or 10 seconds, but continuously without damage to the transistor circuitry! Only the FAIRCHILD 688 Power Amplifier, with transformer-free output, produces 50 Watts with outstanding transient response.

Only the FAIRCHILD 688 has the **New Exclusive TRANS/GARD** overload protection system. The electro-optical TRANS/GARD system allows input of the amplifier to be overloaded by as much as 40 db and still only result in a 1 db change in output of the amplifier. FAIRCHILD TRANS/GARD does not dissipate the power handling capabilities of the FAIRCHILD 688 50-Watt design. This amazing TRANS/GARD system, which does not introduce distortion, protects the amplifier and speaker systems from burnout. Only the 688 and TRANS/GARD prevent sound reinforcement systems from blasting listeners out of their seats due to inexperienced performers in front of a microphone. The unique FAIRCHILD TRANS/GARD system protects the transistors, transducers, loudspeakers and even the listener!

The Model 688 is available with or without transformer input, and a 70V line transformer output is available as an option. Gain 83 db. Sensitivity .15V for 50-Watt output. Height 3½"; Width 19". Rack mountable.

Write to FAIRCHILD - the pacemaker in professional audio products - for complete details.

FAIRCHILD

RECORDING EQUIPMENT CORPORATION
10-40 45th Ave., Long Island City 1, N. Y.

Circle 138 on Reader Service Card

CECIL E. WATTS

• **"The Parastat."** Removes dust, grit, and residue deep within the record groove. The dual function of the Parastat as a Preener when tilted on either side for maintenance of

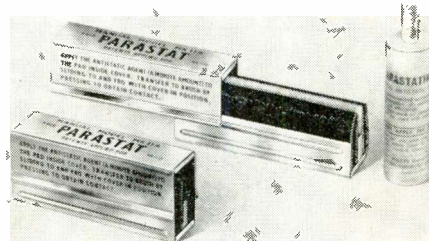

new records, and a cleaner for older records when held upright so that the nylon bristles can penetrate the record grooves, to remove accumulated dirt and residue—actually restores fidelity which was hidden by dirt and residue. Brush made of pure nylon bristles with 0.00025" radius. \$15.00. A21-45.

1. Dust Bug \$6.00
2. Preener \$3.00

WINEGARD

• **SF-S Stercotron.** Gold anodized, 8-element FM yagi cut to receive 88 to 108 mc. Flat frequency response across entire FM band with 8.8 db gain. Accurate 300-ohm impedance match. Double-tuned reflector system gives high front-to-back ratio. Price \$23.65. A21-46.

1. FM3T-omni anodized antenna \$12.55
2. K5-FM 5-element yagi \$13.80
3. AP320 15-db gain preamp \$39.95
4. FM318 indoor FM 18-db booster ... \$17.95

COMMERCIAL SOUND

CS1. AMPLIFIERS & CONTROLS

ALTEC

• **1567A Mixer-Amplifier.** The 1567A is designed for remote broadcast and recording applications when installed in portable carrying case. Without case, the 1567A can be rack mounted or mounted in table top consoles, either singly for monophonic use or in pairs for stereo pickup. Features hinged front panel for immediate internal access without interrupting program connections, non-glare panel with write-in strips for pickup identification. An additional output, not affected by tone and master controls, provides signal for tape recorders.

Specifications: Freq. resp. 30 to 15 k cps



± 1 db; power output, +18 dbm or 50 v. open circuit; input impedance 1 meg. channels 1-25 meg channels; source impedance 30/50 and 120/200 ohms with plug-in mic. transformer; load impedance, line out - 15 k ohms to infinity; noise level; input - 123 dbm, output - 68 dbm. Controls: 5 mixer, master, bass, treble, VU range, power; weight, 10¼ lbs. Dimensions, 19" wide, 5¼" high, 6¼" deep. Price, \$189.00. CS1-1A.

• **250 SU Control Console.** Fulfills stereo and universal operating requirements for all but the largest recording studios. TV, AM and FM broadcast stations. The console comes equipped with all controls and wired with output circuit for single-channel, single-line, two-channel, two-line, dual stereo or three channel/two channel stereo operation. It is only necessary to plug-in the required number of pre- and program amplifiers or input transformers (for tape, disc, line, and network, etc.) to provide the desired functions.

Specifications: Microphone input to line output—gain 98 db; frequency response: ± 1 db 30 to 15k cps; distortion: 0.5% 30 to 15k cps at output level of +20 dbm and less than 1% at +24 dbm, signal-to-noise ratio: 70 db (+18 dbm output with 50 dbm input). High level channels: gain 41 db; signal-to-noise ratio 70 db (18 dbm output with -10 dbm input). Source impedances—microphone inputs: 150 or 600 ohms; line or utility in-

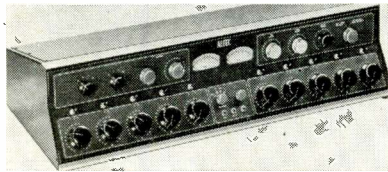

puts: up to 15,000 ohms. Load impedances—line outputs: 600 ohms; monitor outputs: 600 ohms requires separate monitor amplifiers; headphone outputs: 600 ohms. Channels: one, two, or three divided to two for stereo use. Cabinet: hinged two-slope control panels painted dark green. Contains all equipment except power supply and monitor amplifier(s). Dimensions: $9\frac{1}{2}$ " h. \times $39\frac{1}{4}$ " w. \times 16" d. Price, \$1393.00. CS1-1B.

BOGEN

• **MTX30 PA Amplifier.** Transistor 30-watt PA amplifier. Designed for continuous operation at full output. Optimum performance assured at extreme temperatures. Total of 13 inputs; 6 of which may be mixed and faded

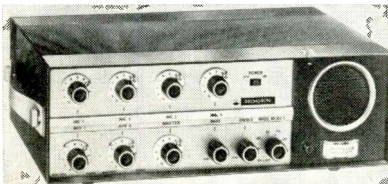

simultaneously. Optional monitor speaker, output meter, locking plate, remote and precedence control, rack panel. Emergency operation from 12-15v. dc. power source.

Specifications: Freq. resp. 15 to 30k cps ± 1 db at 3 watts output; power bandwidth, 7 to 40k cps; IHP music power output, 50 watts per channel; power output, rms 30 watts per channel; harmonic distortion, 2% at 15 watts from 20 to 20k cps; hum and noise, 65 db below 30 watt output; sensitivity, input for rated output-phonos, 8 mv, tuner 0.16 volts; damping factor 6:1. Dimensions, $16\frac{1}{2}$ " wide, $4\frac{3}{4}$ " high, 12" deep. Price, \$374.35. CS1-2A.

- | | | |
|---------------------|-------|----------|
| 1. MX60 60-w PA amp | | \$295.00 |
| 2. MX30 30-w PA amp | | \$231.25 |
| 3. MUI30 30-w amp | | \$149.90 |
| 4. CHB20A 20-w amp | | \$99.90 |
| 5. CHB10 10-w amp | | \$64.75 |

• **MXM Mixer-Preamplifier.** Self-powered, accommodates five microphones, or four microphones and a tuner or phonograph (both crystal and magnetic cartridges). Each channel is regulated by a separate gain control (master gain also provided). Individual speech filters for each channel, output level meter, sockets for plug-in, low-impedance transformers, and new variable level markers which permit instant resetting of controls to previously determined levels. May be remote controlled.

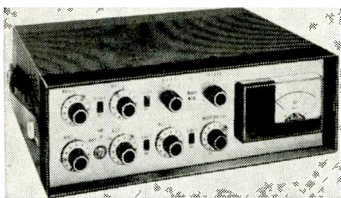

Specifications: Inputs: Mic 1, Mic 2, Mic 3, Mic 4, Mic 5, Mag, Xtal, Aux controls: Vol. 1, Vol. 2, Vol. 3, Vol. 4, Vol. 5; switches: selector, power; outputs: main, 10k ohms, freq. resp. 20 to 20k cps ± 2 db; sensitivity, input for 1 volt output, phono, 4 mv, tuner, 0.5 volts; hum and noise, 70 db below 10 volt output. Weight, 21 lbs; dimensions, $16\frac{1}{2}$ " wide, $5\frac{3}{4}$ " high, 13" deep. Price, \$246.25. CS1-2B.

- | | | |
|------------------------|-------|---------|
| 1. RP-2 program preamp | | \$95.00 |
| 2. MX6A mixer-preamp | | \$67.50 |

FAIRCHILD

• **670 Stereo Limiter amplifier.** Extremely fast attack time can produce full limiting in

the first 5000th of a second. Variable release time from 0.3 of a second to 25 seconds, conveniently available on the front panel in the form of a 6-position switch. Can be used as a

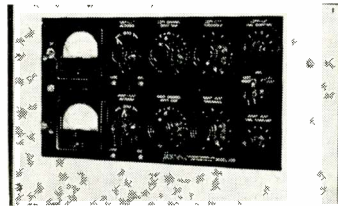

limiter or a compressor depending on the program material and personal preference.

Specifications: input impedance 600 ohms; output impedance, 600 ohms; range of input level, 0 dbm to +16 dbm; output level, ± 4 or ± 8 dbm (+27 dbm clipping point); gain 7db; frequency response 30 to 15k cps ± 1.5 db; separation, A-B position: 60 db; vertical-lateral position: 40 db; noise level, 70 db below ± 4 dbm; harmonic distortion less than

1% at any level up to +18 dbm output; Mechanical dimensions, standard 19" rack, 14" panel space, depth behind panel 11"; weight approximately 65 lbs. CS1-3.

HARMAN-KARDON

• **CA-100 100-Watt Amplifier.** Flexible system at modest price.

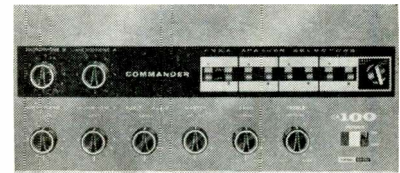

Specifications: Freq. resp. 50 to 15k cps db at 100 watts output; power output 100 watts per channel; harmonic distortion, 5% at 100 watts at 1000 cps; hum and noise, 83 db below 100 watt output; sensitivity, input for rated output-phonos, 3 mv; mic, 4 mv;



PHYLLIS CURTIN

applauds the "Better, Clearer, More Natural Sound" of

Tandberg MODEL 74B

3 SPEED/4 TRACK STEREO MUSIC SYSTEM

As a dedicated artist who strives for perfection at all times, Miss Curtin prefers her Tandberg for many reasons . . . its unfailing dependability; ease of operation; trouble-free use. But, she finds the true mark of Tandberg superiority in its unparalleled record/playback frequency response, the lack of wow and flutter, low tape tension and these fine features . . . FM Multiplex filter, built-in speakers and amplifiers, precision laminated heads, asynchronous motor, "free" tape thread, 2 built-in cathode follower outputs . . . and many more quality extras! Ask for a free demonstration.

ONE YEAR GUARANTEE • AT FRANCHISED DEALERS EVERYWHERE \$449.50

Tandberg of America, Inc., P. O. Box 171, 8 Third Ave., Pelham, N. Y.

Circle 139 on Reader Service Card

output impedances, 4, 6.2, 8, 16 ohms; inputs—phono, aux, mic; weight 28 lbs. Dimensions, 15" wide, 7" high, 10" deep. Price, \$199.88. CS1-4A.

LAFAYETTE

● **PA-423 100 Watt PA Amplifier.** Two solid-state regulated power supplies, one main and one bias for output tubes. Two microphone

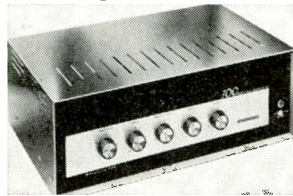

inputs with individual volume controls; phono and radio inputs can be used alternately and are controlled by a fader control. Separate bass and treble controls.

Specifications: Freq. resp. 50 to 15k cps ± 2 db at 100 watts output; IHF music power output, 130 watts per channel; harmonic distortion, 5% at 100 watts; hum and noise, 80 db below 100 watt output; sensitivity, input for rated output—phono, 3 mv; tuner, 1.3 volts; mic, 4 mv; output impedances, 4, 8, 16 ohms; 25 & 70-volt lines; 1 phono, 1 tape amp; weight 35 lbs. Dimensions, 17½" wide, 6½" high, 10½" deep. Price, \$89.50. CS1-5.

1. PA-422 35-w Pa amp \$52.45
2. PA-425W Phono top for PA-422 .. \$17.95
3. PA-424 27-w transistor PA amp. . . \$57.50
4. PA-427 a.c. power supply for PA-424 \$36.95
5. PA-4256W 12v.d.c. phono top for PA-424 \$32.40

LANGEVIN

● **Model AM17-Transistor Plug-in Program or Monitor Amplifier.** The AM17 may be used as a program amplifier or as a monitor amplifier. Output power delivered to load is rated at +39 dbm (eight watts), which may be reduced to +30 dbm (one watt) by the

omission of a strap connection. This omission lowers the current demanded from the external 24v dc power supply.

Specifications: Freq. resp. 20 to 20k cps ± 0.5 db at +24 dbm; distortion, 1.0% at 8 watts from 30 to 20k cps; hum and noise; not

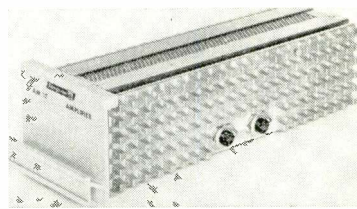

over -115 db (over band of 20-20k cps); output impedances, 150, 600 ohms; controls, balance (serv. adj.); weight, 7½ lbs.; dimensions, 4 3/16" wide; 3½" high; 12½" deep. Price \$210.00. CS1-6A.

● **Model EQ252A Graphic Equalizer.** Circuit: bridged T; impedance: 600/600 ohms; insertion loss: 16 db; input level: maximum +24 dbm, minimum -70 dbm; sections: 7, plug-in, printed circuit; center frequency each section: 50, 130, 320, 800, 2000, 5000 and 12,-

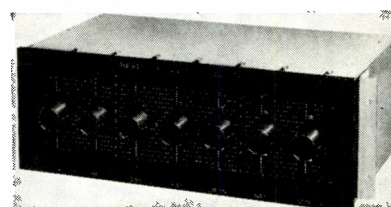

500 cps; range per section: 8 db equalization to 8 db attenuation. Size: 3½" h., 10½" l., 5½" d. Price \$600.00. CS1-6B.

1. EQ270A graphic equalizer rack mount \$600.00
2. EQ251A program equalizer \$270.00
3. EQ258A program equalizer rack mount \$300.00

NORELCO

● **EL6416/00 35-Watt Amplifier.** 19" rack mounting power amplifier for sound systems. **Specifications:** Freq. resp. 20 to 15k cps ± 3 db at 35 watts output; power output, rms, 35 watts per channel; harmonic distortion, 3% at 35 watts at 1000 cps; hum and

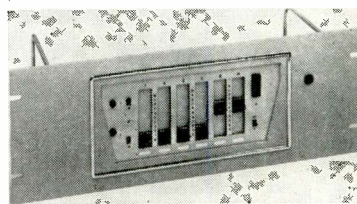

noise, -74 db below 35 watt output; sensitivity, input for rated output, 0.230 volts; output voltages 100, 70, 50, 35, 25, 10v.; weight, 27 lbs; dimensions, 19" wide, 5¼" high, 11" deep; price, \$210.00. CS1-7A.

1. EL6426/00 pwr amp, 70-w \$ 259.00
2. EL6436/00 pwr amp, 140-w \$ 385.00
3. EL6471/00 pwr amp, 1000-w \$3650.00

● **EL6466/00 Rack-mounted Preamplifier.** Designed to provide microphone and/or record player preamplification, mixing facilities, wide range tone controls, volume limiter, and a shaded target volume indicator. For driving EL6416/00 35-watt amplifier, EL6426/00 70-watt amplifier, and EL6436/00 140-watt amplifiers.

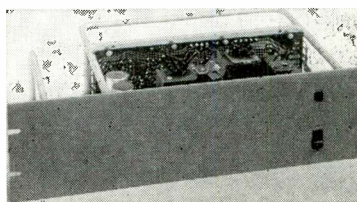

Specifications: Inputs: (2) mic (2) line; controls: (4) vol., bass, treble; switches: pwr., limit, outputs: main 0.25 ohms; freq. resp. 15 to 15k cps ± 3 db at 0.25 volts; IM distortion, 0.5% at 0.25 volts; sensitivity, input for 1 volt output, phono, 170 mv, tuner, 0.170 volts; hum and noise, -68 db below 0.25 volt output. Weight, 8½ lbs; dimensions, 19" wide, 7" high, 6" deep. Price, \$184.00. CS1-7B.

Is there a tape recorder that can do most anything imaginable?

"Yes"! says Audio Magazine about the new Uher 8000 by Martel. "...practically any use that can be imagined is possible with Uher Royal 8000."



"There are seven position-four speeds with three OFF positions between. Selecting the speed also adjusts equalization for each. A second switch together with an interlocked RECORD button, controls all of the electronic functions in its eleven positions, which are marked: 1-4—mono record or play on upper track; 2-3—mono record or play on lower track; STEREO—record or play; MULTIPLAY I—permits recording on the upper track from microphone and mixing with material from lower track; MULTIPLAY II—permits recording on lower track and mixing material already recorded on upper track; DIA-PILOT I—used for recording from microphone and/or from phono record or another tape machine on upper track as commentary for slides; DIA-PILOT II—after making recorded commentary on upper track, this position is used to record sub-sonic tone on lower track at points where a slide is to be changed and for playback with slide projector thereafter, with the slide changing at each point when the tone button was depressed in the second run-through; ECHO 1-4—permits adding delayed sound to an original recording on upper track, the amount of delay depending on the speed of the tape; ECHO 2-3—same operation for lower track; SYN-PLAY I—used for recording on one track for later recording another signal in synchronization with the first but on a second track when the switch is turned to the SYN-PLAY II position. Thus, practically any trick type of recording can be made with no external interconnecting or switching.

AKUSTOMAT makes it possible to use sound as a controlling medium for the recording operation. The machine can be used as a dictating machine, for example, without the need for a start-stop button—one simply speaks and the machine starts recording, and when the dictator pauses, the machine stops. Thus it may be used to monitor and record sounds of an intermittent nature over a long period of time without actually running except in the presence of some sound. We know no other machine which has this feature. In short, practically any use that can be imagined is possible with the Uher 8000.

If you're interested in the complete review of the Uher 8000, Write for nearest dealer and reprint of complete review.

**MARTEL
ELECTRONICS**

see your local dealer or for complete review write

Los Angeles
2356 So. Cotner

New York City
1199 Broadway

Chicago
1141 Merchandise Mart Plaza

Circle 140 on Reader Service Card

CS2. RECEIVERS

BOGEN

● **RP100-BM Monophonic FM-AM Receiver.** 15-watt AM-FM tuner-amplifier. The RP100-BM can power from 1 to 60 loudspeakers by the addition of a booster amplifier. Public address feature. For paging and announcements, Bogen provides the MXE microphone and RY-2 remote control relay. Broadcasts music at one level of volume and announcements at another. The microphone can be placed close to or far from the amplifier.

Specifications: FM: 6 tubes, grounded-grid front end; 3 i.f. stages; ratio detector; controls—selector, volume, bass, treble, tuning; switches—microphone, power; crossmodulation index 75 db; freq. resp. ± 1 db from 20 to 15k cps; signal-to-noise ratio 60 db; IHF volume sensitivity 3 uv; capture ratio 6 db; selectivity 35 db; IHF usable sensitivity 4



uv; AM suppression 35 db; harmonic distortion (100% mod.) 1%; reactance tube a.f.c. circuit; drift ± 20 kc. AM: 3 tube superhet circuit; 2-gang tuning capacitor; 2 i.f. stages; IHF usable sensitivity 10 uv; IHF volume sensitivity 5 uv; freq. resp. ± 2 db from 20 to 4500 cps; harm. dist. 1%. **AMPLIFIER:** Freq. resp. 20 to 20k cps ± 1 db at 1 watt output; power bandwidth, 35 to 16k cps; IHF music power output 18 watts per channel; power output, rms, 15 watts per channel; harmonic distortion, 1% at 15 watts from 50 to 14k cps; IM distortion 1% at 15 watts; hum and noise, 75 db below 15 watt output; sensitivity input for rated output-phonos 3.5 mv, aux. 0.3 volts; damping factor 8; output impedances 8, 16 ohms, 25 volts; inputs—2 phono, 1 aux. 2 mpx; dimensions, 15" wide, 4 1/2" high, 12 1/2" deep; weight, 21 lbs. Price \$186.60. Accessories EN-1 enclosure. CS2-1.

EICO

● **2716 FM Receiver.** Low cost background music and paging system.

Specifications: FM: 11 tubes; 4 i.f. stages; ratio detector; eye tube tuning indicator; freq. resp. ± 1 db from 20 to 15k cps; signal-to-noise ratio 55 db; capture ratio 3 db; IHF usable sensitivity 3 uv; harmonic distortion (100% mod.) 0.6%. **AMPLIFIER:** Freq. resp. 15 to 40k cps ± 1 db; power bandwidth, 30 to

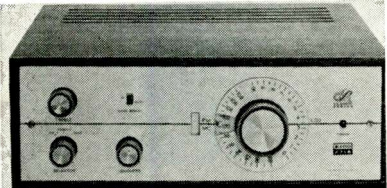

20k cps; IHF music power output 18 watts; power output, rms, 14 watts per channel; harmonic distortion, 2.6% at 10 watts from 40 to 10k cps; IM distortion 2% at 14 watts; sensitivity, input for rated output-phonos, 240 mv, mic. 4 mv; output impedances 8, 16 ohms and 25 volt line; 1 ceramic phono, 1 tape head, 1 mic.; dimensions, 15 7/8" wide, 5 1/2" high, 11 1/2" deep; weight, 17 lb. Price \$199.95. CS2-2.

GROMMES

● **511 Tuner-Amplifier Mixer.** Reasonably priced and compact, amplifier power 12 watts



IHF, 20 watts peak. Can handle up to 20 speakers. Booster amplifier available. 14" x 4 1/2" x 17". CS2-3.

HARMAN-KARDON

● **FA10C Background Music FM Receiver and Announcing System.** The FA10C is an FM tuner, 10-watt amplifier and control center on a single chassis. Features: Local-remote speakers selection, music-mike mode switch

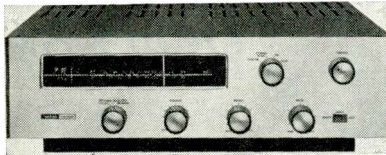

permits you to interrupt music instantly for announcements, and to return to music upon completion.

Specifications: FM: 11 tube grounded-grid front end; 3 i.f. stages; Foster-Seely detector; 1 audio stage; controls—volume, treble, bass, tuning, speaker selector, function; switches—music, mike; sensitivity 2.5 uv for 20 db

quieting; solid-state a.f.c. circuit. **AMPLIFIER:** Freq. resp. 20 to 40k cps ± 1 db at 1 watt output; power bandwidth, 80 to 30k cps; power output, rms, 10 watts; IM distortion 2% at 10 watts; hum and noise, input for rated output-phonos, 6 mv, aux. 0.5 volts; output impedances 4-16 62.5, 500 ohms; inputs—1 phono, 1 tape head, 1 mike; 1 aux.; dimensions, 13 3/4" wide, 4 3/4" high, 11" deep; weight, 18 lbs. Price \$145.46. CS2-4.

CS3. MICROPHONES

AKG

● **D-12 Dynamic Directional Microphone.** Particularly pronounced directional characteristics, separation of 18 db over the entire frequency range. Eliminates feed-back prob-

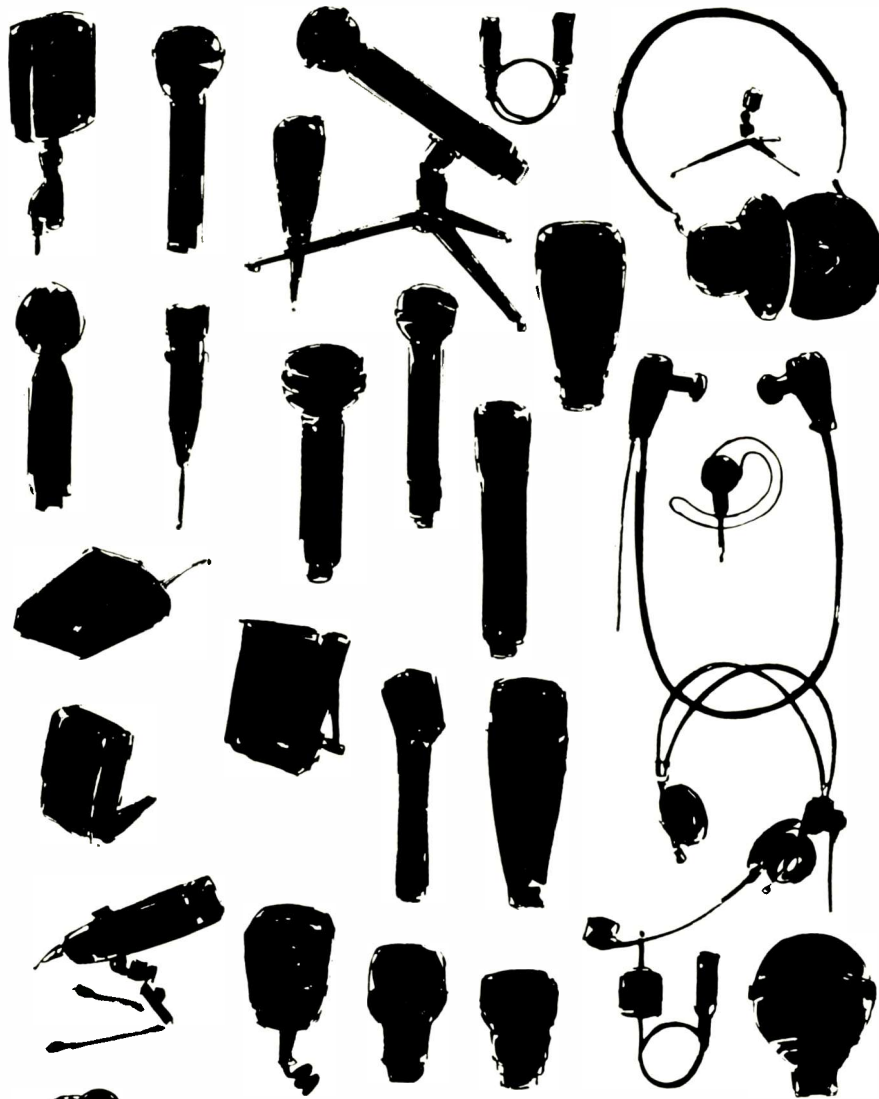

THERE IS A BEYER TRANSDUCER FOR YOUR APPLICATION

Professional microphones for studio use. Dynamic, Moving Coil, Ribbon and Double Ribbon. Optimum performance microphones for high fidelity speech and music reproduction. Microphones for home tape recorders and amateur use. Industrial and special application microphones. Dynamic headphones. Transformers, Windscreens, Stands, Tripods, Adaptors. Write for complete BEYER Catalog No. 1065 giving detailed specifications and curves.



RYE SOUND CORPORATION • 147 ELM STREET, MAMARONECK, N. Y. • 914 OW 8-0080
Circle 141 on Reader Service Card

Telex phones
put individual
Channel Control where
it belongs...



AT YOUR FINGERTIPS

(and only TELEX has it)

Convenience... Precision channel control for perfect stereo balance... Freedom from the extra cost and encumbrance of a separate headphone control center.



That's what you get in the new Telex ST-20 stereo-phones. Smoothly styled control knobs on each earpiece provide separate sound level control for each channel. Exclusive with Telex, this superb fingertip convenience means you always listen at the ideal sound level... the ideal stereo balance.

Insist on seeing... and hearing... the amazing new Telex ST-20 with INTEGRAL

CHANNEL CONTROL. You'll thrill to the kind of pace setting performance you would expect from 26 years of Telex acoustic engineering leadership. Faithful, flawless sound provides breathtaking stereo realism for the most exacting. 16-15,000 cps. 4-16 ohms. Super soft cushions for the ultimate in noise abatement and comfort. \$29.15

A Product of Sound Research



TELEX/Acoustic Products

3054 Excelsior Blvd. • Minneapolis 16, Minn.

TELEX

Circle 142 on Reader Service Card

NEW! LAFAYETTE AM/FM STEREO RECEIVER Model LA-230



139⁵⁰

LA-230

The beautiful LA-230 makes an ideal heart for your stereo system. Features a sensitive AM and FM stereo tuner with "Stereo Searcher" circuit for easy station location; a 24-watt stereo amplifier with a clean response of 20-20,000 cps and complete stereo preamp facilities. Just add speakers for complete stereo system.

Imported

Free!

LAFAYETTE Radio ELECTRONICS
Dept. AH-4, P.O. Box 10,
Syosset, L.I., N.Y. 11791

Rush me FREE Giant 422 Page 1964
Cat. 640

LA-230WX AM/FM Receiver
\$..... Enclosed

Shipping Charges Collect

Name

Address

City State Zip

Circle 143

MARK VINYL*

*pressings of your recordings
sound better and cost less.*

Mark's complete record manufacturing facilities will produce highest quality records from your master tapes, discs, stampers, or even start from sheet music. And, at competitive prices.

Write today for wholesale price list and specifications.

MARK RECORDS Manufacturing Company

5212 East 14th Street
Oakland, California 94601

415-533-2234

* A virgin material specially compounded to offer truest reproduction with least surface noise at minimum cost.

Circle 144

lems. Wide impedance matching characteristics: 50 to 250 ohm.

Specifications: dynamic; cardioid pattern; metal screen case; dark & light finish; output impedance 250 ohms; freq. resp. ± 3 db from 40 to 15k cps; sensitivity—77 db (1



volt/dyne/cm²); length of cable furnished 15 ft.; dimensions—5 $\frac{1}{2}$ x 2 $\frac{1}{2}$ x 2 $\frac{1}{2}$; weight 1 lb. 2 oz.; other features: internally suspended capsule. Price, \$99.00. CS3-1.

1. D-24 dynamic cardioid \$150.00
2. D-58 close-talking dynamic \$ 40.00

ALTEC

• *M-30 Cardioid Microphone System.* Condenser microphone, cardioid pattern, extremely small size. Comes with shock mounting.

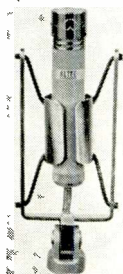

Specifications: condenser; cardioid pattern; stainless steel case; gray finish; output impedance 30, 150 or 600 ohms; freq. resp. 20 to 15k cps; dimensions— $\frac{3}{4}$ " dia., $\frac{25}{32}$ " h.; power supply 2 $\frac{1}{2}$ h., 8 $\frac{1}{2}$ w., 7 $\frac{1}{2}$ d.; $\frac{5}{8}$ "-27 thread mounting. Price \$280.00. CS3-2.

1. M-20 omni condenser mic \$233.00

AMERICAN MICROPHONE

• *Model C331.* Condenser microphone for recording, sound reproduction, broadcasting, and telecasting applications. High output level at all standard high and low impedances. Can be used with a.c. or battery power supply. Each model furnished with calibration curve.



Specifications: condenser; omnidirectional; Mylar diaphragm; aluminum case; anodized finish; output impedance hi-lo ohms; freq. resp. ± 2 db from 20 to 20k cps; sensitivity—55 db; cable connection Cannon XL-5; length of cable furnished 25 ft.; dimensions—7 $\frac{1}{2}$ " long, 1 $\frac{1}{2}$ " dia.; weight 12 oz.; standard $\frac{5}{8}$ "-27 mounting. Furnished complete with 115v. 60-cycle power supply and cables. Price, \$170.00. Accessories—PS331 battery power supply, \$24.00. CS3-3.

1. D44, studio dynamic, omni \$141.00
2. R331, studio ribbon bidirectional .. \$ 84.00
3. D76, dynamic unidirectional \$117.00
4. D33, dynamic omni \$ 78.00
5. D22, dynamic omni \$ 59.70

NORELCO

• *EL6031 Microphone.* Moving-coil microphone, hypercardioid directional pattern. Dust-proof, ruggedized construction.

Specifications: dynamic; hypercardioid pattern; plastic diaphragm material; aluminum case; lacquer finish; output impedance 50, 500, 25k ohms; freq. resp. ± 2 db from 50 to 10k cps; sensitivity 50 ohms, 0.06 mv; cable connection 2 cond. shielded; length of cable furnished 9 ft.; 3-pole female plug; dimen-

sions—2" dia., 13¼" long; weight 1¼ lbs; integral gooseneck mounting. CS3-4.

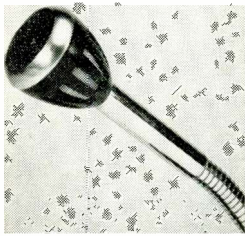

1. EL 6031/56 500-25k ohms \$49.00
2. EL 6031/66 500 ohms \$39.50

CS4. SPEAKERS

ALTEC

• A-7 "Voice of the Theatre" Speaker System. Smallest of the "Voice of the Theatre" systems. A two-way system crossing over at 800 cps.

Specifications: horn enclosure; speakers—1 l.f., 1 h.f.; power handling capacity 30 watts; full section dual LC 12 db/octave crossover

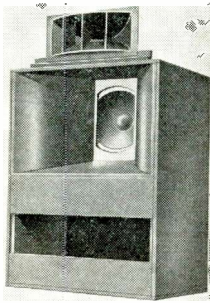

network; dimensions: 30" wide, 52¼" high, 24" deep; weight, 135 lbs.; Price \$279.00. (CS4-1).

1. A7-500 crossover at 500 cps \$315.00
2. 415C full range spkr \$ 67.50

ELECTRO-VOICE

• PA30 P.A. Projector. Thirty-watt paging projector, rectangular horn design, universal swivel bracket permits placement in any position. Accepts Model TR3 line-matching transformers for convenient installation in large systems.

Specifications: re-entrant projector; power handling capacity 30 watts; impedance 8

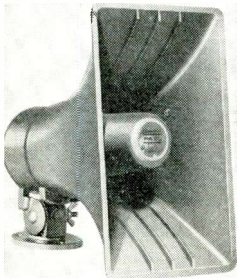

ohms; frequency response, 250 to 14k cps; EIA sensitivity 59 db; magnet weight 11.3 oz; voice-coil diameter 1.5 in.; dimensions 11" h x 6½" w x 8½" d; mounting, universal swivel bracket; weight, 5 lb. 9 oz. Price \$20.70. Accessories: TR3-2 25-volt line transformer, \$9.00; TR3-7 70.7-volt line transformer, \$9.00. CS4-2.

1. 848 compound diffraction projector . \$49.50
2. 847 compound diffraction projector . \$30.60
3. 844 30-w paging projector \$23.40
4. PA7 7½-w paging projector \$16.20
5. AC100 compound concentrating horn \$33.00

FRAZIER

• 8-58 Dirielander. All horn system.

Specifications: horn enclosure; speakers—1 l.f., 1 h.f.; power handling capacity 25 watts; 800 cps LC 12 db/octave crossover

enjoy manual turntable performance—automatically

Your Miracord handles cartridges other automatics can't manage; tracks them automatically at stylus force settings recommended for manuals. It performs gently to bring out the best in your records, and preserves their quality for long-lasting enjoyment. Moreover, the Miracord is the only automatic available with hysteresis motor and with FEATHERTOUCH push buttons. At your high fidelity dealer, or write to: Benjamin Electronic Sound Corp., 80 Swalm Street Westbury, N. Y.

**BENJAMIN
MIRACORD**



BENJAMIN ELECTRONIC SOUND CORP., 80 SWALM ST., WESTBURY, N.Y.

Circle 160 on Reader Service Card

FRAZIER Speakers

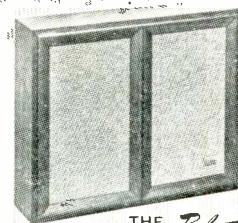

THE *Bel Aire*

19" H x 23¾" W x 5¾" D
Thin line styled for wall mounting.
Floor stand available.



THE *Super Midget*

7-3/16" H x 15½" W x 9½" D
For limited space or as auxiliary unit.



THE *La Fiesta*

10½" H x 23¾" W x 11¾" D
Unique design for bookshelf mounting.

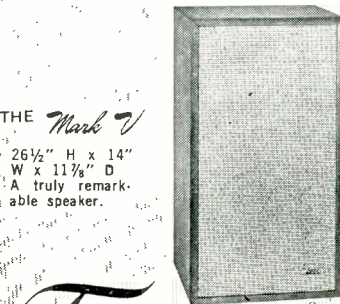

THE *Mark V*

26½" H x 14" W x 11¾" D
A truly remarkable speaker.

FOR THE LOVE OF Sound

From the lowest rumblings of the organ pedal notes to the whispering overtones of the flutes... FRAZIER offers a complete series of full range, two-way, and three-way wide range speaker systems employing both the modified Helmholtz principle, and the exponential horn... Assuring the ultimate in smoothness, balance, and cleanliness from as low as 28 cycles, to 22,000 cycles in the larger systems. Oil Walnut hand crafted cabinetry. Some models available unfinished. Complete Music Wall "Playmate" Systems available in Oil Walnut and Burma Teak. Price Range \$26.95 to \$310.00. Write for complete details on all models. Over 350 Dealers in U. S. Alone.

FRAZIER
INCORPORATED

2649 BRENNER DR., DALLAS 20, TEXAS

Circle 145 on Reader Service Card

Personally Yours!

Whether you listen to records, tape or FM—listen to stereo in its fullest dimension with the world's most comfortable personal headset receiver. Exclusive Direct Acoustical Coupling guarantees you the ultimate in comfort with a quality of reproduction equal to that of the very best high quality speaker system. Listen to the David Clark 100 Series at your Stereo Dealer—enjoy a truly personal and unique musical experience.

Available in 3 Impedances
 Model 100 (8 ohms) \$39.50
 Model 103 (300 ohms) \$39.50
 Model 112 (1200 ohms) \$44.50

High Quality Personal Headset Receivers and Accessories for Stereophonic and Monophonic Applications.
David Clark COMPANY INC. WORCESTER, MASS.

Circle 146 on Reader Service Card

H. F. UNIT

L. F. UNIT

TANNOY

How Close SHOULD They Be???

When instruments, or the human voice, produce the original sound, the entire audio spectrum is closely integrated—both high and low frequencies are created together as a unity. It is only reasonable, therefore, that the reproducing system should adhere to the original principle as far as is possible. Tannoy engineers, realizing the basic problems involved, developed the now highly regarded "Monitor" Dual Concentric principle.

The "Monitor" Dual Concentrics are not just loudspeakers, but precision-engineered instruments: a fine horn-loaded high-frequency unit feeding directly through and closely associated with the low-frequency reproducer provides the close unity between high frequencies and low frequencies which is imperative if we are to re-create the original sound. The curvilinear low-frequency diaphragm continues the high-frequency horn flare, thereby providing the maximum high-frequency dispersion. This integration of the audio spectrum was most desirable monophonically, but in stereo, to ensure early left and right channel integration (without which the "hole in the middle" effect is apparent), we consider it of *paramount importance*.

The Tannoy Dual is noted for its remarkable instrument definition, and critics have referred to it as "the speaker that produces musical sounds." So, if your pleasure is in hearing music, listen to the 'Monitor' the next time you are at your dealer's—there is a difference!

We shall be pleased to send you our literature.

TANNOY (CANADA) LIMITED
 36 Wellington St. East,
 Toronto 1, Ontario.

TANNOY (AMERICA) LIMITED
 P.O. Box 177
 East Norwich, N. Y.

Circle 147 on Reader Service Card

network; impedance 8 ohms; frequency response ± 5 db from 40 to 12k cps; dimensions:

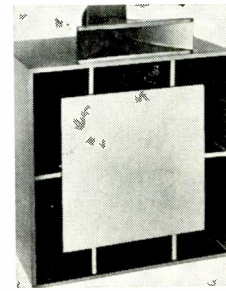

22½" wide, 26¼" high, 15½" deep; weight, 56 lb. CS4-3.

JENSEN

● **DCA-850 8-inch Dual Voice-Coil Speaker.** Two separate voice coil windings make emergency overall warning or alarm signals or voice communications possible whatever the principal program channel circuit condition. No circuit captivating switches or relays needed.

Specifications: dual v.c.; power handling

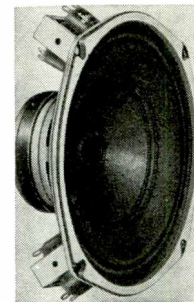

capacity 12 watts; impedance 8/8 ohms; frequency response, 30 to 12k cps; sensitivity 1.0 watts; magnet weight 10 oz.; voice-coil diameter 1"; free air resonance frequency 70 cps. Dimensions 8¾" dia. 3" deep; mounting dimensions, (4) 3/16 in. holes on 3 13/16 r. circle; cutout diameter 6¾"; weight, 2.5 lb. Kwikon® instant connectors. CS4-4.

1. DCA-830 8" dual voice coil speaker
2. DCA-850T with twin 70-v transformers
3. DCA-850S with twin 25-v transformers
4. DCA-830T with twin 70-v transformers
5. DCA-830S with twin 25-v transformers

LAFAYETTE

● **Pa-55 90-deg. Paging Speaker.** Rugged construction, weather proofed, tropicalized. Handles 30 watts, 90-deg. sound dispersion. Equipped with universal mounting bracket.

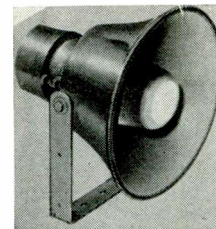

Specifications: horn; power handling capacity 30 watts; impedance 8 ohms; frequency response, 250 to 15k cps; Dimensions 9¾" dia. 8 13/16" deep; shpg. weight, 8½ lbs. Price \$16.50. CS4-5.

1. PA-295 horn speaker \$7.95
2. SK-118 12" cone speaker \$5.25
3. SK-119 8" cone speaker \$3.95
4. PA-57 25-w driver \$9.85
5. SK-175 "Thin Line" extension speaker \$5.95

NORELCO

● **ED 6002/00 Loudspeaker Column.** A column speaker with excellent pattern control.

Specifications: speakers—(8) m.f., (8) coax h.f.; power handling capacity 6 watts ea., 48 watts total; 70-v line; frequency response ± 3 db from 50 to 20k cps; other features vertical dispersion angle 15-deg., horizontal dispersion angle 120-deg. Dimensions: 9" wide, 71" high, 5½" deep; weight, 34 lbs.; finishes available and prices: beige \$187.00. CS4-6.

1. ED 6001 \$136.00
2. ED 6000 \$168.00

- 3. ED 7162 \$ 95.00
- 4. ED 7161 \$318.00
- 5. ED 7160 \$147.00

UNIVERSITY

● **Trumpet Model PH w/1D 60T Driver.** Directional trumpet equipped with 60-watt driver unit.

Specifications: Trumpet, low-frequency cut-off, 85 cps; air column length, 3½ ft.; dimensions: length 15¼", bell dia.—20%; wt.



11¼ lb. Driver power rating, 60 watts; frequency response 70-12k cps; dimensions: length 6¾", dia. 6¾"; wt. 6¼ lbs. Driver equipped with 6-watt matching transformer integral in case. Price \$58.43. CS4-7.

- 1. MIL-A \$ 18.43
- 2. CMIL-A 19.64
- 3. 2 WP 17.64
- 4. CLC outdoor P.A. 69.95
- 5. PP-IT transistorized powpage \$169.95

UTAH

● **PASJC-W.** High-efficiency speaker designed for continuous duty operation in systems requiring reproduction of music. The barium ferrite magnet is bonded with rf-cured epoxy for permanent accuracy of parts alignment. The internal dust cap assures years of dependable operation. Transformer mounting facilities and screw terminals are provided.

Specifications: dual-cone; power handling capacity 30 watts; impedance 8 ohms; frequency response from 32 to 19k cps; sensitivity (watts input for +85-db level 10 feet on axis) 0.03 watts; magnet weight 10 oz; voice-coil diameter 1". Dimensions 8½" dia. 3" deep; mounting dimensions, 4 holes on 7 11/16" circle; cutout diameter 7"; weight, 2.5 lb. Price \$12.25. CS4-8.

- 1. PA8ECS 8" speaker \$ 8.15
- 2. PA8FC 8" speaker \$ 8.30
- 3. PA8CC-W 8" dual cone \$ 9.75
- 4. PA8JC 8" speaker \$11.50
- 5. PA12JC 12" speaker \$14.50

VITAVOX

● **220 Series Multicell Horns.** These multicell horns are assemblies of small exponential units connected to a common throat and correctly angled relative to each other to insure even acoustic distribution.

Specifications: Cut-off frequency, 220 cps; cell mouth opening, 8" x 8"; entry thread—1.362" x 18 tpi (for GP1), 2.620" x 16 tpi

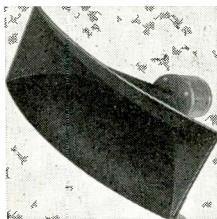

(for S2); finish, matte black; spaces between cells filled with a special compound to insure non-resonance. Priced from \$36.00 to \$236.00. CS4-9.

- 1. S2 driver \$157.50
- 2. GPI driver \$ 55.00

CS5. MISCELLANEOUS

BOGEN

● **1004A Transcription Player.** Variable speed transcription player for all PA amplifiers.

AUDIO • AUGUST, 1964

Sturdy, easy-to-carry, covered wood case. Continuously variable speed control from 29 to 86 rpm, plus click stops at the four popular speeds.

Specifications: Speeds—78, 45, 33½, 16 rpm and continuously variable; rim drive; turntable diameter, 11¾"; turntable weight, 3¼ lbs; turntable material, steel; rubber mat; wow, 0.4%; flutter 0.4%; dimensions of chassis, 14½ x 12½"; clearance required above mounting board, 2½"; below, 2¼"; type of mounting, spring; number of leads to head, 4; number of leads to chassis, 3; Price, \$97.50. CS5-1.

- 1. LPB-3 phono-top \$49.90
- 2. LPC-4 phono-top \$37.75
- 3. LPD-3 phono-top \$49.00

JENSEN

● **LVP-10 70-volt Line Level Control.** Tapped autotransformer for adjusting level in 70-volt or 25-volt line feeding sound to one or more loudspeakers. Mounted on standard 1-gang switch plate. Suitable for use in single-gang deep wall box.

Specifications: Single-gang deep wall box mounting. Single gang wall plate mounted.

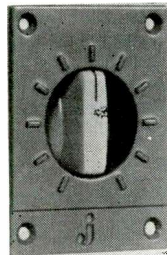

Load to 10-watts. Recessed flush knob. Paintable neutral sand finish. Ten 3-db stops of attenuation and off. Suitable for panel thicknesses up to ¼". CS5-3.

- 1. LCB/5 8-ohm, 5-w continuous pot.
- 2. LT8/10 8-ohm, 10-w, step switch pot.
- 3. LTP-8/10 8-ohm, 10-w, single-gang plate mtd.
- 4. LVP-35 70-volt, 35-w, 2-gang plate mtd.
- 5. LVD-75 70-volt, 75-w, 3-gang plate mtd.

NORELCO

● **EL6911 Delayed Sound Equipment.** Magnetic tape device based on the Haas effect. Used to provide intelligible speech in areas of large reverberation time. May also be used to create reverberation in acoustically dead areas.

Specifications: Speeds—30 ips; heads—8 full track; signal-to-noise ratio, 60 db; wow and flutter, 0.3% at 30 ips; inputs—1 micro-

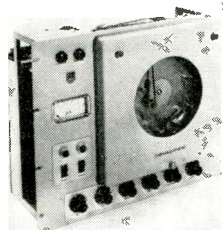

phone, impedance 100k ohms, sensitivity 2 mv; 1 high level, impedance 100k ohms, sensitivity 0.115 volts; amplifier outputs—4, line, impedance 500 ohms. Dimensions, 19" wide, 15¼" high; weight, 60 lbs. Other features: minimum delay 30 milliseconds; maximum delay 900 milliseconds. Price, \$2,380.00. Accessories: Package of 10 tape loops. \$15.00. CS5-4.

SCULLY

● **Model 270.** Solid-state professional long-play tape reproducer (playback), plug-in transistorized preamplifier, Scully patented disc brakes, one piece solid frame, direct drive hysteresis-synchronous capstan motor, 14" reel size, automatic reversing, silicon rectifier power supply. Model 270 designed for broadcasters, background music operators or any application where long life, reliability and exacting performance specifications in tape handling equipment are essential.

Specifications: 3¼-7½ or 7½-15 ips tape speeds; ¼" or ½" tape width; frequency response, ±2 db, 50 to 15k cps at 7½ ips; ±2 db 50 to 7.5k cps at 3¼ ips; flutter and wow better than 0.1% rms at 7½ ips; signal-to-noise ratio, -60 db at 7½ ips; 24v. d.c. control system. Mono, full, or half track, price \$1395.00 CS5-5.

Acoustech Solid State

"...better than the best..."

—Hi Fi/Stereo Review

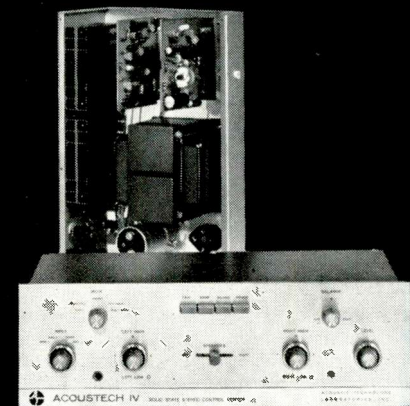

Two New Kits That Make Tube Units Obsolete!

These two new Acoustech kits make anything you've heard sound out-of-date. Direct-coupled circuitry throughout provides performance unattainable with tube units regardless of price . . . factory assembled, plug-in glass epoxy printed circuit boards used in both kits give reliability just not possible until now.

NEW ACOUSTECH IV CONTROL CENTER has under 0.09% I.M. distortion through tuner input, under 0.15% I.M. through phono inputs. Rise time under 1¼ µsec. Features dual mag inputs, tape monitor provisions, Muting. \$149 (\$149.95 West of Rockies).

NEW ACOUSTECH III POWER AMPLIFIER has over 200 watts per channel clean transient power. Under 0.95% I.M. at 60 watts per channel, under 0.45% I.M. at 40 watts per channel. Rise time under 1½ µsec. All silicon transistors throughout. \$199.00 (\$199.95 West of Rockies).



ACOUSTECH, INC.
Dept. A-8, 139 Main Street, Cambridge, Mass. 02142

FREE

Please send free booklet "Why Solid State Amplifiers Can Sound Better" and full information on Acoustech solid state kits to

Name _____

Address _____

City _____ Zone _____ State _____

Circle 148

The Tape Guide

HERMAN BURSTEIN

(Note: To facilitate a prompt reply, please enclose a stamped, self-addressed envelope with your question.)

Herman Burstein
280 Twin Lake E., Wantagh, N. Y.

Disc to Tape

Q. I have been trying to record from phono discs to tape, but have been experiencing trouble with tape distortion in playback. This distortion is apparent only when the source is a phono disc (not on tuner). The trouble seems to be excessive turntable rumble. When the rumble filter on the preamp is used, the distortion is less severe. Can this problem be corrected?

A. You might try installing a rumble filter at the input of your tape recorder, consisting of two RC sections in series. You would have to experiment with the turnover frequency. It is considered good practice to make the turnover frequency of one section somewhat different from the turnover of the other. Thus, as a start, the turnover frequency of the first section could be about 50 cycles and that of the second section about 30 cycles. Accordingly, you could install a 0.01 μf series capacitor at the input with a 333k ohm resistor to ground, followed by another 0.01 μf capacitor with a 470k ohm resistor to ground.

Irregular Tape Feed

Q. I notice many times, while playing the second sequence of a tape after reversing reels, that the tape leaves the feed reel in an irregular fashion. Often the tape bends nearly 30-deg. out of the normal vertical plane; it appears to wobble, as though one edge of the tape had been stretched and the other had not. Hence the tape virtually "flutters" past the head and the music sounds accordingly. I have checked vertical alignment of guide posts and have found all okay. I have installed a pressure pad alongside the reel, but sometimes this doesn't work. This problem seems to occur more frequently with certain tapes where a very pliable base material is used. I would appreciate your ideas.

A. Your problem might be due to warpage of the tape reel, conditions of tape storage, or possibly winding the tape under undue tension, resulting in tape curling. It may be due to a tape guide that is slightly too narrow, forcing the tape to bend as it passes through the guide.

IM Distortion

Q. In specifications for tape recorders, very little if anything is said about IM distortion. Why?

A. Nothing is said about IM distortion because the amounts involved are distur-

ing to an audiofan accustomed to seeing specifications of 1 per cent and less in other audio equipment. Thus in a recently tested machine, IM was about 8 per cent at full recording level. In some tape machines the figure may go appreciably higher. The distortion is on the tape, rather than being caused by the tape amplifiers. Apparently, at least in tape recording, we can live with IM distortion of several per cent.

Pressure Pads

Q. What are the detrimental effects of pressure pads?

A. They tend to increase wow and flutter and head wear.

1/4-Track Conversion

Q. I have a 1/2-track stereo tape machine and want to convert it to 1/4-track operation. I have contacted the manufacturer, but he won't give information to anyone but a dealer.

A. You may be able to get help from one of the agencies that service tape recorders. Or, you can write to one of the companies, such as Nortronics, that makes replacement heads for a variety of tape machines.

Hum

Q. I have a hum problem. By disconnecting the cables from the playback head to the tape amplifier, I completely eliminate the hum. I also find that by tapping the chassis of my audio amplifier several times the hum is greatly reduced, although still present. What do you think is the cause of the hum?

A. There may be an insecure ground connection in your amplifier, perhaps due to poor soldering. One of the cables may be making a poor ground connection. The tape playback head may be inadequately grounded. There may be a ground loop; see what happens if you make a ground connection for both sections of the playback head via one of the cables. The head may be picking up hum from the transport motor and/or the tape amplifier's power transformer; this means that the playback head is inadequately shielded. You may be able to "warp" the hum field in the vicinity of the head by interposing a small piece of magnetic material, such as a lamination from a discarded transformer.

Converting Mono to Stereo

Q. I plan to convert my mono tape recorder into a stereo unit. It now operates at 15 and 7.5 ips, but this will be changed to 7.5 and 3.75 ips. I would appreciate your help in connection with the electronics for the second channel and with equalization.

A. You can copy the circuitry of your present tape amplifier for the second channel. If you use a separate oscillator for

the second channel (because the present one can't drive two channels), synchronize the frequency of the two oscillators by running a small capacitor, about 0.005 μf , from the plate of one oscillator to the corresponding plate of the other. You can retain your present 7.5 ips equalization. For 3.75 ips, you can make a choice between a playback turnover frequency (where bass boost is 3 db up) of 795 cycles or 1,326 cycles; both turnovers are in common use. Record equalization is then tailored to achieve as nearly flat response as is practical. For specific information on equalization circuits, consult your manufacturer.

Mush and Background Noise

Q. I have used my tape recorder exclusively for duplicating tapes and records. In general I have been pleased with its performance, but occasionally the background hiss becomes obtrusive. Its apparent loudness varies with the type of music being recorded. I have also occasionally noticed a peculiar mushiness to the sound which is not present in the original recording. This distortion is related not so much to the loudness as to the type of sound, and is most noticeable with massed voices. I assume that the bulk of the background noise is due to inherent transistor hiss and that the mushiness is due to IM distortion. Could I improve the performance of my machine with different transistors or circuit modifications?

A. You are probably right that the mushiness is due to IM distortion, which in turn is due to excessive recording level. From what I have read about your tape recorder, its VU meter reads 0 VU at about 3% harmonic distortion rather than 1%, so that you don't have a safety margin to guard against over-recording. Try recording at a level about 6 db lower than you have been accustomed to using. The mushiness may also be due to saturation of high frequencies at high recording level, which means a relative loss of treble.

The hiss to which you refer may be tape modulation noise, which varies with recording level. Or it may be transistor noise. Or both. For information on using different transistors and circuits, I suggest you contact the manufacturer of your tape machine.

Recorded Tapes versus Discs

Q. Do I really get a better product in a recorded tape than in its disc counterpart?

A. While tape appears potentially superior, commercial recorded tapes are not as yet demonstrably better than their disc counterparts. There is still too much hiss and breakup in these tapes. The very best tapes and the very best discs seem to me about on a par.

Cable Capacitance

Q. My tape machine has an output impedance of 10k ohms, and I want to use a cable about 5 to 6 feet long? What would be the cable's capacitance before beginning to cause treble loss? I can obtain cable of 18 pf per foot.

A. With an output impedance of 10k ohms, a load capacitance of 530 pf would result in response being 3 db down at approximately 30k cps and only 1 db down at 15k cps. Using regular microphone cable of about 30 pf capacitance per foot, this would permit a run of nearly 18 feet. Using special cable of 18 pf per foot, a run of nearly 30 feet is tolerable. **Æ**

JAZZ and all that

Bertram Stanleigh

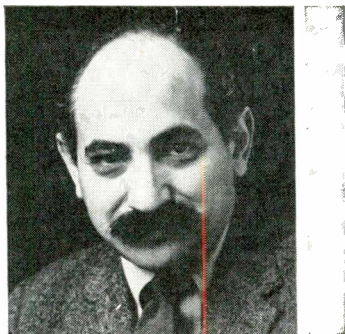

Coleman Hawkins: Body & Soul RCA Victor Vintage Series Mono LPV-501

This is the first release in a series of 1p reissues of great popular, jazz and folk music recordings from the RCA Victor archives. If future releases are as impressive as the two discs received to date, this promises to be a series of major importance for which we can all be grateful. The present set covers a span of thirty-six years in the "Hawk's" career, tracing his history on wax from a 1927 Don Redman arrangement of *St. Louis Shuffle* with an early Fletcher Henderson Orchestra that included Tommy Ladnier, Benny Morton, Jimmy Harrison, Buster Bailey and Kaiser Marshall to two 1963 sessions, *April in Paris* with Joe Williams and Clark Terry, and *Just Friends* with Sonny Rollins.

Sandwiched between these landmarks are a succession of important discs including *Body & Soul*, made in 1939 with his own orchestra, *One Hour*, a 1929 waxing with the Mound City Blue Blowers—Red McKenzie, Glen Miller, Pee Wee Russell, Eddie Condon, Jack Bland, Al Morgan and Gene Krupa—*Early Session Hop*, a 1939 date with Dizzy Gillespie, Benny Carter, Chu Berry, Ben Webster, Clyde Hart, Charlie Christian, Milt Hinton, Cozy Cole and Lionel Hampton and ten more fascinating performances. On one record we can trace Hawkins' development and observe his remarkable success at working with widely differing groups without altering the fundamental character of his style. Not only is the disc crammed with great performances (16 instead of the usual 12), but the liner notes are also jam packed with valuable information—a first rate essay on "Hawk" and his records by George Hoefer and a complete list of session dates and personnel for the contents. Quality of the transfers on the older numbers is excellent with the hiss reduced but plenty of highs retained.

The Great Isham Jones and his Orchestra RCA Victor Vintage Series Mono LPV-504

Like the Coleman Hawkins reissue, this is an exciting and unexpected delight. It's been a long time since any of the Isham Jones recordings were available, and I believe that these are the first long playing reissues by this group. The Jones band was one of the greatest dance orchestras of the twenties and thirties, and Isham Jones was an outstanding arranger, meticulous conductor and the composer of more than 200 songs, among them *I'll See You in My Dreams*, *Swinging Down the Lane*, *The One I Love Belongs to Somebody Else*, *Spain*, *What's the Use?* and *You've Got Me Crying Again*. However only two of the almost twenty years of Jones' recording career were on the Victor label, and as a result many of his important hits are not included in the present collection. While this platter may not qualify as a retrospective view of the career of Jones and his orchestra, it does represent one of his richest periods of recording, and five of his own tunes are included among the disc's sixteen numbers.

Many are bound to prize this collection for nostalgic reasons. Tunes like *Blue Prelude*, *Darkness on the Delta*, *Ridin' Around in the Rain*, *A Little Street Where Old Friends Meet* and *For All We Know* take us back to Depression years and the era of the fox trot. But in hearing the Isham Jones Orchestra after so long a space, it is clear to see the strong influence that this splendid group had, not only on Woody Herman, who began his career as a bandleader when he took over this orchestra

shortly before World War II, but on all of the great bands of the forties. Sound on these sixteen numbers, recorded between December, 1932 and July, 1934 is surprisingly close to present day standards.

The Latin Side of Vince Guaraldi Fantasy Mono 3360

As one would expect, the Latin side of Vince Guaraldi has a strong Brazilian flavor, and in his attractive new lp, pianist Guaraldi offers not only compositions by Antonio Carlos Jobim and Luis Bonfá but five of his own tunes, including his bossa nova influenced *Brasilia*. A string quartet, plus congas, timbales and guitar, supplement the regular Guaraldi trio. The result is some of the most rhythmically satisfying and sophisticated jazz that has come this way in a long time. It's most agreeable warm weather music, and the clear, close up recording with crisp percussion transients does much to enhance the musical merits.

Gale Garnet: My Kind of Folk Songs RCA Victor Stereo LSP-2833

A strong stylist with a rich, full voice, crisp, clear enunciation and rhythmic drive, Miss Garnet is a young woman of twenty-one who does a convincing job of creating the impression that her experience is much greater than her years would indicate. In addition to highly personal versions of traditional folk songs like *I know You Rider*, *Take This Hammer* and *Wanderin'*, she contributes *Malaika*, an African number in Swahili, *Pretty Boy*, a West Indian Song, and five selections of her own creation, *Sleep You Now*, *Nine Years Old*, *Prism Song*, *We'll Sing in the Sunshine* and *Fly Bird*. As a tunesmith, Miss Garnet is a minor talent, but she delivers her trivial creations in a sensitive manner that goes a long way toward convincing one that her songs are of significance. An instrumental group featuring guitar, mouth organ and percussion provides rather lush accompaniments. A small chorus joins in on a few of the numbers, and the overall effect is a little too slick and contrived for serious folk music. The sound is bright and attractive with the accompanying instruments widely spread and Miss Garnet close up in the center.

Roger Sprung: Progressive Ragtime Bluegrass #2 Folkways Mono FA 2371

Enthusiasm is at the core of this mixed bag of country ragtime performances. Tunes as far apart as *Chinatown*, *Misirlou*, *That's a Plenty*, *Arkansas Traveler* and *Puff the Magic Dragon* are all subjected to the rough, ready and vigorous assault of a group of urban bluegrass buffs consisting of Roger Sprung, 5 string banjo, Jon Sholle, lead guitar, Hank Miller, 2nd guitar, Jody Stecher, mandolin, Larry Dunn, backup guitar, Gene Lowinger, fiddle, and Bob Thompson and Frank Benedetto, drums. The group lacks the ultimate refinement of a highly polished ensemble, and the performers are not always as secure in the command of their instruments as might be hoped for, but these slight imperfections are actually a positive asset in the performance of music in this free swinging country manner. All in all, these young musicians make it clear that they are having fun, and their spirit is highly infectious. The recorded quality is entirely adequate but hardly the last word in audio engineering.



WHY YOU PAY MORE FOR THE ENDURING QUALITY OF ALTEC PLAYBACK COMPONENTS

From time to time, we are asked why Altec PLAYBACK Components can't be made to sell for less, so that the quality of PLAYBACK could be enjoyed by more people. Our reply—one that we give quite sincerely—is: How can anyone claiming to offer the quality of PLAYBACK Components sell for any less when all manufacturers pay exactly the same for labor and parts (such as resistors, transistors, capacitors, transformers, tubes, and so on) assuming these parts are of identical quality to the ones we use. Naturally, anyone can sell for less by using fewer components, and cheaper components, and less care in manufacture. It is always possible to make a product much cheaper and a lot worse. But where is the "bargain?" After all, you buy components to obtain the finest sound reproduction available. To settle for less . . . to purchase components on the basis of price alone . . . means that you have settled for second best.

HOW TO DETERMINE WHICH COMPONENTS ARE RIGHT AT THE PRICE:

The logical answer: Buy the same components the professionals buy and use—the broadcast technicians, the recording artists and engineers, the musical conductors—the people whose bread and butter depend on the selection and use of the finest sound systems it is possible to obtain. You will find that Altec PLAYBACK Components are used as standard studio equipment at ABC, Capitol Records, Columbia, Sam Goldwyn, Glen Glenn, Studio 3, Walton and many other broadcast/recording studios of equal technical excellence. These, and many other big name users, are shown in our illustrated brochure, "Altec PLAYBACK Equipment." (We would be happy to send you a copy.) Going back 40 years to Western Electric Company, Altec engineering has been foremost in the broadcast and recording arts and it is this experience that is available to you through Altec PLAYBACK Components.

PREMIUM QUALITY COMMANDS PREMIUM PRICE

Altec PLAYBACK Components cost more than ordinary "hi fi" because equipment that is built to professional standards, for use by professionals, simply can't be built for any less. Your home music center may well be one of the largest single equipment investments you will ever make. And, since you're buying for the years ahead . . . for the ultimate in musical enjoyment . . . in the expectation of always hearing the best that music reproduction has to offer . . . may we suggest that you emulate the professionals in selecting your components? Insist on listening to genuine Altec PLAYBACK Components in a direct comparison with any other units, of any make. Then, see if you don't agree that "the price for the very best is always right . . ."

Altec Lansing Corporation
Anaheim, California

© ALC 1964

THE AUDIO BOOKSHELF

A convenient service to AUDIO readers.
 Order your books leisurely by mail — save time and travel, we pay the postage.

Maintaining Hi-Fi Equipment
 Joseph Marshall
 A valuable reference for anyone whose living or hobby is servicing hi-fi equipment. Outlines the professional approach for servicing all types of hi-fi components. Covers trouble-shooting of electronic, mechanical and acoustic problems. 224 pages.
No. 58 Paperback \$2.90*



Designing and Building Hi-Fi Furniture
 Jeff Markel
 Written by a professional hi-fi furniture designer who has taught furniture design at leading colleges, this book is an authentic reference of value to the hi-fi fan and professional custom builder. Covers everything from types of woods to furniture finishing for the mechanically adept; design principles, styles and arrangements for the decor minded. 224 pages.
No. 79 Paperback \$2.90*

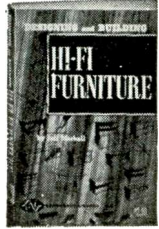

"The AUDIO Cyclopedia"
 Howard M. Tremaine
 Here is one single volume with the most comprehensive coverage of every phase of audio. Concise, accurate explanations of all audio and hi-fi subjects. More than 7 years in preparation—the most authoritative encyclopedic work with a unique quick reference system for instant answers to any question. A vital complete reference book for every audio engineer, technician, and serious audiophile.
No. 123 \$19.95*

- 1280 pages
- 3400 topics
- 1600 illustrations

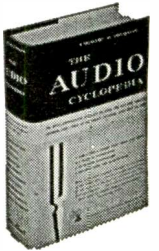

McProud High Fidelity Omnibook
 Prepared and edited by C. G. McProud, publisher of AUDIO and noted authority and pioneer in the field of high fidelity. Contains a wealth of ideas, how to's, what to's, and when to's, written so plainly that both engineer and layman can appreciate its valuable content. Covers planning, problems with decoration, cabinets and building hi-fi furniture. A perfect guide.
No. 115 \$2.50*



The 5th AUDIO Anthology
 Edited by C. G. McProud, publisher of AUDIO. An anthology of the most significant articles covering: stereo recording and reproduction; stereo multiplex; measurements; stereo technology, construction and theory — which appeared in AUDIO during 1958 and 1959. The 5th is truly a collectors' item and a valuable reference for the professional engineer, teacher, student, hobbyist and hi-fi fan. 144 pages.
No. 125 \$3.50

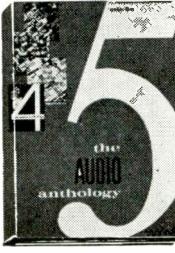

The 6th AUDIO Anthology
 Edited by C. G. McProud, publisher of AUDIO. Includes articles on the two most significant milestones in the field of high fidelity: FM STEREO and TRANSISTORS IN AUDIO EQUIPMENT. A meaningful reference for everyone in the fields of audio engineering, recording, broadcasting, manufacturing and servicing of components and equipment. A necessary book for the high fidelity enthusiast. 144 pages.
No. 130 \$3.95



Tape Recorders and Tape Recording
 Harold D. Weiler
 A complete book on home recording by the author of *High Fidelity Simplified*. Easy to read and learn the techniques required for professional results with home recorders. Covers room acoustics, microphone techniques, sound effects, editing and splicing, etc. Invaluable to recording enthusiasts.
No. 112 Paper Cover \$2.95*

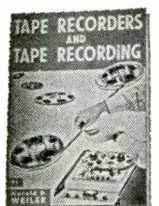

"the best of AUDIO"—
 edited by C. G. McProud
 A new compendium of AUDIO knowledge. Here is a collection of the best of AUDIO — The AUDIO Clinic by Joseph Giovanelli . . . noted audio engineer and the original high fidelity answer-man — EQUIPMENT PROFILES edited by C. G. McProud . . . Editor of AUDIO. Here is a wealth of hi-fi and audio information. Answers to the most important issues in high fidelity and a valuable reference.
No. 124 Volume I \$2.00*



AUDIUGUIDE
 By the editors of AUDIO, the original magazine about high fidelity. A 1962-1963 product review of stereo high fidelity components. Valuable reference for the high fidelity enthusiast and hobbyist. Part I contains a thorough discussion of the *Problems of a Stereo Installation*; Part II is a complete treatise on *Selecting a Tape Recorder*. Indispensable to the prospective buyer of stereo components and tape recorders. Includes a section on where to buy various stereo hi-fi components and accessories. 156 pages.
No. 127 \$1.00

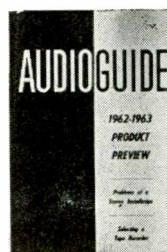

MONTHLY SPECIAL! SAVE \$5.00
 Save almost 50% with this collection of AUDIO books.
 "best of AUDIO" (\$2.00) 5th AUDIO ANTHOLOGY (\$3.50)
 McProud High Fidelity Omnibook (\$2.50) and
 Tape Recorders & Tape Recording (\$2.95)
TOTAL VALUE ALL FOUR BOOKS . . . \$10.95
Your cost only . . . \$5.95 Postpaid
 This offer expires September 30, 1964, and is good only on direct order to the Publisher.
CIRCLE OS400

High Fidelity Simplified
 Harold D. Weiler
3rd Edition
 The complete hi-fi story — answers all questions about tuners, changers, amplifiers, tape recorders, speakers, record players, etc. Lots of ideas for custom installations. Tells how to achieve concert hall reception in your home. 216 pages.
No. 142 \$3.30



AUDIO Bookshelf—RADIO MAGAZINES, INC.
 P. O. Box 629, Mineola, New York 11502
 Please send me the books I have circled below. I am enclosing the full remittance of \$..... (No C.O.D. or billing.)

58	79	112	115	123	124
125	127	130	142	251	OS400

NAME _____
 ADDRESS _____
 CITY _____ STATE _____ ZIP _____

Getting the Most Out Of Your Tape Recorder
 Herman Burstein
 Written in "plain talk" for the man who has, or wishes to buy, a tape recorder. It answers the myriad questions raised by tape recording enthusiasts. Its chapters cover every phase of operation and maintenance—from adding a tape recorder to the hi-fi system, to a thorough dissertation on microphones. Lots of practical information on how to buy. 176 pages.
No. 251 \$4.25



CLASS-D FOR EFFICIENCY

(from page 27)

phase audio inputs from transistors Q_3 and Q_4 rather than from a transformer as shown in Fig. 16. Moreover, the multivibrator works on -6 volts; the audio input voltage therefore produces greater modulation. Resistor R_{22} and capacitor C_{10} drop and filter the power supply voltage to the multivibrator. When the amplifier is first turned on, capacitor C_{10} is discharged, so that the multivibrator starts at -12 volts. Then the capacitor slowly starts to charge, so that eventually the collector supply voltage gradually decreases to -6 volts.

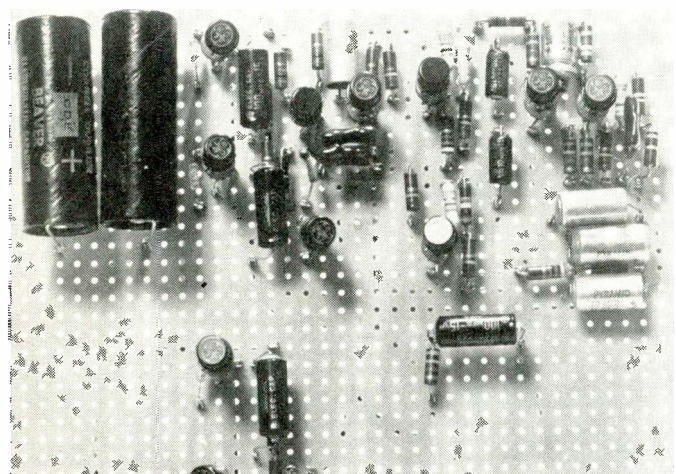

Fig. 26. Astable multivibrator amplifier.

The outputs from the multivibrator are taken from the collectors of Q_5 and Q_6 , and applied to transistors Q_7 and Q_8 , the output driver transistors. The circuit for the output and driver stages, transistors Q_7 through Q_{12} , is identical to the output circuits shown in Fig. 21.

As mentioned earlier, two feedback paths are used. One is the audio feedback through R_{24} to the base of Q_{11} , and the other is the d.c. feedback path through R_{25} and R_9 to the base of Q_3 . First measurements of this amplifier were inconclusive because some of the 60-80 kc switching energy kept feeding through. Thus 1000 cps harmonic readings of 6-7.5 per cent resulted depending on the power. With suitable filters we would expect a substantial reduction in distortion. The listening quality and scope display confirm this expectation.

The current drain for the amplifier is approximately 100 ma from a -12 volt power supply, with a net power drain of approximately 1.2 watts. It has been used on dry cells, where a supply consisting of eight D cells connected in series has provided several hours of op-

eration. The amplifier is presently being used in conjunction with an inexpensive miniature speaker enclosure and a transistorized FM tuner, and has given reliable service for a long time. Æ

REFERENCES

¹ G. F. Cooper, "Class D Amplifiers," *AUDIO*, June 1963, p. 24.

² G. F. Cooper, "Class D Amplifiers," *AUDIO*, July 1963, p. 24 and August 1963, p. 23.

³ B. D. Bedford, patent no. 389,855, September 25, 1931.

⁴ Everitt and Anner, "Communication Engineering," McGraw-Hill, New York, N. Y., 1956; p. 27.

⁵ *ibid.*, p. 34.

⁶ Terman, "Radio Engineers' Handbook," McGraw-Hill, New York, N. Y., 1943; p. 581.

⁷ M. G. Crosby, "Carrier and Side Frequency Relations with Multi-tone Frequency or Phase Modulation," *RCA Review*, Vol. 3, p. 103; July 1938.

⁸ Ley, Lutz and Rehberg, "Linear Circuit Analysis," McGraw-Hill, New York, N. Y., 1959; p. 373.

⁹ *ibid.*, p. 395.

¹⁰ Fitch, "The Spectrum of Modulated Pulses," *J. Inst. Elec. Engrs.*, Vol. 94 Part IIIA, 1947. p. 556-564.

¹¹ D. R. Birt, "Modulated Pulse A. F. Amplifiers," *Wireless World*, February 1963, p. 76.

¹² K. C. Johnson, "Pulse Modulated AF Amplifiers," *Wireless World*, March 1963, p. 135 (Correspondence).

¹³ Burrington's "Mathematical Tables and Formulas," etc.

¹⁴ Millman and Taub, "Pulse and Digital Circuits," McGraw-Hill, New York, N. Y., 1959; p. 214.

COMMERCIAL SOUND

(from page 22)

stall it according to directions that come with it.

Alternatively, you may prefer to buy the necessary parts—relays, switches, and such, and

build your own system. But we suggest you don't try this without being sure you understand exactly what you plan to do. As an example of the pitfalls you

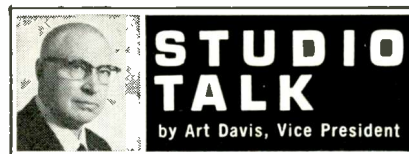

Audio Controls Division
Altec Lansing Corporation

SUPERIOR NEW INSTRUMENT SWITCHES AND ATTENUATORS

It's no longer a secret that our Audio Controls Division at Altec is well on the way to producing what we feel will be the best instrument switches and attenuators ever made specifically for the recording and broadcast industries. Without wishing to detract from my own three decades as a design engineer and manufacturer in this field, nor from the superb facilities available to me at Altec, I must admit that much of the credit goes to the fact that we are starting from scratch on all of our designs. Frankly, this is an engineer's dream—no preconceived ideas, no old designs that have to be adapted, no existing tooling that has to be used. Our only concern is the here and now, and how can we make it better.

LOW NOISE, LOW MAINTENANCE, LONG LIFE

Looks like our switches and attenuators will give you the best set of performance specifications ever available. Here are a few of the things we've done to achieve this superiority: Each brush blade is independently sprung to provide contact all the time. We predict a total absence of contact bounce. The brush springs are completely out of the circuit and will carry no current. Our brushes are made of fine silver ("coin" silver, normally used, contains copper and is subject to oxidation which reduces conductivity and raises noise level among other things). The fine silver does not oxidize—it sulfides. This has two advantages: conductivity is not affected and sulphide of silver has a lubricative quality which is actually beneficial.

MORE INNOVATIONS

As you know, most switches come in round cans. We're putting ours in square ones. You don't have any use for the space around the can anyway so we're using the corners for the wiring. The result is that our switches will give you more positions in less space. For example, most switches have 12 positions at the most. Ours have 31 positions on a 1½" switch and up to 45 positions on the 2¼" one.

To cap the whole thing off, we'll be able to gang up to 8 of our attenuators in tandem so you can operate the whole works with just one control.

NEW SOLID STATE 470A PREAMP NEARLY READY

We announced this device in our last "Studio Talk." It's the one you can use as a preamp or as a line, booster, or program amp with no internal changes needed. By the way, the 470A has a lower noise level than any vacuum tube unit on the market.

And by the time you read this, our 61A Program Equalizer and 62A Graphic Equalizer will be in full production. So give me a call or drop me a line. I'll be happy to send you the latest information on what's here now and what's coming soon.

Art Davis
Art Davis

Audio Controls Division • Altec Lansing Corporation • Anaheim, California

© ALC 1964

Circle 150

LISTEN



SCHOEPS MICROPHONES

Technical data* can only give you the characteristics of a microphone—data can't describe your most important factor—the sound. Get a Schoeps Microphone on a 30 day trial—and listen!

*You will receive this with your microphone

Designed by Schoeps
Manufactured by Schoeps
Patented by Schoeps



Shown: the M221B with MK26 — 3 pattern capsule

INTERNATIONAL ELECTROACOUSTICS INCORPORATED
333 SIXTH AVENUE NEW YORK 14, N. Y. 212 WA 9-8364

Circle 151

AT LAST! A MICROPHONE

WITH A BUILT-IN TAPE RECORDER

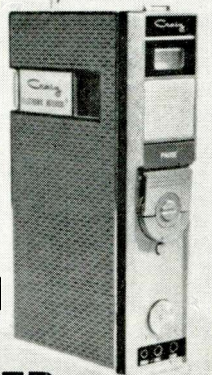

The trick was to make a tape recorder this small with a built-in mike. Here it is, the **Craig 490 Electronic Notebook**,* and the whole thing is smaller than some mikes! Transistorized, battery operated, it works anywhere without attachments. Built-in speaker, touch-control operation, tape-pack for instant loading without threading. Cowhide carrying case and strap, and batteries all included for only **\$79.95**.

Craig Panorama, Inc.
Los Angeles 16, California

*Registered

Circle 152

can run into, we show a circuit for a speaker station in *Fig. 5-9*, which was drawn with intent to fulfill the same function as that at *Fig. 5-8*, without needing a relay. Normally, each speaker would select its own program and volume setting. Then a paging message would be sent out over the special 'bus' that connects directly to each speaker, without going through the selector switch or volume control.

(Continued on page 97)

SYMPHONIETTA NEW HIGH FIDELITY SPEAKER SYSTEM

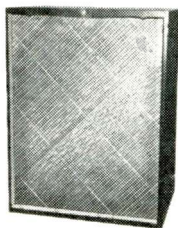

of the 4-way horn-loaded type. Expensive true-fidelity sound reproduction at a popular price. For further details, write:
PROVO HIGH FIDELITY
Box 234, Pittsford, N.Y.



YL ACOUSTIC CO., LTD.

19 Shiba-Tamura-Cho, Mnatō-ku, Tokyo, JAPAN

Circle 153

MORE CLASSIFIED

MINIMIZE TRACKING ERROR. No mathematics, no calculations. Ingenious visual guide enables you to read tracking error directly and shows exact positioning of tone arm for greatest fidelity. Fits all tone arms. Ready to use. \$6.95 postpaid. For literature write TRU-TRAK, P. O. Box 75, Somerset, California 95684.

WANTED: Presto or Audak cutting head. Preferably Presto 1-B or 1-C model. New, used or rebuilt. Benjamin L. Hall, Box 934, Edgartown, Mass. 02539.

LP's I will pay 25% of manufacturer's suggested list price for Standard Labels in all categories: Popular, Classical, Jazz, etc. For information write Kraus, Box 601, Wayne, Michigan, 48148.

CLASSIFIED

Rates: 10¢ per word per insertion for noncommercial advertisements; 25¢ per word for commercial advertisements. Rates are net, and no discounts will be allowed. Copy must be accompanied by remittance in full, and must reach the New York office by the first of the month preceding the date of issue.

HIGH FIDELITY SPEAKERS REPAIRED
AMPRITE SPEAKER SERVICE
168 W. 23rd St., New York 11, N. Y.
CI 3-4812

MILITARY DISCOUNTS: name brands. Free recording tape and stereo handbook. Include rank, serial number, Electronics International, Inc., 3066, Charlottesville, Virginia.

HI-FI COMPONENTS, tape recorders at guaranteed "We Will Not Be Undersold" prices. 15-day money-back guarantee, 2-year warranty. NO CATALOG. QUOTATIONS FREE. HI-FIDELITY CENTER, 1797-V 1st Ave., New York, N. Y. 10028

HARPSICHORD. Same as owned by Philadelphia Orchestra and RCA Victor. In kit form for home workshop assembly, \$150. Clavichord kit, \$100. Free brochure. Write: Zuckermann Harpsichord, Dept. R, 115 Christopher St., New York 14, N. Y.

SELL: Two Tannoy 15" Dual Concentric speakers in enclosures, Dyna PAS-2, Stereo 70, Rek-O-Kut B12H, base individually or as system. W. Bucci, 49 Ayrmont Lane, Matawan, N. J.

A PARABOLOID MIKE MOUNT will extend your pick-up range and power tremendously. Convenient size- and weight-compromise for effectiveness. Molded in Fibreglas plastic. Used in field recording for three years. Send stamped envelope for information. Carl Frank, Creekinoll R#1, Rochester, Minnesota.

NEUMANN DST-62 stereo cartridge for sale. Complete with matching transformers, response curves, equalization circuit for flattest response, and original box. Cost \$120 new; perfect condition, only \$35. Francis Daniel, 207 West 106 St., New York 25, N. Y. Tel: AC 2-0898.

FOR SALE: Ampex 351-2P, used 300 hours, \$1,800. 2 Neumann U47 microphones, stereo system used 20 hours, \$500. 1 Sony wireless microphone system used 5 hours, \$175. Will positively accept best offer on any or all of above listed equipment. Kenneth Fritz, Jr., 1211 Marshall Avenue, South Milwaukee, Wisc. Phone SO 4-4704.

SELL: Tape preamplifier, stereo record/playback, VU meters, Knight KP-70, \$55; Heath speaker system AS-2 (AR2), \$45; "Electrostat 3" tweeter, \$10; equipment like new. Paul Bogdanoff, 1114 Glenview St., Philadelphia, Pa.

3 only: Plate-to-line Cinema AT-13, \$7 each. 2 only Input transformers Cinema AT-11, \$5 each. Never used. Sam Bowlyby, 3534 Conquista Ave., Long Beach 8, Calif.

RECORDING ENGINEER

Responsible, intelligent, young recording engineer desires full, part time, or free-lance work (preferably in New York City area) with recording studio, record company, performers, private individuals or organizations. I have studio and location experience, and own professional tape and disc equipment. Salary no object. Available immediately. Will consider business partnership as alternative. Send offers or requests for resume to: Steve Steinis, 120-28 218 St., Cambria Heights, New York, 11411 or phone: 212 LA 8-5809.

save over 40% on hi-fi

Write For Our Price Now. YOU'LL BE GLAD YOU DID.

- Up to 24 mos. to pay
- * 15 day money-back guarantee.
- * Full 2 yr Warranty-Parts & Labor.
- * Factory Franchised all lines. We ship from stock.
- * Trade-ins Highest allowance-Send your list.
- * 19th year of reliable service-world-wide.
- * We guarantee "WE WILL NOT BE UNDERSOLD."

Best Buy. Hi-Fi List Free.

HI-FIDELITY CENTER
"The House of Low Low Prices"

1797-U 1st Ave. New York, N. Y. 10028

Circle 154

FAST SHIPMENTS
TIME PAYMENTS

COMPONENTS • KITS

- BEST-BY-COMPARISON PRICES.
- VISIT OUR STORE
- FACTORY SEALED CARTONS
- SEND FOR "QJOTES" ON PACKAGE DEALS AND SAVE MORE
- WRITE FOR MONTHLY SPECIALS

CARSTON Studios
125-A East 88 St., New York 28, N. Y.

Circle 155

CANADA
High Fidelity Equipment

Complete Lines • Complete Service
Hi-Fi Records — Components and Accessories

ELECTRO-VOICE SOUND SYSTEMS
126 DUNDAS ST. WEST. TORONTO, CANADA

Circle 156

MORE and BETTER

FM Stereo Multiplex BROADCASTS FOR YOU

with a **FINCO**®
AWARD-WINNING FM Antenna

Model FM-4
\$24.90 List

World's Most Complete line of HI-FI Phased **FM ANTENNAS**

Write for Catalog 20-213.

THE FINNEY COMPANY
34 WEST INTERSTATE BEDFORD, OHIO
DEPT. A

Circle 157

AUDIO • AUGUST, 1964

COMMERCIAL SOUND

(from page 96)

Question—Chapter V

Why wouldn't this work? If you cannot see why—or even if you can, read the answer.

Answer—Chapter V

This is the kind of thing that needs careful thinking. With some experience, you would have immediately spotted that the presence of the 'message bus' connects all speakers together, whether or not a message is being sent. Therefore every speaker would get the same, which is the sum total of what each individual selects—all the programs mixed together in various proportions, even when no message is being sent! This was why the alternative we described (*Fig. 5-7*) used a separate individual circuit back to the control center for this purpose, with switching (which we did not show) to parallel them when needed for a message.

If you spotted this immediately, then with care you may be smart enough to figure out a system to do exactly what you need without running into trouble. If you had any hesitation in spotting it, you should either take a course in symbolic logic, before attempting to design your own system of this kind, or shop around for a ready-made system, which may cost you no more in the long run than designing your own.

In the next installment, we shall consider microphones for various jobs in commercial sound installations. Before that comes, see whether you can think of all the factors, apart from the obvious questions of who makes them and finding the best price for an adequate type, that should be considered in choosing a microphone for a system. In short, how do you go about determining your needs—what factors are involved?

Industry Notes...

HARVEY SAMPSON DIES

Harvey Sampson, owner and founder of Harvey Radio, well known New York City audio dealer, died at the age of 56 on July 2, 1964. He founded Harvey Radio Company in the year 1927. He was 19 years old at the time. The original location was a small store at 100 West 43rd Street near Sixth Avenue in New York City. Over the years he acquired several nearby stores, including a 4-story building fronting on Sixth Avenue, until he had amassed 20,000 square feet.

For many years, Harvey Radio was known as ham headquarters for New York. An industrial department was opened in recent years.

Although primarily a New York City operation, Harvey Radio was known throughout the United States as one of the pioneer high fidelity outlets. Harvey Sampson was known and respected throughout the entire industry. He is survived by his wife Betty and his two sons, Paul and Harvey, Jr.

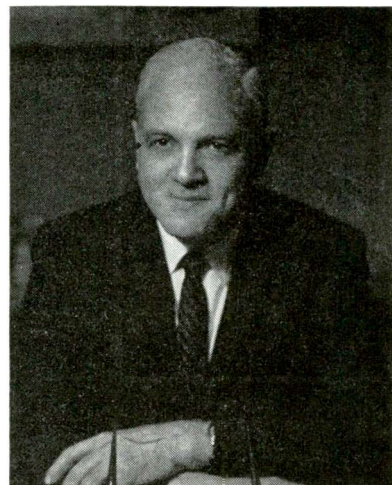

New!



14" MICRO BALANCE TYPE STEREO TONE ARM WITH HYDRAULIC ARM ELEVATOR

MODEL
GA-23

"Neat Onkyo" Does it Again!

A new concept in stereo tone-arms by Japan's foremost audio firm. New Stereo Tone Arms incorporate the precision of the best cameras . . . respond to less than 1 gram of stylus pressure.

- Lever-switch for raising stylus; lowers by oil pressure. 10 mm/sec
- Let's you pick up phonograph safely while record is playing.

NEAT

NEAT ONKYO DENKI CO., LTD.

No 4-1 chome, Kanda Hatago-cho
Chiyoda-ku, Tokyo, Jaapan



VS-2000D

MOVING COIL TYPE STEREO CARTRIDGE WITH A 0.5 OR 0.7-MIL DIAMOND STYLUS

Frequency characteristics: 10-21,000 c/s
Output voltage: 5mV 5 cm/sec. 1,000 c/s
Crosstalk: 30 dB at 40-12,000 c/s
Stylus pressure: 2~3 gr
Compliance: 1.9×10^6 cm/dyne
Stylus point: 0.5 mil; 0.7 mil diamond
Mounting measurement: JIS. EIA

Circle 158

ADVERTISING INDEX

Acoustech, Inc.	91
Acoustic Research, Inc.	75
Acoustical Manufacturing Co., Ltd.	80
AKG of America	79
Allied Radio Corp.	65, 66
Altec Lansing Corp.	4, 93, 95
Audio Bookshelf	94
Benjamin Electronic Sound Corp.	89
Bozak	57
British Industries Corp.	3
Carston Studios	97
Clark, David, Co., Inc.	90
Classified	96
Concertone	9
Craig Panorama	96
Crown International	98
Dynaco, Inc.	11
Eastman Kodak Company	51
EICO Electronic Instr. Co.	59
Electro-Voice, Inc.	Cov. IV, 1
Electro-Voice Sound Systems	97
Elpa Marketing Industries	55
Empire Scientific	5
Fairchild Recording Equipment Corp.	84
Finney Co.	97
Fisher Radio Corp.	7
Frazier (International Electronics)	89
Garrard Sales Corp.	3
Greentree Electronics	8
Heath Company	71
Hi Fidelity Center	97
International Electroacoustics, Inc.	96
JFD Electronics Corp.	83
Kenwood Electronics, Inc.	76
Lafayette Radio	88
Lansing, James B., Sound, Inc.	63
LTV University	12, 13
Magneticord (Midwestern Instruments) Cov.	111
Mark Records	88
Martel Electronic	86
McIntosh Laboratory, Inc.	53
Neat Onkyo Denki Co., Ltd.	98
Newcomb Products Co.	73
North American Philips Co.	61
Pickering & Company, Inc.	17
RCA, Electronic Components and Devices	77
Rye Sound Corp.	87
Sarkes Tarzian, Inc.	78
Scott, H. H., Inc.	Cov. 11
Sennheiser Electronics Corp.	15
Sherwood Electronic Laboratories, Inc.	18
Shure Brothers, Inc.	49
Sonotone Corp.	6
Tandberg of America, Inc.	85
Tannoy (America) Ltd.	90
Telex/Acoustic Products	88
TRW Columbus Division	69
United Audio Products	81
YL Acoustic Co., Ltd.	96

PRINTED BY BUSINESS PRESS, INCORPORATED





— first choice
of those who
demand the best!

NEW

**Solid State
RECORDERS**

**INCOMPARABLE
PERFORMANCE**

Quarter-Track Record/Play Data

ips	db	cps	s/n
7-1/2	±2	50 — 30,000	56db
3-3/4	±2	30 — 20,000	52db
1-7/8	±3	30 — 12,000	46db

The most complete recording instruments ever designed for stereo use. Audio circuitry, $\pm 1/4$ db from 10-100,000 cps; extended range, 5-500,000 cps. Plug-in circuit modules are printed on epoxy and gold plated. Engineered to space craft reliability.



*THE HALLMARK
OF CROWN —
SUPERLATIVE
CRAFTSMANSHIP
THROUGHOUT!*

**INDIVIDUAL PERFORMANCE
RECORD SUPPLIED
WITH EACH CROWN**

WRITE DEPT. AU-08

1718 Mishawaka Rd. • Elkhart, Ind.

Circle 159

WHERE CAN YOU BUY 40 SOUND QUALITY FEATURES?

1. Modular construction featuring complete plug-in record amplifier, reproduce amplifier, and bias oscillator 2. Fully solid-state electronics 3. Hysteresis synchronous metering capstan drive 4. Solenoid operated tape gate, brakes and pressure roller 5. Separate reel drive motors 6. Safely handles all tape, including half mil 7. Front panel microphone jacks 8. Mixing inputs for high level line 9. Front panel mode switch with tally lights 10. Monitoring from tape or source. 11. Separate channel monitor and output switches 12. Durable, easily cleaned, easy-on-the-eye professional vinyl finish 13. Standard readily available American transistors and components 14. Superior tape guiding 15. Military type fail-safe differential band brakes 16. Sturdy die-cast main plate 17. Signal switching available at remote socket 18. Position for optional fourth head 19. Remote "start-stop" 20. Local-remote front panel control 21. Pushbutton transport controls 22. Record safety interlock 23. New "cue" transport control 24. Large, rugged hardened stainless steel capstan 25. Ball bearing inertial stabilizer flywheel 26. Payout compliance arm and tape break shut-off 27. Automatic capstan motor stop for tape run-out 28. Take-up compliance arm 29. Regulated power supply 30. Emitter follower outputs 31. Stereo-mono front panel earphone switch 32. Simultaneous record and playback 33. Double flywheel capstan drive 34. Switchable equalization 35. Auxiliary emitter-follower outputs 36. Auxiliary high impedance inputs 37. Standard "hi-fi" connectors 38. Large "operator" type knobs 39. Earphone monitor jack on front panel 40. V.U. meter for each channel

FULLY SOLID-STATE ELECTRONICS

SOUND-ON-SOUND & SOUND-WITH-SOUND

FOR QUARTER-TRACK STEREO OR MONAURAL OPERATION

TAPE SPEEDS: 3.75 and 7.5 inches per second.

REEL SIZE: 5-, 7- and 8-inch E.I.A. hubs.

HEADS: Four. Selectable ¼-track Erase, ¼-track Record and ¼-track Play are Standard. Accessory two-track Stereo Play available as fourth head.

DIMENSIONS: 19" wide, 15-¾" high, 12" deep.

Unprecedented in our industry, Magnecord, America's first manufacturer of magnetic tape recorders, now introduces a unique model. The NEW Magnecord 1024 offers you the highest possible quality at the lowest conceivable price! For professional sound, design simplicity, moderate price, engineered performance and quality throughout — BUY the most versatile of them all . . . BUY the NEW 1024!



Buy the **NEW**

Magnecord
1024

ONLY
\$595.

for further information write

MAGNECORD SALES DEPARTMENT

MIDWESTERN INSTRUMENTS, INC.

P. O. BOX 7509 • TULSA 35, OKLAHOMA



New E-V Model 668 Dynamic Cardioid Boom Microphone

with built-in
programming panel!

***BRAIN
ON A
BOOM!***

Ey It's just like having 36 microphones in one, at the end of your boom! Simply match the computer-style programming pins to the color-coded jack field inside the new E-V668. You'll get any combination of flat response, (40 to 12,000 cps), bass and/or treble rolloff, treble rise, and 80 or 8,000 cps cutoff. The 668 built-in passive equalizer matches response to need precisely without loss in output level—mixes perfectly with any other microphone.

The 668 cardioid pattern is symmetrical in every plane with excellent rear cancellation at every program setting. Two independent Continuously Variable-D* systems provide this uniformity, yet permit high output (-51 dbm) for distant pickup without added equipment or special cables.

Light in weight and small in size, the 668 with integral Acoustifoam™ wind-screen and shock mount minimizes shadow problems while allowing noise-free fast panning, indoors and out. Its 1 lb., 11 oz. weight eliminates "fishpole fatigue" and counterbalancing problems.

The 668 is guaranteed UNCONDITIONALLY against malfunction of any kind—even if caused by accident or abuse—for two years. And, like all E-V Professional microphones, it's guaranteed for life against failure of materials or workmanship.

The E-V 668 is the result of a three year intensive field testing program in movie and TV studios from coast to coast. It has proved itself superior to every other boom microphone available. Find out why with a no cost, no obligation trial in your studio. Call your E-V Professional microphone distributor today, or write us direct for complete specifications.

List price \$495.00 less normal trade discounts.

Patent No. 3115207 covers the exclusive E-V Continuously Variable-D design.

ELECTRO-VOICE, INC.
Dept. 841A, Buchanan, Michigan 49107

Electro-Voice[®]
SETTING NEW STANDARDS IN SOUND

Circle 102 on Reader Service Card