

# Audio

EUROPEAN LETTER

THE AUTHORITATIVE MAGAZINE ABOUT HIGH FIDELITY • MAY 1979 \$1.25

47425 

**BUILD A  
HEAD-  
PHONE  
AMP**

25¢

25¢

25¢

**LINE  
SURGE  
PROTECTION  
FOR HI-FI  
EQUIPMENT**

**EXCLUSIVE  
TEST-**

**STANTON  
PERMOSTAT  
KILLS  
RECORD STATIC  
FOREVER!**



U0296146 1085 9051503P7202232  
WILLIAM M KAYSER  
197 M BAYVIEW BLVD  
VA 23503



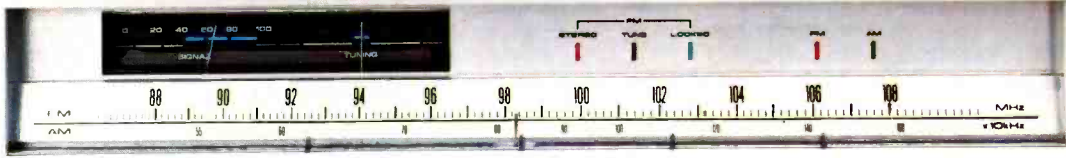

**PIONEER**  
DOUBLE LOCKED STEREO TUNER  
TX-8800

OUTPUT LEVEL

FUNCTION: FM, AM, NARROW, WIDE, PHONO, MONITOR, FILTER, AUTO, STEREO, MONO

**PIONEER** STEREO AMPLIFIER SA-8800

SPEAKERS: OFF, A, B, A+B

METER: L, 0.001, 0.01, 0.1, 1, 10, 100, R

BASS: TURNOVER, 0, 400, 800

TONE: TURNOVER, OFF, ON, 5K, 2K

TREBLE: TURNOVER, 0, 10, 20, 30, 40, 50, 60, 70, 80, 90, 100

BALANCE: LEFT, RIGHT

MODE: STEREO, REV, L+R, L, R

CARTRIIDGE LOAD: 100, 200, 300, 500, 10K, 20K, 50K, 100K

VOLUME: 0, 10, 20, 30, 40, 50, 60, 70, 80, 90, 100

FUNCTION: TAPE, DPLICATE, MONITOR, PHONO, MIN, MAX, TUNER, 1, 2, 1+2, 1-2, 2-1, 2-2





# AND SO IS THE FIGHT ABOUT TUNERS.

At one time the struggle between amplifiers was won by the amp that had the most muscle. And the tuner that brought in the most stations also brought in the most acclaim.

Today, there's one series of amplifiers whose technology has put it in a class by itself. And now, with Pioneer's new TX 9800 tuner it's met its match.

While other tuners offer features that just sound great, every feature in Pioneer's TX 9800 helps to produce great sound.

Unlike ordinary tuners that are content with ordinary circuitry, the TX 9800 has a new Quadrature Discriminator Transformer that works with Pioneer's exclusive PA 3001-A integrated circuit to reduce distortion to 0.05% at 1 KHz and raise the signal-to-noise ratio to 83 dB. Whew!

Many of today's tuners use sophisticated low pass filters to remove the 19 KHz pilot signal that's present in every stereo broadcast. But while they're effective in removing the pilot signal, they're also effective in removing some of the music.

The TX 9800 has Automatic Pilot Canceling Circuitry that makes sure every part of the music is heard all of the time. And that distortion is veritably unheard of.

The crowning achievement of most tuners today is the sensitivity of their front end. And though it's much to their credit to bring in weak stations, it means nothing unless they can do it without spurious noise or other interference.

The TX 9800's front end has three dual gate MOSFET's that work with our five gang variable capacitor to give you an FM sensitivity of 8.8 dBf. And also make sure that your favorite music is not disturbed by what's playing elsewhere on the dial.

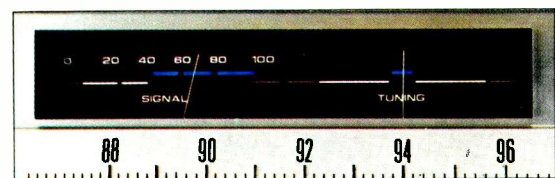

SIGNAL STRENGTH AND CENTER TUNING METERS FOR A DRIFT-FREE PERFORMANCE.

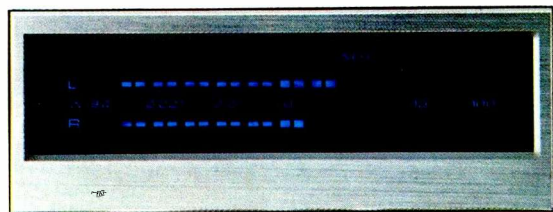

INSTANTANEOUS FLUOROSCAN METERING THAT LETS YOU WATCH EVERY PERFORMANCE WHILE YOU HEAR IT.

And while most tuners today give you one band width for all FM stations, the TX 9800 gives you two. For both AM and FM. A wide band that lets you bring in strong stations loud and clear. And a narrow one that finds even the weakest station on a crowded dial and brings it in without any interference.

All told, these scientific innovations sound mighty impressive. But they wouldn't sound like much without an even more impressive tuning system.

The TX 9800 has a specially designed Quartz Sampling Lock Tuning System, that fortunately, is a lot easier to operate than pronounce.

Simply rotate the tuning dial to your desired station. When the station is tuned exactly right a "tune" light comes on. By releasing the tuning dial you automatically lock onto that broadcast. And automatically eliminate FM drift.

By now, it must be obvious that the same thinking that went into Pioneer's new amplifiers has also gone into their new line of tuners.

So just as Pioneer ended the class struggle between amps, they won the fight between tuners. With a technical knockout.

**PIONEER®**

We bring it back alive.

©1978 U.S. Pioneer Electronic Corp.,  
High Fidelity Components,  
85 Oxford Drive, Moonachie, N.J. 07074.



# THE STRUGGLE BETWEEN THE CLASSES IS OVER.

For years people have clashed over which amplifiers are best. Class A or Class B. Expensive Non-switching Class A amplifiers are known to offer the lowest levels of distortion. At the same time, they also offer the highest operating temperatures.

And while Switching Class B amplifiers increase efficiency, they also increase distortion.

So if you're not paying through the nose for a heat-producing Class A amplifier, you'll be paying through the ear for a distortion-producing Class B.

At Pioneer, we believe most of today's Class A and Class B amplifiers are pretty much in the same class. The class below Pioneer's SA 9800.

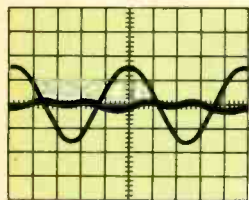

CLASS A AMPLIFIER.  
LEAST DISTORTION  
BUT MOST HEAT.

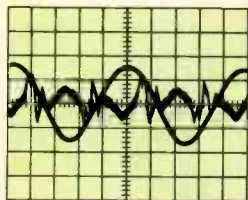

CLASS B AMPLIFIER.  
MOST DISTORTION  
BUT LESS HEAT.

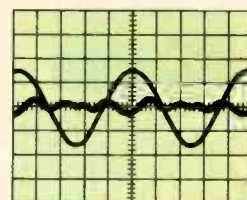

SA-9800.  
LESS DISTORTION, LESS  
HEAT, AND MORE POWER.

Pioneer's Non-switching SA 9800 offers the efficiency found in the finest Class B amplifiers. With a distortion level found in

the finest Class A. An unheard of 0.005% at 10-20,000 hertz.

And while you're certain to find conventional power transistors in most conventional amplifiers, you won't find them in the SA 9800. You'll find specially developed RET (Ring Emitter Transistors) transistors that greatly increase frequency response. So instead of getting distortion at high frequencies, you get clean clear sound. Nothing more. Nothing less.

Instead of slow-to-react VU meters that give you average readings or more sophisticated LED's that give you limited resolution, the SA 9800 offers a Fluroscan metering system that is so fast and so precise it instantaneously follows every peak in the power to make sure you're never bothered by overload or clipping distortion.

And while most amplifiers try to impress you with all the things they do, the SA 9800 can even impress you with the one thing it simply doesn't do. It doesn't add anything to the sound it reproduces. An impressive 110dB S/N ratio is proof of it.

While these features alone are enough to outclass most popular amplifiers, the SA 9800 also offers features like DC phono and equalizer sections and DC flat and power amps that eliminate phase and transient distortion. Cartridge load selectors that let you get the most out of every cartridge. And independent left and right channel power supplies.

Obviously, it took revolutionary technology to build the SA 9800. But the same technology and skillful engineering that went into the SA 9800 also goes into every amplifier in Pioneer's new series.

At Pioneer, we're certain that others will soon be entering the class of 9800. And though they all may be built along similar lines, in terms of value Pioneer will always be in a class by itself.

**PIONEER®**  
We bring it back alive.

©1978 U.S. Pioneer Electronics Corp.,  
High Fidelity Components,  
85 Oxford Drive, Moonachie, N.J. 07074.

**DISCWASHER**

presents

**The Clean Truth  
About Your  
Naked Stylus**

When your stylus plays over one light fingerprint or one tiny "bead" of vinyl stabilizer, the clean naked diamond becomes a glazed, dust-holding abrasive weapon wearing away at your records and masking their true sound. This unseen build-up may actually hold the tracking tip of the diamond out of the record groove.



Accumulated grit on stylus that looks "clean" to the naked eye.

The SC-1 Stylus Cleaner from Discwasher is designed with a brush that is stiff enough to remove harmful accumulation, but gentle enough to avoid damaging delicate cartridge assemblies. Two drops of Discwasher's D3 Fluid add extra cleaning action to the SC-1 without the side-effects of alcohol, which can harden rubber cantilever mountings.

After cleaning with SC-1 and D3 Fluid by Discwasher.



The retractable, walnut-handled SC-1 includes a magnifying mirror for convenient inspection of stylus/cartridge alignment and wiring.

Get the clean truth from your records; get the SC-1.

**SC-1 STYLUS  
CLEANER**

**discwasher<sup>®</sup> inc.**  
1407 N. Providence Rd.  
Columbia, MO 65201

May 1979

Vol. 63, No. 5

# Audio

"Successor to **RADIO** Est. 1917"**Feature Articles**

|  |    |                   |
|--|----|-------------------|
| Surge and Hash Protection<br>for Hi-Fi Equipment | 38 | F.J. Stifter      |
| Catastrophe Theory, Part III                     | 42 | Richard C. Heyser |
| Build a Headphone Amp                            | 56 | Walter G. Jung    |

**Equipment Profiles**

|   |    |                    |
|---|----|--------------------|
| Stanton Permostat Record<br>Treatment           | 60 | Leonard Feldman    |
| Nikko Gamma I Tuner                             | 64 | Leonard Feldman    |
| Nagatronics HV9100 Cartridge                    | 66 | B.V. Pisha         |
| Audio Technology 510 Peak<br>Responding Display | 68 | Howard A. Roberson |
| Advent 500 SoundSpace Control                   | 70 | Leonard Feldman    |
| Visonik DD-8200 Turntable                       | 76 | George W. Tillett  |

**Record Reviews**

|                 |     |                             |
|-----------------|-----|-----------------------------|
| The Column      | 82  | Michael Tearson & Jon Tiven |
| Top of the Pile | 90  |                             |
| The Folk Bag    | 95  | Tom Bingham                 |
| Jazz & Blues    | 98  |                             |
| Classical       | 102 | Edward Tatnall Canby        |

**Audio in General**

|                        |     |                      |
|------------------------|-----|----------------------|
| The Forum              | 6   |                      |
| Behind the Scenes      | 8   | Bert Whyte           |
| Audio ETC              | 18  | Edward Tatnall Canby |
| Audioclinic            | 24  | Joseph Giovanelli    |
| Tape Guide             | 26  | Herman Burstein      |
| Obituary               | 28  |                      |
| What's New in Audio    | 32  |                      |
| Dear Editor            | 34  |                      |
| European Letter        | 80  | Donald Aldous        |
| Classified Advertising | 106 |                      |
| Advertising Index      | 116 |                      |

**About the Cover:** Headphones with their finite cord lengths are a no-no for the roller rink. However, you can build your own headphone amp using Walter Jung's circuit on page 56. Model: Ginny Clark. Photo by Photographic Illustrations, Philadelphia.



Audio Publishing, Editorial, Subscription, and Advertising Production offices, North American Building, 401 No. Broad St., Philadelphia, Penna. 19108. Telephone: 215/574-9600.  
Postmaster: Send Form 3579 to above address.



# What do you get when you put together...

1.

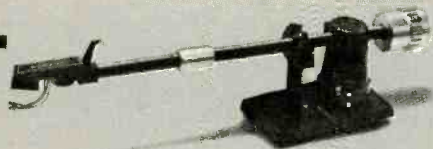

**A tonearm worth \$150...**  
(with UNIPOISE® patented single pivot point suspension)

2.



**A turntable worth \$200...**  
(with GYROPOISE® exclusive patented magnetic suspension)

3.

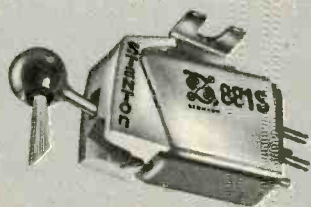

**A cartridge worth \$150...**  
(Professional Calibration Standard with patented STEREOHEDRON® stylus tip)

## Stanton's NEW 8005 turntable system!



### Stanton's handsome new low profile Turntable has unequalled features:

1. The Gyropoise® platter actually floats on air. This magnetic suspension eliminates vertical friction and almost complete acoustical isolation is insured.
2. Unipoise® tonearm with patented single point suspension reduces lateral and vertical friction to a minimum.
3. Automatic stop and lift-off on some models ... manual operation on others.
4. Each Turntable comes with a top-of-the-line calibrated Stanton cartridge (881S or 681 Triple-E).

5. The Universal Cartridge Adapter Head accommodates all cartridges (a free Adapter Head comes with each turntable).

6. Other features:

- a) Precision ground belt drive
- b) Tracking force and anti-skate mechanism
- c) Viscous damped cueing
- d) Die cast aluminum platter
- e) Hinged dust cover adjustable to any position

For further information write:  
Stanton Magnetics, Inc.  
Terminal Drive, Plainview, N.Y. 11803

... "The choice of the Professionals"™

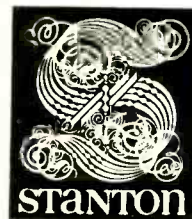

Enter No. 37 on Reader Service Card

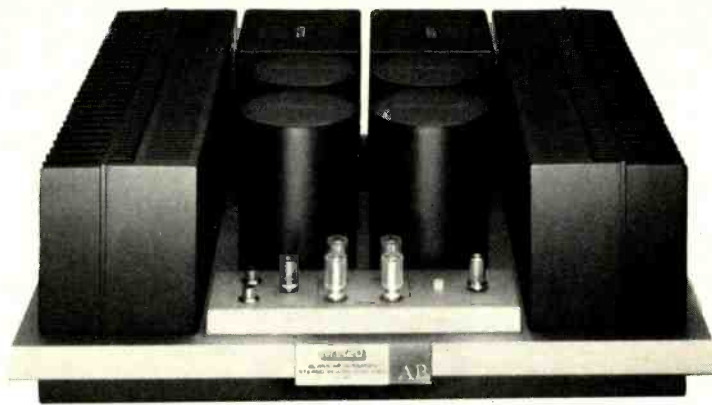

# series20<sup>®</sup>

## IT TAKES GUTS TO BE MORE EXPENSIVE THAN McINTOSH

McIntosh might be considered an expensive extravagance by the average high fidelity consumer. However the true audiophile perceives reliability, proven engineering and classic styling as necessities rather than luxuries.

The true audiophile also appreciates outstanding specs and the state of the art technology that distinguishes Series 20 from the field.

Consider the Ring Emitter Transistor out-put stage in the Series 20 M-25 Class AB Power Amplifier that provides incredible high frequency performance.

Consider the Series 20 F-26 FM Tuner's parallel balanced linear detector that delivers the lowest distortion available.

When you realize how exceptional Series 20 is, you'll marvel at how inexpensive expensive can be.



20 Jewell Street, Moonachie, N.J. 07074

If you would like full information on Series 20, please send us the coupon below.

To: Series 20  
Dept A5  
20 Jewell Street  
Moonachie, New Jersey 07074

Please send me the specs for the following circled Series 20 components.

|  |   |  |
|--|---|--|
| M-22<br>Class A-Stereo<br>Power Amplifier            | D-23<br>Multi-AMP Elec.<br>Crossover Netwk.     | C-21<br>Stereo<br>Preamplifier             |
| F-26<br>Advanced Quartz<br>FM Tuner                  | A-27<br>Class AB Integrated<br>Stereo Amplifier | M-25<br>Class AB Stereo<br>Power Amplifier |
| PLC-590<br>Quartz PLL Servo-<br>Controlled Turntable | PA-1000<br>Carbon Fiber<br>Tone Arm             | F-28<br>Quartz<br>FM Tuner                 |
|  |   | U-24<br>Program Source<br>Selector         |

Name \_\_\_\_\_  
Street \_\_\_\_\_  
City \_\_\_\_\_  
State \_\_\_\_\_ Zip \_\_\_\_\_

### AVAILABLE AT THESE FINE DEALERS

- Alterman Audio
- American Audiophile
- American T.V.
- Another World Electronics
- Another World Electronics
- Appletree
- Appletree
- Appletree
- Appletree
- Appletree
- Appletree
- Appletree
- Appletree
- Appletree
- Appletree
- Audio Dimensions
- Audio Professionals
- Audio Professionals
- Audio Professionals
- Back Door Stereo

- New Orleans, LA
- Valley Stream, NY
- Madison, WI
- Fort Lauderdale, FL
- Miami, FL
- Springfield, IL
- Peoria, IL
- Champaign, IL
- Normal, IL
- Rockford, IL
- Elgin, IL
- Mapleville, IL
- DeKalb, IL
- San Diego, CA
- Overland Park, KS
- Lincoln, NE
- Omaha, NE
- Atlanta, GA

- Executive Audio
- Fred Locke Stereo
- Garehime Music Company
- Hi Fi Haven
- Innovative Audio
- Jonas Miller Sound
- Listen-Up
- Listen-Up
- Metex International
- Music and Sound of Calif.
- Natural Sound
- Pro Audio
- Sights & Sounds
- Sights & Sounds
- Sound Company
- Spaceways Sound
- Summit Sight & Sound
- Team Electronics

- Santa Monica, CA
- East Berlin, CT
- Las Vegas, NV
- New Brunswick, NJ
- Brooklyn, NY
- Beverly Hills, CA
- Denver, CO
- Evergreen, CO
- Laredo, TX
- Woodland Hills, CA
- Framingham, MA
- Sioux Falls, IA
- Chicago Heights, IL
- Oak Lawn, IL
- Minden, LA
- Annapolis, MD
- Jefferson City, MO
- Sioux City, IA

# Audio

Editor  
Eugene Pitts III

**Associate Editors:**  
Edward Tatnall Canby, Bert Whyte  
**Assistant Editor**  
Eugene J. Garvin, Jr.  
**Design**  
Frank Moore  
**Design Assistant**  
Barbara D'Aprile  
**Production Manager**  
Katharine H. Sumner

**Senior Editors:**  
Richard C. Heyser, B. V. Pisha  
Howard A. Roberson

**Contributing Editors:**  
Tom Bingham, Herman Burstein,  
Geoffrey T. Cook, John Diliberto,  
Leonard Feldman, Joseph Giovanelli,  
C. G. McProud, George Pontis,  
Jon Sank, Donald M. Spoto,  
Michael Tearson, George W. Tillett,  
Jon Tiven

**Vice President/Publisher**  
Jay L. Butler



AUDIO is published monthly by North American Publishing Company. Irvin J. Borowsky, Founder and President  
Frank L. Nemeyer, Vice President/General Manager  
Joseph Florentine, Chief Financial Officer  
R. Kenneth Baxter, Vice President/Manufacturing  
Michael Mushrock, Production Director  
Vic Brody, Promotion Director  
Jim Atkins, Subscription Promotion Director  
Mary Claffey, Vice President  
S. O. (Shap) Shapiro, Circulation Consultant  
Jean Davis, Circulation Manager  
Dorothy Yockey, Subscription Fulfillment Manager

**ADVERTISING SALES**  
Jay Butler, Vice President/Publisher,  
545 Madison Ave., New York, NY 10022  
Telephone (212) 371-4100  
**East Coast Sales Office:** Laurel Carr, 545 Madison Ave., New York, NY 10022 Telephone (212) 371-4100  
**West Coast Sales Office:** Jay Martin, 17000 Ventura Blvd., Encino, CA 91316. Telephone (213) 788-9900.  
**Continental European Representative:** V. B. Sanders, International Publishers Advertising Service, Raadhuisstraat 24, P.O. Box 25, Graft-De Ryp, Holland. Telephone, 02997-1303  
**England:** The Paul Singer-Lawrence Media Group, 54 Burton Court, London SW 3 5Y4, England. Phone, 01-730-3592

Title registered in U.S. Patent Office.  
Entire contents copyrighted world wide. No portion may be reproduced in any language without written permission.

World Library Congress Number ISSN0004-752X  
Dewey Decimal Number 621.381 or 778.5

Editorial Contributions are welcomed but should be accompanied by return postage. Submissions will be handled with reasonable care, but the publisher assumes no responsibility for return or safety of manuscripts, photographs, or artwork.  
Printed in U.S.A. at Columbus, Ohio. Second-class postage paid at Philadelphia, PA and additional mailing offices. USPS Number 036-960

U.S. Subscription Rates: 1 year \$12.00, 2 years \$22.00, 3 years \$30.00.

Other Countries: 1 year \$18.00, 2 years \$34.00, 3 years \$49.00.

Back issues, when available, \$5.00 postpaid.

Audio Publishing Editorial, Subscriptions, and Advertising Production offices, North American Building, 401 No. Broad St., Philadelphia, PA 19108.

Telephone: (215) 574-9600.

Postmaster: Send Form 3579 to above address.



The Technics isolated-loop system.  
It's the one big difference  
between their decks and ours.



Every one of Technics four open reel decks has one thing in common: The performance of Technics isolated-loop tape transport system. And that means performance that's comparable to professional open reel decks costing thousands of dollars more.

By isolating the tape from external influences, our isolated-loop tape transport system minimizes tape tension to a constant 80 grams. This not only provides extremely stable tape transport and low head wear, it also reduces modulation noise and wow and flutter to the point where they're detectable on only sophisticated testing equipment.

Electronically, our line of isolated-loop tape decks are equally impressive. The reasons are as simple as their IC full-logic transport controls, highly accurate microphone amplifiers, FET mixing amplifiers and separate 3-position bias/EQ selectors.

And you'll get all this technology whether you choose the two-track RS-1500, the extended playing time of the 4-track RS-1506 (shown above), the convenience of the

4-track RS-170C with auto-reverse or the studio features of the RS-1520.

There's also an optional full-feature infrared wireless remote control (RP-073). With it you can get your hands on all this sophistication from up to 20 feet.

All four decks hit the competition right between the reels. Because all four have: **FREQ. RESP.**: 30-30,000 Hz,  $\pm 3$  dB  $-10$  dB rec. level) at 15 ips. **WOW & FLUTTER**: 0.018% **WRMS** at 15 ips. **S/N RATIO**: 57 dB (1500 & 1700) and 50 dB (1500 & 1520) NAB weighted at 15 ips. **SEPARATION**: Better than 50 dB. **START-UP TIME**: 0.7 sec. **SPEED DEVIATION**:  $\pm 0.1\%$  with 1.0 or 1.5 mil tape at 15 ips. **SPEED FLUCTUATION**: 0.05% with 1.0 or 1.5 mil tape at 15 ips. **PITCH CONTROL**:  $\pm 6\%$ .

Technics open reel decks. A rare combination of audio technology. A rare standard of audio excellence.

Cabinet is simulated woodgrain

**Technics**  
Professional Series

Enter No. 39 on Reader Service Card



# The forum

## AM Clear-Channel Proposal

Dear Sir:

With interest and a sense of deep frustration, I read in *The New York Times* that the Federal Communications Commission has decided to reject the concept of a boost in power for our country's AM clear-channel stations and to remove the moratorium on the issuance of licenses on those frequencies which, up until this decision, aptly were characterized as clear channels.

I am *not* a member of the broadcasting community. I am a lawyer (no broadcasting clients) who happens to enjoy listening to distant stations on the AM radio band.

Until last year, I was a lifelong resident of Michigan and grew up on a small farm 30 miles from Grand Rapids. As you may know, Grand Rapids has a number of radio stations with at least one "regional" AM station, WOOD-AM, 1300 kHz. At night, *not one* AM station from Grand Rapids can be received in a listenable state. There is too much interference. The farm is only 10 miles from the transmitter of WPLB-AM, Greenville, Michigan, and even that station can be received only occasionally through the local channel "hash." In contrast, the following clear-channel stations provided excellent service: WSM, Nashville; WMAQ, Chicago; WLW, Cincinnati; WGN, Chicago; WJR, Detroit; WABC, New York; WBBM, Chicago; WCCO, Minneapolis; WHAS, Louisville; WWL, New Orleans; WLS, Chicago; KDKA, Pittsburgh; WBZ, Boston; WHO, Des Moines; WWWE, Cleveland; KMOX, Saint Louis, and WHAM, Rochester.

Perhaps only half of these stations delivered a listenable signal throughout the nighttime, but that is still far superior to the performance from our local stations.

These clear-channel stations brought the world home to the farm. New York, Chicago, and New Orleans were more than just names on a map. These and other cities came alive with voices and music. In broad terms, AM clear-channel stations define the national identity in terms of its regional

parts, while local stations tend to perpetuate parochialism. Clear-channel stations serve to set industry standards of professionalism, while professionalism is a corner-to-be-cut at the local level if the budget dictates or lack of competition permits.

The situation is not restricted to this one location in Michigan. I drive between New York City and Michigan several times a year and have found that there is virtually no listenable local AM service along vast stretches of this route, day or night. I look forward to nightfall so that I can tune in one of the familiar clear-channel stations for companionship through the night hours. It is not far fetched to suggest that removal of this companionship factor from the nation's nighttime motorists could have an adverse impact upon highway safety.

Adding local stations to the "clear channels" can result only in an overall decrease in service. While I was a student at Michigan State University, I lived five miles from the transmitter of WKAR-AM which operated with 10,000 watts of power throughout the day, signing off the air at dusk. WKAR shared the channel with WWL in New Orleans. During the quarter-hour preceding signoff, particularly between

the months of October and March, interference from WWL seriously impaired the pleasure of listening to WKAR. Traveling further than 25 miles from Lansing, it was impossible to hear either station because of mutual interference. Following each signoff of WKAR-AM, WWL becomes a strong, clear and listenable station.

The proposal to license several local stations on each clear channel for full-time operation would mean more interference, not relief, with nightfall. Stations like WWL would be forever out of the reach of large portions of the nation's AM radio audience. If you add local stations to the clear channels, the immediate locality may benefit from local service though nighttime interference will still be present. However, listeners of the clear-channel stations for hundreds of miles around will lose the only service they will ever have in the "hash" that will result.

I cannot believe that it is in the best interest of the people of this nation for the Commission to take this proposed action. I believe the proposed action would result in a net decrease in the quality of AM broadcasting and a net decrease in the number of people listening to AM radio. If approved, it will be increasingly difficult to hear regional news and views directly from the points of origin and to tune a strong, steady companion for a long night's drive.

Large areas of the nation will be deprived of existing clear-channel nighttime service in order that a few localities might lay claim to a local station. This proposal is clearly beneficial only to those applicants who seek local licenses on the clear channels. I hope that the Commission will reconsider this proposal and reject it on the grounds that it is not in the best interest of the people of this nation.

Perhaps, then the Commission can re-examine its decision respecting a power increase for the clear-channel stations unimpeded by the lobbying efforts of the numerous applicants for local stations on our nation's clear channels.

Lawrence D. Swift  
New York, N.Y.

AUDIO • April 1979







## INTRODUCING THE EMPIRE EDR.9 PHONO CARTRIDGE. IT SOUNDS AS GOOD ON A RECORD AS IT DOES ON PAPER.

It was inevitable . . .

With all the rapid developments being made in today's high fidelity technology, the tremendous advance in audible performance in Empire's new EDR.9 phono cartridge was bound to happen. And bound to come from Empire, as we have been designing and manufacturing the finest phono cartridges for over 18 years.

Until now, all phono cartridges were designed in the lab to achieve certain engineering characteristics and requirements. These lab characteristics and requirements took priority over actual listening tests because it was considered more important that the cartridges "measure right" or "test right"—so almost everyone was satisfied.

Empire's EDR.9 (for Extended Dynamic Response) has broken with this tradition, and is the first phono cartridge that not only meets the highest technological and design specifications—but also our

demanding listening tests—on an equal basis. In effect, it bridges the gap between the ideal blueprint and the actual sound.

The EDR.9 utilizes an L. A. C. (Large Area Contact) 0.9 stylus based upon—and named after—E. I. A. Standard RS-238B. This new design, resulting in a smaller radius and larger contact area, has a pressure index of 0.9, an improvement of almost six times the typical elliptical stylus and four times over the newest designs recently introduced by several other cartridge manufacturers. The result is that less pressure is applied to the vulnerable record groove, at the same time extending the bandwidth—including the important overtones and harmonic details.

In addition, Empire's exclusive, patented 3-Element Double Damped stylus assembly acts as an equalizer. This eliminates the high "Q" mechanical resonances typical of other stylus assemblies, producing a flatter response, and lessening wear and tear on the record groove.

We could go into more technical detail, describing pole rods that are laminated, rather than just one piece, so as to reduce losses in the magnetic structure, resulting in flatter high frequency response with less distortion. Or how the EDR.9 weighs one gram less than previous Empire phono cartridges, making it a perfect match for today's advanced low mass tonearms.

But more important, as the EDR.9 cartridge represents a new approach to cartridge design, we ask that you consider it in a slightly different way as well. Send for our free technical brochure on the EDR.9, and then visit your audio dealer and listen. Don't go by specs alone.

That's because the new Empire EDR.9 is the first phono cartridge that not only meets the highest technological and design specifications—but also our demanding listening tests.

Empire Scientific Corp. **EMPIRE**  
Garden City, N.Y. 11530

Enter No. 45 on Reader Service Card

# Behind the scenes

Bert Whyte

At the conclusion of the first part of my report on the Winter CES, I described the new Carver "magnetic field amplifier" and now I continue the report with Bob Carver's other innovative product, a preamplifier he calls the "Model C-4000 Sonic Hologram Generator." Now there is a mouthful for you! I am sure most readers are familiar with visual holograms produced by a laser beam, which in their three-dimensional projection creates such a vivid image it appears to be real. In the somewhat ambiguous press release put out by Carver's PR firm, the C-4000 preamplifier is said to produce the sonic equivalent of a hologram, with the spatial positioning of musical instruments as "precisely defined" as in the original sound field. Making allowances for catchy adjectives and PR enthusiasm, there is no denying Bob Carver's expertise in signal processing, and his new preamplifier does do some interesting things that do indeed contribute to a heightened sense of musical realism. Bob wouldn't reveal

any details of the circuitry involved, but apparently it is a very clever variation on phase switching and manipulation. Using conventional stereo recordings, when the "hologram" switch on the front panel of the C-4000 is activated, the sound is no longer confined to a direct output of the loudspeakers, but becomes somewhat analogous to a sound "stage." A broad panorama of sound is heard stretching to the left of the left speaker and to the right of the right speaker, as well as the space between the speakers. This is accompanied by an apparent increase of front-to-back depth perspective. There have been such devices used before, but the difference is that this "sonic panorama" is created without some of the anomalies that previously accompanied similar devices. For example, there is no change in the amplitude of the music signals. There is neither "bloating" nor "truncation" of the apparent size of musical instruments. There is no image "wandering," and instruments are in proper spatial

perspective. In essence, the "hologram" facility enables music to be reproduced from loudspeakers without the characteristic "boxiness," which plagues most speakers, even those with wide-dispersion tweeter and midrange drivers. It must be noted that while the "hologram" device affords a "sonic panorama" with most types of loudspeakers, it is most effective with speakers which produce good stereo imaging. The KEF 105 speakers, with which Carver was demonstrating his equipment, are particularly good in this respect. As far as I could determine, the "hologram" circuitry appears to work without any degradation of normal sonic qualities. To gild his lily, Carver had added a built-in delay system to his new preamp. Utilizing the Reticon chip of the "charge-coupled device" variety of time delay, the unit affords initial delays of 50 and 85 milliseconds, which are user adjustable. There is also a 20-watt-per-channel amplifier built into the C-4000 to drive a pair of delay





# In a class by itself.



© 1979 Koss Corp.

There are few stereophones of any kind that can match the full-bandwidth performance of the Koss Pro/4 AAA. That's because the Triple A's oversized voice coil and extra large diaphragm reproduce recorded material with a lifelike intensity and minimal distortion never before available in dynamic stereophones.

With a frequency response from 10 Hz to 22 kHz, a highly efficient element and a perfect seal for low bass response to below audibility, the Triple A lets every note blossom to its fullest harmonic growth. You'll hear so much more of your favorite music, you'll think you're listening to a whole new recording.

Unlike other stereophones, the ear-cushions developed for the Pro/4 Triple A represent a breakthrough in both comfort and acoustical engineering. Through extensive studies on how stereophones are actually worn, Koss engineers were able to reduce lateral pressure with a direct contour Pneumalite® earcushion that not only offers soft pliable comfort, but also creates an ideal environment for minimizing the linear excursion of the driver. Thus, the driver is able to produce any volume level without distortion. So you'll hear all the fundamental and harmonic frequencies exactly as they were recorded.

In addition, Koss has designed a

special Pneumalite® dual suspension headband that creates a feeling of almost weightlessness even over periods of extended listening. It makes wearing the Triple A's as pleasurable as listening to them.

Why not stop in at your audio specialist and see why the Koss Pro/4 Triple A belongs in a class by itself. Or write for our free, full-color catalog c/o Virginia Lamm. Better still, listen to a live demonstration of the incredible Sound of Koss with your favorite record or tape. We think you'll agree that when it comes to the Pro/4 AAA and other Koss Stereophones and CM loudspeakers: hearing is believing.

 **KOSS**® stereophones/loudspeakers  
**hearing is believing**™

**KOSS CORPORATION**, 4129 N. Port Washington Ave., Milwaukee, Wisconsin 53212 International Headquarters: Milwaukee/facilities: Canada · France · Germany · Ireland · Japan

Enter No. 14 on Reader Service Card



## Dawn of a new age in separates.

The Nikko NA-590 Integrated Stereo Amplifier and the NT-790 AM/FM Stereo Tuner. We designed them specifically for those who want professional quality and the new low-profile look in a home stereo system.

There was a time when the only way to get a high quality sound system was to purchase expensive, bulky professional electronics. But now, Nikko delivers all the precision, accuracy, flexibility and reliability of professional components—at a reasonable price.

The NA-590 is both a low-distortion amplifier and a full-function pre-amplifier. It will drive most home loudspeakers accurately at comfortable listening levels. The NA-590 delivers 35 watts per channel, minimum RMS, both channels driven into 8 ohms 20 to 20,000 Hz with no more than 0.05% total harmonic distortion.

The NA-590 features a subsonic filter to reduce distortion caused by turntable rumble or warped records, loudness contour, a professional-type attenuated volume control, and exclusive Nikko protection circuit breakers. Its LED function indicators, ultrathin styling and professional appearance will be at home in any listening environment.



**Nikko Electric Corp. of America**  
16270 Raymer St., Van Nuys, CA 91406 (213) 988-0105  
320 Oser Ave., Hauppauge, N.Y. 11787 (516) 231-8181  
In Canada: Superior Electronics, Inc.



The NT-790 AM/FM Stereo Tuner utilizes Nikko sophisticated circuitry, plus LED tuning indicators, FM high blend (to eliminate background hiss), and T-Locked FM automatic fine tuning for low distortion, high signal stability and wide frequency response with excellent stereo separation. The NT-790 also features professional matte finish, ultra-thin profile and optional kit for rack mounting.

The NA-590 and NT-790: excellent stereo sound made simple, at a cost you can't afford to pass up. See them, as well as the complete line of Nikko separates, at your Nikko Audio dealer. Write for complete information and specifications, or call toll-free (800) 423-2994 for the name of your nearest Nikko dealer.

speakers. Bob had placed a pair of inexpensive speakers at the wall/ceiling junction slightly to the rear of the listening position. Judicious use of the time-delay control in combination with the "hologram" feature can remarkably enhance the illusion of reality. Simultaneously defeat the "hologram" and time-delay switches, and the panoramic sound "stage" you have created collapses rather dramatically. As you might expect, the C-4000 has many other facilities, such as a third-generation auto-correlator noise reduction and peak limiter system, low-noise RIAA phono stage, etc., but the foregoing outlined the highlights of this unusual new preamplifier.

### Heavyweight Turntables

The emergence of so-called "audiophile" discs . . . direct-to-disc, digital/analog hybrid, super carefully processed analog recordings . . . has once again focused attention on disc playback equipment, and at the Jockey Club in Las Vegas there were quite a number of new items, some of them as "far-out" esoteric as you can imagine. For example, the indefatigable Bob Fulton was showing a new turntable, apparently designed for Texas oil barons! The turntable platter was machined from a solid billet of copper and weighs a mere 65 pounds! This massive platter is mounted on equally massive machined-steel tripod supports, with slots in each leg of the tripod so that a phono arm can be mounted on each leg, in the manner of the Micro-Seiki unit. A huge synchronous motor is completely free-standing in its own housing and drives the copper turntable via a special silk belt, which is said to have compliance factors to afford a filtering effect on motor vibrations. Belt tension is adjusted by moving the entire motor/housing assembly. If Bob is serious about this unit, it can be yours for (gasp!) \$6800.00! Obviously, review samples will be on the scarce side.

At the Win Laboratories exhibit, the urbane Sao Win was proudly displaying what has to be the most beautiful turntable I have ever seen, his new model SDC-10. While constructed entirely in this country, it uses crystal-clear, 3/4-inch thick, special German Lucite (or Plexiglas if you like) for the base and dust cover. The base rests on satin-finished stainless-steel tripod supports which incorporate leveling devices and a proprietary suspension system in each leg. The turntable platter itself was lathe turned from a solid billet of aluminum and hence has no balance holes drilled into it. The turntable spindle is made of surgical stainless steel, so hard it must be

# Nikko Audio

For those who take their stereo seriously.



# We've just improved every record you own.

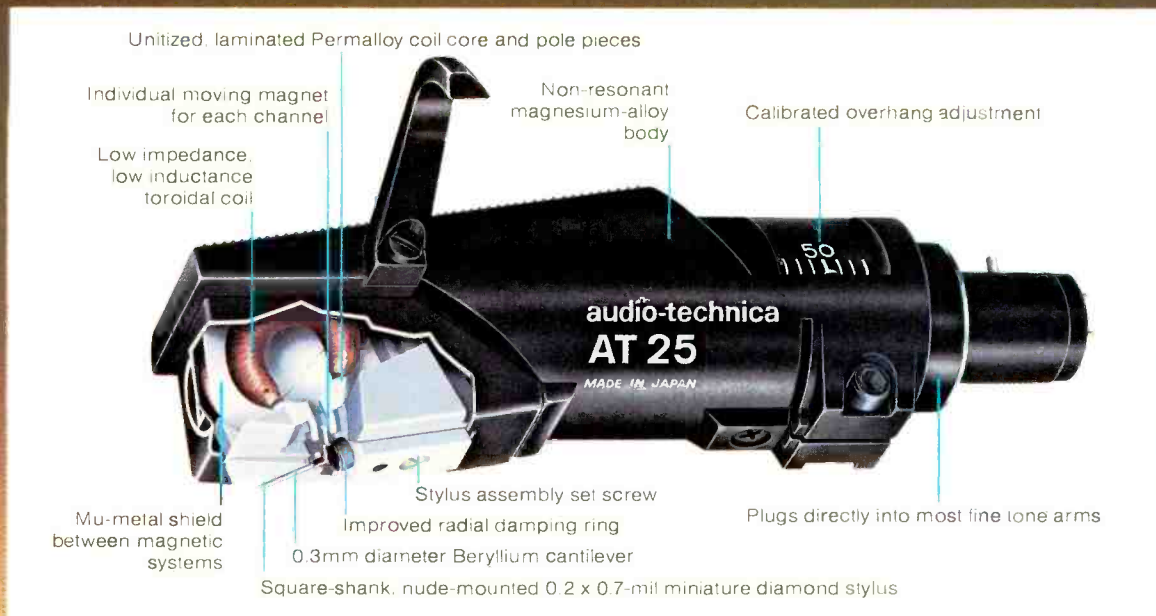

## Bold, creative new technology sets new standards for clarity, dynamic range, and stereo separation.

Of course the new AT25 doesn't look like other stereo phono cartridges. It's entirely different. And not just on the outside. We've rethought every detail of design and construction. All in the interest of the smoothest, cleanest sound you've ever heard. The AT25 frequency response is utterly uniform. Definition and stereo separation are remarkable. Dynamic range is awesome. Even the most demanding digital and direct-to-disc records are more spectacular, more musically revealing.

But set our claims aside and listen. The AT25 is unexcelled for transparency and clean, effortless transient response. Individual instruments are heard crisply, without stridency even at extremely high levels. Even surface noise is less apparent.

The cutaway view shows you how we do it. Start with the coils. Just two, hand-wound in a toroidal (doughnut) shape. A unique shape which cuts losses, reduces inductance, and lowers impedance. The coils are wound on laminated one-piece cores which also serve as pole pieces. Again, losses are lower. Eddy current effect is also reduced. Which all adds up to superior transient response. It's like having the electrical performance of the finest moving coil designs, but with the high output of a moving

magnet. The best of both worlds!

Each magnetic system is completely independent. No common circuits. We even add a mu-metal shield between the coils to insure no leakage between channels. Which results in stereo separation which must be heard to be believed.

But there's more. An entirely new stylus assembly with one of the smallest whole diamond styli in series production. Only 0.09mm in cross section and almost invisible. It's nude-mounted and square-shank to insure exact alignment with the groove. And it's set in a Beryllium cantilever that eliminates flexing.

Instead of snapping into place, this stylus assembly is held rigidly to a precisely machined surface with a small set screw. A small detail which insures perfect alignment, no spurious resonances, and simple stylus replacement.

We treat cartridge shell resonances too, with special damping material applied to the top of the unique plug-in shell. The magnesium shell even has a calibrated adjustment for stylus overhang to insure perfect installation.

The many technical differences between the new AT25 and every other stereo cartridge are fascinating . . . and significant. But the real difference is in the resulting sound. It's almost as if you had plugged your stereo system directly

into the studio console. Every subtlety of artistic expression is intact, no matter how complex—or simple—the music, no matter how loud—or soft—the performance. It's as though a subtle barrier had been removed adding clarity and presence to every record you own.

A cartridge of this sophistication and high quality cannot be produced quickly. Initially the AT25 may be in short supply. But your patience will be rewarded with performance which will send you back through your record library to discover nuances you never suspected to hear. And you'll eagerly await the sonic splendors of tomorrow's digital recording techniques.

This outstanding performance is now available two ways: the direct plug-in AT25 and the standard-mount AT24. Either one will make every other component you own sound better, including your records!



Model AT25 Unitized Headshell/Dual Magnet™ Stereo Phono Cartridge \$275

Model AT24 Dual Magnet™ Stereo Phono Cartridge \$250



**audio-technica**  
INNOVATION □ PRECISION □ INTEGRITY

AUDIO-TECHNICA U.S., INC., Dept. 59A, 33 Shiawassee Avenue, Fairlawn, Ohio 44313

Enter No. 2 on Reader Service Card



## We build a speaker that sounds like music

It can accurately reproduce the 120+ dB peaks that are found in some live music. That's more than just being able to play music loud. It can accurately reproduce the music bandwidth—from below 25Hz to 20kHz. And the Interface:D's vented midrange speaker reproduces midrange sounds with the clarity and purity that allows precise localization of sound sources—both lateral and front-to-back.

The Interface:D is the only commercially available speaker we know of that can meet these criteria. Audition them at your Interface dealer.



**Electro-Voice®**

a GULFON company

600 Cecil Street  
Buchanan, Michigan 49107

# Interface:D™

ground and honed. The SDS-10 is a belt-drive unit, using a special low-speed motor, and is not sold with an arm, the user selecting the arm he prefers. It comes with appropriate mounting plates to avoid drilling the Lucite. Mr. Win was playing a record with an arm of his own design and casually picked up a Discwasher record cleaning brush, which you probably know has a substantial, solid walnut handle. I'm sure Dr. Bruce Maier wouldn't approve of how Mr. Win used his beautiful cleaning brush, but in any case, all of a sudden Mr. Win struck the base of his turntable several hard, resounding blows with the walnut handle of the brush, and, amazingly, there was no effect on the sound of the music nor did the turntable or arm even quiver. A few more lusty whacks of brush on the base, just to prove it was not a "fluke," made a pretty convincing demonstration of the efficacy of the suspension system of this unique turntable. The Win SDS-10 turntable is expected to be produced in fairly limited quantities, with an anticipated price of \$2000.00. No specs available yet, but in two respects, immunity to both external vibration and acoustic feedback, this turntable is the solution (albeit an expensive one) to these problems.

Also contributing to the refinement of turntable mounting and reduction of feedback was the ever-versatile Mitch Cotter. In his exhibit Mitch was showing a special turntable base and suspension system. The heavy mounting board is a laminate of differing materials, combining very high strength with especially inert acoustical properties. Mitch recommends using the top-of-the-line Denon turntable or the Technics SP-10 Mark Two with his base. To accomplish this, the turntables are completely demounted from their usual bases and installed in the special mount in the Cotter base. Details of the suspension system were not revealed, but the mounting board and turntable appeared to be "semi-floating" on the support plinth. Mitch had mounted the new Fidelity Research "long length" arm on his turntable, with an FR Mark Three moving-coil cartridge playing through his Verion transformer. He had his prototype preamplifier on display, but no details or specs as yet. The conversion of the Denon or Technics turntables to his special base is supposed to be strictly a function of dealers handling his line. In other words, it is not envisioned as a consumer "do-it-yourself" project.

Speaking of Fidelity Research, their "long length" arm mentioned above is what they consider their "transcrip-

tion" arm, but instead of the traditional 16-inch length, it is actually a hair over 15 inches. Needless to say, not every turntable can accept this length, and it would be wise to check this point if you have a yen for this arm. Among features of this arm is a maximum tracking error of +1 degrees and an effective mass of 38 grams. As original equipment with this arm is the B-60 tonearm stabilizer. This is a heavy weight which fastens to the arm pillar post beneath the mounting board. Once a rough setting of the arm post is made and tightened with set screws, this stabilizer has a knurled knob which can be used to adjust stylus tracking angle under dynamic conditions. With the proper test record and measuring equipment (or "golden ears"), it is possible to adjust the stylus tracking angle to complement the angle used for the cutting stylus. If you want to indulge in some further "lily-gilding," FR now has available phono cables made of pure silver! Also new from FR is their FR-7 moving-coil cartridge. This uses a pure silver coil with no iron in the core. Looking somewhat like the EMT moving-coil cartridge, the FR-7 has a claimed stereo separation of 28 dB at 20 kHz, which is quite remarkable. Finally, for the "man who has everything," how about the companion step-up transformer for the FR-7, the FRT-5. This unit has toroidal windings of pure silver for ultra-low distortion and is a great Texas stocking stuffer for \$1850.00!

### Phono Cartridges

Of phono cartridges in general there were many new models in evidence from the likes of Empire, Stanton, and Audio-Technica in the moving-magnet and moving-iron camp, and the interest in moving-coil cartridges continues with new models from Supex (lower-priced than their 900 Super E+) Satin, Audio-Technica's new \$100 AT30E, plus their top-end Signet model. Bob Fulton has a \$350 moving-coil cartridge with a conical stylus, and he offers an interesting paper on why he thinks this type of stylus is better than ellipticals or Shibata type. Ortofon has introduced its MC30 moving-coil cartridge, a hand-made model in very low production (so scarce, in fact, that none were available at the show). In combination with Audio Standards Corp. Mx10A pre-preamp, it makes for some outstanding phono reproduction with exceptional definition and transient response. Ortofon was also showing their new, very tiny VMS models. Their "Concorde" does indeed resemble the famous "droop snoot" needle nose of the supersonic



# THE JVC SEPARATES.

Sensitive tuners, plus DC amplifiers that help eliminate sonic backlash.

If you've ever listened to a JVC music system with a separate tuner and amplifier, and thought, "One of these days..."

Well that day is here. The new JA-S44 DC integrated stereo amplifier, with its exclusive built-in SEA graphic equalizer and dual power meters, provides clean, uncannily-accurate music reproduction, with all the power you're ever likely to need.\*

Our "Tri-DC" design in the JVC JA-S55 and JA-S77 further eliminates distortion-causing capacitors within the DC phono equalizer, DC tone control and DC power amplifier sections, providing frequency response from 5Hz to 100kHz (+0, -1.0dB). And they have dual power supplies—not one for each channel, as in conventional designs—but one for the Class A-operated preamp/tone control section, and a second which performs even heavier duty for the Class B-operated DC power amplifier section. This unique design practically eliminates both inter- and intra-channel crosstalk and distortion, or what we call "sonic backlash." The results: increased tonal definition and brilliance, especially with high-level transient signals.

The new JVC JT-V22 AM/FM stereo tuner is a standout in its

class. With an FM front end that uses an FET RF amplifier, combined with a 3-gang tuning capacitor, the JT-V22 brings in the most timid FM stations and makes them sound as though they're just around the corner.

Or, if you're in an area where FM stations are a hairline away from each other on the dial, it delivers clear, interference-free reception. Then, to help you make sure you're on target, it has both signal strength and center-channel tuning meters.

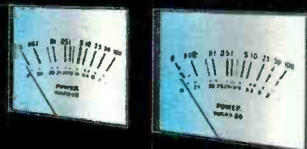

Probably the most significant advance in recent FM tuner technology is JVC's Phase Tracking Loop circuitry in our new top model—JT-V77. This advanced circuit provides high signal-to-noise ratio as well as excellent interference rejection and freedom from multipath effects and adjacent channel interference. It's still another example of JVC's innovative engineering. But sounds speak louder than words. See and hear these magnificently-designed separates at your JVC dealer soon.

JVC High Fidelity Division, US JVC Corp., 58-75 Queens Midtown Expressway, Maspeth, N.Y. 11378. Canada: JVC Electronics of Canada, Ltd., Ont.

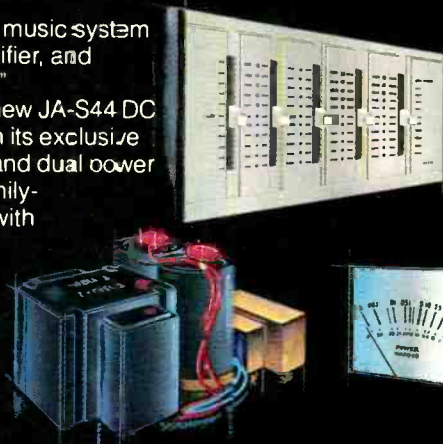

Top JA-S22 Bottom JA-S55 Top JT-V77 Bottom JA-S77

# JVC

Enter No. 12 on Reader Service Card

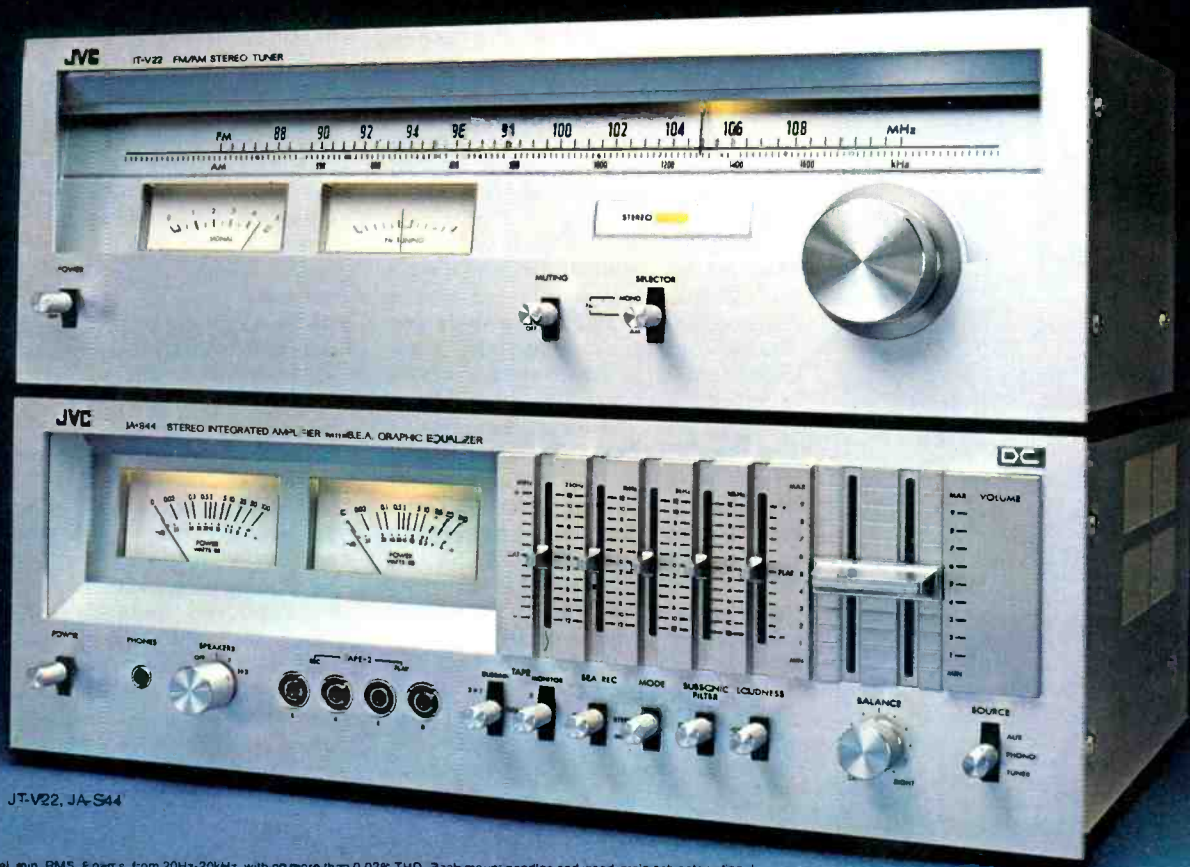

JT-V22, JA-S44

\*45 watts/channel, min. RMS, 8 ohms, from 20Hz-20kHz, with no more than 0.02% THD. Back-mount handles and wood-grain cabinets optional.



Empire's revolutionary cleaning method peels off every trace of dirt, dust and oil from deep down in your record's grooves.

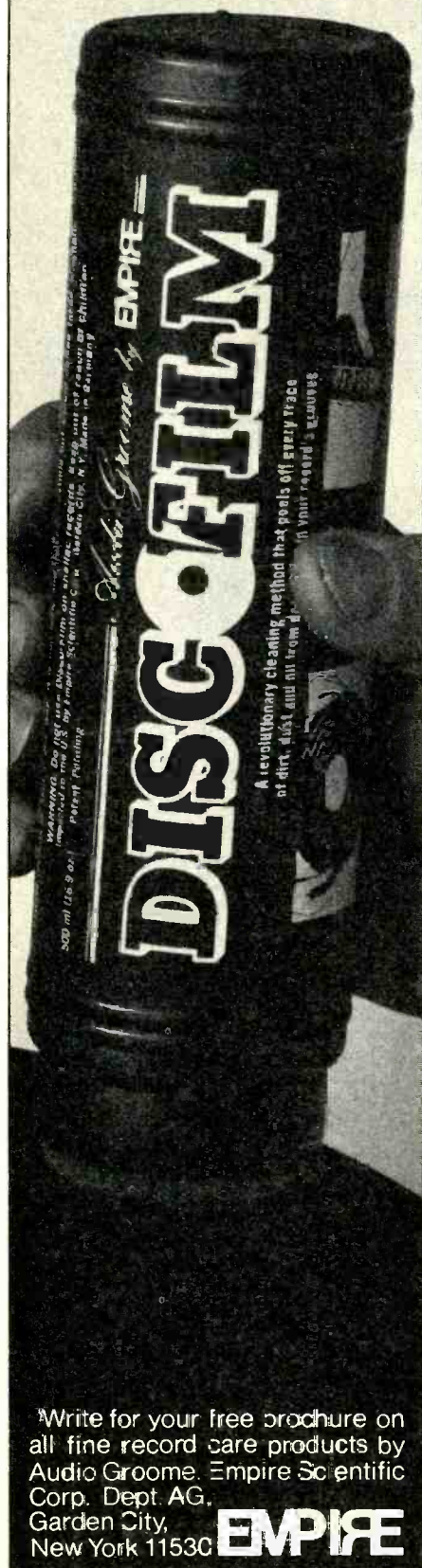

Write for your free brochure on all fine record care products by Audio Groome. Empire Scientific Corp. Dept. AG, Garden City, New York 11530 **EMPIRE**

jet and weighs in at a mere 1½ grams! Before we leave phono cartridges, I should mention the very exotic Electro-Kinetic pickup system, which works on yet another variant of the strain gauge principle and is sold only with its own preamplifier. The brain-child of John Iverson of Electro Research amplifier fame, the system is expected to sell "under \$1000."

The more sophisticated a stereo system becomes, the more it benefits from subtle refinements, especially in the area of phono playback. For example, if you strike most turntable platters, they will exhibit ringing modes. Damping these resonances is a good idea and can be accomplished by such special turntable pads, such as the "Platter Pad," and I have had good success with the very high-density turntable pad from Osawa. With one of these on my Technics SP-10 Mk2, flicking the turntable platter with your fingernail produces a satisfying non-resonant "thunk." A new accessory now becoming available from a number of sources . . . Keith Monks and Audio-Technica to name two . . . is what are termed "record weights." As you are probably only too unhappily aware, the majority of records exhibit "dish warp" and exasperatingly won't lie flat on the turntable. A record weight, at approximately a pound and a half, fits over the turntable spindle and roughly covers the area of the record label. The Audio-Technica model is rubber covered; others add a handy phono strobe marker. Fitting one of these weights on the spindle does help to control the dish warp, but far more important and not generally known, is that the stylus/groove playback dynamics produces a resonant "ringing" in the vinyl which is effectively damped by these record weights.

Finally, on the subject of phono playback, our British cousins had a joint display by a number of English audio concerns, and among them was Metrosound Audio Products. Now, quite frankly, I have always cast a jaundiced eye towards such record cleaning products as adhesive rollers and the like; always figured that they would leave an "icky" residue on the record after use. Well, when I encountered several ultra "audio purists" using the Metrosound rotary cleaner and waxing enthusiastic about its effectiveness, I took another look. The Metro-sound roller is made of a new super-soft polymer, a material purportedly used by the police in lifting fingerprints. Used properly, which means with *light, even pressure*, the unit does indeed get down into the grooves and

picks up the most minute particles, while leaving no residue. Records treated with this unit are audibly quieter and virtually "tickless."

Equalizers of all types continue to proliferate, and there were many in evidence at the WCES. There now appears to be a trend towards the more sophisticated parametric types, and versatile new models were shown by Phase Linear and SAE. These can be valuable additions to a stereo system, when used intelligently and with restraint. There is the rub . . . unfortunately, the interaction of the physiology of the hearing phenomenon and psychoacoustics, with maximum sensitivity in the midrange frequencies invariably seduces the auditor into striving for more "presence" in that part of the spectrum. The resultant "over boosting" makes for some grotesque balances.

As noted in the first part of this report, the power race in receivers has apparently reached a plateau, and now the emphasis appears to one of refinements or innovations. For example, the Bose people, heretofore most famous for their direct/reflecting equalized loudspeakers have introduced what they call their "Spatial Control" receiver. An FM/AM unit, it has four amplifiers, which in bridged mode provide 100 watts per channel. Why four amplifiers? Is it back to quad? No, friends. The Bose receiver must be used with their 901 speakers to achieve the "Spatial Control" effects. As you probably know, the Bose 901 speakers have four drive units on each side of their V-shaped rear panels which reflect off a wall. In the "Spatial" mode, each amplifier drives a corresponding rear panel. A special control on the receiver controls the reflected sound image by directing high frequencies to either the inside or outside rear panels, producing either a wider or narrower sound image. The use and choice is naturally dependent on the nature of the music being played and its interaction with room acoustics. As the Bose 901 speakers normally need an equalizer, a bit of money can be saved by prospective purchasers of the system, since the new receiver incorporates a built-in equalizer.

Well, friends, I could go on and on, as I've said about these Shows time and again. In the midst of all this disheartening news about our economy, the supposed imminence of a "recession" and other alarms, it is nice to realize, that though the audio industry is in a "soft" period, the avalanche of new products at every audio show is proof positive of the viability and resilience of this industry. **A**



# Many amps can deliver pure sound. The Sansui AU-919 delivers pure music.



Today's audio engineering has reached the point where you can select among a number of affordable high-power amplifiers that have virtually no "total harmonic distortion." That's good. But THD measurements only indicate an amplifier's response to a pure, continuously repeating, steady-state test signal (below, left). They don't tell you how the amp responds to the never-repeating, rapidly-changing transient waveforms of real music (below, right). And only an amplifier designed to reproduce the demanding dynamics of music signals can satisfy the critical audiophile. An amp like the Sansui AU-919.

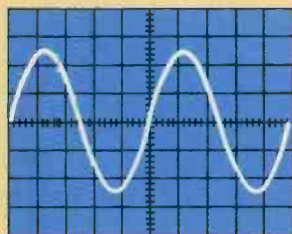

SINE WAVE

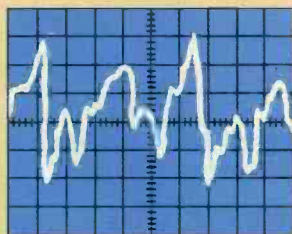

DYNAMIC MUSIC SIGNALS

Because low THD without low TIM is like sound without music, the Sansui AU-919 is designed to respond well to both simple sine-wave test signals and also to handle the jagged, pulsive edges required for realistic reproduction of music—without imparting that harsh, metallic quality known as "transient intermodulation distortion" (TIM).

The Sansui AU-919 sounds better than conventional amps because Sansui developed a unique (patent pending) circuit that is capable of achieving both low THD and low TIM simultaneously.

Our DD/DC (Diamond Differential/DC)\* circuitry provides the extremely high drive current necessary to use proper amounts of negative feedback to reduce conventionally-measured THD (no more than 0.008%, 5Hz-20,000Hz into 8 ohms at 100 watts, min. RMS) without compromising our extraordinary 200V/ $\mu$ Sec slew rate, ensuring vanishingly-low TIM, as well. The power amplifier frequency response extends from zero Hz to 500,000Hz.

Since ultimate tonal quality depends on more than the power amplifier alone, Sansui also uses its DD/DC\* circuitry in the phono equalizer section—where current demands are also particularly high—to prevent TIM. ICL (input capacitorless) FET circuits are used throughout the AU-919, and a "jump switch" is provided that will let you run pure DC from the Aux. input to the output.

Visit your authorized Sansui dealer today, and he'll show you a lot more that the AU-919 has to offer. Like twin-detector protection circuitry and our Penta-Power Supply system. Two-deck monitoring/recording/dubbing facilities. And a high-performance ICL/FET pre-preamp for moving-coil cartridges.

Then listen to the AU-919 with the most demanding music you can find. You'll hear the way the music should sound. Like music. Not just like sound.

\*Diamond Differential/DC, Sansui's (patent pending) totally symmetrical double ended circuitry with eight transistors, is named for its Diamond-shaped schematic representation.

## SANSUI ELECTRONICS CORP.

Lyndhurst, New Jersey 07071 • Gardena, Ca. 90247  
Sansui Electric Co., Ltd., Tokyo, Japan  
Sansui Audio Europe S.A., Antwerp, Belgium  
In Canada: Electronic Distributors



# Audio etc.

Edward Tatnall Canby

Years back when this magazine was adolescent and I used to make up my own zany titles, I occasionally resorted to a sort of catch-all phrase that keeps ringing in my head. Obviously, it originated in the Italian-American community: DIS'A AND DATA. Or was it out of somebody like the Schnozzola Durante? Credit where credit is due. A good rhythm, a give-and-a-take — like to and fro, here and there, back and forth, up and down, His & Hers, take it or leave it. DIS'A AND DATA! I can hear its sonic ambience so nicely — say in a certain passage out of the Berlioz *Fantastic Symphony*, which you may locate for yourself if you can. But on paper the most interesting sort of dis'a and data is the kind of back-and-forth exchange that the rhythm implies — out of our far-flung correspondents. (Just got a recording from Singapore and a super-8 sound film from Hong Kong, for which I have no projector.)

There's only one reason why our energetic correspondents don't appear in all our departments regularly every month for a really lively exchange of ideas — it takes SO long.

You can talk to a sourdough or an Eskimo in Alaska for pennies by phone, and we can pour water out of a bottle on Mars. But a three-minute (reading time) exchange via magazine

is like a phone call to Mars. You ring up and ask, *hey, how's the weather up there?* And more than half an hour later at the speed of light you hear, *fine, but the smog is sort of red.* It takes even longer in a terrestrial exchange of words via magazine. It's grotesque. What with the initial transportation via pony express (courtesy of the Postal Service), the accumulation in the Office Memory Bank (a file folder), the reforwardation to the ultimate destination (me), and then the answeration, back by snail express to the Editor, and the copy reader, and the printer, and the distributor, and eventually, all in due time, to YOU. One can grow old answering correspondence and one often does.

So hail, all you Rip Van Winkles, glad to welcome you aboard. For instance, there is (was) Brian Berkeley, a (then) senior in EE at MIT and author of one of the most genially and totally unintelligible papers presented last autumn at the AES (that is, unintelligible for me — I haven't really learned the digital lingo yet), called "A Floating-Point Digitally Transcribed High-Fidelity Audio Mixing System." Phew! (But I do get his essential point or purpose, which is to begin that rather painful process of intermediate digital

conversion as applied to the many and degrading steps in the audio chain that now must come between a digital original recording and a finished commercial record.) Lo — Mr. Berkeley can also write English, a language that I am often able to comprehend, and he wrote me a few millenia ago to remark on my "digital" column of February, 1978, pointing out one rather important technical error I had made, inadvertently, in my enthusiasm for the astonishing new parameters of digital recording.

## Misunderstood Hyperbole

Thank the Lord, the man liked my piece, and commended me for waving the digital flag, as he put it. But, he said, "I was somewhat disturbed when I read 'signal to noise at virtual infinity — there is no noise; 90 dB is the acceptable figure.'"

Now that phrase of mine, you understand, was mere English hyperbole, not intended as a precise engineering description. I should have said, even so, that *in practical terms*, in effect, as the listener listens, there is no noise. If noise is measured as 90 dB down by any system I know of, then it is really not a noticeable interference to the basic audio signal! Yet Mr. Berkeley was right just the same, and a conscientious engineer and thinker.



AUDIO • May 1979





## Quartz-Lock by Realistic.

$\pm 0.0005\%$  Speed Accuracy.

Don't buy any turntable before you see the new direct-drive Realistic® LAB-500. It's already switched many an audiophile to Radio Shack's 22-year-old Realistic brand. The specs tell you why.

Speed accuracy of  $\pm 0.0005\%$  just 1.5 seconds after start-up, wow and flutter of 0.025%, rumble of

only  $-70$  dB (DIN B). This kind of performance is superior to some broadcast and disco equipment, and is made possible by a massive 12-5/8", 3.1-lb. platter resting directly atop a 12-pole brushless DC servomotor controlled by a quartz oscillator and PLL circuitry. But there's still more to recommend the LAB-500. Like all

Realistic turntables, the price includes dust cover and cartridge. And the cartridge is our best, made by Shure, factory mounted in an integrated headshell for minimum mass and precision tracking even at 3/4 gram. Audio response is a linear 20-20,000 Hz. The automatic arm-return is tripped optoelectronically—assuring no change in record speed even at the end of the disc. Out-front controls, including electronically actuated cueing, make operation easy.

There are single-play/repeat and anti-skate controls, too.

All this, including the \$49.95 value cartridge and hinged cover and low-profile walnut vinyl base, for 259.95\*  
By Realistic. Sold only at Radio Shack!

# Radio Shack

A DIVISION OF TANDY CORPORATION • FORT WORTH, TEXAS 76102  
OVER 7000 LOCATIONS IN NINE COUNTRIES

\*Retail price may vary at individual stores and dealers

# The Watts Parastat

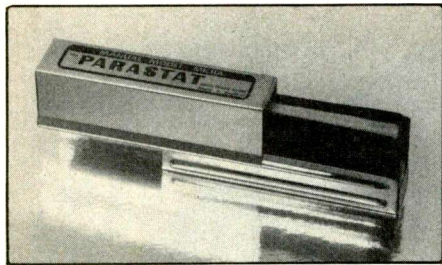

**In 15 seconds  
your records are  
clean, dry,  
and ready to play.**

With some systems you pour liquid on your records (and rub it into the grooves), while with others you brush the dirt around (and rub it into the grooves). The Watts Parastat is neither of these.

By placing a plush velvet pad on either side of a soft nylon brush and adding a drop or two of Parastatik® fluid, a remarkably efficient system is created.

The brush bristles lift the rubbish to the surface. The pads collect and remove it. And the Parastatik® fluid supplies just the right degree of humidity to relax dust collecting static without leaving any kind of film or deposit behind.

No other system does so much for your records in so little time.

So when you want the best, ask for the original. The Parastat, by Cecil Watts.

*Cecil E. Watts Ltd*

Watts products are distributed exclusively in the U.S. by: Empire Scientific Corp., Garden City, NY 11530

Enter No. 42 on Reader Service Card

What amazed me was that not another one of our readers in all their thousands picked me up on this basic point — for it is that. Let me continue with the Berkeley letter, which applies precisely as well today as it did when written.

"There is noise! In a fixed-point representation, the noise is equal to the last significant bit, simply because the signal is not specified to any better resolution. In a floating-point system, things are a little different, but certainly, again, you can't get infinite S/N ratio (i.e. no noise) without having an infinite number of bits in the mantissa.

"At any rate, to achieve a S/N ratio of 90 dB (and essentially a dynamic range of 90 dB), one must use a representation scheme at least 15 bits wide with a fixed-point system, motivating a floating-point scheme. The problem with such a wide representation is that conversion devices (A/Ds and D/As) fast enough to do the job are too expensive to be practical (presently) for home or professional use."

## Correct Rhetoric

At that point I will allow you engineering experts to carry on — I stand corrected on the essential point, which is that one must not use casual infinities like NO noise when such phrases, even rhetorically, are in fact technically inaccurate. I am sorry to have observed, in this connection, that in fact a number of the new and sensational digital products are described just this way — perhaps in some cases technically accurate, in other cases surely not. Described not by me, nor my writing colleagues, but by the promoters themselves. How about, for instance, "Print-through: NONE." I suspect that it might take a lot of our readers a few moments of thought to decide whether that one is technically allowable from a strict engineering viewpoint.

Why else do you suppose that many writers take to using weasel words, to avoid trouble (rightly)? So-and-so travel offer is *possibly* the finest bargain ever to be made available. That new Broadway play is *perhaps* the greatest play in the last 25½ years. Our magazine is *virtually* the only one that prints good equipment reviews. (Ugh—please not that. Because it is *possibly* not the truth.)

I admit to using these terms and similar, once in awhile, if only because I also display a varying amount of noise in my own signal and I try, always, to define that noise element as accurately as I can, opening up or closing down my parameters to fit each case. Horse laughs from you who merely read, and do not write! But the

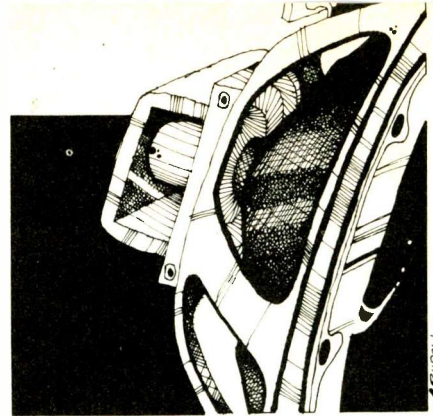

essence of good writing remains in every area to fit your words, your terms, as closely as possible to the case in hand.

Not having done a study, I cannot say that 59 percent of our readers do not know how to spell. Nor could I say that only a few of them are bad spellers. Without the slightest doubt, some of them, quite a number of them, maybe even many of them, even very many of them, are poor spellers. I have much evidence before my very eyes. It exists! There is spelling noise in our readership signal. Dare you deny it? But which words would you use to describe same?

For instance, friend Berkeley, in his latest letter of long-distance, time-delayed follow-up, has proposed a new term that I had not seen before in my craft as a writer. I like it. *Volumn!* Now that may be a digital term, for all I know, like another he uses, namely *two's*. *Volumn* is like *column* and I suppose that the adjective, *columnar* in one case, must be *volumnar* in the other. Or maybe *volumnious*? What I cannot tell you is how to pronounce this new digital term. Should we say "vol-yoom" (and so, of course, col-yoom) — or is it vollum and collum? I wouldn't know. Brian Berkeley, if you wish to short circuit the time delay, may now be reached at Carnegie-Mellon University, Dept. of Electrical Engineering, Schenley Park, Pittsburgh, PA 15213.

Let's round this out with another error exchange, time-lagged as usual. You may remember, back a few infinities, that I got myself all fired up over the terminology used in European languages for the common hi-fi equipment items — and ended up with the thought that the word *deck* was a good one and might be extended by us, as it has been in other languages than ours. Milford S. Brown of El Cerrito, CA, promptly picked me up on this point and he is still right, if the problem is not exactly earth shaking.

## Scientific Semantics

Instead of a "turntable," I had thought, why not a *record deck*. I was talking about the reissued AR manual unit, then and now on the market as a

AUDIO • May 1979



# The standard bearers.



## The high bias standard.

In the past few years, these fine deck manufacturers have helped to push the cassette medium ever closer to the ultimate boundaries of high fidelity. Today, their best decks can produce results that are virtually indistinguishable from those of the best reel-to-reel machines.

Through all of their technical breakthroughs, they've had one thing in common. They all use TDK SA as their reference tape for the high bias position. These manufacturers wanted a tape that could extract every last drop of performance from their decks and they chose SA.



And to make sure that kind of performance is duplicated by each and every deck that comes off the assembly line, these manufacturers use SA to align their decks before they leave the factory.

Which makes SA the logical choice for home use; the best way to be sure you get all the sound you've paid for.

But sound isn't the only reason SA is the high bias standard. Its super-precision mechanism is the most advanced and reliable TDK has ever made—and we've been backing our cassettes with a full lifetime warranty\* longer than anyone else in hi fi—more than 10 years.

So if you would like to raise your own recording standards, simply switch to the tape that's become a recording legend—TDK SA. TDK Electronics Corp., Garden City, NY 11530.

**TDK**  
The machine for your machine.

\*In the unlikely event that any TDK cassette ever fails to perform due to a defect in materials or workmanship, simply return it to your local dealer or to TDK for a free replacement.

Enter No. 38 on Reader Service Card





## Revolutionary! Sound-shaping taping mike.

Never before — a single microphone that gives you the versatility of 16 microphones! Four tiny frequency filter switches built into the new Shure 516EQ E-Qualidyne Microphone let you tailor sound for studio effects in virtually any recording situation: flick a switch to add sizzle

to vocals . . . flick another switch to highlight the sound of a bass drum. You can even compensate for the acoustic response of a room — *right from the microphone!* In all, the 516EQ creates 16 different response variations that can add a new, professional sound to every tape you make. Available singly or in pairs for stereo recording. Ask to hear a recorded demonstration at your participating Shure dealer.



Shure Brothers Inc.  
222 Hartrey Ave., Evanston, IL 60204  
In Canada: A. C. Simmonds & Sons Limited



Manufacturers of high fidelity components, microphones, sound systems and related circuitry.  
Enter No. 33 on Reader Service Card

basic device for producing sound from the LP (and 45) disc. If your hi-fi system makes use of a tape deck, then why not a record deck?

Well, a good reason, as Mr. Brown makes clear. A tape deck is a more complex machine in some respects than a record playing unit, for it includes a preamplifier, equalized to tape-playback parameters. The record player depends on a preamp built into your — uh, let's see, what shall I call it? You know what I mean. A record deck, then, should rightly include a built-in preamp for its phono cartridge, if it is to be comparable to a tape deck. But, like the tape deck, no power amplifiers.

"A record deck seems like a good idea (says Mr. Brown) because it minimizes the distance between the low-level output of the cartridge and the first stages of amplification. In addition, all of the decks in the system could be connected to a switching-volume-tone-etc. unit, which could either be separate from or combined with the power amplifier. Or even better, do away with the power amp as a separate chassis (the box in/on which the bits and pieces are assembled) and put one in each speaker enclosure . . . This complete separation would avoid the cross-channel interaction of a common power supply, and the room that contained the (equipment) would look less cluttered."

Well, I was mainly talking semantics; I thought that *receiver* was a fuzzily inaccurate term as compared to the alternative *tuner*, and still think so. *Table* goes off at still another slant, semantically, and I offered the deck alternative as a useful beginning towards better and more consistent names for the things we make and sell. Again, I stand corrected. So let's have record decks with built-in preamps.

It is quite possible that in due time this may indeed become a new and standard arrangement and for good reasons. I think it would help to simplify the present horrendous complexities of internal switching and external cabling that still clutter our, er, whatever-you-callems. You wouldn't have to *switch* a preamp built into a record deck. It would just be there and act automatically, like the equalized preamp in the tape deck. Though I suppose for awhile a switch would be needed, in case you preferred to use an external preamp as at present, the one built into the next chassis in line.

Well, one thing I know. The semantic demise of the old term *chassis* for what is now called a receiver was a move in the right direction. Mr. Brown would agree. That was decking the fi with boughs of folly. A



# YOU SHOULD EXPECT MORE FROM THE PHASE 4000 SERIES TWO.

Even if you're made out of money, you'd be hard pressed to buy more creamp.

The Phase 4000 Series Two goes way beyond the boundaries of conventional preamps. First, the 4000 processes and amplifies your music without introducing any significant noise or distortion. Then it actually compensates for losses in dynamic range and signal-to-noise ratios that occurred way back in the recording process!

To prevent overloads, studios "peak limit" the high-level attacks common in today's music. The 4000 Series Two has highly advanced circuits to read peak limiting, and immediately restore the dynamic range. The combined overall dynamic range is increased by 17.5dB. So when Charlie Watts hits a cymbal, it sounds like a cymbal!

The 4000 Series Two also spots low level gain riding, where the recording engineer adds volume to a low signal to overcome noise on the master tape. The

Downward Expander immediately expands the dynamics, so you hear the bass as the conductor called for it, not as the engineer delivered it.

The 4000 Series Two second generation Autocorrelator reduces record hiss, tape hiss, and FM broadcast noise. Weighted overall noise reduction is -10dB from 20Hz to 20kHz. So your music comes clean, and the background is silent.

The 4000 has two new RIAA phono stages which eliminate low level switching and reduce hum and CB interference to a minimum.

Tape monitor and dubbing circuits allow copying between decks, while listening to a third program source. There's a separate direct coupled (OCL) Headphone Amplifier. An infrasonic filter eliminates audible effects caused by rumble. We could go on forever, but you get the point.

The Phase 4000 Series Two. It's waiting for you at your Phase Linear dealer.

## AND YOU GET IT.

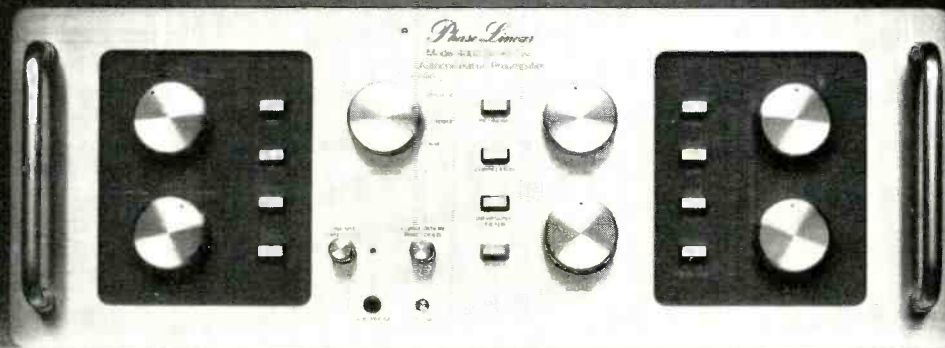

*Phase Linear*  
THE POWERFUL DIFFERENCE

Phase Linear Corporation, 20121 48th Avenue West, Lynnwood, Washington 98036  
MADE IN U.S.A. DISTRIBUTED IN CANADA BY H. ROY GRAY LTD. AND IN AUSTRALIA BY MEGASOUND PTY LTD  
Enter No. 50 on Reader Service Card



# Audioclinic

Joseph Giovanelli

## Meeting Test Standards

*Q. I recently purchased electronic test equipment to test and repair my audio equipment. When I wish to test something according to the test standards like IHF A-202-1978, Section 2.5.2, which states: "Each output terminal whose primary function is to deliver signal voltage to a subsequent device shall be terminated with a load consisting of a 10,000 ohm, 5-percent resistor in parallel with a 1,000-pF, 5-percent capacitor." I constantly come across references to this arrangement when reading electronics literature, but I never get a thorough explanation of why this is done. Please clarify this for me. — Michael Bartholomew, Hellertown, Penna.*

*A.* As for connecting the output of a preamplifier, tuner, or whatever, to a standardized 10-kilohm load shunted by a capacitor, this is done to simulate general use conditions. It is assumed that most input devices have around 10 kilohms impedance and that the capacitance of the interconnecting cable is around 1000 pF. This standardized output load is not intended as a means of matching impedances, but to make a device under test appear to "see" a typical input circuit.

If your main object is to repair your own equipment or, perhaps, that of your friends, you need not be involved with rigorous details of this kind. Problems with equipment are generally gross ones calling for logical judgments rather than pure test setups.

If, on the other hand, you are in the business of evaluating equipment, then you should follow all the test standards precisely, so you cannot be accused of subverting them by not adhering to the letter of the law. Using the standard procedures in this manner assures that all tests can be repeated by any other person doing similar evaluation work.

## Impedance & Amplifier Output

*Q. In the "good-old days" of audio, tube amplifier specs stated one output power for the nominal impedances of 4, 8, and 16 ohms which was usually found on the back panel. The implication was that the output power would not vary with the load impedance.*

*Transistor amplifiers state their power at specific loads, in effect the power varies considerably with the load. Why? — Frank A. Bertolotti, Lucca, Italy, and Kevin Rowley, Rockford, Mich.*

*A.* The output terminals on most tube amplifiers were composed of common 4-, 8-, and 16-ohm connections which were connected to appropriate taps on an output transformer. When loads were connected to their respective output taps, power output would be substantially the same in all cases.

Solid-state amps are, generally, equipped with just two output terminals marked "common" and "hot." No matter what the impedance is, these are the only terminals to be used.

The output impedance of an amplifier is very low, therefore the lower the impedance of the load connected to the amp, the more closely it matches the amplifier's impedance, and the more power that can be drawn. A 4-ohm load is the minimum for most amplifiers.

## Signal Boosters

*Q. I am considering the purchase of a moving-coil phono cartridge but I am confused by the fact that some require step-up devices while others do not. With regard to those that require step-up devices, what is the difference between a step-up transformer and a pre-preamplifier? — S. Campanile, Pleasant Hills, Cal.*

*A.* Some moving-coil cartridges produce so little signal that they cannot drive a preamplifier to anything like full output. Under such conditions, background noise would be higher than it should be, and to overcome this problem, means must be provided to bring this signal up to a usable value.

Because the impedance of such cartridges is low, a step-up transformer is one way of obtaining the necessary voltage to drive the preamp. If the step-up is really high, this means a lot of turns in the transformer secondary and this capacitance will limit the highest audio frequencies which, in turn, can reduce transient response. These losses are often subtle and may not be detected. Most transformers

made for this purpose are well enough designed that this is not a problem.

It is also possible to increase the amount of signal through use of additional electronics to amplify the tiny voltage produced by the moving-coil cartridge. This added amplifier is placed between the cartridge and the conventional preamp, and is called a pre-preamplifier.

## Channel Dropouts

*Q. Sometimes when playing a record, one channel will be silent. If I lift the tonearm and wiggle the cartridge a bit, the sound will reappear when the stylus contacts the record. What is wrong? — O.B. Madenwald, Hines, Or.*

*A.* It is important that good electrical contact be made between the wiring contacts on the cartridge and those on the tonearm. Clean them with a solution like WD-40, and if the channel loss or intermittent hum still occurs, then the contacts may be either bent or distorted. If you can, bend them to make sure they fit snugly enough to insure good electrical contact.

It is also possible that the small wires within the tonearm are broken and defective by having been moved back and forth so often. This could also cause intermittent operation and hum. This means that you will have to replace those wires.

## Added Output

*Q. I am considering the purchase of a moving-coil phono cartridge, but I am confused by the fact that some require step-up devices while others do not. Will a moving-coil cartridge that doesn't require a pre-preamplifier sound audibly better if one is used? — S. Campanile, Pleasant Hills, Cal.*

*A.* If a moving-coil cartridge doesn't need a step-up device and you elect to use one, then this would cause the cartridge to produce too much signal, leading to overload of and distortion in the preamplifier.

If you have a problem or question about audio, write to Mr. Joseph Giovanelli at AUDIO Magazine, 401 North Broad Street, Philadelphia, PA 19108. All letters are answered. Please enclose a stamped, self-addressed envelope.





## Metal... sound from another dimension

Metal tape is a shining breakthrough in magnetic recording. When matched with a suitably advanced cassette deck, metal tape delivers sonic excellence alien to conventional oxide tapes.

The Nakamichi 582 embodies years of intensive research and close work with many of the world's leading tape manufacturers. It is a cassette deck which sets the standard for performance with metal tape.

There is some history-making technology behind the 582's pace-setting performance. Hard-to-erase metal tape is no problem at all for the 2nd Generation Direct Flux Erase Head. The new micro-precision Crystalloy Record Head handles metal's super-high bias requirement with room to spare. And the ingenious "Discrete" 3-head configuration ensures optimum record and play without any of the drawbacks associated with past 3-head designs.

The 582's impressive specifications only hint at its sonic superiority. With metal tape, the 582 produces recordings of startling acuity and incomparable breadth.

But don't take our word for it. Ask your Nakamichi dealer to demonstrate the 582. He'll show you why your first metal-compatible cassette deck should be a Nakamichi.

Write for more information: 1101 Colorado Avenue,  
Santa Monica, California 90401.

 **Nakamichi**

Products of unusual creativity and competence...

Enter No. 20 on Reader Service Card

# Tape guide

Herman Burstein

## Quality Taping

*Q. Could you tell me some of the factors that go into a quiet tape recording?—Victor Joutain, San Francisco, Cal.*

A. Quiet tape recording depends upon, at least, the following factors: 1) Use of a good quality, low-noise tape. 2) Application of as much audio signal as the tape can accept without running into noticeable distortion; different brands and types of tapes differ somewhat in this respect. 3) A properly calibrated meter of good quality to indicate recording level enabling the recordist to apply sufficient signal to the tape so as to get a high signal-to-noise ratio, yet without running into excessive distortion; a peak-reading meter or other peak-indicating device (such as an LED) can be more helpful than an average-reading meter. 4) A tape deck with well-designed and well-constructed record and playback amplifiers producing minimum noise; this includes a well-designed bias oscillator that produces a waveform with minimum distortion. 5) A tape deck with separate record and playback heads, so that the playback head can be specifically designed to produce a high-level signal. 6) Inclusion of a noise reduction unit, either as part of the tape deck or as an external adjunct. 7) Operation of the tape deck at a relatively high speed as the signal-to-noise ratio tends to improve as speed goes up. 8) Use of wider tracks, since half-track recording puts more signal on the tape than does quarter-track recording, so the S/N ratio tends to be about 3 dB higher for half-track. 9) When recording from a microphone, use a microphone with a relatively high output, and use the proper cable to minimize noise pickup. 10) When recording from FM or phono discs, use of audio equipment with minimum noise.

## Distortion Dilemma

*Q. I am encountering a problem in attempting to dub tapes from my open-reel deck onto my cassette deck via my receiver. I get an unusual amount of distortion and excessive volume. I encounter no similar prob-*

*lems when recording from a microphone. My suspicions lead me to believe that the problem lies in the type of patch cord I'm using. Can you advise me?—Charles Spencer, Blackwood, N.J.*

A. The fact that you are getting excessive volume along with distortion suggests that you are recording at too high a level. Try recording at a lower level, preferably by reducing the playback output level on your open-reel deck. If you suspect that a patch cord is at fault (a near-short could cause the sound to seem distorted), substitute another cord. By any chance are you feeding the recording signal into the wrong input jack of your cassette deck, that is, into a low-level (microphone) instead of a high-level jack? This could have the same effect.

## VU Differences

*Q. I've heard that different manufacturers calibrate their VU meters differently so that the optimum recording level may be other than 0 VU. Could you expound upon this?—Anton Verhulst, Everett, Mass.*

A. Makers of high quality tape decks generally calibrate the VU meter to read 0 VU at a signal level which, at a frequency in the range of 400 to 1000 Hz, produces about 1 percent harmonic distortion on the tape. This allows about 6 to 8 dB "headroom" to compensate for the fact that the meter cannot follow sharp transients and, therefore, tends to understate the recording level on peaks of brief duration. A signal level about 6 to 8 dB above 0 VU causes about 3 percent distortion, about the maximum consistent with good recording quality.

## Meter Purpose

*Q. How do you read a VU meter, and what is its purpose besides monitoring the volume level in recording?—J.J., Alhambra, Cal.*

A. Assuming that your deck has a true VU meter (which reads average level rather than peak level), one adjusts the gain control in recording so that the meter doesn't go above 0 VU. However, some audio material has

very sharp transients which the meter cannot adequately follow. Then the recording level should be set so that the pointer doesn't exceed some figure below 0 VU, e.g. -5 VU. Just how much below is a matter of judgment on the recordist's part. He should aim to set the recording level low enough to avoid excessive distortion, but high enough to get a good signal-to-noise ratio. Experience, plus trial and error, will assist his judgment.

In some tape decks, the VU meter is used, through a switching arrangement, to indicate the bias level.

In playback, the meter may be used to indicate the level of signal going to the equipment thereby avoiding the possibility of either overload or of insufficient signal. Also, the VU meter may be more convenient than an external meter to indicate playback level when adjusting equalization and/or bias to achieve flat response. See "Reading VU Meters," *Audio*, Sept., 1976, p. 42.

## Taping Interference

*Q. When recording an FM broadcast a burst of static is audible through the monitors as well as on the tape playback. All interference stops when the tape deck is off, also, no interference occurs when recording through the phono circuit of my receiver. What could be wrong?—Patrick Grealy, Stratford, Conn.*

A. The problem seems to be interference between the 19-kHz pilot signal of stereo broadcasts and the tape oscillator frequency, or between the tuner's oscillator and the tape machine's oscillator. If the latter is the cause, then moving the tuner and tape deck further apart might help. If the former is the cause, you need a 19-kHz filter at the output of your tuner, or at the input of your tape deck. Inquire at your local audio store about a suitable filter.

---

If you have a problem or question on tape recording, write to Mr. Herman Burstein at AUDIO, 401 N. Broad Street, Philadelphia, PA 19108. All letters are answered. Please enclose a stamped, self-addressed envelope.



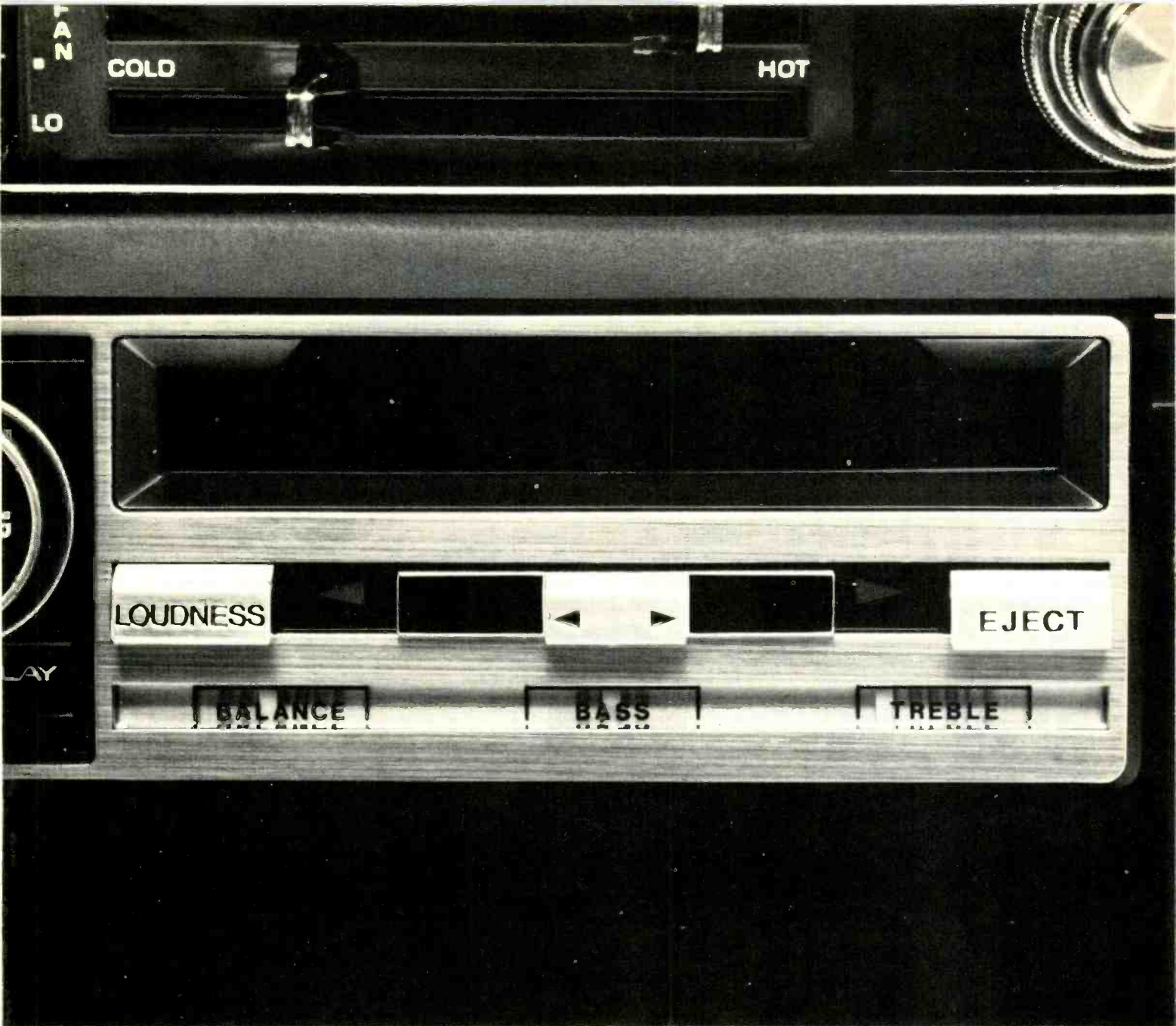

# Fill it up with premium.

What premium gasoline can do for your car, premium tape can do for your car stereo.

And there's no finer premium tape than Maxell.

Every type of Maxell tape is designed to give you the widest frequency response, the highest possible signal-to-noise ratio and virtually no distortion. All of

which results in *high octane* sound.

And to make sure our cassettes don't run out of gas somewhere down the road, we've constructed them to tolerances as much as 60% higher than industry standards. We use the finest high-impact styrene, precision pins, polyester and screws.

Because of this, we believe Maxell makes the world's finest cassettes.

And every year, hundreds of thousands of people who own car stereos are driven to the same conclusion.



**maxell** 

Maxell Corporation of America, 60 Oxford Drive, Moonachie, N.J. 07074.

Enter No. 17 on Reader Service Card

# SME SERIES III

*The best pick-up arm in the world*

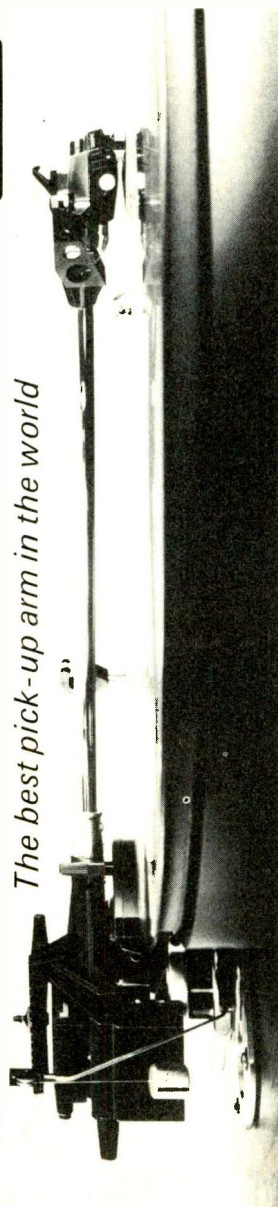

Design Council  
Award 1978

Exclusive distributors for the U.S.: Shure Brothers Incorporated, 222 Hartrey Avenue, Evanston, Illinois 60204  
and in Canada: A. C. Simmonds and Sons Ltd, 975 Dillingham Road, Pickering, Ontario, L1W 3B2

## Informed opinion

Few products in the hi-fidelity world have received such favourable comments from knowledgeable experts as the Series III precision pick-up arm.

They are too numerous to quote here, so we have prepared a special presentation of them which we will gladly send on request. Please indicate whether or not you require details of the arm as well.

Write to Dept 1452

SME Limited · Steyning · Sussex · BN4 3GY · England

## OBITUARY



Clarence C. Moore

Clarence C. Moore, founder and president of Crown International, died on January 24 at the age of 74. His life was characterized by the words devotion, improvement, and sharing, and was molded by his strong devotion to God.

His formal education included a bachelor's degree with majors in English, chemistry, and music, plus graduate study in clinical psychology. He never stopped his drive for additional knowledge, and his life was a striving to improve himself and to be of the utmost use to his friends and God.

Mr. Moore's primary impact on the field of audio was the development of the first tape recorder to include a power amplifier, the invention of the cubical-quad antenna system, the creation of the first 1/4-in. four-channel recorder, the introduction of the first solid-state power amplifier, the concept of electro-magnetic braking, and the introduction of the three-motor mechanism to tape recorder technology and manufacture.

After Mr. Moore finished his formal schooling he became a minister in a small rural community. His radio hobby, in the early 1930s, led him to the development of a special field winding coil so his ham radio operation would remain unaffected by variances in voltage created by the generator in his home. During the late '30s, he struggled with the implications of altitude on short-wave broadcasting, in particular the problems of rarefied atmosphere and high humidity causing arcing from the antenna ends. As a remedy for this, he developed the non-voltage or loop antenna.

In 1950, International Radio & Electronics Corp. was founded, the forerunner of Crown International. His contact, during this time, with missionary groups led him to develop a

tape recorder which included a 15-watt power amplifier. He also developed a special tone-control circuitry so the unit could be used as a public address system. With increasing demand for this new recorder, the Crown line of audio products started in a small farm building.

Over a period of years, the Crown line of tape recorders took on push-button controls, separate electronic and transport sections, relay control, and remote control capabilities. In the early 1960s Mr. Moore encouraged research in the area of silicon semiconductors which led to the development of the first solid-state, professional quality tape recorder.

During the middle 1960s Crown developed a vacuum tube amplifier that became the forerunner of the Model SA 30, the first solid-state amp with a 1 1/4-in. height.

Tragedy struck on Thanksgiving Day, 1971, when the entire manufacturing operation burned to the ground. Through his personal strength and the strong resolve of his employees, the company known as Crown International grew, literally, from the ashes. A heart attack struck Mr. Moore shortly thereafter, and this led to an intensifying of his efforts to build a strong core which could carry on in his absence.

During his last years, he was actively involved with the improvement of the cubical-quad antenna. These refinements included a rotation capability, a characteristic gain approaching 100, and two- through 24-element construction.

Mr. Moore's strong will and enthusiasm for study and hard work are remembered by those in the industry, including his involvement with the audio trade shows during their early years. A



# The ADS 10 digital time delay system Beyond fidelity into reality



While the reproduction of sound has evolved dramatically over the past two decades, even the best two channel stereo sound still provides a limited illusion - a scenic painting between two front speakers. Stereo cannot produce the feeling of "BEING THERE" in the same acoustic space as the musicians.

Now you can experience the impact of hearing sound in THREE DIMENSIONS with the ADS 10 Acoustic Dimension Synthesizer. The ADS 10 brings the concert hall to your home by extracting and recreating the "ambient" sound field which surrounds the listener in any real acoustic space. Critics and reviewers agree there is nothing you can add to a decent stereo system for approximately \$1000 which will improve the realism of music reproduction as much as the ADS 10 digital time delay system. As stated in Esquire recently, "It has been a long time since there was a new development in hi-fi. Quad systems weren't it. The new perfected time delay units are."

The ADS 10 is the first complete time delay system ever offered to the public that encompasses all components for ambient extraction and synthesis and for rear channel amplification. It also includes a matching pair of ultra compact, high performance speakers for unobtrusive placement in your room.

The ADS 10 is fully optimized and offers not only highly advanced circuitry for the most natural ambience, but is also the most flexible and most logically designed time delay system available. It has overcome all the problems of earlier time delays through unique proprietary circuits and it is easier to install and operate than a cassette recorder.

Design of operating controls was human engineered to allow you to easily select the size of the hall (from a small club to a large cathedral), the depth of the stage, the location of your seat, and the acoustic properties of the hall itself.

For more information, write ADS, Dept. AU5, or call 1-800-824-7886 (California 1-800-852-7777) toll free and ask for Operator 463. Or, better yet, take your favorite records to your selected ADS dealer and experience how the ADS 10 can bring the sound of a concert hall to your home.



**Where technology serves music**

ADS, Analog & Digital Systems, Inc. One Progress Way Wilmington, MA 01887 (617) 656-5103







# Power!

## That's the Jensen Car Stereo Triax® II. That's the thrill of being there.

Power is right! 100 watts! Now, all the energy and intensity that went into the original performance comes through the Jensen Triax II 3-way speaker.

This incredible 100 watt capability gives the Triax II an unparalleled clarity of sound throughout the entire spectrum.

What gives the Triax II its great power handling and sound reproduction? For starters, the piezoelectric solid state tweeter with low mass and incredible power handling capabilities. It starts reproducing crystal clear high frequency signals at 6,000 Hz... and keeps going well past the range of human audibility.

The 6" x 9" woofer of the Triax II boasts a new large diameter barium ferrite 20 oz. magnet. Which means better heat dissipation and more efficiency for clearer, truer sound at higher listening levels.

A new high power 1½" voice coil on the Triax II translates into less distortion and the ability to achieve higher sound pressure levels.

The midrange unit of this remarkable speaker produces smoother sound with better transient response, less distortion and higher power handling... thanks to its large 2.3 magnet structure.

And the Triax II is fully compatible with the advanced bi-amplified power sources for outstanding clarity and separation.

So go to the concert. Hear the Jensen Triax II. That's the thrill of being there.

# JENSEN

The thrill of being there.

For more information, write Jensen Sound Laboratories,  
4136 N. United Parkway, Schiller Park, Illinois 60176.

® "Triaxial" and "Triax" are registered trademarks identifying the patented 3-way speaker systems of Jensen Sound Laboratories. (U.S. patent #4,122,315).

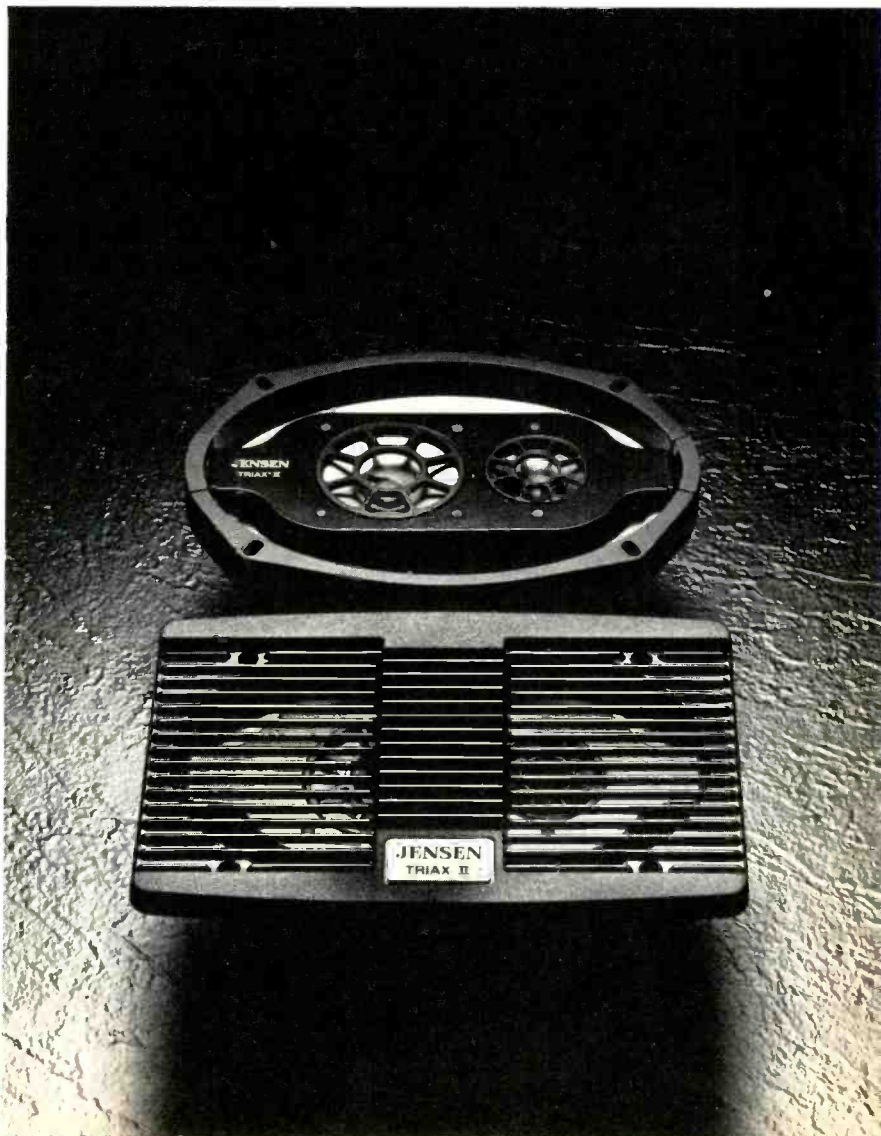

# What's New



## Van Alstine Amplifier

The Model Three amplifier has a 125-watt capacity, d.c. relay speaker protection, two-way On/Off switching, rack mounting, and can be bridged for greater power. Price: \$750.00.

Enter No. 114 on Reader Service Card

## Lux Cassette Deck

The Model K-12 cassette deck is a two-head unit capable of handling the new metal-particle tapes and using direct-coupled d.c. amplifiers in both recording and playback. The deck also



has plasma bar-graph record level indicators with peak hold, Dolby noise reduction, IC-logic controls, and Sensidust record/playback heads. Price: \$995.00.

Enter No. 106 on Reader Service Card

## CSC Pulse Generator

The Model DM-4 Design Mate pulse generator is designed for troubleshooting digital-logic circuits through use of an external signal for the system clock oscillator. The pulse repetition frequency is continuously variable from 0.5 Hz to 5 MHz in seven overlapping vernier-tuned decade ranges. Duty cycle, pulse width and pulse spacing are variable over a 10<sup>2</sup>:1 range, from 100 nS "On" and 1 S "Off" to 1 S "On" and 100 nS "Off." Pulse output is variable from 0.1 to 10 V. A special one-shot mode puts out a single pulse with every push of a panel-mounted button. External triggering to 10 MHz is also accepted. Price: \$129.95.

Enter No. 107 on Reader Service Card

## Chartwell Subwoofer

The Model SW-135 subwoofer has a frequency response from 40 to 120 Hz,  $\pm 2$  dB and is designed to be used in conjunction with the Chartwell LS3/5A and PM-100 speaker systems. Utilizing a 12-in. woofer in a bass-reflex design, the speaker has an SPL of 85 dB 1W/1m with an 8-ohm impedance. Price: \$400.00.

Enter No. 108 on Reader Service Card

## Fidelity Research Tonearm

The FR-12 tonearm has viscous damped cueing, radial ball bearings, weight and lever anti-skating, and a



headshell machined from a solid block of aluminum. The unit handles cartridge weights from 4-12 grams, and has a tracking force range from 0-3 grams in 1/4-gram calibrations. Price: \$400.00.

Enter No. 109 on Reader Service Card

## Errata

There are two updating of the data on the Shahinian Obelisk speaker which appeared in the "What's New in Audio" column in the March, 1979, issue of *Audio*. There are currently four 1-in. mylar dome tweeters, and the present price is \$400.00 per speaker in either walnut or oak, \$450.00 in teak. Other finishes are optional.

Enter No. 110 on Reader Service Card

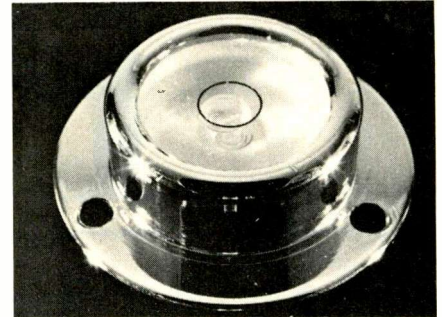
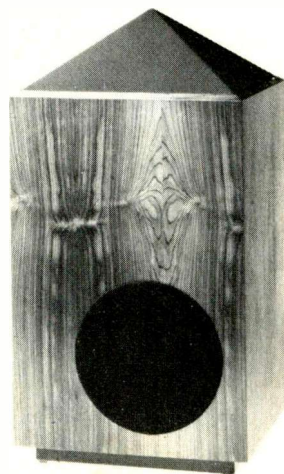

## RST Turntable Level

The Model RST 301 is a circular turntable level encased in a chrome-plated solid brass base. Record playback equipment must be installed perfectly level if optimum performance is to be obtained. The unit is extremely accurate and 1/10-in. of bubble travel indicates a tilt of only 0 degrees, 45 minutes. The base diameter is 1 1/4-in. and it can be used unmounted with equally good results. Mounting screws are supplied. Price: \$10.95.

Enter No. 111 on Reader Service Card



## RG Dynamics Processor

The Model Pro-20 series dynamic processors feature variable expansion from 4 to 20 dB with adjustable noise reduction for use with records, tapes, and FM radio. There is also less than 0.05 percent IM distortion, independent left and right channel processing for accurate stereo image, and complete tape facilities for both recording and playback, plus monitoring from three-head machines. Price: \$395.00.

Enter No. 112 on Reader Service Card

## Crosspoint Comparator

The Model Seven series are a group of modular, digitally controlled comparators that can be used singly or as a part of a system. The three basic models are designed to compare tape decks, preamp/amps, or speakers. All three models share the same control section, they differ only in their respective select modules. Price: \$650.00.

Enter No. 113 on Reader Service Card



# Yamaha<sup>®</sup> goes its separates way.

With unprecedented performance, features and price.

**C-4** Our new C-4 stereo preamp has the most advanced circuitry imaginable to give you sound so real and true, you'll swear it's live. Distortion in the phono preamp section has been reduced to a miniscule 0.0035% at 2V output. Signal-to-noise ratio has been tamed to the virtually inaudible level of 97dB at 10mV. A special Current Noise Reduction Circuit maintains this high S/N ratio regardless of varying impedances caused by using different cartridges. But you really have to hear the sound of the C-4 to believe such pure musical tonality could pass through a piece of electronics.

The C-4's features put you in total command of its superb sound. Unheard of tone control is yours with the exclusive, continuously variable turnover frequencies for the bass and treble controls. You can select from five ranges for both capacitance and resistance to load your cartridge for optimum performance. The C-4's built-in head amp provides the boost necessary for you to indulge in the transparently beautiful sound of a moving coil cartridge. Without extra expense or noise.

And these are just a few of the fabulous features that make the sleekly styled C-4 a super-sophisticated device with possibilities limited only by your imagination.

**M-4** Our passion for pure tonality reaches toward perfection in the M-4 stereo power amp. To deliver the cleanest, most musical sound possible, we built it with DC circuitry in a dual mono amp configuration. The dual mono amp configuration results in dramatically reduced crosstalk for dramatically enhanced listening pleasure.

The M-4's specs are nothing short of spectacular. THD takes a bow at an incredibly low 0.005% at rated output of 120W per channel into 8 ohms, 20Hz. to 20kHz.

Signal-to-noise ratio is, (please hold the applause) an utterly silent 118dB.

Again though, specs can't do the sound of the M-4 justice. This boldly styled, superbly functional power amplifier is solidly in the super state-of-the-art category.

That's what both our new separates are all about. Unprecedented performance, features and styling. And the price? Well, you can benefit from what we learned in precedent-setting sound with our legendary cost-no-object B-1 and C-1 separates. Without paying the price. Audition our new rack-mountable super separates, the C-4 and M-4 for yourself. It's an ear-opening experience you won't want to miss. For the name of your Yamaha Audio Specialty Dealer, check your Yellow Pages or write us.

From Yamaha, naturally



## YAMAHA

Audio Division, P.O. Box 6600, Buena Park, CA 90622.





# CAB



Visonik EURO speakers offer an unparalleled combination of sonic excellence and visual design.

They were conceived and constructed with quality—not price—as the major design criterion.

Both the two-way EURO 5, and larger 3-way EURO 7, are meticulously crafted using the finest German-made components mounted in hand-rubbed walnut veneered enclosures.

Stop in, look and listen at your VISONIK HiFi dealer or write to us for additional information.

## VISONIK® HIFI

You'll hear more from us.™

Visonik of America, Inc.  
1177 65th Street/Oakland, CA 94608/(415) 653-9711

©1979 Visonik of America, ® Registered Trademark, Visonik KG

Enter No. 41 on Reader Service Card

# Dear editor

## Esoterics Explained

Dear Sir:

The questions that have come to me as a result of M. J. Salvati's fine article "Antennas — Part V, Special Antenna Techniques," *Audio*, Jan., 1979, p. 42, are an indication of your reader's interest in quality FM reception. I only wish we could have supplied more information for your article.

The most common question asked us as a result of your article "What is a balun?" was probably the easiest to answer. A balun (for *balanced-unbalanced*) transformer usually consists of a two-window ferrite core with two windings of four turns each, coupled to provide a balanced-to-unbalanced match and an impedance transformation from 300-ohms balanced (antenna) to 72-ohms unbalanced. Ferrite toroids are used because the decreasing permeability with increasing frequency is offset by the increasing reactance of the wire itself, causing a wideband, flat-frequency response.

Although a balanced 300-ohm input is common on tuners, the r.f. amplifier stages are single ended. This means that balun transformer circuitry is used to couple a 300-ohm balanced transmission line to the unbalanced r.f. amplifier.

Bryant Arrington  
Technical Consultant  
Long Engineering Co.  
Winston-Salem, N.C.

## Ear Fatigue

Dear Sir:

I have often wondered, after a lengthy plane trip, how much of the after effects of plane travel are due to what is called "jet lag" and how much is simply due to hearing fatigue.

Recently I flew to England to see some friends and to compare notes and techniques with Enigma Records recording engineer, Tony Faulkner.

On the plane I decided to hire a pair of headphones and watch a movie entitled "The Big Sleep," since if it induced sleep, I would be that much ahead by the time I arrived in London. It was the first time in many years that I had rented a pair of headphones so I examined them with some interest. I found that they were two long pieces of hollow plastic pipe, one ending in

each ear. With the usual horrible noise level in our "modern" jet planes, the movie sound track was extremely well modulated by the vibratory jet noise penetrating the cabin . . . so much so, that I shortly discarded the headphones and watched a "silent" movie, after first taking the precaution of chewing up pieces of paper napkin until they were mushy and packing them into my ear canals. Thus, I travelled to London with a minimum of abuse to my hearing and having only a feeling of being shaken by vibration the whole trip.

As you should know, our ears were designed for hearing the rustle of leaves in a forest, hearing the murmur of the wind through bare branches, and the soft approach of forest animals, not to withstand the crashing, banging noises of our so-called civilization.

Why is it that airplane designers are not aware of the fact that the noise inside the "usual" plane destroys hearing? Couldn't they design a plane in which the outside and inside shells are separated in the same way that a well-designed recording studio is "floated" inside the outside structure? Is it too costly for cheap transportation or is it beyond the scope of the airplane designer's knowledge? Why can't the airlines furnish well-cushioned headphones admitting very little outside noise, together with electrically conducted sound instead of these present horrors provided to unsuspecting victims?

The other day I heard on TV that the head of the CAB was seriously discussing the separation of smokers from non-smokers on planes. Even with islands of serious drinkers between, separating polluters from non-polluters, doesn't he realize the damage to be done through noise pollution? Doesn't he realize the damage created to the human hearing system and brain by the plane's horrendous noise level concentrated at low frequencies? This noise pollution must be a thousand times more damaging to humans than the intake of a few milligrams of cigarette, cigar, and pipe tobacco pollutants!

Joel Tall  
Washington, D.C.

AUDIO • May 1979



**The most important piece of audio equipment you'll ever own.**

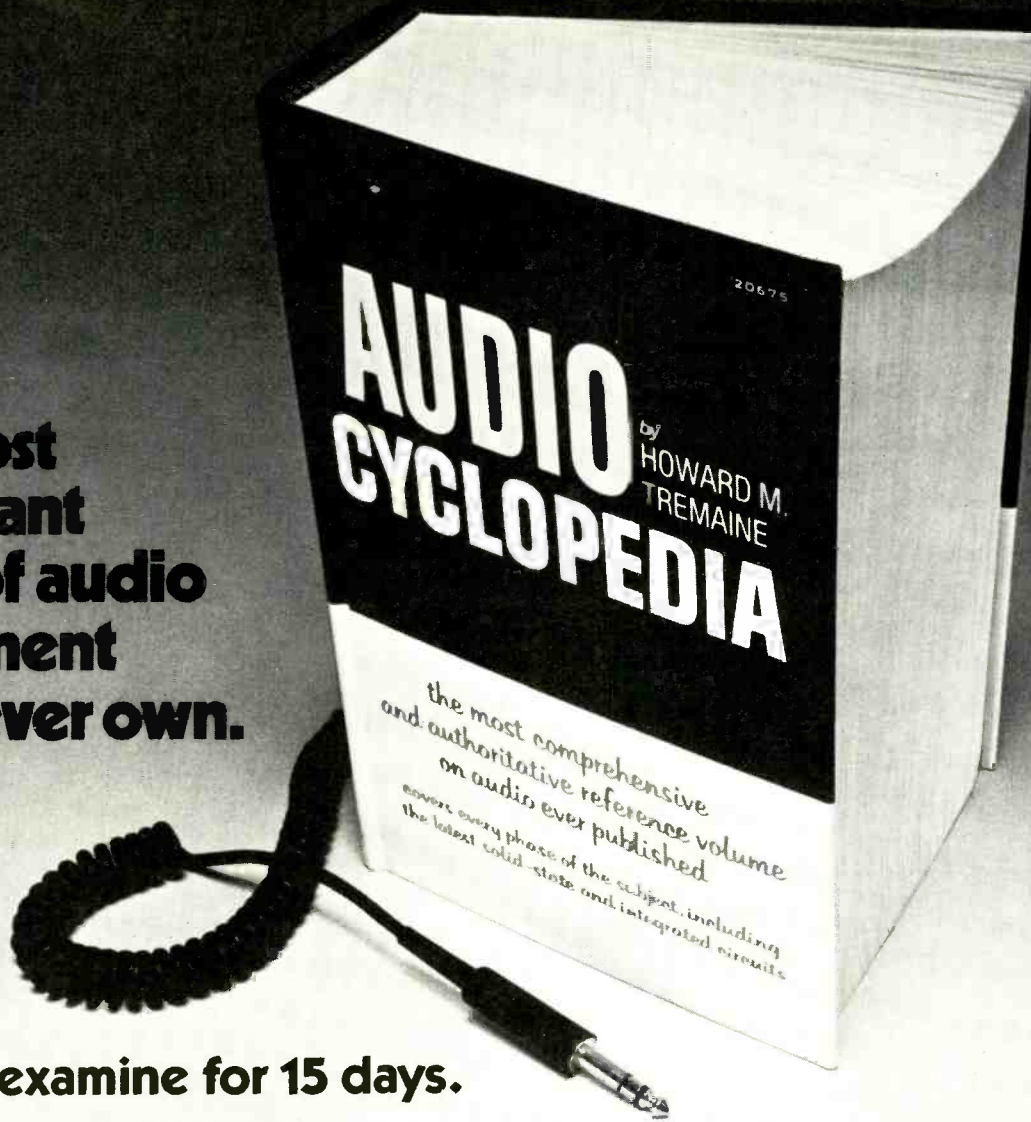

**Yours to examine for 15 days.**

**25 FACT-FILLED CHAPTERS ARRANGED IN "EASY-TO-FIND" QUESTION AND ANSWER FORM**

- Basic Principles of Sound
- Acoustics, Studio techniques, and Equipment
- Constant-Speed Devices, Motors, and Generators
- Microphones
- Attenuators
- Equalizers
- Wave Filters
- Transformers and Coils
- Sound Mixers
- VU and Volume Indicator Meters
- Vacuum Tubes, Transistors, and Diodes
- Audio Amplifiers
- Disc Recording
- Cutting Heads
- Recording and Reproducing Styli
- Pickups
- Magnetic Recording
- Optical Film Recording
- Motion Picture Projection Equipment
- Loudspeakers, Enclosures, Headphones, and Hearing Aids
- Power Supplies
- Test Equipment
- Audio-Frequency Measurements
- Installation Techniques
- General Information, Charts and Tables

Be our guest. Examine the AUDIO CYCLOPEDIA for 15 days. You'll find out why it is considered the most comprehensive and authoritative book ever written on the subject. And you'll get a FREE \$3.50 bonus book to keep no matter what!

The AUDIO CYCLOPEDIA is literally a one-book audio library. It has long been considered "the bible" by amateur stereo buffs as well as professional technicians. That's why you'll find it in constant use not only in home workshops and at stereo centers, but also in recording studios, broadcast booths and concert halls.

This giant reference book is over 3" thick,

and packed with 1,757 illustrated pages. It features 3,645 questions and answers and a 50 page "instant-find" index for subject identification. It is truly the big one in audio electronics and it puts all the information you'll ever need right at your fingertips, chapter by chapter.

Send for the AUDIO CYCLOPEDIA today. If you don't agree that it's the most important piece of audio equipment you own, just return it within 15 days. You won't owe a cent. And no matter what you decide, you'll get a free \$3.50 copy of *The ABC's of Tape Recording* to keep just for mailing the coupon.

**FREE-BOOK/NO RISK COUPON**



Save postage & handling costs. Full

payment enclosed (plus tax where applicable). 15-day return privilege still applies.

Yes, please rush me the AUDIO CYCLOPEDIA (#21455) for my trial. I understand if not completely satisfied, I may return it within 15 days, and owe nothing. Otherwise, it's mine to keep for only \$39.95 plus postage and handling and local taxes (where applicable). **And, whatever I decide, a copy of "The ABC's of Tape Recording" (valued at \$3.50) is mine free!**

Enclosed is my:  Check  Money Order  
 Master Charge  BankAmericard/Visa

Account No. \_\_\_\_\_

Exp. Date \_\_\_\_\_ Interbank No. \_\_\_\_\_ (Master Charge Only)

Signature \_\_\_\_\_

Name \_\_\_\_\_ CT53



Mail to: Howard W. Sams & Co., Inc. Address \_\_\_\_\_

4300 W. 62nd Street City \_\_\_\_\_

Indianapolis, Indiana 46206 State \_\_\_\_\_ Zip \_\_\_\_\_

(Prices subject to change 6 months after issue date.)

Lightning, heavy machinery, and power outages can create damaging power line surges which may damage expensive audio components. Hash is created by hundreds of sources including tools, appliances, microprocessors, business machines, and defective wiring. This article discusses basic causes of surges and hash, effects these phenomena have on component performance, and cures which can be incorporated to reduce undesirable effects.

### Power Line Surges

Surges on the a.c. power line are often caused by lightning. A direct hit on the power line is not required to create a voltage surge many times the normal line voltage.

Lightning is the discharge of two differently charged electrical objects, generally "cloud to earth" or "cloud to cloud." It is estimated the electrical potential between the discharge points can exceed several million volts and the current in the arc or "lightning bolt" can reach one million amperes. This is an instantaneous power of over one trillion watts or over 100 million horsepower! Little wonder that power lines can have large, damaging surges and transients induced by lightning.

Heavy machinery and switch gear can create significant surges when power is interrupted. While nowhere near as impressive as lightning, these surges and transients are often large enough to cause damage. Surges may also accompany loss or restoration of power during a power outage situation. Start and stop of refrigerators, air conditioners, or shop tools may also cause minor line surges.

### Effects of Surges

Power line surges cause damage in several ways. Lightning can induce extremely high voltages between the conductors carrying power to any device, and such a surge behaves essentially like a very high power-line voltage. Audio gear power transformers can have extremely high secondary voltages developed. Rectifiers may be damaged, power transformers may short, and voltage regulators may be destroyed. In short, a "domino effect" could occur, wiping out large sections of electronics. Even turntable motors may be permanently damaged.

Merely because a device is switched "Off" is no guarantee against damage. The voltage surge may be sufficiently high to arc across switch contacts.

\*President  
Electronic Specialists, Inc.  
Natick, Mass.

# LINE SURGE AND HASH PROTECTION FOR HI-FI EQUIPMENT

F.J. Stifter\*

This, in effect, applies high voltage to the equipment with the same disastrous results.

A different situation caused by lightning can result in a common-mode voltage surge, where both power lines are brought up to a high potential relative to earth. When applied to equipment, this high voltage may cause arcing between conductors and ground, destroying cables, switches, or other equipment components. Power transformer insulation may be punctured, rendering the component useless.

Surges caused by heavy machinery or power outages usually are much less damaging than lightning-induced surges. Nevertheless, costly damage may result from these surges and may closely parallel those described for lightning surges.

### Cures for Line Surge

Unfortunately, there is no complete cure for power line surges or hash.

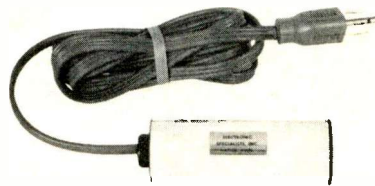

Fig. 1 — Line cord surge suppressor and hash filter.

Power line surges induced by lightning, heavy machinery, or power outages can be controlled by the addition of zeners, thyristors, varistors, or other forms of lightning arrestors. These devices should be placed across the a.c. line and between the a.c. lines and ground. Limited protection can be obtained by placing a high-power zener network across power supply secondaries or even between rectified outputs and ground. Audio equipment a.c. line cords should be removed from wall sockets during electrical storms for the utmost protection.

Commercial surge protectors are also available, and many audio enthusiasts add surge protection as a convenient insurance measure. For a low, one-time cost, valuable audio equipment can be protected against the ravages of power-line surges. We make one model that is mounted in a line-cord package and can be used directly at the equipment to be protected (see Fig. 1).

### Hash

A lot of power line hash is created by arcing in various types of electrical equipment. Tools, motors, appliances, and other small electrical devices are notorious offenders. Even low-quality audio equipment may put out line hash.

Various signals can also be picked up by power lines functioning as an antenna and can create unwelcome interference. Commercial broadcast stations, police, fire, marine, business radios, and CB sets can be the source of this type interference.

Unfortunately, quite a lot of equipment can create hash which gets into the power line during normal operation. A normally operating police or CB radio, that meets all present FCC specifications, may induce fairly strong signals into power lines. If this gets into FM or other equipment and interferes with proper operation, the net result is chaos, frustration, and frayed tempers. All such interference is commonly referred to as hash. In many cases the source is not known; indeed, the source is usually unaware of trouble being caused.

Another common source of hash can be found closer to home. Over a period of time many light sockets, wall sockets, line-cord plugs, wire connections, and the like can become loose, defective, or corroded. Although common and simple hash sources, these offenders are often overlooked. Sometimes this hash is well camouflaged. When a suspected hash source is shut off, the hash disappears. Presto! The



**fact:**  
**dramatic freedom**  
**from distortion comes to a**  
**mid-priced cartridge:**  
**the new Shure M95HE...**



**an affordable, audible improvement**

One of the critically acclaimed advances introduced in Shure's incomparable V15 Type IV pickup is its revolutionary and unique distortion-reducing Hyperelliptical stylus. Now, you can enjoy this standard of sound purity in a new, ultra-flat frequency response, light tracking, high trackability cartridge that will not tax your budget: the new Shure Model M95HE.

**the Hyperelliptical stylus tip**



BIRADIAL (ELLIPTICAL)  
 STYLUS SUCH AS  
 IN M95ED

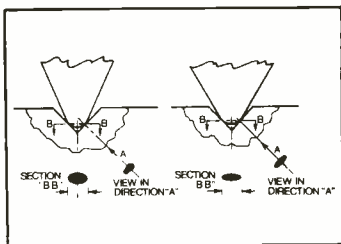

HYPERELLIPTICAL  
 STYLUS OF  
 THE M95HE

The Hyperelliptical nude diamond tip configuration represents a significant advance in tip design for stereo sound reproduction. As the figures show, its "footprint" (represented by black oval) is longer and narrower than the traditional Biradial (Elliptical) tip-groove contact area. Because the Hyperelliptical footprint geometry is narrower than both the Biradial and long-contact shapes such as the Hyperbolic, it is pre-eminent for reproduction of the stereo-cut groove.

SEND FOR FREE BROCHURE AL600.

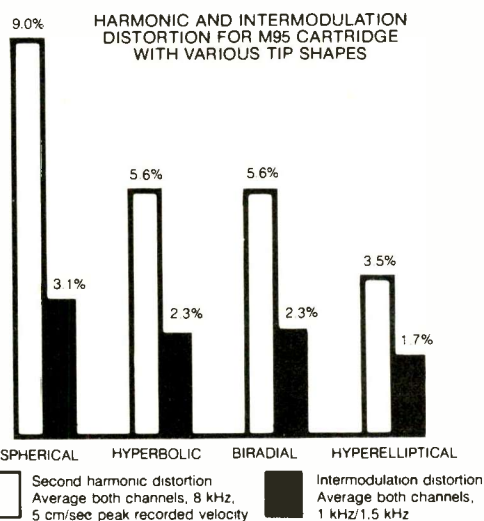

**a measurable drop in distortion**

As a result of the optimized contact area of the Hyperelliptical tip, both harmonic distortion (white bars in graph above) and intermodulation distortion (black bars) are dramatically reduced.

**upgrade your present M95** If you already have a Shure M95 Series Cartridge, you can improve its freedom from distortion right up to the standards of the new M95HE cartridge simply by equipping it with a Model N95HE stylus. The cost is extraordinarily low — yet the difference in sound will be immediately apparent. Takes only seconds to install — requires no tools whatsoever.

**M95HE cartridge &  
 N95HE stylus**



Shure Brothers Inc., 222 Hartrey Ave., Evanston, IL 60204  
 In Canada: A. C. Simmonds & Sons Limited

Manufacturers of high fidelity components, microphones, sound systems  
 and related circuitry.

Enter No. 47 on Reader Service Card

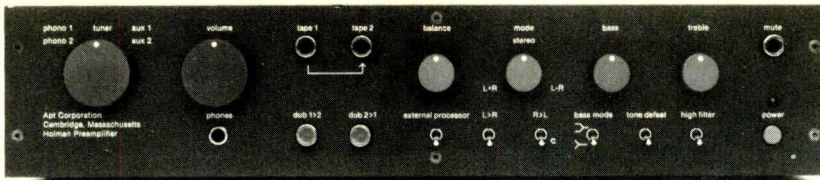

## Sonics

- For a brochure and the name of your local dealer.
- For reprints of reviews.
- For a set of 5 technical papers by Tom Holman, send \$2 (Canada \$3).
- For an Owner's Manual, send \$4 (Canada \$5) refundable with purchase.

Name \_\_\_\_\_

Address \_\_\_\_\_

That, in the final analysis, is what counts.

While Apt can provide you with what is perhaps the most thorough technical explanation of any as to *why* the Holman Preamplifier actually sounds better in a high-fidelity system, what matters in the end is *how* it sounds.

The differences between preamps are not mysterious, and they are clearly audible. Apt seminars have demonstrated this to hundreds of people coast-to-coast. Interfacing problems account for most of the differences between otherwise fine equipment, and the Holman Preamp has been designed to be especially free from interaction.

Thus it sounds better in the wide range of conditions encountered in a high-fidelity music system.

If you would like more information about the Holman Preamplifier or the technical considerations underlying its design, please check the appropriate box(es) on the coupon and send to:

**Apt Corporation**  
Box 512 Cambridge, MA 02139.  
Thank you.

Enter No. 44 on Reader Service Card

## Should You Have Subwoofers?

*At \$145.00 per channel, the answer may be yes.*

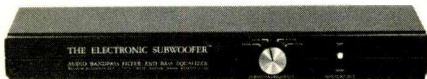

"Full-range" speaker systems (even the best ones) are made to have falling response in the octave from 40 to 20 Hz. This is the result of a compromise required to achieve reasonable cabinet size and efficiency.

It is a good compromise, because there isn't much music in that range. And what *is* there is often lost in the recording process.

Despite this, some people go to extraordinary lengths to achieve bottom-octave reproduction. A pair of subwoofer systems, with an electronic crossover and the extra power amplifier to drive them, can easily cost over \$2,000 and will occupy a lot of space.

Most sensible people would agree that flat response in the bottom octave is

worth something, but probably not that much. Now there is an alternative choice: The Electronic Subwoofer™ filter and bass equalizer system.

Some full-range speaker systems, including those made by Allison, have woofers with as much cone area and as much linear excursion capability as a subwoofer. With the proper equalization these systems can produce flat power output down to 20 Hz. The Electronic Subwoofer system provides that equalization, and it also provides cut-off filters operating at 18 dB per octave below 20 Hz and above 20 kHz. Its price (\$290) and size (14½ by 4½ by 1¾ inches) make it a uniquely practical investment in lowest-octave bass restoration.

Complete descriptions and specifications for Allison® loudspeaker systems and The Electronic Subwoofer system are available on request.

## ALLISON ACOUSTICS INC.

7 Tech Circle, Natick, Massachusetts 01760

Enter No. 1 on Reader Service Card

shut-off equipment must be at fault. Hours later, when the hash has not been cured with various schemes, the hash may be reluctantly accepted as unavoidable. Actually, shutting off the machine stopped electrical current from flowing through the noisy connection or socket, and all traces of hash stopped!

When investigating hash or interference problems, don't overlook: Sporadic problems caused by lightning or electrical storms, fluorescent lamps, SCR or triac controlled lights, motors and power supplies, welders, diathermy, nearby internal combustion engines, OR—(reader fills in the blank).

### Effects of Hash

Hash can cause garbled FM reception or undesired signals in the audio equipment. Direct damage will seldom result from line hash or interference. Reduced enjoyment of favorite programming and undesired noises on taped programs are the major damage. Severe cases, of course, may render all reception impossible.

Hash on intercoms, PA systems, radio, or TV can result in poor communications, personnel annoyance, or morale deterioration. Cost, while difficult to assess, is none the less real.

### Cures for Power Line Hash

Hash filters can be installed at the device suffering hash interference, and, often, this completely eliminates interference problems. A more desirable approach is elimination of hash at the source.

Defective equipment wiring, lamp sockets, and electrical outlets should be replaced or repaired. Filters should be installed on noisy tools, appliances, or equipment. A line cord mounted filter (see Fig. 1) can be utilized at either the victim audio equipment or the hash producing equipment, and models are available which incorporate both the line hash filter and surge suppressor.

Under normal operating conditions, all covers and shields supplied by the manufacturer should be securely fastened in place. This is especially important for FM equipment.

Often, tying all audio equipment to ground will reduce interference from outside sources. When installing a ground system be careful to avoid ground loops, as these may induce system hum. Generally, it is advisable to start with one piece of equipment tied to a good ground; then proceed with a second piece tied to the same ground; and so on. Check system operation after each step. ▲

AUDIO • May 1979



If price alone has kept you from LRS...

# Our new Laboratory Standard Series should definitely be of interest.

LUX's new six-component Laboratory Standard Series was developed out of the same commitment to sonic quality that originated our premier component group: the very impressive Laboratory Reference Series.

The new LSS group of components was designed to enable the advanced audiophile to acquire very nearly the LRS level of performance—and at a much more moderate price.

Now, we simply wish to introduce the LSS to you, point out a few high points of the design, and encourage you to get the full story from your LUX dealer.

The tuner features quartz-reference

tuning circuitry, switchable i.f. bandwidth, variable muting threshold, audible multi-path monitoring and an innovative aid to precise tuning: Accutouch. As you turn the knob, any station that exceeds the muting threshold physically locks at the point of lowest distortion.

For amplification, there's a choice of an integrated amplifier, a preamplifier, a stereo power amplifier, or a mono power amplifier—all pure DC and direct-coupled. They use the same special circuits developed by LUX for the LRS. Transient intermodulation distortion is negligible, and problems of DC drift and phase shift are non-existent.

For frequency balance and adjustment, the preamplifier and integrated amplifier include the exclusive LUX linear equalizer.

For additional flexibility, a ten-octave graphic equalizer with active filter components achieves both low distortion and noise-free operation.

If only the necessarily high cost of LRS has been the obstacle between you and its ownership, it is now time to visit your LUX dealer. You'll have the opportunity to audition today's near-ultimate in high-fidelity reproduction. At considerably less than the ultimate in cost.

## LUX Audio of America, Ltd.

110 Dupont Street, Fairview, New York 11805 • In Canada: White Electronics Development Corp., Ontario

LSS components as shown, top to bottom: T-12 FM tuner with 10.7 dBf (1.8 μV) usable sensitivity, 14.1 dBf (2.8 μV) for 50 dB quieting (INF), 0.8 dB capture ratio and 9C dB selectivity; G-11 ten-octave graphic equalizer provides ±6 or ±12 dB boost or cut at each octave, ≤ 0.005% THD; C-12 preamplifier, ≤ 0.005% THD and 0.002% IM distortion, signal-to-noise ≤ 96 dB, 10 mV input (IHF-A weighting), 300 mV phono overload; M-12 stereo power amplifier, 80 watts per channel, both channels driven, into 8 ohms from 20 to 20,000 Hz, ≤ 0.002% THD.



The LRS line of nine separates includes: 5T50 frequency-synthesized FM tuner with digital readout and 7-station memory; 5C50 preamplifier, DC and fully direct-coupled, THD 0.005%; 5G12 12-octave graphic equalizer; 5F70 tone control unit; 5E24 LED level indicator; 5M21 DC direct-coupled power amplifier with meters. Also: 5L15 integrated amplifier; 5T10 FM tuner with Accutouch; 5M20 power amplifier without meters.



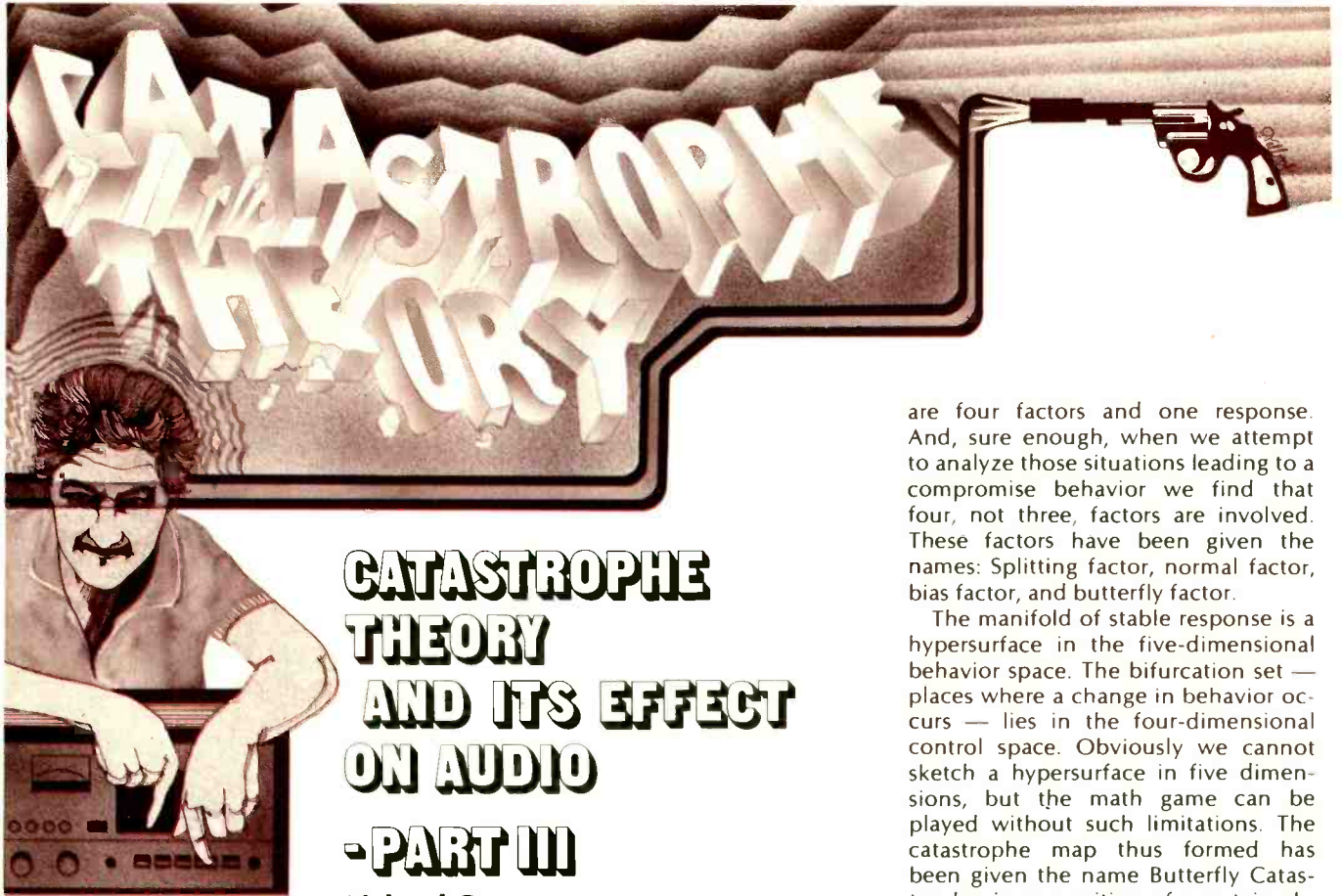

## CATASTROPHE THEORY AND ITS EFFECT ON AUDIO -PART III

Richard C. Heyser

**T**he existence of bimodality of response is a direct clue that the perception of quality is a nonlinear process. It should also be a clue that any objective measurements which are based upon linear theory will not be worth a hill of beans when we try to correlate those measurements with subjective value judgments.

After bimodality, the next most prevalent response characteristic which we note in human behavior is trimodality. Patterns of stable compromise may emerge between equally stable, but opposing, strengths of opinion. In some cases this may show up as an evolutionary transition between what Thomas Kuhn has called Paradigms.<sup>1</sup> A middle ground may be taken between the tradition of old ideas and the promise of new ideas. When this happens, the press of time or of evolving evidence will tend to resolve the compromise position to one paradigm or the other.

Three regions of stable response may occur under a number of circumstances. When a formerly clear-cut situation splits into discernible camps, those who occupy the outermost camps, which represent the extremes of opinion, will tend to assign rubrics

to themselves and to their most extreme counterpart. They are generally self flattering and of a nature which denigrates the opposing view. These are the heraldic flags of strong opinion and the field of audio bears many such flags.

A compromise opinion or reaction to control factors will seldom be identified with strong labels. This is because the trimodal position is less frequently occupied than either of the two extreme positions which surround it. This does not detract from the fact that such a compromise position can be legitimately taken and possess high stability.

### The Butterfly

It might normally be thought that since trimodality is the next degree of behavior complexity from bimodality, it would arise in the next higher level of control dimensionality. But this is not so. Two factors and one response yields the cusp catastrophe. Three factors and one response yields the swallowtail catastrophe; however, the swallowtail catastrophe does not exhibit much in the way of stable behavior, let alone trimodality.

Trimodality shows up when there

are four factors and one response. And, sure enough, when we attempt to analyze those situations leading to a compromise behavior we find that four, not three, factors are involved. These factors have been given the names: Splitting factor, normal factor, bias factor, and butterfly factor.

The manifold of stable response is a hypersurface in the five-dimensional behavior space. The bifurcation set — places where a change in behavior occurs — lies in the four-dimensional control space. Obviously we cannot sketch a hypersurface in five dimensions, but the math game can be played without such limitations. The catastrophe map thus formed has been given the name Butterfly Catastrophe, in recognition of a certain abstract shape which appears when lower-dimensional "slices" of the bifurcation set are sketched.

In order to provide an audio example of this higher dimensional catastrophe, let us again consider the case of a music listener who has an audio reproducing system. Let me assume that the control space is characterized as follows: Music enjoyment is a normal factor, time spent listening is a splitting factor, cost of new equipment is a bias factor, and product awareness is a butterfly factor.

These are the four factors which will control the following behavior, desire to purchase a new audio reproducing system.

### Butterfly Bifurcation

The first two control factors, normal and splitting, are identical to those of the two-dimensional example which we discussed earlier. The response is also the same if we presume that a sufficient dislike of one's existing audio system will relate to the desire to replace that system with one which sounds better.

The terms which are new in this example are the bias factor and the butterfly factor. Bias is that factor which, if all else stays put, tends to multiply the response. I have presumed that one's



bias to purchase something is inversely related to the price of purchase. Hence cost is a bias factor. The butterfly factor has the effect of an almost inexorable buildup in pressure which tries to upset the status quo. In this case I have assumed that the listener also reads magazine articles on sound reproduction and cannot help but see advertisements and product claims. Thus, product awareness becomes a butterfly factor.

It is a feature of Thom's theory that all of the lower dimensional forms of abrupt behavior can be found in the higher dimensional catastrophes. Progressing upward in dimensionality adds new types of catastrophe to the inventory. The fold catastrophe (which we did not discuss, but is the either-or hysteresis jump available in a one-dimensional control space), the cusp catastrophe (control dimension two),

and the swallowtail catastrophe (control dimension three) can be found under certain conditions when there are four control factors. Obviously I cannot go into any sort of detail in this brief discussion, so I will present what I believe may be the more important patterns for audio.

We cannot show four dimensions, so let us concentrate on the bifurcation set (places of abrupt decision) as it appears for the two-dimensional slices with the coordinates of music enjoyment and time spent listening. We will follow the pattern for various cost and product awareness situations. In Fig. 1, I have plotted the bifurcation set as a function of decreasing cost of a new system and with almost no product awareness. The behavior is cusp-like with the cusp swung farther toward the direction of live music enjoyment as the cost of a new audio

system increases. If we trace the journey marked M (for music enjoyment), our desire to purchase a new system will increase as we increase our enjoyment of that music. If we trace the journey L (for listening to our existing audio system), the desire to purchase will diminish with increased listening. This is the same sort of situation discussed in the previous example of the cusp catastrophe.

As an additional set of curves, I also plot the desire to purchase (height of the manifold) as a function of cost. Now we can see a situation emerge which we might not have anticipated. At low levels of listening to reproduced sound, the curve of increased live music experience ( $M_1$ ) cuts the bifurcation set at low cost and high cost, but misses it for medium cost. For a given small amount of listening to reproduced sound, there are response

Fig. 1—Cost, as a control factor in our desire to purchase a new audio component, has the effect shown here when there is very little product awareness concerning components that are available for sale. Three cost situations are sketched: (a) low cost, (b) medium cost, and (c) high cost. Under these conditions the desire to

purchase a new audio component will depend upon the relative amount of experience that we have with natural sound as compared to the amount of time we spend listening to the sound reproduced from our present audio system. If, at the point of relative experience shown here as O, we substantially increase our exposure to

reproduced sound, without changing the amount of time spent attending live concerts, then we move out on the trajectory L. Travelling on L tends to reduce the desire to purchase a new system. Increasing the exposure to natural sound will move us in the direction M.

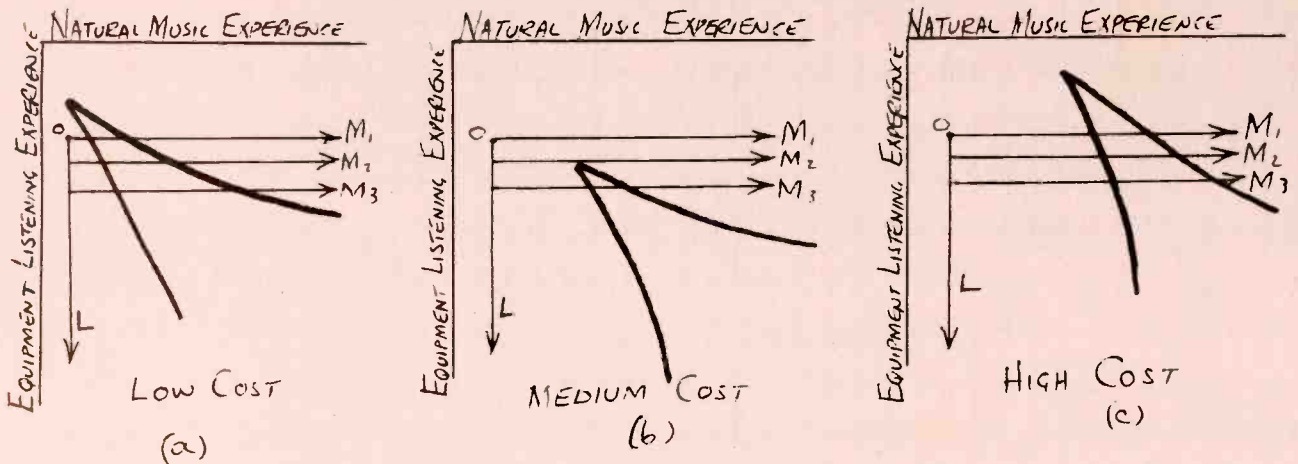

Of particular interest is the situation that arises if we travel the trajectory  $M_1$ . Figure 1(d) is a sketch of what happens when we move along  $M_1$ . As we begin to attend more and more live concerts, our general desire to purchase a new audio system will increase. This increase will take on catastrophic jumps at low cost and high cost situations, but not at medium cost. The low cost catastrophe corresponds to impulse buying, while the high cost situations may be a prestige reaction.

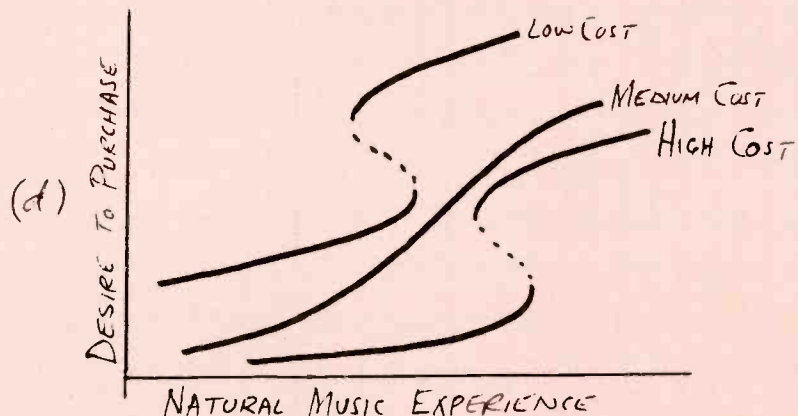





# Are Your Speakers Still Driving A Rattle Trap?

We've eliminated one of the greatest sources of speaker distortion. The conventional paper cone.

We replaced it with an aluminum honeycomb core. Then we coated it with a glass fiber reinforced skin. And the result was music to our ears. For the first time, we had sound reproduction free of unwanted vibration.

The greatest single improvement of this design is in the *quality* of bass response. It not only extends it, but makes it more powerful by freeing it from spurious vibrations.

This improvement is only possible because of the incredible combination of both *lightness* and *rigidity* of the

honeycomb material. With it, we've achieved a level of performance that no conventional paper cone can match.

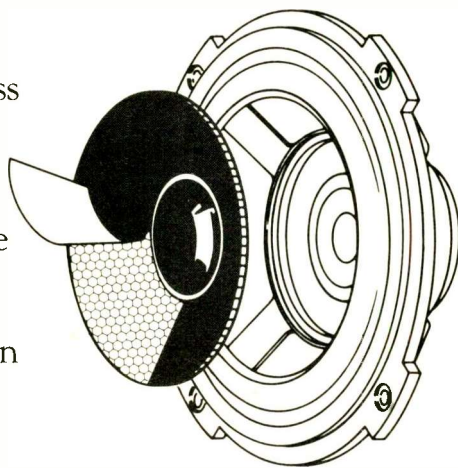

At that point, it would have been easy to quit. The sound sounded perfect to a lot of people. But not to us. So, we coupled our new cone with our patented FN iron ring. And there went 20 dB of magnetic distortion.

Next we went to work on the cabinet. We eliminated

the negative effect of sound diffraction at and around the speaker frames by mounting them flush, with the baffle surface flat to the edge of the cabinet. Finally, we had the sound just where we wanted it.

Then, we surrounded our speakers with hand-rubbed walnut and a black, semi-transparent grille. So, their look is now every bit as impressive as the sound they produce.

Our new Honeycomb Speaker Line is thought to be the most perfect way to reproduce perfect sound.

It ought to be. We've been driving toward perfection for a long time.

 **MITSUBISHI**  
AUDIO SYSTEMS

Mitsubishi's Honeycomb Speakers. MS-10 10" 2-Way Bookshelf. MS-20 12" 2-Way Bookshelf. MS-30 12" 3-Way Bookshelf.  
For more information write Melco Sales, Inc., Dept. A. 3030 East Victoria Street, Compton, California 90221.

Enter No. 19 on Reader Service Card

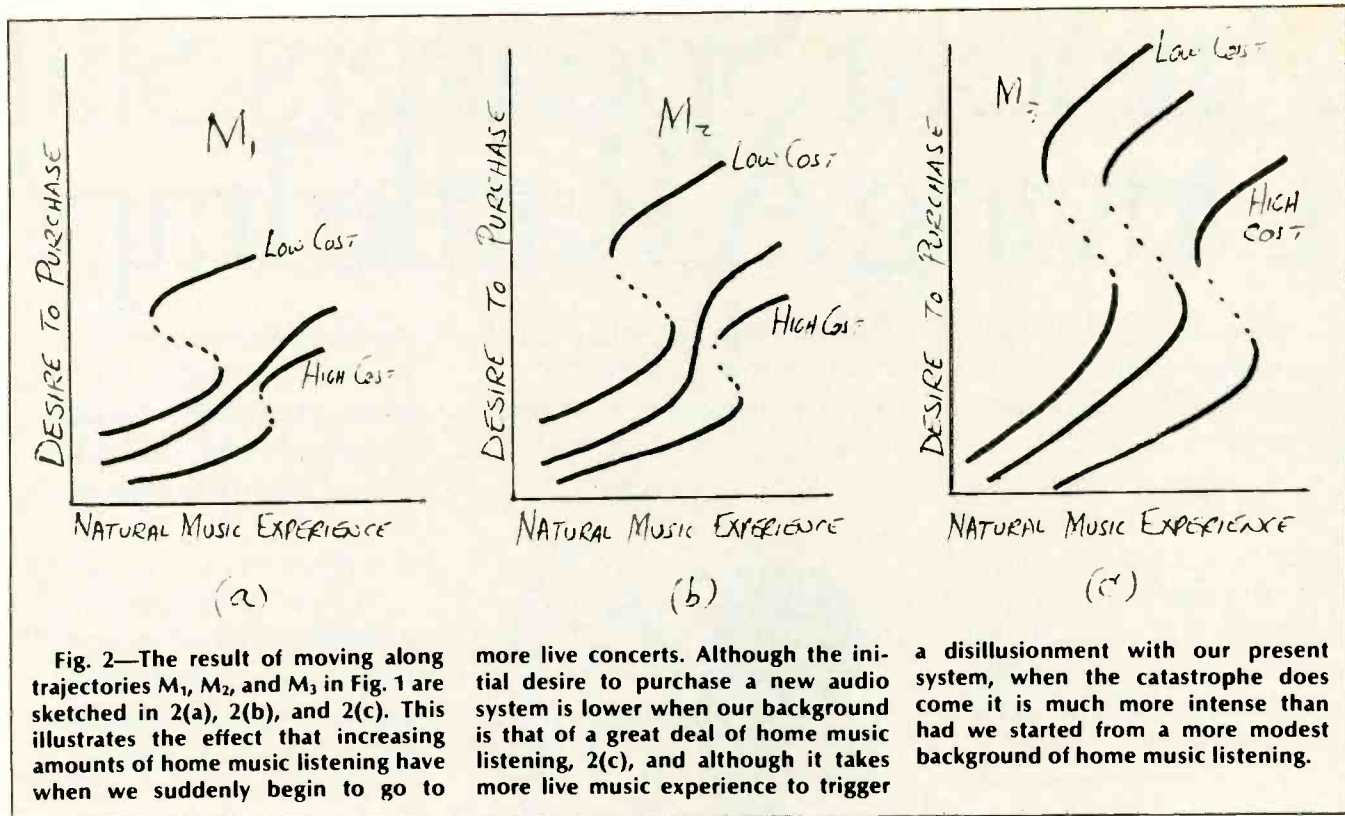

catastrophes at low cost and at high cost situations, but there is a region of cost in which purchase desire is continuous with no jumps. In all cases the desire to purchase goes up as the cost of a new system comes down, but there is a certain range of time spent listening where our opinions take a jump.

This jump at low cost is the sort of behavior which can lead to impulse buying. We all recognize the situation; one day we run across a bargain too good to pass up. We did not really intend to buy a new cartridge or "whatever," but the cost was "right" and the impulse hit us.

The tendency toward impulse buying, according to this butterfly catastrophe situation, will fade as the price rises. Impulse will give way to a smooth curve of deliberation of worth versus cost. But as the price continues to rise we will again enter a region in which our increasing enjoyment of music will cause a sudden jump in purchase desire. This does not mean we will buy the higher priced product, but our desire will "gain ground" faster than we might anticipate as our enjoyment of good sound increases.

The effect which a greater amount of time spent listening to our present system has on the desire to purchase is to offset cost. The trade-off between enjoyment of music, cost, and more listening, is shown in Fig. 2. The interesting fact which emerges from this

situation is that while the general desire to purchase is diminished by more listening to our present audio system, the potential for impulse purchase is greater. Not only do the low-cost impulse catastrophe and the higher cost catastrophe merge to eliminate a smooth change in desire, but the magnitude of behavior jump is much greater due to the increased listening experience.

If we believe the mathematics, the person most likely to whip out his

**Fig. 3—The introduction of product awareness adds an additional factor which begins to warp the simple cusp catastrophe by wrinkling the central sheet of the manifold. This shows the initial stage of the process.**

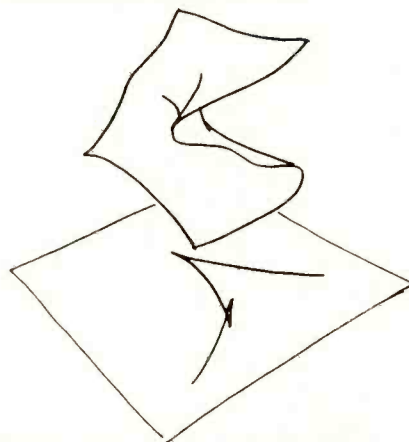

checkbook and make a surprise purchase (even to himself) is the one who does a lot of listening to reproduced sound at home and who has recently become more interested in the enjoyment of live music. That does not seem so surprising, but the magnitude of the desire catastrophe is a surprise.

### The Effect of Advertising

Now let us look at the emotional effect of product awareness. What role does advertising and product chest thumping have on the desire to purchase?

In order to visualize how product awareness (the butterfly factor) can precipitate trimodal behavior, Figs. 3 and 4 sketch the way in which the cusp catastrophe becomes modified with the introduction of the butterfly factor. As product awareness begins to increase, Fig. 3, the simple fold of the cusp catastrophe begins to warp and convolute. Continued increase, Fig. 4, puts a third sheet in the manifold and converts the bifurcation set (the projection of the "edges" of the fold where opinions must jump) into a complicated multi-cusped pattern. This pattern has been likened to an abstract sketch of a butterfly, and is the basis for the name given to this particular response catastrophe.

If product awareness were to increase, the middle sheet would continue to produce a pattern like Fig. 3, but with the line segment break in the



# We just can't quit when we're ahead.



Consider the Sony Audio PS-X70 turntable.

Think of it as a professional transcription turntable, for home use. At a price your audio conscious home can afford.

Think about two discrete servo-controlled motors. One for the platter. Another for the tonearm.

And while you're thinking about motors, think about Sony's hesitation-free BSL motor. No brushes. No slots. And absolutely no cogging. Just even, uniform rotation. Hour after hour. Year after year.

Our own Quartz-locked Magnedisc servo control system makes Sony direct-drive turntables immune to voltage fluctuations. It takes servo control to a new level of accuracy, by measuring turntable speed at the outer rim of the platter—not at the motor.

There's more you should know: front-mounted feather-touch

controls, electro-magnetic braking, special four-clamp head-shell connector, even resonance-free SBMC cabinet with fluid-filled feet to eliminate acoustic feedback.

But perhaps the most amazing thing about our PS-X70 is that it's not alone.

It's just the top of our line. A whole line of new Sony Audio turntables, most of which have most of the features we've listed here.

And every one is designed as a system. With electronic, magnetic, and mechanical technologies contributing to a balanced level of audio performance no single innovation could achieve.

We know about turntable innovation. We practically wrote the book: direct drive, servo control,

Quartz lock, carbon fiber tonearm, Sony gave you them all. Long before almost anyone knew they existed.

But we also know that innovation alone can't make a great audio component. Sound makes a great audio component.

Like the sound you get from our PS-X70 turntable.

Quit, just because we're ahead? Not Sony Audio. Not on your life.

# SONY<sup>®</sup> AUDIO

Sony Industries, 9 West 57th Street, N.Y., N.Y. 10019.  
Sony is a registered trademark of Sony Corporation.

Enter No. 35 on Reader Service Card



bifurcation on the other part of the major cusp line.

Figure 5 shows sketches of the bifurcation set and purchase desire plotted for increasing amount of product awareness, but at fixed cost for a new system. A trajectory of increasing music enjoyment for a critical range of listening is shown by the line N. At a certain level of awareness and at a certain level of cost, the desire to purchase will experience a trimodal behavior. This third mode represents a compromise struck between a strong desire to purchase and a weak desire

to purchase. The feeling one might have is "I sure would like to have that system, but it is just more than I can afford."

Trimodal behavior will disappear if any of the four control factors change moderately, but it will disappear the quickest with a change in the butterfly factor — product awareness. There is, in other words, a critical threshold of advertising which is required to cause the greatest increase in desire to purchase. If the listener can be bumped up to a compromise reaction, it is easier to push him upward to a purchase

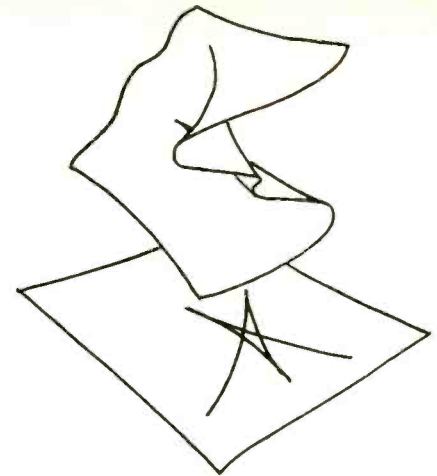

Fig. 4—In the later stages of development of the butterfly factor, the manifold develops a third inner sheet. The bifurcation set which this produces has the shape indicated in this sketch. The term "butterfly" is taken from the shape of this bifurcation set, which has been likened to that of an abstract butterfly.

with a modest increase in advertising than with a proportionately larger drop in price.

As we pointed out, the shape of the bifurcation set at the place where trimodal response sets in is the basis for the name Butterfly Catastrophe. The central region of this set — the body of the butterfly — is often called the pocket of compromise. The effect of the butterfly factor is to drive the bifurcation set from a single cusp shape toward and through this butterfly shape. The effect of the bias factor is to magnify the response at any given set of conditions.

By opening up an intermediate level of stability between an otherwise large jump, the butterfly factor is a trigger mechanism. If we were at place (a) in the response shown in Fig. 5, the size of the jump we would take if we ever got to the fold in the behavior manifold would be quite large if the bias factor (cost) were sufficiently strong. But we do not have to change our listening habits if the butterfly factor is now increased. Symbolically, we are standing on a floor with the ceiling well above us, and the butterfly factor now ripples our floor and bumps us up to an intermediate shelf level between floor and ceiling. Position (a) now changes to position (b) as increasing product awareness opens a pocket. It is now much easier for a modest increase in normal factor to take us to a jump point where we are not at the ceiling — a ceiling we might never have reached without that assistance.

I have called product awareness the butterfly factor because that is the drive which advertising, equipment reviews, and sales claims provide. We

# Soundcraftsmen

**EQUALIZERS... PREAMP-EQUALIZERS... CLASS "H" AMPLIFIERS...**

**"THE PERFECT PREAMPS" - OCTAVE-WIDE TONAL CONTROLS, PLUS PUSH-BUTTON SIGNAL-PROCESSING PATCH-PANEL, FOR OPTIMUM FLEXIBILITY IN PROGRAMMING, SWITCHING, PLAYBACK...**

**SP4002 FEATURES:**

- Dual 10-band ± 15 dB Equalization
- Zero-Gain/LED Level Balancing
- Sub-Sonic Filtering—15 Hz
- Variable Cartridge Loading, 50 to 800 pf.
- Variable 47/100 Ohm Phono Impedance
- ± 20 dB Phono Level Adjustment
- Phono Signal-to-Noise—97dB

- Inputs For Most Moving Coil Cartridges
- Four Mono Phono Preamplifiers
- Three-way Tape Dubbing
- Two Amplified Headphone Outputs
- Two External Processing Loops
- Stepped Level Control

**MADE IN U.S.A.**

The new SP4002 SIGNAL PROCESSING Preamplifier is the most flexible preamplifier available. Its PUSH-BUTTON PATCHING capabilities are endless. The SP4002 was designed for those audiophiles who take a "HANDS ON" approach to their equipment. For tonal flexibility, we have included **TWO TEN OCTAVE GRAPHIC EQUALIZERS** For the tape enthusiast, the SP4002 is capable of handing up to three tape recorders with **THREE WAY** dubbing control. Along with this are **TWO SIGNAL PROCESSING LOOPS** for added accessories, a subsonic filter and stereo/mono mode switching. Our unique **CARTMATCH™** phono preamplifier design allows the use of two moving coil cartridges without head amplifiers and **ADJUSTABLE CARTRIDGE LOADING** on phono 1 and phono 2 from 50 to 800 picofarads. Again the Soundcraftsmen tradition of "affordable separates" is continued.

**NEW BASIC EQUALIZER \$249.00**

**9 EQUALIZER FEATURES:**

1. Environmental EQ Test Record
2. Computone Charts for EQ re-set included
3. EQ Tape Recording
4. Tape Monitor
5. EQ defeat
6. ± 16-12 dB EQ/octave
7. S/N-105 dB
8. Cabinet included as shown
9. Two Master Output Controls.

**FREE! 16-page Full-Color Brochure**

Includes **TEST REPORTS**, complete specifications, Class "H" amplifier **ENGINEERING REPORT, EQ COMPARISON CHART**, and the "WHY'S & HOW'S" of equalization—an easy-to-understand explanation of the relationship of acoustics to your environment. Also contains many unique **IDEAS** on "How the Soundcraftsmen Equalizer can measurably enhance your listening pleasures," "How typical room problems can be eliminated by Equalization," and a **10-POINT "DO-IT-YOURSELF" EQ evaluation checklist** so you can **FIND OUT FOR YOURSELF WHAT EQ CAN DO FOR YOU!**

SEND \$6.00 FOR EQUALIZER-EVALUATION KIT: 1-12" LP TEST RECORD, 1 SET OF COMPUTONE CHARTS, 1 COMPARISON CONNECTOR, 1 INSTRUCTION FOLDER

**MADE IN U.S.A. BY SOUNDCRAFTSMEN, SANTA ANA, CA 92705**

Canada: ESS AUDIO (Canada) LTD., Ontario



**Free**  
Bose Windbreaker  
(value up to \$30) with each  
purchase of a pair of Bose® 601's.  
April 15 thru May 31, 1979

## The Bose® Model 601. Anywhere you sit, you're surrounded with sound.

Sound to the left of you. Sound to the right of you. Sound from behind you. The Bose Model 601 Direct/Reflecting speaker.

Six drivers—two woofers and four tweeters—are precisely positioned within each enclosure to radiate sound in many directions. And fill the room with music.

So no matter where you stand or sit in a room, you hear accurate stereo balance. And accurate location of each instrument.

You hear every musical note with clarity and precision. From the highest strings of a violin to the deepest thump of a bass drum.

Sound is reflected off the walls and ceiling



of the room, as well as directly to you. The result? A proper balance of reflected and direct sound...like that you hear at a live performance.

Plus, the Bose 601 can be driven with amplifiers from 20 to 150 continuous watts per channel.

The Bose Model 601 Direct/Reflecting speaker. Surround yourself with sound.

**BOSE**®

Better sound through research.

100 The Mountain Road, Framingham, MA 01701  
Covered by patent rights issued and pending. Cabinets are walnut veneer.



are constantly bombarded with advertising and product claims. Most of the time this has no effect on us, and we tend to wonder why advertisers spend so much money and time. The power of advertising, according to this butterfly factor behavior model, comes into play when we become interested in possible purchase of a new product.

Months can go by with the same ad appearing month after month and we barely notice it; then, through music enjoyment and time spent listening, we start to pick up an interest in possible purchase. We start to notice the ads (product awareness begins to increase), and we begin to compare

prices (cost factor entering) even though a few months prior we paid no attention to prices or what was new.

This is quite consistent with human behavior, and there would be little reason for mentioning something so obvious to us all. But the butterfly model indicates a condition which we should be aware of. The butterfly factor plays such a dominant role in precipitating a large catastrophe that it "comes on strong" after we have achieved a certain threshold in desire to purchase.

Once we have been pushed high enough on the behavior manifold, there is little time left for rational anal-

ysis leading toward a purchase. At that critical stage we are likely to be triggered into purchase by almost any product claim, either in print or verbally by a salesperson. Geometrically, the gradient of the response manifold has its steepest value just before a catastrophe, and the steepest gradient of all will generally be due to product awareness in the audio situation we are considering. All it might take to precipitate a catastrophe is some small increase in desire to purchase, such as perceived cosmetic improvement over competition or an exaggerated product claim. At that crucial stage we, the audio purchaser, are likely to accept product reviews or hearsay comments or advertising claims which we might normally reject as pap or worthless. Wild claims and come-ons are not intended for the person who has no desire for purchase, but are geared for the last stage of purchase intent when we are most vulnerable.

A good salesman is much like a shepherd who, through artful means, keeps the prospective purchaser on a path which will lead to a commitment to purchase. Mathematically, it is the salesperson's task to keep the customer heading in the upward slope of the response manifold. Skillful employment of product awareness can steepen the slope to the place where a customer can be triggered by an otherwise minor increment in product claim. "Would you prefer this model in walnut or mahogany?" is one such technique which directs the customer upward on the manifold by concentrating his attention on alternative positive features of the product and diverting consideration away from the customer's natural contemplative act, namely, whether he wanted to acquire this product at all. Any situation that offers the opportunity for the customer to consider "not buying" as an alternative, is heading the customer the wrong way on the response manifold (from the salesperson's view) and is to be avoided. This is particularly important prior to the point where the customer can be triggered to a desire catastrophe, but, as we shall see, is still important after the catastrophe occurs.

### Cooling Off

It is not what it is, but what it appears to be, that precipitates a response catastrophe. Once we are triggered, we have jumped to a higher sheet on the response manifold, and once there we are at a place of much higher desire and of lower gradient in response. Product awareness and cost have done their deed and may now be modestly altered without triggering a

## The Interaudio® I. It shows the European appreciation for performance in a compact size.

The Interaudio® I speaker has been one of the best-selling speakers in Europe. Why?

Because Europeans truly appreciate the speaker's outstanding performance, as well as its very compact size.

The Interaudio I fits just about anywhere. On a small bookshelf, the wall or in your van. But no matter where you put it, the Interaudio I delivers a deep, powerful bass and crisp clean highs.

The key to this tremendous sound in such a small speaker is the careful integration of woofer, tweeter, and crossover by the same engineers who developed the famous Bose® 901® Direct/Reflecting® speakers.

Not every stereo dealer carries the Interaudio® I. But then again, you can't buy a BMW at every car lot, either.

## Interaudio®

Bose Corporation  
Framingham, Massachusetts



BMW 320i courtesy Auto Engineering, Inc.



disillusionment catastrophe. The sales slip can add up to a bit more than we thought it would ("... of course, there are shipping charges and ..."), and product awareness can show modest negative factors ("... the color scheme you have chosen is not in immediate stock and will take a few weeks for delivery"), but we are hooked at the moment the catastrophe occurs and will tend to drive toward a purchase anyway.

Generally, product awareness still has the highest gradient among the control factors, even after we have been triggered. That is why a "cooling

off" period, a time lag, is so important before we sign a commitment to purchase. What has happened to us is something familiar in human affairs. A desire catastrophe is a response similar to "falling in love." Once we have "fallen" for something, it is often said that we are blinded against negative factors. That is not completely true, according to the catastrophe model. What has happened is that the gradient of response is significantly reduced when we jump. If we jumped from a place with a large enough splitting factor and normal factor, the increment in desire is so large that it could be lik-

ened to a transition to blinded love — the change in gradient is that large. But if the continued press of product awareness is now directed in a negative manner, the gradient will tend to increase downward. Depending on the interaction of the bias and butterfly factors, the response may stabilize or it may be triggered to a disillusionment. A "cooling off" period may then be said to allow us to "come to our senses" in the rational consideration of our desire (or need) for the audio component.

The role which advertising (and product reviews) plays in this process

**Fig. 5—The butterfly factor introduces a trimodal condition of stability. This figure illustrates the influence which advertising has on desire to purchase an audio component, under conditions of constant cost but for the situation in which we suddenly begin to go to more live concerts. If we are passing along the trajectory N and are at the locations shown by the x, then advertising can be used to bump us up to a higher desire for purchase.**

**Fig. 5(a)—If there is minimal advertising, we are at the position shown as (a). We need to attend more live concerts before experiencing a substantial increase in desire to pay the cost of a new audio system for listening at home.**

**Fig. 5(b)—Advertising has the effect of rolling the manifold back toward lower levels of natural sound experience and of introducing an intermediate sheet. Even with no further increase in live music experience, advertising has bumped us up to position (b). We are in a pocket of compromise and have had the incipient catastrophe moved closer to our position. It now takes less of an exposure to pop us up all the way to a higher desire-to-purchase.**

**Fig. 5(c)—If the pressure of advertising is increased, it may be possible that as the pocket of compromise moves out, the wrinkle in the third sheet pops us up to position (c), a position we could never have achieved**

**without the influence of advertising. Beyond this point, further pressures in advertising will continue to force the bifurcation set farther towards higher levels of live music listening. This means that there is an optimum level of advertising which can trigger us to a locally highest desire-to-purchase, but beyond which further sales pressures will tend to diminish desire. In extreme situations the additional warping caused by high levels of advertising may lose the sale by popping the point (c) back down to some place like (d). Supersaturation by advertising not only turns us off, but actually raises the amount of listening we must do in order to want to purchase that component.**

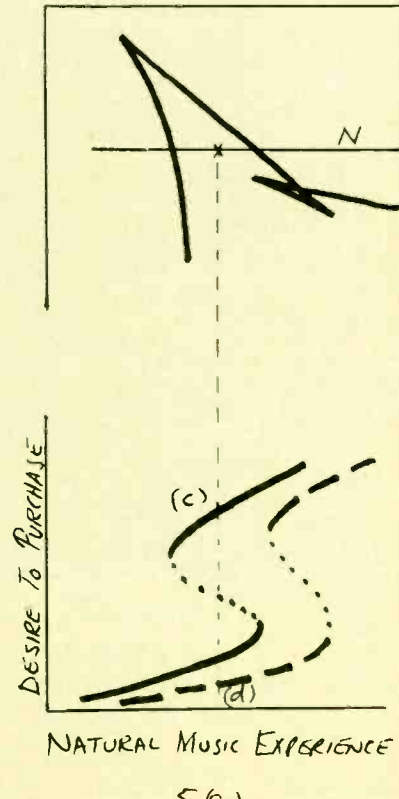
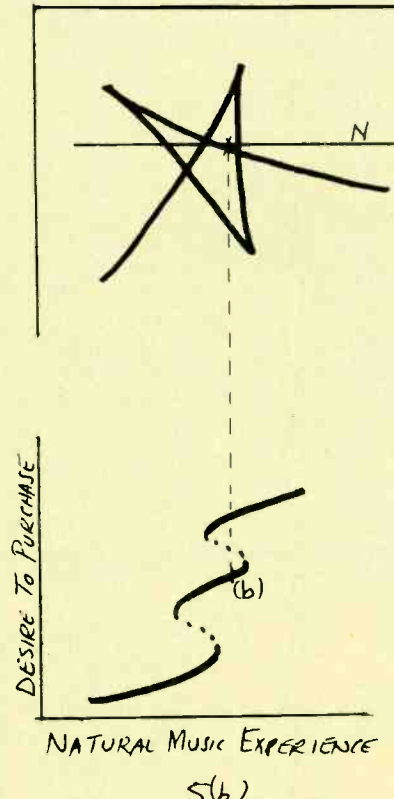
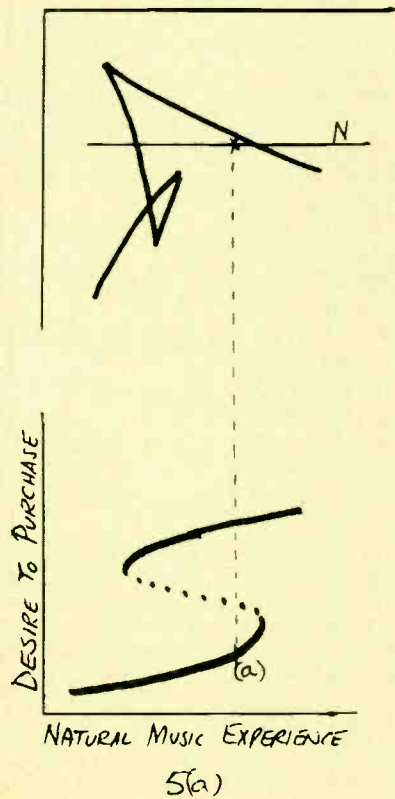

can be helpful if we inject a delay between initial response and eventual commitment. (Within the framework of Catastrophe Theory, there is a process called delay which relates to the conditions under which a transitional response change must occur and refers to a "smoothing" effect on such changes — it is not this smoothing delay to which I refer.) While it is apparent that the initial impact of product awareness can be that of precipitating a response catastrophe, blatant claims and product puffery will have less of an effect during a "cooling-off" period

and, in fact, can turn a sales away if it must compete with accurate product claims when the purchaser is allowed to exercise rational judgment.

A good salesperson instinctively knows that a customer who wants to "think about it" will probably not come back once he walks out the door. Thus, a salesperson who knows what he is doing will not present us, the customer, with an opportunity for a cooling-off period. We must take this step *ourselves*.

During a cooling-off period between a desire catastrophe and com-

mitment to purchase, increased product awareness can drive us back toward a disillusionment catastrophe if the added knowledge reveals things which *we ourselves would consider undesirable*. That is most important. The shape of the behavior manifold, and where we are on that manifold, is *different for each of us*. Two persons can react differently to the same product if they bought it during the passion of sales and then took it home for listening. At the moment of desire catastrophe, both persons might be equally convinced that this is the product for them. But the person with the higher gradient of response will become more quickly disillusioned with that product if additional negative features are revealed. Product awareness on audio components includes knowledge about sonic imperfections. If those imperfections are of a type which will detract from the enjoyment of sound, *in the frame of reference of a particular purchaser*, then it is helpful in the long range satisfaction of that purchaser that he know about such imperfections *before* buying the product, not after. The person who might become the most unhappy about the performance of a product is the one (with the higher gradient) who can best benefit from a cooling-off period during which he is allowed to compare product claims and do comparative listening.

If there is a moral which catastrophe theory teaches us, it is that the time to pay attention to product claims is *before* we are in the store and exposed to the heat of salesmanship; then we should allow ourselves a cooling-off period after we fall in love with a product.

If, during the cooling-off period, the customer becomes aware of enough negative factors, he may find himself dropped into a pocket of compromise. His trimodal condition lies between outright rejection of the product and wild acceptance. Because the drive of product awareness has been stalled by opposing trends, cost may now play a more dominant role in popping the desire to purchase upward to a higher sheet.

Since the bias factor (cost) tends to magnify response, a reduction in price (shopping around for a better deal) may set up a condition where an increase in splitting factor (time spent listening) triggers a jump upward in desire to purchase.

There is no surprise here; shopping around for a lower cost is, or should be, a requisite for any rational purchase. However, the combined effect



# TRUSONIC

10530 LAWSON RIVER AVE., FOUNTAIN VALLEY, CA 92708 714-964-3541

*ONLY*

## ANATOMY OF THE 40 OZ. MAGNET, CHROMED CAST BASKET, 1½" VOICE COIL, 120 WATT, 3-WAY CAR SPEAKER...



### COMPARISON CHART — TRUSONIC VS. COMPETITION

| FEATURE           | TRUSONIC | WELL KNOWN COMPETITOR | BENEFIT  | FEATURE       | TRUSONIC  | WELL KNOWN COMPETITOR                    | BENEFIT  |
|-------------------|----------|-----------------------|--|---------------|---|--|--|
| Die Cast Frame    | Yes      | No                    | Cannot warp or bend due to heat or vibration.  | Power *20 oz. | 40 RMS<br>80 Peak<br>60 RMS<br>120 Peak                             | *30 RMS<br>80 Peak<br>not made           | Heavier magnet structure materials coupled with an over hung voice coil increases linearity at high power levels and enhances the bass frequency reproduction thus minimizing distortion.                      |
| Chrome Plate      | Yes      | No                    | Chrome plating in conjunction with die cast construction prevents rust.                      | Response:     | 20 oz. 5" x 7" coax<br>20 oz. 6" x 9" 3-way<br>40 oz. 6" x 9" 3-way | 50/15,000 Hz<br>40/20,000 Hz<br>not made | The selection of totally solid state mid-range and tweeter elements produces superior sound in the 2,000 Hz range and beyond. Superior magnets and 50% larger voice coils provide greater low end performance. |
| Bi-Amp Capability | Yes      | No                    | Permits hook up to the newer, more powerful dual output automotive systems being introduced. | Warranty      | 5 Years   | 1 Year                                   | Superior construction and design insures years of flawless performance without material or sound deterioration.  |
| Waterproof        | Yes      | No                    | Completely waterproof design is necessary for marine and outdoor use.                        | Price*        | *\$60.00  | *\$55.95                                 | Great performance at a comparable price.   |
| Voice Coil        | 1½"      | 1"                    | 50% larger voice coil handles greater power and reduces distortion.                          |               |   |  |  |
| Utilized Magnet   | Yes      | No                    | Offers 1.6 times more energy than stacked magnets. This permits higher efficiency.           |               |   |  |  |

**ALL TRUSONIC CAR STEREO, MUSICAL INSTRUMENT, AND HI-FI SPEAKERS, ARE MANUFACTURED IN U.S.A.**



## SAE gives you more pre-amp:

If you're looking at pre-amps, you're looking at three things: performance, flexibility and construction.

You're trying to get the most of all three. It's as simple as that.

Why look at SAE? It's as simple as this:

**Two-stage phono circuit.** (All models.) By dividing amplification into two stages, we are able to utilize passive high-frequency equalization.

This dramatically reduces high-frequency feedback, by 20dB in fact, as well as the resulting transient intermodulation distortion (TIM). The audible effect is a greater definition of sound, increased clarity.

**Tape facilities.** (All models.) Take the unique Tape EQ: Now you can modify the recorded sound to suit your personal tastes by switching parametric or tone control circuits between selected input (phono, tape, aux.) and recorder circuits.

**Parametric equalizers.** Providing virtually complete control over bandwidth, center frequency and cut or boost, our parametrics provide greater flexibility and a wider variety of effects than any conventional system has ever offered. (2100 and 2900 models.)

**"Superchip."** We took the integrated circuit out of instrumentation and into audio. Even at full output, our state-of-the-art superchip provides super-low distortion (<0.005%), super-high slew rate (>V/ $\mu$  sec) and excellent transient response. (2100 and 2100L models.)

We make our pre-amps exactly the same way we make our amps, tuners, equalizers, everything. By hand. With the finest materials money can buy and the greatest care money can't buy.

But the most important feature in every SAE pre-amp is sound. It's the only reason we do everything we do. It has greater clarity, finer accuracy, and a more vivid sense of dimensionality.

It had better. It has one other very important feature to live up to: Its name: SAE.

## SAE gives you more pre-amps:



2100 parametric pre-amplifier  
0.005% THD and IM. \$950\*



2100 pre-amplifier with LED display  
0.005% THD and IM. \$800\*



2900 parametric pre-amplifier  
0.01% THD and IM. \$500\*



3000 pre-amplifier with  
3-band tone control.  
0.02% THD and IM. \$300\*

### Write for more.

Name \_\_\_\_\_

Address \_\_\_\_\_

City \_\_\_\_\_ State \_\_\_\_\_ Zip \_\_\_\_\_

Send To: SAE, P.O. Box 60271, Terminal Annex,  
Los Angeles, California 90060

# SAE

Scientific Audio Electronics, Inc.

Enter No. 29 on Reader Service Card

\*Nationally advertised value,  
actual retail prices are  
established by SAE Dealers.

# Listen,



**If you haven't heard the PPA-1, you haven't heard your moving-coil cartridge. Audition the Marcof PPA-1 Pre-preamplifier at one of these fine audio dealers.**

Absolute Audio, Santa Ana, CA  
 American Audiophile, Valley Stream, NY  
 Audio Difference, Palo Alto, CA  
 Audio Alternative, Fort Collins, CO  
 Audio Alternative, Portland, OR  
 Audio Cage, Sacramento, CA  
 Audio Climax, Metairie, LA  
 Audiocom, Old Greenwich, CT  
 Audio Connection, Muskegon, MI  
 Audio Consultants, Evanston, IL  
 Audio Directions, San Diego, CA  
 Audio Emporium, Milwaukee, WI  
 Audio Excellence, Longwood, FL  
 Audio Excellence, San Francisco, CA  
 Audio Forum, Watertown, MA  
 Audio House, Swartz Creek, MI  
 Audio Ltd., Champaign, IL  
 Audio Odyssey, Davenport, IA  
 Audio Perfection, Bloomington, MN  
 Audio Vision, Dallas, TX  
 Audioworks, Harrisburg, PA  
 Chestnut Hill Audio, Philadelphia, PA  
 CSA, Fairfield, NJ  
 Creative Audio, Columbia, MO  
 David Beatty, Kansas City, MO  
 Eardrum, Nanuet, NY  
 Ecologic Ear, Des Moines, IA  
 Golden Gramophone, Akron, OH  
 Golden Ear, Black Hawk, CO  
 Harbor Sound, New London, CT  
 Havens & Hardesty, Huntington Beach, CA  
 Hi-Fi Express, Miami Beach, FL  
 Hi-Fi Haven, Brunswick, NJ  
 House of Stereo, Jacksonville, FL  
 Innovative Audio, Brooklyn, NY  
 Kief's Gramophone Shop, Lawrence, KS  
 Linear Sound, New York, NY  
 Listening Post, Tempe, AR  
 Listening Room, Scarsdale, NY  
 Listen Up! Audiosystems, Denver, CO  
 Music & Sound, Woodlawn Hills, CA  
 Myer TV & Audio, Edwardsville, IL  
 Natural Sound, Framingham, MA  
 Needle In A Haystack, Washington, D.C.  
 Ovation Audio, Pittsburgh, PA  
 Paragon of Sound, Bethesda, MD  
 Paul Heath Audio, Rochester, NY  
 Perfectionist Audio, Pleasant Gap, PA  
 Reference Audio, Gardena, CA  
 Sights & Sounds, Chicago Heights, IL  
 S K Audio, No. Lindenhurst, NY  
 Sound by Singer, New York, NY  
 Speaker Craft, Webster Groves, MO  
 Stereo Shoppe, Boise, ID  
 Wilson Audio, New Orleans, LA

Exclusive Canadian distributor:  
**Trans Audio Marketing**

**ME Marcof  
 Electronics**

7509 Big Bend Blvd.,  
 Webster Groves, MO 63119

Enter No. 16 on Reader Service Card

of bias (cost) and splitting/normal (music listening) factors can now set up another trigger condition. A good salesperson can pull the butterfly trigger by letting a customer know that demand for the product has so thoroughly outpaced deliveries that this demonstrator model is the last one in stock. Desire catastrophe! Pull out the checkbook! What salesperson could be cruel enough to turn down the tearful request of a customer who wants to take home the prize of his desire. This particular ploy also sidetracks any further opportunity for a cooling-off period, so beware.

## Approximate C. T.

The foregoing analysis applies when there are four distinct, identifiable factors and one response. One's own personal emotions, when considering purchase of an audio component, may involve more than four factors, and there may, indeed, be several responses which those factors elicit. In setting up an example which illustrates the application of Catastrophe Theory to audio, I have chosen what I consider to be the most significant factors and have tried to relate them to the mathematical terms to which they most nearly correspond.

It is my opinion that, at this time, the most important use we can make of Catastrophe Theory is to uncover trends in response under the influence of conflicting factors. When there are many factors, but four of them are dominant and relate to each other as does the normal, splitting, bias, and butterfly factors, and when there is one dominant response, we can use Catastrophe Theory to determine the *most likely* behavior. The influence of other, less dominant, factors will not change major aspects of the probable behavior, but will color the details of that response.

While not explicitly stated in most technical discussions of Catastrophe Theory, one can often simplify the analysis of a problem by reducing the dimensionality to that of the most dominant behavior space. For example, if there are 10 apparent factors, but only four of them stand out as dominant, then the situation can be reasonably approximated by the butterfly catastrophe. If, in turn, two of these four factors are considerably more important under a given set of circumstances, then we can resort to the cusp catastrophe.

The reason I suggest we use this simplification wherever possible (which I personally call "approximate catastrophe theory") is because of the

enormous increase in detail complexity which occurs with rise in dimensionality. It simply gets out of hand and we may tend to lose the forest (general trends) for the trees (fine details).

When there are two responses, the type of catastrophe maps which are involved produce hypersurfaces which Thom calls "umbilics." Within Elementary Catastrophe Theory there are six umbilic catastrophes, ranked according to dimensionality of the behavior space. Time does not permit us to discuss the application of umbilic catastrophes to audio, although there are several of these and, perhaps, at a much later date we can discuss them.

## Mathematics of Emotion

In this discussion we have essentially been considering a mathematics of human emotion. Improperly used, such a theory could cause considerable mischief; however, one of the quickest ways to defuse this potential weapon is to be aware of its existence. That, in part, is why I have not hesitated to discuss what might otherwise be considered a touchy subject.

Computer-programmed advertising campaigns, or, for that matter, political campaigns, may not be very far off. As a consequence we must be aware that any assault on our pocketbook must begin with a play on our emotions. That is the game, and we all play it. And as long as we all understand the rules, the match is balanced and the game is fair.

Up to now each of us has had to learn the rules by experience, either our own or what we observe from others. Now, a weird, far-out, abstract mathematics has come into existence which, while not originally developed for that purpose, seems to model some of the primal rules of human emotion. As a service to the readers of *Audio*, I believe it is better to point out the existence of this new game plan and to let you know what might be coming, than to suppress the knowledge in hope that overzealous advertisers would never find out about it.

On a more pleasant note (that is, less sinister) we can now begin to appreciate the part that human emotion can play in our judgment of the subjective listening quality of audio components. All of us, I am sure, have experienced the situation where we "liked" the performance of a particular component one time, then something happened and we "didn't like" the same component when we heard it again. Perhaps we learned something which caused us to change our minds.



It is only human; a new factor was introduced. But the component did not change — the measured technical performance did not change — we changed. Or, more properly, our response changed.

In light of what we have been discussing, this does not seem so mysterious. Yet think how capricious this might seem to a technically oriented "flatlander" who found that nothing had changed in the technical performance of that component.

The investigation of these delights and other properties of perception are yet to come. They can be the subject of a future discussion.

### Subjective Impressions

The final point I would like to discuss in this three-part series involves the reason I am personally interested in Thom's geometric theory. The intangibles of audio include perception, cognition, and valuation. Perhaps with Catastrophe Theory we can, for the first time, begin to understand how one's personal subjective impressions of quality can be linked to conflicting circumstance.

We can begin to realize that it is not inconsistent for us to "like" something one time, then "not like" it another time, even under seemingly identical conditions. It is not where we are, that determines the intensity of our emotions, but *how we got there*.

The old complaint "why can't someone measure what I hear?" now takes on a different tone. We can "measure" under stable conditions, but that may not be sufficient for the determination of subjective valuation. Education, knowledge, experience, and training are factors involved in subjective valuation. It is often said that we can hear with different ears. It now appears that this is quite true.

We can be fooled into perceiving one thing while actually being subjected to something else. The stage artistry of a master illusionist can make us "see" things contrary to reality, such as flowers from thin air or a person sawed in half and then reassembled in front of us. Similar artistry can allow a ventriloquist to "project" a voice so that we "hear" it coming from an impossible location. And even as early as the 1920s a live vs. reproduced experiment was conducted in which an audience was substantially unable to distinguish whether the sound they heard coming from a stage was that of a live performer, whom they could see, or the playback of that performer from an Edison acoustic phonograph. The perceived sense of reality in all such

cases is an illusion supported by factors other than those of the principal sensory organ which is involved.

So, too, it is in this present business of audio reproduction. It is not reality, but the illusion of reality which the present audio industry depends upon. We must perceive an acceptable illusion in order to have any success in so-called high fidelity reproduction.

The type of analysis embodied in Catastrophe Theory might begin to address this very important audio problem from a new direction. We can begin to look at the human process of perception, cognition, and evaluation as responses under sets of factors, some of which may be conflicting. We might also begin inquiry into a very important problem in present audio, namely, what are those factors necessary to support an acceptable illusion?

It is not a retreat either from reality or from technology to accept the existence of human emotion. Nor should technology ignore the role played by emotional response in establishing the quality of the listening experience.

Returning to the theme we discussed in the first part of this three-part series, those of us who pursue endless quests of measuring vanishingly smaller amounts of system distortion for sine-wave and square-wave signals are scrambling around under the wrong lamppost. The wrong lamppost, that is, if we want to correlate such measurements with subjective quality. It is the wrong place to look for two reasons: First, those distortion measurements are derived from linear theory and are, at best, on shaky ground; second, such measurements take no cognizance whatsoever of the intangibles of the listening experience. The light is not so bright and cheery when we walk into the bushes and search for audio truth with nonlinear tools.

Catastrophe Theory is one of those newly evolving mathematical tools which show promise of being able to provide us with a framework for handling those types of distortions, either real or imagined, which lead to instability of perceived form. It can score the most heavily in those situations poorest handled by linear methods. I really do not know whether Catastrophe Theory can be of any lasting value in our understanding of the dilemma of perception. But we will never find out until we give it a try.  $\Delta$

### Reference

1. T. S. Kuhn, *The Structure of Scientific Revolutions*, The University of Chicago Press, Chicago, 1970.

# McIntosh

## "A Technological Masterpiece ..."



McIntosh C 32

### "More Than a Preamplifier"

McIntosh has received peerless acclaim from prominent product testing laboratories and outstanding international recognition! You can learn why the "more than a preamplifier" C 32 has been selected for these unique honors.

Send us your name and address and we'll send you the complete product reviews and data on all McIntosh products, copies of the international awards, and a North American FM directory. You will understand why McIntosh product research and development always has the appearance and technological look to the future.

Keep up to date.  
Send now - - -

McIntosh Laboratory Inc.  
Box 96 East Side Station  
Binghamton, NY 13904

Name \_\_\_\_\_

Address \_\_\_\_\_

City \_\_\_\_\_ State \_\_\_\_\_ Zip \_\_\_\_\_

If you are in a hurry for your catalog please send the coupon to McIntosh. For non-rush service send the Reader Service Card to the magazine.

Enter No. 18 on Reader Service Card



# BUILD A HEADPHONE AMP

Walter G. Jung\*

Although IC op.amps are extremely useful in audio applications because of their high gain, small size, low cost, and general versatility, most of them are not capable of delivering more than a few milliwatts of power to a load. The standard  $\pm 10$  V output swing into the rated 2-kilohm load represents only about 25 mW of power, which is quite modest. Audio applications that require greater power often demand voltages and currents far in excess of what the standard op amp can deliver. For some of these applications, specialized IC types can be used, but, in general, some means of increasing both the output voltage swing and the output current capability is necessary in order to take full advantage of the high-gain properties of IC op amps. Here we will examine a power application for a simple one-watt headphone driver.

Virtually any standard op amp can be used to drive a

single set of high-impedance (2-kilohm) headphones at a 25 mW level. All that is necessary is to select a suitable configuration and provide the required gain. The IC type can be chosen almost from convenience or personal preference, since most types can deliver 25 mW into 2 kilohms.

However, when a number of high-impedance headphones (or a smaller number of low-impedance types) are to be driven, the power requirements exceed the output capabilities of the standard op-amp types.

One type that is ideally suited for this application is the 540 power driver which has a 150 mA, 1.0 W output capability. A circuit incorporating the 540 for this application is shown in Fig. 1. In this circuit, the 540 is operated as a variable-gain amplifier with maximum gains of either 30 or 40 dB, selected by the user by

choosing the appropriate components from the

\*Adapted from "Audio IC Op-Amp Applications" (Cat. No. 21558) by Walter G. Jung ©1978 by Howard W. Sams & Co., Inc. See Audio's book ad at the beginning of the classified section.

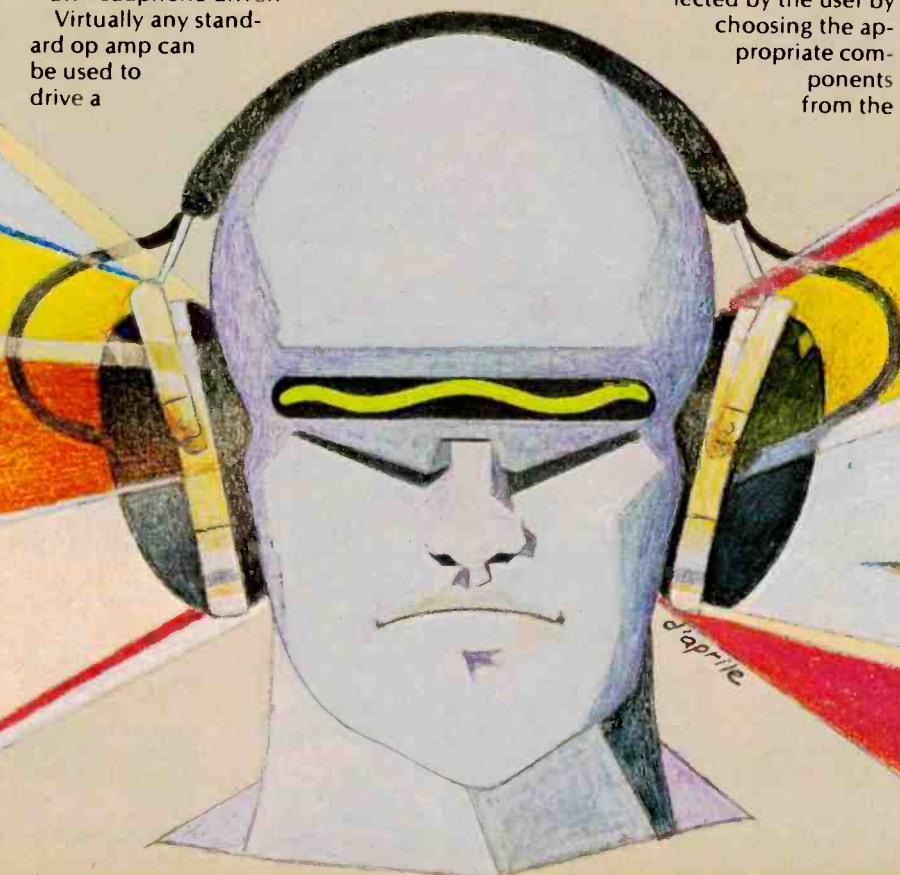





## The Concorde.

The reason for its name is obvious. Less apparent is that the Concorde launches a new era in the reproduction of sound from records. A strong claim, but true.

Consider. The weight or mass of your phono cartridge as well as the "headshell" of the tonearm in which it is installed, is a most decisive factor in record wear and distortion.

Although the new Ortofon Concorde (shown actual size) combines a cartridge *and* headshell within a single form, it weighs less than most headshells alone! And since only low mass can respond adequately to record warp, the Concorde offers the best way to track every record — even those that are badly warped.

What about the cartridge of the Concorde? First, it weighs 1.5 grams.

That's 1.5 grams!

Second, the cartridge operates on the variable magnetic shunt (VMS) principle. This patented system provides high separation and astonishingly low distortion (less than 1%!).

That's less than 1%!

Quite obviously, the VMS design and unparalleled low mass, places Ortofon at the frontier of cartridge technology. The dividends it offers to those who love music and struggle to protect their records is incalculable.

We suggest that you contact us for complete information about the Concorde.

From Ortofon, 122 Dupont St.,  
Plainview, N.Y. 11803.

ortofon 

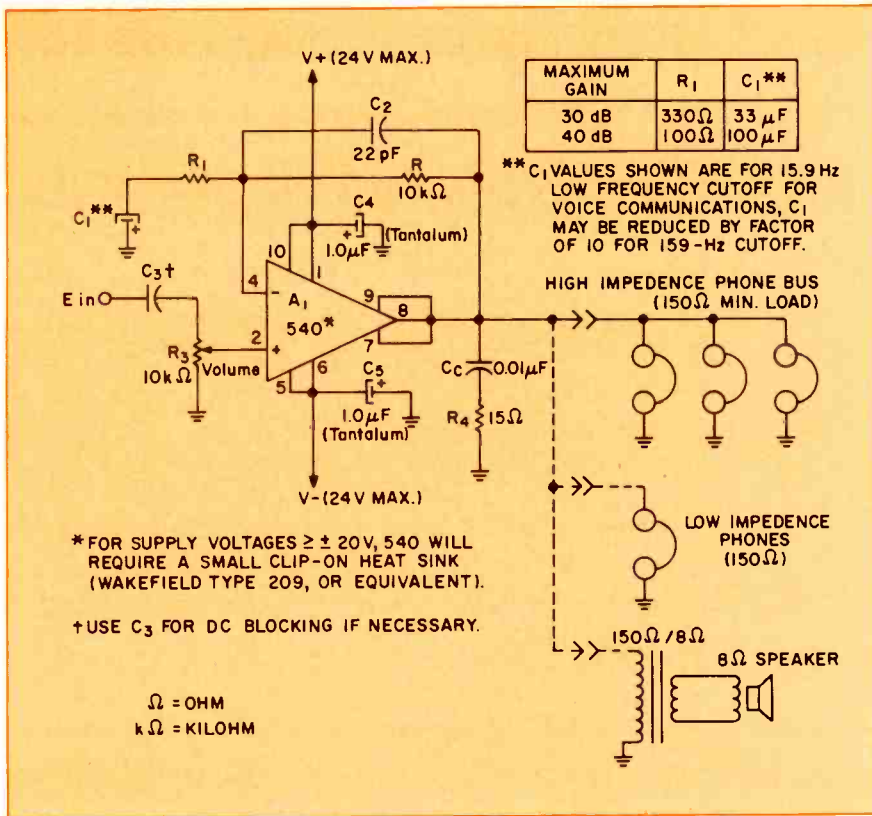

Fig. 1—One-watt headphone driver using the 540 op amp.

tabulated values given in Fig. 1. The output level is adjusted with volume control R<sub>3</sub>, which controls the input level to the 540.

Due to the wide power-supply operating capability of the 540, there is a wide range of maximum output levels available from the circuit in Fig. 1. With ±24 V supplies, for example, the 540 will deliver 1.0 W into a 150-ohm load, such as might be represented by a set of 150-ohm headphones, a parallel network of high-impedance headphones, or a transformer-driven 8-ohm speaker. This circuit has a variety of uses such as a multiple-headphone intercom system, high-fidelity headphones, studio cueing amplifier, etc. The total harmonic distortion (THD) is less than 1.0 percent, even at maximum output. At lower output levels and also with load impedances higher than 150 ohms, the distortion reduces proportionally. If the 540 is operated at supply voltages of ±20 V or above, a clip-on heat sink, such as the Wakefield Type 209 (or equivalent), should be used. Also, since the 540 is a wide-bandwidth device, a compact layout with bypassed power-supply leads is recommended. Other possible alternatives for a headphone driver are the 759, 791, or 5534 devices. ▲

# High technology lowers the price of high performance.

## Introducing the new MP cartridge by Osawa.

With innovative engineering, Osawa has made superior cartridge performance affordable.

In the new MP cartridges, Osawa uses Permalloy to modulate the magnetic field generated by a cobalt magnet. This unique, lightweight, high-output combination ensures high signal-to-noise ratio and a freely moving stylus for perfect tracking of highly modulated grooves. You get clarity, frequency response and a dynamic range that only the most expensive cartridges can match.



The cantilever is perfectly formed (and made of carbon fiber in our top 300MP model) for high strength, low mass and uniform frequency transmission. It's supported in a special "Butyl" synthetic rubber damper to provide just enough restraint to keep the tip in the groove. Butyl is virtually unaffected by temperature and humidity, so your music won't change with the seasons.

The new Osawa MP cartridges are priced from \$35 and up. So there's one for every budget. Each is available unmounted or conveniently pre-mounted in the unique Osawa Universal Head Shell. Visit your Osawa dealer for a complete demonstration. When you hear the MP perform, you won't believe the price.

Be sure to ask your dealer for a free copy of Osawa's "Consumer Guide to Phono Cartridges." Or write directly to us.

**OSAWA**

OSAWA & CO. (USA) INC./521 Fifth Avenue  
New York, N.Y. 10017/(212) 687-5535-9/TELEX: 236593





# Scotch® Recording Tape... it sounds like money well spent.

To get the best out of your expensive cassette system, nothing but the best will do. The little extra you pay for a Scotch® Master™ Cassette is *truly* money well spent—because nobody delivers a truer, clearer sound.

The Scotch Master Series offers three totally different oxide formulations, each designed for a specific bias/EQ switch position.

Our Master I Cassette is for normal bias recording. It features excellent dynamic range, low distortion, uniform high frequency sensitivity and output that's 10 dB more than standard tapes. Our Master II Cassette is for

chrome-equivalent bias recording (70 microsecond equalization). It gives a 3 dB better signal-to-noise ratio at low and high frequencies than chrome cassettes. Our Master III Cassette is a ferri-chrome formulation (FeCr) with a 3 dB output improvement at low frequencies and 2 dB at high frequencies.

All three tapes are housed in transparent shells and equipped with precision guidance systems. Technology this advanced doesn't come cheap. But when you hear how magnificently the Scotch Master Series lets the truth come out, you'll agree that for the slightly higher price—you've got something priceless.

Scotch® Recording Tape. The truth comes out.

**3M**

Enter No. 15 on Reader Service Card

EXCLUSIVE  
TEST

# Equipment profiles

Stanton Permostat Anti-Static Record Treatment

Price: \$19.95.

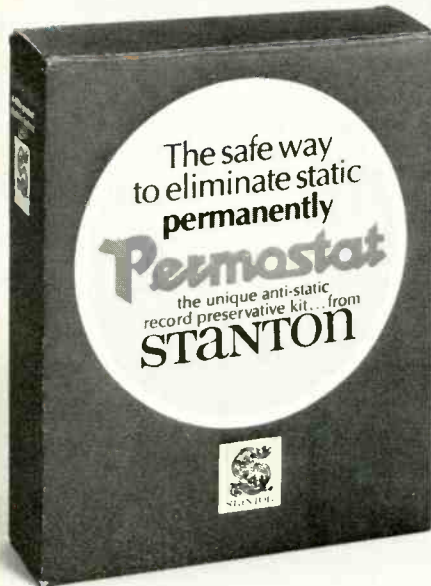

In the past year or so, we have literally been deluged with record-care products. It would seem that almost all at once the record-playing public has become aware of the importance of keeping records clean, dust free, properly stored and, if possible, free of static charges. Nor have record-care products been confined to items intended for application to the record itself. Now there are cleaning kits for styli, timers which are designed to tell you when your diamond stylus may be ready for replacement, and many more.

There was a time when audio enthusiasts weren't even aware of the problems connected with static charges on a record. That was in the days of shellac records, which have long been superseded by polyvinyl chloride pressings. PVC records are a highly insulating material and are therefore very susceptible to static charges, particularly through frictional contact. Charges of as high as 20,000 volts and more have been measured on the surfaces of highly polished records.

Such static charges tend to draw free-floating dust particles onto the record where they can be pushed around or even "welded" into the record grooves by the heat and pressure generated by the stylus, causing increased record wear, noise, and distortion. A highly charged record surface can also cause uneven attraction of the cartridge itself, altering vertical-tracking angle and stylus-tracking force which, in extreme cases can even increase wow and flutter. Discharges of static via the stylus to ground can also result in audible pops and clicks during record playing.

Over the past few years there have been several products made available which have as their sole purpose the elimination of static charges on a record surface. We have seen ion guns that resemble futuristic space weapons, conductive

turntable mats, liquids which in addition to cleaning and reducing friction in record grooves also have anti-static additives; you name it.

Now, Stanton Magnetics has begun to market a product called Permostat. Originally developed by Milty Products Co. in Great Britain, claims for the product are that it "totally and

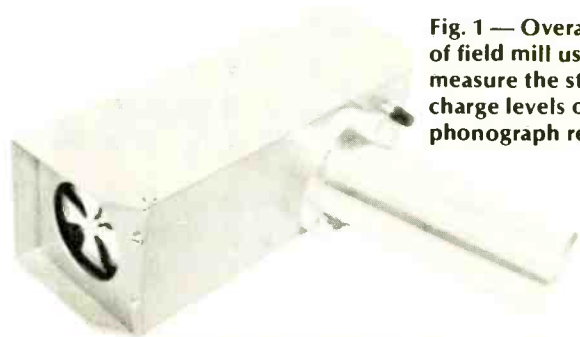

Fig. 1 — Overall view of field mill used to measure the static charge levels on phonograph records.



Fig. 2 — Meter on rear of field mill test instrument reads directly in volts/cm and also indicates polarity of the static charge.



permanently eliminates static for the normal considered record life expectancy without any detectable change in sound quality, surface noise, frequency response, or fidelity." That's quite a statement, and if it were not for the fact that the product is being sold in this country by as reputable and well known a manufacturer as Stanton, we might well have dismissed the claim (and the product) out of hand.

The product, Permostat, consists of a 3-ounce bottle of clear fluid and a felt-like buffing pad. The bottle containing the fluid is capped with a finger pump arrangement which, when depressed, forces a fine spray of liquid from its nozzle. Instructions indicate that approximately 8 to 10 sprays will cover one side of an LP record. Of course, *both* sides of a disc must be fully treated in order for Permostat to be effective. Based upon these requirements, the fluid supplied should be enough to treat between 25 and 30 12-in. LPs. The velvet pad is used to buff the surface of the record until it is shiny. Once the record is treated and buffed on both sides, the makers say that it can be played immediately. Identifying self-adhesive tabs are supplied with the kit so that treated records can be identified.

### Testing The Product

There were three areas of testing which we decided to pursue. First and foremost, we wanted to determine whether the claims for "permanent" destaticizing of a record through the application of Permostat were true. Next, we wanted to determine whether the application of this fluid would in any measurable way degrade audible performance of records. Finally, we wanted to do some careful listening to records before treatment, after treatment, and after repeated playings for a subjective comparison.

### Measuring Static Charge

Measurement of static charges were made using a precision-built, hand-held integrated field mill specially designed and developed for measuring static charges on insulating surfaces. The battery-powered instrument, made by Industrial Development, Bangor, North Wales, U.K., is pictured in Fig. 1. This field mill, in addition to quantifying static charge in volts/centimeter also indicates whether a charge is negative or positive. A close up of the control and meter portion of the instrument (at the rear of the device) is shown in Fig. 2. Three ranges of meter sensitivity are provided, making it possible to read all the way to "zero volts" and up to 10,000 volts. Readings on the meter are then multiplied by the distance between the sensing end of the instrument and the surface whose charge is being measured. For example, if the meter reads 3,000 volts and the sensing rotors are 4 centimeters from the surface being measured, the static charge on the surface has an amplitude of 12,000 volts.

### Test Records

We used two identical copies of CBS Test Record STR-130 for measuring the effective charge on a PVC disc with and without Permostat treatment and for determining the effect, if any, on frequency response, noise, and distortion when Permostat is applied.

The test record chosen contains spot frequencies from 20 kHz down to 20 Hz with identifying voice announcements. A reference 1-kHz tone is also included, followed by a long leadout groove (silent) which was used to determine initial distortion and surface-noise levels and those same parameters after 100 playings. The 29 spot frequencies were used to plot frequency response for an untreated and a treated disc during mint-condition playing and after 100 playings.

Figure 3 is a plot of frequency response for the untreated record during its first playing (solid curve) and after 100 playings using an elliptical stylus with a downward tracking force

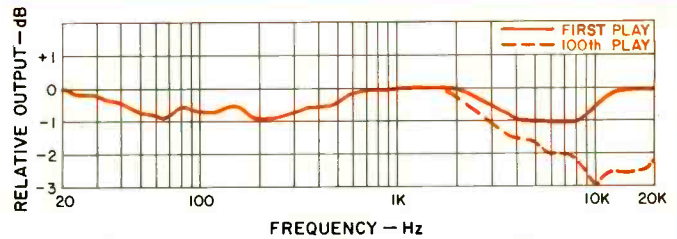

Fig. 3 — Frequency response of untreated test record during first play and after 100 playings.

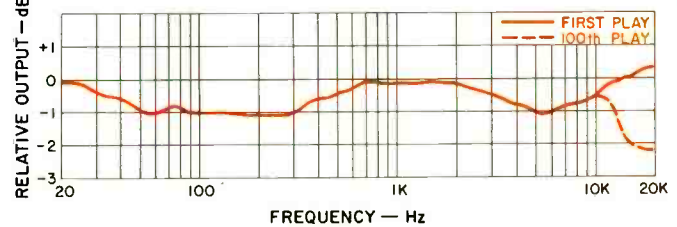

Fig. 4 — Frequency response of test record treated with Permostat during first play and after 100 playings.

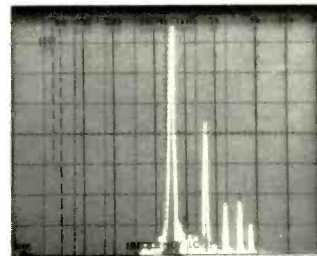

Fig. 5 — Spectrum analysis of 1-kHz signal from untreated record after first playing.

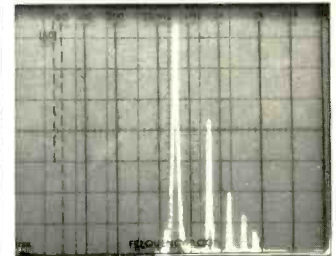

Fig. 6 — Spectrum analysis of 1-kHz signal from untreated test record after 100 playings.

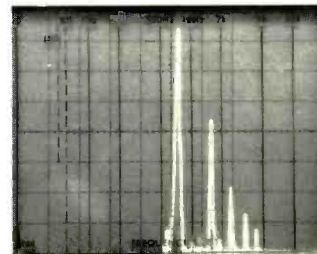

Fig. 7 — Spectrum analysis of 1-kHz signal from Permostat-treated test record after first playing.

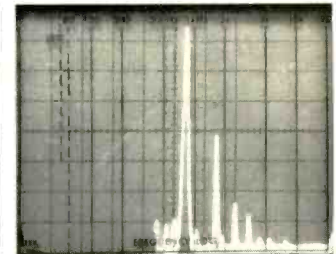

Fig. 8 — Spectrum analysis of 1-kHz signal from Permostat-treated test record after 100 playings.

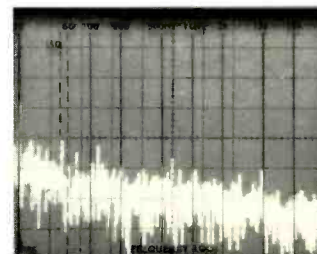

Fig. 9 — Spectrum analysis of surface noise content in "silent groove" portion of untreated test record during first play.

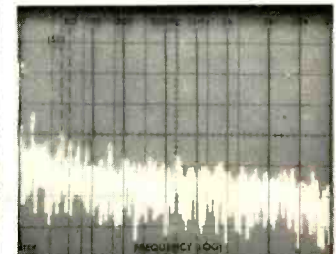
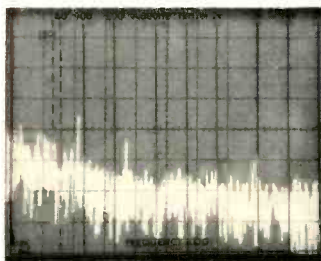
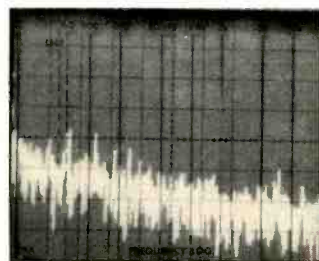

Fig. 10 — Spectrum analysis of surface noise content of "silent groove" portion of untreated test record after 100 playings.

**Fig. 11 — Spectrum analysis of surface noise content in "silent groove" portion of Permostat-treated record during first play.**



**Fig. 12 — Spectrum analysis of surface noise content in "silent groove" portion of Permostat-treated test record after 100 playings.**



of 1.5 grams. The amplitude scale of the graph has been deliberately expanded to show minute changes in response. Clearly, for the untreated record, some deterioration in high-frequency response has occurred. A second record, treated with Permostat, was also measured and plotted during its first playing and after 100 plays. As shown in Fig. 4, considerably less loss of high frequencies has occurred in the case of this treated record.

During the 100 plays of both the untreated and treated discs, measurements were made periodically to determine static charge level on each disc. At the conclusion of the tests, each disc was rather violently rubbed with a silk handkerchief to induce static charge, measured with the field mill, are summarized in Table I. They dramatically confirm the claims made for Stanton Permostat, at least on a

short-term basis (the 100 playings were done consecutively, over a period of no more than two or three days).

### Harmonic Distortion Measurements

Next, using the 1000-Hz reference tone on Test Record STR-130, we applied the output of a connected equalizer/preamplifier to our spectrum analyzer. Figure 5 displays results obtained with the first playing of the untreated disc. The tall spike in this and all subsequent scope photos represents the desired 1-kHz fundamental. The next spike to the right represents second-order distortion and is largely a function of tonearm/cartridge geometry. Of interest in our tests were the higher order distortion products; 3rd-, 4th-, and 5th-order components are visible in Fig. 5. Analysis of distortion was repeated after 100 playings of the untreated disc, and results are shown in Fig. 6. Note that 3rd-order distortion has risen noticeably after 100 plays (scale is 10 dB per vertical division).

Similar tests were analyzed with the treated disc. Figure 7 shows harmonic distortion content during first playing of the treated disc, while Fig. 8 displays the results obtained for the treated disc after 100 playings. If anything, the 3rd-order distortion has actually gotten somewhat lower after repeated playing. Certainly, overall THD has not increased after 100 playings of the treated disc.

### Surface Noise Tests

Employing much the same technique, we analyzed surface noise content for the untreated and treated records, both during initial playing and after 100 plays, by employing the silent-groove portion of the test record. Figure 9 shows the noise distribution vs. frequency observed during the first

**Fig. 13 — Magnified view of single groove of untreated record after 100 playings.**



**Fig. 14 — Magnified view of single groove of Permostat-treated record after 100 playings.**





playing of the untreated disc. Figure 10 shows noise distribution in the same disc after 100 plays. Note that at the right-hand portion of the sweep (higher frequencies), noise content has increased significantly.

Figure 11 shows noise distribution in the audio range for the treated disc, during its first playing, while Fig. 12 shows noise distribution in that same disc after it was played 100 times. Clearly, there has been no increase in average noise content in any portion of the audio spectrum.

### Subjective Listening Tests

In addition to treating the test records, we also experimented with a few commercially available direct-to-disc records, among them **Big Band Jazz** and **Efrem Zimbalist, Father & Son**, both distributed under the Umbrella Label (UMB-DD4 and UMB-DD3), **Tricentennial of Vivaldi** (Sonic Arts Lab Series), and **David Montgomery: The Piano** (Sonic Arts). These were first played in mint, untreated condition and were then treated with Stanton's Permostat. Again, treated records exhibited no measurable charge when measured with the field mill, even after several playings, insertions into and withdrawal from record sleeves, and repeated attempts to induce a charge artificially. More importantly we could detect no difference when comparing playback of these discs with playback of an additional copy of each disc that had not been treated with Permostat.

It has now been several weeks since we measured the static charge on the treated and untreated test records and on the musical records we auditioned for the tests. To date, the treated records still exhibit no measurable static charge nor can a voltage charge be induced upon their surfaces deliberately. While I have no knowledge whatever of what "magic"

**Table I: Average Static Charge Measured on Disc Surfaces.**

|   | Untreated Disc | Disc Treated With Permostat |
|---|----------------|-----------------------------|
| Upon Removal from Sleeve (Both Discs Untreated) ..... | 4800 volts     | 4500 volts                  |
| First Play Following Treatment .....                  | N/A            | 0 volts                     |
| After 25 Playings .....                               | 4400 volts     | 0 volts                     |
| After 50 Playings .....                               | 8000 volts     | 0 volts                     |
| After 75 Playings .....                               | 6000 volts     | 0 volts                     |
| After 100 Playings .....                              | 7000 volts     | 0 volts                     |
| After Rubbing .....                                   | 13,500 volts   | 0 volts                     |

substance is contained in the clear liquid we applied, I can say without reservation that the stuff works, as claimed, and that based upon our tests, it does not degrade sound quality of records that have been treated with it.

In discussing my results with the folks at Stanton, I asked them whether they had been able to verify Permostat's effect on record grooves in a more direct manner than I had been able to do by my indirect measurements. I was aware that Stanton Magnetics owned an electronic microscope by means of which they could examine and photograph record grooves at tremendous magnification levels. While I was perfectly content with my own test results and was ready to accept the fact that Permostat actually prevented record wear in addition to providing permanent anti-static qualities, it is one thing to ascertain these qualities by indirect analysis and quite another to be able to examine "before and after" photos of the record grooves themselves. Accepting the chal-

# SUPER SPECS!

It takes a lot to make a really special performer's microphone. A mike that's almost totally immune from feedback, even at earsplitting rock concert and disco levels. With 40-16,000 Hz response. Built-in pop and handling noise suppression. And more.

You need a mike that's built to take it, with solid metal housing and special internal shockmount. Plus a silent on-off switch, with a safety feature to prevent accidental turnoff.

We have it, and it's called the MD 431. You'll call it super.

## SENNHEISER

ELECTRONIC CORPORATION  
10 West 37th Street, New York 10018 (212) 239-0190  
Manufacturing Plant: Bissendorf/Hannover, West Germany  
©1979, Sennheiser Electronic Corporation (N.Y.)



Enter No. 31 on Reader Service Card

lenge, George Alexandrovich, an engineer with Stanton, supplied me with two photos, reproduced here in Figs. 13 and 14. Figure 13 is a photo of one record groove (magnified 5000 times) taken of an untreated record that had been played 100 times with an elliptical stylus at 3 grams vertical tracking force, using a Stanton 680 SE stylus. No anti-skating force was applied, and you can clearly see greater groove wear on the left wall than on the right.

Contrast this with Fig. 14, a photo of one groove of a Permostat treated record that had been played the same 100 times with the same vertical tracking force, and you have

ample proof of the wear-retarding qualities of Permostat. Needless to say, I am most envious of Stanton Magnetics. If I had access to that electron microscope I could have saved myself weeks of tedious work and drawn the same conclusions simply by examining this pair of photos. I was, however, gratified to find that my results, however crude by comparison, were confirmed by these pictures.

To conclude this report, I decided to pull out that treated test record once again (it is now four months since the disc was treated) and measure static charge for the last time. It still measures "zero volts"!

Leonard Feldman

Enter No. 100 on Reader Service Card

## Nikko Gamma I Stereo FM Tuner



### MANUFACTURER'S SPECIFICATIONS

**Usable Sensitivity:** 10.3 dBf (1.8  $\mu$ V).  
**50-dB Quieting Sensitivity (Mono/Stereo):** 14 dBf/34 dBf.  
**S/N (Mono/Stereo):** 78 dB/ 75 dB.  
**THD at 1 kHz:** Mono, Wide/Narrow, 0.04 percent/0.08 percent; Stereo, Wide/Narrow, 0.06 percent/0.2 percent.  
**Frequency Response:** 30 Hz to 15 kHz, +0.4, -0.8 dB.

**Capture Ratio (Wide/Narrow):** 1.0 dB/1.5 dB.

**Selectivity (Wide/Narrow):** 35 dB/85 dB.

**I.f., Image, and Spurious Response Rejection:** 110 dB.

**AM Suppression:** 60 dB.

**Stereo Separation at 1 kHz (Wide/Narrow):** 55 dB/45 dB.

**Stereo Separation from 50 Hz to 10 kHz (Wide/Narrow):** 40 dB/32 dB.

**Sub-Carrier Rejection Ratio:** 70 dB.

**Muting Threshold:** 10 dBf (1.74  $\mu$ V).

**Output Level (Variable):** 0 to 1.3 V at 1 kHz, 100 percent modulation.

**Output Level (Fixed):** 0.65 V at 1 kHz, 100 percent modulation.

**General Specifications**

**Power Requirements:** 120 V, 60 Hz, 18 watts.

**Dimensions:** 19-in. (48.3 cm) W x 2½-in. (6.4 cm) H x 10-in. (25.4 cm) D.

**Weight:** 12.1 lbs. (5.5 kg).

**Price:** \$399.95.

Nikko's Gamma I FM-only tuner is a rack-mountable unit which occupies only 2½ inches of vertical rack space. Its solid-looking front panel, finished in matte black anodized aluminum, features a large dark-colored cut-out area which houses a linearly calibrated FM frequency scale (with markings at every 0.5 MHz), signal-strength and center of channel tuning meters, and the usual stereo indicator light. The cut-out area is asymmetrically positioned on the front panel, as are the meters within the cutout area itself. To the right of

the dial area is a large flywheel-coupled tuning knob, while all remaining controls are positioned at the left end of the panel. These include a lever-switch for power turn *On*, a rotary output level control, and three pushbuttons for selection of wide or narrow i.f. mode, a high-frequency stereo-blend switch (for noise reduction when listening to weak-signal stereo), and a mode switch for selection of mono or stereo reception. This latter switch defeats the muting circuit when mono is selected and, conversely, the muting circuit is always engaged when the stereo mode is selected.

The rear panel of the Gamma I is equipped with the usual array of 75-ohm and 300-ohm antenna terminals with the 75-ohm input duplicated in the form of a standard coaxial connector. Variable as well as fixed output jacks are provided and just to their right is a 25/75 microsecond de-emphasis switch for those users who wish to equip their systems with an external Dolby FM adaptor. The rear panel also includes an FM detector output jack, as well as jacks for connection to the horizontal and vertical inputs of an oscilloscope for observation of multipath signals.

Virtually no information regarding the circuit design or approach was provided in the owner's manual, but a cursory examination of the internal construction of the unit revealed that the front end is equipped with dual-gate MOS-FETs and, of course, the availability of wide and narrow i.f. modes suggests a rather elaborate i.f. circuit design. The phase-lock loop approach is used in the stereo decoder section.

**Fig. 1 — Mono and stereo quieting and distortion characteristics in the wide i.f. mode.**

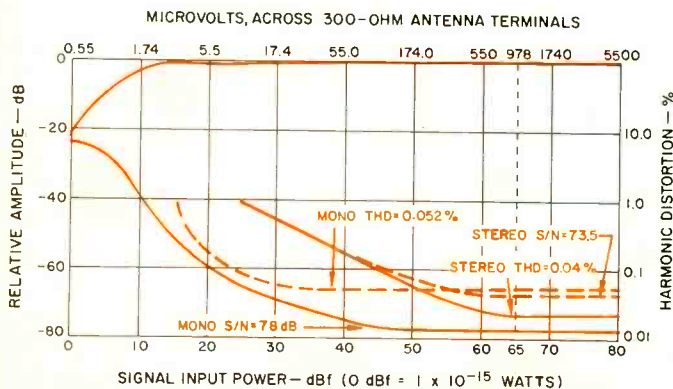



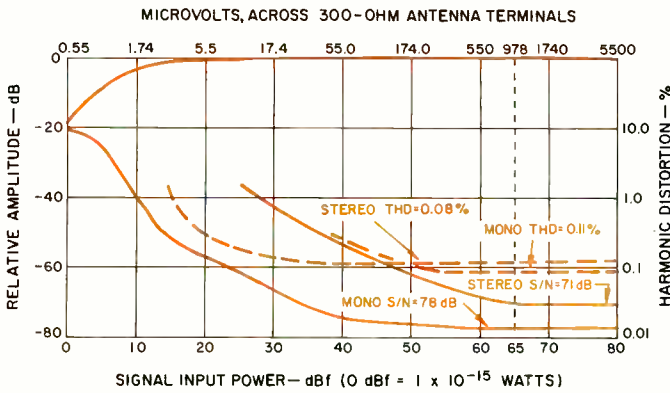

Fig. 2 — Mono and stereo quieting and distortion characteristics in the narrow i.f. mode.

Laboratory Measurements

Many of the performance measurements of the Gamma I (or, for that matter, of any tuner which boasts selectable i.f. bandwidth) had to be taken for each i.f. mode setting, since the change from narrow to wide i.f. mode alters the entire performance of the tuner.

In the wide mode, usable sensitivity measured 12.43 dBf (2.3 μV) in mono and 25.2 dBf (10.0 μV) in stereo. Switching to the narrow mode, usable sensitivity became somewhat poorer, as was to be expected, with a reading of 14.14 dBf (2.8 μV), while stereo usable sensitivity remained essentially unchanged. The 50-dB quieting point in mono (regardless of i.f. bandwidth setting) measured 14 dBf, exactly as claimed, but in the stereo mode, the 50-dB quieting signal strength was 35 dB (31 μV) for the wide position and an unusually high 45 dBf (97 μV) in the narrow setting.

The curves of Fig. 1 show mono and stereo quieting and distortion characteristics with increasing signal strength for a 1-kHz, 100-percent modulation signal. Distortion at 65 dBf for the wide i.f. setting was incredibly low in both mono and stereo, with readings of 0.052 percent and 0.04 percent. Signal-to-noise ratio measured 78 dB in mono and 73.5 dB in stereo in the wide i.f. setting. Corresponding results using the narrow i.f. setting are shown in the curves of Fig. 2. The classical trade-off between distortion and selectivity is clearly seen, since distortion now read 0.11 percent in mono and 0.08 percent in stereo. While S/N in mono remained constant at 78 dB, it was slightly lower for the narrow settings with a reading of 71 dB. Considering the high order of selectivity achieved with this setting, however (better than 80 dB), these results are still quite outstanding. It could be argued that the wide i.f. setting really isn't necessary in view of the results obtained in the narrow i.f. mode.

Fig. 3 — Distortion vs. frequency in the wide i.f. position.

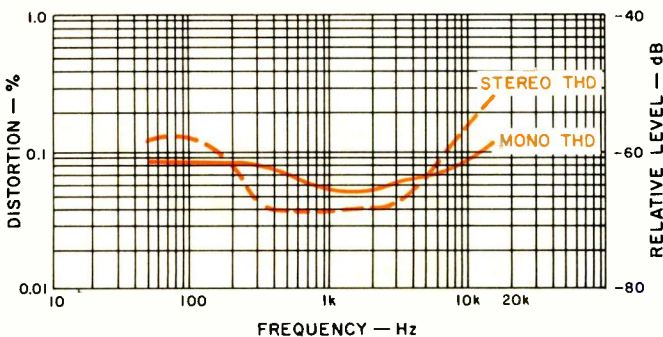

Figure 3 is a plot of mono and stereo distortion versus frequency for the wide i.f. bandwidth setting. Interestingly, distortion at mid-frequencies is actually lower in stereo than it is in mono, though at the frequency extremes, stereo THD rises somewhat, as is to be expected.

Stereo threshold occurs at 25.2 dBf (10 μV), as does the muting threshold in the wide i.f. setting. Muting threshold is a bit lower when the tuner is operated in the narrow i.f. mode, 22.1 dBf or 7.0 μV. I.f., image, and spurious response ratios all measured in excess of 100 dB (the limit of our test setup), while AM suppression measured fractionally better than the 60 dB claimed. Capture ratio was 1.5 dB in the narrow position and 1.1 dB in the wide setting.

Frequency response exhibited a slight rise at around 5 kHz, as can be seen in the upper trace of Fig. 4 (in which each vertical division represents 10 dB of amplitude), and was down just over 1.0 dB at the 15 kHz extreme, relative to the prescribed 75-microsecond de-emphasis characteristic. Stereo separation in the wide mode was excellent, with readings of 54 dB at 1 kHz, 37 dB at 100 Hz, and an unusually high 46 dB at 10 kHz. Switching to the narrow position resulted in some decrease of separation, but not enough to really matter. Separation decreased to 52 dB at 1 kHz, and 43.5 dB at 10 kHz, remaining constant at 37 dB for a 100-Hz test signal. Overall channel separation in the wide mode is depicted by the lower trace in Fig. 4.

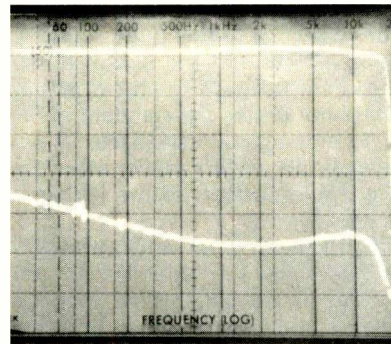

Fig. 4 — Frequency response and stereo separation.

Use and Listening Tests

Devoid of unnecessary frills, the Nikko Gamma I proved to be an excellent performer for its price range and picked up about the usual number of mono and stereo signals (more than 50, all told) which we would expect to receive when a high-quality tuner is hooked up to a good five-element outdoor antenna in our particular listening location. When strong signals were received, we could not detect an audible difference in the quality of sound heard using the wide or narrow i.f. positions, though we did detect some change when we tried to "DX" or zero in on signals having an incoming level of between 15 and 20 dBf. Selecting the "narrow" position under such conditions did reduce noise slightly, but not really enough to make these very low-strength signals usable.

Cosmetically, the unit is functionally handsome, with its large FM dial scale, and it will fit into most front-panel color schemes, what with the matte black and brushed aluminum alternatives. The rack-mount tab cut-outs may prove to be displeasing to some audio buffs who simply wish to place the tuner on a table top or shelf, though this professional look is the "craze" these days.

In summary, the Nikko Gamma I tuner performed quite well considering its price level and should provide just about everything one could wish for in most listening locations.

Leonard Feldman

Enter No. 101 on Reader Service Card

## Nagatron HV9100 Ribbon (Velocity) Magnetic Phono Cartridge

### MANUFACTURER'S SPECIFICATIONS

**Type:** Ribbon (velocity) magnetic.

**Frequency Response:** 20 to 30,000 Hz.

**Effective Mass of Stylus Cantilever Assembly:** Less than 0.5 mg.

**Output Voltage at 1 kHz:** 0.04 mV, 5 cm/S; 4 mV via HA9000 head amplifier.

**Channel Separation at 1 kHz:** More than 25 dB.

**Channel Balance at 1 kHz:** Less than 1 dB.

**Dynamic Compliance:**  $7 \times 10^{-6}$  cm/dyne.

**Output Impedance at 1 kHz:** 3 ohms.

**Recommended Cable Capacitance:** 200 to 500 pF (not critical).

**Tracking Force:** 1.6 to 1.8 grams — optimum 1.7 grams.

**Vertical Tracking Angle:**  $24^\circ$ .

**Recommended Load:** 10 to 30 ohms.

**Stylus Tip:** 0.4 x 0.8 mil; special ellipti-

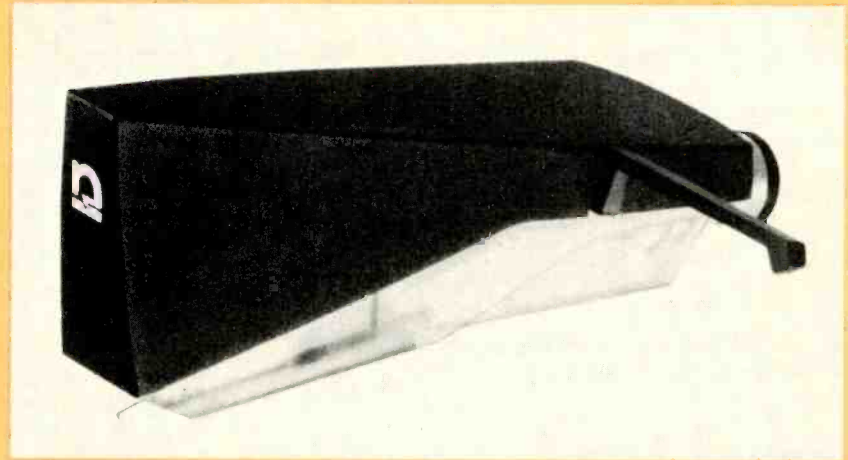

cal, nude, solid diamond with 0.15mm square shank.

**Cantilever:** Titanium (crystallized).

**Weight:** 19 grams.

**Replacement Stylus:** RS HV9100.

**Price:** \$220.00.

In recent months the adherents to the moving-coil cartridge mystique have had much to rejoice with the introduction of the Nagatron HV9100 ribbon (velocity) magnetic cartridge. The HV9100 is a true ribbon cartridge, quite similar in operation to the transducing principle of the ribbon microphone. However, the less-than-full-turn metallic ribbon "coil" acts in a magnetic field not unlike the standard multi-turn coil commonly used in moving-coil cartridges. Its frequency response is not affected by wide variations in resistive and capacitive loading. An important feature is that its output is inherently phase linear.

Unlike moving-magnet and variable-reluctance cartridges, the ribbon design concept does not rely upon varying the magnetic field in order to induce a voltage. Instead, the magnet is fixed, and the two flat strands of metallic ribbon (one per channel) move in direct proportion to the stylus-tip motion within the constant magnetic field. In this way, magnetic flux density is always constant and directly proportional to actual stylus-tip velocity. The magnet is a rare-earth samarium-cobalt structure yielding a magnetic flux density of 10,000 Gauss that produces a nominal output level of 40 microvolts (0.00004 volts). The ribbon is made from a special silver alloy, which includes zinc, nickel, platinum, and other elements, resulting in excellent conductivity, not just on the surface, but throughout the entire metallic ribbon body.

The stylus and cantilever assembly is quite different from the usual systems. The exclusive one-point support eliminates rotational shifting at the pivot axis by utilizing a

square-shaped damping panel and high-elasticity damping compound. IM distortion is thus kept to a minimum. The cantilever, made of crystallized titanium, is a straight-line tapered cantilever tube which precludes spurious local resonances that usually arise in curved-cantilever shapes. The elliptical nude diamond stylus is cut from a solid, square diamond. Moving-coil cartridge enthusiasts should be quite pleased to learn that the stylus is user-replaceable, thus eliminating part of the high cost of stylus replacement.

Many cartridges are becoming available already mounted in a standard headshell, thus eliminating the vexing problem of properly mounting the cartridge. Nagatron has gone one step further and built the cartridge into a headshell, all as one unit. It would be nice if the manufacturer placed a vertical (6 mm) white index line on the center front of the shell for easier cueing. Although the overhang cannot be adjusted, it should cause no serious problem in tonearms using the universal four-pin plug since their head shells are designed for a  $51 \pm 1$  mm spacing between the stylus tip and bayonet base, which is an EIAJ standard. It is strongly recommended that no attempt be made to correct the overhang error, which is not off by more than 1.5 mm, through any tone arm adjustments or other means.

The headshell-cartridge combination is quite heavy, weighing 19.3 grams. However, we found that some other standard headshell-cartridge combinations weighed as much. It may be necessary to add additional weight to the counterweight on some tonearms so that the arm-cartridge combination can be properly balanced prior to adjusting the tracking force.

### Measurements

All measurements and listening evaluations were made using the Mark Levinson JC-1DC moving-coil cartridge preamplifier at its high gain position. We checked out the JC-1DC to ascertain that it would not affect any of the measurements. The gain of the JC-1DC at 1 kHz was 48 dB, while the frequency response was down 1 dB at 20 Hz, flat to 20 kHz, and down 1 dB at 60 kHz. Moving-coil cartridge transformers currently available cannot be used with the HV9100 because of insufficient gain.

During the test period the average room temperature was  $70^\circ \text{F} \pm 1^\circ$  ( $21.11^\circ \text{C}$ ) and the relative humidity was 55 percent,  $\pm 3$  percent. All measurements were made at the rec-

**Fig. 1—Frequency response and stereo separation with the Nagatron HV9100 Cartridge.**

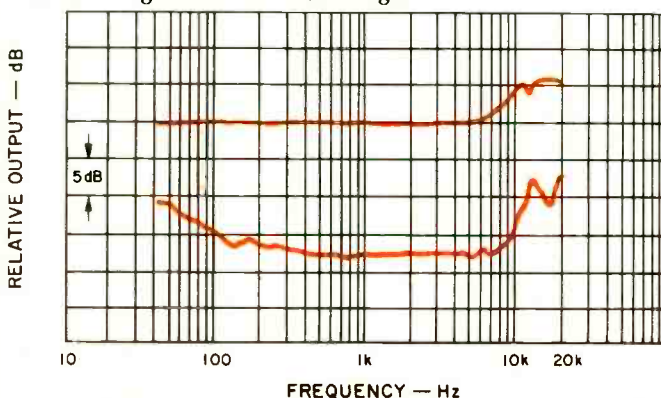



ommended 1.7 grams tracking force and an anti-skating force of 2 grams.

Frequency response of the Nagatron HV9100 cartridge, using the Columbia STR-170 test record and our reference tonearm, an Audio-Technica AT-1009, mounted on a Technics SP-10 turntable, is flat within  $\pm 0.5$  dB from 40 Hz to 6 kHz, ascending to  $+5.5$  dB at 12 kHz, and  $+6$  dB at 20 kHz. Separation was 18 dB at 1 kHz, 17 dB at 10 kHz, 18 dB at 15 kHz, and 13 dB at 20 kHz. This separation is more than adequate inasmuch as a good stereo effect is evidenced with as little as 15 dB separation between channels.

Over a period of many years we have used just about every test record commonly available and a few not so easily available. One thing they all had in common was that no two gave identical results, particularly in cartridge frequency response and separation measurements. We have frequently compared the various cartridge test records and continue to be amazed how different a simple measurement can be between all the test records, using the same cartridge for all measurements. Recently, our colleague, Julian D. Hirsch, of *Stereo Review*, wrote an excellent review of this problem. It should be required reading for all involved in using test records or interpreting results obtained from them. The article appeared in *Stereo Review*, January, 1979, and we highly recommend it to the readers of *Audio*. Further, since phono cartridge measurement standards do not exist, either domestically or internationally, we would like to propose that such a committee be formed for the purpose of establishing standards for the measurement of phono cartridge performance.

Returning to the HV9100, the square wave response has a large overshoot, followed by a few cycles of well-damped ringing that rapidly decreases to near nonexistence. Arm-cartridge resonance was  $+1$  dB at 9 Hz. Intermodulation distortion was the lowest we ever measured.

The following test records were used in making the reported measurements: Columbia STR-170, STR-112, STR-100, and

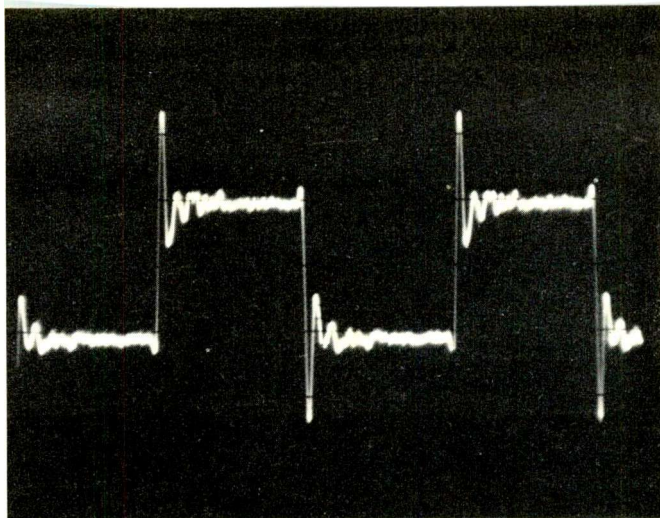

Fig. 2—Response to 1-kHz square wave.

SQT-1100; Shure TTR-103, TTR-109, TTR-110, and TTR-115; Duetsches HiFi No. 2; Micro-Acoustics TT-2002, and Nippon Columbia Audio Technical Records (PCM) XL-7004.

Wt. 19.3 gm; tracking force 1.7 gm; opt. anti-skating force 2.0 gm; output 2.1 mV/cm/S; IM dist. (4:1)  $+9$  dB lateral, 200/4000 0.85 percent,  $+6$  dB vertical, 200/4000 0.38 percent; crosstalk (using Shure TTR-109)  $-30$  dB; ch. bal. 0.75 dB; TTR-103 trackability: high freq. (10.8 kHz pulsed) 30 cm/S, mid freq. (1000 + 1500 Hz lateral cut) 31.5 cm/S, low freq. (400 + 4000 Hz lateral cut) 24 cm/S; Deutsches HiFi No. 2 300-Hz test bands tracked to 86 microns (0.0086 cm) lateral at 16.20 cm/S at  $+9.66$  dB and 55.4 microns (0.00554 cm) vertical at 10.32 cm/S at  $+5.86$  dB.

The Nagatron HV9100 encountered no difficulties in playing all tracking and transient ability bands of the Micro-Acoustics TT-2002 musical test record, including tracing the computer-generated high, low, and high/low mixed frequencies.

## Evaluation Equipment and Records

The equipment used for the listening evaluation included a Technics SP-10 turntable with the Audio-Technica AT-1009 tonearm, Crown IC-150A preamplifier, a pair of Crown DC-300A amplifiers used in the monophonic mode, a pair of stacked Duntech DL-15B speakers in each channel, Mark Levinson JC-1DC moving-coil cartridge preamplifier, and a Columbia SQL-400A SQ decoder. Each pair of speakers was connected to the amplifiers with Polk Audio SoundCables, using Polk's RC terminating network at the speaker end.

The following records, along with many listed in previous reviews, were used to aurally evaluate the Nagatron HV9100.

## Stereo

Haydn: *The Creation*, Dorati, Royal Philharmonic Orchestra — London OSA 12108.

Rimsky-Korsakoff: *Scheherazade*, Stokowski, Royal Philharmonic Orchestra — RCA ARL1-1182.

Shubert: *Symphony No. 9 in C major (The Great)*, Mehta, Israel Philharmonic Orchestra — London CS 6948.

Respighi: *Feste Romane, The Pines of Rome*, Maazel, Cleveland Orchestra — London CS 7043.

Bernard Herrmann Conducts *Jane Eyre and Other Film Scores* — London Phase Four SPC 21177.

Walton: *Belshazzar's Feast, Coronation Te Deum*, Solti, London Philharmonic Choir and Orchestra — London OS 26525.

Sibelius *Masterpieces*, Kord, New Philharmonia Orchestra — London Phase Four SPC 21155.

Roussel: *The Spider's Banquet, Op. 17, Petite Suite Pour Orchestre, Op. 39*; Honegger: *Pacific 231, Ansermet, L'Or-*

chestre de la Suisse Romande — London Treasury Series STR 15395.

*The One for Me*, Acker Bilk his clarinet and strings — PYE NSPLX 41052.

## Direct to Disc

*The First by Sleepy*, H. Matsumoto — Toshiba LF-95008 (distributed by Audio-Technica).

*Big Band Jazz*, Rob McConnell and the Boss Brass — Umbrella UMB-DD4 (distributed by Audio-Technica).

*Big Band Jazz, Volume 2*, Humber College Jazz Ensemble — Umbrella UMB-DD7 (distributed by Audio-Technica).

*Emergency*, Count Buffalos — Toshiba LF-95002 (distributed by Audio-Technica).

Buddy Spicher and Friends, *Yesterday and Today* — Direct Disk DD102.

Cal Tjader, *Huracan* — Crystal Clear Records CCS-8003.

Arthur Fiedler and the Boston Pops — Crystal Clear Records CCS-7003.

## Pulse Code Modulation (PCM)

Bach: *Orgelmeisterwerke*, H. Rilling (Organist) — Denon OX-7027-ND (distributed by American Audioport, Inc.).

Bach: *Orgelchoräle durch das Kirchenjahr*, H. Rilling (Organist) — Denon OX-7023-ND (distributed by American Audioport, Inc.).

## Quadraphonic — SQ

Donizetti: *L'Elisir d'Amore* — Columbia M3 34585.

Puccini: *Edgar* — Columbia M2 34584.

*Go for Your Guns*, The Isley Brothers — T-Neck Records, Inc. PZQ34432 (distributed by Columbia).

The Shure Obstacle Course — Era 111 was no challenge to this cartridge except for a hint of stridency at level 5 of the violin band. With the new Shure Obstacle Course test record — Era IV, both the orchestral bells and the flute were just beginning to sound harsh at level 4, but this was not evident when playing the combination of orchestral bells and flute through level 5. The harp alone or the harp and flute combination presented no problem. Only an occasional cartridge can claim to be able to play all levels of the instruments on the Era 111 and IV test records without encountering some difficulty.

### Listening and Use Tests

As always, our listening tests were performed both before and after laboratory testing of the Nagatron HV9100. Upon

prolonged listening, using both the records listed below and some reported in previous reviews, we concluded that the cartridge sounded excellent. We could not detect any audible coloration or brightness due to the rising frequency response at the high end. Transient and tracking ability were excellent, particularly when playing the high recorded levels present on many direct-to-disc recordings. Sonic clarity was beyond reproach, and bass response was excellent. The HV9100 encountered no difficulties in tracking warps that are nowadays apparently considered a *must* in record manufacture.

We are certain that the Nagatron HV9100 ribbon (velocity) magnetic cartridge will undoubtedly find a top niche among the best moving-coil cartridges available today. *B.V. Pisha*

Enter No. 102 on Reader Service Card



## Audio Technology Model 510 Peak Responding Display

### MANUFACTURER'S SPECIFICATIONS

**Sensitivity:** Line, 50 mV to 5 V.

**Power Display:** 0.003 to 400 watts.

**Frequency Response:** 20 Hz to 20 kHz.

**Input Impedance:** Line, typically 100 kilohms; Power, 20 kilohms.

**Dynamic Range:** 45 dB.

**Accuracy:**  $\pm 0.25$  dB.

**Attack Time:** 50  $\mu$ s for 20-dB rise.

**Decay Time:** 300 mS for 20-dB decay.

**Dimensions:** 7½ in. (19 cm) W. x 1¾ in. (4.5 cm) H x 5½ in. (14 cm) D.

**Weight:** 2.2 lbs. (1 kg).

**Price:** \$139.95.

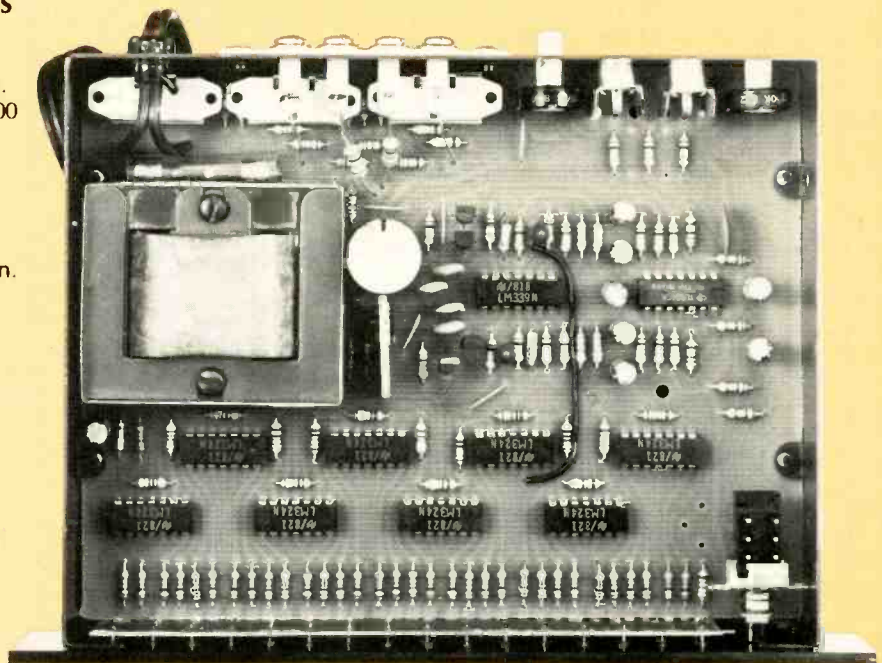



The Audio Technology 510 LED display unit provides a convenient and accurate means to measure peak levels. The device has two parallel rows of 16 red LEDs, each with thresholds every 6 dB from -39 dB to -15 dB, every 3 dB from there to -3 dB, and in 1 dB steps to +3 dB. The final LED threshold is 3 dB above, at +6 dB. Two sets of inputs are provided on the back panel, for line (dBm) and for power-amplifier (dBw) outputs, selectable at the front panel with a pushbutton switch. This is an important feature of the 510. There are other units which require changes in connections and calibration if such a switch is to be made. The Audio Technology display is just 1¼ inches high, and a rack-mounting front panel is available as an option. The device is also available with a vertical reading front panel for those who want that orientation.

On the back panel, phono jacks are used for line inputs and a screw-terminal strip for connections to power-amplifier outputs. There are individual adjustment pots for the two line inputs. The speaker-input selection consists of two slide switches for 4-, 8-, or 16 ohm speaker impedances and for 0-dB display reference of 25, 50, or 100 watts in each channel. The power *On/Off* switch also includes a position, *Cal*, which introduces a +4 dBm signal into both line inputs. This enables setting the display 0 dB quickly and accurately to standard line level, an outstanding convenience feature for some potential users. The manufacturer should also be commended for the "Fuse Inside" label next to the power switch; all too much equipment has hidden and unmentioned fuses.

The circuitry was all contained on one large PCB, with the exception of the LED-display strip. Soldering was excellent, with slight flux residue at a couple interconnection points. The layout was very neat, but there were no labels of any kind (not important as there are no adjustments to make). External resistance checks had shown that the grounds were common for the line inputs, but not for the amplifier/speaker connections. This is a good idea for amplifiers that cannot have their returns tied together or for amps operated in bridged mode, but such a display requires a common at some point. The solution: The two (-) inputs had 1K resistors to the common point which give plenty of isolation for speaker impedances, but which are a very small percentage of the input impedance of the 510.

## Performance

The measured frequency response was flat within  $\pm 0.25$  dB from 20 Hz to 20 kHz. The low end was down just 1 dB at 4 Hz, and the high end was down a dB at 125 kHz in line (dBm) mode, at 84 kHz in power (dBw) mode. In dBm, the 0-dB indication could be obtained with inputs as low as 40 mV and as high as 10 V. As these end points were quite touchy, the specified 50-mV-to-5-V range is a very practical one. The internal calibration level was about +3 dBm, at variance with the data sheet and below specification. The thresholds of all LEDs in both channels were within a total spread of 0.5 dB at most over the entire 45-dB range. The great majority of steps were within 0.1 dB, outstanding performance. The hysteresis from increasing levels vs. decreasing levels was always less than 0.1 dB.

In dBw, the -39 dB LEDs, with 25-W and any impedance setting, turned on at the specified 0.003 W. The power readings were about 0.3 dB low on the average, for all impedances and all power-level references. The total spread in the errors was less than 0.5 dB, acceptable for the intended usage. With a continuous signal, the input pots were set to just turn on the 0-dB LEDs. The display responded fully to bursts as short as 500  $\mu$ s, to -1 dB to a single cycle of 3 kHz. Response for a 20-dB rise was less than 50  $\mu$ s. Decay times



were 250 mS for 20 dB and 700 mS for 45 dB. Varying the d.c. offset of the function generator output showed that the 510 was not polarity sensitive and displayed the correct peak-to-zero level of the shifted waveform. The 510 does this with two separate peak detectors, one for the positive-going peaks and one for negative going. The outputs are then summed so that the larger of the two is actually the one displayed. This is a very desirable and important characteristic of any such device to be used for measuring the peak levels in music waveforms, which are very "peaky" in nature and not evenly or symmetrically distributed in a positive- or negative-going manner. Tape saturation or amplifier clipping frequently occurs on just the negative- or positive-going peak, and it is therefore proper to continuously monitor both waveform excursions for accurate indication of peak signal level.

## In-Use Tests

The high brightness level of the LEDs was immediately obvious, a great aid in reading levels under a range of lighting levels. The peak level of a 10-mS tone burst was quite detectable with illumination of 200 footcandles, a very high intensity. With more normal lighting ambients, it was easy to read the display from across the room. The 510 was connected to the preamp output (dBm) and to the power amp output (dBw). The use of the display was interesting and educational at the same time. For example, I learned that the relative levels from one channel to the other varied measurably when switching FM stations or when playing another record. When setting up for some tape copying, the 510 speeded up the process of setting and balancing channels.

The Audio Technology unit came in handy for checking levels at a sound reinforcement system set up for a ballet program at a ski area. As I had to carry any gear with me on the ski lift, the compactness of the 510 was most welcome. Line and power outputs for each section of the system were quickly checked and adjusted without any diddling or running back and forth. It was clearly shown that sound reinforcement systems of any size could benefit from such a device. It might be noted here that the 510 is not a power meter, even in its dBw mode. Its calibration is based upon the rms voltage corresponding to the stated power reference. The detection and the display are *peak-responding*, however, which thereby indicates the likelihood of clipping or speaker damage.

The instruction book is excellent, which the manufacturer states is being further improved. A test record is included with test signals and transient-type music. Various mounting accessories are available. The Model 510B (\$149.95) offers a three-color LED display as an optional extra. Whichever options are selected, this unit provides excellent performance for use in any studio/audio/sound system.

Howard A. Roberson

Enter No. 103 on Reader Service Card

## Advent Model 500 SoundSpace® Control



### MANUFACTURER'S SPECIFICATIONS

#### Rear Channels

**Frequency Response:** 20 Hz to 20 kHz.  
**Distortion:** Less than 0.1 percent for 1.5 V output at 1 kHz.  
**Dynamic Range:** 80 dB.  
**Input Sensitivity:** 0.3, 1.0, or 3.0 V for rated output.  
**Bass Control:** Baxendall type with varying corner frequency from 95 to 200 Hz with increasing rotation of control.  
**Treble Feed Control:** 6 dB boost to infinite cut above 6 kHz.

#### Front Channels

**Unity Gain:** Straight wire bypass.

#### General Specifications

**Power Requirements:** 95 to 135 V a.c., 50/60 Hz, 30 watts.  
**Dimensions:** 15¾ in. (40 cm) W x 3¼ in. (8.3 cm) H x 10¼ in. (27.3 cm) D.  
**Weight:** 10¼ lbs. (4.6 kg).  
**Price:** \$595.00.

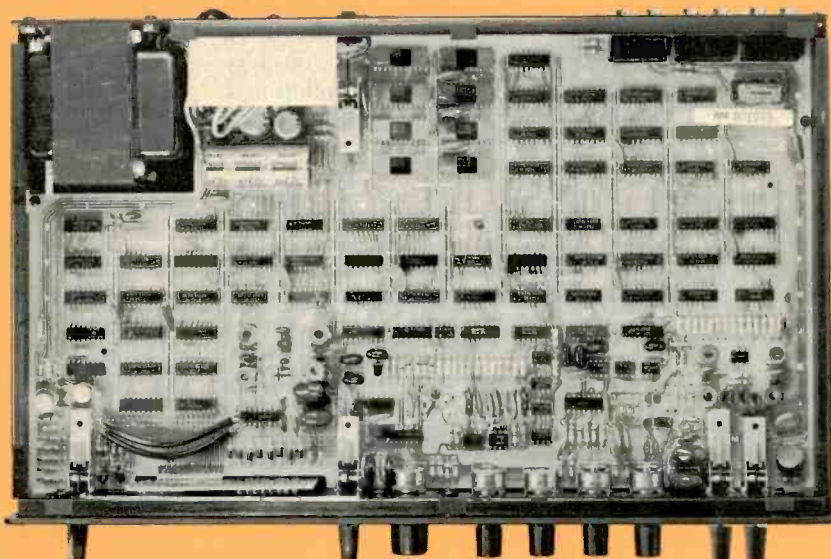

Let me begin by stating, without reservations or qualifications, that Advent's Model 500, to my ears, offers the best and most realistic synthesis of a large listening space that I have yet heard from any of the electronic audio time-delay units that I have either heard or tested. Furthermore, the unit's control arrangement offers greater precision and variation of delayed and reverberant sound effects in a typical listening room than do those of any other time-delay units I have listened to at this date.

Once the unit has been installed (Advent suggests that its proper installation point is between preamp out and power

amp inputs, so that the master gain control of your stereo system controls both front and rear sound amplitudes simultaneously, as opposed to using the tape-out jacks where rear levels would have to be adjusted each time front volume is changed), and input sensitivity is adjusted to prevent overload of the digital A/D conversion circuitry, you are in a position to select virtually any listening space size or acoustic characteristics.

Sensitivity, or proper input level, is indicated by left and right channel banks of LEDs, which should be adjusted so that the red LEDs only flash occasionally, on peak signals.



# See It. Feel It. Just About Taste It.



## Above All, Hear It.

Car audio has come of age. And Mitsubishi has applied its respected audio technology and experience to its new line of car audio products. There is no compromise. Reliable. Rugged. Well designed. But the proof is in the listening. That's where they shine. Be it the RX-69 or RX-7 In-Dash AM/FM Auto-Reverse Cassettes or the RS-67 AM/FM 8-track, Mitsubishi is miles ahead in car audio. In addition, three

Under-Dash Cassettes, one Under-Dash 8-track, and an ambitious array of quality car hi-fi speakers complete the line. Mitsubishi transcends the ordinary. Ready to extend your limits? Look into the entire line of car audio component separates. Get a taste of Mitsubishi Car Audio...

But, above all, hear it.



**MITSUBISHI®**  
**CAR AUDIO**  
SOUND US OUT

©1979 Melco Sales, Inc., 7045 N. Ridgeway Ave., Lincolnwood, Ill. 60645, 800-323-4216 (Outside Ill.) 312-973-2000 (Within Ill.)

Enter No. 46 on Reader Service Card

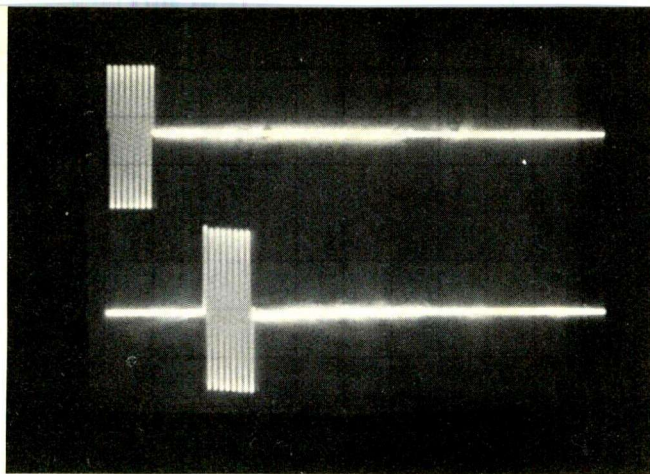
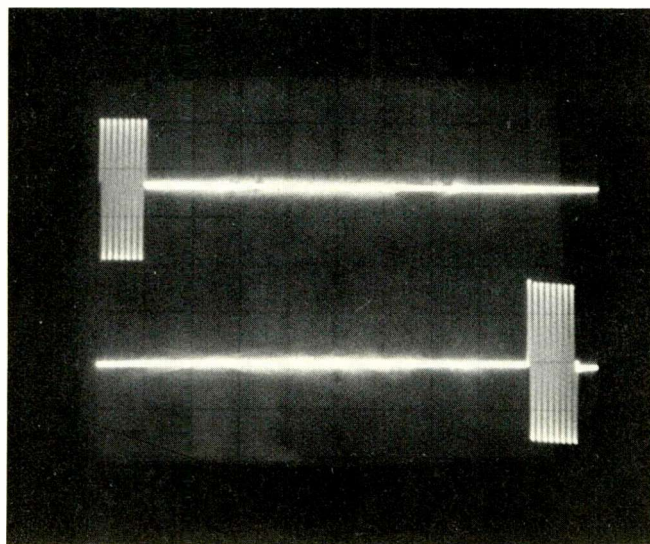

**Fig. 1a** — Tone burst input to Advent 500 delayed 10 mS. Upper trace is input signal, while lower trace shows output from the rear channel jacks.

The window area housing these LEDs also have a numerical digital display which shows first-reflection delays from 0 to 99 milliseconds. This initial delay is varied by means of a toggle switch which is moved to the + or - position and held there until the desired delay time is dialed up on the display. Rotary controls along the face of the panel include a continuously variable reverberation control (which varies the "liveness" of the acoustic space created by the basic time delay), a volume control for the rear-positioned speakers, balance control, and bass and treble controls. A toggle switch near the right side of the panel selects direct sound to rear speakers (no delay), reverb (normal operation) or "off." A second switch enables the user to turn off the front channels and is useful if you simply want to hear what is coming out of the rear channels at any time.

The rear panel contains left and right input jacks, left and right front-channel output jacks (for connection to your main stereo power amplifier), and left and right rear-channel output jacks for connection to the secondary amplifier and speaker combination. Advent suggests that around 15 watts of power per rear channel will be adequate for most installations. They also recommend side-positioning of the rear speakers as well as placement above ear level. If speakers must be placed on the floor, aiming them upwards will give satisfactory results. As a further refinement, Advent suggests the use of two speakers per rear channel, rather than one, for a most consistent spread of sound throughout the listening area. Fortunately, as with most time-delay setups, the rear speakers need not be of the same wideband design or high power handling capacity as your primary front-positioned speaker array.

**Fig. 1b** — Tone burst is delayed 99 mS. Upper trace is the input signal, while the lower trace shows output from the rear-channel jacks.



### How The Model 500 Works

The circuitry of the SoundSpace control uses eight random access memory devices (RAMs) with 4,096 bits each, 57 digital ICs (mostly Schottky MSI TTL Logic), 15 integrated amplifiers, three integrated regulators, nine bi-polar transistors, 24 diodes, eight LEDs, and two monolithic numeric LED displays. Circuit device count is equivalent to more than 43,000 conventional transistors!

Each incoming audio signal passes through a variable gain buffer amplifier and is then filtered into high- and low-pass segments. The low-pass filtered signals are sampled every 62.5 microseconds, and each sample is converted into a 10-bit digital representation using a floating point technique which provides up to 80 dB of dynamic range. According to Advent, this technique treats every sample independently and avoids the hysteresis distortion which is typical of some forms of delta-modulation time-delay systems.

Conversion to digital signals takes place in two discrete operations. First, the sample is sized in 10-dB steps, thereby determining the value of the two floating point bits. Then the remainder of the sample is compared with a linear ramp and eight bits of continuous digitization are derived. The combined 10-bit representation is stored in random access memory to be recalled when needed by the 10-MHz, crystal-clock controlled logic.

At the appropriate time, each sample is retrieved from memory and converted into its analog equivalent by an operation which is the reciprocal of that by which it was digitized. The value the user selects by altering the "size" control on the front panel determines the time delay (in milliseconds) for the longest "early reflection" and provides an index of apparent room size.

A single, large memory holds discrete information from both left and right channels, each sample having a distinct "address." Delayed information is purposely mixed, contoured, and multiply delayed in controlled proportions. Each output channel therefore contains delayed information from its corresponding input blended with signals from prior times and other spatial origins and becomes, in effect, a formulated time series corresponding to the sound field of a specific space. The front panel reverberation control determines the liveness of the various modeled "surfaces" off which sounds are being "reflected." In our listening tests we quickly discovered that the reverberation range is more limited when short time delays are selected than when longer early-reflection times are chosen as, indeed, it should be.

In addition to the processed low-pass signals, the Model 500 allows the user to add measured amounts of treble information present at the input. This treble information, whose amplitude is controlled by settings of the treble control, is



# The Fisher CR5150 cassette deck. Gorgeous up close. Even better from a distance.

Great styling and state-of-the-art performance are two things this new Fisher cassette deck has plenty of.

But it's got something even more exciting: full-function remote control—without wires! It's the first tape deck ever to offer this sensational feature.

Think of it: by touching a button on the remote infrared transmitter, you can control Play, Record, Pause, Stop, Fast Forward, and Rewind modes—from up to 20 feet away! You can record, edit, search, and listen to cassettes—without leaving your easy chair. And the CR5150 is just plain fun to operate.

Wireless control would probably make the CR5150 a big seller even if its performance was only average. But Fisher went all out, and gave it 3 heads for 30-19,000 Hz response, dual-



to record anything you want at a preset time, whether you're home or not. The clock display doubles as an electronic tape counter with memory rewind. Silky-smooth, feather-touch buttons control the solenoid tape mechanism.

But considering the prices of other decks with similar performance and far less features, the Fisher CR5150 at \$650\* has to be one of the greatest values in high fidelity today. No matter how you look at it. Available at better audio stores or the audio departments of fine department stores.

process Dolby\*\* for 68dB S/N ratio, and a servo-controlled transport with 0.04% wow & flutter (WRMS). Superb specs that only a handful of ultra-high priced cassette decks can match.

Feature-wise, there's a built-in digital clock that will turn on the CR5150 deck (or your receiver)

\*Manufacturer's suggested retail value. Actual selling price determined solely by the individual Fisher dealer.

New guide to buying high fidelity equipment. Send \$2 for Fisher Handbook, with name and address to Fisher Corp., Dept. H, 21314 Lassen St., Chatsworth, CA 91311.

 **FISHER**  
The first name in high fidelity.®

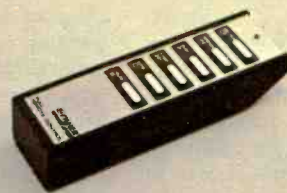

CR5150

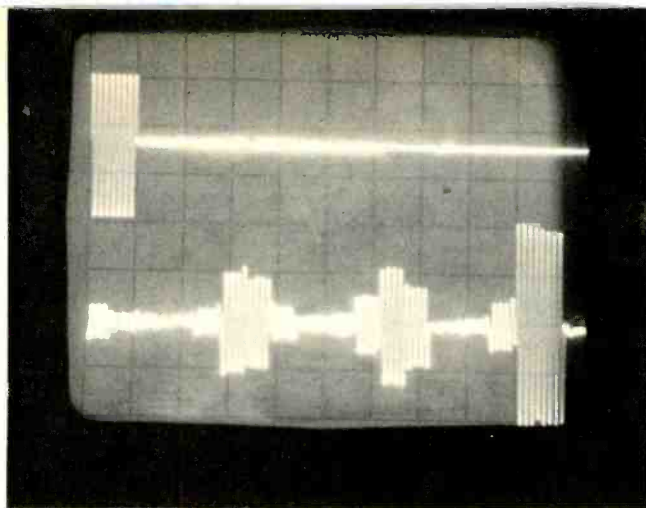

**Fig. 2 — Adding substantial amounts of reverberation alters output signal of Fig. 1 to that shown in lower trace.**

not delayed in time but, according to some experts, measured amounts of undelayed treble added to the delayed and processed rear channel sounds enhances spatial realism over a wide listening area and minimizes localization shift. In our tests we preferred minimal addition of such undelayed treble components, but that may well have been a function of our particular listening room acoustics.

#### Test Bench Measurements

There are, of course, few static measurements which are meaningful when it comes to evaluation of an electronic time-delay unit. With the treble control turned up, response was flat to within 1 dB from 40 Hz to 20 kHz. Without the "direct" addition of undelayed highs, response of the delayed rear channels is down 1 dB at 5.5 kHz. Distortion at mid-frequencies measured 0.05 percent for a 1.0 V output at 1 kHz. Signal-to-noise ratio ("A" weighted, referred to maximum input level before overload) measured 75 dB. Measured per the new IHF standards (0.5 V input, 0.5 volts output), the S/N was 73 dB.

Figure 1(a) and 1(b) are intended to show the precision with which Advent has calibrated the primary delay in their Model 500. For Fig. 1 (a) we "dialed up" a delay of 10 milliseconds, as indicated on the digital display. Our scope sweep was set for 10 milliseconds per horizontal division and, as you can see, the output (rear channel, lower 'scope trace) is exactly one division away from the input, horizontally. Similarly, by setting the delay to 99 milliseconds, the delayed rear-channel output (lower trace of Fig. 1(b) ) appears to be just 10 divisions away from the input signal shown in the upper trace. Both of these photos were taken with the reverberation control set to minimum. With the delay still set for 99 milliseconds, we then added maximum reverberation by means of the separate reverb control, and the output is shown in the lower trace of Fig. 2. As you can see, a rather complex but carefully controlled series of lower-amplitude replicas of the original tone burst, displaced in time relative to the primary delayed rear-channel output (you are actually seeing secondary reflections of an *earlier* tone burst output not visible on the 'scope), in addition to the primary delayed signal that is related to the input burst seen at the left of the upper trace.

#### Listening and Use Tests

As with all electronic time delay setups with which we have had some experience, in setting up the Advent Model 500, if you can hear the rear channel speakers as sources of discrete sound, you've got too much signal coming from those rear speakers. The idea is to back off to the point where

rear sounds are not obvious or obtrusive but do contribute to the spatial enlargement of the listening room. We found that settings of between 25 and 40 milliseconds gave us the sensation of being in a small intimate club space. Increasing the delay to around 50 or 60 milliseconds and adding a moderate amount of reverberation enabled us to simulate moderate-sized auditoriums and was particularly effective when listening to small instrumental groups, including string quartets and three- or four-piece pop groups. Orchestral works sounded best when a delay of some 75 to 80 milliseconds was used, with the degree of reverberation dependent, in our case, not so much on our listening room acoustics as on the "dryness" or "liveness" of the original stereo recording.

Highest settings of delay were useful only for cathedral-type effects such as pipe organ recording reproduction and religious choral works, though we wouldn't recommend the use of such extreme delays for any material containing soloists, either vocal or instrumental.

Subjectively, the Advent Model 500 suffers from none of the "twangy" effects with even moderate amounts of time delay which were present in other units we've tested. I did find that adding undelayed treble to the rear channel content tended to make it harder for me to keep the delayed rear channel sounds from becoming evident or even dominant, but that is a matter of taste, and some listeners may find this "mixed highs" approach very satisfying. In any case, Advent was wise enough to make it a user's choice, since it is possible to work with *only* delayed or reverberant sound emanating from those rear speakers.

Speaker placement was not nearly as critical as Advent may seem to suggest. I used moderately priced two-way speaker systems (8-in. woofers, plus dome tweeters) for my rear channel "ambience" coupled with much higher priced three-way, floor-standing primary stereo speakers, and the overall effect was, to say the least, glorious. It has been said before, but I must say it again . . . once you have listened to stereo program sources enhanced by a well-designed time-delay system such as the Advent Model 500, it is very hard to return to ordinary stereo sound in a typical home listening room.

While the Advent 500 is competitively priced against several of the other popular time delay units currently available, I do feel that it does the job intended for it better than anything I have heard to date. The digital display of actual milliseconds of delay may be considered by some to be a bit of "overkill," but I suspect that the added cost of this frill is minimal (what with the low cost of numeric readouts these days), as it represents only a small percentage of the total cost of this product and it does add a certain feeling of elegance to the unit.

*Leonard Feldman*



# HIGH SPEED AMPLIFIERS: FASTER TRANSIENT RESPONSE THAN ANYBODY.

Today, it's not enough to select an amplifier simply by power specs and THD.

That's why Kenwood first introduced DC amplification and dual power supplies in integrated amplifiers to improve low frequencies and eliminate crosstalk distortion.

Now comes the next significant breakthrough: Hi-Speed. It allows the amplifier to react more quickly to a change in the input signal than ever before. So what comes out of the amplifier matches precisely what went in.

The mid-to-upper frequencies are particularly vulnerable to degradation caused by a slow transient response. But Hi-Speed creates a rapid voltage change (slew rate) which makes the amplifier as fast as the music.

On test equipment, an accurate output signal will show a square wave. And the more rapid both the rise and decay time, the more square the wave. It's an easy way to see the difference Hi-Speed makes. Compare it with any of the competition.

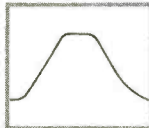

*Pulse waveform response of a conventional amplifier.*

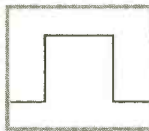

*Pulse waveform response of Hi-Speed amplifier.*

To hear the difference, listen to a familiar record through a Hi-Speed amp. You'll notice depth and definition that will amaze you. Like each violin individually heard in a string section. Even separate handclaps in recorded applause. Until recently, Hi-Speed was available only in our limited production Audio Purist Group. But now, the next chapter of high fidelity is available to anybody with the ear to appreciate it.

It's at your Kenwood dealer, now.

**HI-SPEED™**

*Hear the future of high fidelity*



**KENWOOD®**

For the dealer nearest you, see your Yellow pages, or write Kenwood, P.O. Box 6213, Carson, CA 90749. In Canada: Magnasonic Canada, Ltd.

Model KA-907: \$1000. Model KA-801: \$600. Model KA-701: \$450. Nationally advertised value.

Actual prices are established by Kenwood dealers.



## Visonik Model DD-8200 Turntable



### MANUFACTURER'S SPECIFICATIONS

**Motor:** D.c. servo.

**Drive:** Direct.

**Speed Variation:**  $\pm 3$  percent.

**Wow & Flutter:** 0.05 percent (DIN 45 507).

**Rumble:** -70 dB (DIN B).

**Dimensions:** 18 in. (45.7 cm) x 13.2 in. (33.5 cm) x 6.1 in. (15.5 cm).

**Weight:** 22 lbs. (10 kg).

**Price:** \$250.00.

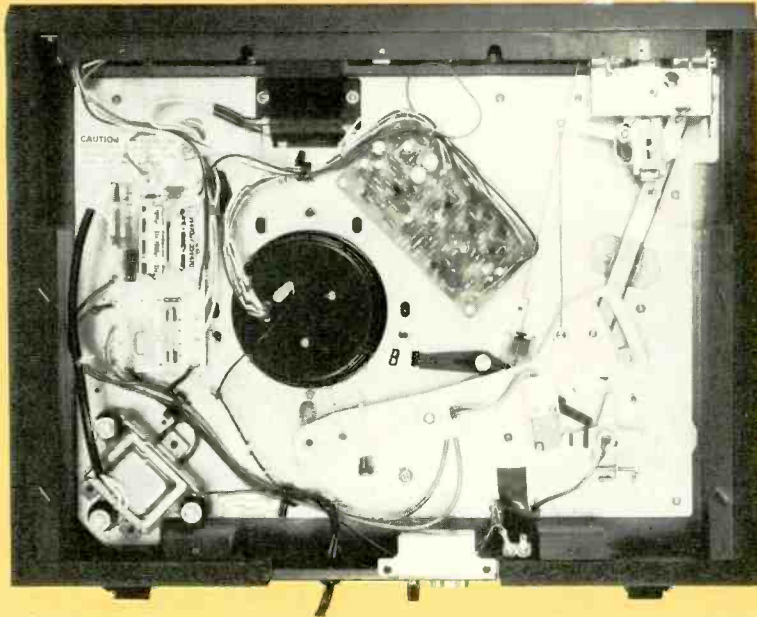

Visonik has made quite a name for itself as makers of a range of loudspeakers, particularly their unique "micro-miniature" models and subwoofers. But they also make a number of turntables, with the top of the line being the DD-8200, a direct-drive model with a servo-controlled d.c. motor, variable speed control, and a neat "mirror strobe." All the controls are accessible with the dustcover closed — a design trend which I, for one, find very sensible.

A two-position, 33 and 45 rpm, speed switch is on the left-hand side, and next to it is a 6-in. window containing the mirror strobe indicator and horizontal slider for speed adjustment. Then comes a *Reject* lever and, right at the end, is the *Cue Lift* control. Indication for the speed selection is provided by two red lights positioned just above the actual switch. The tonearm is the familiar S-type design, made of matte finish aluminum and measuring 8½ in. from stylus to pivot.



**If the bass isn't as clean as you'd like...**

## **The problem may be your tonearm. Not your amplifier or speakers.**

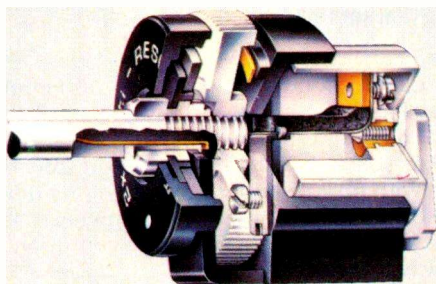

Cutaway view of anti-resonance counterbalance.  
(A feature of Dual models 604, 621, 721 and 1246)

Solid lines show effectiveness of anti-resonance filters in damping resonant amplitudes of three different cartridges (compliance 15, 25 and 43 x 10<sup>-6</sup> cm/dyne). Broken lines show higher resonant amplitudes with conventional counterbalance.

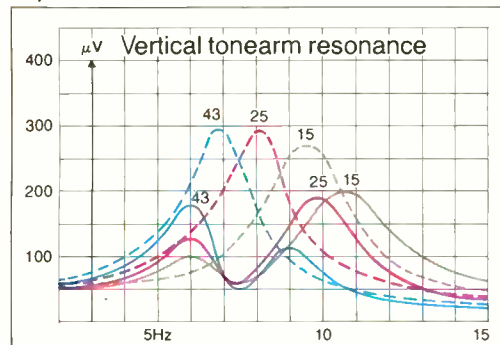

These are specially tuned to damp resonant energy in the tonearm/cartridge system and chassis.

The startling effectiveness of these filters in lowering the resonant amplitude of three cartridges having different compliances can be seen in the graph. Whether the improvement in the bass is subtle or obvious to you depends on the other components and your listening environment.

We've prepared a technical paper on this subject which we'll send to you if you write us directly. You may discover that you don't have to replace your amplifier or speakers after all.

If you've been wondering why your high-powered amplifier and great speaker system don't deliver deep bass as cleanly as you'd like—especially at high listening levels—the problem may well be the effects of resonance on the stylus.

Ideally, the stylus should move only in response to the contours of the record groove. But in reality, the stylus tip also responds to various resonances: its own (with the stylus shank) and the combined resonance of the tonearm/cartridge system.

These subsonic frequencies, though inaudible in themselves, can have very audible effects. Especially with warped records. They can drain amplifier power and cause excessive movements of the low frequency driver. They can cause the tonearm to vibrate and even to momentarily leave the groove. All of which results in audible distortion.

Competent tonearm designers know all this and do their best with materials, masses and compliances to establish the inevitable resonances at the least harmful frequencies (usually between 8 and 10 Hz) and with the lowest possible amplitudes.

Dual's tonearm designers have taken a significant step beyond this.

The unique counterbalances of our direct-drive models (604, 621 and 721) and our top belt-drive multiple-play model (1246) contain two mechanical anti-resonance filters.



**Dual**®

**For the life of your records**

United Audio, 120 So. Columbus Ave., Mt. Vernon, NY 10553

Enter No. 6 on Reader Service Card



The rear counterweight is calibrated from 0 to 2.5 grams, and there is a wide extension weight for lateral balance. The low-mass headshell is made of a special aluminum alloy, and slots are provided for accurate alignment of the phono cartridge. The anti-skating dial is located at the base of the tonearm and calibrated in a similar manner to the counterweight.

As most readers know, there are two schools of thought regarding turntable platters — some engineers favoring a light platter, while others favor the flywheel action of a heavy one. The 8200's platter weighs in at 3¼ lbs. (1.47 kg), plus almost ½ lb. for the substantial rubber mat, which puts it into the heavy category.

### Measurements

For test purposes a Stanton 881S phono cartridge was mounted in the headshell and aligned with the position gauge supplied. The range of the speed control was checked first and was found to give a variation of +4.5 percent and -2.5 percent, slightly more than claimed. Wow and flutter was a low 0.035 percent (DIN 45 507), and rumble was an excellent -62 dB using the ARLL weighting. Tracking error was within the normal 0.5 degrees per inch, typical of this kind of tonearm, and bearing friction was negligible, being too low to measure accurately. Arm resonance came out to 8.5 Hz with the Stanton cartridge, the rise being just under 3 dB. Calibration of the tracking force weight was quite accurate, being within 5 percent above 1 gram, and the anti-skating dial gave a close match. Optimum results with the Stanton 881S were obtained with a tracking force of 1.25 grams and the anti-skating dial set to 1.5 grams.

### Listening and Use Tests

The oil-damped, cue-lift control works a little differently from most — depressing the lever brings the tonearm slowly down, but to bring it back up the lever is pressed down again and released. It takes some time to get used to it, but the operation is smooth with no backlash, so this is a minor quibble. There are four strobe calibrations, one pair for 50 Hz and the other pair for 60 Hz, but there should be no confusion as the viewing window is quite large.

As mentioned earlier, all controls are accessible with the dustcover closed — it is obvious that considerable thought has been given to the ease of operation. As the measurements indicate (especially the low wow and flutter figures), the Visonik DD-8200 is a very fine performer and offers a remarkably good value for the quite modest price of \$250.00.

*George W. Tillett*

Enter No. 105 on Reader Service Card



## A free safe deposit box for your Silver and Gold.

Audio buffs looking for a sound investment put their money into Maxell Silver and Gold.

Maxell Silver (UD-XL I) is the most highly valued tape for normal bias. And Maxell Gold (UD-XL II) is equally

valued for chrome biasing.

We realize the world's finest tape is worth a lot.

So when you buy three, we'll give you something to protect your investment. A free cassette

storage case that holds up to 12 cassettes.

The way we figure it, once you hear the sound of Silver and Gold, you'll find the dividends far greater than the investment.

**maxell**

Enter No. 49 on Reader Service Card

Maxell Corporation of America, 60 Oxford Drive, Moonachie, N.J. 07074



# BEYOND DC



Another  
Step Closer  
to Perfection.

## ONKYO'S EXCLUSIVE SUPER SERVO INTEGRATED AMPLIFIERS.

Just when you think audio technology's reached its peak, along comes Onkyo, making it even better. Our latest is an improvement on the superb performance of DC amplifiers.

Super-Servo circuitry—another Onkyo exclusive—uses the extraordinary characteristics of operational amplifiers in a unique, negative feedback loop. Thus you get the benefits, particularly at the low (2Hz and below) frequencies not offered by other DC amps.

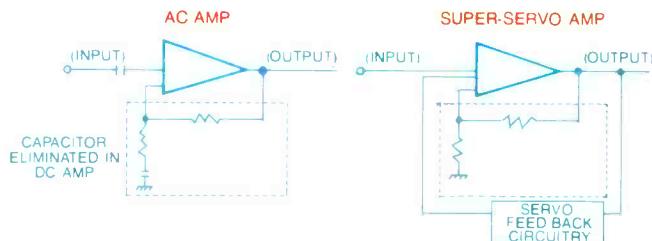

Going to DC amps was not the end. For Onkyo, it was the beginning.

While DC amplifiers increased bandwidth for better high frequency performance, spectrum analysis in Onkyo's labs found that very low frequency components below 2Hz, resulted from interactions with the amplifier's power supply. True, at 2Hz or less, you had to see it rather than hear it, but we felt that any unwanted component should be eliminated.

When we did, the result was three-dimensional imaging such as you've never heard. Sound you won't hear in conventional amplifiers. Or in other DC amplifiers. Only in Onkyo's Super-Servo amplifiers.

You have a choice of three, Super-Servo Integrated Amps:

**A-7040**-50 watts per channel, minimum RMS at 8 ohms, both channels driven from 20-20,000Hz with no more than 0.026% THD.

**A-7070**-70 watts per channel, minimum RMS at 8 ohms, both channels driven from 20-20,000Hz with no more than 0.02% THD.

**A-7090**-110 watts per channel, minimum RMS at 8 ohms, both channels driven from 20-20,000Hz with no more than 0.018% THD.

Talking about power is only part of it. Onkyo's Peak Power Indicator is an array of LED's which light up according to power output per channel, from the very bottom to, and over the top... calibrated in watts at 8 ohms.

Of course you get everything else you'd expect from Onkyo. Multiple inputs and outputs. Total protective circuitry for speakers and amplifier. Human engineered control placement with sound-shaping noise and filters. An immense, cool-running power supply.

Hear the brilliant audio quality of Super-Servo performance at your Onkyo dealer, or write for additional information. Super-Servo... another example of how Onkyo stays a step ahead of state-of-the-art.

Artistry in Sound

## ONKYO®

**Eastern Office:** 42-07 20th Avenue, Long Island City, NY 11105 (212) 728-2970

**Midwest Office:** 935 Sivert Drive, Wood Dale, IL 60191 (312) 595-2970

**West Coast Distribution Center:** Damar Industries, Inc. 20600 Nordhoff Street, Chatsworth, CA (213) 998-6501

**Canada:** Sole Distributor, Tri-Tel Industries, Ltd., Ontario, Canada

Enter No. 22 on Reader Service Card

**J&R** THE ONE-STOP MUSIC SHOP AT WHOLESALE PRICES

|                           |        |                                     |         |
|---------------------------|--------|-------------------------------------|---------|
| <b>BLANK TAPES</b>        |        | <b>REEL-TO-REEL</b>                 |         |
| <b>CASSETTE TAPES</b>     |        | Maxell UD 35 90 1800 ft. \$6.49     |         |
| Ampex Grand Master I C-60 | \$2.14 | Maxell UD XL 35 908 1800 ft. \$6.75 |         |
| Ampex Grand Master I C-90 | \$2.78 | Maxell UD 35-180 3600 ft. \$10.11   |         |
| BASF Studio C-90          | \$1.99 | 104" 1" \$15.30                     |         |
|                           |        | Scotch 212 1800 ft.                 | \$4.35  |
|                           |        | Scotch 207 1800 ft.                 | \$5.18  |
|                           |        | TDK L-1800 1800 ft.                 | \$5.22  |
|                           |        | <b>VIDEO TAPES</b>                  |         |
|                           |        | <b>BETA FORMAT</b>                  |         |
|                           |        | Sony L-750 (3 Hour)                 | \$10.95 |
|                           |        | Sony L-500 (2 Hour)                 | \$13.95 |
|                           |        | Scotch L-600 (2 Hour)               | \$13.50 |
|                           |        | Zenith L-500 (2 Hour)               | \$13.95 |
|                           |        | Ampex L-500 (2 Hour)                | \$12.95 |
|                           |        | <b>VHS FORMAT</b>                   |         |
|                           |        | JVC T-120 (4 Hour)                  | \$10.75 |
|                           |        | TDK T-120 (4 Hour)                  | \$10.50 |
|                           |        | Fuji T-120 (4 Hour)                 | \$17.95 |
|                           |        | RCA VK-250 (4 Hour)                 | \$18.95 |
|                           |        | RCA VK-125 (2 Hour)                 | \$14.95 |
|                           |        | Parasonic NVT-120 (4 Hour)          | \$18.95 |
|                           |        | Parasonic NVT-60 (2 Hour)           | \$14.95 |

Minimum Order 12 Tapes — 100% Guaranteed.

**CARTRIDGES**  
audio-technica

|                |         |                  |         |
|----------------|---------|------------------|---------|
| AT-20 SLA      | \$18.00 | <b>SHURE</b>     |         |
| AT-15 SA       | \$85.90 | V15 TYPE IV      | \$89.90 |
| AT-14 SA       | \$45.90 | V15 TYPE III     | \$69.95 |
| AT-12 SA       | \$4.90  | V15 TYPE III     | \$29.75 |
| AT-10          | \$12.00 | M91ED            | \$21.00 |
| <b>STANTON</b> |         | M44E             | \$13.80 |
| 8815           | \$72.50 | M70E             | \$9.90  |
| 681EE-S        | \$55.00 | <b>PICKERING</b> |         |
| 681EE          | \$42.50 | XSV/3000         | \$49.95 |
| 680EE          | \$24.90 | XV15/200E        | \$39.95 |
| 502E           | \$12.60 | XV15/750E        | \$32.50 |
|                |         | XV15/625E        | \$25.77 |
|                |         | XV15/400E        | \$22.45 |

**HEADPHONES**

|                   |         |             |         |
|-------------------|---------|-------------|---------|
| <b>SENNHEISER</b> |         | <b>KOSS</b> |         |
| HD-44             | \$23.88 | PRO 4AA     | \$39.90 |
| HD-400            | \$26.28 | PRO 4 AAA   | \$48.00 |
| HD-414            | \$44.88 | HV1         | \$29.97 |
| HD-424            | \$65.28 | HV1LC       | \$35.97 |
|                   |         | K/6A        | \$19.97 |

**HOW TO ORDER:** For shipment within 48 hours, send money order or certified check. Two weeks delay on personal checks. Please add \$3.50 per order for shipping & handling. (\$5.50 for orders outside U.S.). N.Y.S. residents add tax. No C.O.D.'s. All merchandise 100% guaranteed, brand new & factory fresh.

**J&R MUSIC WORLD**

Dept. A, 33 Park Row, N.Y.C., 10038 (212) 732-8600  
**ORDER TOLL FREE (800) 221-8180**  
**CALL OR WRITE FOR FREE 96 PAGE CATALOG**

Enter No. 11 on Reader Service Card

**String Synthesizers**  
Can Be: Just strings...  
...But when designed by Marvin Jones they have:



violins/cello/piano, variable chorusing, keyboard split, synthesizer interface, variable sustain controls, jacks for foot controls, dual violin/cello mixers, separate mixable piano output, stereo string & computer interface options.

*Stringz 'n' Thingz*

just \$295 kit \$600 assembled from **PAIA** You're gonna love it!

**TELL ME MORE**

( ) Send Assembly & Using Manual \$5 refundable upon purchase Stringz 'n' Thingz.  
 ( ) SEND FREE CATALOG

name: \_\_\_\_\_  
 Address: \_\_\_\_\_  
 City: \_\_\_\_\_ State: \_\_\_\_\_ Zip: \_\_\_\_\_

**PAIA ELECTRONICS** Dept. 5-A  
 1020 W. Wilshire Blvd., Oklahoma City, OK 73116 (405) 843-9626

Enter No. 25 on Reader Service Card

# European Letter

Donald Aldous

DBX is recognized as one of the leading manufacturers of top-end consumer and professional audio equipment, particularly tape and disc noise-reduction systems and dynamic range expanders. In my letter, published in July, 1978, *Audio*, I mentioned noise reduction devices, including the dbx system.

In January, it was announced here that BSR Ltd., a major British company whose range of record players and changers is known all over the world, have — through their subsidiary company BSR (USA) — acquired the whole of the issued share capital of DBX of Boston, for the sum of \$8 million, payable in cash.

The present management will continue to be responsible for the administration and development of the company. The two principal shareholders have signed service contracts for a minimum period of two years. This move certainly makes a change from our American and Japanese friends buying into the British electronics and TV market.

One outstanding example of this sort of move is the Rank-Toshiba operation, in which the joint TV and audio manufacturing group began production in UK towards the end of 1978 and announced a £3 million investment plan.

The new company is 70 percent owned by The Rank Organization and 30 percent owned by Toshiba. It will concentrate on television and audio items under the Rank Radio International brands, Bush, Murphy, and Rank-Arena, and also for Toshiba's UK and European marketing outlets. The chairman of the new company is Kenichiro Hiyama, President of Toshiba UK.

Turning now to Italy, Zanussi, one of the biggest Italian electronics organizations, has introduced a line of high-class hi-fi products, under the trademark *Seleco*. A test line of tuners (STC 1010), a preamp (STC 2000), and an 80-watt power amplifier (STC 3000) are being used to investigate the potential of the market. If well received, more modest hi-fi units will be created to be in direct competition with the Japanese ranges.

In closing this business section of my current letter, after the announcement of the closure of Norway's Tandberg company, which is state-owned, the employees of one of the plants have been carrying on the production of Tandberg TV, hi-fi, and radio equipment by forming a new company. Another company has been registered, with the Norwegian government financial assistance, to continue production of its industrial and laboratory equipment. The German Siemens concern is showing interest in the data processing side of Tandberg, but the continued manufacture of Tandberg brown goods (furniture, etc.) is not considered to be feasible.

Coming down from the dizzy heights of industry finance, let's look at the "music-center" growth in Britain. Regarded as only a step on the path to the "real hi-fi," the compact three-in-one combination for home audio has expanded in the last few years from sales of around 450,000 in 1974 to nearly 900,000 systems last year, with even more projected for this year.

More sophisticated models have come on to the scene today, not unworthy of comparison with modest hi-fi systems, but a change in the potential market has come about with the "rack" or "tower of power" arrays of separates, which have such a following in Japan. These are more versatile than music-centers, allowing each link in the chain to be individually selected, as well as being available in compatible series with suitable furniture to house them.

One all-British system is the Ferguson, produced by the Thorn Industries group. System 25 incorporates a long-wave, medium-wave, and stereo VHF tuner; belt-driven, die-cast turntable with electronic speed control and Shure M7565 cartridge; a 25-watt amplifier, and a cassette deck with Dolby N/R and bias and equalization switching for all types of tapes. It comes with matching floor-standing loudspeakers, plus horizontal housing unit, with smoked glass door. This system is made entirely in the UK, with an imported material content of only about 2 percent.



Some trade prophets believe that this year may well prove to be the last year for mass sales of music-centers, with horizontal towers and stacking racks taking over the mass audio market. Certainly some elegant systems from Japan (Sony, Hitachi, Toshiba) are appearing in Britain. Another growth area here is the radio-cassette recorder which, in the better designs, can be considered as good stereo equipment with hi-fi pretensions.

British tape and disc record care and cleaning accessories continue to appear from many sources, with Bib items finding a world outlet. One product, from a miniscule company, GA Audio, 82 Bromsgrove Road, Redditch, Worcs., is attracting a lot of attention by audiophiles seeking to extract the last ounce of distortion-free sound from their systems. This is a Soundisc glass turntable mat designed as a direct replacement for the usual rubber mat found on most turntables. Critical listeners claim that the mat offers an increase in clarity and stereo imagery when used on a first-class, hi-fi system.

This Soundisc is available in two thicknesses: the standard model is 6.5-mm thick requiring a spindle length above the platter of 8 mm (with the existing mat removed, of course), and the Soundisc 4 requiring a 6 mm spindle length above the platter. Getting the local glazier to fabricate these mats is not as easy as it might seem, what with choosing the right type of glass, cutting it, and drilling the center hole in exactly the right spot. Price in Britain is a little less than £10 sterling.

With the thinner types of LP disc now being produced, warpage — as well as clicks and pops — is among the complaints common to the present-day record collector with fastidious standards. One way of tackling this problem is the use of a heavy weight placed over the spindle of the turntable to flatten out the LP during play. Such a weight is now available in the UK and weighs just over 2 lbs., while another device to cope with this de-



fect is a screw-on clamp, going over the spindle.

The old shellac 78s or the early heavyweight, thick-vinyl LPs did not suffer from this defect to any great extent, as I recall, which may be why a growing number of recording enthusiasts are getting a lot of pleasure in finding, refurbishing, and displaying old phonographs and cylinder machines.

Several exhibitionss of early reproducers (cylinder and disc) have been mounted in Europe in the last year or so. At the Royal Scottish Museum in Edinburgh, to celebrate the 1977 Edison Centenary, a vast array of such models was shown. The accompanying picture shows the Triple-horn table gramophone supplied to the Amerixan Manufacturing Co. (of Hamburg, Germany). This type was not uncommon in Europe, particularly when fitted for coin-slot operation. On the right can be seen the Auxetophone Gramophone, successfully developed by the Hon. (later Sir) Charles Parsons. This early design dates back to 1903, and production models in 1906 employed compressed air through a special soundbox. This idea of modulating the compressed air "carrier" in a way

analogous to normal speech had been outlined by Edison in his British Patent No. 1644. Several other machines of this type were invented by Pathé Orphone, Fortophon, Stentorphone and Mammut-Aerophon. These machines certainly amplified the sound, as I have heard, but were noisy in operation, due to the compressed air carrier.

As further indication of the current nostalgic interest in the record-playing systems of yesteryear, a new magazine has just been issued in the UK called *Sounds Vintage*. Due for bimonthly publication, this magazine will survey vintage wireless sets, acoustic gramophones, cylinder machines, works of the pioneers, and collector information. Published from 28 Chestwood Close, Billericay, Essex, England, this is not the first publication of this kind, as there are two long-established journals, *Talking Machine Review* (issued by the doyen of collectors, Ernie Bayly, of Bournemouth) and *The Hillandale News*, the official publication of The City of London Phonograph and Gramophone Society. Inaugurated in 1919, the society must be the oldest group devoted to this subject anywhere. 

DYNAMITE

DIMENSION

LAB SERIES  
MINI SPEAKERS

MKII



With the amazing success of the MKIA, Dimensions has just introduced their new MKII incorporating a dome tweeter to further enhance the high frequencies. Their solid walnut construction and totally advanced speaker suspension employs heavy-duty voice coils and a bass boost cross-over network. Its attractive styling blends beautifully with any decor for home, boat, R.V., plane or auto use.

*Custom Craft*

819 S. Kraemer Blvd. / Placentia, CA 92670 / (714) 630-5440  
DEALER INQUIRIES WELCOME

Enter No. 4 on Reader Service Card

Jon Tiven

Michael Tearson

# The column

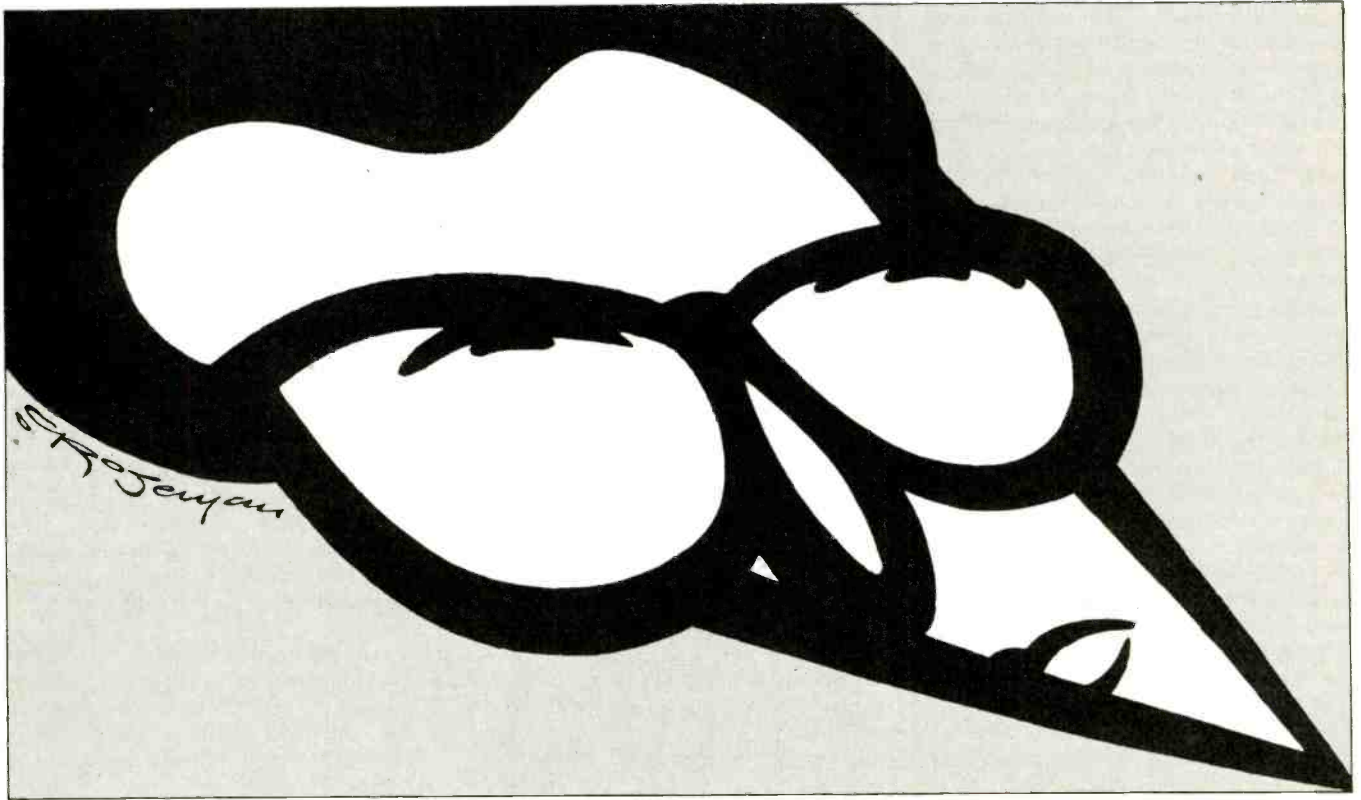

**Armed Forces:** Elvis Costello & the Attractions

**Columbia JC 35709**, stereo, \$7.98.

Despite that ludicrous stage name, Elvis Costello is for real. Any doubts left lingering after last year's **This Year's Model** are totally wiped out by **Armed Forces**, Elvis' third album. Produced as always by Nick Lowe and backed, as on **Model**, by his snappy band The Attractions, **Armed Forces** exudes so much nervous self-confidence that simultaneously it appears cocky and paranoid. And disturbingly, inescapably unforgettable . . . it's that desperate edge his voice has.

This time out most of Costello's songs are not hurt by dream girl images . . . instead the real world keeps popping up. *Oliver's Army* is about recruiting mercenary soldiers. *Goon Squad* is a chiller about the limited choices of a lad who has "grown up too soon" and is determined not to "let them make a lampshade out of me." *Green Shirt* blurs the edge between real life and television commercials. *Two Little Hitlers* could be a description of Dan Aykroyd and Steve Martin's two wild and crazy Czecho-

slovakian Festrunk brothers; a telling line goes "I'll face the music, I'll face the facts/Even when we walk in polka dots and checkered slacks." Then there's the album's closing song, *What's So Funny About Peace, Love and Understanding?* written by Nick Lowe, an anthem for the confused.

The production is very similar to **This Year's Model**. Lowe has crafted songs around quirky arrangements and textures to heighten their built-in anxiety. Echoes of the pre- and barely psychedelic 60s are commonplace on Costello's records. I think of things like Count Five's *Psychotic Reaction*, Paul Revere & the Raiders' *Just Like Me* and especially *Kicks*, The Electric Prunes and others like that, the then-new and slightly dangerous bands. The swirling Farfisa organ sounds, the drum style, the G to A key change in *Oliver's Army*, the breathy vocal and arrangement of the poignant *Accidents Will Happen*, these sounds all point to that earlier watershed era for pop music. The devices manage to regenerate the drive and excitement of those old hits without the clean test-tube sound that is the current vogue. The edges are

rough, but with purpose and effect. Elvis' melodies are so strong and catchy and memorable, his songs so bite-sized that the subversive storylines are almost disguised, which makes the man that much more dangerous.

Incidentally, the original working title of the album was **Emotional Fascism**, and it still survives on the inner sleeve. One would think the working title scared the record company.

An added bonus for the first 200,000 copies is an enclosed EP. The 7-in. disc is from a June, '78, concert at Hollywood High, and contains *Alison* and *Watching the Detectives* originally on the first Costello album **My Aim Is True** plus another version of *Accidents Will Happen* crooned to a sweeping piano accompaniment. The performances are riveting.

Elvis Costello is not going to go away. His songs and band are so strong that they don't grow stale to me even with saturation listening like the 30-plus listenings, spread over more than two weeks, which I needed to get past my emotions to be able to write about the album. And I'm not yet even



beginning to feel burned out on it. Or, for that matter, am I tired of **This Year's Model** a whole year later. M.T.

Sound: C

Performance: A

**Spirits Having Flown:** the Bee Gees  
RSO RS-1-3041, stereo, \$8.98.

It's pointless to knock a group like the Bee Gees, as their execution is flawless — who would have guessed that this threesome who began as a minor hit of the pre-psychedelic U.K. Invasion would outlast their idols the Beatles, outsell The Rolling Stones, and launch the Seventies into a campaign based on dance music that would dominate the end of the era. One can laugh at their voices, which may not be the most powerful in the world but are certainly the most listened to; one can accuse them of self-plagiarism, as most of **Spirits Having Flown** sounds like the songs from the last album with new lyrics, but regardless, guess what entered Billboard's Hot 100 chart this week at #3 and is salesmaker of the week? It's not a **Superman** soundtrack, it ain't even Elvis Costello or Bruce Springsteen, it's the brothers Gibb (three of them, anyway — Andy's slightly lower).

One cannot deny that their tenure entitles them to something, although being the world's #1 pop group isn't exactly my idea of just rewards for longevity. They may someday soon embark on a successful artistic project, where they write songs instead of sing over a predictable beat. The Bee Gees were practically a dead issue in the record industry for half a decade before Arif Mardin decided that this bunch of wimps might just as well be singing their minimal melodies over a triumphant four-four suitable for The Bump, and thus a phenomenon was born. Not much for loyalty, Arif was quickly sacked (and not even credited as the producer when they released one of his songs on **Saturday Night Fever**) and their engineers, Albhy Galuten & Karl Richardson, were deputized as Producers. Millionaires are rarely made quicker.

Now that they've got nothing to worry about, why don't they try something a little less predictable, as they once were capable of writing a decent song (*World*). But no, if they ceased to disco, perhaps their listeners would be forced to stop dancing, and then they'd actually start to (shudder!) hear the music and (gasp!) learn the lyrics and heck, who's got time for that these days when you can do the Latin Hustle? Boogie!  
J.T.

Sound: B

Performance: C

AUDIO • May 1979

**SKITE:** Alberto y Lost Trios Paranoias  
Logo 1009, stereo, \$8.98 (U.K. import).

These guys are lunatics. Take two tips from the cover. At the top of the back cover is the legend "PURE PAPER FOR BLAND PEOPLE," a parody of Nick Lowe's already nicely ironic "Pure pop for now people." Same side lower right corner the notice of the guest appearance of Bonzo Dog alumnus Roger Ruskin Spear plus a parenthetical "The Bonzo's Live." They mean "live" as a verb, not as an adjective.

Alberto is a very British outfit that is to the late '70s what the Bonzos were a full decade ago, namely a no-holds-barred satiric group whose lampoons draw blood. **SKITE** is their third album, also the best produced. That much of the material (but not all) evidently comes from a stage production called **SKITE** is irrelevant since the satire stands on its own most of the time. *Heads Down, No Nonsense Boogie* perfectly skewers punk — "Got no time for intellectual music." *Where Have All the Flowers Gone* has become a reggae song, and a ganja anthem at that. Plus there is a marvelous dub version on the album's other side. They have nerve enough to take the

**Dance a Little Light:** Richie Furay  
Asylum 6E-115, stereo, \$7.98.

**John Hall**

Asylum 6E-117, stereo, \$7.98.

Richie Furay (with Buffalo Springfield, Poco, and the aborted Souther/Hillman/Furay Band) and John Hall (with Orleans and prolific studio work) both have been responsible for lots of fine music, little of which shows up on their new solo albums. Both sets

Sex Pistols *Anarchy in the U.K.* and do it doo-wop style . . . big yuks there. The finale *GOD IS MAD* opens with the perfect Devo send-up — "Are we not men? No, we are bozos!" — then turns to the not easily dismissed proposition that the Supreme Being is bonkers.

Some things just don't work. After a promising intro borrowed from The Prisoner TV series — "We want information." "You won't get it." — before it disintegrates into pure paranoid confusion. Real psychedelic. Usually they have better sense about not milking ideas too far. As is so important in doing satirical material convincingly they play excellently.

As the material demands the production is often multi-leveled with near subliminals. With the variety of genres present, the recording has been done very thoroughly.

Some may find the humor alien, but those same probably don't care for Monty Python either. To you, phooey.

Note: as an import you may find the Albertos misfiled as a New Wave band. M.T.

Sound: B

Performance: B+

fall neatly into the great faceless middle level. Both are bloodlessly mechanical and short on soul . . . product due and delivered at the appointed time. Both are at least adequately recorded, but mechanical aptitude alone, even with Hall's all-star cast, doesn't make an album special. M.T.

Sound: B-

Performance: C-

Richie Furay

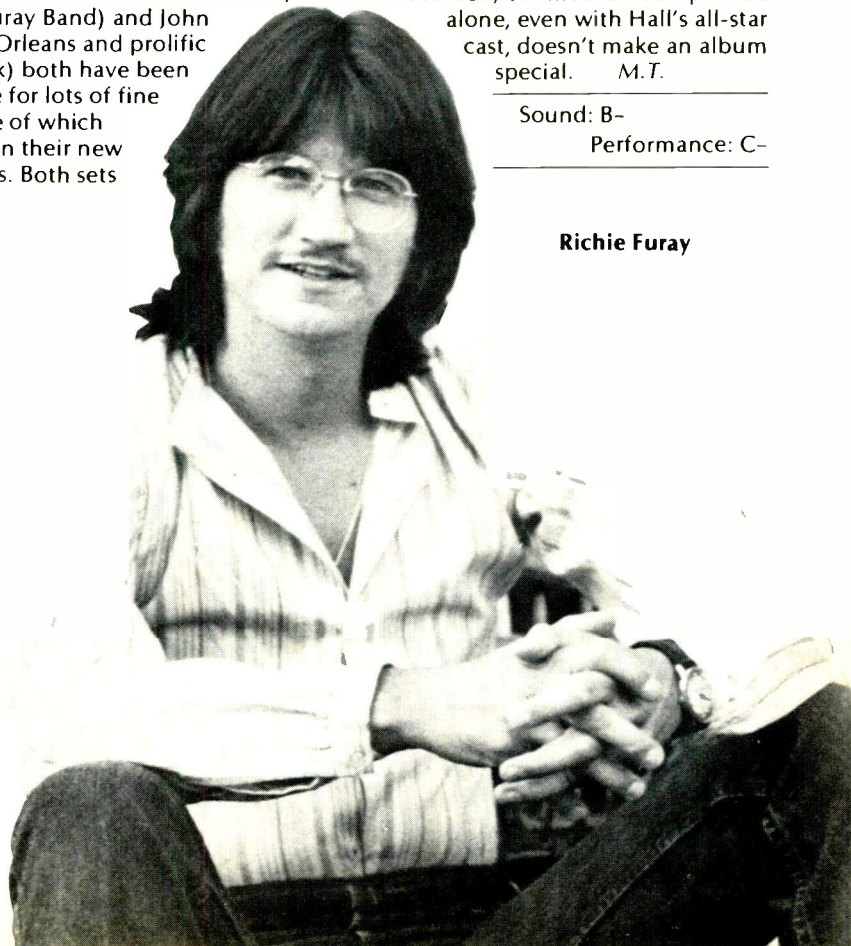

**Briefcase Full of Blues:** Blues Brothers  
**Atlantic: SD 19217, stereo, \$7.98.**

The Blues Brothers are Joliet Jake and Elwood Blues, tough guys who learned about the blues from the janitor of their high school. When Jake finally got sprung from Joliet, the brothers reunited their great band to assault America with the blues. Or at least that's how the legend goes.

Seriously though, The Blues Brothers is the brainchild of John Belushi and Danny Aykroyd of NBC's "Saturday Night Live." As with so many characters spawned by that show, Joliet Jake and Elwood are believable enough with a full history and context.

But why would this become a very hot release, selling over a million in 6 weeks? It is not just their high visibility

or the "Saturday Night Live" comedy album of a while back would have sold much more. No, it has got to be something in the grooves. The music is rhythm & blues to soul music with a lot of backbeat. That Stax/Volt sound of the '60s is a big part of it. In realizing the concept, Belushi and Aykroyd have had the inordinate good sense to hire the best band you could imagine

**Head First:** The Babys  
**Chrysalis CHR-1195, stereo, \$7.98.**

They're as sincere as they look, which is to say, not in the least. The Babys are the formula group that failed — somebody sunk a lot of money into this four-man outfit that could sing like, play like, and look better than Free except that these clowns couldn't write a song worth beans. The first album was dismissed as a hype, so when it came time for a second, they got some outsiders to write hits for them which, unfortunately, sounded more like they were written for Barry Manilow than a hard-rock group. Nevertheless, this heavy metal-plus-strings hybrid managed to make an

impact on the singles charts, so even more record company money was spent to make sure of this. Before they'd finish recording their third album, a member of the group would leave and sue The Babys Inc., they'd delay the record by three months due to tasteless cover art, and make lots of newspaper copy by posing in Rod Stewart's house.

But album number three is upon us, and they still haven't written a song, although heaven knows they've tried collaborating with others to no avail. Ron Nevison, best known for his work with Bad Company, is still producing them and trying to mix orchestration with their hard rock attempts and is still coming up empty-handed. They must have absolute vacuums between

their ears to come up with something like this, and to tell the truth John Waite's voice is wearing thin and doesn't even come close to the originality and power of Foreigner's Louis Grammatico. As far as instrumental performances, even help from L.A. sideman doesn't affect them; the Babys sound like they are clones, or pods, or anything but original. Never has so little been touted as so much — my only consolation is that the vast majority of rockers are not falling for it. For those of you who insist on buying **Head First**, may I interest you in a certain bridge out in Brooklyn? *J.T.*

Sound: C-                      Performance: D-





for the particular music. Hey, starting with Steve Cropper on guitar and Duck Dunn on bass is heavy. They were on countless Atlantic and Stax/Volt sessions as half of the Stax house band, Booker T & the MGs. One of their classics is even recreated here, Sam & Dave's *Soul Man*. The remake is accurate even to Dave (or was it Sam's?) saying "Play it, Steve" to Cropper after a hot riff. Additionally the Blues Brothers' band has a cracker-jack horn section including Tom Scott, Tom Malone, and Lou Marini.

What's more, they had the smarts to record the album in live performance during a week of opening for Steve Martin in Los Angeles, thus guaranteeing a sympathetic audience ready for anything because of Belushi and Aykroyd's rep and the power of their visibility.

Ultimately it has to come down to what's in the grooves and the big question, "Do they cut it? More than a few friends of musical taste and sophistication have put down the album as yet another white rip-off of black music . . . and there is that aspect to consider, but I don't buy that. Ever since the plane carrying Otis Redding crashed and disco grabbed hold of the downbeat — the one and three — with a stranglehold, while taking soul uptown, there has been nearly no popular music focussed on the backbeat — the two and four. This is what is so appealing about the Blues Brothers. They've gone back to the music that went out of style just about the moment when Wilson Pickett put on his first velvet jacket. And these guys swing with the backbeat.

No accident that these tried-and-true charts are as lively as they ever were. What is most remarkable about them is their economy which is timeless. Frills come and go with regular swings back through the core. And a swing through the backbeat is way overdue.

So I am not about to bitch at a lively version of *Soul Man* which has always been a fave, or Joe Turner's *Flip, Flop and Fly*, or Buddy Guy & Junior Wells' *Messin' With the Kid?* Hey, I grew up happy on this stuff. And hearing Cropper and Dunn launch into the intro and outro theme from Otis Redding's *I Can't Turn You Loose*, just like on **Otis Redding, Live In Europe**, is worth it all by itself to me.

So, hey, roll up the carpet and let the Brothers Blues out. And if you've never heard Otis first hand, let the boys give you a little taste. Sure, they're not the original vintage, but they sound like they feel it too. Next go check out the real thing. You can't

question the good intentions of a guy like Joliet Jake who says on the record, "I suggest you buy as many blues records as you can." Me, I'm not about to argue with that. M.T.

Sound: B+ Performance: A-

**A Tonic for the Troops:** Boomtown Rats

**Columbia JC 35750**, stereo, \$7.98.

When the Boomtown Rats first album appeared I somewhat naturally and mistakenly lumped them into the ugly thrust of the so-called New Wave, lauding their great rock & roll spirit while deploring the terrible recording quality of the album.

The second album is a big improvement. With scathing and pungent wit they have already become a band not to ignore in England where they have moved to from their native Dublin. Clearly they hope **A Tonic for the Troops** will expand their world to America. Thus they are treating the new album as their proper American debut to the point of including two songs that also appeared on the first album, their first English hit *Mary of the 4th Form* and *Joey's on the Street Again* which has the wide-screen scope of a Bruce Springsteen tableau and the feel of an anthem.

Their new material shows growth. After the strong opener *Rat Trap* are several songs worthy of Randy Newman at his most perverse, *Me and Howard Hughes* about the effects of being a hermit and recluse, and *I Never Loved Eva Braun* sung from the vantage point of Hitler who takes the opportunity to apologize for everything in a startling and uproarious song. With their dare-anything rock and roll sensibility the Boomtowners might be compared to Cheap Trick who are equally literate and witty and rock like blazes, too. Both bands have an extremely sharp sense of image.

Robert John Lange's production is quite frankly average stuff, but still an improvement over the first go.

With **A Tonic for the Troops** it begins to look as though the Boomtown Rats are going to be a band that matters after all. M.T.

Sound: C+ Performance: B

**Life for the Taking:** Eddie Money

**Columbia JC 35598**, stereo, \$7.98.

Eddie Money's debut album was one of the real surprise breakthroughs of last year. Full to the brim with catchy, up, eminently hummable tunes, in retrospect it had to be considered a natural.

So it is no small surprise when Eddie's second sounds like a clone of the first. Nor is it much of a shock to see Eddie with make-up, pouty lips and cheeks sucked in sexy-like on the cover trying to make his image as a pretty boy stick.

As to the technical and musical ends, suffice to say no chances were taken. Despite some inspired play from guitarist/collaborator Jimmy Lyon, the limiting factor is the Money man himself and his sensitive-but-tough pose.

With all respect, I expect **Life for the Taking** to do very, very well in the marketplace. But it moves me no more than Boston's clone of a second LP.

In the never ending battle between content and form, chalk up a skirmish won by form. M.T.

Sound: B- Performance: C-

**Champagne Jam:** Atlanta Rhythm Section

**Polydor PD-1-6134**, stereo, \$7.98.

**Shine On:** Climax Blues Band

**Sire SRK 6056**, stereo, \$7.98.

Climax Blues Band and Atlanta Rhythm Section are both time- and road-tested outfits who have worked hard for whatever success each has earned. Each has recorded and released albums with regularity for years. Both are what I would call "middle level bands," by which I mean they are bands who do not blaze paths of great originality on the firmament of modern music, but they do deliver goods readymade for their audiences.

**Champagne Jam** is one of ARS' best releases. Its top track is the smash hit *Imaginary Lovers*, a song foredestined to muzak everywhere in 1979. As a whole, the album goes by effortlessly if anonymously.

So does Climax Blues Band's. The big difference between their sounds is Colin Cooper's sax which gives Climax a recurring lead voice. It is their material that keeps them from becoming household words.

Oddly, both bands have outlived their names. ARS is not so much a rhythm section anymore, and Climax hardly ever plays anything recognizable as blues. But they both keep grinding them out keeping their fans happy. M.T.

ARS

Sound: B+ Performance: B

Climax

Sound: B- Performance: C+

**American Dream:** Jesse Colin Young  
Elektra 6E-157, stereo, \$7.98.

Jesse Colin Young's first studio album in a long while, his first with his new label, is definitely a two-sided affair. The real meat is on side 2 which is completely covered by *The American Dreams Suite*, a cycle of five songs all segued together. Being a seamless and moving whole will seriously limit its radio exposure, a bit unfair since it is so good. It relates Young's view of the '60s turning into '80s. It is easily the most adventurous thing Jesse has done on record.



Side One is more standard. It has three new originals framed by a pair of oldies, Buddy Holly's *Rave On* and Eddie Floyd's *Knock on Wood*. Though there is nothing startling on this side, it still is very satisfying; call it the fun side.

Either side is no trouble to take. That one of them is as challenging as it is an unexpected delight. Production values are excellent and uncomplicated throughout. M.T.

Sound: B+ Performance: B+

**The Inside Story:** Robben Ford  
Elektra 6E-169, stereo, \$7.98.

Never a big fan of this sessionaire (Joni Mitchell, et al.), this humble critic was not particularly amazed by the lack of distinctiveness of Robben Ford's first solo outing. Just because Jeff Beck hasn't put out a studio album in three years, in steps this L.A. groover and tries to fill his shoes. He borrows a former Beck producer (Steve Cropper,



recently seen with The Blues Brothers) and the standard **Blow By Blow** approach, coming up with a totally drab album. The beauty of the Beck jazz-tinged albums was that Beck lent his fire to this relatively cool approach, but all Ford has to give is fluidity and never the biting edge. Of course, now he can go back to playing behind Joni and feel like he's put in his two cents worth; hopefully we won't be subjected to volume two of this. J.T.

Sound: C Performance: D(ull)

**High 'N' Inside:** The Yankees  
Big Sound BSLP-037, stereo, \$7.98.

I have to be honest. When I saw that The Yankees was the band of none other than Jon Tiven with whom I share these pages I had to listen closely. For several reasons. Lots of us critics either secretly want to be performers or are or were (I was). Second, both Jon and I have a rep as "tough" critics that I take seriously in any case.

That said, I gotta tell you I like the Yankees album a lot. It starts strong with a little poppin' Tiven tune *Take It Like a Man* and moves surely through two covers. There's *Everyday I Have to Cry* which Arthur Alexander wrote and the Rolling Stones played too, long ago, and then there's *Bad Boy*, a ripping old Larry Williams song Jon prologues with the cry "Roll over, John Lennon." With *Can't Stop Talkin' 'Bout My Baby* and *Boys' Night Out*, a pair of strong originals that close the side, the first side is the better one.

The second side still has some dandy moments. Like the classic guitar riff from *Satisfaction* showing up in the Motown oldie *Something About You*. And the tough rocker *Take Me Home & Like It*.

Hey, I approached The Yankees' album with a "show me" attitude and I consider myself showed. M.T.

Sound: B Performance: B

**Music For Films:** Brian Eno  
Antilles AN 7070, stereo, \$5.98.

Those who were sent into ecstasy by the past two David Bowie albums should check into Eno's work on his own, the most recent example being **Music For Films**. Eno's approach is, perhaps, eclectic but at the very least it's the most fascinating mood music to be had these days. The English pressing of this is far superior, but for non-initiates the domestic version should suffice. Most of the instruments are synthesized, and the result is a pulsating, surprisingly warm series of works that sound like what one would imagine a musical biorhythmic chart would resemble. It's not overly intellectual, and for the times that you want music that you can drift into without feeling like a total slug, it's worth the six bucks. J.T.

Sound: C (bad pressing)  
Performance A-

**No Mean City:** Nazareth  
A&M SP 4741, stereo, \$7.98.

**Air Special:** Brownsville  
Epic 35606, stereo, \$7.98.

**Trouble:** Whitesnake  
United Artists UALA937H, stereo, \$7.98.

Nazareth has been idle for some time, Brownsville (they dropped the "Station") has just recently resurfaced on a record label after years of Midwest gigging, and Whitesnake is a new group with two ex-Deep Purplers trying to relive past memories. For those who thought Heavy Metal was dead just because *Heroes of Rock* excluded it totally from their "big for television legitimacy" (including Led Zeppelin), think again. Although it had healthier days in the post-hippie/pre-punk & disco age, here is living proof that there are still rocking outfits ready for the beer-and-quaaludes crowd.

Nazareth have added guitarist Zal Cleminson (ex-Sensational Alex Harvey Band), and one would think that the band would improve greatly as Manny Charlton was more of a rhythm man. Unfortunately, lead singer Dan McCafferty doesn't sound as full-bodied as he used to — here he's all rasp, and it just doesn't make it in my book. For me, Nazareth's best recordings were the ones produced by Roger Glover (*Bad Bad Boy* was great, as was *This Flight Tonight*) and in particular the ones released around 1973-74. Once they tried for the pyrotechnical bash rather than the straight-ahead rockers, it was all over for me. The material here is also a little weak, but still



they're out on the road, working hard to be successful — personally, I hope they make it and I know they're capable of much better than this.

Brownsville, on the other hand, are a total shock — producer Tom Wer- man uses the sound he gets from Cheap Trick and makes them sound lively, like capable instrumentalists, and like a promising English rock band. I don't know how he did it, but their material is really entertaining, the playing and production is quite good (production particularly, and I'm no great fan of Mr. Werman's Cheap Trick

albums actually). The only weak song is a cover of a Phil Wainman tune, but it doesn't deter from the rest of the album which rocks hard.

Whitesnake features David Cover- dale and Jon Lord, the lead singer and organist from Deep Purple, but credits like that can't help you when your songs aren't really songs but riffs with lyrics laid on top of them. The playing is decent, but I think they're going to have a difficult time getting across with as little distinction as to be found here. Still, no doubt they'll give it a good try for another three albums or

so, and then call it a day when they're a quarter of a million in the hole. That's show biz!  
F.M.

Nazareth:

Sound: B- Performance: B-

Brownsville:

Sound: B+ Performance: B+

Whitesnake:

Sound: C- Performance: B-

**Mirror Stars:** Fabulous Poodles  
Epic JE 35666, stereo, \$7.98.

Early part of '79 has been bleak for debut albums. *Nothing* has been coming out. With the exception of the Fabulous Poodles first American album nothing has captured my ears.

*Mirror Stars* is made up of tracks from two English albums and a single. The English debut was produced by John Entwistle of The Who. He would seem a very strong choice as the band's songs are very reminiscent of early Who. Not so much for the sound, but for wacko subject matter like *Sub- stitute*, *Happy Jack*, and *Pictures of Lily*. From that first set come *Work Shy* especially for those of us who work at night just so that we can sleep through the morning, *Mr. Mike* a love song to you directly from the microphone, *Cherchez La Femme* about the grand

old sport and *Roll Your Own* written by friend of the band Mel McDaniel about the pleasures of roll-your-owns as opposed to "the ready-rolls."

The four songs from the second album feature the lean production of Muff Winwood, a producer who knows when not to add extras. There's the title track *Mirror Star* for all of us who ever practiced being a rock star to the bedroom mirror, *Chicago Boxcar* and *Oh, Cheryl* for slices of life among the trendy adolescent set, and *Tit Photographer's Blues* for life among the sleazy.

The two remaining tracks are self- produced by the band and salute *B Movies* and slam life among the normals in *Toytown People*.

The Poodles made their rep in Eng- land as an "over the top" band with an outrageous stage act. They've man- aged to keep their essence intact on the record, their pungent humor undiluted. My greatest fear for them is that they are "too English" for America.

The big challenges for the Poodles will be to successfully bring their stage show across the pond and not to run dry of new ideas. Their studio pres- ence shows strong growth from their first English album to the second and that is not likely to diminish.

With *Mirror Stars*, the Fabulous Poodles are off to conquer America. Whether or not they will make it re- mains to be seen, but their debut is very impressive.  
M.T.

Sound: B Performance: B+



**Backless:** Eric Clapton  
**RSO RS-1-3039**, stereo, \$7.98.

On **Backless** Eric Clapton sounds like a man who has just figured out that he has tapped into a goldmine. Following **Slowhand's** huge success, he has made an album of high spirited and tuneful stuff. Highlights include the lilting single *Promises*, along with *Watch Out for Lucy* which neatly updates *Frankie*; a pair of new songs Bob Dylan has written with Helena Springs from the **Street-Legal** backing singers, and *Tell Me That You Love Me* which sounds like a song that will be covered often. Glyn Johns' production is nearly invisible. The album has a happy and loose feel that Johns rides herd on from the booth in subtle ways. He doesn't make turkeys.

Adventurous **Backless** ain't. But it feels real good. M.T.

Sound: B Performance: B

**To the Limit:** Joan Armatrading  
**A&M SP-4732**, stereo, \$7.98.

Another Glyn Johns production job and another fine album. **To the Limit** picks up directly where **Joan Armatrading** left off two albums back. Avoiding the nervousness of the interim **Show Some Emotion**, the new one is confident, almost pig-headed. The

ingredients are not much different from **Emotion** same producer and studio, many of the same players. But **To the Limit** clicks. From the opening song, *Barefoot and Pregnant* it is obvious that Joan is not pulling her punches. Her sense of self and quirky sense of humor are great strengths.

Joan Armatrading sounds like no one else. If you've not yet discovered her, **To the Limit** is an excellent way to get to know her. M.T.

Sound: A- Performance: A-

**First Light:** Richard & Linda Thompson  
**Chrysalis CHR 1177**, stereo, \$7.98.

Richard Thompson's songs sound like they've been hanging around in the air for centuries waiting for someone to write them down. They have also been a secret that has been too well kept in America. If you have never discovered him through his work on the first half dozen Fairport Convention albums (he was a charter member) or under his own name or with his wife Linda, his music may come as a revelation. His songs are vivid and striking, often stark and haunting.

**First Light** is Richard's most aggressive album. It owes a lot to the players, especially the Andy Newmark/Willie Weeks rhythm section which makes

possible songs like *Don't Let a Thief Steal into Your Heart* which sounds like a traditional English disco ballad. Another, *Died for Love*, is an excellent example of Thompson's often morbid imagery, a chilling and superb song.

**First Light** could well be the most "accessible" album the Thompsons have done. Unfortunately, its prospects for success in the American marketplace are severely limited by the very British taste of the music, which makes it less appealing to modern radio and reviews like this that much more important. Try it out. M.T.

Sound: B Performance: A-

**All Mod Cons:** The Jam  
**Polydor Pd-1-6188**, stereo, \$7.98.

As they're already are on their third album, one would think that The Jam would have outgrown their image as The Who Reborn; unfortunately for them, their **All Mod Cons** only confirms Paul Weller as the new Pete Townshend. Whereas Bruce Springsteen did an about face to discourage the Dylan comparisons and Billy Joel sends out disclaimers that he is anything but an American Elton John, The Jam are locked into their Who fantasies so strongly that they cannot establish an identity of their own. It's a re-

*Don't fret over technical or systems questions...*

## Get Your Own AUDIO 1978 Annual Bound Volume!

This handsome, hardcover, library-quality, buckram-bound volume gives you a permanent record of the audio industry's achievements throughout the year—increasing in value and service to you in years to come.

**AUDIO's Bound Volume Gives You the Most Comprehensive Coverage Available from One Source.**

Here, you will find discussions, analyses and tests of developments and problems associated with professional and home-use audio components—all from the perspective of the entire year. So you can study, compare and evaluate trends at your leisure—without wondering what happened during those months for which you may not have an issue of **AUDIO**.

Month after month, no other magazine devotes as many editorial pages to component equipment as **AUDIO**. Thus, here is the most complete record of the audio industry's successes—and failures—that you can find anywhere.

**AUDIO's Bound Volume** is the handiest, practical reference you can own. It makes a distinctive addition to your personal library... an ideal gift for the discerning audiophile.

Order Your  
**AUDIO Bound Volume**  
 Today...

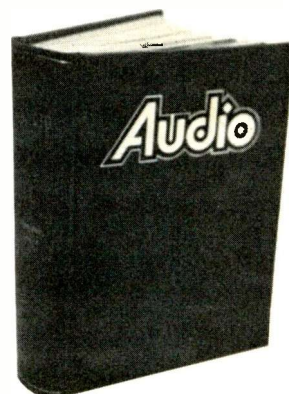

ORDER FORM

**AUDIO 1978 Annual Bound Volume Price \$28.00**

**AUDIO**  
 North American Building  
 401 North Broad Street  
 Philadelphia, PA 19108

**Yes**, please send me \_\_\_\_\_ copy(s) of the **AUDIO** 1978 Annual Bound Volume. The \$28 price includes shipping and handling, USA only. For all other countries, the price is \$30. My check or money order is enclosed. (Payment must accompany order.)

Name \_\_\_\_\_

Address \_\_\_\_\_

City/State/Zip \_\_\_\_\_



lief that at least they've now improved in the studio to the point of the harmonies being "on" and the rhythm of a track remaining steady throughout; their latest album is by far their best. The minus is that most of it could easily be mistaken for outtakes from **The Who Sell Out**, **Magic Bus**, or **Direct Hits**.

There are no obvious steals, mind you, the only case of plagiarism being *Billy Hunt* which is nicked from a previous Jam song, *The Modern World*. It's simply that they're a three-piece group with a wild drummer, trebly bassist, and a guitarist whose approach so closely follows The Pete Townshend Method (in both playing and choice of chord sequences) that it's virtually impossible to listen to them without thinking of The Who. They try to get away from it on their single (included here), *Down At The Tube Station At Midnight*, but they only avoid comparisons there by telling a tale with lyrics which takes all the attention away from the music of the track.

I actually enjoy Side One of **All Mod Cons** quite a bit, much more than I do **Who By Numbers** or **Who Came First** — all the songs are quite well-written and performed with no shortage of spunk, including an old Kinks tune *David Watts*. Side Two starts off badly,

revs with *It's Too Bad*, but never reaches the highs of Side One's closer, *In the Crowd*. Altogether not a bad record, and The Jam are certainly showing signs of vast progression in terms of transferring the live energy onto vinyl, but conquering a 10-year time warp is very difficult. I just hope they don't have to write rock operas and get nostalgic about "The Good Old Days" before people flock to see them, as they obviously have the best of intentions and genuine talent — it's the proper focus and perhaps a strong producer that they lack. *J.T.*

Sound: B

Performance: B

**Summer Holiday:** Ian Gomm

**Albion ALBG 100**, stereo, \$7.98 (import).

Ordinarily this is not an album I would have gone out of my way to hear, having been no great fan of Gomm's group Brinsley Schwarz (where he played beside Nick Lowe, Elvis Costello's producer), but as a friend of mine chose to thrust the album into my possession I subjected myself to it. This was to be my good fortune, as the album turns out to be a winner after all — Gomm sounds nothing at all like his previous incarnation and proves not only to be a

worthwhile songwriter but a fine singer as well.

His covers of others' material seems to be a parody of Elvis Costello (Chuck Berry's *Come On* and The Beatles' *You Can't Do That*), utilizing a slow pace with minor chords substituted for majors. The rest of the album, however, is far more lively — *Hooked On Love* and *24 Hour Service* are bouncy rockers which are closer to Graham Parker's jumpy r&b tunes, *Airplane* and *That's the Way I Rock 'n' Roll* rock in a straight-ahead fashion, and even reggae gets a shot in *Sad Affair*. There isn't stylistic continuity, but, at least, there are quality songs and performance.

The production by Martin Rushent gets to be a bit much with horns that come on too strong, but the playing is good enough to make up for the excesses (particularly Herbie Flowers' bass). There are strains of early Seventies Paul McCartney in this, as well as a few others, but it's no matter — even if there isn't the consistency or stylistic uniqueness of a John Lennon here, it's still a mighty impressive debut. I would recommend it highly to any fan of melodic Seventies rock who seeks a superior Gerry Rafferty. *J.T.*

Sound: B

Performance: B+

## HOW TO INSTALL DAHLQUISTS IN YOUR CAR.

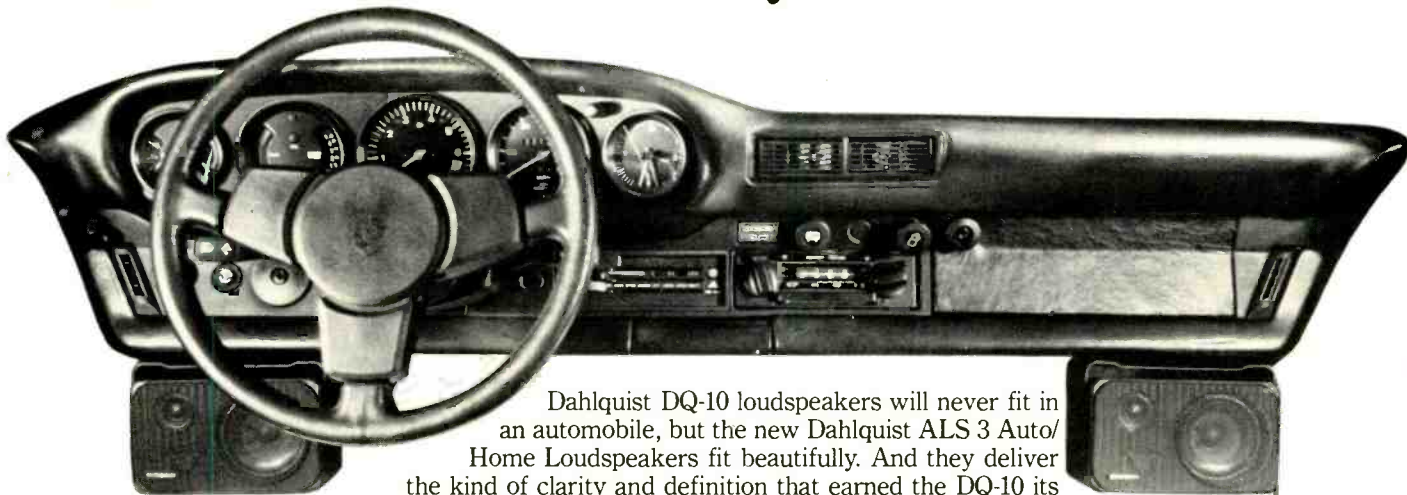

Dahlquist DQ-10 loudspeakers will never fit in an automobile, but the new Dahlquist ALS 3 Auto/Home Loudspeakers fit beautifully. And they deliver the kind of clarity and definition that earned the DQ-10 its legendary reputation.

The new ALS 3 is an example of Dahlquist's forward-thinking approach to design—a three-way system with the drivers mounted on a special anti-diffraction baffle plate; switchable EQ to optimize either auto or home use; and a mass-loaded woofer for deeper, cleaner bass. (The ALS 3 tweeter is the identical unit used in the DQ-10.)

The ALS 3's are furnished in black, heat-resistant, pressure-cast aluminum cases, with removable 90° rotatable mounting brackets, and no-solder connecting cables—at a price below anything approaching their quality.

*Don't be impressed by anyone comparing their car speakers to their home speakers until you find out how good their home speakers are.*

FOR FREE ALS 3 MANUAL WRITE TO:

**DAHLQUIST**

601 Old Willets Path, Hauppauge, N.Y. 11787

THIS BORDER IS THE SIZE OF AN ALS 3.

Enter No. 5 on Reader Service Card

# Top of the pile

## Mobile Fidelity's "Original Master Recordings"

For the better part of the year, Brad Miller of Mobile Fidelity Record Company has been engaged in a unique venture. Sensing a need on the part of the audiophile for high-quality transfers and pressings of best-selling pop records, he has convinced several major record companies to lease him the master tapes for subsequent produc-

tion of audiophile-quality discs. The rationale as seen by the leasing company is that Mobile Fidelity production, because of its restricted distribution through high-fidelity channels, will not interfere with the sales of recorded product through record stores. At normal audiophile disc prices, this is probably a safe assumption. It is important to note that Brad Miller is using the very same master tapes for his

production that the record companies used for theirs. There is no remixing whatever from multitrack earlier generation sources.

When Miller secures permission from a company to issue what he calls an "Original Master Recording," the tape is transferred at half speed by Stan Ricker at the JVC Cutting Center in Los Angeles. Ricker and Miller analyze the product, establish what they consider an appropriate transfer level and perhaps make minor adjustments in the equalization of the tape. Normally, there would be no compression or limiting employed. The master discs are then sent to the Victor Company of Japan for replication. The pressings are made with typical Japanese care on CD-4 type vinyl for long life, and the records are packaged in high-quality plastic innersleeves. The album jackets carry the same artwork as the original with the added legend, "Original Master Recording" appearing at the top on both front and back. At the present time, there are about 10 or 12 recordings licensed in this manner from major record labels. I have played a number of these discs and can attest to their superiority in all cases over the standard American production. The thing that is most striking is the extension of frequency response at both the high and low ends of the spectrum as well as the extremely low noise level on the discs. One senses as well better separation at high frequencies, more like listening to a master tape, and this may well be the result of the half speed transfer processes with its improved separation at high frequencies. Although the recorded spectrum tells only a part of the whole story, it is very interesting to look at these recordings on a 1/3-octave spectrum equalizer. For these measurements, we took three pairs of discs and played them back via an Ortofon MC20 moving-coil cartridge with left-plus-right preamp output being fed to a B&K Model 2131 1/3-octave spectrum equalizer. The B&K has a peak-hold capability plus storage; thus it was possible to play similar passages on the standard product vs. Mobile Fidelity product and compare the two later. Figure 1 shows the peak values measured on John Klemmer's *Touch*, originally issued by ABC

**Fig. 1 — The peak values measured on John Klemmer's record originally issued by ABC Records (shown by dotted line) and the Mobile Fidelity version (straight line). These curves represent the peak values for the first 1:45 minutes of Side One.**

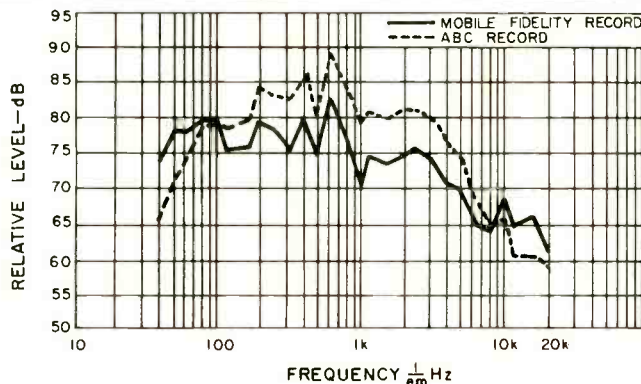

**Fig. 2 — The peak values for the record by Supertramp, originally issued on A&M Records (shown by dotted line) vs. the same record by Mobile Fidelity for the first 2:15 minutes of Side One.**

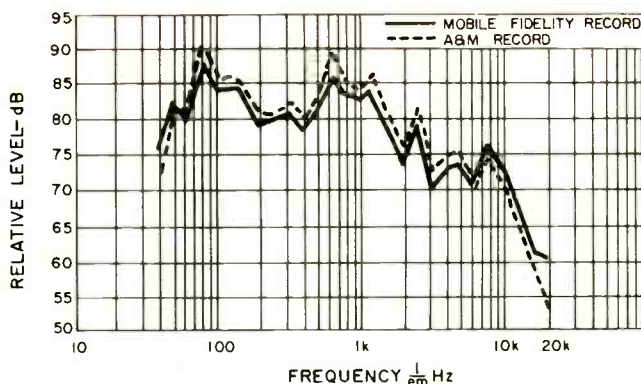

**Fig. 3 — The peak values for the record by the Los Angeles Philharmonic showed the smallest differences between the London Record (dotted line) and Mobile Fidelity. The reason for this is that Stan Ricker made both transfers.**

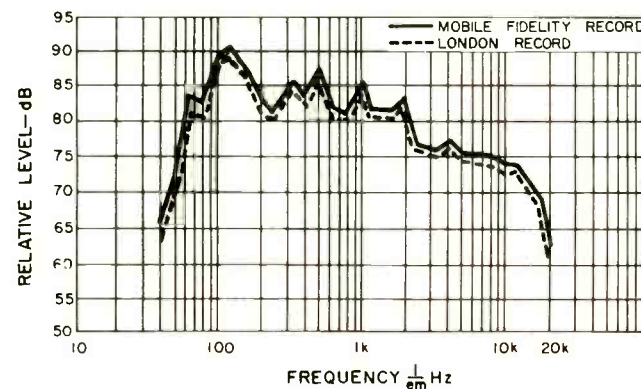



Records. (The Mobile Fidelity disc number is MFSL 1-006). These curves represent the peak energy reached during the first 1:45 minutes of Side One. The solid line represents the Mobile Fidelity product and the dotted line the standard ABC product. One is immediately taken by the extension of frequency responses in both directions and the fact that the overall midrange level is lower by some 7 or 8 dB on the average. Miller is not fighting a level war as most domestic producers are; with the superlative Japanese processing, there is no reason to seek higher levels. Obviously, the original production favored a large midrange boost, presumably for the purposes of AM airplay. The result of this was to bring John Klemmer's tenor saxophone way to the fore, while down playing subtle percussion detail and bottom end. Mobile Fidelity's version restores the musical balance, and the result, frankly, has the impact of a new mix. (Remember the same master tape was used in both cases.)

The next pair we examined was the *Crime of the Century* by Supertramp, originally issued on A&M Records. (The number of the Mobile Fidelity reissue is MFSL 1-005.) Figure 2 shows the recorded spectrum for both versions. Again, there is an extension of frequency responses in both directions, and the level has been reduced. However, neither has been done quite to the extent we saw in Fig. 1. It is interesting to note the significant differences in responses in the top octave between 10 kHz and 20 kHz. The recorded spectra represent peak values registered during the first 2:15 minutes of Side One.

The third pair of pressings we checked showed the smallest differences between standard and Mobile Fidelity product of the entire set. It was the London Records recording of *Star Wars* and *Close Encounters* with Zubin Mehta conducting the Los Angeles Philharmonic. (The Mobile Fidelity record number is MFSL 1-008). The peak recorded spectra for the first 1:20 minutes of Side One are shown in Fig. 3. In this case, the Mobile Fidelity product is just about one dB hotter across the band. The spectra are just about identical — not surprising in as much as Stan Ricker made both transfers (the telltale SR initials are to be found in the lockout area of both discs). There is, however, a quality edge still in favor of the Mobile Fidelity product.

We have refrained from commenting on the musical aspects of this product; after all, these recordings have been available for some time and have certainly established themselves

as bestsellers. What we are addressing here is simply the technical quality of the newer transfers. All of this does raise some interesting questions about the general state of record and transfer quality as normally practiced by major U.S. labels. Brad Miller has certainly demonstrated that there is a need at the audiophile level for quality transfers and quality processing. He is proving moreover that premium prices can be charged for this product and that excellent sales levels will result. *There is absolutely nothing that he is doing with these leased master tapes that the*

*lessors themselves could not do if they had a mind to do it.* While we can enjoy, with gratitude, what Mobile Fidelity is doing, we can't help question, with some bewilderment, why the domestic industry in general doesn't take more positive steps to clean up its act. We will note in passing that many U.S. record companies, while falling short in the processing area, are investing in far better master lacquer transfers than was the case several years ago. Brad Miller's efforts underscore the remaining improvements which there are to be made.

John Eargle

# WE DARE YOU

Stop reading. And start listening. It's that simple.

Even with today's tape technology, there's no such thing as an ideal tape for every machine. Only what's best for *you*. Which depends only on the sound *you* like and the response of *your* deck.

Compare specs if you wish — we'll match ours against anyone else's. But we honestly think you'll be more impressed by comparing the *sound* of our FX-I or II to that of any other premium cassette.

Visit your audio dealer and take the Fuji challenge.

## FUJI

Magnetic Tape Division  
of Fuji Photo Film U.S.A., Inc.  
350 Fifth Avenue,  
New York, New York 10001

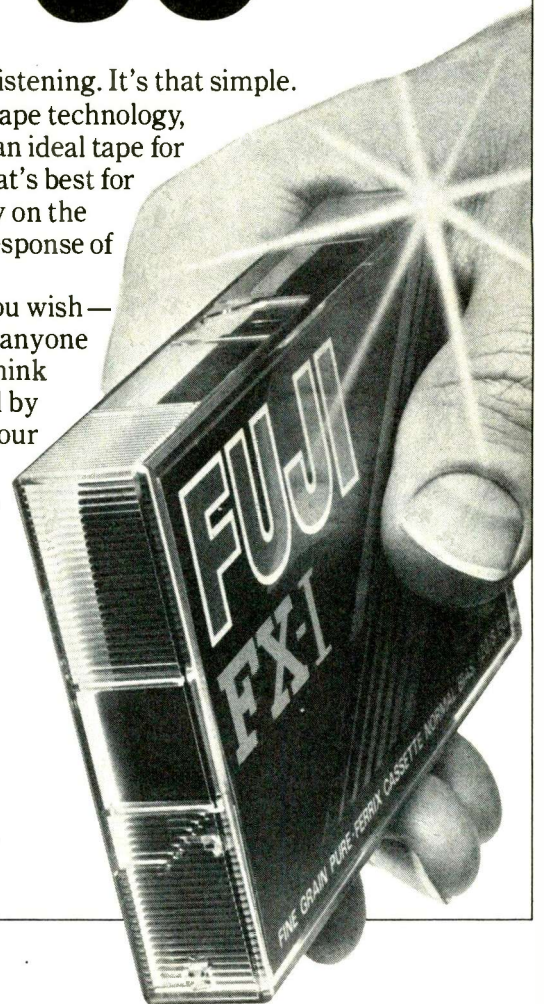

**Just Friends:** L.A. 4

**Concord Jazz CJD-1001**, direct-to-disc, \$15.00.

**Straight Tracks:** Great Guitars

**Concord Jazz CJD 1002**, direct-to-disc, \$15.00.

**Autumn:** Tommy Tedesco

**Trend TR-514**, direct-to-disc, \$14.95.

The direct-to-disc method of recording has certainly found some fervent adherents in the West Coast school of jazz. These musicians play in a style that is marked by even, swinging tempos, clean articulation, technical precision, and snappy melodic improvisations. I picked this trio of records because they have all the above in common and, in addition, they feature guitarists.

The hottest record here is the L.A. 4. It's hot not because it features the acoustic guitar of Laurindo Almeida, but because there are two other strong voices in the quartet, alto saxophonist Bud Shank and bass player Ray Brown. They give **Just Friends** a texture and thrust that is lacking in many West Coast records. Shank's tone is so pure that even at his highest level of intensity (and these guys never get that intense), he maintains a crispness and transparency that is perfectly captured by the DTD process. Ray Brown is a bassist with a muscular, full-bodied sound. He maintains a dialogue between the drums and Shank that often make Almeida's background comping superfluous. Almeida's presence is felt most strongly in his solo spots, and his lyricism dominates the baroque *Nouveau Bach* based on Bach's *Pre-*

*lude in C Minor*. His unaccompanied segment on *Spain* finds every nuance intact with no loss of dynamics when he emerges from the ensemble mix.

**Straight Tracks**, another Concord Jazz recording, was also produced and engineered by the same people, Carl E. Jefferson and Phil Edwards respectively, so it shares many basic characteristics with **Friends**. The mix here is marked by a sharp separation between instruments with the leads split on the left and right, drums spread across both speakers and the bass smack in the middle. There's also a dryness in the recorded sound which I don't find all that alluring. In their dependence upon the natural ambience of the room, they don't lose much presence, but they are lacking in sonic punch.

With **Great Guitars** I expected to find an interesting contrast between Charlie Byrd's acoustic guitar and the electrics of Herb Ellis and Barney Kessel. Although there's no mistaking the three guitarists, only Kessel uses the electric guitar for its special tonal qualities. And on **Straight Tracks** he's very subdued. Their sounds are distinct,

whether from Byrd's classical intonations, Kessel's subtle nuances, or Ellis' lightning fingerings. Joe Byrd's electric bass does get lost in the shuffle at times, however. But Wayne Phillip's drums have a sharp attack and a lovely roundness to their tone.

Tommy Tedesco is yet another West Coast session musician with formidable chops. **Autumn** features him playing electric guitar on one side and acoustic on the other. There's so little difference in his approach to either instrument, I wondered why he even bothered trying. Of the three records, this one is the most lackluster recording. Both the bass and drums lack depth, and Jon Kurnick's rhythm guitar is almost an annoyance with his choppy attack. At two points during *Dolphin Dance* I heard a brief dip in the left channel levels that was disturbing, particularly when I listened on headphones.

**Just Friends**, **Straight Tracks**, and **Autumn** are all records cut from the same cloth. They couple musicians and their highly developed techniques with state-of-the-art recording. In spite of all this they make music that is neither offensive nor uplifting. It's simply enervating and doesn't matter.

Though the records of Concord Jazz and Discovery, Trend's parent company, are normally available in record stores you might have to write to them for these limited-edition, direct-to-disc recordings: Concord Jazz, P.O. Box 845, Concord, CA. 94522; Trend, Box 48081, Los Angeles, CA. 90048.

John Diliberto

Just Friends

Sound: A

Performance: B-

Straight Tracks

Sound: A

Performance: C

Autumn

Sound: B+

Performance: C-

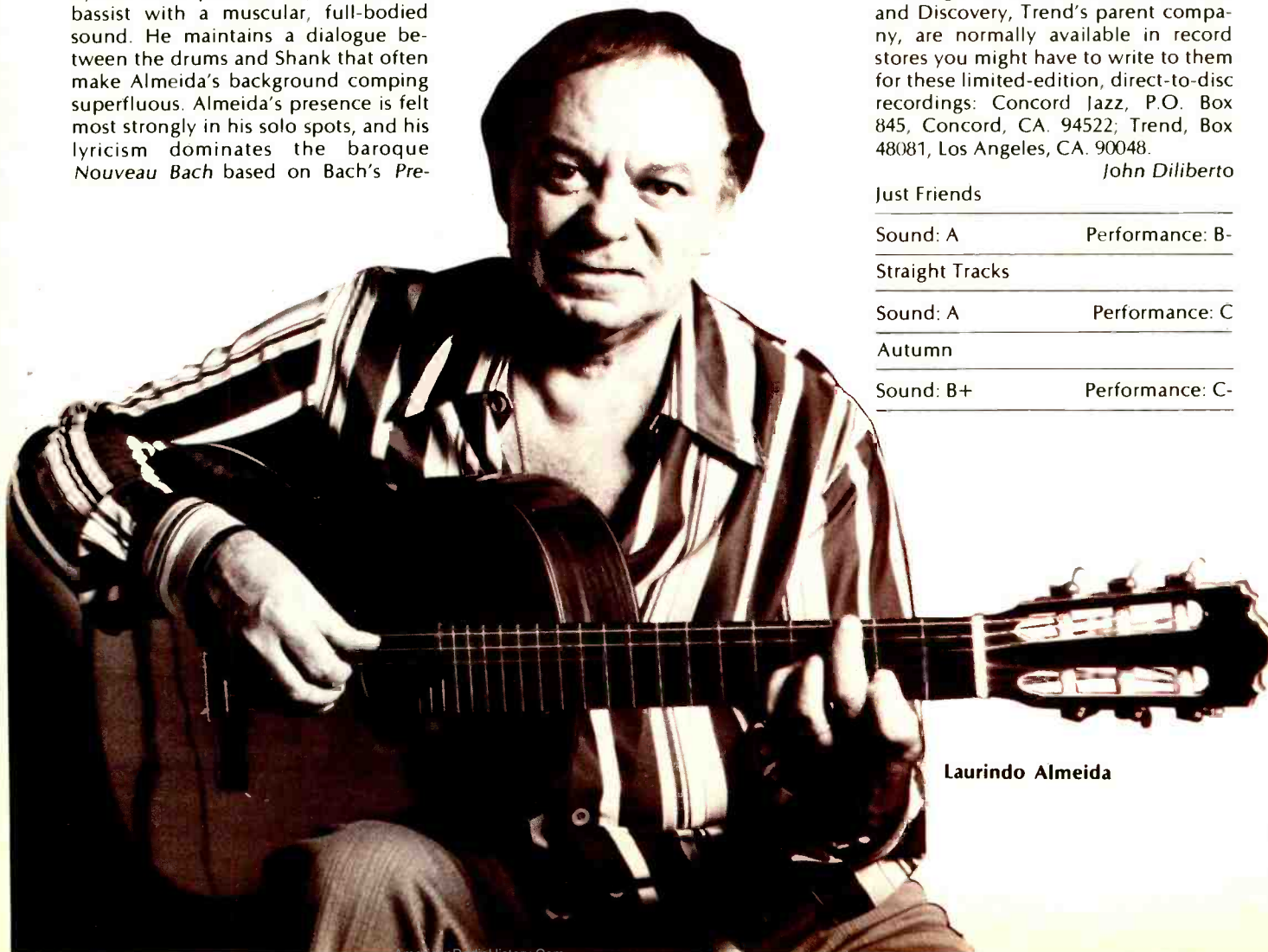

Laurindo Almeida



### Live from Beautiful Downtown Burbank: Tommy Newsom

Direct Disk Labs DD-108, stereo, \$14.95.

For those of you who are regular watchers of the Tonight Show and are Big Band fans, one of your more frustrating moments must be when the show comes back from a commercial break, just in time to hear the band playing the last few bars of an arrangement that has the audience stamping and shouting. Then Johnny makes things worse by saying something like "It's too bad you folks at home can't hear how great the band sounds tonight."

Well, your frustrations are over. Direct Disk Labs has now released an entire album featuring the Tonight Show Band, led by Mr. Excitement himself, Tommy Newsom.

All kidding aside, this is one of the most natural sounding D-D albums to land on my turntable in recent weeks. Most of the non-classical D-D albums I've heard have been multi-mike recordings made in acoustically dead studios, the notable exception being Sheffield's single-stereo-mike recordings of Harry James.

With this recording, however, Direct Disk Labs has chosen a "middle road" approach by using multiple stereo mikes (aided by an occasional spot mike) in a large recording environment (Capitol's Studio A) and made liberal use of Capitol's famous "natural" reverberation chamber. (No steel plates or springs; instead, a series of interconnecting rooms, driven by loudspeakers, with the reverb picked up by strategically placed mikes.) The result is a recording with an excellent sense of space that holds up even when played back via headphones.

The pressing was excellent and, unlike many direct disc recordings which are pressed in West Germany or Japan, it was pressed in the U.S. The only anomaly I noticed was a very faint hiss that was probably due to the plating process. But let me hasten to emphasize that this hiss was not audible during music passages but only during the rather long pauses between selections. When the overall pressing quality is high, the slightest defects become noticeable.

The jacket notes list Dr. Thomas Stockham as part of the engineering team (he seems to be everywhere these days) which indicates that Direct Disk Labs (as have others) has made a digital safety recording of these sessions. There was also a note stating the disc was also in dbx-encoded form. Now that's interesting! While dbx-en-

Quality. Uncompromised.

# ROTEL

from the 2000 Series:  
The Basic Threesome—for very high standard  
music control center

## THE HEART AND SOUL OF SOUND

**RT-2100** FM Stereo Tuner  
with Quartz PLL tuning and  
built-in Dolby FM.

**RC-2000**  
FM Stereo DC Control  
Amplifier with built-in  
MC headamp.

**RB-2000**  
Stereo Class AB/DC  
Power Amplifier.  
120 watts per  
channel at 8Ω,  
20 to 20,000  
Hz with  
< 0.01%  
THD.

Dolby is a trade  
mark of Dolby  
Laboratories, Inc.

ROTEL OF AMERICA, INC.  
1055 SAW MILL RIVER ROAD,  
ARDSLEY, NEW YORK 10502  
(in Canada—WHITE ELECTRONICS, Malton, Ontario)



Enter No. 28 on Reader Service Card

# CONSTANTLY BETTER

Pioneer  
RT 701

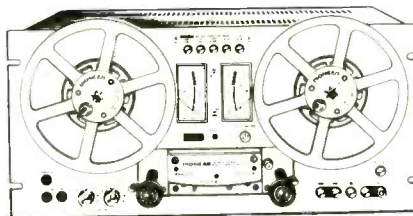

**\$377**

**PIONEER**

CALL Weekdays 9-6  
Saturdays 9-5

**WDS**  
WISCONSIN DISCOUNT  
STEREO

2517 Whalen Lane Madison, Wisconsin 53713

Over 60 Brands like:

|          |        |      |          |
|----------|--------|------|----------|
| Technics | Maxell | Sony | AKG      |
| Pioneer  | Empire | Teac | EV       |
| Marantz  | Altec  | Akai | JBL      |
| Kenwood  | Sharp  | Dual | TDK      |
| Sansui   | Sanyo  | Koss | Audio    |
| Jensen   | Shure  | DBX  | Technica |

TOLL FREE  
800-356-9514



coded discs have been available for some time, none of them have been also direct-cut discs. Producer Joe Overholt informs me that all previous Direct Disk Labs recording sessions have also been cut in dbx encoded form. During the sessions, one of the lathes has had its signals dbx encoded before being fed to the lathe electronics.

As of this writing, none of the dbx direct discs have been released but this situation may change soon when dbx begins production of their proposed low-cost decoder. The use of dbx should not only remove any traces of noise on the disc, but it will also permit the length of a side to be increased to over 20 minutes since the recorded signal is compressed 2:1.

I hope to review the dbx version of this recording when it becomes available.

Charles P. Repka

C.P.E. Bach: **Cello Concerto No. 3 in A major**; Josef Haydn: **Cello Concerto in D major**. London Chamber Orch., Paul Tortlier, cond. **Unicorn/Barclay-Crocker UNC D 0207**.

Bernard Herrmann: **String Quartet "Echoes,"** The Amici Quartet; **Clarinet**

**Quintet-Souvenirs de Voyage**, The Ariel Quartet, Robert Hill, clar. **Unicorn/Barclay-Crocker UNC D 0337**.

The Unicorn label has not been well known in the U.S. but this has not been true of their recordings, which have been available over the years on Nonesuch, Musical Heritage Society, HNH Records, and are now available in open-reel form from Barclay-Crocker in New York.

These two recordings present two completely different recording perspectives, which is a bit unusual for a small record label such as Unicorn. The smaller companies very often have equally small production and engineering staffs which results in a consistent "sound" to their recordings... This is not the case here. The cello concerti have been recorded with an up-close, highly detailed perspective, much more of an American approach to recording than I expected from this English company. Let me hasten to add that this is by no means objectionable. The overall music and the sense of space are excellent, as are the performances by the London Chamber Orchestra and their conductor/soloist, Paul Tortelier. The tape duplication is up to Barclay-Crocker's usual high standards.

The Bernard Herrmann tape has a more distant and diffuse quality, which is in perfect harmony with the quiet, introspective character of the music. Most of us are familiar with Bernard Herrmann's music from his film scores but few of us have heard (or are even aware of) his "serious" music compositions. These hauntingly beautiful works are in complete contrast to the bombastic music usually associated with him.

This particular recording allows us to hear the high-quality nature of Barclay-Crocker's tape duplication. The *Echoes Quartet* was recorded in 1966 without the benefit of Dolby A noise reduction. As a result, some slight tape hiss is audible. The *Quintet* was recorded eight years later, in 1974, with the same engineering crew but this time equipped with Dolby A electronics, which produced a recording with a greatly reduced background noise. The fact that this difference is still noticeable pays tribute to Barclay-Crocker's careful processing and quality control. High marks should also be awarded to recording engineer Bob Auger who has provided us with remarkably similar sound in these two works in spite of the eight year hiatus between sessions.

Charles P. Repka

# CORELLI, CALINDA AND CANTATA

Each of these popular loudspeakers is an excellent example of the KEF total system design approach, whereby the drive units, the cabinets and the electronic circuits are developed together, using the computerised digital analysis techniques which KEF pioneered. The Corelli, designed for shelf mounting, offers remarkable bass performance and surprisingly high power handling from such a compact system. The Calinda and Cantata are tall, elegant floor-standing loudspeakers with a special arrangement of the drive units which give a truer frequency response, greater clarity and a sharper stereo image than any previous speakers of comparable size.

And because we make all our own drive units, we can offer a consistency in manufacture and performance which is unrivalled in the Hi-Fi industry.

Write for literature and the name of your nearest dealer.

KEF Electronics Ltd., US Distributors Intratec,  
PO Box 17414, Dulles International Airport,  
Washington DC 20041.

**KEF**  
The Speaker Engineers

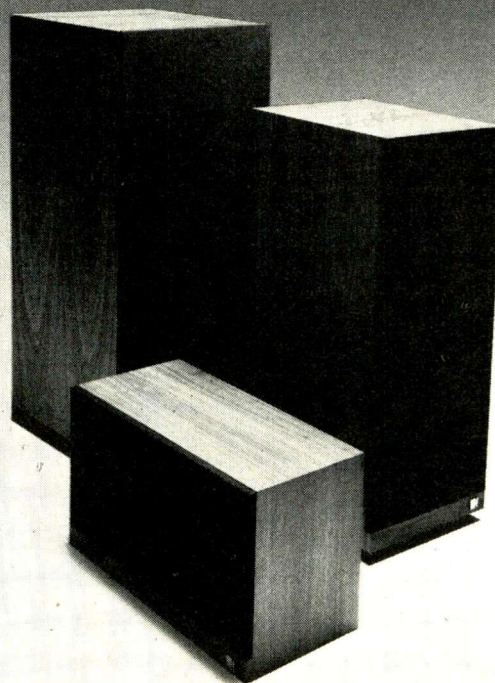

Enter No. 13 on Reader Service Card



# Folk bag

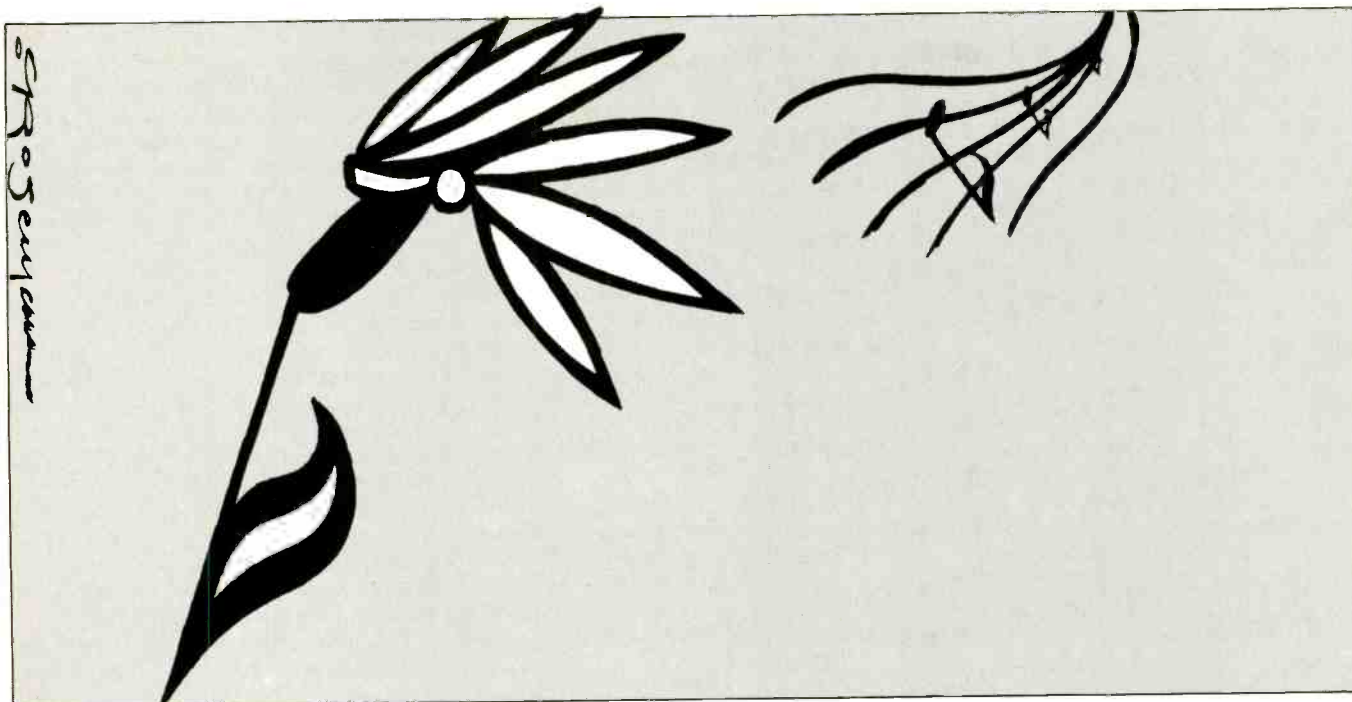

## Navajo Sway Songs

Indian House 1501, Mono \$7.98.

## Night & Daylight Yeibichei

Indian House 1502, mono, \$7.98.

## Navajo Skip Dance & Two-Step Songs

Indian House 1503, mono, \$7.98.

These three albums are part of an extensive series of recordings of traditional Navajo music on the Indian House label. All three are by groups from Klagetoh, Arizona, led by Boniface Bonnie.

Although Navajo singing is far less intense than the blood-curdling falsettos of Indians from the Great Plains, it can hardly be considered less emotional. The singers heard on these albums have a way of cutting notes short so that they seem to get caught in the adam's apple, creating a dynamic tension that's quite unique. Whereas Plains songs tend to start at the top of the scale and tumble downwards, Navajo tunes are built on a reiterated bottom tone, above which the rest of the melody is intoned with subtle rhythmic jerks and twists. The group singing is entirely in unison, as harmony is a concept alien to Native American music.

**Navajo Sway Songs** contains 42 songs (each of them much less than a minute long) associated with the Enemy

Way ceremony. (If I understand the liner notes correctly, this is a type of exorcism rite.) Don't be put off if at first most of the songs sound pretty much alike. With increased familiarity, you should begin to appreciate the melodic and rhythmic intricacies which give each song its distinctive character. The only instrument used is a drum, generally (though not always) hit squarely on the beat, sometimes skipping every fourth beat. I'd suggest the novice listener *not* tap his/her foot along with the drum, however, since the duple and triple meters common to most Western music do not apply here.

**Navajo Skip Dance & Two Step Songs** contains music for social dancing during the Enemy Way ceremony. The 24 skip dance tunes heard here are lighter, comparatively more melodic than the sway songs. The seven two-step songs are quicker-tempoed and noticeably more aggressive vocally. It's also worth noting that the drum pattern is mildly syncopated on the two-steps. Non-Indian listeners will most likely find this the most accessible of these three albums.

The Yeibichei is a more recondite healing ceremony than the Enemy Way. The songs begin with falsetto

yelps, like bird imitations. The "night" tunes are primitive chants made up of simple, tightly closed, repeated phrases. Those from the daylight ceremony are considerably more intricate and more musically developed (though remember, the purpose of the songs is to aid in healing, not to entertain outsiders). The drum is replaced by gourd rattles on the order of maracas. From a standpoint of strange and compelling listening experiences, I'd recommend **Yei-Be-Chai Songs** on the Canyon label (4143 North Sixteenth St., Phoenix, AZ 85016) over this record, though the Indian House LP is certainly a valuable document. Indian House's address is P.O. Box 472, Taos, NM 87571.

Tom Bingham

Sound: B-

Performance: A

## Easter Snow: Tim Lyons

**Green Linnet SIF 1014**, stereo, \$7.98

"Tim Lyons is one of the best singers in Ireland," says Mick Moloney on the liner notes to **Easter Snow**. If that's enough recommendation, as it is for me, then just put on the record, and sit back for a warm, smooth, subtly controlled display of *sean nos* (unaccompanied "old style") singing, replete

with grace notes, swooping slides, and lilting trills without a false quaver. The songs run from cleverly-rhymed comic verse ( *The Humors of Whiskey* ), through Irish versions of Scots ballads ( *Lord Gregory* ), some nonsense-lilting ( *Miss Walsh* ), and sweet, slow airs ( *Easter Snow* ) to satirical songs of the Irish rebellion ( *The Peeler and the Goat* ) and tongue-in-cheek eulogy ( *The City of Mullingar* ).

Of course, one's enjoyment of the album might be heightened by having heard Mick Moloney himself performing some of these songs, and contrasting Mick's workmanlike versions with these lovely things. But even if you've never heard Moloney, this album stands on its own as a fine example of the revival of old music among young Irishmen. Celebrate the tradition; thanks to people like Tom Lyons, it's in full flower again.

The sound, by the way, suffers somewhat from the conditions of field recording, with some faint pre-echo and even what sounds like parallel singers to be heard faintly in the background at various points, notably at the beginnings of songs, but also during some of the pauses in the singing. Blame Patrick Sky, who recorded it, but don't let that put you off Tim Lyons' singing. Available from Innis-

free-Green Linnet Records, 70 Turner Hill Rd., New Canaan, CT 06840.

John McLaughlin

Sound: B-

Performance: A+

**Mick Moloney with Eugene O'Donnell**  
**Green Linnet SIF 1010**, stereo \$7.98.

Ireland has contributed dozens of first-rate artists to America's ever-expanding traditional-music revival, but few as unabashedly multi-talented as Philadelphia's Mick Moloney. Moloney's Green Linnet debut is so filled with memorable instrumental performances, elegant singing, and superb material, it's too good to be true.

Of all of Moloney's talents, none is so astounding as his matchless tenor banjo picking. Moloney replaces the unyielding inflexibility associated with many Irish banjoists with a light, supple, rhythmic resiliency. His triplet ornamentations have a crisp, dancing snap that's truly unparalleled. His quick, agile touch on mandolin is equally unique and thoroughly engaging.

His guitar accompaniments are sensitive, carefully formulated, and beautifully executed. His break on *The Limerick Rake* is decorated with the same triplets which enliven his banjo and mandolin work. His use of the Greek

bouzouki (an increasingly audible component of the Irish-music scene) adds novel and refreshing chordal textures. On *West Limerick Medley* and *John of Dreams* (a contemporary song based on Tchaikovsky's *Pathetique Symphony*), it has an effect not unlike strummed harpsichord strings. Moloney is also an excellent singer with a strong sense of lyrics, thoughtfully phrased, and neatly embellished.

Moloney's "co-star," fiddler Eugene O'Donnell, contributes much to the album's success. His slow air, *Killin's Fairy Hill*, is so impassionately wistful, it can't help but bring a tear to your eye. His sweetly mellow tone and smooth bowing on the dance tunes augurs well for his forthcoming Green Linnet album of set dances.

Joe McKenna (uilleann pipes, tin whistle), producer Patrick Sky (tin whistle), and Shelly Posen (guitar, concertina, harmony vocals) also add much to the album. McKenna in particular shines on an intricate pipe-banjo duet (*Sean Reid's Reel/Toss the Feathers*) with Moloney. The horn-pipe set opening side two is arguably the best of the expanded-ensemble tracks, an inspired combination of irrepressible melodies, springing rhythms, and striking tone colors.

This is the best-recorded Green Linnet album I've heard yet. There's quite a bit of overdubbing (generally considered a *no-no* by folk purists), but the parts have been mixed so skillfully and naturally you'd never know the difference. The surfaces could have been quieter, though.

Available from Innisfree, Inc., 70 Turner Hill Road, New Canaan, CT 06840.  
Tom Bingham

Sound: B+

Performance: A

## GET A FREE TDK T-SHIRT WITH THE PURCHASE OF 10 AD C-90 CASSETTES.



Right now your participating TDK dealers would like to deck you out. For a limited time, if you buy 10 AD C-90 cassettes from them, they'll give you an "Excellent Response" t-shirt, free. TDK AD is the cassette with the "hot high end."

For use in your car, where highs are hard to come by, its performance is unequalled. In your home system or portable it will deliver the crisp, clean sound that brings your music

to life. And it's so reliable, we back it with a full lifetime warranty.\* So wherever you go, you'll have two nice things to take with you: your music (on great-sounding AD cassettes) and an "Excellent Response" t-shirt (on that gorgeous bod of yours). TDK Electronics Corp., Garden City, NY 11530



**TDK**  
Quality Recording Tape Products

\*In the unlikely event that any TDK cassette ever fails to perform due to a defect in materials or workmanship, simply return it to your local dealer or to TDK for a free replacement.

Enter No. 48 on Reader Service Card



Ridge, Michael Cooney's Yankee-style *Lady Isabel and the Elf Knight*, and De Danann's riproaring Irish dance medley, to Kate Wolf's clean and lovely singing of Paul Seibel's *Then Came the Children*, John Jackson's wicked *Step it Up and Go*, and newly married Odetta's triumphant *I Gotta Be Me*. And that's just the first side.

The second side comprises Dave Van Ronk's squeaky-voiced *Green, Green Rocky Road*, Lou Killen's masterful conducting of the crowd in *All for Me Grog*, a rollicking *Wild Goose Chase* from Roger Sprung's Progressive Bluegrassers, Debby McClatchy's dirty song from A. L. Lloyd *A Little Piece of Wang*, and the tight jazz of the Lew London Trio in Gershwin's *Glory of Love*. The finale was the Highwood String Band's twin-fiddling bounce to *Dance All Night*, in which they're accompanying the Green Grass Cloggers, whose shuffling boots can be heard tromping along throughout, getting you in the spirit.

If you missed it the first time, it will give you some sense of what you missed; if you enjoyed the 1977 Philadelphia Folk Festival, it's a pretty good souvenir. Cleanly recorded on site, it's another in Bruce Kaplan's series of festival recordings, fit to place next to his Telluride anthology (FF-068) and the New Grass Revival album also recorded at that Colorado Festival in the Summer of 1977. Maybe this year he'll get up to Massachusetts and cut an album of the 8th Annual Eistedfodd. Available from Flying Fish Records, 1304 W. Schubert, Chicago, IL 60614.

John McLaughlin

Sound: A Performance: A/B

**Shady Gove; Gove Scrivener**  
**Flying Fish 048**, stereo, \$7.98.

It must be 12 years back now. I was singing in a coffeehouse outside of Baltimore when a terrific blues singer, then based in Virginia, appeared on our little scene and became something of a treasured irregular. In '71 or '72 he put out an album on a now defunct label and then vanished from my experience.

With **Shady Gove**, Gove Scrivener has returned, true to himself, with a delightful, exuberant album free of pretense. Gove's main collaborator on the album is Doc Watson. His presence adds a glow to the album especially on the two instrumentals he and Gove play together, the graceful *Minuet for the Backroads* and the tour de force *Pigeon River Breakdown*. Other assists come from John Hartford, Buddy Emmons, and David Briggs among others.

AUDIO • May 1979

Mistake me not . . . this is Gove's album. His personality, voice, excellent playing, and tastes are the album's core. Co-produced by Gove, Mike Melford, and Ernie Winfrey, the project has a warm, relaxed atmosphere with prominent acoustic textures.

Michael Tearson

Sound: B Performance: B+

**Tahuantinsuyo, Music of the Andes**  
**Adelphi AD 3001**, stereo, \$7.98.

Tahuantinsuyo is a Quechua word, the name the Incas gave their empire, and it's also the name of this trio of South Americans living in New York. Their music is traditional with some Spanish accents, wonderfully melodic and rhythmic music of the spirit.

For the record they have used environmental sounds as bridges between selections and to provide perspective. In the studio their music carries them, transports them so that little squeals of joy that the playing evokes are part of the music. The natural feel is intact. However, my pressing had an unfortunate number of pops and clicks on the outer third.

Some years back Paul Simon used a South American group called Urubamba on his live album for *El Condor Pasa*, *The Boxer*, and *Duncan* and subsequently produced a wonderful album by them (Columbia KC 32896). **Tahuantinsuyo** is similar, but a bit more street-conscious.

Michael Tearson

Sound: C+ Performance: A

**The View from Home: Bryan Bowers**  
**Flying Fish FF-037**, stereo, \$7.98.

Autoharp virtuoso Bryan Bowers' first album is a low-keyed homespun one. It includes several instrumentals, some solo and some duets, and three with the more elaborate support of the Seldom Scene and the Newgrass Revival. There are also three vocals with accompaniment, and one *Walkin' in Jerusalem* sung à capella with Steve Goodman and Jim Post.

I don't think of the autoharp as a solo instrument, but Bowers pulls it off as he picks melodies complete with counter parts, dazzling stuff. But his consummate skill is no mere flash in the pan, and his love of tradition tempers his music with a real humanity.

As the title suggests, **The View from Home** is a very personal album of favorites played with the company of friends, played with distinction, and played with love. It is very warm and very real.

Michael Tearson

Sound: B Performance: A-

**8 IMPORTANT REASONS WHY MORE PEOPLE BUY TOP QUALITY EQUIPMENT FROM INTERNATIONAL HI-FI THAN ANY OTHER MAIL ORDER COMPANY**

**MORE THAN 80,000 CUSTOMERS NATIONWIDE**

1. Guaranteed lowest price . . . you pay same price many dealers pay.
2. No-risk, no-deposit . . . phone orders shipped C.O.D. or Credit Card.
3. Same day shipping when ordered by 1 p.m.
4. Seven audio advisors provide professional help for the inexperienced buyer.
5. Fully insured shipments plus full manufacturers' warranty.
6. Exclusive "no lemon" guarantee.
7. Fully staffed customer service department.
8. Over 70 top name brands . . . equipment most mail order and discount dealers can't supply.



**CALL NOW**  
**(301) 488-9600**  
**Mon.-Fri. 9-9, Sat. 9-4**

Write for: • Brochure with prices and lines  
• Tips on buying by mail

**International Hi-Fi Distributors**  
Moravia Center  
Industrial Park Dept. A5  
Baltimore, Maryland 21206

Enter No. 10 on Reader Service Card

**Special Offer!**

**ADENT 4-WAY SPEAKER SYSTEM \$99.88/Pr. SAVE 75%**

Cabinet, mid-range, speaker, woofer, passive radiator, 2-4 1/2" super horn, Piezo Tweeters, terminals grill cloth, wire, acoustic dampening material, hardware, & instructions etc. Freq. resp. is 30 Hz TO 25,000 Hz., 60 watts max. power. Sh. Wt. 98 Lbs. (3 Pkgs.)  
\* Use this great speaker system for big band speakers, monitor speakers, all around music speakers or with "DISCO" systems. Don't delay - These will go fast! Seconds, Nick's, Chips, Cab. Structurally sound - you finish & save!  
9110123 . . . \$99.88/pr.  
20 pr. for \$1,698.88 . . . 9110123



**PRES. 4-STUDIO SYSTEM KIT SAVE UP TO 78%**

Freq. Resp. 28 HZ. TO 25 KHZ., power min) (10/100) x-over freq. (1000 HZ), woofer (10" dia., 2" voice coil, mag. Wt. 40 oz., foam edge, F.S. 25 HZ, passive radiator (12" dia., Mid-range 5" dia., 1" voice coil, mag. wt. 9 oz., Ferro Fluid Damped, F.S. 550 HZ), tweeter, 3/4" Super Horn Piezo 3 KHZ TO 25 KHZ, (grill, (foam) dimensions: 42" Hg. X 15" X 13 1/2" Dp. Sh.Wt. 75 Lbs. each  
9310105 . . . \$298.88/Pr.  
6 Pairs for \$1,588.88 . . . 9310105 . . . \$1,588.88/6



**GEN11 LOUDSPEAKERS**

Full size speaker system with full size sound - yours for only \$68.88 per pair. Build these kits yourself & save 80%! The cabinets have slight dents, vinyl de-laminations. Cabinet size is 25 1/2" Hg. X 14 1/2" W X 11 1/2" Dp. Speakers: 8" woofer, 10" passive radiator, 3/4" super horn tweeter, real wood cabinets, dampening, X over terminals - 75 Watts Freq. Resp., 25Hz. To 22kHz., X over 3.5KHZ. Size: 26 Hg. x 15 W X 12 1/2 Sh. Wt. 98 Lbs. (2 Pkgs) 9310091  
9310105 . . . \$198.88/Pr.  
6 Pairs for \$1,088.88 . . . 9310091 . . . \$1,088.88/6 Pair



**4-WAY SPEAKER KIT**

Save 70% Off List Price - This fabulous system regularly sells for \$688.00/Pair - But we offer you a much, much lower price by having you DO-IT-YOURSELF & you save big! Yours in kit form for only a fraction of the original cost \$198.88. Specs - 8" woofer, 10" passive radiator, 3/4" mid-range, 3/4" super horn, Piezo tweeter, real wood cabinets, dampening, X over terminals - 75 Watts Freq. Resp., 25Hz. To 22kHz., X over 3.5KHZ. Size: 26 Hg. x 15 W X 12 1/2 Sh. Wt. 98 Lbs. (2 Pkgs) 9310091  
9310105 . . . \$198.88/Pr.  
6 Pairs for \$1,088.88 . . . 9310091 . . . \$1,088.88/6 Pair



**B&F ENTERPRISES DEPT. 10% -SR-5**  
119 Foster Street Peabody, Mass. 01960  
Phone Orders - Charge It! (617) 531-5774 AE-MC-Visa

TERMS: Add Postage. VISIT OUR NEW STORE!  
NO C.O.D.'s please So. Willow St. (near Woolco) Manchester, N.H.  
SEND FOR OUR FREE CATALOGUE  
SAY "STEREO REVIEW & GET 10% OFF THESE ITEMS"

Enter No. 3 on Reader Service Card

# Jazz & blues



**Stormy Blues:** Billie Holiday  
Verve 2-2515, mono, \$7.98.

This double-set is the second group of Verve reissues devoted to all of the recordings Holiday made for Norman Granz in the early and mid-50s. The first Verve volume covered many splendid sessions made with top-notch jazz groups for the Clef and Verve labels between 1952 and 1954, and this set continues the sessions through 1955. Lady Day's work for Norman Granz was neither from her first great days nor from her very last ravaged ones. On the February 14, 1955, date, where she receives superb support from clarinetist Tony Scott, tenor man Budd Johnson, and trumpeter Charlie Shavers, the Holiday vocals on *Everything Happens to Me*, *Ain't Misbehavin'*, *Say It Isn't So*, and *Always*, show a marked deterioration of vocal quality, and yet it is precisely because of this that her performances cut very deeply. On these tracks and on the cuts taken from the August and September, 1954, sessions, her vocal cords, darkened and coarsened by her losing battle with drugs, project an anguished beauty.

Indeed, the mood conveyed throughout this Verve collection might be described as gloomy, with Lady Day projecting her unique brand of tautly emotional feeling. Her musicianship, of course, remains impeccable. Like the expressive, resourceful jazz artist she was in the 30s, she can still create swinging variations on a tune like *I Wished on the Moon* or re-fashion melodic patterns on songs like *Gone With the Wind*, *Prelude to a Kiss*, and *I Don't Stand a Ghost of a Chance With You* — raising a note, adding an accent, or delaying a phrase. Moreover, she gives these songs a depth and a meaning they have not received before or since. On these sides Holiday works with all star jazz men, most of them old friends like Harry Edison, Willie Smith, Barney Kessel, Jimmy Rowles, and Benny Carter, who add deft instrumental accompaniment and sensitive obbligatos to her songs.

The remastering from the original Verve tapes is excellent; the mono hi-fi sound is crisp and sparkling.

John Lissner

Sound: B

Performance: A

**Philly Mignon:** Philly Joe Jones  
Galaxy GXY-5112, stereo, \$7.98.

Philly Joe Jones should need no introduction as the drummer with Miles Davis in the '50s, who synthesized the styles of Max Roach and Art Blakey into a personal musical expression. But it's been just recently that Philly Joe has committed his skills to vinyl. This is his first U.S. date as a leader in years and as such, serves as its own introduction.

**Philly Mignon** is an unambitious record that gives Philly Joe a chance to stretch out in his most comfortable style, be-bop. With contemporaries like Nat Adderley, Dexter Gordon, and Ira Sullivan, plus Ron Carter and George Cables, he rips through some bop standards beginning with Charlie Parker's *Confirmation*. Philly Joe shows you right away that the intervening years have not meant a loss of chops. He shoots off rim-shots, bombs, and high-hat riffs in a constant shift of percussive inflections. Ira Sullivan takes the lead with a strong melodic solo on tenor.

But the album never really cooks with any intensity. Dexter Gordon's two leads on *Neptunis* and *Polka Dots and Moonbeams* are skillfully wrought

AUDIO • May 1979



with those soft-shoe nuances that only Dexter is capable of. But for out-and-out smoking, multi-instrumentalist Ira Sullivan is the one to look for on this session. Dexter's stoned narration that introduces *Polka Dots* is a gas however.

**Philly Mignon** is excellently recorded with Jones' drums crisp and resonant and the rest of the unit with a live presence. The album places Philly Joe where he'll feel most at ease. The result is music that takes no chances. After all, while everyone else has moved on, Philly Joe still lives in Philadelphia.

John Diliberto

Sound: A-

Performance: B-

**Muddy "Mississippi" Waters Live:**

Muddy Waters

**Blue Sky JZ 35712**, stereo, \$7.98.

The current series of Muddy Waters albums under Johnny Winter's auspices (he has produced the new live one, too) have been some of the best, most swinging work Muddy has done in ages. His band has been mostly his seasoned road band with well selected guests like Winter and James Cotton, both of whom appear on the live album. The material has been an excellent mixture of vintage and new, and again so is the live set. *Mannish Boy* is a perfect set opener, whipping up some spirit in the crowd and the

players. *She's 19 Years Old* sounds just mean. Standards like *Baby, Please Don't Go* and *Nine Below Zero* stand up well against the more recent *Howling Wolf*, the hot *Deep Down in Florida*, and *Streamline Woman*.

A *Village Voice* critic has called the blues not a dying but a dead artform. I can't agree . . . not with stuff as lively as this and Albert Collins' new one on *Alligator* coming out. Not with the success of the Blues Brothers, admittedly a white imitation (good, though) repeating history by taking the form and making the biggest splash.

What matters is the life in the grooves, and the grooves have it. With the mechanical sound of mellow rock and disco dominating, good old blues and rhythm & blues sounds, with the big backbeat, sound better than ever. I think it is the music's economy that makes it timeless.

Which brings us right back to Muddy Waters' new live album. Okay, so Winter gets kinda carried away sometimes, but the guy is working with a legend, a childhood hero on equal ground, and that can be awesome. He is blowing the best he ever has on Muddy's records.

What matters the very most of all is that the music gives me something I can feel.

M.T.

Sound: B

Performance: A

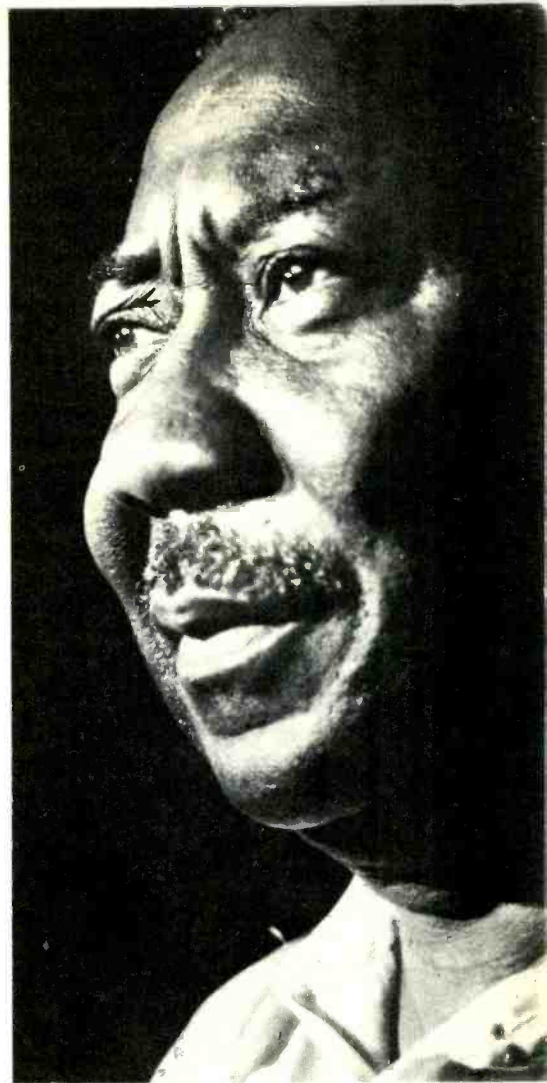

**New Orleans Heat:** Albert King  
**Tomato TOM-7022**, stereo, \$7.98.

On records Albert King has been erratic, sometimes gritty and true,

sometimes downright silly and sometimes tragically miscast . . . but I think we've got something here.

For **New Orleans Heat**, Albert went

down to Allen Toussaint's Sea-Saint Studios in the Crescent City where Toussaint produced it and co-engineered with Cosimo Matassa whose track record goes back to Fats Domino's earliest and beyond. Toussaint surrounds King with some great players including ex-Meters George Porter (bass) and Leo Nocentelli (guitar), the legendary Wardell Quezergue on piano and Toussaint himself on added keyboards.

The material, too, is well matched to Albert's robust style at its best. The remake of the song he made a standard *Born Under a Bad Sign* is a mighty good start. Adroitly selected songs include the Lee Dorsey hit *Get Out of My Life, Woman* and *We All Wanna Boogie* with both handled just right. *Flat Tire, I Got Evil*, and *Angel of Mercy* are all selected from the Stax/Volt song catalogue. Nocentelli's *I Got the Blues* lets King stretch it out comfortably.

For once, an Albert King album does him right. It sounds right. The songs are right. The groove is right.

M.T.

Sound: B+

Performance: B+





**Rare Gems:** Various Artists  
**Roots TR1005**, stereo, \$7.98.

It's not unusual for bluesmen to get together between club dates and perform in informal settings. It's downright extraordinary, however, for such memorable occasions to be captured on tape and made available years later.

**Rare Gems** consists of previously unissued recordings made in Chicago during the '60s, selected by producer Norman Dayron from his personal collection. Nearly all of the musicians perform in older blues styles as opposed to the contemporary electric band blues then favored in Chicago.

From a set rich in highlights, my personal favorites include *Annie Lee/Sweet Black Angel*, a medley by Robert Nighthawk, recorded on Maxwell Street, Chicago's famed open air flea market, featuring searing electric slide guitar that ranks among the most powerful I've ever heard; two moving piano blues by Otis Spann on the death of Martin Luther King; a pleasing interpretation of Big Maceo Merriweather's *Worried Life Blues*, by one of his most talented pupils, Johnnie Jones, in a rare solo performance, and *Ugly Man Blues*, a wry look at aging by Louisiana-born Robert Pete Williams, a

prime example of his unique composing style that's aptly been likened to a "stream of consciousness" writing style.

Also represented are Little Brother Montgomery, Big Joe Williams, James Cotton, Paul Butterfield, Elvin Bishop, Reverend Robert Wilkins, Maxwell Street Jimmy, Billy Boy Arnold, J.B. Lenoir, and John Lee Granderson.

This important two-record set lists for the price of one disc and includes knowledgeable liner notes and photos of many of the artists. **Roots'** distribution of this set has been spotty at best. If you can't find it locally, contact Mr. Steve Stephens, c/o T.K. Records, 65 East 55th Street, Penthouse, New York, NY 10022.  
Roy Greenberg

Sound: C

Performance: B +

**Mel Torme Loves Fred Astaire**  
**Bethlehem 6022**, mono, \$6.98.

Here is an album, originally recorded in 1956, that testifies to Torme's overriding qualities as a vocalist. Torme has been called a musician's singer, and there is no doubt that this jazz-oriented artist, who can also play middling drums and piano, is one of the most skillful performers in the business.

Working with the Marty Paich Dekette on these tracks, he demonstrates a remarkably agile voice with an innate feeling for the flow and pulse of jazz. The Paich arrangements are lean and functional. While they may lack the drama required by more flamboyant Las Vegas-type entertainers, they are in consistently good taste and they swing. At the time these sides were made, Paich's ensembles had similarities in tone and texture to the Gerry Mulligan 10-piece band of the mid-50s. The charts still sound fresh, and it is a pleasure to hear Torme augmenting Paich's instrumental lines by using his voice as an additional horn. The vibrant Paich backgrounds add an extra dimension to such melodies as *They All Laughed*, *Cheek to Cheek*, *The Piccolino*, and *Top Hat, White Tie and Tails*.

Torme is in top form throughout, providing a lesson in fundamentals—simplicity of interpretation, meticulous regard for time and intonation, and crystal-clear diction. Some of the yowlers, screamers, and whiners who are topping the "charts" today ought to listen to this record as a refresher course in singing. The reissued mono hi-fi sound is clear and well defined.

John Lissner

Sound: B

Performance: A-

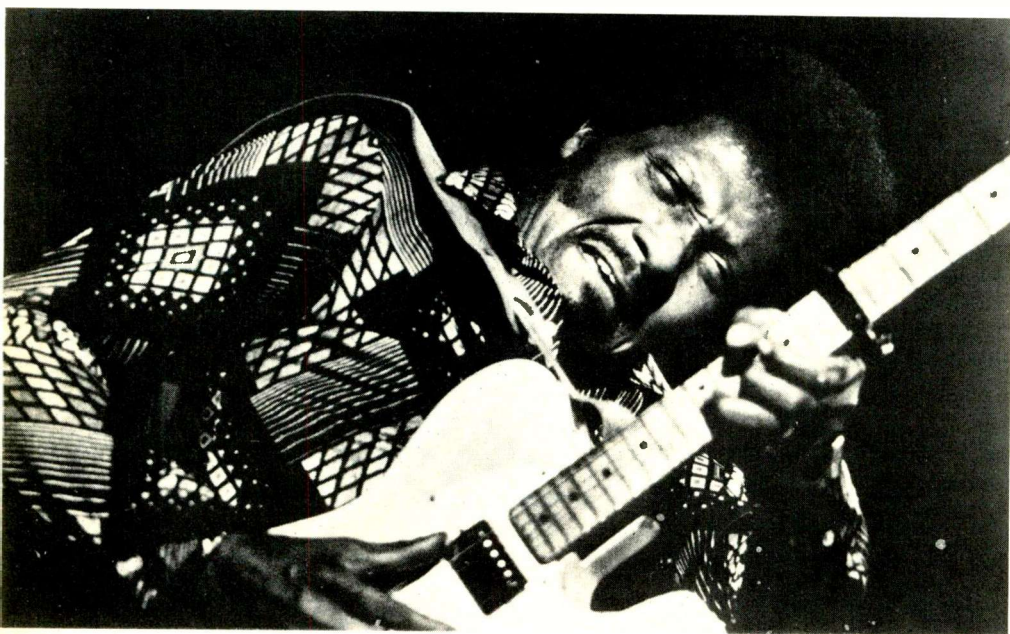

**Ice Pickin':** Albert Collins  
**Alligator AL 4713**, stereo, \$7.98.

**Ice Pickin'** is as strong an album as electric blues guitarist Albert Collins has ever cut, and should come as quite a surprise to anyone who's never seen him in concert. Most of his recordings to date took their musical direction from the early '60s driving instrumentals that were his first hits. Few of those later discs successfully captured the spirit of his initial sides, and none of them gave any indication of Collins' true scope as a modern bluesman. **Ice Pickin'** intelligently breaks with that sorry tradition by placing the Texas-born guitarist in a variety of settings that allow him to display his ample strengths as an intriguing stylist.

Collins skillfully blends such Texas roots as T-Bone Walker and Gate-mouth Brown with the inevitable debt to B.B. and Albert King into an instantly recognizable style ripe with unique personal flourishes. Compared to many of his better-known peers, Collins' sudden interjection of unpredictable riffs into his guitar breaks some-

times make his solos seem disjointed, but that's a small enough price to pay for a style that's both original and forceful.

Collins is an adequate if not outstanding singer, but turns in a moving vocal performance that complements poignant guitar work in his tribute to T-Bone Walker, *Cold, Cold Feeling*. *When The Welfare Turns Its Back On You*, a slow Chicago blues, is at times reminiscent of such innovative Windy City guitarists as Jimmy Dawkins in its shading and casual reliance on sustained tones. Rounding out the set are two of Collins' famed patented killer instrumentals, *Ice Pick* and *Avalanche*, that are a throwback to the days when such sides were his bread and butter.

Forget all about Albert Collins' dismal Imperial albums, and let **Ice Pickin'** serve as a proper introduction to a fine young bluesman.

Roy Greenberg

Sound: B

Performance: B+



# Reintroducing A World Standard...

## CBS Laboratories' STR Professional Test Records



For over ten years, the original series of these high-precision test records set a standard for the audio industry. Now the new series sets an even higher standard. It's been revised, recut and expanded.

The new series consists of eight records for professionals and one for non-professional audiophiles.

Each record contains a complete series of easy-to-use tests to help you rapidly and accurately evaluate components and systems. Even one of these records can eliminate the need for costly, additional equipment. Each will find productive use and save you hours in the laboratory, on the production line and in field testing.

Take a look at what this essential testing series contains:

**SEVEN STEPS TO BETTER LISTENING**—For only \$6.98, you can improve your system with CBS Laboratories' "Seven Steps to Better Listening." This high-precision test record enables you to make sure that your equipment functions properly . . . to tune your system to your ears and your room acoustics. Included is a detailed 16-page booklet by Audio's Edward Tatnall Canby explaining how to use the record to improve the performance of your system. With the record you can perform the following "ears alone" tests: left-right identification, phasing, loudspeaker balance, tone control setting, alternate phasing, buzz and rattle elimination, lateral tracking, and vertical tracking.

★ **STEREOPHONIC FREQUENCY TEST RECORD STR 100** Designed for the evaluation of pickups and systems. Provides a constant amplitude characteristic below 500 Hz and a constant velocity characteristic above 500 Hz. Tests include: Sweep Frequency—with the sweep rate synchronized for use with a graphic level recorder; Spot Frequency—with voice announcements; Channel Separation; Wavelength Loss and Stylus Wear—to pinpoint oversize or worn-out stylus, and excessive pickup tracking force; Compliance; Phasing; Vertical and Lateral Tracking; Tone Arm Resonance—to check system performance at low and subaudible frequencies and thus reveal undamped resonance which may cause equipment overloading.

★ **318 MICROSECOND FREQUENCY RESPONSE TEST RECORD STR 170** Provides pickup designers and recording studios with a high-level, easily-equalized signal for frequency response and channel separation measurements. The STR 170 employs a 318 microsecond characteristic corresponding to the "test" or "flat" mode common to most disc recording equipment. Constant amplitude recording is employed in the region below 500 Hz with constant velocity recording in the region above. The transition is smooth, in contrast with the STR 100 which employs a sharp breakpoint at 500 Hz. The record is suitable for use with a graphic level recorder to provide permanent, visible records for precise evaluation.

★ **SQUARE WAVE, TRACKING AND INTERMODULATION TEST RECORD STR 112** Enables detailed study of tracking capabilities of stereophonic phonograph pickups. The square wave modulation allows a rapid appraisal of stylus-tip mass, damping, and tracking. Low frequency compliance and tracking are determined by means of 300-Hz bands of progressively increasing amplitude. Intermodulation distortion measurements are made possible by graduated 200-Hz intermodulation test bands. The Str 112 has been cut with vertical angle approximating 15°, which is representative of current recording practice.

★ **WIDE RANGE PICKUP RESPONSE TEST RECORD STR 120** Makes possible the measurement of pickup response at frequencies far beyond the audible range, where elusive distortion elements can cause audible distortion. The low-frequency range includes glide-tones at twice normal level for the detection and elimination of arm resonance, loudspeaker cone and cabinet rattles. Other tests include: silent grooves for measuring rumble and surface noise characteristics; and standard level bands at 0 dB for overall system S/N measurements. This record is suitable for use with a graphic level recorder to provide permanent, visible records for precise evaluation.

★ **BROADCAST TEST RECORD STR 151** Developed especially to meet the needs of broadcast engineers, audiophiles, and other professionals seeking a convenient signal source for the testing and adjustment of all audio equipment. Tests include: phonograph pickup response and separation, speed accuracy at 33 1/3 and 45 rpm, wow and flutter, rumble and hum detection, ballistic test of V.U. meters and many others."

★ **QUADRAPHONIC TEST RECORD SQT 1100** Designed for calibration, verification, and adjustment of SQ™ decoding equipment. The record provides test bands for pickup measurements, for adjustment of decoder electronics and for channel identification and balance. Each band is described in terms of recorded characteristics and its intended use.

★ **RIAA FREQUENCY RESPONSE TEST RECORD STR 130** Provides RIAA frequency characteristics for the calibration of professional recording equipment and for testing the response of professional and consumer record reproduction equipment. This record is suitable for use with a graphic level recorder to provide permanent, visible records for precise evaluation. Spot frequency bands for use without automatic equipment are included.

★ **RIAA PINK NOISE ACOUSTICAL TEST RECORD STR 140** Designed for acoustical testing of systems and loudspeakers and for psychoacoustic tests on reproduction equipment. With the STR 140 it becomes possible to test loudspeakers in the room in which they will be used. Spot frequency tones with voice announcements facilitate the testing procedure. Continuous glide-tones in 1/3-octave bands cover the frequency range from 30 to 15,000 Hz and are synchronized with a graphic level recorder.

The original series has been unavailable for many years. Quantities of the new and improved series are also limited. So make sure you have perfect copies on hand for years to come by ordering duplicates. Fill out and mail the coupon now for immediate action.

SQ is a Trademark of CBS Inc.

Only a limited quantity are available. Be sure to order enough for many years of use.

Send me the following test records:

- Seven Steps to Better Listening (STR 101) \$6.98 each. Quantity \_\_\_\_\_
- Stereophonic Frequency (STR 100) \$10.00 each. Quantity \_\_\_\_\_
- Square Wave, Tracking and Intermodulation (STR 112) \$15.00 each. Quantity \_\_\_\_\_
- Wide Range Pickup Response (STR 120) \$15.00 each. Quantity \_\_\_\_\_
- RIAA Frequency Response (STR 130) \$15.00 each. Quantity \_\_\_\_\_
- RIAA Pink Noise Acoustical (STR 140) \$15.00 each. Quantity \_\_\_\_\_
- Broadcast test (STR 151) \$15.00 each. Quantity \_\_\_\_\_
- 318 Microsecond Frequency Response (STR 170) \$15.00 each. Quantity \_\_\_\_\_
- Quadraphonic Test (SQT 1100) \$15.00 each. Quantity \_\_\_\_\_

SEND TO:  
AUDIO TEST RECORDS  
401 N. Broad Street  
Philadelphia, Pa. 19108

AU5

Amount Enclosed \$ \_\_\_\_\_  
(Payment must accompany order)

Name \_\_\_\_\_

Address \_\_\_\_\_

City \_\_\_\_\_

State \_\_\_\_\_ Zip \_\_\_\_\_

# Classical reviews

Edward Tatnall Canby

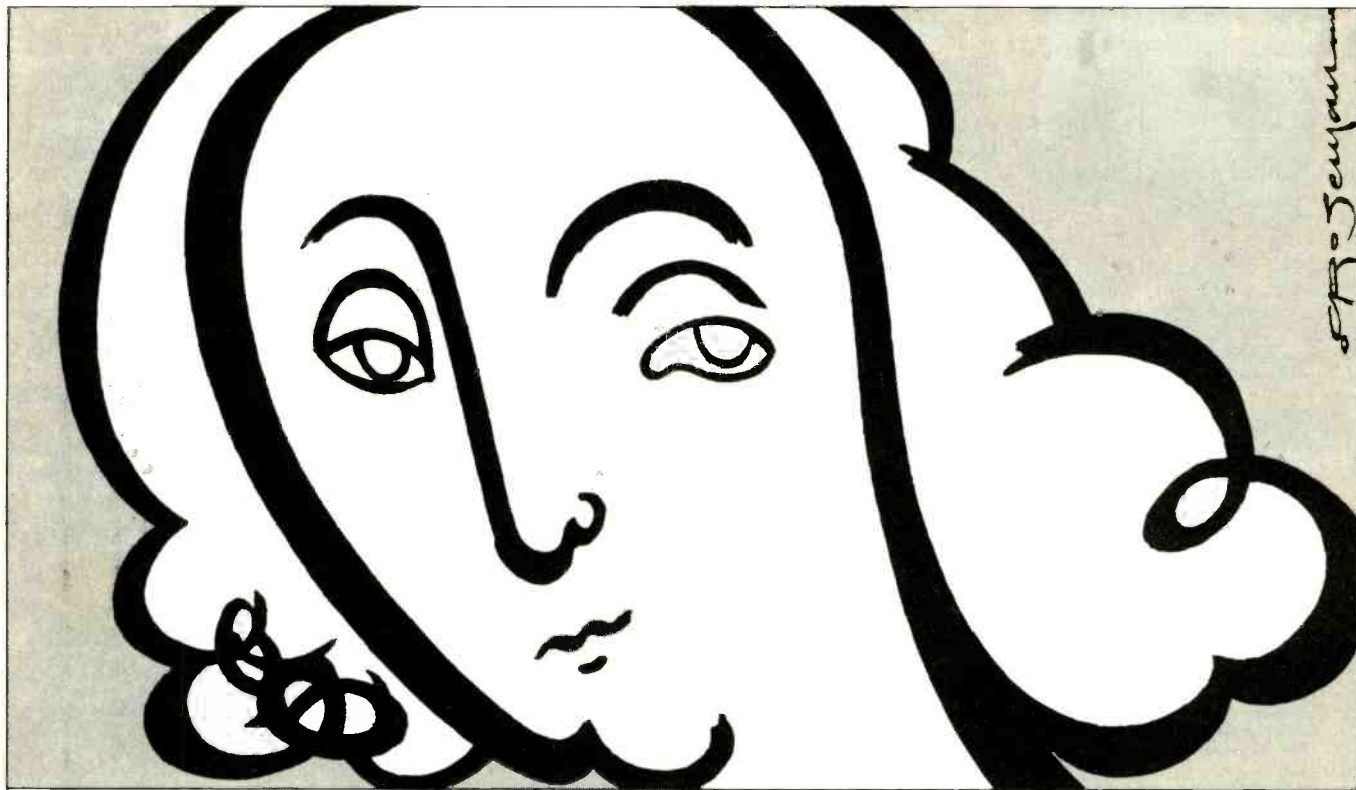

**Vivaldi: Complete Sacred Choral Music, Vols. 1 and 2: Soloists, Two Choirs and Two Orchestras.** Marshall/Murray/Collins/Johnson/Hall; John Aldis Choir, English Chamber Orch., Vittorio Negri. **Philips 6700 116**, 2 discs, stereo, \$17.96.

This big, international-minded edition of the impressive and, until now, little-known big choral works of Vivaldi is splendidly practical and listenable, a very positive compromise between any number of didactic alternatives that might have made it less so. I enjoyed it from start to end, the British performers and the Italian conductor alike.

Definitely, a celebrity-slanted flavor, of the big-time concert world, making for brilliance and professionalism of a sort that sells well to plenty of ears. But also the essentials, the basics, of modern musicology, the important things. Lively, sprightly tempi (instead of the old heavyweight Vivaldi); good, strong ornament and excellent "dotted figure" passages (still often done pon-

derously and out of rhythm), a clean, transparent sound; plenty of drama, and lots of tonal contrast. With these you can go far! No "olde instruments"—heavens, not that. But modern ones, well managed. And a choir that is strictly and typically 1970's pro, British subdivision (you could date the performance by that sound alone)—steely, operatic voices, highly trained and highly unblended, more so at the lower end, less (women? boys?) at the higher end, with an overall finesse and sense of drama that is impressive. Probably far from Vivaldi's choirs, but nevertheless very effective in the music.

Only the solo voices are really "way out"—out of style. Excellent pros and the two sopranos, Margaret Marshall and Ann Murray, are outstandingly musical. But the manner is Puccini, not Vivaldi. Right country, wrong century. The solo parts are extremely elaborate, obviously for voices (probably youthful) that could sing anything a violin or an oboe could play in the way of

ornamental trills and roulades—here, every high note is a shattering, ceiling buster, 20 times too loud, and the trills sound like choking goats, to be accurately descriptive. (Well, bleating sheep, if you wish.) All this is present-day standard "oratorio" styling and NOT, by any conceivable chance, what Vivaldi had in mind—but then, he also made his compromises when needful; he gave his bass solos at times to young ladies (it says), not to mention his soprano parts to elderly males. So why quibble? This is the sound of singing today, for better or worse, and these modern performers are indeed all of them musical and dedicated. They do not really damage the impact of the whole! Even if old Vivaldi himself might roll over like Beethoven if he heard.

The double aspect of choir and orchestra is only modestly evident in the recorded sound but was probably not much more so in the original, which had the advantage of a doubled visual impact. There is much "echoing" from



one group to another and the separation is enough to make this aspect of the sound interesting. The large forces involved are very well balanced in the whole, in what must have been a tough assignment for the record makers.

Sound: B+ Recording: A- Surfaces: A-

**Mendelssohn: A Midsummer Night's Dream, Op. 21/61.** Netherlands Radio Chorus; Rae Woodland, Helen Watts; Concertgebouw Orch., Haitink. **Philips Festivo 6570 021**, stereo, \$6.98.

**Grieg: Peer Gynt Incidental Music.** Adele Stolte; Gewandhaus Orch., Neumann. **Philips Festivo 6570 017**, stereo, \$6.98.

This pair of the new Philips lower priced discs, mostly reissues, like so many others on different labels, is typical — that is, utterly different. You are not going to be able to make generalizations about any such batch of chosen price values, on any label.

Here we have two famous sets of incidental music, each to spoken plays, each with orchestral numbers and a few vocal items mixed in. Each of these is ultra-familiar, at least in the principal pieces — and each has unusual and seldom heard odd items that normally get left out of purely musical performances. Of the two, Grieg is by a hair the most often played, the most tired, the most frequently debased to mood music or whatever — but the Mendelssohn *Wedding March* is not far behind. So . . .

The Mendelssohn is a Dutch performance, with two British singers for the solos, since they are in English. Helen Watts, you will note, is a top-level singer by any standards and the Amsterdam Concertgebouw Orchestra has been one of the world's greatest for a very long time. So should this not be a splendid and memorable version of the music?

Sorry to say that it is strictly high-level pedestrian. The orchestra is, of course, technically first rank — but its members are unable to interpret on their own or else are deliberately doing a bad job here — who knows? It is coarse, unfeeling Mendelssohn for the most part, a real hack job and not even accurate in detail, as though being sight-played after long neglect. Once in awhile things perk up — they almost have to, with such a potentially fine orchestra. The final movement, with women's chorus and solos, is the only one that seemed to me to rise up — at last — to the sense and the magic of the music itself. How much the conductor, Bernard Haitink, had to do with all this is not to be known, but

AUDIO • May 1979



**Rediscover Your Records**

We're extremely proud to announce the availability of a complete preamplifier, built around our all new PS III. Our passive RIAA curve along with our completely current sourced class A circuitry and straight wire gain bypass feature, will enable you to really hear your records for the first time. Want more? Read issue #4 of the IAR (now available) and write us at PS Audio.

**PS PS AUDIO** 1529-C Stowell Center, Santa Maria, Ca. 93454

Enter No. 27 on Reader Service Card



**How To Save On Hi Fi Speakers**



We're one of the largest manufacturers in the U.S.: we're famous for our loudspeakers.

Soon we'll be famous for our speaker kits as well, and you'll save up to 50% without sacrificing quality.

We supply the kit and our twenty-five years experience as a major manufacturer. You supply the labor. It's that simple.

"Kit" P.O.B. 447 Sudbury, Mass. 01776

Check one for free spec sheet:

- complete speaker kit with enclosure
- matched speakers and crossover
- individual speakers and crossover
- enclosure kits
- kit building accessories

Name \_\_\_\_\_  
 Address \_\_\_\_\_  
 City \_\_\_\_\_  
 State \_\_\_\_\_ Zip \_\_\_\_\_

**The most valuable issue of The Audio Critic yet.**

In its forthcoming issue (Vol. 2, No. 1), The Audio Critic breaks new ground. For the first time, its test reports find a number of newly introduced *medium-priced* components to be just a small notch below State of the Art, a rating that would have been unimaginable as recently as a year ago.

Another first, possibly of even greater value to audiophiles, is the partial transcript of a unique all-day seminar on audio design, featuring the uncensored views of some of today's most highly respected technologists.

The Audio Critic is the only audiophile review that combines (1) no advertising by either manufacturers or dealers, (2) technical sophistication above and beyond the "underground" cultist level, (3) advanced laboratory facilities and test programs, and (4) in-depth listening evaluations.

You may want to start your subscription with the previous issue (Vol. 1, No. 6), which is a cumulative reference work with over 150 reviews. Send \$30 for 6 issues by first-class mail (no Canadian dollars, \$6 extra for overseas airmail) to The Audio Critic, Box 392, Bronxville, NY 10708.

S-AD

name \_\_\_\_\_  
 address \_\_\_\_\_  
 city \_\_\_\_\_ state \_\_\_\_\_  
 zip \_\_\_\_\_

**MAIL THIS COUPON AND WE'LL SEND YOU THE BEST SPEAKER CATALOG YOU EVER READ!**

No kidding. Speakerlab's catalog took longer to write than some of our competitors have been in business. In fact, we created an industry by "building great kits so you can afford great speakers." Our catalog is an invaluable



manual of speaker function and design. And, it will introduce you to the finest speaker kits made anywhere... with the strongest money-back guarantee. Find out for yourself...FREE. FREE, that is. Mail the coupon now.

**Speakerlab®**  
 Dept. S-AD, 735 N. Northlake Way  
 Seattle, WA 98103

judging from other performances by him I would guess quite a lot.

Too bad the Mendelssohn above did not originate at the very home of Mendelssohn's music, the Gewandhaus at Leipzig, from which we recently had that superb album of all the Mendelssohn symphonies on Vanguard. Instead, from that source we get Grieg, the other incidental music. At the very first notes you hear the startling difference! Even the recording seems cleaner, sharper. This music is alive and real. True, the Gewandhaus-recorded ambience, very full and round, is really too much for the music. But the playing — and singing — is in astonishing contrast to that on the Dutch record, taut, precise, dedicated, and fervent. And this conductor is able to make the most hackneyed and trite parts of the *Peer Gynt* music sound interesting — I would not have believed it.

So choose your lowered price items with more care than you expend on the first-line expensive editions — for these tend to be of more regular value simply because they are all new and contemporary and so of a similar character, label by label. There's plenty of good stuff on Philips Festivo, but you'd better be choosy, even so.

**Beethoven Sonatas Op. 14, Nos. 1 & 2; Op. 31, No. 5.** Bruce Hungerford, piano. **Vanguard VSD 71252**, stereo, \$7.98.

This is the eighth and last disc in a Bruce Hungerford series, leaving the *Sonata* incomplete — the pianist was killed in a car crash. It is musically a fantastic recording of the three early works. Playing them twice straight through, and again while I write this, I have been regretful that I had not kept up with all those earlier Hungerford discs. They are unique in an area that is heavily populated with discs by almost everybody.

Curious that numerous "big" pianists of the present middle generation are exactly that — to put it bluntly, fatties. Compare with Horowitz, Paderewsky, Arrau! Big, soft body; double chin and jowls; pudgy hands; Hungerford had them all. So also does Alfred Brendel. And Andor Foldes among others. In these pianists the soft body conceals a strength of steel and a mind of formidable proportions, not to mention finger muscles even more so. The intelligent fatty is a phenomenon, definitely. It is no coincidence that Alfred Brendel is also a forceful writer and that Hungerford was a highly professional still photographer who recently specialized in documentary work in Egypt.

So — if you go for Beethoven and especially if you have more than a few Beethovens on hand already, go out and buy this one immediately. The man simply exudes musical power and thinking. Some of the most beautifully thought-out phrasing and shaping I have ever heard, much more than merely faithful to Beethoven's markings! One big mind brings out another.

The piano sound is modest and unbrilliant but suitably so — this piano seems to have many of the qualities of an early 19th-century instrument. Good! Beethoven is definitely not Steinway music.

Sound: B Recording: B+ Surfaces: B+

**Lalo: Piano Concerto in F Minor. Pierné: Piano Concerto in C Minor, Op. 12.** Marylene Dosse; Stuttgart Philharmonic, Kuntzsch. **Vox Candide QCE 31102**, stereo/quad, \$4.95.

**Saint-Saens: Morceau de Concert for Harp and Orch.; Fantaisie in A Minor for solo harp. Pierné: Concertstück for Harp and Orch.; Impromptu Caprice for solo harp.** Catherine Michel; Orch. Radio Luxembourg, De Froment. **Vox Turnabout QTV 44960**, stereo/quad, \$4.95.

Two nicely matched discs of big French Romantic music and don't ask me why one is Candide and the other Turnabout at the same price. You get three turn-of-the-century composers, Pierné on both records, all-new music, interesting to hear, two excellent soloists, piano and harp (you haven't heard of them? So what!) plus very good recording and — believe it — superb surfaces. If you're an audio buff who listens to music, then, why not be adventuresome? Try these and save a bunch. Both for much less than the price of one half-length, double-cost, hi-fi whammy.

On the first disc, Lalo is Side 1, the big name; but his *Concerto* is big, blousy, and sometimes boring though expertly composed with all the sound effects. Dosse does all she can to keep it afloat but she sounds sort of desperate now and then. However, turn over and you have the Pierné, an astonishing work that will really knock you, a real show piece sounding like Rachmaninoff though long before (1887), plus plenty of Liszt (long afterwards). It's a show stopper, dramatic, furious, witty, and you can almost hear the audience cheers at the end.

On side 1 of the second record I really enjoyed the big, jovial Saint-Saens *Concerto for harp and orchestra* (a pretty big *morceau*), wonderfully expert and sonically expansive with fireworks for everybody — and was

amazed to find that he composed it at age 84 in 1919. So much the better — his gift matured well. The solo harp piece that follows is more pretentious, out of the 1890s, but you'll tolerate it OK. This Catherine Michel is a whiz of a harpist — France is definitely harp country.

Then on Side 2 comes Pierné again. His *Concertstück* (same idea as the *Morceau de Concert* — a shortish concerto), more fussy than his *Piano Concerto* on the first record, with heavy suggestions of Césaire Franck in the ominous segments and, oddly, a sort of Sir Edward Elgar pomposity in the sunny parts. Not bad at all. Pierné should be revived. What follows this, the little *Caprice Impromptu* for harp alone is just delightful, a fresh, breezy, warm-hearted piece composed at 18, ever so expertly and sounding just like 18. You won't forget it.

The orchestras are good workhorse European outfits, the Luxembourg on the second record decidedly the better. Stuttgart must be sight reading; there's a lot of fuzz and out-of-tune playing, which, however, you won't really notice because they make the right effects and the soloists do the heavy work as intended. First rank ladies, Ms. Dosse and Ms. Michel.

Sound: B+,B Recording: B+ Surfaces: A-

**Brahms: 3 Sonatas for Violin and Piano; Horn Trio.** Stoika and Dora Milanova; Vladislav Grigorov, horn. **Monitor MCS 2158/9**, two discs, stereo, \$13.96.

Three of these four works, the three *Sonatas op. 78, 100 and 108*, are really beautifully played here by two sisters in Bulgaria, Stoika on violin, Dora on piano. Amazing how, in the long span of time, European musical culture survives all sorts of political upheaval! Today Bulgaria might as well be on the moon, but Brahms is doing very well there. Few performances of these equal-minded sonatas, the two instruments on a par of interest, are more perfectly coordinated than these, nor more correctly styled in the Brahms manner.

The horn player, Grigorov, an intense youngster looking less than 30, is of a different temperament and does not agree well with the sisters. They are alive and relaxed, he is all intensity and power. Technically excellent horn, not good Brahms. He fights the sisters at times — *get going, faster, faster!* he seems to say. His playing has little of the benign, mellow quality that makes this *Horn Trio* one of the finest of all Brahms works. No false notes, no hor-



ny blasts — not this man! But I still did not really warm up to him. Too calculated, too ambitious.

The Bulgarian engineering (Monitor is a New York-based label specializing in imports of this sort) is not as good as that from Romania reviewed here a year or so ago. Good basic sound and the balances are fine, but the loud passages edge into the kind of very slight distortion we have left behind us, we hope, in our own audio. Not bad — and yet too reminiscent of the way things used to be around our parts in audio. Perfectionist? Definitely, even from me. Excellent surfaces — where from, Monitor?

Sound: B- Recording: B- Surfaces: A-

**Mussorgsky: Pictures at an Exhibition. Hindemith: Symphonic Metamorphoses.** Chicago Symphony, Raphael Kubelik. Mercury Golden Imports SRI 75114, electr. stereo, \$7.98.

It is curious to hear again these famous Mercury recordings, once the sensation of the hi-fi world, especially the earlier recordings in mono, made mostly with the celebrated single-microphone technique, the purest of the pure! This one is re-channeled, if that is the word, very circumspectly and well, to give a modicum of separation and avoid the hunched-up center sound of straight mono played on stereo equipment. There is definitely a slight edge of distortion. Is it in the reprocessing or the original? Strong passions will be aroused on this point — I can only say I do not know! I suspect the original, alas. No excuse today for a mild rechanneling circuit to add an audibly noticeable distortion. But who knows? Ask Philips. (And get no answer!)

Kubelik at Chicago was not a very persuasive conductor. He came at a bad time and had a bad time. The *Pictures* go right along smartly, played well enough but without much excitement. The musicians know the music plenty well enough to play it alone. The Hindemith, one of his most delightful and humorous works, with Hindemith jazz in it, is just plain colorless here. This was where Kubelik mattered — and nothing much happens. All in all, I'd suggest letting this one lie.

Sound: C+ Recording: B— Surface: B

**Contemporary Concert Music for Solo Instruments and Percussion:** Theodore Frazeur and Friends.

**Grenadilla GS-1042**, stereo, \$7.95.

Despite its rather cumbersome (albeit descriptive) title, this album is a

refreshing collection of chamber music by four performers who seem to genuinely enjoy each other's musical company.

Ingolf Dahl's *Duettino Concertante for Flute and Percussion* is the most familiar piece here, and deservedly so. It affords both musicians ample opportunity to display their virtuosity — the flutist through precise tonguings, tricky fingerings, trills, etc., the percussionist through the constant changes of coloration obtained by striking the various instruments in different places. This interpretation, by Holly Stackhouse (flute) and Theodore Frazeur (percussion), is the most logically consistent I've heard. The DiTullio/Ervin version (Crystal S641) has a much better-coordinated arioso movement, while the Dwyer-Firth recording (RCA LSC-6189) evinces a very high degree of communication in the Fughetta. Nonetheless, Stackhouse and Frazeur play the entire piece with such an open, lighthearted spirit, it's hard to resist. Their one major interpretive gaffe is a lengthy pause between the last two movements, which to my ears interferes with the logical, uninterrupted flow of the music.

Frazeur's *Frieze* is an evocative work for violin (Charles Joseph) and tuned percussion (the composer on marimba and tympani). The mood shifts from subtle, neo-primitive rhythms, to freely expressive violin over thunderous tympani rolls, to quasi-Romantic violin interacting with melodic marimba. Both the composition and its realization are most impressive.

Frazeur's *4 Sea Fragments* is a drier, rather more academic work. Again there is much variety in the percussion writing, which the composer executes with his usual combination of ease, flexibility, and exactness. The clarinet part (played by James East), however, is rather cold, despite the use of Impressionist scales. As a result, the piece fails to capture the listener's fancy the way *Frieze* does.

Peter Tanner's *Diversions for Flute and Marimba* is an enjoyable pastiche with an ever-present feeling of *deja-vu*. Though not by any stretch of the imagination a work of great originality, it does point out how close the flute and marimba can be harmonically and tonally. The performance, by Stackhouse and Frazeur, is skillful and entertaining.

The recording is somewhat deficient in depth and presence. Greater stereo spread in the Dahl might have brought out a great deal more of the work's inherent color. Tom Bingham

Sound: C Performance: A-

## IN CHICAGO STAY AT THE Lake Shore Drive Hotel

THE BEST LOCATION  
IN TOWN . . .



99 STEPS EAST OF MICHIGAN AVE.

Lake Michigan and the Park at your front door • Adjacent to business district and Michigan Ave. shops • Spacious Rooms and Suites (some with Kitchen & Bar) • Complimentary continental breakfast • Complete hotel service • Meeting and Banquet facilities up to 300 persons.

DINING AT  
**Sage's**  
EAST

WRITE TODAY  
FOR BROCHURE  
& TARIFF  
DONALD O. CRONIN,  
Gen. Mgr.

181 EAST LAKE SHORE DR.  
CHICAGO, ILL. 60611  
(312) 787-8500

## HELP!

Anytime you have a question about your Audio subscription, please include a mailing label to insure prompt service on your inquiry.

AFFIX  
LABEL  
HERE

### CHANGE OF ADDRESS

If you're about to move, please let us know approximately four weeks before the move comes about. Or, if there is anything wrong with your current mailing label, please let us know on this form also. Simply affix your present label here, and carefully print the updated information below.

### PLEASE HELP US TO SERVE YOU BETTER

AUDIO MAGAZINE  
401 N. Broad Street • Phila., Pa. 19108

Name \_\_\_\_\_  
(Please Print)  
Company \_\_\_\_\_  
Address \_\_\_\_\_  
City \_\_\_\_\_ State \_\_\_\_\_ Zip \_\_\_\_\_

# Classified

## CLASSIFIED ADVERTISING RATES

**BUSINESS ADS-** For Sale. Help Wanted. Services. Business Opportunities. Tape Recordings, etc. etc. \$4.80 per line. First line set in bold face type at no extra charge. Extra lines \$9.60 per line. One point ruled box, extra charge \$8.00. Full payment must accompany order.

**NON BUSINESS ADS-** Situations Wanted, used equipment for sale by private individuals \$2.80 per line. First line set in bold face type at no extra charge. Extra lines set in bold face type \$5.60 per line. Full payment must accompany order.

**FREQUENCY DISCOUNT-** 3 times, less 10%. 6 times, less 15%. 12 times, less 20%. (fine copy ads only)

**DEADLINE-** 1st of two preceding months. (Dec. 1 for Feb. issue).

**BLIND ADS-** Box numbers may be used at \$5.00 extra for handling and postage.

### MAIL ORDER AND DISPLAY CLASSIFIED RATE

|            |       |
|------------|-------|
| 1 col x 1" | \$125 |
| 1 col x 2" | \$180 |
| 1 col x 3" | \$250 |
| 2 col x 1" | \$180 |
| 2 col x 2" | \$320 |

Advertiser must supply complete film negative ready for printing for display ads.

**AUDIO Magazine**  
401 North Broad Street  
Philadelphia, Penna 19108

### HOW TO ANSWER BOX NUMBER ADS

When replying to an Audio Box Number Ad, please use this address Box No. — c/o Audio, 401 No. Broad Street, Philadelphia, Pa. 19108

## FOR SALE

**DOLBY ADD-ON ENCODES/DECODES RECORDINGS, BROADCASTS.** Latest ICs, quality components, complete kit. Calibration tapes available. Comprehensive test report. AAP INTEGREX, Box 747, Havertown, PA 19083.

## FOR SALE

**ALBUQUERQUE - HI-FI HOUSE - 30 YEARS** serving audio needs with care. Advent, Acoustat, Acutex, BGW, Apt-Holman, Grace, Ampex, Alan Hills' Plasma Speakers, Audio-Pulse, JBL, JUC, KEF, DBX, McIntosh, Maxell, NAD, Teac, Tascam, Sennheiser, Yamaha, Urei, etc. Custom home and commercial installations. 505-255-1694, 3011 Monte Vista N.E., 87106.

**THE ABSOLUTE SOUND™**, in its current issue (# 14), contains major reviews of the Levinson ML-2 amplifier, the Keith Monks Record Cleaning Machine, the Audio Research D-110 and D-52 amplifiers, and the Grandson amp. There is a special report on nine preamplifiers, ranging from the Quantum Electronics to the Van Alstine and Paoli modifications of the classic Audio Research SP-3a, which devotes considerable attention to some long overlooked aspects of preamp distortions, including spatial distortion. Also reviewed in this issue: The Bryston 4b amp; the SME 3009 Series III pickup arm; the DB Systems amplifiers; the improved Beveridge electrostatic and the New Advent speaker. There's a long analysis of the "sonic" attributes of the Linn-Sondek turntable, and a sneak preview of the \$3000 Scheiber four-speaker decoder. For record buffs, there's a behind-the-scenes report on the Telarc digital recording of the Atlanta Symphony; an interview with David Mottley, former EMI producer and winner of the Audio Technica sonic excellence award, not to mention the usual record reviews, which are unusual in that they deal with recorded sonics, helping you differentiate the good from the bad; listings of the best recordings, imported, audiophile and what-not.

You can also read what audio experts have to say, when they are being candid, about subjects ranging from the lousy sound at Hi-Fi Shows to the inherent flaws in today's digital recording process (hint: The sampling rate is too low). Also, veteran disc cutter, Stan Ricker, lets his hair down in an uncensored view of what's wrong in the record mastering business.

If you subscribe now, you'll get, in upcoming issues, the first review of the Philips/MCA videodisk system; reviews of a new generation of electronics, ranging from an tube/transistor hybrid amplifier from Infinity to a new tube amplifier from Audio Research. Also upcoming: a new upsurge of ideas in turntable designs, from the Sao Winn plexiglass table to Yamaha's \$3,600 straight-line tracking disc player.

Send \$18 (four issues), \$19 (Canada), \$25 (outside North America; air mail too) to The Absolute Sound™, Box L, Drawer A, Sea Cliff, New York, 11579.

## FOR SALE

**ACCURATE, QUALITY AUDIO EQUIPMENT DISCOUNTED!** Low prices on high-end components rarely discounted. Send SASE, call for quotes and literature. Denco Audio, PO Box 6104-U, El Monte, CA 91734. (213) 444-9978 evenings, wknd.

**ACOUSTAT X SPEAKERS** newer with warranty custom fabric bases \$1350 218-724-8088

**ALAN HILL'S PLASMA SPEAKERS**, acclaimed the most superior in the world. \$7000 FOB, Albuquerque. Custom installation - air fare only. Call or write for consultation. Hi-Fi House, 3011 Monte Vista N.E. 87106. 505-255-1694.

## TANGENT IN THE WEST

- Accurate Audio
- Venice, CA. 90291
- Audio Components of Carmel, Ltd.
- Carmel, CA. 93921
- Audio Directions
- San Diego, CA. 92123
- Bel-Aire Camera & Hi Fi
- Los Angeles, CA. 90024
- Definitive Audio
- Seattle, WASH. 98105
- Executive Audio
- Santa Monica, CA 90403
- Garehime Music
- Las Vegas, NV. 89105
- Lakeside Audio
- Honolulu, Hawaii 96818
- Shimeks Audio
- Anchorage, Alaska 99503
- The Gramophone Ltd.
- Moscow, Idaho 83843

Tangent Marketing of America  
12 Irving Street, Framingham, MA 01701  
617-620-0677

## ARIZONA AUDIOPHILES

Dahlquist, S.A.E., Revox, Rabco, Nakamichi, Yamaha, Crown, Grace, Stax, Tandberg, Sonab, Supex, Gale, Klipsch, Phase Linear, Uher, Burwen, J.B.L., Harmon-Kardon Citation, A.D.S., Spectro Acoustics, Beveridge, Sennheiser, Teac, Thorens, Stanton, Aiwa, Stax, Micro-Seiki, Fidelity-Research, Genesis, Optonica, R.T.R., B&W, Toshiba, DBX, Signet, Mitsubishi and Mitsubishi V.S.S.

## JERRY'S AUDIO EXCHANGE

PHOENIX—334 E. Cambridge Rd. (602) 263-9410  
TEMPE—130 E. University Dr. (602) 968-3491  
TUCSON—5750 E. Broadway. (602) 622-7407  
MAIL ORDER HOT LINE—MR. WOZ (602) 265-7841

TF

## the audio advocate

- SME
- POLK
- LS35A
- SHURE
- DECCA
- GIZEK
- DENON
- ONKYO
- QUATRE
- ADVENT
- ARISTON
- ACOUSTAT
- MAGNEPAN
- FORMULA-4
- NAKAMICHI
- AUDIO RESEARCH

505 Millburn Avenue Millburn, NJ  
(201) 467-8988

AUDIO • May 1979

# THE AUDIO ALTERNATIVE

FINE AUDIO COMPONENTS FOR THE DISCRIMINATING LISTENER

## CSA AUDIO

Designs featured by CSA:

**SUPEX**  
**DAHLQUIST**

**DAYTON WRIGHT**

**KEF**

**Loudspeakers**

**QUATRE**

**FRIED**

**Hartke**

**vanalstine**

**Linn**

**Sondek**

**MERIDIAN**

**Connoisseur**

**Precision Fidelity**

**DENNEZEN**

**Graco**

**sound concepts**

**ARISTON AUDIO**

**THIEL**

**Stax**

CONTEMPORARY SOUND ASSOCIATES

PRIVATE LISTENING AUDITIONS BY APPOINTMENT

30 min. from G.W. Bridge, Route 46W to Passaic Ave. exit left then first light beyond overpass.

35 LITTLE FALLS ROAD, FAIRFIELD, N. J. 07006 201/575-1135



**FOR SALE**

**DALLAS / FORT WORTH**

Magnepan  
Denon  
Dahlquist  
Advent  
Stax  
HK

Acoustat  
GAS  
Audio Standards  
Cizek  
Grace  
Bic

Keith Monks Record Cleaning Machine  
**AUDIO VISION, in Carillon Plaza**  
13601 Preston at Alpha, Dallas, 233-8513

**DAVID HAFLER IS BACK!**

The man behind the original Dynakit is back with his own company and a new state-of-the-art preamplifier at a bargain price! Available as a KIT or CUSTOM ASSEMBLED by expertly trained wireners—each performance certified. For further details write or call AUDIOKIT—260 Old Country Road, Hicksville, N.Y. 11801 (516) 822-5749

**DB SYSTEMS PREAMP** with power supply. Lowest distortion on market. Perfect condition. 1 yr. old. Warranty. Cost new \$425. Sell \$275. 415-658-6608.

**DB-1A PRE-AMP \$325 LUX M2000 120/CH \$650 OHM F Speakers \$550 Orofon MCA-76 Pre-preamp \$135 Thorens 160C Turntable \$100 Mayware Formula 4 tonearm \$100. Jim Breeding PH-703-334-2642.**

**DEMOS, DISCONTINUED AND USED EQUIPMENT SALE.** Dynavector, Microseiki, JH, Denon, AEA, Accuphase, Mac Audionics, B&O, Klipsch, Aiwa, Frazier, Stax & others, imported and direct to disc records. Send for list. Stereo Odyssey, 9324 West 75th, Merriam, KS 66204. 5-9

**DENON 103D** - \$99; AU-320 transformer - \$99; GRACE 840F tonearm - \$85. All for \$255. Ted Piotrowicz (315) 638-4781.

**DESIGN ACOUSTICS DEMONSTRATED**  
NEW YORK AND NEW JERSEY

All Models in Stock  
Phone your "MUSIC MAN" for demo appointment  
**212-463-1208 OR 516-621-2126**  
Custom Audio Systems Designed and Installed

**DIAMOND NEEDLES** and Stereo Cartridges at Discount prices for Shure, Pickering, Stanton, Empire, Grado, Audio Technica and ADC. Send for free catalog. LYLE CARTRIDGES, Dept. A, Box 69, Kensington Station, Brooklyn New York 11213. For fast service call toll free 800-211-0906. TF

**Does your cartridge have TQA?** The Supex SD-900/E+ Super and SD-901/E+ Super moving coil cartridges do. If your cartridge does not have TQA you may be paying too much for too little. What is TQA? Total Quality Assurance and each and every Supex moving coil cartridge has it. For complete information on TQA and Supex moving coil cartridges, see your local Supex dealer or write to: Sumiko, Inc., P. O. Box 5046, Berkeley, CA 94705.

**DYNACO TRANSISTOR/TUBE COMPONENTS — FREE LIST.** SCC, BOX 8014, CANTON, OHIO 44711

**DYNACO WALNUT CABINETS** (for all "faceplate" models): CAB-1D (Single), \$19.95; CAB-2D (Double), \$24.95. Greatly improves Dynakit appearance! "Quadaptor: QD-1/Kit, \$9.95; QD-1/Wired, \$24.95. Postpaid. SCC, Box 8014, Canton, OH 44711. 5-9

**Electrocompanist preamp and amp** with warranty cards. Retail value \$2,000 asking \$750 914-967-4708.

**FOR SALE**

**ELECTROSTATIC TRANSLATORS ARE HERE**

Come and audition this fine new line of electrostatic loudspeakers along with: Audire, Audio Technology, Cestation, Clarke, Decca, Grado, Braun Satellites and subwoofer etc. . . .

**PERSONALIZED AUDIO**

723 Bound Brook Rd., Dunellen, NJ 08812  
Appointments available call 201-752-3883

**FASTER THAN A SPEEDING BULLET  
MORE POWERFUL THAN A LOCOMOTIVE  
ABLE TO PASS PULSES IN A SINGLE BURST**

IS IT A BIRD?  
IS IT A PLANE?  
NO! IT'S THE INCREDIBLE  
**VANDERSTEEN MODEL II SPEAKER SYSTEM**

Exclusively at:

**AMERICAN AUDIOPHILE**  
5 SUNRISE PLAZA  
VALLEY STREAM, NY 11581  
FOR APPT: 516/561-7114

ALL SHIPMENTS PREPAID AND INSURED  
FREE THROUGHOUT CONTINENTAL U.S.  
Master Charge & Visa Accepted

**EQUALIZATION TEST RECORD** Octave bands of pink noise on 7" EP. \$2.00 postpaid. Crosswind Records, Shrewsbury, Pa. 17361

**ERC D-76A + ARC fan base!** Retubed and spec'd 1-75 \$900. SA6A \$1000 and SP3A2, \$550. Phone: 408-738-3310.

**FIDELITY RESEARCH: THE ULTIMATE** in phono reproduction. Sonic Precedence P.O. Box 17947 Memphis, TN 38117 (901) 795-1256 Wkends.

**FOR SALE**

**FOR SALE:** Audiopulse one, \$400; McIntosh MR-78 tuner, \$650; Sony TTS-3000 turntable with KMAL tone arm and prometean (G-1) cartridge, \$250. Chuck Cabell, 7 Clark Circle, Bedford, Mass. 01730: (617) 274-7162.

**FRANK VAN ALSTINE MODIFICATIONS** for Dynaco, Audio Research, Dahlquist, Paragon, and other audio components can be the most cost effective way for you to achieve State of the Art audio performance. Our FET-5 MARK 5 mod for the PAT-5 & PAT-5 BIFET will equal the performance of any preamp in existence. The DOUBLE 400 SERIES 2 is all new with vastly improved sound. It's new life for your St-400 or St-416. FREE MOD PLANS for the Dyna ST-70 and PAS with a large stamped envelope. Low cost updates for any units we have modified in the past. New power supply mods for the ARC SP3A.

Read the esoteric magazines, our mods work.  
JENSENS STEREO SHOP 2202 RIVER HILLS DRIVE  
BURNSVILLE, MINNESOTA 55337 612-890-3517 1-0

**FREE CATALOG . . . CLASSICAL.** Cassettes, Stereo-Dolby . . . Quality Guaranteed . . . Discounted . . . Credit Cards Accepted . . . EKR Classics, GPO Box 1977AE, New York, NY 10001.

**STEREO COMPONENT Video Tape Equipment**

**AKAI • B•I•C • Harman Kardon  
Phase Linear • ALTEC • Kenwood •  
TEAC • Marantz • Sony • Technics •  
Sanyo • JVC • JBL • Pioneer • Dual •  
RCA** Photographic Equipment Too!  
**TO ORDER CALL TOLL FREE  
(800) 421-8537**



**Houston and the Gulf Coast**

Mark Levinson/Threshold/G.A.S./Apt/Holman/Hafler/Advent/Nakamichi/Dahlquist/Magneplanar/KEF/Acoustat/KM Systems/DCM Time Window/Cizek/Snell/Denon/Klipsch/Fidelity Research/Grace/Signet/Cotter/Ivie Analyzers



2200 SW Freeway at Greenbriar Houston, Texas 77098 713/527-0774  
Credit Cards Accepted Freight Prepaid in Continental USA

**AT SOUND COMPONENTS, INC.  
WE'VE GOT IT ALL . . . . .**

Audionics . . . . Bang & Olufsen . . . . Beveridge Cylindrical . . . . Briston  
. . . . DCM . . . . Denon . . . . Dynavector . . . . Fidelity Research . . . . Fulton . . .  
Grace . . . . Great American Sound . . . . Hafler . . . . H.Q.D. Reference System  
. . . . Janis . . . . KEF . . . . Kenwood Purist . . . . Linn Sondek . . . . Magnepan . . .  
Mark Levinson . . . . Paragon . . . . Pyramid Metronome . . . . Quad . . . . Rega  
. . . . Rogers . . . . Sonex . . . . Sendor . . . . Stax . . . . Verion . . . . Yamaha . . .

Master Charge & Visa accepted

We ship prepaid within U.S.

**SOUND COMPONENTS, INC.**  
2710 Ponce de Leon Blvd., Coral Gables, Fla. 33134  
(305) 446-1659

AUDIO RESEARCH • JANIS • GALE • BREUER

TECHNICS • **Audio Reference Systems** • MAGNEPAN •

808 • 732-3303 • Kahala Office Center  
Suite 201 • Honolulu, Hawaii 96816

ROGERS • GREAT AMERICAN SOUND • SONEC

**FOR SALE**

**AUDIOWORKS**  
**AUDIOWORKS ASSUMES THERE IS MUCH, MUCH MORE TO SOUND REPRODUCTION THAN IMPRESSIVE, BUT MEANINGLESS SPECS, GEE-WHIZ TECHNOLOGY, AND VIRTUOSO SALES HYPES. THERE IS THE MUSIC.**  
 RAPPAPORT, SYMDEK, SNELL ACOUSTICS, FIDELITY-RESEARCH, DENON, SPENDOR, CONRAD-JOHNSON, AUDIONICS, BRYSTON, VANDERSTEEN, TANGENT, GRACE, CLARKE, AMBIENT, Z-MOD CARTRIDGE, DECCA, PLATTER PAD, MOGAMI CABLE. Authentic high-resolution sound at AUDIOWORKS, Box 4314, Harrisburg, PA 17111. Tel. 717-652-6996.

**A SINGER'S DREAM!**



**REMOVES VOCAL FROM MOST STEREO DISCS**  
 The Thompson Vocal Eliminator can actually remove most or all of a solo vocalist from a stamca d stereo record and yet leave the background music virtually untouched! Not an equalizer! We can prove it works over the phone. Write for brochure and demo record below.  
 COST: \$195.00

**ECHO Ambiance**

**We do it BETTER for LESS**  
 Whether your interest is in using the ambience for a concert hall effect or as an echo chamber for studio recording use, we manufacture a broad line of sophisticated analog delay Echo and Reverberation devices at prices which only direct sales make possible. Prices range from \$159 to \$495.  
 Write for a brochure and demo record. Include \$1 to cover costs (refundable with order.)  
 Write to: **LT Sound Dept AU**, P.O. Box 1061, Decatur, GA 30031 (404) 284-2155

**FOR SALE**

**BACK ISSUE MAGAZINES.** Over 200 titles. 1890 to 1978. Send stamped Envelope. Free List. Everybody's Bookshop, Dept. AU, 317 West 6th, Los Angeles, Calif. 90014. TF

**BLANK TAPE: PREMIUM SCREW CASSETTES** loaded with AGFA PROFESSIONAL I: C60 \$1.25; C90 \$1.60; C120 \$2.50. If you like Maxell, try these! DuPont Crolyn C90 \$2.40. Min order 10 cassettes. REEL: NEW AMPEX 642 LN/HO: 3600' pancakes 6/\$35.76 or respooled 1800' reels (boxed) 10/\$37.80. Shipping \$2.00 per tape order. AIWA CASSETTE DECKS: new, custom adjusted for Agfa tapes: 6300 \$205; 6600 \$405; 6900 \$765. Shipping \$4/deck. NJ residents add 5% sales tax to orders. Direct-to Tape Recording Co., 14 Station Ave., Haddon Hts., NJ 08035.

**BOULDER SOUND GALLERY, LTD.** The Rocky Mountain region's audio dealer with a point of view. We carry LUX/LUX L.R.S., B & W, Mark Levinson, Spendor, Denon, Dahlquist, Stax, Polk, ADC tone-arms, Signet, Van Alstine, Quad, the K-M System, Janis, R.H. Labs, JSH Labs, N.A.D., Revox, Conrad-Johnson, Chartwell LS-3/5-A, etc. If your goal is to get from the source material back into the air with the least possible change, we can help.

**B & O 4002 USES "ANY" CARTRIDGE** with standard mounting centers after our modification. Effective mass 2.5 grams. Adjustable silicone damping. \$199.00 with money-back guarantee. JML Company, 39,000 Highway 128, Cloverdale, CA 95425 8-9

**FOR SALE**

**"BONGIORNO IS BACK"**

After more than 1½ yrs of absence we are proud to announce the new Sumo Amplifier. It is different in every way - and consistent with the advancements of designs by James Bongiorno.

In the past, Mr. Bongiorno has designed the Dynaco 400, the entire line of S.A.E. amps, and more recently the products from G.A.S. These were and still are great products. But time moves on and new progress and new ideas must be born.

The new Sumo amplifier will be at your dealer soon along with the Sumo preamp. They will also have features that are new and original, but at prices that can be afforded, in the Bongiorno tradition.

- The Sumo cartridge
- The Sumo Bridge
- The Very Clever Little Crossover
- The Sumo Preamp
- The Sumo Amplifier

See Them Soon  
**SUMO ELECTRIC CO. LTD.**  
 1230 N. Horn Ave.  
 W. Hollywood, CA 90069  
 (213) 659-4370

**BRAND ELECTRONICS** Florida's heading Crown Dealers is honored to now have the amazing DL-2 Distinction pre-amplifier in stock. Designed to be State-of-the-Art. Years from now using computer technology. Treat your ears now to the Crown DL-2 at Brand Electronics - from Jacksonville to Miami. Brand Electronics, 3550 N.W. 77th St., Miami, FL 33122.

**BRYSTON 2B \$400.** Kamaha T-2 \$500., Rappaport Pre-1 \$425. 215-535-8928.

**BUILDING SPEAKERS? CONSIDER KEF.** 8 Proven Plans. Reflex and AS. \$3 E. Carver. 1226 Mound St., Madison Wis. 53715.

**CABLE FM BROADCAST STATION.** Unique no investment/experience business makes money! Others work for you! Free details. "CAFM", Box 130-N5, Paradise, CA 95969

**Circuit boards and parts for builders of M. Leach's** revides Low TIM 3 Amplifier, new FET Wide Bandwidth Preamplifier, Push-Pull Pre-amplifier, and Strapping Circuit. Send stamped envelope for price list. Custom Components, P.O. Box 33193, Decatur, GA 33033.

**CONNECTICUT:** A.D.S., Advent, A.P.T. Holman Audio Pulse, B&O, B.I.C., Citation, Dahlquist, D.C.M. Time Windows Epicure, Hafler Harman/Kardon, J.B.L., Mitsubishi, Nakamichi, Ortofon, Phase Linear, Micro-Acoustics, N.A.D., Stax, Tandberg, Yamaha, Cizek, Sonus. Will ship prepaid. Sounds incredible, 39 Federal Road, Brookfield, CT. 06804. (203) 748-3889—phone quotes only. TF

**CROWN SX724,** tape counter, pro hubs. Excellent condition, \$700 firm. (303) 481-2758.

**CUSTOM BUILT DISCO SYSTEM.** D L Board, amp, Cabinet, Speakers, Send \$3 Refund on First order. Satin Sound, P.O. Box 15341, Detroit, Michigan 48215.

**WRITE US AND WE'LL SEND YOU THE BEST CATALOG YOU EVER READ!**

No kidding. Speakerlab's catalog took longer to write than some of our competitors have been in business. In fact, we created an industry by building great kits so you can afford great speakers. Our catalog is an invaluable manual of speaker function and design. And it will introduce you to the finest speaker kits made anywhere... with the strongest money-back guarantee. Find out for yourself... FREE. FREE. that is. Write now. Right now.

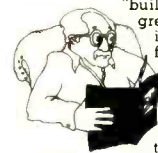

**Speakerlab®**  
 Dept. C-AD, 735 N. Northlake Way  
 Seattle, WA 98103

**Rogers**  
 BRITISH HIGH-FIDELITY  
 Reference Monitor Int. Inc., 4901 Marena Blvd., Suite 309, San Diego, CA 92117 (714) 270-0970

*The most accurate mini monitor in the world.*



# Audio's Book Store...

## Your Best Source to Build a Worthwhile Library for these Reasons:

**Audio** Editors are Always Searching for Worthwhile Books and Manuals for Our Readers.

**Audio** Editors Review these Books and Manuals, and Choose the Ones that Offer the Most Up-to-Date Information and Technical Knowledge for Audio Readers.



**No. 759—Audio IC Op-Amp Applications.** Newly revised 2nd edition includes many new high-performance audio circuits.

**No. 755—Direct Current Motors.** Understand the most-basic electric motor of all. Includes testing and maintenance section.

**No. 750—Japanese Servicing Manual.** Fix-it data with schematics on Hitachi, Realistic, Sanyo, Sharp, Soundesign, Superscope, and more.

**No. 751. Microphones.** Complete manual shows how to record anything. Special section tells how to interpret spec sheets.

**No. 756—Home Audio Systems, Vol. 1.** Most up-to-date service/schematic manual for Capehart and Zenith.

**No. 757—Home Audio Systems, Vol. 2.** Latest service data for Channel Master, Hitachi, and Coronado. Includes schematics.

**No. 758—Home Audio Systems, Vol. 3.** Repair Admiral, Automatic Radio, Midland, and Sharp with this complete service manual.

**No. 754—Photo Guide to AM/FM Stereo Repair.** Step-by-step troubleshooting guide shows what parts break down and how to replace them.

**No. 753—Antenna Construction Handbook.** CB, ham, and SW listeners can build high performance antennas for their custom rig.

**No. 752—Design, Build & Test Speaker Systems.** Do-it-yourself guide shows beginner and expert how to get the best from a speaker.

- 759, AUDIO IC OP-AMP APPLICATIONS, \$4.95
- 755, DIRECT CURRENT MOTORS CHARACTERISTICS & APPLICATIONS, \$14.95
- 750, JAPANESE RADIO, RECORD & TAPE PLAYER SCHEMATIC SERVICE MANUAL, \$7.95
- 751, MICROPHONES—HOW THEY WORK & HOW TO USE THEM, \$5.95
- 756, HOME AUDIO SYSTEMS/SERVICE MANUAL VOL 1, \$5.95
- 757, HOME AUDIO SYSTEMS/SERVICE MANUAL VOL 2, \$5.95
- 758, HOME AUDIO SYSTEMS/SERVICE MANUAL VOL 3, \$5.95
- 754, PHOTOGUIDE TO AM/FM STEREO REPAIR, \$6.95
- 753, THE ANTENNA CONSTRUCTION HANDBOOK FOR HAM, CB & SWL, \$5.95
- 752, HOW TO DESIGN, BUILD AND TEST COMPLETE SPEAKER SYSTEMS, \$6.95

Please send me the book(s) I have checked.

Enclosed is my proper remittance for \$\_\_\_\_\_

I understand if I am not fully satisfied I may return my selection(s) in undamaged condition within 10 days for a full refund.

Name (please print) \_\_\_\_\_

Address \_\_\_\_\_

City/State/Zip \_\_\_\_\_

Please allow 4-6 weeks for delivery.

### YOU MAY PAY FOR YOUR BOOK(S) ON YOUR CREDIT CARD

CREDIT CARD NO. \_\_\_\_\_

VISA    AMERICAN EXPRESS    DINERS CLUB

MASTER CHARGE \_\_\_\_\_ M/C BANK NO. \_\_\_\_\_

NUMBER MUST APPEAR \_\_\_\_\_

IF USING MASTER CHARGE                      EXP. DATE \_\_\_\_\_



Book and Learning Systems Division  
North American Publishing Company, North American Building,  
401 N. Broad Street, Philadelphia, PA 19108

**FOR SALE**

**AUDIONICS - BERNING**

We have in stock the CC-2, the NEW IMPROVED BT-2 and the BERNING BA-150 is on the way! Free shipping. Visa & Master Charge honored. Demo. by appt. OXFORD AUDIO CONSULTANTS, P.O. Box 145, Oxford, OH 45056. 513-523-3895. 2-9

**TAKE 5 AUDIO**

CONN.'S HIGH-END AUDIO SHOP

|         |             |        |
|---------|-------------|--------|
| Bryston | Verion      | DCM    |
| Denon   | Signet      | NAD    |
| Hafler  | Symdex      | ADC    |
| Pyramid | Rappaport   | M & K  |
| Cizek   | Watson Lab  | AT     |
| Tangent | Promethean  | DAC    |
| LS-3/SA | Sound Cable | KMAL   |
| Supex   | Platter Pad | JR 149 |
| Cybele  | Discwasher  | Grado  |

- \* 4 private sound rooms
- \* East Coast's largest direct-disc dealer
- \* Keith Monk's record cleaning

105 WHITNEY AVE.  
NEW HAVEN, CT. 06511  
203-777-1750



**FOR SALE**

**AUDIO ALTERNATIVE, A UNIQUE SPECIALTY AUDIO SHOPPE**

Featuring Grado, Promethean, Signet, Supex, Win, Nagatronics, SME, Hadcock, Audiocraft, Mitchell Focus, Thorens, Micro-Seiki, Grace, Denon, ADC, Hafler, Audionics, Sumo, NAD, Conrad-Johnson, TVA-1 Marcoff, RG, Sound Concepts, Rogers, Shahinian, J.R. 149, Thiel, Mordaunt-Short, Swallow, Allison. Mail inquiries and orders promptly and courteously answered. 1124 East Elizabeth, Fort Collins, Colorado 80524.

ATTN: LEACH AMP BUILDERS: news letter & hard to find parts sources. Prebuilt details. TA, BOX 90 RRI, Surry, ME 04684. 12-8

Audio and TV tubes factory boxed, speakers, semiconductors—low prices, free price list. Transisleteronic Inc., 1365-39th St. Brooklyn, N.Y. 11218 212-633-2800 TF

AUDIO BARGAINS — FREE LIST. Closeout/bankruptcy specials. SCC, Box 8014 (A-6), Canton, Ohio 44711. 5-9

AUDIO CAN MAKE MONEY FOR YOU! Sell Equipment at your college. No investment; experienced saleshelp and incentive programs provided. Audio Outlet, Inc., 10 Commerce Ct., Newark, NJ 07102. 201-622-3250.

**FOR SALE**

**AUDIO DEN AND POLK AUDIO**

The Audio Den is proud to have on display and demonstration the amazing Polk Audio Monitor Series. Our customers say "Fantastic! Compares with the finest loudspeakers I have heard. Probably the best value in the history of Audio!!!" Audiogram®, from the Audio Advisor said, "We were so impressed that we could not believe the prices . . . Other \$200 speakers simply do not come close to the standards set by the Model 10 . . . And at their price, they are simply a steal." Come in for an audition or write us for information on Polk or our other state-of-the-art products. Polk is shipped free in the continental U.S. Audio Den Ltd. 1320-34 Stony Brook Rd., Stonybrook L.I., N.Y. 11790, 516-751-3350. TF

**AUDIO DEN LTD.**

Long Island's leading audio store has on demonstration, THE STATE OF THE ART

AUDIO RESEARCH ELECTRONICS  
(THE NEW SP6 TUBE PREAMP)  
THE NEW ACOUSTAT MONITORS

EMT & GREADD SIGNATURE CARTRIDGES  
(AUDIO CRAFT) ULTRA CRAFT UNI-PIVOT TONEARM  
We also have the following lines, B&O, Chartwell and new Chartwell woofer, CM, Denon, Fulton, Grace, Koss, Luxman, Magneplaner (including Tympani series), M&K woofers, Nakamichi, Polk, (Quad ESL and electronics), Rappaport, Rogers, RTR, Sonus, Thorens, Yamaha, largest selection of direct discs on Long Island.

FREE INSTALLATION IN NEW YORK AREA  
WITH IVIE SPECTRUM ANALYZER.

ALL GOODS SHIPPED PREPAID AND INSURED — COME SEE THE WORLD'S FINEST RECORD CLEANING MACHINE BY KEITH MONKS.

AUDIO DEN LTD.  
1320-34 Stony Brook Road  
Stony Brook, New York 11790  
516-751-3350 TF

**AUDIO HOUSE - FLINT MICHIGAN**

|                |                |                |
|----------------|----------------|----------------|
| Mordaunt-Short | Marcof         | Watson Lab     |
| Audionics      | Sound Concepts | Linn Isogariks |
| Linn Sondex    | Rogers         | Setton         |
| Bryston        | Conrad-Johnson | M&K            |

GONZA wire is big, safe, twisted #12 Gauge speaker wire. 40' per ft. Sample \$1.00. 5232 Sagamore Dr., Swartz Creek, Mich. 48473 (313) 732-4670 by appointment. TF

AUDIO MAGAZINES: complete 1962, 63, 64, 65, 66, 68, 1973, 74, 75, 76, and 77. Also 6 issues or more of 1954, 57, 58, 59 - 1970, 71, 72. Also many Electronics World make offer Strubhar, 518 Blair Avenue, Calexico, Calif. 92231.

**ONLY THREE THINGS REALLY MATTER IN A PREAMP'S PERFORMANCE**

1. Accuracy of frequency response
2. Low noise
3. Low distortion

The DB Systems DB-1A has. . .

1. The most accurate phono equalization available ( $\pm 0.07$  dB 10Hz - 40kHz).
2. Noise as low as any on the market with actual cartridge attached (moving magnet type).
3. The lowest distortion of any preamp available (less than 0.0008%, 20Hz - 20kHz).



DB SYSTEMS • P.O. Box 187 • Jaffrey Center, NH 03454

**You can pay \$5.00 for an advanced state-of-the-art 60 minute cassette.**

**Why? Larksong will sell you one for \$1.30 or less.\***

- \* Pure Micro-Acicular Ferric Oxide
- \* Fully Bias and Equalization Compatible
- \* Five Screw Case
- \* Outstanding Signal to Noise Ratio
- \* Lifetime Guaranteed

Treat your hungry power-packed tape machine to a Larksong cassette and get a lot more entertainment for your money. No longer does its thirst for quality cassettes need to be limited by your lean budget. Now you afford the best — Larksong. One top line of exceptional cassettes available in two styles of boxes. ★ Dollar Special — Your first Larksong C-60 cassette with complete tape specifications and postage-free order blank for only \$1. Limit one per customer. Larksong puts it all together so you get more music out. Larksong, Dept. IC, 10 Scott St., Point Arena, CA 95468.

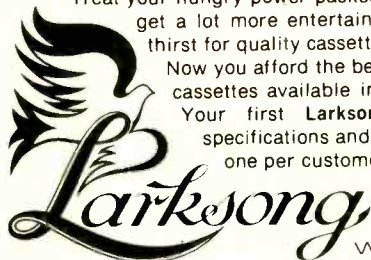

WHOLESALE INQUIRIES INVITED

**The Real tape breakthrough you've waited for.**

**ACTIVE ELECTRONIC CROSSOVERS**

Plug-in Butterworth (maximally flat) filters in 6 db., 12 db., or 18 db., per octave attenuation, any frequency specified. Filters flat beyond 100 KHz.

Complete crossover in attractive metal cabinet with all terminations and regulated power supply;

**STEREO BI-AMP \$139**

Tri-amp, quad-amp, and monaural types available at comparable prices. Other available features: Summer for "single woofer" systems, Subsonic noise elimination filters supplied with or without bass boost, level controls.

**FOR OEM'S AND HOME ASSEMBLERS**

500 Series dual filters and/or plug-in filters, regulated power supplies.

FREE CATALOG & PRICE SHEET  
Write to:

**DeCoursey ENGINEERING LABORATORY**  
11828 Jefferson Bl. • Culver City, CA 90230  
Phone: (213) 397-9668



**FOR SALE**

**AUDIO MODIFICATION MANUAL** 200+ pages of priceless information. Step-by-step procedures for many common components, general information applicable to almost anything you own. Emphasis on tube circuitry. **AUDIO:** "... a wealth of ideas ..." **STEREOPUS:** "easy to read, entertaining ... a painless education ..." **HIGH FIDELITY:** "chock full of goodies ..." This unique book provides information available nowhere else. Includes one year's free consultation service. \$25. U.S.A. and Canada \$27. elsewhere. California residents add \$1.50 tax. Overseas customers provide \$7.00 for Insured Air Parcel Post. M/C, Visa orders accepted: (714) 278-3310. **AUDIO DIMENSIONS**, 8898 Clairemont Mesa Blvd., San Diego, Calif. 92123. **TF**

**AUDIOPHILE COMPONENTS: PRICE REDUCTION**

|   |       |
|---|-------|
| Audionics T52spkr (365) ea                | \$299 |
| Conrad-Johnson preamp (590)               | \$450 |
| CM Labs 912A amp (900)                    | \$699 |
| Onkyo P303 & M505 amps (990)              | \$750 |
| Dyna Mark III mono amp (225)              | \$175 |
| Leach LNF-1A amp (575)                    | \$399 |
| Ace 35x2 amp & 3000 pre (500)             | \$399 |
| Hitachi 8300 class "G" amp (800)          | \$599 |
| Harbeth HL Monitors (400) ea              | \$299 |
| Anthem Array Spkr (600) ea                | \$480 |
| Anston IIE turntable (380) w/arm          | \$250 |
| Sonus Gold Series "Blue" cartridges (140) | \$.99 |
| SME Type II tonearms (175)                | \$.99 |

Most of the above components are new, some are displays, all have full warranty. Also used: SP-4 Audio Research preamp \$699, Phase Linear 4000 & 700B \$750, B&O 4002 with new good cartridge \$499. We pay shipping & insurance. Plus super delivery on Audioics CC-2 amps and BT-2 series II preamps - Tangent RS8 speakers - The Beveridge 2 SW-1 System.

When it comes to musical accuracy, Audio one is not just another alternative, Audio one ... is the answer!

**AUDIO ONE**

Box No. 167 n. woodward, birmingham, mi 48011 (313) 646-6666

**AUDIOPHILES' HIGH FIDELITY COMPONENTS!**

BOSE, TANDBERG, REVOX, NAKAMICHI, YAMAHA, CROWN, LUX, INFINITY, ADVENT, SAE, NIKKO, AIWA, AR, JVC, OTHERS. SIX TIME-DELAY SYSTEMS, LOW, LOW PRICES! **AUDIO AMERICA** (MARYLAND). 301-862-3088. PHONE HOURS: 5-9 PM WEEKDAYS, 9AM-9PM SATURDAYS, SUNDAYS. CALL TODAY FOR LITERATURE AND LOW PRICES.

**AUDIOPHILES' HIGH FIDELITY COMPONENTS**

BOSE, TANDBERG, REVOX, NAKAMICHI, YAMAHA, CROWN, LUX, INFINITY, OTHERS. LOW, LOW PRICES! **AUDIO AMERICA** (VIRGINIA). 804-793-3820. HOURS: 10A.M. - 6P.M. CALL TODAY FOR LITERATURE AND LOW PRICES!

**AUDIO RESEARCH DUAL 50G AMP**, excellent cond., \$350 or best offer. 414-332-8009.

**DO YOU KNOW . . .**

- The truth about "transient intermodulation distortion"?
- The real story about speaker-cable construction?
- What is audio's "missing link"?
- What are the world's best preamp, amp, phono cartridge, speaker, etc.?
- Which subwoofer has a flat frequency response to 3 Hz?
- What BADAP 1 is and does?
- What is the world's finest amp for quadrasonic enthusiasts?
- The truth about phase-aligned speakers?

**BARCLAY  
RECORDING & ELECTRONICS**  
233 East Lancaster Avenue  
Ardmore, Pa. 19003

**FOR SALE**

**AUDIO REPORT**

**STAN WHITE Glasscone™ Speaker**

**AUDIO Magazine** (Germany 2/78) reports on Stan White SHOTGLASS loudspeaker, "Er klingt so als ob ein im Halbdunkel spielendes Orchester poltztlich von starken SCHEINWERFERN beleuchtet wurde, so dass jeder Mann mit seinen Instrumenten poltztlich sichtbar wird." For further information write TACHYON, P.O. Box 204, Bloomingdale, Ill. 60109 Sole U.S.A. distributor. 312-529-9468.

**AUDIO RESEARCH SP4A**, McP1 \$950.00, D350 \$2250.00, TID's \$1095.00 Lux Quartz locked direct drive, Stax Carbon Fiber & Emt, complete for \$995.00. Yamaha CT7000- \$600.00. Nakamichi DS200 \$130.00, McIntosh 2300- \$1200.00. Total \$7,220.00, or make offer for total package. T.R. Wulff, Suite 400, Century Bldg, Paducah, Ky. 42001, 502-442-7611. **7-9**

**AUDIO SYSTEMS II "SPECIAL OF THE MONTH"**

1 Pair New Large Advent Speakers - Vinyl Finish  
1 Technics SU 7100 - 35 watts per channel Integrated Amplifier  
1 Technics SL 220 turntable with 1 Empire 2000 EIII OR Grado F3e+

**COMPLETE SYSTEM \$409.00** (Add \$22.00 for Walnut finish Speakers). Includes free shipping, handling and insurance to anywhere in the Continental United States. All merchandise **BRAND NEW** and factory sealed. **QUANTITIES LIMITED.** Campus rep. inquiries invited. Write for our full line brochure. **SEND CERTIFIED CHECK OR MONEY ORDER** for immediate shipment to:

**AUDIO SYSTEMS II**  
200 West 57th Street, Suite 1004  
New York, N.Y. 10019

**IF LATIN MUSIC TURNS YOU ON**, let us send you our free brochure. We specialize in 8-track, cassettes and reels of Salsa and Tipica. **SOUL-SOUNDS**, P.O. Box 312, New York, NY 10471

**FOR SALE**

**AUDIO RESEARCH**— D100A, \$895, SP-4AA \$725; Dyna-vector Dv505 \$295; ERA MK6 \$95; ShurrllIG \$30. Bob (216) 375-7580 or (216) 434-0467. **5-9**

**AUDIO TECHNOLOGY L.E.D. READOUTS MODEL 510.** \$109.95 each plus \$3.00 postage and handling. C.O.D.'s if desired. PA res. add 6% tax. E & A Associates, 501 North St., Marion Heights, PA 17832 or call (717) 373-1470 or (717) 339-3243 after 5:30 P.M.

**WOOFERS • MIDRANGES • TWEETER  
ZERO PHASE ERROR CROSSOVERS**

High power handling 5 1/4" midrange unit  
• One hundred watt 6", 8", 10" & 12" woofers with 4.7 lb. or 7.6 lb. magnet structures • High quality 1" cloth dome tweeter with 3 lb. magnet structure • Wide dispersion, low distortion piezoelectric tweeter handling 150 watts r.m.s. • Revolutionary new **ZERO PHASE ERROR CROSSOVERS** built on glass epoxy printed circuit boards for 2, 3 & 4-way systems • Crossovers are matched to system utilizing our drivers or systems utilizing the high quality **POLYDAX** units mfg. by **AUDAX** in France • Large inventory of nonpolar capacitors, non-inductive wire wound resistors & air-core coils. Custom crossovers designed to your specifications.

**SEND \$3.00** for prices & **CATALOG** of complete engineering data, application notes and simplified procedures for measuring Theile and Small's parameters, refundable with order.

**EMS, inc.** 615/546-7374  
2727 Magnolia Ave.  
Knoxville, TN 37914

**lower**

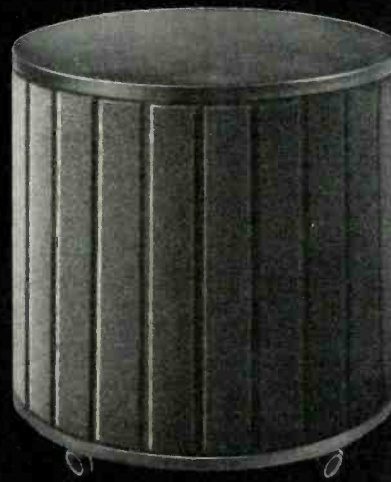

the response of your speaker system with the **JR Super Woofer and LPA unit**—our little brown box that segregates and amplifies the low frequencies. By the way, our LPA (Low Pass Amplified) unit can be used with other sub-woofers, too.



**H & H International**, 354 State St., Rochester, N.Y. 14608 • 716/325-5275

## FOR SALE

ALTEC LANSING 749A EQUALIZER, Rack Mountable, w/ sound level meter & tapes. Paid \$1100, sell for \$500. (412) 435-0263 5-9

**AMERICA'S LOWEST PRICES AND LARGEST SELECTION** of quality audio and video products. Many esoteric and professional brands, all discounted. We will try to meet or beat any price! Write for a computerized price quote today. Stellar Sound, 6260 Melody Lane, Suite 1024, Dallas, TX 75231 (214) 368-7197.

**ANOTHER AUDIOPHILE PUBLICATION?** All issues of AUDIO UPDATE have been published ON TIME. Update Seven featured an explanation of "supercables," with reasons why some cables operate better than others. Update Nine offered a complete technical and user report on the Rogers LS3/5a, with a computer-assisted analysis of the crossover and a guide to the use of this remarkable speaker system. In each issue, you'll find modifications to perfectionist equipment... look for the Marantz Nine, the Lux MB 3045 and others... includes step-by-step procedures. If your library doesn't include this bi-monthly publication, your system is not performing as well as it could. Annual subscription \$12. U.S.A. and Canada (add \$1.50 for first class mail), \$14. other countries (add \$4.38 for airmail). AUDIO DIMENSIONS, 8898 Clairemont Mesa Blvd., San Diego, CA 92123. (714) 278-3310. TF

AMPEX ATR3102, Ten Hours Total Use, \$5,200. REVOX A-700, Twenty Hours Use, \$1,800. CROWN Model 700, Ten Hours Use, \$900. Tele-computer, P.O. Box 2798, Opelika, AL 36801 (205) 749-8261.

AMPEX TAPE—NEW 1800 on 7" reel 12 for \$18 POSTPAID, 1200' 12 for \$13 POSTPAID—free list—WIDE RESPONSE, 6114A, SANTA MONICA BLVD., HOLLYWOOD, CA 90038 TF

## Western Pennsylvania's Quality Audio Dealer

|                 |                   |
|-----------------|-------------------|
| Mark Levinson   | Grace             |
| Bryston         | Janis Woofers     |
| Dayton-Wright   | M&K Woofers       |
| Watson Labs     | Denon             |
| DCM Speakers    | Ariston           |
| Snell Acoustics | Connoisseur       |
| Linn-Sondek     | Thorens           |
| Rogers LS3/5A   | Fidelity Research |
| Van Alstine     | Supex             |
| Hegman          | Formula 4         |
| Hafner          | Decca             |
| Magneplanar     | dbx               |
| Polk Audio      | Verion            |
| AIWA            | Nikko             |
| Dahlquist       | SAE               |
| Infinity        | Armstrong         |
| Marantz         | AR                |
| Visionik        | AEI               |
| Threshold       | Technics-Pro      |

plus much more...

Direct-To-Disc Recordings

SHIPPED PREPAID & INSURED

### Ovation Audio

6019 Broad St. Mall  
Pittsburgh, Pa. 15206

(412) 441-4550

## FOR SALE

## AMERICAN AUDIOPHILE

HOME OF

AUDIONICS  
AUDIO GENERAL  
AUDIO STANDARDS  
AUDIO TECHNOLOGY  
CIZEK  
DCM  
DECCA  
DENON  
HADCOCK  
HAFLER  
H. A. P. I.  
IMPULSE  
JANIS  
MARCOF

NEXUS  
PRECISION FIDELITY  
PREMIERE  
QUATRE  
RAPPAPORT  
SERIES 20  
SHURE  
SIGNET  
SME  
STAX  
STD  
SUPEX  
SYMDEX  
TANGENT

VANDERSTEEN  
AMERICAN AUDIOPHILE

5 Sunrise Plaza  
Valley Stream, NY 11581  
(516) 561-7114

716 Madison Ave.  
New York, NY 10021  
(212) 751-9733

ALL SHIPMENTS PREPAID AND INSURED  
FREE THROUGHOUT CONTINENTAL U.S.  
Master Charge & Visa Accepted

ALLISON ONES, Mint Cond., 6 mos. old. Trans. Warranty, \$599, (516) 825-3959.

AT CUSTOM SOUND, WE'VE SPENT MORE THAN TWO YEARS DESIGNING AND DEVELOPING THE VERY BEST CABINETS AND RACKS FOR HOUSING STEREO COMPONENTS. FEATURES INCLUDE: —Flexible modular design expandable to suit any size system. —Accommodates any size components including the largest. —Totally enclosed design with locks prevents dust buildup, unauthorized tampering, or theft of valuable equipment. —Bottom casters for mobility and rear door for easy rear access. Special separate record or tape storage module. —High grade furniture design, materials, and construction. —Low prices because you buy direct from the manufacturer. Send 25c (stamps O.K.) for our latest illustrated brochure. Custom Sound Service, Algonac, Mich. 48001.

### THE JANIS BASS SYSTEM

Available at

### AMERICAN AUDIOPHILE

5 Sunrise Plaza, Valley Stream, NY 11581

(516) 561-7114

716 Madison Ave, New York, NY 10021

ALL SHIPMENTS PREPAID AND INSURED  
FREE THROUGHOUT CONTINENTAL U.S.

MASTER CHARGE & VISA ACCEPTED

**ANOTHER HYPE-FREE SPEAKER AD!** The VMPS Super Tower and Super Tower II are the lowest distortion, most powerful and widest-band with speakers ever designed for home use. THD at 1W20Hz-20kHz: St 0.5%. STII0.25% Efficiency: 103 db/1m/1w. Power Handling: 350W rms for ST, 500W rms STII. Output SPL: 128dB for ST, 132dB for STII at 1m w/ rated max. input power. Both units feature multi-band bass (w/dual 15" woofers incl. integral sub-woofer plus add. 12" woofers), minimum phase response, biamping w/o ext. xover. The Super Tower is a 50" high walnut cabinet with 180° dome tweeter array, the STII a 7' tall theatre black cabinet w/8 tweeter vertical line source. Prices: Assembled ST \$799 ea. STII \$1299 ea; easy-to-assemble KITS ST \$499 ea., STII \$799 ea. plus shipping. 9 VMPS models available, kit or assembled. ITONE AUDIO 7301 Rockway El Cerrito cal. 94530 (415) 526-7084. 5-9

AT LAST! THE ULTIMATE CABINET DESIGN FOR HOUSING STEREO COMPONENTS - THE CUSTOM SOUND MODULAR EQUIPMENT CABINET. EARLY TWO YEARS IN DEVELOPMENT FEATURING:

- Flexible modular design expandable to suit any size installation.
- Accommodate any size components including the largest.
- Totally enclosed design with locks prevents dust buildup, tampering, or theft of valuable equipment.
- Bottom casters for mobility and rear door for easy rear access.
- High grade furniture design and construction.
- Very attractively priced.

Before you invest in a rack, call or write for our free illustrated information. Custom Sound Service, 8460 Marsh Road, Algonac, Michigan 48001. (313) 794-5400. 11-8



### The UNKITS!

- They don't LOOK like kits!
- They don't SOUND like kits!
- They just SAVE like kits!

Build your own speakers — Save 50% or more...  
No soldering required!

FREE KIT BROCHURE — I'm interested — send me your free 8-page Brochure (kits from \$55.00 each).

\$1.00 Catalog/Manual — Give me all the details — send me your comprehensive manual on speaker kits, crossovers, basic components and engineering data with "How-to-do-it" article by noted speaker designer John Hoge. \$1.00 enclosed.

Acusta Craft

Dept. AU P.O. Box 12030 • Shawnee Mission, Ks. 66212

Acusta Craft®



## FOR SALE

### ANOTHER NEW YORK CITY HIGH END AUDIO STORE?

Not really. Instead of rush A/B comparisons, electronics B.S., flashy switching systems, or high pressure salesmanship, we offer honest advice, audiophile to audiophile, and an open invitation to audition, at your leisure the finest components available in a comfortable homelike setting on Manhattan's upper east side.

Linn-Sondek, Linn Isobarik, Naim, Marcoff PPA-I, Meridian, Michaelson & Austin TVA-I, Spondor, Fried, Mordaunt-Short, Precedent Audio, Spatial Coherence, Van Alstine, Strelieff Systems, STD, Connoisseur, Rega Planar, Grace, Supex, Signet, Micro-Acoustics, NAD, AGI, Hadcock, CPU Micro-Tuner, Berningft-10 and many others.

#### SOUND BY SOUND; AN ALTERNATIVE

For information or an appointment call (212) 929-2356 (10:00 AM-10:00 PM) We ship anywhere. 5-9

**ANTI-SKATING for AR TURNTABLES!!** Proven counterweight design of nickels steel & aluminum construction. Install yourself in minutes. \$7.95 postpaid. (Dealer inquiries invited.) AUDIO INNOVATIONAL PRODUCTS, P.O. Box 1607, Portsmouth, N.H. 03801.

#### AT LAST! A HYPE-FREE SPEAKER AD!

The VMPS TOWER II guarantees the following performance specifications: THD less than 0.7% 22Hz-20kHz/1W; low frequency cutoff -3dB at 22Hz; sensitivity 103dB/1m/1W; multi-sur. mid, two front tweeters plus one top-firing supertweeter; biamping w/o external xover. Output level w/ 250W rms or more, that of live music. Price: \$549ea assembled, KIT just \$369ea plus shipping. SPEAKERWORKS, 2578 Shattuck, Berkeley, Cal 94704 (415) 548-5302 Nine VMPS speakers available kit or assembled, write or call for details!

#### ATTENTION SOUTHERN AUDIOPHILES

|                |                      |
|----------------|----------------------|
| Yamaha         | Great American Sound |
| Dahlquist      |                      |
| Polk Audio     | Denon                |
| Bang & Olufsen | Klipsch              |
| Advent         | Technics             |
| M & K          | Visonik              |
| Aiwa           | Sonus                |
| Philips        | Maxell               |

#### Available at Sound Advice

Village Plaza Ruston LA. 71270 (318) 255-8000. 9-9

**ATTENTION SOUTHERN AUDIOPHILES!** Acoustat, Audionics, Apt-Holman, DCM Time Window, Yamaha, Lux, Stax, Gale, Denon, Grace, Sonus, Mitsubishi, B&O, Advent. Available at AUDIO SYSTEMS, INC. Suite L, 3302 Johnston St., Lafayette, Louisiana 70503 (318) 984-7007.

**NEW ENGLAND AUDIOPHILES** Goodwin's Inc. is unique in the audio field, offering a few select products which are acknowledged to be the finest. These products are properly set-up, and may be auditioned in a comfortable, relaxed, living room environment.

Our reference is the Mark Levinson HQD system, with 30ips master tapes played on a Mark Levinson Studer A-80. The degree to which this system approaches the sound of live music is literally breathtaking.

Goodwin's represents: Mark Levinson, Quad, Linn Sondek, Syrinx, Verion, Draco, Symdex, Precedent Audio, Fidelity Research, Pedersen Acoustics, and Win Labs.

If you would like to avoid the planned obsolescence of most stereo components, and are interested in the finest music reproduction, please call Goodwin's for an appointment.

Goodwin's Inc.  
(617) 266-0608

33 Newbury St.  
Boston, MA 02116

#### TURNTABLES

Denon • Visonic • Supex • Linn Sondek  
Transcriber • SAEC • Grace • Sleeping Beauty  
AKG • Formula 4 • Dynavector • Mitsubishi

#### Audiocom HIGH TECHNOLOGY AUDIO

177 Sound Beach Ave Old Greenwich CT  
Phone: (203) 637-3621

## FOR SALE

**AT PARAGON OF SOUND:** New and superb Conrad-Johnson tube amp and Berning FT10 tube-transistor and the Precision Fidelity C-4 preamps. In speakers: the new Snell Acoustic, the MZ MOD3, Rogers LS3/5A, and Acoustic Concept AC-24; M & K and Fundamental Research Subwoofers. Armstrong 624 FM Tuner; Berning Stereo 20 amp. S.T.D. Turntable, Hadcock tonearm, Denon, Grace, Supex, and Dynavector products. Call 301-229-2676 (Bethesda, MD) or write P.O. Box 189, Cabin John, MD. 20731 7-9

**ATTENTION ADVENT/AR OWNERS,** the revolutionary HARTKE TWEETERS can extend the high frequency response, and improve dispersion with almost all cone type speakers.

The added open sound of these tweeters will shock your senses.

These extremely well constructed add-on, in their own walnut cabinet, come complete with built-in crossover and level adjustments. \$175 per pr.

#### PREPAID AND INSURED

#### AUDIO DEN

#### HEARING IS BELIEVING

1320-34 Stony Brook Road, Stony Brook, N.Y. 11790

(516) 751-3350.

#### ATTENTION VIDEO RECORDER OWNERS

Calvec is currently expanding its video exchange club. As a member you will be entitled to exchange movies and features as many times as you wish. Over 500 uncut and uncensored titles currently available—ALL RATINGS—One year membership only \$15. TDK video tape (the best available) TDK 4 hour VHS \$20.61. Also JVC, RCA, etc. 4 hour VHS 19.45 2 hour BETA 14.60. Quantity discounts available. SAVE MONEY. Clean your own heads. Kit with complete instructions \$4.95. Send \$3 for our catalog (refundable with first order). Calvec/7355 Slater Ave./Huntington Beach, Ca. 92647. 5-9

## FOR SALE

### ATTENTION DCM TIME WINDOW OWNERS

We now offer a convenient and attractive way to improve the sound of your speakers. The DCM Time Window, when raised 9 inches off the ground, has an airier and tighter sound: the image is raised and standing waves reduced.

THE DCM TIME WINDOW PEDESTALS are made of heavy duty wrought iron and suit the shape and appearance of the Time Window perfectly. They sell for \$65. per pair. If there is no dealer nearby, order postpaid (Master Charge & Visa accepted) from

#### R. S. PARK AUDIO ASSOCIATES

5 SUNRISE PLAZA, VALLEY STREAM, NY 11581

(516) 561-7114

DEALER INQUIRIES INVITED

### Get QUALITY HI-FI with PROFESSIONAL ADVICE call the Pros at Audio Concepts

#### Franchised Dealers For:

JBL, AR, TECHNICS PRO, GREAT AMERICAN SOUND, MICRO-SEIKI, BOSE, DAHLQUIST, AVID, ADS/INAKAMICHI, MAXELL, DISCWASHER, MXR, YAMAHA, ONKYO, OPTONICA, SATIN ADC, AC-CUPHASE, PHASE LINEAR, TANDBERG, AKG, DBX, WIN LABS, SONUS, MICRO ACOUSTICS, HARMAN KARDON, AUDIOPULSE, VISONIK, STAX, DENNON, HAFFLER, G.A.S., OTHERS.  
Free freight on most items.

Call us TOLL FREE. It's worth it!!!

(800) 423-4170

#### AUDIO CONCEPTS

1127 W. Huntington Dr., Arcadia, CA 91006  
(213) 445-3663

# poor



little speaker. He's just come from England, and someone mean told him that Americans think good loudspeakers should be large and come in boxes. But he's little and cylindrical, and he wants to let everybody know how outstanding he really is. Won't you help him make friends here?



H & H International, 354 State St., Rochester, N.Y. 14608 • 716/325-5275

**FOR SALE**

**FORD AUDIO JOINS CROWN** - in recognizing the newly developed Distinction Series as definitely the finest in home listening components. Computer assisted design using the latest technology has created a new era in sound reproduction that you must hear. The complete line is now available at Ford Audio & Acoustics, Inc., 1815 Clessen Blvd., Oklahoma City, OK 73106 405-525-3343.

**FREE SHIPPING & THE LOWEST PRICES**

12 MAXELL UDXL I or II C-90 TAPES @ \$3.39 each (\$40.68 per carton)  
 10 TDK SA-90 tapes @ \$2.99 each (\$29.90 per carton)  
 DISCWASHER Brush & Fluid \$9.95  
 DISKIT - Includes brush, fluid, zerostat, SG1 Stylus cleaner and organizer \$32.75

This is just a sample of our extensive line of audiophile equipment . . . at prices everyone can afford. To place an order, send **CERTIFIED CHECK OR MONEY ORDER** and add **NOTHING** for shipping, handling and insurance to anywhere in the Continental United States. All tapes sold in cartons only. To obtain a brochure in our line of high end, name brands, and economic audio systems, just send your name and address to:

AUDIO SYSTEMS II  
 200 West 57th Street, Suite 1004  
 New York, N.Y. 10019

The only place  
 in the country  
 where you can buy

**KOSS**  
 Model II ELS

**eakin  
 audio**

6403 Roosevelt Way NE  
 Seattle, WA 98115  
 (206) 525-0200

**FOR SALE**

**FULTON PREMIERE SPEAKERS**, mint, \$2500 delivered; Paoli 60 Me amplifiers, better sound than D76a, \$500; (617) 648-4191.

**G-B ELECTRONICS**

Audio sales and laboratory service in northern New Jersey since 1945. We offer: Snell Acoustics, Spondor, Symdex, JR, Gale, Threshold, Conrad-Johnson, Rappaport, AGI, Leach, Denon Electronics, Denon Turntables, Linn-Sondek, Linn-Naim, Connoisseur, Grace, Hadcock, Promethean, Decca Products, Platter Pad, Audio Source, Sheffield, Crystal Clear & Levinson discs and others. G-B Electronics, Box 385, Hawthorne, N.J. 07507 (201) 427-8885 for appointment. We welcome mail orders, free shipping.

**GET INTO BROADCASTING!** Learn how to receive free records, tapes, get an FCC broadcast license, start your own station. Free details. "Broadcasting", Box 130-N5, Paradise, CA 95969.

**GREAT GRACE & SUPER SUPEX**

We have in stock the Grace 707 MK2, 704, F-8L, F-9L, Linn mods for the 707 MK1 & MK2 & the Supex SD-900/E+ Super. Free shipping in the U.S. Visa & M.C. honored. Demo. by appt. OXFORD AUDIO CONSULTANTS, Box 145, Oxford, OH 45056, 513-523-3895. Eve & weekends too.

**HAFLER DH-101 PREAMP**

We expect to be in stock on this exciting new preamp by Dec. 12th. Kit price is \$199.95. Custom wired and tested, \$299.95. Immediate prepaid shipment via UPS. **THE AUDIBLE DIFFERENCE**, 435 Tasso, Palo Alto, California 94301. (415) 328-1081. TF

**HAFLER HEADQUARTERS IN CANTON, OHIO** - The Listening Room, 1807 Cleveland Ave. NW. (216) 452-6332. Hours: THURS/FRI/SAT, 10-7. 5-9

**HAFLER IN THE SOUTH!**

In stock, the superb Hafler DH-101 preamp. Kit \$199, factory assembled \$299. Immediate free shipping. Also Fried, Audionics, more. READ BROS, STEREO, 593 King St., Charleston, S.C. 29403 (803) 723-7276. 5-9

**HAFLER PREAMP CABINETS.** Literature. GEOMETRIX, Box 612, Mexico, MO 65265 7-9

**H.Q.D. SYSTEM** (no woofers) with Lux 2003 X-over (7khz & 100hz) \$2000; Pioneer M-22 Class A Amp \$400. All mint, buyer pays freight. 206-778-1904.

**FOR SALE**

**HAFLER: PREAMP, HEAD AMP, AMP & ACCESSORIES**  
 We have in stock the DH-101K \$199.95, DH-101A \$295.95, DH-102 head amp \$74.95, DH-103 black knobs \$19.95, DH-104 rack mount kit \$24.95, DH-105 preamp cabinet \$24.95 & DH-101A with DH-102 installed \$375. We anticipate having the DH-200K \$299.95 & DH-200A \$399.95 amps by June 15, 1979. World-wide shipping. Free shipping in the US. Visa and M.C. honored. Demo. by appt. OXFORD AUDIO CONSULTANTS, POBox 145, Oxford, OH 45056, 513-523-3895. Also open evenings & weekends.

**HAVING TROUBLE FINDING DIRECT-TO-DISC AND SOTA RECORDINGS? WE HAVE THEM ALL. SEND FOR FREE CATALOGUE. KNOT SO CHEAP RECORDS, 7505 BIG BEND, DEPT. AM12, WEBSTER GROVES, MO. 63119. 1-8**

**HEAD AMP HEADQUARTERS**

We have the finest head amps available: Denon HA-1000 \$440, Hafler DH-102 \$74.95 (we can tell you how to build an ac supply), Lentek head amp \$160, Linn & PNAG \$300. Free shipping in the U.S. Visa & M.C. honored. Demo. by appt. OXFORD AUDIO CONSULTANTS, P.O. Box 145, Oxford, OH 45056 513-523-3895. Eve. & weekends too!

**HEAR THE INCREDIBLY DETAILED SOUND**, unusual imaging and depth offered by the Crown Distinction Series of audio components. Audio Consultants invites you to audition this new line of Crown products now on display at Audio Consultants, Inc., 517 Davis Street, Evanston, IL 60201; Audio Consultants, Inc., 757 N. Milwaukee Ave., Libertyville, IL 60048.

**HI-FI ENTHUSIASTS WANTED!!!** Earn more than just spare money in your spare time. We need campus representatives to sell name brand stereo components at discount prices in your area. No investment required. Serious inquiries only please. Contact: Mail Order Dept., K&L Sound Services Co., 75 N. Beacon St., Watertown, Mass. 02172 TF

**INSIDERS know that AUDIO FORUM MAGAZINE** provides the most extensive coverage of the esoteric audio market ... Do YOU!? Audio Professionals know how AFM helps them to keep in touch with the ever-changing audio market with vital information often exclusive, always first, months before the others. Audiophiles like the first reports on new equipment, ways to improve their systems, and increasing their understanding of some of audio's most complex and controversial topics. You should subscribe today. Send \$18 (1st class) or \$22 U.S. (overseas air) for six bi-monthly issues to AFM, Box 22544 A-5, Portland OR 97222. BAC/MC honored. Full MONEY BACK GUARANTEE if not satisfied.

**INVISIBLE HANGERS FOR ADS, Braun, Visonik/David speakers.** Pair \$12.00, \$1.00 postage. Plexiforms, 1016 1/2 Gilbert Court, Iowa City, IA. 52240

**IS YOUR PREAMP MERELY "STATE OF THE ART"?**

The new Crown DL-2 preamplifier is the result of a totally uncompromised effort to design the quintessential preamp. Only Crown has the engineering expertise to conceive and construct a preamplifier whose sound quality surpasses its superior specifications. Discerning audiophiles know that BARCLAY is also dedicated to satisfying those listeners who strive for the finest musical reproduction attainable. We feature the complete Crown "Distinction Series," including the new SA-2 amplifier (500 watts/4 ohms) and the EQ-2 equalizer (unquestionably the world's best). Visit our showrooms to see and hear the Crown DL-2 preamplifier: tomorrow's "state-of-the-art" preamp available today.

**BARCLAY RECORDING & ELECTRONICS**

233 East Lancaster Avenue  
 Wynnwood, Pa. 19096  
 (215) 649-2965

1-9

**SUPERIOR AUDIO COMPONENTS:** Audio Pulse; Audio Research SP-6 tube preamp and D-110 amp; Badap 1; Celestion; Cizek; Crown Distinction Series DL-2, SA-2, and EQ-2; Dayton Wright; dbx; Decca; Denon; Dynavector; EMT; Formula 4; Grace; Hafler kits; KEF; Kenwood Purist; Lux LRS; Magneplanar; Mitsubishi; Mobile Fidelity records; Nakamichi; Plasmatronics; Polk; RTR; Verion; Watson speakers.



233 East Lancaster Avenue, Wynnwood, Pa. 19096.  
 (215) 667-3048 or 649-2965.

**IN CENTRAL MASSACHUSETTS...**

- |             |           |            |
|-------------|-----------|------------|
| MAGNEPAN*   | POLK      | APT-HOLMAN |
| HAFLER      | G.A.S.    | KEF        |
| ADS         | DAHLQUIST | B&W        |
| AMBIENT     | NAKAMICHI | STAX       |
| D-B SYSTEMS | GRACE     | LUXMAN     |

\*Exclusive N.E. dealer for MAGNEPAN MG-I and MG-IIA

**Hearingthings**

319 Main St. (Mechanics Hall) • Worcester, Mass. 01608 • (617)757-9658

**SPEAKER SYSTEMS**

Beveridge • Rogers L35A • JR Rogers 149  
 DCM • Snell Acoustics • Dahlquist • ADS  
 Allison • Mitsubishi • BW • Janis



**AUDIOCOM** HIGH TECHNOLOGY AUDIO  
 177 Sound Beach Ave. Old Greenwich, CT  
 Phone: (203) 637-3621



**FOR SALE**

**IVIE ELECTRONICS REAL TIME ANALYZERS**, etc. Some very slightly used demonstrators at discount. Full factory warranty. Money-back guarantee. JML Company, 39,000 Highway 128, Cloverdale, CA 95425.

**JACK THE GIANT KILLER**

Among the many megabuck amplifiers we find the humble AUDIONICS CC-2, A modest 70-watt stereo amplifier (bridgeable for 225 watts) with the sonic integrity that the giants offer but rarely delivers! Audition the AUDIONICS CC-2, PZ3 & BT2 at

**AMERICAN AUDIOPHILE**  
5 Sunrise Plaza, Valley Stream, NY 11581  
(516) 561-7114  
716 Madison Ave., New York, NY 10021  
(212) 751-9733  
ALL SHIPMENTS PREPAID AND INSURED  
FREE THROUGHOUT CONTINENTAL U.S.  
MASTER CHARGE & VISA EXCEPTED

**J. E. SUGDEN A48 Integrated Stereo Amplifier \$350.** P51 Mono/stereo power amplifier \$300. C51 Control unit \$225. In factory sealed cartons. Complete array of printed boards and spares for Quad 33 & 303. R. Bernavides, 630 Sun Valley Ct. Indianapolis, IN 46217

**TANGENT IN THE EAST**

American Audiophile Trading Company  
Valley Stream, New York 11581  
Audio Sorum  
Watertown, MA. 02172  
Audio In-Sight  
Ft. Lauderdale, FLA. 33308  
Audio Works  
Harrisburg, PA. 17111  
Chestnut Hill Audio  
Philadelphia, PA. 19146  
DKL Sound Lab  
Silver Springs, MD. 20910  
Ear Drum of N.E.  
Cambridge, MA. 02138  
Ear Drum of N.E.  
Burlington, MA. 01803  
Landes Audio  
Orange, New Jersey 07930  
Landes Audio  
Chester, New Jersey 07930  
The Listening Room  
Scarsdale, New York 10583  
Lyric Hi Fi, Inc.  
New York, N.Y. 10028  
Sound Components  
Coral Gables, FLA. 33134  
Suber's Stereo  
Charlotte, N.C. 28207  
Take 5 Audio  
New Haven, CT. 06511  
  
Tangent Marketing of America  
12 Irving Street, Framingham, MA 01701  
617-620-0677

**Bob Heenan Sells Great Used Equipment**

Tel: 617-734-2727  
Sound Advice  
Box 782  
Brookline Village  
MA 02147

|                |                 |              |
|----------------|-----------------|--------------|
| AR             | Marantz (Tubes) | SAE          |
| DB             | Magneplanar     | Sony         |
| EPI            | McIntosh        | Siex         |
| Bose           | Levinson        | Quad         |
| B & W          | LS 3/5A         | Revox        |
| Crown          | H - K           | Yamaha       |
| Advent         | Linn            | Thorens      |
| Dahlquist      | GAS             | Tandberg     |
| Dyna (Tubes)   | JBL             | Nakamichi    |
| Audio Research | Lux             | Phase Linear |

**Money Back Guarantee**  
**Sound Advice, Box 782,**  
**Brookline Village, MA 02147**  
Equipment bought, sold, traded & brokered.

**FOR SALE**

**LEACH LNF 1-A AMP**, professionally modified and tested, conforms to latest low - TIM/II \$375. JR 149s, \$295. Custom JR stands, \$30. Promethean IIA+, \$75. SME III, \$195. Mike, (608) 835-5580.

**LED POWER LEVEL DISPLAY** plans, easy and inexpensive to build (about \$25). Send only \$3.50 for complete plans and schematics to: P.O. Box 19686, San Diego, CA 92119 5-9

**LONG HAIR WOOL** carded — cleaned for stuffing speakers, \$7/lb incl. ship. J. Ebbert, 770 Holly Rd., Wayne, PA 19087 (215) 687-3609

**LOWEST DISCOUNT PRICES ANYWHERE** on audio equipment. All major brands discounted. Write for quotes, K&L Sound Services, 75 N. Beacon St., Watertown, Mass. 02172. TF

**LOWEST POSSIBLE PRICES!** Most stereo brands! Request quotes only! Allegheny, Box 1029-U3. Johnstown, PA 15907. 7-9

**FOR SALE**

**LOWEST PRICES ON STEREO-ESOTERIC COMPONENTS & Tapes!** Over 150 brands. Send # 10 SASE for quotes. Audio Unlimited, 401 Reynolds Circle # 12-C, San Jose, CA 95112 (408) 289-8875 1-6 Monday-Friday. 5-9

**LOWEST PRICES:** BOSE, SAE, NAKAMICHI, PHASE LINEAR, DBX, ADS, HK, JBL, AND MANY MORE. QUOTE FROM DYNAMIC SOUND, BOX 168, STARKVILLE, MS 39759. 601-323-0750.

**LS3/5a BBC MONITORS** The worlds most accurate loudspeaker \$399 p/pair free delivery within USA Reply to Box A 923, c/o Audio. 5-9

|   |                          |  |             |           |
|---|--------------------------|--|-------------|-----------|
|  | <b>GOLDEN gramophone</b> | 2858 W. Market Street<br>Akron, Ohio 44313<br>Phone (216) 864-4411 |             |           |
|   | Audio Research           | Direct Disc  | Hatler      | Revox     |
|   | Advent                   | DynaVector   | Kenwood     | Rogers    |
|   | ADS                      | Electro Research   | LinnSondek  | Setton    |
|   | Armstrong                | E. M. T.   | Magneplanar | Sonus     |
|   | Bravura                  | FMI (Fulton)   | Nakamichi   | Stax      |
|   | Connoisseur              | GAS  | Quatre      | Technics  |
|   | Denon                    | Grace  | Rappaport   | Threshold |
|   |                          | Grado Signature  | Rega        |           |

**LEGENDARY.**

Mark Levinson. Threshold. Grado. Audionics. Janis. Pyramid. Grace. Spendor. Rogers. DCM. Quad. F.R. Bryston. Snell. Linn-Sondek. B & W. Precedent. Cotter. Symdex. Revox. All these legends at Chestnut Hill Audio, 2302 Lombard Street, Philadelphia, Pa. 19146. (215) KI6-6178.

**CHESTNUT HILL AUDIO.**



**DESIGN FEATURES & BENEFITS:**  
ELECTRONIC CROSSOVER for reduced harmonic distortion and accurate integration of low and high frequency speakers. Not found with passive units.

BI AMPLIFICATION reduces IM distortion and improves dynamics.

CROSSOVER FREQUENCY AND SHAPE  
Complex design utilizing 1st and 3rd order slopes at optimum frequency eliminating minor LS 3/5a resonances in the 70 Hz region. Coaration reduced and phase response maintained due to correct crossover shape.

MID RANGE DETAIL AND DEFINITION of LS 3/5a improved with addition of woofer system.

HIGH POWER HANDLING CAPACITY  
Continuous program levels of 150-150w

TWO BASS ENCLOSURES imperative for correct stereo imaging.

**THE ONLY WOOFER SYSTEM TECHNICALLY CORRECT FOR THE LS3/5a**

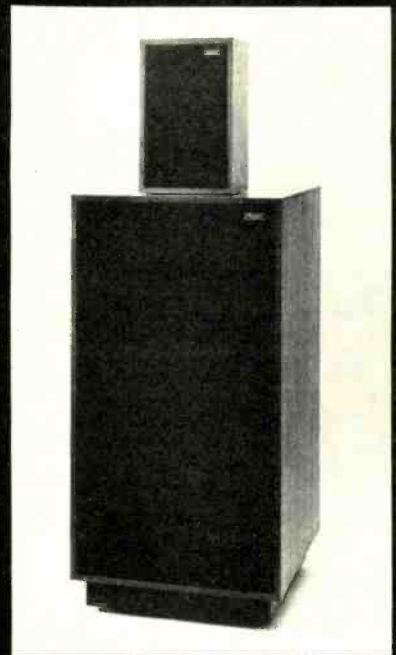

**Rogers**

BRITISH HIGH-FIDELITY

Reference Monitor Int. Inc., 2380 "C" Camino Vida Roble, Carlsbad, CA 92008

*The Reference Monitor System.*

Musically Superior

# Advertising Index

| Advertiser  | Page          | Advertiser   | Page        | Advertiser  | Page     |
|---|---------------|--|-------------|---|----------|
| Acusta Craft<br>Speaker Kits<br><b>Write Direct to Advertiser</b>                             | 112           | Chestnut Hill Audio<br>Audio Store<br><b>Write Direct to Advertiser</b>                | 115         | Fuji<br>Tapes<br><b>Enter No. 9 on Reader Service Card</b>                            | 91       |
| ADS<br>Digital Time Delay System<br><b>Write Direct to Advertiser</b>                         | 29            | CSA<br>Audio Components<br><b>Write Direct to Advertiser</b>                           | 106         | Garland Audio<br>Audio Store<br><b>Write Direct to Advertiser</b>                     | 116      |
| Allison Acoustics<br>Electronic Subwoofer System<br><b>Enter No. 1 on Reader Service Card</b> | 40            | Custom Craft<br>Mini Speakers<br><b>Enter No. 4 on Reader Service Card</b>             | 81          | Golden Gramophone<br>Audio Store<br><b>Write Direct to Advertiser</b>                 | 115      |
| Apt Corporation<br>Holman Preamplifier<br><b>Enter No. 44 on Reader Service Card</b>          | 40, 119       | Dahlquist<br>ALS 3 Car Speaker<br><b>Enter No. 5 on Reader Service Card</b>            | 89          | Goodwin Inc.<br>Stereo Components<br><b>Write Direct to Advertiser</b>                | 113      |
| Audio Advocate<br>Hi-Fi Components<br><b>Write Direct to Advertiser</b>                       | 106           | D. B. Systems<br>Preamplifiers<br><b>Write Direct to Advertiser</b>                    | 110         | H & H International<br>Speakers<br><b>Write Direct to Advertiser</b>                  | 111, 113 |
| Audio Com<br>Hi-Fi Components<br><b>Write Direct to Advertiser</b>                            | 113, 114, 117 | DeCoursey Engineering<br>Electronic Crossovers<br><b>Write Direct to Advertiser</b>    | 110         | Hearingthings<br>Speakers<br><b>Write Direct to Advertiser</b>                        | 114      |
| Audio Concepts<br>Hi-Fi Components<br><b>Write Direct to Advertiser</b>                       | 107, 113      | Discwasher<br>SC-1 Stylus Cleaner<br><b>Write Direct to Advertiser</b>                 | 2, Cover IV | Henry's camera<br>Hi-Fi Components<br><b>Write Direct to Advertiser</b>               | 107      |
| Audio Critic<br>Publication<br><b>Write Direct to Advertiser</b>                              | 103           | Discwasher D3 Fluid<br><b>Write Direct to Advertiser</b>                               |             | International Hi-Fi<br>Audio Mail Order<br><b>Enter No. 10 on Reader Service Card</b> | 97       |
| Audio Excellence<br>Hi-Fi Components<br><b>Write Direct to Advertiser</b>                     | 117           | Dual (United Audio)<br>Tonearms<br><b>Enter No. 6 on Reader Service Card</b>           | 77          | Jensen<br>Triax II 3-Way Speaker<br><b>Write Direct to Advertiser</b>                 | 30, 31   |
| Audio Horizons<br>Publication<br><b>Write Direct to Advertiser</b>                            | 117           | Eakin Audio<br>Headphones<br><b>Write Direct to Advertiser</b>                         | 114         | J&R Music World<br>Audio Mail Order<br><b>Enter No. 11 on Reader Service Card</b>     | 80       |
| Audio Insight<br>Stereo Equipment<br><b>Write Direct to Advertiser</b>                        | 118           | E. A. R. S. Inc.<br>Stereo Components<br><b>Write Direct to Advertiser</b>             | 120         | Jules Rabin<br>Hi-Fi Components<br><b>Write Direct to Advertiser</b>                  | 112      |
| Audio Reference<br>Speaker Kit<br><b>Write Direct to Advertiser</b>                           | 107           | Electro-Voice<br>Interface: D Speaker<br><b>Enter No. 7 on Reader Service Card</b>     | 14          | JVC<br>JVC Separates<br><b>Enter No. 12 on Reader Service Card</b>                    | 15       |
| Audio Technica<br>Hi-Fi Equipment<br><b>Enter No. 2 on Reader Service Card</b>                | 13            | Empire Scientific<br>EDR Phono Cartridge<br><b>Enter No. 45 on Reader Service Card</b> | 7, 16       | KEF<br>Speakers<br><b>Enter No. 13 on Reader Service Card</b>                         | 94       |
| Barclay Recording & Electronics<br>Hi-Fi Components<br><b>Write Direct to Advertiser</b>      | 111, 114      | Record Care Products<br><b>Enter No. 8 on Reader Service Card</b>                      |             | Kenwood<br>KA-7100 Amplifier, KT-7500 FM Tuner<br><b>Write Direct to Advertiser</b>   | 75       |
| B&F<br>Audio Mail Order<br><b>Enter No. 3 on Reader Service Card</b>                          | 97            | EMS, Inc.<br>Speakers<br><b>Write Direct to Advertiser</b>                             | 111         | Koss<br>Pro/4AAA Stereophones<br><b>Enter No. 14 on Reader Service Card</b>           | 11       |
| Bose<br>Model 601 Direct/Reflecting Speaker<br><b>Write Direct to Advertiser</b>              | 50, Cover III | Ess<br>Speakers<br><b>Write Direct to Advertiser</b>                                   | 103         | Lake Shore Drive Hotel<br>Hotel<br><b>Write Direct to Advertiser</b>                  | 105      |
| Interaudio Stereo Speakers<br><b>Write Direct to Advertiser</b>                               |               | Etc.<br>Quad Record Demodulator<br><b>Write Direct to Advertiser</b>                   | 116         | Larksong<br>Stereo Components<br><b>Write Direct to Advertiser</b>                    | 110      |
|   |               | Fisher<br>CR5150 Cassette Deck<br><b>Write Direct to Advertiser</b>                    | 73          |   |          |



# Advertising Index

| Advertiser   | Page     | Advertiser   | Page       | Advertiser  | Page    |
|--|----------|--|------------|---|---------|
| LT Sound<br>Hi-Fi Components<br><b>Write Direct to Advertiser</b>  | 108      | Pioneer<br>TX 9800 Tuner<br><b>Enter No. 26 on Reader Service Card</b>   | Cover II,I | Sound Advice<br>Used Stereo Equipment<br><b>Write Direct to Advertiser</b>  | 115     |
| Lux<br>LSS Stereo Components<br><b>Write Direct to Advertiser</b>  | 41       | PS Audio<br>Hi-Fi Equipment<br><b>Enter No. 27 on Reader Service Card</b>  | 103        | Sound Aids<br>Tweeters<br><b>Write Direct to Advertiser</b>   | 117     |
| 3M<br>Master Series Recording Cassettes<br><b>Enter No. 15 on Reader Service Card</b>  | 59       | Radio Shack<br>Realistic Lab-500 turntable<br><b>Write Direct to Advertiser</b>  | 19         | Sound Components<br>Hi-Fi Components<br><b>Write Direct to Advertiser</b>   | 107     |
| Marcof<br>PPA-1 Pre-preamplifier<br><b>Enter No. 16 on Reader Service Card</b>   | 55       | RG Dynamics<br>Dynamic Processor<br><b>Write Direct to Advertiser</b>  | 116,119    | Soundcraftsmen<br>4002 Preamplifier<br><b>Enter No. 36 on Reader Service Card</b>   | 48      |
| Maxell<br>Maxell Tapes<br><b>Enter No. 17 on Reader Service Card</b>   | 27, 78   | Rogers<br>Speakers<br><b>Write Direct to Advertiser</b>  | 108,115    | Speakerkit<br>Loudspeaker Kits<br><b>Write Direct to Advertiser</b>   | 119     |
| McIntosh<br>Preamplifier<br><b>Enter No. 18 on Reader Service Card</b>   | 54       | Rotel<br>2000 Series Hi-Fi Components<br><b>Enter No. 28 on Reader Service Card</b>  | 93         | Speakerlab<br>Speaker kits catalog<br><b>Write Direct to Advertiser</b>   | 103,108 |
| McKay Tapetown<br>Blank Tapes, etc.<br><b>Write Direct to Advertiser</b>   |          | SAE<br>Hi-Fi Equipment<br><b>Enter No. 29 on Reader Service Card</b>   | 53         | Stanton Magnetics<br>Turntables<br><b>Enter No. 37 on Reader Service Card</b>   | 3       |
| Mitsubishi<br>Car Audio Components<br><b>Enter No. 46 on Reader Service Card</b><br>Speakers<br><b>Enter No. 19 on Reader Service Card</b> | 44,45,71 | Sams<br>Audio Cyclopeda<br><b>Write Direct to Advertiser</b>   | 35,36,37   | Take-5<br>Hi-Fi Components<br><b>Write Direct to Advertiser</b>   | 110     |
| Nakamichi<br>582 Cassette Deck<br><b>Enter No. 20 on Reader Service Card</b>   | 25       | Sansui<br>AU-919 Amplifier<br><b>Enter No. 30 on Reader Service Card</b>   | 17         | Tape World<br>Blank Tapes, etc.<br><b>Write Direct to Advertiser</b>  | 121     |
| Nikko<br>Hi-Fi Equipment<br><b>Enter No. 21 on Reader Service Card</b>   | 12       | Saxitone<br>Tapes and Tape Recorders<br><b>Write Direct to Advertiser</b>  | 121        | TDK<br>T-Shirt<br><b>Enter No. 48 on Reader Service Card</b><br>Hi-Fi Equipment<br><b>Enter No. 38 on Reader Service Card</b> | 21,96   |
| Onkyo<br>Hi Fi Equipment<br><b>Enter No. 22 on Reader Service Card</b>   | 79       | Sennheiser<br>MD 431 Microphone<br><b>Enter No. 31 on Reader Service Card</b>  | 63         | Teac<br>Tape Recorders<br><b>Write Direct to Advertiser</b>   | 49      |
| Ortofon<br>Concord Phono Cartridge<br><b>Enter No. 23 on Reader Service Card</b>   | 57       | The Sensible Sound<br>Hi-Fi Components<br><b>Write Direct to Advertiser</b>  | 118        | Technics<br>Open Reel Tape Decks<br><b>Enter No. 39 on Reader Service Card</b>  | 5       |
| Osawa<br>Tonearm and Cartridge<br><b>Enter No. 24 on Reader Service Card</b>   | 58       | Series 20<br>Amplifier<br><b>Enter No. 32 on Reader Service Card</b>   | 4          | Trusonic<br>3-Way Car Speaker<br><b>Enter No. 40 on Reader Service Card</b>   | 52      |
| Ovation Audio<br>Audio Components<br><b>Write Direct to Advertiser</b>   | 112      | Shure<br>M95HE Cartridge<br><b>Enter No. 47 on Reader Service Card</b><br>516 E-Qualidyne Microphone<br><b>Enter No. 33 on Reader Service Card</b> | 22,39      | Visionik<br>Hi-Fi Equipment<br><b>Enter No. 41 on Reader Service Card</b>   | 34      |
| PAIA<br>String Synthesizers<br><b>Enter No. 25 on Reader Service Card</b>  | 80       | SME<br>Series III precision pick-up arm<br><b>Enter No. 34 on Reader Service Card</b>  | 28         | Watts<br>Record Care Products<br><b>Enter No. 42 on Reader Service Card</b>   | 20      |
| Phase Linear<br>4000-II Preamplifier<br><b>Enter No. 50 on Reader Service Card</b>   | 23       | Sonikit<br>Speaker Kits<br><b>Write Direct to Advertiser</b>   | 121        | Wisconsin Discount<br>Pioneer RT 701<br><b>Enter No. 43 on Reader Service Card</b>  | 93      |
|  |          | Sony<br>PS-X70 Turntable<br><b>Enter No. 35 on Reader Service Card</b>   | 47         | Yamaha<br>Amplifier, preamplifier<br><b>Write Direct to Advertiser</b>  | 33      |

**FOR SALE**

**LUX PD 121 TABLE \$295**, KMAL MKIII Arm new \$125, Formula 4 Arm MKII \$95, Hartly Zzoms Bass Drivers new \$265 pr. Sme 3009 II non detach \$75, Decca Arm w/Decca Plum Cart \$175, Audio Pulse Delay \$425, Keff15 Tweeters \$35 pr. Louis eves. 201-671-5584. 5-9

**LUX PD-121 \$350**; S.A.E. C. WE-308 \$150; Yamaha C-2 pre-amp \$450. All in perfect shape. Call (318) 828-5597

**L.A. — SOUTHERN CALIFORNIA**

|  |                    |
|--|--------------------|
| STAX                                   | KOSS ELECTROSTATIC |
| THETA                                  | SEQUERRA-PYRAMID   |
| DENON                                  | DECCA RIBBON       |
| OSAWA                                  | LINN SONDEK        |
| LENTEK                                 | ULTRACRAFT         |
| ROGERS                                 | SATTERBERG         |
| TANGENT                                | AUDIONICS          |
| MERIDIAN                               | SERIES 20          |
| PROFESSIONAL SYSTEMS ENGINEERING (PSE) |                    |

There are seven high-end audio stores in Southern California. If you are interested in equipment which is sold on its merit, then it will pay you to find out about what we have to offer.

**EXECUTIVE AUDIO**

BY APPOINTMENT ONLY (213) 394-6463  
2210 Wilshire # 207 Santa Monica, Ca. 90403

**MAGNEPAN MG II \$485** Harmon Kardon ST-7 \$250 906-485-4174.

**FOR SALE**

**MAGNEPAN MG-2** beige \$450. Duntech Labs DL 157B speakers \$550, Phase Linear 400 with cabinet and power supply mods, \$350, Luxman CL350 pre-amp with rose-wood cabinet \$275. Techniques SL 1300 turntables \$115. All in mint cond. (313) 477-8180 Michigan.

**MARANTZ + KLIPSCH!** Marantz 4300, SQA-2, CD400, + wood case, all \$650. Klipsch LaScala, black, 2.5 years, \$850/pair. Call Joe, (305) 646-2841.

**MARANTZ 4400 QUAD RECVR**, CD-400 Demod., 115 Tuner, 1070 Amp. Tim Bulgrin, Owen, WI 54460 (715) 229-2146 day, 229-4464 night.

**MARANTZ 500-AMPLIFIER \$750.00** - Box 3456, Walnut Creek, Cal. 94598.

**MAGEPLANAR Tynpani 1-C**, black, mint; \$750. Steve Bruenn, 3609 N.W. 4th Ct., Boca Raton, FL 33431. 305-392-0711 (after 8 PM) 6-9

**MICHIGAN AUDIOPHILES.**

|            |             |                |
|------------|-------------|----------------|
| Apt Holman | Hafler      | Revox          |
| Bryston    | Hitachi     | Sumo           |
| Cabasse    | Linn Sondek | Sherwood       |
| Denon      | M & K       | Sonus          |
| Dahlquist  | NAD         | Snell          |
| DB Systems | Nakamichi   | Spendor        |
| Grace      | Onkyo       | Soundcraftsmen |
| Grado Sig  | Polk        | Stax           |
| GAS        | Pyramid     | Threshold      |
| Grafyx     | Rega        | Visonik        |

**ABSOLUTE SOUND**

"Michigan's High Accuracy Audio Dealer"

Detroit, 12400 Morang Ave. (313) 527-2244  
Royal Oak, 4354 N. Woodward (313) 549-7550  
Ann Arbor, 312 S. Stae St. (313) 662-2026  
Shipping Prepaid

**FOR SALE**

**MARANTZ 7C PREAMP & E.V. PATRICIAN** 4-way horn spkr. '56 vintage. Good cond. (312) 758-9137.

**McINTOSH MAS 1700** Stereo FM Receiver 55 w/rms exceeds specs. Pristine. Original box, Service and Owners Manuals. \$600. Bill Moss - 303-925-4090.

**METRO-NEW YORK CITY**

G.A.S., FR, Dahlquist, B&O, Lux, Linn Sondek, AVID, Janis, Baure & Wilkens, Grace, Tangent, R.H. Labs, Direct Discs, Grado, many others. All issues of Absolute Sound. UNIVERSITY STEREO-Ridgewood, N.J., 57 E. Ridgewood Ave.(201) 447-5700  
20 minutes from G.W. Bridge 12-9

**MID-MICHIGAN, KEF, M&K, ADS**, Denon, Onkyo, Sonus, Stax, Satin, SAE, Grado, Monster Cable STOA Records, Disk SE22 turntable mat. We strive for natural reproduction of sound. Mark One Audio, 314 S. Saginaw, Midland, Mich. 48640. We ship anywhere. 517-835-6754. 5-9

**MILWAUKEE! THE AUDIO EMPORIUM—NAD** (New Acoustic Dimension) receivers/integrateds, remakable electronics that are price competitive with masses yet rival top separates, NAD proves receivers can sound good with critical speakers (Polk, Magnepan etc.) Model 7060 (60 w/ch) only \$490. ARC, B&O, Connoisseur, Dahlquist, Decca, Denon, GAS, Genesis, Grace, Grado, Grafyx, Hafler, Lux, M&K, Magnepan, NAD, Polk Audio, RH Labs, Revox, Rogers, Shreve-Rabco, Sonus, Sumo Electric Co, Supex, Technics, Platter Pad, Audio Perfectionist Cables — many direct discs. Open Tues. thru Sat. 10-6, 6900 W. Brown Deer Rd., 354-5082

**MILWAUKEE & WISCONSIN'S ONLY TRUE AUDIOPHILE DEALER**

Specialists in components by; G.A.S., Yamaha, KEF, Tandberg, Dahlquist, DCM, Fried, Quatre, Stax, SAE, Connoisseur, Transcriptors, Grace, Nakamichi, Infinity, Dynaco, Crown, Ortofon, Sonus, ADC, Hafler, DBX, Akai, Teac, Revox, MXR, Technics and many many more. Featuring a very unique switching system for instant component comparisons. Also, one of the largest tape recorder displays in the country, with over 130 machines on display. WACK ELECTRONICS, INC. 5722 W. NORTH AVE. MILWAUKEE, WI. 53208. PHONE: 414-442-3441 TF

**MIXER** made especially for tape duplication. Will produce enhanced high quality second generation tapes. KUHN ELECTRONICS, 1801 Mills Ave., Norwood, OH 45212. TF

**MONTANA AUDIOPHILES DISCOVER ROCKY MOUNTAIN HI FI**

|                 |                |        |
|-----------------|----------------|--------|
| DAHLQUIST       | NAKAMICHI      | SONUS  |
| ACOUSTAT        | GAS / AMPZILLA | GRACE  |
| BEVERIDGE       | AUDIONICS      | VERION |
| DCM TIME WINDOW | HEGEMAN        | STAX   |
| FULTON/FMI      | SONY           | POLK   |
| R. H. LABS      | N.A.D.         | B&W    |

812 Central Ave., Great Falls, Montana 59401  
Phone (406) 761-8683

**SPATIAL**



**Exclusive patented circuitry optimizes stereo image.**

For information write: RG Dynamics  
4448 W. Howard St. Skokie, IL 60076

**THE RG PRO-16B DYNAMIC PROCESSOR**

**GARLAND AUDIO, INC.**

**WHERE ONLY THE FINEST IS GOOD ENOUGH**

|                |                   |               |
|----------------|-------------------|---------------|
| AUDIO RESEARCH | B & W             | MARK LEVINSON |
| MAGNEPAN       | ROGERS            | SEQUERRA      |
| LUXMAN         | NAKAMICHI         | QUATRE        |
| DENON          | MITCH COTTER      | GRACE         |
| GALE           | FIDELITY RESEARCH | QUAD          |
| F.M.I.         | R.H. LABORATORY   | G.A.S.        |

Call or write for a FREE subscription to our quarterly newsletter!

**GARLAND AUDIO**  
2960 Stevens Creek Blvd. • San Jose • (408) 244-6724

Tues/Thurs, 11-8 — Wed/Fri, 11-6 — Sat, 10-5 — and by appointment—

**SPECIAL PURCHASE!**



**Sansui**  
Model QC-04 CD4 Four-Channel QUAD RECORD DEMODULATOR!

**12<sup>95</sup> EA.**  
\$9.95 ea., lots of 3.  
\$8.95 ea., lots of 100.

Sensational Factory Surplus purchase! A goldmine of parts and circuitry! 1500 in stock. With schematic. (5 lb.) 025H099.

**FREE! EXCITING CATALOG!**

Hundreds of surplus & unusual items — Write today!  
**ELECTRONICS**  
Dept. 044,

**ETCO**  
NORTH COUNTRY SHOPPING CENTER  
PLATTSBURGH, N.Y. 12901



## FOR SALE

## MOVIES ON VIDEO CASSETTES

—ALL RATINGS—Send for our 1 hour sampler \$39.00 Specify rating desired and format (VHS or BETA) Our 1979 catalog \$3 (refundable with first order) CALVEC/7355 Slater Ave./Huntington Beach, Ca. 92647 5-9

**Nakamichi 1000** with remote and service manual \$800. Audionics BT-2 preamp \$250. Professionally assembled Heath AJ1510A tuner \$500. Sherwood micro CPU 100 \$800. Micro Seibi DDX 1000 with MA 505 arm \$500. Pioneer Series 20 preamp \$250. Series 20 M-22 Class A amp \$500. Series 20 D-23 crossover \$400. ARC Tympani III A's, \$1,250. C. Smith, 549 Harrington Rd., Wayzata, Minn. 55391. 612-475-1271

**NAKAMICHI 700II** 3 head deck featuring IC logic transport, 50dB peak reading meters, crystal permalloy head, +++ Calibrated for Maxell tape. \$895 (218) 326-1992.

## NORTH CAROLINA

A complete selection of high quality components for the discriminating music lover. For your pleasure, we offer two locations drawing audiophiles from the Blue Ridge to the Atlantic, knowledgeable staff with decades of combined experience, and these fine products:

|              |                               |
|--------------|-------------------------------|
| AVID         | ANALOG ENGINEERING ASSOCIATES |
| STAX         | DCM TIME WINDOWS              |
| DENON        | MICRO-ACOUSTICS               |
| REVOX        | CONNOISSEUR                   |
| SONUS        | KEITH MONKS                   |
| LUXMAN       | YAMAHA                        |
| VISONIK      | HAFLER                        |
| ACOUSTAT     | FRIED                         |
| RAPPORT      | CROWN                         |
| AUDIONICS    | ONKYO                         |
| DYNAVECTOR   | GRACE                         |
| LINN SONDEK  | SUPEX                         |
| PHASE LINEAR | REGA                          |

PLEASE VISIT ONE OF OUR SHOWROOMS  
STEREO SOUND

175 E. Franklin St. 3443 Robinhood Rd.  
Chapel Hill, N.C. 27514 Winston-Salem, N.C. 27106  
(919) 942-8546 (919) 768-0150

## NORTHERN CALIFORNIANS

It is our goal to make the joy of music possible for everyone. At any price we offer solid value, superior performance, and traditional service.

We operate on the theory that you as our customer will achieve the greatest long term satisfaction only through a careful analysis of your audio requirements. We strive to offer sober, highly cost effective solutions to meet your specific needs. Please stop in for a refreshing experience with music.

OUR SELECTION INCLUDES:

|                |            |           |
|----------------|------------|-----------|
| Magnepan       | Audionics  | Dahlquist |
| Tandberg       | Threshold  | Chartwell |
| Onkyo          | Audire     | B&W       |
| JVC            | Hafler     | Cizek     |
| AKG            | P.S.E.     | AVID      |
| Denon          | Lux        | Stanton   |
| Micro          | Grado Sig. | AIWA      |
| Connoisseur    | Sonus      | M&K       |
| Soundcraftsmen | Grace      | Rogers    |

HIGH FIDELITY SHOPPE  
1511 North Main Street  
Walnut Creek, Calif. 94596  
(415) 932-2242

"WE BUILD BETTER SYSTEMS FOR YOU"



**Piezo Electric add-on tweeters** for speakers lacking extreme highs. Sophisticated filter gives ultra smooth response from 5,000 Hz-25,000 Hz. ±3dB Send \$50 per pair, to SoundAids 395 Riverside Drive, NYC 10025



**Repair split record jackets** permanently, elegantly, quickly. Kit contains materials for all jacket types. Send \$5 to SoundAids 395 Riverside Drive, NYC 10025

## FOR SALE

**Northern N.J.'s finest store-Lux**, Mod DQ-10, Grace. B&W, G.A.S. Sleeping Beauty, FR, B&O, Linn, Sondek, Janis, Tangent, R.H. Labs, Grado, AVID and more. University Stereo, 57 E. Ridgewood Ave., Ridgewood, N.J. 07450. 20 minutes from the G.W. Bridge. 201-447-5700. TF

**OVER 900 FM STATIONS** transmit special programs concealed from you by multiplex technology. SCA adapter converts FM radios to receive this service. Article, details 25 cents, FM Publishing, Adolf, MN 55701.

## PERFECTIONISTS PREFER DYNAKITS

Before Purchase You Owe Yourself Our Quote Mainline IIa, 971 Fronheiser, Johnstown, PA 15902 TF

**POINT 3 SPEAKER SYSTEMS**, Now Available. These are a unique 3-cabinet design that uses a time-aligned tweeter and mid-range in the upper unit. And 2-10" drivers in the subwoofer. Comes with its own crossover. And has a flat response from 20 to 20khz. With the ability to handle any power from 20 to 200 watts. And more importantly the sound is very clean, detailed, and open. With no coloration. What is the cost? \$395.00 for the system, PPD. Hard to believe? Write or call: E. Smith, 2941 N. Gransback St., Phila., Penna 19134. Phone: (215) 427-1359. 10 to 10.

## POLK AUDIO LOUDSPEAKERS AT SPECIALTY SOUND

We have the incredible Polk Audio Monitor Series loudspeakers in stock. The Polk's are definitely the best performance per dollar value ever offered in a truly accurate; inexpensive loudspeaker. State of the art sound is now available at \$109.95 for the Model 5, \$149.95 for the Model 7A, \$209.95 for the Model 10. We ship freight prepaid anywhere in the U.S. within 24 hours upon receipt of order. Write or call for information on the Polk Audio Monitor Loudspeakers.

SOUND ADVICE CO.

Village Plaza Ruston, LA 71270  
(318) 255-8111 9-9

**PRECISION FIDELITY C4**. The new generation tube preamplifier with innovative cascode circuitry and solid state regulation is here. If you haven't heard it yet, write us for information and your nearest dealer. Precision Fidelity, 1169E Chess Drive, Foster City, CA 94404 (415) 572-1811.

## FOR SALE

**POLYDAX (AUDAX)** Bextrenes, soft domes etc., Decca Ribbon tweeters Leach Amplifiers. Catalog: TA Box 97A, W. Cornwall CT. 06796. Postage now 40¢, please help with stamps. 9-8

**Professional Hi-Fi Home Study Course**—Instructors include Len Feldman, Julian Hirsch, Larry Klein, and Larry Zide. Send \$2.00 for full color AUDIO PRIMER and information on joining (SAC) Society Audio Consultants, Dept. A. PO Box 552, Beverly Hills, CA 90213 TF

**PROTECT YOUR LPs**. POLY SLEEVES FOR JACKET 9", ROUND BOTTOM INNER SLEEVES 8", SQUARE BOTTOMS 6", POLY LINED PAPER SLEEVES 15", white jackets 35", POSTAGE \$1.50. HOUSE OF RECORDS, HILLBURN, NEW YORK, 10931. TF

## QUICKEST AIRMAIL SERVICE DIRECT FROM TOKYO

CARTRIDGES: Coral 777EX \$103.00, Denon DL-103S \$128.00, DL-103D \$170.00, Entre EC-1 \$148.00, Grace F-9L \$93.00, F-10L \$210.00, FR FR-1/III \$172.00, Dynavector 15BQ (same as 20B) \$132.00, 20C \$187.00, Satin M-18BX \$200.00, JVC MC-1 \$240.00 TONEARMS: Audiocraft AC-300/II \$220.00, Denon DA-307 \$187.00, FR FR-64S \$300.00, FR-66S \$610.00, Grace G-704 \$190.00, G-714 \$195.00, G-945 (Silver) \$230.00, Dynavector DV-505 \$286.00, Stax UA-7CF \$220.00.

All brand new w/full warranty. Ready for prompt shipment. Packing & Air Postage all included. Send order with Cashiers Check. Many other items available - Ask for Quotations with \$1.00 for postage. JAPAN AUDIO TRADING CO., LTD., Saikaen Bldg., 4-33-21, Kamimeguro, Meguro-ku. Tokyo 153.

**REVOX A-700**, mint cond. New heads \$1400.00 402-464-9052. 5-9

## ELECTRONICS

GAS • Nakamichi • Mitsubishi • AGI  
Spectro Acoustics • APT • Audiopulse • ADS  
Burwen • Audionics • Denon • Setton • NAD

**Audiocom** HIGH TECHNOLOGY AUDIO

177 Sound Beach Ave Old Greenwich CT  
Phone (203) 637-3621

## AUDIO HORIZONS

P.O. BOX 10973  
St. Louis, Missouri 63135

Our second issue, which is now available, contains reviews of the AGI 511A, STRELIFF SYSTEM DESIGNS DC-1, LINN SONDEK LP-12, TECHNICS EPA-100, ULTRACRAFT AC-300 MKII, DENON DL-103S, DYNAVECTOR 20B and 20C, GLANZ G-7, GOLD-RING G-900SE, MK2 and G-900E, GRADO G1+ and Signature II, J.V.C. MC-1 and MC-2E, Micro-Acoustics 530MP, Ortofon MC-20, MC-10, M20E Super, and M20FL Super, SHURE V-15 Types III, IIII, and IV, SIGNET MK-111E and TK7E, SONUS Gold "Blue" and "Red", SONY XL-55, STAX CP-Y/ECP-1, and SUPEX SO-900E+ Super

Our third issue, now being put together, will contain PART II of our phono cartridge survey, plus a small survey of pickup arms. There will be reviews of arms from BREUER DYNAMIC, DYNAVECTOR, FIDELITY RESEARCH, GRACE, HADCOCK, INFINITY, JML, LUSTRE, MAYWARE, SERIES 20, SME, STAX, SYRINX, and ULTRACRAFT

Subscription rates to AUDIO HORIZONS: for six issues are U.S.A. - \$18 (sent First Class), Canada - \$20 (sent First Class), and outside North America - \$24 (sent Air Mail). Sample copies of any issue are available for \$4.50 each (U.S.A. and Canada) and \$6.00 each (outside North America) U.S. DOLLARS ONLY

# Audio Excellence

A UNIQUE STEREO SHOWROOM DEDICATED TO THE PERFECTIONIST

Presenting Components from the Prestigious Companies of

**AUDIONICS DENON GRADO SIG. SIGNET  
BEVERIDGE SNELL MAGNAPAN HAFLER  
THRESHOLD DCM CONRAD J. ROGERS  
PLASMATRONICS PSE OBELISK BRYSTON**

SHIPPED PREPAID THROUGHOUT THE U.S.

584 Washington Street. San Francisco 94111 415-433-1335

## FOR SALE

**RAPPAPORT AMP I** Real Time power amplifier may be now heard with the improved Snell Type A, Symdex Sigma, or Vandersteen speakers at our studio. A marvelous listening experience awaits you. Phone for appointment. **AUDIOWORKS**, Box 4314, Harrisburg, PA 17111, Tel. (717) 652-6996.

**RENOUNCE ROTTEN RECORDINGS!** Read selected British reviews in the bi-monthly **EURO-DISC GAZETTE**, then order these European discs judged the finest in technical and musical excellence. Selections mainly classical. Send for free sample issue. No obligation. **EURO-DISC GAZETTE**, PO Box 337-A, Peterborough, NH 03458. TF

### ROGERS REFERENCE MONITOR SYSTEM

This is a bi-amplified system designed by Rogers using the incredible LS3/5a's. Hear this system as well as the Rogers Monitor II's, Compact Monitor's, LS3/5a's, A75 amp and T75 tuner at **OXFORD AUDIO CONSULTANTS**, P.O. Box 145, Oxford, OH 45056. By appt. Free shipping. 513-523-3895.

## SALE!!!!

**TWO FOR LESS THAN THE PRICE OF ONE.** Now you can buy two fine RCA (Japan) direct to disc records, Beethoven's 'passionata' and Lew Tabackin quartet's 'trackin'' for only \$11.95 including postage. That's right. Two records for \$11.95! Rated as reference recordings in the *Absolute Sound* & *Stereophile*, these records retail for \$30 for both. Hurry, supply limited. Send check or money order to: **Specs Corp.**, 130 Fallen Leaf Drive, Hillsborough, Calif. 94010 CA residents add Sales tax. 2-0

### Reduce acoustic feedback!

### ISOMATE™ mounts for turntables

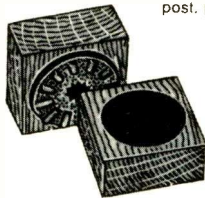

1295 post. pd.

10 db more power without distortion, howling, or mistracking from structure-borne sound. Block speaker vibration, shock from your turntable stylus. 4 isolators in walnut feature high-damping, low resonance, designer styling. Satisfaction guaranteed.

ENID Corp., Box 194-16 Riverside, Ct. 06878

## FOR SALE

### SAVE 50% ON SPEAKERS

Now you can own a stereo subwoofer plus 2 Time Align™ Satellite Speakers at 50% less than comparable equipment. For full details write: **Designatron Stereo Store**, 260 Old Country Road, Hicksville NY 11801.

**SAVE! INTRODUCTORY OFFER!** Order a minimum of 20 blank cassettes, reels, or 8-tracks. — cut any current advertised price 5c. Add \$2.50 shipping. Similar savings on car stereos. Tapeking, 864 East 7 Street, Brooklyn, NY 11230

**SAVE UP TO 69% ON OVER 100 TOP BRAND AUDIO COMPONENTS FROM CARSTON STUDIOS.** NEW ENGLAND'S AUDIO SUPERMARKET ONE OF THE OLDEST MAIL ORDER FIRMS (EST 1952) AND CERTAINLY ONE OF THE MOST RELIABLE. ALL ORDERS SHIPPED FROM STOCKED WAREHOUSE. SEND FOR PRICE QUOTE AND PRICE LIST. **CARSTON STUDIOS**, OLD BROOKFIELD ROAD, DANBURY, CONN. 06810. TF

**SIMPLY INCREDIBLE** — the **CROWN DL-2 Distinction Series** controller pre-amp. In using state of the art digital controls and superior audio circuitry, **CROWN** has eliminated all extraneous noise to an inaudible minimum, available exclusively, at one of Central P.A.'s finest audio dealers, **DS AUDIO**, 833 PARK ROAD NORTH WYOMISSING, PA 19610 215-376-4917

**SNELL ACOUSTICS TYPE A LOUDSPEAKER** sets a new standard for music reproduction. Hear it with the finest electronics at **AUDIOWORKS**, Box 4314, Harrisburg, PA 17111. Tel. (717) 652-6996 for appointment and consultation.

**SONY PS-4750 TURNTABLE** B&O SP-14 cart. \$210.00 (614) 464-0810.

**SOUND ADVICE AND POLK AUDIO LOUDSPEAKERS** We have the incredible Polk Audio Monitor Series loudspeakers in stock. The Polk's are definitely the best performance per dollar value ever offered in a truly accurate inexpensive loudspeaker. State of the art sound is now available from less than \$200 per pair. We ship freight prepaid anywhere in the U.S. within 24 hours upon receipt of order. Write or call for information on the Polk Audio Monitor Loudspeakers.

SOUND ADVICE  
Village Plaza Ruston, LA 71270  
(318) 255-8000 9:9

## FOR SALE

**SEMI-PRO AND CONSUMER AUDIO EQUIPMENT:** TEAC/Tascam, Dbx, AKG, Maxell, Delta-Lab, Technics, Others. Best Prices! Prompt Delivery! **WDI**, P.O. Box 340, Cary, NC 27511. 919-467-8122.

**SIEMENS, TELEFUNKEN, GENALEX AND AMPEREX** and other top quality audio tubes available at very competitive prices. Contact **Jim Wallace** at 1203 Success St., Pittsburg, PA 15212 or (412) 322-4706 TF

### SPENDORS ARE SPLENDID!

See **OAC** for the Spondor SA-1's, BC-1's & BC-3's. Free shipping. Visa & Master Charge honored. Demo. by appt. **OXFORD AUDIO CONSULTANTS**, P.O. Box 145, Oxford, OH 45056. 513-523-3895. Also open evenings & weekends.

### SOUND COMPONENTS INC.

EXCLUSIVE SOUTHEAST DEALER FOR THE INCOMPARABLE **MARK LEVINSON H.Q.D. REFERENCE SYSTEM**

The H.Q.D. reference playback system consists of the following components:

- 2 Hartley 24 in sub-woofers
- 4 Quad ESL loudspeakers
- 2 Decca ribbon tweeters (modified)
- 2 Levinson LNC-2 Crossovers (100 hz & 7 Khz)
- 1 Levinson ML-1 (LEMO) preamp
- 6 Levinson ML-2 amplifiers
- 1pr. Hand-crafted oak or ash trestle stands (for Quads & Decca)

THE H.Q.D. SYSTEM WITH GOOD SOURCE MATERIAL, WILL REPRODUCE A MUSICAL EVENT BETTER THAN ANY SYSTEM WE KNOW OF.

For more information, please write or call:  
**SOUND COMPONENTS**  
2710 Ponce de Leon Boulevard  
Coral Gables, Florida, 33134  
305-446-1659

TWX 812-848-7627

tf

### STAN WHITE

Latest thoughts on loudspeaker enclosure Geometry OR 'Demise of the Theory of Relativity' Send \$1.00 to: **Tachyon™ P.O. Box 204 Bloomingdale, IL 60108.**

### STATE OF THE ART IN N. CALIFORNIA

is now on demonstration at **The Audible Difference**. Hear the superb **Threshold NS-10 preamp/400A power amp** through **Dick Sequerra's** stunning **Metronome loudspeakers**. Audition **Peter Snell's** superb **Snell Acoustics Type A loudspeaker system** with **Threshold's** new medium power **CAS-1 amplifier**. For the ultimate in high-power amplification, audition the **Threshold 8000A mono amplifiers**. Hear how good a bi-amp system can be with **John Curl's** new transient perfect crossover from **Symmetry**, the **ACS-1**, plus **Paragon's** 125 watt solid state bass amp. Experience the beautiful new **Paragon 12A preamp**, plus **Theatra II** from **G.A.S.**

Hear the ultimate direct drive turntable, the **Denon DP-6000**, plus the audiophile reference **Linn Sondek** with **Linn-modified Grace 707 tonearm**. Examine the precisely machined bearing of the new glass platter, belt drive **Planar tables** from **Rega Research**. Hear the ultra-musical **Paragon System E preamp**, plus the new high performance, moderate cost **Thalia/grandson combination** from **G.A.S.** Audition a new generation of compact high performance loudspeakers from **Polk** and **Cizek**, plus **BBC minimonitors** from **Spondor** and **Rogers**. For the music listener who demands the best, we offer the **Breuer Dynamic Tonearm**, plus the **EMT cartridge** with **Verion transformer**.

For that extra measure of sonic purity so important to the critical audiophile, we recommend and stock **Polk Sound Cables**; **Mogami wire**; the anti-resonant **Platter Pad**, \$24.95; **Audio Perfection audio interconnect low capacitance cables**, \$15/pr; plus the **Stylift** at \$19.95 and a wide selection of audiophile quality recordings including **Gale Maximum**, **Fidelity** and **Denon PCM**.

We ship all products prepaid throughout the United States.

**THE AUDIBLE DIFFERENCE**  
435 Tasso, Palo Alto, CA 94301  
(415) 328-1081

TF

### NEW—ISSUE #6—WE REVIEW THE FOLLOWING. PLUS MORE!!

# THE \$ENSIBLE \$OUND

AGI 511A, Conrad Johnson, Series 20 (Pioneer) C-21, Kenwood L-07C, Grado G1 + and F3E +, Ortofon MC-10 with STM-72, Pickering XUV-45000, Stanton 881S, Onkyo T-9 and Yamaha T-1 tuners, Dahlquist DQ-LP1, Audioplate, Allison 3, AR 15, Cizek 2, Fried H/2, Essence 8a, Micro-Acoustics MS-1, Spondor BC-1, Rogers Compact Monitor, ESS 10b, Kustom Impulse and Imp, Isophon DIA-2000, PSU II, Warpknot, Pixoff, Audio Technology 510, Nortronics QM4, Sound Guard, Uni-Sync PMS-1, Setton TS-11, Epicure 14, Denon DP-790, Onkyo T-4, Monitor Audio MA-4, Reviews of over 40 audiophile discs, a \$25 product that will improve the sound of your system, and our usual zero cost tips and inside industry info. **SUBSCRIBE TODAY: \$12 (4 issues) 3rd class mail, \$14 first class & Canada, \$17 foreign air mail.**

403 DARWIN DR., SNYDER, NY 14226

### Now in Fort Lauderdale...

State of the art components for the audio perfectionist and serious listener.

Audio Research • Acoustat • Denon • B & W • Armstrong • Chartwell • Lux Tangent • Polk • GAS • Conrad Johnson • Audire • Ariston • Connoisseur ADC • Grace • Supex • Grado • Goldring • DB Systems • Quatre • Stax Sonex • Plasmatrix • Transcriptors • Dynavector • Vandersteen  
Complete selection of direct to disc recordings.

### AUDIO INSIGHT

The Promenade at Bay Colony  
6286 N. Federal Hwy., Ft. Lauderdale, FL 33308 • 305/491-7677





## FOR SALE

**SOUSA RECORDS.** Free catalog upon request. Stanford. Box 36163, Grosse Pointe, Mich. 48236. 1-0

**SOUTH CAROLINA'S ONLY HIGH-END STORE** the finest audiophile equipment: British American Sound, P.O. Box 1247 186 King Street, Charleston, SC 29402 6-9

**Spendor BC-1's Pr.** Walnut, with stands, excellent ent. \$225. 1-717-529-2497

**STACKED QUADS** in Levinson stands, used only for a few hours, replacement value: \$4,000 asking \$2,200 914-967-4708.

**State-Of-The-Art** speaker systems factory direct; fully assembled and kits. Also Decca, Richard Allan, Dalesford, Audax, Kef drive units, crossover components, more. Write for our new catalog: COMMONWEALTH ELECTRONICS, 822 South Victory Boulevard, Burbank, CA 91502. (213) 846-6336.

### STEREO REPRESENTATIVES NEEDED!!!

Sell 100 brands!! Lowest Possible Prices!! Krasco—REP DEPT. —998 Orange Ave. West Haven, Conn. 06516 TF

### SUB - WOOFERS

\$189.00 & up Hi Fi Sound Sys.  
1809 E. McDowell Rd., Phx., AZ. 85006  
602-258-8324

**SUPER SOUND, FROM PRIVATE** collection, excellent condition \$100 ea., Sheffield S-10 AM Biphon QR 7301, 7302, 7303, SR 7501, 7502, Sonar, SR 130, 160, 150, (219) 287-1353.

**SUPEX - ORTOFON - DENON - OTHER MOVING-COIL CARTRIDGE OWNERS** Send 50¢ for literature on our Micro-Preamp. Superb Performance at \$129.95. Huntington Electronics, Box 2009-A, Huntington, Conn. 06484.

**SYMDEX SPEAKERS** -state-of-the-art. At **AUDIOWORKS**, by appointment. Tel. (171) 652-6996, Box 4314, Harrisburg, PA 17111.

**TANDBERG 10XD ½ TRACK TAPE DECKS** (2) with remote and pitch controls, Dolby. (1) has never been opened, mint, \$1,500 (2) mint \$1,100. Write Jim Coker, P.O. Box 1531, Montgomery, Ala. 36102.

**TANDBERG 9200QB**, \$850.00, Soundcraftsmen PE2217 \$300.00, Advent 201 \$200.00. All mint. 1-704-365-3590. 5-9

**TAPCO and ELECTRO-VOICE**, mixers, equalizers, amps, mics, and raw loudspeakers. Write for low mail order prices, Sonix Co., P.O. Box 58, Indian Head, MD 20640 8-9

**TEAC 3340, 2 MARANTZ SLT-12U**, \$1000 takes all or make offer. Wanted: Teac 1250 or 4010. (402) 467-1532.

**TEAC 3340S, AX-10, AX-20** and road case. All exc. cond. Rick 906-482-5261. Leave your number. 5-9

**THE ABSOLUTE SOUND™**, in its current issue (# 14), takes in-depth looks at the Mark Levinson ML-2 amplifier, the Keith Monks Record Cleaning Machine, Grandson, and the Audio Research D-110 and D-52 amplifiers. There is also a special report on preamps that cover hitherto neglected sonic attributes (lateral image width, phono overload, for instances), featuring analyses of Audio Research's SP-5, the Quantum Electronics CP-1, the Audionics BT-2 and many others. Considered are the Bryston Pro 4 amplifier, the SME 3009 Series III arm, the Van Alstine Model 2 amplifier. Plus a revisionist look at the Linn-Sondek turntable. Stan Ricker, master of half-speed cutting and a salty iconoclast, is interviewed. You'll also get the background on the Telarc digital recording of the Atlanta Symphony. As well as the latest developments in the Acoustar Monitor controversy. Subscribe now, and in Issue 15, you'll see the first review of the Philips/MCA "Discovision" videodisk. Infinity's Class A Hybrid Amp (tubes/transistors), Audio Research's SP-6a (no joke), the improved dedicated to covering every audiophile disc on the market. Prices: \$18 (four issues), \$19 (Canada, U.S. Currency), and \$25 (outside North America, air mail, U.S. Currency). Send your checks to The Absolute Sound, Drawer A. Box L. Sea Cliff, New York, 11579.

AUDIO • May 1979

## FOR SALE

**"TANDBERG 9200 XD** open reel tape deck with Dolby. \$675. Bob Duca, P.O. Box 93, Beverly, N.J. 08010; (609) 386-7041."

**THE AUDIOGRAM®**, a pithy independent newsletter now in its third year, provides timely, money saving reports on the latest products and techniques. Our critical integrity and realistic sense of proportion fill the gap between the commercial magazines and the neurotic underground press. Our latest issue of number 12 contains reviews of:

- The best moving magnet cartridge
- The best headamps
- The best turntable mat
- The best tube preamp
- Ultracraft AC300 Mark II

A review of tonearms by Paul Messenger.

\$10/6 issues/1 year. AUDIOGRAM, Box 27406, St. Louis, MO 63141.

**THE BASS BOX-A** transmission line woofer with electronic crossover-mixer-equalizer that goes lower, plays louder, has better detail and less midrange interference than the other boxes. \$695 plus shipping. Aardvark Quark Audio, Box 55022, Seattle, WA 98155. Dealer inquiries invited.

**THE CROWN DL-2** - Transparent, detailed, imaging capability far beyond normal pre-amps. Almost a computer in its function - Brownell Sound & Hi Fi, 1107 7th St., Or. City, OR 97045.

### The Listening Room Loves

#### POLK AUDIO MONITORS

The golden ear of Marcel Wittman has established the Listening Room as one of the nation's premier audio salons. Not only do we have the finest estoteric audio equipment costing well into the five figures price range, we have the Polk Audio Monitor Series Loudspeakers beginning at just \$99.95 each, and easily worth many times their price in sound value. Come in to listen, write them for full literature, or give us a call. Shipped free anywhere in the U.S.

Listening Room  
590 Central Park Avenue  
Scarsdale, N.Y. 10583  
(914) 472-4558

9-9

## FOR SALE

### THE CRITICAL RECORD REVIEW

Issue 2 is ready. We offer sound reviews of SOTA and D-D discs in bimonthly newsletters. \$6 per vol., 6 issues. P.O. Box 8766, Jacksonville, Fl. 32211

**THE CROWN DL-2** represents major progress in pre-amp design and sound quality. Read the review in this issue, then stop in for a complete demonstration. Mail orders accepted. Listen-Up, Inc., 685 South Pearl, Denver, Colorado 80209.

### THE LISTENING ROOM INC.

590 Central Park Avenue  
Scarsdale, N.Y. 10583  
(914) 472-4558

Cordially invites you to audition our fine line of equipment. THRESHOLD • BRYSTON • GREAT AMERICAN SOUND • PYRAMID METRONOME 2 + 2 • DAYTON WRIGHT ESL • QUAD ESL • SNELL ACOUSTICS • DAHLQUIST • DYNAVECTOR • DENON • YAMAHA • TANDBERG • POLK AUDIO • LUX REF. • KEF • GRACE • NAKAMICHI • STAX • R.H. LAB • L3/5A BBC MINI MONITOR BY CHARTWELL • SEQUERRA • PHASE MATRIX • HAFER • JANIS • FONTEK HEADPHONE • AUDIO PULSE • SPATIAL • OASIS • EMT • VERION • DIRECT TO DISK RECORDS • Visit our private studios. We ship free anywhere in the U.S. We invite inquiries. TF

**THOUSANDS OF LIKE NEW LP's** and prerecorded tapes. Catalogue—\$1.50. House of Records, Hillburn, New York 10931. TF

# SEAS

SEAS loudspeaker kits are the result of an extensive research and development program. No effort has been spared in developing what is one of the most advanced range of speaker systems on the market today.

SEAS FABRIKKER A/S, one of Europe's largest and most up to date speaker manufacturers, ensures the quality of this range of loudspeakers, to guarantee you the utmost in listening pleasure.

For SEAS Catalogue, containing full technical info:

**SpeakerKit**  
P.O. BOX 12A  
MENOMONIE, WI 54751

# ADDICTIVE



**"Removing it from the signal path makes just about every program sound squashed and flat!"**  
Len Feldman

For information write: RG Dynamics  
4448 W. Howard St. Skokie, IL 60076

**THE RG PRO-16W DYNAMIC PROCESSOR**

## The Apt/Holman Preamp

For literature, the name of your local dealer, and ordering information, please check the box.

For a collection of five technical papers by Tom Holman, please check the box and send \$2.00.

Name \_\_\_\_\_

Address \_\_\_\_\_

Apt Corporation Box 512 Cambridge, Massachusetts 02139

## FOR SALE

### THE MONITOR SERIES FROM POLK AUDIO

**AUDIO BREAKTHROUGHS** now has on demonstration the remarkable new Polk loudspeakers priced from less than \$200 per pair. Compare them to the finest loudspeakers in the world. All Polk Audio Monitors utilize high definition polymer laminate bass-midrange drivers, wide dispersion soft dome tweeters and fluid coupled sub-bass radiators. They are capable of reproducing a highly defined phase accurate three dimensional sonic image which rivals the thousand dollar super speakers. They sound great with a small receiver, yet reveal the fine subtleties of state of the art electronics. Shipped free in U.S. Send for free brochures on Polk or our other fine lines. **AUDIO BREAKTHROUGHS**, 1534 Northern Blvd., Manhasset, LI, NY 11030 (516) 627-7333 TF

**THE NEW REFERENCE — CROWN DL-2** fully utilizing the latest technology is the most accurate, flexible system controller available. Sonically unmatched and offering a new level of versatility, the DL-2 may be critically auditioned along with the new SA-2 power amp and EQ-2 Equalizer at Sounds Good To Me! 60 Shiawassee Ave., Akron, O. 44313.

**TONEARMS-CARTRIDGES-TURNABLES** at lowest prices. Most brands available, including MC cartridges. Other quality brands available. Send #10 SASE for quotes. Audio Unlimited, 401 Reynolds Circle #12-D, San Jose, CA 95112 (408) 289-8875 1-6 M-F. 5-9

### TONE ARM SHOCK ABSORBER PLANS

Attaches easily to any turntable - assemble it in minutes from parts commonly found in your home. No tools required.

- 1) Improves separation
- 2) Reduces distortion
- 3) Reduces surface noise on worn and warped records.

#### EXTRA BONUS

Modify your speaker wires to get the same high performance as high cost, high definition speaker cable for no cost and in less than a minute.

Also - complete info and wholesale price for projection TV and Kits. Send S.A.S.E. and \$5 for all this valuable info., To: M.B.M., Inc., 10-01 162 St. 6B, Whitestone, N.Y. 11357.

**TOURING SOUND SYSTEMS**, 2, 4 and 8 Track Studios. Disco Sound, Cerwin Vega BGW, Altec, Shure, AKG, Tapco, Dyna, Revox, EV, Beyer, Cetec, etc. K & L Sound Service, 75 North Beacon At., Watertown, Mass. 02172. (617) 787-4072. Att: Ken Berger. TF

### TRADE UP to the MICRO CPU 100 fm tuner

It may have been out of the question at \$2000, but the new \$995 retail plus a trade-in can put it within reach. We offer very generous trade-in allowances on your old tuner or other audio equipment. A rare chance to own the best at a reasonable price (see Audio, Nov. '77). Write us for a quote, or better yet, phone after business hours and we can discuss your trade-in: (617) 874-0706, m-f, 5-8 pm. (ask for Dick).

**AUDIO CALIBRATION**, box 250, Westminster, MASS 01473

**TUBES — GENALEX, TELEFUNKEN**, — for audiophiles who demand premium quality European replacements for Audio Research, Conrad-Johnson, Dyna, LUX, Paragon, Marantz, McIntosh and other tubed preamps, amps and tuners.

Just a few popular types include:

|                         | Matched Pns. | Each    |
|-------------------------|--------------|---------|
| GENALEX: KT88/6550      | \$67.00      | \$29.50 |
| TELEFUNKEN: ECC83/12AX7 |              | \$4.95  |
| ECC82/12AU7             |              | \$4.95  |
| EL34/6CA7               | \$23.95      | \$10.95 |

Quotes provided on request for other than advertised tubes. Save 10% and get a complete Re-tube Kit for any specific unit.

Now! **HARTLEY 7", 10", 18", 24"** drivers and complete systems. Send orders and inquiries to: **SOUND SERVICES**, Lake Walton Road, Wappingers Falls, NY, 12590. Telephone: 914-226-5414. TF

**TURN-ON THUMPS AND NOISE?** Send 50¢ for literature on our Suppressor. Huntington Electronics, Box 2009-A, Huntington, Conn. 06484.

## FOR SALE

**THE NEW YORK AUDIO SOCIETY, INC.** is a non-profit member-supported Hi-Fi Club. Come and hobnob with others like yourself to widen your knowledge of Audio Products and Systems and make new acquaintances. Informative monthly meetings feature new product demonstrations, lectures on latest Hi-Fi developments and exchange of information. All Audiophiles are invited to attend one session as our guest. Details about meetings and membership available. Write Box 125 Whitestone Sta., Flushing, N.Y. 11357 or call (516) 593-6538.

### THRESHOLD

Audition the complete line of Threshold products including their new cascade-class A amplifier and preamplifier. We offer: Model 400-A Cascade, 4000, CAS-1; NS-10 and SL-10; M-1 & M-7 impedance matching modules. G-B Electronics, P.O. Box 385, Hawthorne, N.J. 07507 (201) 427-8885 for appointment.

**VACUUM TUBES** and tube-peculiar parts. We offer a complete inventory of high voltage capacitors, precision resistors and tubes. Kits or separate parts available for building circuits described in our 220+ page Audio Modification Manual. Write for parts list and literature. **AUDIO DIMENSIONS**, 8898 Clairemont Mesa Blvd., San Diego, Calif. 92123. TF

**VIDEO TAPE VHS** - VK250 10 for \$169.50, Beta L-500's 10 for \$119.50. We ship anywhere. Video Hotline 408-224-0606 MC/VISA

**WANTED: McIntosh C-20 PREAMP.** State price & condition. Barry Clark, 1280 Hickory Lane, Va Beach, VA 23452 call collect 1-(804) 340-5300 day, 340-5069 eve.

**WEST VIRGINIA'S AUDIO PERFECTIONISTS . . . . THE CROWN DL-2 DISTINCTION** pre-amplifier has arrived and is now on display with the new CROWN SA-2 power amplifier and EQ-2 EQUALIZER. The incredibly detailed sound of these components is receiving international acclaim due to excellence of engineering and state of the art musical accuracy. These components must be critically auditioned to be believed. Now available at West Virginia's Premier Audio Center.

### THE SOUND POST

BECKLEY - 325 Neville St 304 252 5369  
CHARLESTON - 4120 Mac Corkle Ave SE 304 925 4726  
MORGANTOWN - 387 High St 304 292 8464  
PRINCETON - 852 Mercer St 304 252 5369

**Wisconsin Has:** Audionics, Denon, Luxman, Hafler, Polk, Mayware, STAX, Micro-Acoustics, Connoisseur, Nagatronics, Aiwa, Hitachi, Kenwood. Lit. and prices on request: The Sound Seller, 1706 Main St., Marinette, WI 54143 715-735-9002.

### TANGENT IN THE MIDWEST

Audio Limited  
Champaign, ILL. 61820  
Audio Mart  
Kansas City, MO. 64129  
Audio One  
Birmingham, MI. 48001  
Sound of Music  
Duluth, NM. 55811  
Marshall Music  
Lansing, MI. 48827  
Quintessence Audio  
Hinsdale, ILL. 60521  
Sound Enterprises  
Kansas City, MO. 64108  
Woodburn Sound  
Iowa City, Iowa 52240  
Youngblood Sound  
Oklahoma City, OK. 73120

Tangent Marketing of America  
12 Irving Street, Framingham, MA 01701  
617-620-0677

**2 AMPEX 440-Bs** two-track in console \$2800 each excellent cond. 303/473-1259.

## FOR SALE

### WORLD AUDIO WESTCHESTER, INC.

Westchester's finest audio sales and service dealer is proud to announce the addition of:

#### Fried Loudspeakers

to the already fine lines of AR, AKG, ADC, Pro-Accutrac, Quanta, CM Labs, Celestion, Decca, Dir.-to-Disc, Discwasher, J.V.C., J.V.C. Pro., Kos, Lux, L.S.S., Maxell, Panasonic, Pickering, Qysonic Array, Rotel, Scott, Sennheiser, Soundcraftsman, Sound Source, Stanton, Supex, Thoren, Tandberg, TDK. Shipping is free in continental U.S.

### WORLD AUDIO WESTCHESTER, INC.

211 North Avenue  
New Rochelle, NY 10801  
914-576-3230

2-0

**3600' New L/N Scotch** or Ampex tape, 10 1/2" metal reels 5 for \$38.00 12 New Ampex 42 min. 8 Tracks \$9.00. 6 New Ampex 370 C-60 cassettes in Stackette \$5.50. C-90 \$6.50. Sound, Peachtree DeKalb Airport, Chamblee, Ga. 30341

## RECORDS

**DIRECT TO DISC RECORDINGS:** All labels at low prices. Sheffield, Crystal Clear, Mobile Fidelity, Century. Send \$2.00 for descriptive catalog. DISConnection, P.O. Box 10705, Tampa, FL. 33679.

**EMI/ENGLISH DECCA:** Reference quality records. Send SASE for price list. SGB Records, Box 947, Memphis, TN 38117. 5-9

**FREE SOUNDTRACKS & CASTS CATALOG!** Personalities! ST/OC Valuebook: \$4. RTSA 711 W. 17th G-1 Costa Mesa, CA 92627. TF

**LP's, Tapes, Imports, Cutouts, Current, Oldie 45's,** catalogs \$2; NERT, Box 268-A, Lawrence, Mass. 01842.

**MILWAUKEE! — The Audio Emporium-Audio Perfectionist Cables, Audio Research, Bang & Olufsen, Connoisseur, Dahlquist, Decca, Genesis, Grace, Grado, Grafyx, Great American Sound, Hafler, Kenwood Pro, Linn, Lux Magnepan, Polk, Revox, Rogers, Sonus, Supex, Technics, many direct discs, 6900 W. Brown Deer Rd., Open Tues. thru Sat. 10-6. 414-354, 5082. tf**

**MILWAUKEE! THE AUDIO EMPORIUM —** large selection of direct discs and other high quality LP's, many labels, constantly new releases. Open Tues. thru Sat. 10-6, 6900 W. Brown Deer Rd., 354-5082.

**RARE OUT-OF-PRINT LP's.** Factory Sealed — 99¢ to \$3.99 ea. Over 25,000 in stock. List — \$1.00 Record Warehouse, Box 4617, Dept. AO, Rochester, New York 14613.

**RARE OUT OF PRINT Jazz & Popular Vocal LP's** sold by auction. Free Lists. Leon Leavitt, P.O. Box 38395, Los Angeles, CA 90038.

**RECORD JACKETS.** Replace old, torn, LP jackets with clean, glossy, pure white or black jackets. Plastic lined inner sleeves, 78 sleeves, opera boxes. Free catalog. CABCO A6, Box 8212, Columbus, Ohio 43201. TF

### RECORDS, RECORDS, RECORDS

Old, New & Direct Disc too! Send \$1. for Complete Info, S.E.O.J., 519 Wheat, Johnstown, PA 15902. 4-9

### SUPER-FI RECORDS!

All types, labels; quick, personalized service; huge catalog only \$1.00 Try us! Cosmic Chords PO Box 4873 Boulder Colo 80306

### NOTICE: RECORD RATERS WANTED

(No experience required) Each month you will receive nationally released albums to rate **THERE IS NO EXTRA CHARGE** for the LP's you receive. You pay a small membership fee which covers all costs of the LP's. We pay postage. In return for your opinion, build your LP collection. "First come basis." For application write: EARS, DEPT ADBox 10245, 5521 Center St., Milwaukee, WI 53210.



**RECORDS**

**WHILE YOU WERE LOOKING** for out-of-print records, you should've been looking for us. DISContinued. 444 S. Victory Blvd., Burbank, Ca. 91502 TF

**TAPE RECORDINGS**

**OPEN REEL TAPES.** 7½ips, Dclbyized releases from RCA, London, DG, Warner and others. Airline tapes, quad. Catalog and updates, \$1. THE REEL SOCIETY, P.O. Box 9337-A, N. Hollywood, CA 91609. 9-9

**MUSICAL INSTRUMENTS**

**UP TO 60% DISCOUNT.** Name brand instruments. Catalog Freeport Music, 114R Mahan St., W. Babylon, N.Y. 11704. TF

**SPEAKERS**

**HIGH FIDELITY SPEAKERS REPAIRED  
AMPRITE SPEAKERS SERVICE  
655 Sixth Avenue, New York, N.Y. 10010  
212-CH3-4812**

TF

**VENEER SPEAKER CABINETS** Hardwood Walnut Speaker Cabinets with grill. Routed or unrouted, front baffles, or complete **SPEAKER KITS.** Send self-addressed stamped envelope for complete brochure. **KUSTOMIZED SPEAKER SYSTEMS, 260-A GLENN CIRCLE, POWELL, TN 37849.**

**PLANS & KITS**

**TAPE-SLIDE SYNCHRONIZER,** multiprojector lap-dissolve plans, \$5.50. With mixer, compressor, preamp schematics, \$8.50. The Millers, 1896 Maywood, S. Euclid, OH 44121. TF

**MISCELLANEOUS**

**ELECTRONIC BARGAINS, CLOSEOUT, SURPLUS!** Parts, equipment, stereo, industrial, educational. Amazing values! Fascinating items unavailable in stores or catalogs anywhere! Unusual FREE catalog. ETCO-008, Box 762, Plattsburgh, N.Y. 12901 TF

**HYDROPONIC GARDENS** - Grow Vegetables year-round indoors, outdoors without soil. Complete Home Units. Information - catalog \$2.00. River Products, Box 1071, Church Street Station, New York, NY 10008.

**J-E-E-P-S . . . !! \$59.30! . . . CARS . . . !! \$33.50! . . . !! 450,000 ITEMS! . . . !! GOVERNMENT SURPLUS! . . . !! MOST COMPREHENSIVE DIRECTORY AVAILABLE** tells how, where to buy! . . . !! YOUR AREA! . . . !! \$2.00! . . . !! **MONEYBACK GUARANTEE!** . . . "Government Information Services," Department SA-3, Box 99249, San Francisco, California 94109.

**!!!QUAD LIVES!!!**

For information on an organization dedicated to the perpetuation of 4 channel sound, send a self-addressed-stamped envelope to: 4 QUAD, 23757 Canzonet Street, Woodland Hills, Ca. 91367.

**UNLIMITED FUNDS** available, any amount or purpose. Send \$1 refundable, to Mr. Walton, 317 E. 67th St., New York, N.Y. 10021. 5-9

**YELLOW PAGES OF AUDIO—\$3.95**

Sourcebook to 1,100 periodicals. 250 books, 7,500 products! Future Publications, 137 Valley Park S. Bethlehem, PA 18018 1-9

**50 DIFF. OLD U.S.** Stamps between 1861 and 1939 \$1.00. Ed Roush, 423 Shepard, Mansfield, OH 44907. tf

**HELP WANTED**

**AUSTRALIA—NEW ZEALAND WANT YOU!!** 50,000 Jobs! Big Pay! Reports \$2.00. AUSTCO, Box 2069-K, La Puente, CA 91746 1-0

**EMPLOYMENT INFORMATION CENTER:** Whether you want to search the ocean, climb mts. or hunt in the wilderness, we can help you by supplying information for all 50 states and Canada. Live where your action is. J. Fraser, Dept. D, 208 S 4th, DeSoto, MO 63020.

**OVERSEAS JOBS** — Now hiring all Occupations. High pay. Transportation. Computerized Reports, \$2.00 TRANSWORLD, International Airport, Box 90802-K, Los Angeles 90009 TF

**RADIO-TV Jobs.** . . Stations hiring nationwide! Free details: "Job Leads," 1680-PH Vine Hollywood, CA 90028

**BUSINESS OPPORTUNITIES**

**Beat the Races!** "Lifetime Income Frome Racing-flats, trots." Elias, Box 47AA, Brooklyn, New York 11219

**BUSINESS OPPORTUNITIES** Businessman helps mail-order beginners and opportunity-seekers make Big-Money. For report send \$2.00 to Mr. Walton, 317 E. 67th St., New York, N.Y. 10021. 5-9

**CABLE FM BROADCAST STATION.** Unique no investment/experience business makes money! Others work for you! Free Details "CAF.M," Box 130-N4, Paradise, CA 95969

**CAMPUS REPRESENTATIVES** - Earn big money as a QSI Campus Rep! For info, contact **QUADRAPHONIC STUDIOS INTERNATIONAL, 4151 Emerson St., Skokie, IL 60076.**

**CAMPUS REPS** - High Performance Loudspeakers, Box 18009, Seattle, WN 98118 TF

**\$500 STUFFING** envelopes. Free Supplies. Send self addressed stamped envelope, Bradford, Box # 505, Sun Valley, Idaho 83353

**\$600/THOUSAND PROFIT!!!** Guaranteed Earnings, stuffing envelopes, RX, DGWING, Box 311, Novato, California 94947

**BUSINESS OPPORTUNITIES**

**SIMPLE-X RUBBER STAMP PRESSES.** Hydraulic Operated. Electrically Heated, Sizes 5"x8". 8"x12", 10"x15". Starting Outfits. Order for Presses. Supplies Shipped Day Received. Send \$2.00 for Catalog and Brochure. Custom Manufacturing, Box 211-PS, Springfield, MO 65801. 4-9

**Want money? Hate hard work? Lazy way to big money.** Cleaver plan \$2.00 (Refundable) Noble, Box 10033, Houston, TX. 77206.

**TAPE AND TAPE RECORDERS**

**BARGAINS! RECORDS. TAPES:** blank, prerecorded. Close-out prices! Catalog \$1.00 (refundable). Tower, Box 12, Lewes, Del. 19958. 7-9

**CUSTOMIZED TAPES,** Jazz, Big-Band. Over 900 standard tracks. 80 minute cassettes or 8-tracks, \$8.00. Open reel, \$10.00, catalog \$1.00 (refundable). Tapes Unlimited Box 163 Portsmouth RI 02871 TF.

**FREE CATALOG.** . . CLASSICAL, Cassettes, Stereo-Dolby . . . Quality Guaranteed . . . Discounted . . . Credit Cards Accepted. . . EKR Classics, GPO Box 1977AB, New York, NY 10001.

**FREE PROFESSIONAL CASSETTE** w/specs. Save direct-air-mail. Discover LARKSONG, Box 468F, Point Arena, CA 95468 tf

**LOWEST PRICES ON MAXELL, BASF, TDK, FUJI TAPES!!!** Send #10 SASE for free catalog. All new, guaranteed!! Audio Unlimited, 401 Reynolds Circle # 12-E, San Jose, CA 95112 5-9

**NAME-BRAND RECORDING TAPE,** custom loaded. Available in cassettes, reels, cartridges. Huge savings direct from manufacturer. Also low everyday prices on Maxell, TDK, Ampex, Scotch, BASF, etc. New catalogue now available. MJS, 2514 Seaboard Ave., San Jose, CA 95131. (408) 262-8793.

**OLDIES ON OPEN REEL TAPE.** Rock n' Roll songs by their year of release. Free Brochure. Rock n' Reel Rental, 38 Fairland Dr., Wethersfield, CT 06109.

**SCOTCH RECORDING TAPE,** lowest prices TAPE CENTER Box 4305B Washington, D.C. 20012. USA, APO, FPO 5-9

**TDK, MAXELL, MEMOREX, BASF,** cassettes, reels 8-tracks. Lowest prices. New, Guaranteed. FREE CATALOG S&S Audio, P.O. Box 94485, Schaumburg, IL 60194 TF

**VIENNESE LIGHT MUSIC SOCIETY** — Waltzes, Polkas. Overtures on imported Dolby cassettes. Most non-Schwann. K.C. Company, Box 793, Augusta, Maine 04330. 7-9

**SAVE up to 60% BY MAIL on:** SCOTCH, TDK, BASF, MAXELL, MEMOREX, CAPITOL MUSIC TAPE, CERTRON (over 180 different reel & cassette tapes to choose from); top brand recorders, America's largest collection of taping accessories, too. Same day service. **FREE catalog.**

America's Recording Tape Specialists  
**SAXITONE TAPE SALES**  
1776 a Columbia Rd., Washington, D.C. 20009  
(202) 462-0800

**BLANK TAPE SALE**

|                              |      |                           |       |
|------------------------------|------|---------------------------|-------|
| TDK SA-C90                   | 3 05 | AMPEX Grandmaster I-90    | 2 69  |
| TDK AD-C90                   | 2 45 | AMPEX Grandmaster II-90   | 3 09  |
| TDK D-C90                    | 1 59 | Discwasher Complete Sys   | 10 49 |
| TDK SA-C60                   | 2 15 | Soundguard Rec Pres Kit   | 4 59  |
| BASF PRO I C-90              | 2 79 | TDK L-1800                | 5 13  |
| BASF PRO II or III C-90      | 2 89 | TDK LB-1800               | 6 31  |
| BASF Studio I or II C-90     | 2 59 | AMPEX Grandmaster 1800 ft | 5 95  |
| SCOTCH Master II or III C-90 | 3 15 | SCOTCH 207-7R-1800        | 5 09  |
| SCOTCH Master I C-90         | 2 69 | BASF Studio 1800 ft. Reel | 6 49  |

All tapes can be assorted. No minimum order. Shipping \$3.00 per order. Or write for free catalog of over 250 products, including lowest prices in US on complete line of Maxell products. All tapes 100% guaranteed.  
412-283-8621  
TAPE WORLD, 220 Spring St., Butler, PA 16001

**Goo, Screw & Save  
YES, KITS!**

Choose from The World's Largest Selection of Speaker Kits including FRIED, DALESFORD EXPORT, JANSZEN ELECTROSTATS & SEAS.

Here's just one example

**DALESFORD EXPORT SYSTEM 110**

**\$ 185 each**  
complete kit  
(\$275 ea., if pre-assembled)

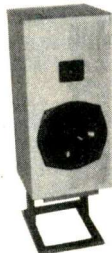

Dalesford low-coloration Bextrene drivers are world-renowned and used in many highly praised systems. The System 110 uses the Dalesford 10" Bextrene bass/mid unit combined with the famous 1" Audax low mass soft dome tweeter. Response is ±3 dB from 40Hz to 20kHz. An advanced multi-element compensating crossover is used and the specially-designed enclosure is damped with bituminous felt and Australian long-fiber wool. Power handling: 20-100 Watts RMS/Ch. Specs & Prices subject to change without notice.

No matter how good your other components, you won't hear high definition sound if your speakers can't reproduce it!

**FREE MINI-CATALOG—OR SEND \$1 FOR NEW SPEAKER MANUAL/COMPLETE CATALOG**  
(\$1 Refunded with Purchase)

The Speaker Specialists  
**Sonikit** 1173L - 65th Street  
Oakland, CA 94608

For Free Mini-Catalog, Use Reader Service Number Below.

□ Here's my \$1 check—send my Speaker Manual/Catalog. A10

Name \_\_\_\_\_  
Address \_\_\_\_\_  
City \_\_\_\_\_ State \_\_\_\_\_ Zip \_\_\_\_\_

## WANTED TO BUY OR TRADE

**CASH FOR** your unwanted LPs & reel to reel tapes. Records, Box 323, Hillburn, New York 10931. TF

**MARANTZ & McINTOSH TUBE EQPT. FUTTERMAN, QUAD** and CITATION TUBE EQPT WHEN AVAILABLE CALL COLLECT 617-734-2727. SOUND ADVICE, Box 782, Brookline, MA 02147.

**MARANTZ 7C, 9, McIntosh C22, Mc275.** State price and condition. J. Fong, 1238 Green St., San Francisco, CA 94010 (415) 572-1812 10-9

**MARANTZ 9 (PAIR).** Must be in good shape and reasonable. Philip Chance, 50 N. Medical Drive, Salt Lake City, Utah 84132.

**McINTOSHMI-2, K-107, MI-200, Marantz 7C rack mt. panel,** 8B tube cover, JBL SE-460, & any McIntosh, Marantz (tube), or JBL electronics literature. Tube pre-amps & amps manufactured by Acrosound, Brooks, Brociner, Fairchild, Grommes, Langevin, Leak & Rodgers, as well as promo. literature, owner & service manuals for above equipment. State price & condition. Les Gueydan P.O. Box 455, Metairie, La. 70004.

**McINTOSH OR MARANTZ any kind of tube amps:** Pay top dollar (213) 278-3430, 8633 Airdrome St., LA, Calif. 90035.

**OPEN REEL** pre-recorded tapes. Rock, folk, jazz, classical stereo, quad (8 - track quad also). A few of each for sale too. SSAE. Ray, 1293 French Ave., Lakewood, Ohio 44107. 11-9

**TEAC AN-180 DOLBY** mint, Lang, POB 523, APO, N.Y. 09238.

**USED INFINITY QLS-1 SPEAKERS.** State price and condition. R. Mota, 7 Rue Zurlinden, 1207 Geneva, Switzerland.

**WANTED: PAIR OF PIONEER PROJECT 100 B SPEAKERS** IN MINT CONDITION. Brain Jensen, 553 East Center St., Nephi, Utah 84648.

**WANTED: SENCORE FS134 FIELD STRENGTH METER.** State price. Greg, 788 Condon Ave., Modesto, Calif. 95351. 5-9

**WANTED:** Wollensak 8075 recorder. Mike, 1344 Ivanhoe, Youngstown, Ohio 44502.

## INSTRUCTION & EDUCATION

**R.E.I. SCHOOL OF RADIO ANNOUNCING** and broadcasting engineering can train you for the exciting field of broadcasting.

F.C.C. 1st Class License in 5 weeks.  
Creative commercial production.  
Call (813)-955-6922 or write, R.E.I., Inc.  
61 N. Pineapple Ave., Sarasota, Fla. 33577.

**SHORT INTENSIVE SUMMER COURSES** in Recording Techniques, Electronics, Electronic Music, Jazz Improvization, Contemporary Song Writing, Popular and Jazz Harmony, Musical Instrument Repair and Instrumental Workshops in Saxophone, Clarinet, Flute, Trombone, and Percussion, with Allard Oberbrunner, Rascher, Goebel, Purcell and Strohmman. Write or call Frank Stachow, Summer Workshops. (717) 867-4411 Ext. 275, Lebanon Valley College, Annville, Pennsylvania 17003.

## SERVICES

### ALL SPEAKERS REPAIRED

**FAST SPEAKER RECONING SERVICE** ON ALL TYPES OF TRANSDUCERS, FACTORY AUTHORIZED SERVICE FOR JBL, ALTEC, CETEC AND ELECTRO-VOICE, ESS. DEALERS DISCOUNTS AVAILABLE. ANTECH LABS, INC. 8144 BIG BEND ST. LOUIS, MISSOURI 63119 (314) 962-565

**JBL SPEAKER WARRANTY STATION-** RCI, 8550 2nd Ave. Silver Spring, Md. 20910. Mail orders Welcome.

## SERVICES

**NASHVILLE RECORD PRODUCTIONS** WILL PRESS HIGH QUALITY PURE VINYL RECORDS FROM YOUR TAPES. SEND FOR SAMPLE RECORD AND PRICE LIST. ALSO FINEST DISC MASTERING. 469 Chestnut St., NASHVILLE TENNESSEE 37203 TF

**CUSTOM RECORDING SERVICE,** Tapes, discs, and cassettes. Stereo and mono. Live and copies. Editing. Masters and pressings. High quality at reasonable rates. Joseph Giovanelli, Audio-Tech Laboratories, 2819 Newkirk Ave., Brooklyn, N.Y. IN9-7134 TF

## RADIO PROGRAMS

**CATALOGS.** Broadcasts, soundtracks. Personalities of Thirties, Forties. Box 225, New York, N.Y. 10028. TF

**GOLDEN AGE RADIO.** Your best source for radio, tapes — reels or cassettes. Box 25215-DA, Portland, OR 97225. 7-9

**OLD RADIO PROGRAMS ON TAPE.** Finest sound, competitive prices. Ask for free flyers, BRC OTR DISTRIBUTORS, 17173 Westbrook, Livonia, MI 48152

**RENT RADIO SHOWS:** Make your own copies or just listen. Great way to build your collection reasonably. Catalog \$1 refundable. OTR Rental, Box 1146, Livermore, Ca. 94550 TF

**VINTAGE RADIO:** Lowest rates, post free. Traders welcome. Also trading for comics, films, pulps, etc., video tapes, too. SIGNALS, Box 5063, Sta. E. Edmonton, Alta., CANADA. 3-9

**YESTERDAYS RADIO ON TAPE.** Reels-Cassettes. Quality Sound. Reliable Service. Giant catalog \$1.00 refundable with first order. ADVENTURES, Box 4822-A, Inglewood, California 90302. TF

**1930-1962 RADIO PROGRAMS.** Beats television!! Tapes. \$1.00 hour! Established esteemed dealer, informative 200 page catalog \$1.25. Cassette samples \$2.00. AM Treasures. Box 192AU, Babylon, N.Y. 11702 TF

## HIGH FIDELITY

**UNZOO OBFUSCATION OF SALON AUDIO.** STATE-OF-THE-ART: PHASELIN-EAR II, ANALOG, TECHNICS PRO, NAKAMICHI, KENWOOD PURIST, PSE, NIKKO, PRO DENON, RTR, MARK LEVINSON, VAN ALSTINE, DYNA, TANDBERG, KIRKSAETER, LECSON. OTHERS: ADS, BOSE, B & O, MC INTOSH, KLIPSCH, AUDIO PULSE, BRYSTON, THRESHOLD, DAHLQUIST, KEF, SAE, YAMAHA, LUX, AND OVER 141 MORE. INCREDIBLE DISCOUNTS, PROFESSIONAL ENGINEER AVAILABLE TO GIVE FREE, NO B.S. ADVICE AND INFORMATION. SEND \$3.00 FOR NEW 17½ PAGE CATALOG CONTAINING 2,500 HIGH-END AUDIO ITEMS; EVALUATED: G.E.A./E., P.O.B. 296 (DEPT: A), IDAHO SPRINGS, COLORADO, 80452. OR CALL: (303) 582-5200, 1:00 p.m. until 9:00 p.m. (MST) GOLDEN EAR AUDIO/ELECTRONICS ACCEPTS: MC, VISA, BANK, CHECKS, TRADE-INS AND HOME TRIALS.

**DIRECT-TO-TAPE RECORDINGS ARE HERE!** The next step up from direct-to-disc. Reels (2 or 4 track option Dolby or DBX2), cassettes, cartridges ONLY! Send SASE for info & introductory offer. Direct-to-Tape Recording Co., 14 Station Ave., Haddon Heights, NJ 08035.

See What You've  
Been Missing...  
Read Audio's  
Classified

# Audio Subscriber Service

When writing  
about your  
subscription  
please attach  
your mailing  
label here

and mail form to: AUDIO  
401 N. Broad St.  
Philadelphia, PA 19108

### ADDRESS CHANGE?

Just write in your new address below and attach your mailing label above. Please allow 6-8 weeks advance notice.

### NEW SUBSCRIPTION?

If you are a new subscriber, check the box below and fill in your name and address. (For gift subscriptions, just attach a separate letter, giving full information.)

### RENEWING YOUR SUBSCRIPTION?

First, make sure your mailing address is correct. Check the box below. As you can see, you can send payment, or we will bill you.

### Please send AUDIO

For 1 year, \$12.00

- New subscription  Renewal  
 Payment enclosed  Bill me later

Name (Please Print)

Firm

Title

Address

Apt. No.

City

State

Zip



# YOU CAN'T TAKE ANY MACHINE AT FACE VALUE.

Every tape recorder is a machine by definition. Pretty faces, knobs and buttons are incidental to the recorder's fundamental responsibility. To move tape. And that is where a TEAC shines.

Twenty-five years of specialization has taught us that balance is the critical factor in determining how accurately and for how long a tape recorder will move tape.

Balance means no part stands alone. It also means delicate physical relationships. Good drive motors produce tremendous energies, magnified in fast modes. The slightest imbalance will cause vibration and audible deterioration.

Our hysteresis torque motors, one on each reel, maintain the delicate balance between start-up, back torque and running torque to prevent tape stretch and breaking. Precise tape-to-head contact is maintained to pre-



vent high frequency loss. That's why a TEAC sounds better initially and maintains its sonic integrity after years of use.

The most important part of any drive system is the capstan assembly, where balance, again, is crucial. For accurate tape speed, the size and roundness of the capstan shaft are of utmost importance. So we use automated lathes to form each shaft. Then micro-grind each one to a

tolerance of 0.2 micron (0.000008 inch).

Our hysteresis synchronous capstan motor is specifically designed for speed accuracy. Deviations (wow & flutter) are kept to the absolute minimum. Our massive flywheel is dynamically-balanced and coupled to the drive mechanism with belts that are tested under the most severe temperature, humidity and

atmospheric conditions to assure dimensional stability for years to come.

For fast action and positive feel, we use highly responsive micro-switch transport controls. They activate solenoids almost twice as powerful as those in other machines. You can even hear the distinctive sound of a TEAC mechanism in action.

Our erase, record and playback heads are secured to a steel mounting plate — itself a product of over 20 years of design refinement — then aligned in the three critical planes.

Finally, we mount everything to a ¼-inch high density duralumin base plate. Physical relationships must remain constant. Especially in the tape world of micro-tolerances.

To us, it's a matter of craftsmanship. To you, a matter of decision. That's why we invite you to look beyond mere face value. Peel away the cosmetics and you'll find the real measure of any tape recorder. Especially ours.

For more information, see your TEAC Audio Specialist dealer or write us at Dept. AO-5.

## TEAC®



**The first high-technology record cleaner was the Discwasher System. Four scientific revisions later, the Discwasher is literally years ahead of all other devices.**

**WITH PRIORITY TECHNOLOGY:**

Discwasher D3 Fluid is proven by lab tests to be the safest active cleaning fluid for record care. But a good fluid is not enough. The Discwasher System is also a *precision removal system* that uses capillary action with slanted micro-fibers to lift dust, dirt, and dissolved debris off the record, rather than pushing them around like "dry" and "constant humidity" methods. The real dimensions of record care are safety plus integrated function.

**WITH PROVEN VALUE:**

The uniquely styled Discwasher handle is constructed of hand-rubbed walnut which will long outlast "plastic wonders". This easily held handle is lightweight because of an integral cavity which conveniently holds the D3 Fluid bottle. A special brush to clean the directional-fiber Discwasher pad is included without charge, and also fits inside the handle cavity.

**WITH GENUINE SATISFACTION:**

Only Discwasher gives immediate performance, long-term record safety, pleasing physical characteristics and a price that hasn't changed in five years.

Seek out the Discwasher System, by name. Only Discwasher delivers technology, value and satisfaction.

# YOUR RECORDS DESERVE SUPERIOR CARE: SEEK OUT THE DISCWASHER® SYSTEM



**discwasher, inc.**  
Columbia, MO 65201