

The
Authoritative
Magazine
About
High Fidelity

Audio

MARCH 1982 • \$1.50 • F06030

**-ORACLE-
BEST
TURNTABLE EVER?**

**SONY PCM-F1-
RECORDINGS
AS GOOD AS A
DIGITAL DISC?**

**HOW PHONO
CARTRIDGES
WORK**

**SONIC
HOLOGRAPHY
TEST DISC
INSIDE!**

**REVIEWS-
DENON DR-330
CASSETTE DECK**

**SONUS
DIMENSION 5
CARTRIDGE**



LAUREL
16723 GOLDSBOROUGH
MR FRED B MAXWELL
03
460350 MXW 67226094 44 9 JUL82



THE BEOCORD 9000. MOST TECHNICALLY ADVANCED

THE PROMISE FULFILLED.

Ever since their invention in the mid 60's, cassette decks have held out the promise of quality sound reproduction, combined with true convenience.

Convenience has been achieved, to one degree or another.

But no cassette deck has ever succeeded in accurately delivering the wide dynamic range associated with the live performance.

Until now.

BANG & OLUFSEN HX PROFESSIONAL*: THE FIRST SIGNIFICANT IMPROVEMENT IN CASSETTE PERFORMANCE SINCE THE INVENTION OF DOLBY. (DOLBY LABS AGREES.)

In 1978, Bang & Olufsen began exploring technologies which could complement noise reduction systems by offering significant headroom expansion.



The result of these explorations is Bang & Olufsen HX Professional (not to be confused with Dolby HX**), pioneered by Bang & Olufsen of Denmark and perfected in collaboration with Dolby Laboratories.

Utilizing an automatically regulated variable bias oscillator to compensate for the bias effects of high frequency signals, Bang & Olufsen HX Professional offers the discriminating audiophile a cassette deck that, for the first time, truly achieves disc-quality sound reproduction.

Overall dynamic range is increased by up to 10 dB. Definition of bass frequencies is audibly superior. Frequency response with any type of tape is ± 1.5 dB from 20 to 20,000 Hz, with a S/N ratio of up to 80 dB. The ability of any kind of tape to record and play back higher levels of mid-range and

high frequency signals is increased significantly.

Bang & Olufsen HX Professional operates independently on each channel, allowing optimum compensation for the particular signal content of each channel. And since Bang & Olufsen HX Professional is not an encoding system, tapes recorded on it will sound better, even when played on other cassette decks.

OPTIMUM CALIBRATION, FOR EVERY INDIVIDUAL TAPE. IN JUST 9 SECONDS.

The second major advance that is unique in the Beocord 9000 is a computerized tape calibration system that performs all tape calibration functions, completely automatically, in just 9 seconds.

You simply insert a cassette, and push the Tape Calibration button. The Beocord 9000 proceeds to record a test tone on the



BEYOND A DOUBT THE CASSETTE DECK IN THE WORLD.

cassette, and sets the appropriate bias, sensitivity, and equalization. It also actually reads the tape itself to determine what type it is and indicates the tape type via LED.

In the calibration process, the Beocord 9000 also measures distortion and sets its recording levels and meters according to the characteristics of the particular tape you are using. This exclusive Peak Program Meter function assures you of recordings free of audible distortion, with any tape you use. The specifications on types of cassettes you use frequently can be placed in memory and recalled instantly, making future calibration unnecessary.

IN EVERY OTHER RESPECT, MERELY STATE-OF-THE-ART.

There is not space here, to go into further detail on the many other capabilities of the Beocord 9000.

It of course includes Dolby B and C, and all of the functions, such as LED real-time tape counter with real-time tape remaining, random access programming, automatic return, and programmable timer, that you would expect in a state-of-the-art deck.

You will only find them unexpectedly simple to use.

WRITE FOR THE WORDS. AND THE MUSIC.

As much as we've said here, there is a great deal more to be said for the Beocord 9000.

And we've said it in a white paper which we will gladly send you, at no cost whatsoever. It will allow you to absorb, at your leisure, the remarkable capabilities of this unique machine.

We have also prepared a cassette of music recorded on the Beocord 9000. Played on any cassette deck of reasonable quality, it will allow you to immediately appreciate the accuracy of music recorded with Bang & Olufsen HX Professional. If you send us \$3.00 to cover handling costs, we will

send you the cassette, and the white paper. Please allow 4 to 6 weeks for delivery. Offer expires June 30, 1982. Please address requests to Dept. AM.

Bang & Olufsen of America
515 B Juse Road
Elk Grove Village, IL 60007

Bang & Olufsen

of Denmark



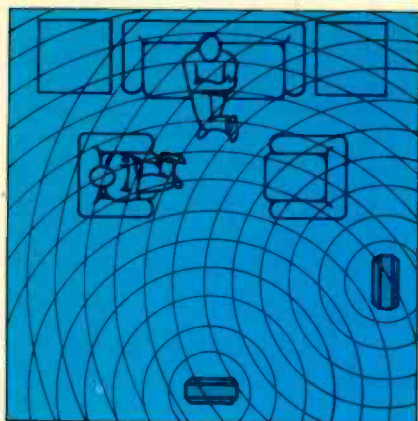

BES Speakers

AT LAST A DIFFERENCE IN SOUND YOU CAN SEE.

Most speakers give you true stereo in just one part of the room. BES Speakers give you true

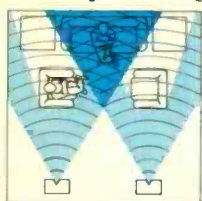

Other speakers

stereo virtually everywhere. That's because the heart of a BES Speaker is not a cone, but a diaphragm

that vibrates much like a guitar string, projecting sound in every direction simultaneously. You get 360-degree sound. True omnidirectional sound. Sound as close to live as you can get.

Listen to BES and hear true stereo. Everywhere.



BES SPEAKERS
THE NEXT DIMENSION IN SOUND

Bertagni Electroacoustic Systems, Inc.
345 Fischer Street, Costa Mesa, CA 92626
Telephone: (714) 549-3833 Telex: 67-8373

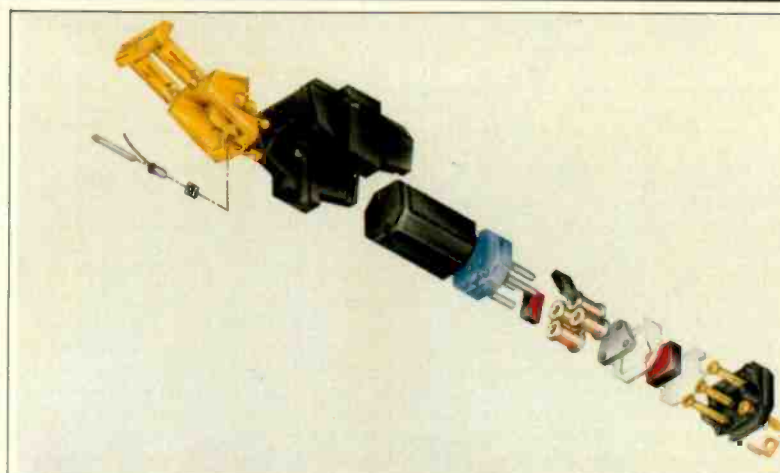

FEATURE ARTICLES

SONIC HOLOGRAPHY	Robert W. Carver	26
NEW CASSETTES TESTED	Howard A. Roberson	37
HOW PHONO CARTRIDGES WORK	Peter Milton	42

EQUIPMENT PROFILES

SONY PCM-F1		
DIGITAL AUDIO PROCESSOR	Leonard Feldman	48
ORACLE TURNTABLE	Edward M. Long	54
SONUS DIMENSION 5 CARTRIDGE	George W. Tillett	61
ACE AUDIO 4100 FILTERS	Howard A. Roberson	63
DENON DR-330 CASSETTE DECK	Howard A. Roberson	64
TEAC X-20R OPEN-REEL RECORDER	George W. Tillett	68

RECORD REVIEWS

THE COLUMN	Michael Tearson, Jon & Sally Tiven	22
------------------	--	----

AUDIO IN GENERAL

VIDEO SCENES	Bert Whyte	6
BEHIND THE SCENES	Bert Whyte	12
TAPE GUIDE	Herman Burstein	16
AUDIOCLINIC	Joseph Giovanelli	18
WHAT'S NEW IN AUDIO		20
THE FORUM	Joel Schwartz	36
CLASSIFIED ADVERTISING		71
ADVERTISING INDEX		84
AUDIO ETC.	Edward Tatnall Canby	87
THAT'S THE WAY IT WAS	Walter I. Seigal	94



The Cover Photographer: Carl Zapp.
The Cover Equipment: Sony PCM-F1 digital audio processor and compact disc.

Audio Publishing, Editorial and Advertising
Production Offices, 1515 Broadway,
New York, N.Y. 10036.

Subscription Inquiries, (800) 525-9511; in
Colorado (303) 447-9330.



SA-X. HIGH BIAS IS RICHER FOR IT.

The greatest honor a cassette can receive is to be held in higher esteem than the one now setting the high bias standard. SA-X has already gone beyond SA in frequency response, sensitivity, and resolution. It was intended to. With its ultra refined dual layer of Super Avilyn and the Laboratory Standard Mechanism, nothing less was possible. TDK believes sound reproduction should have no set barrier. No limit. For us, high bias was a limit to be surpassed. SA-X has won three international audio awards to date. It will no doubt win others. But we take awards philosophically. They represent our continuing effort to create the machine for your machine. In that, we could not be happier with SA-X.

 **TDK.**
The Machine For Your Machine



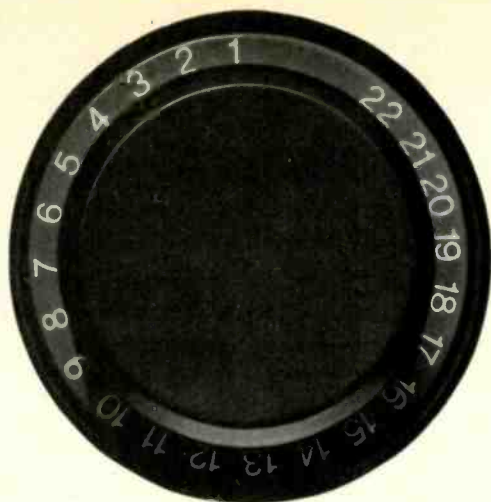

If If everything were perfect . . . a control unit would consist of a volume control and a program selector switch.

Unfortunately this is not the case as any prospective high fidelity buyer—be he neophyte or hardened campaigner—quickly discovers.

everything He is faced with a choice

He can attempt to sift the vast quantities of conflicting information gathered from high fidelity magazines, retailers and "my friend who is an electronics engineer and knows quite a bit about high fidelity" . . .

were . . . or he can buy a Quad 44.

In the latter case he can be confident that whatever the program sources, he will be able to match them correctly, and apply tonal correction when necessary to obtain optimum results.

perfect... Moreover he can be confident that he need not change his preamplifier to meet future developments.

To learn all about the Quad 44 he only has to write for a brochure and a list of authorized dealers:

QUAD
425 Sherman Avenue
Palo Alto, California 94306

In Canada:
May Audio Marketing Ltée, Ltd.
Longueuil, Quebec J4G 1P8

QUAD 

for the closest approach
to the original sound

QUAD is a registered trademark.



© 1982 QUAD

Audio

Editor
Eugene Pitts III

Assistant Editor
Kay Blumenthal

Editorial Assistant
Andrea Lynne Hecker

Art Director
Cathy Cacchione

Production Manager
Elaine S. Geiger

Associate Editors:
Edward Tatnall Canby, Bert Whyte

Senior Editors:
Richard C. Heyser, B. V. Pisha
Howard A. Roberson

Contributing Editors/Artist:
Tom Bingham, Herman Burstein,
Ted Costa, John Diliberto,
Leonard Feldman, Joseph Giovanelli,
Edward M. Long, C. G. McProut,
Jon Sank, Walter I. Seigal, Donald Spoto,
Michael Tearson, George W. Tillet,
Jon & Sally Tiven

Vice President/Executive Publisher
Charles Stentiford
Publisher
Jay L. Butler

AUDIO (ISSN0004-752X) is published monthly by CBS Publications, The Consumer Publishing Division of CBS Inc., 1515 Broadway, New York, N.Y. 10036.

Robert J. Krefling, President
George H. Allen, Senior Vice President/Magazines
Francis P. Pandolfi, Vice President and Group Publisher
Michael Brennan, Vice President and Gen. Manager
Leon Rosenfield, Circulation Marketing Director
John J. Miller, Group Business Manager
James Stockbower, Associate Business Manager
Karen L. Rosen, Production Director

ADVERTISING SALES
Audio, 1515 Broadway, New York, N.Y. 10036
Jay L. Butler, Publisher
Telephone (212) 975-7247
Stephen W. Wittholt, Eastern Adv. Mgr.
Telephone (212) 975-7654

West Coast Sales Office:
Audio, 3807 Wilshire Blvd., Suite 1201
Los Angeles, Calif. 90010
Jay Martin, Western Adv. Mgr.
Telephone (213) 487-5880.

Classified Advertising:
Audio, 1515 Broadway, New York, N.Y. 10036
Laura J. LoVecchio, Classified Adv. Mgr.
Telephone (212) 975-7530

England: The Paul Singer-Lawrence Media Group,
54 Burton Court, London SW 3 5Y4, England
Telephone, 01-730-3592

AUDIO is a registered trademark of CBS Inc. ©1982, CBS Publications, The Consumer Publishing Division of CBS Inc. All rights reserved.

Dewey Decimal Number 621.381 or 778.5

Editorial Contributions are welcomed but should be accompanied by return postage. Submissions will be handled with reasonable care, but the publisher assumes no responsibility for safety or return of manuscripts, photographs, or artwork. The Publisher, in his sole discretion, reserves the right to reject any ad copy he deems inappropriate.

Printed in U.S.A. at Columbus, Ohio. Second Class postage paid at New York, N.Y. 10001 and additional mailing offices.

U.S. Subscription Rates: 1 year \$13.94, 2 years \$22.94, 3 years \$29.94

Other Countries: Add \$6.00 per year.

Back Issues, when available, \$5.00 postpaid.

Audio Publishing, Editorial and Advertising Production offices, 1515 Broadway, New York, N.Y. 10036.

Audio Subscription Offices, P.O. Box 5318, 1255 Portland Place, Boulder, Colo. 80322.

Postmaster: Send Form 3579 to P.O. Box 5316, 1255 Portland Place, Boulder, Colo. 80322.



Soundcraftsmen presents...

'CX' for \$15.00!!

PLUG IN THE SOUND-CRAFTSMEN CX-4 INBOARD CX DECODER...

ENJOY the newest CX-encoded records TODAY!

Do-it-yourself in minutes, no soldering, no special tools. Special introductory price, with any Soundcraftsmen 4000 series pre-amplifier... \$15.00



1981 HI-FI GRAND PRIX AWARD* "PREAMPLIFIER-OF-THE-YEAR"



The Soundcraftsmen SP4001 is one of the most versatile stereo components available. On one compact chassis is a superb 10-Band Graphic Equalizer featuring our Exclusive 0.1 dB True Zero-Gain circuitry for lowest noise and distortion, and a State-of-the-Art Phono Preamp/Control center. The SP4001 accepts two turntables, two tape decks with cross-dubbing facility, two signal-processors with front-panel patch bay, a tuner and an auxiliary program source. Overall performance is unmatched at... \$549

*Voted by retailers—with confirming review of leading audio critics—for fidelity of sound reproduction, design engineering, reliability, craftsmanship, product integrity and cost performance. The HI-FI Grand Prix Award is a trademark of and sponsored by AudioVideo International, also a registered trademark.

INTRODUCING... THE NEW LA2502 POWER MOSFET 125-WATT AMPLIFIER.

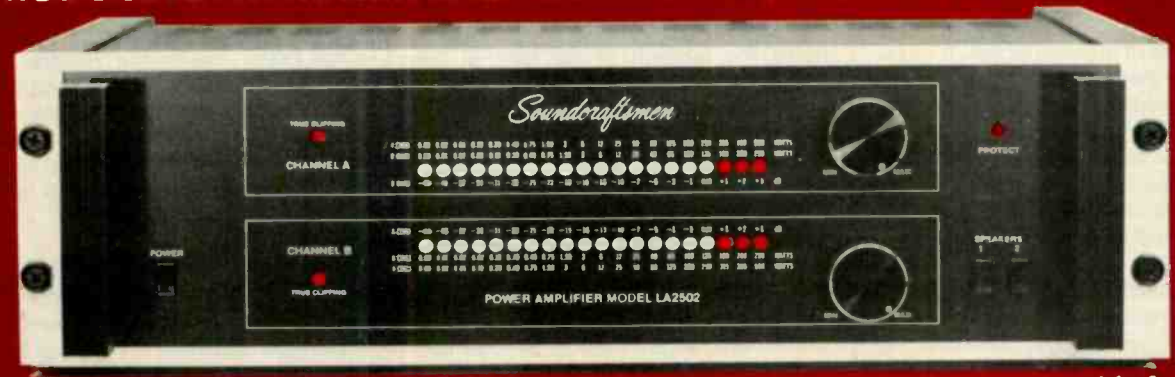

Featuring the latest in amplifier technology for exceptional performance, plus every usable feature, such as level controls, calibrated LED power meters, 2-speaker switching, TRUE clipping indicators and genuine walnut side panels. Only... \$649

EQ-EVALUATION KIT. \$10.00 SPECIAL OFFER!

SEND ONLY \$10.00 FOR REG. \$19.95 COMPLETE KIT: 1-12" LP FREQUENCY SPECTRUM ANALYZER TEST RECORD, 1 SET OF COMPUTONE CHARTS, 1 COMPARISON CONNECTOR, 1 INSTRUCTION FOLDER.

VIDEO SCENES

BERT WHYTE

Akai has garnered a lot of attention with its Activision VP-7350 portable VHS videocassette recorder. It is a very versatile unit with some unique features, not the least of which is that stereo recording is possible and Dolby B noise reduction is incorporated in its audio circuitry. The VP-7350 is part of a system which includes the VU-7350 color TV tuner and, of major import, the VC-X1 auto-focus color video camera. This new camera may well signal the beginning of a new era in what we used to call home movies.

The VP-7350 VCR is fairly large for a portable recorder. Without the nickel-cadmium battery, the machine weighs in at a rather substantial 14.5 lbs., but a built-in handle helps to tote it around. The tape-motion controls are of the usual piano key mechanical type and are quite usable. In this particular unit, the play and record levers must be pressed simultaneously to initiate recording. The front panel of the VP-7350 is plentifully endowed with various controls. Among them are an audio monitor selector switch for the left and right channels of the stereo input with a mix position, normal- and double-speed tracking control, still/cue and slow control, Dolby NR switch, sound dub key, dew/battery/tape-run LED indicators, camera and earphone jacks, and microphone jacks for channels one and two of a stereo input. Another feature of the VP-7350 is a keyed lock, presumably to prevent unauthorized use of the unit. On the rear panel are inputs for external power, r.f. out jack, and two audio-out jacks for left and right channels of a stereo signal. A compartment on the top rear of the recorder houses the nickel-cadmium battery for portable powering; an accessory charger is available to keep the battery at the proper voltage level, and this VCR can also be powered from a car's cigarette lighter via a special adaptor.

The VC-X1 color video camera weighs 5.3 pounds, making it fairly easy to handle. It is a fascinating exercise in optical high technology. Needless to say, while we have had both still- and motion-picture cameras with automatic iris diaphragm control in years past, automatic focusing is a relatively new development. Here is a brief explanation of how the auto focusing feature of this camera works. On top of the camera lens housing are two "windows" which



admit light to fixed mirrors and image-forming lenses. The light beam is then directed to opposite sides of a mirror prism. The prism reflects two images to a 240-segment charged coupled device which converts the light to electrical signals. The output of the CCD is monitored by a microprocessor which compares the difference between the signals, notes the position of the lens at the moment of signal address, and then activates the zoom lens motor to move the lens backward or forward to achieve an accurate constant focus. The VC-X1 uses a single $\frac{3}{8}$ -inch vidicon pickup tube with a 2-to-1 interlaced 525-line scanning system. Horizontal resolution is more than 270 lines, and the video signal-to-noise ratio is more than 46 dB. The camera has an automatic sensitivity adjustment range of 50 to 64,000 lux, providing a minimum practical illumination of more than 50 lux at a diaphragm opening of f1.4. The f1.4 zoom lens ranges from 11 mm wide angle to 70 mm telephoto. A two-speed motor activated by a switch on top of the camera permits easy forward or backward zooming, while a macro position on the lens

allows focusing as close as two inches from the subject. Underneath a slide cover are special controls, including a white balance selector (automatic white balance is provided). An iris control is available to override the automatic diaphragm for greater or lesser light input, and fade-in and fade-out buttons can be used to provide professional visual and audio fades. The Normal/Reverse selector is, in essence, a reverse polarity control. While the instruction manual makes much of the so-called "creative" possibilities of this feature, its real value is that typical color film negatives can be converted to videotape positives with an adaptor.

The VC-X1 is equipped with an electronic viewfinder, which of course shows you the picture field in black and white. Within the viewfinder are various colored LEDs which either flash at varying rates or remain illuminated to indicate battery condition, fade in/fade out, VCR recording, normal or reverse polarity, and if there is sufficient light to record. On the auto focusing housing are controls for selection of manual, semi-automatic, and automatic focusing. The camera's

Professional quality breaks the cassette barrier.

A true professional recorder must do more than deliver superb sound reproduction. It must do so consistently, hour after hour, year after year.

Now, for the first time, you can buy a cassette deck with long-term performance comparable to the finest reel-to-reel recorders. Not surprisingly, it's from Revox.

When you look inside a Revox B710, you'll see the difference immediately. First, the tape transport chassis is made from aluminum alloy die-castings

(not plastic or imprecise metal stampings), with parts machined to the same critical tolerances as in our pro recorders. And second, the B710's dual capstan tape drive employs two servo-regulated Hall Effect motors, with two additional microcomputer-controlled motors for tape spooling. No belts, pulleys, or clutches will be found in the B710, because such compromises are not acceptable in a professional machine.

Granted, the B710 does offer a long list of convenience features. A precise 4-digit LED counter, for example. A 24-hour timer for programmable start and stop in record or play. Mic/line mixing.

Automatic sensing of tape types. Automatic start-of-oxide cueing with counter reset to zero. And Dolby noise reduction.

But don't let the features or pretty face fool you. At heart, the B710 is a seasoned pro. Hear it today, along with our other superlative audio components from Switzerland and West Germany, at your Revox dealer. For more information, contact: Studer Revox America, 1425 Elm Hill Pike, Nashville, TN 37210; (615) 254-5651.

STUDER REVOX

Professional standards in audio components



Enter No. 19 on Reader Service Card

Akai's VP-7350 permits stereo recording and incorporates Dolby B noise reduction in its audio circuitry.



The Akai VP-7350 portable videocassette recorder.

built-in folding handle has a handy camera switch. When this switch is depressed, it activates recording in the VP-7350 VCR; pressing the switch again will stop recording.

On the right-hand side of the camera is a built-in cardioid microphone mounted on an extendable boom of about 8 inches, while a jack for an external microphone is located on the camera's bottom left side. On top of the camera housing is an accessory shoe designed to accept the ACM-11V one-point stereo mike. This is apparently a pair of cardioid microphones in a 90° pattern, affording a sort of coincident pair stereo pickup. Unfortunately, this is a rather new item and was not furnished to me. I did some stereo recording via the two input jacks on the VCR using a pair of Crown PZM mikes.

In use, the camera viewfinder was bright and sharp with good contrast, and the motor-driven zoom lens worked quite smoothly. With the automatic diaphragm and auto focusing, operating the camera became as simple as the old aim-and-shoot techniques of the Brownie Cine Kodak of yore. The video recordings made with the camera and played back through the VP-7350 VCR were of excellent quality with good resolution, brightness ratio, and contrast. Colors were quite pure and well saturated, and black-and-white images were very clean. The sound from the built-in microphone with or without Dolby noise reduction was fairly wide range and clear. However, it must be said that even with Dolby noise reduction, I could still detect some residual tape hiss. The same could be said of the stereo recording, although directional effects were well maintained. As I noted some months ago, Akai intends to make prerecorded videocassettes available with stereo sound, but I

have not heard any as yet. In all, the combination of the VP-7350 and VC-X1 proved to be of excellent quality and is apparently quite reliable.

A few caveats are in order, however. In spite of the fact that the extendable microphone is of the cardioid pattern, the whine of the zoom lens motors was picked up and heard on playback. With the camera in the automatic focusing mode, as the system worked to establish and then maintain focus, I heard a low-frequency "clicking" noise which unfortunately also appeared during playback. Of course, it is entirely possible that the auto focusing system needed adjustment. What is happening is that the device is "hunting" in an attempt to maintain focus, and you can see this in the viewfinder. At times this process is quite rapid and therefore imposes many of the clicks on the sound. It is possible to establish a focus so that the "hunting" can be avoided by using the semi-automatic function of the focusing device, although any panning or changing of focal distances with subject movement will upset the initial focus. On playback of the VCR recordings, some scenes were slightly out of focus, but for the most part the auto focusing mechanism did a far better job than one is likely to obtain from manual focusing. Of course, depth of field is also working, even with the auto focusing in operation, and this helps to obtain a consistently sharp picture.

The suggested retail price of the VC-X1 camera is \$1295.00, with \$1695.00 the price for the VP-7350 portable videocassette recorder and VU-7350 tuner/timer. Summing up, in general these units offer a winning combination, but some attention should be paid by Akai to the elimination of the zoom and auto focus motor noise imposed on the recordings. *A*



If you cannot readily find an NAD dealer in your neighborhood, send this coupon for literature on the Model 1020 and other fine NAD home entertainment products, as well as a dealer list, to NAD (USA) INC., 575 Canton Street, Norwood, MA 02062.

NAD

Name _____

Address _____

City _____

State _____

Zip _____

**NAD introduces another best value
for your high fidelity dollar.
The NAD 1020 state-of-the-art
preamplifier is yours for under \$150!
Incredible? See your local NAD audio expert!**



Bob Carver explains (briefly) how the Magnetic Field Amplifier works. (Others tell how it sounds.)

Q. How is it possible for an amplifier as small and as light as the M-400 to deliver so much power and to cost so little?

A. The M-400's size (less than 7 inches) and weight (less than 10 pounds) reflect the advanced technology and the new patented designs used in both its power supply and amplifying stages—and the innovative relationship between them. (Not to mention the incredibly low price that resulted: \$399.)

Q. What is different about the M-400's power supply and amplifying stages?

A. In any amplifier, the power supply produces and stores energy for use by the amplifying circuits.

Conventional amplifier power supplies are very inefficient because they produce a constant high voltage level at all times—irrespective of the demands of the ever-changing audio signal—and even when there's no audio in the circuit at all!

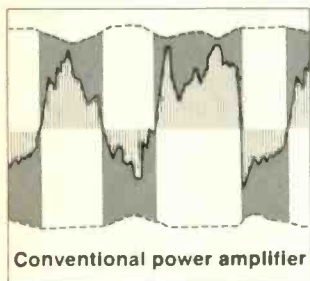

Solid line: audio output signal
Broken line: power supply voltage
Shaded area: wasted power
Vertical lines: power to speakers

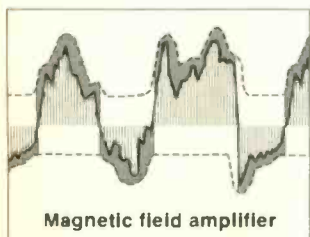

Magnetic field amplifier

This inefficient approach demands large and expensive power transformers and electrolytic capacitors. Large heat sinks are also needed to get rid of the heat associated with the constant high voltage of conventional power supplies.

In sharp contrast, the M-400's "smart" power supply produces only the power that the amplifier section needs from moment to moment to handle the signal accurately. In effect, the M-400's power supply is *signal-responsive*. As a result, overall efficiency is extraordinarily high.

Q. Do I really need 200 watts per channel?

A. Yes! If you want to hear music reproduced with full realistic impact and dynamic range, the musical peaks must be handled without compression, clipping or overload.

You'll be amazed at the improvement in openness and clarity when your system is able to deliver the power that music really requires.

When full digital audio arrives, dynamic-range capability will be even more significant. And the M-400's power will be even more necessary—with its ability to deliver 500 watts in mono, 900 watts for brief time periods, and more than 1200 watts on peaks!

Q. Now I understand why the M-400's power capability will improve my system, but can my speakers take it?

A. Speakers with a power rating of 50 watts or so will have no problem with the M-400. That's because speakers are not generally blown out by high, clean power, but rather by low-powered amplifiers pushed beyond their overload points. These low-powered amplifiers

"clip", generating speaker-damaging transients.

In addition to providing better sound and sufficient power, the M-400 has special protective circuits that guard both itself *and* your loudspeakers from almost any conceivable damaging circumstance. These include long and short-term overload, sudden overdrive signals (such as from dropped styli), shorted speaker leads, etc.



M-400 Magnetic Field Amplifier
201 watts minimum continuous power per channel (500 watts mono) into 8 ohms, 20 Hz to 20 kHz, with no more than 0.05% total harmonic distortion.

All this protection operates via the signal-controlled power supply circuits, not the amplifier stages, so there's absolutely no chance of the typical distortions caused by conventional protection circuits.

Q. Aside from the technical innovations in its design, how does the M-400 sound when it comes to music?

A. My design goal was to make it sound musically accurate, and I'm proud to

say that it does. More convincing perhaps, others confirm this. Leonard Feldman in *Audio* reported: "Music reproduction was superb and completely free of any false bass coloration or muddiness. The amplifier handled the toughest transients we were able to feed to it with ease... there was none of the brittle quality that one often detects from amplifiers that are beginning to strain."

Julian Hirsch reported in *Stereo Review* that "... Its distortion and noise levels are entirely negligible... hardly conceivable that a small, inexpensive, lightweight cube such as this could deliver as much clean power as any but a few of the largest conventional amplifiers on the market—but it does."

Q. Is the M-400 limited to systems with separate amplifiers?

A. No. The M-400 can be used in many different types of systems, including those with receivers and integrated amplifiers. With our new Z-coupler device, you can upgrade your existing low-power system into a superb 200 watts-per-channel system. What's more, the M-400 is easily connected without accessories to put out 500 watts mono!

Q. How can I get more information?

A. Easily. For literature, test reports and the address of your nearest Carver dealer, circle the number below. For faster response, write to us directly.

CARVER
CORPORATION

P.O. Box 664, 14304 N.E. 193rd Place Woodinville, Washington 98072

Enter No. 6 on Reader Service Card

BEHIND THE SCENES

BERT WHYTE

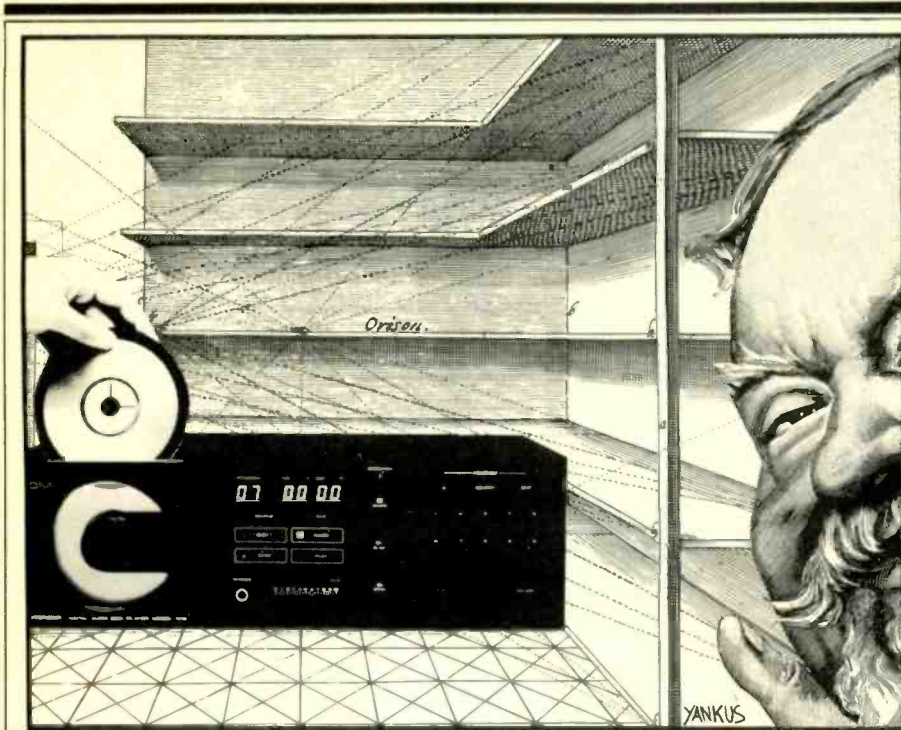

As noted last month in the first part of my report on the 70th AES Convention in New York, the resolution to establish digital recording standards means that digital recording has finally come of age. The introduction of new digital recording equipment into the professional marketplace had been proceeding at a moderate rate, with a certain amount of timidity evident in some manufacturers' attitudes towards digital technology. Now, with the imminent establishment of digital recording standards, the "digital derby" will be off and running. Apparently, there were quite a number of manufacturers who anticipated the standards, for there certainly was much new digital equipment on display. I reported on several items last month, and herewith a run-down on more new digital devices.

Not all the digital equipment was in the form of recorders. Sony drew large crowds with a demonstration of their CD (compact disc) DAD (digital audio disc) player, which was jointly developed with Philips. The device has been demonstrated before, but this time it appears to be close to being a production prototype. The laser tracking is via a solid-state laser diode, and the digital-to-analog circuits are apparently in the form of

a Sony-developed LSI chip. Although the music played during the demo wasn't my cup of tea, it was obviously very clean and of wide frequency range, albeit not the kind which would show the 90 dB dynamic range of which the CD disc is capable.

The CD system is slated for introduction in Japan this fall, but the present economic situation in the audio industry might just hurry things along a bit. Polygram is supposed to have a CD software plant in West Germany ready for production by June, and Sony says that the LSI chip production is proceeding ahead of schedule. Thus, an earlier introduction of the CD system isn't out of the question, especially since Polygram (and supposedly CBS/Sony) would have "blades for the razors!"

Not to be outdone, Pioneer also showed a prototype CD digital audio disc player. Pioneer had previously developed a proprietary laser-scanned digital audio disc system but decided to become a licensee for the Sony/Philips CD system. Their player loads the 4.7-inch diameter digital disc in a "disc well" on the front panel, somewhat in the manner of a front-loading cassette deck. A semiconductor laser is used to track the CD disc, rather than the larger gas laser Pio-

neer uses in their video LaserDisc player. According to Pioneer, the CD player has extraordinary random-search capabilities and can be ordered to search out any program selection in three ways: By program number, by elapsed playing time from the start of the disc, or by elapsed playing time in a given musical selection. Even such a complex search function as, for example, ordering the player to commence play at 2 minutes 10 seconds into the third selection of the disc takes only a few seconds to accomplish. All commands are visually confirmed via the player's front-panel program and time displays.

Technics was on hand with some very practical new digital devices. They feel, and rightly so, that fancy digital recorders shouldn't have to accept analog signals from such things as mixers, equalizers, and reverb units. Thus, they introduced their Digital Audio Mixer/Equalizer and Digital Audio Reverberator with memory. The mixer/equalizer handles digital signals with eight inputs and two outputs. (There also are two analog outputs for monitoring.) Full panning and level adjustment are provided as well as facilities for special effects via AUX output terminals. The fully digital equalizer uses recursive-type digital filters to allow high-speed real-time data processing of complex digital filtering operations. Linearity is maintained with an internal 35-bit capacity — more than twice the usual 16-bit signal to be processed. The equalizer affords high- and low-frequency roll-off and shelving, as well as mid-range cut and boost. Quantization is 16-bit linear, and while the sampling rate on the device is currently at 50.4 kHz, you can be sure it will be changed to the new proposed 48-kHz standard.

The Technics Digital Reverberator has two digital input and two digital output channels. Initial delay times range from 0 to 155 milliseconds, while reverberation covers 0 to 10 seconds. Quantization is also 16-bit linear with a 50.4-kHz sampling rate at present. Low, high and midrange reverberation can be applied separately to simulate the absorption and reflection characteristics of particular acoustic environments. The device is equipped with three programmable memories, each of which can store four kinds of data: Initial reflections and later reflections in low, mid and high range. The memories are nonvolatile,

MAGNIFICENT OBSESSION.



In our zeal to build superb tape recording equipment in the extreme, we at Teac are sometimes driven to steal. From ourselves.

The extraordinary X-1000R illustrates this very well. In it, we have incorporated professional features originally designed for our TASCAM recording studio equipment.

These include a linear LED counter which measures tape in hours, minutes, and seconds. A Search To Cue (STC) and Search To Zero (STZ) capability. In addition, there's Auto Reverse in both directions, in play or record.

The X-1000R, as is current professional practice, employs DBX* noise reduction. An exclusive in home reel-to-reel. And also, as in professional recording equipment, full-tension servos guarantee high stability and accuracy. And low wow and flutter specs of just .03% @ 7½ IPS.

All of which add up to an impressive collection of features, we think you'll agree. And if we happened to borrow a lot of them from our professional designs, well that shouldn't bother you one bit.

TEAC MADE IN JAPAN BY FANATICS.

COPYRIGHT 1982. TEAC CORPORATION OF AMERICA. 7733 TELEGRAPH ROAD, MONTEBELLO, CA 90640

* dbx® IS THE REGISTERED TRADEMARK OF dbx, INC., NEWTON, MA

Enter No. 22 on Reader Service Card

THE DL-300 SERIES



DL-300 This may well be one of the most significant cartridges in Denon's history, because it brings the price of Denon Moving Coils under \$100. Yet, it offers all of Denon's significant moving coil technological developments, such as a two piece cantilever and dual-damping rings for optimum resonance control; and no pole pieces for lower mass and more efficient manufacturing.

(Shown with stylus guard removed.)

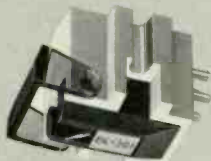

DL-301 To control resonances, the cantilever fulcrum of all Denon MC cartridges is independent of the damping rings. The DL-301 uses two damping rings, each optimized for its portion of the frequency range.

In addition a special magnetic structure eliminates pole pieces, reducing both weight and cost for the best sonic value in MC cartridges.

(Shown with stylus guard.)



DL-303 The first of the DL-300 Series, the DL-303 has repeatedly been judged "best of its class." It features Denon's cross-shaped coil and dual cantilever design and a special tensioning device that maintains ultra-high performance for extended periods.

With the imminent establishment of digital recording standards, the "digital derby" will be off and running.

which means you won't lose them during a power failure, and settings can be held for subsequent mix-down sessions. The system features very natural reverberant generation, without the colorations characteristic of plates, springs, etc. A remote control is available.

The Studer company has been quite active in digital equipment. While their multitrack digital recorder won't be introduced until the 71st AES Convention in Montreux, Switzerland, they did show their interesting new Digital Sampling Frequency Converter (SFC-16) in New York. This unit makes possible interchange and recording between digital recorders with differing sampling frequencies. For example, if a recorder has a 44,056-kHz sampling rate and another digital recorder has a 50-kHz sampling rate, they can successfully be converted, up or down, through the Studer SFC-16. The converter accepts arbitrary sampling frequencies, and since it operates strictly under control of the clock signals, no programming is required. The SFC-16 will permit dubbing from one digital recorder to another without leaving the digital domain. In other words, it makes digital-to-digital dubbing possible. In addition to format conversion, one of the major uses of the SFC-16 will be in mastering to the 44.1-kHz sampling frequency of the Sony/Philips CD digital audio disc.

Of course, in the midst of all this digital activity, analog audio is still very much with us. In fact, at the Studer exhibit, engineers were casting lustful looks at the Studer A80 MK Two, an update of their well-known analog magnetic recorder now featuring two-channel stereo recording on half-inch tape. Ampex introduced this format several years ago, and it has become quite popular. It is claimed that in the A80 MK Two, with all electronics nicely tweaked and using a hot tape at 30 ips, the signal to-noise ratio approaches 80 dB!

Speaking of Ampex, they are helping to keep analog magnetic recording alive. They have a new machine, the ATR-800, which is specifically designed for the international broadcast market. There are certainly features galore that will appeal to broadcasters, a "dump edit mode," cue amplifier, and quick change heads in mono, stereo and four-channel formats in both quarter-inch and half-inch tape widths. The ATR-800 is

switchable between NAB and IEC setups, including bias and level changes as well as equalization curves. There is a universal power supply, and single point "search-to-cue" is standard, as is three-speed operation. The ATR-800 does have a capstan/pinch roller drive, but it is under closed-loop servo control. There are many other standard features as well as several options, things like a built-in tape marker, a tape cutter, and a noise-reduction interface kit for Dolby or dbx. Price begins at \$5,450.00 for the basic two-channel recorder, and delivery is expected by the time you read this.

JVC exhibited their DAS 90 digital recording system, but they also showed photos and details of the newly modified and updated JVC Cutting Center in Los Angeles. In addition to a special direct-drive motor for the Neumann cutting lathe, they have a newly designed CH-90 cutter head. This unit features a "rocking bridge" cutter bar system, which has no cantilever and is extremely stable as to phase and crosstalk characteristics. A highly heat-resistant (250° C) material is used for the moving system which, combined with a double-chambered helium cooling system, permits high dynamic ranges with a maximum velocity of a staggering 127 centimeters per second! This is also possible due to the new CA-9011 cutting amplifier, using their "Super Linear" circuit which puts out a mere one horsepower (800 watts) per channel!

I have previously reported on the JVC UHQ (ultra-high quality) 200-gram "super record." Here is how one was recently produced. JVC took their DAS 90 digital recording system to Moscow and recorded the Moscow Radio Symphony Orchestra in Stravinsky's "Rite of Spring." Then it was cut with the new cutter head and cutting amplifier and pressed on a UHQ disc. The result is rather terrifying — there are monumental transient pulses on this disc that present a formidable challenge to the tracking abilities of even the finest phono cartridges. Unfortunately, this recording is not permitted to be sold in the United States; if you want a copy, you must pick it up in Japan or arrange for someone there to send it. But if you do manage to get one of these recordings, I think you will find JVC has made a significant advance in the state of the art in disc processing. It's a doozy!

DENON
Imagine
what we'll
do next.

Denon America, Inc.
27 Law Drive, Fairfield, N.J. 07006

MAXELL IS PLEASED TO PRESENT AN EVEN HIGHER PERFORMANCE TAPE.



If you're familiar with Maxell UD-XL tapes you probably find it hard to believe that any tape could give you higher performance.

But hearing is believing. And while we can't play our newest tape for you right here on this page, we can replay the comments of Audio Video Magazine.

"Those who thought it was impossible to improve on Maxell's UD-XL II were mistaken. The 1981 tape of the year award goes to Maxell XL II-S."

How does high bias XL II-S and our normal bias equivalent XL I-S give you such high performance? By engineering smaller and more uniformly shaped epitaxial oxide particles we were able to pack more into a given area of tape. Resulting in a higher maximum output level, improved signal-to-noise ratio and better frequency response.

To keep the particles from rubbing off on your recording heads Maxell XL-S also has an improved binder system. And to eliminate tape deformation, XL-S comes with our unique Quin-Lok Clamp/Hub Assembly to hold the leader firmly in place.

Of course, Maxell XL II-S and XL I-S carry a little higher price tag than lesser cassettes.

We think you'll find it a small price to pay for higher performance.



IT'S WORTH IT.

Enter No. 11 on Reader Service Card

Maxell Corporation of America, 50 Oxford Drive, Moonachie, N.J. 07074.

Stacking the Decks

Q. My integrated amplifier has provision for two tape decks. I would like to use an open-reel deck in addition to my present phono cartridge and cassette decks, but I detest the job of swapping my three decks among the two sets of tape jacks. Inasmuch as the amplifier has unused preamp-out/main-in jacks, may I successfully use these jacks for the third deck? — Henry Stafford, Jr., Cincinnati, Ohio

A. If the third deck has provision for routing the incoming signal straight through (from deck input to deck output) when the deck is not in use, you could use the preamp-out/main-in jacks for this unit. Otherwise, all other signal sources will be cut off from the power amplifier section. Also, the deck so connected will be subject to the volume and tone controls and other signal processing elements of the preamp section when recording, but it will not have the benefit of these elements in playback. I think a better solution would be to purchase a tape switching device that permits two or more tape decks to be connected to one set of tape jacks.

Recording Levels

Q. I am aware that high-frequency response tends to improve as record level is reduced when using a cassette deck. Is it necessary to reduce the record level to the neighborhood of -10 to -20 dB, thus adversely affecting the signal-to-noise ratio, in order to maintain high-end frequency response? Or are the high frequencies generally at a low enough level in relationship to the other frequencies so that one can record at about the 0-dB level without affecting high-end response? — Tom Irwin, Davis, Cal.

A. Rephrasing your own statement, musical material above 1,000 Hz or so typically declines in amplitude to an extent sufficient to compensate for the growing inability of the tape system — at low tape speed — to cope with high-level signals as frequency increases. This inability to cope is due to the treble boost required in recording. The lower the tape speed, the greater the treble boost required. Therefore, a problem which is slight at 7½ ips and nonexistent at 15 ips becomes a considerable problem at 1½ ips.

If the record level indicator of your cassette deck is peak reading, ordinarily

you should be able to record safely (maintain extended treble response along with low distortion and high signal-to-noise ratio) at or about the 0-dB level. If the indicator is average reading, it will have been calibrated by the manufacturer (assuming good quality control in the plant) to make allowance for high-magnitude transients that might otherwise be overrecorded — with consequent distortion and treble loss. Typically, such a meter reads 0 dB when the signal is about 8 dB below a level producing 3% harmonic distortion. If you are recording off the air or from a disc, you can probably record near the 0-dB level. But if you are recording live, particularly material with strong transients (such as guitar), you may find it necessary to back down on the recording level about 5 to 10 dB in order to avoid obvious distortion.

Reversing the Aging Process

Q. I've heard that tapes start to deteriorate after the first few plays. Is this true? What can I do to prevent or slow down this process? — Mike O'Leary, Waialua, Hawaii

A. During the first few plays of a tape, there tends to be a loss of a few dB in the upper frequencies. At the higher tape speeds these losses tend to occur at frequencies far above the normal range of human hearing. At lower speeds, however, particularly at 1½ ips or less, these losses may occur within hearing range. On the other hand, continuing improvements in tapes tend to make such losses quite small, and perhaps insignificant, even at speeds as low as 1½ ips. Choice of tape is one of your recourses. Another is to regularly clean the tape heads so as to remove tape oxide that can form a barrier between the heads and the tape, thereby impairing treble response.

Souvenirs from The Sixties

Q. I have several reels of tape bought in 1966. Some are virtually unused. I have just purchased an open-reel deck and hesitate to use this tape if it may damage the heads. I would also like to ask about prerecorded tapes that I bought between 1966 and 1968. Do you think these could damage the heads of my new deck? — Raymond Disbrow, Belleville, N.J.

A. I very much doubt that use of your old tapes will in any way harm your tape

deck. The only possible reason for not using the old tapes has to do with their suitability for recording on modern tape decks. These decks generally provide greater bias than was required by the old tapes; the result would be a drop in treble response. However, this drop might not be an audible one or, if audible, would not necessarily be so gross as to produce displeasure.

With respect to your prerecorded tapes, or tapes that you recorded, there is no problem in playback. Bias does not enter the picture in playback, and playback equalization standards haven't changed. Therefore, such tapes should play back perfectly well, assuming that both the deck on which the tapes were made and your new deck have correct azimuth adjustment and that the old tapes were in the correct quarter-track stereo format.

Speaker Rumbles

Q. After using my cassette deck for a year, I have begun to notice a slight rumble which is audible through my speaker, even without a cassette in the deck. Could you give me a reason for this? — Neil Nagai, APO Mich.

A. I suspect that the problem lies in the playback electronics of your tape deck; a faulty resistor, capacitor, or transistor could be responsible. It is also possible that the problem is in the power supply; a likely culprit is the filter capacitor(s). You will require the help of an authorized service station.

Angle Angst

Q. I notice that my cassette deck loads the cassette at an angle of about 3° rather than loading it parallel with the front of the deck. Does this affect the deck or the sound? — Tracy Ching, Sacramento, Cal.

A. I doubt it. Even though the cassette is not parallel with the front of the deck, what counts is whether it is in proper position with respect to the transport mechanism. Generally, these mechanisms will not operate unless the cassette is in correct alignment. To alleviate your concern, you might visit your local audio store to see whether other decks of the same model have the same or similar offset. However, if these other decks appear to have parallel alignment, it may be best to have your unit checked.

Life in the Fast Lane

Q. I own two open-reel decks which I frequently use with 10½-inch reels. At times it is necessary to use the fast rewind mode in order to locate a desired point in the recording. However, I am unhappy with the excessively fast rewind speed and would like to reduce this by about half. I have been thinking of using a rheostat during the fast rewind mode to reduce voltage and thus reduce the speed. But would this damage the motor or other components? — Anthony Benson, Pacifica, Cal.

A. I am somewhat dubious about your method of reducing the rewind speed. Operating a motor at substantially reduced voltage could be harmful unless the motor is designed to be operated in this manner. Another possible problem is that at reduced speed you might not get as smooth a wind of the tape onto the reel.

By far the best course is to seek an answer from the manufacturer of your deck. They know the machine better than anyone else and can suggest a proper solution to the problem of reducing its rewind speed.

Consider the Source

Q. When making a tape, would you recommend equalizing (if necessary) during recording, or recording flat? If you equalize during recording, should the tape be played back flat? — Bob Hoffman, Worth, Ill.

A. Equalize in recording only if you believe that frequency response of the source is incorrect. If you do equalize in recording, try to avoid excessive treble emphasis, because this increases the risk of tape saturation. If a good deal of treble must be added, it may be wise to add part of this in playback (although this raises the hiss level). Once you have recorded a tape in such a manner that you believe response abnormalities have been fully corrected, the tape should be played back "flat" — meaning that only standard playback equalization is supplied — unless you want to compensate for a response error in the playback system (such as dull-sounding speakers). ▽

If you have a problem or question on tape recording, write to Mr. Herman Burstein at AUDIO, 1515 Broadway, New York, N.Y. 10036. All letters are answered. Please enclose a stamped, self-addressed envelope.

Introducing TDK AD-X. The normal bias tape with Super Avilyn technology.



Enter No. 21 on Reader Service Card

New AD-X is the first normal bias cassette with TDK's Avilyn magnetic particle, inspired by our widely acclaimed Super Avilyn formulation.

This means you can now record and play back—in the normal bias/EQ position—over a wider dynamic range, with higher MOL, lower bias noise and with far less distortion. Even at higher recording levels, AD-X's increased headroom easily handles strong signal input without over-saturation.

The higher sensitivity of the new AD-X makes it ideal for all-around home entertainment and it's also suitable for any cassette player.

You're assured years of dependable use with the Laboratory Standard Mechanism which is backed by TDK's lifetime warranty.

Make high quality recordings in the normal bias/EQ position with new TDK AD-X. And discover the Avilyn advantage: superior overall performance.

TDK
THE MACHINE FOR YOUR MACHINE

**Nine independent
reviews you should
read before you buy
a stereo cartridge.**

"The XSV/4000
emerges a
clear winner"
— AUDIOPHILE



This 16-page book of reviews from High Fidelity, Stereo Review and Stereo is available at your local audio dealer... or write to: Pickering & Co., 101 Sunnyside Blvd., Plainview, NY 11803

THE SOURCE OF PERFECTION

PICKERING

"for those who can hear the difference"

Paint It Black

Q. I found while studying organic chemistry that polyvinyl chloride ranges from colorless to amber. All of the records I have ever seen are black. Why do record manufacturers add pigments to make the records black?

Doesn't this degrade the quality of the record? If so, why do present audiophile records, which are supposed to be of superior quality, continue to use pigments which may have the potential to degrade the quality of the record? — Filemon K. Tan, Jr., Arlington, Tex.

A. The pigment which was used for many, many years to produce the black coloring in phonograph records is called lamp black or carbon black. Today, however, a black liquid dye is used, so that you really don't have to worry about noise from non-pure PVC since the dye is not finely divided grains as was the carbon black. The reason the record makers issue black records is that the general public seems unable to accept records in any other color, save as a novelty item.

The Hole Story

Q. Please tell me why a standard 12-inch LP record has a small center hole while a 7-inch, 45-rpm record has a large one. —Richard Savoy, Methuen, Mass.

A. The small center hole in phonograph records has been used from the inception of flat discs. When Columbia produced the first successful micro-groove, 33 1/3 rpm disc, this center hole was retained. The difference consisted of a lower turntable speed along with a greater number of grooves per inch — with consequently smaller styli tip radii. Naturally, the competition immediately went into action.

To promote its development, Columbia Records introduced a very inexpensive record changer; it was practically given away. This changer was capable of playing microgroove discs, and micro-groove discs only. No attempt was made to incorporate the then-existing 78 rpm record speed.

Not to be outdone, RCA introduced its own inexpensive record changer, again designed as a virtual giveaway to promote its new product: The 45 rpm record.

Thus there existed two completely different standards, not including the 78

rpm disc. One used a small center hole with a turntable rotational speed of 33 1/3 rpm; the other used a large center hole with a turntable rotational speed of 45 rpm. Rather than one of these giants becoming successful to the detriment of the other, both systems coexisted and caused the ultimate demise of the 78 rpm record. Inventive phonograph manufacturers were able to provide machines capable of playing all three varieties of phonograph record. This is essentially where we stand today.

Just You Weight

Q. I get a lot of distortion when playing warped records. This distortion consists of a wavering sound and sometimes includes a muffled "pop," almost as if there was a scratch on the record.

Included with my turntable is a 7.5-gram weight to be used on the headshell if the phono cartridge weighs less than 6.0 grams. Because my cartridge weighs 5.5 grams, I added the weight. When I set the balance weight at 0.5 to 0.8 gram, the tonearm bounces off the warp. Increasing tracking force beyond this point produces the muffled pop and wavering sound.

How can I eliminate this distortion? What does the headshell weight do? — J.C. Fat, Sacramento, Cal.

A. The headshell weight is intended to balance light phono cartridges. Without it, you might not obtain proper tracking force or the tonearm might not even rest on the record. The problem is that such a weight also adds mass to the system, and this added mass is sufficient to change tracking characteristics of the cartridge and tonearm such that they cannot follow a warped disc. The stylus is bouncing rather than tracking the grooves.

I suggest you remove the weight and try to adjust tracking force and anti-skating. If you are successful in obtaining adequate tracking force, then try playing some of your warped discs. I think you will probably need to use an independent force gauge to verify the tracking force.

If the problem clears up, fine. If it does not or if you find that you do need to add the weight, I suggest that you add a subsonic filter to your system. This filter will reduce low-frequency response and reduce intermodulation distortion in both the speaker and the amplifier. It

should also remove that pop, which may have resulted from the speaker's voice-coil moving beyond its design maximum (which could wreck the speakers in time) or from the action of your amplifier's protection circuits.

In any case, there appears to be a fairly serious mismatch between the characteristics of your tonearm and those of your cartridge. As you've noted, the cartridge alone, at 5.5 grams, is just under the minimum specified by your turntable's maker. But the cartridge and the weight together, at 13 grams, is too much for the cartridge to operate properly. Check with the maker of your turntable to see whether a 3- or a 5-gram weight is available. The combined weight of 8 to 10.5 grams seems to be the area where your cartridge operates best so as to track warped discs.

Separate Tables

Q. I have accumulated three turntables and have use for each of them. Can I hook up tables two and three to "Station 2" on my preamplifier by way of a "Y" connector? I would not be using them at the same time because they would be serving separate purposes. — C.M. Flores, Saginaw, Mich.

A. You would not want to connect both turntables to a single preamplifier input. This arrangement could lead to added hum and loss of flat frequency response. The cable capacitance of one turntable would be added to that of the other; one phono cartridge would feed into the other one while driving the desired preamplifier input. No harm can result from doing this, however. If the sound is at least satisfactory, all well and good.

A more sophisticated approach requires connecting turntable 2 to "Station 2" of your preamplifier. Turntable 3 would be connected to a phono-stage preamp, sold by various mail-order houses and also manufactured by some phonograph cartridge makers. The output of this unit would feed into one of the high-level inputs of your preamplifier.

Switch Before You Feed

A. Can one set of speakers be hooked up to two power amplifiers by running wires from the speakers to one amplifier and another set of wires directly to another amplifier? By utilizing one amplifier at a time, would any damage be

done to either the amplifiers or the speakers? —Robert G. Delorme, West Warwick, R.I.

A. You cannot use one set of speakers connected to two separate amplifiers as you have proposed. Even if one amplifier is turned off, the amplifier being used will, in addition to feeding the speakers, feed into the other amplifier. This second amplifier will present impedance to the amplifier being used and damage it. The fact that the speakers will likely not be damaged is academic.

Switching must be provided so that the speakers are connected only to the amplifier actually in use. This switching will eliminate the need to physically connect or disconnect the speakers to or from either of the two amplifiers.

On Cable

Q. I have considered locating my amplifier midway between the speakers, which would result in equal, 9-foot cable runs. I now have a 25-foot cable run on one speaker and 15 feet on the other. Are there advantages in using equal cable runs? — C.T. Lewis, Morrisonville, N.Y.

A. No problems will be encountered because of differing lengths of cable from amplifier to speakers.

No Morning Glory

Q. Before I bought my tuner and timer I had a problem with the volume control on my amplifier. Occasionally, when I tried to lower the volume, the sound level remained constant until I turned this control up and down several times.

Since I bought the tuner and timer, I have had a different problem. We use the timer, tuner and amplifier to wake us up at 6:30 a.m. and turn off at 7:30 a.m. After coming on and playing for perhaps 20 minutes, the volume gradually rises to a loud level all by itself, when no one is near the equipment!

I wonder if this second problem is caused by the same source as the first one. — Jeff Culbertson, Overland Park, Kans.

A. Both of these problems are the result of a volume control which, at the

very least, is in need of cleaning with appropriate contact cleaner; at most, it will have to be replaced.

A volume control which is either defective or has oxidized contact surfaces will tend to change resistance at the point of contact between the wiper and the resistance element, leading to erratic

changes in volume even if you have not touched the control.

If the volume control is not sealed, squirt some contact cleaner into it at the point where the connecting terminals emerge. If the problem still persists or if you cannot force cleaner into the control, replace it. 

“...closest thing to a seat in the hall!”

—BILLBOARD



These five latest Telarc releases are further proof that, by using no more than three carefully-spaced microphones and taking full advantage of excellent acoustics, Telarc preserves the musical dynamics and balance of the orchestra without distortion or obtrusive engineering.

Combine this "naturalistic" approach with the sophisticated Soundstream digital recording process and the most meticulous record production standards, and the

results speak for themselves.

Now there are 26 albums in the unique Telarc catalog. They include many considered "landmark" recordings for both performance and technology. And the Telarc difference can be appreciated no matter what record-playing system you own. Listen to Telarc today at better record stores and audio showrooms, or write for catalog. AUDIO-TECHNICA U.S., INC., 1221 Commerce Drive, Stow, Ohio 44224.

If you have a problem or question about audio, write to Mr. Joseph Giovanelli at AUDIO Magazine, 1515 Broadway, New York, N.Y. 10036. All letters are answered. Please enclose a stamped, self-addressed envelope.



audio-technica

Enter No. 23 on Reader Service Card

WHAT'S NEW IN AUDIO

AKAI Cassette Deck

The GX-F66RC features Intro Scan and Blank Search, automatic play of one side, both sides or continuous playback, and automatic tape selection. Intro Scan allows quick and easy location of specific songs, while Blank Search seeks out unrecorded sections of the tape to

facilitate recording on partially recorded cassettes. This cassette deck also has a microprocessor-controlled Random Program Search System that can select up to 20 programs in any order up to 99 selections on either side of the cassette. The Dolby B and C noise-reduction systems are

featured, along with AKAI's automatic reverse, 16-segment LED bar meter and electronic digital tape counter. Frequency response for metal tape is 25 to 19 kHz, ± 3 dB. Price: \$575.00.

Enter No. 100 on Reader Service Card

Bang & Olufsen Receiver

The Beomaster 6000 is a 75 watt/channel remote-controlled, computer-directed, programmable receiver. It can be programmed to start or stop automatically, play a radio program, or shut off the system at any time. Microcomputers control the receiver and reduce complex operations to a touch of a button. The Beomaster 6000's control panel or the wireless remote control terminal will select any of six preprogrammed FM stations, raise or lower the volume, or turn the entire system on or off. The volume control is also automatic, and can be programmed for seven different volume levels as well as preset for a favorite listening level. This receiver also allows for interruptions while a recording is being made. Volume can be turned off by touching the mute button without interrupting the recording process; touching the mute button again will return the volume to the prior sound level. The Beomaster 6000 can be combined with the Beogram 8000 turntable, Beocord 8002 cassette recorder, or the Beocord 9000 cassette recorder. Price: With remote control, \$1,600.00.

Enter No. 102 on Reader Service Card

Proton Table Radio

The Radio is a self-contained music system with add-on capability for accessory speakers as well as tape players. It comes equipped with a single two-way, biamplified speaker, with 20 watts for the woofer and 5 watts for the tweeter, and a built-in equalizer

insures bass response down to 60 Hz. A single add-on speaker converts the system to full stereo operation, while up to 10 pairs of speakers can be connected to provide music in any room of a home or office. Prices: The Radio, \$280; additional speakers, \$150.00 each.

Enter No. 101 on Reader Service Card

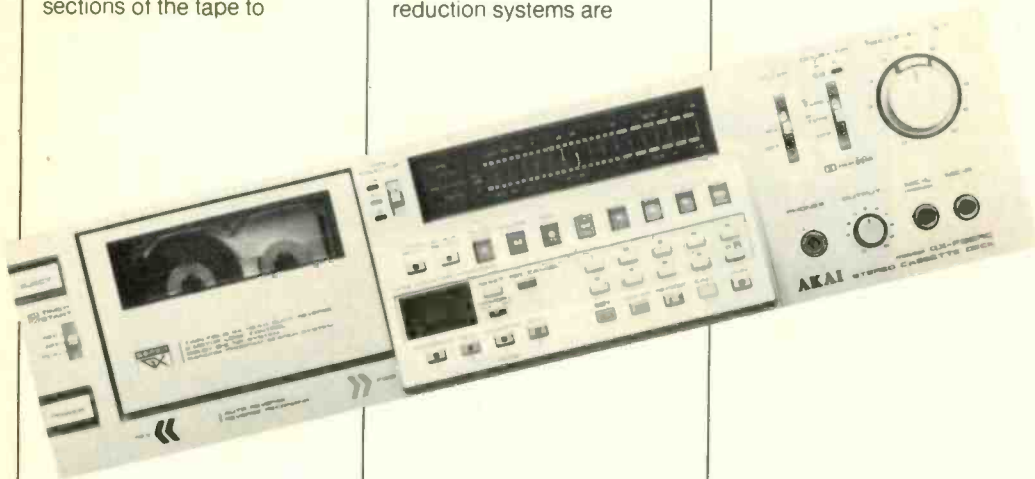



**TEAC Open-Reel
Tape Deck**

The X-1000R uses a dual-capstan, closed-loop drive and full tension servo control in its transport system. Transport functions are handled through a logic system that permits search to zero, search to cue, and

block repeat operations. Bidirectional record and playback facilities are included using a six-head arrangement, and reel sizes up to 10 1/2 inches can be accommodated. Both the dbx noise-reduction system as well as the ability to use the new EE, or extra efficiency,

tape formulations are offered as features on this unit. In addition to wide-range VU-type meters, full mike/line mixing facilities and separate-channel input and output controls are provided. Price: \$1,400.00.

Enter No. 103 on
Reader Service Card

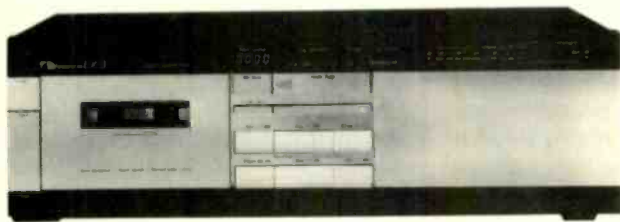

Nakamichi Cassette Deck

The LX-3 is a two-head cassette deck featuring a microprocessor-controlled tape transport which allows automatic playback after rewind or fast forward, record mute, high-speed shutoff, and slack-tape take-up as well as remote operation and unattended recording and playback via any accessory timer. The unit offers both Dolby B- and C-type noise

reduction, as well as a Master Fader with choice of two fade rates. The LX-3 incorporates separate bias and EQ switches for ferric, chrome and metal tape formulations, as well as individual record-level controls, output control, and defeatable MPX filter. The 16-segment peak-responding LED display indicates record levels over a 50-dB range. Price: \$545.00.

Enter No. 104 on Reader Service Card

Mordaunt-Short Loudspeaker

The Pageant 3 uses three transducers in a distributed reflex design to achieve a free-field response of 60 Hz to 20 kHz, ±3 dB. Designed primarily for those who desire a high quality system within practical budget limitations, the system is intended to eliminate the unpleasant colorations associated with single ducts with a large cross-section. This allows excellent generation of low frequencies with great clarity, transient attack, and low distortion. The midrange unit

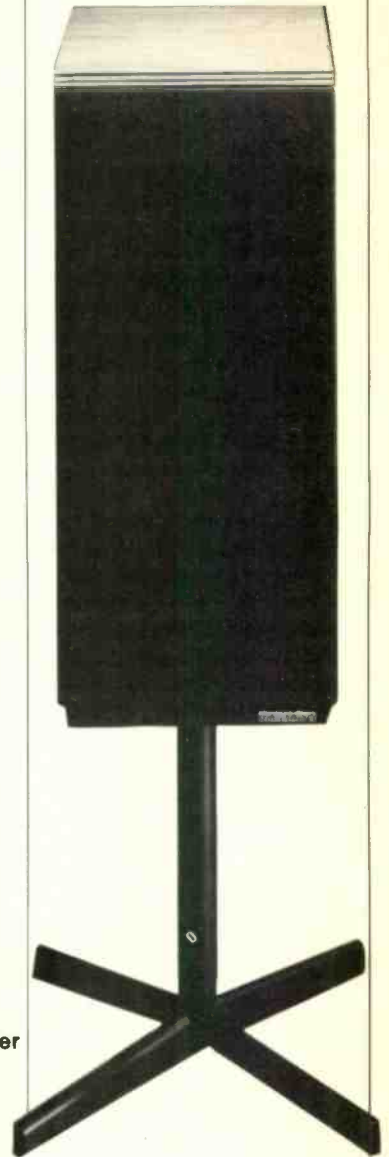

has its own sealed enclosure to prevent interaction with the woofer, while the tweeter is only 12 mm in size for minimum loss of high frequencies off axis. Price: \$765.00 per pair; with stands, \$815.00 per pair.

Enter No. 105 on
Reader Service Card

THE COLUMN

MICHAEL TEARSON
JON & SALLY TIVEN

Shake It Up: The Cars
Elektra/Asylum 5E-567, stereo,
\$8.98.

Sound: B Performance: A

On their debut LP, *The Cars* appeared to have the essentials for an aesthetic and commercial success — great material enhanced by state-of-the-art production. A number of hit singles — "My Best Friend's Girl," "Let the Good Times Roll," and "Just What I Needed" — propelled the group and their producer to instant superstardom, becoming the new yardstick by which other pop groups were measured. Although he became the industry darling, accruing accolades along with astronomical percentage points on each successive project, Roy Thomas Baker couldn't make lightning strike the second or third time he and *The Cars* ventured into the marketplace. Concentrating more on futuristic production than the quality of the compositions, *The Cars'* second and third attempts wandered away from the rock 'n' roll basics they had perfected the first time out. It appeared that this group was misdirected into transcending a form they had lost their feel for. Now, three years after their initial splash, *The Cars* have managed to make their second rock 'n' roll album.

Shake It Up is full of killer tunes — these guys have been suffering for their art or graced by the Muse lately, because the songwriting comes close to that on the first LP. Structurally and lyrically, the songs are a shining example of the less-is-more school of pop composition. Ocasek maintains a constant muffled rhythm with his guitar, Easton plays spare but tasty fills and solos, but most of the melodic figures are left to imaginative keyboardist Hawkes. The spacious quality of this LP compliments the simple tunes perfectly — this time out the synthesizers aren't used as screen for song fragments, but are moderately employed to add an evocative level to Ocasek's deadpan delivery. "Shake It Up," for instance, is propelled by repetition and a rolling beat so well that we overlook such throwaway lyrics as "Dance all night, get real loose/You don't need no bad excuse." *The Cars* come off best when they shake off their pretensions to the making of pure art and get down to rocking, and with *Shake It Up* it would ap-



pear that they have returned to this form. It is a record as masterfully created as their first, yet ably demonstrates that they *have* grown both as individuals and as a unit without losing their focus.

Jon & Sally Tiven

Time: ELO
CBS FZ37371, stereo, \$8.98.

Sound: A Performance: B

If you like your Beatles transformed into heavy metal, you listen to Cheap Trick, but if you like your Beatles orchestrated, you go for ELO. What they do is faultless — *Time*, like all their previous albums, boasts great production values, terrific vocals, and fine arrangements, all built on a meaty rhythm track that lends this group their rock 'n' roll validity. The only way you could dislike this LP is on principle, because its sound is impeccable. Despite the preponderance of background music numbers on this record, there are a few standouts that make the band sound absolutely like what's happening.

"Ticket to the Moon" is a pretty ballad that shows Lynne's basic vocal and songwriting skills in a positive light. "The Way Life's Meant to Be" is a good country & western flavored rocker with amusing lyrics and Spectroesque production from the multiple backing vocals through handclaps to lush string sections. ELO

can imitate genres as well as they synthesize their primal musical influences (Beatles, Spector, and Roy Wood if you're too young to catch their stylistic borrowing), and they offer a cute reggae number called "The Lights Go Down" to break up the sequence of futuristic pop tunes here. Whatever style of composition this outfit lends their touch to, they manage to load it with saccharin without being too cloying, and it's no wonder that ELO was one of John Lennon's favorite bands — they sound a lot like him. So much so, in fact, that one is surprised that they didn't do more of a tribute to the late Beatle on this LP — an ELO version of "Imagine" could, in fact, be mind-blowing.

Unfortunately, the group isn't particularly into blowing minds these days. Their inventive heyday ended somewhere around the third album, and ever since they've been very nice but hardly astounding. You'd think that with all the dough they rake in, they would be able to move a little further left of center, but instead they stay heavily indebted to their progenitors and make pleasant albums. One can't wait around for Jeff Lynne to get inspired once more, but you have to give him some credit for not sounding forced and making pop music a few steps ahead of what you hear on the AM dial. The trouble is he is capable of much more.

Jon & Sally Tiven

Best of The Blues Brothers

Atlantic SD 19331, stereo, \$8.98.

Sound: B

Performance: B+

With tongue firmly in cheek, John Belushi and Dan Aykroyd pay tribute to blues and soul classics of years gone by, and not so amazingly have established a humongous following. It's not that amazing because (a) John can really sing, (b) Dan plays a mean harp, and (c) these are all great tunes. As an added attraction, the band comprises half of the original Booker T. & the MG's (who wrote some of The Blues Brothers' hits) as well as some of New York's top session men, so it isn't exactly amateur night at the OK Corral. This is your typical repackaging to catch the Valentine's Day market, and it contains some of The Blues Brothers' best-known tunes like "Rubber Biscuit," "Soul Man," and "Gimme Some Lovin'," as well as the previously unreleased "Expressway to Your Heart," all tied together in a snazzy cover designed by Judith Jacklin (an up and coming bassist in her own right).



Those detractors of the brothers Blues may claim that (a) John and Dan are far too white to sing these classics and (b) their versions do not measure up to the originals. But the artists responsible for these tunes are likely more than happy to see these songs once again in the public ear, and it is indeed a service to black-music lovers everywhere that

The Blues Brothers are bringing this heritage to a new and younger audience. Granted, John is not Otis Redding and Dan is not Junior Wells. But the chemistry between the two of them and these tunes is something else again, and no one can tell us that their rendition of "She Caught the Katy" is any less moving than Taj Mahal's. Jon & Sally Tiven

Rock & Roll Adult: Garland Jeffreys

Epic FE 37436, stereo, \$8.98.

Sound: B-

Performance: B+

I don't like many live rock albums. They tend to be note-for-note reconstructions of studio performances but with less precision. They also tend to be fillers during periods when the artist owes an album and hasn't been able to develop enough real new stuff to make it worth going into the studio, so they add little to the body of an artist's work. Rare is the live album that reveals a dimension of the artist that the studio kept hidden. Garland Jeffreys' *Rock & Roll Adult* is one of those, rare, fresh and urgent.

Jeffreys is no spring chicken. Pushing 40, he rocks with abandon and cool at the same time. Here he's got a major prerequisite for a hot live recording: A hot-shot, crackerjack band behind him, namely Graham Parker's former band The Rumour, guys who play with authority and real power. Then there's the material, always one of Garland's strong suits. "Wild in the Streets" is a bonafide classic song, and "R.O.C.K.," "I May Not Be Your Kind," "Matador," and "35 Millimeter Dreams" deserve to be.



In live performance, Garland brings whole new meanings to them.

The sound has the raw edge of live performance and the feel of the live staging in its mix. The crucial element of Steve Goulding's drums has been cap-

tured with a sock you can feel, while the guitars really sting.

Garland Jeffreys has always made songs of real substance. If you have not yet made his acquaintance, *Rock & Roll Adult* is the place to do it. M.T.

AC/DC is good at its craft, but most of its craft is making money rather than music.

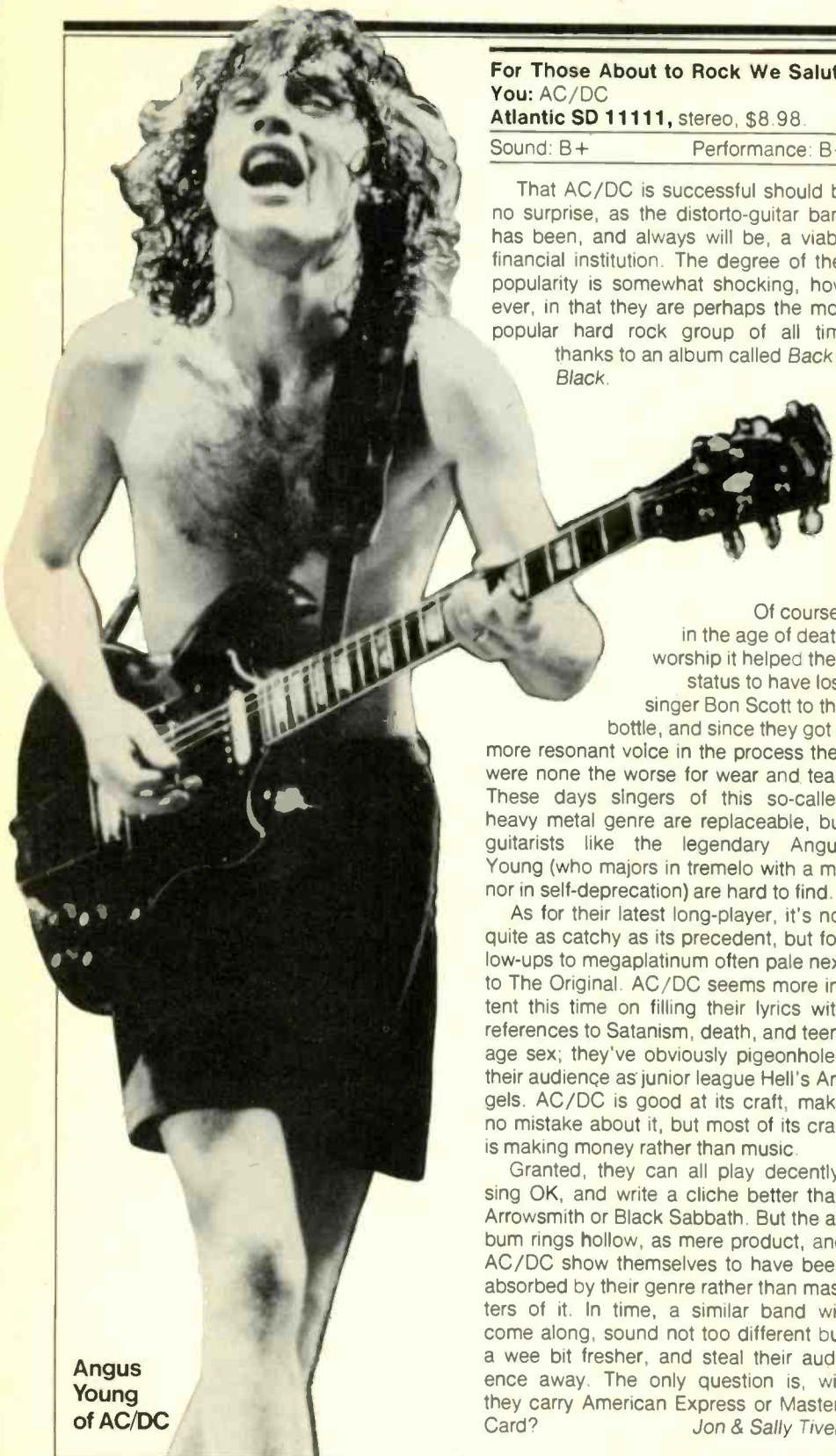

Angus Young of AC/DC

For Those About to Rock We Salute You: AC/DC
Atlantic SD 11111, stereo, \$8.98.

Sound: B+ Performance: B+

That AC/DC is successful should be no surprise, as the distorto-guitar band has been, and always will be, a viable financial institution. The degree of their popularity is somewhat shocking, however, in that they are perhaps the most popular hard rock group of all time thanks to an album called *Back in Black*.

Of course, in the age of death worship it helped their status to have lost singer Bon Scott to the bottle, and since they got a more resonant voice in the process they were none the worse for wear and tear. These days singers of this so-called heavy metal genre are replaceable, but guitarists like the legendary Angus Young (who majors in tremelo with a minor in self-deprecation) are hard to find.

As for their latest long-player, it's not quite as catchy as its precedent, but follow-ups to megaplatinum often pale next to *The Original*. AC/DC seems more intent this time on filling their lyrics with references to Satanism, death, and teenage sex; they've obviously pigeonholed their audience as junior league Hell's Angels. AC/DC is good at its craft, make no mistake about it, but most of its craft is making money rather than music.

Granted, they can all play decently, sing OK, and write a cliché better than Arrowsmith or Black Sabbath. But the album rings hollow, as mere product, and AC/DC show themselves to have been absorbed by their genre rather than masters of it. In time, a similar band will come along, sound not too different but a wee bit fresher, and steal their audience away. The only question is, will they carry American Express or MasterCard?
Jon & Sally Tiven

Beds: The Beds
Elektra/Asylum SE-533, stereo, \$8.98.

Sound: A Performance: B

New Wave music has infiltrated mainstream America to the extent that U.S. Army recruitment commercials are accompanied by a blistering soundtrack of punk rock guitars, so it shouldn't be surprising to discover a Vegas singer backed by synthesizers. Maybe she'd disavow the label, but compared to the Chrissie Hyndes of this industry, The Beds' Merle Miller is just that — a well-trained voice that's stronger on technique than sincerity. Still, Miller has a sense of humor and a command of funny voices which she performs on this LP, and this puts her miles ahead of other cabaret crooners clothed as New Wavers, who it would be kinder not to name. Now that the group Blondie has fallen by the wayside, perhaps The Beds' electronic cabaret music will be propelled by their sexy front woman to the top of the charts, a place where they'd appear positively innovative compared to the heavy-metal queen Pat Benatar and her reign of boredom that's plagued the airways much too long.

Jan Warner, the musical arranger, composer and keyboard player on this LP, is responsible for its extremely modern, at times even futuristic, sound. The drums, synthesizers and vocals ride way in front of the supporting instruments — an unusually humble position for a guitar which plays some beautiful figures unjustly buried in the mix. The single outstanding tune, "Don't You Shy Away Boy," melds a Latin beat to humorous lyrics and a chorus that rocks.

The producers did well by the clean mix, which is the only context in which The Beds' cabaret synthesizers could really excel. From Miller's husky pipes to the sparing instrumentation that dramatizes them, The Beds' first album is nothing if not well crafted. *Jon & Sally Tiven*

It Don't Hurt to Flirt: Keith Sykes
Backstreet BSR-5277, stereo, \$8.98.

Sound: B+ Performance: B-

When I spent some time living in Memphis, Keith Sykes was a performer of some note (Jerry Jeff Walker had covered a couple of his tunes) and he was



able to attract Memphis' most talented out-of-work musicians to his fold. At that time he was doing a lot of Carl Perkins covers, had a semi-rockabilly approach distinguished by the stinging guitar of the late Chris Bell, and was spending a fair amount of time in the studio making demos. The demos eventually got him a deal with Midsong Records, which released an overproduced album of his about four years back. Eventually, Keith landed on Backstreet, which did fairly well by him a year ago with his debut album.

This brings us to the record most people know as Keith Sykes' second, which is a little bit on the mediocre side with no melodic instrument to interact with the lead figure. (Sykes is playing all the leads this time, and he's not much of a player.) The support of John Hampton (drums and engineering) and Mike Brigardello (bass), both formerly of Walk 'n' Wall, is ample but not exactly blistering. It ends up sounding like Derek & The Dominoes without Eric Clapton or Duane Allman playing lead guitar. The songs are alright, the singing is somewhat droll, but the album lacks the fire to distinguish it from elevator music. Keith Sykes is a good (not great) rockabilly songwriter; unfortunately he's leaning altogether too hard on that. It isn't enough to make this album a must-have. J.T.

The Other Side of Town: Chuck E. Weiss

Select SEL 21611, stereo, \$5.98.

Sound: C- Performance: A-

The third half of an infamous triangle with Tom Waits and Rickie Lee Jones, Chuck E. Weiss is finally heard from with this seven-song mini LP that is crackling good low-life fun. His songs are as lively, clever and smart as they'd better be, considering the company he keeps. Speaking of company, he's got an amazing studio band for the album, with Mac "Dr. John" Rebennack on the 88s,

Alvin "Shine" Robinson on guitar, Freddy Stahle on skins, and funky Larry Taylor on bass. Friend Rickie Lee joins in too for an uncredited cameo duet on the woozy, boozy "Sidekick."

The territory is familiar and run-down and outrageous, but that just lets everyone get funky and into the spirit of

The songs are alright and the singing somewhat droll, but Keith Sykes' album lacks the fire to distinguish it from elevator music.

things. Rob Fraboni's recorded sound and production are nicely uncluttered, but Select's pressing is just lousy enough to gum things up a bit.

I don't know if Chuck E.'s still in love or not, but I'm in love with his little album. (Contact Select Records at 175 Fifth Ave., New York, N.Y. 10010.) M.T.

ADS L1230. A STUDIO MONITOR FOR THE HOME.

It is no surprise to us that our ADS L1230 Professional Monitor Loudspeaker has become one of our largest selling speakers to home music enthusiasts.

Born of ADS' developmental technology for professional monitor speakers for the new digital recording industry, the L1230 is a phenomenal performer. First, it is sold and shipped in mirror-symmetrical matched pairs only. The two long-excursion 8" diameter woofers, acoustic suspension soft-dome midrange driver and Barium Ferrite tweeter in each speaker are produced entirely within ADS under stringent controls. Each driver is hand calibrated and hand tested. The result is exceptionally uniform extended frequency response, unusually wide dynamic range, outstanding transient accuracy, low distortion, perfect "point source" stereo imaging and superior driver linearity. And one further advantage

instantly converts the price from an expenditure into an investment. The extremely advanced design and new technology embodied in the L1230 ensures that it will not become obsolete with today's fast-developing improvements in program source material quality.

It is a worthwhile experience to listen to a pair of L1230's. We suggest that you call toll-free 1-800-824-7888 (in California 1-800-852-7777) and ask for operator 483, Dept. AU3. We'll send you technical literature and a list of ADS Dealers where you can enjoy a demonstration.



Analog & Digital Systems, Inc.,

Where Technology Serves Music
One Progress Way, Wilmington, MA 01887



Enter No. 1 on Reader Service Card

— SONIC — HOLOGRAPHY

The illusion presented by conventional stereo sound is, in my estimation, severely flawed by fundamental distortions of space and time. Although we accept it because we must, and love it when we can, I don't think any of us really believes this illusion approaches a real-life experience. By "conventional stereo" I mean the sort of presentation that works mostly or entirely through loudness or amplitude manipulations. For a sound supposed to come from the left, the left speaker dominates in amplitude; for a sound from the right, the right speaker plays louder. The speakers are equally loud for a sound intended to come from exactly in between, and appropriate degrees of louder or softer are employed for "somewhat left" and "somewhat right" sounds. *Interaural amplitude difference* or IAD is one common name for these manipulations we use to fool the ear and brain. Thus, if the left ear picks up a sound as being significantly louder than the right ear, the ear-brain mechanism will locate the sound source to the left. The converse is true when amplitude favors the right ear. If both ears detect no amplitude difference in what they separately hear, the ear-brain "visualizes" the sound source as being directly in front of the listener.

A classic acoustical experiment, made some years ago, vividly illustrated the power of this mechanism. Listeners were exposed to identical and simultaneous impulse "pips" coming from two spaced loudspeakers, one of which was a little closer to the listeners so that its output arrived slightly ahead in time. The listeners perceived both sound sources as one, and identified "it" as coming from the near speaker. But when the near speaker was turned down in level and the far one up, it was possible to make the pips shift gradually over to the far speaker, showing that amplitude cues could be made to override temporal cues in the ear-brain's localization process. It took quite a difference in amplitude to bring this about, however, and listeners also noted that the sonic character of the pip changed with the shift, becoming somehow fuller and more diffuse.

*President, Carver Corp., Woodinville, Wash.

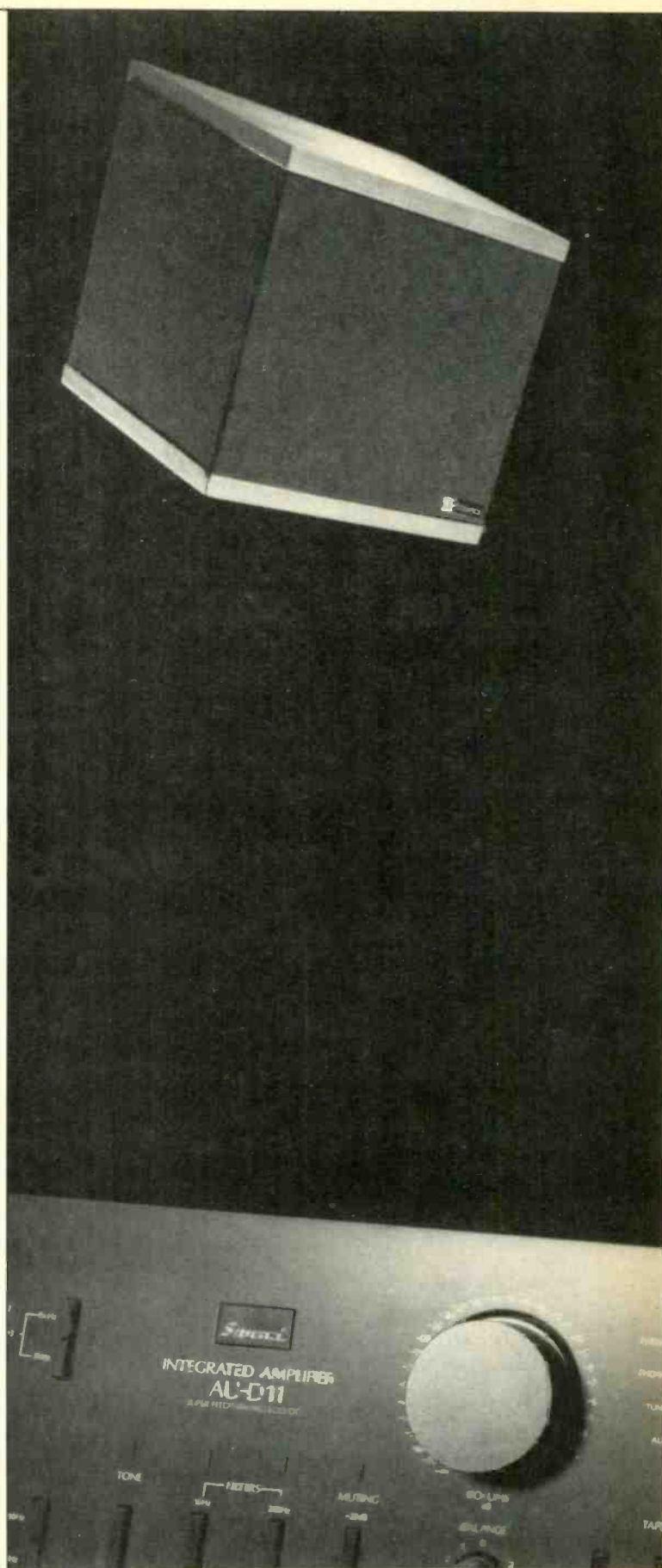

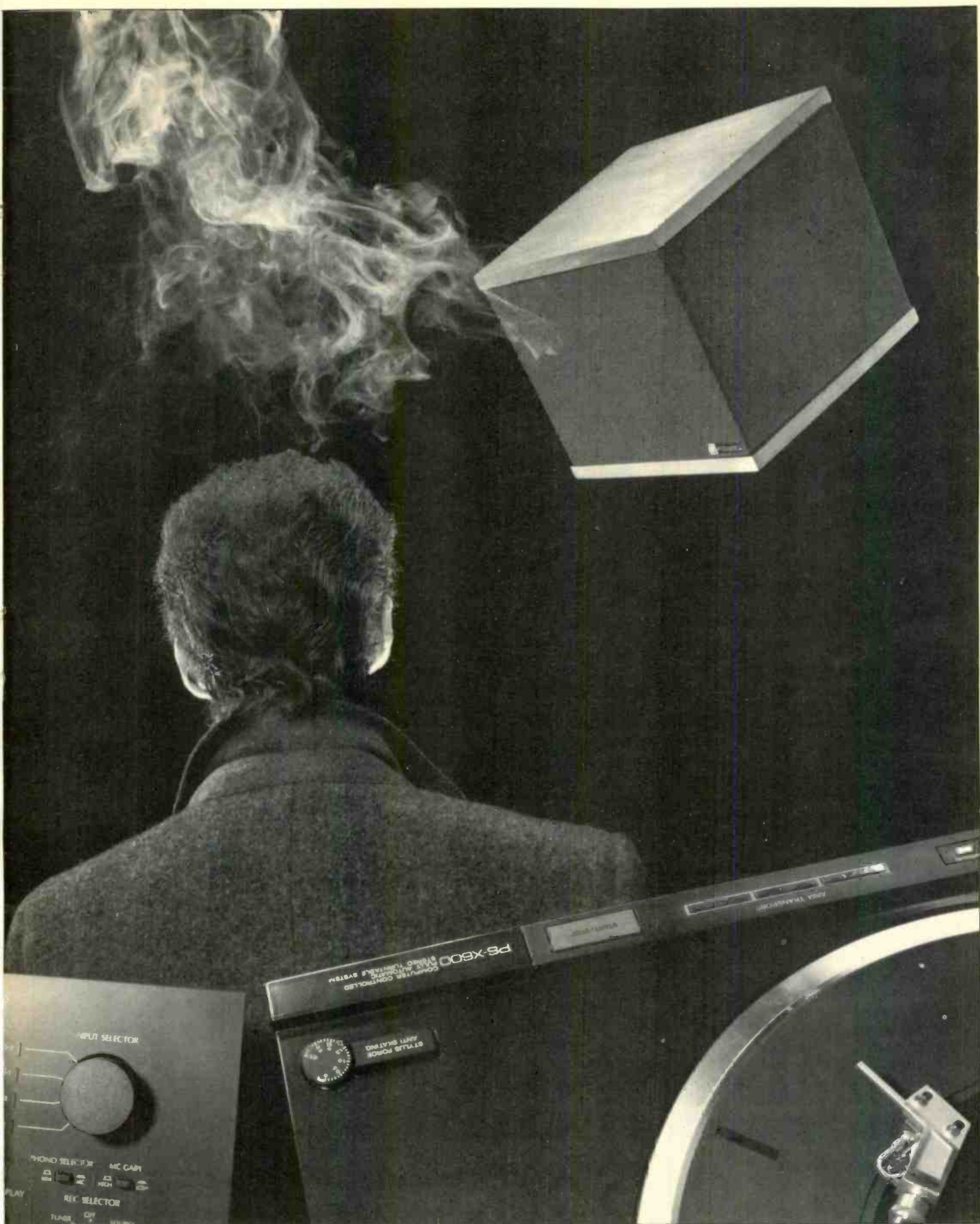

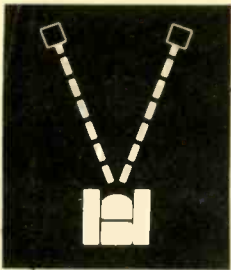

Nevertheless, the mechanism can persuade the ear-brain that it heard sounds from places other than their true origins, and it is the basis for what we call stereophony. It works well enough to be the basis for most all sound recording today, and especially for the creation of records from multitrack tapes.

Just because this trick could be performed, it was easy to assume that we had unlocked the whole of nature's secret to ear-brain localization. But this was wrong because the ear-brain functions with several localization mechanisms, which can reinforce or conflict with each other. It may be true that amplitude cues such as IADs are important and even dominant for close sounds. But because of the inverse-square law, IADs reaching a listener seated back in an auditorium are negligible, even for first-arrival or direct sounds. As Fig. 1 shows, IADs can be expected to reduce to about 0.4 dB at a 16-foot distance from the sound source — an amplitude difference that would have had virtually no effect on localization of the pip in the above experiment.

On the other hand, although IADs rapidly diminish with distance, temporal cues, that is, interaural time differences (ITDs), remain absolutely unchanged for a given sound-source direction, no matter what its distance. We appear to have an internal clock that ticks steadily and reliably away under all circumstances, timing the interval between a sound's arrival at ear 1 and ear 2 (see Fig. 2). Therefore, it seems reasonable to conclude that for a typical audience member at a concert, ITDs have great importance in localization of sounds, but IADs mean next to nothing.

Another localization factor often cited is acoustic "shadowing" of the far ear by the head and face. Shadowing alters the frequency spectrum perceived by the far ear, presumably in a way that is informative to the ear-brain about sound-source location. Unquestionably this is an important factor, but probably more so in a nonreverberant environment such as occurs outdoors, where the head casts a truly steady and well-defined shadow. In an auditorium the far ear is not shadowed from the all-enclosing reverberant field, so the ear-brain has only the ITD period associated with the first-arrival sound to sense shadowing. Since

determining spectrum shape requires a much longer sample of sound than ITD discrimination, it's by no means certain that shadowing is quite the aid to localization in concert halls it might be otherwise. But that doesn't mean shadowing won't have to be considered in the context of home listening rooms.

For purposes of source localization then, IADs are probably of very small consequence in auditoriums. Shadowing may have some consequence, but it's hard to assign an absolute or even typical rating of influence. ITDs, we know, are fixed and always present, and they seem to be of central importance.

A Matter of Time

Ironically, however, it is timing or temporal cues that get the shortest shrift in conventional stereophony. Multi-microphone techniques pretend they don't exist. There is no spaced-microphone array that rationalizes them properly for loudspeaker listening. Coincident microphones eliminate them totally, a shame because they're sorely missed by the ear-brain. Perhaps most seriously, stereo loudspeakers ultimately make a mess of the time factors by adding new and utterly inappropriate temporal cues.

Figure 3 shows how this happens. Let's take, as an arbitrary example, a "phantom" sound image that has been panned so it seems to come from directly between the two speakers. Equal-amplitude sounds travel from left speaker to left ear along the path L and from right speaker to right ear along path R. The ear-brain's IAD detector is satisfied and shouts "Sound dead ahead." For an instant the ITD sensor is satisfied too. But 100 microseconds or so later, sound traveling from the left speaker along path L reaches the right ear simultaneously with the right-speaker sound's arrival at the left ear along path R. At this point the ear-brain's ITD sensor whispers "Not a single sound dead ahead, but two equal sounds equally spaced to right and left," and there is confusion at the helm.

Ultimately, your conscious mind will probably accept the decision of the IAD sensor, for otherwise, stereo wouldn't work at all. But there is still the situation of conflict in which one localization mechanism is trying to "fuse" two separate sounds into a single sound while another keeps insisting that it just isn't so.

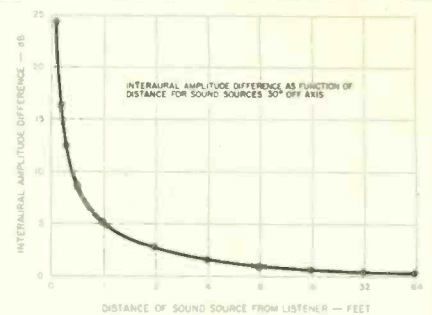

Fig. 1A—Interaural amplitude differences diminish rapidly with increases in distance from the sound source.

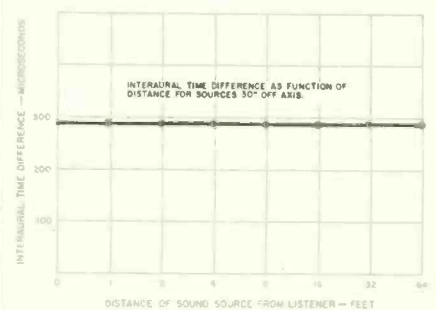

Fig. 1B—Interaural time difference remains constant whatever the subject's distance from the sound source.

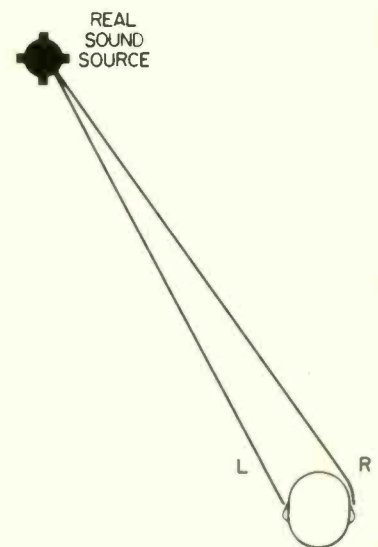

Fig. 2—How the sound from a real source, located to the listener's left, approaches the listener's ears.

Evidently, ITDs can be bullied by stereo techniques into letting IADs have the final say, but this is no victory for the integrity of our perceptions. ITDs are basic to our sound-localization ability, not secondary or supplementary. If ITD sensors are to be satisfied, they must hear two and only two arrivals from a single sonic event, and not the four that occur during conventional stereo playback. Anything else is nonrealistic and subject to deep suspicion if not outright rejection.

Is it any wonder that, if we're honest with ourselves, we never find our stereo systems sounding nearly as convincing and credible as the real thing? There is, in the end, an indistinctness, flatness, and diffuseness (if you recall the listener impressions in the experiment described earlier) that never quite go away unless certain brain centers have been lulled into a mood of acceptance. It is not so much as if something were missing, but more as if something spurious has been added. I submit that the "something" consists of two extra sound arrivals that never exist in real life and that result in a conflict of localization cues and a consequent indistinctness of time and place in the stereo image.

Sonic Holography Defined

Let's look back at Fig. 3 again. Remember that when we had just paths L and R, both the IAD and ITD sensors were satisfied. For a magic 100 microseconds or so, everything was fine. But then L_r and R_l intruded, and the "one source versus two" dilemma arose. Suppose it were possible to eliminate L_r and R_l , not just for a center-front image, but for sound images occurring anywhere on the stereo stage — to make it as if the left speaker didn't exist for the right ear and vice versa? Might this help? And if it does, how could it be accomplished?

First of all, it clearly could not be done by any electronic method alone. It would require an electronic method designed to invoke the assistance of some other mechanism, specifically, the mechanism of wave interference. We know that sound waves interfere in the air of any environment in which sound is contained, and that the interference gives rise to local reinforcements and cancellations of sound throughout the area. We're used to thinking of such interference as being, if not unpredictable, at

Fig. 3— How conventional stereophony uses equal amplitude signals to produce a stage-center location for the apparent sound source. But note that both speakers are heard by both ears.

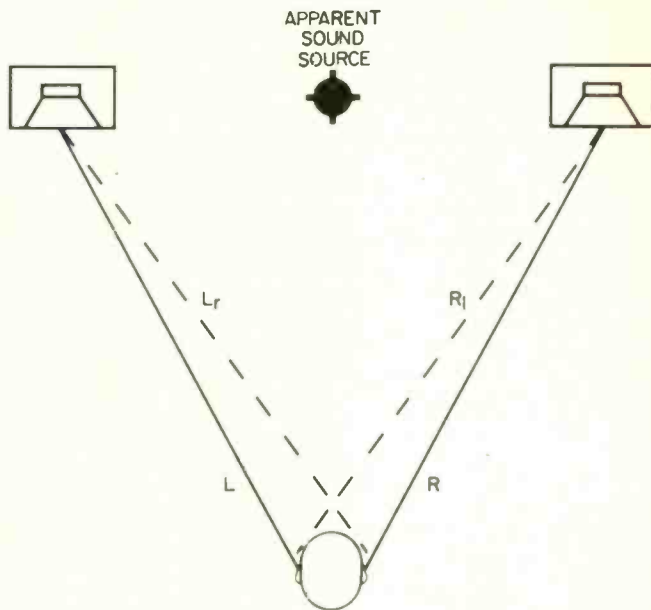
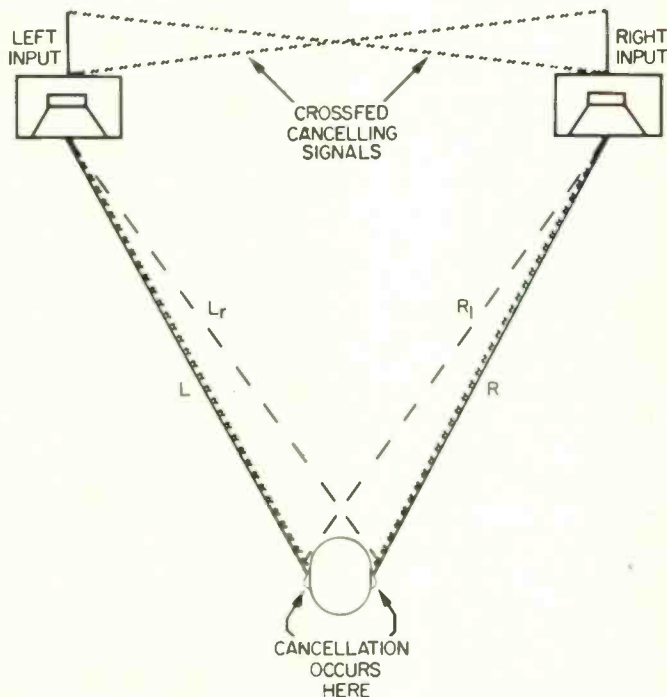
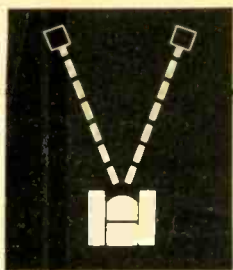

Fig. 4— Careful addition of the crossed cancelling signals will cause the L_r and R_l signals to drop out of the sound field at a selected listening location.





least too complex to be controllable. Yet while this may be essentially true for much reflected sound, it is not true for sound proceeding directly from a sound source to a prescribed destination. In this case, we know the sound's point of origin, its speed, and how far it has to go. Therefore, it's theoretically possible to arrange for an interfering sound to meet the unwanted sound at its destination and, by acoustical interference, cancel much or all of it. If the sound's origin is the left speaker, its path L_1 , and its destination the right ear, cancelling that sound upon its arrival should make the left speaker disappear for the right ear. And the same thing should be possible for the left ear vis-a-vis the right speaker.

What is required of the cancelling signal? First of all, it should be appropriately derived from and related to the unwanted signal coming along L_1 , but 180° out of phase with it. Second, it must arrive at the ear the instant the L_1 signal does. Finally, it must come from some other source than the left speaker, or the signals would cancel at the speaker itself and nothing would come out. The obvious choice is projecting it from the right speaker. This turns out to be the way to do it. Conceptually, all we need do is tap off part of the left-channel signal at some line-level stage, invert its phase, adjust it temporally for simultaneous arrival with the L_1 signal at the right ear, and then crossfeed it to the right channel for launching through the right speaker. A portion of the right channel is tapped off and processed in the same way to cause cancellation of the R_1 signal at the left ear. Figure 4 shows the total result.

The temporal adjustment needed is about a 100-microsecond delay (125 microseconds, to be exact), which is nothing more than the ITD between the left ear, which receives sound along the shorter path L_1 , and the right ear, which hears the left speaker along the slightly longer path L_2 . Needless to say, the listener's ears must be in the approximate spots the whole process expects if the proper cancellations are to take place right at them. However, although such interference effects are relatively local, position is not quite so critical as you might expect. So long as the listener's seat is where it should be, he can move his

SONIC HOLOGRAPHY RECORDED

Sonic holography happens because of acoustical interference patterns set up in the air around a listener's head, but the signals that bring about holography are not so intangible. They can be detected, quantified, analyzed, and replicated. They can even be recorded — on a tape by you, if you have a Sonic Hologram Generator, or on an ordinary phonograph record such as the Soundsheet bound into this magazine. Playing the tape or record produces the full holographic effect. A Sonic Hologram Generator is needed only for material that has not been holographically encoded.

Nevertheless, just playing the enclosed Soundsheet record may not do a thing for you unless you take steps to ensure that your listening chair (and you should use a chair) and your loudspeakers are properly positioned relative to each other, and sufficiently far from walls and other reflecting surfaces that might impair the propagation of the holographic image. Remember that you're trying to achieve the intersection of your head and two relatively small regions of acoustical interference. Special pains taken in positioning — at least at first — will not go unrewarded.





The Soundsheet record has been especially recorded in sonic holography and will play back on a normal, conventional stereo system to produce the full sonic hologram sound image. To set up your system for sonic holography, follow these step-by-step instructions. You will first need to obtain a steel tape measure, length of nonstretchable rope or speaker wire for measuring distance, and a temporary listening chair that may be easily moved about. Inspect Fig. B1, which represents a top view of a room, two stereo speakers, and a listening chair. The first step is to temporarily move your loudspeakers out and

away from all walls and reflecting surfaces, as shown in the diagram. Next, space the speakers relatively close together (three to five feet, center to center, is good). Using the nonstretchable wire, rope or tape measure, carefully measure the distance from the left speaker to the center of the listening chair. Repeat the measurement for the right speaker, and make both distances (d_1 and d_2) exactly the same. Accuracy to within $\frac{1}{8}$ inch is desired; the actual distance themselves are not too critical as long as d_1 and d_2 are equal.

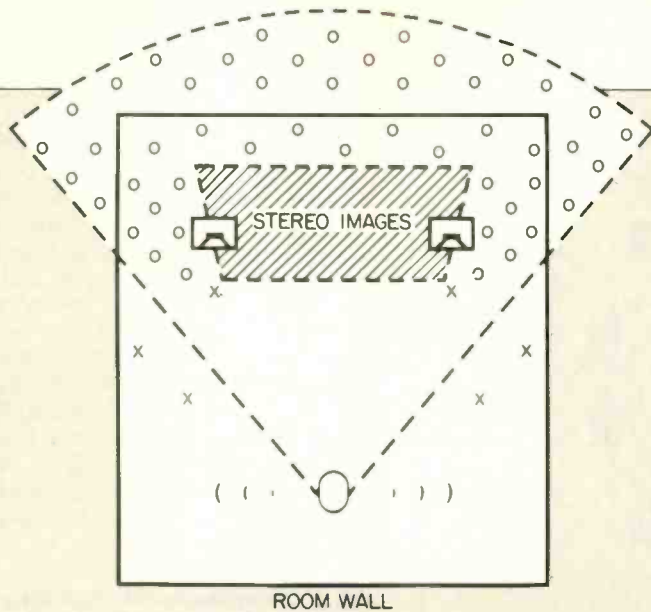
The Soundsheet record is too flexible to be supported by a ribbed or contoured turntable mat, so support it with a conventional LP. Play the record, and listen for the following: (1) A performance extending in an arc in front of you, with a spread ranging from 45° to 90° ; (2) sound images that normally spread beyond the boundaries of the left and right speakers, and occasionally turn up at full-left and full-right positions, but without instabilities or elusiveness; (3) an augmented sense of front-to-back depth, with sound images occurring well behind the speaker plane and occasionally in front of it, and (4) a palpable spatial dimension and clarity to the performance, suggestive of flesh-and-blood musicians occupying actual space.

Turning your head or otherwise moving it should not materially affect your perception of the above, so long as you remain seated in the listening chair. Getting up and leaving the chair should diminish the experience to no more than what you're used to from conventional stereo. If you're not certain you're hearing the full holographic effect, or that you notice a drastic diminution of it when you leave the chair, review the accuracy of the chair and speaker positionings and try again.



-  = CONVENTIONAL STEREO IMAGES
-  = PRIMARY IMAGES HEARD WITH HOLOGRAM
-  = REVERBERATION AND AMBIENCE OF CONCERT HALL/STUDIO (HOLOGRAM ONLY)
-  = OCCASIONAL IMAGES HEARD WITH HOLOGRAM

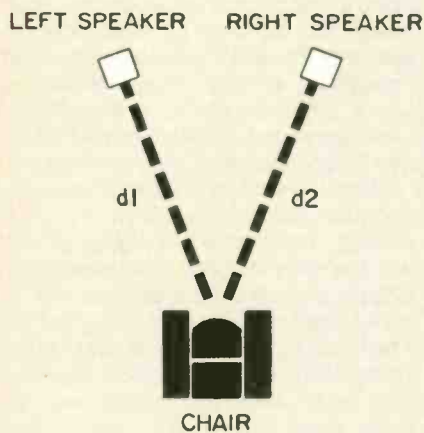

Fig. B1—Setup for sonic holography. Make d_1 and d_2 as close to equal as possible.

Once you've got a "fix" on the holographic experience, begin gingerly inching your speakers back toward their original locations to find out just how far you can go before unacceptable loss occurs. Be sure to keep d_1 and d_2 equal at all times.

One final note. The Soundsheet record is plainly not the sort of vehicle to raise expectations of ultimate sonic excellence, and indeed nothing very spectacular has been attempted or achieved on it. Thus you may find that fidelity limitations require a few mental adjustments on your part before you can appreciate the substance of what you're hearing, but you'll probably be surprised at how few will be necessary.

Sonic Holography in Detail

The block diagram, Fig. B2, shows the basic configuration of the Sonic Hologram Generator, with the various operators indicated. The injection-ratio block is actually switchable between nominal values of -3.5 dB relative to the main signal, which

is the theoretically correct value for the interference signals, and -5 dB, which has occasionally been found subjectively preferable for certain installations and recordings — particularly those employing "manufactured" stereo sound from multitrack masters.

The delay introduced in the crossfeed lines is essentially 125 microseconds, but two designs incorporating the Hologram Generator permit two additional delays of 115 and 95 microseconds to be switched in as well. Working together, the three delays make the position of the ideal "stereo seat" somewhat less critical so as to accommodate other listeners.

The spectral-shaping circuitry has not been mentioned and certainly deserves an explanation. Shaping is performed both on the cancellation-signal channels and on the main channels. The contours employed are shown in Fig. B3. They were determined empirically, but once established they clearly fulfilled certain requirements that might have been predicted beforehand. At least three factors are involved:

Factor One. One of the great flaws of conventional stereo is that signals L and R , and R and L , as well, as shown in Fig. 3, unavoidably interfere at the point where they are listened to, and one inevitable result is a change in perceived spectrum, which becomes different from what is actually embodied in the left and right channels of the recording. Often the recording engineer hears this when he listens to the master tape (in stereo, of course) in the process of mixing it down to final form, and he'll often attempt to "fix" it with equalization. If so, the holographic generator must "unfix" his fix, because sonic holography does not suffer such interference effects and needs no compensation for them.

Factor Two. A number of complex things happen when sound wavelengths shorten to approach the human-head dimension that produces ITDs — things that conventional

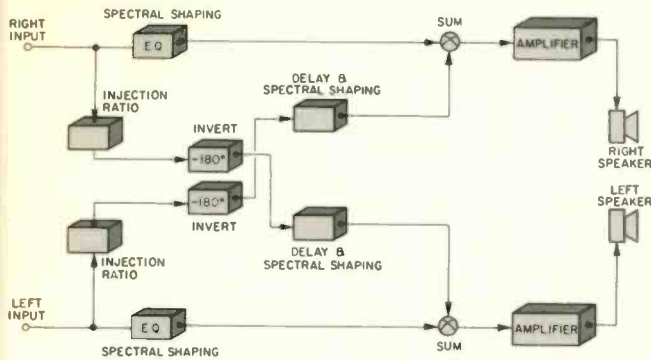
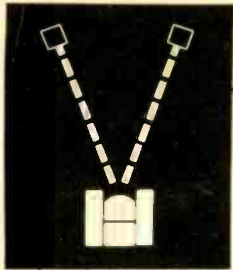

Fig. B2—Basic block diagram of the Sonic Hologram Generator.

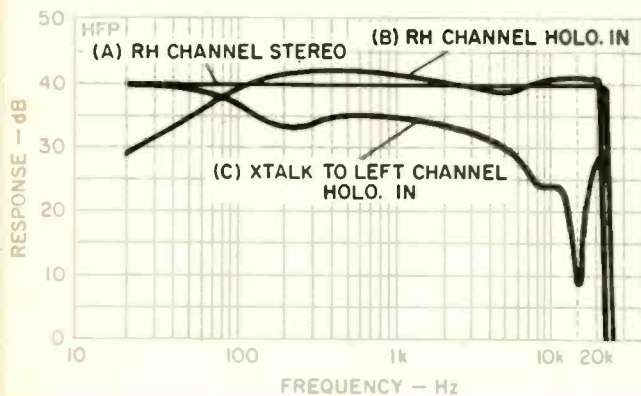

Fig. B3—Frequency shaping in the Hologram Generator: (A) Response in standard stereo, (B) contouring on main channel through Generator, and (C) relative level and contouring on cross-fed signal. Chart recorder causes roll-off above 20 kHz.

stereo has never properly taken into account. First, the L and R_i (and R and L_i) interferences tend to become additive rather than subtractive, and an appreciable peak forms. Second, acoustic shadowing of the far ear by the head starts coming into its own. (You'll remember we underplayed the importance of shadowing in the reverberant-field conditions of an auditorium. However, in the direct field of nearby loudspeakers, shadowing is certain to assume a more significant role.) And third, the ear rises to its point of maximum sensitivity. The chosen contours deal with these matters in combination, in a way that properly corresponds to the spectra generated by real-life ("nonphantom") sound sources.

Factor Three. We all know and despair of what happens when deep

bass is reproduced in a home listening room of typical size. The long wavelengths, confined within close room boundaries, set up large-scale interference patterns ("standing waves") with sizable fixed regions of reinforcement and cancellation. Since sonic holography works by controlling interference patterns in the vicinity of the listener at *all* wavelengths, it represents a golden opportunity to attack this problem at its roots. The low-frequency contours chosen for the main and cancellation signals are particularly effective in subduing the speaker-to-rear wall room mode—the most troublesome one in the majority of stereo installations. Note carefully that, despite casual appearances, the contours as shown do actually sum vectorially to flat response.

head around freely without risking serious anomalies. Two listeners cannot occupy the same seat, of course, but even a listener a bit removed from the prime stereo seat will experience some of the benefits, while listeners well removed will experience nothing worse than conventional stereo heard under those conditions.

I call the results of this acoustical mathematics "sonic holography" because of its obvious similarity to the sort of wave interference that creates an optical holographic image. In terms of what is perceived, there are other parallels between the sonic and optical images as well.

Experience of Holography

Those who have heard sonic holography properly presented report an impression of realism and palpability, with a good sense of depth, three-dimensionality and solidity imparted to the performance. Sound localizations occur behind, in front of, and beyond the plane between the two loudspeakers, and seem entirely natural when they do so. The sound becomes dissociated from the listening space, seemingly transported back to its original environment. Bass seems less troubled by room boundaries, and it seems to be spreading itself throughout a much larger volume of space. The experience is beyond the usual stereo but is clearly related to the best that conventional stereo can do.

Here I should anticipate a question that has probably occurred to many readers: Does sonic holography help with the many temporal problems that inevitably are built into the average recording? I don't think it does. They remain intact, just as undesirable as ever, awaiting some other kind of solution. But does that mean sonic holography will not make these undesirable records more listenable? Emphatically not.

It's my impression that many phase or time difficulties encountered in recordings are not fixed disfigurements that persist throughout both sides. Rather, I think they shift around or come and go with a sort of randomness that makes them less than blatantly obtrusive—or if they were blatant, they probably got tidied up a bit in the mix. But the problems that sonic holography aims to cure (and they have both temporal and spectral aspects) are fixed by the geometry of

the home listening situation, and as such can be thought of as extreme and permanent colorations that influence everything coming through the sound system. Alleviating them can only improve the sound of everything that passes through the system, no matter how good or bad it intrinsically is.

Work on sonic holography was begun several years ago because the intent of conventional stereo to dissociate the stereo image from the loudspeakers that were the actual sound sources seemed fundamentally unrealizable. With some recordings, played under some circumstances, you could convince yourself that there was genuine depth, spread and space conveyed by the image and that the loudspeakers were no more propagators of the sound than were the microphones used to pick it up originally. But a certain amount of convincing was always necessary.

Sonic holography grew as a research project when we realized that the underlying theory of stereo reproduction needed amendment if a convincing and consistent sense of space, with integrity, was to take place. The sense of space came fairly easily; there are a number of signal processors now on the market that afford it. But consistency, integrity and credibility were harder to achieve. In the end they could be gotten only with a linear device, behaving in a theoretically correct way, that addresses itself to the several crucial faults in conventional stereo and leaves everything else pretty much alone.

Conventional stereo is a deliberate illusion, and sonic holography is a deliberate illusion. Neither one is a replica of what we experience in the real world. But by all psychoacoustical considerations, I believe sonic holography comes closer to reality and I hope you can appreciate that from the theory. But try listening to it yourself. **A**

Editor's Note: We wish to thank Bob Carver and the Carver Corp. for the technical and financial assistance which made possible the inclusion in this issue of an Eva-Tone Soundsheet demonstrating Sonic Holography. Additional thanks to RealTime Records and the Roger Wagner Chorale for the music "Encore," RT-110, and to Boston Letter-shop for the music "Chords." — E.P.

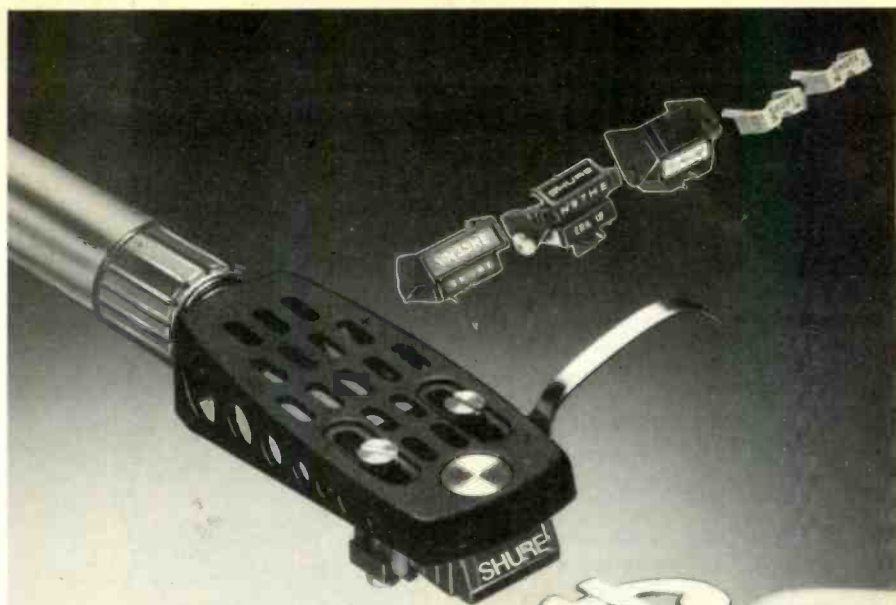

THE ROI* FACTOR

(* Return On Investment)

A small investment can upgrade the sound of your entire hi-fi system.

If you're one of the millions who have bought a Shure V15 Type III, M97 Series, M95 Series, or M75 Series phono cartridge, we have a way of making it perform *better* than it ever has before. It's the Shure Hyperelliptical (HE) upgrade stylus (needle) series. We've taken all the high trackability/low distortion benefits of the HE stylus tip (first introduced on the famous V15 Type IV), and put them into styli that will match perfectly with your cartridge, for an audible improvement in your system's sound at an absolutely minimal cost to you!

Upgrading your phono cartridge with an HE replacement stylus will give a large return on a very small investment. You already own a phono cartridge with proven performance; now you can get even better performance from that same cartridge. Ask your dealer for the Shure HE replacement stylus that's right for you, and take advantage of the ROI factor.

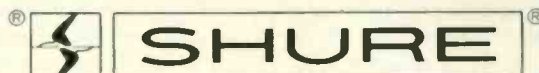

Shure Brothers Inc., 222 Hartrey Ave., Evanston, IL 60204
In Canada: A. C. Simmonds & Sons Limited
Manufacturer of high fidelity components, microphones,
speakers, sound systems and related circuitry.

"The Forum," which appears periodically, gives our readers the chance to share their feelings about specific areas of common interest or concern. Mr. Joel Schwartz, Vice President of Mordaunt-Short, Inc., has some comments regarding the single-brand systems now appearing in the marketplace.

New concepts seem to come in cycles, somewhat like a seven-year plague. Each time they are accompanied by their outriders, hype taking the point, with advertising and promotion guarding the flanks. In the early 1970s it was the "compact system"; in the mid 1970s it was "quadraphonic sound"; a few years back it was the micro-miniature components, and today, the audio enthusiast is being offered the single-brand system. Caveat Emptor — Let The Buyer Beware!

My father used to say that there was no one in this world who served no purpose, that the worst among us could always serve as a bad example. Though it may not be true that the single-brand system represents such an extreme, there are very few benefits in it for the consumer, some benefits perhaps, but the detriments far outweigh them. The only absolute benefit is for the first-time buyer who, for convenience sake, may choose the single-brand system. Rather than having to face an enormous and confusing smorgasbord of componentry, with almost infinite permutations and combinations, the first-time buyer can visit his local department store or discount store and find a single-brand system. The cost of this convenience is high — mediocrity.

If each single-brand system represented the best that the manufacturer had to offer, the concept might work. Unfortunately, this is not the case. When the consumer purchases a single-brand system, he is buying a manufacturer's weaknesses as well as his strengths. Though the manufacturers of one-brand systems would be loath to admit it, they do have weaknesses. Perhaps one manufacturer is better at amplifiers than preamplifiers, another better at turntables than cassette decks, and the next better at cassette decks and turntables and weaker in amplification. The single component that is weak in virtually all one-brand systems is the loudspeaker system.

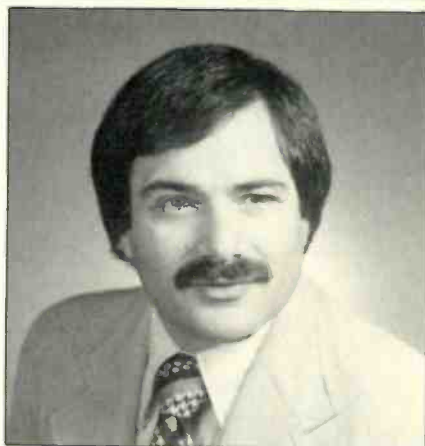

Joel Schwartz, Vice President,
Mordaunt-Short, Inc.

When purchasing a single-brand audio system, the consumer is buying a manufacturer's weaknesses as well as his strengths.

Loudspeakers, where accuracy, musicality, stereo image, ease of listening, dynamic range and value for dollar are to be the end result, should not ever be an afterthought to be quickly included in a single-brand system. The number of independent loudspeaker manufacturers around the world is in the hundreds. Each of these manufacturers has given his undivided attention and the bulk of his effort to the design of loudspeakers that will express his design philosophy about musicality and sound. Since we all readily admit that there is no such thing as "the perfect loudspeaker" and that all designs are one form of compromise or another, the consumer has always been the final judge as to whether the design and the execution of this design through manufacture has been successful. Now we have a number of electronics manufacturers, admittedly good at what they do best, invading another arena for the sake of convenience.

The true audio enthusiast knows better. He has always and will always demand the right to mix and match componentry to get the very best sound and value for his dollar. If this sounds too

pompous, perhaps it is just that the enthusiast has always demanded the right to make his own mistakes in componentry, rather than permit the manufacturer to do that for him. Audio is the most subjective area in the consumer electronics field, and the human ear must be the ultimate judge of what is better and what is only good. If the consumer is satisfied and, over a long period of time, enjoys the sound of the system to which he listens, he has made the correct choice of componentry.

How then, you might ask, can the first-time or uninitiated buyer improve on the convenience offered by the single-brand system? The simplest and most direct way is to upgrade the loudspeakers. If the store will not or cannot accomplish this, he should go to another store, preferably to an audio specialist. How can the first-time or uninitiated buyer determine what is the best sound? It's true that the memory of sound lasts only for seconds, but there is one area of listening that travels well from store to store and is a good and true test of loudspeaker systems — stereo imaging. This dramatic and noticeable acoustic phenomenon can be defined as a field of sound produced by mixing both stereo channels to develop a definite and stable stage-like image. On vocals, the voice will usually appear directly between the two loudspeakers. The accompanying instruments will appear behind, to the left of and to the right of the vocalist, but not directly from either loudspeaker. When the consumer closes his eyes and listens, he should not know where the speakers are. If he can hear and determine where they are, the speakers are getting in the way of the music! The majority of the single-brand systems being offered today will fail this very simple and basic test, but a good loudspeaker system will not.

Seek out the loudspeaker system that offers you the musicality, image, accuracy, listenability, value for dollar and the overall pleasure that you anticipate when you purchase an audio system. Pleasure is what audio is all about. Visit an audio specialist and take the time to audition a system that he recommends, filled with different manufacturers' strengths, not a system filled with both strengths and weaknesses of a single manufacturer. It is well worth the lost convenience of the single-brand system. *A*

HOWARD ROBERSON

NEW CASSETTES TESTED

UPDATE

This article constitutes a follow-up to the survey in the September 1981 issue of *Audio*, and covers a total of 14 formulations: Five Type I or ferric, four Type II or chrome bias, one Type III or ferrichrome, and four Type IV or metal particle. Loran's Normal/Ferric was covered in the earlier report, but improvements made in this tape since then required a second look. Sony introduced a new formulation, UCX-S, in early December, and the additions were updated versions of Denon DX1, DX3, DX5, DX7, and DXM, Scotch Master I and II, and Metafine, and TDK AD, SA-X, MA and MA-R. It should be noted that all formulations showed worthwhile improvements since their last review.

I ran the same collection of tests as for the September article: Swept frequency responses at Dolby level and 20 dB below that, maximum record levels (MRLs) at 100, 400, 1k and 2k Hz using limits determined by third-harmonic distortion = 3%, MRLs at higher frequencies using limits determined by twin-tone intermodulation (TTIM) distortion = 3%, a check on the loss in level at 15 kHz with 10 replays, the signal-to-noise ratio (without Dolby NR) with reference to the 3% distortion point at 400 Hz, the modulation noise with a 1-kHz test tone, bias, sensitivity, output-level stability, dropouts, flutter, skew and consistency. In the past, I have stated that results on my Nakamichi 582 test deck seemed to be confirmed in a relative sense on other decks. In this test cycle, I ran extensive comparisons on the MRL figures for all tapes both on the 582 and on an Aiwa AD-3600. I also included a brief look at the stability of HDL₃ with a recently

received deck. This unit had shown great variations in the distortion level from moment to moment at the same time that the fundamental was stable.

In reviewing the results from the earlier survey, it was obvious that many of the -20 dB responses were almost exactly the same. This was particularly true for the Type I and Type IV tapes. A simple experiment was devised: The Nakamichi deck was adjusted for best performance with each tape using the built-in 15-kHz tone, and then pink noise was recorded and played back. The pink-noise playback was fed to a one-third octave real-time analyzer (RTA) and a storage scope (Fig. 1). The top-most display includes the responses of all Type I tapes covered in this report, plus two others run as a check. All responses were well within ± 1 dB of each other. The greater spreading in the low end is partly from the characteristics of the noise and the RTA. With this result, the decision was made not to include responses at -20 dB, since they were all the same as long as bias was set correctly for best response.

The results with the Type II tapes (second from top) were not as consistent. Denon DX7 and TDK SA-X were exact matches, with the flattest (middle) response at 5 kHz, but curving up the most at 20 kHz. The response with Scotch Master II was slightly elevated at 5 kHz (top) and fell to zero at 20 kHz. The -20 dB responses were run for all Type IIs, with the exception of DX7 which had matched SA-X so closely. The Type III results were not an exact match (third from top), and those responses were run in each case.

The matching from one tape to the other was very close for the Type IV tapes (bottom display). The total spread was mostly the result of the statistics of the pink noise, except for a little spreading at the highest frequencies. There were no -20 dB responses plotted for this tape type. The conclusion was that the record/playback response would be as flat as adjustments to the recorder would make it. There are plots of the Dolby-level responses for all of the formulations, and the maximum record levels (MRLs) are plotted over them. The MRLs are listed in the table which also includes the test results, including the high-end -3 dB points for both Dolby level and -20 dB. Now, let us take a look at the results with each tape with reference to the table and the response and MRL plots.

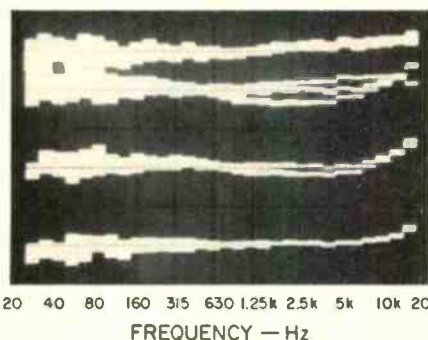
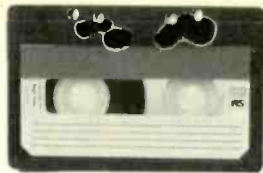

Fig. 1—Top, Type I tape responses. Second, Type II tape responses. Third, Type III tape responses. Bottom, Type IV tape responses. See text for discussion. (Vertical scale: 5 dB/div.)



TYPE I

Denon DX1: This formulation had very good MRLs, little or no skew, and was very consistent among all C-90 and C-60 samples. The modulation noise was very low, the output level was quite stable, and nothing appeared in the analyzer scans that could be classified as a detectable dropout. Overall, this is a well-performing tape.

Denon DX3: As the results show, this is very much like DX1 in most respects, but the lower frequency MRLs are higher, and that does have value. The noise level was slightly lower, but there was slightly more skew. In general, one of the better Type I tapes.

Loran Normal/Ferric: One of the more obvious changes from the earlier samples was the improvement in consistency with steady output and no skew in any of the C-90 or C-60 samples. There was some increase in the low-frequency MRLs — always welcome, as was the sizable reduction in modulation noise. Overall, one of the better Type I tapes.

Scotch Master I: This formulation delivered the highest low-frequency MRLs and the lowest modulation noise in this group, along with excellent consistency and substantially no skew. The output level was quite stable, and there were no dropouts even close to the detection threshold. This is one of the best Type I tapes.

TDK AD: The measured MRLs were very good, the modulation noise was low,

and the signal-to-noise ratio matched the best ever measured for a Type I tape. There was just the slightest skew at times, with excellent consistency, in general. The output level was very stable, and there was little that could be called any sort of dropout — one of the best of all tapes in these respects. In toto, one of the best Type I tapes.

TYPE II

Denon DX7: The -20 dB response with this Denon tape was excellent, but the Dolby-level response, however, shows limited headroom, which is further indicated with the low MRLs. There was excellent consistency among all of the samples, both C-90 and C-60, and there was no measurable skew. The output level was stable most of the time, but there were occasional variations of over a dB. Overall, a typical Type II tape.

Scotch Master II: This latest version from Scotch provided high MRLs and low noise with very good output-level stability. A few dropouts appeared in the analyzer scan, but none of them approached the threshold of audibility. Consistency was very good, and there was very little skew. The -3 dB point at -20 dB was not as far out as some of the other tapes because of its particular response shape. Altogether, one of the best Type II tapes.

Sony UCX-S: Samples of this latest offering from Sony were received just in time to meet the test deadline for this

survey. The results were excellent, as shown in Table I, with very high MRLs, low modulation noise, and high signal-to-noise ratio. The frequency responses were quite similar to Scotch Master II, as shown in the response plots. There was no skew observed with any of the UCX-S samples. The output level (at 3 kHz) was very steady, and there were no dropouts. This new entry, in my opinion, is one of the best of all Type II tapes.

TDK SA-X: With very high MRLs, excellent responses, an excellent signal-to-noise ratio, and low modulation noise, this formulation performed at the top of its group. Consistency was excellent with no skew and very smooth output, stable within less than 0.3 dB. This is certainly one of the best of all Type II tapes, perhaps the best.

TYPE III

Denon DX5: This formulation is not that of a typical FeCr, being a dual-layer ferric, and the excellent -20 dB response shows the advantage of this approach. There was some low-end to high-end droop, but much less than with most FeCr and some CrO₂ tapes. The MRLs were quite good, and the noise was low. The results were very consistent, although there was some skew. The output stability was very good, and there were no dropouts. In summary, this formulation shows some high-level headroom limitations, but, in other respects, it is a match for most Type II tapes.

TEST RESULTS

BRAND	DESIGNATION	TYPE	MAXIMUM RECORD LEVEL												
			RESPONSE AT -3 dB (kHz)		dB re 400-Hz Dolby Level				15-kHz			S/N	MOD	BIAS	SENS
			0 dB Level	-20 dB Level	HDL ₃ = 3%				TTIM=3% 10-PLAY						
Denon	DX1	I	10.4	23.1	+3.5	+5.2	+6.8	+5.6	-1.8	-8.6	-1.0	55.2	-49.8	-0.2	+1.1
Denon	DX3	I	10.2	23.6	+5.0	+6.3	+7.1	+4.8	-1.9	-8.7	-0.5	55.3	-50.4	+0.3	+1.2
Loran	Normal/Ferric	I	10.5	24.0	+4.6	+5.8	+6.9	+5.4	-1.8	-8.7	-1.2	56.4	-48.8	+0.1	+0.7
Scotch	Master I	I	10.8	25.4	+7.5	+8.0	+7.8	+4.6	-1.4	-8.0	-1.8	57.2	-53.2	-0.1	+2.0
TDK	AD	I	10.7	23.7	+5.0	+6.2	+6.8	+4.2	-1.3	-7.8	-1.0	58.6	-49.3	+0.8	+0.3
Denon	DX7	II	8.4	25.9	+1.3	+2.6	+2.0	0.0	-6.5	-10.5	0.0	55.4	-49.2	-0.4	-0.2
Scotch	Master II	II	10.5	21.6	+5.3	+6.5	+6.5	+3.5	-5.7	-10.7	-0.3	59.7	-52.9	+0.5	+2.0
Sony	UCX-S	II	10.5	23.8	+6.7	+8.0	+8.5	+4.9	-4.0	-9.5	0.0	60.5	-51.8	+0.8	+2.1
TDK	SA-X	II	11.2	25.6	+6.3	+7.9	+8.7	+5.4	-4.5	-9.5	0.0	60.9	-51.3	+1.8	+3.1
Denon	DX5	III	7.8	24.2	+4.2	+6.2	+5.7	+1.8	-6.3	-11.7	0.0	60.1	-48.8	+2.0	+0.8
Denon	DXM	IV	13.0	25.8	+7.3	+8.9	+8.9	+5.3	-0.6	-5.0	0.0	61.2	-49.8	+4.6	+0.7
Scotch	Metafine	IV	13.2	24.6	+7.3	+8.9	+9.8	+6.2	0.0	-4.4	0.0	62.6	-51.2	+4.0	+1.0
TDK	MA	IV	13.4	26.1	+7.7	+9.7	+9.9	+5.8	+0.4	-5.1	0.0	60.9	-52.4	+4.2	+0.4
TDK	MA-R	IV	13.5	25.9	+8.2	+10.2	+11.2	+6.5	+0.7	-4.6	0.0	60.8	-54.3	+4.9	+0.8

Here's how we kiss the hiss goodbye.

BASF Chrome. The world's quietest tape.

With BASF Chrome, you hear only what you want to hear — because we "kissed the hiss goodbye."

In fact, among all high bias tapes on the market today, only PRO II combines the world's lowest background noise with outstanding sensitivity in the critical high frequency range for superior dynamic range (signal-to-noise ratio).

PRO II is unlike any other tape because it's made like no other tape.

While ordinary high bias tapes are

Magnified
15,000 X

Perfectly shaped and uniformly sized particles of pure chromium dioxide provide a magnetic medium like no other tape in the world.

made from modified particles of ferric oxide, only PRO II is made of pure chromium dioxide. These perfectly shaped and uniformly sized particles provide a magnetic medium that's truly superior — so superior that PRO II was chosen by Mobile Fidelity Sound Lab for their Original Master Recording™ High Fidelity Cassettes — the finest prerecorded cassettes in the world.

PRO II — a tape so superior, a cassette so reliable, that it was the one chosen by Mobile Fidelity Sound Lab for their Original Master Recording™ High Fidelity Cassettes.

For the best recordings you'll ever make.



BASF

Audio/Video Tapes

And like all BASF tapes, PRO II comes encased in our new ultra-precision cassette shell that provides perfect alignment, smooth, even



BASF designed and developed the world's only Measurement Reference Tape Cassette. And our new ultra-precision cassette shell is the logical culmination of that development.

tape movement, and consistent high fidelity reproduction.

So when you want to hear all of the music and none of the tape, turn on to BASF Chrome. It's the one tape that kissed the hiss goodbye.



Enter No. 4 on Reader Service Card

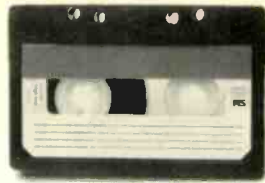

TYPE IV

Denon DXM: This metal-particle tape showed the typical type characteristics of high MRLs, extended responses, and low noise along with excellent consistency. There was no skew among any of the C-90 or C-60 samples, and the output-level stability was outstanding with no dropouts. Denon DXM is a typical, good Type IV tape.

Scotch Metafine: It had been some time since the last testing of this pioneer metal-particle tape, and there have been a number of improvements. The MRLs were good and high across the band, the S/N ratio was among the best measured to date, and the modulation noise was low. The results were very consistent with substantially no skew, and with a stable and smooth output level, with no dropouts approaching the audibility threshold. Scotch Metafine takes its place as one of the better Type IV tapes.

TDK MA: With its high MRLs, excellent responses and low noise, this formulation demonstrated the appeal of the metal-particle tapes. Consistency was the rule, with just the slightest skew in a few cases. The output level was very steady, with infrequent dropouts only halfway to the audibility threshold. In toto, a very good Type IV tape.

TDK MA-R: For those who might be confused, let it be stated immediately that MA-R has a slightly different formulation from MA. The major difference was that the MRLs were at least 0.5 dB higher, in general, and the modulation noise was also somewhat lower. The results were very consistent with substantially no skew. The output-level stability was very good, with perhaps 0.3 dB wander at most. There were just occasional dropouts that approached the audibility threshold. Add it all up: This is one of the best Type IV formulations.

CONCLUSION

With the improvements in all formulations, there may be some basis for reconsideration of the trade-offs involved. For example, using 70- μ S EQ with a Type I tape will reduce noise at the expense of headroom, and using 120- μ S EQ with a Type II tape will improve the headroom but bring up the noise level. Here's another way to look at it: The ratio between the level for 3% distortion and the noise at any one frequency will remain the same, whatever the EQ.

With Dolby C on the scene and more decks appearing with dbx II systems, there may be more of a basis for the user to experiment with both Type I and Type II tapes and trying "the other" equalization. With either tape, it's 120 μ S for better headroom or 70 μ S for lower noise. There is no doubt, however, that the best results come from metal tape and a well-designed deck. 

TAPE RESPONSES

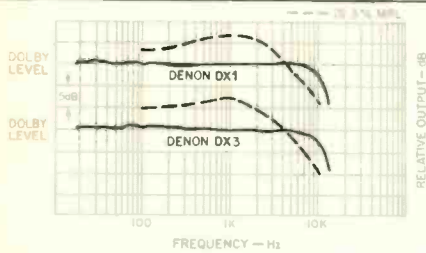

DENON DX1 (TOP) AND DX3

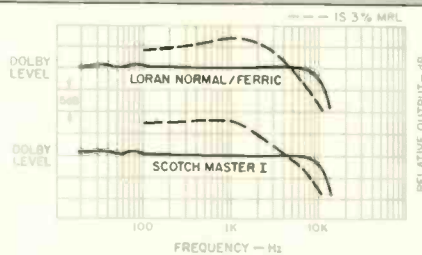

LORAN NORMAL/FERRIC (TOP) AND SCOTCH MASTER I

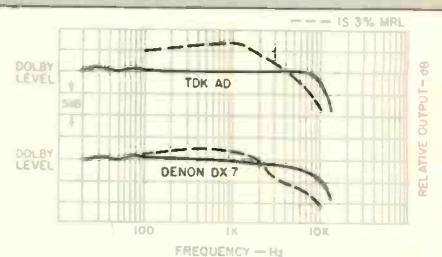

TDK AD (TOP) AND DENON DX7

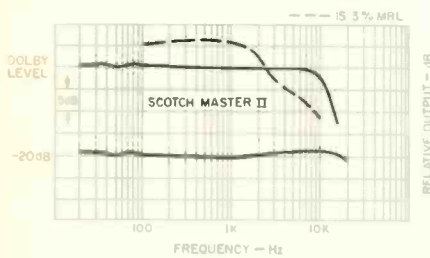

SCOTCH MASTER II

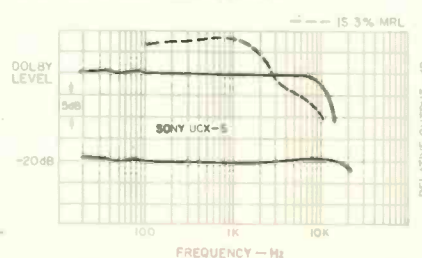

SONY UCX-S

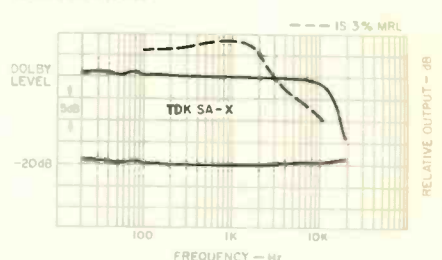

TDK SA-X

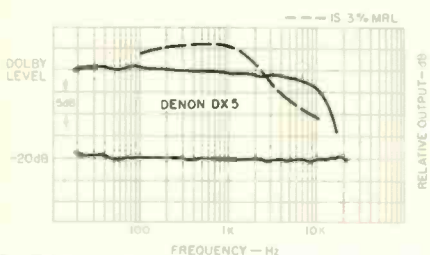

DENON DX5

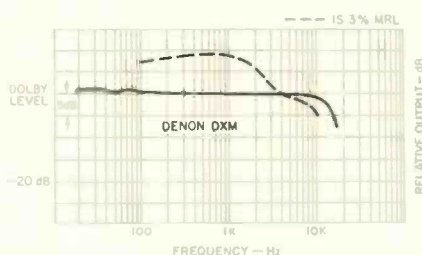

DENON DXM

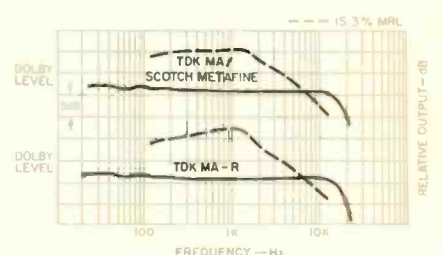

SCOTCH METAFINE, TDK MA & MA-R



MERIDIAN TAKES HIGH FIDELITY BEYOND THE MUNDANE

Meridian is a unique line of audio components produced by Boothroyd Stuart Limited of London, one of the most prestigious design teams in the world. Now in America, Meridian signals the arrival of a new, beautiful and unconventional approach to high-fidelity.

Meridian products are designed to create an utterly believable musical experience in your home. Meridian's quest for excellence, demands engineering of the utmost sophistication, but excessive complexity of no redeeming benefit to the user is carefully avoided. Meridian form is always dictated by function, and yet, the components never fail to blend gracefully into the most tasteful home settings. Above all, Meridian products represent exceptional value and deliver performance which, in many respects, is unsurpassed at any price.

Meridian electronic components are distinguished by their appealing visual design, absolutely state-of-the-art performance, and

unique modular configuration. The modular design provides unusual update capability and maximum system flexibility.

Meridian InterActive Loudspeakers reflect the world's most sophisticated active loudspeaker technology and embrace some of the most crucial elements of human psychoacoustics. Each loudspeaker includes two built-in power amplifiers and special time delay circuitry which ensures coherent arrival of bass and treble information. Despite their compact, elegant proportions, Meridian InterActive Loudspeaker systems can produce substantial deep bass energy. Their slimline styling actually helps improve dispersion and enables them to reproduce music with astonishing multi-dimensional clarity and detail.

Meridian products have received rave reviews from hard-to-impress audio critics around the world. Find out why. Write for more information, review reprints, and the name of the authorized Meridian dealer nearest you.

MERIDIAN AUDIO OF AMERICA

Dept. AU-182, P. O. Box 653, Buffalo, NY 14240

Models shown: Preamp/Control Unit 101, FM Tuner 104, InterActive Loudspeaker M2

HOW PHONO CARTRIDGES WORK

PETER MILTON

The arguments over the relative merits of moving-coil cartridges versus those with fixed coils has been going on, I suspect, since Alan Blumlein developed the moving coil principle in the 1920s. There has always been a mystique associated with the delicate art of making a moving-coil cartridge, and the higher cost of production has normally led to the conclusion that the quality of the product is higher.

This may have been true when the audiophile had a choice limited to the standard groove-gougers and a custom-made product from a hobbyist-turned-manufacturer, but times have changed; high price and high precision are no longer the sole domain of the moving coil. But legends persist, and most of the moving coil's glamor remains. There are those whose flat statements lead me to believe that they would prefer a \$100 moving coil to a \$500 moving magnet on principle, but it is a rare listener who can hear the difference consistently under controlled conditions. It is time, perhaps, to re-examine our Articles of Faith and try to see what the basis is of the fabled moving-coil sound.

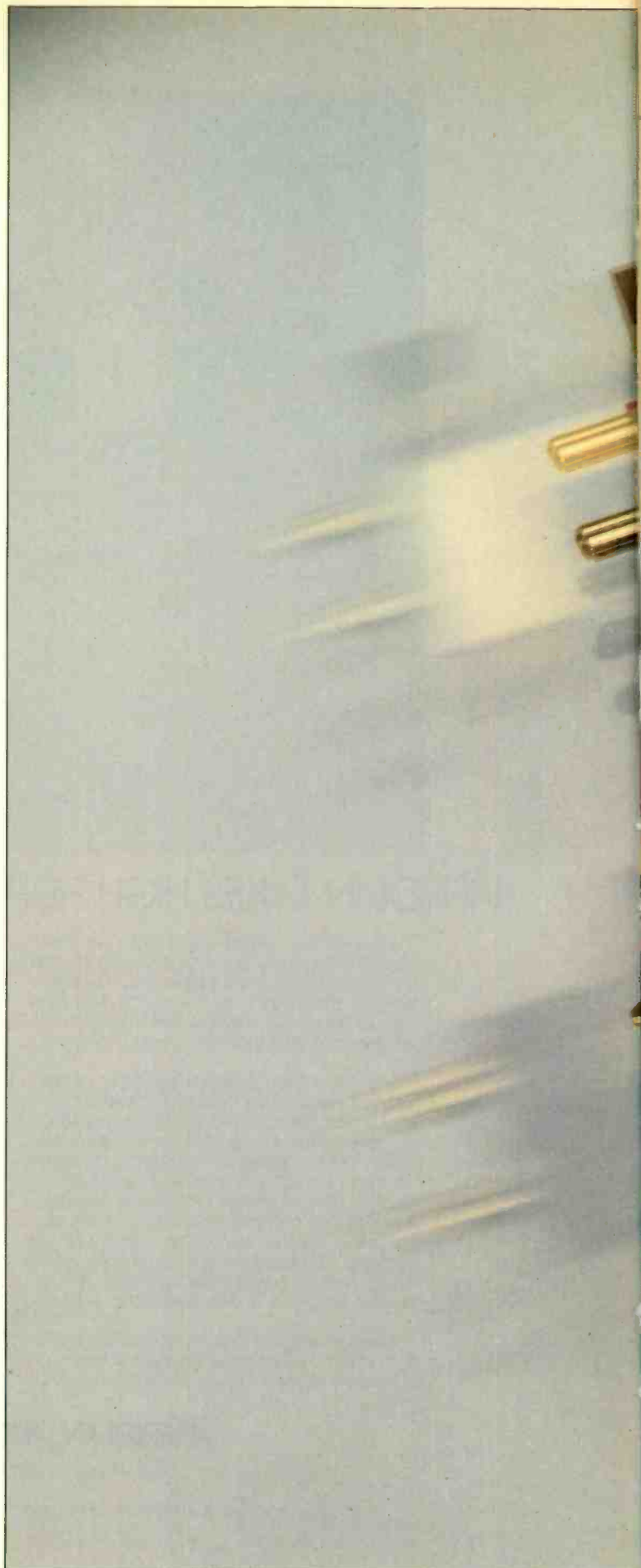

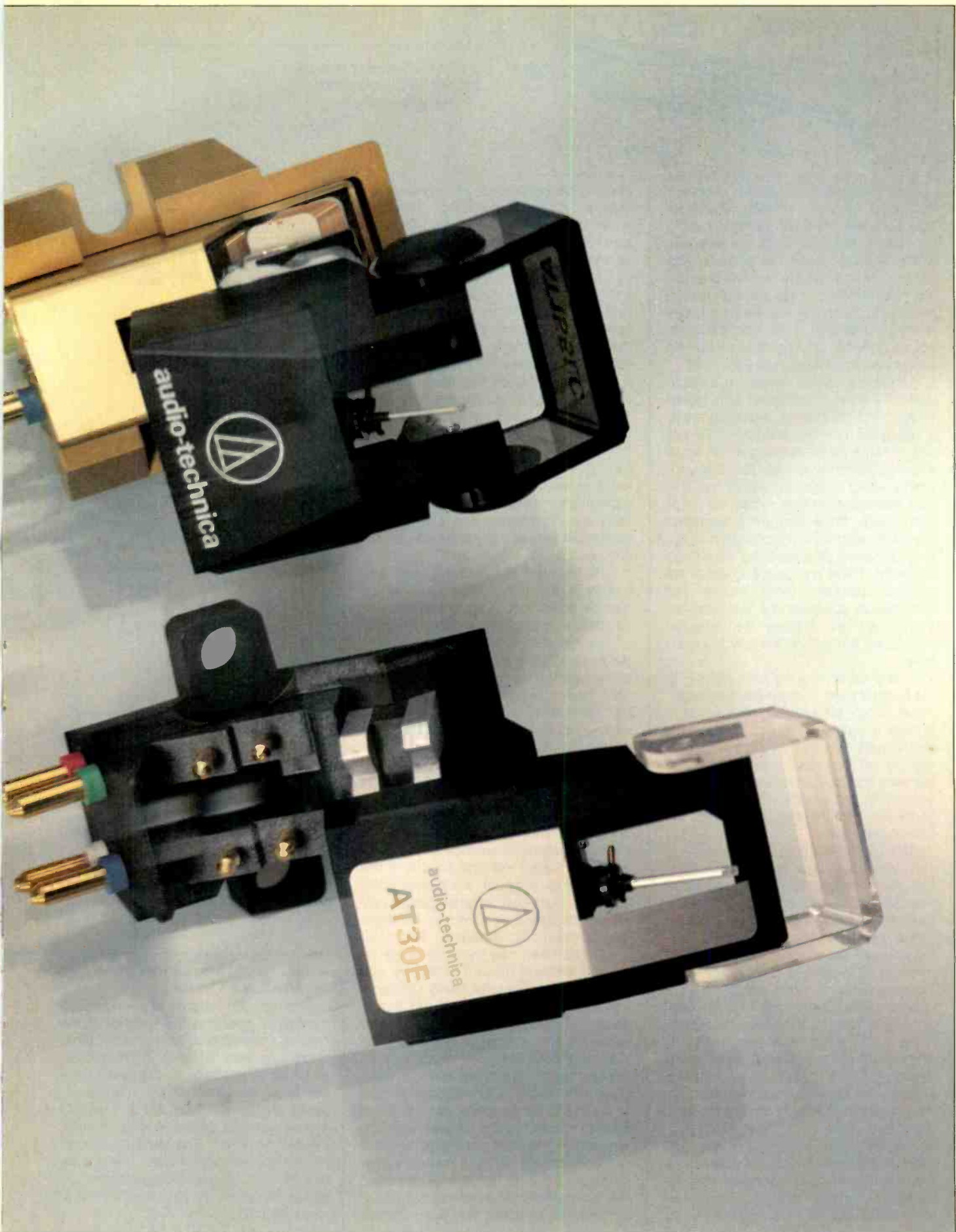

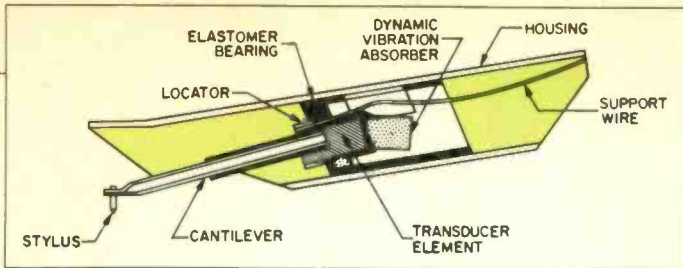

Fig. 1 — Cut-away view of the V-15 Type IV cartridge, courtesy Shure Bros.

During my research I spoke to several respected phono cartridge engineers about the practices and politics of pick-up design, attended long listening sessions, and discussed the problem with others, like me, whose reviewing activities have forced them to pronounce, in a few hours, on the patient results of years of skilled research. (The words I quote are as accurate and as near to context as possible, but the opinions are mine.)

I am often asked, usually at a party, when my mind is occupied with higher things, "Which is better, a moving-coil or a magnetic phono cartridge?" This is typical of the woolly thinking which tends to surround the topic. I am asked to generalize about a product which has brilliant examples of both types, which is bad enough, but evidently my questioner seems to regard the principle of moving-coil cartridges as something other than magnetic. There is a parallel question regarding speakers which implies that electrostatic speakers are nondynamic. Sometimes, by defining the question clearly, we are well on the way to an answer.

In any case, moving coils belong to the general class of magnetic cartridges. Three things are required: A magnet to provide a suitable magnetic field, a system of coils in which an electrical signal can be induced, and finally a stylus to translate the undulations of the groove walls into movement. The way these items are tied together determines the type of cartridge.

The moving-magnet design forms a very large subclass, and its simplicity has made it very popular. In essence, a tiny magnet is attached to the end of the cantilever which is pivoted in a ring of rubber or plastic fitted around the cantilever near the magnet. Usually a restraining or locating wire holds the cantilever assembly in place and defines the location of the pivot point. A good example of this type of construction is found in Shure's V15 Type IV, shown in Fig. 1, and Fig. 2A is a simplified diagram of the system. A soft iron core, passing through the coils, is shaped to form an air gap which intercepts the flux from the magnet.

The early moving magnets, such as those introduced by Elac, were relatively massive affairs, with magnets nearly a quarter of an inch long. The sensitivity was adequate, but the high-frequency

tracking performance was very poor by today's standards. Research into new materials for magnets and into stylus design has led to a progressive reduction in tip mass and magnet size. The shape has also changed from the square section bar magnet to the minute disc used by Technics and to the dual magnet system of Audio-Technica (Fig. 3). The idea behind the variations on the theme is to reduce the moment of inertia of the moving parts, and hence the mass reflected at the stylus tip, to an absolute minimum. The approach used by Audio-Technica is to cause the magnet associated with the unused channel to rotate about its own axis. This minimizes the effective mass of the unused channel, and since a bar magnet which rotates about its axis produces no effective flux change, the separation between channels can be improved.

The broadest group of magnetic cartridges is the moving-iron type, which can be subdivided into two categories, variable reluctance and induced magnet.

The variable-reluctance types place the magnet in the iron-core system of the pickup coils; thus there is always a magnetic flux across the air gap. The stylus bar terminates in a hollow iron tube which moves inside the magnetic gap. As the iron moves from the central position, the magnetic reluctance in the gap changes and the flux linking the coils is changed (Fig. 4).

The straightforward variable-reluctance principle carries with it the disadvantage that the reluctance in the magnetic gap varies with the square of the gap spacing. Although the system is virtually a push-pull arrangement, very careful design is required to minimize second harmonic distortion. The challenge has been met by what could be called a series of Elegant Variations, one of the most successful being Ortofon's Variable Magnetic Shunt (Fig. 5). In this design a ring magnet surrounds the iron armature at the end of the cantilever. The magnetic field does not go across the gap as in the normal variable-reluctance type, but runs fore and aft, parallel to the axis of the structure, in a doughnut shape surrounding the magnet. The iron armature is therefore parallel to the lines of magnetic flux. As the armature moves closer to the inner surface of the magnet, a progressively greater proportion of the lines of magnetic flux are shunted,

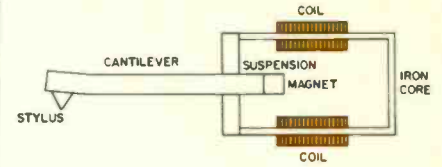

Fig. 2A — Simplified drawing of a moving-magnet type phono cartridge. (After Ortofon's "Everything You Need to Know About Cartridges.")

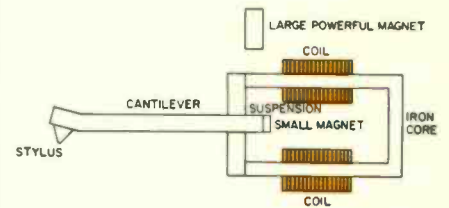

Fig. 2B — Simplified drawing of an induced-magnet cartridge. (After Ortofon.)

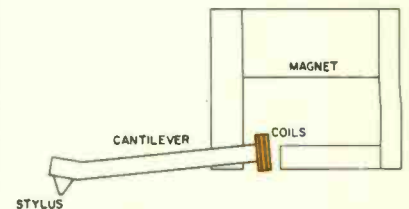

Fig. 2C — Simplified drawing of a moving-coil cartridge. (After Ortofon.)

which changes the flux linking the coils and produces an output.

The induced magnet is an ingenious method of obtaining the linearity of the moving magnet and, at the same time, dispensing with its mass. A hollow iron armature is attached to the end of the cantilever and an external magnet induces a magnetic field into it. The field moves with the cantilever and, in turn, induces an e.m.f. into the coils wound around the soft iron poles. The advantage here is that the magnetic circuit operates effectively at zero flux for maximum linearity.



Fig. 3A — Audio-Technica's dual magnet system shown in a moving-magnet cartridge, AT155LC.

Photo: Susanne Buckler

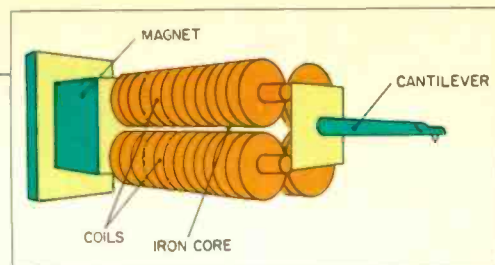

Fig 3B — Audio-Technica's dual magnet stylus assembly.

A popular example of the induced-magnet design is illustrated in Fig. 6, showing Empire's construction. The importance of zero flux in the magnetic cores is emphasized in this design, which has an exclusive method for eliminating the residual flux, as does the Sonus.

Moving-coil cartridges are almost as diverse in construction as fixed-coil cartridges. In all cases the coils are rigidly attached to the stylus bar, which usually makes it necessary to return the complete cartridge to the manufacturer when the tip needs replacement. Two exam-

Fig. 4 — Simplified drawing of a variable-reluctance cartridge. (After Osawa's "A Consumer Guide to Phono Cartridges.")



ples will serve to illustrate the construction of a moving-coil cartridge. Figure 7 shows the Ortofon MC-20. The cantilever projects through one pole of the magnetic structure so that the lines of flux are parallel to it. The pivot point is just behind the pickup coils, which are wound on a flat square former. Movement in one channel causes one pair of coils to rock, which allows the flux to cut the turns and produce an output. The coils associated with the other channel twist around their central axis, which produces no output.

Technics uses an entirely different form of construction. The coils operate in completely separate magnetic gaps and are attached to a driving yoke so that the front view has a strong resemblance to Mickey Mouse. The magnetic field is radial, but operates over half the area of the coil so that the output is not cancelled. The inoperative channel twists around its diameter so that there is no output.

Each of the designs described has been the basis of a successful and highly respected line of cartridges. However, we have not touched on the other important features — damping, stylus construction and material, tip shape and mounting — because the point at issue is the relative merits of the moving coil versus The Rest. But let us redefine the question: Which fixed-coil is better than which moving-coil cartridge and under what circumstances? If we do not consider this, then the inescapable conclusion is that one or the other type is intrinsically better. The question was asked in a different way of James Kogan, President of Shure Brothers: Why does he favor the moving-magnet design? His reply brought in another factor. "We have thought about the moving-magnet and moving-coil approaches very carefully; we are quite capable of making a superb moving-coil cartridge. There are trade-offs to be made in both designs. We have evaluated most of the cartridges of the opposition, and we feel that the moving-magnet cartridge gives a better balance between price and performance." He then added the intriguing comment, "Of course, that does not rule out a moving coil in the future." The real progress, he felt, will be in refinements of technology rather than in a particular method of generating the output. The trade-off known as cost effectiveness is

also a factor which we should consider, and if this is to be the criterion, then the traditional moving coil is inferior.

If the moving coil were better technically, then we could smugly explain the presence of the fixed-magnet types on the grounds of cost alone. However, brilliant and marginal performers are found in both categories, so the cost criterion is unacceptable. But, this does give rise to a new form of the same question.

During the November 1981 AES Convention in New York, I asked the cartridge designers: "If you were starting from scratch with an unlimited budget, what form would your cartridge take?" No clear-cut preferences were expressed. The area of cartridge design is so confined with patents that it is most likely that the designer would tend to work along lines already established by his own company.

Fig. 5 — Simplified drawing of Ortofon's Variable Magnetic Shunt principle. (After Ortofon.)

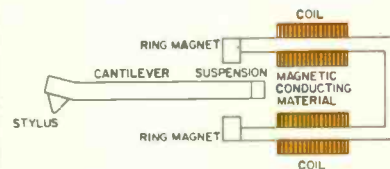

Are there no inventors out there? Well there are, but the commercial world is competitive and nobody likes to tip his hand.

By what criteria do we judge the cartridges? Ortofon's Frits Nygaard rates the moving coil superior on the grounds of lower moving mass and improved phase response. The moving coil also has a better rise-time and its lower source impedance makes it less susceptible to amplifier interface problems.

This prompts a few specification problems. One important factor is tip mass, which is normally automatically assumed to be lower in a moving coil by reason of the ultra-miniature construction. Lower moving mass can only be taken to mean the effective mass as "seen" at the stylus tip, which is not necessarily the mass of the actual tip. The effective mass comprises the total mass of the moving parts — tip, cantilever, and generator reflected through the lever action of the stylus arm and pi-

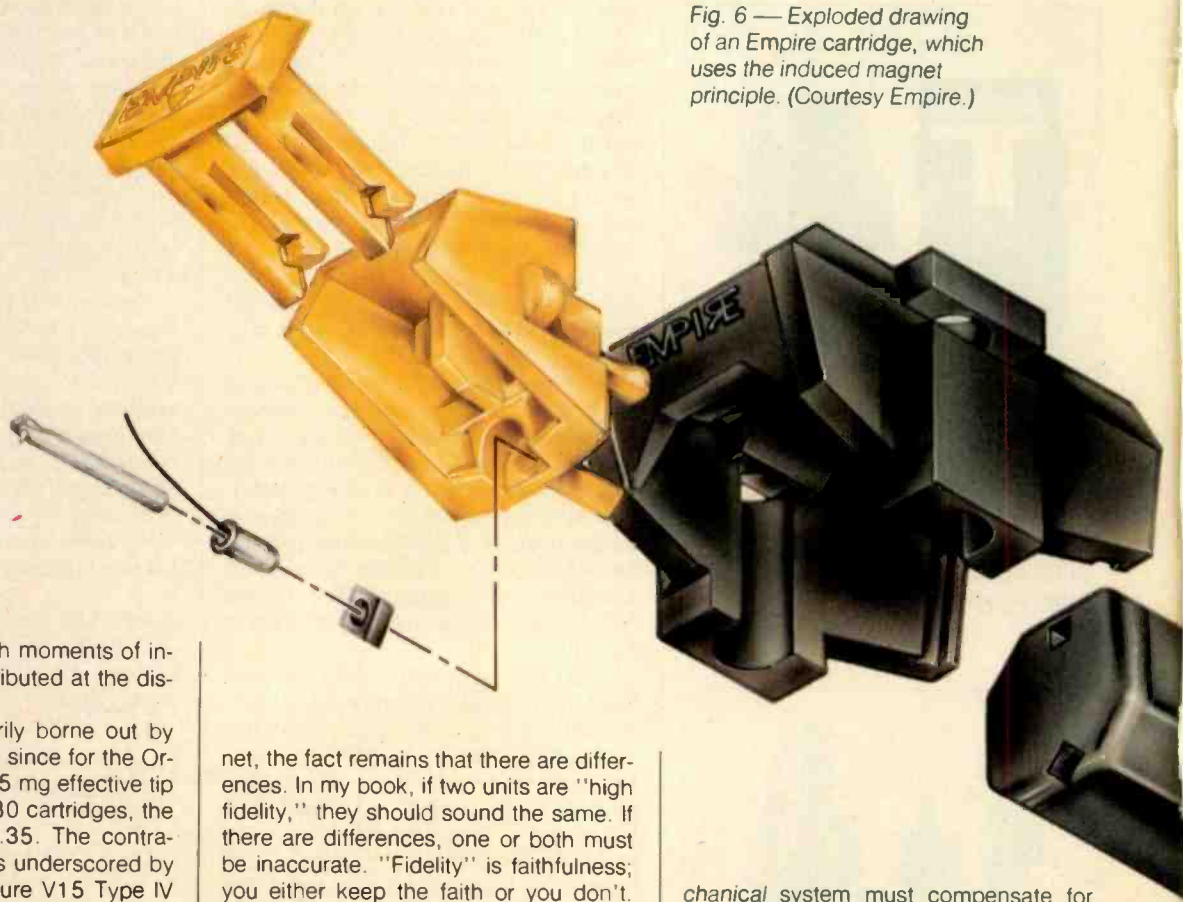

Fig. 6 — Exploded drawing of an Empire cartridge, which uses the induced magnet principle. (Courtesy Empire.)

vot. We are dealing with moments of inertia which can be distributed at the discretion of the designer.

This is not necessarily borne out by the published literature, since for the Ortofon MC-20 we find 0.5 mg effective tip mass and for their LM-30 cartridges, the effective tip mass is 0.35. The contradictory state of affairs is underscored by the 0.33 mg of the Shure V15 Type IV compared to, say, the 0.3 mg of the Technics EPS-305MC. To be fair to both camps, the 0.6 mg of Empire's 600LAC should be mentioned.

It is clear that effective tip mass alone does not account for the differences between the two methods of construction. Identical frequency responses can be obtained with a wide range of tip mass, since it is possible to juggle the effective stiffness of the record surface by changing the contact area.

However, under normal circumstances, the difference between a moving-coil and a fixed-coil cartridge can be heard. On occasion one is substituted for the other in order to achieve an acceptable sound in a hostile listening environment. For instance, when faced with a "hot" hotel room, no time to modify the acoustics, and a preamp with an inflexible high-frequency roll-off, a smart demonstrator will substitute a moving magnet for a moving coil. Whether you favor the "airy" ambience of a moving coil or the less spectacular moving mag-

net, the fact remains that there are differences. In my book, if two units are "high fidelity," they should sound the same. If there are differences, one or both must be inaccurate. "Fidelity" is faithfulness; you either keep the faith or you don't. Unfortunately, "high" fidelity implies different heights of excellence.

If cartridges having the same tip mass, or nearly so, can have different tonality, then we are left with phase response and frequency response.

Arnold Schwartz, President of Micro-Acoustics, in the March 1981 issue of *Audio*, indicated one possible cause of the differences in sound when discussing the cartridge output network. In his laboratories, he demonstrates the experimental setup which simulates the effect of the pickup coils, the amplifier input resistance, and the cable capacitance on the electrical frequency response of the cartridge. These elements form a low-pass filter for each type of cartridge. The higher relative resistance for the moving coil, coupled with its lower source impedance, renders it less susceptible to the effects of cable capacitance and gives it a more gentle roll-off than the fixed-coil type. Consequently, in order to extend the overall frequency response to beyond audibility, the me-

chanical system must compensate for the fall in electrical output. This can only be achieved by allowing the stylus/record system to resonate, thus producing a compensating peak. In the hypothetical cases illustrated, if the stylus resonance is assumed to be 20 kHz, then the mechanical Q of the moving-magnet phono cartridge would have to be 2, and that of the moving coil a little over 1.

Unfortunately it is difficult to achieve exact compensation in a magnetic cartridge, and the resulting curve often has a 1 to 2 dB dip between 5 and 15 kHz. The gentler moving-coil characteristic usually causes a slight but smooth rise in the high-frequency range — minor but significant differences.

The bandwidth limitations imposed by the electrical network also affect the transient response, as measured by the rise-time, significantly. If the rise-time is to be measured in terms of the reproduction of the leading edge of a square wave, then bandwidth limitations which suppress the upper harmonics will also

slow the response of the cartridge. The solution to the problem of obtaining flat response from a phono cartridge, at least from the point of view of the generating mechanism, is to make the electrical bandwidth greater than the mechanical so that the stylus assembly is freed from its compensating function.

The ultimate test of a phono cartridge is the listening test. It is almost impossible to control all factors in a listening test, but interesting results can be obtained if a large panel of listeners undertakes a series of blind tests and the responses subjected to statistical analysis. Dr. Floyd Toole of the National Research Council in Canada conducted large scale tests in Ottawa during 1980, first of all with nine cartridges and 16 listeners, and then three cartridges, selected from the first batch, with 13 listeners. The listeners were placed in the optimum stereo seats, not more than three

The Denon was found to be brighter than the Ortofon, and the Ortofon seemed to sound similar to the Shure cartridge. In most of the cases the excess of high frequencies was criticized, although there were two listeners who consistently preferred the extra highs of the moving coil. The effects were noticeable only with selected good records, during certain passages and with experienced listeners, but even then, the differences were not particularly different statistically.

During the second part of the test, the Shure was equalized using a Technics 9010 parametric equalizer so that the response was within 0.2 dB of the Ortofon. Again, the results were close, with the interesting result that the moving magnet gained a slight edge over the moving coils, not so much by increasing its score on the evaluation sheet, but by causing the marks given to the moving coils to drop slightly.

It is very tempting to generalize from a test of this nature. One listener was able to pick out the moving-coil cartridge consistently and expressed a clear preference for it.

The closeness of the results surprised several listeners, particularly the moving-coil aficionados who were embarrassed

to find that they had given their votes to the moving magnet!

But are these results so surprising? Many critics hold the opinion that two amplifiers having the same measured performance will have an identical sound when used under identical conditions. Any listening differences which can be proved to exist would then be the result of some parameter as yet unmeasured. Why should this not also apply to phono-graph cartridges?

Mr. Shuichi Obata, General Manager of the Engineering Department for Technics, says of his philosophy of cartridge design: "The recording engineer and the performers have worked very hard to get the sound of their music into the grooves of the phonograph record. I think that it is the duty and the courtesy of the cartridge designer to extract all of this information as accurately as possible. The cartridge should have no tonality of its own. Regarding the choice between moving coil and moving iron, both choices are equally valid in the hands of a competent engineer and will likely be influenced by the historical preferences of his company. Two cartridges having identical measured performance in all respects, even though the principle is different, will have the same tonality. I think that it is more important to concentrate on the stylus assembly and the distribution of mass.

"Up to now there have been too many other factors interfering with our judgment of the moving-coil principle compared with the moving magnet. We have done a lot of research into this and this is one of the results."

Continued on page 92

at a time, and were cautioned against moving, since some of the differences would be subtle. They were also cautioned about the possibility of nonverbal communication ("body language") influencing the opinion of the group. The three final cartridges selected were the Ortofon MC-30, Denon DL 103D and the Shure V15 Type IV, with the tests divided into two sections — equalized and non-equalized.

Differences were noted during the tests with the non-equalized cartridges.

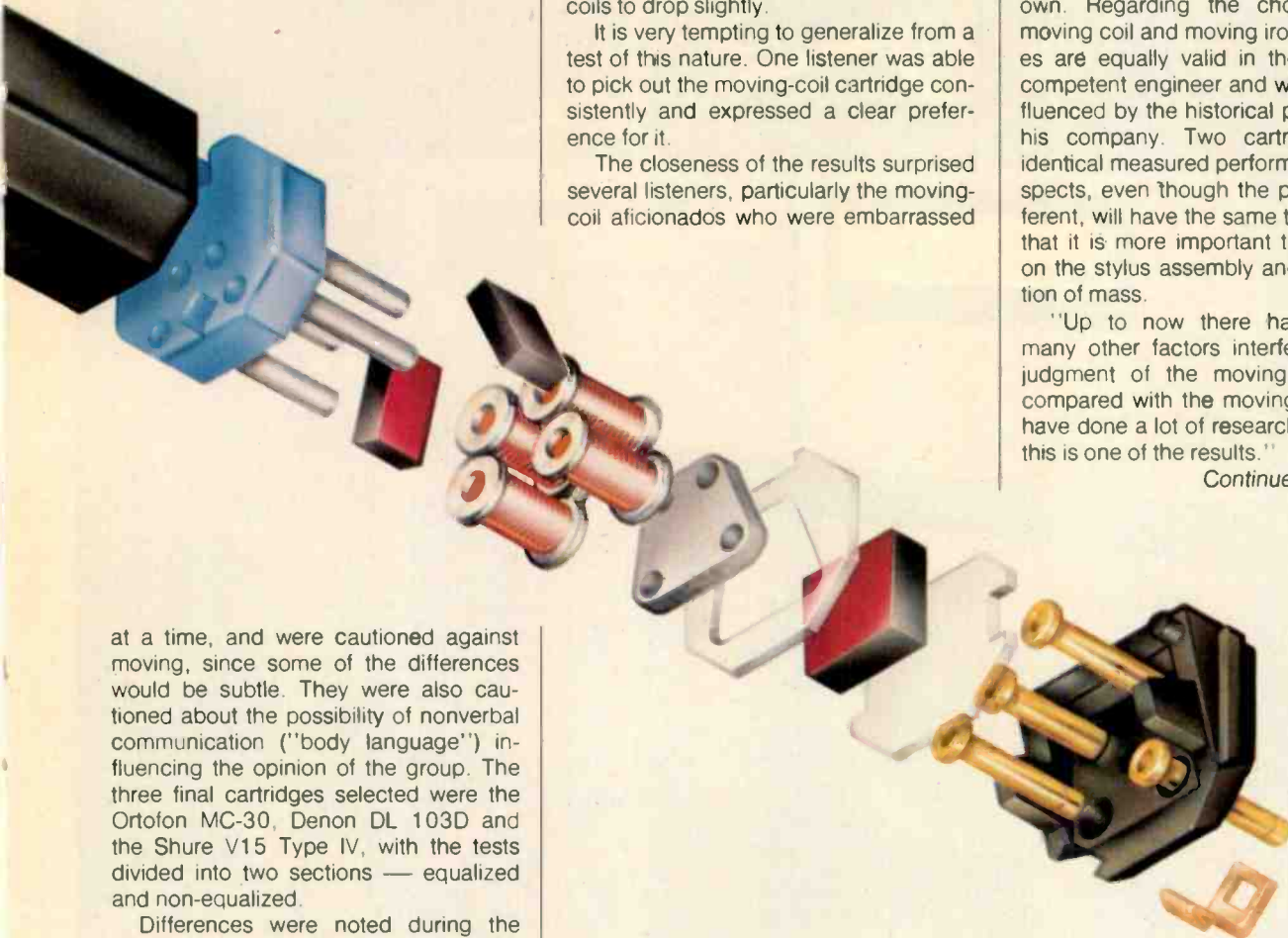

1

SONY PCM-F1 DIGITAL AUDIO PROCESSOR

Manufacturer's Specifications

Signal Format: NTSC TV standard.

Coding Format: EIAJ standard (14-bit) or 16-bit format.

Sampling Frequency: 44.056 kHz.

Quantization: 14- or 16-bit linear.

Frequency Response: 10 Hz to 20 kHz, ± 0.5 dB.

Harmonic Distortion: 14-bit mode, less than 0.01%; 16-bit mode, less than 0.007%.

Dynamic Range: 14-bit mode, more than 86 dB; 16-bit mode, 90 dB.

Wow and Flutter: Below measurable limits.

Input Sensitivity, 0-dB Record Level: Mike, 0.435 mV; line, 95 mV; video composite during playback, 1.0 V p-p.

Line Output Level: 95 mV.

Video Output Level: 1.0 V p-p.

Copy Output Level: 1 V p-p.

Headphone Output Level: Variable, from 50 to 775 mV.

Power Consumption: 17 W d.c.

Dimensions: PCM-F1, 8.46 in. (21.49 cm) W x 3.15 in. (8.0 cm) H x 12 in. (30.48 cm) D.; power supply Model AC-700, 4.2 in. (10.67 cm) W x 3.15 in. (8.0 cm) H x 12 in. (30.48 cm) D.

Weight: PCM-F1, 8.8 lbs. (3.96 kg); power supply Model AC-700, 6.6 lbs. (2.97 kg).

Price: PCM F-1, including a.c. power supply but not including portable VCR, \$1,900.00.



When I spent several "kilobucks" just over a year ago for my latest tape and tape deck tester from Sound Technology, little did I suspect that I would run into a tape recording system that would surpass my lab measurement capabilities so soon. But that's exactly what happened to me during these past weeks as I encountered Sony's third-generation PCM digital audio processor — an incredibly small unit that's styled very much like that company's newest portable videocassette recorder, the Model SL-2000, which I used as the tape-transport system in my tests of the audio capabilities of the new PCM adaptor. Long-term readers of *Audio* may remember that we tested the very first PCM adaptor made by Sony (Model PCM-1) more than two years ago. That device was superseded by the PCM-10 shortly thereafter, largely as a result of a Japanese industry (EIAJ) standard having been developed and approved for such video-related PCM audio processors and of Sony's desire to conform to those standards.

The new digital processor, PCM-F1, tested here, features two high-performance ICs recently developed and now being mass produced by Sony: The CX-889 A/D (analog-to-digital) converter and the CX-890 D/A converter, which is also the LSI to be used in Sony's compact disc player. (A compact disc is shown on the cover with the PCM-F1.) Until the development of these new ICs, monolithic chips of this type and complexity were difficult to produce, and the yield was very low. Sony's success in producing these devices at lower cost is part of the reason for the relatively low cost of this new PCM processor. (The older PCM-1 and the later PCM-10 both carried suggested retail prices of around \$5000.00 in this country!)

The PCM-F1 also incorporates three new LSIs (one for recording and two for playback) which process digital signals, performing the encoder, sync-separator and decoder functions

shown in the block diagram of Fig. 1. The new LSIs were developed jointly by Sony, Sanyo and Toshiba in early 1981, replacing hundreds of ICs previously used in earlier digital processing circuitry. It is the use of these and other ICs that has made possible reduction in the volume and weight of the new PCM-F1. By way of comparison, the PCM-F1 is one-eighth the volume of the PCM-10 and one-fifth the weight; best of all, it sells for about one-third the price.

A typical hook-up for the PCM-F1 is illustrated in Fig. 2. In this diagram, supplied by Sony, the portable VCR shown is the incredibly lightweight, small SL-2000 Betamax unit, and indeed, that VCR makes an ideal companion for the PCM-F1 processor. However, I am sure that Sony is not implying other VCRs can't be used with the PCM-F1; to prove this, after I was through checking out the PCM-F1 with the Betamax SL-2000 and its companion TT-2000 tuner-timer, I hooked up the PCM-F1 to another VCR which uses the "other" format and the PCM-F1 did just as well. All VCRs in the U.S. must be able to deal with an NTSC TV signal format, and that's what the video output jack of the PCM-F1 supplies. I am sure it would work well even with the *third* VCR tape format — the one that uses 1/4-inch, smaller videocassettes, in case you just happen to own one of those.

Control Layout

The PCM-F1 can be powered in a variety of ways; for example, you can hook it up via the a.c. power supplied by the Sony TT-2000 tuner-timer. You can operate it from battery power or even from a car battery (using an optional cable). And, as in my case, you can power it from its supplied a.c. power supply, the Model AC-700, in which case the TT-2000 tuner-timer would be available to power the portable SL-2000 VCR which I used first in my tests. If all of that seems very complicated, it isn't — once

Fig. 1 — PCM audio processor, block diagram.

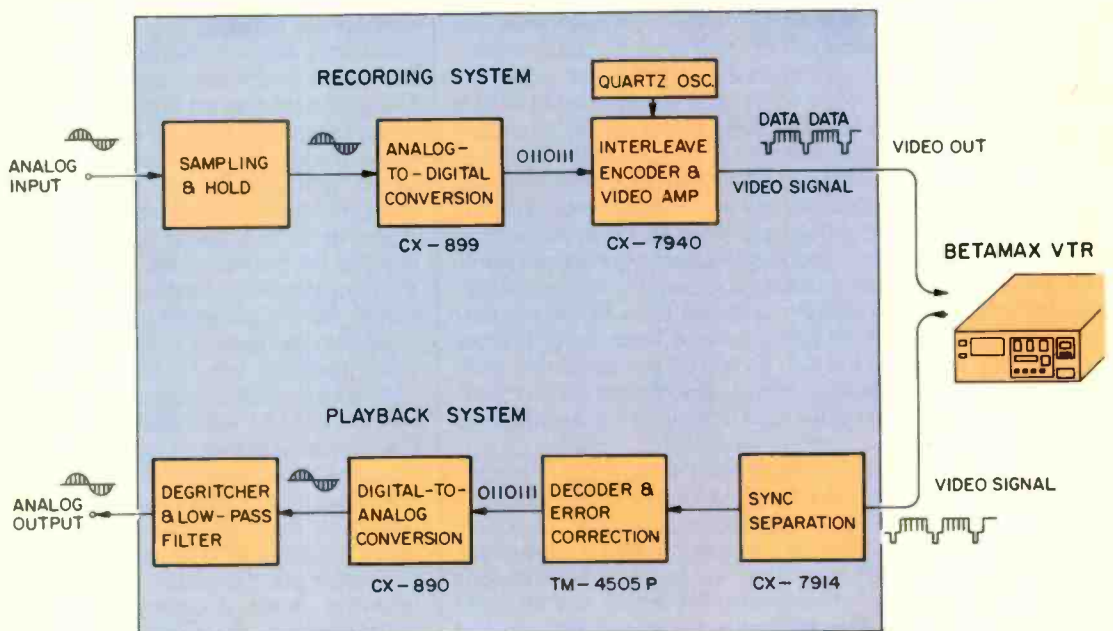

It's clear that
PCM digital recording
is the sound source
of the future.

Fig. 2 — Digital audio
PCM system
connections.

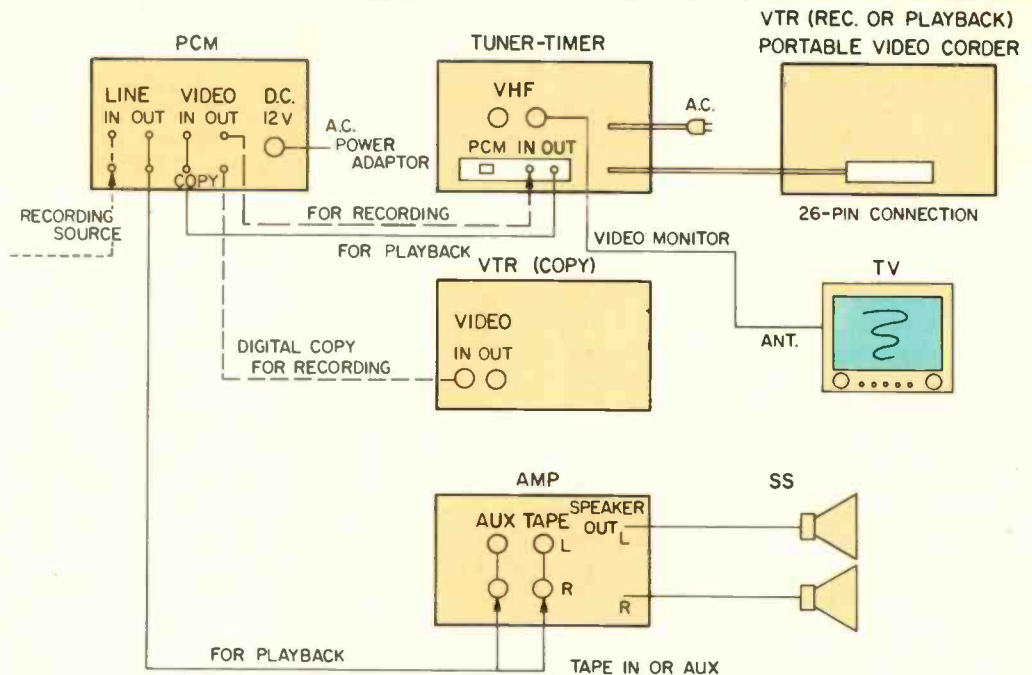

you have all the pieces in front of you and read the diagrams in the owner's manual.

An enumeration of the front panel controls will aid in appreciating the sophistication of this PCM processor. At the left we find a power on/off switch, and just below are a headphone attenuator switch and headphone jack, by means of which you can monitor material being recorded (during the recording phase) as well as playback. A major portion of the left section of the panel is given over to expanded scale LED record/playback level meters (calibrated from below -50 dB to 0 dB and "over record" indications) for left and right channels. Below these scales are several indicator lights; *Mute* lights up if the associated VCR is mistracking or skewing tape or if there are excessive dropouts. *Emphasis* illuminates automatically for all tapes made or played on the PCM-F1. Tapes made on other processor/VCR combinations which may not incorporate pre-emphasis for improved S/N and played on this machine will automatically be played without the de-emphasis circuitry, and the *Emphasis* light will not illuminate for such tapes. Some tapes may have a "copy inhibiting" code included and, if that is the case, the *Copy Prohibiting* indicator on the front panel will light. Finally, a *Tracking* light comes on when you adjust the tracking control on the associated VCR. The right-channel meter scale assists in achieving correct tracking when a *Meter* button at the right of the panel is depressed to select that function.

Controls along the right section of the front panel include individual left- and right-channel record level controls, a momentary record/mute button, the meter-function selector button, peak-hold and reset buttons for the meters, and a battery-check button. Tiny toggle switches below the touch buttons choose muting on/off, copy on/off and mike/line inputs. Left and right microphone input jacks are located at the lower right corner of

the processor. The muting switch is normally left in the On position to guard against possible dropout noise bursts which, if not squelched, could conceivably cause amplifier or speaker damage. If you are sure of a perfect, dropout-free tape, however, this automatic muting feature can be defeated with the muting switch.

Left- and right-channel audio line-in and line-out jacks are found on the rear panel, along with video in and out jacks (these connect via supplied cables to the VCR being used with the processor), and a *Copy Out* jack. When the *Copy* switch on the front panel is activated, an error-corrected signal is available at this output for copying from one digital tape to another. In other words, the signal remains in digital (albeit error-corrected) form at this output jack. Also located on the rear panel is a resolution switch, with positions for 14-bit or 16-bit. I suspect that this is a bit of individuality being exhibited by Sony, whose experience in digital audio processing is extensive. Perhaps what they are trying to tell the rest of the industry is that, despite the fact that the EIAJ-approved standard calls for a 14-bit linear quantization format, Sony's advanced technology permits a finer, 16-bit encode/decode approach for even greater dynamic range and lower distortion. What it all means is that if you should come upon a tape made on any other PCM processor/VCR combination, the PCM-F1 will automatically play it back using the correct EIAJ format. However, in making your own tapes on the PCM-F1 (plus a VCR) you can either use the EIAJ format (if you intend to give tapes to others whose machines may only have EIAJ decoding) or the somewhat superior 16-bit format of which the PCM-F1 is capable. If you opt for 16-bit for your own recordings, you would put the switch in the position that indicates 16-bit recording. Again, in playing back, the position of the switch is not important — the circuitry detects the mode used.

The PCM-F1 is one-eighth the volume, one-fifth the weight, and one-third the price of Sony's previous digital audio processor.

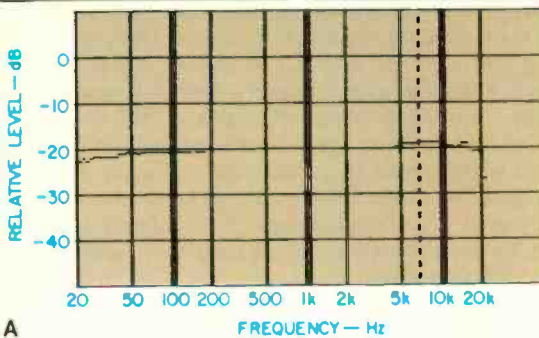

A

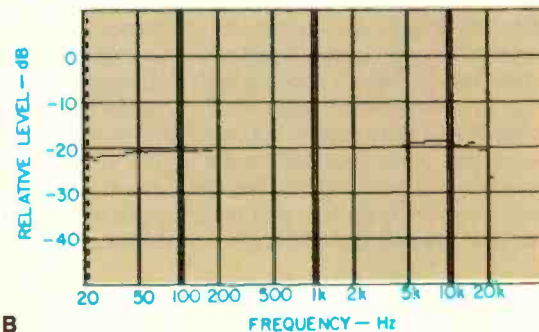

B

Fig. 3 — Frequency response at 0-dB record level, 14-bit mode, with cursor set to show "worst

case" deviation from flat response at treble end (A) and bass end of spectrum (B).

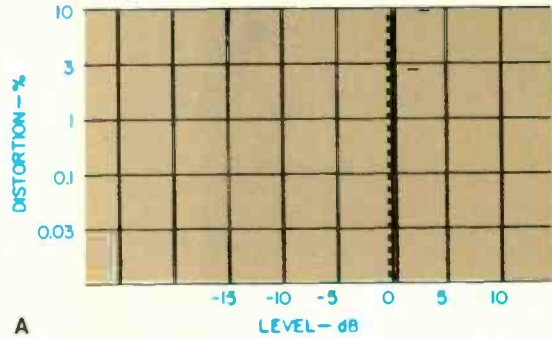

A

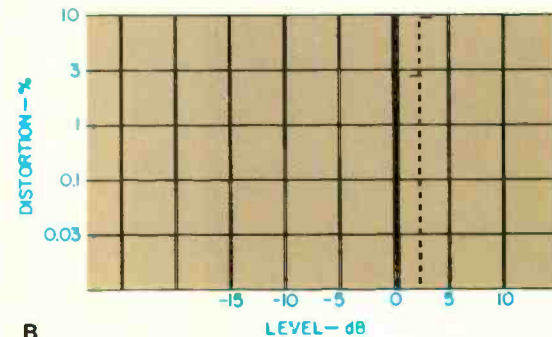

B

Fig. 4 — At 0-dB record level, distortion is virtually unmeasurable on Sony's PCM-F1 processor (A), but

recording, 3rd-order HD rises rapidly when record level maximums are exceeded (2.8% at +2 dB), unlike analog tape

A couple of interesting asides before we get down to the performance specifics of the PCM-F1. Sony recommends that if a Beta format VCR is used with the processor, only Beta I or Beta II speeds should be used. In most cases, that pretty well restricts things to Beta II (only professional Beta-format machines include the Beta I speed). I surmised that if you were to use a VHS VCR with the PCM-F1, that would mean staying with the SP (2-hour) speed, which is what I did when I later tried the PCM-F1 with that alternate type of VCR. Sony also suggests not using anything longer than an L-500 tape package (again, referring to the Beta format). I used L-500, L-250 and L-125 tape packages in my experiments using the SL-2000, and all produced excellent results. (I followed Sony's advice, and did not try using an L-750, for fear of possible dropouts due to thin base material and thin magnetic coatings.) In my experiments with a VHS VCR, I did try T-90 and T-60 tape packages with perfect results. I also tried a few T-120 tapes and found that a few dropouts did occur with some of these. In this regard, of the T-120s tested, Fuji, TDK, JVC and Maxell videocassettes offered best results. All tapes worked well in the T-90 and T-60 lengths, however.

Measurements

One thing the Sound Technology 1500A audio tester was able to do quite adequately in measuring the performance of the PCM-F1/VCR combination was to depict record/play frequency

response. Note that in Fig. 3 I have expanded the vertical scale so that each division represents only 2 dB of amplitude change (as opposed to my usual presentations which use a scale of 10 dB/division). In Fig. 3A I moved the dotted-line cursor to the point of maximum deviation from flat (it occurred at 6.9 kHz), which turned out to be an insignificant peak of three-tenths of one decibel (+0.3 dB). In Fig. 3 I sought out the greatest deviation from flat response at the low end, and that turned out to be a half decibel (-0.5 dB) at 21 Hz! Note, too, that these measurements were made at "0 dB" record level, as indicated on the PCM-F1's LED metering system. Imagine ever getting results like that from any analog tape recording system at that recording level! Such is the beauty of PCM digital tape recording!

Next I tried to measure third-order (D3) harmonic distortion as a function of recording levels; results are depicted in Fig. 4. Note that with the cursor set to reference "0 dB" record level, the third-order distortion reading (in Fig. 4A) is 0.01%. In fact, it's probably lower than that, but I happen to know that the Sound Technology tape tester has a test signal with about that level of residual distortion. However, Fig. 4B shows us an important lesson about all digital (PCM) recording systems: Once you go OVER the maximum permitted recording level (in this case, 0 dB on the PCM-F1's level meters), things get pretty horrible pretty quickly. Expressed in oversimplified terms, there aren't enough "bits" to accommodate such signal amplitudes, so the system

Finding source material good enough to "show off" this magnificent recording system's capabilities was difficult.

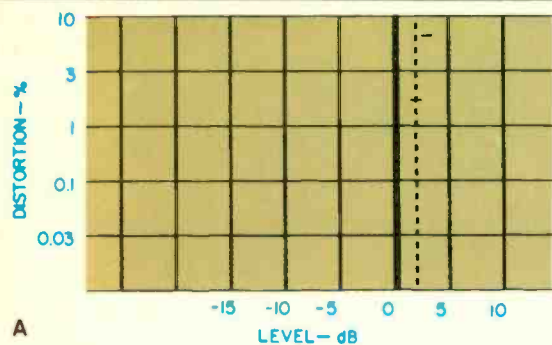

A

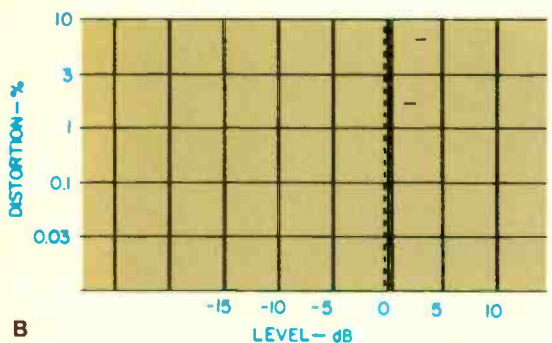

B

Fig. 5 — A slight improvement in 3rd-order harmonic distortion is noted when 16-bit mode is used on Sony PCM-F1 (A), but so long as recording level does not exceed 0-dB (B), 3rd-order HD is insignificant in both 14- and 16-bit modes.

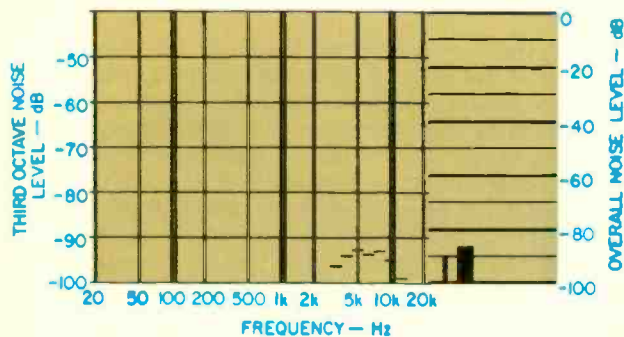

Fig. 6 — Have you ever seen this sort of S/N figure for a "tape recorder" before? The 86.1 dB (below 0-dB record level) is actually the residual noise of the test unit!

encodes with gross levels of error, i.e. distortion. Even as little as a +2 dB of overrecording resulted in third-order distortion levels of 2.8% (Fig. 4A). Had I gone to +3 dB (moving the cursor one more space to the right), we'd intersect a dash-line near the top of the display in Fig. 4A which denotes almost 10% third-order distortion! The lesson, of course, is that even though PCM recording offers vastly greater dynamic range and vastly improved signal-to-noise ratios, these benefits must be taken at levels from "0 dB downward," and the concept of "headroom above 0 dB" (which we've all become accustomed to in analog tape recorders) no longer applies.

I was curious to learn whether operation in the 16-bit mode would provide measurably better performance (not that there was anything that I could possibly criticize in the 14-bit results obtained thus far). So, I repeated the distortion measurement using that alternate quantization format and, sure enough, at the +2 dB (overrecord) level, where I had previously observed a third-order distortion of 2.8%, I now did read a somewhat lower 1.7% (see Fig. 5A). My attempts to detect improvement at other, legal recording levels were again frustrated by the limitations imposed by the test signal provided by the Sound Technology tester. As you can see from Fig. 5B, the best I could read was 0.01% (even though I'm quite sure that Sony's claim to a somewhat lower 0.007% is well founded and no doubt substantiated in their labs).

I ran into the same sort of test equipment limitations when I tried to measure signal-to-noise ratios for the PCM-F1/SL-2000 combination. I thought I was getting a totally accurate reading of 86.1 dB, as displayed in Fig. 6 (and was all set to exclaim "Gotcha!" to Sony for claiming 90 dB or better in the 16-bit mode), until I disconnected all inputs and outputs to the tester and asked it to measure signal-to-noise ratio (relative to the same previous reference level, of course). As you've probably already guessed, the tester still read -86.1 dB or so. The only reason I'm showing you the video printout of this test is because it's probably the first time you will have ever seen a signal-to-noise ratio of any audio tape recording system that exceeds 85 dB and doesn't require any sort of external electronic noise-reduction system!

By this time, having become very nearly totally frustrated with my inability to measure the superb performance levels of this PCM recording system, I tried to measure wow and flutter, and the "smart" test machine told me to forget it by explaining that the "signal (is just) too low." So all that remained for me to do was to measure the audio input sensitivities and output levels of the PCM-F1, and all of these turned out to be pretty much as specified.

Use and Listening Tests

Abandoning the lab bench, I was now ready to try my hand at some actual PCM stereo recording. I was, as in previous PCM recording experiments, immediately confronted with the problem of finding source material that would be good enough to "show off" the capabilities of this magnificent recording system. My editor summarily dismissed my request that he send a 50-piece orchestra to my home so that I could record some wide-dynamic-range live music. Nor was I afforded special permission to set up this equipment at one of the more prestigious concert halls in New York City. That left only two possible alternatives; first, I sang my heart out, using one of my better microphones

During the listening tests, the PCM-F1 neither added nor subtracted *anything* that was audible.

(one I normally use for calibration purposes). When I played back my own performance, it was clear that PCM digital recording is the sound source of the future. No background hiss! Not a bit of pitch wavering (other than the natural kind inherent in all good voices) and no *added* distortion that was discernible. The recorded songs were limited strictly by the quality of the mike, the amplifiers used, the speakers, and — of course — the performance itself!

On to my second experiment! As in previous tests of earlier PCM processors, I resorted to dbx-encoded discs. By first decoding them and using the expanded, decoded results as source material to be recorded in digital form using the Sony PCM-F1/VCR combination, I would have a variety of musical source material with enough dynamic range and with inaudibly low record surface noise so that I could judge the quality of the PCM recording process. Since I have a rather large collection of dbx-encoded discs, I must confess that I am *still* engaged in this process. From what I've heard so far (and this setup makes for an easy form of direct A-B comparison between the decoded dbx disc played back directly and the PCM-recorded version of the same decoded disc material), I can say with absolute certainty that I can hear no difference whatsoever between these two forms of the same program source. This suggests that the PCM-F1 is neither adding nor subtracting *anything* that is audible to

this listener. Of course, the experiments may take several more weeks to complete. During that time I will absolutely have to hang on to the PCM-F1, the Sony SL-2000 VCR, and the companion TT-2000 tuner-timer and a.c. adaptors. I hope Sony isn't in too much of a hurry to get them back. It's for the benefit of science after all!

Leonard Feldman

Enter No. 90 on Reader Service Card



AUDIO

THE ULTIMATE PLAYBACK SYSTEM

- All of AUDIO's 1981 issues have been Bound into an attractive and durable volume. AUDIO '81 gives you rapid "playback" of valuable, easy access to vital facts, figures, reviews, and articles.
- Refresh your knowledge of speaker technology, construction projects, distortion theory, and more.
- Only a limited quantity is available. A few sets also remain from 1975, 1977, 1978, 1979 and 1980. It's first come, first served, so place your order now.
- Send a check or money order for \$30.00 plus applicable sales tax.
- DO NOT SEND CASH!
- Price includes shipping and handling in the U.S.A. only.

AUDIO, CBS Publications, 1515 Broadway, New York, N.Y. 10036

1981 1979 1977
 1980 1978 1975

Name _____

Address _____

City _____ State _____ Zip _____

FREE

McIntosh

STEREO CATALOG and FM DIRECTORY

Get all the newest and latest information on the new McIntosh stereo equipment in the McIntosh catalog. In addition you will receive an FM station directory that covers all of North America.

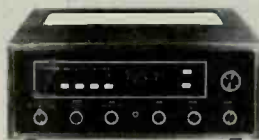

SEND TODAY!

McIntosh Laboratory, Inc. A
 East Side Station P.O. Box 96
 Binghamton, N.Y. 13904-0096

NAME _____

ADDRESS _____

CITY _____ STATE _____ ZIP _____

If you are in a hurry for your catalog please send the coupon to McIntosh. For non rush service send the Reader Service Card to the magazine.

Enter No. 12 on Reader Service Card

2

ORACLE TURNTABLE

Manufacturer's Specifications

Speeds: 33 1/3 & 45 rpm.

Selector Method: Pushbuttons.

Motor Type: 24 volt d.c., Hall effect.

Motor Mounting: Direct to main chassis, isolated from subchassis.

Drive System: Belt.

Bearing: Tungsten carbide.

Suspension: 3 tapered springs.

Platter Diameter: 11 7/8 inches.

Platter Weight: 6 lbs. (2.7 kg).

Platter Material: Magnesium alloy.

Tonearm: Not supplied.

Dimensions: 19 in. (482 mm) W x 14 1/2 in. (368 mm) D x 6 1/4 in. (158 mm) H.

Total Weight: 22 lbs. (10 kg).

Power Required: 100-130 V a.c. 50-60 Hz.

Ground Wire: None.

Price: \$1,095.00.



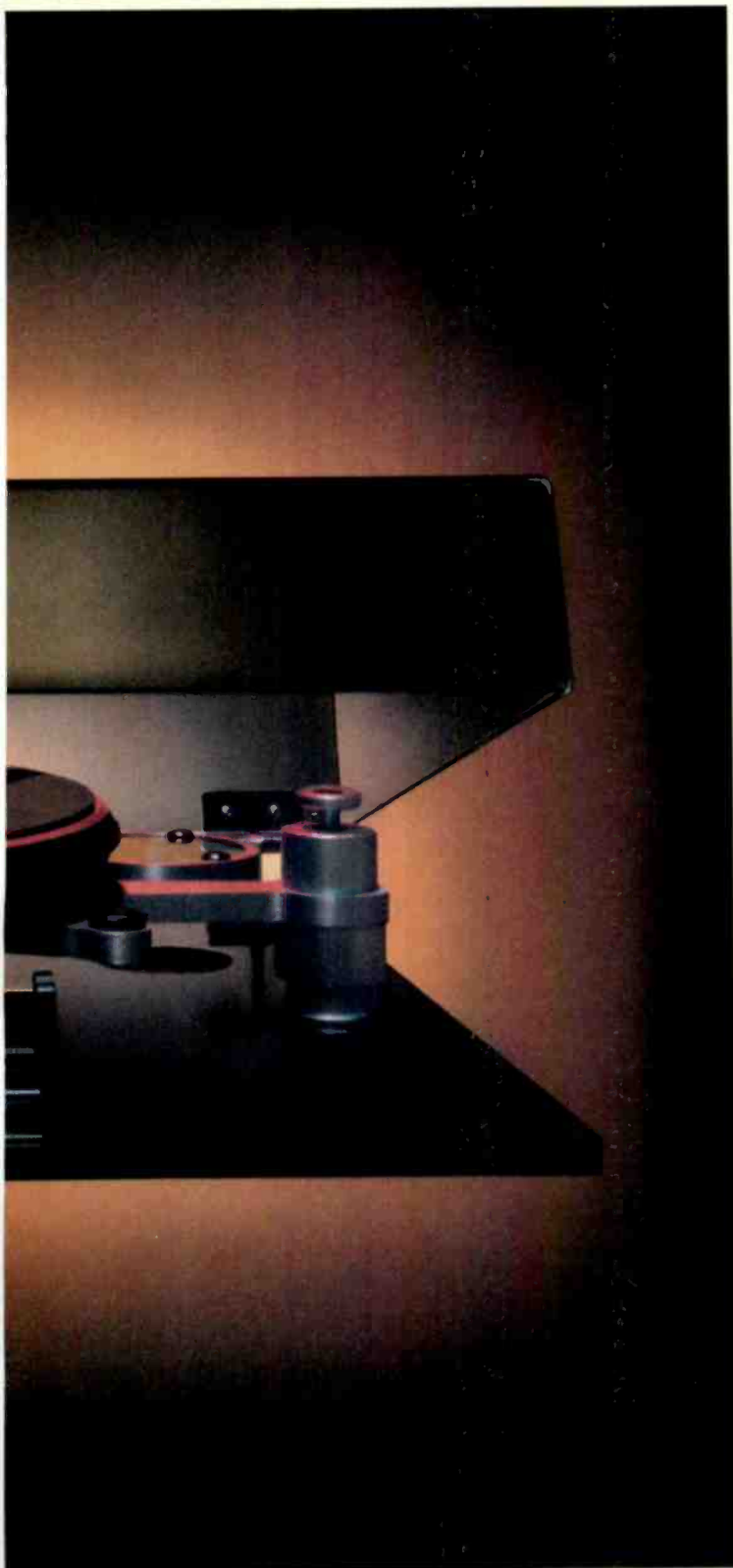

In recent years, it has been shown that turntables greatly affect sound quality, but correlating sonic performance with laboratory measurements still needs much experimentation. Conceptually, a turntable that contributes little coloration or distortion to the reproduced sound should present a difficult measurement problem, and the Oracle does exactly that, thus deserving its reputation for high performance capability.

The Oracle's appearance suggests, and its performance verifies, that it is not an ordinary turntable. The suspension towers, which support a skeletal subchassis, combined with the smoke-colored main support chassis and the hinged dust cover, impart a distinctive appearance. The attention to detail and care of finish, and even the well-designed protective packaging, exhibit a substantial amount of pride in manufacture.

Each of the three support towers (shown cut-away in Fig. 1) encloses a spring of a different stiffness. The reasoning here is that since the mass of the turntable and tonearm are distributed unevenly, the stiffness of each support should be different. When the proper springs are used, the whole subchassis, platter and tonearm should move up and down evenly, without rocking motion or rotational modes.

Figure 2 shows the unusual design of the subchassis — a seven-layer laminate consisting of four layers of magnesium-aluminum alloy separated by three layers of a special bonding substance, which absorbs internal vibrations. The tonearm mount is a round acrylic disc which can be changed for different tonearms without much difficulty. The manufacturer recommends that the tonearm be fastened securely to the platform without any compliant interface, such as a rubber washer, between them. When the record is clamped firmly to the platter (as it is with the Oracle system) and the phono cartridge is mounted in a stable tonearm with good bearings, the whole assembly moves together as a unit, which is as it should be. I used The Arm from Sumiko for testing.

The Oracle incorporates other interesting features which are designed to achieve what Trans Audio calls Groove Isolation. Part of this isolation is accomplished by clamping the record to the turntable mat with a screw-down clamp, as shown in Fig. 3,

MEASURED DATA

Serial No.: 2413			
Specification	Speed	Measured	
Speed Accuracy	33.3	2.5% slow	
	45.0	4.0% slow	
Speed Stability	33.3	0.213%	
Wow DIN unweighted	33.3	0.25%	
	DIN weighted	33.3	0.12%
Flutter DIN unweighted	33.3	0.07%	
	DIN weighted	33.3	0.07%
W&F DIN unweighted	33.3	0.25%	
	DIN weighted	33.3	0.13%
Rumble	Unweighted	33.3	-66.8 dB
	"B" weighted	33.3	-82.0 dB
Suspension Resonance		3.5 Hz as specified; moderate "Q"	

**1939...FIRST DIRECT-DRIVE TURNTABLE SYSTEM.
1951...FIRST MOVING-COIL CARTRIDGE.
1972...FIRST DIGITAL (PCM) RECORDING.**



Direct drive. Moving-coil. Pulse Code Modulation. All synonyms for technological innovation in the high-fidelity field, these phrases fill the pages of the audio magazines and the conversations of serious music enthusiasts. But aside from being major breakthroughs in audio engineering, they have one other element in common. They are all innovations developed by one company. Denon.

While other companies have just begun to offer products incorporating these new technologies, Denon originated them. And only Denon has had 41 years to refine direct-drive turntables, 29 years to perfect moving-coil technology, and almost a decade to further develop their invention of PCM digital recording.



1982...DENON DRA-600. THE FIRST RECEIVER FROM A TRUE AUDIOPHILE COMPANY.

The Denon DRA-600, a synthesis of Denon's greatest technological strengths. From our thirty years of experience with moving-coil cartridges, we gave it a moving-coil preamplifier stage sonically as transparent as our renowned separate head-amps.

From our fifty-plus years of electronics design experience, we powered the DRA-600 with a proprietary Denon Class-A power amp, a design that delivers unparalleled definition and openness, yet avoids the excessive heat, size and cost of traditional Class A amplifiers.

And, from our decade of experience since our invention of commercial digital recording (PCM), we equipped the DRA-600 with a digitally synthesized tuner stage for the most precise station tuning with the lowest distortion. Plus we added the convenience of eight AM and eight FM presets with automatic station scanning. The DRA-600 from Denon, where innovation is a tradition.

Enter No. 8 on Reader Service Card

DENON
*Imagine
what we'll
do next.*

Denon America, Inc.
27 Law Drive, Fairfield, N.J. 07006

The Oracle's appearance suggests, and its performance verifies, that it is not an ordinary turntable.

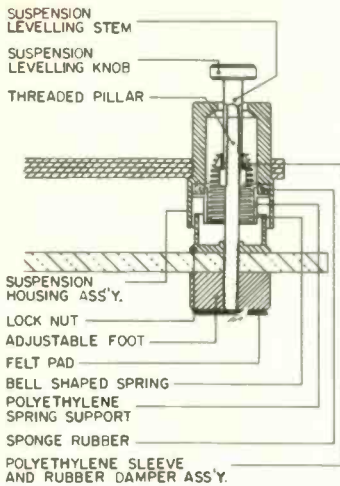

Fig. 1—Cut-away side view of one suspension tower, showing detail of spring mounting.

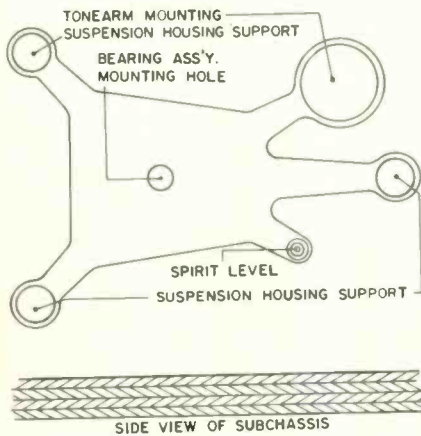

Fig. 2—Side and top views of the subchassis show the unusual design and construction.

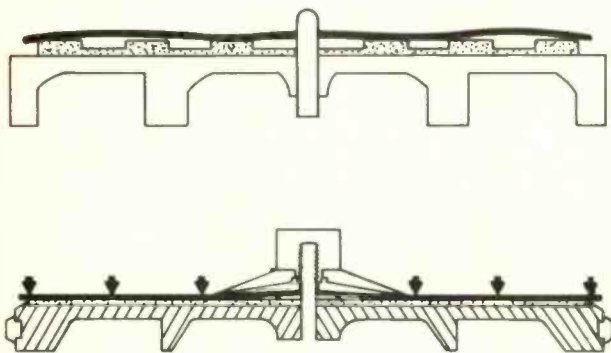

Fig. 3—Top, warped record on an ordinary

platter; bottom, clamp system used in the Oracle.

which allows dish-warped records to be flattened and fastened securely. The mat is made of a special composition designed to absorb mechanical vibrations from the record. These vibrations, a result of the stylus interaction with the record groove, have been largely ignored until recently. Such vibrations travel back and forth within the record, forming delayed reflections of mechanical energy, which, if not damped quickly, are picked up by the stylus and blur the detail of reproduced sound.

Another source of unwanted mechanical energy is caused by the normal bell modes of a turntable platter. To absorb this energy, the outer rim of the Oracle's platter has a band of relatively hard rubber the firm calls a Peripheral Wave Trap. My experience with damping the vibrational modes of loudspeaker diaphragms has taught me that this is an excellent way to deal with turntable platter resonances and, indeed, the Oracle has the deadeast platter of any I have tested.

The Oracle's unweighted rumble was -66.8 dB below the 10-cm/S lateral groove modulation reference. The rumble using DIN "B" weighting was -82 dB. Since this rumble figure is an average value of all the spectral components up to 500 Hz, two turntables could have the same rumble figure and still have different sonic characteristics. The spectrum of the Oracle's rumble is shown in Fig. 4. The spike in the center, where the cursor is set, is at 18.75 Hz, and the rumble measures -41.9 dB at this frequency. The peak may be due partially to the B&K 2010 test record. In general, rumble measurements are difficult because they are limited by the rumble cut into the grooves of the test disc. The computer-controlled Nicolet 660-2D FFT spectrum analyzer, which was used to make all the 'scope photos and measurements shown, allows a sufficiently detailed analysis to check even the 50-Hz powerline hum, which was measured as -50.3 dB. (This test disc comes from Europe, where the a.c. powerline frequency is 50 Hz.) Analysis of Fig. 4 revealed that the Oracle has very low rumble with the major contribution below 20 Hz, a desirable condition.

The wow-and-flutter meter readings, using the DIN Standard, were 0.25% unweighted and 0.13% weighted. Readings for wow alone were 0.24% unweighted and 0.12% weighted; for flutter alone, readings were 0.07% both weighted and unweighted. Figure 5 displays the spectrum of wow components between 0.125 and 50 Hz. The cursor is set at 0.5 Hz and the next major spike is at 1 Hz; these two frequencies relate to full and half platter rotations at $33\frac{1}{3}$ rpm. This cyclical variation results from the difficulty inherent in making a perfectly concentric record and then getting the hole precisely in the center. For these tests I adjusted the disc until this variation was at a minimum. A very noticeable reduction in the 0.5-Hz component occurs when this is done, and the contribution to wow caused by record warp for the 4- to 10-Hz range is more apparent.

The Oracle's lack of flutter was readily noticed by the people who auditioned it during a long series of comparisons with other fine turntables. It was particularly easy to hear when we used a recently released Sonic Arts piano recording, Lab 16, which was mastered digitally. This recording's lack of scrape flutter (usually encountered with analog tape recorders) allowed the intrinsic flutter caused by the different turntables to be easily heard as more or less blurring of detail in the reproduced sound.

Absolute speed stability, while quite good in the Oracle, was not exceptional, but this affects sonic performance less than wow and flutter, rumble, or groove-to-groove isolation does. Fig-

The attention to detail and care of finish exhibit substantial pride in manufacture.

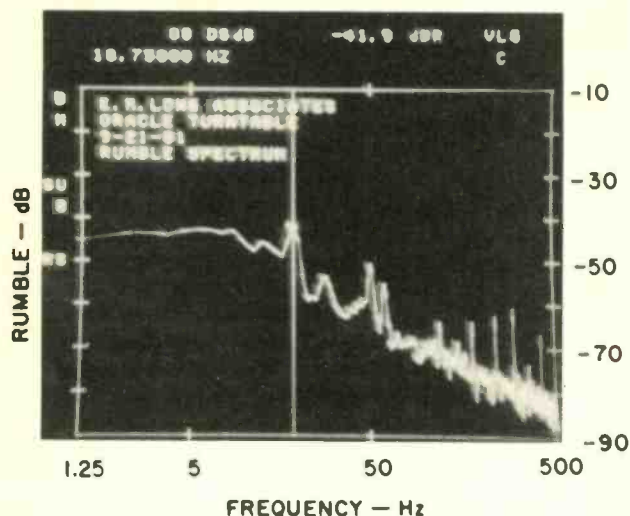

Fig. 4—Rumble spectrum, with most components below 20 Hz. Spikes are harmonics of hum and occur below -60 dB.

Resolution of spectral detail is excellent. (Note: Unless noted, 0 dB ref. is 10 cm/S lateral groove modulation.)

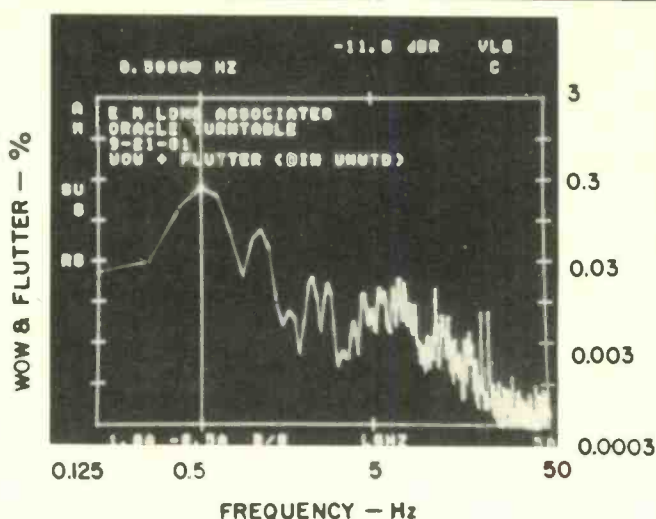

Fig. 5—Wow and flutter spectrum from 0.125 to 50 Hz, with main wow at 0.5 and 1 Hz (see text).

Wow at 7 to 10 Hz is probably caused by slight variations in tracking force due to tonearm resonance.

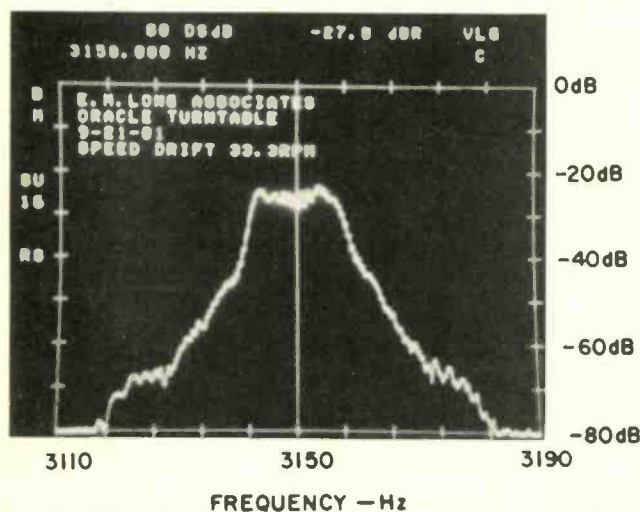

Fig. 6—Speed stability vs. time; shown is pitch variation. Stability was calculated to be $\pm 0.123\%$ for a 20-second sample. (Horizontal scale is 8 Hz/div.)

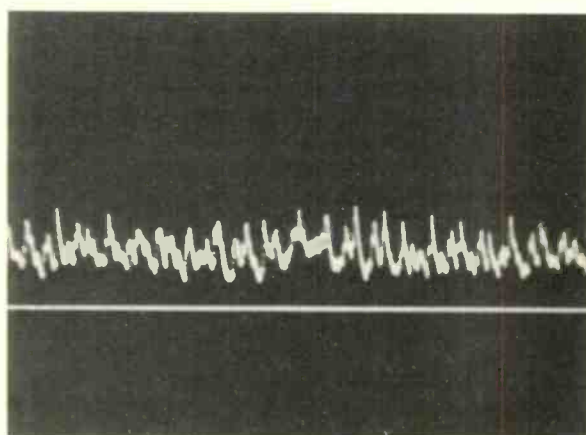

Fig. 7—Speed drift vs. time. Note the cyclic variation of the 3150-Hz tone of Fig. 6.

Figure 6 shows the range of speed drift for 16 samples over a 20-second period. The cursor is centered on the 3150-Hz tone of Band 8 of the B&K 2010 test record. The display is calibrated to show 8 Hz per horizontal division and a total window width of 80 Hz. The drift in speed was $\pm 0.213\%$. Another more commonly used method of displaying speed drift is shown in Fig. 7, a 40-second recording taken from a wow-and-flutter meter. This measurement indicates the somewhat random, low-frequency nature of the drift. During the listening sessions, no comments were made which could be connected directly with the Oracle's

speed stability, even when listening to piano recordings which are very good for revealing pitch variation.

The importance of Fig. 8A lies in what it doesn't show. The average level of background noise from the B&K 2010 test record is about -75 dB. There is no indication of any spectral contribution between 200 Hz and 5 kHz from the Oracle, which is as it should be. Figure 8B displays the spectrum from 0.5 to 200 Hz and indicates how good the signal-to-noise ratio remains at the lowest frequencies of interest. The main bump in this spectrum is due partly to tonearm resonance.

The Oracle has very low rumble, with the major contribution below 20 Hz—a desirable condition.

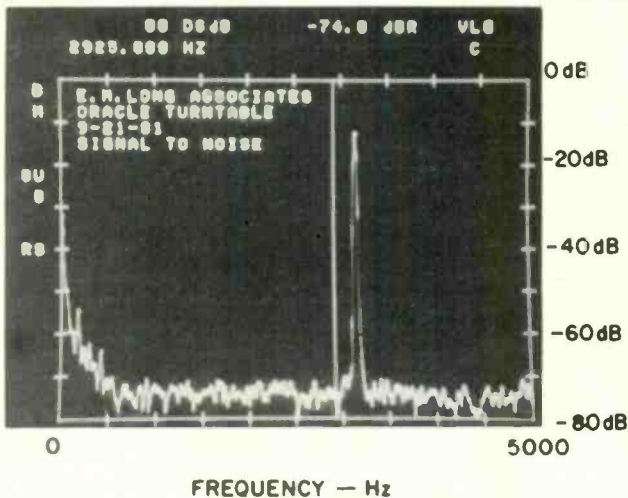

Fig. 8A—Spectrum of signal-to-noise ratio with 3150-Hz tone from B&K 2010 test disc. (Note: Scale is linear.)

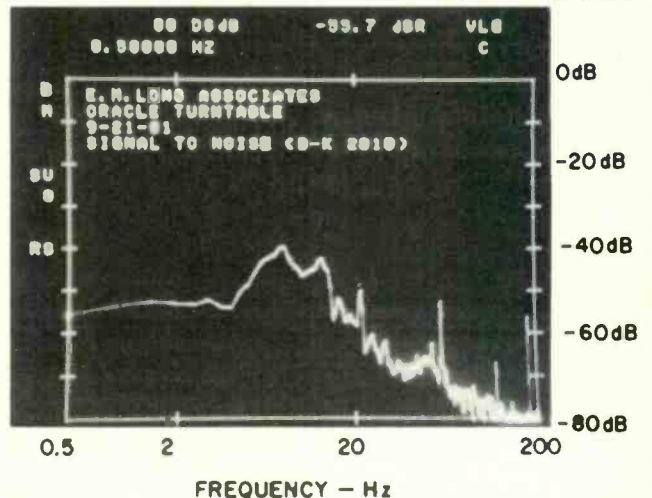

Fig. 8B—As in Fig. 8A but from 0.5 to 200 Hz with log scale. Tonarm resonance is responsible for most of the increase from 7 to 10 Hz, but the level is over 40 dB down from the 10 cm/S reference.

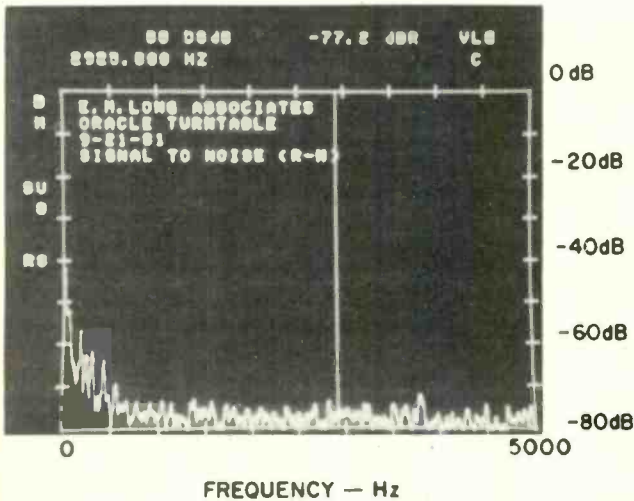

Fig. 9A—Similar to Fig. 8A but measured using Thorens Rumpel-messkoppler and showing an even lower noise floor.

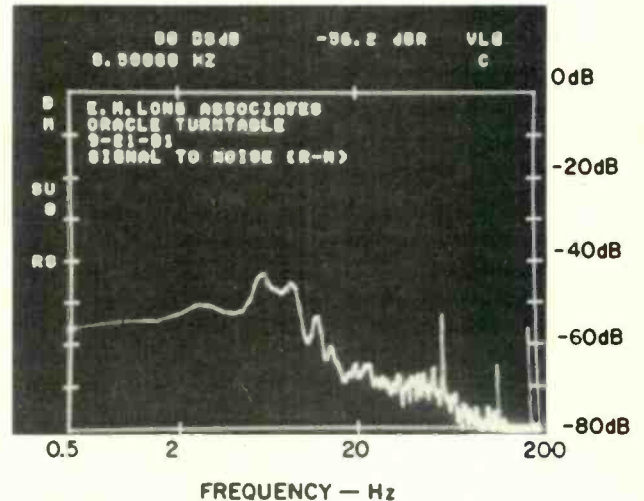

Fig. 9B—Similar to 8B but with the Rumpel-messkoppler. The arm resonance is still evident, but the spike at 20 Hz is not, indicating it is probably an artifact of the test disc.

I also measured the signal-to-noise ratio with the Thorens Rumpel-messkoppler method. The S/N ratio improvement, shown in Figs. 9A and 9B, is 3 to 4 dB over the results using the B&K 2010 test record. One listener commented on the apparent reduction of background noise when the same record was switched to the Oracle after being played on another turntable. Groove Isolation apparently causes an audible improvement in the background noise level.

The effectiveness of damping the turntable platter resonance with the Peripheral Wave Trap is shown in Fig. 10. I removed the

record mat during this test and placed the stylus tip on the metal platter at a distance of approximately 5/8 in. from the spindle before applying a series of eight mechanical impulses to the upper edge of the platter rim and obtaining the average. Then I monitored the uniformity of the spectral content for each impulse and verified the repeatability of these measurements.

The important results of this test lie within the frequencies where energy is concentrated. Absolute level is related to the level of the input impulse and, therefore, is of secondary significance. The relative level among various frequencies, however, is

The Oracle turntable is an excellent choice for those interested in hearing *all* the detail contained in record grooves.

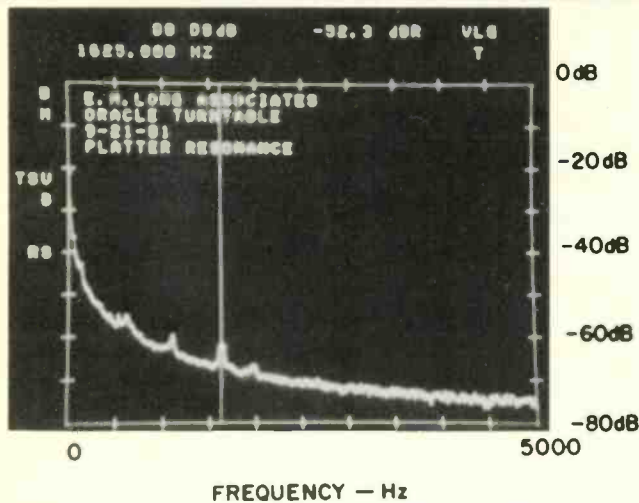

Fig. 10—Spectrum of platter resonance. See text.

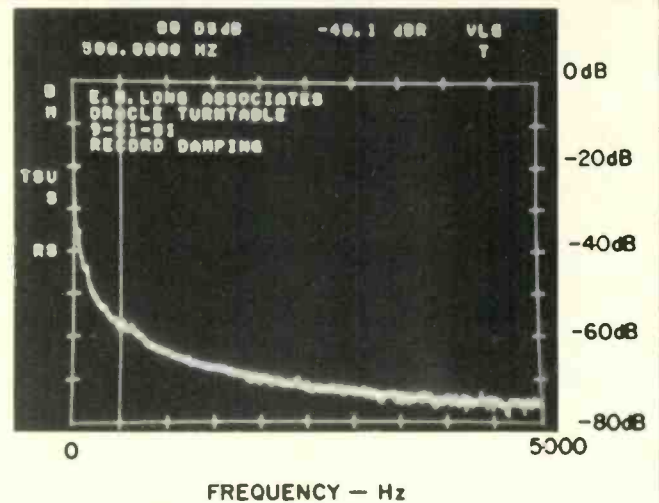

Fig. 11—Spectrum of a record's internal resonances. See text.

of interest and shows that energy in the platter is concentrated at 550 Hz, 600 Hz, 1100 Hz, 1625 Hz (cursor position), and 2000 Hz. The data in Fig. 10 compare most favorably with results from other turntables. The natural resonances of the Oracle's platter are damped very well, even without the record mat in place.

For the next measurement, I placed the record mat on the platter, clamped a standard record in place, and positioned the stylus tip in a quiet groove at the inside diameter of the record. Leaving the turntable stationary, I applied the same mechanical impulses to the rim of the record. Both channels were monitored on the Nicolet spectrum analyzer, but only one channel is shown in Fig. 11

The results of this measurement are extraordinary when compared to those obtained from other turntables. The correlation between comments made by all of the people auditioning the Oracle and this objective test seem to be excellent. The uniform distribution of spectral components is amazing. Listeners remarked about clarity and realism in the reproduced sound, especially noting how the timbre of individual instruments seemed so well defined. These comments can be traced directly to the Oracle's control of extraneous spectral energy in the record which can otherwise blur such detail. Additional listening tests, conducted with the clamp partially released and with the clamp and domed washer completely removed, revealed a deterioration in this clarity and detail.

I was curious to see if the same improvements could be heard with dbx-encoded records. To find out, I used M&K's RT-202 recording which features Dukas' "Sorcerer's Apprentice" and Chabrier's "Espana." The results were just as significant as those heard with standard recordings. I was not prepared for the substantial differences I heard with different digital recordings. I was surprised to hear a type of defect on some of them which I can only describe as "grudge," and the Oracle allows this

defect to be heard quite easily. The M&K recording (digitally recorded with dbx encoding) did not have this "grudge" and sounded excellent. The previously mentioned Sonic Arts Lab 16 also lacked this defect, so I concluded that this particular form of distortion marred some digital recordings, but not all of them.

The Oracle turntable is an excellent choice for people interested in hearing *all* the detail contained in their record's grooves. I also suspect that Oracle owners will be in the vanguard of those clamoring for better record quality.

Edward M. Long

Enter No. 91 on Reader Service Card



3

SONUS
DIMENSION 5
CARTRIDGE

The Sonus Dimension 5 is now the top-of-the-line cartridge from Sonic Research, and its main difference from others in the Series II range is an unusually shaped, highly polished jewel stylus called "Lambda." This is a chisel-shaped design and is mounted in a short low-mass aluminum cantilever. The micro-machined armature is said to have the lowest possible dynamic mass for the required efficiency, and the high-frequency resonance of the moving mass has been pushed up to the 35 to 40 kHz range. The result is that very little damping is needed, and so tracking force can be reduced accordingly. Because the Lambda stylus is mounted to form a smooth extension to the cantilever, instead of making an angular projection, the single transmission path is claimed "to achieve a degree of phase coherence impossible in any stylus-cantilever design now in use." A circular elastomeric unipivot suspension provides equal freedom of movement over 360 degrees. The cartridge is nicely packaged in a small, padded wooden box and comes complete with mounting hardware and a good stylus brush.

Measurements

For test purposes, the cartridge was mounted on a Sony PS-X800 SLT turntable, and the tracking force set to one gram — the lowest recommended figure. The first measurement performed was for frequency response, and the results are shown in Fig. 1. Output began to rise from about 13 kHz, and a further

Manufacturer's Specifications

Frequency Response: 10 Hz to 20 kHz, ± 1 dB; 20 to 40 kHz, +2, -5 dB.

Compliance: 50 cm/dyne $\times 10^{-6}$

Vertical Tracking Angle: Nominal, 20 degrees.

Channel Separation: 1 kHz, 30 dB; 20 Hz to 20 kHz, 20 dB.

Weight: 5.5 grams.

Recommended Tracking Force

Range: 1 to 1 1/2 grams.

Inductance: 150 mH per channel.

Resistance: 300 ohms.

Price: \$250.00; replacement stylus, \$125.00.

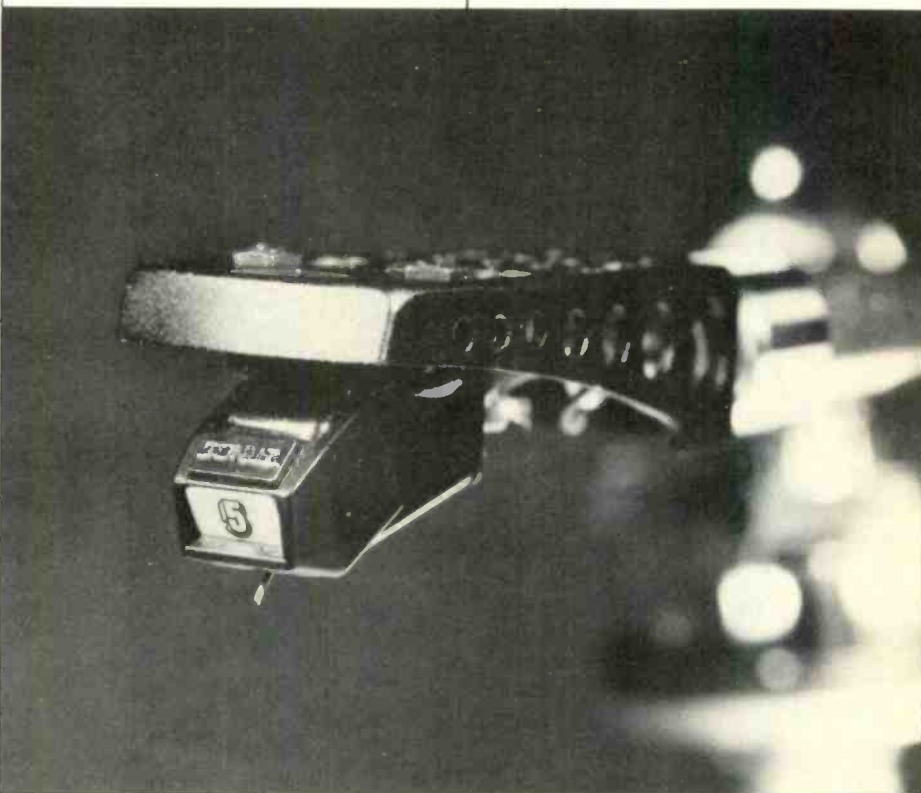

check with a wide-range test record, the CBS STR-120, revealed that the response continued up to about 30 kHz before rolling off gradually.

Separation was 25 to 30 dB in the midrange, decreasing to a quite respectable 17.5 dB at 20 kHz. The square-wave response, shown in Fig. 2, shows a fast rise-time with a single overshoot that is well damped.

Trackability has to be rated as good to excellent. Though the tracking force needed to be increased to 1.5 grams, the Dimension 5 successfully negotiated both the Shure Obstacle Course — Era III's bands four and five and the Deutsches Hi-Fi Test Record No. 2 300-Hz, 80-micron band. IM distortion was quite low — less than 2% at 25 cm/S velocity as measured with the Shure TTR-103 disc.

Output was 4.2 mV at 1 kHz for a 5-cm/S test signal, so that there should be no level or sensitivity problems with a standard preamp or receiver. Channel balance was within 0.5 dB, and thus there will be no shifting image with changes in frequency. Inductance was a relatively low 150 mH, so that a capacitive load should not be at all critical. All of my measurements were made with a total load of 250 pF, but increasing the capacitance to 450 pF produced no significant change in the response in the audio band.

Use and Listening Tests

My listening tests were made with a wide variety of records, which included *Hammond Castle Pipe Organ*, Decibel DB-1000; Earl Klugh's *Finger Paintings*, Mobile Fidelity MFSL 1-025, and Fiedler

We feed the American mind. Take a bite.

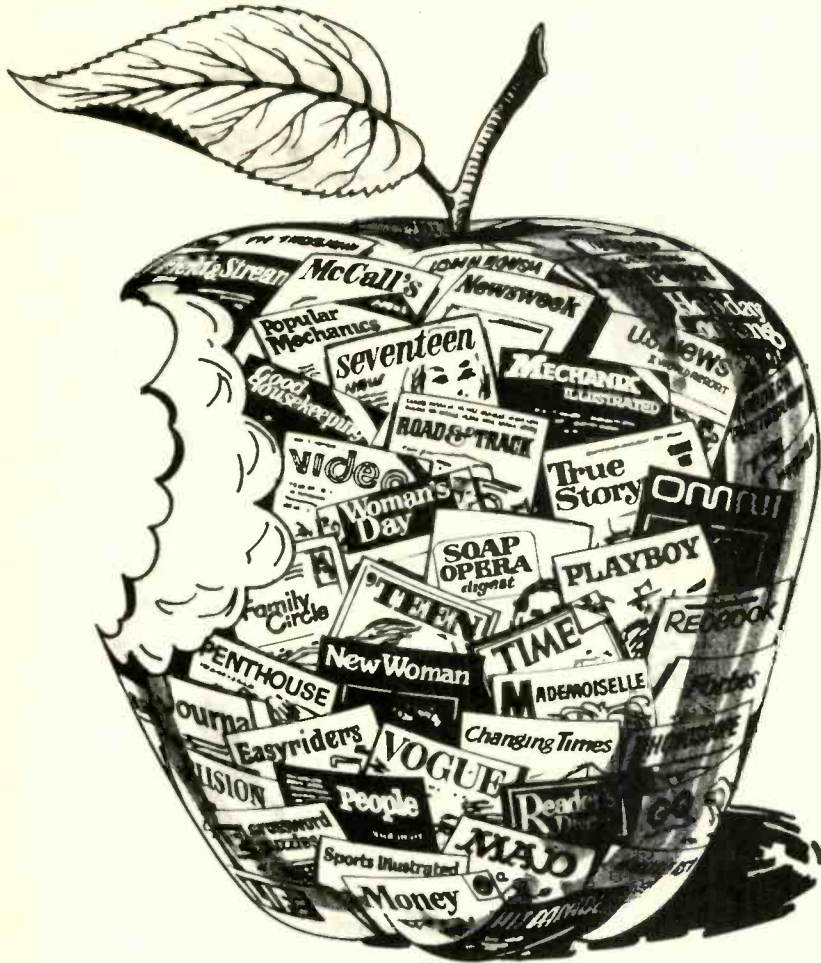

Consider for a moment. Your body needs nourishment about three times a day. But your mind has an insatiable appetite. It's the world's first and still our most intricate computer. It senses. And it absorbs. From the printed word, for example. Meaningful ideas, concepts, thoughts.

You'll find magazines and paperback books at 155,000 stores all across this land. We think they're the kind of nourishment you need. More and more.

Bite into some good reading today.

IPDA



The Dimension 5 has a few equals in trackability, but in distortion I know of no cartridge which offers better test results.

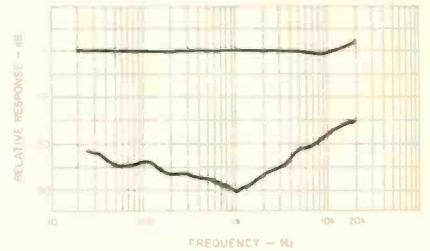

Fig. 1 — Frequency response and separation.

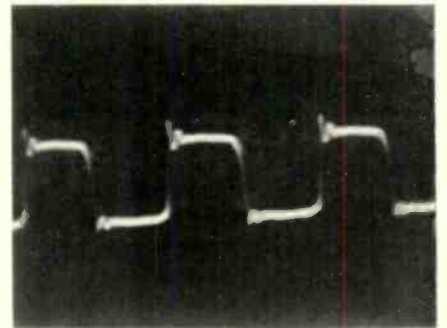

Fig. 2 — Square-wave response.

and the Boston Pops doing Tchaikovsky's *Capriccio Italien*, Crystal Clear CCS-7003. One disc which sounded particularly lifelike was Amanda McBroom's *West of Oz* on Sheffield Lab 15. Incidentally, Peter Pritchard of Sonus tells me that the Dimension 5 is used by Telarc to demonstrate the cannon shots on their *1812*.

Transient response was excellent, while bass was tight and well-defined. The stereo image was stable with a good sense of depth so that large-scale symphonic works were reproduced with a pleasing spaciousness. Occasionally the sound quality had the extra "zing" or "front row center" sort of clarity associated with the rising high end of moving-coil cartridges.

All in all, I must rate the Dimension 5 as a most musical sounding phono cartridge. There are a few which will score equal or higher marks on the trackability tests, but in the distortion measurements, I don't know of any cartridge which comes in with better results.

George W. Tillet

Enter No. 92 on Reader Service Card

4

ACE AUDIO MODEL 4100 FILTERS

The Ace Audio Model 4100 is a band-limiting unit that incorporates both infrasonic and ultrasonic filtering; in other words, it serves to roll off both the high end and the low end. This is handled by a neat little box with *Left* and *Right* input and output jacks, making four in a row — which are a touch too close together for some phono plugs. On the back is an accessory a.c. outlet, a worthwhile convenience in that the outlet the 4100 uses is replaced. The interior layout is open and straightforward, with good separation between the power supply section and the signal filters. For those who like construction, the kit version would be a good choice with a \$30.00 lower price.

Performance

The noise measured at the output jacks with the inputs terminated in 1 kilohm was less than 10 μ V with A weighting. The signal-to-noise ratio referred to 1 V was over 100 dBA, or over 106 dBA referred to 2 V. The frequency response of the 4100 filters is shown in Fig. 1. The -3 dB points were at 17 Hz and 29 kHz. The response was down 2.5 dB at 20 Hz and 1.7 dB at 20 kHz. Between 30 Hz and 10 kHz, the deviations from zero were very small. The high-pass filter is down about 17 dB at 7 Hz, with a slope of 18 dB per octave with decreasing frequency. This design should gain good reduction of record warp effects with very small effect on most music. The low-pass filter serves as a small-signal roll-off device to reduce the possibi-

Manufacturer's Specifications

Infrasonic Filter: -3 dB at 20 Hz, 18 dB/octave.

Ultrasonic Filter: -2 dB at 20 kHz, 12 dB/octave.

Distortion: 0.025% at 2 V output.

Impedance: Input, 47 kilohms; output, 1.5 kilohms.

Gain: Unity.

Maximum Output: 7 V.

Signal-to-Noise: 90 dB, at 2 V.

Dimensions: 4 1/2 in. (113 mm) W x 6 in. (155 mm) H x 2 1/4 in. (58 mm) D.

Weight: 0.9 lb. (0.4 kg).

Price: \$83.00 kit, \$108.50 wired — ordered direct, sent postpaid.

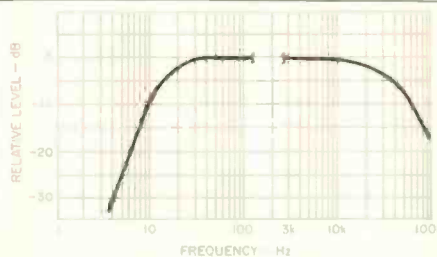

Fig. 1 — Frequency response of 4100 filters.

ty of slew limiting in the power amplifier, as well as removing miscellaneous high-frequency garbage. The attenuation on music energy is very small, but there is a reduction of 17 dB at 100 kHz, where the final 12-dB per octave slope is already well established.

At 1 kHz, the output was just 0.15 dB lower than the input, which is very close to the specified unity gain. At 1 V in/out, THD + N was 0.006% or less, from 20 Hz to 20 kHz, with a good part of the energy from 60- and 120-Hz hum/buzz components. The actual distortion products were down around 0.0015% to 0.0036%, and they did not increase until a level of about 3 V. With 3 V in at 100 kHz, the output amplitude was reduced almost down to 0.3 V, from the filter roll-off, with absolutely no evidence of slew limiting.

The maximum voltages were 7.7 V at 20 Hz, 8.1 V over most of the band and 6.9 V at 20 kHz, plenty high for any normal usage. The input impedance varied quite a bit across the band: 115 kilohms at 20 Hz, 67 kilohms at 1 kHz, and 19 kilohms at 20 kHz. In most cases, the 19-kilohm figure is more than high enough, and the change in impedance would have little or no effect on the signal delivered from connected units. As was expected with the 1.5-kilohm output impedance, there was a drop of a few dB in output when switching loads from 100 to 10 kilohms. The lower load also caused increased attenuation from the high-end filter — a small change, but worth keeping in mind if very flat, extended response is important.

Use and Listening Tests

To check out the Ace Audio filter unit, I inserted it in the normal signal path from the preamp to the power amplifier. First of all, it can be stated that there was no observed deterioration, such as hum or added distortion. It did prove its worth with a few records which have warps, as my present system doesn't have a subsonic filter. I did not get any listening proof-of-performance of the ultrasonic filter as I don't have a slew-limiting problem, but I didn't notice any music missing. For those who need to add such filtering to their present (or future) system, the Ace Audio Model 4100 performs very well and has an acceptable price.

Howard A. Roberson

Enter No. 93 on Reader Service Card

5

DENON DR-330 CASSETTE DECK

Manufacturer's Specifications

Frequency Response: 30 Hz to 19 kHz, to 20 kHz with CrO₂ tape, to 21 kHz with metal tape.

Signal/Noise Ratio: 67 dB, CCIR/ARM weighted.

Separation: 40 dB

Crosstalk: -65 dB

Input Sensitivity: Mike, 0.35 mV; line, 70 mV.

Output Level: Line, 775 mV; head-
phone, 1.2 milliwatts.

Flutter: 0.04% W rms.

FF& RWD Times: 90 S for C-60.

Dimensions: 17 in. (434 mm) W x 4.6
in. (117 mm) H x 11.8 in. (300 mm) D.

Weight: 15.4 lbs. (7.0 kg).

Price: \$500.00.

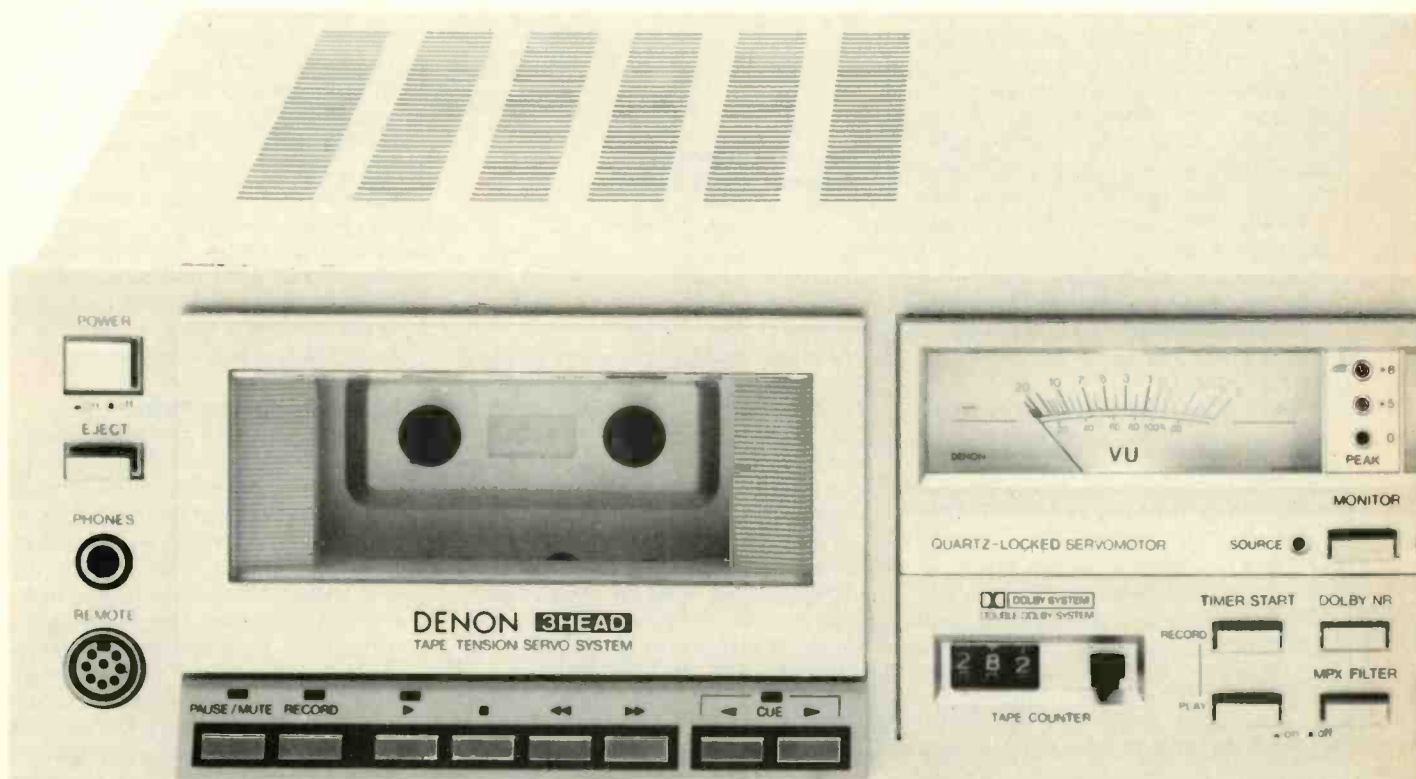
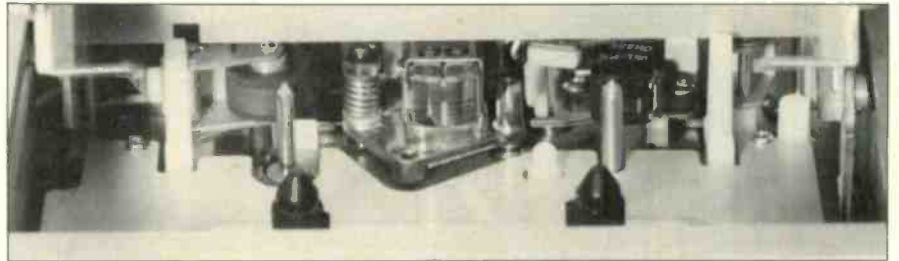

Denon is one of Japan's oldest producers of professional tape recording equipment, with more than three decades of experience in the field. Their machines are seen not only in the broadcast rooms of the Japanese government's NHK stations but also those of privately held stations, and they were one of the first companies to adapt digital or PCM technology to audio recording.

The Denon DR-330 cassette deck combines very good performance and a number of useful features with an attractive appearance for a medium price. The black lettering on the brushed aluminum front panel is quite easy to read, even in dim room light. The cassette compartment door opens smoothly with a push of the eject button. Loading is a simple drop-in, and there is good access for maintenance tasks, particularly with the clear window door snapped off. Worthy of note is the record-head/playback-head assembly for off-the-tape monitoring while recording. The light-touch tape-motion pushbuttons have helpful status lights for *Play*, *Record* and *Pause/Mute*, which last performs in a special way. It gives the expected pause for either play or record functions, but if held in while in the *Record* mode, it mutes the incoming signal (still indicated on the meters if in *Source*), thereby recording a blank space until releasing puts the

deck in *Pause/Record*. This is a good scheme, making one button do what requires two on most other decks. There are also forward and reverse *Cue* buttons which are effective from any mode, allowing relatively fast winding to the beginning or end of a piece. Holding a button in permits winding past any number of selections, and a status light indicates the location of any music (On) or blank sections (Off). This is a less involved design than some, straightforward and easy to understand.

The Denon DR-330 incorporates a Tape Tension Servo System (TTSS), which is designed to maintain a constant and stable tape-to-head contact pressure, and a non-slip reel-motor drive system, which is intended to add to transport stability by eliminating clutches, belts, etc. A sensing arm in the TTSS is inserted in the tape path and feeds information back to the supply motor so that tape tension is kept within fairly strict limits. The reel drive system is similarly electronically controlled. Examination of the drive system led to the conclusion that it was stable and rigid, with the quartz-lock PLL servo motor and large capstan flywheel most impressive.

The two VU-type meters are very well illuminated, scaled up to "+6" with the Dolby-level reference symbol at "+3." There are three peak-responding LEDs between the meters: Green for zero, orange for "+5" and red for "+8," making for a good combination of record-level metering. The monitor switch just below (a convenient location) has associated indicators: Orange for *Source* and green for *Tape*. The inclusion of such indicators is desirable, so it was a little surprising that there was none for the Dolby-NR *On* condition. The multiplex filter in/out switch is a separate pushbutton. There are similar buttons for timer start: One for *Record* with power turn-on, the other for *Play*. The tape counter has a reset button, but the deck has no memory function, which would be nice to have even with the included cue system.

Bias Fine Adjust is an important feature of this Denon deck, and there is a useful detent at zero for the control. *Tape Select* has four positions, including one for FeCr. There is an output level control, sometimes needed for good matching to the rest of a system and essential for headphone listening. Better index marks would minimize possible errors in the above three functions; the knobs might also be on the small side for some, especially the rotary tape-select switch. In contrast, the dual-section input-level pots have large knobs with fine knurling and "just-right" friction between sections. Use of the mike jacks just below does not disconnect the line inputs. The line-power and eject pushbuttons and jacks for phones and remote control are at the opposite end of the panel.

Measurements

The playback responses were similar for both 70- and 120- μ S equalizations: Accurate for most frequencies, but rolled off a few dB at the high end. The play-level meter indications were within 0.5 dB, and play speed was just 0.2% fast. The record/playback responses were made at Dolby level and at 20 dB below that using Denon DX3 (Type I), DX7 (Type II), DX5 (Type III) and DXM (Type IV). Many other formulations could be well matched to the deck using the bias trimmer. The best results with these other tapes were obtained with Scotch Master II, Sony FeCr, Memorex Metal IV and TDK MA-R, with TDK AD, OD and SA, BASF Professional II, Sony EHF and Metallic, Osawa FC, Scotch Master III and Metafine, and Fuji Metal not far behind.

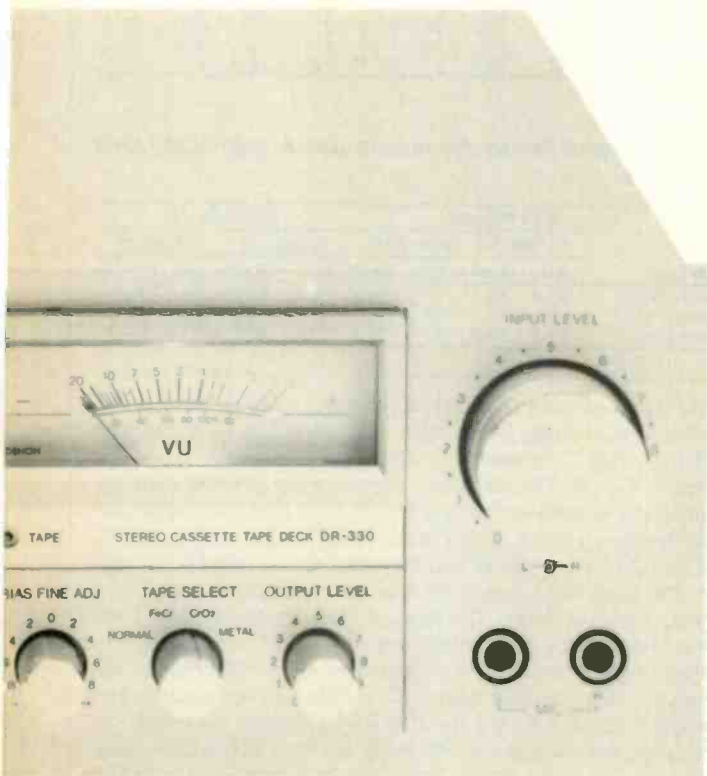

Using Denon's DXM metal tape, the DR-330 had superior performance in both response and in low distortion.

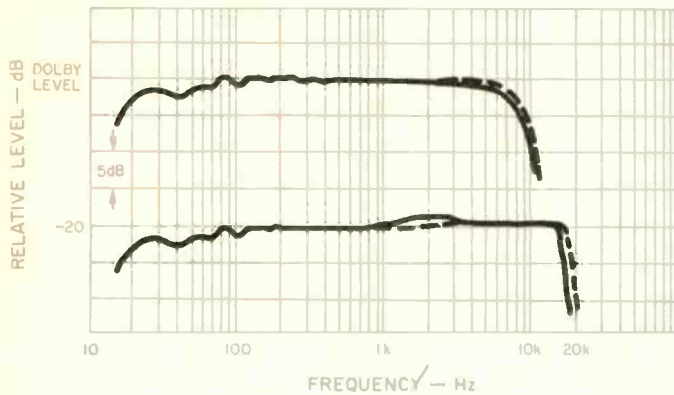

Fig. 1—Frequency responses with Denon DX3 tape with and without (---) Dolby NR.

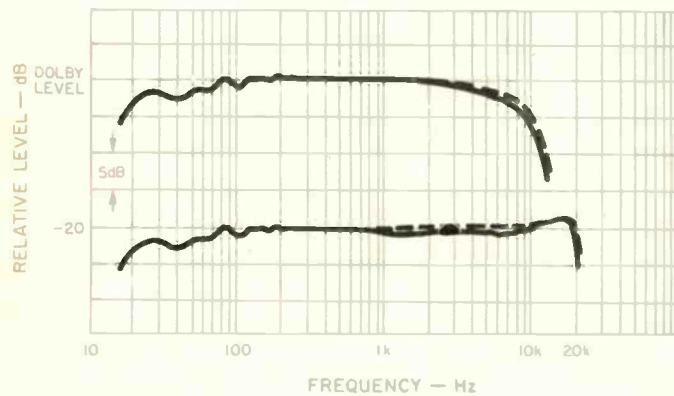

Fig. 2—Frequency responses with Denon DX7 tape with and without (---) Dolby NR.

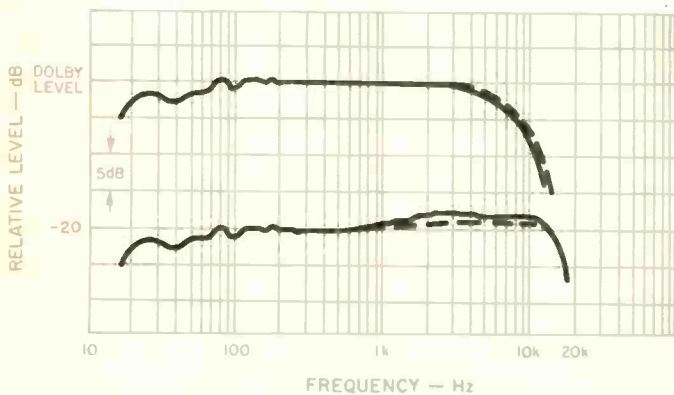

Fig. 3—Frequency responses with Denon DX5 tape with and without (---) Dolby NR.

The best results with the Denon tape came with bias set very closely to that recommended in the instruction manual.

Figures 1 to 4 and Table I show the swept responses and list the 3 dB down points with and without Dolby NR. In general, the responses have very good flatness from 100 Hz to over 10 kHz and excellent Dolby tracking. There is some rise in the response around 3 kHz with DX5, more so with Dolby NR than without. The results, however, are quite superior to those obtained with most Type III formulations on most cassette decks. The superiority of the DXM metal tape is most evident in the headroom extension at Dolby level.

With DX7 tape, the bias trimmer could be set for response anywhere from +1.8 to -4.5 dB at 10 kHz, from minimum to maximum setting. Response of the FM multiplex filter was 1 dB down at 15.4 kHz and had its maximum attenuation of 38.4 dB right at 19.00 kHz — the best observed to date. Bias in the output during recording was very low. With a 1-kHz test tone, separation was 50 dB, and crosstalk and erasure were down at least 80 dB — all excellent figures. Erasure of metal tape at 100 Hz was at least 73 dB, also excellent.

Table I—Record/playback responses (-3 dB limits).

Tape Type	With Dolby NR				Without Dolby NR			
	Dolby Lvl		-20 dB		Dolby Lvl		-20 dB	
	Hz	kHz	Hz	kHz	Hz	kHz	Hz	kHz
Denon DX3	21	7.8	21	16.2	21	8.5	21	18.4
Denon DX7	21	7.3	20	20.0	21	9.0	20	20.3
Denon DX5	21	6.5	20	16.8	21	7.2	20	17.0
Denon DXM	22	11.0	21	20.7	22	12.0	21	21.1

Table II—Signal/noise ratios with IEC A and CCIR/ARM weightings.

Tape Type	IEC A Wtd. (dBA)				CCIR/ARM (dB)			
	W/Dolby NR		Without NR		W/Dolby NR		Without NR	
	@DL	HD=3%	@DL	HD=3%	@DL	HD=3%	@DL	HD=3%
Denon DX3	59.8	63.3	51.3	53.5	57.7	61.2	48.0	50.2
Denon DX7	62.6	65.7	54.8	56.5	61.7	64.8	52.2	53.9
Denon DXM	61.2	68.2	53.0	59.6	59.3	66.3	49.8	56.4

The third harmonic distortion level, HDL₃, was measured with a 1-kHz tone in Dolby mode from -10 dB to that level resulting in HDL₃ = 3%. The results for the Type I, II and IV tapes are plotted in Fig. 5. The excellent performance of DXM over the entire range is quite evident, although DX3 had the lowest distortion below -5 dB re: Dolby level. The three-percent points for DX3 and DX7 were not as impressively high as with DXM; however, the level used would actually be 1 dB above the "+6" maximum on the meter. The level of HDL₃ measured with DXM tape in Dolby mode at a record level of -10 dB is plotted in Fig. 6. These results are superb — less than 0.2% distortion at the frequency extremes, less than 0.07% distortion in midband, and the most unusual 0.016% result at 2 kHz. As the data were not continuous with frequency, the exact curve is in doubt — indicated with the dashed line. A number of points were checked and rechecked, with consistent data in each case.

Signal-to-noise ratios were determined for the DX3, DX7 and DXM tapes with and without Dolby NR, both IEC A and CCIR/ARM weightings. All of these results for both Dolby level and the

It was a pleasure to use this deck with its ability to go to any function without going through the stop mode.

HDL₃ = 3% points are listed in Table II. The perceptive reader may note that there is usually a larger difference between Dolby level figures and 3% limit figures when in Dolby mode than without NR. This is just one indication that there is less distortion with Dolby for most recorders over a range of levels. In any event, the results are excellent, particularly with DX7 and DXM tapes.

Input sensitivities were 0.35 mV for mike, exactly to specification, and 62 mV for line, better than spec. Input overloads were plenty high: 75 mV for mike and over 30 V for line. The line input impedance was 54 kilohms at midband, falling somewhat at the highest frequencies. The output clipping point was at a level equivalent to +14.5 meter indication. The two sections of the input level control tracked adequately for most purposes. The line output was exactly to spec. The headphone drive was more than adequate for any of the headphones tried. The line output impedance was very low (good), less than 200 ohms over the entire band. The output level pot sections tracked within a dB for only about 15 dB down from maximum, rather marginal in performance if level matching to another unit is required. The response time was a little short for a VU meter, reaching 0 dB with a burst of 180 mS. With the standard burst of 300 mS, there was about 1.5 dB overshoot. Scale accuracy was quite good, better than most. The peak-level indicators had thresholds that were exactly as designated, a well-implemented feature.

Flutter was checked both to wtd. pk. and W rms standards. Each trial was separated from the next by using combinations of tape-motion controls to jiggle the tape around before the next check. The Denon deck was unusual in that the results were very consistent, no matter what was done: Excellent figures of 0.06% wtd. pk. and 0.04% W rms. The wind time for a C-60 cassette was 77 seconds. Time for run-out to stop from wind or play was about 2 seconds. Switching between wind directions took much less than a second; from wind to play took less than a second.

Use and Listening Tests

Loading and unloading, cleaning and demagnetizing were all easy tasks with this front-loading deck. All of the tape-motion switches performed without any sort of malfunction, whatever was tried. It was a pleasure to use this go-to-any-function design, and Cue was an added plus at times. Setting levels was quite easy with the high-legibility meters and the peak-responding LEDs. The bias trim control was of continual value, and the FeCr tape-select option allowed trying some tapes not easily used on other decks.

The owner's manual has all of the basic information needed, but some of the text would benefit from a rewrite. A bias setting vs. tape chart is a worthwhile inclusion, but its value would be greatly increased if the listing were more in accordance with the formulations available in this country.

A series of listening tests were conducted using a variety of sources including discs and pink noise. The records were some of the dbx-encoded issues and Mobile Fidelity Sound Lab's offerings, such as Respighi's *Feste Romane* with Maazel and the Cleveland Orchestra, and Genesis and *A Trick of the Tail*. There was excellent sound with all of the tapes, and several times I noted a very pleasant, though slight, increase in presence with Dolby NR.

As expected, DXM stood out in the area of high recording

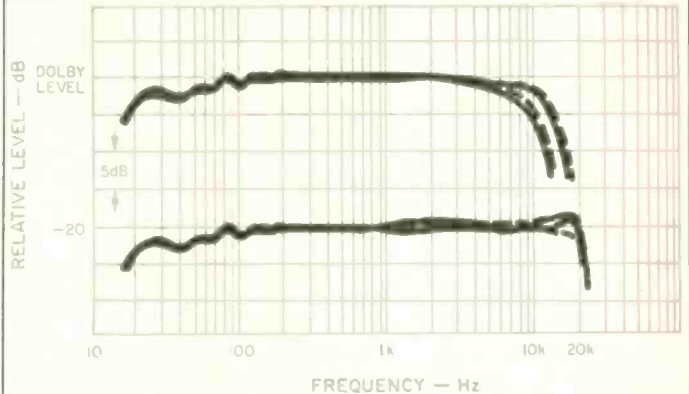

Fig. 4—Frequency responses with Denon DXM tape with and without (---) Dolby NR.

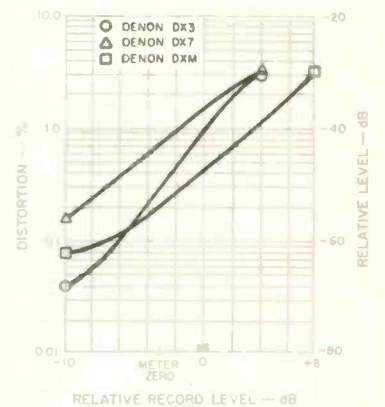

Fig. 5—Third harmonic distortion vs. level in Dolby mode at 1 kHz with Denon DX3, DX7 and DXM tapes.

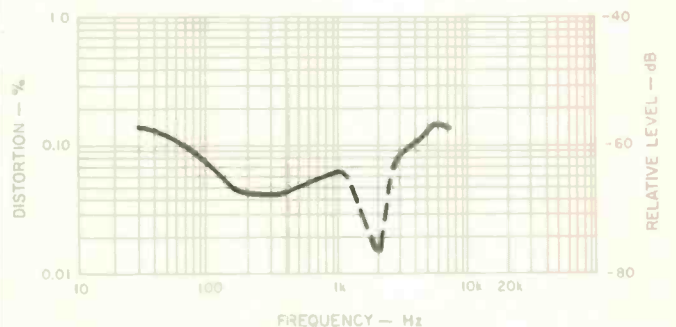

Fig. 6—Third harmonic distortion vs. frequency in Dolby mode at 10 dB below Dolby level with Denon DXM tape.

levels with minimum negative effects. Record mute was judged to be a good scheme. Timer start had about a 3-second delay after power turn-on. No record or pause clicks were detected, and stop sounds were down in tape noise. The Denon DR-330 has very good to excellent performance in most all categories, and it compares very favorably with other units in the same and higher price ranges.

Howard A. Roberson

Enter No. 94 on Reader Service Card

6

TEAC X-20R OPEN-REEL RECORDER

Manufacturer's Specifications

Type: Quarter-track, bidirectional.

Speeds: 3¾ & 7½ ips.

Wow & Flutter: 0.03% at 3¾ ips and 0.04% at 7½ ips, wtd. rms.

Frequency Response: 30 Hz to 28 kHz ± 3 dB at -10 VU, 7½ ips; 30 Hz to 16 kHz ± 3 dB, 3¾ ips.

Distortion: 0.8% at 0 VU.

Signal-to-Noise Ratio: 63 dB; with dbx, 100 dB.

Crosstalk: 50 dB at 1 kHz.

Dimensions: 17 in. (43.18 cm) W x 18 in. (45.72 cm) H x 9 in. (22.86 cm) D.

Price: \$1,400.00.

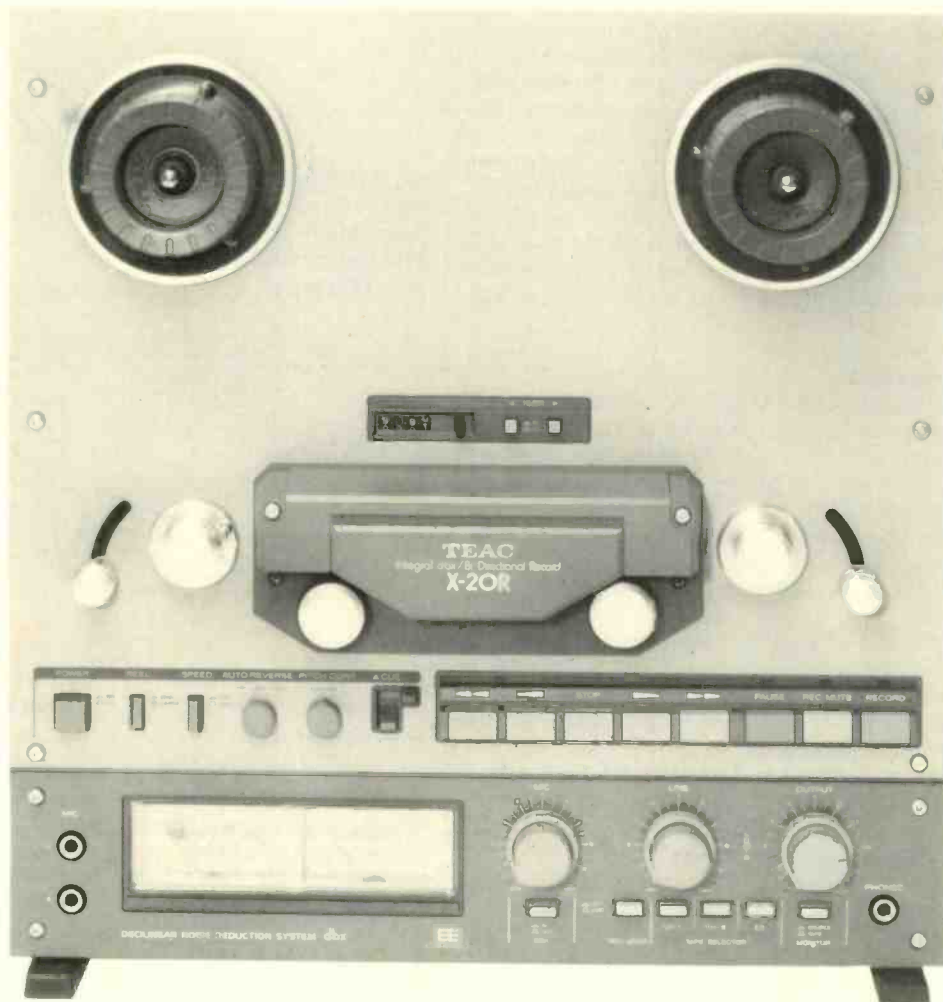
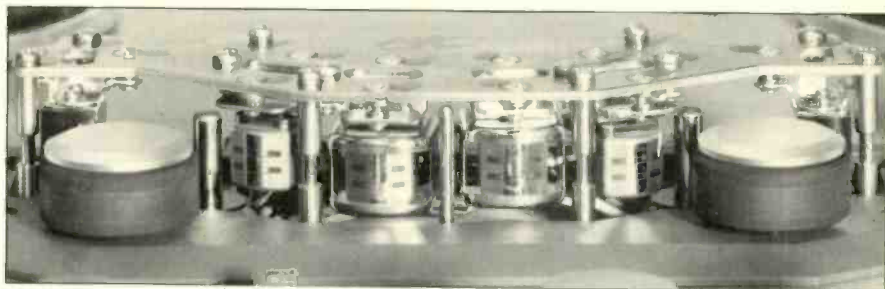

When quality cassette decks came along, many experts were quick to prophesy the early demise of open-reel machines but here they are, nearly 20 years later, alive and well. In the last *Audio Equipment Directory*, there were some 46 machines listed from 14 manufacturers. Although cassette decks have improved enormously over the past few years, open-reel models still offer many advantages. Headroom over the whole band is better, frequency response is wider, and then there is the ability to edit. Signal-to-noise ratios are around 65 dB without noise-reduction systems, and if a dbx unit is employed, as it is here, you have a dynamic range capability of 100 dB!

At the present time, few machines have a dbx system actually built-in. One of them, however, is TEAC's X-20R deck which is a quarter-track model with bidirectional record and playback capability. It features a monitor head, full-logic controls, provision for large reels, and a pitch control. The front panel measures 17 inches wide by 18 inches high, including the feet, and it is finished in gray with a brown subpanel at the bottom. Two large VU meters are on the left of this small panel, and three dual-concentric controls are located to the right. The first knob is for microphones, the second controls the line input, and the third is the output control. Underneath are pushbutton switches, one each for dbx noise reduction and *Rec Mute*, three for tape selection, and then one for tape/source monitoring. Microphone sockets are at the extreme left, while the phone jack is over on the right. Above the VU meters on the main panel are the following switches: On-off, small/large reels, speeds (3 3/4 or 7 1/2 ips), auto-reverse, pitch, and a lever marked *Cue*. This last disengages the tape lifters in the fast wind or pause modes so the user can listen for the beginning or end of a particular selection. Next to the *Cue* lever is a line of tape transport pushbuttons which include a *Pause* button, one marked *Rec Mute* and, right at the end, one marked *Record*. There are, in fact, two *Record* buttons but I'll explain that later. Above the tape head assembly is a digital counter and two timer buttons — one for each tape direction. There are three motors, and the transport system uses a dual-capstan closed-loop drive. This kind of system isolates the tape from tension produced in the reels, and the stability is usually better because the length of unsupported tape is kept to a minimum. The capstan shaft is kept in firm contact with the thrust bearings by an arrangement of two magnets TEAC calls "Magnafloat." Thus, the capstans maintain a precise axial relationship to the tape without the use of springs or pressure plates.

Table I — Signal-to-noise ratios vs. tape speed and tape type. ("A" weighted, re: 3% THD; all tapes are from Maxell.)

Speed — ips	Tape Type	S/N — dB
3 3/4	UD 35-90	63
3 3/4	XL II 35-90	66
7 1/2	UD 35-90	65
7 1/2	XL II 35-90	68

Input and output sockets are in a convenient angled recess at the rear, together with a multi-socket for a remote-control unit, Model RC-100.

This is one of the first machines offered with the ability to handle the new EE or extra efficiency open-reel tapes, which can be thought of as chrome or chrome-equivalent tapes for

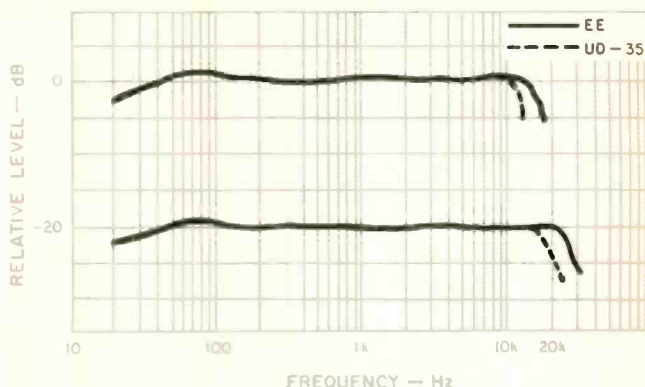

Fig. 1 — Record-replay response at 3 3/4 ips.

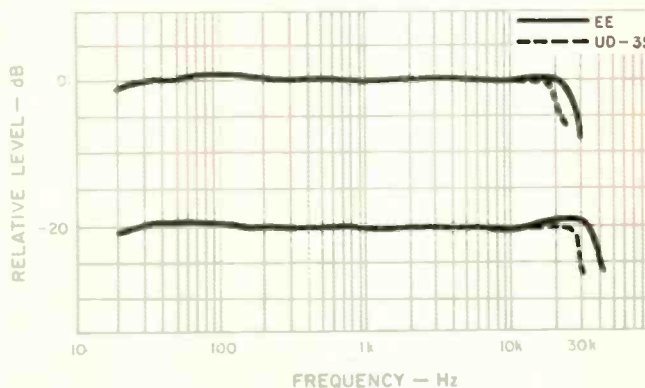

Fig. 2 — Record-replay response at 7 1/2 ips.

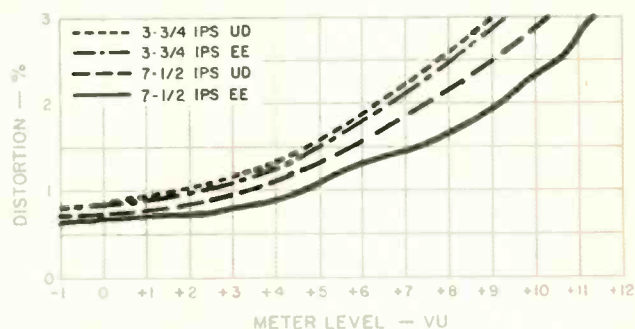

Fig. 3 — Distortion and headroom at 1 kHz.

such decks. As we will see later, there is a significant improvement in both headroom and frequency response in such a machine, so that slower speeds can be used with quite good results. Since open-reel tapes are not inexpensive, this can produce a real savings in tape costs, as well as making for ease in recording because the setting of levels is not so critical.

The X-20R open-reel recorder was a delight to use. The logic controls worked smoothly, while the VU meters were remarkably accurate.

Measurements

The playback response with standard test tapes was within ± 1 dB from 40 Hz to 18 kHz at $7\frac{1}{2}$ ips and within ± 2 dB from 40 Hz to 12 kHz at $3\frac{3}{4}$ ips, showing the normal slight rise at the high end. As mentioned above, the X-20R is one of the first machines designed to take advantage of the new EE tapes, so this was the kind used for most of the tests. The type selected was Maxell XL II 35-90, and it was compared with a standard Maxell high-efficiency formulation (UD 35-90). Figure 1 shows that the EE tape extended the 0 VU response from 12 to 16 kHz and the -20 VU response from 19 to 24 kHz. At $7\frac{1}{2}$ ips (Fig. 2) the gain was from 19 to 23.5 kHz and from 28 to 33.5 kHz. Headroom at 1 kHz can be seen in Fig. 3: Note that 0 VU is at 185 nWb/m and that there is 8 to 11 dB headroom.

Distortion versus frequency is shown in Fig. 4, and these measurements were made at 0 VU, not at -10 dB. It looks as if the claim that "EE tapes can increase the response at $3\frac{3}{4}$ ips to equal the response of ordinary tapes at $7\frac{1}{2}$ ips" is a reasonable one. However, I found that the gain in signal-to-noise ratios to be just as important, and the figures are given in Table I. Switching in the dbx system increased these figures by about 40 dB. The expansion ratio is the standard 2:1 — the same as for the dbx-encoded records. However, no provision is made for using the unit for records — which seems a pity, though, curiously enough, a switch for this purpose is provided on TEAC dbx cassette decks!

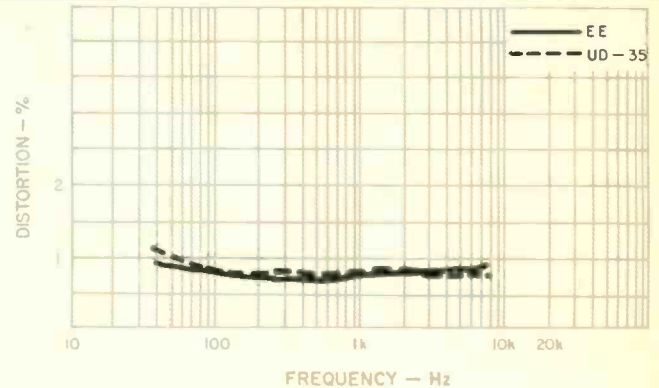

Fig. 4 — Distortion vs frequency.

But here are some more figures: Input required for 0 VU was 73 mV line and 0.23 mV for microphone. Output varied between 600 and 700 mV, depending on the kind of tape used. Maximum signal handling capacity at the microphone inputs was 27 mV. Signal-to-noise ratio decreased by 6 to 7 dB when a microphone was connected. Wow and flutter measured 0.02% at $7\frac{1}{2}$ ips and 0.035% at $3\frac{3}{4}$ ips (DIN 45-507). Rewind time was 62 seconds for an 1800-ft. reel. The pitch control gave a variation of $\pm 6\%$. Crosstalk was better than 50 dB at 1 kHz and 40 dB at 10 kHz. Erase efficiency was better than 70 dB. Finally, the VU meter ballistics were checked and found to be within 0.5 dB of the ANSI standard response for 300-mS pulses.

Use and Listening Tests

The procedure for recording is as follows: Having selected the correct position for the tape selector buttons, the *Rec Mode* button is pushed. The indicator located just above the red *Record* tape-transport button will now show a flashing light, so the next step is to depress this button at the same time as one of the two *Play* buttons. If so desired, the *Pause* button can be pressed and the input levels checked before actually commencing recording. If a mode change is made during recording or playback, the tape motion stops and there is a 5-second delay before the new mode starts to operate. Thus, the tape can be switched from slow to fast speeds, forward to reverse without any danger of the tape breaking.

I found the machine a real delight to use: The logic controls worked smoothly, with a nice professional feel, while the VU meters were remarkably accurate. The above-average headroom — especially with EE tape — is a definite plus, as is the convenience of bidirectional operation. And then there is the dbx facility with its almost incredible 100-dB-plus range. I made a number of dbx recordings and found that the best results were obtained with the VU meters kept below the 0 mark on peaks. If the signals were peaking in the +2 or +3 dB range, a slight breathing effect could be heard. I imagine most readers will have heard a dbx system at one time or another, but for those who haven't, the tremendous dynamic range and dead quiet background will be a revelation.

George W. Tillet

Enter No. 95 on Reader Service Card

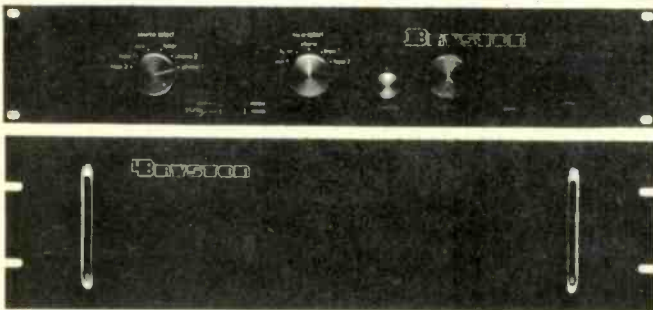

the perfect combination...

The musical accuracy of Bryston components is a revelation. Every note emerges with perfect clarity from a background of silence, then vanishes. The progression of musical events seems real, tangible, almost visual in its presentation...

Bryston believes there is a need for reference standards of musical accuracy. That is why we designed our Models 2B, 3B and 4B power amplifiers, and our Model 1B preamplifier. Their only reason for existing is to provide the most faithful electronic rendition of a musical signal possible within the bounds of available technology. Write to us and we'll tell you how we do it, and where you can listen to our perfect combination.

IN THE UNITED STATES:

BRYSTON VERMONT
RFD #4, Berlin, Montpelier, Vermont 05602
(802) 223-6159

IN CANADA:

BRYSTON MARKETING LTD
57 Westmore Dr., Rexdale Ont., Canada M9V 3Y6
(416) 746-0300

Enter No. 5 on Reader Service Card

CLASSIFIED ADVERTISING RATES

BUSINESS ADS- 75c per word, minimum charge \$6.00 per line for spaced ads specifying five or less words per line. First line set in bold face type at no extra charge. Extra words set in bold face type \$1.00 per word. One point ruled box, extra charge \$8.75. **ORDERS WILL NOT BE PROCESSED WITHOUT ACCOMPANYING CHECK OR MONEY ORDER FOR FULL AMOUNT.**

NON BUSINESS ADS- 50c per word, minimum charge \$4.00 per line for spaced ads specifying five or less words per line. First line set in bold face type at no extra charge. Extra words set in bold face type \$1.00 per word. One point ruled box, extra charge \$8.75. **ORDERS WILL NOT BE PROCESSED WITHOUT ACCOMPANYING CHECK OR MONEY ORDER FOR FULL AMOUNT.**

FREQUENCY DISCOUNT- 3 times, less 10%. 6 times, less 15%. 12 times, less 20%. (line copy ads only). AGENCY DISCOUNTS DO NOT APPLY TO LINE ADS.

DEADLINE- 1st of month two months preceding the cover date. If the first of the month falls on a weekend or holiday, the closing date is then the last business day before the holiday or weekend. ADS RECEIVED AFTER THE CLOSING DATE WILL BE HELD FOR NEXT ISSUE UNLESS OTHERWISE STATED.

BLIND ADS- Box numbers may be used at \$5.00 extra for handling and postage.

GENERAL INFORMATION Ad copy must be type-written or printed legibly and received on or before the 1st of the month, two months preceding the cover date. Display advertisers must make a space reservation on or before the closing date, material (Camera Ready Only) may follow by the 10th. The Publisher, in his sole discretion, reserves the right to reject any ad copy he deems inappropriate. All advertisers must supply: Complete name, Company name, Street address (P.O. Box is insufficient), and telephone number before ads can be published. Classified ads are not acknowledged and do not carry Reader Service Card Numbers. Frequency contracts not fulfilled will be short-rated accordingly. Ads submitted for a 3 time frequency or less are unchangeable. Classified ads are payable in advance **BY CHECK OR MONEY ORDER ONLY.** (Sorry, we can not accept credit cards.). Additional information available upon request. Contact: Laura J. LoVecchio, Advertising Coordinator, 1515 Broadway, NYC 10036 . . . Direct Dial (212) 975-7530.

MAIL ORDER AND DISPLAY CLASSIFIED RATE

1 col x 1"	\$175
1 col x 2"	\$275
1 col x 3"	\$375
2 col x 1"	\$275
2 col x 2"	\$475

ADVERTISER MUST SUPPLY COMPLETE FILM NEGATIVE READY FOR PRINTING FOR DISPLAY ADS. PRODUCTION CHARGES WILL BE ASSESSED ON AD REQUIRING ADDITIONAL PREPARATION.

AUDIO Magazine
1515 Broadway
New York, N.Y. 10036

HOW TO ANSWER BOX NUMBER ADS
When replying to an Audio Box Number Ad, please use this address Box No. — c/o Audio, 1515 Broadway, New York, N.Y. 10036

FOR SALE

AAAAAH AUDIOPHILES — FINALLY FOUND YOU! We are an **AMERICAN** enterprise specializing in the direct sale of **JAPANESE** cartridges • tonearms • transformers • cables • interconnects (yes — BANSEI available) • accessories • etc. All manufacturers—lowest prices. Advise your requirements—we'll quote immediately. **INTERSONICS**, PO Box 113, Toyohashi 440, JAPAN.

AAAAHH, AT LAST — POLYPROPYLENE DRIVERS, Ribbon Tweeters, Xovers, Horns, Plans, Replacements, Ferrofluid Domes, Catalog \$1.00. **SOUNDBOX**, Dpt. A 411 South Carliste Street, Philadelphia, PA 19146

AAA—COMPONENTS FOR THE AUDIOPHILE. Q/LC Audio has the Q/LC Bass Module, Haffler, Marcol, PS Audio, Audire, Amber, Adcom, Vandersteen, Precision Fidelity, Grace, Lustre and much more. All at reasonable prices. Call or write Q/LC Audio, 1006 Berkshire Road, Dayton, Ohio 45419 or (513) 439-1745 or (513) 293-7287. Dealer inquiries welcome.

ABARGAIN! Grace F9E \$129; FR201 \$212. All unused (212) 784-2939.

FOR SALE

AAA-HIGH PERFORMANCE LOUDSPEAKER kits wholesaled to the public. Package deals featuring NAD, YAMAHA electronics, Japanese Tonearms and Cartridges. New, used and demo. Audioworkshop, 5823 Thurgood Lane, Jacksonville, FL 32209 and 3303 East Denny Way, Seattle, WA 98122.

ABARGAIN: Technics EPA-100, \$235., FRMC-201, \$175., Lustre GST-801, \$250., Dynavector ruby, \$180., Supex SDX-100, \$250., JVC UA-7045, \$170., Grace F9E, \$129., Latest Promethean, \$110., Series-20 crossover, \$499.. Want AR3a. ALL UNUSED (212) 784-2939 evenings.

A BARGAIN! YAMAHA M4 AMPLIFIER, C4 PREAMPLIFIER, BRAND NEW, SEALED \$650 THE PAIR OR WILL SPLIT. YAMAHA MC1-S CARTRIDGE BRAND NEW SEALED \$110. AUDIO PRO B2-50 SUBWOOFER MINT \$575. BILL GALLAGHER, 723 HIGGANUM ROAD, DURHAM, CT 60422, (203) 349-1560.

"A BASIC 400W POWER AMP FOR ONLY \$269?" YES! "BLACK BOX 410" 200/200W kit includes preassembled boards, cooling fan, assembly manual. 1-year parts warranty. VISA/MC, CODs welcomed. (614) 889-2117. SCC, Box 551, Dublin, OH 43017.

A BETTER NAD '20 SERIES!

Get the most from the classic circuitry of your NAD 1020, 3020 or 7020. The Kindel Audio modified NADs rival any preamp for sheer listenability. Call or write for complete information and prices. Kindel Audio, 1710 Newport Circle, Unit 0, Santa Ana, CA, 92705.

WHEN THE MONSTER SPEAKS . . . EVERYONE LISTENS.

Monster Cable significantly improves the sound of any sound system for very few dollars. Designed specifically for audio signals, Monster Cable's high purity copper stranding and exclusive "Duraflex™" jacket make it the choice of audiophiles and professionals worldwide.

For all current Monster Cable owners, see our new precision gold connectors that give you more contact area and greater contact pressure for positive contact. Ask your audio dealer for a Monster demonstration.

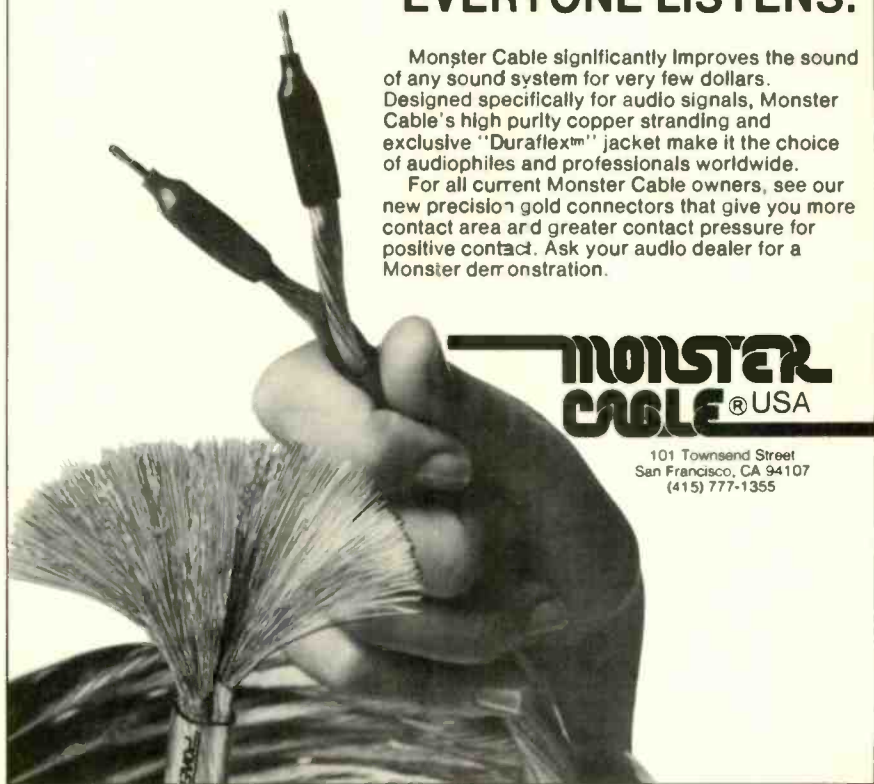

MONSTER CABLE® USA

101 Townsend Street
San Francisco, CA 94107
(415) 777-1355

Fans

International Mark 1
Sales & Repairs

FONS CQ30 Finest belt drive electronic transcription turntable. \$200 without tone arm.

Send money orders to:

LORD BROTHERS P.O. Box 6430, Denver, Colorado, 80206, 303-534-7590. Will ship same day.

Full price \$200.00 shipping included.
Or send 25% — balance plus shipping COD.
Colorado residents add tax. Ninety day warranty.

High Performance Review

Full tests and listening evaluations: equipment from B&W, Threshold, KEF, Denon, SAE, Hafler, Dynavector, Technics R&B, STD, ADC, Ariston, Teac, Trans Audio (Oracle), Studer-Revox, Tandberg, Fidelity Research, Acoustat, Thorens, ADS, Sumiko (Grace), Apt, Sony Esprit, Ortofon, JVC and more. The latest and best units.

The first audiophile magazine with all of these features:

Technical Advisory Board: J. Robert Ashley, University of Colorado at Denver; Elliot Mazer, record producer/engineer; James A. Moorer, Lucasfilm, Ltd. and Stanford University; Vincent Salmon, acoustical consultant.

Comprehensive equipment tests using state-of-the-art precision instrumentation from Tektronix, Bruel & Kjaer and Hewlett-Packard.

Careful subjective listening evaluations under controlled conditions.

Authoritative reviews of over 70 recordings per issue: Popular, jazz and classical—find high quality sound plus outstanding performances among current releases.

Expert opinion on important developments in audio technology. Discussion of current problems and possible improvements.

High/Performance Review has the best features available. Our magazine tells you what you want to know about high quality audio components and records. Knowledgeable critics have called our first issue "... Impressive, unbiased... good concept... detailed reviews... for the serious listener." Join us today. The special charter subscription rate is \$24.00, one year, four issues. Our issues average over 120 pages each. We have published over 240 pages thusfar—Issues 1 & 2 are ready now. Each issue has a colorful cover and is printed on fine quality paper. Don't miss out! Send your order today. Money-back guarantee (send for details).

High/Performance Review

Box 2989; Stanford, CA 94305 USA

Yes, enter my charter subscription. All subscriptions begin with Issue 1.

I enclose \$24.00 by check or money order.

Overseas and Canadian subscribers: Please note that payment must be in US Funds Net payable on US Bank or Agency. Add \$4.00 for non-USA postage.

Name _____

Street _____

City _____

State _____ Zip _____

For Questions: Telephone: (408) 446-3131, M-F 10-4 (Pacific Time)

FOR SALE

ABATE THE HIGH COST OF YOUR NEXT AUDIO PURCHASE! DIRECT DISCOUNTS LTD. offers many of the finest lines of audio gear from budget equipment to typically non-discounted components, cartridges, speakers, etc. Whether you're a novice or seasoned audiophile, we believe that our incredibly wide selection, low prices and helpful advice could make us your one-stop audio bargain place. Some of the lines that we offer include ADVENT, AR, ADCOM, BOSE, dbx, DENON, ESS, HAFLER, HARMAN/KARDON, INFINITY, MITSUBISHI, NAD, NIKKO, ONKYO, PHASE LINEAR, SAE TANDBERG, THORENS and many many more. As an added service to our customers, we also offer video equipment (incl many of the Large-screen Tvs, VCRs, etc.) and even a new "wireless" extension telephone for less than \$200.00 (sugg. retail \$560.00). Just call us at (212) 254-3125 for additional prices or information, or send \$2.00 for our current brochure to: DIRECT DISCOUNTS LTD., P.O. Box 841, Cooper Station, NY 10276. Shop with us by phone with your VISA or M/C. No sales tax charged to out-of-state customers!!

A BETTER DEAL

AUDIO DISCOUNTS OFFERS A QUALITY SELECTION OF AUDIO COMPONENTS AT DISCOUNT PRICES. FOR SPEAKERS, RECEIVERS, CASSETTE-DECKS, TO TURNTABLES, CARTRIDGES, ETC., OR A NEW CAR STEREO. GREAT PRICES, SERVICE AND OUR FRIENDLY SALES STAFF WILL BE GLAD TO ASSIST YOU. FOR MORE INFORMATION MONDAY THRU SATURDAY, PLEASE CALL 301-593-8224 — 301-593-8244 OR WRITE TO AUDIO DISCOUNTS, 1026 MCCENEY AVENUE, SILVER SPRING, MD 20901. WE HONOR VISA & M/C AND C.O.D. FOR YOUR CONVENIENCE.

ABSOLUTE AUDIO: MISSION, RGR, SNELL, NAD, Leach, V.P.I., Oracle, Thiel, Revox, Marcof, Platter Matter, Audio File 1202 South Congress Avenue, Austin, Texas 78704, (512) 443-9295.

ABSOLUTELY BEST VALUE S.O.T.A. BUY DIRECT TAX & DUTY FREE. New model Mayware MKIV tone-arm \$135 (Better than Formula 4) Mayware MC-2V moving coil cartridge Ogura Nude 'Vital' super-polished diamond stylus, incredibly only \$79. MKIV/MC-2V sounds better with more punchy bass than Ittok/Koetsu. Mayware astatic cohesive 'Platter Mat' \$15. VISA/MC accepted. Literature \$1 bill. Mayware P.O. Box 58 Edgware, Middx. England.

ABSOLUTELY THE LOWEST PRICES AVAILABLE on hard-to-find audio. SAE, Soundcraftman, Nikko, Phase Linear, and many others. Prompt delivery. Free Catalogue on request. DURON DISCOUNT AUDIO 7 South State Street, Concord NH 03301 (603) 225-3094 VISA/MC Accepted.

ACCURATE AFFORDABLE AUDIOPHILE EQUIPMENT. Specialists in Cartridges-Tonearms-Turntables-Headamps. We offer: QUALITY ADVICE * FAST SERVICE * REASONABLE PRICES. Please! Call or write. You'll be glad you did! HCM AUDIO, Box 2029-G, Chico, CA 95927 (916)343-0558

ACCURATE, QUALITY HOME/CAR AUDIO AFFORDABLY PRICED! Denco Audio, P.O. Box 6104-U, El Monte, CA 91734. (213) 961-6158 evenings, weekends. Send Stamp—MONTHLY SPECIALS, FREE CONTINENTAL SHIPPING, MC/VISA.

ACOUSTIC RESEARCH-9'S SPEAKER's. Brand new, less than 50 hrs. used. Full 5 yr. warranty in effect. Must sell for \$1300. Call (609) 734-0197 ask for Phillip.

FOR SALE

ABSOLUTE ACCURACY

APATURE • AUDIONICS
ARMSTRONG
AUDIOSTATIC
BEDINI • BERNING
BEVERIDGE • B & W
CHARTWELL • COTTER
CONNOISSEUR
DAYTON-WRIGHT
DECCA • DENNESEN
DYNASECTOR
EIDOLON RESEARCH
FRIED • FR • GRACE
GNP • GRADO • HAFLER
HARMAN KARDON
KEITH MONKS
KOETSU • LUSTRE
LIVEWIRE • MIRAGE
MUSICAL FIDELITY
MUSICMAT • ORACLE
PETERSON • PLEXUS
PLASMATRONICS
PROMETHEAN
PSE • REVOX • RH LABS
RGR • SHAHINIAN
SOTA • SOUND LABS
SPATIAL • STAX
STRELIÖFF • SUPEX
SUMIKO (THE ARM)
3D ACOUSTICS
VANDERSTEEN
WIN LABS & MORE

since 1974 Audio One has consistently offered the ultimate in musically accurate components — before the reviews, try the 'World Class' audio store for your next purchase... there is a difference.

AUDIO ONE

Beverly Hills CA 90211 By Appointment
(213) 276-7776
Hemosa Beach CA 90254 820 Pacific Coast Hwy
(213) 555-1212
Birmingham MI 48011 1650 South Woodward
(313) 646-6666

ABSOLUTE SOUND

MICHIGAN'S HIGH ACCURACY AUDIO DEALER
Will ship postage prepaid anywhere in the United States

CONRAD JOHNSON BOSTON ACOUSTICS

NAIM AUDIO LINN SONDEK

DAHLOQUIST NAKAMICHI

MISSION SPECTRUM

HAFLER GRACE

NAD APT

REGA STAX

REVOX ONKYO

SNELL DELPHI

SPENDOR BRYSTON

THRESHOLD POLK AUDIO

HARMON KARDON GRADO SIGNATURE

Or visit any one of our stores in Southeastern Michigan

DETROIT — 12400 Morang (313) 527-2244

ROYAL OAK — 4354 N. Woodward (313) 549-7550

ANN ARBOR — 312 S. State Street (313) 662-2026

E. LANSING — 1045 E. Grand River (517) 351-9300

Mastercard, VISA, American Express, Diners accepted

CROWN DISTINCTION SERIES: FM-1, EQ-2, DL-2, SA-2, ETC., IN STOCK — BEST PRICES — IMMEDIATE SHIPMENT. (213) 467-5725.



Audire

Introduces a limited production amplifier, **FORTE**, and preamplifier, **DIFFET 2**. They have been uncompromisingly designed for the discriminating listener who appreciates the finest in sound reproduction.

Write or call for literature and dealer list - AUDIRE, INC. 9576 EL TAMBOR AVE., FOUNTAIN VALLEY, CA 92708 - (714) 968-1236

FOR SALE

ADIRONDACK AUDIOPHILES Northern New York State House of Hi-Fi is now open with Mariah, Polk Audio, DCM Time Windows, NAD, Harman Kardon, Sola, Audionics, Apt-Holman, Halfer, Hegeman, Eumig, McIntosh, Marcof, Nakamichi, Fidelity Research, Toshiba, Sony, Signet, Alpine Car Stereo, Denon, Shahanlan, Conrad Johnson, RG Dynamics. For Info. call 518-793-6639 Mon. to Fri. 10-9 Sat. 10-6. HOUSE OF HI-FI, 50 Miller Rd., (Rt. 9) Glen Falls, N.Y. 12801.

ADVENT SOUNDSPACE CONTROL, original carton, manual, mint cond., \$300., 1-317-521-3247 or 1-317-521-1174.

AFFORDABLE ESOTERICA

Central NY State

RGR APT
OED*NAD MISSION
MIRAGE*LAST HAFLER*KLIPSCH
3D ACOUSTICS*B&O M&K*MONSTERCABLE
BOSTON ACOUSTICS*PLATTER MATTER*CARTALIGN
STELLAR STEREO
384 Elmira Rd., Ithaca, NY 14850 607-272-2644

AGFA & AMPEX 10 1/2" & 7" OPEN REEL TAPES — THE BEST! THE FINEST CASSETTES: DIRECT TYPE II (C68 & C96) and ASF (C66 & C96). DIRECT-TO-TAPE RECORDINGS for the finest recorded sound available, called "Truly superb" by Charles Repka in AUDIO (Oct, 1980). Only available on real time duplicated reels & Cassettes, optional dolby or dbxII. Ampex video cassettes. WRITE for FREE newsletter subscription & current specials. Direct-To-Tape Recording Co., 14 Station Ave., Haddon Heights, NJ 08035.

HARMAN-KARDON HIGH TECHNOLOGY SEPARATES, RECEIVERS, CASSETTE DECKS: ELECTRO-VOICE INTERFACE A, B, C, D SPEAKER SYSTEMS: THORENS TURNTABLES. ALL IN STOCK — IMMEDIATE SHIPMENT.
EAST: 305-462-1976 WEST: 213-243-1168

AILING EQUIPMENT? We make house calls! Your system can sound better. S.O.TERIC, 5256 Section Avenue, Cincinnati, OH 45212. (513) 396-6042.

ALL MAJOR BRAND AUDIO @ WHOLESALE. A & T Audio, Springfield, Ma. (413)737-6227.

ALL-NEW, QUALITY FM-SCA ADAPTER CONVERTS YOUR FM set to double as a receiver of hidden talk, music programs. Instructions and catalog included. \$10 kit; \$17 assembled unit. FM Atlas, Adolph MN 55701.

AMAZING? ISN'T IT

The amount of nonsense that gets thrown around in the audio world. If you are sick of being treated like a 5-year-old child by shoe salesmen masquerading as audio experts, you owe it to yourself to give us a call. Our opinions are based on a solid foundation of experience with the components we sell as well as those sold by our competitors. Most importantly we don't simply sell the finest audio equipment available, we arrange it in complementary systems designed to extract the greatest benefit from your audio dollars chosen from among the following lines we represent:

ACOUSTAT, ACOUSTIC ELECTRONICS, AUDIO RESEARCH AUDIBLE ILLUSIONS, ADCOM, AUDIO INTERFACE, AUDIO CONTROL, CARVER, DENNESSEN, DCM, DECCA, DYNAVECTOR, ENTRE, FULTON, GRACE JR, LINN SONDER, LUSTRE, MARCOF, MERIDIAN, MICHAELSON AUSTIN, MONSTER CABLE, MORDAUNT-SHORT, MUSICAL FIDELITY, NAIM AUDIO, NAD, ORACLE, POWER LIGHT, POINT SOURCE, PRECISION FIDELITY, QUAD, REGA, ROGERS, SNELL ACOUSTICS, SOUNDLABS, SPATIAL COHERENCE, STRELIUFF SYSTEMS, STD, STAX, SUPEX, TANDBERG, THETA, TECHNICS, R&B

SOUND BY SINGER, LTD.
227 Lexington Avenue
New York, NY 10016
(212) 683-0925

We ship anywhere (A.E., M.C., VISA ACCEPTED)

AMBIENCE DECODER FOR REAR CHANNELS, \$149.95. Literature 50c. Huntington Electronics, Box 2009-A, Huntington, Conn. 06484

ANTI-SKATING for AR TURNTABLES!! Proven counter-weight design of nickels steel & aluminum construction. Install yourself in minutes. \$7.95 postpaid. (Dealer inquiries invited.) AUDIO INNOVATIONAL PRODUCTS, P.O. Box 1607, Portsmouth, N.H. 03801.

FOR SALE

A NEW BATCH OF GOODIES IN JACKSONVILLE! Improve your Grace F9E or L with the new ruby stylus • High performance and low price typify the sota sapphire turntable, a real beauty! David Berning Co.'s superlative TF-10 preamp/EA-230 power amp, simply the finest currently available • Dynavector's newest series of highly defined moving coils • Oracle tables, tonearm, mat, record brush • Fidelity Research • Superlitz cable and the incredible SB-1 speaker cable • Fulton • "The Arm" by Sumiko • The World Reference Standard Quad ESL 63 electrostatic electronics and Impressive new analog/digital tuner • Marcof glassmat • The all new Threshold electronics • KEF • Infinity, including the superb i-car auto speakers with emit's • Cotter • Audionics • Decca • Pyramid • JVC nbbons • Audio Pro • Super specials on Infinity 4.5 R.S., 2.5 R.S., Bedini 45/45 & 10/10 • House of Stereo, 8169 Arlington Expressway, JAX., FLA. 32211. (904) 724-4988. (Any written inquiries please include postage.) Call us!

ANOTHER AUDIOPHILE PUBLICATION?

AUDIO UPDATE is published ON TIME. This bi-monthly includes modifications construction projects, improvement methods, data available nowhere else. It's provocative, informative, and a MUST if you enjoy audio. Annual: \$14.00. MasterCharge/Visa welcome. AUDIO DIMENSIONS, 8888 Clairmont Mesa Blvd., San Diego, CA 92123. (714) 278-3310. TF

APT: HOLMAN PRE-AMP, MODEL 1 AMP. Call or write for quotes or information, Designatron's Stereo Stores, Inc., 260 Old Country Rd., Hicksville, N.Y. 11801. (516) 822-5277

ARC EQUIPMENT

D-52(G) top condition, manual, \$695.; SP. 5 pre-amp, near new, manual, \$425. 512-644-2438.

A&S SPEAKERS has raw drivers, kits and custom mobile speaker systems. Specializing in plastic cone drivers, our brands include Audax, Dalesford, Dynaudio, JVC, Falcon-Acoustics, SEAS, Philips, Becker, Great America and Peerless. Featuring the "Bill Reed" Signature Kit. A&S SPEAKERS, Box 7462A, Denver, CO. 80207. (303) 399-8609.

!!! ASTOUNDING !!!

THIEL Loudspeakers: models 03a, the new 04a, and the 02.
AUDIO CONNECTION, Verona, NJ (201)239-1799

ATTENTION: "FOREIGN" AUDIOPHILES AND DEALERS! Western World Audio Exporters can supply virtually ALL brands of hi-fi components, speakers, cartridges, etc. (incl. esoteric lines) at VERY attractive prices. Quotes, terms and availability furnished on request. Write To: WESTERN WORLD AUDIO EXPORTERS, 373 Fifth Avenue, Suite 1556; New York, NY 10016. TELEX—423826 SAKIUR.

ATTENTION LONG ISLAND and METRO NEW YORK AUDIOPHILES: Audiflon Frank Van Alstine modified Dynaco equipment in a home environment. Find out why audio reviews have been astounded by his latest modifications. Auditions by appointment only. Nassau (516) 541-0312. Suffolk (516) 277-5336.

Audio and TV tubes factory boxed, speakers, semi-conductors—low prices, free price list. Transistronic Inc., 1365-39th St. Brooklyn, N.Y. 11218 212-633-2800 TF

HOW TO ANSWER BOX NUMBER ADS

When replying to an Audio Box Number Ad, please use this address Box No. — c/o Audio, 1515 Broadway, New York, N.Y. 10036

AudioVisions

a new store, with a fresh view
on the audio and video horizon

Residents of NEW YORK CITY and WESTCHESTER, as well as LONG ISLAND, will soon be hearing more and more about Audio Visions, a store which offers the very latest technology, combined with true old-fashioned hospitality. Come visit and meet with Richard Levy (formerly technical editor of Modern Hi-Fi & Music and Sound Trax), Nicholas Martino (formerly manager for Designatron's Stereo Stores), and Steve Komins (formerly engineer with the Real Appeal recording studio).

In-store seminars with noted musicians & engineers. Call us to receive our free newsletter. Discount concert ticket information, technical reports, features.

• THREE COMPARATOR AUDIO ROOMS •
PLEASE NOTE: APPOINTMENTS SUGGESTED •
• IN-HOME SPEAKER TRIALS AVAILABLE •

electronics
DENON • HAFLER • MARCOF • MITSUBISHI • TOSHIBA
loudspeakers
ACCULAB • ALLISON • DAHLQUIST
DESIGN ACOUSTICS • INFINITY • M&K • THIEL
turntables, cartridges, tape decks
ADC • ADCOM • DENON • GRADO • MICRO-ACOUSTICS
SIGNET • SUMIKO • THORENS

WE REALLY LOVE MUSIC. DO YOU?

WHAT'S NEW? Audio Visions is new. The model DA • 30 speaker system from DESIGN ACOUSTICS also is new. Have you had problems fitting speakers properly, and attractively, into your listening room? A three-piece (subwoofer/satellites) system may be the answer. Did you read the test report on the DA • 30 in the November issue of Stereo Review? Watch out. 3D Acoustics: Till now, you had it too easy, you were the only moderately-priced three-piece system available. The DA • 30 costs a little more, but delivers so much more dynamic range, and needs so much less amplifier power. At Audio Visions, the DA • 30 is supplied complete with MONSTER CABLE, including all necessary custom-fitted gold connectors.

FOR A LIMITED TIME ONLY...

Very special SALE PRICES are still being offered, but only for another few weeks, while construction of one more demo room (the largest one) is being finished and Audio Visions makes ready for a really grand, festive, opening celebration.

• MASTERCARD • VISA • AMERICAN EXPRESS •

Real wood finish (not vinyl) audio cabinets
by BARZILAY, NAIAD, CWD, etc.

Audiophile records at special prices

Phono needles • Microphones by AKG • Blank tape
Dishwasher products. Monster Cable, etc.

FINANCING AVAILABLE FOR QUALIFIED CONSUMERS

near Southern State Parkway & Long Island Railroad
please call for directions

1067 MONTAUK HIGHWAY
WEST BABYLON, NEW YORK 11704

(516) 661-3355



DB SYSTEMS

(603) 899-5121
P.O. Box 347
Jaffrey, NH 03452

Custom made DB-3 ACTIVE CROSSOVERS are available in 2-Way and 3-Way with 6, 12, 18 and 24 dB per octave slopes. THD less than 0.0008%, five year warranty. Send for our free literature on crossover applications.

FOR SALE

ATTENTION OWNERS OF RACKMOUNT EQUIPMENT. Send for FREE detailed brochure on solid Oak/Walnut modular cabinet system. Designed to fit individual 19" rack mount components. Free shipping in continental USA. Wood Tailoring Co. Box 11314, Portland Oregon, 97211.

ATTENTION: "VAN GALEN" LOUDSPEAKERS

Discover latest fabulous State-of-the Art Brazilian Speaker System. New performance plateau. Use of exotic Amazonian hardwoods for vibrationfree cabinets and uncolored sound.

VAN GALEN, Rua Dr. Ribeiro de Almeida, 158 — SAO PAULO, CEP 01137, BRAZIL.

Bob Heenan's Q Audio Sells Great New & Used Hifi. BEST PRICING

**HAFLER GRACE
APT/HOLMAN NAD**

**PYRAMID
REGA DYNACO
JANIS QUAD**

**ACOUSTAT
NAKAMICHI
MCINTOSH**

**AUDIO RESEARCH
VACUUM TUBE CLASSICS**

Lowest Priced Accessories

WE

**BUY SELL TRADE
CONSIGN BROKER
WORLD'S BEST STEREO**

Send \$1 for Catalog
SHIPPING WORLDWIDE

Q Audio

95 Vassar St. Cambridge, MA 02139
617-547-2727

MASTERCHARGE & VISA WELCOME

FOR SALE

ATTENTION ALL DYNACO AND DYNA KIT OWNERS:

Frank Van Alstine can rebuild and/or repair your Dyna amplifiers, preamplifiers, and tuners. We have all new PC cards and all new highest quality internal circuits for most Dyna units. New POWER MOS-FET circuits for Dyna ST-150, ST-300, and ST-120 amplifiers. New J-FET circuits for Dyna PAT-5 and Bi-Fet preamplifiers. All new circuits for FM-5 tuners with phase-locked loop Mpx, new 8 stage differential IF, new buffered outputs, no drift, super musical, super sensitive. We rebuild all ST-400, 410, 416 amplifiers and can repair any, no matter how badly blown. External 100,000 mfd power supplies for ST-400 and 415. All new internal circuits for Dyna PAS tube preamps. New Noble precision stepped controls for all Dyna preamps. New Mos-Fet circuits for Dyna PAT-4 preamps. Improved audio circuits for Si-70 tube amps. Rebuilt Nagatron, Sonus, and Grado phono cartridges. Read AUDIOGRAM, MR. AUDIO'S BI-MONTHLY, AND SENSIBLE SOUND for reviews on our equipment. No charge for repair labor when we rebuild your Dyna unit. We ship worldwide and have brand new 120 volt and 240 volt modified Dyna units available. For details and our recommendations on how to make a hi fi system sound like music, write or call: JENSENS STEREO SHOP 2202 RIVER HILLS DRIVE BURNVILLE, MINNESOTA 55337 (612) 890-3517.

ATTN: LOWEST PRICES. LINN ITTOCK, STAX-PHONES, DYNAVECTOR, DENON, FID, RESEARCH, GRACE, FULTON, SUPEX, ETC. M. Corb. 11122. Atwell, Houston, TX 77096, 713-728-4343.

ATTN: WANTED JBL HARTSFIELD EV. PATRICIAN, Quads, Linn Sara + ISO, Berning, All McIntosh, etc. 713-728-4343, M. Corb, 11122 Atwell, Houston, TX 77096.

ATTRACTIVE PRICES: LINN ITTOCK, ASAK, STAX, DYNAVECTOR, FULTON, DENON, FR, GRACE, QUAD ESL, SOTA SAPPHIRE & MORE. ALSO TUBE CLASSICS & NEW. 713-728-4343, MAURY CORB, 11122 ATWELL, HOUSTON, TEXAS 77096.

• WE WILL •

NOT BE BEAT!

SUPER SELECTION • FULL WARRANTY • FAST DELIVERY
• HI-FI, HIGH END & VIDEO •



VISA CALL (203) 934-5291 NOW! MAC

★ AUDIO PEOPLE ★

1000 Orange Ave., West Haven, CT 06618

FOR SALE

ATTENTION NY—NJ!!!

- ACOUSTAT
- DCM
- MONSTER
- ACOUSTIC ELECTRONICS
- DENON
- MUSIC REFERENCE
- AUDIO RESEARCH
- FUTTERMAN
- NAD
- B&O
- HAFLER
- RGR
- BOSTON ACOUSTICS
- INFINITY 4.5
- SNELL
- B&W
- KENWOOD 'AUDIO PURIST'
- SUMO
- CARVER
- LINN PRODUCTS
- DAHLQUIST and more only at:

CSA AUDIO

The Audio Professionals since 1972. Only knowledge and experience equal superior sound and service. Discover high performance stereo with complete customer satisfaction. For orders and information (serious inquiries by phone only):

201-744-0600

VISA, Master Charge Accepted
CSA AUDIO

193 Bellevue Avenue
Upper Montclair, NJ 07043

Sound system consultations to home music lovers, professional theatrical arts and the audio industry.

ATTENTION . . . AUDIOPHILES

Northeastern's Largest Hi-End Audio Salon

Now has a larger selection of
Quality Components

Featuring:

Linn Sondek, Kenwood Purist Group, LS3/5A, B+W, Spondor, Supex, Stax, Adcom, Mitsubishi, Decca, Tandberg, DB Systems, I.M.F., Grado Sig., Shahinian Obelisk, Monster Cable, Dahlquist, Audio Pro, Grace, Avid, Marcof, Micro Acoustics, Dual, Strathclyde, Audio Source, S.A.E., Magneplaner, Carver, Dynavector, Audio Linear, Radlan Research, Fulton, Promethean and Nagatron.

We Ship Anywhere in the World

The Sounding Board, Inc.
75 Franklin Avenue
Ridgewood, N.J. 07450
Call us at (201) 445-5006

AUDIO CONNECTION IN NORTHERN NEW JERSEY

ADS	Electrocompaniet	RG Dyn./RGR
Audio Pro	Gem Turntable	Rogers
Amber	Grace	Rotel
Belles Research	Leach LSR&D	Spectrum
Benchmark	Live Wire	Spica
Clarke Systems	Lume' Tonearm	Thiel
Delphi	Mariah	VPI
Denon	PS Audio	& more

613 Bloomfield Ave., Verona NJ 07044
(201) 239-1799

AUDIO DEN AND POLK AUDIO

The Audio Den is proud to have on display and demonstration the amazing Polk Audio Monitor Series. Our customers say "Fantastic! Compares with the finest loudspeakers I have heard. Probably the best value in the history of Audio!!" Audiogram™, from the Audio Advisor said, "We were so impressed that we could not believe the prices . . . Other \$200 speakers simply do not come close to the standards set by the Model 10 . . . And at their price, they are simply a steal." Come in for an audition or write us for information on Polk or our other state-of-the-art products. Polk is shipped free in the continental U.S. Audio Den Ltd. 1320-34 Stony Brook Rd., Stony Brook L.I., N.Y. 11790, 516-751-3350. TF

***AUDIO EMPORIUM, MILWAUKEE — a progressive alternative. Free catalog. 6914 W. Brown Deer Rd., Milwaukee, WI. 53223, 414-354-5082.

AUDIO HEIGHTS

"We do things a little differently"
To serve your Hi-Fi and Video needs.

Call us at (212) 237-9847.

Amber, Allison Acoustics, Audio Pro, Aiwa, ADC, AR, ADS, AKG, Alpine Car Stereo, Audio Control, Bose, DBX, Tandberg, Thorens, Onkyo, Nikko, Sherwood, Ortofon, Micro Acoustics, Stanton, RCG, Omnisonic, JVC, Hitachi, RCA, Ultravision Projection TV.

IN NEW ENGLAND...

No hyperbole — just the kind of knowledge, creativity, and dependability you expect from a dealer who represents these manufacturers.

mark
evinson

M.A. Cotter
Dahlquist
Denon
DCM
Dynavector

Magnepan
Marcof
Mirage
M & K
NAD

Nakamichi
Oracle
Pyramid
Signet
Supex

Symdex
Vandersteen
VPI
Win Labs
Yamaha

ADS Audio Pro
ADS Pro Bryston
Apt-Holman Carver
Audionics Conrad-Johnson

Fidelity Research
Grace
Hafler
KEF

5 listening rooms . . . New England's largest
Audiophile record dealer . . . Keith Monks
record cleaning . . . In-store service . . .
All shipments pre-paid.

5 TAKE AUDIO

M-W 10-6
Th & Fri 10-8
Sat 10-5

105 Whitney Ave., New Haven, CT (203) 777-1750

Master Charge, VISA, AMEX

FOR SALE

AUDIO LTD IN CHAMPAIGN, ILL.

Quad KEF David Hafler
Carver NAD Linn Sondek
Mission Vandersteen Dynavector
Audio Research 3-D Acoustics Rega
and much more. 115 N. Walnut 61820. 217-359-3774.

AUDIO MODIFICATION MANUAL - 230+ pages step-by-step procedures for many common components. Data applicable to almost any unit. Tube circuitry emphasized. Applauded by AUDIO, STEREOPIUS, HIGH FIDELITY, SOUND ADVICE, et al. Unique information provided no where else. \$25 USA/CANADA, \$27 elsewhere. California tax applicable. Master Charge/VISA Welcome. (714) 278-3310. AUDIO DIMENSIONS, 8888 Clairmont Mesa Blvd., San Diego, CA 92123

AUDIONICS: NEW PRODUCTS

Announcing the NEW RS2 preamp & the NEW CC2-S2 amp. These components along with the RS1, BA150, Space & Image Composer, LK1 and Revox replacement cards are available at OXFORD AUDIO CON., INC., Box 145, Oxford, OH 45056. Visa & MC. By appt. Free shipping in U.S. & P.R. WORLDWIDE shipping. 513-523-3333, telex: 427791.

AUDIO PULSE SERVICE. Factory trained technicians. For reservations/information, write to White Labs, 10528 Lower Azusa Rd., Suite 192, El Monte, CA 91731.

AUDIO RENAISSANCE, INC.

Audible Illusion PS Audio Grace Stax Rega
Precision Fidelity Music Reference Dynavector KEF
Meridian Acoustat Linn Products Mordaunt-Short
Theta ReVox Audio Innovations Symmetry And More
We stock one of the largest
collections of Audiophile Albums in Mid-America
Try our modifications for improved high end
Bryston Mod-Any Model Dahlquist DQ10 Mod
Used Audio Research D-100A Amplifier \$800
Used Audio Research SP-4 Preamplifier 700
Used Decca Arm with Elec. Lift 85
Used Stax DA80 Power Amplifier 850
Used McIntosh 1900 Amplifier Tuner 550
4122 Broadway Kansas City, MO. 64111 (816) 531-3261

audio renaissance, inc.

audio research ★ stax ★ audio innovations ★
grace ★ symmetry ★ ps audio ★ theta ★ precision
fidelity ★ rega ★ audible illusion ★ mordaunt-short
★ acoustat ★ music reference ★ kef ★ dynavector
★ linn products ★ meridian ★ revox ★ chartwell/
satterberg ★ and more

we stock one of the largest
collections of audiophile albums in mid-america
mobile fidelity ★ windham hill ★ am gram ★ crystal
clear ★ nautilus ★ telarc ★ ysl ★ opus 3 ★ sheffield
★ dd lab ★ delos ★ european imports
try our modifications for improved high end
bryston mod-amplifiers ★ ★ ★ dahlquist dq10 mod
4122 broadway, kansas city, mo 64111
(816) 531-3261

AUDIO REPLAY is New England's leading dealer in secondhand audio. Now you don't have to come to New Haven to browse through our Inventory. Two dollars will bring you our current listing, typically 100-200 items long. We recondition and warranty what we sell, so you can shop with confidence. Audio Replay, Dept. AM, 252 Park St., New Haven, Ct. 06511

AUDIO SHOP — A SPECIALTY STORE WITH a few select lines for your musical pleasure: GRACE, FR, C.J. Walker, Mitchell, Basik, Audire, PS Audio, Conrad-Johnson; Daybreak, Acoustat, Mission. Inquiries Welcomed. The Audio Shop, 1124 East Elizabeth St. Fort Collins, CO 80524. (303) 221-1496

AUTOMOTIVE AUDIOPHILES TAKE NOTE

MIAH sells and installs all premium brands including ADS, Mitsubishi, Infinity, Concord, Dahlquist, Alpine, Sony, Altec Lansing, JBL, Visonik, Blaupunkt, EPI, Bose, Linear Power, Monster Cable and many more. **CALL TOLL FREE**, MIAH, 6660 Busch Boulevard, Columbus, Ohio. 43229. 800-848-7383, 614-885-5298. Visa, MasterCard and American Express accepted.

BEFORE YOU BUY-CHECK OUR PRICES. Send for free catalog featuring audio and video equipment and accessories at discount prices. House of Tape P.O. Box 191 Mineola NY. 11501

FOR SALE

A WHOLE NEW SYSTEM FOR \$29.95 CART-A-LIGN

An incorrectly aligned stylus can degrade even the finest audio system. Reviewers agree, Cart-A-Lign's unique engraved mirror aligns best. You'll think you changed your whole system for only \$29.95.

At select audio dealers. Write for reprints of reviews and a list of dealers.

CART-A-LIGN RESEARCH CORP.
122 East 42nd St. Suite 411
New York, N. Y. 10165

BASS REPRODUCTION AT ITS BEST. The newly developed Q/LC Bass Module is incredibly accurate, cosmetically beautiful and reasonably priced. Call or write for more information on this outstanding product. Q/LC Audio, 1006 Berkshire Road, Dayton, Ohio 45419 or (513) 293-7287 or (513) 439-1745. Dealer inquiries welcome.

BELLES AMPLIFIERS. The Mountain Ear, (303) 963-3269.

BENCHMARK - Ambience restoration at its best! Audio Connection, Verona NJ 201-239-1799

BEST IN THE WEST

NAKAMICHI	N.A.D.	MAGNEPLANAR
DAHLQUIST	LINN	HARMAN KARDON
ORACLE	POLK	TIME WINDOW
THRESHOLD	ADCOM	APT HOLMAN
ACOUSTAT	B&W	DENON
TANDBERG	SONY	HAFLER

ROCKY MOUNTAIN HI FI

812 Central Ave., Great Falls, MT (406) 761-8683

BEVERIDGE 25W-2 FULL RANGE SPEAKERS, \$3,695; Rosewood Klipsch horns, \$2,995.; Audio Research D-100B amplifier, \$1,095.; Luxman R1050 receiver, \$375.; Dynavector Diamond cartridge, \$635.; Bueur arm, \$649.; Linn Sondek LP12 turntable, \$495. (509)946-1529 evenings.

FOR SALE

B & O USES "ANY" CARTRIDGE with standard mounting centers after our modification kit or at factory. Effective mass 2.5 grams. Adjustable silicone damping. \$199.00 with money back guarantee. JVL Company, 39,00C Highway 128, Cloverdale, CA 95425. TF

B & W DM6 SPEAKERS, walnut, mint condition. \$750.00/pr. 1-609-924-8167

ACTIVE ELECTRONIC CROSSOVERS

Plug-in Butterworth (maximally flat) filters in 6 db., 12 db., or 18 db., per octave attenuation, any frequency specified. Filters flat beyond 100 KHz.

Complete crossover in attractive metal cabinet with all terminations and regulated power supply.

STEREO BI-AMP \$139

Tri-amp, quad-amp, and monaural types available at comparable prices. Other available features: Summer for "single woofer" systems, Subsonic noise elimination filters supplied with or without bass boost, level controls.

FOR OEM'S AND HOME ASSEMBLERS

500 Series dual filters and/or plug-in filters, regulated power supplies.

FREE CATALOG & PRICE SHEET
Write to:

DeCoursey ENGINEERING LABORATORY

11828 Jefferson Bl • Culver City, CA 90230
Phone (213) 397 9668

A

p

t

Apt Corporation

P.O. Box 512
Cambridge, Massachusetts
02139
617 492-5145



1979



1980

In 1979 and 1980 respectively, Apt Corporation presented two products which demonstrated what we expected and required of thoroughly designed, useful preamplifiers and power amplifiers. The Apt/Holman Preamplifier and the Apt 1 Power Amplifier, with their unequalled combinations of features and performance coupled with their comparable affordability, were both catapulted into the coveted "Product of the Year" category as acclaimed by audio dealers across the country.

Sonic excellence and the name Apt are synonymous. We have achieved this reputation as a result of our careful attention to detail and to common-sense engineering for the "real world". Elimination of component interactions, revised tone controls and filters, large dynamic headroom, and a unique "mode control" is just a partial listing of the design features which make these products the preamplifier and power amplifier for the critical listener.

Now, the Apt **Power-Tracking Integrated Amplifier** combines Apt Corporation's preamplifier and power amplifier expertise with an original power supply design. By causing the power supply to "track" the audio signal, this integrated amplifier sets a new standard in efficiency, size, and dynamic headroom. Weighing in at a mere 12 lbs. with continuous power of 80 watts per channel and 6 (not a misprint!) dB of headroom this amplifier will reproduce complex musical waveforms better than anything in its class.

For more information contact fine audio dealers across the country or write us directly for detailed brochures and technical papers.

STILL MORE RAVE REVIEWS FOR VMPS LOUDSPEAKERS

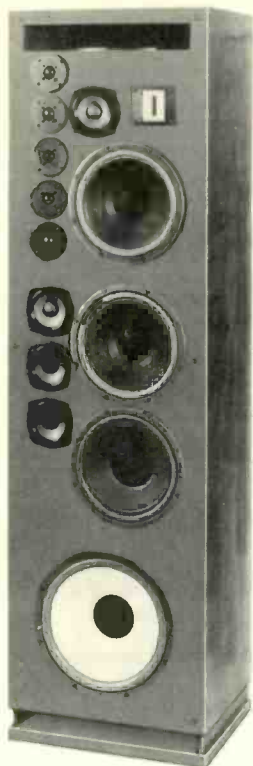

The VMPS Super Tower IIa/R, \$1499ea (black), \$1699ea (walnut); Kits \$999ea (black), \$1199ea (walnut). 76" H x 21" W x 17" D, 300lbs. Sold in mirror-image pairs.

From **Hifi Buyer's Review**, November 1981:

"As we've often said when discussing speaker design, bigger is better, as least as far as reproducing low bass is concerned. Driver size is only part of the story—big drivers also require a big cabinet to work effectively. This is what Itone Audio has employed in the VMPS Super Tower IIa/R... We measured the nominal impedance as 7 Ohms and were pleased to see little impedance variation across the audio spectrum. Sensitivity was 100dB/1m/1W. This high efficiency shows one of the benefits of the VMPS approach. The multi-driver design also produced excellent high frequency dispersion... The critical test of a system such as this is the ability to produce accurate stereo imaging without the multiple drivers sounding like discrete sound sources. In this the STIIa/R succeeded admirably: stereo location was precise, with the overall sound clean and with no evidence of coloration... At wall-shaking levels there was no evidence of distortion or doubling, and extreme low frequency sounds were reproduced exactly as they were recorded. High frequency transients were undistorted even at the loudest listening volumes... If your budget allows, and if you have the space required by these very large speakers, the VMPS Super Towers will provide you with a sonic experience not often found in the home environment."

VMPS manufactures loudspeakers with lower distortion, greater dynamic range, and wider bandwidth than any others regardless of price. Nine models are available from \$78 to \$1699ea, including kit versions of the Mini Tower II (\$309ea), Tower II (\$419ea), & Super Tower/R (\$649ea). Write for our brochures and copies of reviews from Bert Wright, B. V. Pisha, Hifi News & Record Review and the complete test report from Hifi Buyer's Review. All prices include **free shipping** in USA.

VMPS AUDIO PRODUCTS

a division of Itone Audio

1016 Contra Costa Drive El Cerrito CA 94530
(415) 526-7084

Hear VMPS at The Listening Studio, Boston; Mike Hilliard Audio, Shreveport LA; Bedini Electronics, Sylmar CA; Itone Audio, El Cerrito CA; Odyn Sound Stereo, Longmont CO; Sound Alternative, Ft. Myers FL.

FOR SALE

B&W DM6 SPEAKERS, walnut, w/floor stands, stunning sound, \$900.-pr. (503) 256-2350.

CABLE TV DESCRABLERS AND CONVERTERS. Plans and parts. Build or buy. For information send \$2.00. C&D Electronics, Inc., P.O. Box 21, Jenison, MI 49428.

CALL TOLL FREE 1-800-826-0520 FOR ACOUSTIC, CARVER, NAD, POLK, 3D, ONKYO, AUDIOCONTROL, B&W, AMBER, BEDINI, MICRO-SEIKI, DAHLQUIST, DENON, HAFER, dbx, TANDBERG, VANDERSTEEN, DCM, GRACE, DYNAVECTOR, AND MORE! THE SOUND SELLER, 1706 MAIN St., MARINETTE, WI 54143 (715)735-9002.

CAPACITORS — CABLES — CONNECTORS

Custom designed 200 volt Polypropylene capacitors with solid copper leads — all Teflon, low dielectric absorption inner connect cables with solid brass, gold plated connectors. Send \$2.00 for our complete catalog.

RANDALL RESEARCH, (714) 760-1539
719 Fernleaf, Corona Del Mar, Ca. 92625

CARVER IN THE SOUTH

In stock! Fast, free shipping. READ BROS. STEREO, 593 King St. Charleston, S.C. 29403 (803) 723-7276. Also FRIED KITS.

CARVER— PRE-AMPS, HOLOGRAM GENERATOR, AMPS, TUNERS Call or write for quotes or information. Designatron's Stereo Stores, Inc., 260 Old Country Rd., Hicksville, N.Y. 11801 (516) 822-5277

HARMAN-KARDON HIGH TECHNOLOGY SEPARATES, RECEIVERS, CASSETTE DECKS, ELECTRO-VOICE INTERFACE A, B, C, D SPEAKER SYSTEMS, THORENS TURNTABLES. ALL IN STOCK — IMMEDIATE SHIPMENT.
EAST: 305-462-1976 WEST: 213-243-1168

Circuit boards, plans, parts, and transistors (author approved) for **M. LEACH'S DOUBLE BARRELED AMP**, Low TIM 3 Amp, FET Preamp with tone controls, and Current Mirror Pre-Preamp. Send stamped envelope for price list. Custom Components, Box 33193, Decatur, GA 30033.

CJ WALKER-55 TURNTABLE. The best sounding turntable, save one. The best-buy in turntables, save none! \$350. With Linn Basik tonearm & cartridge, \$499. British American Sound; PO Box 1247; Charleston, SC 29402 (803) 723-6025

CONNECTICUT: Advent, A.P.T. Holman, B&O, Boston Acoustics, Carver, Dahlquist, D.C.M. Time Windows Polk, Hafler, Harman/Kardon, M&K Mitsubishi, Nakamichi, Ortofon, Micro-Acoustics, N.A.D., Stax, Cizek, Signet, QED, Teac, Marcoff. Will ship prepaid. Sounds Incredible, 39 Federal Road, Brookfield, CT, 06804. (203) 775-1122—phone quotes only. TF

A SINGER'S DREAM!

TVE

REMOVES VOCAL FROM MOST STEREO DISCS
The Thompson Vocal Eliminator can actually remove most or virtually all of a solo vocalist from a standard stereo record and yet leave most of the background music untouched! Not an equalizer! We can prove it works over the phone. Write or call for a brochure and demo record below. **COST: \$295.00**

Time Delay/Ambience

Superior:

- Realism
- Frequency Response
- Versatility
- Dynamic Range

TAD-4

Time delay is new to consumer audio. Recording Studios have been doing it for years. They have developed much more realistic systems than are presently offered for consumer use, with One notable exception... Our TAD-4.

Call or write for a 24 page brochure on our line of 18 products. Included will be a product review of the TAD-4 and a demo record which will allow you to compare our TAD-4 with other units. At \$650 we aren't cheaper... We're Better!

Write to: **LT Sound, Dept. AU, P.O. Box 338, Stone Mountain, GA 30086, Phone (404) 493-1258**

FOR SALE

CROWN DISTINCTION SERIES: FM-1, EQ-2, DL-2, SA-2, ETC., IN STOCK — BEST PRICES — IMMEDIATE SHIPMENT. (213) 467-5725.

CROWN M-600 MONO AMPLIFIERS, Absolutely mint, three available, \$1,250. each. Otari MX-5050QXHD, 4 track recorder, never used, needs electrical repairs in transport, \$1,200. Call 301-862-4487.

CROWN: NEW STRAIGHTLINE SERIES: Preamp, Power Amp, Tuner Distinction series: Tuner, Equalizer, Pre-amp, Power amp
Call or write for quotes or information. Designatron's Stereo Stores, Inc. 260 Old Country Rd., Hicksville, N.Y. 11801 (516) 822-5277

CUSTOM POLYACOUSTIC FOAM RUBBER SPEAKER GRILLS MADE TO YOUR SPECIFICATIONS. Any size, color, pattern or quantity. Audiophile, speaker builder or manufacturer inquiries invited. Send SASE for information to Custom Sound, Algonac, MI 48001.

DACABLES Improve clarity and definition of entire system by eliminating "time smear" distortion inherent in normal patch cords. 1/2 meter — \$12.75 1m- \$16.00 2m- \$25.00 Send SASE for detailed information D.A.C. P.O. Box 200 Otis, MA 01253

DAVID BERNING TF-10 AND EA-230. The Mountain Ear (303)963-3269.

DAVID BERNING EA2-150 (similar to Audionics BA 150) 150 watts per channel tube amplifier. (303) 963-3269.

DB SYSTEMS ELECTRONICS AND AUDIOPHILE ACCESSORIES ARE WORTH KNOWING ABOUT. Ultra-low distortion Preamplifiers, Power Amplifiers, Active Crossovers and more. ACCESSORIES include: DBP-10 Phono Alignment Protractor \$21.95, DBP-6 Phono (capacitance) Equalization Kit \$32.95, DBP-6MC Resistive Loading Kit \$32.95, DBP-11 (and 11MC) Capacitive (and Resistive) Loading Switch Boxes \$79.95, DBP-2J Switch Box \$43.95, DBP-2JAU with all gold (10) jacks \$52.95, DBP-12 Audio Cable — 10 meter, 400 pF \$65.95 — other lengths \$17.00 plus \$1.75 per foot, DBP-8 Speaker Wire (12 gauge), DBP-CK Cramolin Audio Kit contact treatment \$11.95, GOLD PLATED CONNECTORS (eight per package) include: DBP-13J (1/4") Phono Jacks \$11.95, DBP-13JR (3/8") Phono Jacks \$14.95, DBP-9AU Banana Plugs \$11.95, DBP-13P Phono Plugs \$7.95, DBP-9J Dual Banana Jacks (2 per pkg) \$14.95. Complete information available at SELECTED AUDIO STORES or direct from DB SYSTEMS, P.O. Box 347A, Jaffrey, NH 03452 (603) 899-5121. Orders under \$45 add \$2.50 handling. Dealer inquiries invited.

DB SYSTEMS PRODUCTS ARE AVAILABLE IN PUERTO RICO AT POP MUSIC, INC., Calle Peral, Mayaguez 00709. (809) 833-2598.

Decca Record Brush Improved with Zero Ohms Control, million microfibre bristles, eliminates static, dust without chemicals or radio-activity \$19.95; individually calibrated Decca Gold Cartridge \$257; Plum \$197; International Tonearm \$177; Ribbon Supertweeter \$497 pair. Free Shipping. Audio Access, Box 385, White-stone, N.Y. 11357. Dealer inquiries invited.

DELPHI SPEAKERS. The Mountain Ear, (303) 963-3269.

DIAMOND NEEDLES and Stereo Cartridges at Discount prices for Shure, Pickering, Stanton, Empire, Grado, Audio Technica and ADC. Send for free catalog. LYLE CARTRIDGES, Dept. A, Box 69, Kensington Station, Brooklyn New York 11218. For fast service call toll free 800-221-0906. TF

DQ-10 REVISION

New Mid Bass, modified Panasonic Ribbon Tweeter, baffle board, mounting brackets, felt covers and complete instructions — corrects problem with this fine speaker. Kit \$250. Tweeter Mod, includes Modified Panasonic Tweeters, brackets and Instructions \$150.

NEW YORK AUDIO LABORATORIES, INC.
33 North Riverside Avenue
Croton on Hudson, NY 10520

ELECTRONIC CROSSOVERS — ALL TYPES Updated definitive booklet describes applications, how to improve speaker systems; \$5.00 postpaid, credited to first purchase. Huntington Electronics, Box 2009-A Huntington, Conn. 06484.

FOR SALE

DYNACO OWNERS: 60,000 LB PARTS INVENTORY! Don't give up... send 6-digit Dyna part number, description, and model for quote. 20-page parts list: \$1.00. **PAT-5 BI-FET** Preamp: Complete Parts/Assembly Manual Package, \$169; **RCT-5 Relay Kit**, \$20; **BI-FET Conversion Kit** (upgrades original PAT-5 to BI-FET), \$49. VISA/MC, CODs welcomed. (614) 889-2117. SCC, Box 551, Dublin, OH 43017

ELECTRONIC X-OVERS: 6, 12, or 18dB/octave. Kits from \$97.00. Also transient-perfect crossover model 6000-6, \$175.00. Free folder with reviews. ACE AUDIO CO. 532-5th Street, E. Northport NY 11731-2399. (516) 757-8990.

FASCINATING OLDTIME RADIO SHOW CASSETTES! Free Catalog! Sample \$2.99. Heritage-A, 412 Redbud, Oxford, MS 38655

FINALLY — THE BOTTOM END KIT

Our MB-1 Bottom End kit for the Dahlquist DQ-10 loudspeaker will astound you with dynamic range and coherency when coupled with our DRT-1 Ribbon Tweeter modification. The MB-1 kit includes 2 ea. 5" Polypropylene midbase drivers, 80 uf replacement capacitors, resistors and crossover components to modify the woofer crossover point and slope. \$159.00 Postage paid In U.S. Visa, M.C., Check or Money Orders welcome. Calif. residents please add 6% sales tax.

RANDALL RESEARCH, (714) 760-1539
719 Fernleaf, Corona Del Mar, Ca. 92625

FREE ADVERTISING for your USED EQUIPMENT! Pay low commission ONLY IF YOU SELL! Stamp for details. AVI, Box 264-A3, Buffalo, NY. 14215.

FREE AUDIO NEWSLETTER

Improving and verifying the musical naturalness of your stereo system need not be difficult or expensive. Our newsletter will share our methods of system setup, our choices of truly natural recordings, and our preferences in components.

MUSICAL CONCEPTS
1060 Fifth Plaza, Hazelwood, MO 63031

FREE SPEAKER CATALOG!

Woofer, mids, tweeters, hardware, crossovers, grille cloth, plans, kits, information, much more. Discount Prices! UNIVERSAL SOUND, Dept. AO, 2253 Ringling Blvd., Sarasota, Fla. 33577 (813)953-5363.

FREE TUBE BIBLE III

This month only, our 50 page book is yours just for the postage. Learn how to get your tube amps and preamps working right, kits, capacitors, high volt regulators, ARC Mod. Plans, a must for Dynaco and Marantz owners. Our NB electronics — cascode & cascode preamps. Nuvistor head amps — complete with schematics. Read all about it. Send 75¢ to

TUBE GOD
33 North Riverside Avenue
Croton on Hudson, NY 10520

FOR SALE

"FRESH AIRE" Special Price \$12.95 each. All four volumes available (free freight In USA, \$4/order to Canada) Visa, M/C, Am Ex, C.O.D., check. Free catalog of audiophile recordings. Supersound Record Service, Box 82-A Forest Park, ILL 60130.

FRIED A/2 LOUDSPEAKER now in stock. Call, write or come hear the A/2 and the other amazing, moderately priced new FRIED "high technology" speakers. THE SOUND INVESTMENT, 2935 Woodstock Avenue, Silver Spring, Md. 20910. 301-589-4808.

FRIED SPEAKERS & KITS

State-of-the-art sound. Try our prices! Fast, free shipping. READ BROS. STEREO, 593 King St., Charleston, S.C. 29403. (803)723-7276. Also Hafler, PS Audio, NAD, Carver, more.

FRIED SPEAKER CABINET SALE!!! Reduced prices while supply lasts. (919) 945-5310.

FULTON PREMIERES USED 10 HOURS, full warranty \$4,300.. FR MC-201 cartridge as above \$185. 503-641-5937. No answer leave message at 206-747-2894.

FUNDAMENTAL RESEARCH SUBWOOFERS, \$450. a pair. (303) 963-3269.

FUSELIER SPEAKERS. The Mountain Ear. (303) 963-3269.

FUTTERMAN OTL AMPLIFIERS

Even if you can't afford them, you must experience the only tube amplifiers that use no output transformers. Listen to these OTL amplifiers on any high definition speaker and experience a new level of musicality and lucidity. This is the only tube amp that has been under continuous development for 25 years. Send \$2 for technical papers & information package to:

NEW YORK AUDIO LABORATORIES, INC.
33 North Riverside Avenue
Croton on Hudson, NY 10520

GEM + GRACE = AFFORDABLE PERFECTION

If you've wanted the sonic advantages of a state-of-the-art belt-drive turntable, but haven't wanted to pay the high price, nor hassle with tonearm set-up and compatibility problems, then the new GEM/Grace combination is for you. A perfectly matched and tuned suspension with a Grace 707 mk II or 747 tonearm, jeweled sapphire platter bearing, and superb platter sheet all add up to achieve the greatest information/noise ratio value today. For information and quote: Designatron's Stereo Stores, Inc., 260 Old Country Rd., Hicksville, N.Y. 11801. (516) 822-5277.

GENE RUBIN AUDIO—LOS ANGELES

PS AUDIO	LINN SONDEK	ACOUSTAT
NAD	REGA PLANAR	THIEL
HAFLER	PYRAMID	LS3/5A
PREMIER	GRACE	SPENDOR
QED	DYNAVECTOR	CHARTWELL

Pre-paid shipping (213) 571-1299 (Pacific time)

- ACOUSTIC ELECT.
- AUDIO PULSE
- B&W
- THE DAVID BERNING CO.
- COLONEY
- CRAMOLIN
- DAHLQUIST
- DENON
- DYNAVECTOR
- FULTON
- GOLDMUND
- GRACE
- GRADO
- HAFLER
- HILL PLASMATRONICS

- JANIS
- KEITH MONKS
- KOETSU
- LAST
- LINN SONDEK,
- LIVE WIRE
- LOCI
- LUSTRE
- MARCOF
- MONSTER CABLE
- MUSICAL FIDELITY
- MUSIC REFERENCE
- NAKAMICHI
- PLATTER MATTER
- PS AUDIO

- PSE
- POLK AUDIO
- PRECISION FIDELITY,
- PROMETHEAN
- PYRAMID
- SNELL ACOUSTICS
- SPATIAL
- SPICA
- STAX
- SUMO ELECTRIC
- SUPEX
- TANDBERG
- THETA ELECTRONICS
- VPI
- YAMAHA

the listening room

590 Central Park Avenue Scarsdale, NY 10583

Mon., Thurs. 10-9 P.M. Tues., Wed., Fri. 10-7 P.M. / Sat. 10-6 P.M.

Ample Free Parking • Credit Cards Accepted

We Ship FREE Anywhere in the Continental U.S.A.

914-472-4558

Impossible

A loudspeaker designed with regard to high definition can't LOOK very good?

The most stylish looking loudspeaker couldn't SOUND very good?

And even if by some miracle, this feat could be accomplished — surely it wouldn't be affordable.

Black Magic

Affordable Esoterica for the Distinguished Listener

For more information and a dealer near you:

Black Acoustics

1760 MONROVIA • SUITE A-22
COSTA MESA, CA 92627 • (714) 845-8877

FOR SALE

GAS

FACTORY SEALED—LIMITED QUANTITIES

• THALIA I PREAMP	\$200
• THALIA II PREAMP	\$225
• THOEBE PREAMP	\$350
• THAEDRA II PREAMP	\$550
• GRANDSON 40 W/CH AMP	\$225
• SON OF AMPZILLA 80 W/CH AMP W/METERS	\$350
• SHIBITA CARTRIDGE	\$150
• SUPER ELLIPTICAL CARTRIDGE	\$100
• SPHERICAL CARTRIDGE	\$ 75
ALSO AUDIO METRIC HEAD AMP	\$ 80

SHIPPING FREE IN CONTINENTAL U.S.
VISA—MASTER CHARGE—MONEY ORDERS

THE SOUND CENTER

8033 SUNSET BLVD., SUITE 194
WEST HOLLYWOOD CA.

90048

or call

(213) 650-0060

GET INTO BROADCASTING! Learn how to receive free records, tapes, get an FCC broadcast license, start your own station. Free details. "Broadcasting", Box 130-N5, Paradise, CA 95969.

GET SOUND PRICES ON CAR STEREO SCANNERS - CB

Call or write Monday - Saturday 10-8 (312)960-1327. Visa/M.C. R.S. Engineering, 522 Sherman, Downers Grove, Ill. 60515.

GRACE AND SUPEX

We offer the Grace 747, 707MK2 (Linn Mods for each), 704, F-9E & Supex cartridges. By appt. Free shipping in U.S. & P.R. Visa & M.C. OXFORD AUDIO CONSLTS. INC., Box 145, Oxford, OH 45056, 513-523-3333.

HAFLER: AMPS, PRE-AMPS, SPEAKERS.

Call or write for quotes or information. Designatron's Stereo Stores, Inc., 260 Old Country Rd., Hicksville, N.Y. 11801 (516) 822-5277.

FOR SALE

HAFLER DH-101 PREAMP

We expect to be in stock on this exciting new preamp by Dec. 12th. Kit price is \$199.95. Custom wired and tested, \$299.95. Immediate prepaid shipment shipment via UPS. THE AUDIBLE DIFFERENCE, 435 Tasso, Palo Alto, California 94301. (415) 328-1081. TF

HAFLER DH-500K \$515. DH—110K \$250, unbuil SAE 3000pre, 2200 amp \$550, warr. 30pre, 31Bamp \$235 SONY ST-J75 \$300, FX6C \$280, PS-X600 biotracer \$288 MARANTZ 140 amp \$200, BIAMP TC-60 \$235, 90W PIONEER SF—850 triamp xover \$235. 203-777-1476.

HAFLER IN THE SOUTH!

In stock, the superb Hafler DH-101 preamp and DH200 amp. kits & factory assembled. Also new models. Immediate free shipping. Also Fried (Speakers, Kits), Carver, Vandersteen, NAD, Mirage, Audire, PS, Klipsch, more. READ BROS STEREO, 593 King Street, Charleston, S.C. 29403 (803)723-7276.

HAFLER-NEW PRODUCTS

We are stocking the following: DH101K \$199.95, DH101A \$299.95, DH101AP \$399.95, DH103 \$19.95, DH104 \$24.95, DH105 \$24.95, DH106 \$19.95, DH110K \$299.95, DH110A \$399.95, DH110AP \$499.95, DH112 \$74.95, DH200K \$329.95, DH200KE \$339.95, DH200A \$429.95, DH200AE \$439.95, DH201 \$24.95, DH202 \$24.95, DH500K \$599.95, DH500KE \$619.95, DH500A \$749.95, DH500AE \$769.95. By appt. Free shipping in U.S. & P.R. We ship WORLDWIDE. Visa & M.C. OXFORD AUDIO CONSLTS., INC., Box 145, Oxford, OH 45056, 513-523-3333, telex: 427791. cable: OXAUD-COIN.

HARMAN-KARDON HIGH TECHNOLOGY SEPARATES, RECEIVERS, CASSETTE DECKS: ELECTRO-VOICE INTERFACE A, B, C, D SPEAKER SYSTEMS: THORENS TURNTABLES. ALL IN STOCK — IMMEDIATE SHIPMENT.
EAST: 305-462-1976 WEST: 213-243-1168

FOR SALE

GNP OUR LOUDSPEAKERS

In the past two months we have given you a brief description of who we are, and of the kind of innovative and imaginative thinking that has been instrumental in the development of our complete line of loudspeakers. In this column we would like to discuss with you our loudspeakers on an individual basis. Please note, however, that the systems described below are only suggestions; all GNP products are modular and may be "mixed and matched" in accordance with individual listening, space, and budgetary requirements. Of course, this flexibility makes it exceptionally easy to upgrade and improve your system whenever desirable.

The **LEAD CYLINDER** (Pat. Pend.) represents our contribution to the state-of-the-art in dynamic loudspeaker design. The innovative and functional shape and construction, designed to both ensure phase coherence and minimize diffraction effects and cabinet resonances, are responsible for its effortless, unstrained, and open sound. Moreover, the **LEAD CYLINDER**, as with all fine audio components, is a loudspeaker whose superior qualities become even more apparent and respected after extended listening.

The **SYSTEM TWO** employs much of the advanced and innovative technology of the state-of-the-art **LEAD CYLINDER**, including a fully braced, highly damped enclosure for the tweeter and midrange drivers. Its sound quality represents only the slightest of compromises, and even that is audible only in direct comparison to the superlative and unsurpassed **LEAD CYLINDER**. The **SYSTEM TWO** features outstanding clarity, focus, and resolution, along with an ability to handle music dynamics in a completely unstrained fashion. Like the **LEAD CYLINDER**, the **SYSTEM TWO** employs the identical woofer system, thus permitting easy upgrading should your listening requirements change.

The **GNP SYSTEM THREE** provides outstanding full-range music reproduction in an especially economical package. The **SYSTEM THREE** features a highly rigid tweeter and midrange enclosure to curtail the spurious colorations that come from cabinet resonances. And, as a result of its smaller size, its minimal front panel area limits diffraction and secondary radiation effects. As with all GNP products, the speaker is a polarity coherent design, which is one of the reasons for the **SYSTEM THREE**'s open and natural sound. The **SYSTEM THREE** brings the unparalleled experience of music into the home for those who appreciate performance, artistry, and sonic fidelity.

In many ways, the **SYSTEM FOUR** represents our proudest achievement. Its small size clearly belies its performance capabilities, and first time listeners are startled when they hear the clarity, resolution, and focus of music emanating from such a compact package. The **SYSTEM FOUR** employs many of the technological advances incorporated into our more expensive speakers. With the addition of two carefully matched **GNP** woofer systems, the **SYSTEM FOUR** can easily be upgraded to our three-way **SYSTEM THREE**. The **SYSTEM FOUR** is an excellent introduction to the delights of faithful music reproduction in the home.

We encourage you to listen to our loudspeakers at your own specialty audio dealer. For further information, see your local dealer or write:

GNP
1244 E. Colorado Blvd.
Pasadena, Ca. 91106
(213) 577-7767

HAFLER SUPERMOD PREAMP BY MUSICAL CONCEPTS

Audiogram says "The sound of the Super Mod transcends its origin, its parts, and its piddling cost, fulfilling our musical expectations . . . for the here and now, this is the one."

The Super Mod is available as a kit for \$200, or installed for \$250. Also available are an amp mod kit for the DH 200, and a more modest preamp mod kit for \$100.

Musical Concepts
1060 Fifth Plaza
Florissant, MO 63031
(314) 831-1822 Dealer Inquiries welcome.

AUDIO HORIZONS

P.O. BOX 10973
ST. LOUIS, MISSOURI 63135

Issue #5 is now available. It contains reviews of the **ACM** Linn platter assembly, the **CART-A-LIGN** alignment protractor, the **JMAS** moving-coil cartridge, **LAST** record treatment, the **ACM**, **LEVINSON** "Silver", and **MENDOTA** interconnecting cables, the **MAGNEPAN** Unitrac I pickup arm, the **MARCOF** PPA-2 headamp, the **ORSONIC** DS-250 disc stabilizer, the **SUNO** "Nine" power amp, and the **WIN LABS** SDC-10 turntable. Issue #5 also features a survey of 9 turntable mats, and another survey of 19 speaker cables.

Subscription rates to **AUDIO HORIZONS** for four (4) issues are: U.S.A.—\$20 (FIRST CLASS MAIL) Canada and Mexico—\$22 (FIRST CLASS MAIL) and outside North America—\$26 (AIR MAIL). PLEASE REMIT IN U.S. FUNDS ONLY. Sample copies of all issues are available for \$6.00 each (U.S.A., Canada, and Mexico), and \$7.50 each (outside North America).

Vampire Wire™

Speaker cable is no longer the weak link in your audio system.

VAMPIRE WIRE™ is a ten-gauge, 826 strand, oxygen-free, 99.9% pure copper speaker wire which can help to improve the sound of any audio system.

VAMPIRE WIRE™ is also an affordable speaker cable.

For more information on **VAMPIRE WIRE™** and the name of your local **VAMPIRE WIRE™** dealer contact:

Sound Connections Intl.
P. O. Box 16543
Tampa, FL 33687
(813) 985-7033

FOR SALE

INTERFACE SPEAKER SYSTEMS BY E.V. BEST PRICES — IMMEDIATE SHIPMENT. (305) 462-1976.

IVIE ELECTRONICS REAL TIME ANALYZERS, etc. Some very slightly used demonstrators at discount. Full factory warranty. Money-back guarantee. JML Company, 39,000 Highway 128, Cloverdale, CA 95425.

J.B.L. SPEAKER SYSTEMS AND COMPONENTS bought, sold and traded. 1-313-229-5191 or 5115 Red Fox, Brighton, MI 48116.

KLIPSCHORNS, MINT, \$1995. pr. (919) 477-4233.

LEVINSON ML-7 (L-3) almost new, finest stereo preamp available. (201) 746-2794.

LINN ASAK DC-2100K CARTRIDGE, very low hours, \$190. (212) 454-3205.

LINN DISC SYSTEM ALWAYS IN STOCK! GENE RUBIN AUDIO (213) 571-1299 (PAC).

LINN ISOBARIK DMS SPEAKER SYSTEM, with latest tweeters & stands, \$2,400. (212) 454-3205.

LINN PRODUCTS, MODIFICATIONS & NAIM

We are pleased to offer the complete line of Linn products: LP12, Asak, Ittok, Basic, PMS, DMS, SARA, KAN & Nirvana mod for LP12; and, Naim electronics: head amp, preamps, & amps. By appt. Free shipping in U.S. & P.R. Visa & M.C. OXFORD AUDIO CONSLTS., INC., Box 145, Oxford, OH 45056, 513-523-3333.

"LOWEST PRICES: BOSE, HAFLER, NAKAMICHI, ADS, ADVENT, DBX, GRADO AND MORE. DYNAMIC SOUND. BOX 168. STARKVILLE, MS 39759. (601) 323-0750 1 pm-9pm."

MAGNEPLANER TYMPANI III-A T/M panels, black, feet, \$650.; Precision Fidelity C-4 preamp, \$475.; JVC QL-50, Grace 704, new Dynavecator ruby \$415.; Powerlight MC4e, \$225. (707)938-1131, eves.

MARK LEVINSON LNP-2, early model, no updates, perfect shape, \$2000; offers considered. (415)948-6434.

McINTOSH BOUGHT, SOLD AND TRADED. 1-313-229-5191 or 5115 Red Fox, Brighton, MI 48116.

McINTOSH, MARANTZ, ARC TUBES. WANTED 713-728-4343.

McINTOSH MC2300, \$1500, NAKAMICHI 582 excellent, \$650. Dave 503 686-4598 or 484-9284 (after 18:00 P.S.T.)

— GOODWIN'S GROWS —

Goodwins Music Systems proudly announces a new expanded location. Goodwin's now features larger listening rooms, additional staff, and more of the very finest audio components. Goodwins Music Systems offers sales and service for Mark Levinson, Quad, HQD, Linn, Goldmund, Bryston, NAD, MIT, Tandberg, Symdex, Pyramid, Futterman, Magnepan, Stax, Celestion SL-6, Rega, Koetsu, Oracle, B&W, Soundlab, Astatic, Cotter, Janis, FR, Dynavecator, Grace, Spectral, VPI, Dan Queen, Keith Monks, Monster, D&K, Esotech, Vandersteen, Mirage, Live Wire, Hafler, and more. Goodwin's dedication to the purity and integrity of music reproduction is widely acknowledged. Goodwin's is unique in New England, representing products of classic quality, value and performance. If you would like to avoid the planned obsolescence of most stereo components and are interested in the finest music reproduction, please call or come visit.

16 ELIOT ST.
HARVARD SQUARE
CAMBRIDGE
MASSACHUSETTS
02138
492-1140

EXPORT SPECIALISTS
MAIL AND PHONE
ORDERS WELCOME

CABLES MADE
TO ORDER

GOODWINS
MUSIC SYSTEMS

FOR SALE

MICHIGAN AUDIOPHILES

Apt Holman	Grafyx	PS Audio
Adcom	Hafler	Rega
Boston Acoustics	Hitachi	Revox
Bryston	Isobarik	Snell
Conrad Johnson	Linn-Sondek	Spendor
Dahlquist	Mission	Spectrum
Dual	NAD	Stax
Grace	Nakamichi	Harmon Kardon
Grado Signature	Onkyo	Threshold
Naim Audio	Polk Audio	

ABSOLUTE SOUND

"Michigan's High Accuracy Audio Dealer"

Detroit, 12400 Morang Ave. (313) 527-2244
Royal Oak, 4354 N. Woodward (313) 549-7550
Ann Arbor, 312 S. State St. (313) 662-2026
East Lansing, 1045 East Grand River (517) 351-9300
We Ship Prepaid
VISA/M.C./AMER. EXPRESS WELCOME

MIRAGE IN THE SOUTH!

In stock. Free Shipping! READ BROS STEREO, 593 King Street, Charleston, S.C. 29403 (803) 723-7276.

MIXER made especially for tape duplication. Will produce enhanced high quality second generation tapes. KUHN ELECTRONICS, 4586 Carter Avenue, Norwood, OH 45212. TF

MODIFIED PANASONIC RIBBON TWEETER

Superior to JVC in every respect — compare them to T1's — will improve any speakers top end dramatically \$125 per pair. 12db at 6khz crossovers \$50 per pair. NEW YORK AUDIO LABORATORIES, INC. 33 North Riverside Avenue Croton on Hudson, NY 10520

MUSICAL CONCEPTS SUPER MODIFIED HAFLER DH 101, only \$349.00. (303) 963-3269.

FOR SALE

NAD: RECEIVERS, AMPS, PRE-AMPS, TUNERS, TURNTABLE, CASSETTE DECKS Call or write for quotes or information. Designatron's Stereo Stores, Inc., 260 Old Country Rd., Hicksville, N.Y. 11801 (516) 822-5277

NAIM AUDIO AVAILABLE AT GENE RUBIN AUDIO (213) 571-1299.

NEW ENGLAND ELECTRONICS EXCHANGE

provides a national marketplace for audiophiles buying or selling quality new and used equipment. Monthly newsletter subscribers enjoy the benefits of its nationwide distribution, equipment grading standards and the guarantee of full and prompt payment for products sold. Write or call free for a free sample newsletter or subscribe (\$6.00/yr.) 617/491-3000. (7-11 PM EST/M-F) Box 82 Harvard Square, Cambridge, MA 02138.



Accurate Audio 7 LOCATIONS IN SOUTHERN CALIFORNIA

A REFRESHING CHANGE

We offer you a chance to make an intelligent decision about audio equipment in a relaxed, private, pressureless environment. Our specialty is getting you the best sound for your audio dollars.

DCM, QUATRE 8000, NAD, DENON, PSE, SUMO, HAFLER, PYRAMID, ROGERS, DYNAVECTOR, PETERSON, LIVEWIRE, GRACE, KINDEL, STAX, MARCOF, MUSICAL FIDELITY, NOMADIC, VPI

SANTA MONICA	(213) 399-HIFI
STUDIO CITY	(213) 766-7478
PASADENA	(213) 792-4444
TORRANCE	(213) 542-5275
VALENCIA	(805) 255-2487
LAGUNA BEACH	(714) 494-2030
NEWPORT BEACH	(714) 645-7131

By Appointment 7 Days a Week

"WE Take You to The Concert, Not to The Cleaners"

EVERY PAIR IS HAND BUILT TO WITHIN 1dB & HANDLES 350 WATTS (Peak Program)

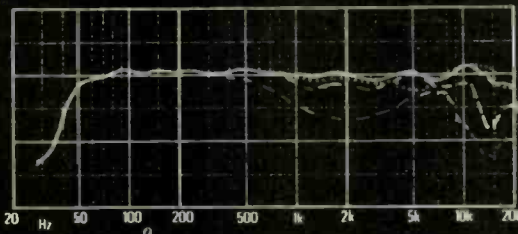

Rogers
BRITISH HIGH-FIDELITY

STUDIO 1

WHO ELSE BUILDS SPEAKERS LIKE THIS?

AVAILABLE FROM:

AZ Mesa	Hi Fi Sales	(602) 969-1338	MA Framingham	Natural Sound	(617) 879-3556
CA Palo Alto	Audible Difference	(415) 328-1081	MI Birmingham	Audio Dimensions	(313) 642-6383
CA San Diego	Audio Directions	(619) 278-3310	MI Swartz Creek	Audio House	(313) 655-8639
CA Encinitas	North Cnty. Stereo	(714) 753-3546	MD Baltimore	Soundscape	(301) 889-1134
CA San Francisco	Audio Excellence	(415) 433-1335	MD Bethesda	Paragon of Sound	(301) 229-2676
CA Sausalito	Music by Design	(415) 332-2142	NJ Verona	Audio Connection	(201) 239-1799
CA Westminster	Audio Today	(714) 893-8835	NY Wappinger Falls	Arnee Audio	(914) 297-2262
CA Burlingame	Audio Venture	(415) 342-6289	NY Lake Grove	Audio Den	(516) 360-1990
CA Los Angeles	Bel Air HiFi	(213) 477-9569	NY Great Neck	Ears Nova	(516) 466-5674
CA La Puente	Exceptional Audio	(213) 961-6158	NY New York	Lyric HiFi	(212) 535-5710
CA Beverly Hills	Chris Hansen Ltd.	(213) 858-8112	NY New York	Sound by Singer	(212) 683-0925
CA Santa Monica	Jonas Miller Sound	(213) 828-5613	NY Rochester	Stereo One	(716) 227-6181
CA San Diego	Stereo Unlimited	(619) 223-8151	OH Columbus	Custom Stereo	(614) 235-3531
CA Fountain Valley	Systems Design GP	(714) 964-7827	OH Oxford	Oxford Audio	(513) 523-3333
CA Ventura	Ventura Audio	(805) 653-5924	OK OK, City	Young Blood Sound	(405) 751-2532
CO Ft. Collins	Audio Alternative	(303) 221-1496	PA Philadelphia	Chestnut Hill Audio	(215) 923-3035
FL Coral Gables	Sound Components	(305) 446-1659	TN Knoxville	Alternative Audio	(615) 522-4045
IL Champaign	Audio Ltd.	(217) 359-3774	SC W. Columbia	Upstairs Audio	(803) 791-1885
IL Chicago	Victors Stereo	(312) 787-0750	VA Leesburg	High 'C' Stereo	(703) 777-7799
IN Indianapolis	HiFi Gallery	(317) 253-5141	WA Seattle	Definitive Audio	(206) 524-6633
LA New Orleans	Wilson Audio	(504) 866-3457			



a step nearer audio perfection

6074 CORTE DEL CEDRO • CARLSBAD, CA 92008



FOR SALE

NEW YORK AUDIOPHILES. AudioWorld can save you money. Not only do we offer bargain prices on audiophile equipment, we also eliminate the sales tax hassle for out-of-state customers. AudioWorld, Box 6202, Grand Rapids, MI 49506. 616-451-3868. M-F 11:00 a.m. to 6:00 p.m. EDT. Visa and MasterCard accepted.

NETTY GRITTY RECORD CLEANING MACHINE IN STOCK! \$349.00 shipped prepaid! Phone orders welcome. HCM AUDIO (916)343-0558

NORTH CAROLINA AUDIOPHILES

Acoustat, Magnepan, Vandersteen, Mirage, Dahlquist, 3D, Conrad-Johnson, Haller, Denon, Luxman, Kenwood, Dynavector, Grace, Grado, Plexus, VPI, Monster Cable, Gramolin, Keith Monks, Platter Matter.

AUDIO ADVICE

3532 Wade Ave. Raleigh, NC 27607 (919) 828-9221. MC, VISA, AE.

ONKYO, JBL, SONY CAR STEREO, PIONEER, TECHNICS — The Stereo Factory, Box 1326, Huntington, W. Virginia 25714. Phone, 304-522-8031. MC & VISA OK.

PAST ISSUES PROFESSIONAL MAGAZINES

IRE — IEEE — AC. SOC. AM. — NEC Apply for details M.W. Scheldorf Box 84 Marseilles Ill. 61341.

Eliminate Your Speaker Switching Problems



With an SPS-1 Speaker Selection System.

- Play any, or all simultaneously
- Floating (separate) grounds
- Power handling: 100 watts per channel
- Accommodates up to 14 gauge wire
- Amplifier overload protection
- Accommodates 4 pairs

Price: \$79.95. Available direct or through selected dealers. To order, or to obtain further information, write or call: Niles Audio Corporation/Dept. 1A/P.O. Box 160818/Miami, FL 33116/(305) 271-9181

FOR SALE

NORTHERN CALIFORNIANS

It is our goal to make the joy of music possible for everyone. At any price we offer solid value, superior performance, and traditional service.

We operate on the theory that you as our customer will achieve the greatest long term satisfaction only through a careful analysis of your audio requirements. We strive to offer sober, highly cost effective solutions to meet your specific needs. Please stop in for a refreshing experience with music.

OUR SELECTION INCLUDES:

Magnepan	Audioics	Dahlquist
Tandberg	Threshold	Chartwell
Onkyo	Audire	B&W
JVC	Halfler	Cizek
AKG	P.S.E.	AVID
Denon	Lux	Stanton
Micro	Grado Sig.	AIWA
Connoisseur	Sonus	M&K
Soundcraftsmen	Grace	Rogers

HIGH FIDELITY SHOPPE

1511 North Main Street
Walnut Creek, Calif. 94596
(415) 932-2242

"WE BUILD BETTER SYSTEMS FOR YOU"

"PLATINUM" RECORDS! Unique gift idea suitable for framing. Unlabeled and industry award identical. Single - \$26.50, Album - \$36.50 postpaid. Strocker Project, P.O.B. 4052-A, Overland Park, Kansas 66204. Dealer inquiries welcome.

POLK AUDIO SPEAKERS—BEST PRICES—IN STOCK—IMMEDIATE SHIPPING.

EAST: 305-462-1976 WEST: 213-243-1168

PREAMPS: JVC JP-S7, \$300.; Pioneer SPEC-1, \$250., with boxes and instructions; HK Citation II with instructions, \$175. 717-299-4161.

PS AUDIO=UPERB VALUE

GENE RUBIN AUDIO (213) 571-1299.

PYRAMID MET 7 IN STOCK. FREE SHIPPING GENE RUBIN AUDIO (213) 571-1299 (PAC.)

PYRAMID MET 7 SPEAKERS. The Mountain Ear, (303) 963-3269.

FOR SALE

PROPER TONEARM GEOMETRY! Optimum offset angle, overhang, vertical pivot height and angle. Resonance damping construction. Jewelled pivots. Height adjustable while playing records. Effective mass 2.5 grams. Damped cueing. Anti-skate bias. TA-3A with silicone damping, \$249.00. "Universal" nylon hardware, \$1.00; alignment protractor, \$3.00. Prices include postage and money-back guarantee. JML Company, 39,000 Highway 128, Cloverdale, CA 95425 TF

QUADRAPHILES! Your number one source for four-channel recordings and news is the MCS Review. Annual subscription, \$4.00 in the U.S., Canada, Mexico; \$7.00 elsewhere. Published by QUAD Incorporated, P.O. Box 19-A, Capron, VA 23829-0019.

QUICKEST AIRMAIL SERVICE DIRECT FROM TOKYO. All Japanese Cartridges, Arms, Headphones, Microphones, Tweeters and Turntable Accessories. Ask for Pricelists with \$1 for postage. JAPAN AUDIO TRADING CO., LTD. Saikaen Bldg. 4-33-21 Kamimeguro, Meguro-Ku, Tokyo 153

REGAL REGA RESEARCH

We are pleased to offer the complete line of Rega tables: Planar 2 & Planar 3, armed or armless. By appt. Free shipping. Visa & M.C. OXFORD AUDIO CONSULTS., INC., Box 145, Oxford, OH 45056, 513-523-3333.

REGA PLANAR TURNTABLES IN STOCK!

GENE RUBIN AUDIO (213) 571-1299 Pac.

HARMAN-KARDON HIGH TECHNOLOGY SEPARATES, RECEIVERS, CASSETTE DECKS, ELECTRO-VOICE INTERFACE A, B, C, D SPEAKER SYSTEMS, THORENS TURNTABLES. ALL IN STOCK — IMMEDIATE SHIPMENT.

EAST: 305-462-1976 WEST: 213-243-1168

ROGERS-NEW SPEAKER & CHARTWELL

The Rogers Studio 1 is a significant addition to the line of superb Rogers products. All of the Rogers speakers, electronics & Chartwell speakers are available at OXFORD AUDIO CONSULTS., INC., Box 145, Oxford, OH 45056. 513-523-3333. Visa & M.C. Free shipping in U.S. & P.R.

ROGERS, SATTERBERG, SHERWOOD, KENWOOD PRO, CLARKE SYSTEMS, HAFLER, AUDIRE, ADCOM, GRACE, GRADO, MARCOF, MICRO SEIKI, HARMON KARDON, LIVEWIRE, THORENS PSE and more EXCEPTIONAL AUDIO. (213) 961-6158 evenings, weekends PST. FREE SHIPPING! P.O. Box 658-U, West, Covina, CA 91790.

SALE ON THE FAMOUS KENWOOD AUDIO PURIST SEPARATE COMPONENTS! Up to 50% savings! All new, factory sealed. The LQ7M mk II mono amps (150w ea.) were \$600 ea, now \$395 ea. The LO5M mono amps (100w ea) were \$395 ea, now \$195 ea. Call or write for super combination savings with the LO7C mk II pre-amp and LO7T mk II tuner! Designatron's Stereo Stores, Inc., 260 Old Country Rd., Hicksville, N.Y. 11801 (516) 822-5277.

SAVE 60% TO 75%, BUILD YOUR OWN SPEAKER SYSTEMS. P/C CROSSOVERS, WOOFERS, MIDS, TWEETERS, INSTRUCTIONS. COMPLETE SELECTION, HI-FI, M.I., PRO, DISCO AND AUTO SYSTEMS. SEND \$2.00 FOR CATALOG REFUNDABLE WITH PURCHASE. DKI AUDIO, BOX 284, DAVIS, IL. 61019

SIEMENS, TELEFUNKEN, GENALEX AND AMPEREX and other top quality audio tubes available at very competitive prices. Contact Jim Wallace at 1203 Success St., Pittsburg, PA 15212 or (412) 322-4706 TF

SILVER + TEFLON + GOLD = SWL'S QUICK-SILVER INTERCONNECT CABLE. Fine strand silver coated copper cable with teflon dielectric and outer jacket. Low capacitance, hi cond. & propagation vel. Highest quality commercial duty heavy gold plate RCA plugs machined to exact tolerances. Available in 1/2, 1, & 2 meter stereo sets (\$25, \$30, \$45 respectively. Add \$1 S&H. TX res. add 5% sales tax). Custom lengths & connectors also available. Send SASE for complete product listing. STEPHEN WORSHAM LABS 3720 Maplewood Dr., Dallas TX 75205, Ph. 713-763-6061.

SOUND TECHNOLOGY AUDIO ANALYSIS SYSTEM Harmonic/IM Distortion Analyzer, FM Generator, complete accessories. Lab Standard Equipment. \$3500. Dan McKenna, 1901 Gordon, Lansing, MI. 48910 (517) 371-5955

Music Lives Here

Ears Nova presents high quality music reproduction equipment in an environment which is relaxed and comfortable. With care and integrity we will help build a playback system in your home that is uniquely satisfying.

BANG & OLUFSEN · BEDINI · BRYSTON · CONRAD-JOHNSON · DAVID BERNING · DENNESEN · GRACE · KEF · LINN DISC PLAYBACK (turntable — tonearm — cartridge) · LINN ISOBARIK · MISSION · MITCHELL COTTER · NAD · NAIM AUDIO · PSE · QUAD · REGA PLANAR · ROGERS · SHAHINIAN · OBELISK · SNELL · SUPEX · THIEL · VPI

ears nova

749 Middle Neck Road, Great Neck New York 11024 (516) 466-5674

Shipping free in Continental U.S.

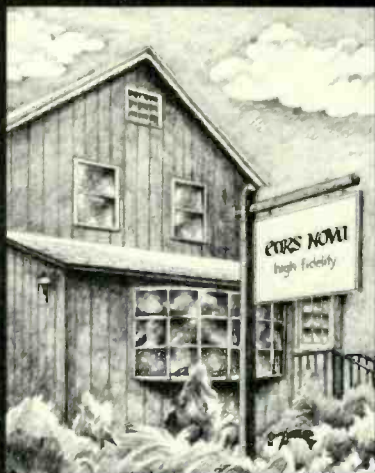

innovative audio

Music for your home. We make it simple.

We are experts dedicated to musical excellence. Our demonstrations of audio and video components offer personal attention and unlimited time for evaluation. Our extensive library of quality recordings will help you decide which components are a perfect match to your home environment. Our service policies provide continued satisfaction. Trade-ins accepted.

APT-HOLMAN, AUDIO RESEARCH, BANG & OLUFSEN, BEDINI, BOSTON ACOUSTICS, B & W, BRYSTON, COTTER, DAHLQUIST, DENON, DYNAVECTOR, FIDELITY RESEARCH, GRADO, INNOTECH, KLIPSCH, KLOSS NOVABEAM, KOETSU, LS3/5A, LINN SONDEK, MISSION, NAD, NAKAMICHI, OBELISK, OHM, PYRAMID, QUAD, REVOK, SIGNET, SUPEX, ETC.

182 HENRY STREET • BROOKLYN HEIGHTS, NY 11201 • (212) 596-0888

FOR SALE

SNELL ACOUSTICS DESIGNATRON'S STEREO STORES, INC.

Designatron's Stereo Stores are proud to demonstrate the precision Snell Type A and Type 1 loudspeakers! Our customers have found that Snell's attention to detail in both design and construction more than justifies the price of these fine products. Audio magazine said: "If what you're seeking is top-notch sound in a handsome, well crafted, quirk-free package, the Snell Type 1 deserves a place on your auditioning list." All Snell products shipped free in continental U.S. Designatron's Stereo Stores, 260 Old Country Rd., Hicksville, N.Y. 11801 (516) 822-5277.

SONIC STIMULATOR/TOUCH SYSTEM. High fidelity tactile display. Connects to stereo. Plans \$10. How Wachspress, Box 99141, San Francisco, CA 94109.

SOTA AND GEM TURNTABLES. S.O. Teric head amp, Seiguh speakers, large moving coil and tonearm selection. Sound Connection—Sonex—Osawa. Audionics, Hafler, Phase Linear amplifier modifications. S.O. Teric, 5256 Section Avenue, Cincinnati, OH 45212. (513) 396-6042.

SOTA SAPPHIRE TURNTABLE. The Mountain Ear, (303) 963-3269.

SOUTH CAROLINA'S ONLY HIGH-END STORE the finest audiophile equipment: British American Sound, P.O. Box 1247 186 King Street, Charleston, SC 29402 TF

SPEAKER BIBLE

Over 20 pages of hard hitting, up front speaker building facts that will curl your woofers. Find out how to build speakers the right way, without compromises that degrade imaging, clarity and transient response. \$2 will straighten your bottom end.

NEW YORK AUDIO LABORATORIES, INC.
33 North Riverside Avenue
Croton on Hudson, NY 10502

SPEAKERCABLE SOUNDS SO GOOD, 1/8 inch outer diameter, \$2. per ft. Add \$6. by air. Send to: Mr. Choi, 31A, Haven St., 8/Fl., Hong Kong. Dept. A3

SPEAKERLAB & NAD IN SALT LAKE CITY Hear the outstanding Speakerlab speakers and NAD components at Speakerlab, 2121 South, 11th East, SLC, UT 84106. (801) 487-8184

SPENDOR-NEW SPEAKERS & LOWER PRICES

In addition to the renowned SA1 & BC1, we offer TWO NEW Sendor speakers, the SA2 & SA3. Lowered prices on all speakers. By appt. Free shipping in U.S. & P.R. Visa & M.C. OXFORD AUDIO CONSULTS., INC., Box 145, Oxford, OH 45056, 513-523-3333.

SPICA Audio Connection

How can we say in two lines what the SPICA loudspeakers do so right, so musically pleasing for the most discerning set of ears? Please, hear them for yourself in Verona NJ, 201-239-1799

STAX/FUTTERMAN HEADPHONE AMPLIFIER

Julius designed a direct coupled tube headphone amplifier for Stax. This masterpiece has 12 tubes, finest quality parts, regulated power supplies and is the ultimate in lucidity. An excellent device for testing cartridges, tonearms, and preamps.

NEW YORK AUDIO LABORATORIES, INC.
33 North Riverside Avenue
Croton on Hudson, NY 10520

STEREO REPRESENTATIVES NEEDED!!! LOWEST POSSIBLE PRICES!!! OVER 100 BRANDS!!! KRASCO Rep-AP, 998 Orange Ave., West Haven, CT 06516.

SYMDX LOUDSPEAKERS

We are pleased to introduce the further improved Symdex Sigma and the new companion subwoofer, a three-way system of unparalleled accuracy and low coloration. This reference system, which sets new standards for definition and transparency, is a result of thorough optimization of all design factors plus construction and components of a quality never before used in loudspeakers. The sonic results of this effort have been described by listeners as a redefinition of the state of the art of dynamic loudspeakers.

For further information, contact: Symdex, 319 A Street Rear, Boston, Massachusetts 02210

Current Symdex owners note that factory updates are available.

FOR SALE

TAPCO and ELECTRO-VOICE, mixers, equalizers, amps, mics, and raw loudspeakers. Write for low mail order prices, Sonix Co., P.O. Box 58, Indian Head, MD 20640 8-9

TAPE HEAD REFINISHING - Precision method full frequency response. \$15.00 ea. One day service. E. Maher, 5 Evans Place, Orinda, CA 94563.

CROWN DISTINCTION SERIES: FM-1, EQ-2, DL-2, SA-2, ETC., IN STOCK — BEST PRICES — IMMEDIATE SHIPMENT. (213) 467-5725.

HARMAN-KARDON HIGH TECHNOLOGY SEPARATES, RECEIVERS, CASSETTE DECKS, ELECTRO-VOICE INTERFACE A, B, C, D SPEAKER SYSTEMS, THORENS TURNTABLES. ALL IN STOCK — IMMEDIATE SHIPMENT.
EAST: 305-462-1976 WEST: 213-243-1168

THE AUDIOGRAM an irregular newsletter by serious music listeners by-passes the trivial and establishes the best for sure value. Issue #16 includes:

- the best preamp (surprise)
- the best tube amp
- the best headamp
- the best MM
- the best MC and transformer (surprise)
- the best small speaker
- USA and Canada \$12.00 (4 issues); 1st class
- Foreign rates \$17.00 (4 issues); airmail
- Audiogram, Box 27406, St. Louis, MO. 63141

THE AUDIOPHILE BEST SOUND PER DOLLAR SYSTEM (under \$2200)

Regaplanar 2 turntable
Rega Cartridge
Hafler DH-101A Preamp
NAD 4020 Tuner
Hafler DH200A or Morduant-Short Padgient II's DCM Time Windows

SOUND BY SINGER, LTD.
227 Lexington Avenue
New York, NY 10016
(212) 683-0925

We ship anywhere (AE., M.C., VISA accepted)

FOR SALE

THE BIG "10" SYSTEM (Under \$10,000)

TURNTABLE: Oracle or Linn Sondeck
TONEARM: Linnitok
CARTRIDGE: Linn-Asak
SET-UP: Audio Interface
PRE-AMP: Audio-Research SP6-B
POWER AMP: Audio-Research D-120
SPEAKERS: Snell Type A's or Acoustat Monitor III's
Rogers T-75
Tandberg TD-20A

TUNER: SOUND BY SINGER
TAPE DECK: 227 Lexington Avenue
New York, NY 10016
(212) 683-0925

We ship anywhere (M.C., A.E., and VISA accepted.)

McKAY SETS THE STANDARD FOR COMPACT AM RECEIVING ANTENNAS

DA100D OUTDOOR ANTENNA and DA9-DL4 LOOP ANTENNA

For specs & details contact these dealers

HARVEY RADIO & BARRY ELECTRONICS New York City
HENRY RADIO Los Angeles, CA
GILFER ASSOCIATES Park Ridge, NJ
EDMOND SCIENTIFIC CO. Barrington, NJ
ELECTRONIC EQUIPMENT BANK Vienna, VA (D.C. Area)
PROMAR Tampa, FL
FRANK L. BEIER RADIO INC. Jefferson, LA
THE BASE STATION Concord, CA
J-MAR ELECTRONICS Toronto, Canada
INTERNATIONAL RADIO WORLD INC Vancouver, Canada

800/854-7769 Local • 714/621-6711
except Telex • 910-581-4990
Calif., Alaska, Hawaii

G. E. McKAY & CO.
111 S. College Ave.
PO Box 5000
Claremont, CA 91711

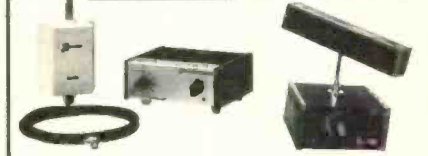

"WORLD'S ONLY"

PURELY MECHANICAL LINEAR TONE ARM

SOUTHERN SLA-2

Introduced at the SCES and covered by Bert Whyte in the Sept. Audio. This exotic design provides for vastly superior performance with EQUA-MASS® concept and ABSOLUTE ZERO tracking error. Fits most turntables/cassettes. Custom made to order. FULL DETAILS, SPECS and COLOR PHOTO \$3.00 refundable. "DEALER INQUIRIES INVITED"

\$600.

(617) 828-5050

SOUTHERN ENGINEERING PRODUCTS

SINCE 1961

M 429 YORK STREET

CANTON, MASSACHUSETTS 02021

Actual Tone Arm Weight - 1.1 grams patent pending

Here are
56+
reasons for
visiting
**Sound Components
by Peter McGrath.**

Plus a record room featuring a large collection of imported pressings and specialty records.
Plus complete international export facilities. Spanish spoken.
Plus American Express, Diners Club, Master Card and Visa accepted.

Sound Components, Inc.

Adcom	Oracle	John Marovskis	Dennessen
Ampex	Fourier	Audio	Electrocompaniet
Bedini	Rogers	Klyne	Futterman
Koetsu	Solar Tading	Mark Levinson	Hartley
Denon	Spendor	Naim Audio	KEF
Esotech	Tandberg	Milab	Koetsu
Goldmund	Braun	Proton	H.Q.D. Reference
Insync	Apt Holman	Pyramid	System
KWAL	Bryston	Ram Labs	Celestion
Last	DCM	Sequera	Monster Cable
Linn Products	Discwasher	Sound	Nitty Gritty
Magnepan	Fidelity Research	Connections	Quad Electro-
NAD	Hafler	Stax	acoustics
		Daybreak	Rega Research
		Grado	Snell Acoustics
		Bang & Olufsen	Spectral Audio
		D & K Imports	Symmetry

2710 Ponce de Leon Blvd., Coral Gables, Florida 33134. Open Tuesday-Friday 11AM-8PM. Saturday 11AM-5PM. Closed Sunday and Monday.

Sales: (305) 446-1659
Service: (305) 448-6553

FOR SALE

THE INTERMEDIATE AUDIOPHILE SYSTEM

(Under \$4,250)

Turntable: REGA PLANAR 3
 Cartridge: DYNAVECTOR RUBY KARAT
 Set-up: MUSICAL FIDELITY
 Pre-amp: PRECISION FIDELITY C-7
 Power Amp: TRILOGY
 Speakers: SNELL TYPE 1
 Tuner: ROGERS T-75
 SOUND BY SINGER
 227 Lexington Avenue
 New York, NY 10016
 (212) 684-0925

We ship anywhere (A.E., M.C., and VISA accepted)

THE NEW SOUND PANELS — UNQUESTIONABLY SUPERIOR TO ANYTHING UNDER \$1,000.00. AMAZINGLY CLEAR AND NATURAL WITH IMAGE REPRODUCTION SO UNBELIEVABLY DETAILED AND ACCURATE THAT THE LISTENER WILL BE SIMPLY ASTOUNDED. HEAR THEM WITH THE AMBER ELECTRONICS AND THE GRACE F9E EXCLUSIVELY IN WESTERN SUFFOLK AT TUCKER'S COMPONENT AUDIO. (516) 673-1124.

THE OUTRAGEOUS BLACK BOX LOUDSPEAKER — THE NEWEST CULT SPEAKER THAT SIMPLY OVERWHELMS THE COMPETITION. HEAR THEM WITH THE AMBER ELECTRONICS AND THE GRACE F9E EXCLUSIVELY IN WESTERN SUFFOLK AT TUCKER'S COMPONENT AUDIO, HUNTINGTON, N.Y. (516) 673-1124

THETA TUBE ELECTRONICS

Theta has introduced an IMPROVED preamp, the 1B. It along with the OPT amp & head amp are available at OXFORD AUDIO CONSULTS., INC., Box 145, Oxford, OH 45056. Free shipping in U.S. & P.R. We ship WORLDWIDE. Visa & M.C. 513-523-3333, telex: 427791, cable, OXAUDCON.

THIEL Loudspeakers: Audio Connection, Verona NJ Just beautiful...! (201) 239-1799

THIEL SPEAKERS = MUSIC

GENE RUBIN AUDIO, (213)571-1299 (PAC.), FREE SHIPPING.

THORENS TURNTABLES — BEST PRICES — IN STOCK — IMMEDIATE SHIPPING.

EAST: 305-462-1976 WEST: 213-243-1168.

TOP-RATED CARTRIDGES UP TO 70% OFF!!

We offer just about all of the finest phono cartridges on the market at the lowest possible prices. Our selection includes several brands that are typically sold at the full retail price. Call or write to us for prices on ACUTEX, ADC, DYNAVECTOR, GRADO, NAGATRON, ORTOFON, SHURE, SONUS, STANTON and more. Just call (212) 254-3125 or write to: DIRECT DISCOUNTS LTD., P.O., BOX 841, COOPER STATION, NY 10276. We accept M/C and VISA and will ship COD if requested.

VAN ALSTINE MODEL TWO POWER AMP, \$600., Technics SU9070 preamp, \$150. (812) 372-6975.

FOR SALE

UDS—USED, DEMO STEREO

Speakers: Beveridge System III (6000)-2200 (U), KEF 1051's-1350(U), Fulton Premiers (5500)-1900(U), Kinetic Audio Sub Woofers (450)-249 (demo), KEF 104 aB's (950)-575(U), Visonik 602's (mini's) (350)-110(U). **Pre-Amps:** Dayton-Wright SPS Mk III (updated) (600)-275(U), Phase Linear 3000(600)-250(U), Threshold NS10 - 600(U), McIntosh C26-195(U). **Amps:** Dynaco 416 (C-100 outboard power) - 650, Luxman M-6000 (300 W.P.C.)-1300(U), McIntosh: 2100-380(U), MC 240-399(U), MC 30-145(U) (716)-461-1585.

UNDERGROUND SOUND

The Merrill A.R. turntable mod kit complete with new suspension chassis, makes your old A.R. state of the art and allows new tone arm accommodation — \$39.00, New bearing assembly for A.R. mod - \$15.00. Updated GP-1 (glass/lead) platter pad \$27.00, Weight-\$7.00
 Audiophile Quality New & Used Equipment
 2125 Central Avenue, Memphis, TN 38104
 (901) 272-1275

VACUUM TUBES, tube-peculiar parts. All kits/parts for circuitries described in our 230+ page Modification Manual. Write for list to AUDIO DIMENSIONS, 8888 Clairemont Mesa Blvd., San Diego, CA 92123. (714) 278-3310. 9-0

VANDERSTEEN IN THE SOUTH

In stock, the superb new Mod. 2C. Fast, free shipping.
 READ BROS. STEREO
 593 King St. Charleston, SC 29403 (803)723-7276
 VISA & M/C OK. Carver, Hafner, PS, M/rage.

WANTED: ALL HIGH END SOUND EQUIP. 713-728-4343.

WOOFERS-MIDS-TWEETERS-CROSSOVERS AT TREMENDOUS SAVINGS. EV, BECKER, SEAS, POLY-DAX, PEERLESS, PHILLIPS, EMILAR, GAI AND MANY OTHERS IN STOCK FOR IMMEDIATE DELIVERY. SPEAKERS FOR HI-FI, CUSTOM AUTO, REPAIRS, PRO-SOUND AND MUSICIANS. LARGEST SELECTION OF PARTS AND ACCESSORIES IN THE U.S. FOR SPEAKER BUILDERS AND HOBBYISTS. SEND \$2.00 FOR THE ALL NEW '81 CATALOG (REFUNDABLE WITH FIRST PURCHASE) TO SRC AUDIO DEPT AD3, 3238 TOWERWOOD DR., DALLAS, TX 75234.

YAMAHA B1 WITH METERS, \$950.; Yamaha CL \$1000.; both perfect. Offers considered. (415)948-6434.

YAMAHA T-2 TUNER. Mint. Card, 608-849-7207.

1 MARANTZ 10B Mint, Marantz 7C very good. Pr. McIntosh Mc 75's, Mono. 1 McIntosh 2100. Will ship to Europe or Japan, Mel, Day 212-330-3719. Nite 212-881-2455.

FOR SALE

1-800-245-3986 TAPE WORLD

TDK: SA-C90	2.79
TDK: SAX-C90	3.99
TDK: AD-C90	2.39
TDK: ADX-C90	3.29
TDK: SA-C60	2.19
TDK: D-C90	1.65
TDK: MA-C90	4.99
TDK: VAT-HG120	15.99
TDK: L-750	12.99
Maxell: UDXL I, IIC-90	3.19
TDK: VAT-120	12.99
TDK: MAR-90	7.49
TDK: LX35-90B	5.89
TDK: GX35-90B	7.99
TDK: LX35-180BM	16.95
TDK: GX35-180BM	19.99
TDK: HD-01(Cass. Head Demag.)	14.69
BASF: PRO I,II, or IIC90	2.59
Fuji: Fx I or II-C90	2.79
SCOTCH: 207-7R1800	5.49

3.50 Shipping any size order in US. Visa & MC no extra charge. Dealers COD no extra charge. PA 6% sales tax. We will honor any price in this book. Personal checks 1 week delay. 412-283-8621
 Tape World, 220 Spring St, Butler, PA 16001

RECORDS

AUDIOPHILE RECORD GALLERY DISCOUNTS ultra sound direct disc, digital, half mastered, more! Free catalog, P.O. Box 2668, La Mesa, CA 92041 or P.O. Box 1073, Vienna, VA 22180.

DIRECT TO DISC AND DIGITAL RECORDINGS: All labels at low prices. Telearc, Discwasher, Audio-Technica, Sheffield, Denon PCM, Crystal Clear, Mobile Fidelity Labs. . . WE HAVE THEM ALL!! (and more!!) Send for FREE price list and Newsletter or \$2.00 for descriptive catalogue DISConnection, P.O. Box 10705 Tampa FL 33679.

FREE RECORDS

Current Disco, Rock and others. Singles, 12 Inches. Albums all new completely Free (D.J.'s Delight). No tricks/Gimmicks just follow our details! Rush \$3.00 to: J.A.M., P.O. BX-3, N.Y. 10463

FREE SOUNDTRACKS & CASTS CATALOG! Personalities! ST/OC Valuebook: \$4. RTSA 711 W. 17th G-1 Costa Mesa, CA 92627. TF

PROTECT YOUR LPs. POLY SLEEVES FOR JACKET 12¢. ROUND BOTTOM INNER SLEEVES 10¢. SQUARE BOTTOMS 6¢. POLY LINED PAPER SLEEVES 15¢, white jackets 35¢. POSTAGE \$2.00. HOUSE OF RECORDS, HILLBURN, NEW YORK 10931. TF

"RECORD JACKETS. Replace old, torn, LP jackets with clean, glossy, pure white or black jackets. Plastic lined inner sleeves, 78 sleeves, opera boxes. Free catalogue. CABCO A6, Box 8212, Columbus, Ohio 43201." TF

THOUSANDS OF LIKE NEW LP's and prerecorded tapes. Catalogue—\$2.50. House of Records, Hillburn, New York 10931. TF

SPEAKERS

ELECTRO-VOICE INTERFACE A, B, C, D QUALITY SPEAKER SYSTEMS. BEST PRICES — IN STOCK — IMMEDIATE SHIPMENT.
 EAST: 305-462-1976 WEST: 213-243-1168

WANTED TO BUY OR TRADE

AR INTEGRATED AMP. 212-438-5714 eves.

ATTN: TUBES, MCINTOSH, MARANTZ, ARC, W.E. M. Corb, 11122 Atwell, Houston, TX 77096, 713-728-4343.

BOSE 901 SERIES II, Leon 615-870-1360.

BUY MCINTOSH AND MARANTZ TUBE EQUIPMENT. Leland 713-772-4653.

FISHER FM 100-C TUNER. 212-438-5714 eves.

FISHER PR-6 BASIC PREAMP. 212-438-5714 eves.

FISHER TFM-200, TFM-300 TUNERS. 212-438-5714 eves.



Audiocom
high technology audio

Adcom, ADS, AGI, Aillson, Amber, Apt, Ariston, Audionics, Audio Pulse, Audio Technology, Beveridge, Beyer, Blaupunkt, Bruer, Burwen, B&W, Cotter, Dahlquist, Dayton Wright, DCM, Denon, Draco, Dynavector, EMT, EV, Eumig, FR, GAS, Grace, Grado, Hafner, Janis, JR, KEF, Kenwood Purist, Linn Sondek, Lustre, Mitsubishi, M&K, Mogami, NAD, Nakamichi, Ortofon, Queen Labs, Revox, RG, RH Labs, Rogers, Snell, Spectro Acoustics, Stax, STD, Symmetry, Tandberg, 3D

Our Service Department specializes in maintaining, calibrating, and modifying high performance audio equipment. Custom equipment design and fabrication on premises. System installations for car, boat, home, and aircraft. Major credit cards honored. Phone orders shipped promptly.

177 Sound Beach Avenue, Old Greenwich, CT 06830 (203) 637-3621
 Out of state, call Toll-Free 800-243-7516

WANTED TO BUY OR TRADE

FISHER X101-C AMPLIFIER, 212-438-5714 eves.

FISHER 600-T STEREO RECEIVER, 212-438-5714 eves.

I'LL BUY OR TRADE tube gear by McIntosh, Marantz, Western Electric, and Audio Research. Top dollar paid! (215)324-4457.

INTEGRAL SYSTEMS 10 PREAMP, 212-438-5714 eves.

MAGNACORD 1028 or 1048. FISHER MF300 or MF320. Russell, 7 Normandy Ct., Binghamton, N.Y. 13903

MARANTZ MODELS 2, 3, 6, 7, 8, 9 & 10B; MCINTOSH C-22, MC240, MC275 & MC3500. Sam Aberst, P.O. Box 5455, Beverly Hills, CA 90210 (415) 889-7729.

MARANTZ 1120 AMPLIFIER, 212-438-5714 eves.

PAY ATTRACTIVE PRICE FOR MCINTOSH OR MARANTZ TUBE TYPE (any model) pre-amps, power-amps. ARC SP-3A-1, D-75(A), D-76(A), THORENS TD-124. GARRARD 301, 401. WESTERN ELECTRIC tubes, amps, drivers, horns, speakers, mixers, microphones, others 213/576-2642 David Yo PO Box 832 Monterey Park, Ca. 91754.

SCOTT LT-110 TUNER, 212-438-5714 eves.

SCOTT 272, 299-C AMPLIFIERS, 212-438-5714 eves.

SHURE M65 CONVERSION PREAMP, 212-438-5714 eves.

TECHNICS ST-8600 TUNER, 212-438-5714 eves.

TOP PRICES PAID: MARANTZ, MCINTOSH tube equipment. WESTERN ELECTRIC and ERPI speakers, drivers, horns. (206)323-4987.

USED AUDIO:

QUAD of England, MCINTOSH, AUDIO RESEARCH, DY-NACO, LEVINSON, MARANTZ tubes, JBL, WESTERN ELECTRIC, ElectroVoice PATRICIAN 600 and most other esoteric separates, mc. carts, tonearms, tuners, amps. NO MASS MERCHANDISE, please. Call collect (617) 969-2727 or write: Bob Heenan, Box 782, Brookline Village, MA 02147. Also soon starting audio museum for USA audio from 1930's to date. Interested consignors with FISHER, SCOTT, PILOT, RCA et al. and suggestions please contact: (617) 969-2727

WANTED: Advent MPR-1 Mic Preamp (201) 474-2862

WANTED: EICO HF 89 or HF 89A AMPLIFIER IN ANY CONDITION. Call Tom (213) 981-4493 6-10 PM (PST).

WANTED HARMAN KARDON MODEL 430 RECEIVER, working condition preferred. Call after 6 pm, central time, 314-849-0876.

WANTED: Infinity 4.5, (516) 561-7735, (212) 867-4000, Ext. 250.

WANTED: OLDER BRITISH SPEAKERS: Tannoy (8 ohm) 12"-10" "Golden" and Altobass each dual concentrics. Hartley 12" wide range, 10" coaxial. Vitavox 12" duplex coaxial DU 120. Goodmans 12" axioms, triaxions. Stentorian 12"-15" duplex coaxials. Lowther PM-6, PM-7. Lorentz 12" coaxial LP 312-2. Bakers 12" "Ultra-Twelve". Duode 12" #12C, #12B-C speakers. Gramplan 12" #1255/15. Norelco full range 12"-8". Trusonic (Stephens) coaxials 12"-8". Old Raton 12"-15" #15HTX. Calrad 12" triaxial #12TX-1, 12" coaxials, 8" coaxial #CR-8X. Stromberg-Carlson 12" coaxial like RF-487. RCA 12" biaxial SL-123, 15" #LC-1A. Old Western-Electric 12" full range #728-B. No cabinets. Ask, write friends esp. British. Kalish, 565 Walnut Ave., Redlands, Calif. 92373.

WANTED 3M/4" PROFESSIONAL TAPE TRANSPORT. J.P. Sammut, P.O. Box 214615, Sacramento, CA 95821, 916-726-2263.

BUSINESS OPPORTUNITIES

CABLE FM BROADCAST STATION. Unique no investment/experience business makes money! Others work for you! Free Details "CAF.M", Box 130-N3, Paradise, CA 95969

BUSINESS OPPORTUNITIES

AUDIO REPAIR AND PRO SOUND business in mountain resort area of Colorado for sale. Unique opportunity for technician or engineer type. Reply box 1-282 Audio for details.

COLLEGE STUDENTS — EARN EXTRA MONEY SELL AUDIO EQUIPMENT AT YOUR SCHOOL

No investment. Professional sales help. 60 top brands. Incentive programs. Limited positions available. Call or write. Audio Outlet, Inc. 10 Commerce Court, Newark, NJ. 07102 201-622-3250.

FOR LICENSE TO PROMOTION MINDED MFR.— UNIQUE CLOCK WITH

copyrighted sound effect system on tape (digital?). universal appeal, great conversation piece. Principals only on your L/H. TIM, 328 E. Traube, Westmont, IL 60559.

Want money? Hate hard work? Lazy way to big money. Cleaver plan \$2.00 (Refundable) Noble, Box 10033, Houston, TX. 77206.

TAPE RECORDINGS

ON OPEN REEL from master tapes. Philips, Argo, Telefunken, Vanguard, Unicorn. Catalogue \$1.00. Barclay-Crocker, Room 1470-A, 11 Broadway, NYC, 10004. TF

RADIO PROGRAMS

CATALOGS. Broadcasts, soundtracks. Personalities of Thirties, Forties. Box 225, New York, N.Y. 10028. TF

RENT RADIO SHOWS: Make your own copies or just listen. Great way to build your collection reasonably. Catalog \$1 refundable. OTR Rental, Box 1146, Livermore, Ca. 94550 TF

YESTERDAYS RADIO ON TAPE. Reels-Cassettes. Quality Sound. Reliable Service. Giant catalog \$1.00 refundable with first order. ADVENTURES, Box 4822-A, Inglewood, California 90302. TF

1930-1962 RADIO PROGRAMS. Beats Television! Tapes \$1.00 Hour! Established esteemed dealer. Informative 200 page catalog, \$1.25. AM Treasures, Box 192 AU, Babylon, NY 11702.

PUBLICATIONS

ARE YOU INTERESTED IN QUALITY, USED STEREO EQUIPMENT? Send for the **PLAY IT AGAIN SAM** newsletter — hundreds of listings — items for sale — items sought — published 6 times per year. \$6 1-year subscription, \$1 sample copy. Send today to **PLAY IT AGAIN SAM**, 12611 Madison Avenue, Lakewood, Ohio 44107, (216) 228-0040. Master Charge and Visa accepted.

TERRIFIC SWAP OFFERS NATIONWIDE

Rcvrs., amps, TTs, Audio, Ham Gear, Etc. 5 Issues \$2! "Electronic Trader," Box 73-A, Folly Beach, SC 29439. T.F.



GOLDEN gramophone.

Audio Research	Dynavector	Magnepan Products
Acoustat	Fidelity Research	Marcot
Adcom	Grace	MAK
ADS	Grado	Mirage
Apt/Holman	Hafler	NAD
Astatic	Kenwood/Purist A	Nakamichi
Berning	Kloss Video	Oracle
Boston Acoustics	Koetsu	Polk Audio
Crown	Linn Products	Prosonics
Denneson	M.A. Cotter	Rega
		Signet
		Snell Acoustics
		Sony
		Stax
		Tandberg

2858 W. Market St. Akron, Ohio 44313 Phone (216) 864-4411

TAPE AND TAPE RECORDERS

NAME-BRAND RECORDING TAPE, custom loaded. Available in cassettes, reels, cartridges. Huge savings from manufacturer. Also low everyday prices on Maxell, TDK, Ampex, Scotch, BASF, etc. SASE new catalogue. MJS, 2514 Seaboard Ave., San Jose, CA 95131. (408) 262-8793

OPEN REEL TAPE — Mostly Ampex, used once, unboxed, unspliced. 1800' 50 Reels; \$65.00. Sample; \$2.00. 3600' 10 Reels; \$25.00. Sample; \$2.50. New, premium C-60 cassettes, Sample; \$1.00. AUDIO TAPES BOX 9584-S ALEXANDRIA VA 22304.

SERVICES

CUSTOM RECORDING SERVICE, Tapes, discs, and cassettes Stereo and mono. Live and copies. Editing. Masters and pressings. High quality at reasonable rates. Joseph Giovanelli, Audio-Tech Laboratories, 1158 Stewart Avenue, Bethpage, NY 11714 (516) 433-0171 TF

NASHVILLE RECORD PRODUCTIONS WILL PRESS HIGH QUALITY PURE VINYL RECORDS FROM YOUR TAPES. SEND FOR SAMPLE RECORD AND PRICE LIST. ALSO FINEST DISC MASTERING. 469 CHESTNUT ST., NASHVILLE TENNESSEE 37203 TF

STYLUS RETIPPING — DIXIAF 99, Maple Stream Rd. Hightstown, N.J. 08520. 609-443-5765.

Accuphase
ENRICH LIFE THROUGH TECHNOLOGY

This is the guiding principle behind all Accuphase components. The name Accuphase was derived from the prefix ACCU (from the word "accurate") combined with PHASE, an all-important factor in audio technology. The Accuphase line consists of power amplifiers (A/B operation), preamplifiers, integrated amplifiers, tuner and crossover networks.

Accuphase products represent extra value, fully displaying the merits of handcrafting.

C 2300 P 2600 M 1000

For more information and dealers near you, contact **D & K IMPORTS**
146 E. Post Rd. White Plains, NY 10601 • 914-946-3031
Dealer Inquiries Invited

Audio by Caruso

• ACOUSTAT • ARGENT • ARISTON • AUDIO PRO • AUDIRE • BOWERS & WILKINS • CM LABS • CONRAD-JOHNSON • COUNTERPOINT • THE DAVID BERNING CO. • DAYTON WRIGHT • DECCA • DELPHI • DENNESEN • DYNAVECTOR • ELECTRO RESEARCH • FRIED • GRACE • HAFLER • HEYBROOK • K BETH MONKS • KENWOOD AUDIO PURIST • KRELL • LAST • LEACH • LIVE WIRE • LUSTRE • MICHELL • MARCOF • MICRO • NAD • PETERSON AUDIO • POLK AUDIO • PS AUDIO • RGR • R.H. LABS • SHAHINIEN • SOTA • SOTA SAPPHIRE • SPICA • STRAIGHT WIRE • SUMIKO (The Arm) • SUMO • SUPLEX • THIEL • THRESHOLD • VPI • WIN LABS

13831 South Dixie Highway, Miami, Florida 33176 (305) 253-4433

Call or write for literature on specific items.



**WE
EARNED
OURS.**

INTEGRITY HAS NOTHING WHATSOEVER TO DO WITH PRICE.
AND EVERYTHING TO DO WITH FIDELIS.

By offering superbly engineered audio components.
And matching these into systems of superior musical
merit. To your music and value preferences.
Call on us. For your
good fortune.

Fidelis

Commitment to Musical Integrity

418 BEACH STREET SAN FRANCISCO, CA 94133 (415) 885-3488

LEGENDS AS USUAL.

These highly respected names can be found at Chestnut Hill Audio: Acoustat, Adcom, Amber, Apature, Apres, Audio Pro, B&W, Berning, Cabasse, Colter, Dahlquist, Dayton Wright, Dennesen, Denon, Discwasher, Dynavector, Fidelity Research, Fourier, Gilmore, Grace, Grado, Hafler, Impulse, Janis, Kenwood Purist, Leach, Marcol, Mariah, Monster Cable, Mordaunt-Short, NAD, Oracle, PS, Audio, Quad, R.G.R., Rogers, Signet, Spondor, Stax, Symmetry, Tandberg, Theta, 3D Acoustics, Thorens, Threshold, VPI, Vandersteen, 311 Cherry Street, Philadelphia, Pa. 19106. (215) 923-3035.

CHESTNUT HILL AUDIO LTD.

Audio

Subscriber Service

Place label here

MOVING? Please give us 8 weeks advance notice. Attach label with your old address, and write in new address below.

RENEWING? Check box below and attach label with corrections marked, if any.

SUBSCRIBING? Check box and fill in coupon. For gift subscriptions attach a separate sheet.

Send Audio for 1 year at \$13.94

Outside the U.S.: add \$6.00 per year.

New subscription Renewal Payment enclosed Bill me

Name _____

Address _____

City _____ Zip _____

51557

For faster service call toll-free any business day, 7 A.M.-7 P.M. Mountain time.

800-525-9511

(In Colorado 303-447-9330)

AUDIO, 1255 Portland Place, P.O. Box 5318, Boulder, CO 80322

Firm (Reader Service No.)	Page
ADS (1)	25
Allison Acoustics	92
Audio-Technica (2)	93
Bang & Olufsen (3)	Cover II & 1
BASF (4)	39
BES (9)	2
Bryston Manufacturing (5)	70
Carver Corp. (6)	11
Denon (7, 8)	14, 56
Discwasher	Cover IV
Fourier Systems (10)	92
Kenwood	88
Maxell (11)	15
McIntosh (12)	53
Meridian (13)	41
Mission (14)	Cover III
NAD (15)	8
Ohm Acoustics (16)	89
Pickering (17)	17
Quad (18)	4
Revox (19)	7
Sansui (20)	91
Shure Bros. (25)	35
Soundcraftsmen (24)	5
Studer-Revox (19)	7
TDK (20, 21)	3, 17
TEAC (22)	13
Telarc (23)	19

It seems to be Readout time these days, reflecting our new microprocessor heaven, and I have to note a few of the implications. Practical, of course, for tuners, receivers, super cassette decks and the like. Also and especially, a new super computer turntable from Nakamichi.

This Readout Revolution is incredible. (I mean, with poetic license, every sort of flashing mini-light, red, green, amber, pink and blue, as well as the computer's orthodox TV screen or out-printed fold-paper.) Everywhere you look, there they are, the lights and the numbers, maybe even on kiddiecycles and can openers. Pretty soon you'll need a green light from the computer inside your suitcase before you'll be able to unlock it. All of which is, of course, taken for granted by persons beneath middle age. Not by me. Nor, I think, by anybody if you look at the long run. A lot of this is sheer novelty. Soon it all will become so routine that people won't buy unless it's really useful. We do face up to facts, sooner or later. So I have hope, though my eye grows bilious when it comes to much of what we now have around. Even in hi-fi.

We are dealing here on two levels, of course. These flashing indicators merely refer to what's going on inside (though a few are purely decorative, like so many Christmas tree lights). What goes on inside is too often just silly. And yet —

And yet, not all is bad that looks bad. Take me and these new tuners, decks and so on. Splendid equipment, but give me time! Before I could use them at all I had to learn their Readout languages. No longer do I merely reach for familiar knobs and (large) pushbuttons. Radio! I couldn't even get station WXYZ, right there in the middle of the dial (what dial?), until I had inputted the tuner's elaborate memories. No more easy flick of the tuning knob, the pointer flying straight to the station of my choice. That was a good system for 50 years, but it is gone. Now you have to commit everything to memory. The tuner's.

Well, good or bad? We'll have to see. It's early in this game. I'll go along. So then there's the cassette deck. Yes, there are little fingertip buttons, activating numerous lights, which more or less follow the old familiar configurations, fast-forward, play, rewind; also a lot of other pushbuttons and lights, needing a magnifying glass to decipher. I couldn't

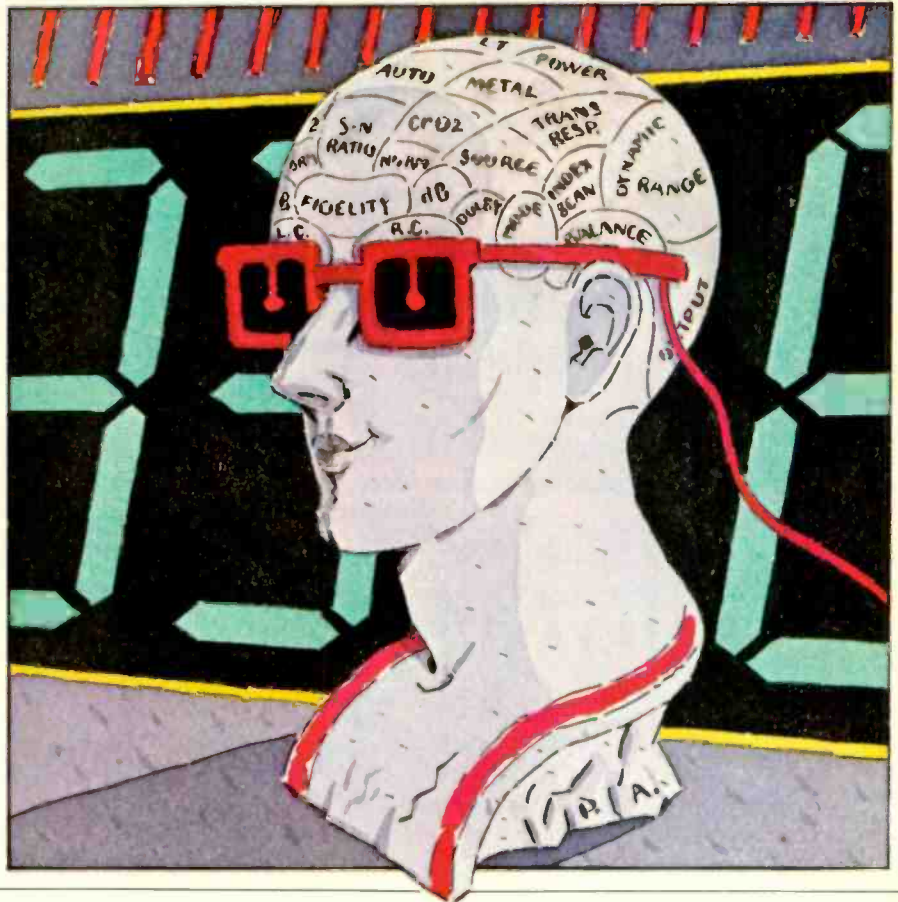

for the life of me get into simple record mode until I'd read the book on how to tell the machine. Memory? Several memories. It's mine that is now at fault; I can't remember to inform these memories what I want them to remember until I remember to look at the Memory Instructions. All very confusing. But —

The *raison d'être*, the Reason for Being, in all this, whether good or bad, zany or sober, is very simply an electronic overabundance, mushrooming straight out of the now-familiar and omnipresent chip, the IC, the microprocessor, the minicomputer, a development that has increased our electronic potential by maybe 10,000 to one, or is it 10 million? We have such staggering capability now that we really don't know what to do with it all. So we do everything — anything.

What's an engineer supposed to think when he's tossed a thousand transistors on a fingernail and told to get busy and USE them for something? (Can you remember the size of a thousand vacuum

tubes and the bulk of the first mainframe computers, using tubes?) Likely as not, our fingernail engineer will go berserk, in a highly integrated way, and come out with — you know what. Flashing lights. Elaborate ways of doing things that used to be so simple, if requiring a bit of thought, as well as muscle, not to mention knowhow.

You're telling me (by computer) when to shift gears on my manual-shift economy car? After my long years of experience! An insult. (But I suppose, helpful for you beginners.) And do I need a power can opener with computer which, when it jams on a sardine can, goes into reverse, flashes red lights, activates a squawk box, and then blows its fuse? I use the simple manual type and I know what to do with sardine cans. And yet. And even so —

Once the overwhelming novelty of all this begins to pale, we'll begin to cut the sheep from the goats, the dogs from the foxes, in the well-known marketplace selection. We'll do okay. Plenty will last.



WHAT TYPE ARE YOU?

Power has its price. Unfortunately, with many receivers, you usually end up paying for a lot of power you may not necessarily need in order to get the computerized features you want.

At Kenwood, we don't think that's playing fair.

Which is why every one of our new Hi-Speed™ receivers offers a host of very intelligent engineering advances.

Like Direct Coupled, Hi-Speed amplifier circuitry for absolutely brilliant musical clarity, down to OHz.

And microprocessor controlled Quartz PLL Synthesizer tuning to give you perfect, drift-free FM reception.

We've even included the convenience of our computerized AutoScan tuning. And instant, automatic computer-memory tuning of 6 AM and 6 of your favorite FM stations.

But best of all, we didn't restrict all this intelligence to just our new KR-850 Hi-Speed receiver.

You can also find it on our new KR-830.

And our new KR-820.

And even our new Slimline KR-90.

Examine all the possibilities at your Kenwood dealer. With all the choices we offer, you'll find the computerized receiver that's exactly your type.

At your type of price.

 **KENWOOD®**
The audio company that listens.

P.O. Box 6213, Carson, CA 90749

Wow is a fundamental problem in all disc reproduction, directly related to music enjoyment.

Plenty is already good. It already leaps at you. Like that marvelous little Canon LC card calculator I got for Christmas-before-last. For more than a year, month in and out, that slim little thing has marked off my days and my hours, minutes and seconds without a stop, all on a battery the size of a thin quarter, and it even keeps time to itself, invisibly, while simultaneously doing my entire checkbook arithmetic. I've even learned to tell it about February. There are dozens of other functions in this little miracle that I'll never use, but each of them is practical and helpful, for somebody.

Surely, a lot of our more flashy hi-fi includes useful elements just as remarkable, which will last and last, after the silliness is over. Time will tell which — and it'll have to be pretty soon, if I guess right. We're going to have to clean up this Readout act (we and our friends in Japan) in somewhat of a hurry if we are to sell our too-expensive fi in these unpleasant times. Look at autos. This could happen to hi-fi from overseas? Perhaps. And yet —

Look at Nakamichi. If you make something really new and useful, where no such thing existed before, you can use two thousand transistors. And charge \$7,000: The Nakamichi TX-1000 Computing Turntable is that sort. It is unique, and uniquely useful. At the price, I do not ever expect to play with one at home, but I was astounded by its demo performance and I see a large future for the computing principle involved, once it filters down to less costly levels. For the first time in audio history, this turntable cancels out LP disc off-center wow *in the actual playback*, on the spot, dealing individually with each record, reducing the eccentricity to an Absolute Center of Rotation with incredible precision, every time. You can hear the result and it is astonishing.

This TX-1000 is an enormous table, squat and wide with great toad-like feet. It comes, dishearteningly, with neither arm nor cartridge nor even the usual simplified automatic functions. All this you must provide yourself. Nor will you fit the thing into a rack or on an inconspicuous stand; you'll need half a room for it, or a piece of a professional studio. But the thing solves a basic problem that has never before been addressed during a full century of disc manufacture and use. So it will find its place, at any cost.

When you listen to the new Ohm Walsh 2™, the first thing you hear is a life-like stereo image. This is because we have eliminated stereo ghosts.

What is a Stereo Ghost?

Stereo ghosts are similar to TV ghosts. On TV, ghosts are caused by parts of the broadcast signal reflected off surfaces, arriving out of sync with the picture. Stereo ghosts are secondary sound images caused by a similar effect; the out-of-sync arrival of sound in your ears.

With conventional speakers it is easy enough to distinguish between extreme left and extreme right. But the real life position of the performers, "the stereo image" often seems jumbled and it varies with your listening position.



Stereo Ghosts confuse the stereo image with conventional speakers.

The New Ohm Walsh 2™* eliminates Stereo Ghosts to give you a real life stereo image anywhere.



The new Ohm Walsh 2™ gives a real life stereo image anywhere you sit. To eliminate stereo ghosts, the new Ohm Walsh 2™ uses a unique proprietary design.

Conventional loudspeaker — single arrow represents pulse travelling down cone causing out-of-sync fragments (as represented by 3 horizontal arrows) to enter air along the way causing stereo ghosts.

This problem is further aggravated by use of multiple drivers.



Ohm Walsh 2™ loudspeaker — single arrow represents pulse travelling down inverted surface causing in-sync fragments (as represented by 3 horizontal arrows) to enter air along the way eliminating the problem of stereo ghosts.



Ohm turned conventional loudspeaker theory upside down and inside out.

To eliminate stereo ghosts the Ohm Walsh 2™ uses a completely new and different technology related to that of our world famous \$4000 a pair Ohm F.

Unlike loudspeakers that use a series of separate conventional drivers, at the heart of the Ohm Walsh 2™ is a proprietary inverted conical surface that radiates sound in perfect synchronization. The result is a stereo image of lifelike clarity anywhere in the room.

Prove it to yourself.

Listen to conventional speakers and walk from side to side. Ghostlike, the stereo image seems to shift. Then, listen to the Ohm Walsh 2™ and contrast the lifelike image you will get from any listening position.

Great value, beauty, and realism in one.

Hand finished in genuine oak or walnut wood veneer, they are affordably priced. The Ohm Walsh 2™ is our most technologically advanced way to eliminate stereo ghosts and make sound become frighteningly real.

Ohm gives away \$125,000 in superb sound!

No entrance fee, nothing to buy, 11,500 winners! Top prizes? 100 new Ohm loudspeakers and 1500 Audiophile records.

Adding up to \$125,000 of top tech sound and the discs to prove it.

Call for details, toll-free 800-221-6984.

New York residents — 212 783-1120.

Or write to:

Ohm Acoustics Corp.,
241 Taaffe Place,
Brooklyn, NY 11205.

*Patent Pending, Trade Mark applied for.
© 1981 Ohm Acoustics Corp.



We make loudspeakers correctly.

Perfectly good LPs sound strangely different and better after the Nakamichi TX-1000 has done its work.



The Nakamichi TX-1000 turntable.

Look for a moment at wow. It comes from off-center rotation of the tight spiral of record grooves and it is a product of a whole chain of circumstance — that's the trouble — going back to the earliest stages of disc master preparation. That little center hole is extremely tricky. What is the mathematical center of an uneven spiral? Not at all simple, mathematically. But our problem is to determine it in terms of practical fact — and then produce records with a tight fit on every turntable (impossible) and absolutely no warping, shrinking, or other aberration in the plastic (impossible)—to play on tables of variable quality and exactitude, plus damage such as slightly bent spindles. Do we come out with the theoretically perfect spiral that our phono arms are supposed to trace in playback? In spite of enormous effort, hardly ever, though we come close.

There is only one way to do precision correction. On the spot. At playback, for each and every performance. Has it ever been done before? (Well, I did it after a fashion, back in the '30s.) Not, in any case, by machinery.

The human ear is remarkably sensitive to short-term variations in pitch of this rhythmic sort. In the longer run, we have poor pitch memories. We forget in minutes. But once around on an LP, worse on a 78, and anybody's accuracy of discrimination is phenomenal. You need no fancy wow meter to show you, even though Nakamichi did use one (via projection TV) at their TX-1000 demo. So "almost" is not enough. Wow is a fundamental problem in all disc reproduction, directly related to musical enjoy-

ment. There is *no* wow in live music. Nor in genuine real-time live broadcasting. Any musician or music lover can tell the difference, although, minus comparison, we don't much notice it. Just learn to take our wow, like other distortions.

That center hole has always been a problem. I once visited the Columbia pressing plant in Bridgeport (Conn.) shortly after the LP's beginning, when the old traditional centering system was still used, strictly by hand and instinctive expertise. I remember a little man who just stood there and at the psychologically right moment whammed down a lever that punched a hole to match the grooves of a prototype master. (The original lacquer center had earlier been removed.) Now there are improvements but, still, inaccuracies. Plenty of room for Nakamichi to work on most of our present discs when they come to the test of playback.

As for me, I have always detested wow as the worst of all musical distortions, and I was out fighting it with my earliest 78-rpm records. Wow in 78s can be really awful, especially the inner grooves. In those times, the shellac holes seemed to enlarge with every playing, and many were sloppily large to begin with. There was "play" at the spindle on most of them, and a sideways push on the disc could make the difference between good music and excruciating wow.

After trying many times to push those records sideways while they played (no use), I had a bright idea which Nakamichi will appreciate. I would mark six or seven places around the rim of a record,

then carefully push-at each one, for a playing trial, until I found which position wowed the least. A permanent reference mark went on the rim at that point — just place disc on turntable, push sideways as marked, and play. Success! It worked like a charm. Hours and hours of music were rescued from the curse of wow.

So you've guessed it, Nakamichi pushes too. Though not the record. The TX-1000 is two tables, one above the other. The top one is movable sideways on two axes via machinery underneath. You put on your record, a small auxiliary arm rises up on your left and swings over, to play a few turns of the leadout grooves. That's enough. A "special infrared LED/shutter/photo-diode system" linked to that arm measures its exact out-of-spiral motion and feeds the info to (what else?) an A/D which sends its digital signal to the computer. Said computer, as the arm retires back into its hole, then tells the upper turntable's mechanism exactly how to push sideways *while the record turns* until the precise Absolute Center of Rotation is reached. Whereupon everything locks up, lights flash, and you're in biz.

The correction is indeed remarkable. Perfectly good LPs, the sort you'd never question, sound strangely different and better after the machine's work. Almost impossible to describe. Smooth water freezing to ice. All motion ceases. Space becomes immovable. Only the music plays on. Like live. Uncanny. There's been absolutely nothing like it before. Unless, maybe, the Canby finger-push system. A

...and then came the "Z" Receivers.

There was a time when you had to buy separate components to enjoy the control flexibility and power needed for true high fidelity music reproduction.

Not anymore. Sansui now has developed its "Z" series receivers.

Whether you choose the super-powered 9900Z, the modestly-sized 3900Z, or any of the four models in between, you get the full-frequency benefits of Sansui's DC-servo amplifier technology. And distortion-free FM is assured by genuine digital-synthesized tuning, with the

added accuracy of quartz PLL circuitry in our three top models. Twelve convenient instant-tune presets bring in your favorite FM or AM stations (6 of each) at a button's touch.

Real-time spectrum analysis that lets you see the shape of the sound you hear is included in our three most advanced units, along with Dolby FM decoding in the 8900ZDB. All but one of the "Z" receivers include LED displays that instantaneously show you just how much power is going to your speakers. Touch-button FM tuning and volume controls, two-deck dub-

bing facilities, dual phono capability and multi-system speaker switching are all to be found, in various combinations, in the "Z" receivers. You'll also find all the additional features you've come to expect from a company that has pushed high fidelity to its limits from its beginnings.

And for all their technological sophistication the six Sansui models in the "Z" series will appeal to your eye no less than to your ear. Visit your nearest authorized Sansui dealer. He'll show you why "Z" stands for the last word in high fidelity receivers.



SANSUI ELECTRONICS CORPORATION
Lyndhurst, New Jersey 07071, Gardena, CA 90248
Sansui Electric Co., Ltd., Tokyo, Japan

Sansui

Enter No. 20 on Reader Service Card

The most successful compromise in loudspeaker engineering.

The "no-compromise" loudspeaker exists only in advertising copy. In the real world, the laws of physics dictate inevitable trade-offs between bass response, size, efficiency and other design parameters. The Fourier 1 speaker system therefore claims to be only a finely tuned and superbly effective compromise.

In a stunningly handsome cabinet of only 3.0 cubic feet internal volume, the Fourier 1 goes down to 32 Hz loud and clear (you'll never need a subwoofer!), approaches disco speakers with its efficiency rating of 90 dB and its tremendous dynamic headroom, yet sounds as uncolored and delicately transparent as a good electrostatic. All for \$1325 the pair.

Can any other full-range box speaker make that statement?

FOURIER

FOURIER SYSTEMS, INC., 540 NEPPERHAN AVENUE, YONKERS, NY 10701. (914) 965-5800

Enter No. 10 on Reader Service Card

Astonishing.

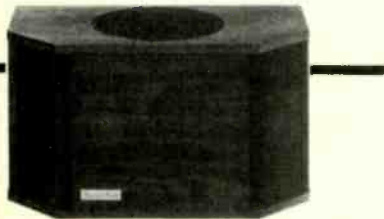

"The sound of this diminutive speaker is nothing less than astonishing."

"Listen to the Four if you possibly can. It is worth hearing — even if you are not shopping for a speaker — just for a demonstration of how good a small box can sound."

STEREO REVIEW June, 1978.
Copyright Ziff-Davis Publ. Co.

For literature and information call
(800) 225-4791 or send coupon.

The Allison: Four — costs \$280 each in oiled walnut, \$290 in oiled oak cabinet.

ALLISON ACOUSTICS

Seven Tech Circle/Natick, MA 01760, U.S.A.

Name _____

Address _____

City _____ State _____ Zip _____

HOW PHONO CARTRIDGES WORK

Continued from page 47



Fig. 7 — Ortofon MC-20 MkII.



Fig. 8 — Technics's EPC-100 Mk3.

He then produced the latest Technics moving-coil cartridge, the EPC-305 Mk2. The tapered boron cantilever used in this design has the same 0.098-mg effective tip mass as their previous top-of-the-line cartridge, the EPC-100C Mk3. The frequency response is 10 Hz to 100 kHz, wider if anything than the

EPC-100C Mk3. The performance is backed by a new "amorphous" transformer, rated to 300 kHz. In effect, the two cartridges have the same stylus system and identical frequency response for at least an octave above the audio band, which should isolate the operating principle.

A very interesting hybrid approach has been taken by the sister firms, Stanton and Pickering, in their XLZ/7500S, 980LZS, and 981LZS cartridges. In basic design these are moving-magnet types, but they have a very low inductance, 1 mH; low d.c. resistance, 3 ohms, and low dynamic tip mass, 0.2 mg. Their output is also low, at 0.06 mV/cm/S, so they require some sort of step-up device. However, these cartridges appear to offer all the advantages of a moving-magnet cartridge without the disadvantages of an MC type.

The moving-coil controversy is far from dead. As cartridges get better and closer in measured results, the tonality differences become vanishingly small. Moving magnets have become so advanced that at the high end, the majority of listeners would find no real difference and the decision of one type over the other would be based on economics.

We must not, however, ignore the lone golden-eared individuals who can hear the differences. We could have another TIM situation on our hands.

It is usually the prodding of some lone, serious, experienced listener that spurs the research and development of hi-fi equipment to greater refinement. At the moment, we may admit the differences. We must now find out if they are due to the construction of the cartridge, and indeed, if the "acceptable" sound is indeed accurate. Even our lone and consistent moving-coil fan admitted that his preferences were towards a slightly "hot" high end.

A grace note to our interview, Shuichi Obata said that even the latest and best records are not perfect and that considerable work is needed to perfect them. "Ask for better records," he said, "as well as better cartridges."

The differences are becoming so small that, from my vantage point on the sidelines, the whole issue is becoming a non-controversy. But my guess is that there will still be arguments about it when the last cartridge rolls off the line and into history. A



No stereo system is better than its first $\frac{3}{10}$ ounce!

No matter how much you spend on your record playing system, it can't be better than its first component: the phono cartridge. Because, unless the cartridge tracks the groove faultlessly, and precisely reproduces all the recorded sound, no amount of electronic wizardry can make up for its faults.

Which is why you'd do well to start your system with an Audio-Technica *Vector-Aligned™* stereo phono cartridge. Constructed with the same unique geometry as the cutting head which engraves every stereo groove, A-T cartridges are outstanding for wide range, low distortion,

excellent tracking, and superb stereo separation.

There is an Audio-Technica model to match every tone arm and every budget. And each meets our high standards of uniformity and quality... unsurpassed in the industry.

Every great stereo system can use a little Audio-Technica at the start. Insist on nothing less. At leading high fidelity stores or write for our catalog today. AUDIO-TECHNICA U.S., INC.
1221 Commerce Drive
Stow, Ohio 44224.

• Hirsch-Houck Labs Test Report *Stereo Review*, Sept. 1981

Clearly, the Audio-Technica AT155LC excels in just about every area of cartridge performance, and it came as no surprise to find that it was as silky smooth and "forgettable" when playing music as its measurements would suggest. We would have difficulty describing the "sound" of the cartridge, since it contributes so little of itself to the final sonic quality. Good records often sound superb when played with the

Write today for a copy of the complete test report and descriptive literature.



Model AT155LC \$225.
Other models from \$40 to \$275.



audio-technica.
Great sound... right from the start!

Enter No. 2 on Reader Service Card

THAT'S THE WAY IT WAS

WALTER I. SEIGAL

Before his death in 1923, electrical engineer and inventor Charles Steinmetz (right) had a chance to try the mike at radio station WGY. By 1925 Atwater Kent had become a household name; in the photo below the Philadelphia radio manufacturer adjusts the volume on his own Model 10 receiver and loudspeaker. (Charles Steinmetz photo courtesy of the General Electric Broadcasting Company; Atwater Kent photo courtesy of A. Atwater Kent, Jr. and Thomas A. De Long, author of *The Mighty Music Box: The Golden Age of Musical Radio*.)





and when you switch over to the 770's
you will smile and say...it's magic
because there is nothing like it
under the sun!



Enter No. 14 on Reader Service Card

Mission North America, 89 Galaxy Boulevard, Rexdale, Ontario, M9W 6A4 Canada
Mission Electronics, George Street, Huntingdon, Cambridgeshire, PE 18 6BD England

Protect Your Stereo System and Maintain Its Sound



The D4™ Record Care System

The highly active D4 fluid and unique directionally fibered pad removes harmful microdust and debris that can cause permanent damage to your recordings.

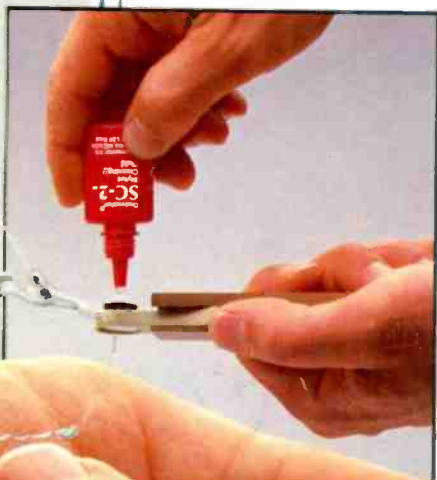

The SC-2™ Stylus Care System

SC-2 fluid with the exclusive nylon fibered brush effectively loosens and wipes away stylus contamination, a major contributor to record wear.



The Discwasher® D4 Record Care System and the Discwasher SC-2 Stylus Care System are available separately or together as DiscSet™.

discwasher®
PRODUCTS TO CARE FOR YOUR MUSIC

For a free copy of our "Guide To Record Care" write to Discwasher.

1407 North Providence Road, Columbia, MO 65201 USA
A DIVISION OF JENSEN an ESMARK Company