

dB

THE SOUND ENGINEERING MAGAZINE
NOVEMBER 1969 75c

A First-Hand Report on Russian Recording
A Super-8 Film/Sound System
Just Step up to the Mic



Just listen to the money-making jingle of multi-sound recordings. That's where the money is.

The chart is now overflowing with new multi-channel recording creativity from studios with Ampex MM-1000's.

This unique multi-channel recorder/reproducer has given the audio engineer a front seat in the talent team. He shapes new sounds, part by part . . . Controls each take and balance, track by track . . . Works with artists to master money-makers in totally new sound dimensions.

The MM-1000 is the only field-proven recorder that lets you start at 8-track one-inch tape and expand on up to a fantastic 24-track on two-inch tape.

Of multi-track money-makers throughout the world, virtually all studios have chosen Ampex MM-1000. Are you listening?

Call Ampex collect (415) 367-4400. Or write: Ampex, M.S. 7-13, 401 Broadway, Redwood City, Calif. 94063.

AMPEX MM-1000
RECORDER/REPRODUCER

AMPEX

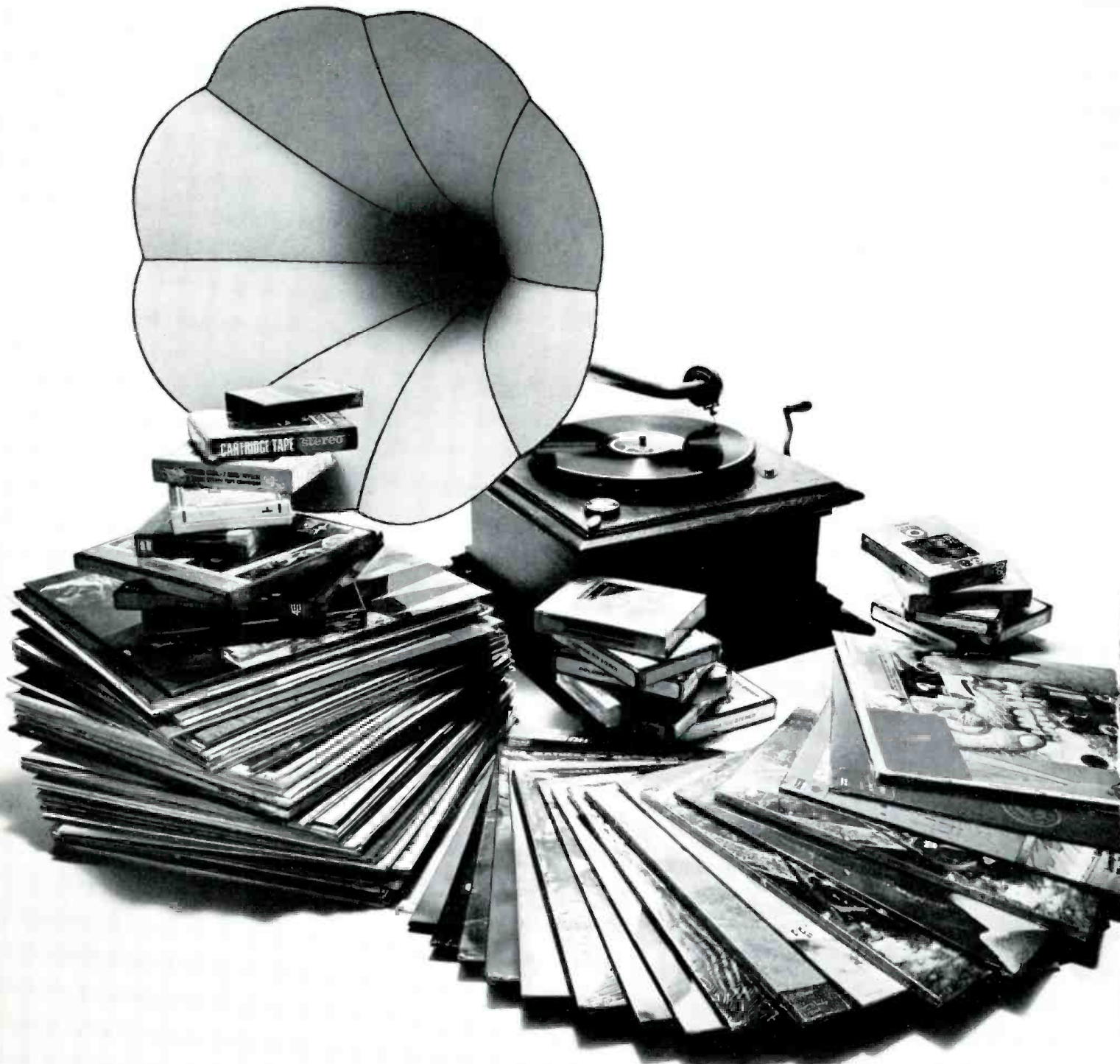
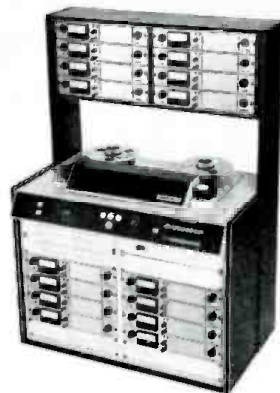

**The sound of money as recorded
by the Ampex MM-1000**

Coming

● **TETRAPHONIC SOUND** is the title used by James E. Cunningham for his examination of the new phenomenon of four-channel stereo sound. Questions of microphone placement and listener perspective are discussed.

Allan P. Smith has prepared an article describing an amplifier for state-of-the-art phono reproduction. Both the theory and practice of achieving all that is coming from the cartridge is covered.

With signal-to-noise ratios being reduced close to the theoretical, the noise that comes from other factors in the studio are increasingly annoying. Michael Rettinger's article **ILLUMINATION NOISE CONTROL** examines the noises you may get from lighting sources in the studio—and he details what can be done about it.

Highlights of the New York AES Convention will fill our picture gallery next month.

And there will be our regular columnists, George Alexandrovich, Norman H. Crowhurst, Martin Dickstein, and Arnold Schwartz. Coming in **db**, The Sound Engineering Magazine.

About the Cover

● Microphones from the early days of broadcasting. **JUST STEP UP TO THE MIC** with Robert Hawkins beginning on page 26.

← Circle 10 on Reader Service Card (Ampex, Cov II)



NOVEMBER 1969 • Volume 3, Number 11

Table of Contents

FEATURE ARTICLES

- Soviet Recording Studios
John M. Woram 23
- Just Step up to the Mic
Robert Hawkins 26
- A Super 8 Film/Sound System
Larry Zide 28

MONTHLY DEPARTMENTS

- Letters 2
- The Audio Engineer's Handbook
George Alexandrovich 4
- The Feedback Loop
Arnold Schwartz 8
- Theory and Practice
Norman H. Crowhurst 16
- Sound with Images
Martin Dickstein 18
- Editorial 22
- New Products and Services 32
- The db Bookcase 34
- Classified 35
- People, Places, Happenings 36

EDITORIAL BOARD OF REVIEW

George Alexandrovich
Sherman Fairchild
Norman Anderson
Prof. Latif Jiji
Daniel R. von Recklinghausen
William L. Robinson
Paul Weathers
John H. McConnell

db, the Sound Engineering Magazine is published monthly by Sagamore Publishing Company, Inc. Entire contents copyright © 1969 by Sagamore Publishing Co., Inc., 980 Old Country Road, Plainview, L.I., N.Y. 11803. Telephone (516) 433-6530. **db** is distributed to qualified individuals and firms in professional audio—recording, broadcast, audio-visual, sound reinforcement, consultants, video recording, film sound, etc. Application must be made on an official subscription form or on a company letterhead. Subscriptions are \$6.00 per year (\$7.00 per year outside U. S. Possessions, Canada, and Mexico) in U. S. funds. Single copies are 75c each. Controlled Circulation postage paid at Easton, Pa. 18042. Editorial, Publishing, and Sales Offices: 980 Old Country Road, Plainview New York 11803. Postmaster: Form 3579 should be sent to above address.

only one
amp
has
all
these
features



**CROWN
DC300**

- ✓ Industry's highest power - 300 watts/channel RMS @ 4Ω
- ✓ Industry's lowest distortion
- ✓ Superb S/N - over 100db
- ✓ Unbeatable cost ratio - under \$1 per watt
- ✓ Complete output protection
- ✓ 3-year parts & labor warranty
- ✓ Compact design - only 7x10½x19"
- ✓ Ruler-flat response ±0.1db 0-20KHz

You could settle for less – but with a cost ratio like *this*, you don't have to! DC300 professional net is \$685. For PA use, a \$75 adaptor gives you over 500 watts mono for balanced 70v line. For tech data sheet, or to arrange for demonstration, call 219+523-4919. Or write Crown, Dept. DB-11, Box 1000, Elkhart, Indiana, 46514.

Crown

MADE ONLY IN AMERICA
Circle 13 on Reader Service Card

Letters

Robert Bach
PUBLISHER

Larry Zide
EDITOR

Bob Laurie
ART DIRECTOR

Marilyn Gold
COPY EDITOR

Richard L. Lerner
ASSISTANT EDITOR

A. F. Gordon
CIRCULATION MANAGER

Eloise Beach
ASST. CIRCULATION MGR.

SALES OFFICES

New York
980 Old Country Road
Plainview, N.Y. 11803
516-433-6530

Denver
Roy McDonald Associates, Inc.
846 Lincoln Street
Denver, Colorado 80203
303-825-3325

Houston
Roy McDonald Associates, Inc.
3130 Southwest Freeway
Houston, Texas 77006
713-529-6711

Dallas
Roy McDonald Associates, Inc.
Semmons Tower West
Suite 714
Dallas, Texas 75207
214-637-2444

San Francisco
Roy McDonald Associates, Inc.
525 Market Street
San Francisco, California 94105
415-397-5377

Los Angeles
Roy McDonald Associates, Inc.
1313 West 8th Street
Los Angeles, California 90018
213-483-1304

Portland
Roy McDonald Associates, Inc.
2305 S. W. 58th Avenue
Portland, Oregon 97221
503-292-8521

Japan
TECHNOSERVICES, LTD.
31-16 Akazutsumi 1-Chome
Setagaya-Ku
Tokyo 156, Japan

The Editor:

Martin Dickstein's otherwise excellent article on *Can Man Survive?* the audio-visual mixed-media show at the Museum of Natural History, has one astonishing omission: the name of the composer of the tape-and-electronic score he so graphically describes.

The composer is Eric Salzman, Music Director of WBAI-FM, and well-known writer and composer of various electronic music-theater and mixed-media works. Mr. Salzman, who has just returned from a three-month tour of South America presenting his mixed-media works, is the composer of *The Nude Paper Sermon* for actor, Renaissance consort, chorus and electronics, recently released on Nonesuch Recordings and the first avant-garde music-theater work composed specifically for and through the medium of records. The tape-and-electronic score for *Can Man Survive*, which includes synthesized, concrete, musical and vocal sounds, was realized at the Columbia-Princeton Electronic Music Center. The original contains twenty channels of sound organized into various one, two and four channel cartridge loops. (None of it actually synchronized with the visuals. The quite original technique is entirely "environmental" with overlapping pools of sound creating a series of relevant sound environments. In effect each spectator creates his own mix as he walks through!)

WBAI presented a specially-prepared synthesis of the score at the time of the exhibition's opening last spring and will shortly broadcast a stereo version.

Frank A. Millspaugh, Jr.
General Manager, WBAI
New York, N. Y.

THE BIGGEST

Introducing the mixing console that fills the gap.

Between the expensive, custom-made console that has everything... when you finally get it. And the small, rigid-design broadcast mixer that gives you low price... but no reverb, no EQ, and only rotary mixers.

The Studer 089 Mixing Console is the happiest possible medium. Made by one of the most famous names in tape recorders, it has *all* the "goodies." Twelve input units, all with EQ, cut-off filters, pan-pots, phase reversing switch, gain vernier and linear attenuator, two or three line outputs, two reverb outputs, and two subgroup buses. Plus visual and acoustical monitoring facilities you usually get only on large scale consoles. Yet it weighs only 144 lbs. and fits into a transport case for field use.

It costs \$15,000. And you can have it immediately. Because Gotham has these mass-produced Swiss precision mixing consoles in stock in the U.S.

It would take a book to tell you *all* about it. And Gotham has the book. A 24-page color brochure. Send or call for it now. And if it makes you want the Studer 089 Mixing Console right away... that's just when Gotham can give it to you.



Exclusive U.S. and Canadian Representative

GOTHAM

AUDIO CORPORATION

2 West 46th Street, New York, N.Y. 10036 (212) CO-5-4111
1710 N. LaBrea Avenue, Hollywood Ca 90046 (213) B74-4444

For price information and literature outside
the U.S. and Canada, contact:



EMT WILHELM FRANZ GMBH
5430 Wettingen (AG) Switzerland

THE SMALLEST

Circle 17 on Reader Service Card

The Audio Engineer's Handbook

GEORGE ALEXANDROVICH

MINIATURIZATION

●We all know all too well how important the miniaturization of the electronic equipment is and what influence it places on the design, packaging and performance.

Most of us have taken advances made in the field of audio for granted without the realization that one of the most important contributions to this progress was the invention of transistor and its use in the design of audio equipment. I don't say that this progress was impossible without solid-state technology but certainly it would have taken different forms and perhaps a different philosophy of equipment design and operation.

We hear and read a lot about new integrated circuits, thick-film circuits, hybrids, and many others. Let us take a close look at the miniaturization as we have it in the design of audio equipment.

We have all seen transistor chips (or at least tried to with the naked eye). Most of them, especially the low power ones, are mounted right on the end of the collector wire. The body of the transistor is many hundreds of times larger than the transistor chip itself!

Compare the size of the old-fashioned tube and the transistor—the advantage of the transistor is obvious. Most of the components used in transistor circuits have been reduced in size of late sufficiently so that Dick Tracy radios and pocket t.v. sets are no longer pure fiction.

Combining miniaturization with reliability and high performance standards the designer of audio equipment is faced with certain limitation as far as the size, price, and quality are concerned. If you take a 1969 vintage printed-circuit board and observe the amount of space used up by transistors and condensers, resistors and other components, the ratio will be somewhere between the 1:5 to 1:20. Obviously

passive components are the present limitation to miniaturization. Some of you may point out the fact that hearing aids are built with much smaller components. True, there are much smaller components than the ones we use commercially; there are tantalum capacitors; there are 1/8-watt resistors, miniature connectors, inductors, and potentiometers.

Well, let us assume that we have built a complete preamplifier or booster amplifier on a one square inch area of printed-circuit board, and that we have squeezed all the amplifiers for an audio mixing console into a package not larger than a cigar box. We have made our console somewhat lighter and smaller, but our faders remain the same size, as did the v.u. meters, connectors, input, and output transformers.

If you have an 8-channel console with 16 inputs, the size of your mixing area would most likely be larger than 36 inches and the depth of the console would be at least 24 inches. If you can mount all the amplifiers or active circuits into the area left vacant (after installing all those basic components) you have reached the practical limit in miniaturization, since further reduction in size will only increase the cost of the system, make maintenance more difficult, and perhaps degrade the performance.

Let us analyze this point more closely. If individual transistors are used in the circuit, maintenance and trouble shooting are possible by competent personnel and repair of the circuit if failure of one of the semiconductors has occurred is a routine matter. Let's assume that the amplifiers in our system are built with integrated circuits. In general ic's have been developed for the use in the computer field, only a small part of the ic industry is dedicated to the linear ic's suitable for the use in audio circuits. Techniques used in their production allow etching of several transistors, diodes, and resistors all interconnected on a chip few thousands of an inch

square. Usually, many hundreds of such circuits are etched on a single wafer the size of a half dollar. The process is complicated and involves many steps of etching, masking, and plating (material deposition—usually vacuum deposition). Reduction in the size of the original artwork is photographically accomplished and involves a reduction of many thousands of times. Mass production of ic's makes their cost reasonable. Every ic except for a very few, suffer from compromise in performance. Because there are so many different components and steps in their production, quality of ic's still suffers and rejection rates remain high. 50 per cent rates are not unusual and then even for audio applications out of remaining 50 per cent, half cannot be accepted.

Quality of ic's is improving and we will someday have first-rate devices at a cost and reliability exceeding those of a transistor.

Another aspect of ic's which should be considered very carefully is the amount of external components required for the ic to work. Sometimes the number of components is the same or exceeds the number required for the regular transistor circuit—with one difference much higher cost.

In general ic's are still much too noisy for audio circuits, distortion is high, they are much harder to replace (up to 12 contacts have to be unsoldered at once), and they are sensitive to heat.

This is only generalization, excellent ic's exist and are being used, but the purpose of this report is to draw the attention of audio engineers ready to take a plunge into the field of ic's to possible faults with the long list of available devices.

One of the qualities for which you may pay a premium price is really an audio detriment—wide frequency response. Many ic's, because of small size and negligible in-circuit losses due to capacitance and inductance, amplify well into the mega- and gigahertz range. For
Circle 16 on Reader Service Card →

Stereo on location: Only 24 lbs. 11 oz.

Lightweight. A full 7-inch reel capacity studio professional tape deck. Pick it up and take it anywhere or use it in your studio. Operates on a self-enclosed rechargeable nickel-cadmium battery pack — or plugged into AC.

Better-than-Studio Specs.

Frequency response: 20 Hz to 22 KHz, 40 Hz to 18 KHz ± 2 dB @ $7\frac{1}{2}$ ips, S-N ratio at peak level to unweighted noise: (Model 770-2) 58 dB or better; (Model 770-4) 56 dB or better. Wow and flutter: less than 0.09% @ $7\frac{1}{2}$, less than 0.12% @ $3\frac{3}{4}$, less than 0.2% @ $1\frac{7}{8}$.

Exclusive Sony Noise-Reduction System.

Sony "SNR" automatically reduces gain of playback amplifier by 6 dB during very low passages, when background noise is most predominant. Noise level is greatly reduced, dynamic range expanded 100%. Also incorporated is a built in limiter to automatically control overload distortion. Both "SNR" and limiter are switch defeatable.

Three Speeds. $7\frac{1}{2}$, $3\frac{3}{4}$, $1\frac{7}{8}$ ips. Other features include two professionally-calibrated VU meters, built-in line-and-mike mixing, push-button operation, scrape flutter filter, low-impedance Cannon plug mike inputs, tape/source monitoring.

Four Heads. The 770-2 has two-track erase, record, and playback heads plus a four-track playback head. The 770-4 has four-track erase, record, and playback heads plus a two-track playback head.

ServoControl Motor with VariSpeed Tuning.

Automatically maintains exact speed during mechanical load changes and voltage variations. Built-in VariSpeed tuning permits vernier adjustment of plus or minus 7% of any of the three speeds. Ideal for critical timing of program material.

Sony Model 770. Priced at \$750. For a free copy of our latest tape recorder catalog, write to Mr. Phillips, Sony/Superscope, Inc., 8207 Vineland Avenue, Sun Valley, California 91352.

SONY SUPERSCOPE An Agency of Philips

You never heard it so good.

GATELY "BUILD-YOUR-OWN" AUDIO SYSTEMS the performance you need...at a price you can pay

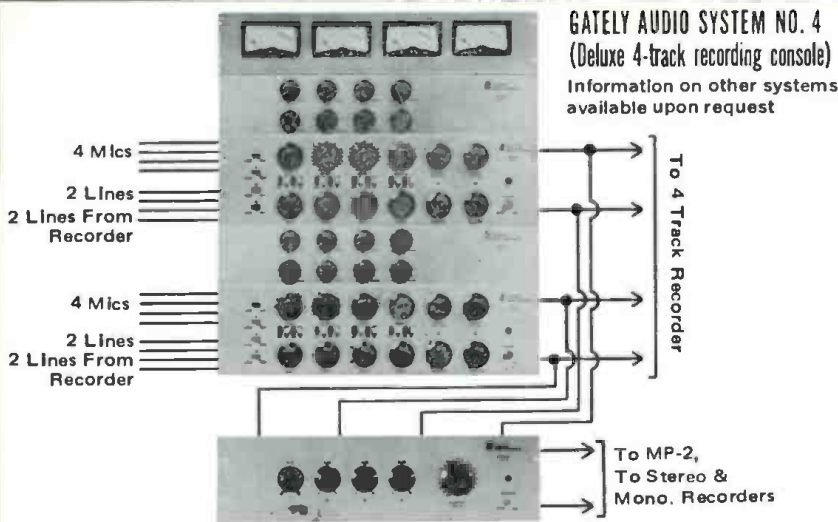

Why pay twice as much for a console with capabilities beyond your requirements? Gately's "build-your-own" audio systems allow you to choose components to meet your immediate needs. And you can add components if requirements increase. So why delay? Have your dealer or Gately Electronics recommend the right system to give you 2, 4, or 8 channel mixer-equalizer capability—at half the cost!



GATELY ELECTRONICS

57 West Hillcrest Avenue, Havertown, Pa. 19083 • (215) HI 6-1415
...have you checked Gately lately?

Circle 14 on Reader Service Card

STEP UP

...to the finest stereo cartridge in the world!

Ortofon



If you're settling for less than an Ortofon, you're making do with less than the best!

The SL-15T — for the better automatic turntable. \$75.00

The S-15 — for the transcription turntable. \$80.00

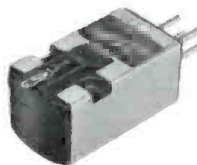

Endorsed by Elpa because it successfully meets the stringent standards of performance Elpa demands. Write for full details on The Complete Ortofon line of Cartridges and Tone Arms.

Elpa Marketing Industries, Inc., New Hyde Park, N. Y. 11040

Circle 18 on Reader Service Card

audio applications it is desirable to roll off all frequencies above 100 kHz and prevent excessive RF amplification which sometimes results in circuit saturation distortion and noise.

One of the better types of integrated circuits for audio—the operational amplifier—becomes an approach to an ideal amplifier. Input impedance of an opamp is usually very high, output impedance is very low. It is a direct-coupled circuit so that the amplifier works from d.c. and up into the megahertz range. It should be linear in response and phase. It is normally temperature compensated and has large amount of negative feedback reducing distortion to a small fraction of 1 per cent. A typical opamp can have as many as a dozen transistors on the chip and just as many diodes and resistors. Many modern opamps require only a small number of external components but the large number of terminals requires a sizeable area for mounting the device.

With all this excellent performance of the opamp we are still faced with 1930/1949 type of supporting components and equipment. What's the use of making a power amplifier the size of a pack of cigarettes if the speaker is fifty times larger? What does one do—mount the amplifier on the speaker frame? What's the use of cutting the power requirements of the console down to milliwatts when the pushbutton and vu meter lights take amps of current.

We are faced with a long line of inconsistencies in the audio field, starting with the premise that the equipment has to be large in order to perform well, or has to look impressive for the customers. We still cling to old concepts and resist any change about which we know little and have no experience. We are also guilty of not applying sound reasoning to many things we do. Most of the guilt lies with the people responsible for the major decisions, not with engineers who are left to work out the details.

The question may be asked what is the use of talking about it if nothing will remedy the situation? I think we can do something by talking about it. We can influence manufacturers of electronic components so that programs of further miniaturizations get started. We should try to convince them that we need size reduction not only of semiconductors and resistors, but the other supporting components such as meters, transformers, shielded wire, switches, condensers, and others. Although significant strides have been made in the right direction, much more can and should be accomplished. When we will be able to pack a complete sound studio into a suitcase, our use of microcircuits will become more meaningful.

**the
world's
finest
records
have
something
in
common**

... the **DOLBY A301**
Noise Reduction System
now in use by record
companies in 26
countries — making good
recordings even better.



DOLBY LABORATORIES INC

333 Avenue of the Americas New York N Y 10014
telephone (212) 243-2525 cables Dolbylabs New York
for international inquiries contact:
346 Clapham Road London S W 9 England
telephone 01-720 1111 cables Dolbylabs London

S. Calif.

Audio Industries Corp.
1419 N. LaBrea Ave., Hollywood, Calif. 90028
Tel. 213-HO 5-4111

N. Calif.

Audio-Video Systems Engineering
1525 Tennessee Street, San Francisco, Calif. 94107
Tel. 415-647-2420

Midwest

Expert Electronics, Inc.
7201 S. Western Avenue, Chicago, Illinois 60636
Tel. 312-HE 6-2700

Canada

J-Mar Electronics, Ltd.
6 Banigan Drive, Toronto 17, Ontario, Canada
Tel. 416-421-9080

Circle 15 on Reader Service Card

The Feedback Loop

ARNOLD SCHWARTZ

● Loudspeakers and microphones probably are the subject of more controversy than any other type of equipment in the radio station and recording studio. In contrast to purely electrical devices, electro-acoustical and electro-mechanical devices cannot easily be evaluated. For example, amplifier specifications are readily understood and may be verified with test equipment that is available in most situations. Specifications of loudspeakers are not as reliable, and cannot be easily verified since few of us have such specialized equipment as an anechoic chamber. Although it is difficult to evaluate loudspeakers objectively, there is a considerable body of knowledge and methods of analysis which do give us insight into their functioning.

Loudspeaker designers and acoustical engineers analyze the operation of a loudspeaker in terms of analog circuits. A loudspeaker converts the electrical waveform into a vibrating mechanical replica by means of a reciprocating electrical motor consisting of a voice coil and associated magnetic field. A cone is attached to the voice coil and vibrates the air, converting the mechanical motion to acoustical energy. This is a complex device with three distinct sets of quantities involved: electrical, mechanical, and acoustical. *Dynamic analogies* allow us to describe this complex system in terms of a simple set of analog electrical elements arranged in a series circuit. The behavior of this purely electrical circuit is analogous to the behavior of the electrical, mechanical, and acoustical aspects of the loudspeaker, and can be used to understand and predict its behavior.

What are the dynamic analogies, and how is the analog circuit derived?

By mathematical analysis, and intuitive reasoning as well, a mass in a mechanical system is analogous to an inductance in an electrical circuit. Similarly, the compliance of a mechanical spring has its electrical analog in an electrical capacitance, and a mechanical resistor has its analog in the electrical resistor. In acoustical systems a moving volume of air, and an enclosed volume of air have their electrical analogs in an inductance and capacitance respectively. The only acoustical resistance we are concerned with here is a quantity called radiation resistance which represents the coupling between the air and the vibrating speaker cone.

With this information in hand we can examine the loudspeaker itself

(see Figure 1) and derive the electrical analog. The voice coil and cone have a combined mass of M . The suspension system is a mechanical spring having a compliance of C . There are mechanical resistances in the loudspeaker but the more important resistance derives from the electrical circuit connected to the voice coil. While the loudspeaker can be viewed as a reciprocating motor, it can also be seen as a reciprocating generator; that is a moving coil in a magnetic field. If you turn a hand-crank generator with the load open-circuited there is little resistance encountered. When the load is connected and the generator delivers current there is a drag or resistance to the turning. Similarly, there is mechanical resistance

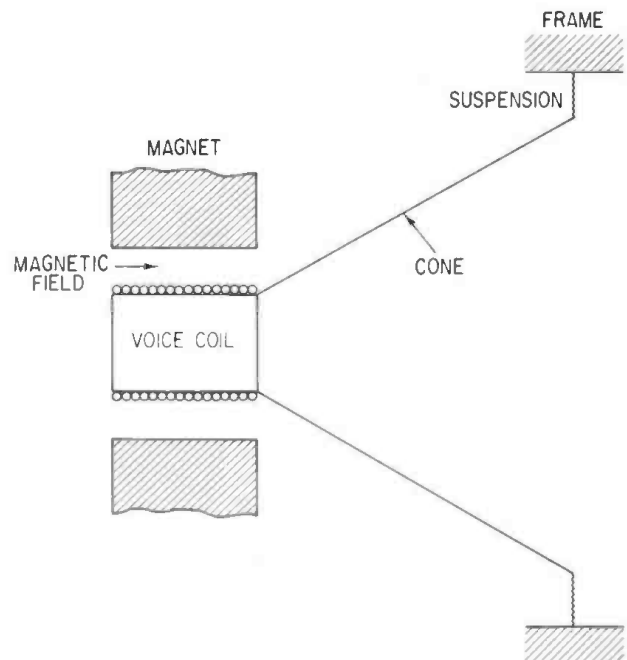

Figure 1. A cross section through a simple loudspeaker.

FM Broadcasters

There are several ways you can increase your effective radiated program power — compare the costs:

1. New transmitter
\$6,200
2. New high-gain antenna
\$1,895
- ✓ 3. Audimax and Volumax
\$1,360

Audimax and Volumax together can increase effective program power 8 to 1 over conventional limiters and automatic or manual gain controllers.

Call today for a 30 day free trial, (203) 327-2000.



PROFESSIONAL
PRODUCTS

CBS LABORATORIES

Stamford, Connecticut 06905
A Division of Columbia Broadcasting System, Inc.

Circle 20 on Reader Service Card

**A Major
Breakthrough
In Sound
Reproduction...**

**THE RABCO
SL-8**



ACCLAIMED BY EXPERTS...

"Without question, the Rabco arm does what it is supposed to do, and does it nicely. ...minimized record and stylus wear, superb reproduction."
Audio Magazine

"Extremely well engineered...unprecedented low tracking force, no skating effects, minimum groove wear, and minimum stylus wear. ...ruggedly constructed: after months of continuous use the SL-8 remains as responsive and foolproof as when first installed."
Hi Fidelity Magazine

**THE ONLY STRAIGHT LINE
SERVO TONE ARM**

RABCO

11937 TECH ROAD,
SILVER SPRING, MARYLAND 20904

Circle 19 on Reader Service Card

Figure 2. The analog circuit of a loudspeaker installed in an infinite baffle enclosure.

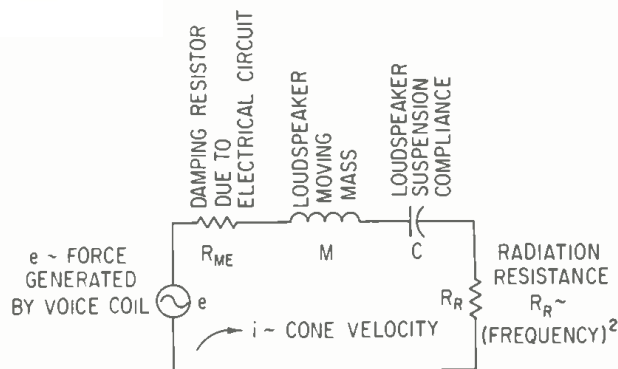

to the reciprocating voice coil which is moving in the magnetic field. The electrical load in this case is the output circuit of the amplifier. The size of this damping resistor, R_{me} , is proportional to the square of the flux density, and inversely proportional to the output impedance of the amplifier. We can see that the damping resistor will be larger as the flux density increases and as the amplifier output impedance decreases. The acoustical quantity in the analog circuit is the radiation resistance, R_r , which represents the coupling between the vibrating cone and the air. With the speaker mounted in an infinite baffle the radiation resistance increases with frequency at a 12-dB-per-octave rate up to a frequency where the cone diameter is approximately one-third wavelength.

The analog circuit is shown in FIGURE 2 with all the elements described above arrayed in a series circuit. The voltage source is the analog of the force generated by the voice coil, the current is the analog of the cone velocity, and the power dissipated in the radiation resistor is the analog of the acoustical energy absorbed by the air from the vibrating cone. We now have all the necessary quantities needed to analyze the loudspeaker behavior. If the current is plotted as a function of frequency with various values of R_{me} , we have the familiar set of damped resonance curves with different damping factors (see Figure 3) where curve 1 has the minimum value of R_{me} and curve 4 has the maximum value. Above the resonance frequency the current is falling at

a 6-dB-per-octave rate, and the radiation resistance is rising at a 12-dB-per-octave rate. With this combination the power in the radiation resistor (i^2R_r) remains constant—representing a flat acoustical output (see FIGURE 4). Below the resonance frequency both current and the radiation resistance are falling, and the power dissipated in R_r , and hence the acoustic power, falls very rapidly. In the ideal case; above the loudspeaker mechanical resonance the acoustic output is flat, below the resonance the response falls off and represents the speaker low-frequency cut off. The effect of varying R_{me} is shown in FIGURE 4. Where the damping resistor, R_{me} , is minimum (curve 1), the acoustic response has a pronounced peak. For woofers this accentuates certain sounds in the low-frequency range and accounts for the so called "boomy" effect we often hear about. Where R_{me} is maximum (curve 4), the acoustical output is most uniform above the cut-off frequency.

We have assumed in the above discussion that the speaker is mounted in an infinite baffle. If a speaker is used without a baffle, we have an acoustical doublet. This means that at low frequencies the front and rear radiation which is 180 degrees out of phase will tend to cancel, thus attenuating the response at these frequencies. The most practical way of avoiding this cancellation is to mount the speaker in an enclosed box, isolating the front and rear radiation. The enclosed volume of air that is now introduced by the box becomes a capacitor in the analog circuit.

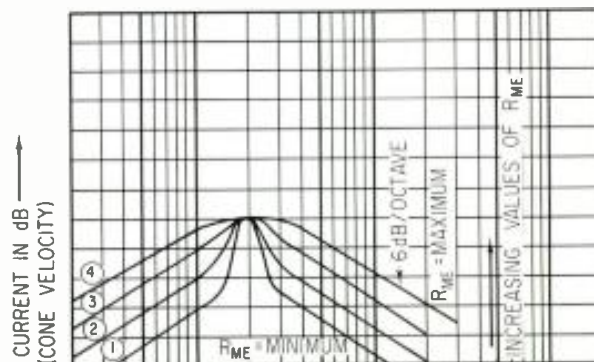
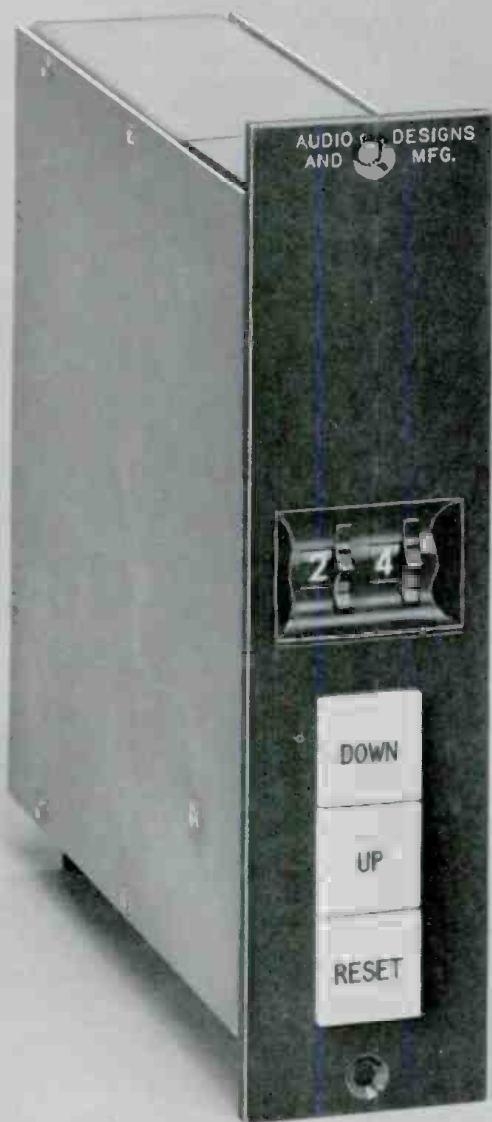

Figure 3. The analog circuit current for different values of the damping resistor R_{me} .

FADEX™

*...another automation innovation
from Audio Designs...*



*the fader that can automate,
insure accuracy and
repeatability of fade time in
a multi-channel audio system*

New from Audio Designs . . . Fadex is a unity gain device designed to operate in a line level circuit of any audio system . . . adding greater flexibility to audio consoles. Variable timing of fading in separate channels can be automated and controlled. Automation and excellent circuitry assures repeatability. Fade time can be set in one second increments from 1-29 seconds. Fadexes may be tandemed together and operated from one set of controls. It also lets you program a tape and have a fade initiated either up or down at a given point. Illuminated push-buttons indicate setting. The fade element comprises components superior to Fet's, transistors, or L.D.R.'s. It is a new solid state device by Audio Designs pioneering automation in the audio field.

Available in 3 models: #424A Fade Down Only, #424B Fade Up Only, and #424 Combination Fade Up-Down.



To learn all about new Fadex or any of our other modular components, simply write or call . . .

AUDIO DESIGNS / 15645 Sturgeon / Roseville (Detroit), Michigan 48066 / (313) 778-8400
Circle 21 on Reader Service Card

www.americanradiohistory.com

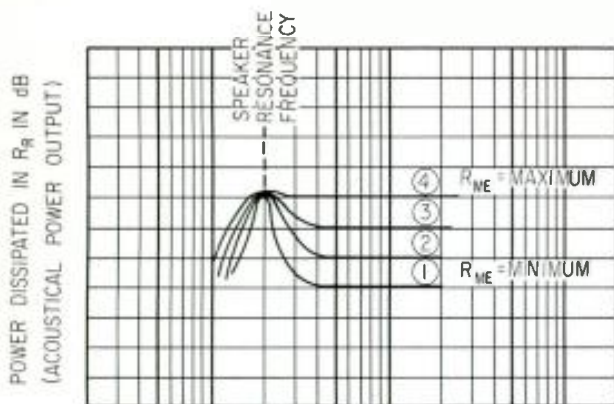

Figure 4. Power dissipated in radiation resistance of an analog circuit (acoustic power output).

Because this capacitance is in series with the other circuit elements, the resonance frequency of the circuit increases and raises the low frequency cut-off. As a consequence of the higher resonance frequency, the resistor R_{me} become less effective in damping the response peak. It is interesting to note that the size of this capacitor will decrease with the fourth power of the loudspeaker diameter. Therefore, we pay a high price in terms of response and damping for using a large woofer. The ideal woofer should be that with the smallest cone size which is capable of handling the required acoustical power.

A letter from reader Warner Clements makes a comment on the July Feedback Loop. In the discussion of transformers, the ideal iron-core inductance is connected as a transformer with unity coupling coefficient. The effect of unity coupling coefficient is to cause the leakage reactance to go to zero. Mr. Clements points out that the shunt inductance is not affected by the coupling coefficient. This quantity becomes infinite only because we assumed an ideal core material.

MOVING?

Have you sent us a change-of-address notice? It takes time for us to change your plate so let us know well in advance of your move. Be sure to send us the complete new address *as well as your old address*. Include both zip numbers. Keep db coming without interruption!

BACK ISSUES AVAILABLE

A limited number of back issues of db are available to interested readers who may have missed or misplaced earlier issues. When ordering please indicate date of issue desired and enclose 75c for each copy.

CIRCULATION DEPARTMENT
 db—The Sound Engineering Magazine
 980 Old Country Road
 Plainview, N.Y. 11803

TAPE TIMERS • TAPE TIMERS • TAPE TIMERS

TIMEKEEPER has the new Michael Scott TAPE-TIMERS in stock for immediate delivery. These low-cost, high quality tape timers offer these advantages:

- Easily mounted on any 1/4 inch tape machine.
- Accuracy within 2/1000 independent of tape speed.
- Precision ball bearings—no need for lubrication ever.

Save time and money by winding tape at high speed with the same timing accuracy associated with normal speeds.

Why use a TAPE-TIMER in place of a stop watch? Simply because the stop watch is independent of the tape which itself is subject to elongation or contraction—plus other factors associated with the recorder itself. Most important, the stop watch cannot be rewound with the tape! Only a TAPE-TIMER moves with the tape so that you always know where you are for any editing, processing, or revisions. It is an indispensable tool for the serious tape user. At this low price you can no longer afford to be without one.

Two models are available:

- Professional High-Speed TAPE-TIMER.....\$79.95
(7.5 and 15 in./sec.)
- Standard TAPE-TIMER.....\$39.95
(7.5 and 3.75—can also be used at 15 in./sec.)



PRO MODEL

Each TAPE-TIMER is fully guaranteed to meet with your complete satisfaction or your money will be promptly refunded. Use the handy coupon.

TO: TIMEKEEPER
 P.O. Box 762
 Mineola, New York 11501

Enclosed is a check for \$..... Please send....Pro Model TAPE-TIMERS at \$79.95 each.

....Standard Model TAPE-TIMERS at \$39.95 each.

Shipping costs: add \$1.00 to order regardless of quantity.

Name.....Company.....

Address.....

City.....State.....Zip.....

(New York State residents must add 5% sales tax)

Circle 23 on Reader Service Card

STUDIO IN USE



THROUGH THIS DOOR

PASSES THE INDUSTRY'S MOST COMPACT 16 TRACK RECORDER WITH LOTS OF ROOM TO SPARE, AND LOTS MORE TO OFFER!

The 3M Brand 16 Track Recorder is unexcelled in the familiar studio game of squeezing the most out of floor space. Overall base dimensions are 27 inches wide by 22.5 inches deep. (In square feet that's only 4.2.)

But compactness is only a small part of the story. Added to this space economy, studios continue to enjoy the top performance that has made 3M's professional audio recorder a new standard in the recording industry. In the last three years, playback pre-amp and overdub noise has been improved by

10 db. Mincom's exclusive Isoloop® tape drive utilizing a differential capstan maintains constant tape tension in just 3½" of unsupported tape. This results in the lowest wow, flutter and scrape in the industry. Erasure has been improved by 10 db.

Plus: DC transport and dynamic braking, advanced electronics, unequalled no-stretch no-snap tape handling, stable and rugged 1.5-inch cast top plate—and Remote Sync Control, 7" x 7" x 4", included at no extra cost.

Write for details and specifications.

Mincom Division **3M**
COMPANY

3M Center • St. Paul, Minnesota 55101
300 South Lewis Road • Camarillo, California 93010

Circle 25 on Reader Service Card

beyond the state of the art



SPECTRA SONICS announces a rack-mounting limiter/compressor so new—in both concept and performance—that it requires a new name: **COMPLIMITER™***. It performs the functions of peak-limiting and volume-compression, either independently or simultaneously, as a direct function of the type of program input and amount of compression desired with performance that is unequalled by most linear amplifiers! As the fastest of all peak-limiting devices (100 nanosec. to 2 microsec.), peak-limiting can be employed with no audible distortion of any kind, thus allowing undistorted recordings (typically less than 5/100ths of 1%, 30 Hz to 20 kHz) at significantly higher than conventional "0" VU (+4 dBm). Available only on the Model 610 COMPLIMITER™: visual lamp indication for essentially instantaneous peak-limiting and also for system overload; continuously variable compression ratio from 1.1:1 to over 100:1. For the smoothest inaudible protection available, order your Model 610 COMPLIMITER™. Now!

Contact your distributor, write or telephone:

SPECTRA SONICS

LEADER IN ADVANCED TECHNOLOGY

770 Wall Ave.

Ogden, Utah 84404

801-392-7531



*U. S. Patent No. 3,376,515 and other Patents Pending

Theory and Practice

NORMAN H. CROWHURST

● About a year ago this column delved fairly thoroughly into the theory and practice of the multivibrator type of oscillator. Periodically I receive questions about the other kind; the kind that uses a tuned circuit. There is also another type (or two) that use R-C networks of various kinds to make an oscillator.

In the days of tubes as the amplifying element, various oscillator circuits were named after the people who first employed them, or who at least were credited with being the first. There were Hartley and Colpitts and other circuits. Then they were also designated according to whether the principal tuned circuit was in the plate or the grid circuit, and a third type that used two tuned circuits.

Those of us who grew up with tubes, I suppose naturally, tend to try to relate the new things with those for which familiarity has bred some form of understanding (hopefully not contempt). But the more we gain understanding of the operation of solid-state devices, transistors, fets, etc., the more we realize that our training in tube technology didn't really help at all, when it comes to solid-state devices.

In fact, this impression was reinforced the other day rather forcefully. The pump attendant at a local gas station is a neighbor who would like to branch out and asked me if I could recommend a good correspondence school with which he could take an electronics course. Well it happens that I wrote a course for one such school, but don't know anything about the others, so I felt this disqualified me from making an impartial recommendation.

And I also remembered seeing that a community college in a neighboring town has electronics courses, so I asked him if he didn't think that would be a more effective proposition. Then he told me that a friend of his had taken this course, but that it completely failed to qualify him for a job he applied for.

The reason, apparently, was that the instructor covered tube technology reasonably thoroughly, but gave nothing whatever about solid-state devices. When he tried to apply what he learned to solid-state circuitry, he might as well not have had any training at all, for all the good it was to him.

← Circle 22 on Reader Service Card

As I know the president of the community college personally, I thought I'd check on this matter—after all, our tax dollars support that college! Yes, my information was correct. The instructor was an old "tube man" with tenure, who wouldn't update himself. But now they'd let him go, after repeated requests to become more current had availed nothing, and the new man would change all that. He recommended that my friend come in and talk with the new instructor, before deciding about enrolling.

After that little bit of theory and practice in human relations, I'll get back to the subject. The practical point to emphasize here is that, very much more so than in tube circuits, the functioning of a circuit depends not only on the circuit configuration, but on the precise circuit values used in that configuration.

Take the circuit shown at **FIGURE 1**, which would immediately be identified by a man with tube background as a Hartley circuit. This circuit actually has two distinct modes, in each of which it can generate a substantially sinusoidal waveform. To understand this, you can view the operation as either grounded collector (emitter follower) or grounded emitter.

True, from the external circuit viewpoint, this circuit is grounded collector, even if you don't readily recognize an emitter follower. But from the transistor's viewpoint, you could regard the emitter as the reference, or ground point. The fact that collector and the bottom end of the tuned circuit have an external-circuit a.c. ground merely means that the oscillation pumps the whole transistor "up and down" with the oscillation.

Working this way, the turns between the top, connected through coupling to base, and the tap connected to emitter are a small fraction of the major turns, between tap and external ground. Viewing the emitter tap as being the "transistor's ground", the major tuned circuit, with the exception of the few turns coupled to base, appears as a collector load. (**FIGURE 2**).

Now, assume the dynamic impedance of the major tuned circuit is 50K, and the base input resistance of the transistor, operated grounded emitter, is 3K, while its beta is 100. This means the

transfer impedance, which relates output voltage for current input, is 100 times 50K, or 5 megohms. With tight coupling between the major turns and the few between emitter and base, a ratio of 1000:1 will be more than adequate to ensure oscillation.

Actually, the transistor will be biased so its average beta will be 60, to yield stable operation, if this ratio is used, and the base input impedance is 3K at that operating point.

From tube experience, you'd conclude that using more turns between emitter and base would cause harder oscillation, and thus a deterioration of waveform. To an extent this is true. But go far enough and you're in a different ball park altogether.

That little bit of theory assumed that the transistor operates in its conducting, and therefore its amplifying mode, for most of the oscillatory period. Distortion may come because, by oscillating too hard, it gets out of that mode for part of the oscillatory cycle. However, if the tapping is somewhere in the middle region, so the feedback current is major fraction of the tuned-circuit current, the transistor practically wops itself out of the ball park.

Now the circuit behaves as if the transistor isn't there, for most of the period. Only once every cycle, for a tiny portion of the cycle, does this feedback

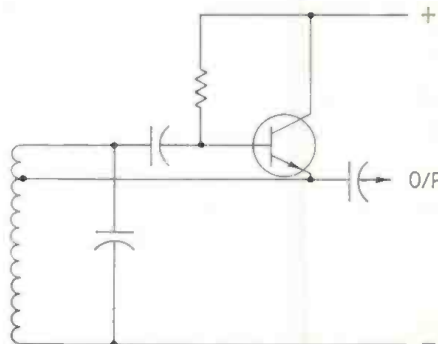

Figure 1. A type of tuned circuit oscillator that can operate in more than one way, according to circuit proportions.

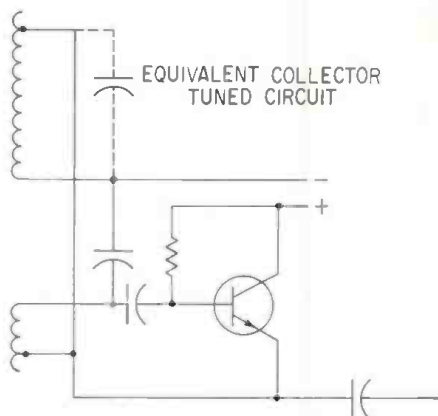

Figure 2. The same circuit redrawn to make the emitter the "ground" reference point, to help visualize transistor operation.

Figure 3. A circuit for a vibrato oscillator, essentially as published (some supply and output details have been simplified).

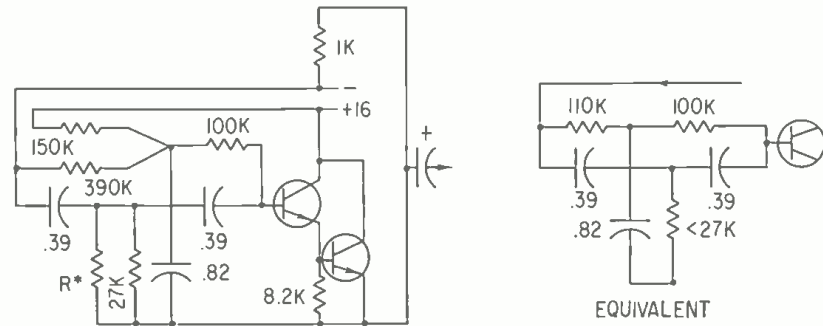
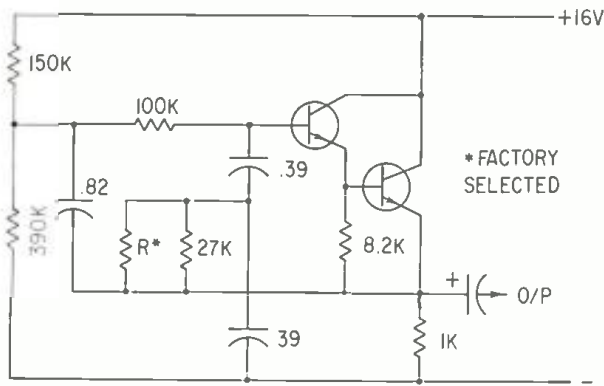

Figure 4. The same circuit as in Figure 3 redrawn to show the twin-T feedback reduced to more familiar relationship. On the right, the values are simplified to an equivalent simple twin-T.

action come into play to wop the transistor back out of the park again, and top up the oscillatory level to maintain amplitude in the tuned circuit.

Actually, the quality of sine wave generated now depends almost exclusively on the tuned circuit Q, while the transistor is inoperative. The higher the Q, the purer the waveform, because the transistor then has to apply a much smaller slug every time around, to keep it going.

With tube circuits, if you didn't have the cathode at, or near an a.c. ground, you must have a pretty good reason. By its very nature, the grounded grid stage was a little difficult to grapple with, in theory. But in transistor circuits, there's no need to have a specific ground reference, because there isn't, all that extra stuff hanging on.

FIGURE 3 is another example. This is from one of the Baldwin organ schematics—a vibrato oscillator. Apparently it's some kind of cascaded grounded collector stage, with a modified twin-T feedback. First time I looked at this, I asked myself, "How can it oscillate?"

At first my tube upbringing got in the way. I said to myself, "a grounded collector stage must have a very slight degeneration, like a cathode follower, so whatever happens, the signal at the output emitter has to be slightly regenerated and fed back to the input base at slightly higher level". And I didn't see how any kind of a twin-T network could do this.

So I redrew the thing (FIGURE 4) as a grounded emitter sequence, and then reduced the thing to equivalent twin-T elements. Now, although I'm taking the output from what looks like ground from the transistor's viewpoint, and I'm grounding the collector (by connecting it to my supply voltages), I'm looking at it the way the transistors work as a gain stage.

The ratio between the two series capacitors is slightly more than 2:1 (not far from the classical null network) but the ratio between the equivalent resistors is more than 3:1 without the selected-in-factory" resistor, and probably nearer 5:1 in practice. From these values, I glean, by referring to my charts, that this circuit will feedback a phase-reversed signal about 22 dB below the level of signal applied at the output end.

This will most definitely oscillate. The operation of the transistors is controlled by voltage at the divider point 150K and 390K across 16V, with those resistances and the 100K in series to control input base d.c. With a 1K output load resistor, this looks like a pretty good oscillator circuit, after first thinking it couldn't possibly!

Next month, I'll continue this with some more exercises in looking at transistors the right way.

STEP UP

... to the finest record-care accessories in the world!

CECILE E. WATTS Ltd.

If you're setting for less than Cecil E. Watts Ltd. record-care products, you're making do with less than the best! from \$4.00 to \$15.00



Endorsed by Elpa because it successfully meets the stringent standards for performance Elpa demands. Write for invaluable volumes on record protection and care. Enclose 75¢ for postage and handling. Elpa Marketing Industries, Inc., New Hyde Park, N. Y. 11040

Circle 24 on Reader Service Card

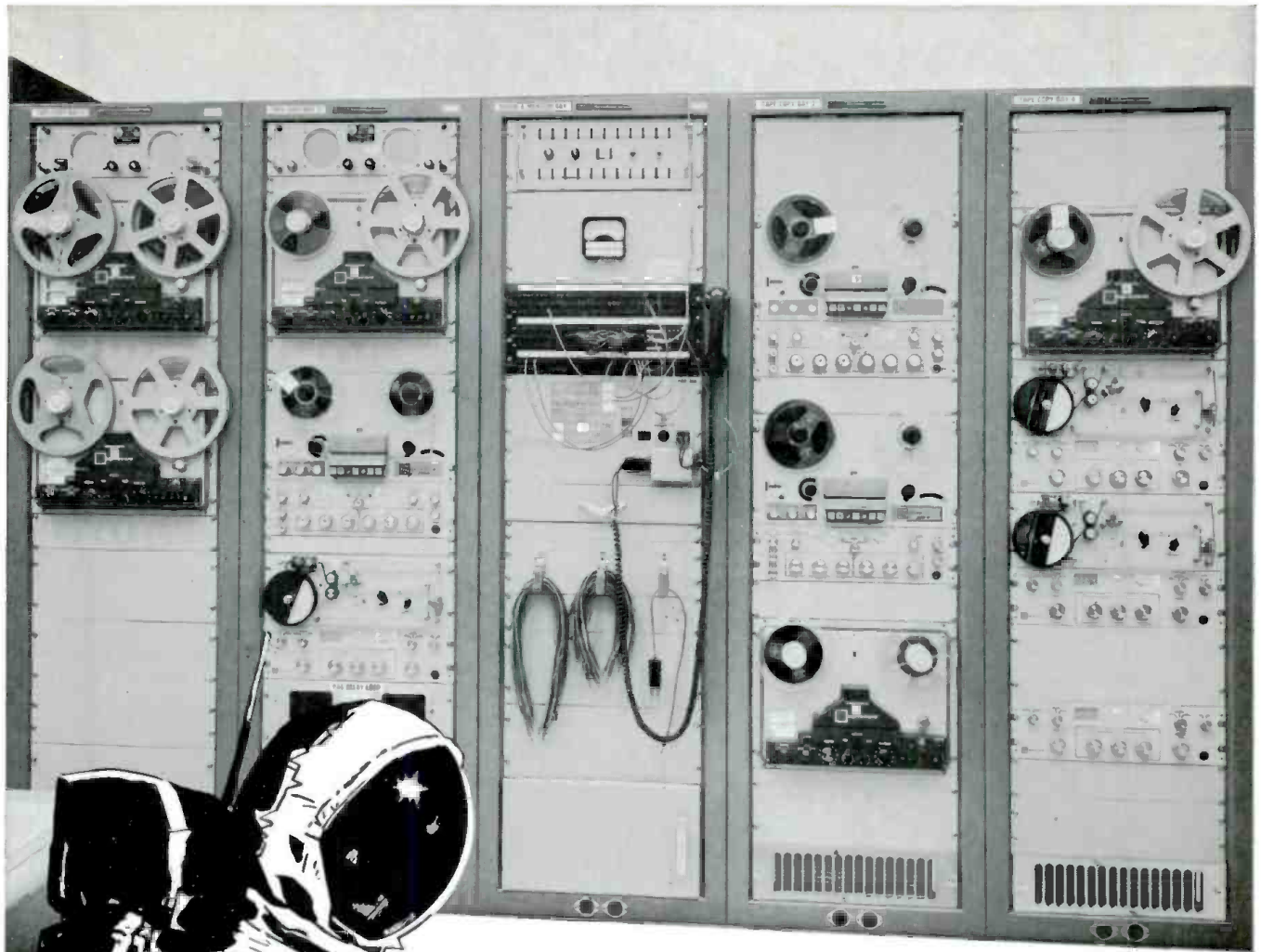

NASA Manned Spacecraft Center, Houston, Texas

WHEN MAN CLIMBED DOWN ONTO THE MOON'S SURFACE, THESE MAGNECORDS RECORDED HIS HEARTBEAT, HIS BLOOD PRESSURE, AND CONVERSATION

While the men of Apollo were off making history, NASA sound engineers were back in Houston getting it all down on tape. Bio-medical information on each of the three astronauts. Voice communications to and from the lunar module. And all other pertinent data that passed through NASA's world-wide network of communications during the flight of Apollo.

Magnecord Tape Recorders have been following our astronauts around the world since the early days of the Gemini program. Recording space flight history as it happens, the way it happens. If you've got recording history of your own to make, do it on the most reliable equipment available — do it on a Magnecord.

PRODUCTS OF SOUND RESEARCH
TELEX[®]
COMMUNICATIONS DIVISION
9600 Aldrich Avenue South
Minneapolis, Minnesota 55420

Circle 28 on Reader Service Card

Sound with Images

MARTIN DICKSTEIN

IMAGES WITH SOUND

● What ever happened to the 3D movies that were coming out in the 1950's where you had to wear those funny glasses to see the image? Well, they've almost come back. . .not in the original form, of course, but in the near future they'll be there to amaze and amuse the viewers (and scare them, too) and without any glasses or other devices. And then it won't be long until there's 3D on the t.v. screen at home. Not tomorrow, but soon.

To take a quick look at the development and the present state of the 3-dimensional image, it is only necessary to go back to the turn of the century. . . not this one, but the 19th. At that time, the phenomena of interference patterns was explained and that, more or less, started the ball rolling. However, nothing was done with this phenomenon to further the development of 3D t.v. until the turn of the present century. At this point in time, the first color photographs using a method based on interference of light waves were made. Perhaps the intervening 100 years were allowed to pass because the scientists were able to foresee something we can't see even today. However, the next 50 years saw many uses and applications of light interference such as the improvement of the electron microscope.

Then, in the late 1940's, it was realized that the light interference patterns could be used to create 3D images and this began the study of *holography*, a term taken from the Greeks (who always seem to have a word for almost anything). Loosely translated, it means totally written.

The first holograms were crude and 2-dimensional, but the principals of waveform reconstruction had been worked out. The failure in the creation of good 3-dimensional holograms was due to technical difficulties beyond control at the time. The light source used was not monochromatic, not strong enough and could not be concentrated into a sharp beam. In 1960, the invention of the laser answered all these problems.

The laser beam of light, created in generators of crystal or gas or liquid in specially designed tubes, provided a

great intensity in a narrow beam of monochromatic illumination. The next 10 years saw application of the laser in medicine, mining, communications, outer space experimentation, crystal piercing, night-time surveillance and the military.

The 2-D holograms were made of transparent objects. The light used was shown through the subject and some of the light allowed to pass around the object to get to the screen undisturbed. This same method was then used when the laser was first tried. Further experimentation showed that the laser beam could be reflected from opaque subjects and this same beam could be split so that some of its light, unimpeded, could reach the film, and interact with the reflected light. This permitted attempts at hitting the film with two beams at an angle and the results achieved were better in clarity of 3D.

Photographic film is used to record the interaction of the laser beams, but the developed negative is completely different from a regular photograph. The film looks gray and grainy where a more normal one would have a picture on it. In a photograph, the reflected light from the subject hits the film when the shutter is snapped and the emulsion is affected by the color and intensity of the incident light. In a hologram, however, the intensity of the incident light is recorded along with the phase of the wavefront of this light.

Thus, with the wavefront of the reflected light from each point on the subject recorded, the image appears as realistic as the original object when properly presented to the eye. By reflecting a coherent light from the object and shining part of the original (undisturbed) laser beam toward the film, the two rays meet at the plate and interference patterns are formed. Where the two wavefronts are in phase, they will reinforce. Where they are out of phase, they will cancel.

The recording plate with a recording of the phase interaction has, therefore, acted as a mixer as well as a storer of the information. It has been proven mathematically that where the wavefronts meet there is a sum and difference result, and the reference beam is

modulated by the reflected waves in a manner analogous to acoustic theory.

The information on the plate must be retrieved, now, to provide a visual image. This is accomplished by shining a laser beam through the film negative. The information on the film is then decoded (demodulated) and the reference beam is now subtracted to leave an image of the original subject. However, this image is not on the negative as in a photograph. When viewed from the front, the image seems to be floating in space behind the film. Every point on the original subject has been brought back to its original position in space with respect to the film and the resulting image is a completely realistic representation of the original object. (It is true that another image is also formed in front of the negative, but this one is not visible to the viewer in normal observation and steps to eliminate this image are taken when it is not desired.)

It will be noticed that the fact that the laser beam is coherent plays an important part in the production of the hologram. If the light were not coherent, there would not be a definite wave pattern to form an interference image on the film. If the light beam striking the subject has to be coherent to be able to modulate the reference beam, then it should be possible to use a beam of sound to "illuminate" the subject of the hologram, provided the sound is a pure tone or single frequency. This has been found to be possible, and holograms have been made with sound as the reflected wave.

There are several catches to making good reproductions by this method but they are being overcome rather quickly. The methods of recording such interference patterns have now been developed. Strangely enough, it has been found that photographic film will record these wavefronts. Another method is to have the sound waves form ripples on the quiet surface of water and then photograph these. However, the film must still be illuminated by a laser beam to reproduce the image. It has been shown that the greater the frequency difference between the original reference beam and the reproducing

SHURE

SM53

UNIDIRECTIONAL
DYNAMIC
MICROPHONE

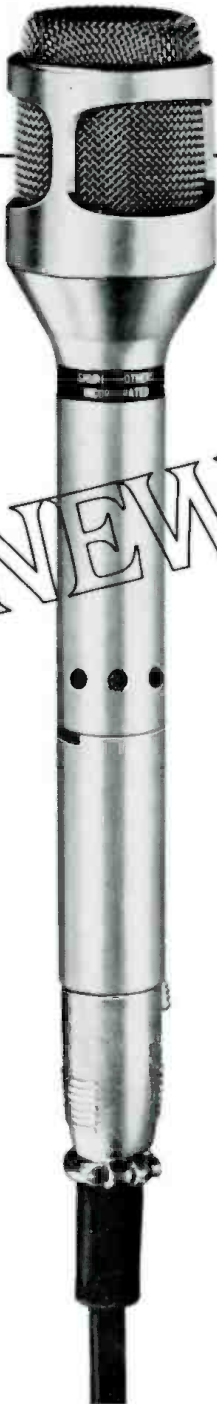

one or all of these provable advantages can make this your most effective and reliable microphone!

1. WIDER FRONT WORKING ANGLE

The SM53 allows *greater freedom of performer movement*—tonal quality is *unaffected by movement throughout* the broad effective pickup area. *Eliminates "holes" and "hot spots"* when using multiple microphones. These valuable attributes stem from a broad, true cardioid frontal pattern *at all frequencies, in all planes*—freeing the user from the restrictions of overly tight angular sensitivity.

2. MORE EFFECTIVE REJECTION OF UNWANTED SOUNDS

The SM53 prevents sound coloration due to off-axis reflections or reverberation—and, in addition, unwanted sounds (even air conditioner rumble) are effectively controlled. These properties are achieved through the polar pattern which is singularly uniform with frequency (even at the extreme low end) and is symmetrical about its axis.

3. MECHANICAL NOISE ISOLATION

Built-in effective shock mount significantly reduces the objectionable stand, cable, and handling noises associated with many unidirectional microphones. The SM53 can be used in many applications where conventional units have proved marginal or unusable.

4. EXTRAORDINARY RUGGEDNESS

You can even drop the SM53 directly on its nose without damaging the microphone element—and it will maintain its excellent performance characteristics.

5. SUPERIOR HUM REJECTION

Built-in hum-rejection system reduces magnetic hum susceptibility by as much as 20 db compared to other units! Makes it far more usable in distant pickup applications and in areas with extremely high magnetic fields.

6. LESS SUSCEPTIBILITY TO "POP"

Integral "pop" filter minimizes explosive breath noise without external screening. Works well where other microphones are marginal or unusable.

7. MINIMIZED PROXIMITY EFFECT

Uniform tonal quality is maintained (without objectionable low-end build-up) regardless of whether the microphone is worked close up or from a distance.

8. FIELD SERVICEABILITY

Element (cartridge), connector, front screen, roll-off switch can all be replaced in minutes.

SHURE BROTHERS INC., 222 Hartrey Avenue, Evanston, Illinois 60204

© 1969 SHURE BROTHERS INC.

Circle 27 on Reader Service Card

beam, the greater is the distortion of the visible image. Until they devise a method of illuminating the developed film to reproduce the image, therefore, the laser beam will have to be used for the time being, and the frequency of the sound beam must be as high as possible. It has been found that working in the 1 to 10 MHz range produces fairly acceptable images. Within this range, it has been found that particular frequencies may produce certain desired results so the work goes on in this field to perfect the hologram recording and reproduction.

One advantage of using sound instead of light to reflect from the subject is that the sound wave loses relatively

little energy in passing through dense media while light loses quite a good deal of its energy. This might be applicable to underwater or underground observation, as well as experimentation with inherent military and industrial possibilities.

Another advantage of using sound is that the sound pressure of a wave on a surface can be detected by the deformation of that surface. The flexing resulting from the pressure of a sound wave front can then be recorded and measured even though the deflection is minute. Still another possibility lies in the introduction of the reference frequency after the reflected wave has been picked up through electronic

sensors. The mixing of the received signals and the base frequency could then be accomplished without projecting more than just the original sound wave at the subject. Thus, holographic reproduction of complex opaque objects and difficult-to-monitor operations have been shown to be completely feasible using sound waves as the original detecting waveform.

Going onward and upward, the next developments will be in the recording and reproduction of moving subjects. Up to this time, the objects of holograms have been stationary. Movement of the subject (or the film) ruined the resolution or sharpness of the image and the reproduction was completely unrecognizable. Now, the laser beam is pulsed extremely rapidly and a special shutter arrangement allows the required staccato illumination of the moving object. To produce a motion picture, the film must also be moved, and the double motion of the subject and the film has now been worked out and is being perfected. Speed of movement is still somewhat of a problem, but it won't be long now. A short film has already been made of tropical fish swimming in a tank, and the precise movements are quite clearly visible on reproduction of the holographic movie.

Other solutions are being devised to problems such as how to record a human face with a laser beam shining into the eyes without blinding the person; how to create good clear color images rather than monochromatic ones; how to record on a single 2-dimensional film plate a complete 3-dimensional image (by slowly revolving the subject and recording each view separately on consecutive slim segments of the film until the total subject has been recorded—allowing the viewer to see all around the object simply by moving his head from side-to-side while looking through film); and how to record many thousands of typed pages or millions of bits of data on a single small native.

Most recently, research is attempting to produce holograms which will use ordinary light instead of laser beams to record the image. This system uses a fly's-eye lens which has many tiny facets to it. Thus, objects seen through it can be recorded with each facet of the lens providing a slightly displaced view from any other.

More than a hundred companies are now involved in the production, research, and development of the hologram or related fields or equipment. Many of these are working on the projection of the hologram for audience viewing. Others are developing methods of transmitting and presenting holographic images by t.v. It won't be long now before both movies and t.v. are in the 3D presentation business through the use of holograms.



PORTABLE/SOLID STATE/BATTERY OPERATED/TAPE RECORDER

At first, it was almost a labor of love to meet all the rigorous demands for Tandberg excellence. Then, after exhaustive development, this fine product was born for critical, on-the-spot, professional-type recordings that require "better, clearer, more natural sound." The quality speaks for itself — Tandberg. Try it. But first, to start with, review these important features: 3 separate heads; 3 speeds; 7" reel capacity (cover off); mixing facilities with separate level controls; $\pm 0.5\%$ absolute speed tolerance; automatic limiting control; 200 ohm monitor headphone socket; built-in speaker; accepts ten 1.5 D cell or nickel cadmium batteries; weight 10 lbs.

SPECIFICATIONS

Frequency Response: $7\frac{1}{2}$ ips — 30-20,000Hz (± 2 -db 40-16,000Hz); $3\frac{3}{4}$ ips — 30-13,000Hz (± 2 -db 50-9,000Hz); $1\frac{1}{8}$ ips — 30-7,000Hz (± 2 -db 60-4,500Hz). Signal-to-noise Ratio: @ $7\frac{1}{2}$ ips 61dB. Wow: $7\frac{1}{2}$ ips better than .1%; $3\frac{3}{4}$ ips better than .15%; $1\frac{1}{8}$ ips better than .35%. Erase & Bias Frequency: 85.5KHz ± 2 KHz; below 5% distortion. Transistor Complement: 41 transistors, 8 diodes, 2 zener diodes. \$449.50

Optional Accessories:

Carry Bag \$29.95 AC Power Supply \$44.95

for better, clearer, more natural sound

Tandberg
TANDBERG OF AMERICA, INC.

P.O. Box 171, 8 Third Avenue, Pelham, N. Y. 10803
914 PE 8-0772



Model 11-1-P

For Professional Sound/Film Synchronization and Audio Engineering. Rugged, climatized construction. Synchronizer and power supply optional. \$699.00

Circle 26 on Reader Service Card

Neve designed and built it for **THAMES**

TELEVISION LTD

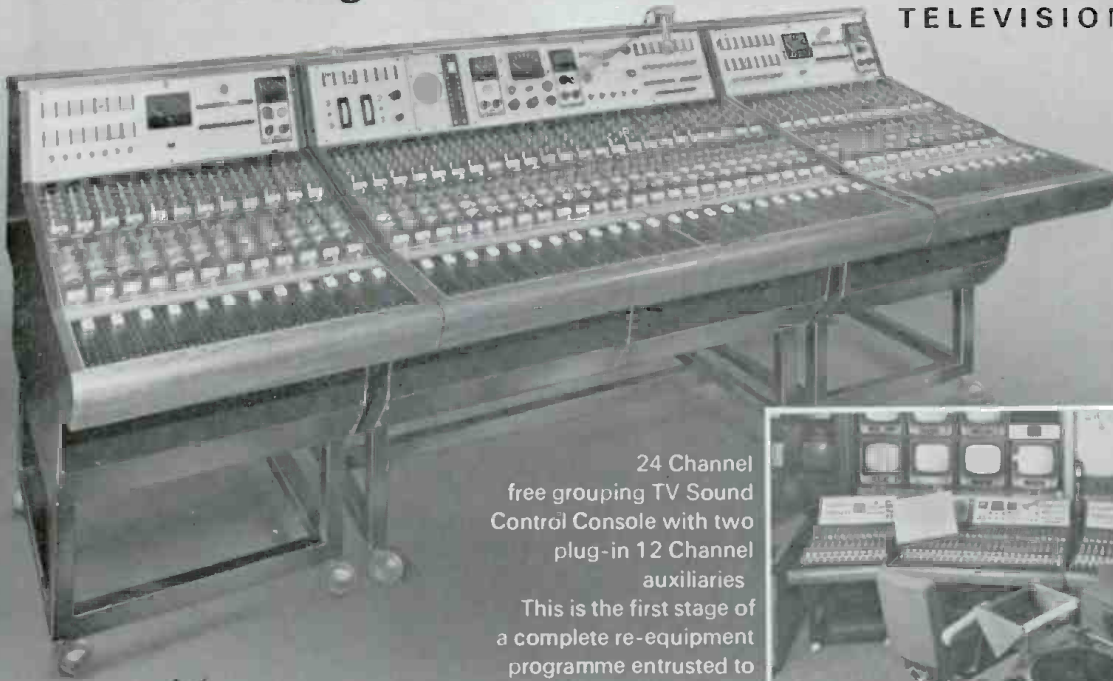

24 Channel
free grouping TV Sound
Control Console with two
plug-in 12 Channel
auxiliaries

This is the first stage of
a complete re-equipment
programme entrusted to
Rupert Neve & Co. Ltd. by
THAMES TELEVISION LTD



Rupert Neve & Co. Ltd. Cambridge House, Melbourn, Royston, Herts.

Telephone MELBOURN 776
(STD: 0223-975) Telex 81381

Circle 29 on Reader Service Card

NOW THERE'S A CASSETTE TAPE WITH MUSCLES.

New Maxell F-20 Magnetic Tape helps you make better cassette recordings—with fewer problems. Reason? Real muscle. Maxell F-20 has 10% greater tensile strength than conventional recording tape. Prevents tape breaks, headaches, lost studio time. Lower print-through level, too. And our secret Hush-Hush Tape Formula virtually wipes out hiss, delivers pure fidelity in mono or stereo. It's specially developed to give you an ultra-precise recording of fine music. Your ears will prove it—and your budget will like it. Write us today for more facts.

HITACHI MAXELL, LTD.

501 Fifth Avenue, New York, N.Y. 10017

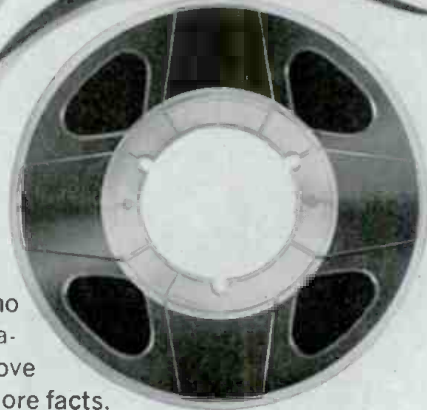

Circle 31 on Reader Service Card

Editorial

THIS ISSUE marks the start of our third year of publication. Since it is generally considered (in the magazine field) that it takes two years or more for a publication to become established, it is with no small degree of pride that we pass this point in our growth. But we feel it more important to point out that db Magazine has provided a much needed source of meaningful material to our readers, and we are grateful to many of them for their continuing flow of letters of encouragement and comments.

In our original statement to the industry we said: "db will stress the practical rather than the abstract. By showing what *is* being done, not what might be done, it will be an indispensable working tool for sound engineers."

Many readers have commented on the value of this approach. We quote one letter which summarizes this thought in a way that we all understand:

"May I take this opportunity to express my appreciation of the usefulness of content of db Magazine. I especially appreciate articles on those topics pertaining to audio equipment design and construction practices. *Usefulness of Content* is, I suppose, a rather awkward phrase, but it describes exactly what db is to me. Just two of the many articles have made db well worth my subscription cost. I refer to the item on shielding techniques in audio control board construction and the recent item on balanced vs. unbalanced lines—rather elementary to some of your readers, but for those of us with more interest than experience, and those of us operating on a shoe-string of equipment, articles such as these are quite useful."

Professional audio is growing at an unprecedented rate. We will strive to keep abreast of these changes in order to continue to provide issues that are useful, accurate, and timely—and thus continue to earn your support and encouragement.

R.B.

Soviet Recording Studios

JOHN M. WORAM

The author recently returned from a visit to the Soviet Union where he toured recording facilities in Moscow and several other Russian cities. His impressions are set forth in this article.

AS EVERYONE WHO READS THE DAILY PAPERS must know by now, the Soviet Union and the United States do not quite see eye-to-eye on all points. At times, our little political differences tend to obscure our human similarities. And, in an attempt to support our own points of view, we sometimes find ourselves denigrating *all* aspects of each other's society. Many Americans smugly point to the—by our standards—bleak living conditions in the Communist world. And Soviet newspapers keep their readers well informed about American race riots and assorted scandals. At times, diplomatic affairs are conducted at a level that would embarrass a kindergarten class. In Moscow, foreign residents are not permitted to live in the same apartment houses as Soviet citizens. Recently, former Vice President Hubert H. Humphrey noted that Soviet visitors to America are not permitted to visit Minneapolis. (Mr. Humphrey made this observation to a group of Americans who were visiting Kiev, U.S.S.R. at the time.)

A New York organization known as the Citizen Exchange Corps has the notion that Americans and Russians who have actually visited each others' countries, and talked, perhaps even argued, people-to-people, will be less inclined to do something silly, like launching World War III. After all, Russians *are* people, they catch colds, worry about the younger generation, and work in recording studios, just the way good Americans do. So, reasons the Citizen Exchange Corps, let's get Americans to meet Russians with colds, Russians with kids, and Russians in recording studios; let's compare notes, and try to figure out a way to live together and keep our minimum daily dosage of Strontium-90 at a reasonably low level.

As a recording engineer, and a member of CEC's advisory board, I was asked to go over to the Soviet Union this past summer and meet with Russian recording engineers and musicians as a part of CEC's program of getting people with similar jobs together. After all, a land that has given the world Moussorgsky, Tchaikovsky, and Shostakovitch, can't be *all* bad. And if I could manage to chat with an engineer or two in Moscow, perhaps at a later date some Soviet re-

ording people might get interested in visiting the U.S.A. And then maybe some more Americans would stop off in Moscow, and so on. With a little luck, and a lot of faith, some good might come of the whole thing.

So, under CEC auspices, I visited recording studios in Moscow and Leningrad and talked with engineers and musicians about their work. It would take a lot more than the three weeks that I had to analyze the Soviet record industry, and make an intelligent statement about its responsiveness to consumer demand *vis-a-vis* governmental directives, so this article is really just a "surface check".

The current two-track tapes being recorded in the Soviet Union are remarkably good, so it's probably safe to speculate that multi-track—8 or more—recording will not become popular unless there is a significant change in the type of music being recorded. And since music as a form of expression has certain obligations to Socialist Realism which may seem incomprehensible to western observers, the future of Soviet music (and ergo, recording) will depend to some extent on Kremlin policy.

To further digress; in the Soviet system, Communism is regarded as the ideal condition, but one that has not yet been reached. The present condition—Socialism—is a step towards Communism. And during the Socialist period, all aspects of Soviet life have a primary obligation; to advance the state towards complete Communism. This philosophy is considered contrary to human nature by many westerners, but it cannot be dismissed in any analysis of Soviet affairs, including recording. (Prolonged thinking in this field is probably beyond the scope of **db**, and certainly beyond that of the author. But, it can be seen that the arrival of the first 16-track machine will involve more than an order to Ampex or Scully.)

For the moment, Soviet recording remains a fairly straightforward process, free of all the paraphernalia that has become an integral part of recording in this country.

But now, to the studios. They're very good indeed. The Radio Moscow studios are especially pleasant. Studio 5 (FIGURE 1) is a large room, completed in 1967. It is often used by Melodia for recording large groups. The console, shown as FIGURE 2 was manufactured by WSW, the *Wiener Schwachstromwerke Gesellschaft M.B.H.* in Austria. The tape recorder complement consists of four Studers; one 4 track,

John M. Woram is a recording engineer with RCA Victor in New York City.



Figure 1. Studio 5 in Radio Moscow. The view is from the elevated control room.



Figure 2. Melodia engineer Nicolai Danilin at the W.S.W (Austria) console at Radio Moscow (a shared facility of Radio Moscow and Melodia).

two 2 track, and one mono machine. Most recording is done on two tracks only, especially since the X-Y, and M-S systems are widely used here. The 4-track machine is generally reserved for overdubbing.

Melodia has permanent control rooms in the Bolshoi and Tchaikovsky Theatres in Moscow, and in Leningrad at the Philharmonic Hall and the State Academic Chapel (FIGURE 3). At the Leningrad locations, the consoles are of modular construction, and were built in Czechoslovakia by Tesla. A typical module is shown in FIGURE 4. Notice the patch point located on the face of the module itself. There is a shorting plug inserted here for normal operation. To insert an external

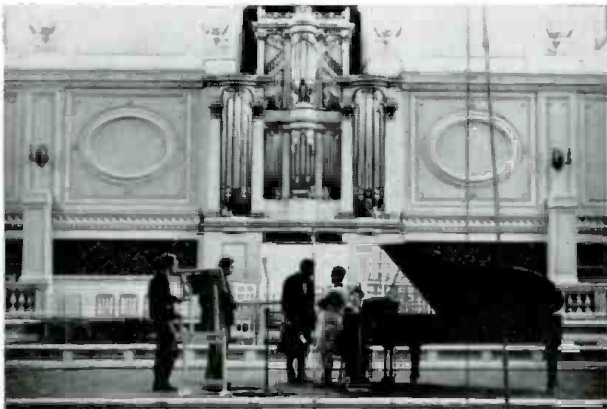

Figure 3. Leningrad State Academic Chapel's stage.

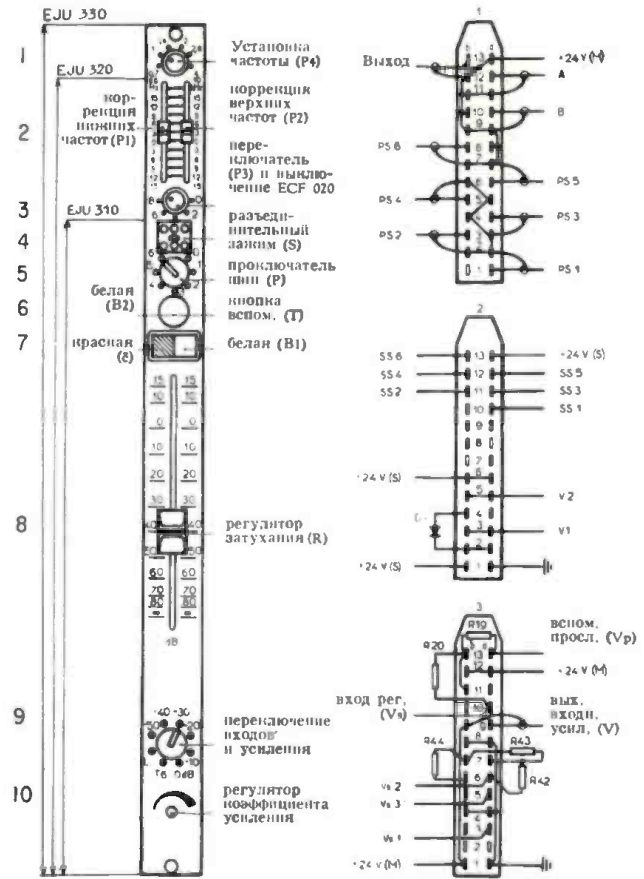

Figure 4. This illustration of a Tesla module is from a Russian specifications sheet. We have added the numbers on the left to indicate: 1. presence equalizer; 2. high- and low-frequency equalizers; 3. low-end cutoff; 4. patch point; 5. bus selector switch; 6. preview switch; 7. on/off indicator; 8. slide pot; 9. preamp pad; 10. preamp trim control.

device, the shorting plug is removed and a plug wired to the appropriate device is inserted.

In general, studio equipment is pretty much like that seen in Western Europe. Neumann microphones—especially 67's—are quite popular, as well as stereo mics, such as the SM69. EMT 140's are in use, as well as room-type echo chambers. Most of the speakers I saw were made in Eastern Europe, with the exception of a few Goodmans mounted in Hungarian enclosures.



Figure 5. The author (leaning over the Moog) brought a portable synthesizer with him. This group of Russian electronic-music composers was impressed by its performance characteristics.

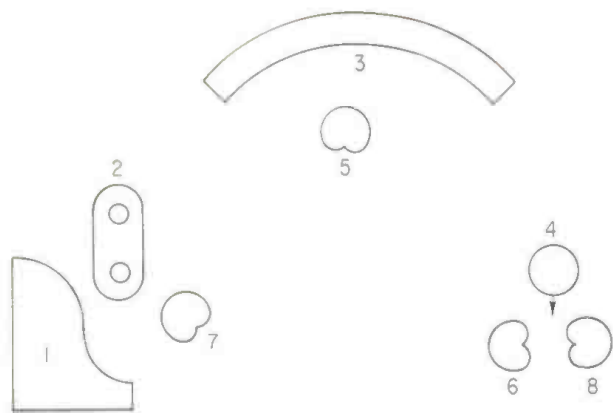

Figure 6. An illustration from a Russian audio textbook on studio operations. This is for a vocal/instrumental ensemble. 1. is piano; 2. bass and guitar; 3. vocal group; 4. soloist; 5. first right-track cardioid; 6. second right-track cardioid; 7. first left-track cardioid; 8. second left track cardioid.

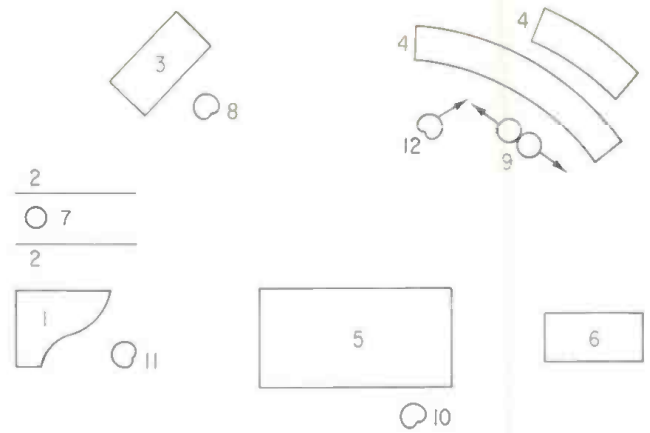
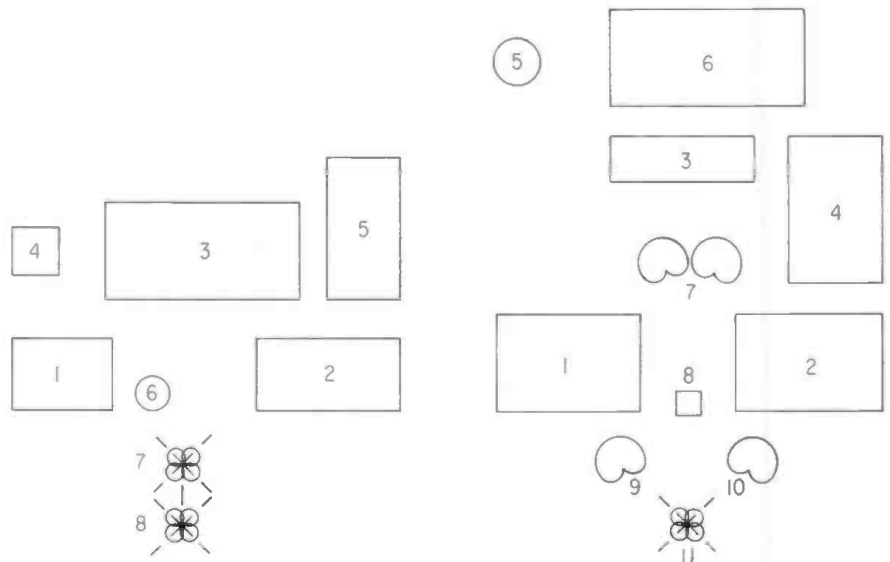

Figure 7. From the same book as Figure 6. This is a light music setup. 1. piano; 2. flutes; 3. percussion and guitars; 4. woodwinds and brass; 5. violins; 6. violas and 'celli; 7. upright bass; 8. first right-track cardioid; 9. second right-track figure 8; 10. first left-track cardioid; 11. second left-track cardioid; 12. third left-track cardioid.

Figure 8. Two setups are shown in this illustration from the Russian text. On the left is a soloist with accompanying symphony orchestra. 1. violins; 2. violas and 'celli; 3. woodwinds and brass; 4. percussion; 5. contrabass; 6. soloist; 7. two figure 8 microphones; 8. again, two figure-8 microphones but arranged at a greater distance from the performers.

The setup on the right is for a symphony orchestra in a studio of about 4600 cubic meters. 1. violins; 2. violas and 'celli; 3. winds and brass; 4. 'celli and contrabass; 5. percussion; 6. winds and brass; 7. cardioid microphone; 8. director; 9. cardioid microphone; 10. cardioid microphone; 11. two figure-8 microphones.



TO RUSSIA WITH MOOG?

In Moscow, I found a studio devoted to experimental electronic music. The Studio contained a variety of tape recorders and the Soviet A.N.S.—Electronic Instrument for Composition. The A.N.S. is a large machine containing a glass plate covered with an opaque paint-like film. Portions of the film are etched away with a scribe, and the plate is passed in front of a light sensitive read-out device. Depending on the vertical location and length of the scribed marks, sine waves of controlled frequencies and durations may be produced. The length of a real-time performance is limited to the time it takes for the glass plate to pass the light sensitive read-out device, at which time the plate must be removed, and a new one inserted before continuing.

From New York, I had brought along with me about 150 pounds of MOOG Synthesizer, and the composers at the studio (FIGURE 5) were particularly impressed with its wave forming capabilities, and the keyboard which permits practically continuous performance.

In discussing the type of electronic music work being done in the Soviet Union, I was advised that the composers considered their work as *innovative* rather than *avant garde*, the latter is a term apparently not in favor at this time. I also

was told that their compositions were done within the framework of Socialist Realism.

While in the Soviet Union, I investigated the possibilities of returning at a later date with a group of Americans interested in the field of music and recording. Mr. Boris Lebedev, General Secretary of the Committee for U.S.S.R. Participation in International Power Conferences has kindly offered to receive an American group during the spring of 1970, and the Citizen Exchange Corps is now making preliminary arrangements. Any **db** readers interested in visiting recording studios in Moscow, Leningrad, and perhaps one or two other cities are invited to write to me, care of **db** for further details.

db Magazine will be glad to co-sponsor a trip such as the author suggests. It is expected that such a trip would encompass a three-week period. Estimated *total* costs, including air fare from New York, should be just about \$1000. If you are interested write to the author, **John M. Woram, db Magazine, 980 Old Country Road, Plainview, N. Y. 11803.**

Just Step up to the Mic

ROBERT HAWKINS

Like Topsy the mic has just grown And
there are a lot of readers, surely all of them
under 30, that may assume that the mic
was always there. Well, it had a beginning
but the best that could be said of those mics
is that they were already more developed than
some of the apparatus they would be
connected to.

WHEN THE ENGLISH PHYSICIST, Duddell, harnessed the electric arc generator in 1900, he paved the way for the continuous carrier wave needed for radio telegraphy as well as telephony. The problem then was to figure out how to hook on a microphone. Telegraph keys were easy to come by, but efficient microphones were a long way off. Heretofore, most microphones were actually mouthpieces, or sound collectors, as in the early phonographs. Sound was transferred mechanically, with the brute strength of a performer's voice pushing the sound waves down a makeshift cardboard horn and forcing a diaphragm back and forth, which in turn, drove a steel needle into the soft wax master. The answer to the problem of a radio telephone lay in the just developed carbon mouthpieces of the fledgling telephone industry.

Dozens of scientists and inventors began work on the project, including the Americans, Fessenden and De Forest. In just a short time, however, a Danish engineer, Vladimir Poulsen, had merged the high-frequency arc, a radio transmitting circuit and a carbon microphone to create the first wireless telephone. Crude and sputtering though it was, in 1904, Poulsen was transmitting his voice over considerable distances, thus becoming, for all practical purposes, the world's first radio announcer.

Those early microphones were scarcely more elaborate than the early transmitters, and were often borrowed, in parts or design, from early telephone mouthpieces. By 1909, most types in use consisted of a flat cartridge with two contact buttons, which was slipped into a holder at the small end of a grotesque-looking fibre or cardboard horn. The whole thing was little more than a pile of carbon granules between two carbon frames. When the entire current output of the arc transmitter passed through it, the mass of particles would begin to fry and sputter, and would often bake completely solid by the heat developed. While one engineer was busy shouting into the horn or playing a phonograph into

it, another stood by with a screwdriver, ready to tap the microphone holder and break up the rapidly packing carbon grains so that the precious sound would be transmitted. Even though each of the cartridges cost around \$3.00, a serious sum for those days, their average useful life span was around five minutes.

As the infant industry grew and studios slowly sprouted at both ends of the continent; more varieties of microphone began to appear. Soon the innovations and improvements seemed to appear almost weekly. By the early twenties, with such stations as WJZ in Newark, KDKA in Pittsburgh, and KGO in San Francisco moving ahead quickly, both in programming and equipment, one popular model was the "tomato-can" mike. It probably had a more scientific designation but appeared as a long tube, in models both five and ten inches long, whose circumference was completely wrapped with copper wire. It was suspended on springs or wire from various stands. Each of these varied greatly in appearance, ranging from former music stands and hatracks, to dentist's drilling extensions and old birdcage stands.

Another popular model was the Phonotron or "dishpan" microphone. It looked much like a dishpan or shallow pot-lid hung gracefully from a gong-holding stand. The performer stood about two feet away, sang or shouted into the electromagnetic unit, and the sound was "collected" by its shape. Today's parabolic reflectors work in much the same way.

All of these microphones trailed a braided copper-covered cable, often fairly thick, which was connected to the speech amplifier. The amplifier, which had to be quite close by, was usually a rubber-wheeled truck or cabinet loaded with a variety of batteries, vacuum tubes, heavy reostats and switches, and over which performers invariably stumbled.

Microphones were generally placed at the beginning of a broadcast, then when they failed, replaced as the show continued. There were few mic volume controls in those days, and fewer control-room operators. Announcers would have to move the cantankerous instrument further and further away as a performer's volume grew, and would check as often as possible the show's quality over crystal-set earphones. Sometimes the mic would have to be moved all the

Robert Hawkins is the director of station operations for KVI in Seattle, Washington.



Figure 1. A collection of old mics, the same as appear on our cover. Can you identify each one of them?

way across the room. Often singers or other exuberent guests would "paralyze" the microphone with a loud or sudden blast, which would necessitate vast and speedy tube and fuse changing.

Experiments continued. Some situations developed the desk-type microphone which closely resembled the standup desk telephone of the day. As programming grew more varied, many famous stage and musical performers were being slowly persuaded to make their radio debut, but almost invariably succumbed to mic fright. To many, the ominous blackness and heavy wire of the tomato-can suggested deadly electricity. To others, the springs of the carbon mike leered like some kind of steel trap, and they were stricken. The studio solutions to combat this were delightful. In WJZ's fancy Aeolian Hall, where many musicals were to be given, technicians covered one of the mics with a decorative metal shade in the form of a world globe, all pleated and colored and about the size of a medicine ball. KDKA took the more subtle approach, mounting some of its mics on floor lamp stands, and covering them with fringed cloth lampshades. The nervous performer would step up to the mic and be encouraged to sing her number into the dangling fringe.

By 1925, WJZ had developed a double desk-stand microphone which was made by mounting two boxed carbon mics on a wooden holder 6-inches apart. It was primarily for the use of speakers who, while seated, might move emotionally back and forth, and possibly out of the thirty-degree range of a single microphone. Another prime contributor to the technical improvements of microphones and radio for a time was the American Telephone and Telegraph station, WEA in New York. While several companies were manufacturing variations of the carbon microphone, (Western Electric, Universal, RCA, Continental, and Standard Telephone and Cable), AT&T improved on the then-standard circular metal frame with its familiar spring mounts. They encased the mic in a rounded steel case, well ventilated with 13 wire mesh holes on each side. At six pounds, it was no lightweight but nonetheless enjoyed great use the next few years, alongside the nation's most popular model, the now historically familiar double-button carbon microphone, with its four to eight springs. (Each station had its own method of stringing up the microphone.)

In 1929, a dramatic improvement was introduced with the *camera* or condenser microphone. At first, it was squat and square and metallic, like a box brownie, but the quality was there. Although it was alive only on one side, and had a familiar looking telephone mouthpiece, all the hissing and delicacy of the carbon mike was gone. It had a wider fre-

quency range and better fidelity but retained a few deficiencies. The performer still had to be as close as eight or ten inches and not more than thirty degrees from the microphone axis. Also some care had to be taken in holding or moving it or the 180 volts in its diaphragm and plate condenser would set you across the room. Even with its cumbersome amplifier right next to, or built into, the microphone, the condenser gained great popularity. Engineers found it more sensitive to humidity and barometric pressure than its forebears, and confined it mostly to studio use.

In 1931, Western Electric introduced a vast improvement in its dynamic microphone. It consisted of a diaphragm on which is mounted a small coil of wire. This unit would vibrate in the field of a strong magnet, generating small electric currents proportional to the incoming sound waves. It was unidirectional and only had a range from 40 to 10,000 Hz but its fine response to low frequencies made it an instant favorite for broadcast of the human voice. Since it was more rugged than most, impervious to weather conditions and vocal blasting, it became a natural for remote work. Many are still found in daily service. Other variations of this dynamic are the so-called *salt-shaker* and the *eight-ball* microphones, both of which are non-directional and pressure-actuated with fairly flat ranges up to 10,000 Hz.

Crystal mics, though not often used for broadcast, were another fairly early type. Like the carbon and condenser, they work on the pressure-actuated principle and use a mounting of certain salt crystals, principally rochelle salts, which, under pressure, develop an electric charge. With their fairly low range, their use today is mainly restricted to public address and intercom systems, talk-back systems, and some recording equipment.

In the early thirties, a move toward real quality was made with the introduction of the velocity or *ribbon* microphone, so-called because the sound waves vibrate a narrow corrugated duraluminum ribbon suspended between the poles of a strong magnet, setting up small electric currents which are then amplified. The ribbon mic is highly sensitive on both broad sides of its face but scarcely at all on the edges, and has a frequency range from 30 to 15,000 Hz. Used almost always indoors due to its extreme sensitivity, it immediately was universally acclaimed for both dramatic and orchestral use.

In a short time, Western Electric introduced a cardioid directional microphone which was really a combination of two mics, the ribbon and the dynamic, with an adjustment so each type could be used independently. It contained two ribbons: one free-moving and one baffled acoustically with a sound-absorbing material. This was the first instrument to combine not less than three pickup characteristics in a single unit. By switching, its pattern could range from non-directional to unidirectional to cardioid. RCA followed with their variation of the cardioid 3-way adjustable, the 77-B, which had the characteristics of a velocity mike with the advantages of directionalism. Each of these are fairly flat up to 10,000 Hz.

This trend toward adjustability has led in the past fifteen years to an infinite selection of highly versatile microphones that can be set to operate under intensely varying conditions. One may purchase adaptability and versatility or utilize highly specialized instruments, designed for distinctive and singular applications. Frequency ranges have extended into the hundreds of thousands of cycles. They have been specialized, emphasized, synthesized, miniaturized, stylized, powerized, and transmitterized. Some have even gone to the moon, and that's quite a ways to go in sixty-five years.

A Super 8 Film/Sound System

LARRY ZIDE

This article describes a recently introduced low cost system that offers synchronized sound capability with motion pictures.

Nowhere as versatile as 16mm, this system may nevertheless offer many users all that they need to get their audio/visual messages across. It is fully compatible with existing super 8 film systems.

THERE HAS LONG BEEN A NEED by many industrial and semi- or light-professional users of audio-visual materials for a method of producing a sound/picture system lower in cost to 16mm or video tape. With this in mind, I have taken a serious look at the Bell & Howell Filmosound system as a possible answer to the problem.

Basically, the system uses conventional super 8 film cartridges in the camera. The camera is attached to a cassette recorder. The recorder lays down two tracks, one for audio, and one for sync information. For playback the recorder is attached to the projector and the sync track then serves to control the speed of the projector, keeping it in lip sync with the sound track.

Purely in terms of its ability to maintain lip sync, the system works well. But before it can be considered as a serious tool—beyond the hobbyist market—it must be able to perform certain functions:

- Are the pictures of good quality?
- Is there enough camera and film versatility?
- Is the sound track of good quality?

- Is the system editable?
- Is the system duplicatable?

Not all of these questions can be clearly answered. The question of picture quality is one that is limited by the image size formed within the super 8 format. It is probably not good enough for large-screen projection where grain and image-quality loss may become objectionable to the viewer. But for smaller groups, quality is clear, grain is sufficiently low, and there should be little viewer objection.

There are now an adequate number of cameras varying from simple automation to high versatility. At this writing, only Bell & Howell is supplying cameras. With their own label, they supply two purely hobby models and one with features for serious use. In addition, they distribute the sophisticated Canon super 8 cameras, several models of which are now equipped for the sound system. The Canon cameras are of high performance capability and will do all that the super 8 format will permit. (You cannot backwind the cartridge so lap dissolves are impossible on the original film.)

Color and black-and-white emulsions are available from Kodak, and color-only from all other major film suppliers.

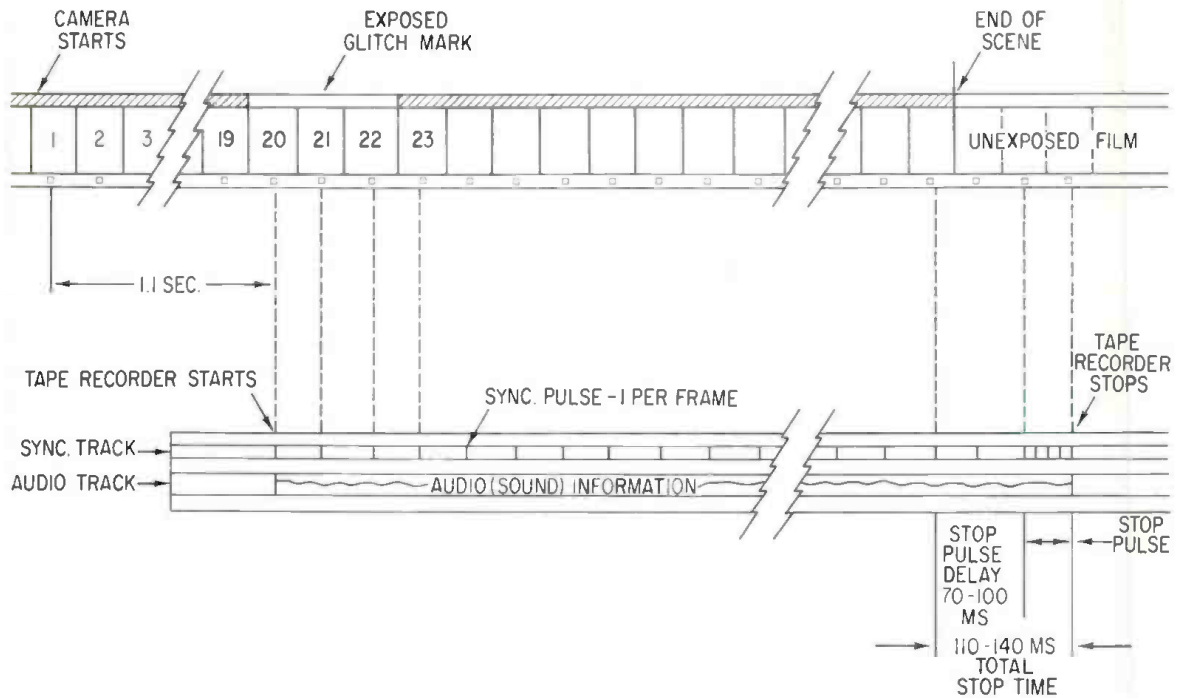

Figure 1. The film-to-tape sync/time relationships of the Bell & Howell Filmosound System.

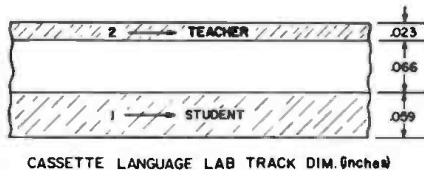

Figure 2. The track configurations used in the Filmosound tape system. This language-lab head is used, with the student track used for audio and the teacher track used for the sync signals. The student track coincides with the standard audio track positions used in conventional cassette equipment.

All of the films are reversal types, no negative material is presently available.

The audio track is recorded on half the width of a cassette tape. Bandwidth and flutter characteristics are quite acceptable for this kind of work, but the relatively poor s/n (perhaps 40 dB) requires careful monitoring of level if the high-annoyance hiss is to be kept well down.

The system is editable. The picture is edited in pretty much the normal way, with allowances made to preserve the scene-starting glitch marks on the film (or at least to replace the originally-recorded one). Cassettes can be directly edited—though it must be admitted that narrow tape and $1\frac{7}{8}$ in./sec. speeds make it difficult. Editall makes an aluminum editing block for cassette tapes. But there is a better way.

FIGURE 1 shows the audio and sync information as it appears on the tape. Bell & Howell uses a head such as is made for the language-laboratory field. Stereo cassette players can have such a language-lab head installed in place of their regular stereo head. Thus, the synced cassette can be dubbed to high-speed reel-to-reel for editing; then the edited version (matching the edited film) can be dubbed back to the correct

cassette format for use with the system. FIGURE 2 shows such a head.

Making duplications for wider distribution is perhaps the weakest point of the system. So far, no method exists to convert the two-step system (separate film and tape) into single system (sound-track on film, either optical or magnetic). And maintaining sound and picture quality in this system may be difficult. At any rate, I know of no efforts in this direction.

METHOD OF OPERATION

FIGURE 3 is a block diagram of the basic filming/recording system. The cable from the camera to the recorder is obviously a special one supplied by Bell & Howell. A total of five correlated switches must be activated if the system is to work. These are shown in FIGURE 4.

As the camera begins its run, one-per-frame pulses are sent down the cable. This turns the cable's transistor electronic switch on, permitting the signals to be sent to the recorder's count circuit. The signal also serves to block the action of the stop circuit.

The count circuit counts approximately 20 pulses and then activates the following events: 1. The glitch lamp in the camera is fired once exposing the edge of the film for a few frames. 2. A turn-on pulse starts the drive circuit and audio electronics of the recorder. 3. The drive motor starts, turning off the motor brake, and pulling the tape. As can be seen in Figure 1, the tape starts with frame 20 and continues recording audio and frame pulses until the camera is stopped.

Once this happens, the electronic switch turns off, and the flow of pulses from the camera immediately stops. With this interruption, the stop circuit becomes activated and sends a stop pulse to the tape head. The length of this pulse on the tape is equal to the time required to turn off the drive motor,

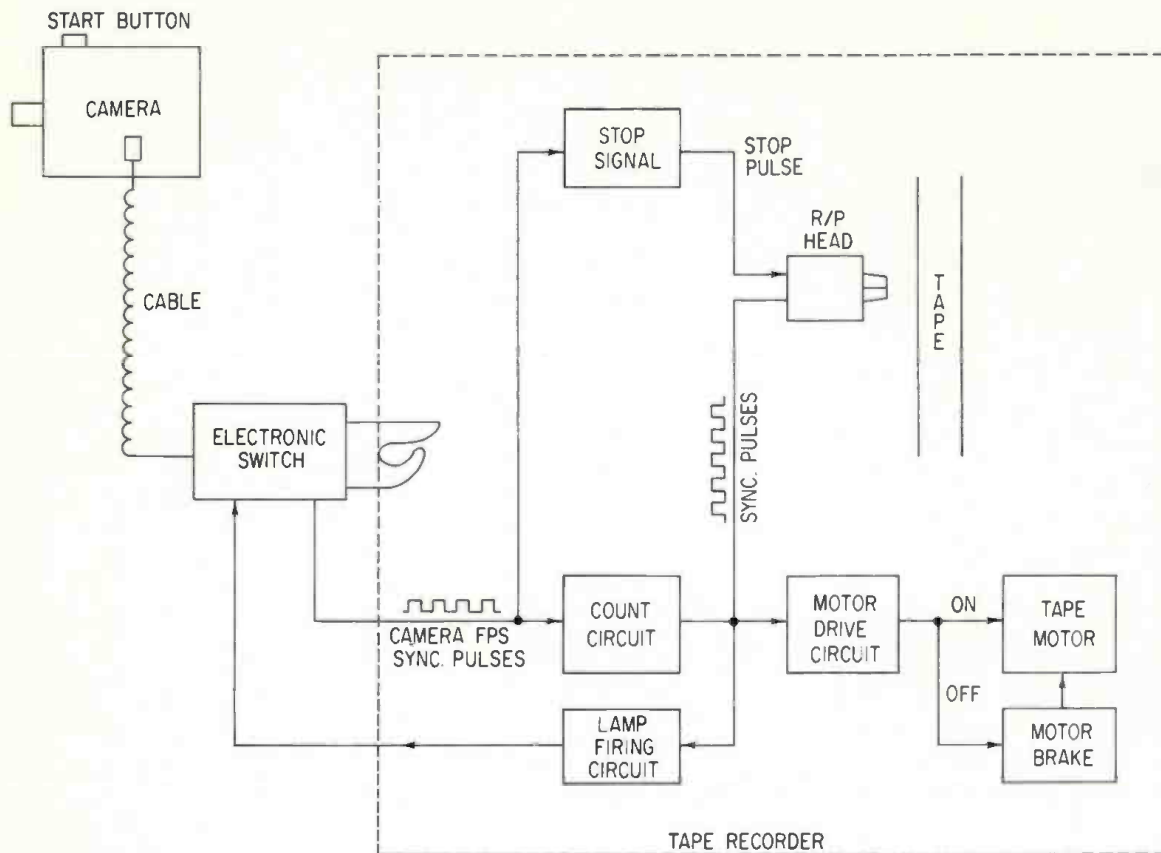

Figure 3. A block diagram of the film/record mode of operation. The electronic switch is part of the special record cable supplied by Bell & Howell.

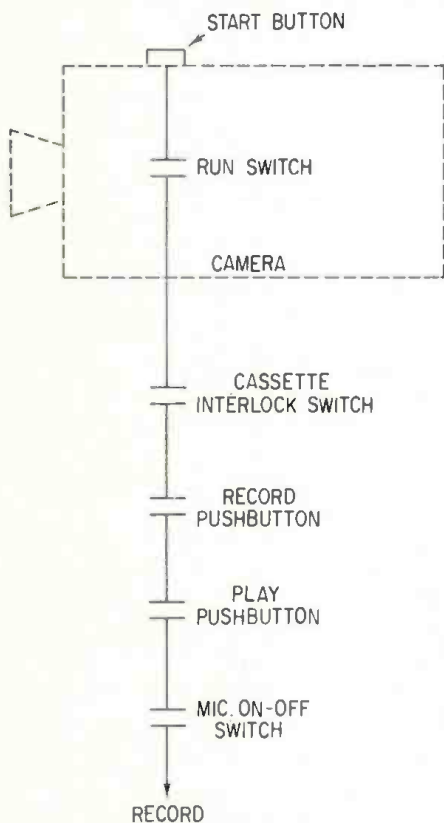

Figure 4. The switching arrangement necessary for recording during filming.

energize the brake motor circuit and stop the tape motor (about 40ms.)

PLAYBACK

The block diagram of FIGURE 5 shows the interaction of signals during playback. Again, a special (playback) cable is connected, this time between the recorder and projector. The projector sends a once-per-frame signal generated by the reed relay and rotating magnet wheel shown in inset B of FIGURE 5. This signal is sent to the recorder's error detection circuit, where it is compared with the signal from the tape. This sends a correction voltage to the drive motor control of the projector and thus controls its speed, keeping it in sync with the sound track. The glitch signal on the film has been read by the projector (inset A) and is used to start the tape at the correct point. At the end of the sound track for a particular scene, the stop signal on the tape, stops the recorder where it then waits for the next glitch mark on the film to start it for the following scene. In the mean time, with no comparison signal, the projector free-wheels at its maximum speed until the next control signals take over. In practice, this is not discernable on the screen.

I have been using the system, with two of the Bell & Howell cameras, the recorder, and their deluxe auto-threading projector. Within its limitations as a photographic medium, project is good. Cassette sound is likewise good. No, it's not 16mm with a Pilotone Tandberg, but the cost differences are notable. The Bell & Howell system might cost (for equipment) from \$400 to \$600 depending on choice of camera and pro-

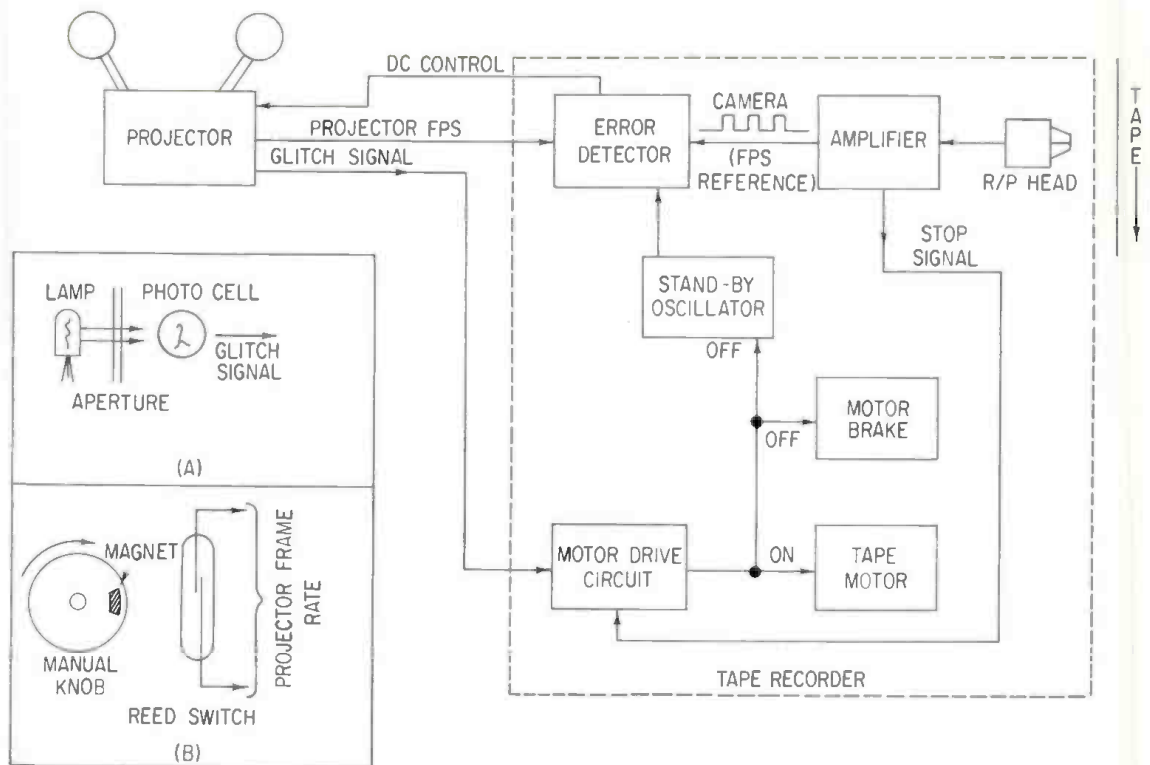

Figure 5. A block diagram of the project/play mode of operation. Inset A is located near the projector's aperture gate. The clear glitch mark activates the photo cell. Inset B is the projector's manual knob which contains a magnet. It rotates once per frame and activates the adjacent reed switch.

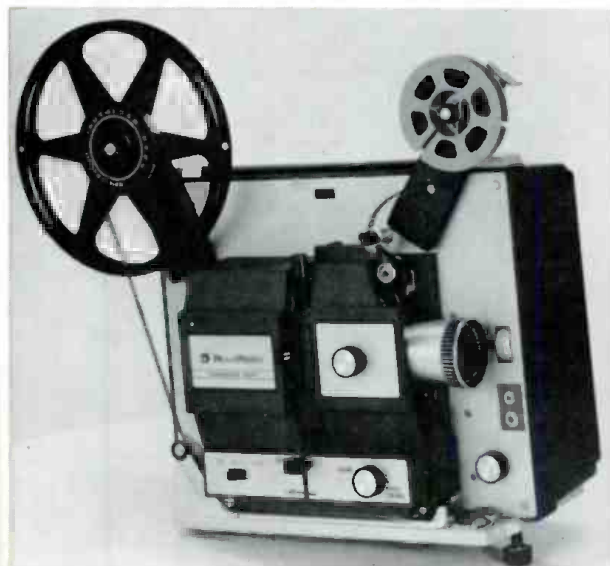

Figure 6. The deluxe projector described in the text. It can be used to show standard and super 8 films, the later silent or sound.

jector. On the other hand, a 16mm Bolex/Tandberg is well over \$1400. Granted the latter are more versatile performers singly or in tandem, but many of these characteristics can be beyond the need of industrial a/v users.

Costs must also be examined for the film. It requires \$11 worth of 16mm Kodachrome to put about 4 minutes on the screen. That same time and material in super 8 is about \$4. For the low-budget user, the differences in film cost over several thousand feet of film can be substantial.

Still it must be realized that the Filmosound system does provide lip-sync sound of a high degree of accuracy, with sufficient versatility for training films, and the like. As such, it should be considered.



Figure 7. One of the Canon camera models available that are equipped to sync with the tape unit.

New Products and Services

CARTRIDGE DISPENSER



● An expandable rotary file puts tape cartridges at the engineer's fingertips has replaced four conventional files according to Radio Station KGNU of Santa Clara, California at which the illustration was photographed. The Carrousel File is molded of high-impact polystyrene and is available in five standard capacities ranging from 60 to 576 units. The unit shown holds 240 units. Quik snap-in installation requires no tools.

Mfr.: Information Design, Inc.
Price: (as shown) \$120
Circle 64 on Reader Service Card

LEVEL INDICATOR



● Nine increments are used in this visual all-electronic level indicator to show you all the level all the time. It is a plug-in module that permits multi-track level displays. Sixteen units require 21 inches of width. The Model ELD is five times faster than avu.-meter and its backlighted scale is graduated to +6. Balanced bridging input circuitry does not load the source, and its sensitivity is adjustable from -20 to +8 dBm for 0 indication. Scale graduations of -20, -10, -6, -4, -2, and 0 are amber color; +2, +4, +6 are red. A non-glare lens and the vertical straight-line display make the meter easy to watch.

Mfr.: Electrodyne Corporation
Price: under \$100
Circle 66 on Reader Service Card

CONTACT CLEANER

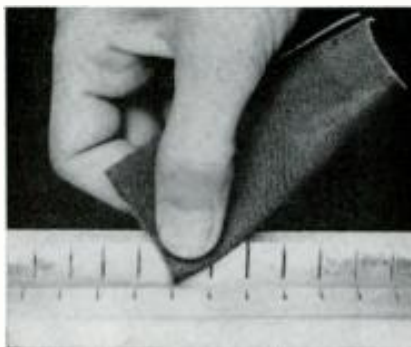

● Ace Bright, a contact cleaning material used for over 15 years in the telephone industry is now generally available. It is designed to clean off non-conductive films without damaging the base material. It is made of a nylon velvet material with carefully chosen abrasive material applied solely to the tips of the fibers. Light strokes across the area to be cleaned are all that are necessary. Even with difficult-to-clean areas, no excessive pressure is required, just more strokes. The substance is required, just more strokes. The substance is recommended for the cleaning of relay contacts, contact fingers, switch contracts, sliding contacts, and similar applications.

Mfr.: Metex Corporation
Circle 67 on Reader Service Card

db Binders

only \$4.95
 postpaid

Heavy-weight binders are now available to hold the thirteen issues of Volumes 1 and 2. Rich brown leather-grained virgin vinyl, with our name printed in black on the spine and front cover, is electronically sealed over rigid board to give your volumes of db lasting protection. Keep your copies preserved in perfect condition, protected from dust and damage.

Please send me _____ copies of the db Magazine binder. My check for \$_____ is enclosed (sorry, no c.o.d.).

Name _____

Address _____
number and street

city _____ state _____ zip _____

(New York State residents please add 5% sales tax).

Mail to: db, the Sound Engineering Magazine, 980 Old Country Road, Plainview, N.Y. 11803.

FAIRCHILD

FAIRCHILD'S PRECISION MAKES 57 OF THE WORLD'S FINEST PROFESSIONAL AUDIO COMPONENTS

... Fairchild's complete Series of Attenuators: 10 models with new packaging plus Slide Wire Fader / The Integra I Series: an automatic Attenuator, 3 Preamplifiers, 3 Compressors, 3 Program Equalizers, 4 Dynalizers, De-Esser / 692 Remote Card Series: over 12 inputs with extensive switching capacity / Integrated Control Module Series: Input-Output-Monitor Modules / 7 Audio Control Devices including the well known Conax, Limiter and Reverbertron Systems / 2 Gain Shifter Intercom Systems / 7 Power Supply Models / over 24 Accessories. Contact your Fairchild Distributor or write FAIRCHILD RECORDING CORPORATION Dept BM2, 10-40 45th Ave., L.I.C., N.Y. 11101.

Circle 32 on Reader Service Card

FOUR
CHANNEL
PAN POT

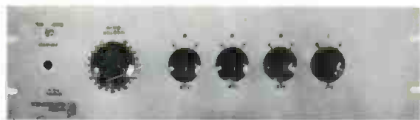

● Model PP-4 is a pan pot that accepts up to four input signals. Automatic level compensation is incorporated so that the signal level appears constant no matter where in the stereo image it is located. A stereo master-gain control is also included. Low-noise, high-output circuitry is also included to provide less than -75 dBm with the master gain set for unity. Maximum output capability is +30 dBm without clipping. There is 20 dB of overgain permitting the use of the unit with low-level sources. Input impedance is 10k Ω unbalanced bridging, and output impedance is 600/150 Ω or unbalanced.

*Mfr.: Gately Electronics
Circle 63 on Reader Service Card.*



POWER
AMPLIFIER

● Stereo amplification that may be strapped for mono use is featured in the new SAE Mark II amplifier. Massive power supply and full output electronic protection assures reliability in monitoring functions. Stability is assured, regardless of resistive or capacitive loads. Modular construction is used. Specifications include: 60+ watts continuous per channel into 8- Ω loads, from 20-20,000 Hz. At this range and load, in mono, the amplifier will deliver 100+ watts. Total harmonic distortion is less than 0.2 per cent at 60 watts over the full audio range. Measured i.m. is less than 0.2 per cent at 60 watts and under 0.1 per cent at lower levels. Signal/noise is 110 dB below 60 watts, and power bandwidth is +0, -2 dB, 3 Hz to 100 kHz, at one watt. 1 volt input is required for full output.

*Mfr.: Scientific Audio Electronics
Price: \$400
Circle 60 on Readers Service Card.*

ACOUSTIC FEEDBACK SUPPRESSORS

For all P.A. work — churches, theatres, stadiums, conference rooms, auditoriums, transportation terminals, etc. — available from stock or built to specifications. Demonstrations — Rentals — Sales. Write
AUDIO INSTRUMENT CO. INC.
311 Mountain Rd.
Union City, N. J. 07087

**THE SECOND THING WE DID WAS
MAKE A 16-TRACK TAPE CONSOLE
QUIETER THAN THE QUIETEST
ONE-TRACK TUBE SYSTEM BUILT.**



The first thing we did was design JH5 solid state electronics. Because without the one, you can't have the other—the JH5 has that many performance, stability and dependability improvements wired into it.

Now you're saying, "Where am I going to get the money for a new 16-track console?" And the answer is, you don't have to.

Just let us convert the transports you have (and save you a whole lot of money), with JH5 modules.

That's the beauty of it—the JH5 concept is completely modularized. We can simply update your tube tracks, or expand your entire system, just by adding modules.

And if this isn't good enough for you... Well, okay, go ahead and buy our ultra-quiet 16-track console. There are lots more (plus some pretty fantastic 1-, 2-, 4- and 8-tracks) where this one came from. Which is from...

MEI

1140 North Flagler Drive / Ft. Lauderdale
Florida 33304 / Phone: 305 / 524-4435

Circle 30 on Reader Service Card

The db Bookcase

As a service to our readers we are pleased to offer these books from prominent technical publishers. All prices listed are the publishers' net. Shipping charges are included.

Use the coupon at the bottom of the page or give the complete title, author and coupon number. Be sure to indicate quantity on the special instructions line if more than one copy of a title is wanted. Full payment must accompany your order. We cannot ship c.o.d. Checks or money orders should be made payable to Sagamore Publishing Company, Inc. Because of the time required to process orders, allow several weeks for the receipt of books.

Broadcasting

RADIO BROADCASTING

edited by Robert L. Hilliard. Each of the five chapters has been written by a prominent educator with an extensive background of practical experience in commercial and educational broadcasting. The areas covered include: management and programming, operating and studio facilities, producing and directing, writing, performing. For those of you who want to, or must, operate on both sides of the control room, this is virtually required reading. 190 pages, 6 1/4 x 9 1/2, indexed, clothbound.

\$6.95 (\$8.35 in Canada)
Circle 2 on Coupon Below

Reference

New 17th Edition of the famous RADIO HANDBOOK

Tells how to design, build and operate the latest types of amateur transmitters, receivers, transceivers, amplifiers and test equipment. Provides extensive, simplified theory on practically every phase of radio. Broad coverage; all original data, up to date, complete. 847 pages.

\$12.95 (\$15.50 in Canada)
Circle 10 on Coupon Below

How To

PRACTICAL PA GUIDEBOOK: HOW TO INSTALL, OPERATE AND SERVICE PUBLIC ADDRESS SYSTEMS

by Norman H. Crowhurst. 1967. This book gives all the basics needed to become a successful PA operator, in any situation where the reinforcement, relay, or distribution of sound can provide a service. It shows how to properly install, operate and service public address systems. All aspects of the subject, from survey to the selection of appropriate equipment, to installation, to routine operation and the maintenance of a finished system, are covered. Attention is given to solving problems encountered in providing successful service. The book's systematic and practical approach makes it highly useful to radio-TV servicemen, hobbyists, and PA equipment manufacturers. 136 pages; 6 x 9; illus; softbound.

\$3.95 (\$4.60 in Canada)
Circle 15 on Coupon Below

CLOSED-CIRCUIT TELEVISION HANDBOOK

by Leon Wortman. Gives comprehensive detailed information about the field in an easy-to-understand presentation. It's particularly suited to those who plan to use, install, and service cctv. Covers the subject from the simple single-camera system to the most exotic systems. 288 pages; 5 1/2 x 8 1/2; clothbound.

\$7.95 (\$9.50 in Canada)
Circle 18 on Coupon Below

Electronic Music

ELECTRONIC MUSICAL INSTRUMENTS

by Richard H. Dorf. Now in its third edition and sixth printing since its first appearance in 1954, this is considered the authority on electronic organs. This edition is completely rewritten to explain everything technical about today's organs. The book is of special value to organ designers and service technicians as well as electronics-minded hobbyists and prospective organ purchasers. Of special value are the author's many practical comments and expressions of opinion based on his years of musical, engineering, and management experience with electronic musical instruments. 393 pages; 239 diagrams and photographs.

\$10.00 (\$11.95 in Canada)
Circle 19 on Coupon Below

General Audio

THE TECHNIQUE OF THE SOUND STUDIO

by Alec Nisbett. This is a handbook on radio and recording techniques, but the principles described are equally applicable to film and television sound. It describes how the highest standards may be achieved not only in the elaborately equipped studio but also with simple equipment out on location. 264 pages; 60 diagrams; glossary; indexed; 5 1/2 x 8 1/2; clothbound.

\$10.50 (\$11.95 in Canada)
Circle 1 on Coupon Below

DESIGN OF LOW-NOISE TRANSISTOR INPUT CIRCUITS

by William A. Rheinfelder. 1964. Written for students as well as circuit design engineers interested in low-noise circuit design. Throughout, the book gives a multitude of time-saving graphs and design curves for the practical circuit designer. Simple derivations of all important formulas are also presented to help the reader obtain a deeper insight into the fundamentals of practical low-noise design. 128 pages; 6 x 9; illus.; clothbound.

\$5.50 (\$6.50 in Canada)
Circle 14 on Coupon Below

NEW!

THE AUDIO CYCLOPEDIA (2nd EDITION)

by Dr. Howard M. Tremaine. New and updated, here is the complete audio reference library in a single volume. It provides the most comprehensive information on every aspect of the audio art. This new edition includes the latest audio developments including the most recent solid-state systems and integrated circuits. It covers all subjects in the fields of acoustics, recording, and reproduction with more than 3400 related topics. Each topic can be instantly located by a unique index and reference system. More than 1600 illustrations and schematics help make complicated topics masterpieces of clarity. 1760 pages; 6 1/2 x 9-3/8; hardbound.

\$29.95 (\$35.95 in Canada)
Circle 20 on Coupon Below

ACOUSTICS—ROOM DESIGN AND NOISE CONTROL

by Michael Rettinger. 1968. The enormous problems and hazards presented by noise are dealt within an orderly and practical manner. With many charts, graphs, and practical examples, the text covers the physics of sound, room acoustics, and design, noise and noise reduction. The author's many years of experience in the field and extensive knowledge (set down in two earlier books on acoustics) make this work a boon to architects, builders, designers, planners, and engineers. 392 pages; hardbound.

\$17.50 (\$20.90 in Canada)
Circle 21 on Coupon Below

Sagamore Publishing Company, Inc.
980 Old Country Road, Plainview, N.Y. 11803

Please send me the books I have circled below. My full remittance in the amount of \$..... is enclosed. N.Y. State residents add 5% sales tax.

1 2 3 4 5 6 7 8 9 10 11 12 13 14 15 16 17 18 19 20 21 22
23 24 25 26 27 28 29 30 31 32 33 34 35 36 37 38 39 40

Name.....

Street Address.....

City.....State.....Zip.....

Special Instructions.....

HANDBOOK OF ELECTRONIC TABLES & FORMULAS, (3rd Edition)

A one-stop source for all charts, tables, formulas, laws, symbols, and standards used in electronics. Devotes complete sections to items of interest to service technicians and to circuit design data. Includes a 8-page, full-color fold-out chart showing latest FCC allocations for the entire frequency spectrum. 232 pages; 5 1/2 x 8 1/2, hardbound \$5.50 (\$6.60 in Canada)
Circle 8 on Coupon Below

Test and Maintenance

INTERMODULATION AND HARMONIC DISTORTION HANDBOOK

by Howard M. Tremaine. A complete reference guidebook on audio signal intermodulation and harmonic distortion. 172 pages; 5 1/2 x 8 1/2, softbound \$4.95 (\$5.95 in Canada)
Circle 9 on Coupon Below

Circuitry and Components

PASSIVE AUDIO NETWORK DESIGN

by Howard M. Tremaine. A complete and comprehensive guide to the design, construction, and testing of all types of attenuators, equalizers, and wave filters for the practicing audio technician or engineer. This authoritative text is one of the few written on the subject, and requires only nominal mathematical background. Written in easy-to-understand language, the content presents the basic design, construction, and testing considerations without the confusion often associated with passive networks. 288 pages; 5 1/2 x 8 1/2, softbound \$5.50 (\$6.45 in Canada)
Circle 5 on Coupon Below

TRANSISTORS FOR AUDIO FREQUENCY (AUDIO-FREQUENCY AMPLIFICATION)

by Guy Fontaine. 1967. This systematic and detailed treatment of the application of transistors in audio-frequency amplifiers shows how the published transistor characteristics are related to the principles of design. To assure clarity, the figures are rendered in several colors and placed opposite the related text. Simple equations reinforce the lucid approach. An ideal textbook or reference on the subject for engineers and advanced technicians. 384 pages; 5 1/2 x 8, illus., clothbound. \$7.95 (\$9.55 in Canada)
Circle 12 on Coupon Below

ACOUSTICAL TESTS AND MEASUREMENTS

by Don Davis. Provides a solid understanding of the entire subject of acoustical measurements; based on actual field test work, using commercial equipment. Contains practical, time-saving solutions to actual problems encountered in the field; minimum math is required for understanding. The author is an expert in this field, and an authority on auditorium acoustics. An invaluable book for phone company special service engineers, plant maintenance engineers, communications engineers, noise control specialists, architectural engineers, broadcast engineers and technicians, hi-fi fans and students. 192 pages; 5 1/2 x 8 1/2, hardbound. \$6.95 (\$8.35 in Canada)
Circle 7 on Coupon Below

Classified

Closing date is the fifteenth of the second month preceding the date of issue. Send copy to:

Classified Ad Dept.

db

THE SOUND ENGINEERING MAGAZINE
980 Old Country Road
Plainview, New York 11803

Rates are 50c a word for commercial advertisements. Non-commercial and employment offered or wanted placements are accepted at 25c per word.

FOR SALE

SCULLY TAPE RECORDERS — one to twenty-four track and model 270 auto players, many models in stock for immediate delivery. SCULLY LATHES — Previously owned and rebuilt. Variable or automatic pitch. Complete cutting systems with Westrex heads. MIXING CONSOLES — Custom designed using Wiegand Audio Lab modules. From \$7,000.00. Wiegand Audio Laboratories, 3402 Windsor Road, Wall, New Jersey 07719. Phone: 201 681-6443.

SOLID-STATE AUDIO PLUG-IN OCTAL (1" Dia x 2" H) modules. Mic preamps, disc & tape preamp-equalizers, tape bias osc. & record ampl., power amps & power supplies. Send for free catalog and audio applications. Opamp Labs., 172 So. Alta Vista Blvd., Los Angeles, California 90036.

AUDIO AND VIDEO JACK PANELS and patch cords. 500-500 ohm repeat coils. New and used. Send for list. Gulf Electro Sales, 6325 Beverly Hill, Houston, Texas 77027

AMPEX AG-500-2 PROFESSIONAL RECORDER two channel in portable case—NEW. Original \$1626. Sale for \$1100. Wellington Lee, Box 427, Bowling Green Station, New York, N. Y. 10004. Phone: (212) 344-9700, Ext. 266.

EQUALIZERS AND LIMITER FOR RECORDING. New. Write Kuhn, 1397 Washington Circle, Forestville, Ohio 45230.

AMPEX MR-70 3 CHANNEL (1/2-inch tape). Purchased new 8/13/68. Has never been used. Transport and electronics modified from original 15-30 ips to 3 3/4-7 1/2 ips. (Modification performed by Expert Electronics, Chicago.) To be sold "as is," F.O.B. Morton Grove, Illinois. Write: D. J. Gulliford, Radiant Educational Corporation, 8220 North Austin Avenue, Morton Grove, Illinois 60053. Phone: (312) 966-4200.

THIRD CLASS LICENSE instruction booklet, reviews all phases necessary for license, also contains sample test. \$1.00 each. Order from Baker Publishing, 443 So. 13th Street, Lincoln, Nebraska 68508.

ELECTRONICS FOR AMPEX 350 WITH POWER SUPPLIES FOR 1, 2, 3, or 4 track. Box 11-B, db Magazine, 980 Old Country Road, Plainview, N. Y. 11803.

EMPLOYMENT

PROFESSIONAL RECORDING PERSONNEL SPECIALISTS. A selective service for employers and job seekers: engineers, tape editors, production and studio mgrs, traffic assts, etc. Call us today! Smith's Personnel Service, 1457 Broadway, N.Y.C. 10036. Alayne Spertell 212 WI 7-3806.

TRANSDUCER ENGINEER. Assignment in loudspeaker design and development. BS in EE required. Submit resume to Wm. T. Soulli, Cleveland Electronics, Inc., 1974 E. 61st Street, Cleveland, Ohio 44103.

MAINTENANCE ENGINEER, LARGE N. Y. RECORDING STUDIO. Must have studio experience. Salary open. Write Box 11-A, db Magazine, 980 Old Country Road, Plainview, N. Y. 11803.

EXPERIENCED TELEVISION AUDIO ENGINEER who is second best but tries harder, would like change into the recording industry as mixer. Would also consider films. Want opportunity to advance with growing concern. Resume on request. P.O. Box 2169, Grand Central Station, New York, N. Y. 10017.

EDUCATION

FCC LICENSE TRAINING by correspondence. G.I. Bill approved. Free brochure. Write: Dept. E-4, Pathfinder School of Electronics, 1505 N. Western Avenue, Hollywood, California 90027.

WANTED

WANTED: TELEFUNKEN U-47 condenser microphone in good condition. Joel Newman, WOMN, Decatur, Georgia 30030.

DISCONTINUED LP WANTS. Unusually high prices. All Categories. Include number, performer. The Record Undertaker. Box 437, New York, N. Y. 10023.

SERVICES

WHATEVER YOUR EQUIPMENT NEEDS — new or used — check us first. Trade your used equipment for new. Write for our complete listings. Broadcast Equipment & Supply Co., Box 3141, Bristol, Tenn. 37620.

CUSTOM STYLUS — cartridge re-tipping, re-building, replacements. International Audio Stylus Corp., 111-D Lake Ave., Tuckahoe, New York, 10707 (Telephone: (914) SP9-1297.

AUDIO BUFFS who tinker, test, scratch-build and redesign for pleasure get together in Audio Amateur, 307 Dickinson, Swarthmore, Pa. 19081.

People, Places, Happenings



An announcement from **United Recording Electronics Industries (UREI)** tells of the addition of **Shelly A. Herman** to the staff. His responsibilities will include the compilation of applications and engineering bulletins, and he will, in general, be the company liason directly with the end user.

● **Carl S. Nelson** has joined **Gauss Electrophysics**, a division of **MCA Technology, Inc.**, as vice-president and director of engineering. In the announcement by **Kieth O. Johnson**, president of the firm, it was noted that Mr. Nelson comes to Gauss from **Capitol Records** where he was the development engineering director at the Los Angeles, California-based recording company.



● In an announcement from **McMartin Industries**, **Don Jones** is named as the new product manager. The announcement by **Ray B. McMartin**, president, also noted that Mr. Jones has been with the company since 1965 but has had experience in background music and commercial sound work since 1960. In his new position he will be responsible for sales and market development activities for the complete range of **McMartin** background music equipment.

● **John Eargle** has been appointed as chief engineer for **Mercury Sound Studios** in an announcement by **Irving B. Greene**, president of **Mercury Record Corporation**. Based in New York, Mr. Eargle will be responsible for all recording facilities, mastering, etc. Prior to joining Mercury, he was in charge of recording facilities, maintenance, construction, and quality control for **RCA Records**. At his acceptance, Mr. Eargle said: "(I am) delighted at the opportunity to work with the creative and cooperative people at Mercury Sound Studios. We intend to build Mercury Sound Studios to a dominating position of excellence—with a built-in accommodation for change to keep up with the changes in the industry."

● **Scully Recording Instruments**, a division of **Dictaphone Corporation** has established a new California facility to be known as **Scully West** for the distribution and servicing of Scully recording equipment in western markets. **Lawrence J. Scully**, president, said that the new facility will enable Scully to further its expansion in an area where the use of recording gear for broadcast and record making is growing rapidly. Headquarters for the branch is at 670 National Avenue, Mountain View, California. Manager of the new division is **David T. Nicholls**, former product manager of the Video Tape Recorder Division of **Visual Electronics Laboratories**.



● **James L. Wilson** is the new vice president and general manager of the **Audio-Video System Division of Philips Broadcast Equipment Corp.** Mr. Wilson comes to Philips from **NBC** where he was vice-president, engineering for the network. He had been with **NBC** since 1948 in various engineering positions. He brings to Philips extensive experience in t.v. systems construction.

● Three engineers have been promoted to new positions in the production services division of **Reeves Telecom Corporation**. **Arthur R. Guth**, who has been the chief engineer since January becomes director of engineering. He joined Reeves four years ago as a video engineer.

Joseph Kiss is the new chief engineer of the division. He was previously a maintenance supervisor, a position he has held since joining the company over three years ago.

Henry Sleight, formerly a staff engineer, becomes maintenance supervisor. He has been with Reeves for three years.

● Sharp sales increases are stated as the reason for the move of **Infonics Corporation** to new headquarters with a plant capacity of two-and-a-half times its present facility. According to **Peter H. Stanton**, president of the firm, the sharp sales increase experienced this year is expected to continue with future rapid growth. The new plant is located at 1723 Cloverfield Boulevard, Santa Monica California.

● **Electrodyne Corporation**, North Hollywood, California-based manufacturer of consoles and console equipment, has announced its intention to open a New York sales office that will handle Eastern sales and service. The office is expected to be in operation by press time and will be headed by **Don Schliff**. The address will be announced as soon as final arrangements have been made.



● **Dean Flygstad** has been named vice-president engineering for the **Telex Communications Division**. In the announcement from **Ansel Kleiman**, president of the firm, it was noted that Mr. Flystad has been with Telex since 1960 and most recently was in charge of quality control. He succeeds **John Boyers** who has resigned.

The Sound Of KOSS Looks Like This...

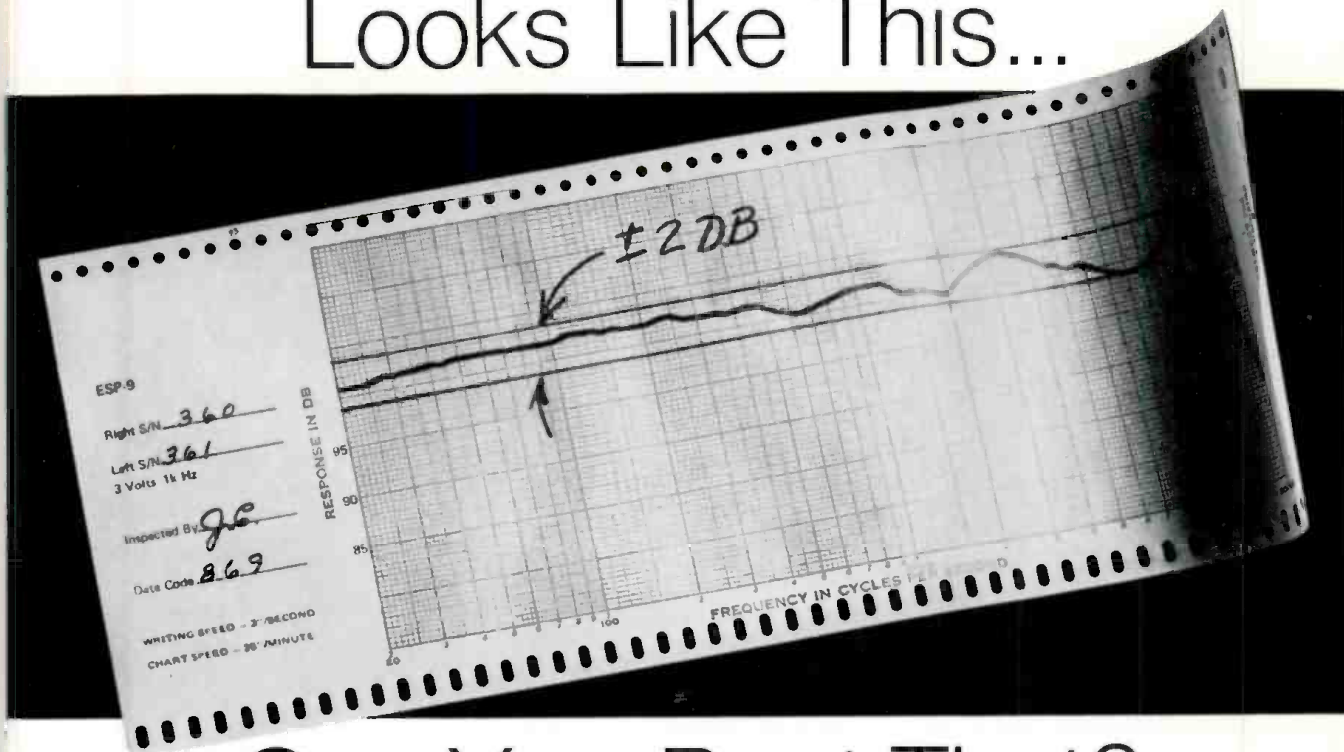

Can You Beat That?

To guarantee performance to specifications, this individual machine-run response curve comes with every ESP-9 Studio Monitor Headset. You get, for the first time, flat ± 2 db monitoring over the entire audible spectrum because the ESP-9 is a breakthrough electro-acoustical development achieved by exploiting electrostatic principles. Only Koss electrostatics give push-pull balanced acoustical circuitry, cancelling all second harmonic distortion to provide fatigue-free listening through long recording sessions. Now you hear what the program material *really* sounds like, uncolored by monitor room reflections. Exceeding the range and cleanliness of any speaker system, the ESP-9 gives the measure of separation and accurately positions the soloist. 40 db isolation through comfortable, fluid-filled cushions relieves the noisy distraction caused by producers, A and R men, time-killing artists, and other visitors in the control room. The ESP-9 eliminates the masking effect of blowers, breath sounds, clothes rustling and other control room ambients. So now you have a running check on low-level system noise. You monitor the sounds you only saw before on the VU meter, like the "whoosh" of a stage door closing, ventilator rumbles and music stand rattles — because speakers simply don't have the super-wide-range you need to hear them.

The ESP-9 has a signal handling capacity of 10 volts at 30 Hz with good wave form versus 6 volts for the integrated ESP-6 introduced last year. This is made possible by increasing the size of the coupling transformers by a factor of 4 and mounting them in the E-9 Energizer external to the cup.

The E-9 Energizer offers the option of self-energizing for the bias supply, or energizing through the ac line; choice is made with a selector switch on the front panel. When energized through the ac line, very precise level measurements can be made. Thus the unit is ideal for audiometry, and for evaluating the spectral character of very low level noise in tape mastering machines and recording consoles.

SPECIFICATIONS

Frequency Response Range, Typical: 15-15,000 Hz ± 2 db (10 octaves) 10-19,000 Hz ± 5 db. An individual, machine-run calibration curve accompanies each headset. Sensitivity: 90 db SPL at 1kHz ± 1 db referred to 0.0002 dynes/cm² with 1 volt at the input. Total Harmonic Distortion: Less than 1/2 of 1% at 110 db SPL. Isolation From External Noise: 40 db average through fluid-filled cushions provided as an integral part of the headset. Power Handling Capability: Maximum continuous program material should not exceed 10 volts (12 watts) as read by an ac VTVM: Provided for transient peaks 14 db beyond the continuous level of 10 volts. Source Impedance: Designed to work from 4-16 ohm amplifier outputs. External Power Requirements: None, except when used for precise low level signal measurement, when external ac line can be selected by a front panel switch on the E-9 Energizer.

See your dealer today or write for free technical paper, "An Adventure in Headphone Design" and ESP Catalog 108.



**KOSS
MODEL ESP-9
ELECTROSTATIC
STEREOPHONES
WITH
E-9 ENERGIZER
\$150.00**



KOSS



KOSS ELECTRONICS INC.
2227 North 31st Street
Milwaukee, Wisconsin 53208
KOSS ELECTRONICS S. r. l.
Via Valtorta 21/20127 Milan, Italia

Circle 11 on Reader Service Card

ALBERT B GRUNDY JR
INTERNATL ELECT INC
333 6TH AVE
NEW YORK N Y 10014

LOUD MOUTH!

The new E-V Eliminator.

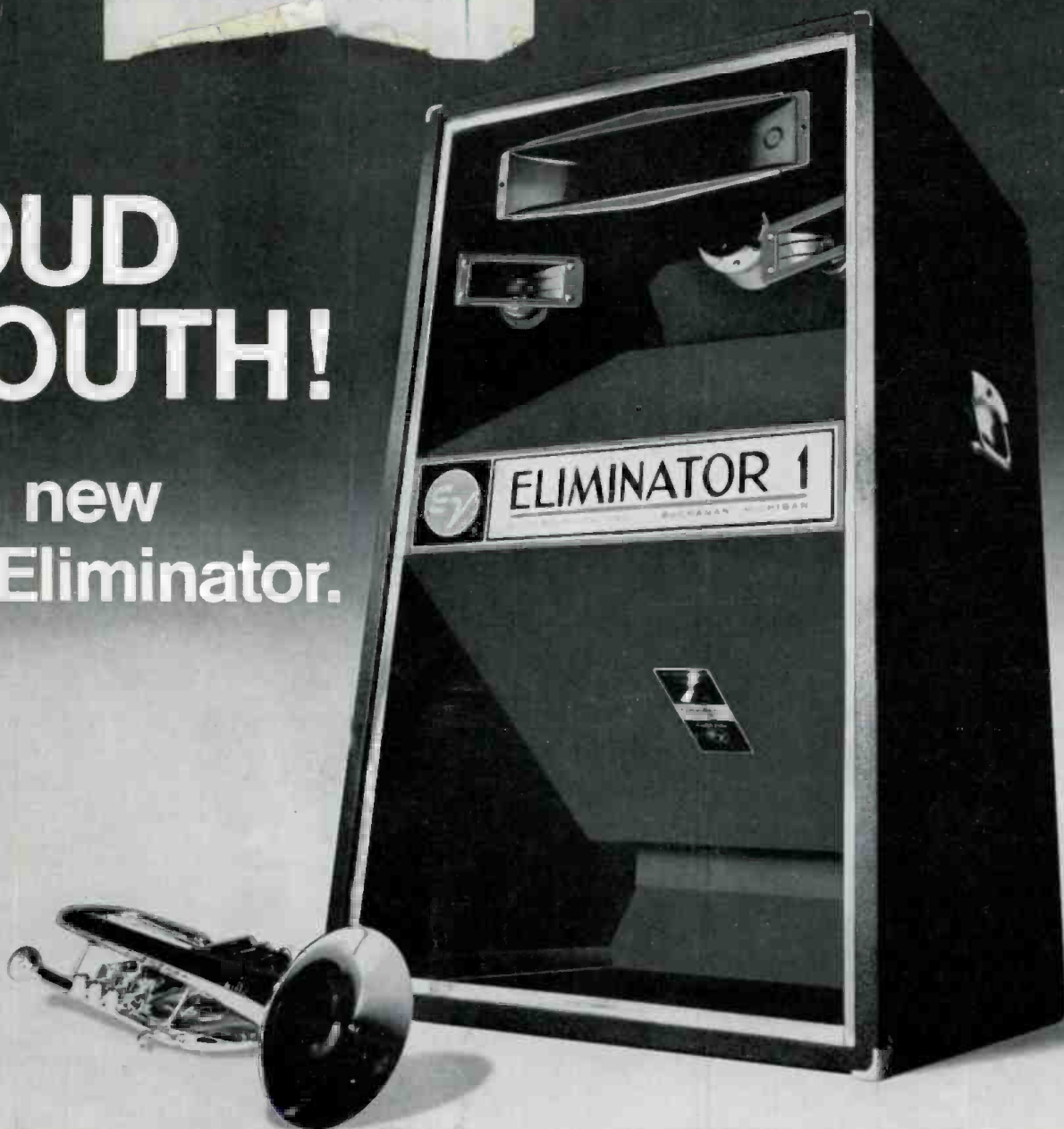

ⓔ The first Eliminator was built to prove a point. Because young musicians, in a search for more volume, were literally driving the guts out of some very good speakers mounted in some very poor enclosures.

It started an intensive investigation into the failure of speakers (ours and the competition) used by guitars and organs. The testing was very rugged. For instance, we took miles of high-speed motion pictures while test speakers destroyed themselves with sound.

We found out a lot about how to improve our speakers. But we also learned that by simply putting our SRO/15 speaker in a folded horn enclosure we created a combination that was unbeatable for efficiency, high power handling capacity, low distortion, and extended bass. It was an important first step.

Of course, this now meant we needed a solid high end. So we added the time-

tested 1829 treble driver and 3HD horn, or (optionally) a T25A treble driver plus a pair of T35 super tweeters. These combinations were a revelation to musicians. They got more sound power per watt than they thought possible. And they could use the Eliminator for both vocals or instruments.

But we weren't quite satisfied. If the Eliminator was good for popular music, what would it do with other kinds of program material? So we tested it in good rooms and bad rooms. With test instruments and with live audiences. And we decided that the Eliminator was too good to sell only to the young.

For example, in one test installation in a difficult domed building, four E-V Eliminator I speakers far out performed an elaborate multicell installation in naturalness of sound for voice and music, in uniform sound pressure level throughout the listening area, and in the ability to reproduce the extremes of loudness

Circle 12 on Reader Service Card

of a big, driving jazz band with ease.

Granted, the E-V Eliminators have a flash of chrome. But don't be misled. They perform to beat the band. And they solve problems. Get turned on to the great sound of the E-V Eliminators today. It can open up an important new market... and shock your old ones!

ELIMINATOR I 3-way system: Response 55-15,000 Hz; Power Handling Capacity 100 watts RMS (white noise shaped to stringent lead guitar frequency spectrum); Dispersion 100°; Sound Pressure Level 122 db at 4' with full power input; Suggested Resale \$399.50.

ELIMINATOR II 2-way system: Response 55 to 10,000 Hz; Power Handling Capacity 100 watts RMS (shaped to stringent lead guitar frequency spectrum); Dispersion 100°; Sound Pressure Level 123 db at 4' with full power input; Suggested Resale \$319.50.



ELECTRO-VOICE, INC., Dept. 1196BD
685 Cecil Street, Buchanan, Michigan 49107

Electro-Voice®

A SUBSIDIARY OF GULTON INDUSTRIES, INC.