

dB

THE SOUND ENGINEERING MAGAZINE
JUNE 1971 \$1.00

Electronic Music



J1
RADIO STATION PRODUCTN
UNIV OF WASH
325 COMMUNICATION BLDG
SEATTLE WA 98105

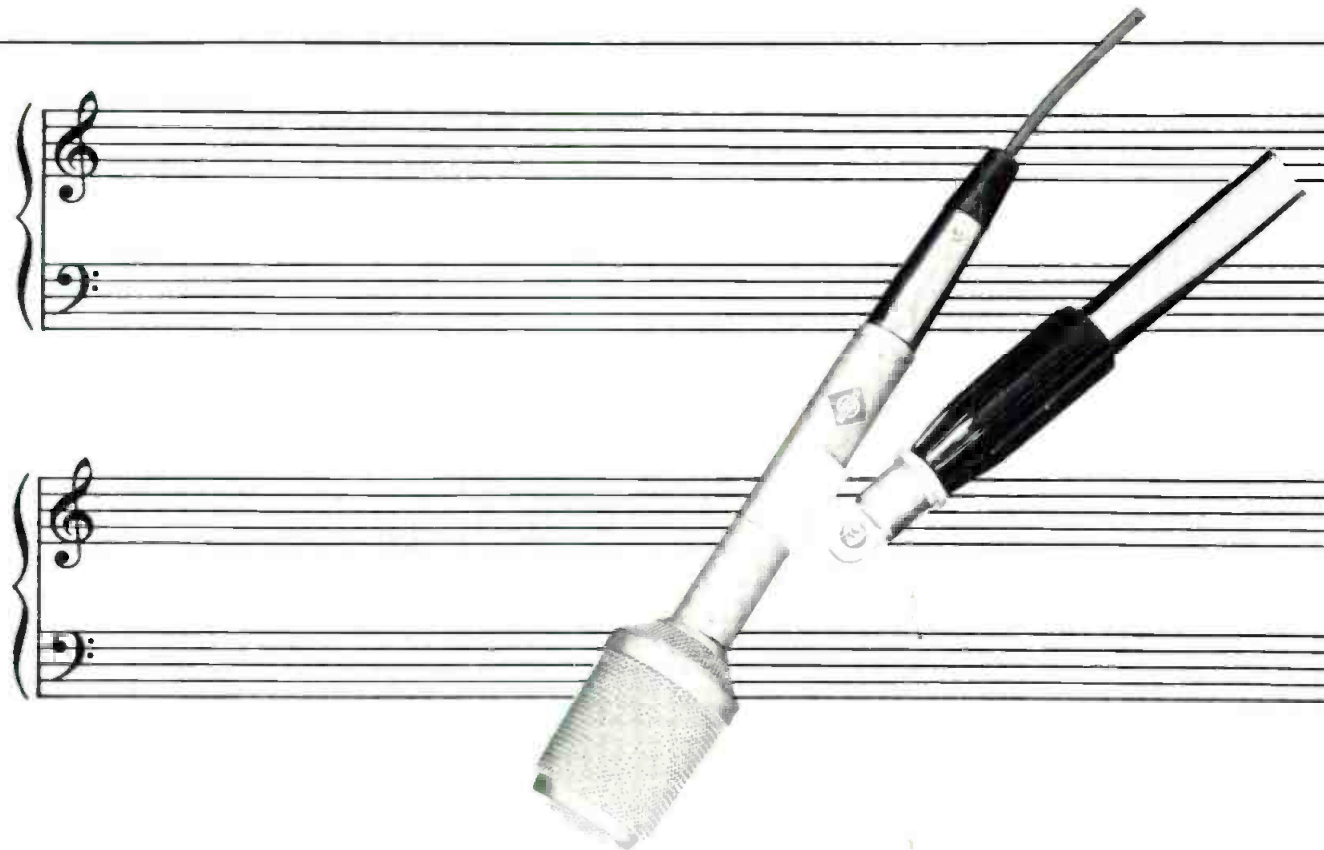

At Capitol Records they don't start without Neumann.



When Capitol Records furnished its new Hollywood Custom Recording facility, it had a world of audio equipment to choose from.

It also had the technical know-how to choose both wisely and well. Not only did it have its own vast experience in judging audio equipment, but it could borrow knowledge. For Capitol's far-flung network of related companies has worked with and tested all of the world's professional equipment.

Capitol again chose Neumann. As they've done every year—in every Capitol installation—since Neumanns became available. They selected Neumann for the microphones that pick

up the great sound in Capitol's new studios. And for the VMS/SX-68 that now cuts the industry's finest masters.

Capitol Records is just one of many great companies that have turned to Neumann for their audio equipment. For Neumann consistently has made outstanding contributions to the technical excellence of American audio.

Gotham is Neumann in the U.S.A. If you'd like to know more, sound us out.

GOTHAM
AUDIO CORPORATION

2 West 46th Street, New York, NY 10036 (212) 265-4111
1710 N. LaBrea Avenue, Hollywood, CA 90046 (213) 874-4444
In Canada: J-Mar Electronics Ltd.



Circle 10 on Reader Service Card



THE SOUND ENGINEERING MAGAZINE

JUNE 1971 VOLUME 5, NUMBER 6

COMING NEXT MONTH

● Robert Ehle will conclude his two-partner on ELECTRONIC MUSIC. This is a valuable addition to the audio literature, functioning as it does to provide the audio engineer with the basics to understand the exploding music synthesis field.

Walter Jung returns to our pages with A DIFFERENTIAL BRIDGING AMPLIFIER. This is a circuit-construction article that touches on what the true i-c revolution could be if designers become attuned to unique audio needs.

A camera belonging to Steve Katz toured the Ampex plant in California during the AES Convention. The resulting pictures will show how some of the products we use are put together.

And there will be our regular columnists: George Alexandrovich, Norman H. Crowhurst, Martin Dickstein, Arnold Schwartz, and John Woram. Coming in db, The Sound Engineering Magazine.

ABOUT THE COVER

● Art Director Bob Laurie's treatment of a photograph of a Moog Synthesizer. The photo is by Jack Fulton, courtesy of Bernard L. Krause and Parasound, Inc.; taken at a live recording session of the Beaver/Krause Warner Bros. album, *Gandharva*, at Grace Cathedral, San Francisco.

21	ACOUSTICS FOR AUDIO MEN, PART 3 Melvin C. Sprinkle
26	db VISITS—COLONIAL WILLIAMSBURG Larry Zide
28	THE TECHNIQUE OF ELECTRONIC MUSIC Robert C. Ehle
2	LETTERS
4	THE AUDIO ENGINEER'S HANDBOOK George Alexandrovich
8	THEORY AND PRACTICE Norman H. Crowhurst
12	THE FEEDBACK LOOP Arnold Schwartz
omitted this month	THE SYNC TRACK John Woram
14	SOUND WITH IMAGES Martin Dickstein
17	NEW PRODUCTS AND SERVICES Picture Gallery—AES Show
34	BOOKCASE
35	CLASSIFIED
36	PEOPLE, PLACES, HAPPENINGS

db is listed in Current Contents: Engineering and Technology,

Robert Bach PUBLISHER	Larry Zide EDITOR
Bob Laurie ART DIRECTOR	John Woram ASSOCIATE EDITOR
A. F. Gordon CIRCULATION MANAGER	Marilyn Gold COPY EDITOR
Eloise Beach ASST. CIRCULATION MGR.	Richard L. Lerner ASSISTANT EDITOR

db, the Sound Engineering Magazine is published monthly by Sagamore Publishing Company, Inc. Entire contents copyright © 1971 by Sagamore Publishing Co., Inc., 980 Old Country Road, Plainview, L.I., N.Y. 11803. Telephone (516) 433 6530. db is published for those individuals and firms in professional audio-recording, broadcast, audio-visual, sound reinforcement, consultants, video recording, film sound, etc. Application should be made on the subscription form in the rear of each issue. Subscriptions are \$6.00 per year (\$7.00 per year outside U. S. Possessions, Canada, and Mexico) in U. S. funds. Single copies are \$1.00 each. Controlled Circulation postage paid at Harrisburg, Pa. 17105. Editorial, Publishing, and Sales Offices: 980 Old Country Road, Plainview, New York 11803. Postmaster: Form 3579 should be sent to above address.

db June 1971 1

Put an AKG on the job.



D-58E

Differential Noise-cancelling,
Dynamic Microphone
\$43.00 Net

It will sound better!

AKG 125

For complete information
on AKG performance
write to:



MICROPHONES • HEADPHONES

AKG USA, Inc.
NORTH AMERICAN PHILIPS CORPORATION
300 EAST 41ST STREET, NEW YORK, N.Y. 10017

AKG CANADA • DIVISION OF DOUBLE DIAMOND ELECTRONICS • SCARBOROUGH, ONTARIO

letters

The Editor:

It only hurts when I laugh, but I'm still laughing after reading Marshall King's article titled A DAY IN T.V. AUDIO in March *db*. We did some acoustical measurements at a dry lake at our Goldstone tracking facility. This is not too far from Edwards Air Force Base either.

We were interested in measuring the sound level of a specially designed "quiet" helicopter rotor. After completing a very quiet electric drive motor for the rotor, we set off for a week at Goldstone. A preliminary trip told us that we could only make measurements for about 2 to 3 hours after sunrise (before the wind came up).

So bright and early—sunrise in fact—we got started. You could hear the rotor as much as 500 feet away (depending on r.p.m.), but we had a very difficult time measuring it. The overall level was about 35 dB S.P.L. at a distance of 100 feet. Obviously we had to run all of our equipment off batteries, then use the generator to recharge the batteries. We used one inch laboratory condenser microphones and recorded the outputs of seven of them on an f.m. recorder.

What did we get? Well, a lot of wind noise, a passing airplane now and then—and very little rotor noise. I will say this—we did prove the inverse square law! So I can say that our mission, too, Mr. King, was a qualified success.

*Ronald Slusser
Acoustical Engineer, Environment
and Dynamic Testing Section,
Jet Propulsion Laboratory
California Institute of Technology
Pasadena, California*

advertisers index

AKG	2
Acoustic Research	7
Allison Research	Cover IV
Audiomatic	31
Automated Processes	27
B & O	9
Beyer	12
CBS	5
Dolby Labs	3
Fairchild Sound	12
Gately	6
Gotham Audio	Cover II
Neve	11
Olive	13
Pacific Recorders	11
Radford	10
ReVox	Cover III
Scully/Dictaphone	16
Tandberg of America	8

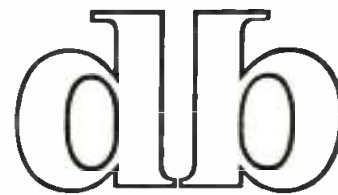

THE SOUND ENGINEERING MAGAZINE

SALES OFFICES

New York

Specifax Media Sales, Inc.
Manfred W. Meisels
603 East 82nd Street
New York, N. Y. 10028
212-249-7768

Boston

Specifax Media Sales, Inc.
William H. Fields III
49 Gray Street
Boston, Mass. 02116
617-426-5315

Denver

Roy McDonald Associates, Inc.
846 Lincoln Street
Denver, Colorado 80203
303-825-3325

Houston

Roy McDonald Associates, Inc.
3130 Southwest Freeway
Houston, Texas 77006
713-529-6711

Dallas

Roy McDonald Associates, Inc.
Semmons Tower West
Suite 714
Dallas, Texas 75207
214-637-2444

San Francisco

Roy McDonald Associates, Inc.
625 Market Street
San Francisco, California 94105
415-397-5377

Los Angeles

Roy McDonald Associates, Inc.
1313 West 8th Street
Los Angeles, California 90018
213-483-1304

Portland

Roy McDonald Associates, Inc.
2305 S. W. 58th Avenue
Portland, Oregon 97221
503-292-8521

Pennsylvania

Specifax Media Sales, Inc.
Andrew N. McCreight
Box 199
Chester Springs, Pa. 19425
215-363-7355

The race is to the silent.

Every duplicator can make cassettes fast.

The Dolby 320 makes them quiet as well.

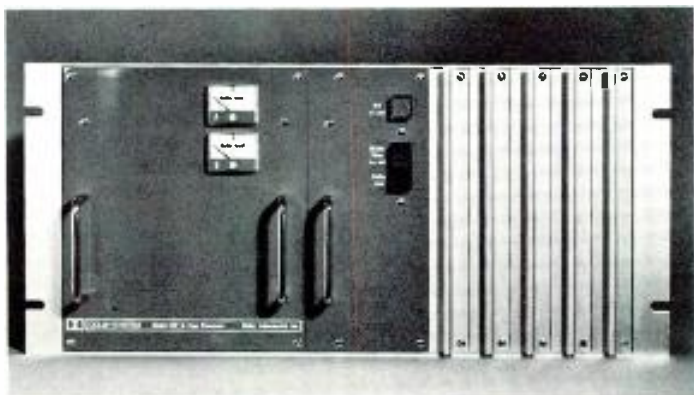

Model 320 2-channel processor for rack mounting. \$1,050 FOB N.Y., £390 FOB London.

More than twenty companies duplicating cassettes now own Model 320 Dolby B-System processors. The reason is simple, although news of it has not yet reached everyone: several dozen of the best-known manufacturers of tape recorders will soon offer cassette recorders which can record and play Dolby B-System cassettes.

When owners of these machines listen to the relatively noise-free cassettes they can make at home, they are not likely to be satisfied by the old type of commercially recorded cassette. They will want Dolby B-System recorded cassettes. Many such cassettes have already appeared, and many more are on the way.

Duplicators can satisfy the demand for low-noise cassettes by using the Model 320 to make the high-speed master from which cassettes are duplicated; the rest of the process remains the same, and the cassettes can be played on any cassette unit, with or without Dolby circuitry. With good duplicating technique, the residual noise of a Dolby B-System cassette will often be that of the original master tape, if the cassette is played on a Dolby-equipped cassette unit.

It is easy to hear the improvement in cassette quality that the Dolby B-System makes. Professionals who have not yet heard the improvement for themselves can arrange to do so by calling the Dolby office nearest them.



Dolby Laboratories Inc

New York

333 Avenue of the Americas NY 10014

212-243-2525

London

346 Clapham Road London SW9

01-720-1111

Tokyo

Tiger Building 30-7 4-chome Kuramae Taito-ku Tokyo

03-861-5371

Circle 19 on Reader Service Card

www.americanradiohistory.com

THE AUDIO ENGINEER'S HANDBOOK

Bipolar Power Supplies For Integrated Circuits

● It is hard to deny that simplicity is the key to reliability. Add to simplicity an improved performance, and you may have technological breakthrough. Integrated circuits represent such breakthrough. Several facts about i.c.s are responsible for capturing the imagination of circuit designers. The first reason is performance; then cost and reliability. Performance and reliability are inter-related because they are functions of the circuit design based upon simplicity and the absence of low-reliability components. The reliability of today's i.c.s grossly depends on the ability of the circuit to protect itself from extreme temperatures, shorted output, and excessive currents. The inability to develop large capacitances on a microscopic i.c. chip have forced designers to work with basic elements—transistors, diodes, resistors, and very small condensers (on the order of several picofarads).

Let us recall what was the major cause of equipment failure in the days of vacuum tubes; heat and high voltage. Most of the circuits were high impedance, and condensers were mostly paper dielectric type; only a few were electrolytics. Heat from the tubes affected those few electrolytics which then would fail, destroying with them other components such as resistors, tubes, transformers, and potentiometers.

Then came transistors; the bulk of the heat problem was eliminated; low voltage supplies replaced high voltage supplies. But in order to decouple transistor stages, large capacitances became needed and only electrolytics were able to pack enough capacity. Slowly, capacitance-coupled stages have been replaced by direct-coupled circuits.

The advent of i.c.s has further reduced the need for large capacitances by using balanced power supplies. The nature of a balanced power supply is such that it sets the potential of the input and output terminals to ground, eliminating the need for the isolation capacitor.

What is a bipolar power supply and how does it affect the reliability of the circuit? A bipolar supply is so called because there are two poles besides neutral or ground terminal. The

supply actually consists of two identical but separate supplies with the positive terminal of one connected to the negative terminal of the other. This point is referred to as a common ground or zero point. The remaining two terminals provide positive and negative voltages to the circuits.

Let us see how a bipolar supply can eliminate the need for a capacitor in the output stage of a simple class A amplifier. The stage shown in FIGURE 1 is a classical common-collector circuit where the transistor base is biased so that with no signal applied to the input of the circuit, potential at the collector is equal to half the potential of the supply. This assures maximum undistorted output with symmetrical clipping of both signal peaks. It also means that the capacitor has a constant bias of half the supply voltage. Since the capacitor for alternating currents in audio range offers very small resistance (almost equal to a short circuit) it is only beneficial for purposes of eliminating d.c. bias voltage being applied to the load. However every electrolytic has some leakage and most of the time it is impossible to eliminate leakage currents entirely. Unless there is a constant resistive path to bleed off this leakage current, it can produce switching transients and other noise if it finds its way into stepped attenuators or switches. A bipolar power supply for the same cir-

cuit raises the potential of the ground to the potential of the collector. Aside from the fact that biasing voltage is eliminated, the need for a capacitor is also eliminated.

One word of caution. An electrolytic decoupling capacitor cannot be used because with signal applied to the input, collector voltage will swing from positive to negative, applying reverse polarity voltage to the electrolytic, causing it to fail. If there is a need for capacitive decoupling (for instance feeding phone lines) use either a non-polarized capacitor with one of the modern dielectrics such as Mylar, glass or paper, or use an alternate circuit with conventional electrolytics such as is shown in FIGURE 2.

Most modern integrated circuits designed to work off bipolar power supplies are designed so that when the input is resistor terminated to ground, the base or the gate of the input stage is properly biased for maximum undistorted output. This in turn eliminates the need for external biasing circuits and input decoupling or isolation capacitors.

Another advantage of a bipolar power supply is that maximum voltages encountered in the circuit are only half of the unbalanced or unipolar supply. Let us say that in order to obtain a certain amplitude at the output it is required to have 24 volts. With a bipolar supply we need two

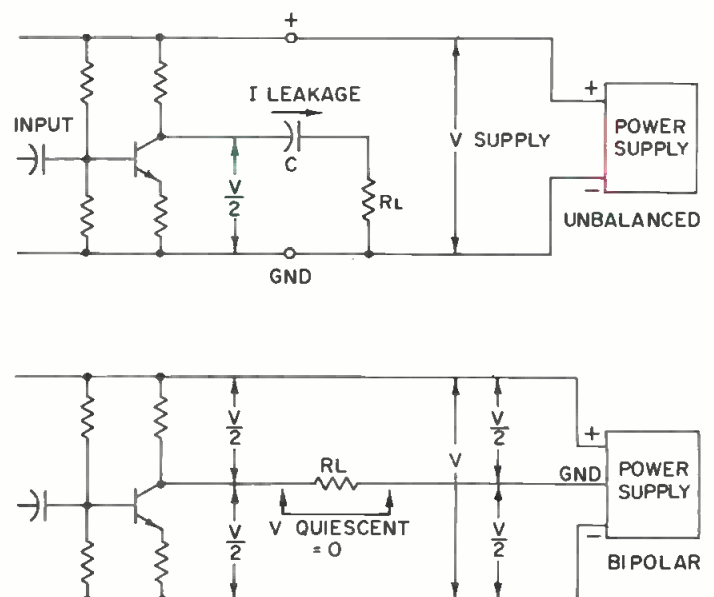

Figure 1. Two methods for the elimination of output capacitors.

shhhh!

DON'T MAKE A SOUND UNTIL YOU HAVE AUDIMAX AND VOLUMAX.



This is the team that quietly goes to work to produce a perfect sounding program. Audimax eliminates distortions like thumping, audio holes and the "swish-up" of background noises. Volumax prevents overmodulation and limits program peaks, permitting broadcasters to achieve maximum power from each watt of carrier power. Together, Audimax and Volumax

produce a new excellence in sound control, increase audience coverage and amplify your station's profits.

CBS LABORATORIES

A Division of Columbia Broadcasting System, Inc.
227 High Ridge Road, Stamford, Connecticut 06905

Circle 17 on Reader Service Card

www.americanradiohistory.com

NEW!

PANNING AND SLIDERS ON A BUDGET



EM-7S Four Input Stereo Echo Mixer

All features of our regular EM-7 Mixer plus slide pots, panning active mixing and IC circuitry. Duplicates all big board effects when used with ES-7 echo unit and PEQ-7 equalizer.

FOUR CHANNEL ACTIVE PEAKING TYPE EQUALIZER



PEQ-7 Four Channel Equalizer

Update your EM-7 system or use with new EM-7S Mixer. Five Hi freq. peaking type curves, 1.5, 3, 5, 10, and 20 kHz. Boost or cut in steps of 2, 4, 6, 9, or 12 dB. EQ in-out switch. Zero insertion loss.

GATELY ELECTRONICS
57 WEST HILLCREST AVENUE
HAVERTOWN, PENNA. 19083
AREA CODE 215 • HI 6-1415
...have you checked Gately lately?

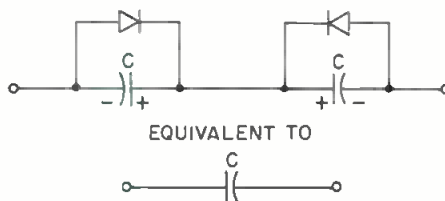
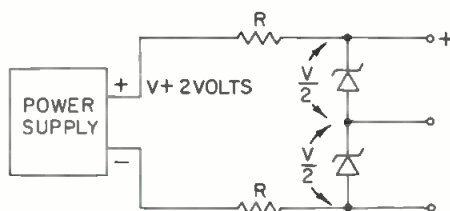

Figure 2. A non-polarized combination of electrolytics.

12 V sections. Each section can drive other unbalanced circuits which can run off 12 V. For example—lights, relays, or logic circuits can be run. At the same time, full voltage of 24 volts is still available with a floating ground. What this all indicates is that having a bipolar power supply permits you to use it with any circuit, providing voltage and current supplying capacity is correct.

Modern power supplies consist of two separate active regulators, sometimes interlinked for ganged voltage sensing and control, and sometimes independent. There are ways to take unbalanced supplies and convert them into bipolar for the cost of couple of resistors and zeners. FIGURE 3 shows a simple approach to a practical power-supply modification which would provide low source impedance, low ripple, and good regulation. Zeners for the circuit should be chosen that are capable of dissipating somewhat more power than one plans to draw from the supply. Resistors in series are current-limiting devices protecting the zeners. Voltage of the power supply should be at least a volt or two higher than the combined zenering voltages, in order to assure reliable regulation. On the other hand, if a simple power supply has one 24-volt zener connected across the output terminals of the supply, it can be replaced by two 12-volt zeners connected in series. The ground terminal for both voltages will be the junction of the two zeners. In the case of a power supply with an active voltage regulator which has adjustable voltage, if two 12-volt zeners are used set the supply voltage higher than 24 volts until you will be able to draw enough current from the zeners at the desired voltage of 12 volts.

Figure 3. The conversion of an unbalanced power supply.



One of the first important applications of the bipolar supply came about in power amplifier circuits in an attempt to eliminate power transformers or large electrolytics. In order to obtain power levels delivered to the 8-ohm load of let us say 70 watts, voltage in excess of 50 volts for each section is required. It is possible to package such a complete amplifier into a space only slightly larger than the volume required for the power supply alone. By now it would be only a repetition to recite the advantages of such a power amplifier. Just compare the size of the output transformer required for the tube-type amplifier with the size of the transistorized power amplifier, and then compare the specifications for both. Bipolar supply has made it possible to obtain almost fantastic damping factors as well as an ability to feed frequencies from d.c. up—increase efficiency of the amplifiers and reducing phase shifts.

If we summarize all the advantages bipolar supply circuits offer us and start to utilize them actively, we will be taking steps in the right direction, thus assuring higher reliability, simplicity and lower cost of the systems. ■

you write it

Many readers do not realize that they can also be writers for *db*. We are always seeking good, meaningful articles of any length. The subject matter can cover almost anything of interest and value to audio professionals.

Are you doing something original or unusual in your work? Your fellow audio pros might want to know about it. (It's easy to tell your story in *db*.)

You don't have to be an experienced writer to be published. But you do need the ability to express your idea fully, with adequate detail and information. Our editors will polish the story for you. We suggest you first submit an outline so that we can work with you in the development of the article.

You also don't have to be an artist, we'll re-do all drawings. This means we do need sufficient detail in your rough drawing or schematic so that our artists will understand what you want.

It can be prestigious to be published and it can be profitable too. All articles accepted for publication are purchased. You won't retire on our scale, but it can make a nice extra sum for that special occasion.

A HIGH-QUALITY MONITOR SPEAKER...

The AR-6 speaker system meets the primary requirement for a monitor loudspeaker: it is an extremely accurate reproducer.

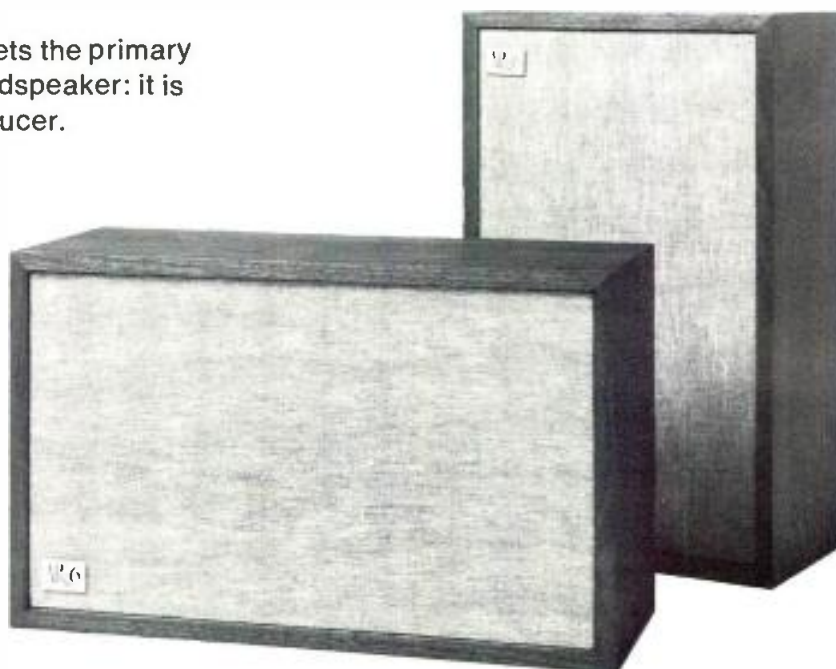

"The response curves taken at CBS Labs tell a good part of the story. Note that across the largest portion of the audio spectrum and especially through the midrange the AR-6 responds almost like an amplifier."

HIGH FIDELITY

"Out-performed a number of considerably larger and far more expensive systems that we have tested in the same way . . . We don't know of many speakers with as good a balance in overall response, and nothing in its size or price class has as good a bass end."

Stereo Review

FOR \$81...THE AR-6.

The price of the AR-6 is \$81 in oiled walnut, \$72 in unfinished pine. It is also portable and ideal for use as a location monitor: 20 pounds, 12" x 19½" x 7".

A complete technical description is available on request.

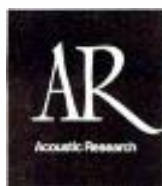

Acoustic Research, Inc.

24 Thorndike Street
Cambridge, Massachusetts 02141, Dept. db-6

Please send complete specifications on the AR-6 to

NAME _____

ADDRESS _____

Circle 15 on Reader Service Card

www.americanradiohistory.com

THE SEMI-PROFESSIONAL PORTABLE RECORDER WITH PROFESSIONAL PERFORMANCE



Feature for feature, the Tandberg Model 11 offers an unbeatable value for full fidelity on the spot recording. Three heads, three speeds, with electronics servo speed control and tachometer head. Limiter circuitry, servo brakes for constant tape tension, will accommodate 7" reels with cover off. Balanced low mic input. Also available with neopilot head for picture/sound synchronization.
Price: \$449.00

Accessories available: carrying bag
AC adapter Resolver

TANDBERG
Tandberg of America, Inc.
8 Third Avenue, Pelham, New York 10803

Norman H. Crowhurst

THEORY AND PRACTICE

● In the more than three years this column has been running, we have not yet discussed microphone choice. Perhaps I have stayed away from it because I thought readers are professionals, so selection of a microphone appropriate for any particular job is something they know about as well as I do. And I guess the fact is that some do, some don't.

Most readers have gotten beyond the first misconception quite common among non-professionals: that a microphone's ability to pick up sound at a distance relatively greater than another microphone can indicate higher sensitivity. Actually, sensitivity is a measure of how much electrical output a microphone will give for a specified acoustical sound input. And this is not what most people think about: rather they visualize the distance that a sound can originate, without failing to be effectively picked up.

"Everything else being equal," which is a popular, but dubious assumption, lack of sensitivity in the purely technical sense—how much electrical output a given acoustic input produces—can be made up by additional amplification. First let us see what that means.

A microphone does not, of itself, have a *range*—meaning a distance in feet at which it will pick up. It picks up whatever sound field reaches its diaphragm. If that sound field has an intensity of 10 millibars (dynes per square centimeter) and the microphone's sensitivity is -54 dBm: 0 dBm is 1 milliwatt electrical output into whatever impedance the microphone is designed for; so -54 dBm is a level of 2 millimicrowatts into the same impedance, provided the level is that specified acoustically.

If the sound field drops to 1 millibar, the electrical output drops 20 dB too, to 20 micromicrowatts—one hundredth the power. If the impedance is 250 ohms, the 2 millimicrowatt level is $v = \sqrt{wr} = \sqrt{.00000002 \times 250} = \sqrt{.0000005} = .00071$ volt, or 710 microvolts. The 1 millibar will produce only one-tenth the voltage, or 71 microvolts.

Another 20 dB of gain in the amplifier can bring this level up to the same electrical level, although it will also amplify noise, thus making the signal-to-noise ratio 20 dB poorer.

In a studio where no loudspeakers can feed back to the microphone that almost ends the story, but not quite. For, as well as the electrical noise level coming up when more amplification is used, the acoustic sound picked up by the microphone itself may deteriorate, due to room effects. There are always wanted and unwanted sounds.

But doesn't a studio have acoustical treatment to keep out unwanted sounds? That is the idea, but sound insulation only produces a specified amount of *attenuation* to the sound: it does not keep it out altogether. If a studio attenuates external sounds by 80 dB, and a source of noise is a jet aircraft taking off from the local airport, a 20 millibar level at the mic might be satisfactory, while a 2 millibar level would allow the jet noise to intrude into the wanted program.

Thus, far, we could conclude that a microphone is simply a transducer, that converts acoustic waves into electrical signals, with somewhat varying efficiency. However there are differences between microphones that affect performance more than just the specified sensitivity, a fact of which any-

Figure 1. The directional qualities of the basic bidirectional unit, idealized. There are two directions of maximum sensitivity, or pickup, and a plane where the pickup is zero.

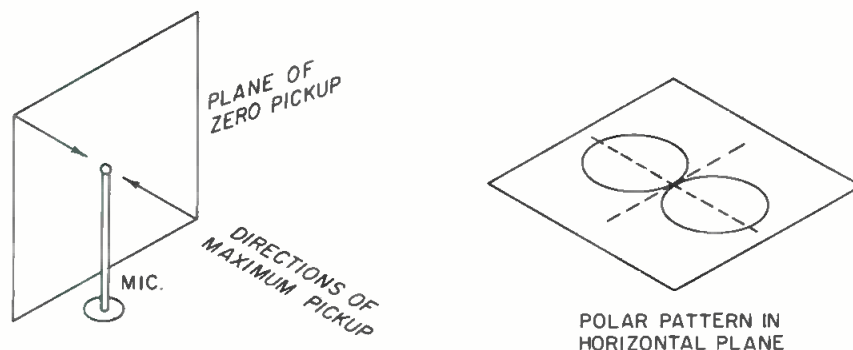

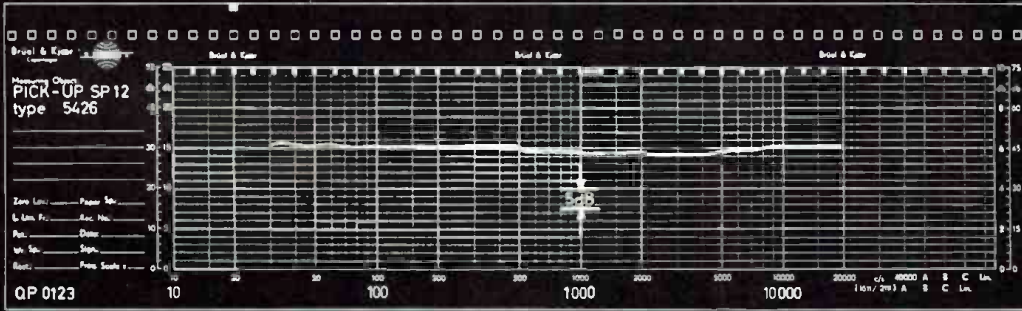

The BANG & OLUFSEN SP 12 cartridge with bi-radial elliptical diamond stylus, has an outstandingly smooth frequency response.

15-25.000 Hz \pm 3,0 dB
 50-10.000 Hz \pm 1,5 dB

And the unique patented MMC-principle extends the tip resonance to 30.000 Hz, thus ensuring absolute linear tracking of audible frequencies with excellent stereo separation. Leading manufacturers of high fidelity equipment all over the world acknowledge the work of BANG & OLUFSEN, in pioneering many of the technical aspects of the industry - and for advanced designs which win international awards for B&O products year after year.



BANG & OLUFSEN OF AMERICA, INC.
 525 East Montrose
 Wood Dale, Illinois 60191

Circle 24 on Reader Service Card

RADFORD

Radford audio measurement instruments enjoy a worldwide reputation as the best available. The Radford Distortion Measuring Set and Low Distortion Oscillator are accepted by broadcasting authorities, recording studios, professional testing laboratories, and audio research and development laboratories all over the world.



The Low Distortion Oscillator is an instrument of high stability which produces virtually perfect sine and square waves over a range from 5 HZ to 500 KHZ. The sine wave distortion is .005% from 200 HZ to 20 KHZ increasing to .015% at 10 HZ to 100 KHZ. The square wave rise time of the Low Distortion Oscillator is less than .1 microsecond.



The Distortion Measuring Set is a sensitive instrument for the measurement of total harmonic distortion and can be easily used in test bays for final product testing as well as in other situations requiring measurement capabilities surpassing the best current domestic equipment. The Distortion Measuring Set is capable of direct reading of distortion products as low as .002% from a calibrated meter.

Write or call for free technical information about these and other Radford audio instruments for professional applications.

RADFORD LABORATORY INSTRUMENTS LTD.

distributed in the USA by
Audionics, Inc., 8600 NE Sandy Blvd.
Portland, Ore. 97220 1 (503) 254-8224

one who has worked with microphones in any way is aware. Just what are these differences?

Because much was made about directional properties when they were first introduced, many years ago now, because these properties enabled the microphones to be selective—to pick up sounds from certain directions more readily than from others—directional properties are still stressed by some. However, it is a mistake to consider choice of directional properties most important, because other factors can outweigh them.

There are three basic directional properties, with some minor variations. The commonest and the first developed is essentially omnidirectional: it picks up sounds essentially uniformly from all directions. This is not quite true: the full range response is invariably slightly better when the sound waves arrive from directly in front; but the deterioration in reproducing sounds from other directions, particularly in level, is not serious.

The next variety to arrive on the scene was the bidirectional, or ribbon, which has a *figure of 8* pattern. It has two directions of major sensitivity and on a plane between these two directions there is a null, where the microphone is essentially dead: sounds from any direction in this plane (FIGURE 1) are not picked up at all.

The third variety is, in a manner, a combination of the other two: one of the major directions in the bidirectional has a maximum sensitivity, the other has zero, while the directions in the plane are intermediate between these extremes (FIGURE 2). This type is called *cardioid*, from its heart-shaped polar curve, or unidirectional.

The cardioid is most popular of the directional microphones, although a variation, called the ultra-cardioid or super-cardioid is also used. This comprises the null in the single backward direction, to slightly narrow the angle of pickup, and thus get a better overall discrimination between sounds directly in front and those in the general back area. (FIGURE 3).

If these somewhat idealized curves, including the omnidirectional, were ac-

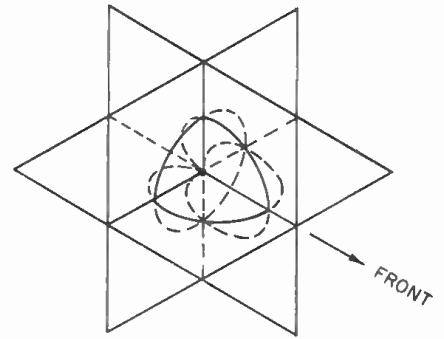

Figure 2. A representation, on three intersecting planes, of the polar characteristics of an ideal cardioid microphone.

tually realized in every microphone, working at every frequency, selection of a microphone good for each purpose would be relatively simple. But it is not that simple, because these characteristics are idealized: they do not apply perfectly.

In a good microphone, of whichever directional type, not only is its response to different frequencies uniform — smooth — but the directional characteristic holds quite well at all frequencies, to what it is supposed to be. But in less expensive microphones, the same general characteristics can prevail, but considerable deviation will be found at different frequencies in the audio spectrum.

One of the most important things to realism in microphone pickup is smoothness of frequency response. This makes any sound picked up sound clean and real. It also keeps unwanted sounds out more effectively, where a directional type is used. Lack of smoothness can actually make a directional microphone inferior in use to an omnidirectional one of comparable frequency-response quality. This is because unwanted pickup, some of which may be reverberation of the wanted sound, is picked up with a far more selective frequency response than the wanted sound. The result is rough sounding.

So much for types of microphone —much more could be said, but that is enough for the purpose here. To conclude this discussion, we need to

Figure 3. Comparison of true cardioid with super- or ultra-cardioid, where width of zone is less than 6 dB down in front reduces from 180 deg. to 157 deg., and width of zone more than 12 dB down in back increases from 120 deg. to 157 deg.

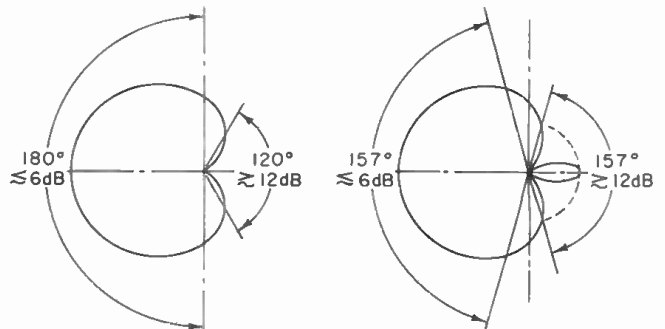

look at microphone placement. For some uses, multiple microphones are used. If a number of performers or participants are scattered over a wide area, microphones at various points over the area can provide coverage. But multiple microphones should never get too close physically, so that two of them pick up the same sound in approximately equal intensity.

This makes the quality of sound picked up very dependent on precise position, or movement, of the sound source. A singer, vocalist or speaker, served by multiple microphones connected to the same amplifier input, will inevitably move his head as he performs, and that movement will cause distracting variations in quality.

This criticism does not apply where the microphones are all connected to different circuits, as when the President speaks: each microphone feeds only one circuit. Where a second microphone is placed in position as a safety precaution, in case the first fails, only one should be turned on at a time.

A mistake often made is the placement of a microphone so it picks up reflected sounds quite easily, by being a short distance from a wall or other reflecting surface. This is made sometimes when one microphone is used

to cover a wide area. The reflected sound produces a sort of confusion on all the sound picked up, which can get quite rough.

The best plan in such a case is to place the microphone much closer to the surface, or even the floor, so that reflection time is almost zero. Foot-light mics are a good example of this. They may be set up as far as possible from the surface behind them, without intruding into the audience's view. It is much better to use an omnidirectional microphone and place it close down against the floor surface.

An omnidirectional microphone should be used in this position, because any directional microphone placed so close to a surface has its directional properties completely invalidated. All microphones with directional characteristics depend on the sound wave being able to flow past the microphone and continue on. If the wave is reflected by objects in proximity to the microphone, it loses its proper directionality.

In the next issue, unless something more pressing turns up that someone wants answered, we will extend this discussion of microphones beyond the somewhat basic considerations introduced here, into the more sophisticated techniques. ■

To have the Sound

that "makes it"--

You need the Equipment

that "makes it"

For the
RECORDING INDUSTRY
we have
EMT, Neumann, Dolby, Ampex

For the
BROADCASTING INDUSTRY
we have
Teletronix, Spotmaster, QRK, Gray

For the
MOTION PICTURE INDUSTRY
we have
Stellavox, Sennheiser, Vega, Beyer

**WE CARRY THEM ALL
WE SERVICE THEM ALL**

Call us, for sales & service:



**PACIFIC RECORDERS
& ENGINEERING CORP.**

10457 Roselle St.
San Diego, Ca. 92121

Jack Williams (714) 453-3255

Circle 22 on Reader Service Card

Neve

The Sound
of
Neve
is
Worldwide



24 Input Channel Television
Recording Console built to the
special requirements of

**ASSOCIATED TELEVISION
NETWORK LTD**

Elstree Studios, Borehamwood,
Herts, England

one more example of a vitally important
organisation entrusting its requirements
to Rupert Neve

**NEVE SOUND CONTROL AND SWITCHING EQUIPMENT IS IN USE BY LEADING FILM,
TELEVISION, BROADCASTING AND RECORDING STUDIOS THROUGHOUT THE WORLD**

The 'S' range of Consoles is available for very quick delivery
Consultant Designed Consoles to customer requirement



RUPERT NEVE & CO LTD.

RUPERT NEVE INC.

Cambridge House, Melbourn, Royston, Herts, SG8 6AU England
Tel: Melbourn 776 (STD 076 386) 10 lines Telex 81381

P.O. Box 122, Bethel, Danbury, Connecticut 06801 U.S.A.
Tel: (203) 744 6230 Telex 969638

Circle 26 on Reader Service Card

THE FEEDBACK LOOP

• Were it not for the 450 foot high antenna tower, the unobtrusive one story building which houses the studios, transmitters, and office facilities of WFAS AM-FM could easily pass

for a suburban home. This is as it should be since WFAS is located in a pleasant, well-kept suburban area near White Plains in the heart of New York State's Westchester County. Jack Pearson, WFAS chief engineer, was good enough to spend a morning with me explaining the operation of his well-run station. When you stop to think about it, (and I have—after seeing a fair sampling of radio stations around the country) running the technical end of a radio station is a complex job. There is a daily quota of big and small problems that require immediate solution. A radio station is like a living organism which is constantly adapting to new situations so that there is a never ending need for modifications and additions to existing facilities. The nature of the problems facing the engineer demand real hard solutions; fuzzy thinking, indecision and procrastination can court disaster. An on-air mistake by program people survives for an instant; a mistake in equipment planning and design can live with you for a good while. The chief engineer who cannot function well under the

demands of his job will generally not last. Despite the high level of competence required and the degree of organization and intelligence he must display, as a group, chief engineers are exceedingly modest about their work. As a result the chief engineer is often taken for granted—as long as the station functions smoothly. You might say that the better the engineer, the less he is likely to be noticed.

WFAS is currently in the midst of a changeover from simulcast to independent f.m. programming. When the equipment has been delivered and installation completed, f.m. broadcasting will be an automated operation.

The studio and control room layout of WFAS is shown in FIGURE 1. The main studio has its console located in the corner of the room and looks out onto the adjacent studio and the master control room. In addition there is a production studio and a news studio. WFAS joins the ABC Entertainment Network once an hour for the national news; local and county news is broadcast on the half hour. The news room is located behind the news studio. The

**Proven
Performance
Power
Amplifiers**

**from
Fairchild!**

**MODEL 610
FEATURES**

- 10 Watts RMS
- Low Distortion
- Flat Frequency Response
- Self-contained Power Supply
- Bridging Input

**MODEL 870
FEATURES**

- 70 Watts RMS
- Low Distortion
- Plug-in Driver Circuit
- High Damping Factor

For complete details write today to:

FAIRCHILD
Sound Equipment Corporation
10-40 45th Ave., L.I.C., N.Y. 11101

Circle 16 on Reader Service Card

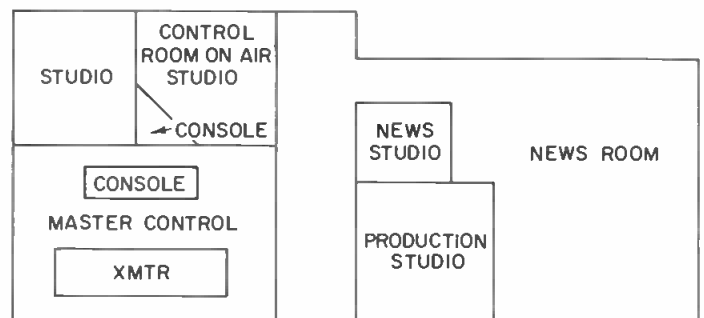

Figure 1. A floor plan of WFAS a.m.-f.m.

master control area contains the a.m. and f.m. transmitters and is also the location of the new Gates Dualux II stereo console currently being installed. Automation equipment for f.m. will be located to the left of the console. Not too many steps away, outside the building stands the 450 foot a.m. antenna. The f.m. antenna is located at the top of the tower.

Switching between studios is accomplished with what Jack Pearson calls a "sequential keying switcher" which he designed and built himself. The switcher has single button operation, with which any studio can go on the air or release to another studio.

**FAMOUS IN EUROPE*
FOR
MICROPHONES
FOR OVER 40 YEARS**

BEYER

*** TELL EVERYONE WE'VE ARRIVED!**
Revox Corporation • 155 Michael Drive • Syosset, N. Y. 11791

Circle 28 on Reader Service Card

Design the ultimate input module.



Suppose you were asked to. When we were it was our decision to use the most advanced state-of-the-art technology available and build in all of the features everyone asked for. Hardware and panel components are the best obtainable and the entire unit is packaged in a single integrated module. We also felt human engineering and aesthetic appeal were as important as technical quality.

The result is our 2010 Input Module that contains all the features you would normally expect in a fine input module, further engineered beyond what everyone is accustomed to. In it you will also find a number of unique features such as a linear fader for echo send, quadraphonic and stereophonic pan pots, a multi-function equalizer, a compressor/limiter and a keyable audio gate. The functional density of an input module this sophisticated is achieved by locating all active circuitry on easily serviceable "mini cards". These plug into the module's large internal carrier board. The whole unique package fits easily anywhere in the console.

Just plug it in.

These and similar ingenious techniques have also kept the price competitive.

Why do we consider the 2010 Input Module to be the best? Watch next month for information on specific features of the Module, or write today for descriptive literature on the Olive Series 2000 Automated Console of which the 2010 is a component module.



olive 

WHILE NEVER THERE IS A NEED

2670 Paulus, Montreal 386, Canada
(514) 332-0331
Cable Olive1, Montreal

Circle 21 on Reader Service Card

Jack got the basic idea for this switcher from a past issue of *db*.

The console in the main on-air studio, custom built for WFAS by Burden Associates, is located in a corner. A corner location presents two advantages. First it increases the reaching power of your arm by about forty percent. The d.j. who operates the console can comfortably reach two turntables, easily operate all the console controls, and reach the cartridge racks (see FIGURE 2). A second advantage of the corner location at least in this installation, is that the operator can work either of two studios with comparable ease.

The console feeds a stereo signal to the f.m. side and a mono signal to a.m. combining left and right channels. A close-up photo (FIGURE 3) shows the simple and uncluttered, yet completely functional, front panel of

Figure 2. The on-air studio of WFAS



the console. This compact layout is largely a result of the electrical design. The console electronics are located in a convenient cabinet at some distance from the operator. The front panel controls are all d.c., and remotely control the circuitry. For example, the faders control the bias on a transistor which in turn controls the current through the lamp of a Fairchild Lumiten. The use of Lumitens, in one sense, eliminates the problem of noisy attenuators. When the contact between slider and resistance element becomes erratic, the resulting "noise" is heard (if at all) as a gain fluctuation and not as a noise component superimposed on the audio as it is in conventional faders. The speed or response time of this type of remote controlled gain is at least as fast as the normal speed with which the operator moves the slider.

Figure 3. The flexible Burden console.

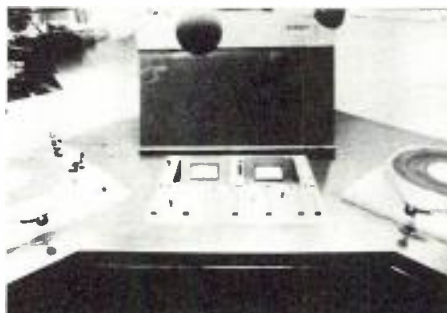

The WFAS-Burden console is similar in concept to the on-air consoles at WINS in New York City, although the latter are somewhat more elaborate. The most obvious advantage of the remote controlled console is the ease of maintenance especially with plug-in modules. An additional advantage is the possibility of a more compact front panel layout as evidenced by the Burden console. How does the cost of a remote controlled console compare to the conventional console? At WINS, Bruce Ratts felt that although the initial cost was higher, the flexibility of operation and the ease of maintenance more than made up for this initial higher cost. At WFAS it seems that the initial cost was about the same or possibly even lower than a conventional console. Comparison is not exact since it is not possible to compare two consoles with exactly the same facilities.

An interesting feature of the faders is that the turntables can be started by moving the faders off the cue position. The turntable is cued up and the record will start with the operation of the fader with no further attention to the turntable. I have seen some major studios where this type of turntable start has been installed but not used. Perhaps there are pros and cons to this subject and some readers would care to comment. Next month we will discuss the WFAS switcher. ■

SOUND WITH IMAGES

Slide Presentations

● Perhaps it does not happen very often that an audio-visual designer or supplier-installer is requested to assist a client in putting together a slide presentation, but it does help to have some general knowledge handy to call upon should the occasion arise.

When a permanent facility is designed to install a slide projector as one of the devices for visual presentations, consideration should be given to the type of slides that will be used. This would include, but not be limited by, such factors as the type of mounting, material to be displayed, format of the slides, necessity for ample space to change slide trays and to edit slides quickly and easily, use of more than one projector in a presentation, use of slide projectors in conjunction with other equipment such as film projectors or tape recorders, and so on. All this information, and more, is necessary to equip properly a facility which will provide a completely satisfactory and acceptable system, but sometimes it is helpful to be able to offer the customer more than just hardware.

SLIDE MOUNTING

Take the type of slide mounting, for example. It is easy to provide just any projector since most of them will probably work satisfactorily under normal circumstances, but is the slide holder, or tray, or drum, or loader the type that allows the use of the thicker and heavier double-glass mounted slides as well as the cardboard type? Will the projector with side-to-side or up-and-down slide motion offer greater flexibility to the user in setting up the slide sequence for use during the actual showings? Will the projector work well with intermixed types of mountings? Does the projector jam with the heavier slides and is it very laborious to remove the tray with a slide stuck in the aperture? Is the heat accumulated around the slides going to unglue the mounting and cause it to peel or stick?

SLIDE IDENTIFICATION

Speaking of heat, common practice is

to put small stick-on labels or pieces of tape on the side of the slide masking frame for marking, numbering or identifying the slides. Although this is a very easy and convenient way to do this, care must be taken in affixing the label as a tip of it may extend beyond the frame and show during the presentation, or (even worse) the thickness of the label or tape could be enough to catch during entry or ejection from the aperture position and jam the slide. Or, still worse, the heat of the projector might cause the adhesive material to soften and cause the tape to slide or peel and result in a slide that will not come out of the projector cleanly. Here is where knowing how to manipulate the slide holder and the slides quickly and easily, without having the other slides fall out of the holder, comes in handy. (Magic Marker on the mount is also used.)

SLIDE MATERIAL AND FOCUSING

Knowing the various types of slides to be used in a particular installation will also help in determining the type of projector to provide. Does the unit have different trays for different slide mounts or can one be used for both glass and cardboard? If the projector will be used with intermixed mountings, will this affect the auto-focus operation of the projector? Projector units have this automatic focusing feature will respond quite adversely if cardboard and glass mounted slides are loaded together in the same tray, and the same is true if slides are inserted with the emulsion side of one facing the light source and another facing the lens. All slides should be inserted facing in the same direction when possible. Also, it is well to remember that projectors with the auto-focus operation may not be adjustable by the focus button on the remote control device. (Usually, projectors with the feature built in come with remote control units which do not have the focus control at all, but in an installation where there are several projectors of the same kind, some may have the feature and some may not

and the remote controls could be interchanged but the focus control will or will not work depending on the particular model of the projector.) Consideration should be given when supplying projectors where previous equipment is still in use, to interchangeability and compatibility of the new units and the accessories.

DRUM CHANGING

The ability to change drums of slides easily is a necessity when more than one tray-load of slides is to be used in a presentation. Space above and/or on the side, depending on how the tray is removed, should be provided especially where other equipment has to be located near the slide projector. This will allow for quick changing and minimum dark-screen time during the change of drums. Also, the projector to be furnished (or recommended) should be the one which permits editing of slides, including easy removal, reinsertion and possibly pre-viewing, if desired, of individual slides within the slide holder. If many slides are to be used during presentations regularly, it might be well to provide a projector which has different types of loaders for various purposes as well as holders which permit more slides to be loaded than on other units. Sometimes these extra-capacity holders require that only cardboard slides be used as they are thinner and permit closer spacing. If this is not a problem to the client, it could be the answer to the problem of frequent tray changing during a slide showing.

BLACK-AND-WHITE OR COLOR

The type of material to be displayed can also help to determine the type of projector to be used. If the slides will contain black-and-white ones which have on them large dark areas solidly black against a white background, care should be taken lest the light source be hot enough to burn the slide due to collection of heat on the dark area. In some slides the effect is a visual hot spot where the emulsion is

damaged. Focusing of the emitted light or the collection of excess heat can be the problem, requiring investigation. Correcting the faulty source focus or added cooling might be the answer, or the slides could be made with a dark *color* (not black) against a *light* background (not white) to avoid burned slides. Or, if black-and-white must be used, the mounting might be changed to permit the slide to remain cooler. A totally enclosed slide (sealed with foil tape on all sides, for example) would contain the heat while an open-mounted (cardboard) slide might be cooler, or a mount with glass on only one side could be used. Different color backgrounds also help, and will also increase legibility, add interest to the presentation. They can be used for differentiating the various segments of the talk, and thus avoiding eye strain for the viewers.

SLIDE FORMAT

The shape of the slides, or the format, must also be taken into consideration for determining the proper size and shape of the screen to be provided, and also to help in laying out the projection geometry and seating arrangement. Super slides with square picture openings require a square screen, of course, but the more usual 35-mm double-frame slides are rectangular in format and a screen is usually provided which will permit showing this type of slide vertically (if possible within the dimensions of the room, and determined usually by the height of the ceiling). It is suggested here that the client be told that a horizontal framing will provide as much, or more, actual picture space on the screen as a vertically made slide if the screen is to be filled to the vertical dimensions. This can be shown by simple math for any 3:2 (width-to-height) slide even if it looks like a vertical picture might be better. If the customer has limited seating space in the viewing room and the ceiling is low and the projector is at the rear of the room, it is fairly obvious that either an aisle must be left down the middle of the room or vertical slides will hit the viewers in the front row, or the top and bottoms of the slide will be on the ceiling and under the screen.

The question might be raised that slides made in the horizontal format for a lengthy presentation would not be as interesting as mixing with verticals, or that some of the information area would be lost. Neither is true. The fact that only horizontals are used does not detract from the presentation as it is possible to mask

a vertical effect into a horizontal format slide. As for loss of space, if the slide is to fill as much of the screen as possible, using long focal length lenses just to accommodate vertical slides (so they do not overlap the boundaries of the screen), will proportionately squeeze horizontal slides down to a smaller size and there is a greater loss of legibility this way. Standardization of the horizontal format also makes for easier loading of trays and slide editing during preparation of the presentation.

TECHNICAL DEVICES

Many times, presentations might be made more interesting by using one of many available devices, either by itself or in conjunction with others. If possible, two projectors can be used along with a *dissolver*. This permits a smoother transition between slides and avoids the disturbing black interlude between images. Some dissolve units operate the light sources (incandescent lamps) and dim one down while the other is turned up. In the case of Xenon light sources, a dissolver could be used which operates with a slide-gate that is located in front of the projector lens. As one gate opens, the other shuts. The effect is an overlap of screen images. Slides are changed behind the closed gate automatically.

A similar device is a *cutter* which switches quickly from one projector to the other. This type of unit is made with quick acting blades and although the transition from one slide to another is not the overlap effect of the dissolver, the length of time the screen is black between slides is a minimum. The quick cut and the slow dissolve effects can be used together in any presentation where both devices can be mounted at the projector location.

If greater variety is desired, there is a *motion* effect which can be added to the above or used alone. This requires, however, special preparation of the slide involving the addition of polarizing material in making the slide and the use of a rotating polarizing disc in front of the lens during showing. The resulting effect, however, is very different and can greatly enliven a presentation.

BLACK SLIDES

One more scheme that is now fairly widely used is the insertion of black slides at the positions in the presentation where there will be a break for either a change of speaker or the showing of a film, or just to move from one subject to another where

the speaker talks for some length but does not refer either to the slide just shown or the one coming up.

Black slides should also be inserted in the tray after the last slide of the showing of a film, or just to move darken screen when the talk is over without the necessity of someone dashing over to the projector to turn off the lamp.

Black slides permit turning the screen dark without the need to turn off the projector each time, as it is possible to move the projector in the process of turning off the source and having to move it back to its proper position when the next slide is shown. (Moving the project while a slide is on the screen is not only unprofessional in appearance but can be disturbing to the viewers.)

Black slides also have a function when inserted in the projector before the tray of slides is mounted. This black slide allows the projector to be turned on prior to the actual start of the presentation and be thus ready for the speaker at his convenience. This also avoids the necessity of having someone standing by to turn on the projector when the speaker starts, and also avoids the fade-on effect of turning on the lamp after the first slide is in the aperture. This slide in the projector also causes the screen to go black (without turning off the lamp) during a tray change. (For slide tray changing, it is also possible to insert a slide that says *Stand by* or *Intermission*, so that the screen has something on it while the change is being made.

CONCLUSION

These, and many more, techniques are all valuable to those directly involved in the putting together of slide presentations, but this information can also prove helpful to the client (or potential customer) in the designing of a new facility. The supplier-installer of audio-visual systems will do well to learn a little more about improving presentations so that he can be able to provide a little bit more than just equipment. It will help make satisfied clients. ■

moving

Have you sent us a change-of-address notice? It takes time for us to change your plate so let us know well in advance of your move. Be sure to send us the complete new address *as well as your old address*. Include both zip numbers. Keep **db** coming without interruption!

**If performance
turns you on
turn on the Scully 100**



Then to really blow your mind look at the price tag

It's a fact. Scully *has* put it all together. A 16-track, professional studio recorder/reproducer that actually out-performs recorders costing at least twice the 100's \$13,700.

The big secret? Like simple. Take the same Scully engineers that design the studio equipment that's been the standard of the business for years. Let them come up with the first really modular unit that lets you buy *only* what you need. Forget all the factory-loaded accessories and extras if you already have them on your consoles. Add them if (and when) you need them.

Then let Scully offer a totally new combined record/playback head, spill-proof silent switching, and a completely new solid-state electronics package. The result? The 100 Series. Half the size and half the cost of available equipment. And performance specs that are outta' sight!

For a demo that'll let you see and hear what we're talking about, write Scully, 480 Bunneil St., Bridgeport, Conn. 06607 (203 335-5146). We'll send you complete 100 specs, and the name of your nearest friendly Scully distributor or Sales/Service office. (There's probably one a dime phone call away.)

What can you lose . . . except all your ideas about how big and how expensive professional recorders really are?

▶ Dictaphone

Scully Division

Circle 23 on Reader Service Card

www.americanradiohistory.com

NEW PRODUCTS AND SERVICES

Picture Gallery – L.A. AES Convention

HEREWITH, THE RESULTS of our camera's inquisition into the products and views seen at the Audio Engineering Society's most successful Convention and Exhibition held recently in Los Angeles. Space permits only highlights, and, at that, not all of them. We do have more interesting photos of new consoles that will make their appearance next month.

If you wish information on any products shown, merely circle the appropriate reader service number on the post card at the rear of this issue and it will come directly from the manufacturer.

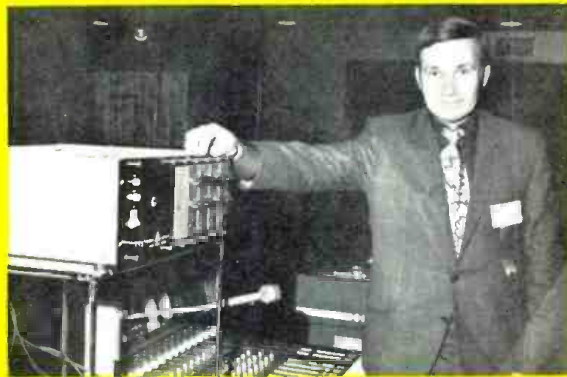

● A proud Steve Temmer displays his Delta-T reverb system. For information, circle 87 on Reader Service Card.



● Dagmar Dolby of Dolby Labs with visitor James A. McShane.

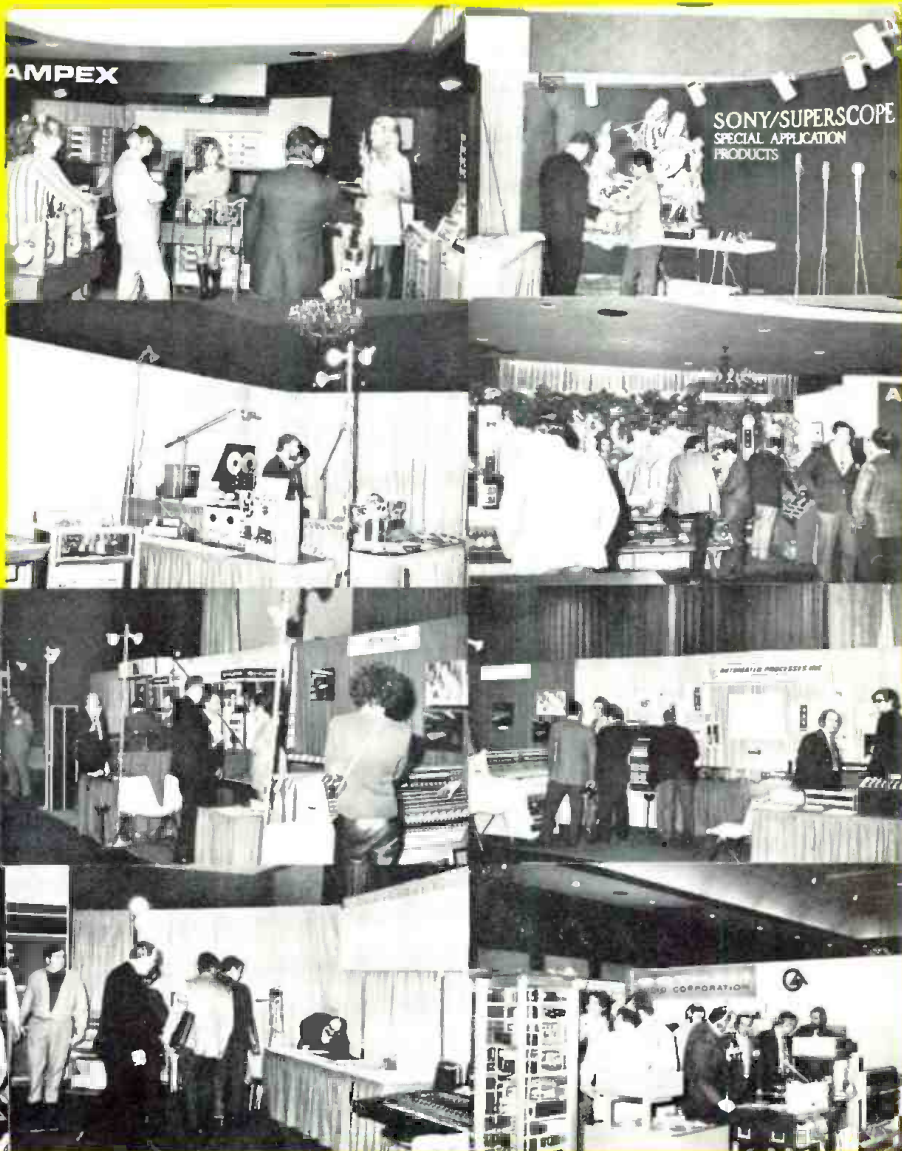



Hammond 4 in and 2 out mixer console matches ReVox machines. *Circle 51 on Reader Service Card.*



Shure A-15 series in-line mic equalizers or attenuators. *Circle 55 on Reader Service Card.*



Spectra-Sonics 1020 series consoles are available from stock. *Circle 59 on Reader Service Card.*



Olive series 2000 consoles have automated memory circuits. *Circle 56 on Reader Service Card*



Integra's equalizer demo let you listen to its effects. *Circle 57 on Reader Service Card.*



UREI monitor console has quad panning facilities built in. *Circle 54 on Reader Service Card.*

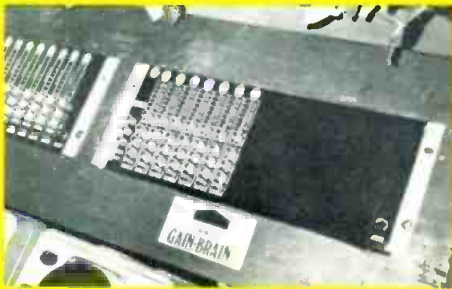

The **Kepex Gain Brain** provides two limiters in one. *Circle 77 on Reader Service Card.*



Norelco packages a variety of mixing desks for recording use. *Circle 72 on Reader Service Card.*

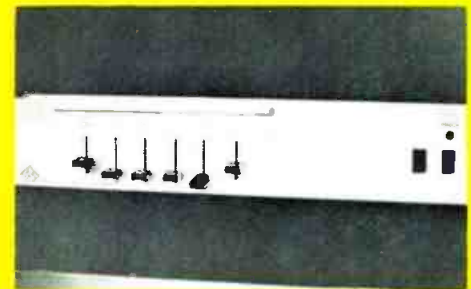

Scientific Electronic Systems has rack-mounted mixers. *Circle 67 on Reader Service Card.*



Quad-Eight recording and remix console for quad stereo. *Circle 58 on Reader Service Card.*

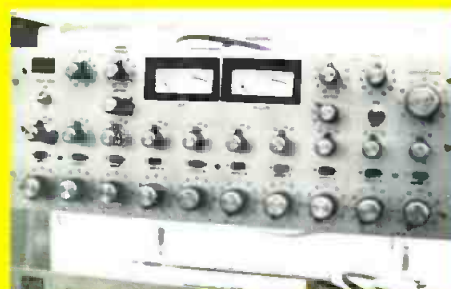

Bozak has a line of mix/amplifiers for sound reinforcement. *Circle 65 on Reader Service Card.*

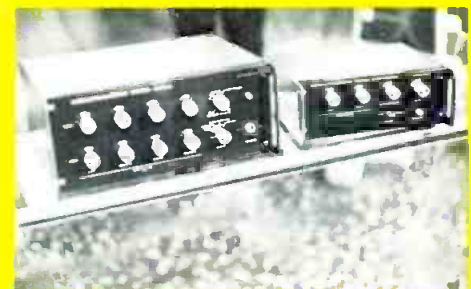

Orban/Parasound stereo matrix and stereo synthesizer. *Circle 68 on Reader Service Card.*



Now in production. **Electro-Voice** condenser microphones. *Circle 70 on Reader Service Card.*



Sony-Superscope. Just one of their condenser and dynamic mics. *Circle 86 on Reader Service Card.*



Crown D-150. A stereo amplifier offering 150 watts at low distortion. *Circle 74 on Reader Service Card.*



The **Sennheiser MHK 415T** mic has a machine run response curve. *Circle 63 on Reader Service Card.*



ARP—versatile music synthesizers in portable carrying cases. *Circle 73 on Reader Service Card.*



Vega Associates make big sounding reinforcement systems. *Circle 61 on Reader Service Card.*



Record m-s stereo using this **AKG** microphone configuration. *Circle 82 on Reader Service Card.*

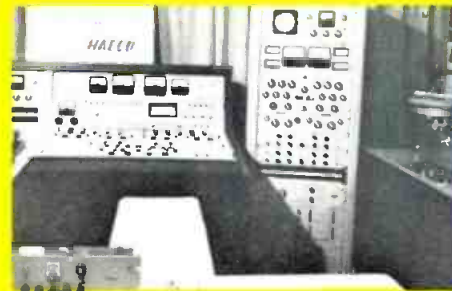

Haeco produces complete disc cutting systems for stereo mastering. *Circle 80 on Reader Service Card.*



Altec 770 systems are monitor speaker-amplifier combinations. *Circle 83 on Reader Service Card.*

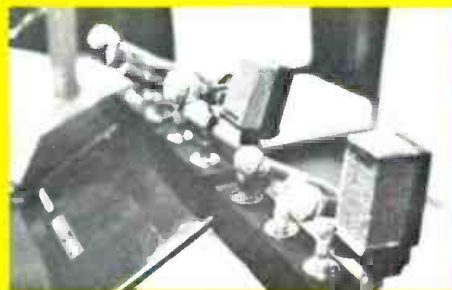

A line of recently-introduced **Beyer** ribbon and dynamic mics. *Circle 81 on Reader Service Card.*

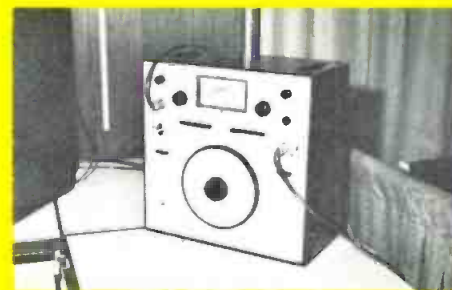

B & K showed their Type 2113 audio frequency spectrometer. *Circle 75 on Reader Service Card.*



This **JBL** monitor speaker can be seen covered and uncovered. *Circle 76 on Reader Service Card.*



Ampex has a footage counter-locator for their machines. Circle 60 on Reader Service Card.



Recortec showed a new automatic cassette tape loader. Circle 84 on Reader Service Card.



16 thin Dolby 361's furnish noise reduction for multi-track. Circle 64 on Reader Service Card.



TEAC records and plays quad-stereo on 1/4-inch tape. Circle 79 on Reader Service Card.



Otari showed a 1/4-inch 2-track mastering tape recorder. Circle 66 on Reader Service Card.



Lipps' rotating table showed many magnetic recording heads. Circle 78 on Reader Service Card.



3M Company's Selectake counts reel revolutions for search-stop. Circle 52 on Reader Service Card.

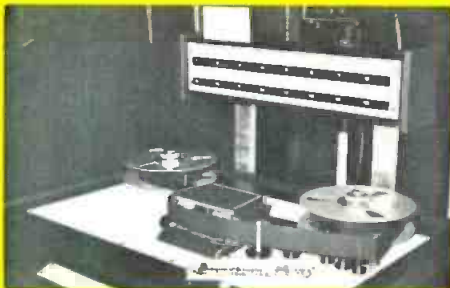

16-track Scully 100—one channel's board lies on top. Circle 53 on Reader Service Card.

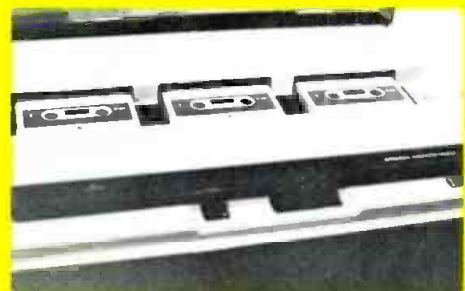

Cassette slaves, and other duplicating equipment from Infonics. Circle 71 on Reader Service Card.



A 10 1/2-inch reel equipped professional Ferrograph recorder Circle 69 on Reader Service Card.

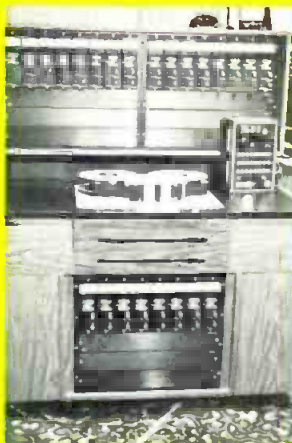

New 16 and 24 channel recorders from MCI have a revolution counter/locator. Circle 85 on Reader Card.



Viewlex has duplicators for small-run cassette copying system. Circle 62 on Reader Service Card.

Acoustics for Audio Men, part 3

In this final installment, the author takes us through the calculation and logic of a particular sound installation in a room.

IN THIS INSTALLMENT of our series on acoustics and its applications to sound system design, we are going to do some practical calculations of the acoustical properties of a typical room. Matter of fact, this room is used for conferences and briefings and the material herein was calculated by me about a year ago when I was called upon to design a sound reinforcing system for the room.

The room in question is shown in plan view in FIGURE 1. Its interior dimensions are 37 ft. 8 in. long and 27 ft. 3 in. wide. It has a hung ceiling of acoustical tile and the ceiling is 11 feet from the floor. The room contains about forty chairs and these are occupied by the audience. At one end is a carpeted platform elevated about 6 inches above the floor, and on the platform is a lectern whereon is to be located the microphone. The room's walls are covered with acoustic tile from the ceiling down 7 feet to a wainscoting 4 feet from the floor. Below the wainscoting, the walls are covered with a hardboard (Masonite or equal). The floor is covered with asbestos tiles. An elevation of a part of the walls on the side and rear of the room is given in FIGURE 2. At the front of the room in the center is a hard screen used for rear projection of slides, movies, and overhead projected transparencies. The screen may be covered with velour curtains when not in use, and when being used, the curtains are drawn back on each side with heavy folds.

The first thing to be done is to calculate the total absorption in sabins present in the room; this enables the calculation of the average absorption coefficient, the reverberation time, and the way in which sound drops off as a function of distance from the source. Unfortunately, in the case of the room in question, it was an existing room and as the exact nature and thereby exact information on the acoustical materials in the room was not available, there were reasonably accurate guesses and assumptions made. The results appeared to be, as engineers jokingly say "close enough for Government work."

Using the room's dimensions, we first calculate the room's volume and interior surface area. These were:

Room volume = 11,291.58 cubic feet
Surface area = 3,481.26 square feet

We next find the area in square feet of each of the interior surfaces which uses or has on it the differing ma-

terials, and find the absorption coefficient for each material. These coefficients can be found in acoustic texts, or from bulletins of the Acoustical Materials Association. We have summarized these calculations in TABLE 1. Note that we have indicated the sum of each of the small areas and this should equal the total interior surface (or come close to it). This summation is a check to make sure that all areas of the room are accounted for in the calculation. Note also that we have included the absorption of a forty-person audience (each person is worth 4.5 sabins).

We should emphasize that the sample calculation presented here was made for a frequency of 500 Hz which is generally used for a quick look. A complete and rigorous analysis would include similar calculations for frequencies of 125, 500, 1000 and 4000 Hz. Anyway, at 500 Hz the total absorption is:

Room materials	1,451.65 sabins
Audience (forty persons)	180.00 sabins
Total	1,631.65 sabins

The average absorption coefficient is obtained by dividing the total absorption in sabins by the room's surface:

$$\text{Average absorption} = 1,631.65 / 3,481.26 = 0.47$$

(with audience)

$$\text{Average absorption} = 1,451.65 / 3,481.26 = 0.42$$

(without audience)

From experience we know that average coefficients of 0.42 and 0.47 mean that acoustically the room is quite dead. We can calculate the reverberation time from the Eyring formula:

$$T_{60} = 0.049 V / -S \log_e (1 - a)$$

where: T_{60} = Reverberation time in seconds
(time for 60 dB sound decay)

V = Room Volume in cubic feet

S = Room surface in square feet

\log_e = "natural logarithm" to the base (e = 2.71828).

a = average absorption coefficient

Using this formula, the reverberation time calculates to:

$$T_{60} = 0.25 \text{ sec. (audience)}$$

$$T_{60} = 0.29 \text{ sec. (empty)}$$

Thus there is little difference between the reverberation time either with or without the audience. This might have been expected since the total absorption in sabins contains a "people contribution" of slightly more than 10 percent.

Melvin C. Sprinkle is a consulting acoustical engineer with the firm Sprinkle, Wildermuth & Associates, Kensington, Md.

TABLE 1

Length of Room	37.67 ft.
Width of Room	27.25 ft.
Height of Room	11.0 ft.
Room Volume	11,291.58 cubic feet
Surface area	3,481.26 square feet
Floor or ceiling Area	1,026.51 square feet
Front or rear wall area	299.75 square feet
Side walls (each)	414.37 square feet

Material	Area (Sq. Ft.)	500 Hz Coefficient	Absorption (Sabins)
Carpet	136.25	0.14	19.08
Floor tile	890.26	0.03	26.71
Ceiling tile	1,026.51	0.75	769.88
Wall tile	718.13	0.75	538.60
Hardboard	410.36	0.05	20.52
Front curtains	123.75	0.05	68.06
Proj. screen	176.0	0.05	8.80
	<u>3,481.26</u>		<u>1,451.65</u>
Audience—40 persons at 4.5 sabins each			180.00
			<u>1,631.65</u>

Average absorption = 1631.65/3481.26 = 0.47 (with audience)

Reverberation time = 0.25 sec. Room constant = 3087.16

Average absorption = 1451.65/3481.26 = 0.42 (without audience)

Reverberation time = 0.29 sec. Room constant = 2520.91

Figure 1. Floor plan of the room discussed.

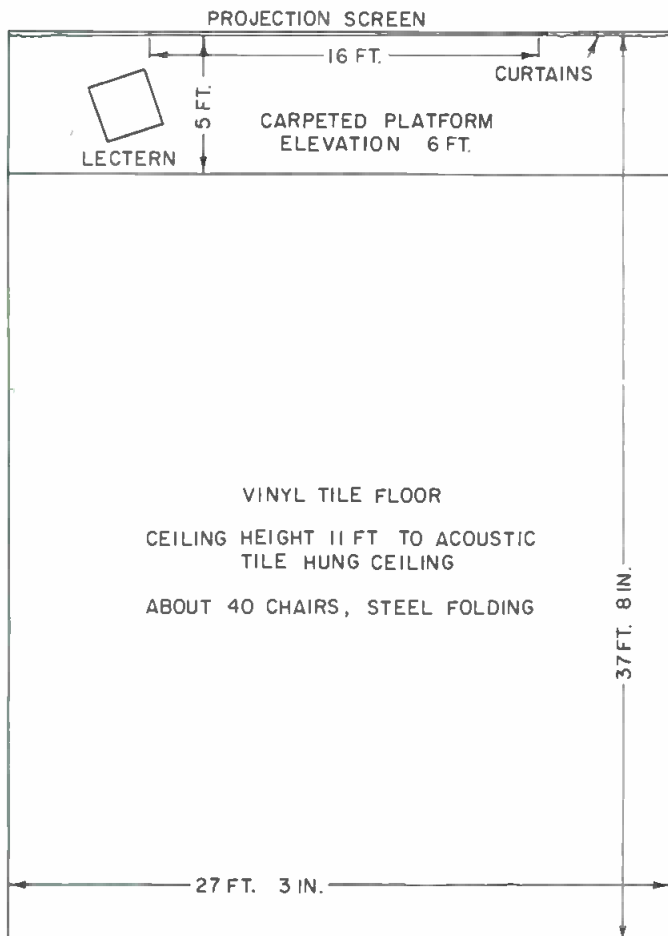

... a frequency of 500 Hz ... is generally used for a quick look.

The relative sound pressure in a room with reverberation is given by the following equation^{1,2}:

$$\text{Relative S.P.L.} = 10 \log_{10} ((Q/4 \pi r^2) + (4/R))$$

where Q = Directivity Constant

$\pi = 3.1416$

r = distance in feet from sound source

R = Room Constant

The factor Q in the above equation is the *directivity factor*. It is a measure of the directional pattern of the sound source. If we have an omnidirectional sound source, then the Q = 1.0. The term is defined as the ratio of the sound pressure of a true omnidirectional source (theoretical only) to the sound pressure of an actual source radiating through a given solid angle at the same distance. For directional sound sources the value of Q increases. For a talker it is 2; for a cone-type loudspeaker it is about 5; for a multicellular horn it varies from 5 to 15 depending upon the beam area. Some manufacturers who are aware of its use in sound-system design, have values for their loudspeakers so that the designer can select the proper loudspeaker for a given application.

The *room constant* is a number which is a measure of the room's acoustical properties. Mathematically, it is:

$$\text{Room constant} = Sa / (1 - a)$$

where S = Interior surface area of room

a = average absorption coefficient of room

From the equation it will be noticed that the *room constant* becomes larger as the value of a increases toward its limit value of unity.

Returning to our conference room, the values of *room constant* calculate to:

Room constant = 3087.16 (with audience)

Room constant = 2520.91 (without audience)

In planning the sound system for this room, two choices were possible. First, a high-level system with one loudspeaker at the front of the room; second, a distributed system with ceiling mounted loudspeakers firing vertically downward could be used.

When we go beyond six feet we find that the dropoff begins to depart from pure inverse square.

... the microphone-to-loudspeaker separation should be, wherever possible, at least equal to the critical distance.

We elected to follow the first choice because the customer had the requirement that he wanted the sound-reinforcement system to reproduce the sound from motion pictures, and for maximum illusion it is necessary that the sound come from the vicinity of the movie screen. We could not adopt the traditional movie custom of loudspeakers behind the screen because rear projection was required (space limitations) and the screen was a solid sheet of translucent material.

In FIGURE 3 we present a plot of the sound dropoff in the conference room as a function of distance from the sound source. This plot is made from the Hopkins-Stryker-Beranek equation presented above and using the *room constant* of 3087.16 and a *Q* of 7 which is the value for the Altec Lansing Model 844 loudspeaker system. This speaker was considered because it is a compact, two-way system.

Let us examine FIGURE 3 which really gives a very clear picture of the nature of sound transmission in a room. The solid line curve gives the sound pressure dropoff at varying distances (We'll come to the dotted lines in a

The first thing which must be done is to calculate the total absorption in sabins present in the room . . .

minute). At distances close to the source, from one to six feet the sound loss is pure inverse square. It follows a straight line when plotted on semi-log paper (as was done here) and has a dropoff or slope of -6 dB per distance doubled. This is pure direct field loss. When we go beyond six feet we find that the dropoff begins to depart from pure inverse square. The sound-pressure dropoff becomes much slower and eventually ceases to decrease. This is the true reverberant field in the room. Actually, the curve in this case becomes asymptotic (that word is in the dictionary) to the value $10 \log_{10} (4/R) = -28.9$ dB. It will be noted that we have two dotted lines on the graph. One of these is an extension of the inverse-square-law dropoff. This line gives the sound pressure loss for the *directly transmitted component* of sound as heard by a listener, since this component always follows the inverse-square-law loss, although the *total* sound as heard by a listener does not (this is solid line). The second dotted line, which is vertical indicates the *critical distance*. The *critical distance* is defined as the distance from the sound source at which the direct sound component and the reverberant sound component are equal. For this graph, the *critical distance* is 20.73 feet, and it will be further noted

that the solid line at the critical distance is exactly 3 dB above the continuation of the inverse square dotted line. This follows that two sounds of equal sound-pressure level and incoherent in nature combine on a root-mean-square basis, which means in practice that the combined sound pressure level is 3 dB greater than either. The *Critical distance* is a very important number. Firstly, it is the line of demarcation between distances where a listener is in the directly transmitted field and where the sound he hears is largely reverberant. Said another way, if the listener is nearer to the source than the *critical distance*, the sound he hears is largely direct, because the contribution from

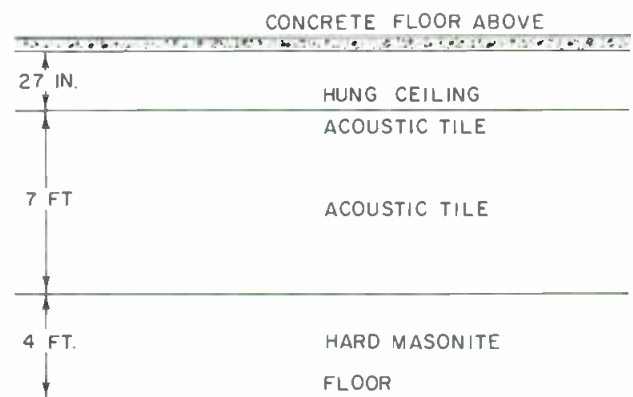

Figure 2. The room of Figure 1 in wall elevation from the sides and rear.

reverberant sound is so much less than the direct sound. As one approaches the *critical distance*, the contribution of the reverberant component becomes increasingly important until finally the sound heard is entirely reverberant and resulting from reflections about the room. At exactly the *critical distance*, the sound heard consists of equal contributions from direct and reverberant components and is 3 dB greater than either alone.

If one wishes to calculate the *critical distance*, this formula is used:

$$D_c = 1.41\sqrt{QR}$$

Since the sound pressure level drops only slightly beyond the *critical distance*, it follows that the *critical distance* is the maximum acoustical separation possible in a given room. Thus if you are in an acoustically poor restaurant, with hard walls, floor and ceiling, whose *critical distance* is, say, ten feet, then you can move anywhere in the room and still be no farther acoustically from the

The critical distance is a very important number.

Figure 3. A plot of the sound dropoff in the conference room as a function of distance from the sound source. Central system, 500 Hz, $Q = 7$, $R_c = 3087.16$.

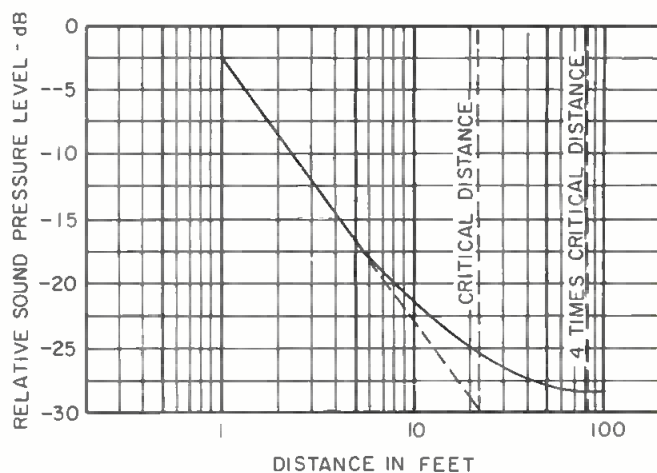

clattering dishes than ten feet, no matter how generous a tip the headwaiter expects (or gets) for a good table.

From the above consideration, it also follows that for maximum acoustic separation, the microphone-to-loudspeaker separation should be, wherever possible, at least equal to the *critical distance*. Further separation buys nothing acoustically, and could cause problems with delay distortion (transmission time of sound) in the event that the listener hears both unamplified sound from the talker and amplified sound from the loudspeaker.

The *critical distance* has another important use in sound systems, since it governs the maximum sound throw of a loudspeaker. I have noted that for optimum clarity and intelligibility it is important that the listener receive the greater part of the sound that he hears via direct transmission (high ratio of direct to reverberant sound). Thus the *critical distance* is the *beginning* of the maximum permissible loudspeaker-to-listener distance. Thanks to the marvelous computer called the human brain, it is possible to operate with sound throws of *up to* four times the *critical distance*. This reasoning follows from the fact that at the *critical distance* the direct sound and reverberant sound have equal sound pressure levels. At twice the *critical distance* the direct sound is 6 dB below the reverberant component and at four times the *critical distance* the direct sound is 12 dB below the reverberant component, and the brain can still sort out the two. This $4D_c$ rule should be considered as an absolute maximum distance and shorter distances are preferable.

It will be recalled that I recommended that the microphone-to-loudspeaker distance be at least equal to the *critical distance*. It will also be recalled that in the previous section I stated that in the reverberant sound field, the

direction of sound arrival is entirely random. This follows from the fact that the reverberant sound field is established from the innumerable reflections of sound from the floor, walls, ceiling or large objects (large with respect to wavelength of sound) in the room. Our recommendation gives the maximum acoustical separation and thereby the system's acoustical gain and stability are improved. Thus it is desirable that the microphone be located in the reverberant sound field of the loudspeaker. But since the reverberant sound field of the loudspeaker is *random* with respect to the direction of arrival of sound, the use of a cardioid or directional type microphone is questionable. With random sound arrival, there is no point in using a cardioid as an aid to system acoustical stability and freedom from sing. Actually in some cases it may be a hindrance, since the rear or side pattern of a cardioid may have frequency peaks, thereby reducing the system stability. I prefer to use an omnidirectional capacitor microphone since the costs are comparable with professional cardioids and the smooth response of the capacitor mic improves sound quality.

Returning to our conference room, we placed the Altec 844 loudspeaker at the upper corner of the front of the room, adjusting its position so that the 90 degree horizontal coverage angle went down one side of the room and the other aimed across the room in front of the lecturer. The mic to speaker distance is 22 feet which is roughly the *critical distance*. This slightly off-center location is admittedly not the best location for illusion but centering the loudspeaker in the front of the room was not possible due to the projection screen height and also the distances were less than critical so that the system gain would have been impaired. It is not so far off center due to room size that the illusion is destroyed, and illustrates

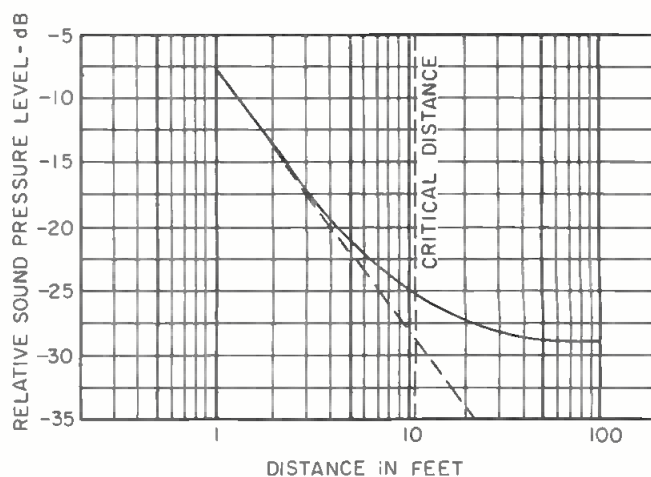

Figure 4. The relative sound-pressure curve for a distributed system. Again, as in Figure 3, 500 Hz is used. Q is now 2. The room constant = 3087.16.

. . . time-delay confusion was publicized some years ago in connection with the sound system in the General Assembly Hall of the United Nations.

the compromises from ideal which are sometimes necessary due to actual conditions.

Had the use of the loudspeaker for motion-picture sound not been required, we would have considered the use of a distributed system with small loudspeakers installed in the ceiling. As an exercise for this article, we calculated the relative sound pressure curve, using a Q of 2 which is typical for a small cone loudspeaker. The result is shown in FIGURE 4. The *critical distance* is now 11.08 feet. Since the ceiling height is 11 feet and the height of the head of a seated listener is about 4 feet, the loudspeaker to listener distance is $11 - 4 = 7$ feet, well within our criteria. The distance between the microphone and the *nearest* ceiling loudspeaker should be at least 12 feet. The system in the room is short enough that problems with time delay should not be encountered.

The subject of acoustical time delay, mentioned above, deserves a hit of exposition. I have said that sound travels at a speed of 1130 feet per second at normal people environment. This may also be expressed in another manner by noting that sound also travels at the rate of 0.000885 seconds per foot or 885 microseconds per foot. Thus for sound to travel 100 feet (not an unusual distance in an auditorium) the travel time is 0.0885 seconds or 88.5 milliseconds. This travel time for sound, being very much slower than electrical signals, can cause problems in sound systems, many time unknown to the installer or user—except that the user senses that the speech is not clear and there is something wrong. For example, suppose that we have a system with a loudspeaker located centrally over the proscenium arch and covering the audience area except underneath a deep balcony. Here the installer has put in some ceiling speakers (good practice so far). Then the problems arise because listeners in the audience seated immediately in front of the balcony now hear two sound sources (1) the sound from the central loudspeakers which (let us say) has traveled 100 feet; and (2) spillover sound from the under balcony loudspeakers. Now the sound from the central system has taken 88.5 milliseconds to travel the 100 feet, while the sound via the under balcony speakers arrives almost instantly. Its time is twice 885 microseconds (1770 microseconds) to travel two feet from the talker to his mic plus say 10 times 885 or 8850 microseconds to travel from the balcony speaker to the listener. The travel time for electrical signals in the system is negligible. Thus our listener hears two signals the first delayed 88.5 milliseconds (or 88500 microseconds) and the second delayed 8850 microseconds (we have subtracted the first 1770 microseconds from the second path because the two foot travel to the mic is common to both paths. Thus the time difference in delay is $88,500 - 8850 = 79,650$ microseconds or 79.650 milliseconds. The annoyance effect of this multiple reception of sounds has been investigated by Haas of Germany, Mason and Moir in England, and Bolt and Doak in the United States. They have found that the annoyance is affected by both the time difference in arrival and the relative loudness of the two sounds. Haas found that if a secondary sound was delayed in reaching a listener from one to 35 milliseconds there was no interference provided that the secondary sound was 10 dB below the primary. Haas also found that the *first* sound to reach the listener takes command and indicates to the listener

the direction of the sound source, especially sideways. Thus in our auditorium if the listener hears the under balcony sound first and it is equally loud as the direct sound, then he will be confused as to the illusion that the sound emanates from the talker at the front of the room. He will also be confused because of the time delay in the front sound reaching him with about 80 millisecond time delay, and a critical listener will even perceive an echo. The time-delay confusion was publicized some years ago in connection with the sound system in the General Assembly Hall of the United Nations. The answer was to feed the rear speakers under the balcony with a signal *delayed* in time about the same as the travel time of the sound from the front of the room plus about 35 milliseconds. This insured that the sound from the rear loudspeakers arrived *after* the sound from the front of the room and completely cleared the confusion problem. The time delay may be obtained from special loop-type tape recorders or from sound transmission through long pipes. The subject of time delay is treated in a paper by Bolt and Doak (which also summarizes the work of Haas) in the *Journal of the Acoustical Society*, July 1950, and readers are referred to this paper for details.

This just about wraps up the story. The subject of acoustics is a fascinating one, and one of extreme importance to anyone connected with sound reproduction or audio. It's something like a teacher of mine told me many years ago: No matter how far you go in mathematics—to calculus or advanced calculus or anything else, the answer always comes out in arithmetic—so you'd better learn arithmetic. So it is in audio. We can talk about exotic amplifiers, and quadraphonic sound, and phono pick-ups and taped music, but the final product is *sound* and that is the field of the acoustical engineer.

In this series of articles we have tried to present the fundamental principles of acoustics as it applies to the installation of sound reinforcement systems and music reproduction. Because of space limitations, we could not get everything into this series. But, we have covered in detail the important principles so that by their application, a *proper* sound installation can be made.

Perhaps some readers may wish to pursue the subject further. The acoustical engineer is concerned not only with sound-system design, but also with the shape and dimensions and materials used in rooms; with the isolation and control of extraneous and harmful noises in factories, from airplanes, trains, trucks and cars: with vibration isolation and control. In fact, he operates, and his services are needed, wherever people are—and that's lots of places. Interested readers are encouraged to acquire and study the several books and papers mentioned in this series—plus others which a librarian can refer to you.

There's more to sound-system design also. We have methods for calculating the sound-system acoustical gain, speaker coverage, etc. but that's another story. ■

REFERENCES

1. Hopkins, H. F. and Stryker, N. R., *A Proposed Loudness-Efficiency Rating For Loudspeakers And The Determination of System Power Requirements*, Proc. IRE, March, 1948
2. Beranek, Leo, *Acoustics*, McGraw-Hill Publishing Co.

db Visits --

Colonial Williamsburg

WHEN THE DECLARATION OF INDEPENDENCE was signed, Williamsburg, Virginia was already an important city on the Eastern Shores. It served as the Capitol of its state until Revolutionary War events forced the Capitol to move inland to safer quarters at Richmond. Williamsburg continued as a city, but its peak had passed and it moved into inevitable decline.

It had virtually lost any appearance it once had when John D. Rockefeller, Jr. undertook its restoration to the appearance of the middle eighteenth century. By a combination of restoring original standing buildings to the way they once looked (mostly by removing gingerbread that had been added later) and rebuilding structures that time had destroyed, a small city was re-created into which you can now pass back into the 1760's.

Artisans have been found to work the old tools in the old ways, so bakers, printers, bootmakers, and the like can be seen at real work in their original surroundings.

The visitor to Colonial Williamsburg can easily become enchanted. During the day, no automobiles can operate on the streets, only at night. There is no charge for admission to the city—which is, in fact, always open. But there are admission to the buildings, and the modest cost is well worth it to anyone interested in this deep look at a piece of American history.

When you first arrive, your ticket to the buildings gets you to see a film on Colonial Williamsburg as it was functioning in the period leading to the revolution. The film employed professional actors you may recognize, was shot on location in Williamsburg and is shown in two opposing

theaters from 70-mm stereo magnetic sound color film. The projection booth is common for both theaters, though each has a separate group of projectors.

I won't dwell on the theaters, their appeal is visual, stereo sound is good, and therefore almost unnoticed in the over-all presentation.

A thriving audio-visual department exists behind the scenes. It is their function to produce audio-visual materials that will enhance the imagery of the present-day operation—and this they do well.

They have produced a number of recordings that are in general release as albums. Among these, are recordings of marching bands as re-created at Williamsburg, and a delightful album of eighteenth century music. This album was recorded at the reconstructed Governor's Palace where such events took place regularly—and are now again take place regularly. A crew from the a-v department recorded such a concert. Musically, it is of particular interest because antique instruments have been used whenever possible.

A modern two-channel recording studio and dubbing/mixing room exists at Williamsburg. It's presided over by audio engineer R. B. Tisdale, Jr. FIGURE 1 shows a view over the console into the small studio. Relatively little work is done here in the way of live recording, so the studio has tended to become something of a store room. The console itself, home-assembled, is fully adequate to the dubbing and editing that is done here. Two studio recorders are used. FIGURE 2 is an Ampex 350-2 which has been transistorized by the substitution of URL AutoTec ATA-SL-1 electronics. Fitted onto either side of the

Figure 1. The main control panel in the recording studio at Colonial Williamsburg.



Figure 2. An Ampex 350-2 modernized with the addition of AutoTec electronics and Electrodyne limiter/compressors.

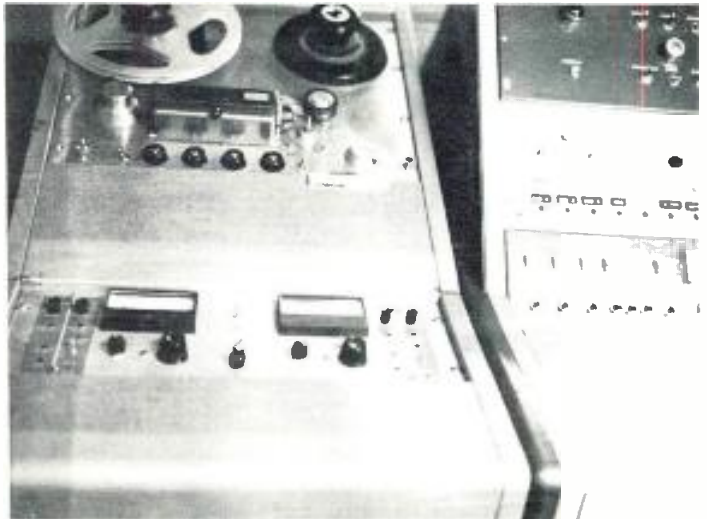



Figure 3. Have portable case, will travel. This Ampex 440 system can move to locations or serve in the studio. The Nagra at right is used for film work—a great deal of which is done at Colonial Williamsburg.

AutoTec you can make out two panels that are Electrodyne CA-700 limiter/compressors. A stereo A-440 is also present and a mono Nagra can just be seen in FIGURE 3.

Disc to tape transfers and auditioning is done on a pair of ancient but thoroughly serviceable Rek-O-Kut units equipped with Gray Research arms. These are seen in FIGURE 4.

Colonial Williamsburg may be an old city, but its present operation is thoroughly modern. At the same time, it must be said that there is no hustler attitude even behind the scenes. Colonial Williamsburg is not in business for profit. It is a valuable center for the modern study of history, a study that could benefit many Americans.

I do wish to thank A. L. Smith, who is the director of the a-v department as well as the aforementioned Dick Tisdale for their cooperation in making my visit memorable for me and my family. Colonial Williamsburg is a place to go for the whole family. ■

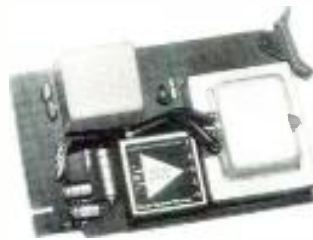

Figure 4. Two Rek-O-Kut turntables and a central switcher serve for disc dubbing and audition.

Comprehensive!

MICROPHONE PRE-AMPLIFIER

Model 312



Transformer coupled input and output. Exceptionally low noise (-129 dBm), $+30$ dBm output capability with low distortion. Adjustable gain. Utilizes Model 2520 operational amplifier.

LINE AMPLIFIER

Model 325



Bridging input. Output capability greater than $+30$ dBm. Adjustable gain, transformer coupled output. Can function as line amp, booster amp or "no loss" combining network. Utilizes Model 2520 operational amplifier.

In both components, the output transformers are unique, permitting simultaneous multiple outputs.

SPECIAL PURPOSE AMPLIFIERS

Models 330P, 330T, 330F, 330G

Models available for RIAA Phono, NAB Tape, and Magnetic Film. Low noise, adjustable gain, high output capability. Equilization adjustable.



330F provides both 16 and 35 mm. curves, externally selectable. Model 330G: Fixed frequency sine wave oscillator with up to $+12$ dBm transformer coupled output. Utilize Model 2520 operational amplifier.

All are PC cards ($2\frac{3}{4}$ " x $4\frac{1}{2}$ " x $1\frac{1}{2}$ "") permitting standard modular use. Power supply decoupling and reverse voltage protection are provided.

CARD FRAMES • Models 411, 405



Eleven amplifiers mount in Card Frame Model 411, $3\frac{1}{2}$ " high, 6" deep, and 19" wide. Five amplifiers mount in Card Frame Model 405, which is 10" wide.



AUTOMATED PROCESSES, INC.

35 CENTRAL DRIVE, FARMINGDALE, NEW YORK 11735 • 516-694-9212

In Canada: PERCEPTION INDUSTRIES, INC.

Circle 25 on Reader Service Card

The Technique of Electronic Music

As electronic music moves more and more into the recording studio and broadcasting station for production purposes, it behooves the audio engineer to learn what it is all about.

ELECTRONIC MUSIC will be viewed here by analyzing the various techniques and methods by which it is constructed. These methods and techniques will be taken one at a time, from the original sources of material to the reproduction of the finished composition, and analyzed in terms of the various possibilities the composer has at his disposal.

This article, then, is to be considered as an over-all guide which may be followed as a recipe for the synthesis of electronic music (pure electronics). Details of specific techniques such as the construction of equipment, etc., must be obtained elsewhere, as must details on non-electronic sources such as are used in *musique concrete*.

SOUND SOURCES

Two basic categories of sources are oscillators and electro-mechanical generators. The oscillator is an electronic device capable of generating the electrical signal which is a replica of an audible sound. When amplified and fed into a loudspeaker, the sound generated will be the equivalent of this electrical signal.

The electro-mechanical generator is a generator such as a vibrating string, reed or membrane, to which an electrical transducer (pick-up) has been attached. This transducer will deliver an electrical signal with a waveform similar to the pattern which the mechanical element describes. However, it may not be identical with this pattern, and considerable transformation of the shape of the wave can be achieved through special designs of transducers or vibrating elements.

In a general sense, a generator is any device which produces an electronic output corresponding to a mechanical input, while an oscillator is a purely electronic device which produces an electrical output corresponding to an acoustical waveform. Both types may be amplified to drive a loudspeaker.

Four simple types of waveforms may be obtained from oscillators or generators. These are:

1. Sine wave (sin, sinus wave; a pure tone containing only one frequency).

2. Square wave (so called because of its appearance on an oscilloscope; a fundamental pitch plus the odd numbered harmonics up to the twelfth or more).

3. Sawtooth wave (so called because of its appearance on the oscilloscope; a fundamental pitch plus all odd and even overtones or harmonics).

4. White noise (so called because it contains equal amounts of all audible frequencies; when some frequencies are missing, the sound is considered to be incomplete white noise, and is sometimes called "pink" noise).

There are many types of electronic oscillators. Some generate sine tones, and other generate square waves, sawtooth waves or white noise.

The multivibrators make up a class of oscillators which produce square or sawtooth waves exclusively; however, other types of oscillators may be designed to generate any of the above waveforms.

GATING, ENVELOPE CONTROL, AND MODULATION

Gating, envelope control, and amplitude modulation are three functions performed on the same instrument or on instruments with a class similarity which, in all cases, may be called a modulator. The distinction of frequency response separates the various functions of gating, envelope control, and modulation and leads us to call some modulators gates if they have a certain low-frequency response.

All of the oscillators listed under the heading **SOUND SOURCES** are continuous wave oscillators; that is, once they are turned on, they will continue to produce an output until they are turned off. With mechanical generating devices such as strings, reeds or membranes, the source of power, such as the motion of a rosined bow or wind pressure, may be stopped. When we are deriving our sound material from electronic oscillators, however, we cannot just turn off the power with a switch in order to stop our tone. The reason for this is that electronic oscillators require a relatively long period of time to warm up and stabilize. When the oscillator is turned back on, the same pitch may not result. Also, the attack may be anything from a sudden thud to a very slow glide as the instrument warms up.

For the above reason, electronic oscillators must be left running constantly while they are in use. But in order to start or stop the sound source, simply disconnect the output of the oscillator from the mixer or amplifier. The output from an electro-mechanical device with a transducer attached may be stopped by this same means, and the generator may actually be left running continuously.

Robert C. Ehle, Ph.D., is teaching at the National Electronics Institute in Denver, Colorado. He has contributed before, and we will have more in the future in **db** on electronic music subjects.

In a general sense, a generator is any device which produces an electronic output corresponding to a mechanical input, while an oscillator is purely electronic . . .

Of course, it is much too inconvenient to continue inserting and removing a plug in the mixer to interrupt the output of one of the oscillators. The solution is to install a switch in the line. With a series of fast-acting and silent switches, the outputs of all oscillators and generators can be controlled without interrupting their delicate operation. This is using the switches as manual gates. This method has the advantage that it does not disturb the operation of the oscillator and therefore will not change the frequency or the waveform (pitch or timbre).

In addition to being able to interrupt the signal of the oscillator, the volume for the oscillator can be changed. This can be done with a simple volume control or a potentiometer, as it is called (because it allows one to control the potential, or voltage at its output). If fast, automatic changes in volume are desired, such as are needed to produce bell tones and piano-type transients (*i.e.*, tones with sudden attacks), a gating device must be used. This device is an automatic volume control which may be operated remotely by another signal, called the control signal.

In the better types of gating devices, the circuit is balanced (as in the balanced modulator, bridge modulator, and ring modulator) and will cancel out the control signal in the output of the circuit. This means that the control signal will change the volume of the input signal, but only the input signal may reach the output.

The volume control on a radio may be used as an illustration of this type of operation. By rotating the volume control up and down rapidly, about five to six times per second, the output of the radio is modulated at five to six hertz. This may also be accomplished by a control oscillator producing a 6-Hz control signal and driving the control input of a modulator.

The need for a balanced modulator will be clear when it is realized that it may be desirable to control or modulate the signal with some audible frequency, say 150 Hz. In such a case, the volume will vary 150 times per second. The 250 Hz produces a tone which can be heard. It is usually not desirable to hear this tone. A balanced circuit does away with this tone.

Figure 1. Oscilloscope presentations of various waveforms. In (A) a sine wave; (B) shows a classic square wave; (C) a triangular wave; and (D) white noise.

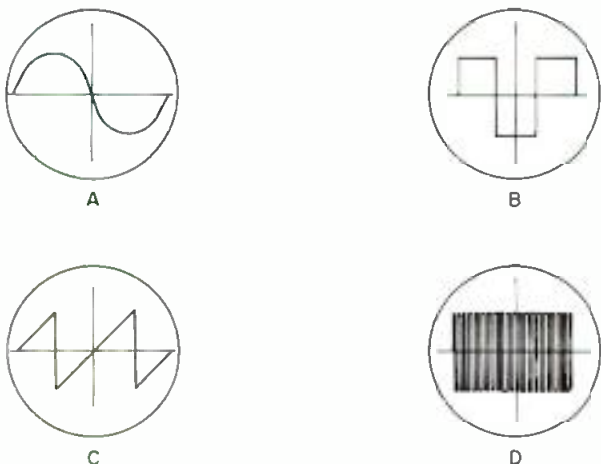

If the gating device has a frequency response down to zero Hz, a *direct current control signal may be used*. This signal may be switched on and off and it will in turn switch the output of the modulator on and off. The voltage of the d.c. control signal may be varied, thus changing the volume of the output of the modulator accordingly. Also, a high voltage may be switched on rapidly and accordingly. Also, a high voltage may be switched on rapidly and gradually reduced, producing an output of a bell envelope shape with a fast attack and a slow decay.

Not all gating devices or modulators have a very wide frequency response. In order to be able to switch a signal on and off, the device must have a frequency response down to d.c. Such devices are commonly referred to as *gates* because they may be used to turn the signal on and off and to adjust the volume of the signal remotely.

On the other hand, an amplitude modulator must be able to handle high frequencies as control signals. The frequency response of the control input is generally about the same as that of the signal input. The unit is used to modulate one signal with another (*i.e.*, to superimpose the waveform of one signal upon that of another; see FIGURE 2).

Although limitations in frequency response may be present in some equipment, it should be realized that an ideal unit will have a control-frequency-response capability, from d.c. to supersonic frequencies. Such devices are complete *gate and modulator* units, requiring only signal and control voltage for their operation at either d.c. or higher audio frequencies.

It should be realized that while a gated signal will have a beginning and an end (an attack and a release, *i.e.*, an envelope) a modulated signal is still a continuous wave, and the modulation is heard as a frequency component of the complex wave. Frequencies below 16 Hz are heard as tremolo and fall between envelope control and actual modulation by audible frequencies.

When a control signal is a varying d.c. signal, it is called an envelope-control signal. When the signal is above this limit, it is actually audibly modulating the original signal. Six Hz is the most desirable frequency for tremolo, according to Carl Seashore.¹ Above this frequency there are a variety of sounds unlike anything commonly available from traditional sources. These are the sidebands, or the spectra, of the modulated signal. They consist of the mathematical sum and difference frequencies of the original signals, and are infinite in variety and complexity. Such sounds are perhaps the unique contribution of electronic music, and may prove to be the most fertile material for future composition.

¹ Seashore, Carl Emil, *Psychology of the Vibrato in Voice and Instrument* (Iowa City, 1936).

Figure 2. A block diagram of an amplitude modulator and the input and output waveforms.

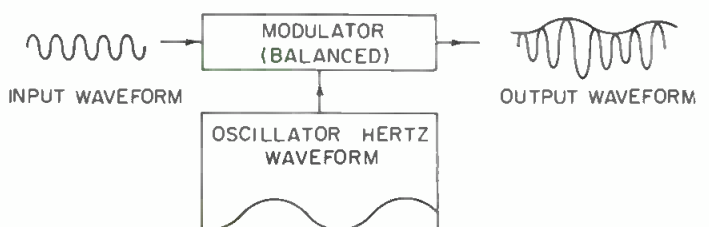

Of course, it is much too inconvenient to continue inserting and removing a plug in the mixer to interrupt the output.

The modulator then, is used to produce complex continuous waves from simple ones. These complex waves may be gated or given an envelope, just as the simple signals may.

It is possible to use one amplitude modulator to produce a complex tone, another to provide tremolo and a third as a gate for envelope control, such as attack and decay control.

Taking the generators and the modulators as a group, the following types of continuous sounds are possible:

1. Sine waves (one frequency only.)
2. Square waves (fundamental plus odd harmonics).
3. Triangular waves (fundamental plus all odd harmonics).
4. Sawtooth waves (odd and even harmonics).
5. Mixtures of the above three types (also called linear mixing).
6. Complex sounds (sometimes called clangorous tones) created by the modulation of one tone by another of the first four types (also called non-linear mixing).
7. White noise.

APPLICATIONS OF MODULATION IN ELECTRONIC MUSIC

Modulation is the process whereby the frequency or the amplitude of one tone or group of tones is varied in accordance with the frequency of a second tone or group of tones. In this definition, a tone or group of tones are equal and similar in nature. There will be both audible and sub-audible frequencies and so there is no definite division between the carrier and the signal frequencies as in radio communications.

In *amplitude modulation* the amplitude (volume) of the input signal is controlled at a certain rate which corresponds to the frequency rate of the control signal. For example, if the control signal is 6 Hz sine wave, the input signal will vary in volume six times per second. Examples of amplitude modulation include tremolo (the variation of amplitude or volume in a musical sound), and flutter tonguing (in which the player starts and stops the sound of this instrument by means of his tongue, in this case the sound is 100 per cent modulated and the signal turns on and off rather than just becoming louder and softer). Morse code is a third example of amplitude modulation in which the volume is changed from on to off. The types of amplitude modulation where the input signal is turned on

and off, are spoken of as 100 per cent modulated, and in some cases, over modulated if distortion occurs. In all cases of amplitude modulation the frequency of the input signal is unchanged. Since this frequency is generated by musicians or by oscillators or other generators and fed to the signal line, it should be obvious that there is no convenient way to change the frequency after it has left its generating source.²

Frequency modulation, unlike amplitude modulation, operates on the generators themselves. That is to say, the oscillators or the musical instruments which are generating the sound are controlled in frequency modulation while the frequency of the generated signal is changed at the rate of the control signal. Two examples, which are familiar to everyone, are the vibrato applied to the violin string when the player moves his finger back and forth thereby lengthening and shortening the string and raising and lowering the frequency, and the trill played on any instrument where the frequency of the instrument is changed at a fixed rate. In the case of the trill, the frequency is changed in fixed steps rather than in a sliding glissando as in the string vibrato. When frequency modulation is applied to electronic instruments, the control signal must affect the actual operation of the generator or the oscillator. This is important. Once the signal has left the generator or the oscillator, it is too late to alter the frequency by any convenient means, at least in real time.

Therefore, to sum up, when a control signal is applied to the control input of an oscillator, the frequency of the oscillator is altered and, therefore, this is called frequency modulation. On the other hand, when the output of the generator or oscillator is put through a gating device, a modulator, or a voltage controlled amplifier and the control signal controls the operation of this unit, the only type of modulation which is convenient and usually possible is amplitude modulation.

When amplitude or frequency modulation is being employed, the oscilloscope is a handy device for checking the results. The patterns illustrated in FIGURE 4 represent various conditions of modulation, and an analysis of each pattern is given.

The lower frequency in the amplitude modulation patterns is represented by the outer pattern, and the higher frequency is the smaller waveform inside of the lower one. If no amplifiers or modulators are being generated, it is possible, through overdriving either an amplifier or the modulator, to distort either of the waveforms. In FIGURE 4, (B) the outer or lower frequency is shown to be distorted at the peaks. In (D) it is distorted at the nodes. Distortion on the peaks is probably caused by driving an

Figure 3. Graph of a gating signal with a rapid attack and a slow (exponential) decay.

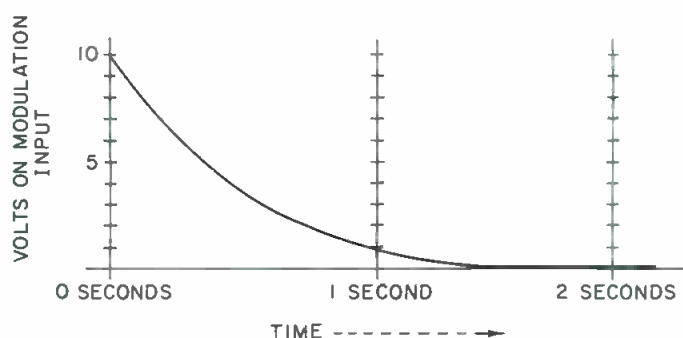

² A method known as phase modulation is used to provide very limited frequency shift in such devices as the vibrato chorus generators and vibrato oscillator units in some electronic organs. A similar type of effect, but using mechanical apparatus, is that obtained from the rotating speaker systems in many electronic organs. In such phase shift devices the signal is delayed by some means, such as moving a speaker, away from the listener or by passing the signal through a simulated long wire which takes more time. Since the frequency can only be lowered for one Hz at a time, the modulation is measured in radians or degrees rather than hertz. It is not applicable to the wider range frequency modulation methods which must be applied at the oscillator or generator itself.

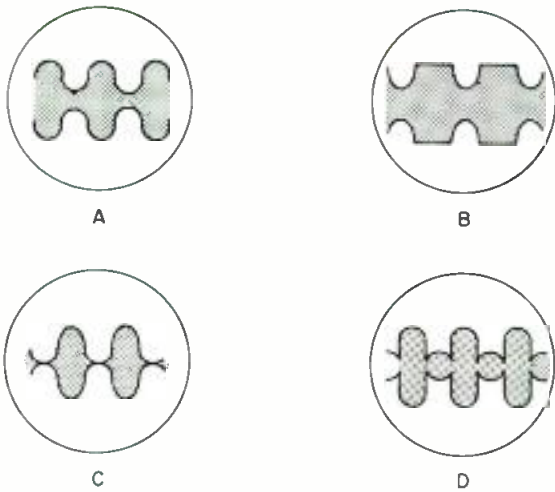

Figure 4. Examples of amplitude modulation oscilloscope patterns. At (A) a normal sine wave modulating signal with less than 100 per cent modulation; (B) is an overdriven amplifier before the modulator—again less than 100 per cent modulation; (C) is a normal sine wave at 100 per cent modulation; and (D) is greater than 100 per cent modulation—the modulator overdriven.

amplifier stage before the modulator into saturation, thereby reaching an amplitude beyond that where the stage is able to respond. Distortion at the nodes is caused by overdriving the modulator itself and cutting the stage which clips the other signal as well. Briefly, (B) was caused by distorting the lower frequency before it reached the modulator while (D) was caused in the modulator itself.

One hundred per cent modulation occurs when the modulator is running at, but not beyond the cut-off condition (FIGURE 4C). The range of the modulation amplitude control which may be employed without distortion falls between 0 and 100 per cent modulation.

The same distortions may occur in the inner patterns representing the higher frequency. However, they may be more difficult to see due to their size. No examples of this condition are shown.

FIGURE 5, (A) and (B) show a sine wave frequency modulated by a sine wave and a square wave. The important thing to notice is that when the lower frequency is a sine wave, the wide waveforms change gradually to the narrow ones while the square wave changes the wide waveforms into narrow ones in abrupt steps.

Balanced modulators permit one of the input signals to be eliminated in the output while the effects of it upon the second signal are permitted to remain. While the removal of one of the signals may seem to be rather inconsequential when complex tones are being generated, it is important for one reason. The signal which is balanced out may be one or a set of constantly running oscillators. They are only heard when the second signal is present.

Figure 5. Examples of frequency modulation oscilloscope patterns. At (A) normal sine wave frequency modulation; at (B) a normal square wave frequency modulation.



The balanced modulator permits a musician to modify the tone of any musical instrument by means of modulation by a constant complex tone array without having to gate the complex tone array itself. In such circuits the modulator serves a double function and gates the continuous tone as well as performing its normal function of modulation.

The actual sound of modulated tones varied from a slightly colored sound to a sound which is practically noise. One of the most attractive techniques in electronic music employing modulators is to begin with the modulation control off and gradually increase the percent of modulation. As the percentage increases the tone becomes gradually more complex, and the original sounds become inundated in a web of related, but new sounds. The transition into and out of a modulated state is quite interesting, and when it is considered how many variables exist in the tones used as signal and control frequencies, it will be seen that an extremely wide range of possibilities exist. Easiest to comprehend are the low-frequency controlled modulations, the trills, glissandi, vibrati, etc. On the other hand, the high-frequency controlled modulations are unique in that they are not found in any traditional musical instruments, a quality which makes them attractive to the musician who desires new sounds to work with.

The last type of modulator to be discussed here is the balanced ring modulator. This type of modulator, which is an amplitude modulator, is unique among the various types in that it is doubly balanced. That is, neither of the input signals pass through it into the output, only the products of modulation are allowed to pass. Therefore, there is no output from the balanced ring modulator un-

audio

brings you the world's best buy in automatic tape splicers

(shown here in cassette operation).



THE ELECTRO SOUND 200

AUDIOMATIC CORPORATION
237 West 54th St. New York, N. Y. 10019 212 582-4870 Cable AUDIOMATIC

Circle 27 on Reader Service Card

Not all gating devices or modulators have a very wide frequency response.

less two signals are present, one at each of the two inputs. The output, then, is composed simply of the sum and difference tones generated between the pair of input.

The single-sideband spectrum shifter (sometimes called the *Klangumwander*) is a special installation of many modulators for a special purpose.

FILTERING

The next technique available is filtering. In order to understand what is accomplished by filtering, it is necessary to understand the nature of the various types of sounds.

The simplest wave is the sine wave. This wave consists of only one frequency. Since by filtering we can diminish the volume of any frequency, we can diminish the volume of a sine wave with a filter; however, we can do the same thing with a volume control. It is only when we wish to diminish the volume of one frequency while not affecting another frequency which is also present, that a filter is of value. Therefore, complex sounds are filtered in order to change their composition, but there is no point in filtering a simple sine wave.

The square wave is composed of a fundamental frequency and the odd-numbered partials in the harmonic series. Since these partials are exact multiples of the fundamental, they seem to blend with it and simply change its character instead of being heard as themselves. But they can still be filtered out individually. The effect of filtering the various partials of a square wave is to change its basic character. Thus, filtering can change the tone quality of a square by removing certain amounts of the various partials.

A triangular wave also contains only the odd partials. These partials, as in the case of the square wave, produce the particular character of the sound. These partials may also be filtered, thus changing the character of the sound. In like fashion, any complex tone which contains more than one frequency may be changed by filtering; for example, white noise may be filtered as well as the various products of the modulation techniques discussed earlier.

Filters are classified as either variable or fixed. Variable filters may be variable in the following three ways: variable roll off frequencies, variable slope, and variable maximum attenuation.

The characteristic called the slope of a filter determines how much a neighboring frequency will be affected by the filter; in other words, the selectiveness of the filter. The roll off frequency is the first frequency affected by the filter, while the attenuation is the amount of suppression applied to a desired frequency. It will be seen that the three are interconnected.

If a filter is made in such a way that it attenuates all frequencies below a certain frequency, it is called a *high-pass filter*. It rolls off the frequencies below the specified frequency. On the other hand, a filter which attenuates high frequencies is called a *low-pass filter*. A filter which removes a particular band of frequencies is called a *notch filter*.

All of the above characteristics of filters may be made variable in all of the above types of filters. Band-pass and notch filters are actually two filters in one, thus producing six variables.

The formant filter is a fixed filter which is of special value in electronic music. This is the type of filter used most often in electronic organs to provide the various

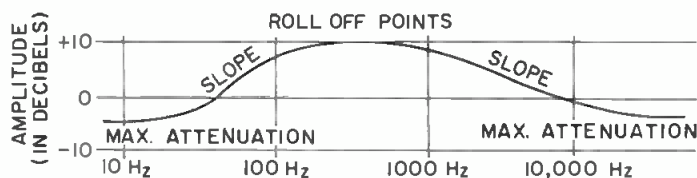

Figure 6. The three basic characteristics of filters.

instrumental imitations. For example, a saw-tooth wave filtered with two different formant filters, may result in two tones with very different colors. The one may be similar to a violin, while the other may sound like a bassoon or an oboe.

The formant filter is the electronic equivalent of the acoustical filter which exists in every musical instrument, such as the bore and the bell of wind instruments, the sound box of the string instrument, etc. The formant filter changes the raw output of the oscillators in an electrical fashion just as the bell, bore, sound box, and various resonators change the raw sound of the reeds and the strings. Just as the acoustical filters change all the tones of a musical instrument in exactly the same way, by always affecting the same frequencies no matter what frequencies are being fed through it. The effect is that the high tones of a musical instrument have a different spectral pattern from the lower ones. Even two adjacent tones have different compositions because the fixed filters affect partials to different degrees on the two tones. Out of all of these different tone qualities a pattern will emerge. This pattern is the formant of the instrument, and it consists of the frequencies which are least attenuated wherever they happen to lie in the overtones of the various pitches of the instrument. Although adjacent tones may be different, there is a common denominator in the formant which gives all tones the characteristic of the instrument. (See FIGURE 8.)

METHODS OF REPRODUCTION

In the recording and reproduction of electronic music, stereophonic effects may be desired. These are usually easiest to obtain by means of a multi-track recorder. A two-track machine provides two real channels and one virtual channel, the resultant when both real channels have the same signal in equal level and in phase.

The techniques of realizing these vertical channels involve mixing the desired pair of channels through a mixer and feeding the result into the amplifier which drives the speaker halfway between the pair of real channel speakers.

Consequently, the following information becomes apparent:

Figure 7. The four categories of filters. (A) high-pass filter; (B) low-pass filter; (C) band-pass filter; and (D) notch filter.

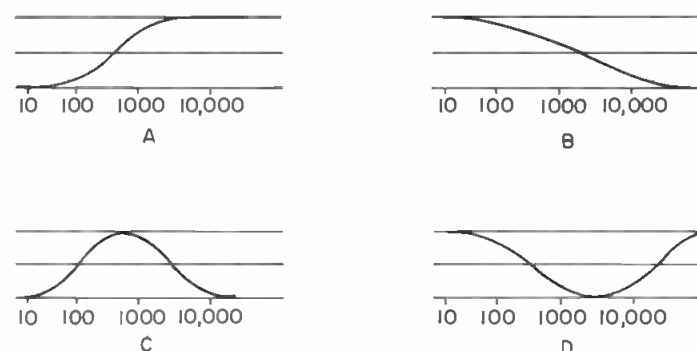

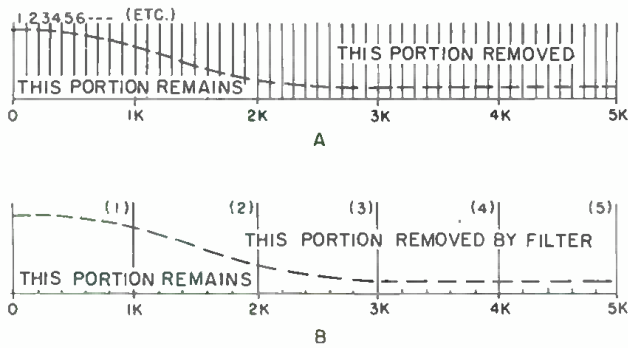

Figure 8. A graph of two sawtooth waves, showing effects when filtered by the same formant filter. At (A) is shown a spectrogram of a one-hundred-cycle sawtooth (all harmonics present) before and after filtering with formant filter. The first ten harmonics are practically unaffected. At (B) is a 1000 Hz sawtooth wave, before and after filtering with the same formant filter as (A) above, showing the difference in the amplitude of the same partials. (Notice that the fifth partial is almost completely suppressed.)

1. Two channels are sufficient for the simulation of a stage at one end of the listening room.
2. Four channels are necessary for true total surround control with all horizontal directions accounted for.
3. It would be necessary to add further channels for the vertical direction if this direction were desired.

DUBBING AND SPLICING

The use of the techniques previously listed (that is, tone generation, modulation, and the encapsulation within one envelope) will produce one element of musical structure. This may be a chord, a tone, or a sound in which all components occur simultaneously. The entire construction is probably best referred to simply as an event.

Any acoustic phenomenon can be broken down into one or more independent components. In the synthesis of a total musical pattern, it will probably be practical to construct the events according to the methods previously outlined. These events must then be assembled in the proper relationships in time. Some pitches will be sounded simultaneously with others but may have longer or shorter durations. Some pitches will be sounded while others have not yet died out. Methods are needed for piecing these parts together as in a puzzle or a mosaic.

Since eventually an entire composition will be assembled on magnetic tape, there is a choice of recording each event on tape separately and then splicing or dubbing (re-recording) the pieces together, or creating the events at the same time that the final version is recorded (real time recording).

Both methods have their supporters and the decision has a basic relationship to the composer's preferences.

Construction of electronic instruments to be performed upon as in the case of traditional instruments. Advantages: Performer has great control over the instrument. He may react as an artist to inspiration at the moment of performance. *Disadvantages:* Complexity is limited by human limitations. Only completed instruments may be used. Special controls are necessary to obtain each desired sound.

Recording each event on tape, followed by assembly of the composition with splicing and dubbing techniques. Advantages: Great complexity is possible. Unlimited flexibility may be attained in setting up individual events. *Disadvantages:* Very slow work; the time required for composition is equal to or greater than that required for traditional composition.

Combinations of the above two methods: parts may be

assembled on tapes and played simultaneously, or groups of events may be constructed in real time and then spliced to assemble the larger pieces of the composition.

Ideally, each type of sound must be produced in the way best suited to it; therefore, the best technique will make use of *all* of the methods available to the composer.

If a composer depends on improvisation only, the first method may be used. The second method is the most precise and also the most difficult. The third method may be used if a composer allows chance (aleatoric) elements in his composition.

Included in the third category is the use of tape loops which are played and superimposed over other material. This technique necessarily involves a certain element of chance, since the moments of intersection of all the events on several loops of tape will probably not be synchronized so that all events will coincide in pre-planned fashion, yet a certain unity in the composition will result.

ENVIRONMENTAL CONTROL

Anyone who has heard sounds in an anechoic chamber will know how great a part of our aural experiences is supplied by reverberation and echo. Man depends upon reverberation and echo to recognize his environment in such simple ways as locating sounds in space, and determining the size, shape, and volume of a room.

The electronic composer has at hand the tools to manipulate this environment in the performance of his music. Reverberation and echo devices may be used to give the listener a sensation of extreme cramped space, great spaciousness, unusual environments such as could not occur naturally, etc. This may be a device of great expressive power if used creatively.

The devices most commonly used for reverberation and echo are the tape recorder reverberation unit, taut springs or sheets of metal with a pickup and a driver, and a hollow tube with a speaker at one end and microphone at the other.

The details of construction of these devices have been related elsewhere and will not be considered here.³ Of greater concern are the ways in which they may be employed.

When a performance takes place in a theater, the same acoustical environment is applied to all events in that performance. Until the discovery of electronic techniques, it was not possible to change this aspect of music. Now it is possible to give each event, instrumental part, section, etc. of a piece of music, its own acoustical environment. Environment consists of several factors including: *echo time* (the time required for the first echo to return); *reverberation time* (the length of time before the reverberating sound dies away to one-tenth its original level); the number of *separate echoes* which unite to form the total reverberation. (In a complex room, every flat surface contributes its own echo, and therefore the result is quite complex); and the *frequency response characteristic* of the reverberation (frequencies most reflected and most attenuated).

Each of the above characteristics has its effect on the environment; through manipulating them, great variety is possible. ■

³ Hahn, S., Reverberation in Audio Reproduction, *Electronics World Magazine* (April, 1962), p. 37-40.

(continued next month)

BOOK CASE

As a service to our readers we are pleased to offer these books from prominent technical publishers. All prices listed are the publishers' net. Shipping charges are included. Use the coupon at the bottom of the page or give the complete title, author and coupon number. Be sure to indicate quantity on the special instructions line if more than one copy of a title is wanted. Full payment must accompany your order. We cannot ship c.o.d. Checks or money orders should be made payable to Sagamore Publishing Company, Inc. Because of the time required to process orders, allow several weeks for the receipt of books.

Radio Engineering Handbook, 5th Ed.
Henney. Prepared by a staff of specialists, this working manual of radio science provides information on each of the branches of radio engineering, with emphasis on working practice, final working formulas, dimensions, and actual useable circuits.

1959. 1,800 pp. **\$31.50**
Circle 36 on Coupon Below

Radio Transmitters

Gray and Graham. Provides, in a logical, easy-to-understand manner, a working knowledge of radio transmitters for quick solution of problems in operation and maintenance.

1961. 462 pp. **\$16.00**
Circle 40 on Coupon Below

Electronic and Radio Engineering, 4th Ed.

Terman. A thorough coverage, in easy-to-understand terms, of those principles and techniques which are the basic tools of the electronic and radio engineer. 1955. 1,078 pp.

\$19.50
Circle 39 on Coupon Below

The Technique of the Sound Studio

by Alec Nisbett. This is a handbook on radio and recording techniques, but the principles described are equally applicable to film and television sound. 264 pages; 60 diagrams; glossary; indexed; 5 1/2 x 8 1/2; clothbound.

\$13.50
Circle 1 on Coupon Below

Radio Broadcasting

edited by Robert L. Hilliard. Each of the five chapters has been written by a prominent educator with an extensive background of practical experience in commercial and educational broadcasting. 190 pages; 6 1/4 x 9 1/2; indexed; clothbound.

\$6.95
Circle 2 on Coupon Below

Transistors for Audio Frequency (Audio-Frequency Amplification)

by Guy Fontaine. 1967. This systematic and detailed treatment of the application of transistors in audio-frequency amplifiers shows how the published transistor characteristics are related to the principles of design. An ideal textbook or reference on the subject for engineers and advanced technicians. 384 pages; 5 1/2 x 8; illus.; clothbound.

\$7.95
Circle 12 on Coupon Below

Closed-Circuit Television Handbook

by Leon Wortman. Gives comprehensive detailed information about the field in an easy-to-understand presentation, suited to those who plan to use, install, and service cctv. 288 pages; 5 1/2 x 8 1/2; clothbound.

\$5.95
Circle 18 on Coupon Below

An Alphabetical Guide to Motion Picture, Television, and Videotape Production

Levitan. This all-inclusive, authoritative, and profusely illustrated encyclopedia is a practical source of information about techniques of all kinds used for making and processing film and TV presentations. Gives full technical information on materials and equipment, processes and techniques, lighting, color balance, special effects, animation procedures, lenses and filters, high-speed photography, and much more.

1970. 480 pp. **\$24.50**
Circle 35 on Coupon Below

Integrated Circuits

Motorola. This complete, authoritative volume of design and construction techniques for modern integrated circuits covers theory, thin-film techniques, diodes, transistors, thermal design, and other vital aspects.

1965. 373 pp. **\$13.75**
Circle 30 on Coupon Below

Basic Bibliography of Science and Technology

McGraw-Hill. Important to the researcher, librarian, or student, this reference book lists and describes over 8,000 outstanding books in every scientific and technical field. A topical index organizes all subject headings into about 100 general categories enabling the reader to locate quickly the listings which pertain to his field of interest.

1966. 738 pp. **\$19.50**
Circle 34 on Coupon Below

Noise Reduction

Beranek. Designed for the engineer with no special training in acoustics, this practical text on noise control treats the nature of sound and its measurement, fundamentals of noise control, criteria, and case histories. Covers advanced topics in the field.

1960. 752 pp. **\$19.50**
Circle 33 on Coupon Below

The Audio Cyclopedia (2nd ed.)

by Dr. Howard M. Tremaine. New and updated, here is the complete audio reference library in a single volume. It provides the most comprehensive information on every aspect of the audio art. This new edition includes the latest audio developments including the most recent solid-state systems and integrated circuits. It covers all subjects in the fields of acoustics, recording, and reproduction with more than 3400 related topics. Each topic can be instantly located by a unique index and reference system. More than 1600 illustrations and schematics help make complicated topics masterpieces of clarity. 1760 pages; 6 1/2 x 9-3/8; hardbound.

\$29.95
Circle 20 on Coupon Below

Circuit Design for Audio, AM/FM, and TV

Texas Instruments. Texas Instruments Electronics Series. Discusses the latest advances in electronic design and application which represent the results of several years research and development by TI communications applications engineers. Emphasizes time- and cost-saving procedures throughout. 1967. 352 pp.

\$14.50
Circle 32 on Coupon Below

Acoustics—Room Design and Noise Control

by Michael Rettinger. 1968. The enormous problems and hazards presented by noise are dealt within an orderly and practical manner. With many charts, graphs, and practical examples, the text covers the physics of sound, room acoustics, and design, noise and noise reduction. 392 pages; hardbound.

\$17.50
Circle 21 on Coupon Below

Sagamore Publishing Company, Inc.

980 Old Country Road, Plainview, N. Y. 11803

Please send me the books I have circled below. My full remittance in the amount of \$..... is enclosed. N.Y. State residents add 6% sales tax.

1 2 3 4 5 6 7 8 9 10 11 12 13 14 15 16 17
18 19 20 21 22 23 24 25 26 27 28 29 30 31 32
33 34 35 36 37 38 39 40

Name

Street Address

City State Zip

Special Instructions

Canada and foreign: Add \$1.00 per book

Acoustical Tests and Measurements
by *Don Davis*. Provide; a solid understanding of the entire subject of acoustical measurements; based on actual field test work, using commercial equipment. 192 pages; 5 1/2 x 8 1/2; hardbound. **\$6.95**
Circle 7 on Coupon Below

Television Broadcasting
Chinn. A practical, compact technical guide to the equipment, systems, facilities, good engineering practices, and operating techniques of television broadcasting. 1953. 695 pp. **\$17.00**
Circle 37 on Coupon Below

Handbook of Electronic Tables & Formulas, (3rd edition)
A one-stop source for all charts, tables, formulas, laws, symbols, and standards used in electronics. Includes an 8-page, full-color fold-out chart showing latest FCC allocations for the entire frequency spectrum. 232 pages; 5 1/2 x 8 1/2; hardbound. **\$5.50**
Circle 8 on Coupon Below

Handbook of Broadcasting, 4th Ed.
Abbott and Rider. This non-technical handbook sets forth clearly and thoroughly the fundamentals of radio and television broadcasting. Over 100 illustrations amplify the text. 1957. 531 pp. **\$9.50**
Circle 38 on Coupon Below

Electronic Musical Instruments
by *Richard H. Dorf*. Now in its third edition and sixth printing since its first appearance in 1954, this is considered the authority on electronic organs. 393 pages; 239 diagrams and photographs. **\$10.00**
Circle 19 on Coupon Below

Intermodulation and Harmonic Distortion Handbook
by *Howard M. Tremaine*. A complete reference guidebook on audio signal intermodulation and harmonic distortion. 172 pages; 5 1/2 x 8 1/2; soft-bound. **\$4.25**
Circle 9 on Coupon Below

Solid-State Electronics
Hibberd. A Basic Course for Engineers and Technicians. An extremely practical reference book for anyone who wants to acquire a good but general understanding of semi-conductor principles. Features questions to answer, problems to solve. 1968. 169 pp. **\$9.95**
Circle 31 on Coupon Below

Practical PA Guidebook: How to Install, Operate and Service Public Address Systems
by *Norman H. Crowhurst*. 1967. This book gives all the basics needed to become a successful PA operator, in any situation where the reinforcement, relay, or distribution of sound can provide a service. 136 pages; 6 x 9; illus.; softbound. **\$4.50**
Circle 15 on Coupon Below

CLASSIFIED

Closing date is the fifteenth of the second month preceding the date of issue. Send copy to: Classified Ad Dept.
db THE SOUND ENGINEERING MAGAZINE
980 Old Country Road, Plainview, New York 11803

Rates are 50¢ a word for commercial advertisements. Non-commercial and employment offered or wanted placements are accepted at 25¢ per word.

FOR SALE

AMERICA'S LARGEST SELECTION of new and used broadcast and recording equipment! Latest bulletins available. **The Maze Corporation, P.O. Box 6636, Birmingham, Ala. 35210.**

RCA 73B lathe: \$100. Universal 1108 amplifiers: \$50.00. Universal 1176 limiters: \$350.00. Western Electric 618 mikes: \$50.00. **G.A.T.E. Sound, 351 "G" Street, San Rafael, California 94901.**

WHATEVER YOUR EQUIPMENT NEEDS—new or used—check us first. Trade your used equipment for new. Write for our complete listings. **Broadcast Equipment & Supply Co., Box 3141, Bristol, Tenn. 37620.**

SCULLY TAPE RECORDERS—one to twenty-four track and model 270 auto players, many models in stock for immediate delivery. SCULLY LATHES—Previously owned and rebuilt. Variable or automatic pitch. Complete cutting systems with Westrex heads. MIXING CONSOLES—Custom designed using Wiegand Audio Lab modules. From \$7,000.00. **Wiegand Audio Laboratories, 3402 Windsor Road, Wall, New Jersey 07719. Phone: 201 681-6443.**

ONE STOP FOR ALL your professional audio requirements. Bottom line oriented. **F.T.C. Brewer Company, P.O. Box 8057, Pensacola, Florida 32505.**

SOLID-STATE AUDIO PLUG-IN OCTAL (1" Dia. x 2" H) modules. Mic preamps, disc & tape preamp-equalizers, tape bias osc & record ampl power amps & power supplies. Send for free catalog and audio applications. **Opamp Labs., 172 So. Alta Vista Blvd., Los Angeles, California 90036.**

NEW YORK'S LEADING supplier of professional recording equipment and hi-fi stereo components. All major brands in stock. Call for quote—sales—service—leasing—trade-ins. **Martin Audio, 320 West 46th Street, New York, N.Y. 10036. Telephone: (212) 265-6470.**

TELEX FOUR-SLAVE two track stereo tape duplicator. Like new, in cabinets. Telex three- or five-slave mono tape duplicator, good condition, in cabinets. **O'Connor Recorders, 1680 Vine, Hollywood, California, Telephone (213) 461-3393.**

EMPLOYMENT

PROFESSIONAL RECORDING PERSONNEL SPECIALISTS. A service for employers and job seekers. Call today! **Smith's Personnel Service, 1457 Broadway, N.Y.C. 10036. Alayne Spertell 212 Wi 7-3806.**

PEOPLE, PLACES, HAPPENINGS

● An announcement from **Gately Electronics** details an arrangement formulated between **Edward Gately** of the Havertown, Pa. firm and **Dr. Karl Schoeps** of **Schalltechnik**, Karlsruhe/Baden, Germany. Gately Electronics now becomes the exclusive import agent for **Schoeps** microphones in North America.

● The Center for Environmental Design at The University of Wisconsin has been established to initiate interdisciplinary instruction and research for graduate students who will ultimately participate in the design professions of architecture, landscape architecture, urban and regional design, industrial design, residential design, interior design and some fields of engineering design.

The Center was established after a two year period of study by faculty committees representing ten academic disciplines. The need for environmental design research and instruction leading to the degree of Master of Science was based on the premise that man is the most important element of society; that research findings have identified relationships between physical surroundings and human performance; that physiological health and psychological well-being are affected by environmental variables; and that social behavior is influenced by enabling elements of physical environment.

The program is aimed at expanding the knowledge of human needs required for all design disciplines and encourages collaborative design experience and research investigations in collaboration with students representing academic source disciplines as well as design students. Team teaching of design problems is aimed at giving students the benefit of critiques by individuals representing both a broad spectrum of design disciplines and the natural, physical and social sciences.

Further details can be obtained by writing the Design Center at the University of Wisconsin, Madison, Wisconsin.

● From England we learn that **Victor Perks**, sales director of **Rupert Neve & Co. Ltd.** has resigned in order to devote himself more fully to wider fields of Christian religious work, a subject of deep personal interest.

● If you've noticed **John Woram's** column missing this month, it's because he has been busy with the involvement of his new position as manager of studio operations for **Vanguard Records**. His monthly column will resume, he assures us, next month. He comes to Vanguard from **RCA** where he had spent many years as a recording engineer. At Vanguard, he assumes executive functions but will continue to be active as a recording engineer as well. We certainly wish him well in his new position.

● **JBL** has reorganized the service and technical information activities by separating them into a customer repair service department under **Rocky James** and a technical information service group headed by **Tom Campbell**, technical editor. According to **Irv Stern**, executive v.p., this will increase the over-all efficiency in handling repairs for consumers and provide increased product information for **JBL** customers, dealers and representatives.

● **Robert N. Vendeland** has been appointed manager, professional equipment division of **JBL**. Mr. Vendeland will be responsible for sales management of both oem products and professional applications equipment. He comes to **JBL** with a record in various technical and managerial aspects of the communications industry. He has been sales manager of the **Conrac Division of Conrac Inc.**, as well as its general manager at one point. He also spent two years with **Dynair Electronics** in the marketing of industrial and educational t.v. systems. Prior to that he was with **Jerrold Electronics** for nine years in the design and marketing of r.f. distribution systems, c.a.t.v. development and closed-circuit t.v. Mr. Vendeland has most recently been active as an independent consultant in the marketing of communications systems.

● **Phillip Petruzzellis** has been named to the new post of vice president of manufacturing operations for the recording automation group of **Dictaphone Corporation**. Petruzzellis will have line responsibility for manufacturing, including cost and quality control, scheduling and materials management at both the **Scully** and **Metrotech** divisions.

● **MCA Technology**, a subsidiary of **Music Corporation of America**, has recently completed a physical re-location to North Hollywood, California. The **Electrodyn**, **Langevin**, **Gauss** and **UDAC** divisions and their operations have been physically transferred into a 25,000 square foot, modern facility located at 13035 Saticoy Street North Hollywood, California, 91605. The North Hollywood facility will house all of the sales, engineering, manufacturing and accounting operations for these divisions. **Lee Grundeis**, **MCA Technology** vice-president of operations, stated, "the transfer of the divisions and their respective product lines into this modern facility will enable **MCA Technology** to maintain closer contact with its customers and to maximize service."

The **Optimization** and **Saki Magnetics** divisions remain at their respective locations in Sun Valley and Santa Monica. **MCA Technology** currently employs 200 people.

● **Harry A. Young** has joined **Quad-Eight** as sales manager—motion picture division. He will be responsible for sales and marketing of **Magna-Tech Film Equipment** and **Quad-Eight** consoles and systems for the motion-picture industry. Mr. Young has had 34 years experience in the film division of **RCA** and is well known in the motion-picture field.

● **Shure Brothers Incorporated**, Evanston, Ill., has announced the appointment of **William R. Graham** to the new position of special assistant to the senior vice president of marketing and manufacturing. Prior to joining **Shure**, he was manager of materials for **Whirlpool Corporation**. He will be working with the top management at **Shure** to solve complex material problems and will be responsible for all the company's materials departments.

● **Mort Sumberg**, former director of sales and marketing of sound products and engineered systems at the **Bogen Division of Lear Siegler, Inc.** and **Norm Sanders**, former sales and marketing director for **Bogen** high-fidelity equipment have formed **Gotham Marketers, Inc.**, a manufacturers' representative firm. **Gotham** has been appointed metropolitan New York area reps for the **Bogen** and **Electro-Voice** lines. The firm has its office at 753 Bergen Blvd., Ridgely, N.J. 07657.

For technical sound recording everything points to Revox

Separate spooling motors of original high torque, low weight construction.

Sealed mains input section and cabinet safety link socket.

Fully electronically stabilised power supply circuit.

Capstan motor servo control panel maintaining speed accuracy to better than 0.2% and incorporating electronic speed change from $7\frac{1}{2}$ to $3\frac{3}{4}$ ips.

Capstan motor of patented construction, cool running, low current consumption and wow and flutter better than international broadcast requirements.

Professional practice glass-fibre panel with integral gold-plated switch contacts.

Unique multi-bank micro-switch unit, providing on-off, speed and spool size/tension variations on one control.

Plug-in record relay.

Plug-in 120 Kc/s bias oscillator obviates multiplex interference.

Plug-in audio input/output amplifiers.

Read head of capstan motor.

Tape transport logic control circuit panel.

Plug-in relays controlling all functions and eliminating damage from inadvertent mis-handling.

New from the Willi Studer Factory comes the revolutionary Model 77 incorporating design developments based on experience gained in the broadcast field with the 37 and 62 Series Studer machines. The 77 is a studio quality machine compactly presented and offering features unique in this price class including total

Write or telephone for further information to:—

REVOX delivers what all the rest only promise.

Revox Corporation, 155 Michael Dr., Syosset, N. Y. 11791
1721 N. Highland Ave., Hollywood, Calif. 90028
In Canada: Tri-Tel Associates, Ltd., Toronto, Canada

indifference to fluctuations in mains supply periodicity. With a wow and flutter level below broadcast standard requirements plus a linear response from 20-20,000 Hz at $7\frac{1}{2}$ ips. (± 2 db) and an ultra low noise level, this new Revox will fulfill virtually every scientific and industrial requirement in the sonic band.



Circle 11 on Reader Service Card

PROTECT NOTES

DESIGN THE "IDEAL" LIMITER

PROBLEM — CONVENTIONAL PEAK LIMITERS DON'T RECOGNIZE APPARENT LEVEL

SOLUTION — CREATE A UNIQUE QUASI-RMS ACTIVATED LIMITER TO YIELD PRECISE APPARENT LEVEL CONTROL. — THIS CREATES ANOTHER PROBLEM —

RMS LIMITING CANNOT CONTROL ELECTRICAL WAVEFORM PEAKS

SOLUTION — ADD A SECOND LIMITER WHICH IS PEAK ACTIVATED...



MAKE 2 COORDINATED THRESHOLDS, ONE PEAK ACTIVATED, ONE QUASI-RMS ACTIVATED, WITH VARIABLE SEPARATION OF THRESHOLD LEVELS!
— PERHAPS SEPARATE INDICATOR FOR EACH THRESHOLD —

PROBLEM — MECHANICAL NOT FAST LIMITING ACT

SOLUTION —

Higher frequencies usually require limiting and are more troublesome. Short duration reduced performance on instruments and pops could be controlled requiring fast reaction time of a device.
Low frequencies because of their inherent release times of slow release times.
When limiters don't exist in a natural function purely of attack time). In the lowest reproducible frequency, is the most inconspicuous release time of a device.
The most conspicuous release time of a limiter is its interaction and lack of audible degradation stated as the fastest-time-possible.
One would think the most inconspicuous after limiting would be instantaneous. But problems of producing harmonic distortion to preserve the quality of the sound, dynamic range, low distortion, the release time is varied from a second to several seconds depending on the severity of limiting action. The more severe the

HEY!
THEY ALREADY MAKE ONE.

GAIN·BRAIN™

knows what you want to hear. It's activated by both the peak and the RMS content of the input waveform. The result is a really accurate control of the output level, for all the instruments, plus an absolute control of peaks. Depending upon your needs, the GAIN BRAIN may be adjusted to act only as a peak limiter, or only as an RMS limiter or anywhere in between.

Light emitting diodes sequentially indicate the gain reduction and the mode of limiting.

This is only the beginning. Contact your nearest Allison distributor or the factory for GAIN BRAIN's astonishing spec sheet.



ALLISON RESEARCH, INC.
7120 SUNSET BOULEVARD
HOLLYWOOD, CALIF. 90046

(213) 874-6615

Exclusive export agent: GOTHAM AUDIO DEVELOPMENT CORP., NEW YORK, N.Y.

ATTACK TIME ≤ 1 μSEC, SNR > 80 dB, THD ≤ 0.3%
EVEN AT LOW FREQUENCIES, +24 dBm OUTPUT CAPABILITY, STEREO INTERCONNECT CAPABILITY, ULTRA-SMALL SIZE & PRICE!

Circle 12 on Reader Service Card