

High-Fidelity

SEP-OCT ISSUE
VOL. 2 No. 2

Published by Milton B. Sleeper

Price \$1.00



PLAYBACK OF A FIRST RECORDING

The Magazine for Music Listeners

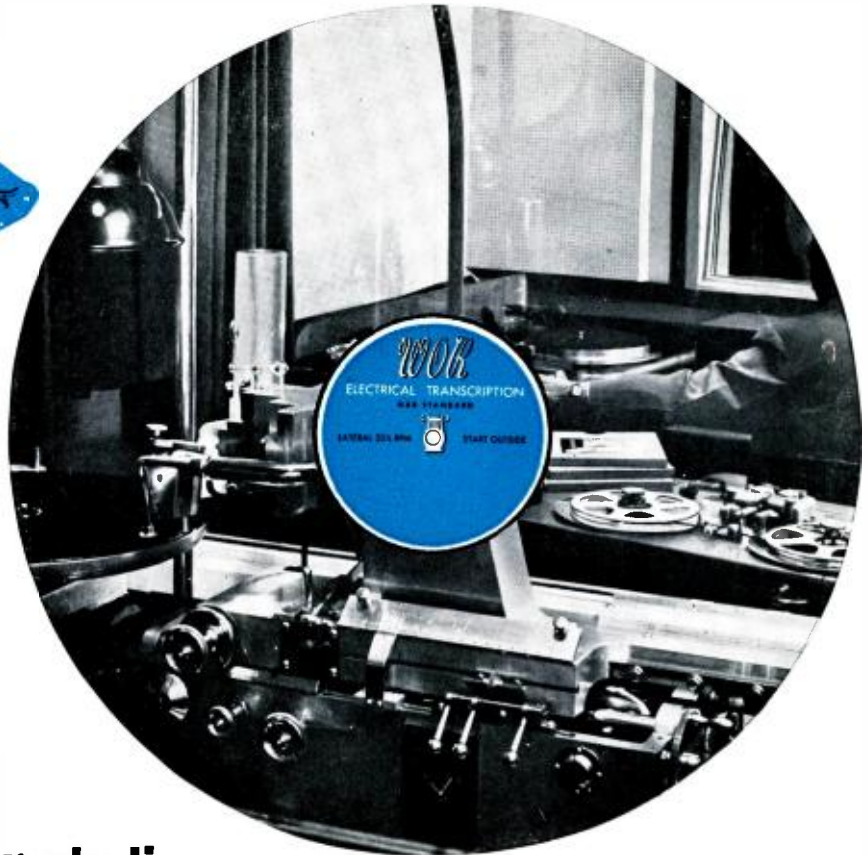

**Behind the
familiar
blue label of
WOR recording studios . . .**

the finest in modern sound recording methods and equipment

Radio stations from coast to coast recognize this label as the mark of a top quality transcription. One that can be depended on to meet or exceed the extremely high broadcast standards of sound quality.

To maintain this reputation, WOR Recording Studios, one of the largest in the world, use the finest and most costly tape and disc recording equipment obtainable. And—what's equally important—their engineers have found that Audiotape and Audiodiscs are an ideal combination for meeting the exacting requirements of broadcast transcription and commercial recording work. This same record-making combination is also being used with outstanding success by America's leading producers of fine phonograph records.

With Audiotape and Audiodiscs, you can achieve this same sound perfection in *your* recording work, too. Their consistent, uniform quality is the result of more than 12 years of specialized experience by the only company in America devoted solely to the manufacture of fine recording media, both tape and discs.

AUDIO DEVICES, Inc.

444 MADISON AVE., NEW YORK 22, N. Y.
Export Dept.: 13 East 40th St., New York 16, N. Y., Cables "ARLAB"

...including

audiotape*



and **audiodiscs***



**Trade Mark*



music lover

audio hobbyist

professional

here's your copy of the new Jensen high fidelity brochure 1020

20 comprehensive pages about high fidelity sound—
including a complete listing of the Jensen Silver
Anniversary line...loudspeakers and cabinets of
unprecedented importance to everyone seeking the finest
reproduction quality attainable today.

write for your free copy!

Jensen

JENSEN MANUFACTURING COMPANY
DIVISION OF THE MUTER COMPANY
6601 S. LARAMIE AVE., CHICAGO 38, ILLINOIS
IN CANADA:
COPPER WIRE PRODUCTS, LTD., LICENSEE



HEAVY DRIVE SHAFT:
A unique feature! Exclusive with Garrard!
Drive shaft for 33 1/3 rpm and 45 rpm is heavy, thus obtaining more consistent quality at critical low speeds. Wows and wavers eliminated.

TRIPLE SPEED SWITCH:
Speed changes are clearly marked, easily made. The RC-80 plays 33 1/3, 45 and 78 rpm. Records are placed on the player and simple settings made. Action is then completely automatic, including automatic shut-off after last record of any size.

CONVENIENT START-STOP-REJECT LEVER:
Start, stop and reject lever are combined and located conveniently away from tone arm.

PUSHER TYPE PLATFORM:
Adjusts simply to 7"-10"-12" records regardless of diameter or size of spindle hole.
No record changing mechanism has been developed to equal the performance of the precision pusher platform. For records with standard center holes, the pusher platform is the only method that gives positive gentle record operation.

PULL-AWAY IDLER WHEEL:
Avoids flattening of drive wheel when changer is not operating.

AUTOMATIC STOP:
Insures positive and unfailing action at end of any type record.

BALANCE-MOUNTED TONE ARM:
Parallel lift tone arm construction guarantees true tangent tracking. Disturbing resonance eliminated.

INTERCHANGEABLE PLUG-IN HEADS:
Carefully engineered to accommodate user's choice of crystal or magnetic cartridges for standard and micro-groove reproduction, such as Astatic, Pickering, Audak and GE twist models.

GARRARD WORLD'S FINEST RECORD CHANGER

WEIGHTED TURNTABLE:
RC-80 turntable is heavily weighted to give flywheel action so that any variations in the drive motor are not reflected in record reproduction. No turntable rumble.

HEAVY DUTY SILENT 4-POLE MOTOR WITH ABSOLUTELY NO RUMBLE:
Speed maintained throughout a wide variation in line voltage. There is no appreciable speed variation operating unit "cold" with a full load or "hot" with one record, regardless of weight, thickness or diameter of records.

IMPORTANT!
Only a 4-pole motor can assure no hum when used with sensitive magnetic pickups.

TWO INTERCHANGEABLE SPINDLES:
Easily inserted, the two Garrard Spindles accommodate all records as they were made to be played. (If user prefers one spindle can be used throughout simply by plugging center hole of 45 rpm records.) a: Typical Garrard spindle for standard center holes. b: Easily inserted wide spindle, for 45 rpm records, remains stationary when record is played. Only a small collar revolves, assuring longer center hole and record wear.

PRECISION GROUND GEARS
Perfectly meshed to insure constant smooth action and years of service.

MUTING SWITCH:
No sound while changer operates on run-in or run-off grooves. Continuity of music undisturbed by noises.

WATCH-LIKE CONSTRUCTION
All parts are precision made, fastidiously assembled and simple to adjust.

A complete stock of replacement parts is readily available to all Garrard owners.

For an excellent description of what to look for in a record changer, we recommend the section devoted to changers in the new book "High-Fidelity Simplified", published by John F. Rider.

MAIL COUPON TODAY
for Garrard Fact Sheet and addresses of dealers,
to Garrard Sales Corp., Dept. 3GF
164 Duane Street
New York 13, N. Y.

Send literature to
Name.....
Address.....
City.....Zone.....State.....

We print this page in order to show you the superb engineering which has caused thousands upon thousands of discriminating people, who enjoy records, to insist upon the Garrard "Triumph", World's Finest 3-Speed Record Changer. Take this advertisement to your favorite sound department, and judge for yourself!
\$42.30 net, less cartridges

AUTHORitatively Speaking

First playback of a first recording is a tense moment. This month's cover catches some of that tenseness, as expressed by — starting at the upper left and reading counterclockwise: Joseph Blatt, Eleanor Steber, Fritz Stiedry, Blanche Thebom, Roberta Peters, David Oppenheim, James Deane, and John Mundy. The occasion is Columbia's recoding of Mozart's *Cosi fan tutte*. What is one of our authors doing on the

front cover, you ask? That's easy — getting the story of the cover picture! James Deane, records editor of the Washington Evening Star, covered one of the *Cosi fan tutte* sessions for his paper. To us he brings sidelights of the session, in pictures and words, beginning on page 19.

Our roving publisher, Milton Sleeper, went out to the West Coast this summer to further the cause of HIGH-FIDELITY and, while furthering with Capitol Records, asked a leading question: how do you determine which records warrant the FDS (Full Dimensional Sound) seal? Their answer is on page 29.

In our mail one day was a letter from J. Gordon Holt asking if we would like to know how to make a treasured 78 rpm. disc last forever. Now, we are allergic to wild-eyed advertising claims, so our reaction was highly negative. Nevertheless, we bit. Glad we did, too; it's a true story, it begins on page 32, and it works. Now it's your turn to bite.

This is definitely the time of year when hi-fi, along with all other infant prodigies, should be sent to school. On page 35, Ulric J. Childs does this for us, when he describes a hi-fi installation in a school auditorium.

Members of the Air Coupler Brigade will have their appetites whetted by the article on page 46, wherein R. S. John tells how he built an 8-ft. reflex Air Coupler which employs a 15-in. speaker.

We hesitate to recommend the article by Roy Allison on page 73 because we are not in a position to furnish the smelling salts which readers who approach the article incautiously will require before they are halfway through. Nevertheless, Mr. Allison's article on dividing networks is a bold, frontal attack on an extremely complex matter. When not writing articles on networks, Mr. Allison edits our sister publication, RADIO COMMUNICATION, a highly technical journal which we have never read. — C. F.

Branch Offices (advertising only): NEW YORK, Room 1209, 6 East 39th Street. Phone: MURRAY Hill 5-8332. Fred C. Michalove, *Eastern Manager*. CHICAGO, 176 W. Washington Street. Phone: Central 6-0469. Charles Kline, *Western Manager*. LOS ANGELES, 1052 West 6th Street. Phone: Michigan 1732. Edward Brand, *West Coast Mgr.* Published by: AUDIOCOM, INC. at Great Barrington, Mass. Tel. Great Barrington 1300. HIGH-FIDELITY is issued bi-monthly in January, March, May, July, September and November. Single copies \$1.00—Subscription rate: \$10.00 for three years, \$5.00 for one year in the U. S. A., its Possessions, and Canada. In all other countries: \$6.00 for one year, \$13.00 for three years.

Editorial contributions will be welcomed by the Editor. Payment for articles accepted will be arranged prior to publication. Contributions will be neither acknowledged nor returned unless accompanied by adequate postage, packing, and directions, nor will HIGH-FIDELITY Magazine be responsible for their safe handling in its office or in transit.

The cover design and contents of HIGH-FIDELITY magazine are fully protected by U. S. copyrights, and must not be reproduced in any manner or in any form without written permission.

High-Fidelity

THE MAGAZINE FOR MUSIC LISTENERS

Volume 2 Number 2

September-October 1952

CONTENTS

As the Editor Sees It	4
Noted With Interest	7
Reader's Forum	12
Birth of an LP, by James G. Deane	19
What goes on at an important recording session? How are the tapes and master discs checked and tested? Here is the story, in pictures and running commentary.	
Ideas—from professionals and amateurs	24
A five-page section of ideas for home music system installations.	
Rating Recorded Music, by Milton B. Sleeper	29
A method of rating the musical and technical quality of phonograph records, as used by a leading record company.	
Immortality for the Immortals, by J. Gordon Holt	32
Complete details on how to preserve 78 rpm. records by transferring the sound to tape.	
Hi-Fi Goes to School, by Ulric J. Childs	35
Designing and installing a high fidelity music system in a school auditorium.	
The Loudspeaker, by G. A. Briggs	39
The why and wherefore of loudspeakers; how they work, and how they can be improved.	
London Newsletter, by Donald W. Aldous	44
English and European activities in the field of sound and recording.	
The Better the Bass, the Better the Sound, by R. S. John	46
Design and construction of an eight-foot air coupler.	
RECORDS AND MUSIC SECTION	49-72
Records in Review	49
The Records of Handel, by C. G. Burke	60
Another in the author's series on the recorded works of the great composers.	
Hither and Yon: Musically	68
The Music Between, by Edward L. Merritt, Jr.	70
A third report on semi-classical music.	
How to Design a Dividing Network, by Roy F. Allison	73
Design data for seventy-six dividing networks.	
New Books	90
Tested in the Home:	
The MagneCordette	96
The General Electric Reluctance Cartridge	108
The Brociner Control Amplifier	111
The Sargent-Rayment Tuner and Amplifier	114
Traders' Marketplace	103
New Equipment	105
Professional Directory	116
Advertiser's Index	119

CHARLES FOWLER, Editor

JOHN M. CONLY, Associate Editor

MILTON B. SLEEPER, Publisher

Copyright 1952 by Audiocom, Inc.

AS THE EDITOR SEES IT

IN JULY, we sweated out a session in Washington during which we observed the birth of a new, nationwide organization, planned to provide important services to music lovers and audiophiles throughout the Country.

The broad purposes of the organization, as stated in its constitution, are:

1. To stimulate interest in the subject of music in all its forms.
2. To encourage a better understanding of the creation and reproduction of music.
3. To provide for the exchange and development of knowledge and information among its members.
4. To provide members with guidance in the technical means of attaining high quality reproduction.

Thus, as we go to press, there is in existence the *Society of Music Enthusiasts*, an organization which will serve and assist individuals as well as music listening and hi-fi groups by providing information and — most important — program material, such as discs and tapes, for local group meetings.

Here at HIGH-FIDELITY we have long felt the need for a Society of Music Enthusiasts. We have received dozens of letters from groups, asking for assistance and suggestions to stimulate interest among their members. We have received many more letters from individuals asking if there were local groups whose meetings they could attend. We have received requests from schools, for help in selecting equipment and in planning music appreciation courses.

The purposes of the SME are broad. Its immediate activities will be toward organizing local chapters as quickly as possible. To that end, it is necessary, first, to find out who is interested in joining and supporting the SME and to interest more people in belonging to the Society. Meanwhile, plans will be set in motion to prepare the tapes and discs to be loaned without charge to local groups of members.

The tapes and discs will fall into two general categories: those on music and those on hi-fi equipment. For example, tapes might be available on What Is an Oboe, and on What Is a Preamplifier. As local chapters grow, live demonstrations will be scheduled.

There will be several classes of membership, to provide for individuals who are attached to local groups, and for those who do not belong to a local chapter but want to share in SME activities. There will also be family memberships and other classes of affiliation. The complete details will be ready in time for publication in the November issue of HIGH-FIDELITY.

The organizers of the SME met with the HIGH-FIDELITY staff in August to discuss the myriad problems of setting up the working organization. By-laws are one thing; an active and growing organization is another. At that time, HIGH-FIDELITY decided to go beyond opening its pages to news of the SME by, in effect, sponsoring the organization. While the SME will remain autonomous (local chapters will elect representatives to regional and national councils), HIGH-FIDELITY will handle the mechanics of processing membership applications, provide headquarters and mailing facilities, and undertake the publication of a bulletin for the Society. The bulletin, by the way, will contain news of local and national SME activities, and special articles prepared under the auspices of the Society.

Basic membership dues in the SME have been established at \$3 per year, which includes the bulletin. Members who are also subscribers to HIGH-FIDELITY will receive their bulletins bound into the Magazine. The economy thus effected will be passed onto such subscriber-members by reducing the dues to \$2 a year.

Let it be stated clearly at this time that it is not in any way necessary to subscribe to HIGH-FIDELITY in order to belong to, and benefit from, the Society of Music Enthusiasts. HIGH-FIDELITY is supporting the Society as fully as possible because it is our belief that the enjoyment of fine music can be encouraged most effectively by all of us working together in an organized, coordinated effort.

We hope our readers will join with us in giving full support to the SME. If you are interested, drop a card to: Society of Music Enthusiasts, Great Barrington, Mass. As soon as complete details and application blanks are available, they will be sent to you.

To the SME: good luck!



the beautiful *Peerage*

sound equipment console
for music lovers!

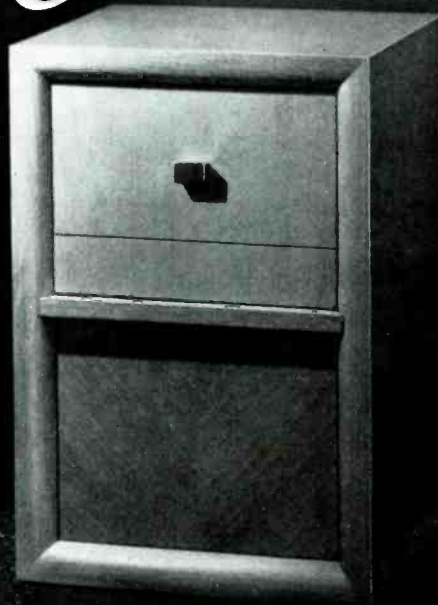

Pivoted, tilting top panel opens with brass pull and mounts all conventional tuners. In open position, controls are at easy-to-read 65 degree angle. Amplifier is mounted on back panel which is readily removed. Changer drawer is directly below tuner panel and is mounted on roller slides for smooth operation.

Note how the PEERAGE complements the famous E-V Aristocrat folded-horn enclosure (below). Its simple, graceful lines harmonize with other E-V enclosures as well and lend themselves to any contemporary setting.



Now, for the first time, a truly beautiful and practical console expressly designed to house virtually any combination of the popularly-known tuners, amplifiers and record changers! Made by furniture craftsmen, the PEERAGE is so cleverly planned that it is a simple task to install—at home, with ordinary tools—all the components needed for High Fidelity sound reproduction. The PEERAGE is made of sturdy, kiln-dried veneers and is available in lustrous Tropical Mahogany or sparkling Blond Korina.

Write for complete brochure No. 192 showing mounting arrangements, internal compartment sizes, and tuner-amplifier and changer combinations which fit the PEERAGE—or see your local E-V distributor.

DIMENSIONS:
29 $\frac{3}{4}$ " high, 20 $\frac{1}{2}$ " wide, 18 $\frac{3}{4}$ " deep.
WEIGHT: Net, 43 lbs.; Shipping, 52 lbs.
PRICE (less tuner, amplifier and changer):
MAHOGANY, List, \$130.00, Audio-ophile Net, \$78.00;
BLONDE, List, \$140.00, Audio-ophile Net, \$84.00.

Electro-Voice Inc., Buchanan, Michigan

Export: 13 E. 40th St., New York 16, U.S.A. Cables: Arlab

THE NEW Webcor® HF SERIES



America's Newest High Fidelity Diskchanger

From the research laboratories of Webster-Chicago comes the new HF series Diskchangers—designed and engineered especially for the challenging task of gently, quietly and quickly changing records in the finest high fidelity installations.

Wherever one sees the handsomely designed Webcor HF Diskchanger, it is the symbol of both quality and luxury. No other changer made delivers the satisfaction that comes with the trouble-free operation of the master mechanical part of any HF installation.



- Webcor HF is a "push-off" type changer considered by experts to be the most gentle method of changing records.



- Webcor HF features the new Webster-Chicago Velocity Trip mechanism for fool-proof, jam-free operation with a minimum of lateral needle pressure.



- Webcor HF has one simple speed control, conveniently located. It is easily accessible in all types of installations.



- Webcor HF has an exclusive "CLICK" muting switch for silencing the amplifier during the record changing.



- Webcor HF series has the Webcor exclusive electrostatically flocked turntable which forms the thickest carpet to provide the softest cushion for record drop.



- Webcor HF series has an extra heavy mainplate made of 18 gauge steel. A bridge-like construction assures that the mainplate will never warp.

The HF series is available in five models:

Webcor 127-HF—a base pan model equipped with turnover crystal cartridge.

Webcor 127-27-HF—a base pan model equipped for use with individual plug-in magnetic or variable reluctance cartridges.

Webcor 127-270-HF—a base pan model equipped with a G.E. Triple Play variable reluctance cartridge.

Webcor 126-HF—a replacement Diskchanger equipped with turnover crystal cartridge.

Webcor 126-27-HF—a replacement Diskchanger for use with individual plug-in magnetic or variable reluctance cartridges.

© W/C 1952

All music sounds better on a

Webcor

by WEBSTER-CHICAGO



1952

Noted with Interest:

Associate Editor

Readers who start at the front of a magazine and work toward the back may have noticed that our Contents Page carries a new name on the masthead: that of Associate Editor John M. Conly. We can sum up our feelings in an unstately fashion: Phew! Are we happy — and fortunate!

JMC needs no introduction. He has already written for HIGH-FIDELITY ("Hi-Fi-Phrenia"), and he has written a great deal more for the *Atlantic Monthly* and for the *Pathfinder*, of which he has been Music and Science Editor. He brings to HIGH-FIDELITY a life-long love and knowledge of music; he succumbed to hi-fi-phrenia about four years ago. In other words, a well-rounded individual, and ideal for his post with us.

We shall now be everlastingly grateful for having taken Applied Psychology 1-A in college. Although it happened to us a long time ago, we remembered enough of it to delay inviting the Conlys for a visit and discussion until the Berkshires were in the middle of a cool wave, and Conly headquarters at Washington, D.C. were breaking all records for heat and humidity. The contrast was too great; even the prospect of being grossly overworked did not outweigh the longing for cool days and nights.

Readers who read from back to front may now proceed on their backwards way to confirm the change on the Contents Page. But from whichever way it is approached, the name John M. Conly on our masthead brings us gladness and a glow of pride. We know that our readers will welcome our associate as warmly as we do.

HIGH-FIDELITY Goes Bi-Monthly

Speaking of John Conly being grossly overworked brings us to good and great news: beginning with this issue, HIGH-FIDELITY will be published six times a year, on a regular every-other-month schedule.

Readers by the hundreds have been clamoring for more frequent publication. Frankly, the problem was largely one of manpower. We have been sadly understaffed and quite unable to keep up with the rapid growth of our publication. Now, with another editorial desk to share the load, we can safely undertake to shift from four to six issues a year. The issues will be no smaller; witness this, the first one on the new schedule. As a matter of fact, they will be bigger than ever, because we shall be better able to prepare editorial material.

With announcement of the new publication schedule, subscription rates will be altered accordingly, as follows:

6 issues (one year)	\$5.00
18 issues (three years)	\$10.00

The single copy price remains at \$1.00. Postage to all countries except the United States, its possessions, and Canada, is \$1.00 per year extra.

Subscribers will have their termination or expiration dates adjusted so that they will receive the same number of copies as orig-

Continued on page 9

for High Fidelity

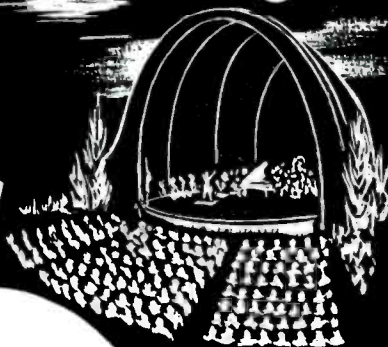

← New High Fidelity Speaker



New Coaxial Speaker →

it's
OXFORD
Speakers

A copy of our latest catalog will be sent upon request.

Available at leading jobbers!

**Preferred for original equipment
... Proven for replacement!**

Other Oxford Speakers for: Radio and Television • Portable Sets • Auto Radios • P.A. Systems • Outdoor and Weatherproof Applications • Intercom

OXFORD
ELECTRIC CORPORATION
3911 S. Michigan Ave. • Chicago 15, Ill.
EXPORT: ROBURN AGENCIES, NEW YORK CITY



Thanks for the bouquets

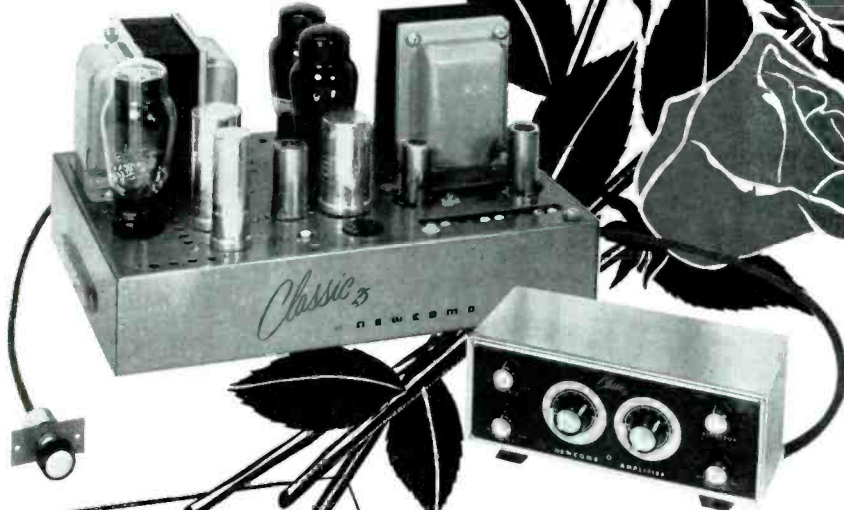

*"Unquestionably
the Greatest Contribution
in years to reproduced
record enjoyment."*

Everybody who has seen these completely new home music amplifiers has had a good word for them. We are proud to quote some of the things they had to say at the Chicago Show and Audio Fair.

... "the first really new amplifiers in years"
... "the best record reproduction I've ever heard"
... "they solve many of our toughest installation problems"
... "they really make installation easier"
... "here are some real improvements"
... "this Audi-balance feature really does away with tube balancing problems"
... "the Adjusta-panel makes cabinet mounting a breeze"
... "I've never seen anything in the field so beautifully designed for the home"
... "women will love them"
... "I find the A.E.S. response position very pleasing"
... "I want the Classic 25 for myself"
... "the finest coverage yet, there's something here for everyone"

On and on like that it went, and naturally we loved it. Those of you who missed the show will want to see this complete line at once. Illustrated above is only one of these Newcomb hi-fidelity custom home music amplifiers designed for thrillingly better listening and much easier installation.

★
Send for Catalog C-20M
8 completely new amplifiers priced
\$39.50 to \$269.50, audiophile net

15 years of quality leadership

★
Newcomb

NEWCOMB AUDIO PRODUCTS CO.
DEPT. W, 6824 LEXINGTON AVE.
HOLLYWOOD 39, CALIFORNIA



NOTED WITH INTEREST

Continued from page 7

inally scheduled. To be specific, the following table gives the new expiration dates:

<i>Subscription now expires with issue of</i>	<i>Subscription will expire with issue of</i>
Fall 1952	September 1952
Winter 1952	November 1952
Spring 1953	January 1953
Summer 1953	March 1953
Fall 1953	May 1953
Winter 1953	July 1953
Spring 1954	September 1953
Summer 1954	November 1953
Fall 1954	January 1954
Winter 1954	March 1954
Spring 1955	May 1954
Summer 1955	July 1954
Fall 1955	September 1954
Winter 1955	November 1954

Changing our circulation department records will be a laborious process; we ask your forbearance if mishaps occur.

Contented Cows

Speaking of the pleasures of a cool, calm (printer: please delete that word; we haven't had a calm moment since the first issue of HIGH-FIDELITY) life in the country, we recently became more firmly bucolic than ever. Perhaps we shouldn't rub it in, particularly at the end of a hot summer, because our city-bound friends may be neither won nor influenced — favorably. But the mean streak in us will out . . . so we're going to tell you about our new home.

Time was when the HIGH-FIDELITY offices were in the very center of this metropolis (pop. 6,000) of Great Barrington, perched on the top floor of what is known, locally, as the old Savings Bank Building. It became apparent last February that if we tried to push one more desk into the space, the plaster really would crack. After looking at a good many possibilities, we purchased a voluminous house of 15 rooms (circa 1890, with the customary high ceilings and large rooms) and 15 acres, a mile from Main Street — real country. Oh sure — lots of lawns, trees, barns, and all the usual trimmings. The stencil machines "cluck" downstairs, the chickens do likewise in the back yard. On sunny days, the girls on the staff (at their lunch sitting in a circle in the shade of a big maple on the front lawn. (There is an equally big tree at the back of the house. We have not inquired why the girls sit in the front, where the traffic whizzes by.)

Up near the barn are the contented cows, three of them. Some unpleasant individuals have suggested that there are some cows on the third floor of the house, where the editorial staff sit, chewing . . . well, at least, we hope they're contented also.

To one and all, an invitation to stop in for a visit whenever your travels take you through the Berkshires. The Publishing House (so proclaimed by a sign outside) is on Route 23, one mile northeast from the center of Great Barrington. The welcome mat is in its proverbial place.

Continued on page 11

Browning

announces

the new

RV-31 FM TUNER

for those who expect the exceptional

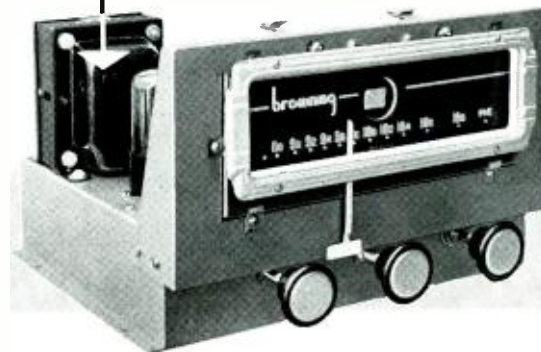

Browning FM and FM-AM tuners have long been recognized as the choice of outstanding audio engineers, when the utmost in performance is demanded. So when we improve them, we can honestly say that we are *adding virtues* rather than correcting faults.

Here's what has been added:

- New, all-triode RF section, for extremely low noise level.
- Higher sensitivity — 3 microvolts for 20 db. quieting, instead of more than 6 microvolts as before. This is desirable in fringe areas and in noisy urban locations.
- Cathode follower output stage, to feed any high-fidelity amplifier at low impedance. For those "remote" installations, this will minimize hum difficulty and high-frequency loss through cable capacitance.
- Power outlets at the rear of the chassis, for convenience in making connections to amplifier and turntable.
- A newly designed edgellighted dial in modern style, with knobs and escutcheon in black and silver.

And here's what has been kept: true Armstrong FM circuit — selectable AFC, which can be switched out at will — drift-free operation without AFC — sensitive tuning indicator, for precision tuning with AFC switched out, and quick tuning using AFC — audio inputs for phono, TV, and recorder, for selection by a panel switch and connection to the audio amplifier — self-contained power supply — small dimensions (6½" x 11" x 9") for easy mounting in limited space.

Ask your distributor of high-fidelity sound equipment for a demonstration. And read the discussion of Browning tuners in HIGH FIDELITY SIMPLIFIED, by Harold D. Weiler — available at all sound studios.



BROWNING
Laboratories, Inc.
Winchester, Mass.

ENGINEERED FOR ENGINEERS

PERFECT TRACKING

 ... with no tone arm resonance



New *Gray* 108-B Arm for all records has new suspension principle

Perfect tracking of records and virtual elimination of tone arm resonances are only two advantages of this versatile, specially-designed arm — the finest yet developed! It satisfies every requirement of LP reproduction, permits instant changing from 78 r.p.m. to LP (micro-groove) or

45 r.p.m. and *assures correct stylus pressure automatically*. GE or Pickering magnetic pickup cartridges are interchangeable and slip into place quickly and easily. Maintains perfect contact with bad records, accommodates records up to 16" in diameter.



106-SP Transcription Arm —

Assures fidelity of tone for every speed record. Three cartridge slides furnished enable GE 1-mil, 2½ or 3-mil. or Pickering cartridges to be slipped into position instantly, with no tools or solder. Low vertical inertia. precisely adjustable stylus pressure.



Gray Equalizers —

Used as standard professional equipment by leading broadcast stations, these specially-designed equalizers assure highest tonal quality ... new record reproduction from old records ... constant velocity frequency response for conventional or LP records. Uses GE or Pickering cartridges.

Please write for bulletins describing the above equipment.

GRAY RESEARCH

and Development Co., Inc., Hilliard St., Manchester, Conn.

Division of The GRAY MANUFACTURING COMPANY—Originators of the Gray Telephone Pay Station and the Gray Audagraph



Hubert E. Ottewill
President

NOTED WITH INTEREST

Continued from page 9

Speaking Of . . .

We shall soon progress to items which do not need to be started with a "speaking of . . .", but for the present, one thing seems to remind us of another. So —

Speaking of welcome mats, we shall move ours down to the Hotel New Yorker for four days beginning October 29, for the New York Audio Fair. HIGH-FIDELITY will join with its affiliated publication, RADIO COMMUNICATION, and hold down the fort in rooms 552 and 553. All are welcome; bring your friends; and bring your pet records. We shall be demonstrating a new wrinkle in amplifier and Air Coupler arrangements which will make those records sound better than ever.

Official days and hours of the Audio Fair are as follows:

October 29	11:00 a.m. to 9:00 p.m.
30	10:00 a.m. to 6:00 p.m.
31	10:00 a.m. to 10:00 p.m.
November 1	10:00 a.m. to 5:00 p.m.

Binaural Sound

At the Chicago Audio Fair in May, Magnecord, Jensen, and Radio Craftsmen combined forces to demonstrate binaural sound. As readers know, practically all radio and phonograph sound today is monaural; that is, it is collected by one or several microphones and handled by a single channel. It is like closing one eye or stopping up one ear. Yet most of us use two eyes and two ears; what each eye sees, and each ear hears, is slightly different — enough different so that we have a distinct sense of visual and auditory perspective. If we stop up one ear, it is hard to tell where a particular sound comes from.

In binaural sound reproduction, two microphones (or two sets of microphones) are used and the sound collected by each processed by separate channels. In radio work, that means two microphones, two transmitters, two receivers, and two loudspeaker systems, each channel, as we have called it, operating separately and independently.

In Chicago, binaural radio was demonstrated: one channel was on FM, the other on AM. As received and loudspeakered in the Conrad Hilton Hotel, the demonstration was not startling. The problem was partly that the AM broadcast got lost in static at the last moment, and a hurried switch to telephone lines had to be made, and mostly that the audience of several hundred people was so noisy that all the finer shadings of the music — the essence of the demonstration — were lost in a babble of voices.

The people who stayed home and set up two radio sets in their living rooms were the ones who were excited about binaural sound. The difference, though subtle and perhaps slight, was definitely audible and decidedly pleasing.

Since Chicago, several radio stations have tried binaural experiments. For instance, KXYZ in Houston used its FM transmitter for one channel, its AM facilities for the other. There will be others. If we can secure the cooperation of the radio stations

Continued on page 80



Balanced tone

... from the flashing sunlight
of Mozart to the storm of
Shostakovich

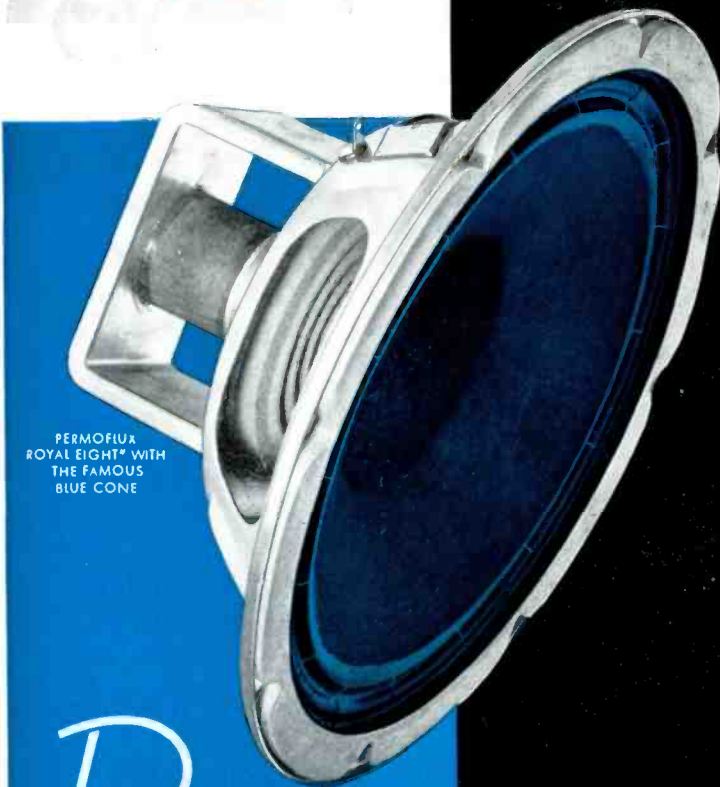

PERMOFLUX
ROYAL EIGHT™ WITH
THE FAMOUS
BLUE CONE

PermoFlux ROYAL EIGHT™

AUDIOPHILES the country over acclaim the clean, brilliant, life-like musical reproduction of the PermoFlux Royal Eight™...the 8" Speaker comparable to any 12"! Combined with the new PermoFlux Corner Baffle, Model CB-8-M, the Royal Eight™ re-creates original programs with even superior sensitivity and fidelity—every instrument in full-range tonal balance. Here's Big Speaker Performance in a small, easy-to-install frame at a sensible price. (\$22.50 List, less Baffle).

See your Radio Parts Distributor or write to PermoFlux today for full information about the complete Royal Blue Line of 6" to 15" Speakers and Baffle Combinations. Ask for PermoFlux Catalog J-207.

"Sound in Design! . . . Sound in Price!"

PERMOFLUX CORPORATION 4916-A.W. GRAND AVE., CHICAGO 39, ILL.
236 S. VERDUGO RD., GLENDALE 5, CALIF.

Canadian Licensee—Campbell Mfg. Company, Toronto, Canada

IF YOU DO NOT
COUNT THE COST

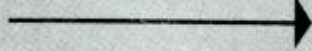

OR IF YOU DO

h. h. Scott

amplifiers are still the best



1st choice, remote-control amplifiers:
H. H. Scott, type 214-A

\$193.75



1st choice, single-chassis amplifiers:
H. H. Scott, type 210-B

\$224.00

A strong statement? Actually it is based on impartial tests of high fidelity equipment by experts of unquestioned authority.

C. G. Burke, with a jury of critical listeners, tested, compared, and rated leading equipment for the new SATURDAY REVIEW HOME BOOK OF RECORDED MUSIC AND SOUND REPRODUCTION. Five music systems in different price categories were selected, each category listing equipment judged to be best in that price class. And H. H. Scott amplifiers are rated "1st choice" in all three top systems.

Price was no object in System I — musical performance alone was the criterion. Yet in System III — well within reach of most of us who count our dollars — an amplifier by H. H. Scott is still given top place.

May we suggest that you yourself appraise the method and results of these impressively complete, most authoritative comparison tests. For real help in selecting equipment, read the discussion in the SATURDAY REVIEW HOME BOOK OF RECORDED MUSIC AND SOUND REPRODUCTION.

FREE BOOKLET
"Controls and the Amplifier"

Readers' Forum

SIR:

While not ordinarily a writer of letters to the editor, I thought I must drop you a line and let you know how much I enjoy HIGH-FIDELITY magazine and particularly the article in your last issue "How to Select an FM Tuner" by Mr. Spindell. Such articles are most appreciated by more or less beginners in high fidelity music, such as myself.

I am planning a really good music system, and it is a considerable problem for a beginner to find out just how to go about selecting the best.

Also, in your Summer issue I noticed a letter from a Mr. Maher about shellac records and record noise. Mr. Maher hoped that someone would design a "collector's" circuit to take out such noise.

This made quite an impression on me since I have quite a few valuable old records myself. The other day, though, I noticed in the 1948 "Record Book", by David Hall, something which sounded very interesting. On Page 174 there is this quotation: "This brings us around to a very clever gadget which gets around most of the shortcomings of the filter systems mentioned above, the dynamic noise suppressor. Essentially it eliminates excessive surface noise and motor rumble from record reproduction without any apparent loss of quality in high or low frequency range." And again, later, "... It works wonders with old and worn recordings."

Could this be something like the collector's circuit Mr. Maher was interested in? If so, is there anything you could tell us about this so-called noise suppressor and its operation?

Keep up the good work.

Ralph F. Magline

White Plains, N. Y.

SIR:

In reference to James T. Maher's letter in "Readers' Forum" (Summer Issue): he would perhaps like to know that the need for a "collector's circuit" has been recognized in this Country in the shape of "variable slope filters" which, apart from giving several "cut-off" frequencies, also enables the attenuation rate above these frequencies to be varied, thus permitting the optimum results from any record. Acoustical of Huntingdon and Leak (see ad on page 104 in Summer issue) both manufacture units of this type whilst D.T.N. Williamson has produced a similar circuit for home constructors which is included in the Williamson Amplifier booklet (see page 85 of Summer issue).

F. W. Street

York, England.

SIR:

As an enthusiastic reader of every word in every issue of HIGH-FIDELITY, I noticed a letter from James T. Maher in your Summer 1952 issue. Mr. Maher is disturbed about the possible fate of the millions of shellac records which "people have lovingly collected". He finishes his letter, saying, "Perhaps someone will have the good

Continued on page 15

HERMON HOSMER SCOTT, INC.
"PACKAGED ENGINEERING"
385 PUTNAM AVE. • CAMBRIDGE 39, MASS.

For Music Lovers

who will not compromise with quality....

TWO TYPICAL "STUDIO PRESENCE" CUSTOM MUSIC SYSTEMS JUDGED "BEST VALUES" BY ALLIED "AUDITIONER" JURIES



FM-AM-PHONO SYSTEM. Preferred and selected by a majority of critical listeners. A beautifully matched system notable for its distortion-free record reproduction and superb FM-AM radio reception. Sensibly priced, truly simple to assemble, capable of re-creating the original quality of tone with the most satisfying fidelity. The complete system includes: the latest Craftsmen C-800 High-Fidelity Tuner, the exceptional Craftsmen C-500 Williamson-type Amplifier, the Garrard RC-80 3-Speed Automatic Changer with Audax cartridge installed, and the unsurpassed Altec 604B 15" Coaxial Speaker. The music system is complete with cables (no solder connections required), necessary hardware and easy-to-follow instructions for quick, simple assembly and operation. Own and enjoy the finest—revel in true-toned, distortion-free reproduction—at a sensible price. Shpg. wt., 111 lbs.

93-962. Only.....\$468.50

Convenient Terms if Desired

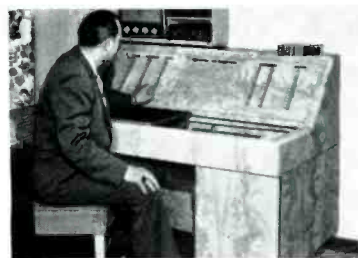

Here is the ALLIED Hi-Fi Auditor, a push-button console capable of demonstrating more than 350,000 combinations of audio components. Thousands have made the ALLIED Auditor listening test, and have selected their systems on the basis of careful comparison. Two typical systems judged best in value by a majority of critical listeners are described at the left.



CUSTOM PHONOGRAPH SYSTEM. Widely preferred by those who desire brilliant record reproduction exclusively, and who want top quality at low cost. This superb system includes: the famous KNIGHT 20-Watt Amplifier with response ± 1 db, 20-20,000 cps—unconditionally guaranteed for one full year; the Webster-Chicago 106-27 3-Speed Automatic Changer with plug-in heads and two General Electric cartridges; the General Electric S1201D high-fidelity speaker. The system is provided complete with necessary cables (no solder connections required), hardware and simple instructions for easy assembly and operation. Here is a truly fine phonograph system that will bring you a revelation in record reproduction—and enduring listening joy. Shpg. wt., 57 lbs.

93-328. Only.....\$126.85

Convenient Terms if Desired

Other Fine Custom Quality Systems Available from \$125 to \$1400

Select your high-fidelity systems
and components at **ALLIED**

Look to ALLIED—high-fidelity custom specialists—to help you select your own fine custom audio components to gratify your personal listening desires. We carry the world's largest stocks of high-fidelity audio equipment in all famous makes. Write today for complete FREE Catalog, or visit our High-Fidelity Studio for actual comparative demonstrations through ALLIED'S unique Hi-Fi Auditor.

FREE 1953 CATALOG

Write today for our complete Buying Guide listing the world's largest selection of High-Fidelity systems and components. Let us help you select the equipment required for the optimum high-fidelity performance you desire. If it's Hi-Fi, you'll find it in your ALLIED Catalog. Send for it.



ALLIED RADIO

ALLIED RADIO CORP., Dept. 49-J-2
833 W. Jackson Blvd., Chicago 7, Illinois

Send FREE 1953 ALLIED Catalog

Ship System No. _____ \$ _____ enclosed

Name _____

Address _____

City _____ Zone _____ State _____

Announcing the new

Revere "T-700" "Balanced-Tone" TAPE RECORDER



BALANCED-TONE CONTROL co-ordinates amplifier and acoustic system response to provide amazingly realistic tonal quality.

Exclusive Index Counter provides complete selectivity and instant location of any part of recorded reel!

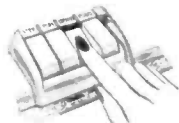

High-speed Forward and Rewind Lever responds to the touch of your finger. No backlash, no danger of tape tearing!

Automatic, simplified key-controls record, play, or stop recorder instantly.



A Masterpiece of Tonal Quality and Operating Ease!

To hear the new Revere "BALANCED-TONE" Tape Recorder is an unforgettable experience. What a thrill you'll get as each delicate sound, each musical note, is reproduced with amazing depth of tone, breadth of range and height of realism heretofore obtainable only with professional broadcast equipment.

Incorporating a sensational new development—the "BALANCED-TONE" Control—with other exclusive electronic advancements, Revere has achieved an extraordinary wide frequency response (80 to 8,000 cycles per second) and rich tonal quality that has won the acclaim of many of the world's leading musicians. Yet,

key-control operation of this recording triumph is extremely simple.

Add to these features such outstanding advantages as 2 full hours recording per reel, lightweight portability, magnificent styling, glamorous beauty, low price—and you'll readily appreciate why this new Revere "BALANCED-TONE" Tape Recorder is the sensation of the industry.

Revere T-700—Complete with microphone, radio attachment cord, 2 reels (one with tape) and carrying case **\$225.00**
TR-800—Same as above with built-in radio. \$250.00

Special Studio Models—Speed 7.50

T-10—Complete with microphone, radio attachment cord, 2 reels (one with tape) and carrying case \$235.00
TR-20—Same as above with built-in radio. \$260.00



BASS REFLEX SPEAKER—For use in auditoriums and schools where ultra fine musical reproduction is required. An exceptionally fine 12" Alnico V Speaker unit acoustically matched to a 16"x22"x13" Bass-Reflex Cabinet. Designed as a console base for the recorder. Lightweight, portable, with plug and 25-ft. cable. TS-706 **\$49.50**

ACCESSORIES—For remote control: Hand Control \$1.00; Foot Control \$17.50; Adapter Cord Assembly \$4.00. Ear Phone \$10.50.

REVERE CAMERA COMPANY



CHICAGO 16, ILLINOIS

READERS' FORUM

Continued from page 12

sense to design a 'collector's circuit' which will permit us to play a wealth of fine music and great performances without bracing for the surface grindings of an 'open' position on a compensator and the contained dull rumble of one of the muting positions."

Actually, Mr. Maher, such a "collector's circuit" has been available for several years at least—the Scott Dynamic Noise Suppressor. I recently bought an H. H. Scott Amplifier with one of these suppressors, and it does exactly what Mr. Maher is looking for. It takes out the record surface noise without deadening the music. Also, it's helpful with noisy long playing records as well as shellac records.

On Page 45 of the issue with Mr. Maher's letter, C. G. Burke, in one of his record reviews, mentions the noise suppressor as removing superficial hiss from LP records. Furthermore, on Page 22 of the Spring 1952 HIGH-FIDELITY, there is a simple description of how the dynamic noise suppressor works. I am not sure that I completely understand it, but it's interesting, nonetheless.

The moral of this story, Mr. Maher, is that if you read every word of every issue of HIGH-FIDELITY you will find almost all your questions answered sooner or later.

John R. Gillingham

Hyde Park, Mass.

See p. 32 of this issue for a method of preserving irreplaceable shellacs.

SIR:

Since I received so much enjoyment and profit from the first four issues of HIGH-FIDELITY it is only fair to tell you why I haven't renewed my subscription.

The truth is my budget doesn't permit me to renew just now. I thought that the record review of Beethoven was alone worth a year's subscription. If I had seen it sooner I could have chosen some LP records more wisely.

I was pleased recently to see that H-F is now on sale at some of our newsstands.

You will be glad to know that high fidelity is gradually spreading in these parts. One of the largest record stores in the city—the Promenade Music Shop—has recently installed a Klipschorn speaker, and a Leak amplifier. Time was, it was no use playing a record in the shops because they had no hi-fi reproduction available.

There are still many disgusting features in the record selling business. E.g. the other day I returned an LP to the shop where I bought it. The first side of the record was obviously defective. When they played it through their equipment they agreed with me and replaced the record with a good copy. However, I noticed that they slipped the defective record back into their stock on the shelves. Some poor sucker will come along and buy it.

Also, wouldn't it be grand if the record-buyer knew whether an LP was "dubbed" or made from a live performance. I have an LP which is quite "live" on one side and dead as King Tut on the other side. How-

Continued on page 17



MagneCordette

THE WORLD'S LOWEST PRICED PROFESSIONAL TAPE RECORDER

Here's a true high fidelity tape recorder that gives *professional* performance! The voices of your family and friends . . . your favorite radio programs . . . can be captured with absolute true-to-life accuracy and replayed at will to give years of enjoyment. Start your family "sound" library with your own recordings, now made so easily on the MagneCordette. It is a handsome cabinet to fit in any decor . . . available in blond or rich dark mahogany.

MAGNECORDETTE in the office preserves an on-the-spot record of important business conferences, sales reports, discussions, and meetings with utmost fidelity for later reference and study.



MAGNECORDETTE is precision built for ultra-accurate sound reproduction. Use it with your present high fidelity or radio amplifier, or on your public address system. Only \$385.00

Magnecord, INC., Dept. HF-9
 225 WEST OHIO ST., CHICAGO 10, ILL.

Name _____

Address _____

City _____

Zone _____ State _____

Write
 for descriptive literature or refer to your classified telephone directory under "Recorders" for a demonstration.

Capitol relies on

AMPEX

to capture the natural color
and true perspective
of original live performances

for

Full Dimensional Sound



Full Dimensional Sound

Capitol
CLASSICS



... in its superb recording techniques, especially created for its Classical FDS Releases, Capitol Records, Inc. utilize to the highest degree the dynamic fidelity and dependability of Ampex Model 300 Recorders.

AMPEX

Magnetic Tape Recorders

AMPEX ELECTRIC CORPORATION Redwood City, California

AX-108



STUDIO CONTROL ROOM



EDITING ROOM



RECORDING ROOM

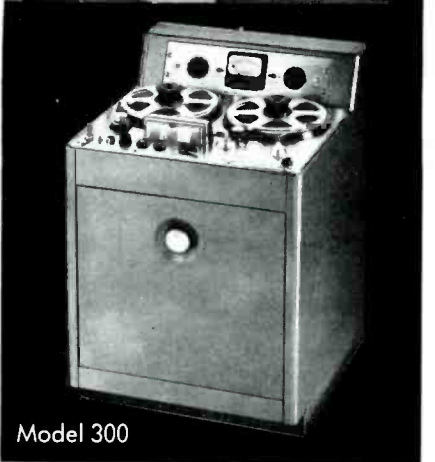

Model 300

READERS' FORUM

Continued from page 15

ever my experience with LP is very limited (due to my limited budget) and I suppose you could tell me lots about it.

I wish you every success with your magazine and, as soon as my budget allows it, I intend to subscribe again.

Vernon O. Clapp

Toronto, Canada.

SIR:

After my third reading of the Spring 1952 issue, wish to go on record that I am in accord with Mr. Burnside's letter about record stores and the chance one takes in buying LP records off the shelf. It seems to me that these shops could have a copy or two of records just for demonstration and if the customer liked them he would be sold a sealed, unplayed recording which, as Mr. Burnside puts it, could not be returned except for a defect in manufacture.

Many thanks are due the gentlemen who contribute to "Records in Review". I make this section my guide in buying all my records. Also enjoyed "Danger! Worn Needles".

Keep up the good work.

George K. Marshall

Livorno, Italy

SIR:

I am for this (Factory Sealed Records) 100%. I am glad someone came out for this and I wish to second this motion. Poor handling and poor playing on inferior equipment has spoiled many a fine record and it is sold regardless.

This is my pet squealing point on the purchase of records. When I purchase a record for \$5.95 I want a new record not one played over for and by purchasers who just want to listen and then walk out saying it is not just what they want.

Let's have a sealed record and then it could be replaced if defective. I don't feel that a person would buy a fine record and take it home and deliberately destroy or deface it. My \$5.95's do not come so easy as I work on a fixed income yearly salary and one bad record will surely throw a wrench in any budget like mine.

"Let's have some more help like this."

J. R. Holloway

Philadelphia, Pa.

SIR:

Kudos to H. M. Evans and yourself — and may I add my vote in favor of at least "sealed editions" of LP records. Each of us could add personal horror stories to those given. The shopper who selects by chance from a display rack, huddles into a cubbyhole designed to deaden sound and listens to a playback from most inadequate equipment is just asking for the disappointments he will receive.

I will wage that most of us who are interested in good recorded music know what we want before we go into a record store. We have our preference for recording companies, conductors, orchestras and artists, and have learned to respect the evaluator's

Continued on page 92

Prerequisite to

Natural Reproduction of Music

THE **BROOK**

ALL TRIODE HIGH QUALITY AUDIO AMPLIFIER

The BROOK will play at extremely low volume, yet retain full naturalness of tone; or, recreate in your home the full volume of a symphony, or dance band, clear and clean. You will hear and FEEL live music and voices.



Write for technical data, booklet

"Better Listening".

and name of local dealer. Dept. FI-2.

BROOK ELECTRONICS, INC.

34 DeHART PLACE, ELIZABETH 2, N.J.

PICKERING

RECORD PLAYING EQUIPMENT

*For flawless reproduction
of the works of the masters*

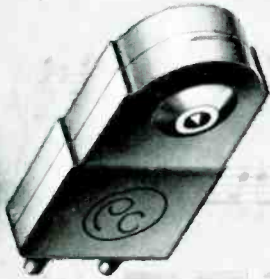

Pickering diamond stylus pickups and related components are the exclusive choice of musicians and lovers of music who insist upon the finest. Engineers acknowledge Pickering audio components as the best available. In every test and performance comparison, they demonstrate their superiority; recreating all the music pressed into modern recordings with the fidelity and realism of a live performance.



Pickering components are created for listening pleasure by Audio Engineers who know music and who know the tastes of discriminating listeners.



Pickering diamond cartridges have no equal. The wear and fracture resistance of the diamond styli in these cartridges is many times greater than that of styli made of sapphire, the next hardest material. Because resistance to wear preserves the precise shape of the stylus point, the life and quality of your valuable record collection is insured.



Don't impair the musical quality of your priceless records.

Use Pickering diamond stylus cartridges . . . they not only wear longer *but, more important*, they preserve the musical quality and prolong the life of your record library.

By all measures, Pickering diamond stylus cartridges are more economical.



PICKERING & COMPANY, Inc.
Oceanside, L. I., N. Y.



Pickering High Fidelity Components are available through leading jobbers and distributors everywhere; detailed literature sent upon request. Address Department H



Here is the story of the birth of a long playing record, from recording session to preparation of masters from which are pressed the discs purchased at the dealer's store.

It is really two stories: one, the side-lights on a recording session, ably jotted down by James Deane, the other — the captions (sometimes facetious) for the illustrations. Commentator Deane observed one of three recording sessions; the illustrations go on beyond recording and into processing and checking for musical and engineering quality.

Here pictured and storied is a notable event: In November, Columbia Records will release the first complete recording of Mozart's *Così fan tutte*, a wonderful but not too well known work which was last season's Metropolitan Opera hit.

At the left, Conductor Fritz Stiedry leads the orchestra while singers Tucker, Steber, Thebom, and Guarrera await their cue.

Birth of an LP

JAMES DEANE

Commentator

FOR the past three years, Columbia Records' New York recording headquarters has been a converted church at 207 East Thirtieth Street. Only the arched ceiling betrays the building's past; the pews are gone, drapes hang along the walls, and a glassed-in control booth has been installed high at one end. Splendid acoustics remain; in years past these must have served clergymen well, and now they serve music.

Last June 4, 5 and 6, a project of more than usual interest occupied the place. This was the recording of Mozart's complete opera, *Così fan tutte*. Columbia and the Metropolitan Opera Company by contract combine their efforts fully once each year; *Così* was last season's Met hit; hence it is this year's complete Met recording. It will reach record dealers as a 3-record set in November.

The event in one way is quite remarkable. *Così* has been strangely neglected. Edward J. Dent, on another company's record jacket (the disc contains ex-

An extra special smile from Roberta Peters keeps the orchestra happy while Messrs. Alvary, Blatt and Stiedry discuss who does what. Mr. Blatt: What page are *you* on?





Stiedry blends Peters with music for a high one.

cerpts only), is quoted as calling it "the Cinderella of Mozart's three Italian comic operas", and this is apt. The Met had ignored it completely for 23 years until last season, and it's doubtful whether a year ago Columbia or anybody else would have predicted that it soon would be scheduled for recording sessions.

The plot, of course, is silly. It concerns the attempt of two young officers, on a bet with an old cynic, to steal the affections of one another's betrothed. The time limit is 24 hours. They succeed, although by means most improbable: The old cynic wins his bet, and the title of the opera is justified — "Cosi fan tutte" (they are all alike) or, as the Met translated it, "Women Are Like That". But what matter a silly situation, considering what Mozart did with it?

The man who, I suspect, persuaded the Met to undertake the hazards of the revival also presided on the recording podium. He, of course, was Fritz Stiedry who, practically alone among conductors, has been a life-long campaigner for *Cosi*.

Stiedry told me that he first led *Cosi* in Nuremberg,

in 1912, and that he has conducted it 42 times. (Whether he was including the recording sessions, I don't know. Counting repeats, these should add at least three to the total.)

The singers were almost the same as in last season's performances. Eleanor Steber and Blanche Thebom were the two uncertain ladies, Fiordiligi and Dora-bella; Richard Tucker and Frank Guarrera played their conniving lovers, Ferrando and Guglielmo. The old cynic was portrayed by Lorenzo Alvary. And the charming role of Despina, the coquettish chambermaid played in the stage version by Patrice Munsel, fell to her pretty understudy, Roberta Peters. These six are all the opera calls for, except a chorus.

Staging the Recording

At the recording studio, Mr. Stiedry's podium was more exposed than the one he occupied at the Met. It was an unadorned platform in the middle of the big floor. To his left was a higher platform for the singers. Fanning out in a semicircle were 54 orchestra players. Microphones were planted at strategic spots, and there was a little signal light that flashed on while actual recording was in progress.

The nerve center of the proceedings, however, was behind the glass of the control room. And that domain was ruled over by a sort of joint chiefs of staff. One chief was a husky, black-haired man in his mid-30's named David Oppenheim. The other was Max Rudolf.

Columbia calls Oppenheim its "A & R man". More officially, he is director of classical artists and repertoire. Subject to the nod of executive vice-president Goddard Lieberson, he decides what to record and who will do it. Mr. Rudolf is more or less the Met's A & R man, too. He is Rudolf Bing's artistic administrator. As such, he oversees all Met productions, including recordings.

The Oppenheim-Rudolph high command sat at a table facing the big window. Each had a big, heavy *Cosi* score. Mr. Rudolf also had a quart bottle of buttermilk and a box of crackers, which he brought in a paper bag. Mr. Oppenheim had a microphone at his disposal, through which he could speak to the musicians below. Next to him sat

Kibitzer Alvary looks disturbed as Rudolf and Stiedry come to a happy agreement over a note he is to sing.

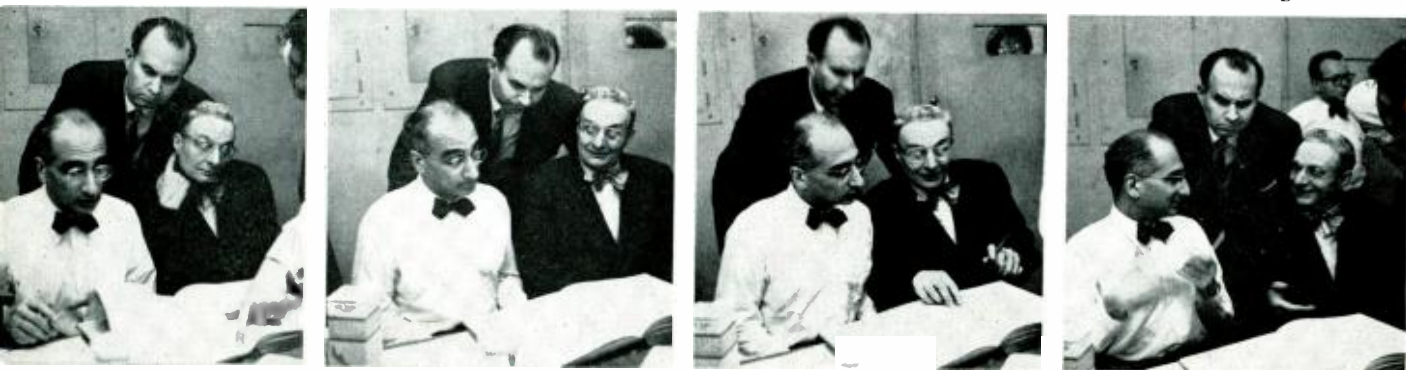



Playback! Seated at the table, Rudolf, Stiedry, Thebom and Columbia's musical Director Howard Scott listen intently while David Oppenheim dashes for the door.

Howard Scott, another Columbia man, with elaborate — if sometimes futile — schedules for the recording takes.

Then there were two technicians. Harold Chapman had his hands resting continuously on big knobs, which he seldom seemed to move. He kept his eyes most of the time on dials which told him the story of volume level, treble, bass, etc. Bob Waller seldom sat still but bounded up and down tending nearby twin tape machines which clicked efficiently on and off throughout the session.

Sidelights on a Session

Because I was able to attend recording sessions only on the third day, I asked Oppenheim whether he'd had any serious problems the preceding days. The only ones he could think of at the moment pertained to Mr. Stiedry: the conductor had forgotten to remove change from his pockets and, worse, he also had a penchant for beating time on his music stand.

There was one other matter: "Stiedry doesn't speak

English," said Oppenheim. It turned out, however, that he was exaggerating.

So much goes on at a recording session that it would require a fair-sized book for a complete report. Here, I shall jot down more or less random notes — sidelights.

The start was prompt. The first thing undertaken that morning — which apparently they hadn't done during the two previous days — was the overture. Mr. Stiedry came forth with something that was very definitely English at the start. He said: "Read this, please, as Mozart wrote it."

The music began. When it was done, I would have said it was fine. They decided, however, to try it over later if there was time — and time is of great importance at a recording session because, as long as the orchestra is around, overtime is paid.

The next number was a duet between Miss Steber and Miss Thebom. An aria by Mr. Tucker followed.

Miss Peters arrived late. She wasn't

needed until the first act finale. Her entrance diverted attention in the control room for a moment because she had on

a very pretty, pleated and full-skirted blue party dress, and it was strapless. She also wore a little straw bonnet.

(Conductor Stiedry, incidentally, also set an interesting fashion note. His garb consisted of tan tweed sport coat, pink shirt, slacks, and florid red bow tie. He never took off his coat, though practically everybody else did.)

A duet between Miss Thebom and Mr. Tucker brought some trouble. Mr. Oppenheim's voice interrupted.

"I stopped," he explained over the

PA system, "because I thought there was too little Tucker."

"That's right," put in Mr. Rudolf, "too much Tucker."



Jacket notator Irving Kolodin ponders his words



Eleanor Steber, Blanche Thebom, and Lorenzo Alvary: is it good?

Lorenzo Alvary and Robert Peters; Eleanor Steber and Blanche Thebom; Frank Guarrera and Richard Tucker

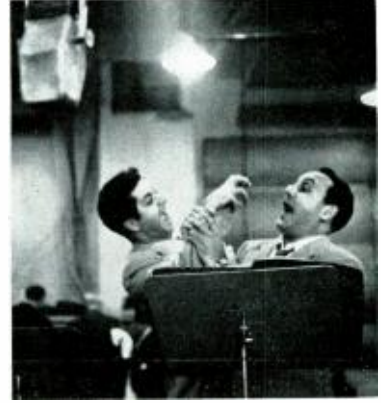



While all the singing and musicking are going on outside, the control room staff is kept hopping. Above, Harold Chapman's alert hands control the balance of the microphones. At the right, Bob Waller keeps two tape recorders spinning.

After the tape is edited and spliced, it is played back repeatedly to check for mechanical and recording defects, as in the illustration below.

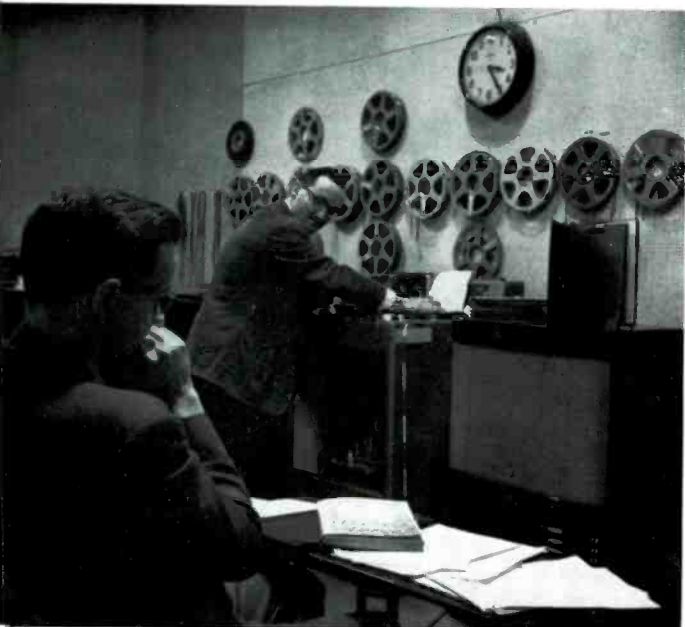

There was a pause, then a conference. The singers waited in suspense. Then Mr. Oppenheim conciliated:

"Maybe," he said, "it's just too uneven." The duet resumed, and this time got the nod.

Miss Steber and Miss Peters climbed the platform, and Mr. Tucker stepped around back of the orchestra and picked up a newspaper. He wore a jaunty Panama, and he let it stay nonchalantly where it was. The singing continued. Finally the three men joined in.

It didn't get the nod, either. After a playback, the whole 17-minute finale was repeated.

This time, Mr. Oppenheim's voice pronounced it "much better, all around." Added was special praise for a line of Mr. Tucker's — a groan.

"Much more stylized," said Mr. Oppenheim.

Once there was a flareup. Mr. Stiedry wanted to consult with the pianist while the orchestra waited. Mr. Oppenheim wanted to go ahead. He said so. Mr. Stiedry



went on with his conversation. Mr. Oppenheim repeated his request, with more insistence.

Mr. Stiedry turned, stamped, and slashed the music stand.

"You," he cried, "are not the conductor. This," he added, gesturing toward himself, "is the conductor."

He finished his conference.

At the end of the session, there was time to repeat the overture. Then the orchestra went home. It was 5:45. Everybody relaxed noticeably. Even though Assistant Conductor Joseph Blatt officially took over for the recitatives, Mr. Stiedry refused to go home. He sat close behind the piano, and now and again he jumped up and resumed conducting. He smiled continuously.

An "mmmm" by Miss Peters had to be repeated. She was supposed to be sampling her mistress' breakfast. Mr.



Above, the music is being transferred from tape to disc. Microscope at the operator's hand permits precise inspection of the record grooves. In the center illustration, a master

disc is being plated in preparation for pressing further test masters from it—an operation shown in the photo at the upper right.

Oppenheim said her second try was better. After the third, he cried, "Wonderful!"

There was quite a conference over a knock by Mr. Alvary. He tried the music stand and the floor. Finally, Mr. Tucker pinch-knocked on the piano top.

At 8 o'clock the recitatives were over. For an hour, all but Mr. Tucker and Mr. Stiedry huddled in front of the loudspeaker.

Everybody bravoed everybody else's singing.

And then it was over.

Mr. Stiedry left just before the recitatives ended.

What, I asked, made him so fond of *Cosi*?

"This," he answered, "is the nicest music in the world."

Why?

"Why!" he echoed, his tone incredulous. "Don't you hear it?"

That, said Mr. Oppenheim, was Columbia's thought, and the reason they had undertaken the recording.

Final judgment on test lacquers is passed by Howard Scott, left, for musical quality and by William S. Bachman, right, for engineering quality. In the center, the lacquer is being checked for mechanical faults.

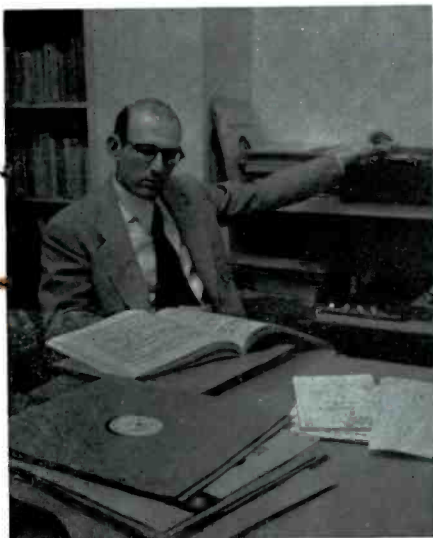

Ideas - from Professionals and from Amateurs

THERE is an ugly rumor going around that high fidelity installations are ugly. The rumor probably stems from the picture published in an early issue of *HIGH-FIDELITY* of the equipment, spread over several living room tables, which one of our authors was testing at the moment.

The pictures on these five pages should disprove, once and for all, any such rumor. They show, beyond a doubt, that high fidelity installations can be as attractive to look at as they are pleasant to listen to. In fact, most installations, designed to blend in with the decor of the living room, are far more attractive than the "Early South American Colonial" gem sold by the average radio store.

The crux of the hi-fi installation is careful design: careful design from both the acoustic and the decorative point of view. A great deal

The unit below utilizes space normally occupied by a fireplace. Equipment includes Radio Craftsmen TV tuner, Altec FM-AM tuner and 604-B speaker (at upper left), and a Webcor changer, located for maximum operating convenience.

KIERULFF, LOS ANGELES



KIERULFF, LOS ANGELES

Above is a storage wall installation, with television and sound facing into the living room. Components are a Convac TV unit, Altec FM-AM tuner and amplifier, Markel player, and Jim Lansing speaker.

of time should be devoted to planning the installation, particularly with an eye to future expansion and additional equipment.

The purpose of these pages in HIGH-FIDELITY is to furnish ideas. Very few readers will be able to copy exactly, but a design feature picked from this installation, combined with one picked from another, and another . . . the result will be satisfaction.

The first three pages are devoted to a variety of what may be called built-in and built-out cabinets, and to some small but good designs which, in shape, are similar to



MARGOLIS, HARTFORD

A small, compact custom built cabinet which embodies good design principles and a complete range of equipment.

factory-built, radio - phonograph combinations. The built-ins belong in new houses, or ones which are being extensively remodeled, for they may require structural changes and careful integration into the decorative and architectural scheme.

The built-outs can be used in any house or apartment, for they require no structural changes in the room. Since they become a major part of the decor, they should be designed not as temporary furnishings but with the same care that would be devoted to a built-in. Some can be constructed in sections, so that a move from one dwelling to another does not require leaving behind the cabinetry.

Plus This

Two units in a wide range of cabinets, designed so they can be used separately as a chairside control cabinet with across-the-room speaker enclosure, or side by side as a single unit.

Equals This

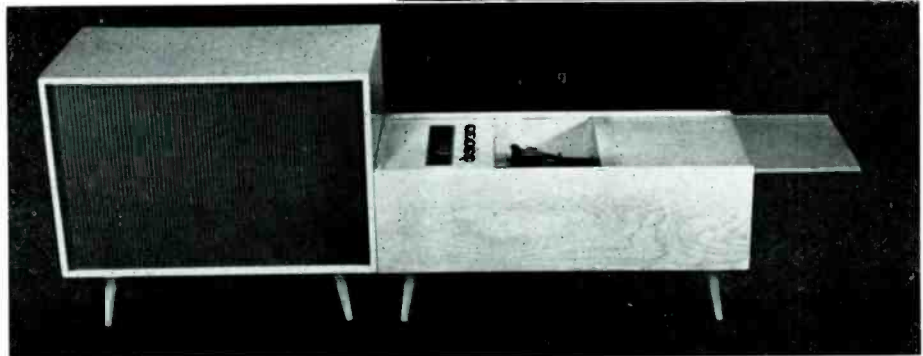

CUSTOMCRAFT - WASHINGTON

Another built-in, in which the hi-fi installation is dwarfed by the cabinets extending completely across one living room wall.

ELECTRONIC WORKSHOP, N. Y. C.

This

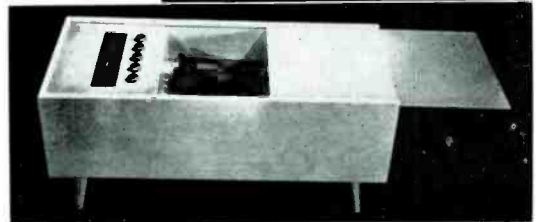
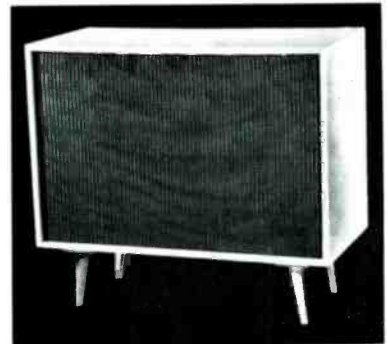



Here the record player is combined with an end table for maximum operating convenience; the television set and speaker face the listening area.

The installation in the center illustration made use of existing bookcases to house a Newcomb amplifier, Browning tuner and Webcor changer. The speaker is in the continuation of the cabinets at the lower left, out of the picture.

AUDIO ARTS, CHICAGO



KIERULFF, LOS ANGELES

The major difference between a factory-built radio-phonograph combination and a custom built cabinet of the compact variety is in the attention devoted to acoustic factors. Loudspeakers are not relegated to a cubic foot or so of space somewhere near the floor with dimensions determined by the amount of space left in the cabinet after the other equipment has been squeezed in. The speaker enclosure must be the dominant factor in the design of cabinets which house both speaker and other equipment; it should be considered first and then additional space provided for record changers, tuners, and amplifiers.

KIERULFF, LOS ANGELES

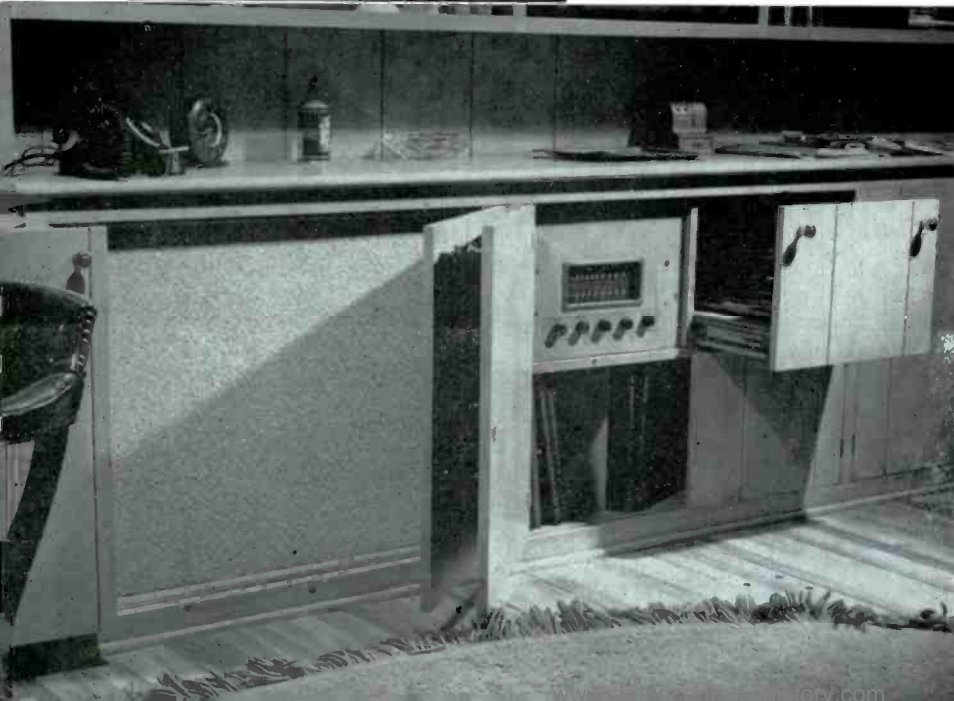

Another idea — to utilize the lower part of a bookcase or across-the-wall cabinet. Folding doors close over the speaker at the left so all the equipment can be hidden from view. The speaker is a Jensen H-510; tuner and amplifier are by Sargent Rayment, and the Webcor changer is in the sliding drawer at the right.

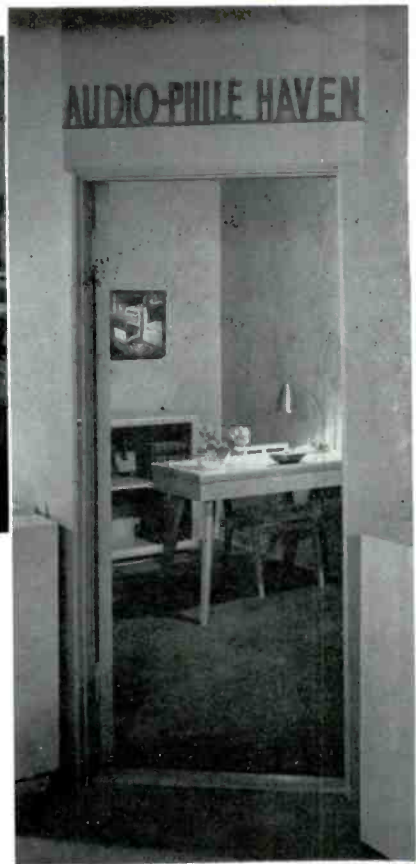

At the Audio Fair in Chicago, we were shown photographs of a high fidelity equipment dealer's showroom which were so representative of the principles which we feel should be used to demonstrate hi-fi equipment, that we have reproduced some of them on this page. In his new store in Los Angeles, "Cap" Kierulff has recreated a home living room (lower right). This, we maintain, is where people listen to high fidelity sound—in their living rooms, not in a cross between a railroad station and a warehouse.

Mr. and Mrs. Customer walk into the Audiophile Haven (upper right) to listen in homelike surroundings. They can hear a simple installation or what might be called the ideal: FM, TV, phonograph, and tape . . . and note that the



the tape is Magnecord binaural; there are two speakers in the squares near the ceiling in the two illustrations at the bottom of the page.

When they are ready to go into the details of the equipment, for a final selection, they can examine shelvesful in the main display room (upper left).

Kudos to Kierulff for selling high fidelity reproduction first, then the equipment.



Here are designs by readers. Judging by the beautiful appearance, some HIGH-FIDELITY subscribers are not only audiophiles but expert carpenters.

Elliott Wright's problem was to blend his speaker enclosures with the sleek finish of his modern house, and still achieve high fidelity sound. He has done it so skillfully that there is a good chance the grille cloth will not show up at all in the illustration at the upper left, even though we darkened one edge a little ourselves so it would not disappear entirely. Up above the ceiling of the farther room, Reader Wright has an air coupler, driven by a Wharfedale 12-CS; his middle and high frequencies are carried by a G-E and a pair of University tweeters. This equip-

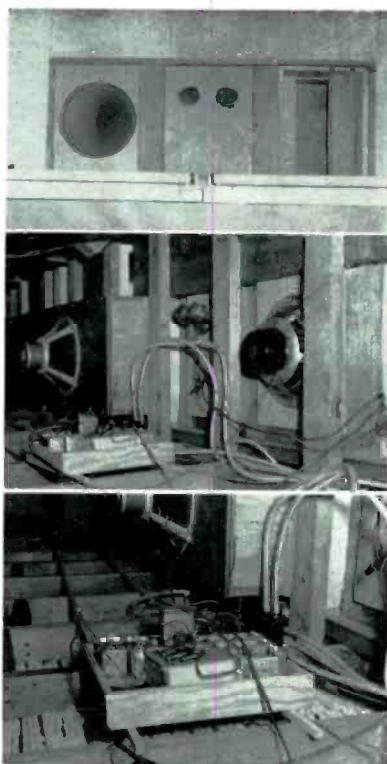

ment, behind the partition, is shown at the upper right. He says, "Tests with a

Cook Series 10 LP test record and an oscilloscope show power down appreciably only at 20 and 20,000 cycles. The audible output is good to slightly below 30 cycles with this record."

The two illustrations at the bottom of the page are of Peter Khoury's music center. He writes: "The entire installation was made by me and represents an initial venture in woodworking at an approximate cost of \$85 for materials. The original wall contained a china closet and



provided housing for the Altec 604-B with about 30 cu. ft. of closed baffle space and, directly below, enough space for the Radio Craftsmen TV tuner. The remaining equipment consists of a Garrard changer, RC-10 tuner, Ampex 400 recorder, Brook 10-watt amplifier, and a Shure 55-S microphone. Needless to say, the expanse of leather armchair next to the Ampex houses yours truly at practically every leisure moment."

Let's have more pictures of I-did-it-myself installations — to encourage others who may misjudge their own abilities.



Control room setup for one of the Capitol recording studios. The Ampex tape machines, running at 15 inches per second, are operated remotely from the control position.

RATING RECORDED MUSIC

Here's an Interesting Idea for Listening Groups

by **MILTON B. SLEEPER**

I THINK this is a good recording." — "I don't think that one is worth buying." — "You have a better recording of this selection than mine."

We hear these expressions of opinions wherever record enthusiasts get together. Whether they are talking about formal music or bebop, it is always the same. Of course, part of the interest in records comes from having opinions about them, and no two people have exactly the same ideas because they neither listen for the same things,

nor hear them exactly the same way. And without standards for judging records, there can be wide disagreement even among experts to whom we might look for guidance.

When Capitol Records introduced their new Full Dimensional Sound series, it was generally assumed that they were produced by some new method of recording or cutting. That was my impression, too, until I visited the Capitol studios in Hollywood, and learned at first hand about the FDS records from Lloyd Dunn and Robert

Myers. Which is the reason for bringing up the subject of opinions about records, and standards for judging them.

First of all, I found out that the FDS label is not related to a particular mechanical or electrical system. Instead, it is a sort of gold-star-for-excellence awarded by a panel of experts. All Capitol releases produced at Hollywood are first recorded on Ampex tape machines, and then the masters are cut on Scully lathes. Some of this equipment is shown in the accompanying illustrations.

Having learned that much, my next questions were "How do the judges decide whether or not a new record merits the FDS label? Do they have some sort of standards for guidance?"

By way of answer, Lloyd Dunn gave me a copy of a bulletin entitled "Classical Recording Quality Rating", and Robert Myers invited me to attend the panel session at which the photographs shown here were taken.

Capitol's procedure is doubly interesting because, in addition to explaining the manner of qualifying records for the FDS series, it offers a plan from which listening groups can work out their own standards and procedures for judging records.

Setup for Record Listening

To avoid confusion from listening to speakers of differ-

ent characteristics from day to day, the twenty speakers installed at various parts of the Capitol studios are of identical design. Sound level measurements at the specified listening levels determine the acoustic response and suitable corrections are made, if necessary, to insure uniform listening conditions. Tone controls, as such, are not employed in any reproducing system. However, to check reproduction as it might be heard on average factory-built sets, they have some standard commercial consoles. If one of these sets is to be used for comparison purposes, the speaker is checked at 100, 1,000, and 5,000 cycles, and the tone controls set for uniform output as indicated by a meter across the voice coil. By means of the meter, the volume is also set to a specified listening level.

A listening panel is always made up of two repertoire men and two engineers. For example, the judges in the accompanying photograph are, from left to right: Robert Myers, West Coast classical department representative; Edward Uecke, chief engineer; Roy Dunnan, acting director of recording; and William Miller, artists' repertoire representative. Thus, there are two judges to listen particularly for the realism of the reproduction, and two who are particularly concerned with technical considerations. Qualified alternates for these men sit in frequently to avoid any personal bias.

Before a session gets under way officially, the judges

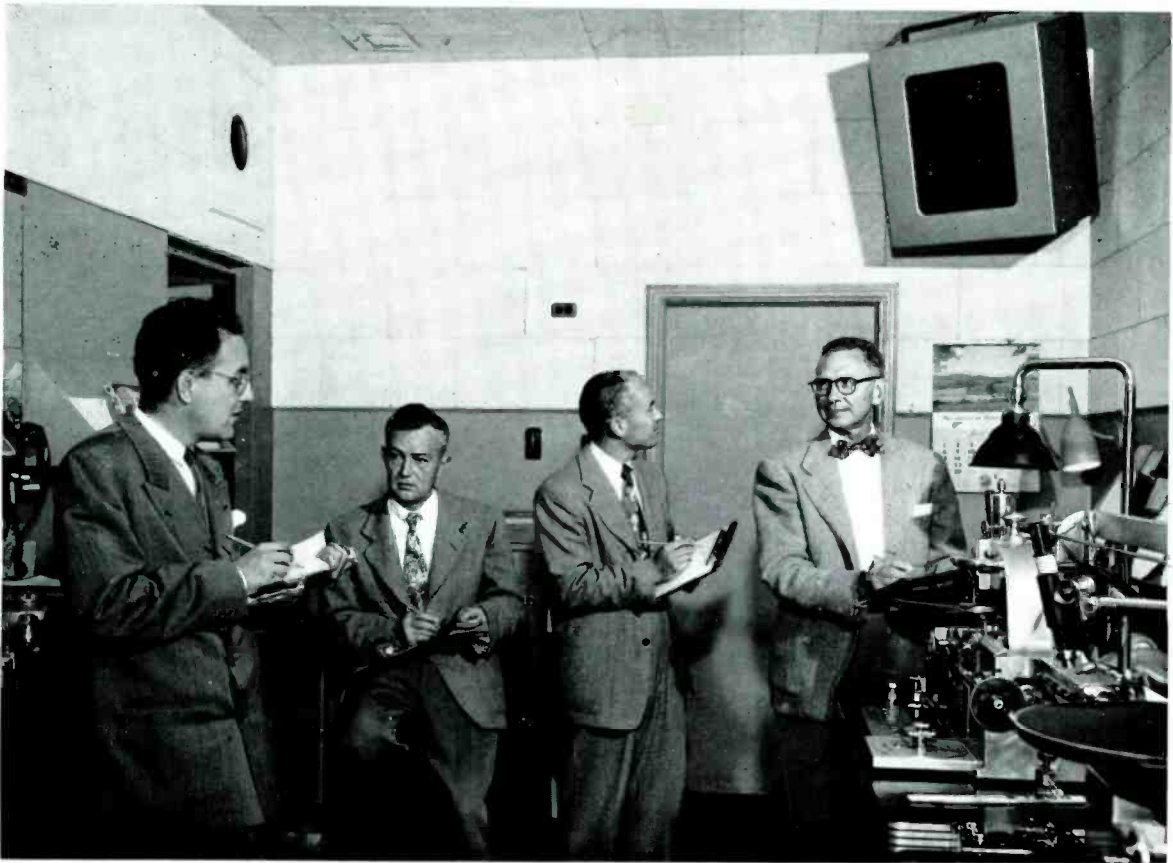

spend half an hour playing other records of a similar character. This has been found to be a very helpful preparation for critical listening.

Scoring Record Performance

Each member of the panel has a chart on which he enters his rating of record performance for:

1. Background noise
2. Electrical distortion
3. Acoustic distortion
4. Frequency range
5. Separation
6. Dynamic range
7. Musical balance
8. Performance

The basis of the point rating is:

- 100 — Excellent, no criticism
- 90 — Good
- 75 — Fair
- 60 — Acceptable

To qualify for FDS rating, an average of 90 points is required, and the rating of any factor must not be less than 80 points. Of course, a record that does not qualify for the FDS label may still be released as a Capitol record, since it may be entirely suitable for average record players, but in that case a different average is used and, of course, the rating on any factor must not be less than 60. This minimum standard is representative of record quality generally considered above average competitive with any except a selected premium product.

The final score on overall performance and the ratings of individual factors are obtained by averaging the point values set down by the reviewers participating.

This brings up the question: "Just what is meant by distortion, or separation, or musical balance?" Obviously, there must be a common understanding of these terms among the judges, or the scoring would have little significance. Capitol has, therefore, worked out the following definitions which are included in the bulletin on quality rating.

1. **BACKGROUND NOISE:** A continuous noise which may consist of system and/or tape noise in the middle or high-frequency range, or it may be low-frequency rumble or hum. It is usually observed just before start of modulation, or during low-level or silent passages in recording. Evaluate degree to which noise is present.

2. **ELECTRICAL DISTORTION:** Distorted sound attributable to electrical causes such as clipping of modulation peaks and/or slow recovery, leaving "holes" in modulation, or "buzz" on certain types of modulation, usually on peaks.

3. **ACOUSTIC DISTORTION:** Distorted sound originating in studio pickup, caused by undesirable intermodulation

Left: A scoring session in progress. Capitol executives taking part are, from left to right: Robert Myers, Edward Uecke, Roy Dunman, and William Miller. Each one has a form on which he records his rating of eight different characteristics of reproduction.

Right: At the other end of the room, a reference lacquer, cut at 33 1/2 rpm. from the original tape, is played for the judges on a system equalized for flat response.

effects heard as unnatural tones of instruments or sections; or confused sounds having unnatural resonances from the reverberation characteristic of the studio. Evaluate degree to which acoustic distortion is present.

4. **FREQUENCY RANGE:** Evaluate the recording as to whether it contains the maximum and minimum frequencies capable of reproduction by the wide-range playback system (40 to 10,000 cycles), or the degree by which the recorded range is restricted.

5. **SEPARATION:** The degree of clarity, transparency, and definition to which the blending of instruments and/or vocalists permits individual instruments, inner voices or choirs to be distinguished and identified, or if they are unnaturally masked by the overall sound.

6. **DYNAMIC RANGE:** This is the maximum and minimum recorded level. Evaluate the degree to which the volume range simulates the range demanded by the scoring, within the maximum limit that can be recorded safely, and the minimum which will be audible above the groove noise.

7. **MUSICAL BALANCE:** The degree of perfection in recording a true orchestral balance and the perspective of sound which will create an illusion of reality in reproduction, as differentiated from an artificial balance often achieved by equalization of the deficient part of the frequency spectrum, which usually destroys the *true* timbre and quality of sound.

Continued on page 118



Immortality for the Immortals

By J. GORDON HOLT

UNLIMITED life for irreplaceable recordings — that seems almost too good to be true, yet with today's phonograph and tape equipment, it can be achieved — easily. How? To answer that question in detail is the purpose of this article.

Standard 78 rpm. records are definitely on the way to extinction in the field of serious music, and many discophiles have already unloaded their entire collec-

A few years ago, we happened upon a particularly wonderful record. It was a 78; we played it over and over again. Finally it became so badly worn that we sent off for a new one. "This record has been deleted" came the answer. There are hundreds of such records . . . Everything from the immortal performances to the family favorites. The performance may be "immortal" but the record is definitely mortal, subject to all the ailments of too many playings. This article tells how the life of any record can be prolonged indefinitely — by transferring the sound to tape, playing the tape and thus preserving the record.

tions to replace them with the quieter, wider range, long playing ones. But what about those whose libraries of 78's include a large number of superbly performed, magnificently recorded items with which they are loth to part, and yet which they hesitate to play too often because, once worn out, they would be gone forever?

For these people, transfer of disc to tape offers the logical and simple solution.

In addition to the long life that tape can give to a recorded performance, it has the advantage of enabling the music lover to combine the series of 5-min. sections to give uninterrupted continuity equal to that of a long playing record. Furthermore, the tape can be transferred to a microgroove disc by a commercial disc recording company and added to an all-33 library.

What Tape Machine Should Be Used?

Any tape machine from the \$300 class up is capable of recording everything inscribed on even the best standard record without loss of quality. All such recorders have a maximum high frequency response of at least 7,500 cycles at a tape speed of 7½ ips. Since very few records available in this Country prior to 1945 could boast a range much greater than this, they may be recorded at this speed, often with a definite gain in listenability.

Amazingly few shellac records are really clean above this frequency, and a little wear on them can make them downright unpleasant to listen to. Recording these at the 7½-ips. speed, has the same effect as playing them through a filter which sharply limits the response above 7,500 cycles. The increase in cleanness is often startling, and surface noise is correspondingly reduced, while the cutoff is sufficiently sharp and at a high enough frequency to cause no loss of brilliance in comparison with the original.

For wider range recordings in good condition, a 15-ips. speed should be used because it ensures a top response of 15,000 cycles.

One model of tape recorder currently on the market is stated to give a frequency range at the 7½-ips. speed almost equal to that at 15 ips. The choice of recording speed here becomes simply a consideration of tape cost and playing time versus standardization. However, if tapes recorded on such equipment are to be transferred to disc, it should be noted that the playback machines used in commercial disc recording studios will not, in

most cases, give the 15,000-cycle response at $7\frac{1}{2}$ ips., even if it is on the tape.

Compensation and Tone Controls

On playback, tape recorders are usually connected into the reproducing system either through one of the high-level input sources on the control unit (usually labelled "Tuner" or "FM"), or directly into the basic amplifier input. In either case, the output from the recorder will be by-passing the magnetic pickup preamplifier-compensator stages, so there is not likely to be provision for compensating for the discs' recording characteristics once the music from them has been committed to tape. Records, therefore, should be compensated as accurately as possible during the initial transfer to tape.

All record manufacturers have published response curves purporting to show how they equalize during the recording process. Unfortunately, these can be used only as a guide to setting up the bass turnover and treble de-emphasis controls, since the sound on a record depends as much upon the acoustic properties of the recording studio as upon the electrical compensation used.

Adjustments of these controls should be made with the disc being played directly through the phono system, and that setting which gives the maximum of realism should be used when the discs are finally transferred to tape.

Phonograph Equipment Requirements

It is impossible to overemphasize the importance of using the best available phonograph equipment for disc-to-tape transfer purposes, if the end result is to represent the best that is in the discs. The requirements are much the same as for conventional high-quality music systems, but with added emphasis on constancy of turntable speed and low noise level.

Any noise in the playback system that changes in volume as the pickup travels across the disc will become extremely noticeable when tapes made from it are edited. Hum which increases or decreases as the cartridge traverses the record will point up the presence of every splice on the finished tape, due to variations in the hum level between spliced ends. Gradual pitch changes resulting from lack of adequate power in the turntable drive system will make the music lover wince with every sudden change of pitch when a splice goes past.

Also, of course, the pickup stylus should be impeccable, which implies either a diamond or a new sapphire.

Amount of Tape Needed

It is advisable to plan in advance just how much tape is going to be needed for a given album of discs, and where the music is to be divided between reels of tape or, if a double-track recording is to be made, between tape directions.

Playing time for an album of standard records may be estimated by multiplying the number of 12-in. sides by

$4\frac{1}{2}$, or by multiplying the number of 10-in. sides by 3.

The result represents the minimum length of time that the album may be expected to run, and the amount of tape needed to record it will depend upon the tape speed and the mode of recording (single or double-track). It is better to overestimate slightly the amount of tape that will be needed than to underestimate it, although the latter is not really a cardinal sin, as the overflow may be transferred to another small reel of tape and later spliced onto the end of the first reel.

If the tape is to be made double-track, the division between directions should be made wherever there is a logical pause in the program, as between two movements of a symphony.

Danger of Over-monitoring

One of the most common forms of amateurishness in home recording is over-monitoring, or excessive twiddling with the volume control during the recording operation.

When recording a live music concert from FM, there is no way of anticipating volume peaks, so it is necessary to monitor the recording volume constantly. But in transferring from disc to tape there need be no such atmosphere of breathless anticipation. Every volume peak is laid out "on a platter" beforehand, and can even be seen on the discs, by holding them so that the light reflects from them in radial bands. The bands of reflected light will be seen to vary in width with the volume of sound in the grooves.

Passages of maximum loudness show up as wide bands of reflection, and these should be used to set the level at which the recording will be made. The tape recorder is set up as it would be to make a recording, with the signal from the phonograph preamplifier-equalizer feeding

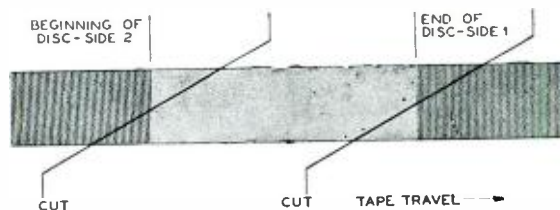

Fig. 1. Position of tape to be cut between sides of two records.

it, and the equalizer controls set to the correct positions as determined by preliminary listening tests. Then each of the loudest portions on the discs is played through the recording system, without the tape in motion. Whenever the recording level indicator reads overload, the record volume control is backed off until the loudest passage on the discs gives an indication of maximum undistorted level.

If the control unit feeding the tape recorder uses a loudness control or any other type of tone-compensated volume control, this should be set forward to the four o'clock or wide open position, where it will not introduce any unwanted bass or treble boost into the tape program. Then, on those control and preamp units

which incorporate an input level adjustment (usually accessible from the back of the unit) this control should be turned back so that the correct record volume indication occurs with the recorder volume control set at about $\frac{3}{4}$ clockwise rotation. This is simply a precaution against overloading any of the early amplifier stages.

With the main volume control set to take the loudest passage from the discs there is no necessity for touching it again through the entire transfer operation.

The tape traversing mechanism may now be set in motion, and the discs played straight through, taking care not to lop off any of the *pp* passages that often begin or end a side. Each side should be started and finished in its run-in grooves, to make certain that nothing is missed.

When it comes to editing out the sections of silence between disc sides, it will be found that different methods have been used by the recording companies to effect the side-to-side transitions from one disc to another. Each requires its own special technique of editing to achieve inconspicuous splices.

Switched Transition

The easiest type of transition to splice perfectly is the switched transition, where the engineers have thrown good taste to the winds and brutally chopped the composition into 4-min. sections by turning the music off and on with a switch.

To mark these for splicing it is only necessary to shuttle the breaks back and forth past the playback head by hand, and listen for the sudden termination of sound. Since it cuts in and out instantaneously it is easy to pinpoint the spot and mark it with a pencil or a small nick at the edge of the tape. Then the tape may be clamped onto the splicing jig and cut with a razor blade. The angle cut on the tape should bisect the line previously penciled across the tape, as shown in Fig. 1, if the least interruption or overlapping of the program is to result.

Orchestra-pause Transition

Another type of transition that is relatively easy to edit satisfactorily is the orchestra-pause, where the conductor pulled his men to a halt every four minutes or so, to allow the engineers to change discs.

This type causes a little more difficulty in spotting where the cut should be made in the tape, because of the lack of clearly-defined points where the sound stops or starts. At the end of one side there may be a full two seconds of hall reverberation, and the next side may start with a low-level bass passage that is practically inaudible when the tape is being moved by hand.

The splicing of an orchestra-pause transition can best be made by a cut-and-try procedure, which begins by cutting the tape at a point roughly in the middle of the silence area. Then the takeup reel is removed from the recorder, and the feed reel is swapped over to the takeup position. When the reversed tape is played the music will be heard backwards, and will come to an abrupt end at the spot on the tape where the orchestra had ac-

tually started playing on that side of the disc. With a pair of scissors, the period of silence following the "end" of the reversed music can now be trimmed off, bit by bit, and the section played repeatedly until the sound runs

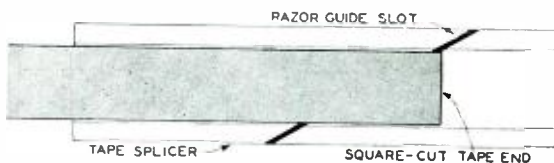

Fig. 2. For diagonal cut, one corner of tape should match guide.

right to the end of the trimmed tape. The trimming cut should be made at right angles so that the end of the tape is easily heard when it passes the playback head.

When the trimming is finished, the end should be cut at the standard splicing angle, using the guide slot on the splicing jig, with the diagonal cut starting right at the corner of the squared end, as illustrated in Fig. 2.

Returning the tape spools to their original positions, the end of the tape dangling from the takeup spool should be threaded through the recorder, allowing enough tape to give about ten seconds of playing time before the end passes the playback head. Then the trimming operations are repeated as before, until there are about two seconds of silence remaining after the last note. Finally, the end of the tape on the takeup reel is trimmed at the standard angle.

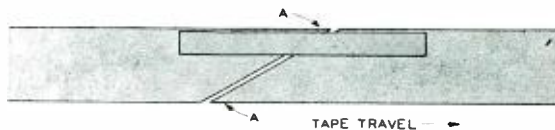

Fig. 3. Temporary splice of two tapes, A, for listening test.

Now a temporary splice, Fig. 3, can be used to join the two loose ends for a preliminary audition of the splice. The tape is played through and careful note made of how much the time lapse between spliced ends interrupts the rhythm of the music, and whether or not there is duplication of the last and first notes between the disc sides. The time lag or duplication of a note is eliminated by separating the ends at the temporary splice and cutting off short lengths of tape on the takeup spool, joining and auditioning the splice each time. This cutting *must* be done toward the takeup spool, otherwise part of the program will be lost. (The supply spool has already been trimmed to the exact spot.)

The splice is finished when the music spanning it flows smoothly, without a break in tempo.

The Fade Transition

Occasionally, a type of transition will be encountered where the music was faded out between the record sides. At the end of one side, the signal loses volume gradually until it disappears.

Continued on page 120

Hi-Fi goes to School

By ULRIC J. CHILDS

EVER since the invention of the Audion vacuum tube, amplifiers have led useful and profitable lives in theatres and auditoriums of all kinds. Many a weak-voiced orator has been able to address a multitude only because an amplifier gave muscles to his vocal chords. In the entertainment field, the crooner owes his livelihood to microphones, amplifiers, and loudspeakers, without which he might have been just another unknown vocalist. Sound motion pictures depend entirely on auditorium amplifiers.

Until recently, however, auditorium audio systems have been limited to reinforcement of sound for the customers in the back seats, and to movie work. In neither of these applications is high fidelity really either considered or achieved. But now, audio systems are being installed for the specific purpose of giving phonograph record concerts to highly discriminating audiences, people who appreciate good music and who are accustomed to hearing it in the flesh rather than out of a can. That such an audience can sit in attentive silence listening to recorded music for an hour or more — and frequently applaud enthusiastically after the first record, as they would at a live concert — indicates that an auditorium audio system can be not just another "PA" job, but a true high fidelity installation.

Because the number of such listening groups is growing rapidly, there is an increasing need for what might be called "hi-fi PA" systems. The need is by no means confined to adult groups; parents, fully aware of the advantages of high fidelity reproduction in the home, are encouraging educational and similar organizations to provide high fidelity facilities for their children.

A Hi-Fi Auditorium System

The author recently had an opportunity to design and install a hi-fi PA system which incorporated several inno-

ventions and improvements. This article will describe this system in detail, because it is felt that the solutions found to the problems encountered here would be helpful to other schools, groups, and organizations which might be contemplating similar music listening facilities.

The system was installed for Keuka College in Keuka Park, N. Y. This institution for girls, while providing the standard commercial courses, concentrates largely on liberal arts and has an extensive music department. The college is located 100 miles from the nearest medium-size city, so that the students and faculty have little opportunity to hear concert artists. To make up for this lack of live music, the college authorities conceived the idea of holding record concerts. At first, however, they were deterred by their memories of the quality of the systems they had heard in theatres and auditoriums.

Fig. 1. Where high fidelity went to school: the Keuka College auditorium.



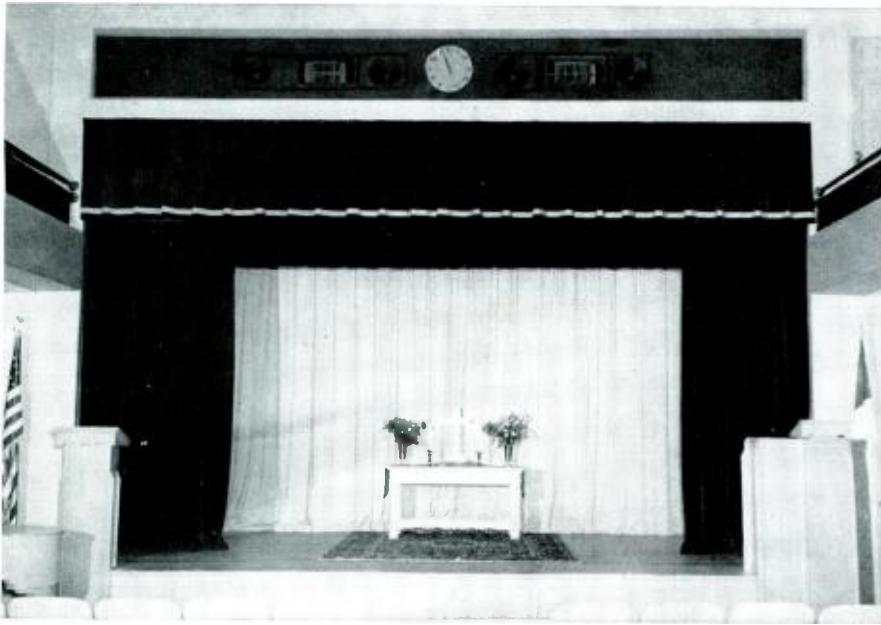

Fig. 2. View of stage after installation of speakers above proscenium. Clock was removed, the entire area including speakers painted black and covered with a porous plastic cloth.

A member of the liberal arts faculty had already initiated the practice of holding record concerts in his home, attended by faculty members and students. Sometimes as many as 60 were in the audience. The home equipment was originally built by the writer around a specially-designed amplifier capable of 35 watts continuous output with only 2½% intermodulation distortion. It was reasoned that here, perhaps, was the solution to the auditorium problem.

Problem in Psychological Acoustics

After a brief look at the auditorium and a little conversation with the college staff, the writer welcomed the opportunity to undertake the design and installation of this system. Here was a new idea in sound; a chance to provide music for large groups of people; a new market for sound products; and an extremely interesting problem in what might be called "psychological acoustics".

Ordinarily, a large group of people listening to a PA system has a visible center on which to focus its attention: performers, speakers, or a motion-picture screen. But at Keuka, the stage would be empty and the entire attention of the listeners would have to be focused on the music. Any deficiency either in components or in the layout of those components would result in audio fatigue much more quickly than under any other circumstances. Any perceptible distortion in records, amplifier, or speaker; any well focused point source of sound; any acoustic inadequacy would start the audience coughing, squirming, and at least whispering, within minutes. The system and its installation, in a word, had to be little less than perfect to hold attention and give enjoyment without any auxiliary visual attraction.

Not the least of the problems was to arrive at some

general conclusions about the design of systems for auditorium music listening so that this kind of installation could be made at other institutions.

Auditorium Specifications

The auditorium at Keuka measures about 40 ft. wide and 60 ft. deep (from entrance doors to stage apron). It has a balcony, as the photo of Fig. 1 shows, and the maximum ceiling height is about 25 ft. The seating capacity is about 1,000.

The acoustics are not ideal, for the walls are hard, without acoustically treated materials. There is some advantage in the fact that the chair backs are upholstered and venetian blinds on one wall aid in suppressing some reverberation. A rough estimate of the reverberation time was between one-quarter and one-half second, making the auditorium fairly live but not objectionably so. When the hall is filled, of course, the acoustics take a decided turn for the better and there is very little liveness added to the reproduced sound.

The stage, pictured in Fig. 2, is about 14 ft. deep. There is considerable space above the upper edge of the proscenium, as indicated in Fig. 3, which is a cross-section of the structure between the proscenium and the auditorium ceiling. The 24-in. wood-and-plaster panel covers the opening shown at the top in Fig. 2; this was originally designed to be filled with a grillwork which was to cover a set of organ pipes.

Placement of Speakers

This wood and plaster panel was the obvious place in which to mount the speaker systems, with the stage itself acting as the enclosure back of the speaker. It was

not necessary to close the front curtain to get the correct effect. The baffle action depends on the spacing between the speakers and the lower edge of the second teaser curtain, for that determines the length of the path which sound must travel from the rear of the speaker cones before mingling with the sound from the front.

When both sounds reach the ear simultaneously they cancel since they are 180° out of phase. When a flat baffle is used (as the proscenium front and the teaser curtains approximate here) the distance between the speaker and the edge of the baffle must be at least as large as one-quarter wavelength of the lowest frequency to be reproduced without attenuation. The distance between the center of the 24-in. panel and the lower edge of the second teaser here is about 9 ft., which allows full reproduction down to less than 30 cycles.

To carry this idea through, the tweeters were not simply mounted against the panel but were placed in boxes with rear covers. Fig. 4 shows the rear of the wood-plaster panel, with two complete two-way speaker systems mounted on it. Each system contains two Altec-Lansing 515 15-in. woofers and one Altec-Lansing 802-B with an H-808 multicellular horn. The rear covers on the tweeter boxes prevent any sound from the backs of the woofers from traveling a short path into the auditorium.

The greatest possible rigidity is an absolute necessity to prevent the woofer frames from vibrating. Each woofer was first mounted on its own $\frac{3}{4}$ -in. plywood baffle with eight carriage bolts and nuts. The baffles were then mounted to the wood-plaster panel with twelve wood screws each through the 1-inch-thick wood of the

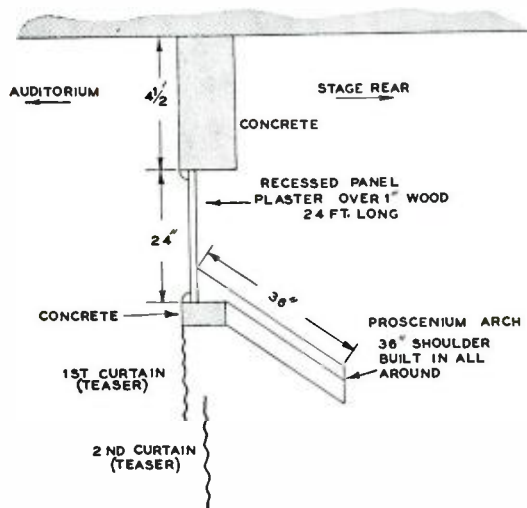

Fig. 3. Sketch showing cross-section of structure above proscenium.

panel. Both wood surfaces were carefully worked to be sure of close fits so that no sound could emerge from the rear of the speaker.

The tweeter boxes were made by screwing and gluing together the four sides. Then they were set into

the panel and the boxes lined with Ozite to prevent sound reflections from the sides. The tweeters were then screwed firmly into place and the rear cover, also lined with Ozite, put in place.

Each speaker system was provided with a dividing network having an 800-cycle crossover frequency. The systems will handle about 30 watts each; since the maximum power output to each speaker in actual use is about 5 watts, this rating is more than adequate for peaks.

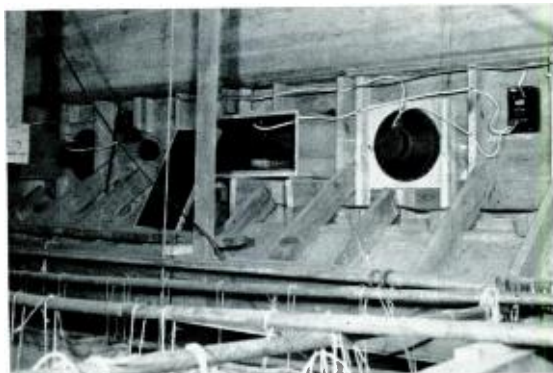

Fig. 4. Rear of speaker panel. Note solid mountings and tweeter boxes. Teaser curtain rods and ropes are in foreground.

An important point was the separation between the two speaker systems. As Fig. 2 indicates, the spacing is not as great as the width of the auditorium would have allowed. While very little separation gives the bad effect of a point source, too much separation confuses the listener, especially when a solo instrument is being heard, by making it impossible to localize the sound source within reason. As it is, the tweeters are spaced 10 ft. apart. The apparent sound source is the stage itself, but there is a pleasant dispersion over the whole area of the stage. The optimum separation between speaker systems was arrived at by placing the speakers on the stage, feeding them a tone from an oscillator, and walking around the auditorium to judge the effective source points.

Electrical Components

As in any audio system, the system as a whole is no better than the weakest link. Assuming good speaker systems, the most difficult problem arises from the amplifier, for it has the job of amplifying in a linear manner and driving a mechanical load with the utmost accuracy.

It was not found necessary to alter the standard amplifier, for use in the auditorium. At its normal home output level of 1 to 2 watts, exclusive of peaks, and feeding into a single speaker system, intermodulation distortion is less than 0.1% and distortion is not perceptible to even the most critical ear. At the level (about 5 watts) being supplied normally to each speaker system in the auditorium under discussion, intermodulation is no higher, and on peaks (around 25 watts) intermodu-

lation rises only to 0.25%. The output regulation is ¼ db, which means that the internal impedance of the amplifier as seen at the 16-ohm output tap is about ½ ohm. Thus the speaker systems are tightly controlled by the



Fig. 5. Equipment includes two complete power amplifiers, two preamplifiers, two Gray pickup arms, and Rek-O-Kut turntable.

signal and there is no tendency for the speakers to carry on any motion on their own hook. Hangover effects, resonances, and rattles are thoroughly damped out. The output stage is four push-pull-parallel triode-connected 807's. Inverse feedback around two loops totals about 25 db.

The system has no microphone input, but includes the writer's preamplifier, which has 20 calibrated, step-type combinations of bass turnover and treble rolloff to compensate for different records.

The loudness control usually included in these preamplifiers to compensate for the ear's inefficiency in the bass region at low sound levels was changed somewhat for the auditorium installation. The music is normally reproduced at about the same level as in the concert hall and bass compensation is not required in normal use. It is needed, however, on the infrequent occasions when the volume is turned down low. Fig. 6 shows the standard loudness control. For this installation, the two dotted-line sections were omitted.

Fig. 5 shows how the electronic components were mounted in a small open-front wood cabinet in the wings of the stage. Two complete amplifiers and preamplifiers were provided, with the inputs connected in parallel. Normally, each amplifier feeds one of the speaker systems, but an extra speaker jack is provided so that the operator

can switch both speaker systems to a single amplifier in the event one breaks down. Because of the output regulation of the amplifiers, adding a second speaker system in parallel with the first changes the output level less than ¼ db, an imperceptible amount.

The turntable is a 16-in. Rek-O-Kut with maximum freedom from rumble, which would be very objectionable in a system with such extended bass response. Separate Gray 108 viscous-damped pickup arms are used for 78- and 33 ½-rpm. records, each with a Pickering diamond-tipped cartridge. A second turntable will be added later to allow continuous playing of 78-rpm. works.

Considering the enthusiasm with which audiences have been listening to, and commenting on, the Keuka College recorded concerts in the thirteen months the system has been in operation, sound men throughout the Country should investigate the possibilities for installing auditorium music systems.

The problems encountered in a given location will differ somewhat from those described for Keuka, but the general solutions will be similar. Above all, however, the installer must keep constantly before him the fact that only the very finest equipment reproduces music with sufficient fidelity to satisfy such critical audiences and to hold their interest.

These points must be remembered: Even though the system may idle at levels of from 3 to 5 watts during passages of average volume level, it must be capable of handling peaks of at least ten times this figure with an absolute minimum of distortion.

The arrangement of the speakers will present the most difficult problem. First, the method of baffling, enclosing, or loading must be such that fundamentals down to 30 cycles are handled without loss. Second, the sound source should appear focalized while, simultaneously, the sound itself must be completely and widely distributed.

If these fundamental prerequisites are met, then the resultant system will be not just another PA job, but a hi-fi auditorium installation.

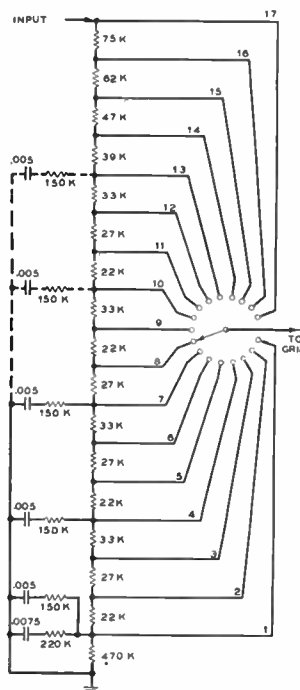

Fig. 6. Schematic of step-type loudness control. For auditorium use, sections indicated by dotted lines were omitted.

The Loudspeaker

G. A. BRIGGS

NOTE: This is the fourth in a series of articles by Mr. Briggs.—Editor

IN THE three previous articles in this series, we have examined the subject of sound reproduction as related to The Human Ear, Response Curves and Room Acoustics. It has, therefore, been possible to tread in unfamiliar paths. As we now get back to the actual loudspeaker — about which so much has already been written — it is very difficult to cover any new ground; the most we can hope to achieve is to turn over a few stones which have not been disturbed for some time and examine with a 1952 eye the mysterious forms of life which are hidden away and often forgotten. In short, let us return to first principles.

Broadly speaking, the three main requirements in a loudspeaker are (1) low cone resonance for good low frequency response, (2) light weight or mass for good high frequency performance, and (3) absence of resonant peaks for smooth response in the middle register.

All vibrating systems, therefore all cone assemblies, have a natural resonance with increased acoustic output in the frequency range involved, and the cone is mass controlled at all frequencies above this resonance.

Now the easiest way to lower the cone resonance — after achieving maximum flexibility compatible with reliable centering — is to *increase* the mass and therefore the weight. But the easiest way to improve the high frequency performance is to *reduce* the mass. We are, therefore, always faced with a fundamental problem — wide response — with diametrically opposed methods of solution.

Commercial Limits

It is not difficult to produce a single loudspeaker which will cover the frequency range of the average commercial radio receiver or radiogram, where high frequencies must be cut to reduce interference and needle scratch, and bass is cut by popular limitations on cabinet size and by cost limits on output transformers, etc. The restricted frequency range of such receivers — excluding possible further high frequency attenuation imposed by sharp tuning — is shown in Fig. 1. The test was made with the tone control set at the position marked optimistically by the makers as "maximum brilliance". Incidentally, this is quite a good response curve in the sense that top cut is nicely balanced with bass cut, thus producing generally acceptable tone quality.

The curve was taken with oscillator feeding the pickup input sockets, and with the secondary of the output transformer loaded with a suitable resistor.

High Fidelity Range

The response requirements for high fidelity are, of course, much more exacting. It is illuminating to compare Fig. 1 with the response curve of Fig. 2, which was taken with a push-pull amplifier with tetrode output and 22 db negative feedback. The output transformer is of generous dimensions with an inductance of 100 henries, and a winding in 7 sections with a leakage inductance of not more than 0.080 henry.

It is very easy to see that a loudspeaker most suitable for the range of Fig. 1 could be almost useless for the response of Fig. 2. Conversely, the cost of a wide range speaker system to match the wide range amplifier would not be justified with the commercial receiver. This has

Fig. 1. Oscillogram of response of amplifier in a typical radio set selling in England at the equivalent of \$50, or at \$125 for radiogram (plus a purchase tax of \$22.50 and \$50 respectively). Output valve is a pentode type with 12 db of negative feedback.

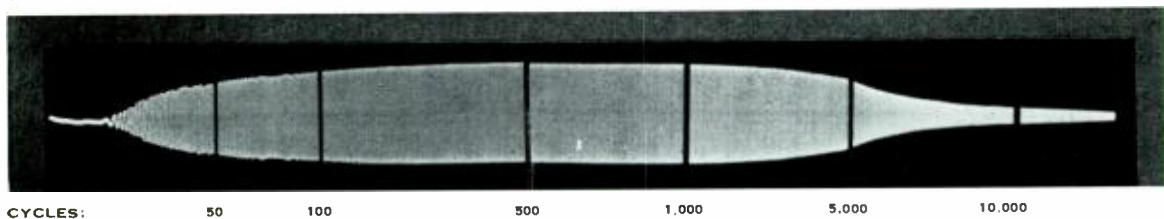

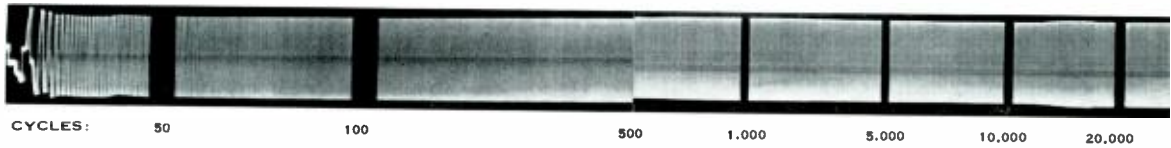

Fig. 2. Oscilloscope of response of wide range, high fidelity amplifier, for comparison with Fig. 1. Voltage output is in proportion to the width of the trace. Tetrode output with 22 db of negative feedback.¹

been said before — thousands of times — but it is still rather startling to observe the difference between the two standards.

Harmonic Distortion

The actual response range of the equipment is only half the battle. Where the low frequency output is restricted by the use of small transformers, there is severe distortion, and where the high frequency response falls off at 5,000 cycles and upwards, the harmonics of most of the notes of musical instruments are either severely attenuated or completely obliterated. These truisms are neatly illustrated in Fig. 3, in which square waves at 50, 200 and 3,000 cycles are shown as generated, and as reproduced by the commercial set. The poor performance at 50 cycles is self-evident. As regards the 3,000-cycle square wave, this comes out as almost a sine wave, showing very little third harmonic at 9,000 cycles and no fifth harmonic at 15,000 cycles.

It is, therefore, quite clear that the loudspeaker has to deal with quality of input to the speaker, after feeding through the set, as well as frequency range.

Low Frequencies

It would be interesting to take one of the early Rice-Kellogg or Magnavox moving coil speakers and compare the low frequency performance with that of the average loudspeaker of today. I think we should find that the old ones were better in the bass. They were usually built with soft leather suspension and flexible spiders (cen-

tring devices), the voice coil working in a gap of generous dimensions with a rather low flux density. High flux density is essential for true sensitivity and sharp transient response, but it has the effect of damping cone excursions at very low frequencies. (Flux density also costs money.)

No doubt the limited frequency response and poor quality of commercial sets below 100 cycles enabled the use of the mass production methods which were applied to the manufacture of moving coil speakers, to the detriment of true bass. During recent years, the response requirements of Fig. 2 have again focused attention on the necessity for true bass.

This brings us to the most important quality in any loudspeaker — other than a tweeter — which is the frequency of the cone resonance. The lower the resonance, the better the quality. Any idea that high cone resonance can be overcome by "matched" reflex cabinets or fancy flares is a fallacy; it is also a mistake to assume that the frequency of resonance is unimportant because the resonance can be damped by high flux density and negative feedback. The reason is that the acoustic output below the resonance tends to fall off and non-linearity results. In view of these facts, it is rather surprising that articles on the subject of speakers and methods of mounting still appear from time to time, in which the question of cone resonance is blandly ignored.

The reader may wonder why all loudspeakers are not made with a low resonance, say at 30 cycles, so that the problem is disposed of once and for all. Unfortunately, the very free suspension required increases the difficulty of production and also increases the risk of trouble from off-centre effects from rough handling during transport. (I do not know how gentle the average American railway employee is; in England the transport game seems

¹From "Amplifiers: the How and Why of Good Reproduction" by G. A. Briggs and H. H. Garner. HIGH-FIDELITY Book Department No. 100, \$2.95.

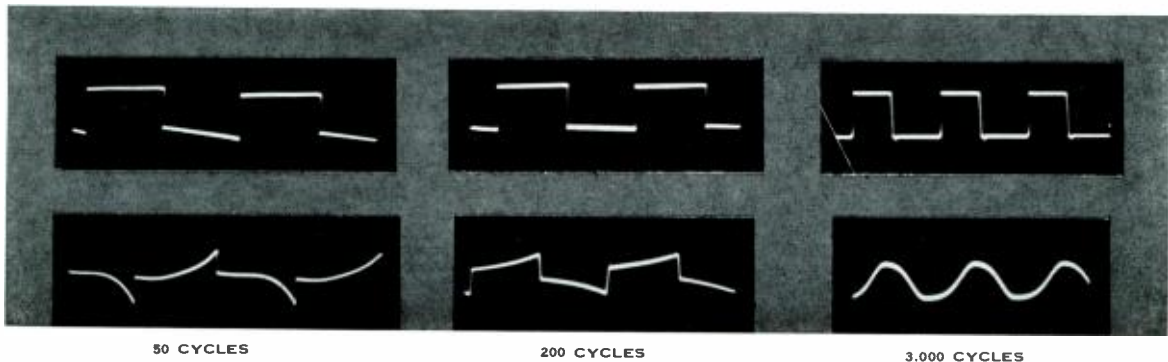

Fig. 3. Square waves as generated (top) and as reproduced (bottom) by the commercial set whose frequency response was examined in Fig. 1.

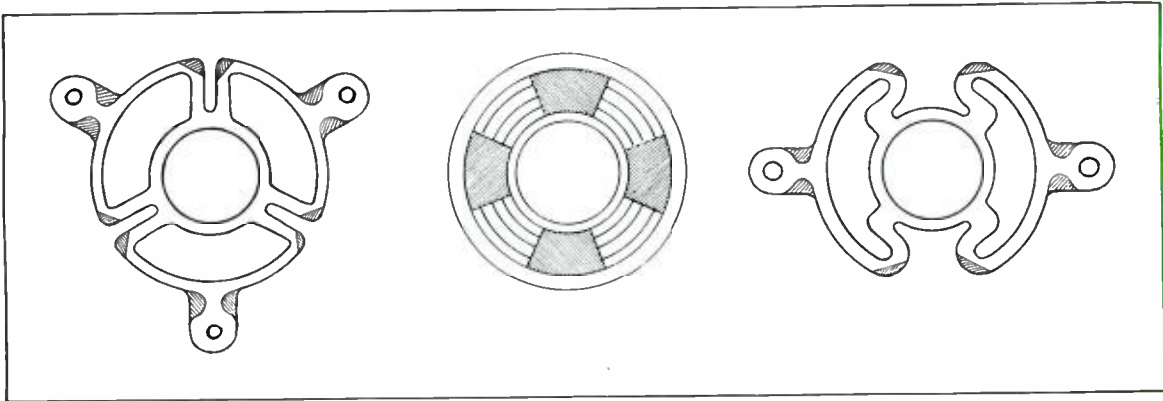

Fig. 4. Typical speaker spiders or centring devices. Shaded portions show areas which can be cut away in order to increase flexibility.

to be to see how far a parcel can be thrown. It is impossible to insulate a loudspeaker from shock by careful packing.)

It is obvious that an immovable voice coil could never go out of centre. It is an axiom that — other things being equal — the possibility of lateral displacement increases as the suspension is made more free, and the elevation of the coil in the gap may go wrong. These faults result in rattle and non-linearity. It is clear from these considerations that frequency of cone resonance is not a question which can be arbitrarily decided by the maker; it is the outcome of many factors, including gap dimension, coil diameter, weight of cone, suspension, centring device, robustness and reliability . . . and a guess as to the destructive ability of parcel handlers!

Experiment in Cone Resonance

If any reader is in doubt about the benefits of low cone resonance, I see no reason why he should not make an experiment on a cheap loudspeaker, not less than 8 ins. in diameter, which he can afford to throw away if results are unsuccessful.

First of all, listen to the speaker mounted in a certain way — baffle, reflex, horn, any loading — then take the unit and wedge the voice coil in position by inserting shims in the gap. Strips of old film make useful shims. Now cut away the corrugations around the periphery of the cone with a razor blade and replace by segments of soft cloth glued first to cone and then to chassis. Leave the cloth free from tension. This grafting operation will usually lower the cone resonance by 10 or 20 cycles. Remove shims and listen to speaker under same conditions as before. The acoustic output should be less, but quality should be better.

If the spider or centring device is stiff, it will be necessary to perform a serious surgical operation to relieve the restriction. The chances of recovery of the patient will be correspondingly reduced, and will depend on the skill of the operator. Chunks of the centring device can be cut away, but a symmetrical plan should be followed as indicated in Fig. 4.

If you find that you are unable to replace and re-centre the cone and coil after these mutilations have been completed, throw the speaker away, buy another, and try again. It is to be hoped that your skill will develop rapidly and keep pace with the depth of your pocket. In awkward cases, the centring device may be discarded and the coil centred by threads as indicated in Fig. 5.

The main point is that it is possible to achieve very free suspension with satisfactory centring and elevation of the voice coil in a speaker which is remaining *in situ*. Once you hear, say, an 8-in. unit with a 20-cycle resonance, you will appreciate the significance of the whole

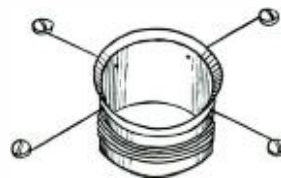

Fig. 5. In stubborn cases of stiff spider-itis, which do not respond to the treatment shown in Fig. 4, the voice coil can be held in place by four threads, as sketched here.

problem. Remember that the *apparent* sensitivity will have been reduced by eliminating resonance, and the power handling capacity of the speaker will also have been cut down, so temper the wind to the shorn lamb when testing.

It has been assumed so far that the reader will only go to work on a loudspeaker which he can afford to throw away if his efforts are unsuccessful. If, as a result of skill and confidence gained in such practice, he decides to tackle more expensive units, the responsibility must rest fairly and squarely on his own shoulders. I do not advocate such a step, because there is more in the design and construction of a high quality loudspeaker than meets the eye.

Precautions

Always work on a clean bench or table, and never take a speaker magnet into a garage or any room likely to be infested with iron or steel filings.

Never allow a magnet to come into contact with another magnet or with a large piece of steel, as demagnetisation will result.

Before replacing a voice coil, always make sure that the magnet gap is free from dirt and filings. The gap may be cleaned by running round it with a strip of cardboard covered with vaseline or petroleum jelly. An odd filing can be removed with the blade of a penknife.

Middle Register

All loudspeaker cones possess an unfortunate tendency to produce increased acoustic output over a range of one to two octaves, due to resonances in the wall of the cone and in the corrugations of the surround. The fault is usually most noticeable in the average 12-in. speaker. The two response curves of Fig. 6 draw attention to the location and extent of such rise in output — roughly 10 db from 2,000 to 6,000 — and they also illustrate how a soft surround tends to mitigate the evil, without actually removing it *in toto*.

It should, however, be stressed that the peak in output can be virtually overcome by judicious design and the use of very high flux density. Different makers employ different tactics. If the editor will allow a personal note² here, I should like to explain that my own method of attack on the 12-in. speaker was to use a cone with bakelised apex, cloth surround, and aluminium voice coil, with a magnet of 17,000 lines flux density (total flux

190,000 lines). Fig. 7 shows how the response level is extended by these steps. Incidentally, the price is also extended by about 60%.

To return to the normal cone speaker, it is worth noting that the rise in output is often used by set makers to improve "top" response which has been attenuated in the tuning process.

How to Remove Peaks

In cases where the rise in output is over-prominent and mars the smoothness of reproduction, it can be removed by the insertion of a resonant circuit similar to those used in crossover filters, although it is not easy for the amateur to locate the exact frequency range involved. He can, however, always fall back on the aid of our old friends, trial and error.

As a rule, the peak will occur around the following regions:

	PROBABLE PEAK OUTPUT	TUNE TO
8-in. speaker	3,000 to 7,000 cycles	4,000 cycles
10-in. "	2,500 to 6,500 "	3,500 "
12-in. "	2,000 to 6,000 "	3,000 "
15-in. "	1,500 to 4,000 "	2,500 "

The tuned circuit, Fig. 8, consists of inductance and capacitance, resonating at the desired frequency, with a resistance to flatten the Q and widen the range of the filter, so that its effect is reasonably inversely proportional to the rise.

Typical values would be as given in the table below, which are calculated around a capacitor of 1 mfd. as this value is easily obtainable.

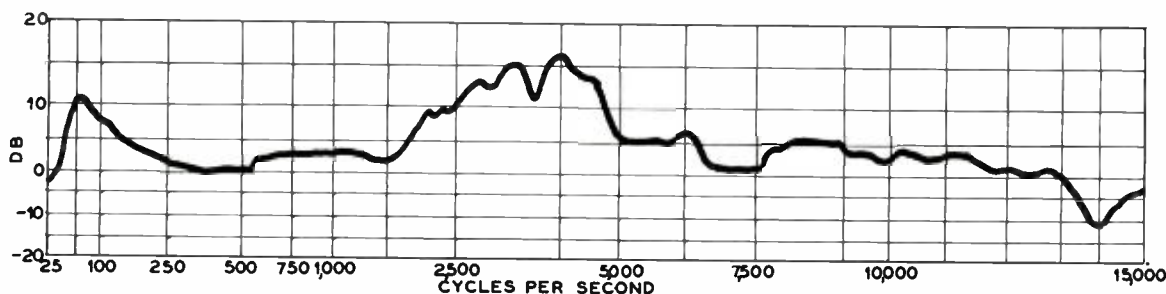
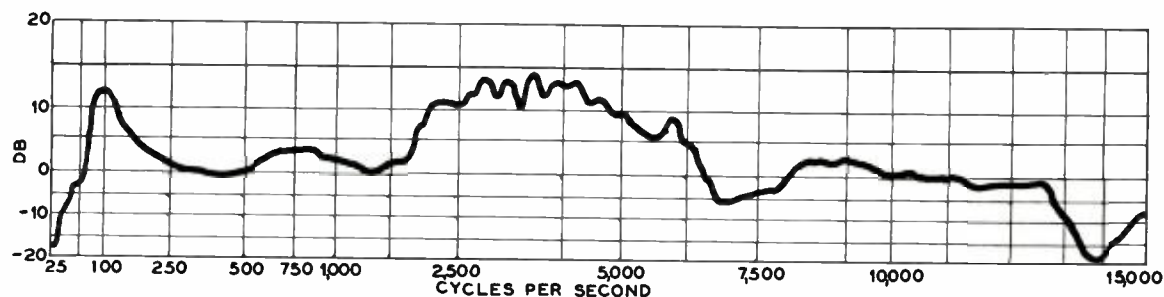

Fig. 6. Response curves of typical 12-in. speakers taken in an anechoic room. Magnets had a flux density of 13,000 lines. The curve at the top shows a unit with a corrugated cone; the bottom curve is that of a speaker with a cloth surround.

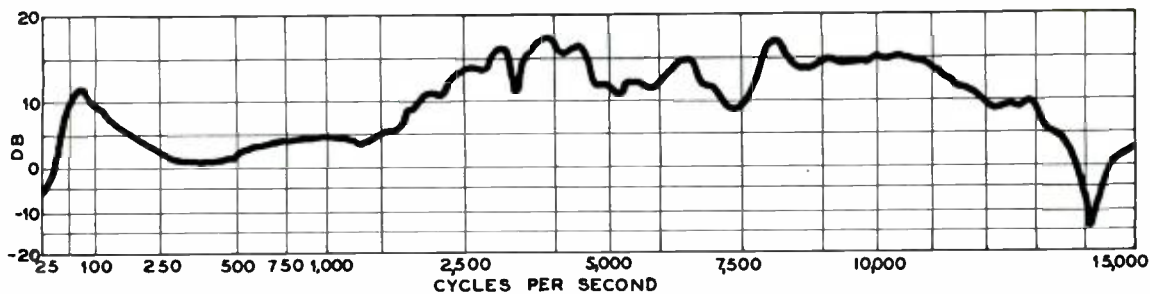

Fig. 7. Response curve of a 12-in. speaker. Flux density of magnet was increased to 17,000 lines. Note, in comparison with Fig. 6, the improvement in "flatness" from the peak at about 3500 cycles to 13,000 cycles.

CIRCUIT VALUES FOR FIG. 8

Mid-Frequency	C	L	R
4,000 cycles	1 mfd.	1.4 Mh.	33 ohms
3,500 "	1 "	2.0 "	33 "
3,000 "	1 "	2.8 "	33 "
2,500 "	1 "	3.8 "	33 "

The inductance should be an air-cored coil. It would be quite a good idea to wind a 4-Mh. coil with various tappings down to 1 Mh. and select the setting which gives the best results. A suitable coil can be wound on a wooden form 2 ins. long and 1 in. in diameter, with No. 18 swg. cotton-covered enameled copper wire. 430 turns (at 32 turns per layer) will give about 4 Mh. with tappings at 390, 330 and 240 turns for 3 Mh., 2 Mh., and 1 Mh., respectively.

The voltage drop in the voice coil circuit, using filter values of 1 mfd. and 2 Mh., is shown in Fig. 9, with and without the 33-ohm resistor.

At frequencies above 5,000 cycles and below 1,000 cycles, which are outside the resonant circuit frequencies of the filter, the loss of power is negligible. For example, the impedance at 250 cycles is increased from 12 ohms to only 13 ohms by insertion of the filter. The difference to the acoustic output is not observable.

If an attempt is made to use constant frequency records for locating loudspeaker resonant peaks, and for estimating the effect of a tuned filter, care must be taken to avoid errors of judgment due to pickup resonance

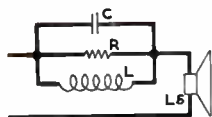

Fig. 8. Schematic of filter to remove peak in output, for speakers up to 15 ohms.

and live room characteristics. It would be advisable to take the loudspeaker into the garden if possible, or, failing this, to face it through an open window and listen outside to the level of response at different frequencies.

Extreme Top

I suppose that the range between 5,000 and 15,000 cycles would generally be accepted as covering the extreme

top. I regret that I have no household hints which could be put forward to improve the performance here, but it is a fact that any reduction of resonant peaks in the middle or lower registers automatically steps up the relative output at higher frequencies, and therefore gives the impression of improved top to the discerning ear. On the other hand, reducing a peak in the 3,000 to 5,000-cycle region would be judged as reduced top by the uncultivated ear. I feel sure that readers of this journal belong to the first of these two classes of listener, and will, therefore, agree that we have in this article rendered some service to the improvement of the highs, despite the short space allotted to them.

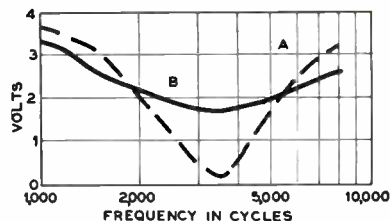

Fig. 9. Effect of inserting filter, Fig. 8, into voice coil circuit.

EDITOR'S CONCLUSION: As Mr. Briggs' response curves show, loudspeaker problems can be divided into four zones: 20 to 200 cycles, 200 to 2,000 or so, 2,000 to 7,000, and 7,000 cycles and over. The final answer to the 20 to 200 zone has not yet been achieved; flattening out the resonance bump and getting efficiency below this point is often partially accomplished by enclosure design (Mr. Briggs' topic for the next article). The area between 200 and 2,000 is relatively flat and good, but here it appears much lower in average output level than the area between 2,000 and 7,000 or above. This is due partly to testing techniques (whether the speaker is tested "naked" or in an enclosure).

At some point above about 7,000 cycles, speaker efficiency falls off. In England, the tendency is improve response (as shown by the difference between Fig. 6 and Fig. 7) as far up the frequency scale as possible. In this Country, we tend to resort to tweeters to carry the burden from at least 5,000 cycles. Since the speaker used by Mr. Briggs in his test for Fig. 7 shows excellent response out to 13,000 cycles, he does not discuss tweeters in this article. However, the speaker whose response is shown at the top in Fig. 6 would be helped by the addition of a tweeter.

London Newsletter

D. W. ALDOUS

FOR MANY years Francis F. Clough and Geoffrey J. Cuming in this Country have been at work on the compilation of an encyclopaedia of recorded music of permanent value. The result of their labours has just been published¹ and one gladly pays tribute to this prodigious volume combining erudition and industry.

In 890 pages the authors have listed in classified form all electrically recorded music, both available and deleted, of worthwhile interest from every record producing country in the world, as well as pre-electric records of historic value. The period covered is from the beginning of electrical recording (1925) until April 1950, with a bound-in supplement up to May-June 1951. To keep the material as up-to-date as possible, the authors hope to combine this supplement and later supplements into a second volume.

Excluding the major companies' makes, over 300 record labels are listed, and a study of the meaning and importance of the record numbering methods of different manufacturers is given.

The pioneer work of the American R. D. Darrell's "Gramophone Shop Encyclopaedia of Recorded Music" (1926-1936) is acknowledged by the authors, but for completeness and accuracy it would appear that there is no comparable text, except possibly by UNESCO, which organization is compiling details of recordings of particular composers and certain aspects of folk music.

Every effort has been made to follow recognized catalogues and systems of music classification. For example, Kochel is followed for Mozart, Longo for Scarlatti, Deutsch numbers for Schubert. The index includes cadenza composers and arrangers and editors of compositions as well as full titles of operas and stage works.

One curious omission is Folk Songs or Traditional music, and national melodies of various countries of the world, but one can only presume this was deliberate. Even humour has infiltrated into this scholarly tome,

as when the authors list some eighty versions of a much-recorded vocal or instrumental item, they add, "and most other tenors" or "and most other cellists".

Truly, this beautifully produced book is a remarkable contribution to discography or discophily, as *The London Times* music critic prefers to call this field. I can do no better than close this review with the words of this eminent gentleman (Mr. Frank Howes, I think, as all *Times*' critics are anonymous) referring to the work of Clough and Cuming: ". . . so now this recording of records, this assembling of entries, this sifting of ciphers will go on ineluctably. Strange phenomenon this discophily, conjunction of instinct and intellect."

I FIND it difficult at times to remember that my friend Norman Leever, a slim, bespectacled, youngish man with a quiet manner, has specialized for over twenty years in the technical side of film production, with particular reference to sound recording.

Mr. Leever, with a B.Sc. degree from London University, worked in the C.F.T.H. Acoustic Laboratories in Paris as far back as 1928, where he designed sound-film apparatus. He became chief sound engineer to British Screen Service in 1933 and formed Leever, Rich and Company in 1936. His firm, with studios in Wardour Street, the film trade centre of London, has been responsible for the sound recording in many hundreds of films, both 16 mm. and 35 mm.

The latest development of this enterprising engineer is the Leever-Rich "Syncropulse" system, a method of synchronizing magnetic tape recording for professional film production. The basic mechanism is the Leever-Rich Type "C" transportable magnetic tape recorder, which is capable of high-quality sound recording using standard 1/4-in. unperforated magnetic tape at 15 ips., with the entire unit operating from one 12-volt car battery.

The Syncropulse system is unorthodox in that it does not depend on the use of a common power supply for film camera and recorder, nor does it involve the use of an alternating current supply or synchronous motors

¹The World's Encyclopaedia of Recorded Music, by F. F. Clough and G. J. Cuming. Published by Sidgwick & Jackson, 44 Museum Street, London, W. C. 1, in association with the Decca Record Company. Royal Octavo, cloth bound.

of any kind, since both camera and recorders can operate off their own local batteries, or even independent clock-work mechanisms.

The system works on the control track principle, whereby a continuous reference tone or timing signal is recorded on the tape simultaneously with, and adjacent to, the speech track. This control track takes the form of a carrier, which is modulated by the picture camera to produce a series of pulses at picture-frame speed. Since the control track is physically part of the recording, it provides a means whereby the sound can always be replayed at a speed to correspond with the projection of the picture. Further, the synchronizing is in no way affected by the speed at which the tape was recorded, or by any slippage or tape stretch. The method normally operates on a "one pulse per frame" basis.

Already such film studios in Great Britain as Ealing and Merton Park have installed this equipment, as well as our Royal Naval Film Unit. One was recently used to record, in conjunction with five 16 mm. cameras, an entire non-stop specially-staged performance at the Drury Lane theatre of the musical show "South Pacific," starring Mary Martin.

Norman Leever demonstrated to me during my visit to his studios some remarkable tape recordings of the noise of helicopter rotor blades swishing through the air, as well as the sound of high-powered racing cars in the Le Mans events. I can recommend these noises at high level for testing loudspeakers!

READERS of this feature in the Summer issue may recall the reference to the then-forthcoming British Budget with its possible increase on the present 66 2/3% Purchase Tax on discs. Fortunately, the Chancellor of the Exchequer spared us further burdens.

The long awaited official announcement from the E.M.I. group on their policy towards LP pressings has now been made, although it simply states an "intention to commence the distribution of microgroove records in the United Kingdom as from October, 1952." It adds that this will not restrict the monthly addition of normal 78's to their catalogues.

It will be noted that the term "long-playing" is not used, but "microgroove", and not the production of these records, but merely the distribution. This has led to the rumor that E.M.I. will market only 7-in. 45's produced from RCA Victor masters, but the best information available still supports the forecast in the Summer issue that discs at both 33 1/3 and 45 rpm. will be marketed this Autumn.

The really fastidious gramophile will not, of course, use an automatic record changer but, if one has to employ these mechanisms, two new British designs are specially noteworthy. The Plessey multi-speed changer, with duo-point pickup, will play and change a stack of eight or ten 10- and 12-in. mixed at 78 or 33 1/3 rpm., or a stack of eight 7-in. 45's, and the ingenious Monarch changer, a product of Birmingham Sound Reproducers Ltd., automatically selects and plays 7-, 10- and 12-in. records, *intermixed in any order*, at 33 1/3, 45 or 78 rpm., with a ca-

capacity of ten records. This unit uses a reversible dual stylus crystal pickup, and models are available for 100/125 or 200/250 volts, 60 cycles AC.

THE 1952 Exhibition of sound recording, reproduction and audio equipment, organised by the British Sound Recording Association, was opened on May 17th at the Waldorf Hotel, London. This may be regarded as the equivalent of the American Audio Engineering Society's Annual Convention.

Twenty-three exhibitors displayed and demonstrated the latest British apparatus in the audio field, ranging from pick-ups to complex magnetic tape recorders. Recent developments in lightweight battery-operated portable tape recorders were illustrated by the new E.M.I. Model L/2 unit which measures only 14 by 7 by 8 ins. and weighs 14 1/2 lbs., including internal batteries. Standard 5-in. spools containing 600 ft. of tape are employed. Other units entirely independent of electric mains are the Wirek (Electronics) Ltd., "Reporter" and "Personal" models. The former is operated by a double-spring phonograph motor and the latter is driven by a miniature electric motor supplied by a bank of dry cells.

The new "Vari-Slope" pre-amplifier, due to H. J. Leak, who exhibited at the American Audio Fair a few years ago, was shown. This advance consists of variable slope low-pass filters (essentially twin-T resistor-capacitor networks) operating on negative voltage feedback principles. No inductors are used at all.

An outstanding new disc recorder of advanced design was shown by Decca. This machine has servo-controlled automatic variable-groove spacing, moving-coil cutting-head, hot stylus attachment with metering, suction device for swarf (thread) removal, present scroll speeds, automatic eccentric run-off groove device, and three turntable speeds, all electrically controlled by switch or push-button. The price is over 1000 pounds Sterling.

Additional space this year was given to the Amateur Exhibits' Competition Stand. The Cecil Watt's trophy was won by Mr. C. L. Appleby, of London, for his portable magnetic tape recorder.

A lively discussion took place on Friday evening, May 16th, between musicians, represented by Miss Anna Instone and Mr. Julian Herbage, of the BBC, and technicians Mr. P. J. Walker (Acoustical Mfg. Co.) and Mr. D. Thomson (Decca), on what constituted an outstanding record from their particular viewpoints. Sir Stewart Wilson acted as Chairman. It soon became apparent that technical fidelity alone would not necessarily satisfy the musician. He sought an indefinable atmosphere that captured or approached the composer's intentions. The Chairman commented that the fundamental problem seemed to be one of communication between technicians and musicians; if they could state their problems clearly in terms both could understand, a real step forward would have been made.

In the next article I shall deal with the gramophone society movement in this Country and also survey the British and Continental magazines covering recordings.

By R. S. JOHN

"It was found that extension of the audible response to the lowest frequencies generated by musical instruments had a most beneficial effect on the entire frequency range as a whole."

The Better The Bass The Better The Sound

AFTER a long period of wishful waiting, the enthusiasm of a friend of mine broke the last straw of my procrastination, and I built an air coupler. The delay was caused by much mental and pecuniary drooling over a large corner horn which did not materialize. Also, the first air coupler shown at the 1950 Audio Fair in New York sounded so good that I took a long time to get over an unfounded suspicion that it just couldn't be as good as it sounded! I didn't think that it was nice of them to have something concealed under the table; moreover, the time following the Fair that it took to tell the inside story was sheer cruelty.

However, now that my mental turbulence is over the rapids, I can find great pleasure in describing the design and construction of an excellent air coupler built to use a 15-in. speaker. This speaker is an Altec-Lansing 604B unit. It was housed first in a 10 cu. ft. bass reflex enclosure of standard design, and later put in a carefully calculated bass reflex with the port made in the form of a tube which extended back into the enclosure about three feet. This throated enclosure, as it is called, with its two low resonances, does help some if it is precisely

designed to match the low resonance of the speaker. That is, it sounds fairly good until one comes home from a concert. I have since found out that this speaker can deliver a plentiful amount of low bass response if the enclosure is made large enough, but then the box becomes so large that it is awkward to live with.

Later, I acquired a Jensen 610 in an enclosure of about 13 cu. ft. My experience was about the same. I thought that I had something better, but the comparison with live music left too much missing. It was after this that the air coupler was built.

Music versus Sound

Before I go into the details of construction, a controversial statement should be made because it has some bearing on the results I wanted to achieve. People who love music never agree on the best location in the auditorium from which to listen. Near the front, every sound from the stage can be heard, but the blending of the instruments is often poor. Also the auditorium effect is frequently overpowered by the loudness of the original source. Farther back, and not too much off center, the instruments are better balanced and the tones of the source blend with the reverberation effect. The music as a whole seems in much better proportion, even if less detail is heard. So, the individual's concept of the sound will vary, depending on listening location. Sometimes, I have wished I could hear an orchestra play the same symphony about five or six times, and between each playing change my seat so I could hear the music from as many different locations. If whole audiences could be so "rotated", the intervals of confusion might defeat the purpose, but the reaction would be interesting!

Listening to Sound

It is also generally true that people listening to a reproducing system in a home or laboratory tend to fall into three categories. The largest group will respond with some more or less indefinite reaction but have no particular criticism of the equipment or the music. To them it is either good, fair or poor, depending often on the reproduced sound to which they have become accustomed, and their acceptance of it.

Engineers are another category! They will be in there listening to the sound only for peaks, resonances, distortion, bandwidth, etc. Often they leave a reasonable doubt that they have heard the music or could recognize it if it were to be repeated. Their listening pleasure seems to be in finding defects in the functioning of the audio system. They seem to me to be somewhat like the saturated musicians who, to be happy, must have a front row seat at the concert.

The third group, the musicians, will often accept poor reproduction in their absorption with interpretation or with some special quality of the music. In many ways they are the most mysterious ones of all!

Many times have I struggled to get my sound system to the highest possible degree of perfection and then, not trusting my own judgment, I have invited special people in to listen. Seldom can I get a usable criticism. Furthermore, the opinions of the three classifications of listeners are multiplied by individual differences and preferences and the answers just move ever farther away from a consensus.

Now to go back to the question, "If I could have a fine audio system, would I want it to seem to put me in the front row, the front center of the balcony or just where?" Different pickups and speakers in a really good audio system can recreate the music and the illusion of location.

Thus, in setting up my installation, I have aimed at pleasing *my* ears and have tried to recreate music (not sound) as I hear it in the concert hall from the seat I like best: first balcony, front row center.

An Opinion on Pickups

Assuming that an audio system is a good one and can handle cleanly anything in the audio spectrum that is put to it, the signal generated in the pickup becomes very important. When a pickup performs at its best in some part of the frequency, it is only natural to exploit those characteristics. When pickups and records were first produced that offered new high-end sparkle and brilliance, I, like others, found them very exciting. However, I have become so saturated with music reproduced with the high frequencies exaggerated that I now want to leave whenever I come in contact with it. Such reproduction puts me up in the bald head row which I like the least. My personal preference is to use an amplitude type of pickup, equalized in response so that the high frequency is as natural as that of the front center balcony. Further requirements are that the preamplifier be designed so that the bass response is essentially flat to about two or three cycles. The pickup must be free from hum, and the turntable free from rumble.

Design of the Air Coupler

Let's get back to the air coupler. I cleared my desk and spread out every magazine article on air couplers that I could find — about a dozen. After studying them over for a good part of two evenings, the choice landed on the 8-ft. one with a reflex enclosure on the back. This called for a 15-in. speaker, so the large cone only of the Altec 604B was the choice for laboratory experiments.

Sketch of parts for 8-ft. Air Coupler with reflex housing to utilize back radiation of speaker. Note particularly that the corners of the folded air tube are rounded with strips of stiff cardboard. The material of construction is 3/4-in. plywood, all pieces covered with sound-deadening paint to secure an absolutely air-tight seal.

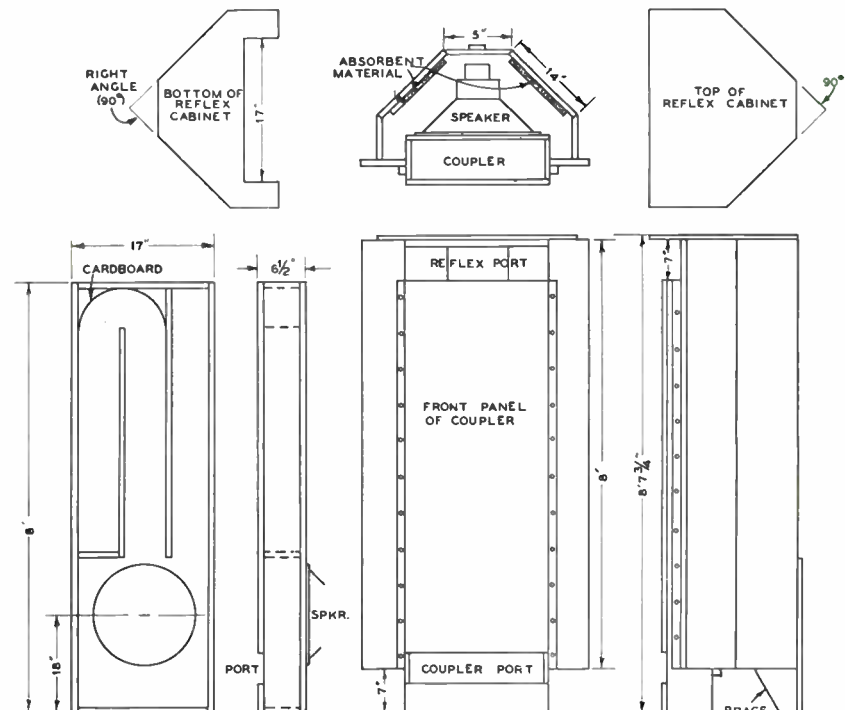

Its resonance was measured at 47 cycles. The air coupler only was built first, using 3/4-in. plywood held together with about 75 2-in. by 10 flathead wood screws. With the aid of a 1/4-in. portable power drill and a spiral ratchet screwdriver the assembly job was easy. The dimensions are shown in the drawing. When the coupler was assembled and the speaker put in place, a 200-cycle series type frequency divider or crossover network was made to divert the low end to the speaker in the air coupler and the rest to the Jensen 610.

The first results with this speaker system were very pleasing, but after using it for about two weeks, it was evident that the low tone definition was not too good. Also, it seemed that the relative level of the low tones varied from day to day, possibly with the effect of changing weather conditions. A check-up revealed the fact that the screws could be tightened, some of them as much as 3/4 of a turn. This tightening brought the performance back to the best that it had been but still left something wanting.

Adding the Reflex Back

It was then that I definitely decided to add the bass reflex enclosure and to try to improve upon the construction of the air coupler. There were many points to be

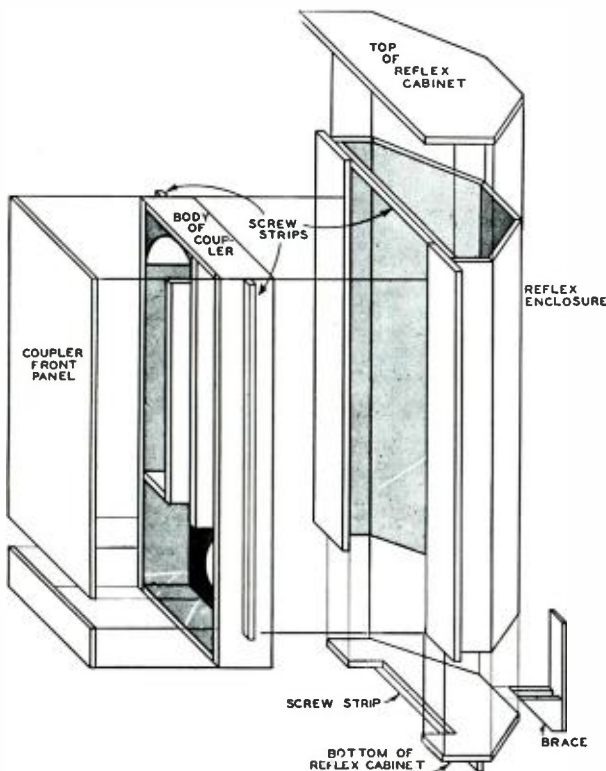

Exploded view of the reflex housing for 8-ft. Air Coupler designed for a 15-in. speaker. The reflex sections were cut short just below the speaker so that one piece of 4 by 8-ft. plywood would suffice.

considered — everything from designing the reflex part so it would balance correctly the speaker characteristics, to utilizing not more (if possible) than one 4 x 8 piece of plywood. The front panel of the regular 8-ft. air coupler was taken off and heavy flexible cardboard was used to round over the folded part of the longer resonating tube. The entire inside surface of the coupler was then given a heavy coating of sound deadening paint. This paint was smeared over the exposed edges of the resonating tubes and the outside edges of the box. The inside of the front panel was also coated and replaced before the paint dried.

The reflex enclosure was made in the shape shown in the drawing so that a single 4 by 8-ft. piece of 3/4-in. plywood would suffice except for the top, bottom, and two side pieces. This enclosure was assembled as a unit and screw holes made in the wood flanges so that it could be fastened to the coupler. After the bass reflex enclosure was assembled, the inside surface was smeared with the sound deadening paint and about 10 to 12 sq. ft. of 3/4-in. thick sound absorbing material fastened to various inside areas with linoleum cement. The joints between the wood panel sections were caulked with caulking putty. The bass reflex enclosure was then put on the back of the air coupler and more caulking putty used to make it air tight except for the port at the top.

The entire assembly was then placed upright in a corner of the room. The air coupler port was down near the floor.

When this rather large affair was put to work, the results were well worth all the effort that had gone into it. The bass definition had been improved beyond my greatest hopes. Using an oscillator, clean, audible response went down to about 20 cycles, which was about the bottom limit of the oscillator. It was found that extension of the audible response to the lowest frequencies generated by musical instruments had a most beneficial effect on the entire frequency range as a whole. Not only did every tone in the complete audio spectrum improve in definition, but it was found that the treble could be exaggerated some without the disagreeable nervous reaction that it often causes. However, in spite of this, I still want the treble to be all there but in a natural balance.

The 8-ft. reflex air coupler was meant for use in the laboratory. Its height was such that it could not be stood upright when we took it to the Audio Fair in Chicago, but it performed just as well on its side on the floor. I expect to use a 12-in. speaker in a 6-ft. scaled-down model for home use, using the same type of construction.

When my wife heard the performance, she was willing, at least in theory, to have me build one just like it for use at home! I am so encouraged by the performance that I do believe that a less pretentious speaker than the one I now use could do a very acceptable job. A 12-in. speaker in a similarly constructed 6-ft. coupler and enclosure should be entirely adequate for home use.

RECORDS

in REVIEW

C. G. BURKE • ALFRED FRANKENSTEIN • J. F. INDCOX

NOTES ABOUT RECORD REVIEWS

With this issue of HIGH-FIDELITY, we are revising the style of our record review material, in order to achieve greater clarity of presentation and thus to facilitate reference by the reader. We shall, as usual, welcome suggestions and comments. — Editor.

All classical long playing releases are arranged alphabetically by composer. If the works of two or more composers are recorded on one disc, the complete review appears under the name of one composer; the others are cross-referenced. Further, in the principal listing, the names of other composers are preceded by a dagger.

Miscellaneous collections, not normally identified by composer, are collected at the end of the classical section, under the heading "Miscellany".

Playing time and prices for records are reported.

ALBINONI *Concerto in D Major* — See Marcello

ARENISKY *Variations* — See Rachmaninoff

BACH, J. S. *Cantata No. 6* ("Bleib bei uns")
Cantata No. 19 ("Es erhüb sich")

Soloists; Stuttgart Choral Society; Stuttgart Bach Orch.; Hans Grischkat, cond.

RENAISSANCE X 34. 12-in. 23, 22 mins. \$5.95.

The sudden proliferation of Bach Cantatas imposes verbal economy. Good solo singing in *No. 6*, with chorus too far in the background. Clean, wide-range recording; bright solo instruments; staid direction. In *No. 19*, marvelous music; Bruno Müller a fine bass; accompanied recitatives superbly imaginative; various oboes a colorful feature; chorus slighted vis-à-vis microphone; commendable semi-professional performance if one is not too great a stickler for pitch. Much better than the companion Renaissance disc of *Nos. 9* and *137*, X 37.

C. G. B.

BACH *Cantata No. 84* ("Ich bin vergnügt")
Cantata No. 106 ("Actus Tragicus")

Magda Laszlo (s) in *No. 84*; Hilde Rössel-Majdan (a), Alfred Poell (bs) in *No. 106*. Akademie Chorus, Vienna; Vienna National Opera Orch.; Hermann Scherchen, cond.

WESTMINSTER WL 5125. 12-in. 18, 22 mins. \$5.95.

No. 84 is virtually a cantata for solo soprano, with a choral conclusion. Miss Laszlo's fine soprano bears its difficult responsibilities therein with distinction, but this space is better devoted to the praise earned by Dr. Scherchen's extraordinary reconstruction of *No. 106* (God's Own Time is the Truly Best Time). The rather familiar ore of this lusty elegy has been transmuted into new and shining metal by the application of the conductor's scrutiny, imagina-

tion and control. Customarily this Cantata is presented as a lugubrious death-song through which we sit in dutiful silence. In Scherchen's hands we hear a dramatic conflict between regret at death and exultation in God's intervention and protection. This has been done by punctuating the music to accord with the text — not a new device, but one undertaken with the most gingerly circumspection in Bach, whose interpretive indications are usually scanty. Dr. Scherchen emphasizes the pulse; he makes contrast unambiguous; he is a master of the subtle transformation of a phrase in repetition. He is indifferent to the influence of a flaccid conventionality but hostile to innovation not immanent in the score. His soloists, chorus and orchestra have been so entirely trained to his will that this Cantata, in its new guise which his musicians could not have helped prepare by prescience, is projected as smoothly as the Garde Républicaine band plays the *Marseillaise*.

Engineered with startling clarity and careful balance (except for a little preeminence to Mr. Poell) with even the harpsichord continuo in proportion, the disc seems sentient, and of the forty-odd records of Bach cantatas in existence at this writing, none seems more desirable.

C. G. B.

BACH *Cantata No. 198* ("Trauer-Ode")

Magda Laszlo (s), Hilde Rössel-Majdan (a), Waldemar Kmennt (t), Alfred Poell (bs); Akademie Chorus, Vienna; Vienna National Opera Orch.; Hermann Scherchen, cond.

WESTMINSTER WL 5123. 12-in. 41 mins. \$5.95.

Cantata No. 198 is a funeral ode for the wife of Augustus the Strong, Elector of Saxony and King of Poland, a curious warrior who instigated the martial greatness of Charles XII of Sweden, by undergoing frightful disaster at his hands, and of Marshal Saxe, by fathering him, although not with the aid of the princess commemorated by Bach. (The crop of casual offspring produced by Maurice de Saxe included the grandmother of that Aurore Dupin who wrote as George Sand, and it may be interesting or agreeable, even in this far-fetched way, to have a worldly connection traced between Bach and Chopin.) For a *pièce d'occasion*, this Cantata is a remarkable accomplishment, particularly in the novel use of a rare assortment of instruments to express an intense and plebeian — almost barbarous — lament for the dead Princess; an expression heightened by the lofty and elaborate treatment of the voices. In the record these are good, even the tenor's who has difficulty managing his. The sound has the exceptional clarity encountered in *Cantatas 84* and *106*, noticed above.

C. G. B.

BACH *Concerto for Violin and Oboe in D Minor*
†*Rozsa: Sonata for Cello and Piano*

Manuel Compinsky, violin; G. Schoneberg, oboe, in the Concerto with Pacific Symphonetta Orch.; Willem van den Burg, cond. Alec Compinsky, cello; Sara Compinsky, piano, in the *Rozsa*.

ALCO ALP 1210. 12-in. 14, 18 mins. \$4.85.

The sound is not the feature of a rather old recording. It has many faults but is passable. The performances, vigorous and incisive in the Bach, sensuous and fluent in the *Rozsa*, deserve praise, and for such rarities are perhaps definitive.

C. G. B.

BACH*Concerto for Piano No. 1 in D Minor*
*Concerto for Piano No. 2 in F Minor*Lukas Foss, piano. Zimblér String Sinfonietta.
DECCA DL 9601. 12-in. 24, 11 mins. \$5.85.

The D Minor Concerto flows its sober way in the steady way of an open faucet. At a signal, it is turned off disconcertingly. Its plodding magic could last indefinitely for our indefinable pleasure. The sober, matter-of-fact performance here seems permanently right, pianist and orchestra in the nicest interjuncture of cool fluency and restrained power. There is no reason to look for another version until reproduced sound will have produced a new grand technological revelation. The sound of this is as correctly matter-of-fact as the interpretation — nothing is salient, and that means that the engineers have done well. The more threatening F Minor Concerto, less celebrated and more debatable in an interpretive sense, seems excellent to these ears. This is an unpretentious record, but Decca has nothing worth greater praise.

C. G. B.

BACH*Partitas for Keyboard; No. 1 in B flat,*
No. 2 in C Minor, No. 3 in A Minor, No.
*4 in D, No. 5 in G, No. 6 in E Minor*Paul Badura-Skoda, piano.
WESTMINSTER WAL 303. Three 12-in. (A Partita for each side.)
20, 21, 21, 31, 22, 29 mins. \$17.85.

This kind of inclusive edition must baffle anyone obliged to give a judgment which can influence music lovers for or against an expenditure. We have here the six works composing Part I of the *Clavierübung* — six works written without interpretational directions, to be played according to tenuous and interrupted traditions. The latitude to the performer is great and this makes his part harder, since if he crowds his latitude to express personal conceits, he invites hostile criticism even when the conceits are judicious. Every hearer has a concept of one or more of these Partitas, or of parts of them. No pianist can gratify all the prejudices of any hearer, and so in places to this one, Mr. Badura-Skoda plays too slowly and in others too fast. Here he seems too grave when he might have been gayer, and there flippant when serenity might have served.

In short, what we have is excellent piano playing, a little on the sober side, intelligently thought and deftly fingered. No revelation, but much persuasion: this is healthy but not brilliant.

The piano sound has been engineered with a steady competence that we take for granted with the opening measures. We have no impression of marvel and none of fault. We hear a piano.

On Allegro records issued at different periods, Rosalyn Turek plays these Partitas, and plays them with more happiness and greater contrasts than does Badura-Skoda. She punctuates weighty passages with the relief of pertness, which is very pleasant; but the close sound of the Allegro discs, more impressive and harsher than the Westminster's, is certainly generally inferior to the even quality of the latter. And to these ears this sound is determinant where interpretation cannot be.

No one has ever protested the inclusion of printed scores with discs on those few occasions when this has been done. The score makes part of the Westminster edition.

C. G. B.

BEETHOVEN*Concerto for Violin in D Major, Op. 61*Alfredo Campoli, violin. London Sym. Orch.; Josef Krips, cond.
LONDON LL 560. 12-in. 44 mins. \$5.95.

The deliberate tranquility of this delicately phrased essay seems to have no contemporary precedent. Its placid flow insinuates at first the uneasiness of unfamiliarity, but later the impervious gentility, born by beautifully proportioned bowing and a lush orchestral mass, insinuates its novelty like a soft caress. There is no violence, and the rondo is singularly attractive in the careful resistance to slurring that the conductor has enforced on his strings. The sound, excellent in the orchestral strings and the solo violin, is a little obscure in the winds at the *rit.* Reduction of the huge bass effects suppression of a low frequency background noise. As a whole, the sound here is the best we have of this work — the interpretation may be too special for tastes habituated to more animation.

C. G. B.

BEETHOVEN*Sonata for Piano No. 16 in G, Op. 31, No. 1*
Sonata for Piano No. 23 in F Minor,
*Op. 57 ("Appassionata")*Kurt Appelbaum.
WESTMINSTER WL 5133. 12-in. 25, 25 mins. \$5.95.

The sixth LP "Appassionata" is as impassioned as any of its rivals

and better recorded than most of them (Kempff not yet considered), although the superb lower two-thirds of the keyboard is complemented by a rather harsh treble. The easier dynamics of the Sixteenth Sonata are much more conciliatory to the treble; and only the sparsest disagreement can be found here with the pianist's concept and his execution of it.

C. G. B.

BEETHOVEN*Quartet No. 7 in F, Op. 59, No. 1 ("First Rasoumowsky")*Vienna Konzerthaus Quartet.
WESTMINSTER WL 5127. 12-in. 41 mins. \$5.95.*Quartet No. 9 in C, Op. 59, No. 3 ("Third Rasoumowsky")*Vienna Konzerthaus Quartet.
WESTMINSTER WL 5134. 12-in. 40 mins. \$5.95.

These are companion discs to the Vienna Konzerthaus version of the "Second Rasoumowsky" noticed in this magazine's Spring issue with unqualified enthusiasm. They have the same strikingly spacious opulence of tone reenforced by mellow room acoustics. At their best, in pure richness of string-sound and absolute differentiation among the instruments, they are unexcelled in quartet recording. But the treble exaggeration of the violins playing high is much more apparent than in the earlier disc, and in the case of the Seventh Quartet tints all the high passages with a coarse and factitious whistle, which can be reduced to a minor annoyance but cannot be eradicated. There is also in this Quartet a recurrent background rumble, not onerous, but detractive. Even with these defects the ripeness of sound surpasses that of the Concert Hall recording (CHS 1205) of the Pascal Quartet. It is probably fair to say that the engineering values, although dissimilar, are not unequal. But the manly playing, straightforward and dynamic, of the Pascals, with their superior sense of contrast and tauter determination, seems considerably more appropriate than the yielding outline and dogged sentimentalizing of the Viennese, especially in the first movement. Before the appearance of the Viennese disc, Pascal was the better of the two versions; now it is the best of three.

The Viennese No. 9 is a vast improvement. Here a good amplifier can discipline the treble without too much difficulty, and the recorded sound, so corrected, emerges with a splendor no competing edition can emit. Nevertheless, the Viennese languor is with us again, and to what may be judged a rather obnoxious degree, in the two central movements. The Andante "con moto quasi allegretto" is plainly a warning to avoid deliberation in the steady pace; and the Viennese adagio we hear seems merely willful. Again the Pascal performance, vivid, conscientious and virile, on Concert Hall CHS 1207, must be deemed preferable by everyone who knows the Ninth Quartet; but the comparative pallor of the Concert Hall sound, heard in immediate succession to this, begins to becloud judgment. After all, one can get used to special preferences in tempo pretty quickly when they are maintained with the redolent persistent ripeness of the Vienna Konzerthaus Quartet. We have again the wicked problem of noble performance versus noble sonics. In such a work as this, the writer votes for the noble performance. (The Pascal version has been used as the standard of comparison here because two others, admirable in different ways, represent uncustomary concepts of the work.)

C. G. B.

BEETHOVEN*Quartet No. 12 in E flat, Op. 127*Vienna Konzerthaus Quartet.
WESTMINSTER WL 5120. 12-in. 39 mins. \$5.95.

Strangely this is only the second LP of a wonderful Quartet. That it is better than its forerunner is to be doubted, in spite of superior engineering. If we could subtract all the acuity from the high violins in the Vienna version, we should find its ripened tone irresistible, and the disc in the front rank of quartet recordings; while the Concert Hall disc (CHS 1209) which provides the competition, gives out a rather hard sound in direct comparison with the Westminster. But the Pascal Quartet, with their alert energy and quick obedience to changes of sentiment, describe the emotions of this work more satisfactorily, and assert its form with a more patent logic, than the Viennese have contrived with their softer attack and more lenient lyricism.

C. G. B.

BEETHOVEN*Songs*Alfred Poell (bs); Victor Graef, piano.
WESTMINSTER WL 5124. 12-in. 14, 4, 7, 3, 4, 2, 2, 3, 2 mins. \$5.95.

An die ferne Geliebte, Der Wachtelschlag, Adelaide, In questa

tomba oscura, Lied aus der Ferne, Wonne der Wehmuth, Ich liebe dich, Mailied, der Kuss

Records have made the malleable Poell bass, in a wide variety of lyric utility, known to thousands of Americans who have never seen him. He is incapable of extrinsic affectation, and the unlabored projection of these basically simple Beethoven songs — the largest single collection on records — with Mr. Graef's splendid and cunning accompaniments in a recording of apparent entire naturalness, makes this disc a substantial and perhaps invincible item. The text of each song is printed in German and English. C. G. B.

BEETHOVEN *Trio No. 6 in B flat, Op. 97 ("Archduke")*

Paul Badura-Skoda, piano; Jean Fournier, violin; Antonio Janigro, cello.

WESTMINSTER WL 5131. 12-in. 43 mins. \$5.95.

The "Archduke" is proud and noble music, positive and final in its affirmations, whose lyricism ought not to hide the rock inside. The poised, beautiful and refined sound contrived here by players and engineers is an end in itself which deviates from the hard bone within to the deceptive softness of its integument. The weakness of accent, and the unwillingness to ruffle a chaste line by pointed intonation, alter subtly the character of the greatest of Trios. The "Archduke" becomes epicene, part Archduchess, lovely but vain of detail, and yielding. Jilka on Remington, and Rubinstein-Heifetz-Feuermann on Victor have defects, the first of finesse and the second of engineered sound, but a masculine "Archduke" is on their records. C. G. B.

BERLIOZ *Roman Carnival* — See Debussy

BOCCHERINI *Concerto for Cello in B* — See Haydn
Quartet No. 1 — See Haydn

BRAHMS *Concerto for Violin in D Major, Op. 77*

Isaac Stern, violin. Royal Philharmonic Orch.; Sir Thomas Beecham, cond.

COLUMBIA ML 4530. 12-in. 40 mins. \$5.45.

The bigness of some of Brahms' bigger works often seems to have been dictated less by an inner compulsion than by the insistence of his friends that he was another Beethoven. Thus it can happen that a cast less than life can emerge from the heroic mould; the epic lines are interspersed with neat *vers de société*; the coat of mail is patched with dimity. These contradictions can have a pleasant irregular charm, and especially in the Violin Concerto where cyclops and elf go hand in hand. The present performance emphasizes the ambiguity, alternating a pregnant massiveness with a tender grace, opposing the ukase by a prayer, strengthening the strong and disarming the weak. The fine line and silvery tone of the Stern violin are on occasion relieved by staccato coarse rejections from the same violin; and the same dramatic and dynamic variety is practiced by the orchestra. The engineers have managed, in the course of a recording of standard merit, to have soloist and orchestra proceed along audible parallels, so that both, at whatever volume, are always entirely distinct in the convolutions of their respective patterns. No other version has the latter advantage. C. G. B.

BRAHMS *Symphony No. 1 in C Minor, Op. 68*

Philadelphia Orch.; Eugene Ormandy, cond.

COLUMBIA ML 4470. 12-in. 43 mins. \$5.45.

No one will call the quality of sound here poor, but music lovers familiar with the recent *Iberia* and Rachmaninoff *Second Symphony* from the Philadelphians will be disappointed to find the newer disc decidedly less imposing, more opaque in timbre, indelibly coarsened in mass. It is hard to say just how this happens. It is not apparent at passages of moderate strength or less, where the distinctive satin fabric of this orchestra unfolds in its habitual sinuosity. Mr. Ormandy's stalwart interpretation, a frank construction continuously mounting in undistorted lines, seems firmer than any bed-rock work he has given us, and warrants consideration on its own very considerable merits. C. G. B.

BRAHMS *Symphonies No. 1-4*

London Symphony Orch. in Nos. 1, 2 and 4; London Philharmonic Orch. in No. 3; Felix Weingartner conducting both.

COLUMBIA ML 4510-13. Four 12-in. 40, 34, 29 and 27 mins. \$5.45 each record.

Columbia's microgroove memorial to the late Felix Weingartner includes also the nine symphonies of Beethoven. While it is generally known that Weingartner was the first conductor to record all thirteen of these foundational works, it is a matter of surprise that no one has duplicated his exploit. The four Brahms records have been tenderly reconstructed from 78's dating to the late 1930's. As sound they are better than the originals and better than the majority of the reconstructed Beethoven symphonies. Acoustically, they may not risk comparison with modern recordings — climaxes are weak and *pianos* are strong. As interpretations, they bear comparison with any.

The master-analyst of phrase and tempo was a master, too, in formulating an underlying and pervading concept of whatever he conducted, and in obtaining submission from his players to his concept. Each of the Brahms symphonies is confined to a homogenous character: its episodes are kept in subordination to its main currents, and the main currents are stipulated with an entire lack of ambiguity. In the First, the concept of conflict, or a concept like conflict, incessantly dominates, and not least when a soft corollary brings it into relief. The Second is always holiday, or something like that; the Third valor; and the Fourth tragedy. The taming of elements that could be hostile to such concepts creates the excitement of inexorability. When we hear these superb contours, and note that the dramatic essence is brought out by a forceful firmness that will nevertheless tolerate no excesses, and united to a lyrical suavity that few conductors have possessed, we wonder whether more eloquence is possible. And if we are acquiring recordings of the Brahms symphonies, we ought to be entirely convinced that the necessarily greater acoustical impact of the newest discs is overwhelmingly desirable before rejecting such masterful Brahms as the Weingartner discs proclaim. C. G. B.

BRAHMS *Vier Ernste Gesänge, Op. 121 (Four Songs)*
†Schubert: *Italian Songs and Der Kampf*, Op. 110

Randolph Symonette (bs-bne); Alberta Masiello, piano.
COLOSSEUM CLPS 1002. 12-in. 33 mins. \$5.95.

Mr. Symonette has a basso cantante of good range, even projection and agreeable quality. He sings the disparate humors of this rather rare music with easy adaptability and without affectation, for a clean recording that places him alive in the hearer's presence. The *Italian Songs* do not seem to have been recorded elsewhere. A neat and effective disc. C. G. B.

CHABRIER *Espana Rhapsody*
†Rossini: *La Cambiale di Matrimonio* (Overture)

Royal Philharmonic Orch.; Sir Thomas Beecham, cond.
COLUMBIA AAL 11. 10-in. 7, 6 mins. \$2.85.

The *Espana* is a dazzler in performance and recording technique that will satisfy need for its pyrotechnics well into the future. The Rossini overture, a cheerful illustration of the composer's offhand devotion to Mozart, and a favorite of Sir Thomas's, is a discal maiden worth a flirt. C. G. B.

CHERUBINI *Quartet No. 1 in E flat Major*
Fugal Suite in D Major

Richard Adeney, flute, in the *Suite*; Aeolian Quartet of London.
LYRICHORD LL 24. 12-in. 32, 10 mins. \$5.95.

Cherubini, an original and very uneven talent, was at his best in the large vocal forms. His First Quartet is full of original ideas, most disagreeable. The *Suite* is arbitrarily arranged from three different technical studies. The Aeolians play with a tiring energy and the first violin is a trial. The engineering per se is of good order, but the acoustical environment inflicts a wooden tone on the instruments. C. G. B.

CHOPIN *Waltzes (Nos. 1-14)*

Dinu Lipatti, piano.
COLUMBIA ML 4522. 12-in. 46 mins. \$5.45.

Of the three editions of the fourteen, one would say that the lamented Lipatti's detached and sane presentation, orderly and a little quick, is easily preferable to the more swashbuckling proclamations of Messrs. Brailowsky and Kilenyi, respectively on Victor and Remington — a preference supported by the superior piano sound of the Columbia. But the Lipatti disc contains all these waltzes arbi-

rarily out of sequence, in accordance with some concept of dramatic propriety that the pianist cherished. This was his right, for public concerts; for us the record, without designatory blank bands between selections, is a nuisance, and argues in favor of 78's for similar collections. C. G. B.

CIRRI *Concerto in A Major* — See Marcello

COPLAND *Our Town*
†Thomson: *Suite from The Plow that Broke the Plains*

Little Orchestral Society; Thomas Scherman, cond.
DECCA DL 7527. 10-in. 12 and 15 mins. \$3.85.

Children's Suite from The Red Pony
†Thomson: *Acadian Songs and Dances from Louisiana Story*

Orch. and cond. as above.
DECCA DL 9616. 12-in. 21 and 19 mins. \$5.85.

Very few American film scores can be listened to in cold blood as concert music. These works of Copland and Thomson are exceptions to that rule. Thomson's music for the government documentary, *The Plow That Broke the Plains*, is an epic in a small space, full of Western tunes, ironic blues, and broad Western atmosphere, but handled with a magnificent simplicity which Hollywood knows nothing about.

His *Acadian Songs and Dances* forms a companion piece to the suite from *Louisiana Story* issued some time ago by Columbia. They are folk tunes, beautifully orchestrated and cleverly manipulated. This is not as important a suite as the one which bears the name of the film, but the two together provide the full text of one of the few really great picture scores so far produced in America.

Hearing Copland and Thomson in immediate succession is quite illuminating. Both composers are much beholden to American folk lore, but Copland's handling of it involves a considerably more complex harmonic palette and more highly elaborated forms. The music for *Our Town*, based largely on New England hymnody, is in a nostalgic, wistful vein, in keeping with Thornton Wilder's play and the movie that was made from it. *The Children's Suite from the Red Pony* is both light and sensitive at once, and its "Dream March and Circus Music" is one of Copland's most brilliant pages. Performance is perfection itself and the recording is flawless. A. F.

DEBUSSY *Nocturnes*
†Ravel: *Rapsodie Espagnole*

L'Orchestre de la Suisse Romande; Ernest Ansermet, cond.
LONDON LL 530. 12-in. 22, 15 mins. \$5.95.

Nocturnes
†Berlioz: *Roman Carnival (Overture)*
†Ravel: *Pavane pour une Infante defunte and Alborada del Gracioso*

The Cecilian Singers; James Aliferis, dir. Minneapolis Symphony Orch.; Antal Dorati, cond.
MERCURY MG 50005. 12-in. 22, 8, 6, 7 mins. \$5.95.

There is a third version of the *Nocturnes* complete, by Dr. Stokowski on Victor LM 1154. Naturally, the couplings cause a familiar indecision. The prominent features of the respective editions are in full conflict. Ansermet has a mature interpretation best expressive of the subtle moods of the music; Stokowski directs the most expert orchestra, and Dorati enjoys a transcendental registration, superior to the others — which nevertheless are excellent — in practically all the details of recording. Indeed, the very clarity, brilliance and distinction of this Mercury disc give to Ansermet on London a certain superiority in *Clouds*, a mysterious amalgam of murmurs in his playing, against an analysis of instrumentation on Mercury. But for *Fêtes*, with its brazen walls and glittering banners, its startling colors, only Mercury may be chosen. So, too, with the three short pieces on the reverse, all in one way or another expositive of advanced orchestral technique — there is no fit rival to Mercury's astonishing revelation of their orchestral actuality. No more than eight or ten LP's are in this class. The Ansermet *Rapsodie Espagnole* is subtler, less violent, than the fine recording of the Philadelphia Orchestra on Columbia ML 4306, formerly the most esteemed record of that music. C. G. B.

DITTERSDORF *Symphony in A Minor*
†Hohenzollern: *Rondo for Piano and Orchestra*

Otto A. Graef, piano. Frankenland State Symphony Orch.;
Erich Kloss, cond.
LYRICHORD LL 26. 12-in. 22, 14 mins. \$5.95.

The overriding genius of Haydn and Mozart has obscured the light of first-class Eighteenth Century composers like Carl Ditters von Dittersdorf, who wrote admirably in all musical forms. The diverting Symphony here is the first acknowledgement he has had from L.P. The spirited performance is indifferent to the play of light and shade, but the recording is notably successful in a bold way, striking for the winds and faulted only in some overprominence of the violins and the solo cello. This is the best sound that we have had from Lyrichord.

The composing Hohenzollern on the reverse was the Prince Louis Ferdinand of Prussia to whom Beethoven dedicated his C Minor Concerto, a figure of high romance killed in the Jena campaign. The music has a mild interest, is well played and very well recorded. C. G. B.

DVORAK *Rusalka (Highlights)*

Soloists, Chorus and Orch. of Czech National Theatre.
SYMPHONIC RELEASES SR 4. 12-in. 45 mins. \$5.95.

Though written some 50 years ago, this work remains virtually unknown and seldom performed, outside its native land and Germany. More's the pity, for on the evidence of these excerpts, this is a lively score, imaginative and colorful in orchestration, with some enchanting arias of lyrical beauty for both soprano and tenor. Its libretto, having to do with mermaids, witches and goblins, is no great shakes but it is no stupider than that of other operas which have achieved universal success.

Vocally, the performance by unnamed soloists and chorus of the Czech National Theatre is of variable quality, only the soprano, singing the difficult music given to Rusalka, sounds like a first class artist. Chorus and orchestral work is somewhat ragged, though there are moments when the brass emerge with some distinction. Some of this muddiness may be due to the recording, which sounds as if it came from a radio broadcast.

For no visible reason, my copy was given to definite periodic clickings, some slight distortion towards the end of both sides, and high surface noise.

For the record, a complete recording of *Rusalka*, sung in German, was issued recently on Urania 219. J. F. I.

GLUCK *Iphigenia in Aulis and Alceste (Overtures)*
†Spohr: *Jessonda and Faust (Overtures)*

Berlin Philharmonic Orch.; Hermann Abendroth, cond. in the *Iphigenia*. German Philharmonic Orch. of Prague; Josef Keilberth, cond. in *Alceste*. Berlin Radio Orch.; Gustav Goerlich, cond., in the Spohr.
URANIA URLP 7028. 12-in. 10, 11, 7, 6 mins. \$5.95.

Excellent sound in *Jessonda*, ugly violins in *Alceste*, the others satisfactory. Performances of the great Gluck Overtures are evenly competent; the Spohr have frisky expositions calculated to augment their minor interest. C. G. B.

GOUNOD *Faust (Ballet Music)*
†Verdi: *Aida (Prelude and Ballet Music)*

Orch. of Metropolitan Opera Assn. of N. Y.; Fausto Cleva, cond.
COLUMBIA ML 4515. 12-in. 13, 13 mins. \$5.45.

Indispensable for devotees of the cymbal. More important, this disc offers as agreeable a sound as Columbia has ever presented, and not exactly like any other. The very brilliant high frequencies are mellowed by a soothing hall tone which does not, however, denature the bass. The whole is large and expansive and in excellent internal balance. The music is led without much concern for subtlety (but this is not subtle music) and it is skillfully played, but the appeal is primarily to the lover of sound as such. C. G. B.

GRIEG *Concerto for Piano in A Minor, Op. 16*

Clifford Curzon, piano. London Symphony Orch.; Anatole Fistoulari, cond.
LONDON LLP 512. 12-in. 30 mins. \$5.95.

Like the Mendelssohn Violin Concerto, this music is unique and in-

imitable. (Plagiarism is not imitation.) Like Tchaikovsky's First Piano Concerto, it has been meanly victimized by plagiarisms and by too much use. Here is the eighth LP version; it must be expected that discophiles who wish the Grieg Concerto already have one. The pity is that to this reporting taste the eighth is the best. The sound is solid and clear, not spectacular but first-rate for piano and orchestra. Mr. Curzon, a pianist who is an admirable musician, emphasizes the musical core of the Concerto by a sober and thoughtful full-breathed and affectionate treatment which minimizes the discrepancy implied by a showier pianism. Mr. Fistoulari is in accord with phrasing, tempos and accent. The record should be heard even by those with another version. C. G. B.

HAYDN

Concerto for Cello in D, Op. 101
†Boccherini: *Concerto for Cello in B*

Antonio Janigro, violoncello. Vienna National Opera Orch.; Felix Prohaska, cond.
WESTMINSTER WL 5126. 12-in. 24, 22 mins. \$5.95.

If the members of this judicious pairing had been written for cello alone, we could exclaim at the unprecedented realism of the tone as recorded, but a good sized orchestra complicates the impression. It is not that the balance is particularly improper, for the *tutti*s are sonorous enough, but rather that the soloist's music and the orchestra's seem to be proceeding along different planes. This is vaguely disconcerting, and so, too, less vaguely, are the plangency of the violins, loud, and a recurrent obscure background noise. Not a poor recording, but one is severe to Westminster when she fails to maintain her own standards. The interpretations are Viennese, which is to say that here the slow movements are ravishing and the quick movements not very quick. C. G. B.

HAYDN

Five Songs
†Schubert: *Seven Songs*

Tii Niemela (s); Pentti Koskimies, piano.
WCFM LP 10. 12-in. 21 and 21 mins. \$5.95.

The Haydn songs are familiar if any by the composer are. The Schubert are neither hackneyed nor obscure. This kind of synthesis, in which the conflicting moods of twelve pieces of music are used as a vehicle for a musician's virtuosity, seems counter to the utility of LP; but the disc under consideration certainly presents a beautiful voice and susceptible temperament. The Haydn side is a polished delight, the Schubert a smooth projection of emotional dexterity. The sound on the latter side is absolutely first rate, real and unforced; the Haydn surface has less volume and a little hum. The pianist's dynamics, to be conservative, are conservative. As a whole, a rewarding record, if not excellent without qualification. C. G. B.

HAYDN

Mass in B flat, St. Bernard's of Offida
("Heiligmesse")

Copenhagen Boys' and Men's Choir; Danish Royal Opera Orch.; Mogens Wöldike, cond.
HAYDN SOCIETY HSL 2048. 12-in. 40 mins. \$5.95.

The jubilant worship of the devout Haydn, translated into forthright melodic exordiums and a masterly counterpoint, has been retranslated seven times into a Mass on discs. This one has the best sound, solid and comforting, easily etched in the high frequencies where we expect difficulties, balanced and differentiated so acutely that those who have never heard of polyphony cannot help but distinguish the tiers of subjects and episodes. The well-drilled choir and orchestra are controlled by what may be called a cool and architectural hand, Mr. Wöldike seldom disturbing a symmetrical projection by modifications not dictated by a score capable of conveying its message complete. C. G. B.

HAYDN

Missa Solemnis in F flat Major ("Harmóniesmesse")

Ilse Katschinka (s); Margarita Kenney (a); Hans Loeffler (t); Keith Engen (bs). Chorus and Orch. of Society of Vienna; Alex Larson, cond.
PERIOD SPLP 541. 12-in. 48 mins. \$5.95.

Fatigue is all too evident in the last of Haydn's Masses, wherein great moments are flanked by long sections of sparse inventions. Vigor is the principal characteristic of a performance marred in the engineering by a cutting treble and feeble bass. C. G. B.

HAYDN

Quartets, Op. 1

Schneider Quartet.

HAYDN SOCIETY HSO-A. Three 12-in. 18, 14, 21, 19 mins. \$17.85 (or separately, two *Quartets* to each disc at \$5.95).

There is simply not enough space here to consider seriously the numeration of Haydn's Quartets. The six now presented include a No. 0 and omit *Op. 1, No. 5*, which has wind parts. The Haydn Society has now issued sixteen Quartets in its unprecedented undertaking of recording them all, and the six of *Op. 50* have been advertised for appearance soon.

Few music lovers can have had a chance to hear *Op. 1*. When Haydn Quartets are publicly played, the completely developed masterpieces of the later years are chosen. *Op. 1* is by a very young composer writing in a young and tentative form hardly recognizable as the elaborate structure we think of as the String Quartet. There are four instruments, a suite of simple songs and dances, and a contagion of unaffected charm. There is a soothing gratification in this music, perhaps best exemplified by *No. 1*. In every respect, the records surpass their predecessors in the series. The players have acquired a warmth of tone not apparent before, while retaining a vivacious precision combined with the fluent accentuation previously associated with them, but here more apparent in the improved recording itself, not only more decisive in articulation but juicier in flow. An extrinsic low frequency pulsation is so faint as hardly to compose an audible fault, and if the review copies are characteristic, surfaces are nearly perfect. An edition pleasant to hear, and an agreeable duty to recommend. C. G. B.

HAYDN

Sinfonia Concertante for Violin, Cello, Oboe and Bassoon, in B flat, Op. 84
Symphony No. 85 in B flat ("La Reine")

Munich Philharmonic Orch.; Fritz Rieger, cond.
MERCURY MG 10116. 12-in. 23, 26 mins. \$4.85.

Galanterie at its most captivating in well-played performances. Orchestral detail is painstakingly clarified amidst a generally large sound, but the disc is not recommended for high fidelity systems, which bare its wiry string quality beyond toleration at this date. C. G. B.

HAYDN

Sonata for Piano No. 46 in A flat
Sonata for Piano No. 49 in E flat

Virginia Pleasants.

HAYDN SOCIETY HSL 3034. 12-in. 17 and 19 mins. \$5.95.

A tidy and unexciting disc, distinct and unassertive in sound, cool and objective in playing distinguished by reticence and nicety of formation. C. G. B.

HAYDN

Sonata for Piano No. 23 in F
Sonata for Piano No. 32 in B Minor

Robert Wallenborn.

HAYDN SOCIETY HSL 3035. 10-in. 12, 10 mins. \$4.75.

Sonata for Piano No. 24 in D
Sonata for Piano No. 30 in A

Robert Wallenborn.

HAYDN SOCIETY HSL 3036. 10-in. 11, 13 mins. \$4.75.

Our pianist has a scholar's detachment towards Eighteenth Century music. His precise but softly rippling staccato is enticing and apropos; his dynamics are maybe a trifle flaccid. There is no displeasure for a Haydnist in this playing, but a Haydnist's pleasure is limited by the player's cool estimate of the place of élan in these Sonatas which here and there glow hot, especially *No. 32* which needs sudden impetuosities. Still, not bad; good Eighteenth Century playing if that Century is considered only in its most formal aspect. The sound is fair enough of the restricted keyboard. C. G. B.

HAYDN

Quartet for Strings No. 6 in E flat, Op. 64
†Boccherini: *Quartet for Strings No. 1 in D, Op. 6*

The New Italian Quartet.

LONDON LLP 320. 12-in. 17 and 13 mins. \$5.95.

The ravishing performance of the Haydn is spoiled by weak and obscure sound. The ravishing performance of the Boccherini has been competently engineered. The Haydn exists also in a good interpretation and excellent recording on Westminster 5034. coupled

with the wonderful Eightieth (Celebrated Largo) Quartet. The Boccherini is not found elsewhere. Herewith the problem to the reader.
C. G. B.

HAYDN *Symphony No. 61 in D* — See Mozart

HAYDN *Symphony No. 92 in G* ("Oxford")
Symphony No. 94 in G ("Surprise")

Vienna National Opera Orch.; Hermann Scherchen, cond.
WESTMINSTER WL 5137. 12-in. 24, 25 mins. \$5.95.

Symphony No. 94 in G ("Surprise")
Symphony No. 101 in D ("Clock")

Berlin Philharmonic Orch.; Fritz Lehmann, cond. in *No. 94*. Rias
Symphony Orch., Berlin; Ferenc Fricsay, cond. in *No. 101*.
DECCA DL 9617. 12-in. 27, 25 mins. \$5.85.

Haydn, a wonderful man whose wonderful prescience calculated a hundred symphonies, not one of which surpasses the capacity of an LP side, would have been as hard put to it as we, to select the best recorded examples of his symphonies on a minimum number of discs. The item in common above is the "Surprise", where music lovers are likely to prefer Lehmann to Scherchen; but the Scherchen 94 is coupled with a superb "Oxford", far ahead of its field. Only the Beecham 94 on Columbia ML 4453 is to be compared with the Decca, and that Beecham is overside of *No. 103*, which competes with a Scherchen better engineered than Beecham but less convincing in performance, and coupled to the only 80 on a disc. Frustration receives a final stimulus when the archives disclose that the Fricsay-Decca "Clock", a fine standard performance, is third to two other versions, one of which is a Westminster-Scherchen with the best 99 overside. In all these records, the sound is good and in all the Scherchen sound is the best, with the Decca "Surprise" clearer than the Beecham "Surprise" whose exquisite performance is preferred here to the vital and direct performance of Lehmann which reasonably could be the choice of a majority of Haydnists. We then find that the Decca "Clock" is acoustically less pleasing than the Decca "Surprise" and the Scherchen and Beecham "Surprises". The problem is pretty: for those who relish particularly the "Surprise" itself, that is most imposing in the Scherchen, a short decibel more forceful than the Lehmann.¹
C. G. B.

HAYDN *Symphony No. 94 in G Major* — See Mozart

HAYDN *Symphony No. 96 in D*
Symphony No. 98 in B flat

Vienna National Opera Orch.; Hermann Scherchen, cond.
WESTMINSTER WL 5111. 12-in. 22, 29 mins. \$5.95.

Surely in the last fifteen months, Dr. Scherchen has committed more superb miles to microgrooves than any three other conductors. *No. 98* is a big, untrammelled work, anticipatory, in its sudden contradictions, of Beethoven who admired it greatly — to the extent of absorbing the Minuet for use in the Trio of his C Minor Quartet. The sound in both symphonies is big and nicely balanced, less incisive in detail than some recent discs from this company, but velvety in the strings and outright in the brass. In *No. 96*, the tone curiously coarsens during the Minuet, then resumes its suave current when the hearer begins to wonder about it.
C. G. B.

HOHENZOLLERN *Rondo* — See Dittersdorf

JACOBI *Concerto for Violin*
Concertino for Piano and String Orchestra
Night Piece and Dance

André Gertler in the Concerto. Irene Jacobi in the Concertino. Francis Stoeffs in *Night Piece and Dance*. Orch. of the Institut National Belge de la Radiodiffusion.
SPA 7. 12-in. 18, 12 and 7 mins. \$5.95.

SPA (Society of Performing Artists) makes its bow with this program of music by an American composer who has been too little recorded. The best of the three works is the energetic, lithe and splendidly organized *Concertino*. The Violin Concerto is good, in a romantic kind of way, but obviously influenced by the violin concertos of Prokofieff. The *Night Piece and Dance* for flute and

strings sound exactly like a *Night Piece* and *Dance* for flute and strings. Mrs. Jacobi's performance in the *Concertino* is most impressive and Gertler does well by the violin concerto. Recording is so-so.
A. F.

KALINNIKOV *Symphony No. 1 in G Minor*

Soviet Radio Orch.; N. Rachlin, cond.
WESTMINSTER WL 5136. 12-in. 42 mins. \$5.95.

For fifty years, this Symphony has enjoyed some repute without enjoying many performances. Its clear and novel ideas explain the repute, and its verbosity justifies its repression. The first recording bears what we may assume to be an authoritative interpretation, and it is played by competent musicians. The sound is unusual: in mass, imposing enough, but its individual constituents — the instruments in solo or small groups — do not sound like those instruments; their color is as if bleached.
C. G. B.

KHACHATURIAN *Concerto for Violin*

David Oistrakh, violin. National Philharmonic Orch.; Alexander Gauk, cond.
COLOSSEUM CRLPX 001. 12-in. 34 mins. \$4.85.

Comrade Oistrakh ought to be heard for the sake of his astonishing talent if not for that of this bumptious, clever and superficial music. He has as many varieties of tone as there are objects of his fatherland's vituperation, and all are bowed with an admirable linear smoothness. He can be as feathery as any violinist living, and as broad. These qualities are patent in a curious recording which ranged from pretty bad to rather effective, with satisfactory treble and tubby bass, but neither consistently.
C. G. B.

KRENEK *Symphonic Elegy* — See Schönberg

LISZT *Heroïde Funèbre* — See Schumann

LOEWE *Four Songs* — See Schumann

MAHLER *Early Songs from Des Knaben Wunderhorn*
Last Songs from Rückert

Anny Felbermayer (s), Alfred Poell (bne). Vienna State Opera Orch.; Felix Prohaska, cond.
VANGUARD VRS 421. 12-in. 18, 15 mins. \$5.95.

From all concerned, a precious realization. Miss Felbermayer and Mr. Poell use their beautiful voices with devoted art. Dr. Prohaska's leadership of a first-class orchestra produces a curiously agreeable compound of warmth and concuscation, and the engineering competence is conspicuous. A sister disc to Vanguard's very successful album of the *Youth's Magic Horn* on VRS 412-3 which, good as it is, has not Miss Felbermayer's lovely simplicity, nor has it quite the engineering class of the newer record.
C. G. B.

MANFREDINI *Christmas Concerto* — See Mendelssohn

MARCELLO *Aria in A Minor for Strings*
†Cirri: *Concerto for Cello, Flute and Strings in A Major*
†Albinoni: *Concerto for Violin and Strings in D Major, Op. 9, No. 7*
†Pergolesi: *Concerto for Four Violins, Viola, Cello and Continuo No. 5 in E flat Major*

Virtuosi di Roma; Renato Fasano, director.
DECCA DL 9598. 12-in. 5, 16, 11, 7 mins. \$5.85.

Only the Pergolesi is at all familiar: It is one of a collection of four concertos by the composer recorded by Westminster. The Cirri, from a later era, has a fresher perfume than the light fragrance of the others. All are diverting and not very important, but as played here with a kind of reverent apprehension that the performance may not attain perfection, they assume the fragility of an irreplaceable bibelot, and a value akin. The recorded sound is smallish but satisfactory.
C. G. B.

MENDELSSOHN *A Midsummer Night's Dream, Op. 21 and 61* (Overture and Incidental Music)
Symphony No. 4 in A Major, Op. 90 ("Italian")

Philharmonic-Symphony Orch. of N. Y.; George Szell, cond. in

¹We are now going to submit this situation to the Committee of Philadelphia Lawyers For The Disentanglement of Confused Chinese Lawyers — for disentanglement. The result will be forwarded to Messrs. Burke and Haydn and, on request, to readers of HIGH-FIDELITY, for their disentanglement.—Editor

the *Midsummer Night's Dream*. Cleveland Orch.; George Szell, cond. in the *Symphony*, COLUMBIA ML 4498. 12-in. 30, 25 mins. \$5.45.

Quite the best sounding recording of this magical score presently available on records though, in performance, it does not match the wizardry generated by Toscanini on Victor LM 1221. Both versions use the same four sections from *Op. 61*: Scherzo, Nocturne, Intermezzo and March, plus the Overture (*Op. 21*), with Toscanini adding the finale, for solo soprano and woman's choir, for good measure.

Szell's carefully detailed, well controlled reading is a most musicianly job, though inclined to heavy handedness in spots. The Overture and Scherzo lack Toscanini's filigree daintiness, but the Nocturne is delightful, both in conception and performance.

Sterling sound, of a beautiful and well balanced texture, with fine woodwinds, and some highly attractive horn work, especially in the Intermezzo.

The *Symphony* is a re-issue, previously available on Columbia ML 4127, coupled with the composer's *Capriccio Brilliant*. J. F. I.

MENDELSSOHN *Symphony No. 9 in C Major*
†*Manfredini: Christmas Concerto*

American Arts Orch.; Karl Krueger, cond.
NEW RECORDS NRLP 102. 12-in. 26, 13 mins. \$5.75.

Mendelssohn wrote a dozen string quartets before he was fifteen, and compounded the confusion of musical nomenclature by swelling their parts and calling them Symphonies. The one recorded is direct, confident, striding and original, although the filtered influence of Mozart is palpable. Manfredini's concerto grosso resembles Corelli in its gentle contemplation. Mr. Krueger has assembled a group of skillful strings who perform in vigorous unity. Sound is of good quality after extra reduction of treble. C. G. B.

MILHAUD *Saudades do Brasil*
Concerto No. 4 for Piano and Orchestra

Zadel Skolovsky, piano, in the Saudades, and in the Concerto with Orchestre National de la Radiodiffusion Francais; Darius Milhaud, cond.

COLUMBIA ML 4523. 12-in. 21 and 18 mins. \$5.45.

Saudades do Brasil is a delightful suite of twelve piano pieces based on the rhythms of the Brazilian tango, each piece bearing the name of a different quarter or landmark in Rio de Janeiro. It is one of Milhaud's earliest works and one of his best. The fourth piano concerto is a recent work, very thick and heavy in texture, but full of intense rhythmic life. Wonderfully played, well recorded. A. F.

MONTEVERDI *Laudate Dominum (Psalm 116)*
Ut Quant (Song of Praise)
Beatus Vir (Psalm 111)

Vocal soloists and chamber orch. of the Scuola Veneziana; Angelo Ephrikian, cond.

PERIOD SPLP 536. 12-in. 14, 6, 21 mins. \$5.95.

Mr. Ephrikian has a strong bent and obvious talent for the liturgical (or religious) music of the older Italian composers, and he has had rather unusual good luck in the quality of engineering devoted to his efforts. The hymn and two psalms presented here are not exceptions to this reign of luck: one is struck by the unforced luminous clarity of voices and instruments, the lack of distortion and the agreeable sound. The voices have been very nearly trained to blend in a smooth and caressing fabric of tone. C. G. B.

MOZART *Concerto for Clarinet (K 622)*
†*Haydn: Symphony No. 61 in D*

Louis Cahuzac, clarinet. Chamber Orch. of the Danish State Radio; Mogens Woldike, cond.
HAYDN SOCIETY HSL 1047. 12-in. 31, 25 mins. \$5.95.

No doubt that the united values of the great K 622 in this sunny and relaxed performance surpass those of its rivals, including the taut and stylish Kell-Zimmler on Decca DL 7500. One manner of playing is as justified as the other, but the warmth of sound, the appealing string tone, the nice delineation of cross-currents in the new version, products of later engineering, are not equaled in this work elsewhere. Then, too, the remarkable variety of tone emanating from the Cahuzac clarinet is an attraction in itself.

The Haydn Symphony, slight and pleasant, not recorded elsewhere, is notable for a serene all around competence, particularly in the Woldike cantilenas and the engineers' balance. C. G. B.

MOZART *Concerto for Violin No. 3 in G Major*
(K 216)
Concerto for Violin No. 4 in D Major
(K 218)

Szymon Goldberg, violin. Philharmonia Orch.; Walter Susskind, cond.

DECCA DL 9609. 12-in. 24, 25 mins. \$5.85.

There are no degrees of perfection, but each of these Concertos exposes a different facet of it. The coupling is heady, and one would say sensible if the music were a little more compatible with such a word. Mr. Goldberg's work is what we have learned to expect of him in Mozart — lyrical, crisp, warm, sparkling, each where it is applicable, and most of the time the Philharmonia Orchestra is at the equivalent level. Unfortunately, the engineering falls short of the point where this disc could be called definitive. For a solid sound, volume must be advanced, and that promotes latent noise; and in the Third Concerto, our old enemy, the artificial violin harmonic, libels the Goldberg tone. In sum, wonderful music, superb performances, fair reproduction. C. G. B.

MOZART *Quartet in F Major, K 370 (Oboe)*
†*Telemann: Sonata in C Minor for Oboe and Harpsichord, and Partita No. 5 in E Minor for Oboe and Harpsichord*

In the Mozart, Harold Gomberg, oboe; Felix Galimir, violin; Gabriel Banat, viola; Alexander Kougell, cello. In the Telemann, Harold Gomberg, oboe; Claude Jean Chisson, harpsichord.

DECCA DL 9618. 12-in. 16, 20 mins. \$5.85.

Gomberg's playing is the last word — beautiful, clear, refined, subtle in tone and nuance, and musicianly to the last degree. His collaborators are of equal quality, and so are the recording and the annotations, by one Egon Kenton, who knows what music is about and how to write what he knows. The whole thing has a well-rounded maturity which is all too rare in recordings of chamber music or music of any other kind. A. F.

MOZART *Quartet No. 20 in D Major (K 499)*
Quartet No. 21 in D Major (K 575)

Stuyvesant String Quartet.

PHILHARMONIA PH 105. 12-in. 25, 23 mins. \$5.95.

These put forward a snug and inviting sound, the four instruments sunny with inchoate, benevolent reverberation. The playing suggests a certain analogous ease, a relaxed but not inattentive community of sentiment, a feeling of comfort in the pastime of making music. This is the only recording of No. 20. There are two other versions of No. 21, on Allegro and Concert Hall, each containing a different Mozart quartet overside. C. G. B.

MOZART *Quintet in A (K 581) (Clarinet)*

Leopold Wlach. Vienna Konzerthaus Quartet.

WESTMINSTER WL 5112. 12-in. 36 mins. \$5.95.

Reginald Kell. Fine Arts Quartet.

DECCA DL 9600. 12-in. 31 mins. \$5.85.

Benny Goodman. American Art Quartet.

COLUMBIA ML 4483. 112-in. 32 mins. \$5.45.

The sound of all three of these is more than acceptable, Columbia being the biggest and Westminster the most warmly insinuating. On purely acoustical considerations, the latter would be the preference of a majority of discophiles. The interpretation by Mr. Wlach and the Vienna Konzerthaus Quartet is also the preference here, although this interpretation of a perfect work is not of a kind we in America customarily receive. It is Viennese, and we have learned to inspect carefully the Konzerthaus emanations of standard chamber music, generally very moving in Schubert, and frequently disappointing in Beethoven. But their long line and the slow tempos, the softening of accent and their romanticizing of tone endow K 581 with a new and deeper beauty in this half-devotional raiment, like the lovely young widow whose softly-tailored black glorifies her flashing eyes and rosy cheeks. The other versions — including the two above and the Duques on Stradivari, but not the Forrest on Lyricord, which was not heard — in their clean and expert figures, are patently meritorious but, after direct comparison with the Viennese edition, seem briskly businesslike and disappointing. C. G. B.

MOZART *Quintet No. 4 in G Minor* (K 516) (Viola)
Quintet No. 6 in E flat Major (K 614)
(Viola)

Milton Katims, second viola. Budapest String Quartet.
COLUMBIA ML 4469. 12-in. 29 and 24 mins. \$5.45.

Of the six works that Mozart wrote for string quartet and added viola, only the early K 174 remains unrecorded by the Budapest Quartet (in one or another of its conformations) and Mr. Katims. The great G Minor Quintet here receives the kind of tense, nervous treatment its passionate foreboding requires. The last Quintet, K 614, is a work of easy and gracious appeal, in a performance of fastidious and fluent precision. The earlier and greater work is the earlier recording by a number of years. Although a little tubby in the cello and somewhat harsh, the sound is satisfactory. The later Quintet in the later recording is one of those LP phenomena which lacerate the hearing with their shrillness or charm it with their crisp delineation of sound, according to the adjustability of the compensator used. When this component can rigorously subdue the treble the sound is splendid; with a less resourceful compensator the sound is appalling. There is formidable recorded opposition to both Quintets, but no duplicate of the present combination on one disc. C. G. B.

MOZART *Serenade No. 7 in D Major* (K 250)
("Haffner")

Bamberg Symphony Orch.; Joseph Keilberth, cond.
MERCURY MG 10117. 12-in. 53 mins. \$4.85.

Inferior in leadership, playing and recording to the Vox version which was ably led, indifferently played and poorly recorded.

C. G. B.

MOZART *Sonatas for Piano: B flat Major* (K 281);
G Major (K 283); *C Major* (K 545);
B flat Major (K 570)

Jacqueline Blancard, piano.
LONDON LL 529. 12-in. 42 mins. \$5.95.

Two early and two late Mozart sonatas, of which two (K 281 and K 283) are little known, one slightly better known (K 570), and then the one we couldn't evade some years ago (K 545), when its first movement was served up ad nauseam, as In an Eighteenth Century Drawing Room, by Raymond Scott. As in nearly all Mozart sonatas, I am enraptured with the slow movements, that of K 570 being a particularly beautiful example.

Blancard has the necessary equipment for these works, and her performances are deft, if somewhat cool, well articulated and well phrased. She plays with uncommonly fine control, and I find her phrasing and tempos much as I like them for my Mozart.

The piano tone is exceptionally lifelike, but my pleasure is greatly diminished by a rumble which London should have eliminated.

J. F. I.

MOZART *Sonata for Piano and Violin No. 37 in G*
(K 379)
Sonata for Piano and Violin No. 39 in B flat (K 454)

Paul Badura-Skoda, piano; Walter Barylli, violin.
WESTMINSTER WL 5109. 12-in. 20, 23 mins. \$5.95.

Two marvels of imaginative literature played with sensitive adjustment to their lovely requirements, by a piano and violin distinguished here by succulence of tone, in a flawless recording, for an unpretentious and altogether admirable disc achievement. C. G. B.

MOZART *Symphony No. 21 in A Major* (K 134)
Symphony No. 19 in E flat Major (K 132)

Ton-Studio Orch., Stuttgart; Hans Michael, cond.
PERIOD SPLP 538. 12-in. 15, 19 mins. \$5.95.

There is no little delectation in this brace of Eighteenth Century airy elegances, albeit the disc is fairly rich in faults. The positive elements are Mr. Michael's energetic direction and a pleasant proximity of sound from the little orchestra. But there is no true piano, and no polish. We hear vagaries of pitch, uneven chords and harsh violins. Nevertheless, some seductive Mozart emerges, and there is no competing edition of either symphony. It is hard to resist the Andante of No. 21, however flawed. C. G. B.

MOZART *Symphony No. 31 in D Major* (K 297)
("Paris")
Symphony No. 39 in E flat Major (K 543)

London Symphony Orch.; Josef Krips, cond.
LONDON LL 542. 12-in. 16, 25 mins. \$5.95.

Ingratating sound below *mf*, beautiful string tone and playing; above *mf* coarse sound, obscuration of winds, obtuse bass. Many felicities of interpretation, beautiful languorous lyricism, unluckily maintained when a whip is needed. No. 31 is best by Beecham for Columbia, absurdly coupled with Schubert's "Unfinished"; and we have no No. 39 worthy of the standards of this date. C. G. B.

MOZART *Symphony No. 33 in B flat Major* (K 319)
†Haydn: *Symphony No. 94 in G Major*
("Surprise")

Concertgebouw Orch., Amsterdam; Eduard van Beinum, cond.
LONDON LLP 491. 12-in. 20, 22 mins. \$5.95.

A brace of masterpieces featured in performance by the serene, gracious and limpid homogeneity of the orchestra, the soft, close-woven texture of the wind providing a cushioned background for the curving patterns of the strings. Violins are silken, for owners of flexible amplifiers which can remove the excess treble. Some incursion of strong hum will be noted in the Mozart, which is, however, easily superior to the versions on Columbia and Mercury. The "Surprise", despite stolid playing of the Minuet, bears comparison with the excellent recent Beecham on Columbia ML 4453, backed by the "Drum-Roll" (which complicates choice). C. G. B.

MUSSORGSKY *Pictures at an Exhibition*

Chicago Symphony Orch.; Rafael Kubelik, cond.
MERCURY MG 50000. 12-in. 29 mins. \$5.95.

Acoustically in the foremost rank of orchestral records. With one gigantic bound, Mercury attains a status she has never had before. Brass timbre has seldom been more successfully engraved than in this bold statement wherein everything is unambiguous and the phalanx is overwhelming. Plainly the Bohemian conductor has already accomplished an impressive betterment of the venerable orchestra, and the brilliant music in Ravel's brilliant orchestration acquires a singular emotional force in this triumph of engineering wherein nothing is lost and everything is in proportion. C. G. B.

MUSSORGSKY *A Night on Bald Mountain* — See Rimsky-Korsakov

PERGOLESI *Concerto No. 5 in E flat Major* — See Marcelllo

PURCELL *Timon of Athens* (Masque)
Fairy Queen (Excerpts)

Margaret Ritchie (s). Instrumental ensemble of Orchestre de l'Oiseau-Lyre; Anthony Lewis, cond.
OISEAU-LYRE LL 16. 12-in. 18, 18 mins. \$5.95.

In a measure, the phonograph record can impose its own deficiencies as normality, after a preparatory minute or two. Perhaps the very nasal violins here will seem to lose their infection with use; if they do, the disc has charm in agreeable stylized playing and Miss Ritchie's unpretentious manipulation of her dear little voice.

The much more extensive presentation from the *Fairy Queen* in Allegro AL 60 is more fully scored and a better recording, although the soprano there has not the address of Miss Ritchie. C. G. B.

RACHMANINOFF *The Miserly Knight, Act II* (In the Cellar)
†Arensky: *Variations on a Theme by Tchaikovsky*

Cesare Siepi (bs) in the Rachmaninoff, with Little Orchestra Society; Thomas Scherman, cond. Same orch. and cond. in the Arensky.
COLUMBIA ML 4526. 12-in. 20, 14 mins. \$5.45.

A rich, detailed, sweeping and seizing sound distinguishes this undistinguished music. *Boris Godounof* is complete without the *Miserly Knight* wherein Mr. Siepi sings well in difficult English; and the pleasure in the Arensky *Variations* is mild. C. G. B.

RAMEAU *Suites in E Minor and A Minor*

Fernando Valenti, harpsichord.
WESTMINSTER WL 5128. 12-in. 22, 22 mins. \$5.95.

The sound of the harpsichord here seems identical with that of the two discs of Scarlatti Sonatas recently issued in Valenti performances. There is something almost spectacular in the blended crispness and resonance of that sound, and with volume down it is probably standard for the harpsichord, or at least for the imposing instrument heard here. The playing is the best kind of virtuosity, coruscating displays of dexterity in evidence but imposed from within, and set off by a singing style unusual on the harpsichord.
C. G. B.

RAVEL *Rapsodie Espagnole, etc.* — See Debussy

RIMSKY-KORSAKOV *Concerto for Trombone and Military Band*

Davis Shuman, trombone. Symphony Artists Band; Tibor Serly, cond.
CIRCLE L 51-103. 12-in. 11, 7 mins. \$5.95.

Three tiny folk songs for woodwind quartet and three "festive moods" for string quartet, totaling eighteen minutes, have more musical interest than Rimsky's dull experiment, played with a lavish variety of tone by the soloist. The striking virtuosity of the disc, however, is its engineering, exact, vibrant and three-dimensional for each of the three ensembles.
C. G. B.

RIMSKY-KORSAKOV *Le Coq d'Or Suite* ("The Golden Cockerel")

†Mussorgsky: *A Night on Bald Mountain*

State Radio Orch. of USSR; Nicolai Golovanov, cond.
VANGUARD VRS-6000. 12-in. 31, 11 ins. \$5.95.

The Snow Maiden (Ballet Music)
†Mussorgsky: *A Night on Bald Mountain*

Boris Godounov: "Polonaise"
Kovantchina: "Entr'acte" and "Persian Dances"

Symphony Orch. of Radio Berlin; Leopold Ludwig, cond. in *The Snow Maiden*. Berlin Philharmonic Orch., same cond., in the Mussorgsky.
URANIA URLP 7035. 12-in. 12, 11, 9, 4, 8 mins. \$5.95.

Both records present a brilliant show. The Urania sound, particularly in *Bald Mountain*, is the best that that company has given of purely orchestral works. The clarity of timbre would give it preference over the Soviet *Bald Mountain* if Ludwig did not flourish a few tricky tempos. There is more in this suite from the *Coq d'Or* than we usually hear, about five minutes. The Golovanov exposition is sturdy and exuberant, like the sound as such, which also glitters. The *Snow Maiden* music dances with fanciful charm. Both discs are of salient good quality, but impossible to compare with competitors, which in no case duplicate both sides.
C. G. B.

ROSSINI *La Cambiale* — See Chabrier

ROZSA *Sonata for Cello and Piano* — See Bach

SCARLATTI, A. *Il Trionfo dell' Amore* (Complete Opera)

Rossana Zerbini (s), Amalia Pini (ms), Ornella Rovero (ms), Eugenia Zareska (c), Amedeo Berdini (t), Sante Messina (t), Afro Poli (bne), Mario Borriello (bs). Orch. of Radio Italiana; Carlo Mario Guilini, cond.
CETRA-SORIA XTV 14511-2. Two 12-in. 1 hr. 15 mins.

Complete recordings of operas are common enough nowadays, but the repertoire of recorded opera before 1750 is still exceedingly slim; *Il Trionfo dell' Amore* is therefore a very important addition to the lists. The work is quite surprising to an ear brought up on the standard repertoire of the present day. Its libretto is one of those complicated comedies of love-intrigue one associates inevitably with Mozart and Cimarosa, but its musical style has the grand sweep, dignity and large gesture of the baroque; in fact, there is one duet ("Spero, Speranza" Act I) which sounds fantastically like the "Qui Sedes" in Bach's B Minor mass. It ante-

dates the B Minor mass, for this 110th of Scarlatti's 120 operas was produced in Naples in 1718. Recording is good and so is the orchestral performance. Singing runs from fair to execrable, but in a case like this, it is the score that counts.
A. F.

SCHONBERG *Erwartung Op. 17* ("Expectation")
†Krenek, Ernst: *Symphonic Elegy for String Orchestra*

Dorothy Dow (s) in "Expectation", with Philharmonic-Symphony Orch. of New York; Dimitri Mitropoulos, cond. Same orch. and cond. in the *Symphonic Elegy*.
COLUMBIA ML 4524. 12-in. 22 and 12 mins. \$5.45.

Schönberg's *Erwartung*, composed in 1909, is a legitimate daughter of Isolde's Love-Death. It is a "monodrama" for soprano and orchestra about a woman who finds her lover dead in a forest. It goes on for quite a while, with typical Schönbergian declamation, in a manner now tonal, now freely atonal, and is especially interesting for its sinister and portentous effects.

Krenek's *Elegy*, composed in 1946 in memory of Anton Webern, is a legitimate son of Schönberg's *Verklärte Nacht*. It is a work for string orchestra of great character and expressive resonance. Performance and recording leave nothing to be desired. The notes give only the English text of *Erwartung*, although it is sung in German.
A. F.

SCHUBERT *Grand Duo in C Major, Op. 140*

Paul Badura-Skoda and Joerg Demus, piano.
WESTMINSTER WL 5093. 12-in. 35 mins. \$5.95.

The art of four-handed piano playing has long since died, more's the pity, and with it some masterpieces have gone into an underserved limbo. Schubert's *Grand Duo* — which some historians believe to be an arrangement of his lost *Gastein Symphony*, although it probably isn't — is Schubert at his most tuneful, most imaginative, most naive, most song-like, most sprawling, most loquacious and most entrancingly interminable. More than any other work, it reminds one of the same composer's "Great" C Major symphony. Excellent performance, fair recording.
A. F.

SCHUBERT *Impromptus: Op. 90, Nos. 1-4, and Op. 142, Nos. 1-4*

Rudolf Firkusny, piano.
COLUMBIA ML 4527. 12-in. 8, 4, 6, 7, 9, 5, 10, 5 mins. \$5.45.

At a first hearing, the following note was inscribed for this record: "Piano-sound hard and repellent throughout". Some weeks later, that judgment is modified: the sound *is* hard, but not especially repellent. The discrepancy must have been caused by a change in atmospheric circumstances. Mr. Firkusny, however, seems as hard as before. The extraordinary pieces require a supple repertory of mutable tempos and force which the pianist, who has the repertory, disdains to make public. One would say that he does not really like the music.
C. G. B.

SCHUBERT *Italian Songs and der Kampf* — See Brahms
Seven Songs — See Haydn

SCHUBERT *Quartet No. 14 in D Minor* ("Death and the Maiden")

Koeckert Quartet.
DECCA DL 9567. 12-in. 37 mins. \$5.85.

The performance tends to be matter-of-fact and the room tone tends to aridity. The editions on Westminster and Mercury are not displaced.
C. G. B.

SCHUBERT *Trio No. 2 in E flat, Op. 100*

Paul Badura-Skoda, piano; Jean Fournier, violin; Antonio Janigro, cello.
WESTMINSTER WL 5121. 12-in. 44 mins. \$5.95.

Schubert, musically prescient of death, describes in magic and heart-rending figures his passionate resentment, his despair and defiance, his elegiac acquiescence and renewed revolt at the premature schedule. With instinctive sympathy, musicians seldom err spiritually in reproducing this Trio. The Austro-Franco-Italian group, quick to their responsibilities, here err not spiritually nor physically. Phrase, accent, intonation and time are cooperative and

coordinated to the appeal of this music, and the sweeping tonal seductiveness of the Janigro cello is hardly noticed in the general spell. This triumph has been engineered with an extraordinary competence, most obvious at the tops of piano and violin and above all in the immaculate dynamic expansiveness. C. G. B.

SCHUMANN, R. *Carnaval*

Sergei Rachmaninoff, piano.
RCA VICTOR LCT 12. 10-in. 25 mins. \$4.67.

Gyorgy Sandor, piano.
COLUMBIA ML 4452. 12-in. 25 mins. \$5.45.

Carnaval
Sonata No. 1 in F sharp Minor, Op. 11

Paul Badura-Skoda, piano.
WESTMINSTER WL 5105. 12-in. 27, 30 mins. \$5.95.

Assuming that there is a proper way of editing the *Carnaval* upon a disc, one of the discs above must be nearer that way than the others; and those others then must be regarded as mere editorial whimsies. The enthusiasm of phonophiles may be tepid at the offhand standards that evaluate these records at nineteen, twenty-two, and ten cents per minute of music, respectively.

All three are well played, in their fashion. Sandor is the showiest, Badura-Skoda the most cordial, Rachmaninoff the crispest and the subtlest. This writer has always thought that R's controlled warmth was exactly appropriate to the *Carnaval*. The best sound is Westminster's, closely followed by Columbia's whose fault is hardness, as if the wavelenghts had been seized too soon. The Victor Rachmaninoff, a resurrection of a recording 25 years old, is an impressive example of the RCA recording adeptness. C. G. B.

SCHUMANN, R. *Overture, Scherzo, and Finale, Op. 52*
†Liszt: *Heroïde Funèbre*

Munich Philharmonic Orch., Adolf Mennerich, cond.
MERCURY MG 10115. 12-in. 20 and 22 mins. \$4.85.

If Schumann had called his *Overture, Scherzo and Finale* a symphony it would be played as often as the four works he did so designate. It is a symphony in three movements in Schumann's most vigorous, brilliant and virile style, and it should be far better known than it is. The Liszt on the other side indicates that Mercury is relentless in its determination to record all of that composer's symphonic poems. *Heroïde Funèbre* sounds at its beginning like a laborious sketch for Siegfried's funeral music in Wagner's *Götterdämmerung*, which, in historic actuality, it probably is. Later on it sounds like a rejected version of *Les Préludes*. A. F.

SCHUMANN, R. *Frauenliebe und Leben, Op. 42*
†Loewe: *Four Songs*

Elisabeth Höngen (a), Ferdinand Leitner, piano, in the Schumann. Josef Greindl (bs), Georg Hann (bs), Hertha Klust, piano, in the Loewe.
DECCA DL 9610. 12-in. 22, 22 mins. \$5.85.

Flexible and dramatic singing by Greindl in Edward and in Der Nöck, mellow singing by the late Georg Hann in Odins Meeresritt and in Meeresleuchren. Since Miss Höngen has repeatedly proved that she can sing, her painful foundering in Schumann's cycle must be considered a sad and mysterious aberration. The sound of the accompanying pianos is light and untrue. C. G. B.

SCHUMANN, R. *Quartet No. 2 in F Major, Op. 41*
†Verdi: *Quartet in E Minor*

The New Italian Quartet.
LONDON LLP 323. 12-in. 21 and 22 mins. \$5.95.

These are performances of extraordinarily unified delicate finesse decidedly applicable to both works, in adequate recordings less incisively chiseled than the best. C. G. B.

SPOHR *Jessonda and Faust* — See Gluck

SPONTINI *La Vestale*

Maria Vitale (s), Elena Nicolai (ms), Renato Gavarini (t), Alfredo Fineschi (bne), Giuliano Ferrein (bs), Albino Gaggi (bs). Chorus and Orch. of Radio Italiana; Fernando Previtali, cond.
CETRA-SORIA 1224. Three 12-in. 1 hr. 58 mins. \$17.85.

Spontini was born twenty years too late and became an anachronism.

Gluck dominated the musical stage in 1774, and during the next pair of decades the impressionable talent of the young Italian was imprinted with a classicism that time did not erase. *La Vestale*, equal to any Gluck except the best Gluck and *Idomeneo*, was first produced, and had a great success, in the Paris of 1807, late for its type, but France was the last country to express in her art the romantic upheaval inaugurated by her Revolution. The steady and sensible libretto is adorned by dramatic music remarkable for rhythmic significance and continuous melodic resourcefulness. That other Gluckist, Richard Wagner, admired *La Vestale*.

The opera is by no means an obscure item, but Americans have not been able to hear it for twenty years. It is Cetra-Soria's considerable contribution to music that it makes available that part of the Italian repertory which everyone has heard of but no one has heard. This album has a number of the familiar Cetra features: a strong wall of sound, energetic and enlightened leadership and sensitive use of the choruses. The singing could be better — several of these principals force their voices, and intermittently they are too near the microphone. But considered as a whole, the projection of a vital opera is moving and illuminating and is recommended without misgivings. C. G. B.

STRAUSS *Der Rosenkavalier* (Finale Act I, Finale Act III)

Tiana Lemnitz, Georgine von Milinkowic, Elfride Trötschel.
The Württemberg State Orch.; Ferdinand Leitner, cond.
DECCA DL 9606. 12-in. 41 mins. \$5.85.

Two considerable excerpts from Acts I and III of *der Rosenkavalier*. One starts with the Marschallin's monologue "Da geht er hin" and continues to the end of the first act. The third act excerpt begins after the Baron's departure, with Sophie's "Mein Got es war nicht mehr als eine Farce" and ends with the final curtain.

In the role of the aging Marschallin, Lemnitz sings with affecting poignancy, nobility, and immense artistry, but also with considerable circumspection so that one imagines she finds the vocal demands of the part rather taxing today. She is still able to produce some ravishing *mezza voce* tones at the top, but the voice sounds edgy and rough in the lower register. Trötschel and von Milinkowic provide admirable support as the two lovers, but the orchestral accompaniments are far too restrained under Leitner's direction. The balance is sadly awry here, with soloists too close and the marvelous orchestral writing is badly clouded, except in the climaxes. J. F. I.

TARTINI *Concerto for Violin in D Minor*
Sonatas for Violin and Harpsichord in E Minor and E Major

Peter Rybar, violin; Franz Hollletschek, harpsichord. Winterthur Symphony Orch.; Clemens Dahinden, cond.
WESTMINSTER WL 5118. 12-in. 12, 13, 10 mins. \$5.95.

Chaste playing and discreet recording give the chaste contours of the Concerto, on the second Tartini LP of the two recorded, an ethereal wistfulness of curious charm. The Sonatas contrast solemnity and high spirits — the E Minor may impress as being dull; not so its Major counterpart. An interesting background disfigurement, like the rumble of faraway thunder, is barely audible intermittently in these. C. G. B.

TELEMANN *Sonata and Partita* — See Mozart

THOMSON *Suite from The Plow that Broke the Plains and Acadian Songs and Dances* — See Copland

VERDI *Aïda* (Prelude and Ballet Music) — See Gounod
***String Quartet in E Minor* — See Schuman**

VILLA-LOBOS *Mass of Saint Sebastian*

University of California Chorus; Werner Janssen, cond.
COLUMBIA ML 4516. 12-in. 32 mins. \$5.45.

The writer of this review provided the notes for this release, and if that disqualifies him to discuss it, you may skip this paragraph. The *Mass of Saint Sebastian* reveals an aspect of Villa-Lobos which is very little known in North America. Here, instead of the Brazilian folk songs and dances with which one has come to associate his name, he goes back to the 16th century Spanish and Portuguese

cathedral music which are of equal significance in the musical tradition of his country.

The work is rather curiously organized. It is written in three-part counterpoint for women's voices, but each part is doubled an octave lower by men's voices. The resulting sonority is extraordinarily beautiful, and so are the supple, freely articulated forms in which the music is cast. This is not a dramatic mass, but one of great devotional power, richness and mysticism. Performance and recording are first rate. A. F.

WEBER *Grand Duo Concertante, Op. 48*
Variations on an Air from Sylvania, Op. 33

Leonid Hambro, piano; Sidney Forrest, clarinet.
WCFM LP 12. 12-in. 20, 15 mins. \$5.95.

An engaging pair of display pieces for the clarinet into which a melodious romanticism has been interlaced with the bravura. The players have not heeded the temptations to excess in the score, and their statement is one of polished rationalism and smoothly undulant song, with Mr. Forrest's endless shading of tone something worth admiring comment. The sound of both instruments seems flawless. C. G. B.

WILLIAMS *A London Symphony*

London Philharmonic Orch.; Sir Adrian Boult, cond.
LONDON LL 569. 12-in. 43 mins. \$5.95.

Ralph V. Williams, who is now venerable, has often sighed at becoming the hyphenated Vaughan-Williams. Futilely, Vaughan-Williams he remains and will stay. On the appeal of the *London Symphony*, he will not soon be forgotten. This has been in repertory for nearly forty years, and time has not weakened its sturdy fabric. We have a performance here, marking the debut of Sir Adrian Boult on London, of heartfelt appeal and Londonian pride, prepared with an affection that does not exclude exactitude. The sound is better than any we have had from London of London people for long — expansive and brilliant both, differentiated and luxurious, notable everywhere for the clean capture of the strings in multiple employments from the darkest to the lightest — and we may divine that this edition will be immune to competition for a while. C. G. B.

MISCELLANY

A TREASURY OF MADRIGALS

By Le Jeune, di Lasso, Costeley, Bertani, Gesualdo, Monteverdi, Wilbye, Weekles, Vautor, Tallis, Byrd, Gibbons, Greaves, Lichfield, Bateson.

The Renaissance Singers; Lehman Engel, cond.
COLUMBIA ML 4517. 12-in. 39 mins. \$5.45.

The problem of selecting, from the immense madrigal literature of the Italian, French and English schools, only enough examples as could be impressed on one 12-in. record, has been ably solved by Lehman Engel in this diversified collection. Nor has he played it safe, for alongside the great names of Monteverdi and Byrd, we find such little known masters as Bertani and Vautor, thus adding variety of style, mood and rhythm to this concourse. I could wish he had included something of Morley's, but the inclusion of the lovely Silver Swan of Gibbons, and his masterly setting of the tragic *What is Our Life* of Sir Walter Raleigh, more than compensate such absence.

I like the choir balance here . . . nothing out of focus, basses solid but not overpowering, women's voices true . . . and not too "plummy". The singing is robust, clean in attack, with an excellent appreciation of the nuance and flexibility of the medium. Though Columbia provides no texts here, their absence is no great hardship, thanks to the clarity of enunciation throughout. J. F. I.

ITALIAN SONGS OF THE 16TH AND 17TH CENTURIES

Magda Laszlo (s); Franz Holletschek, piano.
WESTMINSTER WL 5119. 12-in. 37 mins. \$5.95.

Eleven songs by Monteverdi, A. Scarlatti, Caccini, Carissimi, Marcelllo, Bassani, Pergolesi, Cesta and Campa, a congeries of varied sentiment rich in subtle-simple design, delivered in a vocal line of utmost evenness and purity by a very talented soprano whose mastery of style is also to be noted. The accompaniments are unusually able, and the sound is very clear and close in a disc decidedly out of the ordinary. C. G. B.

SONGS OF SCANDINAVIA

Tii Niemela (s); Pentti Koskimies, piano.
WCFM LP 5. 12-in. 42 mins. \$5.95.

Here we have no fewer than nineteen songs, including some by Grieg and Sibelius more or less familiarized in concert, and two short cycles by Kilpinen remarkable for their expression of persistent loneliness. The singer's voice, flexible and noble especially in mid-range, carries these expertly at the behest of an understanding trained to their speech and mood. Her accompanist phrases well, but is reluctant to vary the intensity of his sound. Engineering is unobtrusively efficient. Texts and translations of five songs are supplied; translations only of six others; and translations in epitome only, of the rest. C. G. B.

HARP MUSIC

16th Century Spanish Masters; Contemporary French and Spanish Masters

Nicanor Zabaleta, harpist.
ESOTERIC ES 509. 12-in. 30 mins. \$5.95.

Spectacular performances of music expressly written for the harp by Spanish and French composers of the 16th and 20th centuries. The 16th century works are music of the purest classical design, of a succinct and expressive style that astonishes with the modernity of its aural impact. That of the 20th century remains, to a certain degree, within the same framework, and is remarkable for its absence of impressionistic effects such as *glissando*, in its writing.

There is an elegance and distinction to Zabaleta's playing that recalls Segovia, for like Segovia, he is a complete master of his instrument as well as an artist of unerring taste. There is subtlety as well as power in the playing, and so clean is the finger work that, at times, one imagines a guitar being played rather than a harp.

The sound of the instrument has been most realistically captured, and there are no extraneous sounds from the damper. This is an exciting and unusual record. J. F. I.

OPERATIC EXCERPTS

L'Elisir d'Amore — Una furtiva largima (Donizetti)

La Gioconda — Cielo e Mar (Ponchielli)

Don Pasquale — Prelude, Scene and Aria (Donizetti)

Lucia di Lammermoor — Recitative and Aria (Donizetti)

Giacinto Prandelli (t). Orch. of Santa Cecilia, Rome; Alberto Erede, cond.

Faust — Recitative and Duet (Gounod)

Raphael Arie (bs); Tomaso Spaturo (t). Same orch. and cond. as above.

Andrea Chenier — Un di all'azzurro spazio (Giordano)

Ferrando Ferrati (t). L'Orchestre de la Suisse Romande; Alberto Erede, cond.

Il Barbiere di Siviglia — A un dottor della mia sorte (Rossini)

Fernando Corena (bs). Same orch. and cond. as above.

LONDON LL 534. 12-in. 42 mins. \$5.95.

A grab bag of operatic favorites, seven in all, and an excellent buy if you like this sort of thing. Probably only Arie and Prandelli, of the singers, will mean anything to listeners, their records having appeared here before. Prandelli, given one complete side of the record, makes the most of it with some extremely persuasive vocalism. I find his performance of the Act III recitative and aria from *Lucia* particularly appealing, and his "Cielo e mar" almost as good. If the singing in "Una furtiva lagrima" had been a little more restrained, this would have been one of the finest I have heard in a long while.

Unless London felt they needed another name to sell the record, I don't know how the Faust duet managed to creep onto this prevailingly Italian disc, but I'm glad it's here. Not since Pinza's palmiest days has the diabolic Mephisto been so ably projected vocally, even though the singer doesn't sound completely at home in French.

I am particularly pleased with the excellent balance that has been obtained between singers and orchestra, quite the best I have heard on any London recording. The recording level is just about perfect for this sort of thing, and the whole record is a tribute to London's engineers. When handing out the bouquets, let us not forget Erede, whose admirably well paced and controlled accompaniments add much to the success of these performances. J. F. I.

the records of

Handel

c g burke

THE YEAR 1685 spawned three infants who grew to most memorable size: Domenico Scarlatti, who became a gracious master of intricate musical miniatures; G. F. Händel, who created the vastest sumptuosity of shattering positivism in tones; and J. S. Bach, whose incomprehensible eloquence burst the circumscriptions of a smug and circumspect epoch of expert musical conformities. Primogeniture in this year of extravagant genius belonged to Händel, by a month before Bach.

Curiously the big, unambiguous man has come down obscure to us. He was not obscure, and he was certainly big, to his contemporaries. Our musical habits have falsified his genius. We revere him by rote as the composer of *Messiah* which we hear performed grossly truncated in soggy rituals, and of the "Largo" which by a damnable perversity we are able to hear only as atmospheric music in one of its unlikely transcriptions. (This wonderful music for tenor and orchestra, in the opera *Xerxes*, tells the thanks of a spent warrior at finding shade.) When we hear Handel he is as big as the first half of the Eighteenth Century found him. Except on the phonograph, Americans have little chance to hear him, and even on this, the principal cultural seizure of a technological feat of our age, his music is sparse.

Back to 1685. Georg Frideric Händel was born in Halle in Saxony. His father was a barber-surgeon, a man who had bled and shaved the vicinal small nobility. Intoxicated with such proximity, he wished his boy to climb; and in a world even then surfeited with lawyers he thought that the downright lad might more easily glorify the family name in splitting hairs than in dividing violas. (He was wrong.)

Musically that period is not well documented. Young Händel developed his bent and became a prodigy on the keyboard instruments. He conducted at Hamburg and wrote some Italian operas for production there. He trav-

eled in Italy and competed at the harpsichord and the organ with Domenico Scarlatti, his junior by eight months, who acknowledged pleasantly the Saxon's superiority on the organ and remained always afterward his admiring friend. He became musical director for the Elector of Hanover whom he had met in Italy; and he visited England.

On that damp island, steaming then with ambition, he remained until the God he had celebrated with such heroic vehemence silenced his music. On occasion he left, as one must leave that implacable humidity, but always he returned. He pleased Anne, the Queen who by her queenship connived in her father's disinheritance; and he mollified the first George whom he had deserted when the George was Elector and he *kapellmeister*. He served the second George, him of Dettingen, well; and died the year before the second was succeeded by the third and most formidable of the Georges.

In that career the Saxon Georg Frideric Händel had assented, in Italy, to Hendl; and in England to Handel, George Frederick, fit for a crypt in Westminster Abbey. He had become the greatest English composer, this Saxon; he trumpeted her increasing might and grew with her growing empire. He never lost his profound accent, and in setting English texts often misplaced the stress. He was proud of his adopted nationality and was aware of his importance as England's musical chronicler. He died while the Seven Years' War was still in dispute, and it is a sentimental pity that he could not know the enormous contagion of British suzerainty following that First World War.

He had titled patrons and he was a courtier, but all his worldly activities were subordinate to his music. He was an impresario to produce his own operas, and bankrupted twice in mounting spectacles of a type that the English public had seen oftener than they could absorb. He turned energetically in his later years to the composition of

oratorios, that hybrid form out of a mating of opera with cantata. He was not excelled in this. The mighty biblical epics he chose were in full accord with the temper of his genius. He wrote more wonderful oratorios than anyone who has lived, and it is doubtful that he ever wrote a bad one. That we his inheritors have chosen to concentrate almost exclusively on *Messiah* is our misfortune, and not the fault of his writing, but of the lethargy of music directors.

His music, idolized by Beethoven, was of an almost unbelievable flood, and flowed with an almost unbelievable facility. Contemporaneous ethics permitted him the convenience of repeated plagiarism from his own works and also from others', but the economy of effort obtained from that process can hardly explain in normal human terms the prodigious vitality of energy contained in the ninety-seven volumes of the Händel Gesellschaft.

Much of that content we shall never hear. The forty operas which were his first and perhaps his deepest love are the most considerable portion. These, almost all composed to Italian librettos on classical antiquity or mythology, are rejected by the culture of our times. Generations conditioned to the comics and the movies are not equipped to make the emotional and intellectual transference necessary to understand the kind of conflicts implicit in *Silla*, *Scipione* and *Tamerlano*. It is doubtful that more than an

infinitesimal band of recent university graduates could identify those personages. We can hope at best for recordings of one or two of the shorter operas and perhaps of edited versions and probably of many excerpts.

On records we have a good representation of his instrumental music, and thanks to the Handel Society the oratorios are beginning to appear. 1959 will be the second Centenary of his death, and that rather distant year may be expected to flourish some special and grand recordings. Before then the production will probably proceed as it has been until now.

We have enough to give us the essence of the man. Big, honest, objective, obstinate, tempestuous, he resembled his music. The involutions of his polyphony are not able to hide the single-minded simplicity of his proclamations. He was not introspective and would have disdained self-analysis and self-pity. He was par excellence the expositor of grandeur and of tenderness. The subtler emotions are not in his music, and some of his finest work is marvelously devoid of any emotion at all. His Italian training imbued his German weight and growing British complacency with a curious grace and a delightful sure taste in the use of elaborate ornamentation.

He ended an age. In England some men continued doggedly to copy him, but aside from these no one wrote music ever, that sounds remotely like his.

CONCERTOS

(Under this least explicit of musical designations are included all the works to which Handel assigned it, regardless of the contradictions of their musical structure. The Keyboard Concertos were written for performance by harpsichord or organ: here they are described for convenience under separate rubrics according to the instruments actually used on the various records. Concertos for Harpsichord and Orchestra, for Organ and Orchestra, although the music is the same. Many of the Handel Concertos are his own transcriptions of other works, including other concertos; and sometimes he transcribed transcriptions, thus giving employment to the musicologists of later generations who reconstructed the pedigrees.)

FOR HARPSICHORD AND ORCHESTRA

These are the Organ Concertos in their harpsichord coloration. Against the three noted here for the latter instrument fourteen have been recorded for organ. Mr. Pelleg, whose work in the harpsichord *Suites* is disappointing, fares much better in company with an orchestra. The conductor is unhampered and sportive; the harpsichordist takes his cue from him in a carefree exhibition of varied tempos and accents. The gracious string playing and string tone are to be commended except when the violins bow high and loud to produce a thin metal resistant to correction.

—Nos. 13, 14 & 19: Frank Pelleg; Zurich Radio Orch., Walter Goehr, cond. Handel Society (Concert Hall) 12-in. HDL 3. 14, 15, 11 min. \$5.95.

FOR OBOE AND STRINGS

The comparatively short Oboe Concertos are fragrant miniatures in the Handel production, imaginative and poetic; fragile almost, in his gallery of giants. If they are not celebrated, and seldom played, the cause is perhaps in our obsession with the image of Handel *pomposo*, not an inaccurate image, but one that should not be entertained as exclusive. The Gassman—Janssen example on Capitol is a demonstration of urgent but controlled vivacity, with an impressive delineation of the involved interlacement of the strings at driving speeds that attests the careful preparation of the orchestra. The preservation of this nicety is the only prominent feature of a somewhat rough but reasonably faithful recording.

The Oceanic disc containing Nos. 3 and 4, Viennese in origin and Viennese in style, has the soft attractiveness of an August breeze. The Kamesch oboe is less acidulous than our American expectation, the phrasing is suave and the orchestral background restrained and amiable. Captivating; and the engineered sound is appropriate—smooth and a little aloof, but lustrous.

—No. 2: Bert Gassman; Janssen Sym. Orch.; Werner Janssen, cond. Capitol 12-in. (with *Alexanderfest Concerto* and Haydn: *Horn Concerto No. 2*). P 8137. 8 min. \$4.98.

—Nos. 3 & 4: Hans Kamesch; Vienna National Opera Chamber Orch.; Ernst Kuyler, cond. Oceanic 12-in. (with *Organ Concertos No. 13 & 14*). OCS 25. 11, 10 min. \$5.95

FOR ORCHESTRA, IN C (ALEXANDERFEST)

Presumably originally employed as the overture or as an interlude in the ode *Alexander's Feast*, the spirited and contagious concerto

under consideration is played separately nowadays when it is played, and its formal similarity to the six concertos for orchestra recorded by the Bach Guild induced that company to include a recording of it in the same album. Labels are often deceptive; and it would be hard to divine, from a Capitol label reading "Double Concerto in C Major", that this is the concerto from *Alexander's Feast*. Nevertheless, in a slightly altered guise, that is what it is. Cellos have been substituted for the two violins as solo instruments, with a consequent darkening of hue compared to the edition by the Bach Guild, a darkening emphasized by an overall sound with less treble insistence. The contrapuntal involutions are maneuvered by Mr. Janssen with delicate flexible skill, and it is quite possible that music-lovers might prefer his work to the more dashing performance of Dr. Prohaska in spite of the changed instrumentation. The sound is of superior order in both versions, brighter and more vibrant on Bach Guild, where it requires, however, severe treble reduction. The conjoined music, nowhere else recorded in either case, makes it impossible to indicate a dogmatic choice of one disc as a unit over the other. Since *Alexander's Feast*, the ode in its entirety, has been announced by Concert Hall, a third version of the concerto will no doubt be available by the time this appears in print.

—Vienna National Opera Orch.; Felix Prohaska, cond. Bach Guild (Vanguard) side 4 of two 12-in. (with *Six Concertos for Orchestra, Op. 3*). BG 505-6. 14 min. \$11.90 (for the set)

—Members of the Janssen Sym. Orch.; Werner Janssen, cond. Capitol 12-in. (with *Oboe Concerto No. 2* and Haydn: *Horn Concerto No. 2*). P 8137. 16 min. \$4.98

CONCERTOS, continued

FOR ORCHESTRA, IN D

The dispassionate years have obliterated the brilliance of an early LP, whose detail now seems to us murky, its bass obtuse. But this record, with those deficiencies, yet offers as enticing a reproduction of the Philadelphia violins and horns — which have no competitors more enticing — as any record made subsequently. The work is actually an isolated organ concerto transcribed by Mr. Ormandy. Discophiles may remember another transcription by the late Sir Hamilton Harty which retained the organ as an integer: the Ormandy job emphasizes the capabilities of his own band; and if it is less characteristic of the original it is certainly effective. And it remains one of the most marvelous exultations of Handel at his most domineering.

—Philadelphia Orch.; Eugene Ormandy, cond. Columbia 10-in. (with *Water Music* excerpts and Corelli: *Suite*). ML 2054. 17 min. \$4.00

FOR ORCHESTRA, OP. 3

Five of the six extraordinary creations composing this Op. 3 did not even exist in a modern working score until the Bach Guild re-fashioned the music from the original editions as reprinted by Chrysander. Thus the credit of recirculating a set of masterpieces belongs to a recording company and the credit is great, for these are of a quality equal to that of the best of the *Concerti Grossi*, plus a more pungent color and greater contrapuntal complexity, thanks to the addition of the woodwinds. In their combination of vivacity and strength, their contrasts of ceremonial and simplicity, and their manly melodies in collaboration with the most logical polyphony, these Concertos are essential Handel, and essential to his devotees.

There is one recording, and in view of its excellence we are not likely soon to have another, unless it be of one or two which a virtuoso conductor may fancy for his talents. The orchestra is beautifully trained to Dr. Prohaska's mutable demands, which include the preservation of individual audibility for each choir at all degrees of volume and every condition of tempo. Since the leadership is imaginative and aspiring, we have a texture of sound as sturdy as it is delicate, a solid fabric in which the most trifling interweavings are yet apparent. In order to bring this out the engineers had to be on their mettle, and the unforced success of the resultant immaculate but muscular sound is consistently maintained. The treble is domineering but can be reduced without difficulty. — These observations apply as well to the *Alexanderfest Concerto* — presumably the Overture to the "ode" *Alexander's Feast* — which occupies the fourth side. One of the outstanding sets in the Handel discography.

—Vienna National Opera Orch.; Felix Prohaska, cond. (with *Alexanderfest Concerto, in C.*) Bach Guild (Vanguard) rwo 12-in. BG 505-6. 11, 12, 8, 11, 11 and 7 min. \$11.90

FOR ORGAN AND ORCHESTRA

The score of concertos that Handel wrote for keyboard, permitting either organ or harpsichord, offer the attractive paradox of

a consistent similarity of method and structure in union with an apparently inexhaustible treasury of the sturdiest musical entertainment. In retrospect all seem to have sounded alike, but while we listen each seems a new experience. Less profound than the *Concerti Grossi*, less varied in temper, the Organ Concertos yet include a number using material taken from the more famous works. Whether they are preferable in harpsichord or organ form is perhaps a matter of personal predilection. It is truly remarkable how their character changes with the change of instruments. The preponderant impression left by a majority of the Concertos on the organ is one of open-faced and cheerful salubrity, extremely resistant to the erosion of frequent hearings because of the toughness of their interlaced texture. On the harpsichord they become friskier; their salubrity acquires whims of catbiveness.

In recording the twelve concertos of *Opp. 4* and 7 and announcing the issuance of five more in the fall, Vox with little ostentation has endowed us with a grand musical monument which we, in the way habitual since LP, have taken for granted. It is a curiously satisfying amalgamation of skills. The virtuosity of the organist is restrained lest it detract from the calculated interest of the athletic drive of the orchestra, maintained by the conductor in a solid line of little nuance and no fussiness at all. We could say unimaginative, except that the underlying and ever-active concept here is of honest strength, which would be at odds with a more precious or elaborate narration. The organ, reconstructed on baroque principles, is mellow and ingratiating, and the big orchestral tone, smoothed by excellent hall-acoustics, has a gallant and expansively exuberant sweep. The engineering merits are similar. If there is some slighting of detail we are not aware of it in the wide, natural synthesis. The bass is firm, the treble shining; the cyclic curve is reasonable. It is quite easy to imagine how another collaboration could obtain more telling results in places in these concertos; but it is extremely doubtful that the unified execution of Kraft and Reinhardt in their congruity of the dozen will not remain standard until the next revolution in recording technique.

Nos. 13 and 14, part of a judicious and valuable miscellany devoted to Handel by Oceanic, are played in more elaborate style, with more embellishments from the soloist and a greater variety of pace and dynamics in the orchestra, which is expert. The organ is reedy to a piercing degree (although this may be a result of the recording process) and is improved by strong reduction of the treble output, which is also necessary for the violins. *No. 13* is the famous "Cuckoo and Nightingale"; *No. 14* is fundamentally the same music as the eleventh Concerto Grosso.

—*Op. 4 complete, Nos. 1-6*: Walter Kraft, organ; Pro Musica Chamber Orch., Stuttgart; Rolf Reinhardt, cond. Vox two 12-in. PL 7130. 18, 12, 11, 16, 9, 9 min. \$11.90

—*Op. 7 complete, Nos. 1-6, cumulatively Concertos 7-12*: Walter Kraft, organ; Pro Musica Chamber Orch., Stuttgart; Rolf Reinhardt, cond. Vox two 12-in. PL 7200. 16, 13, 15, 16, 13, 8 min. \$11.90

—*Nos. 13 and 14*: Gustav Leonhardt, organ; Vienna National Opera Chamber Orch.;

Ernst Kuyler, cond. Oceanic 12-in. (with *Oboe Concertos No. 3 and 4*). OCS 25. 13 & 12 min. \$5.95

FOR STRING AND WIND INSTRUMENTS, IN B FLAT

Has the solid interpretational and engineering qualities of the bigger Concerto in F below, which occupies the obverse. The bubbling blend of oboes and bassoons with the strings points the deftness with which the record has been prepared. Both sides very tasty, and not found elsewhere.

—Orch. of the Collegium Musicum, Copenhagen; Lavard Friisholm, cond. (with *Concerto for String and Wind Instruments in F*) Haydn Society 12-in. HSL 1049. 19 min. \$5.95

FOR STRING AND WIND INSTRUMENTS, IN F

The restoration to repertory of such a triumph of vivacious resourcefulness as this is, like Vanguard's set of Concertos for Orchestra, a significant indication of the phonograph's amazing role since LP, as a rescuator of great works one will not hear in the concert-hall in a lifetime. The composer rewrote for his four oboes, four horns, two bassoons and strings four or five items from other works of his, including a grand chorus from *Messiah* amusingly transformed by the orchestration. The only recorded version has been made by sure hands in a projection both broad and suave, by no means ultimate, but amiable and refreshing; in a sonic realization big and expansive, a little hard but notable for the brave fatness of the wicked horns and the careful proportions of the whole; and the disc can be played to good effect on any instrument capable of negating a reasonable curve.

—Orch. of the Collegium Musicum, Copenhagen; Lavard Friisholm, cond. (with *Concerto for String and Wind Instruments in B flat*) Haydn Society 12-in. HSL 1049. 30 min. \$5.95

CONCERTI GROSSI (12), OP. 6

There are certain homogenies in music formed of independent masterpieces presented or published as a unit (Mozart's six quartets dedicated to Haydn, Beethoven's *Opp. 31* and 59, Bach's six *Brandenburg Concertos*, Haydn's two sets of six London symphonies) that evoke a thunderstricken and silent incredulous worship of the immaculate splendor of man's unaccountable and infrequent ascensions of trans-human spirit. This is one of those. The concerto grosso form was a cramped one, by tradition and practice, and Handel was not an innovator. Yet he pumped into the tired frame a concentration of rhythmic vigor, melodic fancy and ingratiating polyphony that constituted in effect the *coup de grace* of the concerto grosso. As his became known, other composers, discerning the consummation, turned to forms wherein the last word had not yet been said.

Columbia and English Decca had both recorded all twelve before LP — a huge and daring project for which both are entitled to praise. The present Columbia LP's are the same performances; the London discs are by the original players, but in a new recording. Although only eight of the latter edition have appeared at this date, *Nos. 9* and 10 have been advertised and 11 and 12 will

certainly follow soon. It seems fair to assume that the four unheard will have the general qualities of the eight now available, which show a regular similarity of style and proclaim an equality of sonic values except in Nos. 7 and 8 which are better than their predecessors.

Here and there among the twelve the Busch players have little spurts of animated eloquence superior in its intensity at those moments to the best moments of the Neels. That is the only point of Columbia superiority. We discophiles are spoiled: we are offered here a chance of rejecting one of two versions both almost assuredly better than what hazard would produce in the concert-hall. In preferring the Neel records to the Busch records we are merely balancing the respective pluses and minuses and choosing the one with the greater total of net positive worth. At the outset, the Columbia editing upon eight 12-inch sides, with the several concertos separated by narrow blank bands, and some ending on one disc music that had commenced on another, is a severe self-inflicted wound. We generally think of irrational editing as London's prerogative, but in this case there has been an intrusion of common sense, and the allocation of one ten-inch side to each concerto seems proper, convenient and reasonable. The Busch violin dominates the three other instruments of his *concertino* most of the time, giving a vaguely discomfiting effect of a violin concerto, and the *tutti* of Busch strings is rough in comparison with the Neel texture. The Neel soloists are always audible in a line parallel with the *tutti*, thus illuminating the counterpoint, and slow sections have a mellifluous ease foreign to the Busch style.

Engineering traits: Columbia, commendable for its period, rather harsh, not disagreeable. London, for Nos. 7 and 8 (and presumably the four to follow) excellent — a silky and undulant sound; for the first six, massive and imposing, very good after the plangent shimmer of the violins has been exorcised by the compensator.

The Schönberg Concerto based on the seventh Concerto Grosso is more Schönberg than Handel. It is mentioned here as a matter of chronicle. Barring some tonal unpleasantness from the solo quartet it is probably well played, and the sound of the full symphony orchestra is brilliant.

—Nos. 1-8 only; others to appear shortly: Boyd Neel String Orch.; Boyd Neel, cond. London four 10-in. (one concerto to each side). LS 206, 207, 396 & 543. 13, 13, 11, 12, 14, 15, 14, 15 min. \$4.95 each disc.

—All 12: Busch Chamber Players; Adolf Busch, cond. Columbia four 12-in. SL 158. 11, 13, 10, 12, 14, 15, 15, 17, 16, 15, 17, 15 min. \$21.80

—*Fantasy by Schönberg for String Quartet and modern orchestra based on No. 7*: M. Compinsky Quartet; Janssen Sym. Orch., Werner Janssen, cond. Columbia 12-in. (with Bach-Mozart: *Fugues*). ML 4406. \$5.45

FUGUES

(Two short fugues are noted under *Suites for Harpsichord*)

ORATORIOS

ISRAEL IN EGYPT

One of the half-dozen most famous oratorios — which means that if people have not heard it they have heard of it — *Israel in Egypt* is alive with the Old Testamentary savage vigor that was so attractive to Handel's combative spirit. This life is not very savage, not very vigorous, in the only recording, which lacks élan. Dynamics and pace tend to monotony; flaming hope and drear despair are too much akin in this performance. There are no true *pianos*, and we feel that with one exception the participants are not concerned with the text. The tenor Richard Lewis alone seems to have conviction and determination. Many intelligent words have been written on the proportions of chorus to orchestra in the Handel oratorios, and here it was decided to use a small band with a chorus twice as large. This is unsatisfactory — thin and rather pathetic — at the grand dramatic interjections and in sustained *fortes*. It is somewhat embarrassing.

The quality of sound has been as a whole commendably contrived. The range is wide, instruments and voices — barring a persistent faint suggestion of soprano-hoot — are clear and resonant, and the balance faithfully reflects the numerical inferiority of the orchestral players. It is impossible to have any enthusiasm for the performance, although the enormous music imposes itself for long intervals by sheer force of unconquerable genius; but there is no other *Israel*, and disappointing as this one is, it would be hard to do without it.

It is possible that the project was conceived or executed in a hurry: the notes, quoting Dryden's first *Song for Saint Cecilia's Day*, attribute this panegyric to music to the effect of the music of Handel, then a likely boy of two.

—Elsie Morison (s), Margaret Kalmus (s), Marjorie Thomas (a), Richard Lewis (t), Donald Lea (bs), Stanley Riley (bs); Choir and Orch. of the Handel Society of England; Walter Goehr, cond. Handel Society (Concert Hall) two 12-in. HDL 1. 1 hr. 37 min. \$11.90

JUDAS MACCABAEUS

Handel, a shrewd and experienced entrepreneur, composed this glorification of the martial spirit of the ancient Jews partly as bait for Jewish patronage in London (in which he was successful), and partly as a festive if preposterous allegory eulogizing the exploit of Cumberland at Culloden, where the half-famished Highlanders succumbed to a military talent which had been less notable at Fontenoy. At any rate, Culloden ended the Forty-Five and ended the Stuart possibilities, and *Judas Maccabaeus* regained for Handel the favor of courtiers.

The worldly considerations which begot the oratorio — built to a pattern rendering it fit for production as a pageant opera — make those parts of it which jubilate the triumph of arms more moving and more credible than those parts which inscribe the anguish of apprehension, or a lament for the fallen (since not many of the Hanoverian side fell at Culloden.) Thus we have no *Messiah* here, the *Messiah* expressing everything; but we have a rip-snorting clamorous battle-cry

of trumpeting eloquence whenever doughty action is the immediate subject-matter. Our recording was made by a phalanx of singularly appropriate performers, historically speaking; from Utah, itself an historical miracle, an empire seized from the desert under the magic impulse of an Old Testamentary book of Mormon reconstructed in the uncouth recesses of the New York state of 1830 by a Prophet named Smith. This sect, moving westward out of nowhere, underwent the savage persecutions that newness always risks: its adherents were killed, and killed back, copiously and cruelly, with the Great Name always on their lips, as with all other sects that have killed to survive, and all too that have killed and vanished. The miracle is that like the Jews celebrated in *Judas Maccabaeus* they are still with us; and both have earned some peace.

The parallel could have struck the players and choristers who made this work for Concert Hall. There are gusts of bold, exuberant sound here that seem to proclaim: a personal victory, a flow of sustained warlike animation that seems more real than what would have been taught by a chorus-master or conductor alone. The people sound young, as we know they are; the projection is not refined in the way the Shaw Chorale is. Some roughness is inseparable from spontaneous vigor and we have some roughness here; but we have a rude dramatic force in the choral interjections and orchestral commentary more satisfying than the higher polish of a softer effort. Mr. Abravanel is not lithe but he is sensitive and has understanding of an imposing score which he interprets without virtuosity but with variation of mood and of intensity of mood. The soloists are entitled to commendation, particularly Mr. Hayes, whose good bass knows what it is doing, and lets us know what it is singing.

The sound is expansive and almost immaculate, qualities that do not necessarily go hand-in-hand. The voices glow against the enclosure, and against them the orchestra retains a cooler and soberer tone which makes it always audible. Recording faults are minor, while the polyphonic distinctness of the choirs and the full but chiseled bass are accomplishments worth respect.

—Phyllis Moffer (s), Beryl Jensen (a), William Olvis (t), Marvin Sorensen (t), Marvin Hayes (bs); University of Utah Chorus and Utah Symphony Orch.; Maurice Abravanel, cond. Handel Society (Concert Hall) three 12-in. HDL 12. 2 hr. 23 min. \$17.85

MESSIAH

When people think of "oratorio" they think of this. Two hundred years have not lessened the shattering might, the infinite tenderness, the human supplication or the superhuman jubilation of Handel's epic. It may not be his greatest oratorio, or it may be his greatest work of all; but uncontestedly it contains more noble members, more memorable elements, than any composition in the same or similar form. This is wonderful, but the work has suffered from its pre-eminence. It is very widely used at Christian festivals, and routine commemorative performances are hardly ever very rewarding musically. In churches *Messiah* is drastically cut — indeed it is usually shortened in the concert hall — and an organ tries to do the

work intended for the orchestra. Few churches have the soloists required, or choirs of the size and skill essential, or organists capable of extorting a grand dramatic expression from whatever forces they may command. Furthermore, a crystallization of reverent tradition tends to repress the violence of *Messiah*, to soften its joy and discipline its rage into proportions deemed proper for the conduct of polite worship. The gala secular performances, on the other hand, with their huge choirs in vast places, project a force not otherwise realizable, but at the expense of clarity, balance and grace.

The phonograph does not need to imitate either the reticence or the exaggeration. Social pressures do not beset the disc as they constrict the public display. The musicians concealed in gleaming micro-grooves can permit themselves a freer latitude than those undergoing scrutiny in an auditorium. The conventions hampering *Messiah* do not have to be observed for records.

The conductors for two recorded versions, Sir Thomas Beecham and Sir Malcolm Sargent, both old hands and fresh minds Handel-wise, both phonographic veterans, have attempted to achieve musically unsurpassable *Messiahs*. They have done well if they have still not realized what they had hoped. Their recordings, which both appeared originally on 78's about five years ago, have not the vivid sound of the most recent discs. (Although both are pretty good, and the Columbia is a good deal better than this writer thought it was when it made its LP debut, and he had no compensator able to cope with its requirements.) Both have an abnormally heavy bass and a slight tendency to hoot in the soprano choirs. Columbia is more brilliant and has more volume; but if the wind, excepting trumpets, is obscure on HMV-Victor, the organ is much more impressive and the distribution of choirs more skillful. This gives to Victor a truly fine enunciation throughout, and a remarkable contrapuntal demonstration which Columbia has not, but is to be attributed to Sir Thomas's use of an expansible chorus (big for grandeur, small for contemplation) rather than to a superiority of recording technique as such. Sir Malcolm's concept is like that of Sir Thomas's of twenty-five years ago — outspoken and bristling with challenge, while Sir Thomas's deviates a good deal from his own former norm, and is remarkable for its dynamic range, tonal contrasts and long-held tenderesses. Sargent is less flexible — no defect in the sublime choruses — and he has better soloists. The Royal Philharmonic is obviously superior to the Liverpool Philharmonic, especially in the beautifully unified strings, a feature of the Victor set. Finally, the Beecham version is complete; the Columbia permits a number of small excisions routine in public performances. It is surprising how good both are in view of the lack of critical enthusiasm their appearance invoked: repeated direct comparison excites respect for both, with the Beecham more desirable, in this opinion, on the sum of its qualities.

The Remington set, which could not be obtained for comparison, offers the great inducement of an extremely modest price

and the considerable drawback of a German text instead of the King James Version to which Handel wrote his music.

—Elsie Suddaby (s), Marjorie Thomas (a), Hedde Nash (t), Trevor Anthony (bs), Herbert Dawson (organ); Luton Choral Society, Special Choir and Royal Philharmonic Orchestra; Sir Thomas Beecham, cond. RCA Victor four 12-in. LCT 6401. 2 hr. 43 min. \$22.88 (The duration includes a short spoken preface by Sir Thomas Beecham.)

—Isobel Baillie (s), Gladys Ripley (a), James Johnston (t), Norman Walker (bs), Edward Cooper (organ); Huddersfield Choral Society and Liverpool Philharmonic Orch.; Sir Malcolm Sargent, cond. Columbia three 12-in. SL 151. 2 hr. 21 min. \$16.35

—Soloists and Chorus with Orch. of the Mozarteum, Salzburg; Joseph Meissner, cond. Remington three 12-in. 199-69. \$6.57

SONATAS

(There is an embarrassment of confusion in the identification and cataloguing of Handel's Sonatas. An early publisher defied system in his numeration, and the "thorough-bass" accompaniment stipulated for all the sonatas is itself a pretty engenderer of perplexity. For the thorough-bass may be supplied by a viol or a keyboard, or by both, which makes a violin sonata a duo or a trio in fact; while the sonatas for two violins are in performance trios or quartets, and almost impenetrably disguised when presented by two oboes, harpsichord and cello. Op. 1 comprises fifteen sonatas, of which seven — Nos. 1, 2, 4, 5, 7, 9 and 11 — are for flute and thorough-bass; six — Nos. 3, 10, 12, 13, 14 and 15 — are for violin and thorough-bass; and two — Nos. 6 and 8 — are for oboe and thorough-bass.

(The nine sonatas of Op. 2 are written for two violins, two flutes or two oboes at will, with thorough-bass. Op. 5 holds seven sonatas intended for a pair of violins or transverse flutes according to the bent of the players, with thorough-bass. These two *opera* are thus trios or quartets — the latter if a cello reinforces the harpsichord — and are usually called "trio sonatas" even when four instruments are used. It is hoped that the order of presentation utilized for the records will effect some measure of clarification.)

FOR FLUTE AND THOROUGH-BASS (7).
Op. 1, Nos. 1, 2, 4, 5, 7, 9 and 11

If the policies of record companies were less mysterious, we should expect this complete edition (of the sonatas for one flute, not the complete Op. 1) to retain its position of lonely glory for years to come. Mr. Baker's sinuous and stylish columns of seductive sound would seem to block competition for any one of the seven; for even if an equally expert flutist wished to characterize this music differently, it is doubtful that a public of much bulk would become exercised by the challenge. These are in general airy trifles not to be played consecutively; the appeal of one is not dissimilar to the attraction of another; there is no question of a perpetual search for an ultimate perfection,

as in a Mozart aria. Mr. Baker's work is remarkable; Miss Marlowe's is not; and this may be one of the principal virtues of the collaboration, the structure of the sonatas indicating beyond dispute that the flute is king, the harpsichord a handmaiden. The keyboard here, contrary to the modern tendency in harpsichord recording, is restrained and demure, a little staid, a little critical of the fluty exuberance; and in this opinion, as it should be.

Technically such an instrumental combination can hardly terrify the engineers, and an engineering triumph is perforce modest; but it is worth observing in this case that the involved texture of the flute seems exactly true, and presumably that is the first desideratum of recording.

—Julius Baker, flute; Sylvia Marlowe, harpsichord. Decca two 12-in. DX 116. 7, 9, 11, 9, 11, 17, 7 min. \$11.70

FOR VIOLIN AND THOROUGH-BASS (6).
Op. 1, Nos. 3, 10, 12, 13, 14 and 15

The violin sonatas are often considered apart from the other works of Op. 1 and are numbered independently of them. This is the least confusing way, but the record manufacturers have followed it only in the case of the Goldberg disc. Here is the numerical identification of these violin sonatas: No. 1, in A, Op. 1, No. 3; No. 2, in G Minor, Op. 1, No. 10; No. 3, in F, Op. 1, No. 12; No. 4, in D, Op. 1, No. 13; No. 5, in A, Op. 1, No. 14; No. 6, in E, Op. 1, No. 15. Only in the case of the Goldberg record are these designations the ones the manufacturers have been pleased to use. The notes accompanying the Victor disc by Elman-Rosé confound the two works in A. Columbia gives the subdivisions of the original opus-number as "Gesellschaft No. so-and-so", which can hardly be illuminating to the generality of music-lovers, particularly since this German word meaning "company" or "association" is nowhere explained in relation to Handel. The reference is actually to the edition of the Händel Gesellschaft, and the numbers are the same as those in the original publication.

Columbia is the only company to offer all six. Besides this advantage her versions are played in an instrumentation appropriate to Handel's epoch, with the bass "realized" by harpsichord and cello. The old way is not necessarily the best because it is old, but the deep notes of the cello seem to enlarge the design of the works while enriching the harmonies, and the harpsichord satisfies a sense of congruity thwarted by the substitution of a piano, for which Handel did not write. Furthermore, the cello underlines the gravity of Schneider's style, making it doubly effective in those places where it is effective; and since the recording values are somewhat superior to the incomplete competition of the other discs, the Columbia is the most desirable presentation. However, favoring convenience, the sonatas have been edited one to each ten-inch side, with an average duration of nine minutes, no convenience to the personal exchequer.

The Goldberg-Moore projection of No. 4, most familiar of the six, impresses as the finest demonstration of musicianly fiddling of all, in its vivacious but exact phrasing, its even line and judicious accentuation. The sound is big, somewhat acid at the top.



**new "high"
in high fidelity
recordings**

Audiophiles will delight
in the dazzling life-like quality of
sound that distinguishes
these great Columbia Masterworks
releases. Be sure to hear them—
you'll want to own them!

columbia
Lp **masterworks**

The exclusive trade-mark of
Columbia Long Playing Records—
symbol of highest quality

Trade-Marks "Columbia," "Masterworks,"
Reg. U. S. Pat. Off. Marcas Registradas

With the three by Mr. Elman we enter a domain of more patent virtuosity. This violinist displays the greatest variety of tone and the most personal intonation. Since this is not grand but intimate Handel although nowhere introspective, personal idiosyncrasies find their justification if the music submits agreeably. The Elman tendency is towards sportiveness, and in No. 1 is more impressive than the soberer manner of Mr. Schneider, whose way seems more suitable in No. 6.

A detriment to the Victor disc is the pale bass in the piano: if one wishes this restored to health, rumble must be accepted with the restoration.

—Alexander Schneider, violin; Ralph Kirkpatrick, harpsichord; Frank Miller, cello. Columbia three 10-in. ML 2149-51. 9, 9, 12, 11, 7, 8 min. \$4.00 each disc

—No. 4 only: Szymon Goldberg, violin; Gerald Moore, piano. Decca 12-in. (with Haydn: *Violin Concerto in C*). DL 8504. 14 min. \$4.85

—Nos. 1, 4 & 6 only: Mischa Elman, violin; Wolfgang Rosé, piano. RCA Victor 12-in. LM 1183. 9, 15, 13 min. \$5.72

FOR TWO VIOLINS, FLUTES OR OBOES, AND THOROUGH-BASS, OP. 2 FOR TWO VIOLINS OR FLUTES AND THOROUGH-BASS, OP. 5

All sixteen are here considered together, for although the seven of Op. 5 do not specify the oboes as an alternative instrument as in the nine of Op. 2, the sonatas are most frequently played by violins, and it was felt that some clarity might be produced by consecutive numbering of the individuals, especially since the recorded representation is scanty. They are generally called trio-sonatas, and in common with so much of the composer's instrumental music, contain material found elsewhere in his production.

There are no recorded duplications, and only one item in the short discal repertory is outstanding in either good or evil aspects. This is No. 15 on Westminster, the only one to utilize harpsichord and cello for the continuo, played with imagination and finesse and a caressing tonal bloom, values fully realized in a laudable recording. The four on the Urania disc are bowed in decent fashion, but the two violins are tonally cutting, a fault presumably to be attributed to the engineering. The lovely little thing on Classic is played without distinction, and its identification as No. 11 is perhaps incorrect. It arrived too late to compare with a score, but its laconic notes attribute it to Op. 5 and term it a trio-sonata, in which case a second flute is missing.

—No. 15, Op. 5, No. 6, only: Walter Schneiderhan, Gustav Swoboda, violins; Senta Benesch, cello; Franz Hollerscheck, harpsichord. Westminster 12-in. (with Bach: *Sonata*; Telemann: 2 *Sonatas*). WL 5036. 14 min. \$5.95

—Nos. 4, 8 & 9, from Op. 2; and No. 12, Op. 5, No. 3: Willy and Margarete Schweyda, violins; Jan Behr, piano. Urania 12-in. URLP 7046. 11, 12, 12, 11 min. \$5.95

—No. 11, Op. 5, No. 2, only: (Edith Sagul, flute; Marilyn Beabout, cello; Mary Stretch, piano. Classic Editions 10-in. (with K. P. E. Bach: *Sonata*). CE 501. 9 min. \$3.85

SUITES FOR HARPSICHORD

Three collections were published during Handel's lifetime, and we are probably justified in assuming that the Handel Society, which has issued the first six Suites in systematic order, will eventually record them all if the public's response to the first two discs is encouraging. The pattern of one Suite is much like that of another, with fast and slow dances in alternation. Mr. Pelleg may not be the ideal harpsichordist for the enterprise. His abundant muscularity copes easily with the problems of declamation and sustained *maestoso*, but his nimble fingers are parsimonious with grace, and the continued aggressiveness of his attack does suggest a wrestling with daisies. The engineers have accorded him a splendidly big and clear sound in the present mode, which does not diminish his ponderous impression, and this sound ought to be reduced considerably in reproduction. The short-measure Valenti disc, with a weak but pleasantly modulated sound, sets forth the second Suite far more persuasively than Mr. Pelleg has managed. The single Suite (mislabelled as Set II, No. 3 instead of No. 2) on Mercury is adequately played by Heinz Schnauffer and clearly recorded.

Mr. Pelleg's second disc is improved by the inclusion of detailed and forceful expositions of two isolated fugues, in A Minor and D.

—Nos. 1-6: Frank Pelleg. Handel Society (Concert Hall) two 12-in. (with *Fugues in A Minor and in D* on side 4). HDL 4 & 5. 13, 10, 19, 12, 12, 10 min. (Suites). 4, 2 min. (Fugues). \$5.95 each disc

—Nos. 2 & 11: Fernando Valenti. Allegro 10-in. AL 23. 8, 7 min. \$4.45

—No. 10 Heinz Schnauffer. Mercury 10-in. (with Bach: *Keyboard Concerto No. 4*). MG 15033. 12 min. \$3.85

SUITES FOR ORCHESTRA

(The rubric is a catch-all, inserted for the writer's convenience and he hopes for his readers'. It covers all the orchestral music which Handel might have called Suites but did not, Suites assembled by other hands from a single one of his works, and synthetic Suites collected from various works to form a new entity. A pair of such things arranged by Fekete are catalogued by Schwann as occupying a Colosseum record which was not received.)

THE FAITHFUL SHEPHERD

Handel thought enough of his early opera *Il Pastor Fido* to re-write it twenty years later, and Sir Thomas Beecham thinks enough of it to have drawn upon both versions to assemble the charming suite, Italianate and airy, lucently scored, that Columbia has recorded with a skill and delicacy to match the skill and delicacy of Sir Thomas and his orchestra. The sound is unforced and inviting, cohesive and caressing, easy on most types of phonographs, very crisply satisfying in its statement of woodwind timbre. The nimble and refined playing, ranging widely in weight and altitude, proceeds from a discipline less apparent than it

would be were there a few departures from it. Succulent.

—Royal Philharmonic Orch.; Sir Thomas Beecham, cond. Columbia 12-in. (with Haydn: *Symphony No. 93*). ML 4374. 25 min. \$5.45

FIREWORKS MUSIC

No other composer celebrated grand coeval events with the might and conviction of Handel. The *Fireworks Music* embellished the festivities jubilating the Treaty of Aix-la-Chapelle which ended the War of the Austrian Succession; and the stunning program music (Triumph of Arms — Peace — Rejoicing) is one of the composer's own greatest commentaries. It is amazing that we have only one recording of this and fortunate that it is a pretty good one. Its faults — some string coarseness and heavy insecure bass — belong to its recording period; but the sound is big and brazen, and Sir Malcolm Sargent conducts the Harty arrangement for modern orchestra to its shining hilt. Handelians can hardly do without it.

—Liverpool Philharmonic Orch.; Sir Malcolm Sargent, cond. Columbia 12-in. (with Britten: *Young Person's Guide to the Orchestra*). ML 4197. 14 min. \$5.45

JEPHTHA

A first-class arrangement by Zoltan Fekete of items from the composer's last oratorio, in a hard and rather opaque recording of a performance that could easily be better.

—Mozarteum Orch.; Salzburg, Zoltan Fekete, cond. Mercury 12-in. (with *Symphony in C attributed to Haydn*). MG 10066. 17 min. \$4.85

THE TRIUMPH OF TIME AND TRUTH

More of Mr. Fekete's work, an imposing re-orchestration of a gorgeous, aspiring tumult. The concluding *grandioso* is Handel at his most magnificent, the loftiest summit of imperative splendor. Bravely led on the record, not quite so bravely played; boldly engineered, with a good balance beneficial to the complex counterpoint and a clean bass. The violins when loud are a little trying, but not enough to make music-lovers forego such a rouser as this music.

—Sym. Orch.; Zoltan Fekete, cond. Lyric 12-in. LL 25. 31 min. \$5.95

WATER MUSIC

For pure inventiveness the *Water Music* is unequalled by any other composition of similar length, and yet our experience of it is spasmodic and incomplete. Sir Hamilton Harty pulled out of obscurity six of its twenty movements, re-orchestrated them to satisfy modern custom, and presented a balanced symphonic suite to the world. For a generation we have heard the *Water Music* in this abbreviated but dashing form. The pioneering Bales record gave us a chance to hear the rest. It is too bad it is not a little better. Its merits and faults are not those of the Berlin Philharmonic version on Decca; in fact a comparison of their disparities forbids a dogmatic assertion of superiority of one over the other.

The Berlin Philharmonic is a more supple orchestra than the National Gallery, particu-

SUITES FOR ORCHESTRA, *continued*

larly in its strings. The Decca recording is smoother than the WCFM, and has fewer audible distortions. The horns of both are engineered more timidly than we should think mandatory now; but the Bales trumpets ring out brilliantly against the Decca sobriety. Throughout the WCFM has more clarity (and with it violin shrillness) and instrumental detail. It has a more satisfactory bass, and Lehmann has a lighter touch very satisfying except in the broader movements, where the weightier hand of Mr. Bales seems more appropriate. In two words, Decca has insufficient force and WCFM lacks luster.

There are two versions of the Harty arrangement, and one of an arrangement credited to Eugene Ormandy which differs in no very important way from its predecessor — we are performed reminded of Columbus and the egg. The overall sound of the London edition of Van Beinum seems just a trifle better than the Columbia of Ormandy, the difference a degree of truer wind timbre. The Columbia, a product of LP's infancy, is an exceptional disc. Both these two are beautifully played, while Mr. Marrow's orchestra simply has not the pliable responsiveness of the others. Both the brisk pace of Van Beinum and the more deliberate movement of Ormandy appeal in their different ways, and choice should be made on the basis of the appeal overside.

—(Complete) National Gallery Orch.; Washington, Richard Bales, cond. WCFM 12-in. LP 2. 45 min. \$5.95.

—(Complete) Berlin Philharmonic Orch.; Fritz Lehmann, cond. Decca 12-in. DL 9594. 45 min. \$5.85.

—(Suite of excerpts arranged by Harty) London Philharmonic Orch.; Eduard van Beinum, cond. London 12-in. (with Mozart: "Haffner" Symphony, No. 35). LLP 214. 14 min. \$5.95

—(Harty excerpts arranged by Ormandy) Philadelphia Orch.; Eugene Ormandy, cond. Columbia 10-in. (with Concerto for Orch. in D and Corelli: Suite for Strings). ML 2054. 17 min. \$4.00

—(The Harty Suite) Pro Arte Orch.; Macklin Marrow, cond. MGM 10-in. (with Bach: Air from Suite No. 3). E 132. 16 min. \$3.00

MISCELLANEOUS CHORAL

(Includes for convenience all choral music other than oratorios and operas — Odes, Masques, Pastorals, Cantatas, Te Deums, Anthems, etc. — that has been recorded on LP.)

ACIS AND GALATEA

Call it a masque, a pastoral, a serenade, an oratorio, a pictorial cantata, *Acis and Galatea*, written during Handel's earlier years in England, is a kind of stationary opera, in which the actors in costume sing a plot amidst the scenery of a stage, but do not act. This kind of entertainment, built on themes from classical mythology, had a short but widespread vogue; and Handel contributed to it his native genius and the pleasant mellifluousness he had absorbed in Italy. A succession of set pieces, alternating soloists and chorus, states one at a time the most elemental moods or emotions: love, longing, anger, conflict, lament. These are

TO INTRODUCE THESE DISTINGUISHED RECORDINGS OF
"200 YEARS OF AMERICAN MUSIC"
 THE AMERICAN RECORDING SOCIETY OFFERS YOU . . .

One of these superb 33 $\frac{1}{3}$ rpm 10-inch Long-Playing Unbreakable Records

Regularly \$4³⁵ **\$1.00**
 YOURS FOR ONLY

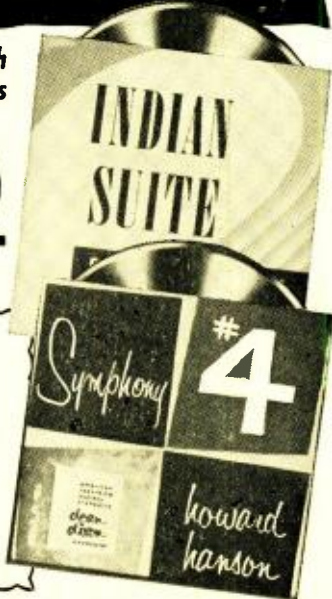

"INDIAN SUITE"
 By Edward MacDowell
 Ever since its first performance by the Boston Symphony Orchestra in 1896 this lovely and melodic suite has been a great concert hall favorite throughout the world. Each of the fascinating five sections is based on genuine Indian themes—legends, festivals, war dances, romances and sorrows. 10" A.R.S. recording.

"4th SYMPHONY"
 By Howard Hanson
 The deeply expressive Pulitzer Prize-winning work by one of America's foremost composers. Since its first performance on Dec. 3, 1943 by the Boston Symphony Orchestra, the *Symphony No. 4* has been regarded as "one of the noblest works ever written by an American" (Serge Koussevitzky). 10" A.R.S. recording.

SINCE the last war a great musical awakening has electrified the music-loving world—a sudden realization that the foremost music being written today is *American music*—and that American composers have been writing enjoyable melodies, important music for the past 200 years! In all the great concert halls the most famous orchestras, conductors, soloists, chamber groups are performing this music for delighted audiences.

And now an outstanding musical organization has embarked on a program of creating high fidelity recordings of 200 years of American music! Every form of musical expression is included in this program—symphonic, choral, instrumental and chamber works, folk-music, theatre music . . . music of America at work and at play; music of America growing, laughing . . . music born of the love of liberty and the love of fun, the love of good living and the love of God. Whatever your tastes—here is music for you!

HOW THIS MUSIC CAME TO BE RECORDED

Recently, the directors of the renowned Alice M. Ditson Fund of Columbia University awarded a substantial grant which made possible the founding of the American Recording Society, whose sole purpose is to record and release each month a new full-frequency recording of American music, on Long Playing records.

ARE THE RECORDS EXPENSIVE?

No, to the contrary. These recordings which are pressed for the Society by the custom

department of RCA Victor are priced below most L.P.'s of comparable quality—only \$4.35 for 10" records, and \$4.95 for 12" records. The American Recording Society Philharmonic Orchestra engages the finest available conductors and artists, and all recordings are made with the latest high-fidelity equipment, and pressed directly from a limited number of silver-sputtered masters.

HOW THE SOCIETY OPERATES

Your purchase of either of the Long-Playing records offered above for only \$1.00 does not obligate you to buy any additional records from the Society—ever! However, we will be happy to extend to you the courtesy of an Associate Membership. Each month, as an Associate Member, you will be offered an American Recording Society recording by a famous American composer, at the special Club price. If you do not wish to purchase any particular record, you need merely return the form provided for that purpose.

FREE RECORDS OFFERED

With each two records purchased at the regular Club price you will receive an additional record of comparable quality **ABSOLUTELY FREE**. However, because the number of records which can be pressed from silver-sputtered masters is necessarily limited, we urge you to mail the coupon at once!

AMERICAN RECORDING SOCIETY
 100 AVE. OF THE AMERICAS, N. Y. 13, N. Y.

THE AMERICAN RECORDING SOCIETY, Dept. 738 HF-9
 100 Avenue of the Americas, New York 13, N. Y.

"INDIAN SUITE", by MacDowell "4th SYMPHONY", by Hanson
 (Check one)

Please send me the record checked above, for which I enclose \$1.00 as full payment. As an Associate Member in the American Recording Society, I will receive the Society's publication which will give me advance notice of each new monthly Society Long-Playing selection which I am entitled to purchase at the special Membership price of only \$4.95 for 12" records, \$4.35 for 10" records plus a few cents for U.S. tax and shipping. However, I may decline to purchase any or all Society records offered to me. With each two Society recordings I do purchase, you will send me an additional record **ABSOLUTELY FREE**.

Name.....
 Address.....
 City..... Zone..... State.....
 Canadian Address: OWEN SOUND, ONTARIO

MISCELLANEOUS CHORAL, *continued*

expressed in *Acis* at considerable length with many repetitions. Since this is an early Eighteenth Century pastoral, a good deal of airy grace is required in performance; and the trouble with the performance on records is its prosiness. The soloists have some sense of style; Chorus and orchestra are rigid and ungainly in tempo, accent and output. Subtle modifications have not been practised in the repetitions where they are absolutely necessary if our interest is not to stale.

A disappointment and a pity, for the sound as recorded is in general excellent: outspoken, healthy and nicely proportioned. If one is conscious of incipient soprano-hoot and some background noise, one is also aware of the exactitude of most timbres and the moderation of the recording characteristic.

We may hardly expect another *Acis* in the near future. The acceptability of this one depends upon the intensity of the musical fastidiousness possessed by music-lovers. Here the grace and tenderness limp but are still apparent; the humor is dogged but still makes its point; the elegy is hardly delicate but is moving nevertheless. If the exquisite fragrance of this enchantment has been dissipated, its vital fluid is left, and can please.

—Margaret Ritchie (s), Richard Lewis (t), William Herbert (t), Trevor Anthony (bs); Choir and Orch. of the Handel Society of England; Walter Goehr, cond. Handel Society (Concert Hall) three 12-in. HDL 2. 1 hr. 44 min. \$17.85

ALEXANDER'S FEAST

A complete recording of this brilliant Ode (Masque) has been announced by the Handel Society, but had not appeared by the time this study was completed. Two recordings of the "Concerto" therefrom will be found noted under *Concertos*.

APOLLO AND DAPHNE

A disc with this title on a Oiseau-Lyre label is catalogued in Schwann, but it resisted attempts to find it.

CORONATION ANTHEM (FOR GEORGE II): (*Let Thy Hand Be Strengthened.*)

The record carries an expert and polished delivery of one of Handel's showiest, and most exciting, illustrations to the history of his times. It has the same quality of sound as that of its companion the *Utrecht Te Deum*, considered below.

—Chorus and Chamber Orch. of the Danish Radio; Mogens Wöldike, cond. Haydn Society 12-in. (with *Utrecht Te Deum*). HSL 2046. 9 min. \$5.95

ODE FOR SAINT CECILIA'S DAY

Handel has set Dryden's translucent text with a literal illustration astonishing in its complexity of expression. The naivety of the directly imitative method is transfigured by the inexhaustible invention of the composer into one of the most brilliant of his cantatas. It is a pity that the recorded version is in German, although the translation is praiseworthy: good music in good English is a favor rare enough not to be sacrificed

without regret. This is not otherwise a very good record, although the leadership is animated and knowing and the soprano most of the time is appealing. The unison of the orchestra is far below perfection, the tenor is too prominent and background noise is frequently oppressive. Dryden's "Sharp violins proclaim" is obeyed too faithfully, and a heavy bass reverberation obscures the contours of the music. If we had assurance that another edition would appear soon this one could be foregone without pain. Assurance wanting, this one will serve.

—Lore Hoffmann (s), Walter Ludwig (t), Lamy Choir and Orch. of Radio Berlin; Arthur Rother, cond. Urania 12-in. URLP 7023. 43 min. \$5.95

TE DEUM FOR THE BATTLE OF DETTINGEN

A well-composed Te Deum is a pat on the Almighty's back for having supported the victors in battle. The whack of this magnificent salute is superb evidence that the Divinity worshiped so flamboyantly by Handel and the England of 1743 was indeed almighty. It is the grandest of the composer's Te Deums, and the trumpet is hero. In the recording the first trumpet, Lloyd Geisler, earns special praise for the dexterity of his vertiginous acrobatics. The entire performance is triumphantly outspoken, the choir regimented and bold. The fault would be an insufficiency of contrast in pace and force which permits climaxes to lose some of their dramatic intensity. A rousing experience nevertheless, in a swelling bright sound, the best engineering WCFM has given us of a considerable ensemble.

—Katherine Hansel (s), Rachel Koerner (a),

George Barritt (t), Harold Ronk (bne), Lloyd Geisler (1st trumpet); Chancel Choir of the National Presbyterian Church and National Gallery Orch., Washington; Richard Bales, cond. WCFM 12-in. LP 6. 44 min. \$5.95

TE DEUM FOR THE PEACE OF UTRECHT

The spectacular but rather unproductive victories of John Churchill — whose acquiescence in the extinction of his sister's virtue was the first strategic act in the sequence that made him Marlborough — produced the Peace which produced the Te Deum which procured for Handel the favor of England's sovereign but not his own, Anne. It thus preceded the *Dettingen Te Deum* by thirty years, and lags behind it in worth. Say that the ratio is that of Beethoven's Second Symphony to his Seventh. Its glory is less splendiferous, its devotion less entirely imperial. This makes it particularly suitable to the unexaggerated style of the Danish performers on the record, whose sense of dramatics is tempered by an equal sense of polyphony. Clarity gains, and drama too, by the exercise of the conductor's firm hand. Like most Danish discs, this one has been engineered with smooth and unstressed competence, resulting in a clean and balanced sound that evokes no exclamations.

—Ruth Guldback (s), Valborg Garde (s), Else Brems (a), Dagmar Schou (a), Ole Walbom (t), Volmer Holboll (t), Einar Norby (bs); Chorus and Chamber Orch. of the Danish Radio; Mogens Wöldike, cond. Haydn Society 12-in. (with *Coronation Anthem, "Let Thy Hand"*). HSL 2046. 29 min. \$5.95

Hither and Yon: Musically

Voice on Records

Lest anyone think that the only thing on long playing records is music (of one sort or another), we would bring to your attention the fact that the range of the spoken word, on discs, is almost as varied as that of music. In addition to the well-known series of "I Can Hear It Now" records by Columbia, we can suggest, for instance, the *Sermon on the Mount*, produced by Harold C. Burke of 306 Southway, Baltimore 18, Md., and impressively and movingly read by David Ross.

If well read poetry makes you sigh and dream of finer things, then a note to the National Council of Teachers of English (211 West 68th St., Chicago 21, Ill.) will bring you a catalog full of sighs and dreams: poetry readings by Vachel Lindsay, Stephen Vincent Benet, Archibald MacLeish, e. e. cummings, and Robert Frost.

In another field, Decca has pulled out all the stops, with its *The Voice of FDR* (DL 9628), which contains excerpts of President Roosevelt's speeches plus a special narration by Quentin Reynolds, the whole supported and dramatized by a chorus and orchestra.

There is a lot more of voice on records; if enough readers are interested, we'll dig around and prepare a list of sources.

Audiophile Records

Readers of HIGH-FIDELITY are no longer unfamiliar with the name E. D. Nunn, whose remarkable pressings have been mentioned several times in past issues. We did our best to warn Mr. Nunn of what would happen — and it has! He received so many requests for copies of his discs that what was once a not too expensive avocation became at least a part-time vocation, made duly official with the adoption of a label for his products: Audiophile Records.

Readers who have in the past hesitated to impose on Mr. Nunn's good nature and personal time may now pester the life out of him and, personally, we would encourage them to do so.

First release of Audiophile Records is an organ recording of Liszt's *Prelude and Fugue on B-A-C-H*, backed by the delightful *Carillon de Westminster* and *Legende* by Louis Vierne. Both are played by Robert Noehren on the organ of the Grace Episcopal Church in

Sandusky, Ohio. Musicianship and sound are as expected: tops.

The record, by the way, is a 12-in. 78 rpm. *microgroove* on vinylite — and shatters any preconceived notion we may have had that a 12-in. 78 plays for 4½ to 5 minutes. By combining microgroove with variable pitch, Mr. Nunn is able to impress just over eleven minutes of music on each side!

Another innovation is the descriptive material which accompanies the record. Nothing is said about the music; all the discussion is devoted to how the record was made and how it should be played back, including a daring warning that "if distortion is noticed, the playback equipment should be examined". Exact data for correct equalization are given, as are suggestions re pickup arms and record care. Quite a change!

The record bears the catalog number AP-3a, and sells for \$5.50 direct from Audio-ophile Records, Saukville, Wisc. It is not sold through dealers.

Nomenclature Confounded

Perhaps we should have headed this item confounded nomenclature. Either way, the situation is the same.

Time was when long playing, microgroove, and 33 ½ rpm. all meant the same thing and achieved the same result: a record which played four to six times "normal".

Now things are messed up. Mr. Nunn, mentioned elsewhere in this column, has contributed his share. The Dutch Philips company, as reported by D. W. Aldous in

HIGH-FIDELITY No. 5, has added its drop to the turbulent bucket. RCA Victor also is squooshing its finger around in the pie.

We might as well get in on the fun, so we will now suggest use of the term *macro-groove*, to contrast with *micro-groove*. The word macrogroove will refer to records designed to be played back with a stylus whose tip has a radius in the vicinity of .003 ins. Microgroove will refer, as usual, to records requiring styli with .001-in. tips.

With that much carefully digested, we can go back to the pie we were talking about.

In the mid-thirties, we had macrogroove 33 ½ rpm. records, produced by RCA Victor. They played for about 12 to 16 minutes, and were discontinued within a year or so.

All was serene, with macrogroove 78 rpm's, until LP came along. That was 33 ½ rpm., like the old Victors, but it was microgroove.

The 45 rpm. records were, and still are, microgrooves.

However, RCA Victor recently produced some semi-long-playing 45 rpm. records, by running the grooves in closer to the center. It is said that up to 8 minutes can be so recorded.

And Philips of Holland has brought out what it calls minigroove records: they are 7-in. microgroove 78 rpm. doodads, which play up to 5 minutes.

And, Mr. Nunn produces 12-in. microgroove 78's which play around 11 minutes.

Now where are we? Sorry, we don't know. The pie isn't out of the oven yet. Meantime, we shall try to be as specific as possible and will freely will to posterity the word "macrogroove".

A 6 POINT

satisfaction guaranteed

MAIL ORDER SERVICE

for HIGH-FIDELITY readers

interested in L P records

* * *

1. All records guaranteed brand new factory fresh copies.
2. All records carefully inspected for visible flaws scratches, etc. before mailing.
3. All records cleaned against dust damage in transit.
4. All records carefully packed and mailed, post free, on receipt of your check or money order, or mailed c.o.d.
5. Every label listed in Schwann carried in stock.
6. Schwann L.P. Catalog gladly mailed, free on request.

The Music Box

279 Main Street
Great Barrington, Mass.



BADURA

SKODA

PLAYS

BEETHOVEN
PIANO CONCERTO NO. 4 IN G MINOR OP. 58
Orchestra of the Vienna State Opera
Conducted by Hermann Scherchen
WL 5143

SCHUBERT
FOUR IMPROMPTUS OP. 90
FOUR IMPROMPTUS OP. 142
SONATA IN A MAJOR OP. 120
WAL 205

BEETHOVEN
CONCERTO NO. 5 IN E FLAT FOR PIANO AND
ORCHESTRA OP. 73 ("EMPEROR")
Orchestra of the Vienna State Opera
Conducted by Hermann Scherchen
WL 5114

NATURAL BALANCE

Westminster
LONG PLAYING RECORDS

THE MUSIC BETWEEN

By EDWARD L. MERRITT, Jr.

WITH this issue of HIGH-FIDELITY, "The Music Between" chalks up its third article in as many issues. The amount of excellent recording which has been accomplished since the advent of the long playing disc is nothing short of fabulous. Everyone recognizes that recording company executives and recording engineers devote their best efforts to capture the great performances of the concert hall, but many of us fail to appreciate the equally fine job done in making an increasingly large proportion of The Music Between discs now found in various catalogues.

While this failure to appreciate such a wide portion of the recorded musical spectrum is more or less general, the reasons for it are very specifically the responsibility of the radio stations of the Country and the recording company executives themselves. From coast to coast, radio stations making any effort to feature The Music Between are in an enormous minority when measured against those stations grinding away at so-called popular music. The one complaint rained down on radio by many thousands of listeners, or potential listeners, is that the entire musical day of so many stations consists of a persistent repetition of the top ten or twenty, as they are called, interspersed with a few numbers culled from the top ten or twenty of some adjacent yesterday. Naturally, there are some stations whose musical diversity provides listeners with a splendid opportunity to satisfy almost any musical taste. And these stations should be marked down gratefully as pioneers, because the advance shadow of the television age is already with us, and the pattern of radio presentation is changing, as surely as day is different from night. Just as WNEW in New York pioneered the music and news radio opera-

tion as we know it today, so this station and a few others continue to make adaptability and improvisation their *modus vivendi*.

The other side of the picture is made up of the executives of various recording companies who are so preoccupied with the "pop" insanities of the moment as to ignore a real campaign to promote and publicize their entries in The Music Between sweepstakes. And it is just such a campaign we are interested in seeing started. We prepare these reports on The Music Between because we really believe in the music itself, and we also believe our interest is shared by untold hundreds of thousands of Americans. These are the people who like to settle down by their radio or phonograph for an evening and listen to familiar music in any one of a dozen various styles of presentation. The individuality of the various artists and the variety of approach all go to make for great enjoyment, but the key is familiarity. And based on familiarity, it may be that the ultimate audience for The Music Between is far larger than the so-called "pop" audience. One of the things you can do, as a music listener interested in The Music Between, is to let us know what you and your friends like in the way of music on the radio; how much you can hear in your home town; and how many of the items we talk about here have been made known to you before you read HIGH-FIDELITY. It may be a big order, but it will be a start in getting more and better programs of The Music Between on the air all over the Country. So, if you like our kind of music and want more of it, let us hear from you, give us your comments, reactions, suggestions and all the rest, and perhaps we can get this musical ship off the ground.

The Months, Op. 27a
Columbia ML 4487. 12-in. \$5.45.

Tchaikovsky arranged by Morton Gould.
Morton Gould at the piano, conducting his orchestra.

In the previous issue of HIGH-FIDELITY, we discussed rather unfavorably Morton Gould's *Curtain Time*. This time, as we look over this new Gould entry, we reverse that opinion.

In his handling of the Tchaikovsky melodies, Mr. Gould sticks to the original and casts his own personal contribution in such a form as to enhance the Tchaikovsky. What emerges is a series of musical vignettes with a charming interplay between the piano and the orchestra.

The recording demonstrates what can be done under optimum conditions. The piano recording is a notable achievement, and the balance between piano and orchestra is superb. These factors, coupled with fine surfaces, make an outstanding record.

Babes In Arms (Complete Musical Score)
Columbia ML 4488. 12-in. \$5.45.

Mary Martin with Mardi Bayne and Jack Cassidy. Orchestra and Chorus conducted by Lehman Engel. Lyrics by Lorenz Hart. Music by Richard Rodgers. Miss Martin's orchestrations by Ted Royal; other orchestrations by Carol Huxley and Ben Ludlow; vocal arrangements by Johnny Lesko.

Overture, Where Or When, Babes In Arms, I Wish I Were In Love Again, Way

Out West, My Funny Valentine, Johnny One Note, Imagine, All At Once, The Lady Is A Tramp, You Are So Fair, Finale.

This is another in the fabulous series of musical comedy recreations produced by Goddard Lieberson. It brings to the phonograph a full score of *Babes In Arms*, reproduced with the very highest standards of fidelity and clarity.

As we remarked in the last report on The Music Between, this particular series marks a high point in the American style of realistic recordings as contrasted with the open auditorium European approach.

For some reason, this disc does not take fire as was the case with *Girl Crazy*, but the overall effect of the Richard Rodgers score is wonderful. One can only look

forward with genuine anticipation for the entries still to come in this musical comedy series.

Puccini Arias

Decca DL 4007. 10-in. \$2.50.

Camarata and his orchestra.

Un Bel Di (Madame Butterfly); O Mio Babbino Caro (Gianni Schicchi); Musetta's Waltz Song (La Bohème); Che Gelida Manina (La Bohème).

Operatic Arias

Decca DL 4008. 10-in. \$2.50.

Camarata and his orchestra.

Celeste Aida and Nume, Custode e Vindice (Aida); Depuis Le Jour (Louise); Flower Song (Carmen).

Decca has brought out a new series of medium priced records with some of the shorter classics. As a part of the first release of this new 4000 series, there are three discs which fall into The Music Between category: the two Camarata recordings under consideration, and a potpourri of Lehar melodies from *The Merry Widow*.

Camarata leads a sizeable orchestra in some straightforward orchestral arrangements of operatic arias. Melody is the keynote here, and the familiar echoes of the opera stage come through with wonderful fidelity. Decca's engineering staff has done a fine job in capturing the richness of the orchestral fabric in both of these. Surfaces are very good indeed.

A Collection of Favorite Waltzes

London LL 570. 12-in. \$5.95.

Mantovani and his orchestra.

Dear Love, My Love; Greensleeves; Mexicali Rose; It Happened In Monterey; My Moonlight Madonna (Poème); I Love You Truly; Lovely Lady; Love Here Is My Heart; At Dawning; Was It A Dream?; Love Makes The World Go 'Round; Dancing With Tears In My Eyes.

The man who single-handed brought about the revival of Charmaine here works over a parcel of familiar waltzes.

The big thing in modern recording has been the echo chamber effect, first introduced by Les Paul in his multiple guitar recordings. This effect has gone on blossoming in every direction. With Mantovani, it reaches one zenith at least. The actual echo has disappeared, but the general effect remains to give this orchestra a particular plus.

The London engineers have made a fabulous recording of these well-known tunes. No *fortissimi* is too great, no *pianissimi* too small, but that they catch it in proportion to the whole. There definitely is engineering involved in the effects here, but it is engineering which borders on art.

This is a disc one can easily recommend as a fine example of recording at its best.

Concert Souvenirs for Solo Violin

Capitol L 8165. 10-in. \$3.98.

Louis Kaufman, violin; Paul Ulanowsky, piano.

Humoresque, Souvenir, Ave Maria, Hymn To The Sun, Meditation from Thais, Andante Cantabile, Traumerei, Londonderry Air.

This is the first of Capitol's "Full Dimensional Sound" recordings to fall to The



SCHWANN
LONG PLAYING
RECORD CATALOG
THE "BIBLE" OF RECORD BUYERS

NOW AVAILABLE AT MORE THAN 3000 RECORD STORES THROUGHOUT THE NATION

- Published every month for over 2½ years
- Lists every long playing record generally available
- Marks new releases prominently
- New features added monthly
- Edited by experts

Sorry, Schwann's Long Playing Record Catalog is not available on a subscription basis. Please ask your dealer for your monthly copy.

W. Schwann 90 Massachusetts Ave. Cambridge, Mass.

"SOUNDS OF OUR TIMES" responds to YOUR OVERWHELMING DEMAND*



with the release of a NEW 10" unbreakable LP

THE PIPE ORGAN IN THE MOSQUE

Selections on the magnificent Wurlitzer concert organ (in theater acoustics) by

MICHAEL CHESHIRE

The great symphonic organist.

Selections:

- In A Persian Market In A Monastery Garden
- Londonderry Air Coppelia Waltz
- Second Hungarian Rhapsody
- and selections from other ballets

Recorded with condenser microphone for widest range, distortionless reproduction. Full deep pedal bass. Exciting dynamic range and color.

*... responses to our recent ad in HIGH-FIDELITY brought an unprecedented 75% return — all requesting this type music.

SOUNDS OF OUR TIMES, COOK LABORATORIES, RT. 2, STAMFORD, CONN.

Please send following 33 1/3 high fidelity LPs at \$4.00 each, plus 50¢ postage, per shipment—

- () The Pipe Organ In The Mosque, No. 1050—Michael Cheshire, organist.
- () Rail Dynamics, No. 1070—The train record that stopped the show at the Audio Fair.
- () The Harp, No. 1030—Edward Vito, harpist.
- () The Great Barrelhouse Piano, No. 1035—The best music of Nickelodeon days.
- () Send catalog of other high fidelity LPs

NAME

ADDRESS

Music Between department. In listening to this disc, we noticed one thing which needs pointing out: while the violin enjoys magnificent reproduction, the piano has a markedly tubby sound, and has a tendency to appear remote. How this particular type of imbalance comes about is hard to imagine, but it certainly exists. On the other hand, the sound of the violin must rank with some of the finest recorded sounds to be heard.

It is to be hoped Capitol will continue to make more and better Music Between entries available as time goes on.

English Songs and Folksongs

London LS 538. 10-in. \$4.95.

Kathleen Ferrier, *contralto*, with Phyllis Spurr, *piano*.

Ye Banks And Braes; Now Sleeps The Crimson Petal; Over The Mountains; Drink To Me Only With Thine Eyes; The Fair House Of Joy; O Waly, Waly; I Have A Bonnet Trimmed With Blue; My Boy Willie; I Know Where I'm Going; I Will Walk With My Love; The Stuttering Lovers.

This little collection of songs can be greeted with complete enthusiasm. Recognizing the fact that the material is not for some, it is perfectly possible to go on and praise London's work without hesitation. Miss Ferrier's lovely voice is beautifully caught by a microphone which also records the piano in admirable balance. As is so often the case, the deceptive simplicity of these songs serves to highlight the voice and the style.

The surfaces of the review copy are in line with London's best, and the recorded sound magnificent.

The Merry Widow (Potpourri)

Decca DL 4001. 10-in. \$2.50.

Elfride Trotschel (*s*), Valerie Bak (*s*), Walther Ludwig (*t*), Willy Hoffman (*t*), Bavarian State Opera Chorus with The Munich Philharmonic Orch.; Edmund Nick, *cond.* Music by Franz Lehar. Recorded in Europe by Deutsche Grammophon.

The potpourri is a device much loved by Europeans and probably had its beginning with the desire to catch the sound of all the hits from a score on a single 12-in. shellac 78 rpm. record. The various Continental catalogues are full of potpourris of opera, operetta and popular music, and apparently the practice has been extended into the field of long playing records. However, it seems like a losing game because of its artificiality. With the long playing characteristic available, it is much more satisfactory to do either a complete score, or complete excerpts. The truncated versions displayed on this and other similar discs have been made ridiculous by the technical advances of the past few years.

This particular disc displays the fine European regard for a wide, full auditorium sonority. The voices boom through over the orchestra and the hand of the engineer is apparent all the way through. Actually, it is a fairly good recording job, but the vocal overemphasis destroys the balance and the record ends up as somewhat less than a

satisfactory offering. The ladies of the ensemble tend to be somewhat shrill, the gentlemen on the whole much more successful.

Tropic Nights

Decca DL 5238. 10-in. \$3.00.

Sung in Spanish by Elvira Rios, with José Morand and his orchestra.

Tu No Comprendes, Perfidia, Flores Negras, Farolito, Noche de Ronda, Murrullo, Vereda Tropical, Te Vi Pasar.

If you enjoy Latin American music in a quiet vocal presentation, you may enjoy this record. Miss Rios brings admirable restraint of performance to these eight south-of-the-border standards and takes her place as an outstanding vocalist along with some of the well-known males: Nestor Chayres, Tito Guizar, and others.

The surfaces are reasonably good, but Decca has previously demonstrated they can do much better when it comes to recording.

Porgy and Bess, Vols. I and II

Decca DL 8042. 12-in. \$4.85.

Todd Duncan (*bn*), Ann Brown (*s*), with Eva Jessye Choir; Decca Symphony Orch.; Alexander Smallens, *cond.*

Overture and Summertime; A Woman Is A Sometime Thing; My Man's Gone Now; It Takes A Long Pull To Get There; I Got Plenty O' Nuttin'; Buzzard Song; Bess, You Is My Woman; It Ain't Necessarily So; What You Want Wid Bess?; Strawberry Woman's Call; Crab Man's Call; I Loves You, Porgy; The Requiem; There's A Boat Dat's Leavin' Soon For New York; Porgy's Lament and Finale.

Almost every record company in business indulges in what might well be called "archive releases". These discs serve as a permanent witness of some past event in the world of music and of the theatre. Decca has two such entries this time, and both are in their own way interesting. The first is this group of selections from Gershwin's *Porgy and Bess*. The unforgettable impact of this score on those who saw the first production can be relived easily with the aid of this original cast recording. All the usual shortcomings of yesterday's techniques, the 78 rpm. speed and the limited response, set these old recordings apart from the magnificent characteristics of the best contemporary waxings. However, nothing can serve to destroy the essential magic caught here. This record marks a prominent milestone in the American musical theatre and as such belongs in the library of every lover of the musical theatre.

Grace Moore Sings

Decca DL 9593. 12-in. \$5.85.

Grace Moore, *soprano*, with orchestras conducted by Alexander Smallens, Josef Pasternack, and Victor Young.

Un bel di Vedremo (Some Day He'll Come), Vissi d'Arte (Love and Music); Standchen (Serenade), Love Me Forever, What Shall Remain, The End Begins, Stars In My Eyes, Learn How To Lose, Our Song, The Whistling Boy.

Musical art in motion pictures has traveled a strange road. The moguls of Hollywood

have done their picking and choosing according to their own set of values. This "archive" disc represents the Grace Moore chapter. After her career on Broadway and at the Metropolitan, Miss Moore enjoyed considerable vogue as a Hollywood star and for many provided the introduction to "good" music. The present disc is a collection of musical moments from several Grace Moore pictures. Here again the recording is indifferent, the response poor, and the memory considerable. Most of these selections were recorded before the Moore voice lost its notable, sensuous quality, as it did in later years. However, this does not constitute major theatrical history in the same way as does the *Porgy and Bess*.

This Is Jazz

Circle L 423. 10-in. \$3.85.

Muggsy Spanier, *cornet*; George Brunis, *trombone*; Albert Nicholas, *clarinet*; Pops Foster, *bass*; Baby Dodds, *drums*; Danny Barker, *guitar*; Joe Sullivan, *piano*; Lucky Roberts, *piano*; Charlie Quener, *piano*.

Bugle Call Rag, Tin Roof Blues, Jada, Panama, Eccentric, A Good Man Is Hard To Find, Muskrat Ramble, Lonesome Road.

Here we have another of the admirable series of recordings being released by almost every company: a permanent record of some recording sessions or broadcasts in bygone years. The incisive, driving horn of Muggsy Spanier was caught during one broadcast of a series presented by The Mutual Broadcasting System. Surrounded by a company of outstanding virtuosi, Spanier's horn makes this an exciting collection of jazz classics. Unfortunately, the old story of limited frequency response and poor studio acoustics, plus bad surfaces, simply removes this disc from any possible consideration as a high fidelity recording.

New Orleans 88

Circle L 411. 10-in. \$3.85.

Armand Hug, *piano*.

Milenburg Joys; Baby, Won't You Please Come Home; Cannonball Rag; Blues For Paul; Eye Opener; How I Miss You; Heliotrope Bouquet; Mr. Jelly Lord.

Just as one or two discs in the month's entries demonstrate the heights to which recording engineers can travel under the right set of conditions, this item shows up the other side of the coin. On the one hand, dry and wiry, on the other tubby and dull, this record runs the gamut from bad to worse.

Piano recording admittedly faces engineers with tremendous difficulties, but to compound these difficulties, as in this case, with over-close microphone placement and dreadful studio acoustics is even more difficult to comprehend.

Armand Hug is an outstanding exponent of piano playing in the New Orleans style but no performance, regardless of its competence, could hope to survive the technical insufficiencies and poor surfaces here present and emerge as more than a dreadful grotesque. It would be nice to hear Armand Hug recorded as it seems he should be.

How to design

Dividing Networks

By ROY F. ALLISON

EDITOR'S FOREWORD: Don't let the formidable appearance of these two pages scare you. A dividing network isn't a bad chap, once you get to know him . . . his bark is worse than his bite! And, for halfway decent sound reproduction, two or more speakers are a must — which means a dividing network. The trouble is that every time speaker impedance or crossover frequency is changed, the network has to be redesigned.

The data presented here will cover a large majority of popular speaker impedance and crossover frequency combinations. If you will walk into this material slowly and alertly, and follow each step carefully, you should wind up with a network exactly suited to your requirements. — C. F.

A DIVIDING network is required for any wide range speaker system because it is impossible, at the present time, to build a single speaker which can

reproduce sound over the entire audio range with efficiency and fidelity.

Mechanical requirements for the production of low frequency sounds dictate a large speaker cone, capable of wide excursions, and a voice coil wound of relatively heavy wire so that it can carry the large currents encountered at low frequencies. At high frequencies, however, the reverse is required: a small cone and a light voice coil. At high frequencies, a large cone vibrates in parts rather than as a unit. Furthermore, large cones focus high frequency radiation into a beam that becomes narrower as the frequency increases. Finally, regardless of the cone size, when a speaker is fed two tones

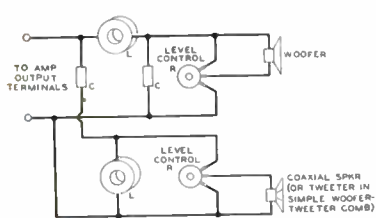

A ← → **B**
 The wiring diagram at the left (A) is a parallel configuration; the one at the right (B) is a series type. Which one to use depends on the crossover frequency desired and on the impedance of the speakers. Indications in Table I should be followed exactly.

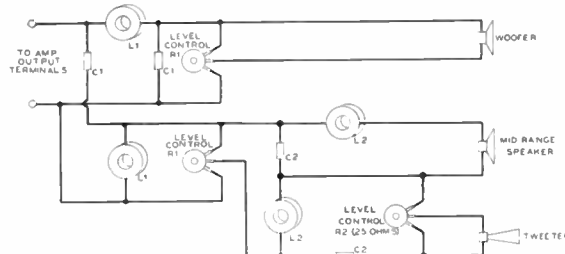
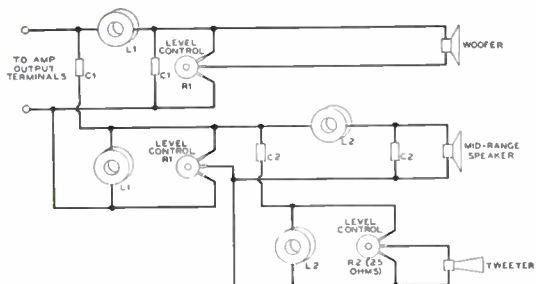
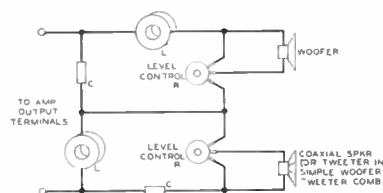

C ↑
 These are three-speaker networks. Careful examination shows that each three-speaker network is actually a pair of two-speaker networks. Thus D, at the right, is a combination of A and B, above. The parallel, or A, section is the left half of D and divides the frequencies

↓ **D**
 into a low and a high band. The series, or B, section is at the lower right in D. This divides the high frequency band of A into two subdivisions; the result is a three-speaker network providing low, medium, and high frequency bands.

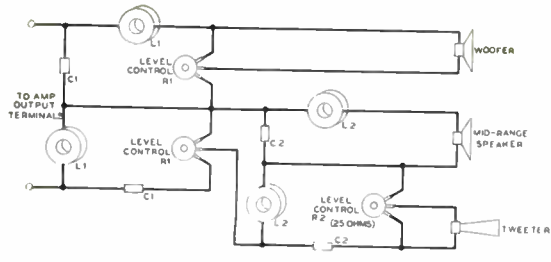

E ↑ Another three-speaker network. This is a series-series configuration, consisting of two B networks. At F is a series-parallel arrangement—a B plus an A network.

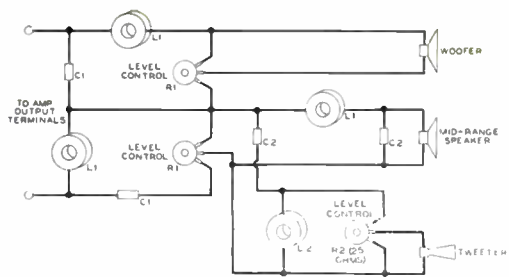

F ↑ As mentioned elsewhere, which of the six network configurations shown on these pages should be used for an installation must be determined from Tables I and II.

of widely different frequency simultaneously, there is an interaction called intermodulation distortion which is most distressing to the ear.

Much better results can be obtained if bands of frequencies can be fed to speakers designed specifically to reproduce those frequencies, rather than all fed to a single speaker whose physical characteristics must be a compromise between mutually exclusive ideals. That is where the dividing network comes into the picture. Its function is to take the electrical output of the amplifier, divide it into two or three frequency bands, and to feed these frequencies into two or three speakers. Each speaker is then required to reproduce only a relatively narrow range of frequencies, and it is able to do a much better job in that small range than a single speaker which must handle the whole audio spectrum.

Dividing networks can be designed to split the audio range into any number of bands. The most common type, at least until recently, has been the simple two-way network used with two speakers—woofer-tweeter combinations. In this system, a large cone speaker with a suitable enclosure is employed for the low frequencies, and a small cone or horn-type speaker is used for the higher frequencies.¹ All tones above a certain crossover frequency are routed by the dividing network to the tweeter; those below the crossover frequency, to

Continued on page 76

¹It should be pointed out here that a true coaxial speaker is a two-speaker system, and requires a dividing network. In such units the tweeter, with its own voice coil, is mounted inside the woofer, which also has a separate and distinct voice coil.—Editor.

IMPEDANCES WOOFER	SECOND SPKR. ^a	CROSSOVER FREQUENCY	DRAW- ING	VALUES OF COMPONENTS			AMP. OUT- PUT TAP
				L in mh.	C in mfd.	R in ohms	
4	3 to 8	85	A	10.2	320	15	4
		175	A	5.1	160	15	4
		275	B	1.6	230	15	4
		550	A	1.6	50	15	4
		1100	A	0.9	24	15	4
8	4 to 16	85	B	10.2	320	25	8
		175	A	10.2	80	25	8
		350	A	5.1	40	25	8
		1100	A	1.6	50	25	8
		2200	A	0.8	12	25	8
16	8 to 24	175	B	10.2	80	25	16
		350	B	5.1	40	25	16
		700	A	5.1	10	25	16
		1100	B	1.6	12	25	16
		2200	A	1.6	3	25	16

^aIf the second speaker is a horn-type tweeter, its impedance may be as high as 25 ohms.

SPEAKER WOOFER	MIDDLE RANGE	HIGH RANGE ^b	CROSSOVER FREQUENCIES LOW MIDDLE	DRAW- ING	VALUES OF NETWORK COMPONENTS					AMPLIFIER OUTPUT TAP, OHMS			
					L in mh.	C-1 in mfd.	L-1 in mh.	C-2 in mfd.	R-1 in ohms				
4	4	3 to 8	85 550	C	10.2	320	1.6	50	15	4			
			85 1100	C	10.2	320	0.8	24	15	4			
			175 550	C	5.1	160	1.6	50	15	4			
			175 1100	C	5.1	160	0.8	24	15	4			
			275 550	F	1.6	200	1.6	50	15	4			
			275 1100	F	1.6	200	0.8	24	15	4			
			550 1100	C	1.6	50	0.9	24	15	4			
4	8	4 to 16	85 550	D	10.2	320	1.6	50	15	4			
			85 1100	C	10.2	320	1.6	12	15	4			
			85 2200	C	10.2	320	0.8	6	15	4			
			175 550	D	5.1	160	1.6	50	15	4			
			175 1100	C	5.1	160	1.6	12	15	4			
			175 2200	C	5.1	160	0.8	6	15	4			
			275 550	E	1.6	200	1.6	50	15	4			
			275 1100	F	1.6	200	1.6	12	15	4			
			275 2200	F	1.6	200	0.8	6	15	4			
			550 1100	C	1.6	50	1.6	12	15	4			
			550 2200	C	1.6	50	0.8	6	15	4			
			8	4	3 to 8	85 550	F	10.2	320	1.6	50	25	8
						85 1100	F	10.2	320	0.8	24	25	8
						175 550	C	10.2	80	1.6	50	25	8
175 1100	C	10.2				80	0.8	24	25	8			
350 550	C	5.1				40	1.6	50	25	8			
350 1100	C	5.1				40	0.8	24	25	8			
550 1100	F	1.6				50	0.8	24	25	8			
8	8	4 to 16				85 550	E	10.2	320	1.6	50	25	8
						85 1100	F	10.2	320	1.6	12	25	8
						85 2200	F	10.2	320	0.8	6	25	8
						175 550	D	10.2	80	1.6	50	25	8
						175 1100	C	10.2	80	1.6	12	25	8
						175 2200	C	10.2	80	0.8	6	25	8
						350 550	C	5.1	40	1.6	12	25	8
			350 1100	C	5.1	40	0.8	6	25	8			
			550 1100	F	1.6	50	1.6	12	25	8			
			550 2200	F	1.6	50	0.8	6	25	8			
			550 2200	F	1.6	50	0.8	6	25	8			
			8	16	8 to 32	85 700	F	10.2	320	5.1	10	25	8
						85 1100	E	10.2	320	1.6	12	25	8
						85 2200	F	10.2	320	1.6	3	25	8
85 4400	F	10.2				320	0.8	1.5	25	8			
175 700	C	10.2				80	5.1	10	25	8			
175 1100	D	10.2				80	1.6	12	25	8			
175 2200	C	10.2				80	1.6	3	25	8			
175 4400	C	10.2				80	0.8	1.5	25	8			
350 1100	D	5.1				40	1.6	12	25	8			
350 2200	C	5.1				40	1.6	3	25	8			
350 4400	C	5.1				40	0.8	1.5	25	8			
550 1100	E	1.6				50	1.6	12	25	8			
550 2200	F	1.6				50	1.6	3	25	8			
550 4400	F	1.6				50	0.8	1.5	25	8			
16	8	4 to 16	175 550	E	10.2	80	1.6	50	25	16			
			175 1100	F	10.2	80	1.6	12	25	16			
			175 2200	F	10.2	80	0.8	24	25	16			
			350 1100	F	5.1	40	1.6	12	25	16			
			350 2200	F	5.1	40	0.8	24	25	16			
16	16	8 to 32	175 700	F	10.2	80	5.1	10	25	16			
			175 1100	E	10.2	80	1.6	12	25	16			
			175 2200	F	10.2	80	1.6	3	25	16			
			175 4400	F	10.2	80	0.8	1.5	25	16			
			350 700	F	5.1	40	5.1	10	25	16			
350 1100	E	5.1	40	1.6	12	25	16						
350 2200	F	5.1	40	1.6	3	25	16						
350 4400	F	5.1	40	0.8	1.5	25	16						

^bIf the third speaker is a horn-type tweeter, its impedance may be as high as 25 ohms.

In the words of LEOPOLD

STOKOWSKI

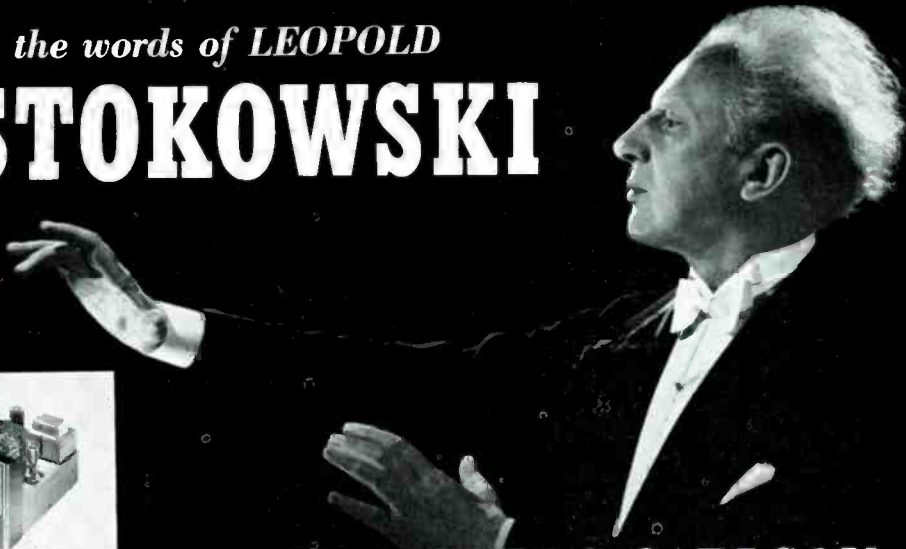

STROMBERG-CARLSON "Custom Four Hundred" HIGH-FIDELITY EQUIPMENT

"gives full musical satisfaction"

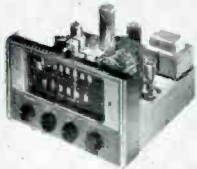

Custom Four Hundred
AM-FM Tuner



Custom Four Hundred Amplifier



Custom Four Hundred
Garrard Changer



Custom Four Hundred Coaxial
Speaker, with exclusive
"Acoustical Labyrinth"

Prior to the introduction of Stromberg-Carlson's new high-fidelity equipment, one of the world's greatest conductors, Leopold Stokowski, was asked to evaluate it. Alone in his own studio, with his library of recordings and his matchless knowledge of music, he tested the equipment. These are his conclusions:

STOKOWSKI STATES:

"For discriminating music lovers who wish to hear great music in its full beauty, I can recommend with confidence the Stromberg-Carlson reproducer, which I have thoroughly tested.

"It has a single stylus with diamond pick-up and

long, light tone arm which reduces distortion to a minimum—a 25-watt amplifier and a pre-amplifier, which incorporates the latest technical knowledge—and a 15" speaker with large enclosure.

"All these features create a reproducer of high quality that will give full musical satisfaction to the discerning music lover."

"Custom Four Hundred" equipment is available in two forms. The high-fidelity enthusiast or music lover will find the matched units all ready to be assembled, or available in complete custom-styled furniture cabinets; with or without radio and television.

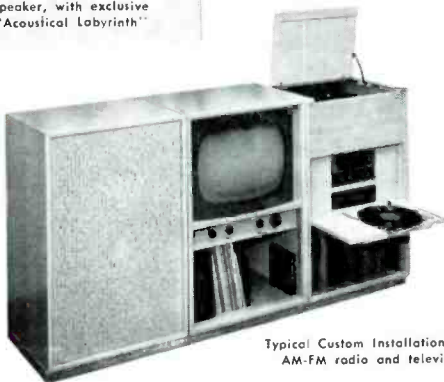

Typical Custom Installation, with
AM-FM radio and television

MAIL COUPON FOR FREE BOOKLET

Stromberg-Carlson, Sound Division

1222 Clifford Ave., Rochester 3, N. Y.

Please send the "Custom Four Hundred" booklet and the name of my nearest dealer.

I would do my own installation I am interested in complete cabinets

Name _____

Address _____

City _____ Zone _____ State _____

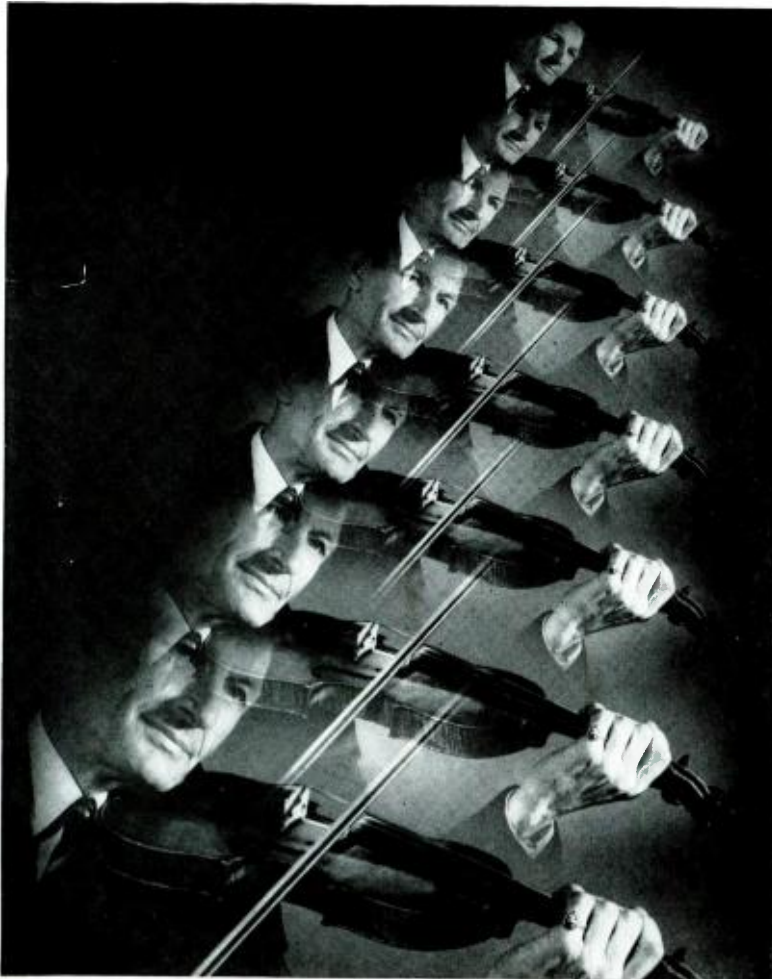

Ewing Galloway

for faithful reproduction—

Whether you prefer disk or magnetic recordings for your high fidelity system, your choice of phonograph needles, recording tape, or recording wire, is important . . . As important to you as the essential components in your system . . . That's why so many high fidelity fans prefer Fidelitone—products manufactured to precise standards of *performance* as well as design.

Fidelitone Phonograph Needles and Styli are available at your record shop, in diamond, jewel and osmium alloy tips. Also Fidelitone Recording Tape and Wire, with ultra-low surface noise factors, in Standard Time Lengths.

PERMO, Incorporated, Chicago 26.

Fidelitone

NEEDLES • TAPE • WIRE

DIVIDING NETWORKS

Continued from page 74

the woofer. The crossover frequency in a two-way system may be anywhere from 500 to 5,000 cycles, depending on the low frequency capabilities of the tweeter. Ordinarily, some frequency between 600 and 2,000 cycles is chosen.

With the increased frequency range of program material available on records and tapes in recent years, it has been the experience of many that two-way systems, while providing greatly improved performance in respect to single speakers, are not as satisfactory as three-way systems, and for the same reason.

There are two general types of three-way systems:

1) The woofer and coaxial speaker combination. Coaxial speakers are, in themselves, two-way speaker systems. A dividing network is normally built into the coaxial speaker assembly or is supplied with it. Crossover frequencies of coaxial speakers are usually high, from 1,000 to 4,000 cycles. Thus, the coaxial speaker assembly can be used in conjunction with another cone speaker for a woofer. In such a case, a two-way dividing network with a relatively low crossover frequency is required *in addition* to the network on the coaxial unit. The large cone of the coaxial speaker then becomes a mid-range speaker.

2) The separate woofer, mid-range speaker, and tweeter. This is usually made up of a 15 or 12-in. cone speaker for a woofer, a 12 or 8-in. speaker or a large horn-type unit for the middle range, and a horn-type tweeter. This system requires a three-way dividing network, which routes all tones below the *low* crossover frequency to the woofer, the tones above the *high* crossover frequency to the tweeter, and those tones which lie *between* the low and high crossover frequencies, to the mid-range speaker.

Crossover networks are made up of coils and capacitors. Variable resistors are added so that the relative volume level of each speaker can be regulated. The coils must be of the air-core type for best results, and should be of very heavy copper wire (at least No. 17). For practical reasons, since they are of such large values, the capacitors must be electrolytic. These capacitors are perfectly satisfactory providing their voltage rating is many times the peak voltage to which they are likely to be subjected.² In practice, capacitors of 150-volt ratings can be employed with confidence.

The variable resistors are used to adjust the relative loudnesses of the individual speakers so as to obtain the best balance among them. Once set for any specific combination of speakers in a given room, they need not ordinarily be readjusted. They should be capable of handling considerable power; for most installations, wire-wound potentiometers of 4-watt ratings are adequate.

The values of the components in a dividing network are determined by: 1) the impedances of the speaker voice coils with which they are to work, 2) the crossover

²For a fuller discussion on this point, see "Design of Crossover Networks", by Sol J. White, RADIO COMMUNICATION Magazine, January, 1952.

Continued on page 78

FOR
HIGH FIDELITY
IN
RECORD
REPRODUCTION

Collaro

MODEL 3/522*
THREE SPEED

Fully Automatic

R E C O R D C H A N G E R

FOR 7, 10, AND 12 INCH RECORDS

 The COLLARO was engineered to meet the most exacting standards of highest quality audio systems. Superbly constructed, it reveals the painstaking care and attention to the minutest functional details. The result is an instrument of unsurpassed performance.

From the very first to the very last cycle, the COLLARO exhibits an almost uncanny gentleness. As each record-play begins, the remaining stack of records is slowly and safely lowered into position. A weighted, rubbermatted, and dynamically balanced, ball-bearing-mounted turntable provides steady, constant speeds, with no record slippage.

Every worthwhile convenience has been included. An automatic muting switch eliminates disturbing 'thumps' and

'clicks'. Plug-in heads are furnished for all standard cartridges. The tone arm rotates on ball bearings providing maximum lateral compliance. Arm resonance has been kept to an absolute minimum. Stylus pressure is adjustable to as little as 3 grams with good tracking.

A powerful, four pole motor with oilite bearings assures long, trouble-free performance, and virtually no hum pickup. No drive belts are employed, and in 'off' position, all drive couplings are completely disengaged, thus avoiding flat spots.

The COLLARO is absolutely jam-proof. The tone-arm may be lifted, moved, or even locked down during the changing cycles with no danger of damage. When the last record has been played, the COLLARO automatically 'shuts off'.

*Intermixes 10 and 12 inch
Records at All Speeds
List Price..... \$65.00

Model 3/521 Fully Automatic
Non-Intermix Model
List Price..... \$54.50

Base Dimensions: 14 $\frac{1}{4}$ " x 12 $\frac{1}{4}$ "
Depth Below Base: 2 $\frac{1}{2}$ "

At your Distributor or
Write for Details:

ROCKBAR CORPORATION
211 EAST 37TH STREET, NEW YORK 16, N. Y.



Beautiful to look at...
now even more beautiful to hear



the new **JIM LANSING**
 acoustical lens gives the
 highs a smoothness your
 ear appreciates instantly

The magnificent Jim Lansing enclosures are a perfect complement to the matchless tone reproductions made possible by the new Jim Lansing *full* acoustical lens.

The new lens, a natural development brought about by the inadequacies of the multicellular horn, distributes sound constantly and uniformly over the entire audio spectrum.

This gives the highs a smoothness impossible to match by any other method.

The band width of the lens, being broader than the entire audio spectrum with which it is used, distributes sound to all points in the listening area without variation of intensity regardless of the frequency.

Drop into your high fidelity dealer and ask for the full story on the Jim Lansing 175 DLH, driver—horn—lens assembly, today.

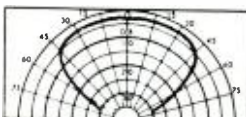
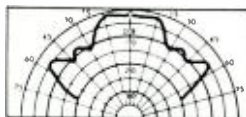

JIM LANSING

→ first in fine sound

James B. Lansing Sound, Inc. • 2439 Fletcher Drive., Los Angeles 39, Calif.

DIVIDING NETWORKS

Continued from page 76

frequency or frequencies to be employed, and 3) the configuration of the network to be used. Only one manufacturer, so far as is known to the writer, supplies a complete line of components for dividing networks for two-way and three-way systems. All these networks are of the half-section constant-resistance type, generally conceded to be most satisfactory for general applications.

The accompanying diagrams and tables are based on the range of coil sizes commercially available.³

Figs. A and B are diagrams of two-way networks, and are to be used when only two speakers are employed. However, one speaker can be a coaxial. Table I gives component values for various crossover frequencies for speakers with various impedances. To use Table I, look up the impedance of the voice coil of the low frequency speaker in the first column, and the voice coil impedance of the tweeter in the second. Then pick the crossover frequency best suited to the installation. The component values are then given in the right-hand columns.

It will be noted that the network is connected to the amplifier output tap that corresponds to the impedance of the woofer speaker. This is done to assure maximum power transfer to the woofer. If a coaxial speaker or cone tweeter is connected to the high frequency output channel of the network, the speaker's impedance should not differ from that of the woofer speaker by more than a factor of 2; that is, it should not be more than twice nor less than 1/2 that of the woofer. When a horn-type tweeter is used, however, a considerably greater mismatch can be tolerated.

Figs. C through F are diagrams of three-way networks, and Table II gives data for component values for speakers of various voice coil impedances used at various crossover frequencies. Whichever combination of crossover frequencies at the desired impedance is selected, that network configuration or schematic (series or parallel) should be used.

Some general rules should be followed in assembly and wiring of crossover networks, although it is not by any means a difficult job. Since the network has no operating controls, it need not be accessible when it is completed. Therefore, it can be assembled on a board, in a wooden box, or in any convenient way. It should not be installed on or in a metal container, nor should it be placed near large masses of metal. Coils should be placed far apart (at least 1 ft. between coils is desirable) and installed at right angles to each other. The network should not be operated close to equipment that gives off considerable heat, and it should be well ventilated, since electrolytic capacitors are affected adversely by high temperatures. All wiring connections within the network should be soldered. The network, of course, must be wired according to the diagram that corresponds to the table from which the component values were taken.

³They also prove, beyond any possible doubt, the enormous complexity of the dividing network problem. Using only four different coil values, Mr. Allison has designed 78 networks!! — Editor.

One minute...
and you'll hear the difference!

no other
cartridge
can match
Fairchild's
fidelity

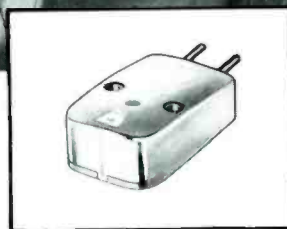

It takes only *one minute* to prove that the professional Fairchild Moving Coil Cartridge is the best in the field. Play your favorite hi-fi recording with any other cartridge. Switch to a Fairchild Moving Coil Cartridge. You'll hear the difference *almost instantly*.

There are good reasons for this superior performance. In the Fairchild Moving Coil Cartridge, the coil is mechanically linked with the stylus and moves with it in a uniform magnetic field. Thus voltage induced in the coil is propor-

tional to stylus velocity. This means life-like reproduction from the record—the ultimate in every playback system. Stop in at your dealer and ask to make the Fairchild One-Minute Test.

The quality Fairchild Moving Coil Cartridge is part of a complete line of professional Fairchild playback equipment, which includes the famous three-speed turntable, compact preamplifier and accurate passive equalizer. Ask your dealer for the bulletin describing these products or write us direct.

**See Fairchild Model 215
Moving Coil Cartridge**

1. Paints a true tone picture with all the shades of color in the recording.
2. Diamond stylus and excellent lateral compliance result in longer life for your records.

**FAIRCHILD RECORDING
EQUIPMENT**

154TH STREET & SEVENTH AVENUE, WHITESTONE, NEW YORK

FR133

You can't buy better performance at any price!



**First wide range diamond-and-sapphire combination
delivers frequency response from 30 to 15,000 cycles.
Tracks all 3 speeds at 6 to 8 grams**

THIS new 1-mil diamond and 3-mil sapphire* stylus assembly lengthens the life of your records and delivers tone reproduction *unsurpassed by any make on the market.*

The replaceable stylus is of the famous G-E "Baton" design. Multiple damping blocks filter out harmonic distortion, needle talk and needle scratch. There are no moving parts in this cartridge — nothing to

wear out. Remember—when you replace a stylus assembly in a General Electric cartridge, you replace every component that is affected by age or wear. A new stylus assembly means, in effect, a new pickup.

Ask your G-E dealer about the Golden Treasure cartridge, or write us for the nearest source of supply. *General Electric Company, Electronics Park, Syracuse, New York.*

**Synthetic*

Send for these new catalogs . . .

General Electric Company, Section 5492-15
Electronics Park, Syracuse, New York

Please send me the items checked:

Phono Accessory Catalog

Wide Range Stylus Folder

NAME _____

ADDRESS _____

CITY _____ STATE _____

GENERAL  ELECTRIC

NOTED WITH INTEREST

Continued from page 11

in letting us know of demonstrations far enough in advance, we'll publish the schedules . . . and we'd appreciate readers telling us of their reactions to any such broadcasts they may chance upon.

So far, no one has produced binaural phonograph records, though there are persistent rumors that attempts are being made. Magnecord is actively promoting binaural tape equipment and tapes.

Six Days In Chicago

Last May is so far back that we're not going to report in any great detail the events of the six days of Parts Show and Audio Fair which we spent in Chicago. The first four days were Parts Show, which was strictly for the trade, and were followed by two days of Audio Fair. Attendance at the Parts Show was excellent, at the Audio Fair surprisingly good for a first time — somewhere around 3,000.

Significant developments in the audio field were few. Stromberg-Carlson displayed its semi-packaged high fidelity series, the first approach to this field by a commercial set manufacturer. Newcomb introduced a complete new line of amplifiers; their Classic 25 is due for a "Tested in the Home" report, probably in the next issue of HIGH-FIDELITY. At least one tape recorder manufacturer, normally in the low price, medium fidelity, "packaged unit" field, came up with a low price, good fidelity "unpacked" unit. We'll have more on this development as soon as we have an opportunity to work with one in the quiet of our own surroundings. (We do not like to judge equipment in the bedlam of an audio show!)

Electro-Voice showed off its mobile sound van — a truck trailer set up as a complete hi-fi demonstration room which is scheduled to tour the Country making music and interesting people in good sound reproduction . . . neat idea, well executed. (Society of Music Enthusiasts chapters please note.)

Paul Weathers showed off his new pickup arm . . . see the "Tested in the Home" report in this issue.

The big doings will be the Audio Fair in New York this Fall. That we shall report in complete detail, in our January issue.

Bedlam Defended

One facet of audio shows was particularly in evidence at Chicago: deafening volume levels. We talked with many exhibitors about this problem, and kidded with our neighbors across the hall as to which of us had the sound and which the fury. At least one exhibitor took the time to put his reasons on paper. They are worth considerable thought on the part of exhibitors as well as visitors — perhaps especially the latter, because the final answer seems to be up to them. Here are quotes: "You pose a very interesting question: 'Why does everyone who puts on an audio demonstration use such extreme volume levels?'"

"Here are the reasons: Number one, and most important, the size of the audience is almost directly related to the intensity of

Continued on page 82

Remember the speaker with the champagne glass?

Welcome news to the thousands who heard it at the Audio Fairs, and were amazed, and to other thousands who have written from every part of the world.

Now available for the first time:

SOME CRITICAL COMMENTS WHEN THE R-J WAS FIRST DEMONSTRATED AT THE NEW YORK AUDIO FAIR.

The R-J Company, New York City. Visitors to this display will probably be mumbling to themselves for months to come—at least until they have another opportunity to hear the R-J speaker in action and verify the fact that they actually did hear a 30-cps note coming from the innards of an 18-inch-square box. First introduced publicly through the pages of *AF* last month, the R-J enclosure already is on the way to commercial acceptance by major manufacturers of custom-built home music systems. The inventors, who conducted the R-J exhibit, were literally swamped with messages of congratulation on their having reduced speaker cabinet size without impairing low-frequency response.

AUDIO ENGINEERING

And now suddenly an enterprising friend of mine has looked at nature's "immutable" law and found a way around it, as simply as you please. So simple that it is just about impossible to believe that nobody in all these years has done it before. His speaker cabinet is tiny, just about big enough for a speaker to fit inside, with inches to spare. But it gives bass performance that challenges the huge monsters we've always thought were *de rigueur*. How?

Nature, it seems, does know how to produce bass without taking up space. The bullfrog, for instance. Adapt the bullfrog's ingenious bass-making system to the phonograph loudspeaker and you have the essence of the new "R-J" speaker enclosure, so named tentatively after its promoters, Frank Robbins and William Joseph. The "R-J" principle is simple, flexible, adaptable to myriads of special circumstances.

SATURDAY REVIEW

This was the reason for the crowds around the Audio Fair exhibit marked "R-J Company." Messrs. R. and J. (Frank Robbins and William Joseph) had made a valiant effort to find a middle ground. Their cabinets (literally "under wraps"—burlap) were cubic and only a few inches bigger than the speakers they housed. A speaker in an R-J cabinet is sealed behind by a very small box but, to equalize this, it is front-loaded, too. The frontal air chamber is closed off but for a slot through which the sound comes. A slot distributes sound rather well. Organ-pipe makers found this out long ago.

THE ATLANTIC

Future development of the R-J is well worth watching carefully, as is the entire trend toward disproving the axiom that good bass reproduction requires giant size.

HIGH-FIDELITY

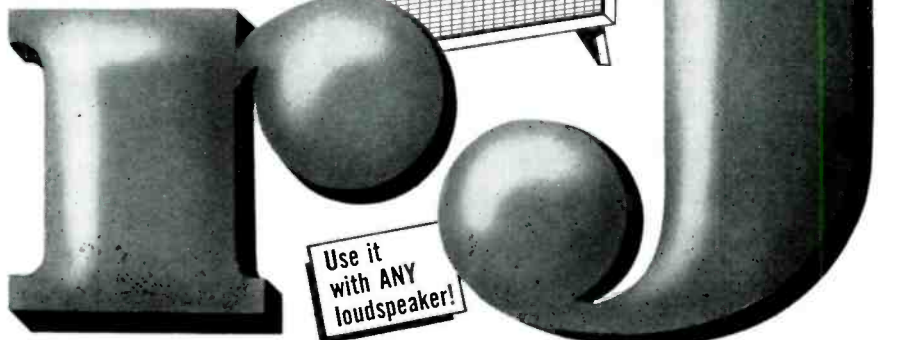

SPEAKER ENCLOSURES

MAXIMUM BASS... MINIMUM SPACE! (Patent Pending)

"Startling!" "Small in size, but mighty in performance!" Thousands of critical listeners who heard R-J Enclosures at the New York and Chicago Audio Fairs actually watched a delicate champagne glass, perched on a 20" x 20" speaker enclosure which was pouring forth the throbbing pedal notes of an organ. There was no cabinet resonance. No motion in the glass or its contents.

Hearing is believing! The R-J Speaker Enclosure, now ready for the home after long experiments and development, establishes an entirely new trend in audio design. Listen to an R-J... hear thrilling performance from your favorite loudspeaker in a cabinet only slightly larger than the speaker itself! Listen... and hear the R-J outperform ordinary enclosures more than three times its size!

R-J Enclosures are simple, flexible, low in price, and particularly adaptable for rooms where space must be conserved. Up to now, cumbersome, costly speaker enclosures have been tolerated because their size was considered essential for good bass performance. This inconvenience has now been effectively overcome by the R-J construction principle.

The R-J Enclosure will permit the user to realize the full potential of any speaker with which it is used. Even the most inexpensive speakers will perform at their best in an R-J housing. With a well-designed speaker, an R-J Enclosure offers clean, smooth bass fundamentals, without peaks, down to low organ pedal notes. Distorting cabinet resonances are completely eliminated.

Remarkable though its bass performance may be, the R-J Enclosure is equally impressive in its unobstructed direct radiation of high frequencies. It has excellent acoustic loading for best reproduction of transients.

R-J Speaker Enclosures also offer the advantages of unusual versatility. Fine furniture construction is used throughout, suited in appearance to any room decor. Enclosures are expertly built of heavy, top-quality genuine Mahogany or Korina veneers, in fine, long lasting hand rubbed dark or blonde finish. Special models are available with surfaces sanded but unfinished, to fit the shelves of bookcases and other similar installations. Cut-outs fit all standard loudspeakers, which may be installed quickly and simply without special tools.

Here is a brand new concept in speaker cabinet design...with many, many possibilities for your own home system—now or in the future. It is a treat for your imagination and a treat for your budget.

See and hear an R-J Enclosure at your favorite sound department. For literature and further information use the handy coupon.

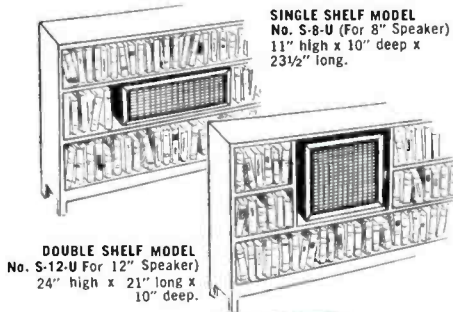

SINGLE SHELF MODEL
No. S-8-U (For 8" Speaker)
11" high x 10" deep x 23½" long.

DOUBLE SHELF MODEL
No. S-12-U (For 12" Speaker)
24" high x 21" long x 10" deep.

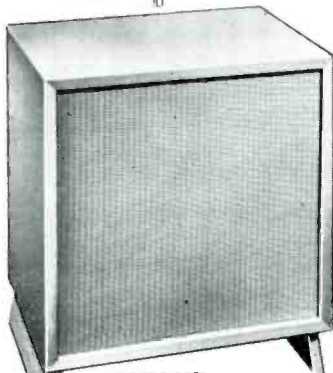

FLOOR MODEL
No. F-15-M (For 15" Speaker, Mahogany)
No. F-15-B (For 15" Speaker, Blonde)
No. F-12-M (For 12" Speaker, Mahogany)
No. F-12-B (For 12" Speaker, Blonde)
20" high x 20" long x 16" deep, plus legs.

\$4995
Net.
Mahogany.
Slightly higher on West Coast.

R-J Audio Products, Inc., Dept. 3
164 Duane Street • New York 13, N. Y.

Gentlemen:

Please send literature and information on R-J Speaker Enclosures.

Name _____

Address _____

City _____ Zone _____ State _____

R - J AUDIO PRODUCTS INC.
164 Duane Street • New York 13, N. Y.

Capture the Missing Music



IN YOUR PHONOGRAPH RECORDS

WITH A

PFAN-TONE Strain-Sensitive Pickup

Discover the hidden wealth of music in your records—untapped by standard phonograph pickup equipment. Let the amazing new Strain-Sensitive PFAN-TONE Pickup bring out the best in your records—old or new. The PFAN-TONE'S strain sensitive action picks up ALL the music engraved on your records . . . reproduces in true beauty all the tonal shadings.

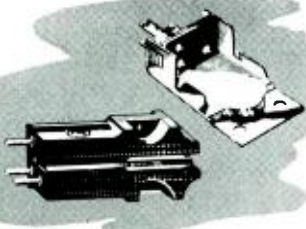

PFAN-TONE PICKUP KIT contains: Cartridges for all standard and micro groove records, quick change cartridge holder with complete wiring, 1 PPRS preamplifier for regular AC-DC outlet. Ask your radio supply man or write today for **FREE INFORMATION**. (Mention name of present changer.)

Now ready—Genuine Pfanstiehl Replacement Needles for all popular cartridges. Remember, no needle is permanent. When replacement is indicated, ask for a Pfanstiehl Replacement Needle tipped with Patented M47B Alloy.

↓ **Operates On New Principle**—Modulates current from preamplifier—makes faithful electrical image of the music. No other pickup operates this exclusive, improved way.

↓ **Prolongs Record Life**—tracks well, operates at low pressure to insure reduced record and needle wear.

↓ **Free From Hummm**—No coils to pick up induced current from turntable motor.

↓ **Easy to Install**—No soldering necessary. Packed in handy kit form, complete with easy-to-follow instructions.



PFAN-WOOD TONEARM

If you own a single play, professional turntable here's the tonearm for you. Truly functional, the PFAN-WOOD Tonearm is made of wood with free moving roller joints. Adjustable for pressure, tracking angle, height . . . tracks beautifully at low pressures . . . free from interfering resonances. Ask for **FREE INFORMATION**.

Pfanstiehl

CHEMICAL COMPANY

110 Lake View Avenue Waukegan, Illinois

NOTED WITH INTEREST

Continued from page 80

the sound level. It is an inviolable role that to reduce the size of the audience, you turn down the level.

"Two, the loudest music sounds the best. The ear falls off drastically in sensitivity at the extremes of the spectrum at low levels. A full orchestra should play at the level at which it was originally recorded. Yes, we know about equalizing the high and low end to compensate at lower levels of playing, but there isn't nearly that amount of equalization available.

"With a crowd of fifteen or twenty people listening to one speaker, the high frequency absorption is tremendous, and the bass requires much over-accentuation to overcome the background noise of the listeners themselves (talking, coughing, etc.)

"Three, the attention of the audience is hard to hold at best; play the music softly, and the listeners start talking. Turn it up a bit and they talk louder; turn it up so that they can't hear themselves talk and then they listen to the product. That is the purpose for which the exhibitor engaged in the show project.

"A few, a very, very few people walk out because the performance is too loud; but don't overlook the fact that they originally came into the room because they could hear the music *way* down the hall."

That is the merchandising point of view, and with it we are obliged to agree. The racket attracts the crowd and what the answer is, we don't know. Perhaps each exhibitor should be allowed to mount a single 5-in. speaker outside his door and make as much racket as possible with that. Once inside the door, the visitor would be asked to maintain concert hall silence, in the hope of hearing concert hall quality.

We agree with the technical aspects of playing it loud. It is true that the sensitivity of the ear to extreme lows and extreme highs falls off, relative to mid-frequency sensitivity, as the volume level is reduced. It is also true, but less well known, that differences in volume level are less well detected at low levels than at high levels.

But we must ask for the addition of one qualifying clause in the statement of technicalities. To the sentence, "a full orchestra should play at the level at which it was originally recorded" let's add "if it is reproduced in the same hall in which it was recorded." Heaven help us if a *tutti* by a full symphony orchestra were ever reproduced at original volume level in our living room!

Therein, by the way, is one of the greatest problems of high fidelity music reproduction.

We don't know the answer to that one, yet. Nor do we know how to attract a crowd without being noisy. We'll see what happens in New York.

"New Loudspeaker Improves FM"

So headlined the *New York Times* of May 23rd. Which is a misleading headline because any loudspeaker which improves FM sets will also improve every other type of sound reproduction.

Continued on page 84

Puts the
Breath of Life
 into Reproduced Music

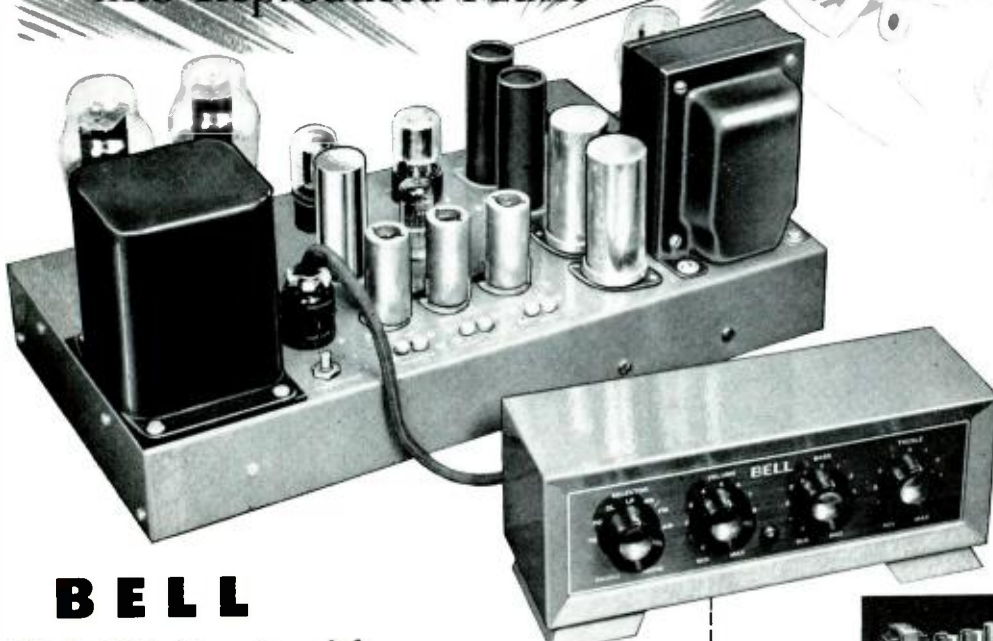

MODEL 2145-A
 WITH
 REMOTE CONTROL

BELL

High Fidelity Amplifiers make your records come to life . . . bring you the entire range of high and low tones with completely-controlled, exactly-amplified clarity. They give the utmost in life-like realism to reproduced music. No hum or spurious overtones come through when a Bell unit is assigned this important position in your home music system!

Compare Bell's line with any other hi-fi units for quality and price. Your ear will tell you that Bell's flat response and maximum freedom from distortion mean better listening . . . more thrilling enjoyment from your custom console or built-in audio system.

Model 2145-A, shown above, is a *truly* remote controlled unit with a nationwide reputation for quality performance. Less than .2% distortion at normal listening levels! Frequency response plus or minus 1/3 db from 20 to 30,000 cycles. It has more convenient features than *any other amplifier*, including six inputs and two AC outlets, separate bass and treble controls, volume control, and selector switch. Peak power: 30 watts.

Small, attractive, remote control unit can be placed 25 feet or more from the basic amplifier. From your easy chair, you can select phono or AM-FM radio, and control the tone and volume to suit your most exacting taste. Write for details today.



MODEL 2200

A new model with amazing ability! Power output 20 watts at less than .3% distortion. Frequency response plus or minus 1/2 db from 20 to 20,000 cycles. Has five-position equalizer switch for all types of foreign and domestic records; selector switch for TV, magnetic phono, radio, crystal phono, and tape recorder inputs; compensated volume control; and separate base and treble controls. Also special microphone input.



MODEL 2122-B

Popular in price and performance! A fine quality, high fidelity amplifier with inputs for radio, crystal pickup, and two magnetic pickups, selected by a three-position switch. Separate bass, treble, and volume controls give full selectivity of tone for best performance. Output of 10 watts at less than .3% distortion, with peak of 15 watts. Frequency response plus or minus 3/4 db, 30 to 15,000 cycles.



BELL SOUND SYSTEMS, Inc.

EXPORT OFFICE: 401 Broadway, New York 13, N. Y.

555-57 MARION ROAD, COLUMBUS 7, OHIO

CLARKSTAN

MANUFACTURERS OF
FINE ELECTRONICS & INDUSTRIAL EQUIP.

THE ARM WITH A HAND



A fine quality tone arm that features the new "SLIDE-IN" cartridge holder. It fits any cartridge. Just a quick twist of the thumb screw and the cartridge is securely held in place. No need for soldering. Silver plated spring loaded plungers maintain positive electrical contact. The quick act-

HAS SLIDE-IN CARTRIDGE HOLDER



ing weight adjustment gives positive and accurate balance plus proper needle force. Meets all requirements for LP records as well as standard speed and groove sizes. Arm made in two sizes, for records up to 12" and also up to 17". See your jobber or write for Bulletin No. 172A.



CLARKSTAN AUDIO SWEEP FREQUENCY TRANSCRIPTIONS

An entirely new method of making instantaneous frequency response runs. Audio Sweep Frequency Transcriptions embody all correction factors in the original recording which eliminates the need for charts and graphs. When used with an oscilloscope, the Audio Sweep Frequency Transcriptions provide an instantaneous response measurement so a few quick adjustments on a circuit complete the job. Used extensively for testing audio amplifiers, loud speakers, microphones, acoustical networks, electrical filter networks, etc. Broadcast engineers can make frequent quick checks of transmission systems and components. Used for production testing. Locates distortion. Excellent for laboratories as well as FM stations, motion picture studio and theatre sound equipment. See your jobber or write for Bulletin No. 104A.



CLARKSTAN AUDIO SWEEP FREQUENCY GENERATOR

A Clarkstan development for testing the behavior of audio and other alternating electrical apparatus with respect to frequency and associated phenomena. The generator operates in the audio range from 40 cps to 10,000 cps. The complete frequency range is regularly recurrent so that the signal may be used in conjunction with an oscilloscope. The Sweep Frequency is governed by 20 synchronizing pulses per second. Where an instantaneous evaluation of the performance of amplifiers at various settings of tone control and pickup correction networks is desired the Sweep Frequency Generator is ideal. A quick performance check on the following can be accomplished with this product... wire recorders, film recorders, broadcast and aircraft receivers, motion picture sound equipment, loud speakers, microphones, transformers, filters, pickups, pre-amplifiers and cutting heads. See your jobber or write for Technical Bulletin No. 157A.



CLARKSTAN RV WIDE RANGE PICKUP WITH EASILY REMOVABLE STYLUS

This wide range variable reluctance pickup meets the requirements of discerning users and FM specifications. Removable and interchangeable styli available with various tip radii for all types records, LP microgroove, etc. See your jobber or write for Bulletin No. 141A.

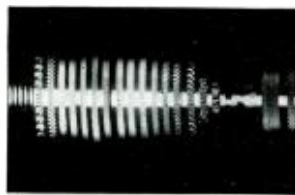

STEADY STATE FREQUENCY RECORDS

Clarkstan now offers three new test records which for the first time conform to exact specifications, permitting the user to work in known quantities. The reproduction of these fine test records involves no polishing and employs the very latest techniques which insure exact duplication of the original recordings in each pressing. Complete specifications of the original recordings are furnished. See your jobber or write for Bulletin No. 181A.

NOTED WITH INTEREST

Continued from page 82

What the *Times* was talking about was the so-called M.I.T. speaker.¹ In essence, the unit incorporates four modified 5-in. speakers in a very carefully designed small enclosure. Anyone can build the enclosure by following instructions, but the modified speakers are not yet available commercially, nor has information on the modifications been made public.

The quality of sound reproduced is reported to be noticeably — but not notably — better than that obtained from four ordinary 5-in. speakers mounted normally. Full bass has not yet been achieved in a small enclosure.

Atomic Speaker

There have been so many reports and articles about a non-mechanical sound transducer invented by Sigmund Klein of Paris that it is time to put this invention back in its place, which is the laboratory. The invention is significant and it may lead to remarkable developments which eventually will have commercial possibilities, but audiophiles should not postpone purchase of new loudspeakers in the hope that this day of commercial availability will arrive sooner than expected.

The Klein transducer is significant because it does away with the principal loudspeaker problem of smoothly converting the electrical energy in the voice coil into the mechanical motion of the cone. But it is still strictly a laboratory instrument because it operates successfully only in the extreme high and supersonic frequencies. This is partly because the orifice, from which the sound originates, has a diameter of only about 1/4-in. To achieve anything resembling low frequency output would require either several orifices or an enormous horn.

Record Equalization

William Isaacs of New York City writes: "Please explain this jargon to your less informed readers: 'Best equalization is at an 800 turnover point, with a 12 db roll-off on the highs. A 2 db roll-off on the bass is possible but largely a matter of individual taste.'"

This was quoted from one of the record reviews appearing in *HIGH-FIDELITY*. We're not going to answer it here, because it would take several pages and because the subject was discussed in detail in *HIGH-FIDELITY* No. 3 (Winter 1951) by Victor Brociner, to which Reader Isaacs is hereby referred.

Be it said, however, that the turnover point refers to bass compensation as used by the record manufacturer, the roll-off in the highs has to do with treble preemphasis, also as used by the record manufacturer, and the additional 2 db roll-off in the bass is further adjustment of bass response by

Continued on page 86

CLARKSTAN

PACIFIC TRANSDUCER CORP.
Formerly CLARKSTAN CORP.
11921 WEST PICO BOULEVARD
LOS ANGELES 64, CALIFORNIA

¹The technicalities were described in *RADIO COMMUNICATION Magazine*, June 1952, available from The Publishing House, Great Barrington, Mass. at 35c a copy.

August 10, 1952

The Los Angeles Times

GUARANTEED QUALITY SPEAKERS

BEVERLY HILLS, Aug. 10.—For the first time in the history of the audio industry a manufacturer is guaranteeing the quality of his loudspeakers. The new Altec Lansing "Duplex" loudspeakers, just introduced this week, have an unconditional factory guaranteed frequency range of 30 to 22,000 cycles. Principals at Altec state that no other speakers on the market have this great a frequency range.

These two new loudspeakers, twelve inch 601A and the fifteen inch 602A are improved versions of famous Altec 604 "Duplex" loudspeakers.

Trading throughout the world, these speakers develop... The key is steady motors and steady almost but toward weakened... A few... between 1... gave the... Most... tions to a

The new Altec **DUPLEX*** LOUDSPEAKERS



602A Net Price with network, \$114.00

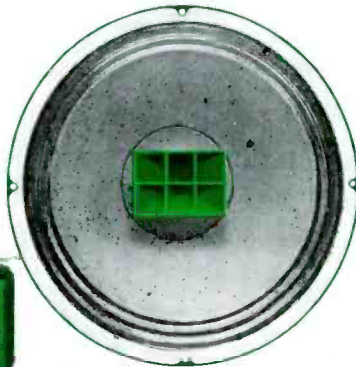

601A Net Price with network, \$89.00

TECHNICAL DATA	601A	602A
Diameter:	12"	15"
Power Capacity:	20 watts	20 watts
Impedance:	8 ohms	8 ohms
Weight:	15 lbs.	25 lbs.

FOR YEARS the Altec 604 "Duplex" has represented the highest quality attainable in a loudspeaker. Now two new speakers join the 604 to provide you with an even higher standard for quality sound reproduction. These two new "Duplex" speakers, the twelve-inch 601A and the fifteen-inch 602A, are the finest in the world. Hear and compare these guaranteed quality speakers at your Altec dealer today.

GUARANTEED QUALITY: When you buy an Altec 601A or 602A Loudspeaker, the quality of your purchase is protected with this guarantee. "The Altec Lansing Corporation unconditionally guarantees that, when mounted in an adequate cabinet, this loudspeaker will reproduce all of the tones from 30 cycles to 22,000 cycles."



the Symbol of Quality

***DUPLEX:** Mechanically and electrically independent high and low frequency loudspeakers mounted within the physical size of a single frame.

ALTEC LANSING CORPORATION • 9356 SANTA MONICA BLVD., BEVERLY HILLS, CALIF. • 161 SIXTH AVE., NEW YORK 13, NEW YORK



ANNOUNCING THE SENSATIONAL

FISHER

All-Triode Amplifier

AND

Master Audio Control

■ THE FISHER Laboratory Standard Amplifier is, beyond a shadow of a doubt, *the world's finest all-triode amplifier* — and yet moderately priced. FEATURES IN BRIEF: High output — less than 1/2% harmonic distortion at 40 watts (.08% at 10 watts). Intermodulation distortion below 3/10% at 30 watts. Uniform response within .1 db, 20-20,000 cycles; 1 db, 5 to 100,000 cycles. Hum and noise better than 92 db below full output. Quality components, beautiful workmanship. ■ THE FISHER Master Audio Control can be used with *any* amplifier. Intermodulation distortion is virtually unmeasurable; complete, professional phonograph equalization settings and tone controls; genuine F-M loudness control; 5 inputs and 5 independent input level controls; cathode follower outputs. Self-powered.

Write for illustrated brochure and full specifications.

FISHER RADIO CORPORATION • 45 E. 47th ST., N.Y.

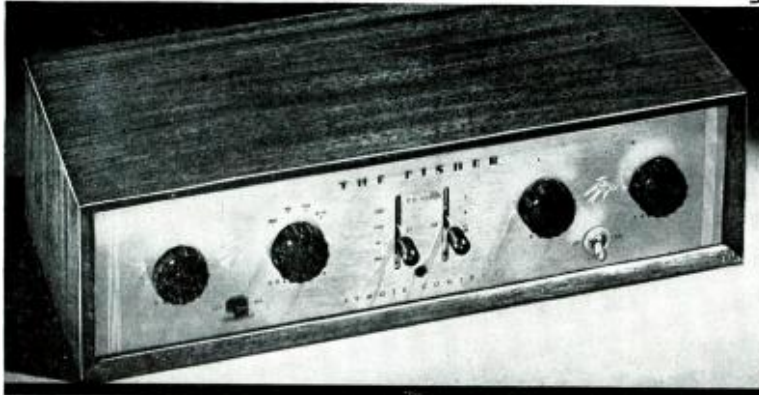

NOTED WITH INTEREST

Continued from page 84

use of the bass tone control in addition to that provided by recording characteristic equalization controls. The need for this final touch of bass control might arise from any one of many causes, such as microphone placement or acoustics of the recording studio.

High Fidelity Television

Widespread advertising publicity by Philco re "high fidelity television" is at least going to familiarize millions of people with the two words which are so important to audiophiles. We wonder, somewhat fearfully, whether or not it will create a new species: the videophile.

How about giving us a little high fidelity audio, along with high fidelity video, eh?

Microphones: Addenda

In one of our early issues, we listed a series of microphones recommended for use with tape recording equipment.

The Astatic Corporation, manufacturers of a well-known line of microphones as well as pickups and other equipment, recently sent us their suggestions, broken down into the three price classes which we originally established. "For recorders in the low price class (under \$200), models could be: CX-1, 241, JT-40, DR-10. For recorders with better fidelity characteristics, microphones having latter response characteristics may be preferred: CX, 240, JT-30, DR-10, DK-1, T-3. For professional recording equipment where fidelity is the main requisite, wide-range flat response microphones such as the K-2 and WR-40 are recommended."

Thanks, Astatic. These suggestions will broaden the base of our original efforts.

Dept. of Further Information

Quite a number of readers have written in to inquire about the tape recorder, shown on page 65 of HIGH-FIDELITY NO. 4, which Barbara Wolfe of the Station WGBH staff uses for tape editing: it's an Eicor, manufactured by Eicor, Inc., of 1501 West Congress Street, Chicago 7, Ill. — and a right good unit, too.

Someday we'll learn that to keep our readers happy, we have to provide *complete* information. We're trying hard, anyway!

Planning Ahead

Chicagoans should start planning right now for big doings in the Fall of 1953: the International Sight and Sound Exposition. Oodles of demonstration rooms, for sound equipment, amplifiers, high fidelity reproduction equipment and television receivers, plus a model home (electronic from start to finish), displays by decorators to show how hi-fi and TV can be incorporated into the modern home, and a Panorama of Progress . . . all of which will tantalize the eye, the

Continued on page 88



KLIPSCHORN

and

REBEL

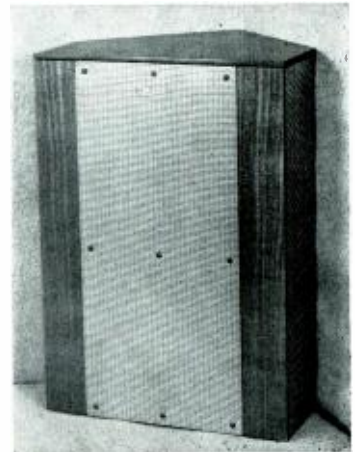

KLIPSCHORN and REBEL speaker systems are widely imitated. Acknowledging imitation to be the sincerest form of flattery, it still happens that such imitation follows Klipschorn leadership at a respectful distance.

Such leadership is merely what one would expect; Klipschorn is one of the few products developed and manufactured under the perfectionistic guidance of its inventor. In the art of high quality sound reproduction, 10 years is a venerable age, and Klipschorn started earning its reputation in 1940.

Rebel, like Klipschorn, employs fundamentally correct, time-tested corner horn principles, with new advances conscientiously applied through qualified engineering.

Technical excellence assuring low obsolescence is matched by consummate styling and dynamic symmetry. Hand finished models are beyond comparison.

Klipschorn, complete functional unit with drivers and network, \$516 to \$711 depending on styling and finish. Rebel, horn housing only, to fit 12" and 15" drive systems, \$81 to \$153. Klipschorn is suggested as the ultimate goal in long range planning; Rebel as an "interim" investment within the structure of a long range plan.

The following names have been added to our previous list of Klipschorn dealers:

Wm. E. Scripps II
11738 Lake Avenue
Lakewood 7, Ohio
Tel: Boulevard 2-9383

Wm. S. Johnson
3841 Nakoma Road
Madison, Wisconsin
Tel: 3-3634

The Golden Ear
13 N. 9th Street
Lafayette, Ind.
Tel: 2-2917

FOREIGN:

R. & R. David & Co.
Calle Real de Ciudad Vieja No. 40,
Guatemala, C. A.

KLIPSCH & ASSOCIATES HOPE, ARKANSAS

Telephones: 7-6795 and 7-4538

Phono-Gard

Trademark Registration Applied For

Patent No. 2,537,555
(Other Patents Pending)

is the **AUTOMATIC ANSWER** to
Your RECORD DAMAGE Problems!

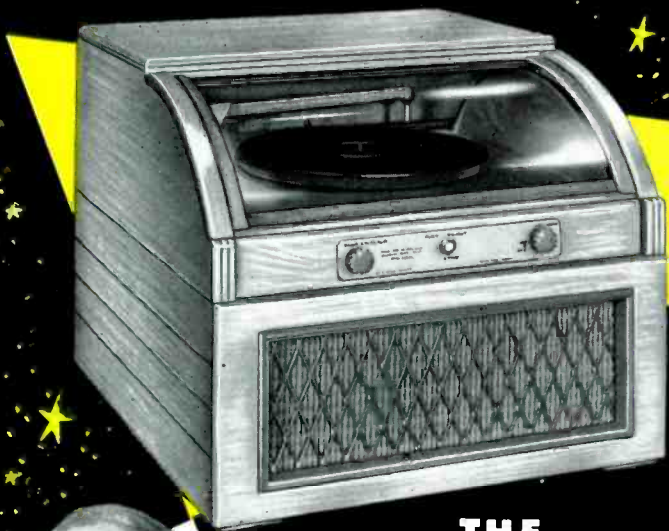

**THE
NEWEST
PHONOGRAPH
DEVELOPMENT
Since THOMAS EDISON'S
ORIGINAL**

All models precision
built and engineered
for **HIGH FIDELITY**
reproduction and are
equipped with high qual-
ity sound components.

**ONLY *Phono-Gard* GIVES YOU
THESE EXCLUSIVE ADVANTAGES!**

- ✓ RECORD SCRATCH-DAMAGE IS
COMPLETELY ELIMINATED!
- ✓ TONE ARM CAN NEVER BE HANDLED
AT ANY TIME!
- ✓ POSITIVE REMOTE CONTROL OF
TONE ARM MOVEMENT!
- ✓ START-STOP-REJECT ACTIONS ARE
PUSH-BUTTON CONTROLLED!

Write for Brochure



line ENGINEERING COMPANY

GENERAL OFFICES

12233 Avenue O, Chicago 33, Ill., SOuth Chicago 8-3665

NOTED WITH INTEREST

Continued from page 86

ear, and the pocketbook. Big doings are planned . . . we'll keep readers posted on developments and exact dates.

HMV to RCA Victor

During the Summer, RCA Victor announced that it would introduce to the American market the "His Master's Voice" label, long well-known in England and Europe for its outstanding 78 rpm. recordings. Through its dealers in this Country, RCA Victor has given limited distribution to the 78's for some years. Now it will bring these releases to us as 33 1/3 and 45 rpm. discs.

As of press time, the new pressings had not been received by HIGH-FIDELITY; as soon as they come in, they will be reviewed in the Records and Music Section along with all other releases.

We're looking forward to receipt of these records, because the list of first releases was imposing: outstanding artists, conductors, and orchestras were included.

Tight Fit

In spite of the fact that this is the biggest issue of HIGH-FIDELITY yet published (124 pages compared with our first issue, which contained a relatively meagre 84 pages), we are cramped for space! Our column, Hither and Yon: Musically, had to be put on such a severe reducing diet that it almost died of starvation, and many an item was left out. The Reader's Forum suffered, and so did several Tested in the Home reports.

We don't feel too badly about it, however, because now that we are publishing on a six times a year basis, instead of quarterly, material held over from one issue to the next doesn't have to be held quite so long.

Music on Tape?

Mention of things omitted for lack of space brings us to the Music on Tape report which was omitted not for lack of space but for lack of tape. We are most anxious to review tape just as we do records, and to bring good tapes to the attention of readers. To do so, however, we must have evidence that tape, worth reviewing, is being produced. Since nothing at all has showed up on our doorstep, we are forced to the conclusion that high fidelity tape, providing a quality of sound comparable to that now available on records, is not being produced.

If readers happen on a little man, working in a dark cellar studio with a bushel basket over his head, who is producing high fidelity tapes, would they please bring him to our attention, or us to his attention?

The Eight Inch Bookshelf

A year ago, an eight-inch bookshelf was entirely adequate for all books on the subject of high fidelity. It is a wise audiophile, however, who has left plenty of room for expansion. The book writers and publishers are getting busy. At least two

Continued on page 90

hallicrafters

Super Fidelity

A NEW PRECISION TUNER AND AMPLIFIER

COMPLETELY ENCASED FOR TABLE USE OR CUSTOM INSTALLATION

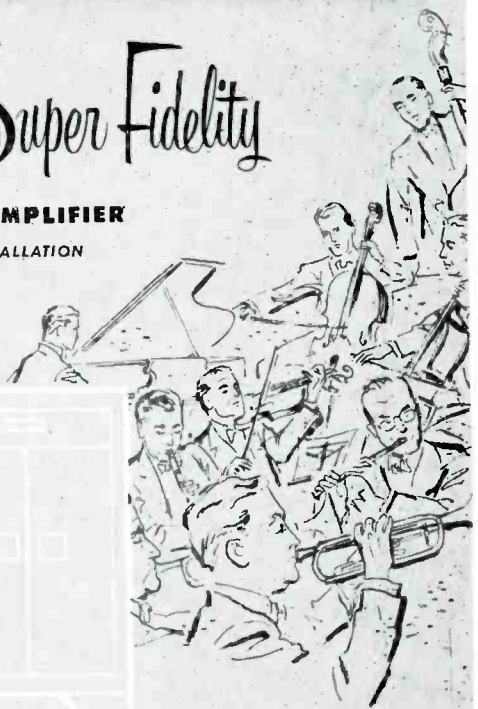

Sensation of the Audio Fair!

Now... Great "Command Performance" Music in Your Home!
Every Sound Humanly Audible...

Distortion-Free, without A.F.C.

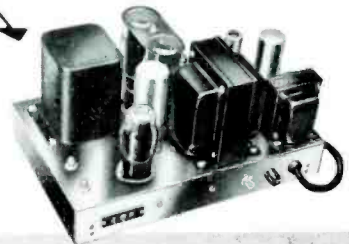
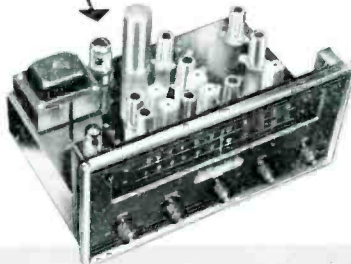

AM-FM TUNER (ST-83)

Hallicrafters Super-Fidelity AM-FM Tuner enables you to hear every sound audible to the human ear... "like a complete orchestra giving a Command Performance in your own home!"

It's the first such tuner to carry the U/L Seal of Approval. Temperature-compensated oscillator does away with need for A.F.C. Input jacks for phonograph, television, tape recorders, etc.

AMPLIFIER (A-84)

The most critical ear will find Hallicrafters Super-Fidelity Amplifier the perfect "mate" for your AM-FM Tuner. Guaranteed frequency range, 10 to 100,000 cycles per second, at 10 watts.

The Super-Fidelity Amplifier utilizes a new output transformer which gives you the widest range ever produced heretofore. And harmonic distortion is less than 0.25% at 10 watts level! Also, U/L-Approved and completely encased for your protection.

Write Today

hallicrafters

WORLD'S LEADING MANUFACTURERS
OF PRECISION RADIO AND TELEVISION
CHICAGO 24, ILLINOIS



The Saturday Review Home Book of Recorded Music and Sound Reproduction, by Canby, Burke and Kolodin. 308 pages. 6¼ by 9¼, 25 illustrations. Prentice-Hall, Inc., New York. 1952. \$4.50. HIGH-FIDELITY Book Department No. 98.

As imposing in content as it is in title, the SRHBORMASR¹ is a masterful treatise on three topics: how music is recorded and phonograph records made, what equipment to use for its reproduction in the home, and what, from the musical point of view, to listen for. These three topics are covered in three sections, written by Canby, Burke, and Kolodin, respectively, and are officially

entitled The Record from Studio to Store, Home Reproduction and How to Improve It, and Learning to Listen and Listening to Learn.

E. T. Canby's 116-page section starts with a brief history of the recording industry and of the development of the processes used. Then the reader is taken on a skillfully guided tour, beginning in the studio and ending at the record shop's counter, which touches upon almost every piece of equipment and every process involved in the creation of a disc. The whole is described and explained in terms familiar to the householder.

In Irving Kolodin's section of 50-odd pages, the reader is given brief but sound advice on how to listen to music, along with some very valuable suggestions on what to look for and listen for when buying records.

¹It is apparent that Messrs. Burke, Canby, and Kolodin are strongly anti-Government. Otherwise, they would have conformed at least slightly to Federal practice and conjured up a set of initials which could be pronounced.

It is C. G. Burke's 115-page section on Home Reproduction and How to Improve It which will be most avidly read by high fidelity enthusiasts. The author dons his shining armor, unsheaths his Excalibur, and fares forth into the battleground of the equipment manufacturers to bring back *his* report of what constitutes "best equipment", classified into five price categories.

Although the equipment recommendations are likely to be the major significance of the book, Mr. Burke also does an excellent job in discussing briefly but clearly the types of equipment used in what he calls the "eclectic" phonograph; he reports the advantages and disadvantages of leading makes within each equipment classification; he summarizes the pros and cons of pickups, arms, turntables, changers, amplifiers, speakers, enclosures — in short, of the impedimenta of high fidelity.

The value of expressing a firm (if personal) opinion far outweighs a few technical shortcomings and two major drawbacks:

Continued on page 95

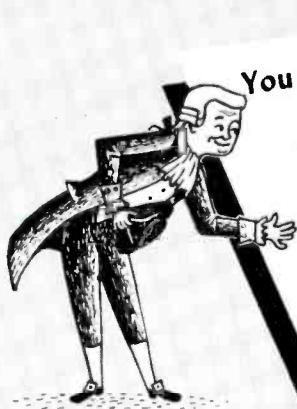

You are Cordially Invited to Visit
America's Only Building
Devoted Entirely to the Finest
in Sound Reproduction
ARROW ELECTRONICS'
Great, New

AudioCenter
at 65 Cortlandt St., New York



*Beauty
in Sound*

If you cannot visit us personally
send for new Sound Brochure "H"

Here, for the first time in audio history, is a complete building devoted exclusively to everything for fine music and sound reproduction. You'll really marvel when you see and hear the wonderful array of high fidelity and sound equipment for home, studio, professional and industrial use at Arrow Electronics' great, new Audio Center. Here are all the world-famed makes of tuners, amplifiers, speakers, record players and recorders in every price range — a veritable dream come true for those who want fine music reproduction.

You'll thoroughly enjoy a visit to our luxurious sound-proofed, air-conditioned Duplex Demonstration Studios. Listen to any of literally thousands of combinations of the finest equipment to be found anywhere. Compare them all at will with our new "Comparator-Control" panels to help you select the system ideally suited for your individual use. The complete privacy of our Duplex Studios permits listening under simulated home conditions. Our unique "Merry-Go-Sound" speaker turntable permits instantaneous "A-B" selection on axis.

SOME OF THE GREAT NAMES IN SOUND FEATURED AT AUDIO CENTER

ALTEC-LANSING
ASTATIC
AUDAX
BELL
BOGEN
BROOK
BROOKS
BROWNING

BRUSH
CONCERTONE
ELECTRO-VOICE
GARRARD
GENERAL
ELECTRIC
JENSEN
LEAK

MASCO
MEISSNER
NEWCOMB
PENTRON
PICKERING
PRESTO
RADIO CRAFTSMEN
REKOKUT

H. H. SCOTT
SHURE
STEPHENS
UNIVERSITY
TAPEMASTER
V-M TRIOMATIC
WAVEFORMS
WEBSTER-CHICAGO

ARROW  **ELECTRONICS, INC.**
65 CORTLANDT ST., NEW YORK 7, N. Y., DIGBY 9-4714



AudioCenter



BEAUTY IN SOUND

PRESENTING COLLINS AM-FM "PRE-FAB" TUNERS

NOW you can
build a Collins
AM-FM tuner from
the Pre-Fab units
shown below!

COMPLETE VERSATILITY is the byword in this new tuner design. Through the addition of the AM circuit, the Collins tuner will meet all requirements for home music systems and installations where a fine tuner is required.

ECONOMY: The very finest in tuner design is offered you at exceptionally low prices. Collins quality is your assurance of a fine product that will work to your complete satisfaction. You cannot duplicate this tuner in its completed form at twice the price!

SAVE by using COLLINS Pre-Assembled Units

Price of the complete FM-AM tuner, suitable for the finest hi-fi custom installation, is only \$77.50. This includes the chassis kit, and the FM tuner, AM tuner, and IF amplifier with all tubes, each assembled, wired, and precision aligned. Separate units can be purchased for special applications.

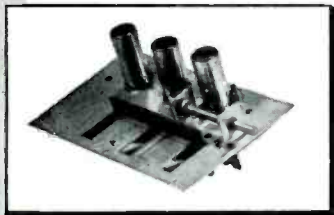

FM Tuning Unit **\$15.25**

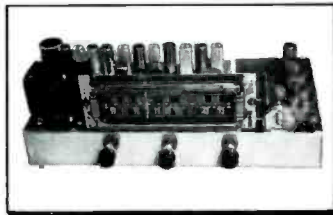

The Collins FM-AM Pre-Fab Tuner Kit As It Looks
After You Assemble It (Total Kit Cost **\$77.50**)

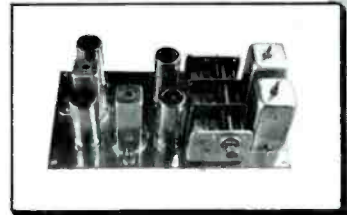

AM Tuning Unit
(Includes IF and
Audio Amplifier) **\$24.50**



FM IF Amplifier **\$19.75**



Chassis Kit

ALL PRE-FAB UNITS ARE ASSEMBLED, WIRED, TESTED, AND ALIGNED AT FACTORY. PRICES SHOWN INCLUDE TUBES.

The FM tuning unit employs a 6J6 dual triode RF amplifier; 6AG5 converter, and 6C4 oscillator. Permeability tuned, stable, and drift-free. High sensitivity of between 6 and 10 microvolts. Dimensions: 7 1/4" x 4 1/2". The IF amplifier for FM uses 6 tubes! 6BA6, (4) 6AU6, and 6AL5 discriminator. High gain, wide band response for highest fidelity reception. Frequency response of FM section, plus or minus 2 DB, 20 to 20,000 cycles. Distortion less than 1/2 of 1%. Dimensions: 11 3/8" x 2 1/2".

The AM tuning unit utilizes a super-het circuit employing four tubes: 6BA6 RF amplifier, 6BE6 converter, 6BA6 IF amplifier, and 6AT6 detector. Extremely high sensitivity and selectivity is accomplished through the use of new, high gain iron-core transformers. Careful alignment provides widest response available from this type of circuit. If builder desires, triode amplifier section of 6AT6 tube may be used as first audio stage.

Chassis Kit includes all necessary parts. Nothing else to buy! Instruction Manual included with detailed, step-by-step procedure, pictures and schematic diagrams.

**MAIL ORDER COUPON
TODAY!**

TO: COLLINS AUDIO PRODUCTS CO. INC.
P.O. Box 368, Westfield, N.J.

Enclosed Find Check Money Order For

In the amount of

for:

NAME _____

ADDRESS _____

CITY _____

STATE _____

RIGHT!



— **from
any
angle**

A challenging answer to low cost, wide-angle high fidelity reproduction. Diffusicone-12 is a newly engineered speaker with exclusive dual concentric cone design, which diffuses the normally beam-like high frequencies. Results in exceptionally uniform response . . . assures full range reception over the entire listening area.

Write today for Bulletin 62N73
— address inquiries to Desk H-9



THE NEW

University DIFFUSICONE-12

An Engineering Achievement of UNIVERSITY LOUDSPEAKERS, INC.
80 So. Kensico Ave., White Plains, New York

build your unit around a **PRESTO "15"**

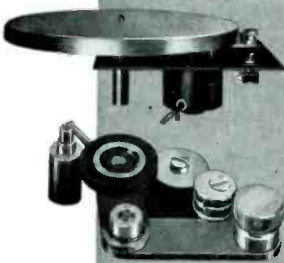

In the PRESTO 15-G-2 turntable—a 12-inch table with the accuracy of a 16"—you'll find features which meet the finest broadcast turntable requirements . . . features which fill the need for high fidelity home installations and assure professional performance that far surpasses any record changer on the market for speed accuracy.

- Extremely quiet—turntable noise well below signal.
- Superior speed regulation—minimum "wow" and flutter.
- Heavy cast aluminum turntable, accurately machined, dynamically balanced.
- Instant speed change—33 1/3, 45, 78 rpm with no pulley change.



RECORDING CORPORATION
Paramus, New Jersey

Export Division: 25 Warren Street, New York 7, N. Y.

Canadian Division: Walter P. Downs, Ltd.,
Dominion Square Bldg., Montreal

WORLD'S LARGEST MANUFACTURER
OF PRECISION RECORDING EQUIPMENT
AND DISCS

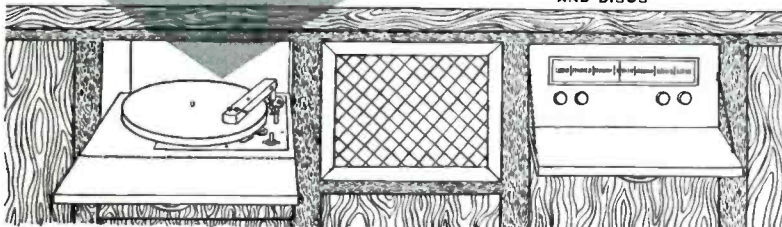

READERS' FORUM

Continued from page 17

of certain critic-reviewers. A sealed record would be but one more step—after we knew that we could trust the manufacturer.

The cost of such selected and sealed records should not be much more than current prices, if any increase was warranted. Certainly, dealers would have fewer damaged records to return or to pass off on the unwary if a personal financial loss were avoided. The average dealer carries only one or two records of many issues and even this represents quite an investment. A damaged record results in lost time for employees, lost sales to discriminating shoppers and lost money in attempting an exchange. Perhaps the dealers could give the best answer as to how frequently classical LP's are auditioned in the stores.

It is surprising how frequently records show manufacturing flaws which are easily spotted at the time a purchase is being made. Again, either the dealer, the manufacturer or the unwary take the loss. Sealed records would place an obligation for closer inspection on the manufacturer. It is asking too much presumably that all records get closer inspection. I have no qualms about returning an unsatisfactory recording.

If you find that the response to Mr. Evans' letter and your editorial is adequate, I will add my part in a "Letter to The Recording Company" campaign.

Morris C. Thomas, M.D.

Madison, Wis.

SIR:

I have a fine collection of old type Edison records, would like to record some on magnetic tape. How can I get an Edison pickup. My old machine is gone.

Thanking you.

Howard Schroeder

Wichita, Kan.

What reader will come to Mr. Schroeder's help? And how about the old cylindrical "discs"? Who has figured a successful way to play back?

SIR:

I can readily see now the tremendous impact your magazine will have upon the whole field. I know it has given me the impetus to get started on my speaker system. Lack of knowledge prevented me from attacking it before, but your very first issue (which I read a few nights ago) gave me the information I needed. This means I will go out and purchase three speakers whereas before I wouldn't go out and buy anything since I just didn't know enough. I also have a friend who, after thumbing through a couple of issues and getting excited over some of the articles, is home now making drawings to fit a custom set into his living room and intends to spend 3 or 4 hundred dollars on hi-fi equipment.

Louis Mazzolla

Paramus, N. J.

Continued on page 94

AT HARVEY You can Hear Them All and Choose the Finest

WILLIAMSON HR-15 AMPLIFIER KIT

The famous, original Williamson HR-15... still acclaimed the leader... in kit form, with the original Partridge Transformers. Assemble this kit, and in 3 hours or less, enjoy the finest sound you ever heard. Operates from a tuner, phono-preamp, crystal pick-up, or other signal source. Absolute gain is 70.8 db with 20 db of feedback. Frequency response: $\pm .5$ db, from 10 to 100,000 cps. Output impedances to match all speakers from 1.7 to 109 ohms. Kit is complete with 5 tubes (1-5V4, 2-6SN7, and 2-6BG6 or 807), 2-Punched Chassis, 2-Resistor Mounting Strips, Sockets, Partridge WWFB Output Transformer, Assembly Instructions, and All Other Necessary Parts. **\$76.50**

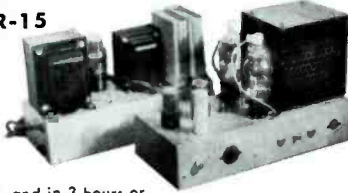

HR-15, as above, but with Partridge CFB Output Transformer (Hermetically Sealed)..... **\$90.00**

PARTRIDGE OUTPUT TRANSFORMERS—Available Separately.
WWFB..... **\$26.00** CFB..... **\$40.00**

NOTE: HR-15 and HR-15T Kits may be had with British KT-66 Output tubes for \$3.00 additional.



The MAGNECORDette

A truly professional tape recorder for the discriminating listener... designed for home use.

- Quickly interchangeable speeds: 7½ or 15 inches/sec.
- Rewinds 1200 feet in 40 seconds.
- Frequency response: ± 2 db, 50 to 15,000 cps. at 15 inches/sec. and 50 to 7000 cps. at 7½ inches/sec.
- Dual AC motors for operation and rewind.
- Maximum flutter 0.3%.
- Housed in an attractive cabinet, natural or walnut.

\$385.00

10½ INCH REEL ADAPTER MECHANISM



Attaches simply and easily to all MAGNECORD and MAGNECORDette Tape Recorders. Permits playback, rewind, and high speed forward with 10½-inch reels. In stock for immediate delivery..... **\$35.00**

JENSEN RP-302 HIGH FREQUENCY UNIT

Makes a 3-Way System From Your Coaxial, or a 2-Way from a Single Unit Direct Radiator.

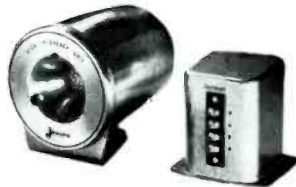

A compact "super tweeter." No installation problems. Simple to mount. Provides smooth, clean highs from 4,000 to approx. 18,000 cycles with extremely low distortion. Model RP-302 **\$32.93 Net**

JENSEN A-402 CROSSOVER NETWORK. Designed for 4,000 cycle crossover. Ideal for use with RP-302 and your present speaker system. Full 180 degree constant-resistance type. Impedance, 16 ohms at input and outputs. **\$6.61 Net**

FIRST AT HARVEY!

The Sensational "Hit" of the New York and Chicago Audio Fairs

The New R-J SPEAKER ENCLOSURE

Designed for use with ANY 12 or 15 inch speaker, this new sensation in high-fidelity has no counterpart in anything available today. The R-J is a new concept. Large enough only to accommodate the speaker, it reproduces tones to the lowest limits of audibility, cleanly and without hangover. The R-J is the amazing solution to the problem of space versus quality.



Order at once for prompt delivery. Specify for 12 or 15 Inch speaker.

Model FM (Mahogany)..... **\$49.95**
Model FB (Blonde)..... **54.50**



CARTER SUPER CONVERTORS

Deliver clean 60 cycle AC power at 115 volts. Operate from storage batteries or other DC source, and available for 6, 12, 24, 28, 32, 64, or 115v input voltages.

Ideal for on-location recordings with quality equipment. Write for complete data and prices.



CANNON PLUGS and CONNECTORS

The standard of quality for over 15 years. You'll find them wherever the ultimate is required in low level sound transmission, and general electrical and electronic applications. Write for complete data and prices.

COMPLETE STOCKS CARRIED AT ALL TIMES FOR IMMEDIATE DELIVERY

HARVEY'S NEW CATALOG OF HIGH FIDELITY EQUIPMENT IS NOW AVAILABLE
Write Dept. HF9

VISIT THE AUDIO-TORIUM. Come in and visit our new sound department... all these items and many more on working display at all times.

HI-FI PICKUP CARTRIDGES

High quality record reproduction begins with the cartridge. Harvey carries a complete line to suit the taste and requirements of the most discriminating audio enthusiast.

AUDAX POLYPHASE

DL-6 "Chromatic"—.001" Diamond and .003" Sapphire Styli..... **\$41.70**
L-6 Sapphire Styli, .001" and .003"..... **20.70**
KL-4 Same as L-6, but with higher output (for record changers)..... **20.70**

G. E. VARIABLE RELUCTANCE

RPX-040 Sapphire .003" for 78 rpm records..... **\$5.97**
RPX-041 Sapphire .001" for 45 and 33½ rpm records..... **5.97**
RPX-050 "Triple Play"—.001" and .003" Sapphire Styli..... **8.37**

PICKERING

S-140S Sapphire .001" for 45 and 33½ rpm records..... **\$15.00**
D-140S Same as S-140S, but with Diamond Stylus..... **36.00**
S-120M Sapphire .0027" for 78 rpm records..... **9.90**
D-120M Same as S-120M, but with .0025 Diamond Stylus **24.90**

Telephone **hrc** LUzemburg 2-1500

HARVEY
RADIO COMPANY, INC.
103 West 43rd St., New York 18, N. Y.

NOTE: In view of the rapidly changing market conditions, all prices shown are subject to change without notice and are Net, F. O. B., New York City.

HEAR THIS!

28 ~ BASS COMPLETE
\$244⁹⁵ NET F.O.B. Los Angeles
500 CYCLE X-0 POINT UNFINISHED



Altec High Fidelity Speakers!
 Smooth Response to 28 Cycles!
 500 Cycle Crossover Point!
 Calif. Sound Toroid Crossover!
 Altec 730A Hi-Freq. Driver!
 Altec 803B L.F. Driver!
 Calif. Sound L.F. Horn!
 Needs No Corner for Full Bass!
 Fits into Small Rooms Easily!
 Adjustable Hi-Freq. Balance!
 34" H x 30" W x 24" D
 L.F. HORN \$68.50 Unfinished.
 MAHOGANY OR BLONDE
 \$45.00 Add.
 F.O.B. Factory, Los Angeles.

CALIF. SOUND PRODUCTS 2-WAY SPEAKER SYSTEM

ANNOUNCING ALTEC LANSING'S GREAT NEW DUPLEX SPEAKER

Guaranteed frequency range 30 to 22,000 CPS. Range never before covered by any speaker system. Full 2-way systems with the N-3000A Network. 3" aluminum edge-wound ribbon voice coils. Three steps of adjustment of high frequency level. Sectionalized horn with 2 x 3 aspect ratio. Designed for high-fidelity custom home music systems. Power handling capacity is 20 watts continuous. Identical except that Model 601A is on a 12" frame and the Model 602A is on a 15" frame. The finest loudspeakers ever made. These amazing Duplex Loudspeakers have the widest and smoothest frequency response of any loudspeaker on the market.



California Sound Products Speaker Cabinet pictured above (less tweeter section) recommended for use with the 602A. \$64.50 unfinished.

TECHNICAL DATA	601A	\$89⁰⁰	602A	\$114⁰⁰
DIAMETER:	12"	NET	15"	NET
POWER CAPACITY:	20 WATTS		20 WATTS	
IMPEDANCE:	8 OHMS		8 OHMS	
WEIGHT:	15 LBS.		25 LBS.	
NOT SHOWN		Net Price with network.		Net Price with network

500 CYCLE TOROID X-0

- Latest Design Using Toroid Chokes
 - Full 1/2 Section — 40 Watt Cont. Power
 - .4 DB Insertion Loss — Compact Design
 - Crossover Point Down Only 2.75 DB
 - Hi-Freq. Attn. Available — .1% Distortion
- \$44⁹⁵** NET

This Network is guaranteed the equal or better of any 500 Cycle network commercially available at any price. Dimensions: 5 x 4 x 2 3/4".



WRITE FOR DESCRIPTIVE LITERATURE ON ABOVE

WEST COAST HIGH FIDELITY CENTER

HOLLYWOOD ELECTRONICS

"ON THE AUDIO MILE"

7462 MELROSE AVENUE • HOLLYWOOD, CALIFORNIA

All Nationally Advertised High Fidelity Components in Stock... Large Listening and Comparison Rooms... Liberal Terms... Quality Service since 1939.

READERS' FORUM

Continued from page 92

SIR:
 As an additional bit of information on the FM situation in Southern California, please be advised that KHJ-FM has moved its transmitter to the top of Mt. Wilson, which naturally improves reception here. The operating hours are something like 1:30 to 9 p. m., however, which means that programs like those of the recent political conventions are left hanging in the air.
 At my sister's home, located about 500 feet from a power company substation with 66 kv. lines, standard AM broadcasts are badly disturbed by noise. She anxiously awaits the hour at which KNX-FM begins operating, for example, so that radio can once more be enjoyed. There is no question in her mind as to which system of transmission is superior.

James M. Sharp

Santa Paula, Calif.

SIR:
 Noting the mentions of FM stations around the Country, I would like to call attention to our local WPOE in Elizabeth, N.J.

WPOE is typical of the small FM stations which are struggling along on limited budgets yet trying to do a job of providing good listening.
 Two better music programs on WPOE are outstanding and are heard six days a week. Mid-afternoon *Musicale* is presented at 3:05 p. m. daily for 55 mins. and *Songs Without Words* at 8 p. m. for 55 mins. Another daily feature is *Footlight Favorites* at 5:05 p. m. for 25 mins. one of the finer music between programs. All are recorded.
 On Saturdays, a 55 min. *Masterworks* of Music program is featured at 5:05 p.m., also recorded.

This is a salute to Cy De Witt, manager of WPOE, and Radio Elizabeth, Inc., the owner, and off-shoot of the Elizabeth Daily Journal.

Robert J. McGarvey

Linden, N. J.

SIR:
 "Noted With Interest" is a very bitter pill for Southern Californians. Here we sit, in the heart of culture, (Hollywood style), with a dozen or more FM stations and not a single live program among them as far as I know. KMGH does a good job with recordings and KNX-FM, with a technically beautiful signal, insists on modulating it off the CBS network.

The listener-sponsored KPFA in Berkeley sounds like a fine and practical idea. Could we hear more about it? I am sure there are enough of us in this area who are looking for something worth tuning our FM receivers to, so that we might be able to finance a similar project.

Harry L. Wynn, HIGH-FIDELITY, Vol. 2, No. 1, page 91, is luckier than he thinks. Our announcers either never saw a high school or, like the horse, just don't give a damn.

Val Adams

La Jolla, Calif.

IMPORTANT BOOKS

Continued on page 90

Mr. Burke's section is already a bit out of date², and quite a few pieces of highly commendable equipment are omitted from consideration.

There is no way for an author to keep current with an industry which is expanding as rapidly as that of high fidelity equipment manufacturing. The lapse of time between putting the last typewritten word to paper, and actual appearance in print of the volume, can be easily six months.

The second limitation is more important: Mr. Burke's section was "intended primarily for the use of people who will not themselves fit the components together . . .". Thus, only complete units which can be readily plugged together are discussed. The vast field of speaker enclosures is limited to a discussion of those which can be unpacked from their crate and set up on the living room floor, necessitating only the attachment of a couple of wires and a final dusting off before the vase of flowers is placed on top. The possibility of mixing components was studiously — and wisely — avoided. We say "wisely", for not even King Arthur himself, Excalibur and all, could undertake to broaden his horizons to include every piece of equipment and every possible combination, and stay within 115 pages!

This mention of limitations is not intended as a criticism. It is a reminder to readers of the SRHBORMASR that the way of achieving a goal described by Mr. Burke is *one* way, and a good way — but it is not the *only* way.

The Saturday Review Home Book of Recorded Music and Sound Reproduction is recommended reading and a valuable contribution to the growing library on the subject of phonograph records and high fidelity. — C. F.

Automatic Record Changer Service Manual, Vol. IV. 8½ x 11, over 200 illustrations. Howard W. Sams & Co., Inc., Indianapolis. 1951-52. \$3.00. HIGH-FIDELITY Book Department No. 99.

Edited primarily for the radio serviceman, this latest Howard Sams' publication is equally important as a reference work for the home hobbyist who likes to tinker with his own equipment. The familiar Sams' exploded-view technique is applied to all current record changers and also to many present-day wire and tape recorders. Installation, operation, and servicing instructions are complete and clear.

The following makes are included: Admiral, Ampro, Concertone, Crescent, Ekotape, Garrard, General Industries, Knight, Masco, Milwaukee, Motorola, Pentron, Philco, RCA Victor, Reelex, Revere, Silverstone, Webster-Chicago, and Zenith.

A valuable feature is a cumulative index covering all record changers and recorders discussed in this as well as any of the three preceding record changer manuals. This index is further cross-referenced by manufacturer and model. For instance, if the

Continued on page 104

²We suggest, naively, that the best way to keep up to date is to read HIGH-FIDELITY.

This **TECHNICAL INDEX** is one reason you need this 28-page volume!



Not just a catalog!

Includes both technical and product data in factual, concise form with dozens of helpful explanatory photographs, charts and tables. Features much engineering information available NO-WHERE ELSE!

IT'S THE **University** **TECHNILOG**

The new 1952 compilation of valuable information that explains and simplifies the application of loudspeakers. A real time and money saver for dealers, contractors, service men and installation designers. The most authoritative, single piece of literature ever published on loudspeakers. It's yours FREE.

TECHNICAL INDEX

SELECTING THE PROPER LOUDSPEAKER SYSTEM	Page 4
METHODS OF CONNECTING SPEAKERS TO THE AMPLIFIER	Page 8
IMPEDANCE MATCHING	Page 9
CONSTANT VOLTAGE DISTRIBUTION SYSTEM	Page 12
IMPEDANCE MATCHING TRANSFORMERS	Page 16
EFFECTS OF MISMATCH UPON POWER TRANSFER	Page 16
CONTROLLING LOUDSPEAKER VOLUME	Page 20
OVERLOAD PROTECTION OF LOUDSPEAKERS	Page 22
PHASING LOUDSPEAKERS	Page 23
REVERBERATION	Page 23
BAFFLING A CONE SPEAKER	Page 26

ADDRESS REQUESTS TO YOUR DISTRIBUTOR



UNIVERSITY LOUDSPEAKERS • INC
80 SO. KENSICO AVE., WHITE PLAINS, NEW YORK

Now for the first time — AVAILABLE FOR ALL RECORD PLAYERS!

hear your LP recordings as you never heard them before!

WITH

DUOTONE
"diamond"



- THE ONLY PRACTICAL NEEDLE FOR LP RECORDINGS
- COSTS LESS PER RECORD PLAYING
- BOTH DISCS AND NEEDLE LAST MANY TIMES LONGER
- THE MOST ECONOMICAL NEEDLE EVER PRODUCED

Your record collection deserves the DUOTONE DIAMOND!

Ordinary needles wear three times faster on LP records, permanently impair record quality. Duotone Diamonds finer tip retains shape, reproduces with higher fidelity, preserves record quality and affords the convenience of the most permanent stylus ever made. Enjoy all the superb original music and protect your costly recordings with Duotone's new LP exclusive! Authentic laboratory tests by recognized sound experts reveal diamond to be the only practical, economical LP needle!

SEE IT...
HEAR IT...NOW!

Made expressly for LP players by
DUOTONE COMPANY
KEYPORT, NEW JERSEY
Famous for phono needles, recording needles,
discs and quality sound accessories.

CLIP... MAIL TODAY

FREE WHAT EVERY AUDIOPHILE SHOULD KNOW ABOUT NEEDLES!

NEW, '52 NEEDLE GUIDE!

Describes:

- Correct DIAMOND needle replacement for individual set.
- Simple installation instructions for all needle replacements.
- Description of original needle supplied with each model.

DUOTONE, INC.

Locust Street

Keypoint, New Jersey

Send free Duotone Needle Guide.

Name.....

Address.....

City..... Zone... State.....

Phonograph Model.....

NEW! 2ND EDITION
of the only complete
reference on **AUDIO!**

**"The Recording &
Reproduction
of SOUND"**

by **OLIVER READ**



Completely
revised and
vastly en-
larged new
edition
**OVER
800
PAGES**

largest selling
book in its field

A "Must" for
Sound Engineers, Hi-
Fi Enthusiasts, P. A.
Men, Broadcasting
Stations, Recording
Studios, Students

CONTENTS:

A Partial List of Authoritative Chapters:

Behavior of Sound Waves; Basic Recording
Methods; Lateral Disc Recording; Microgroove
Recording; The Decibel; Phono Reproducers;
Stylus; Microphones; Loudspeakers and En-
closures; Dividing Networks and Filters; At-
tenuators and Mixers; Home Music Systems;
P.A. Systems; Amplifiers; AM and FM Tuners
— PLUS HUNDREDS OF OTHER SUBJECTS

Now you can have all the *right* answers to
any subject in the field of Audio. Learn how
to select and get the most out of recording
equipment. Tells you how to select the
proper amplifier for given applications, how
to test amplifier performance, how to elimi-
nate hum. Explains microphone, speaker
and pickup principles and selection factors.
Shows how to utilize inverse feed-back, ex-
panders and compressors. Covers hundreds
of subjects—a vast wealth of reliable infor-
mation found in no other single volume. If
you work in the field of Audio, this book be-
long in your library. Order your copy today!

6" x 9" **ONLY \$7.95**
Hard Covers
800 pages 700 illustrations

**ORDER
TODAY**

Order from your Parts
Jobber, or write direct to
HOWARD W. SAMS & CO., INC.
2201 E. 46th St., Indianapolis 5, Ind.
My (check) (money order) for \$.....
is enclosed.
Send copy(ies) of *The Recording &
Reproduction of Sound (RR-2)*. \$7.95 per copy.
Name.....
Address.....
City..... State.....

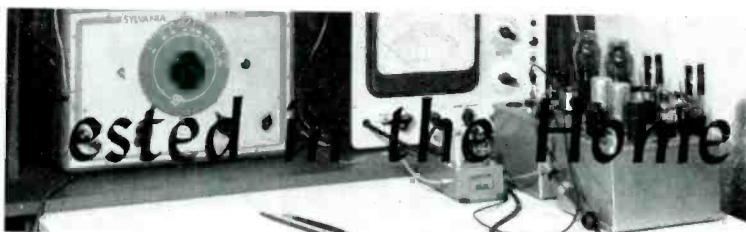

Before discussing in detail the operation
of the MagneCordette tape recorder, it
seems wise to review briefly one or two
fundamentals of the tape recording and
playback process.

Going way back to disc recording, it
will be recalled that when music is trans-
lated onto discs, the loudness of the music
is altered electronically according to its
frequency or pitch. The loudness of the
low frequencies is reduced, relative to the
loudness of the middle frequencies, so that

Tape Equalization

Somewhat the same situation exists with
tape recording. Equalization is necessary
but—and of course, since nothing in the
audio art is simple!—for entirely differ-
ent reasons.

To simplify, perhaps to oversimplify, the
situation, the basic tape frequency char-
acteristic looks like the profile of a hill:
a long, slow climb to a gently rounded
plateau and then a very steep precipice.

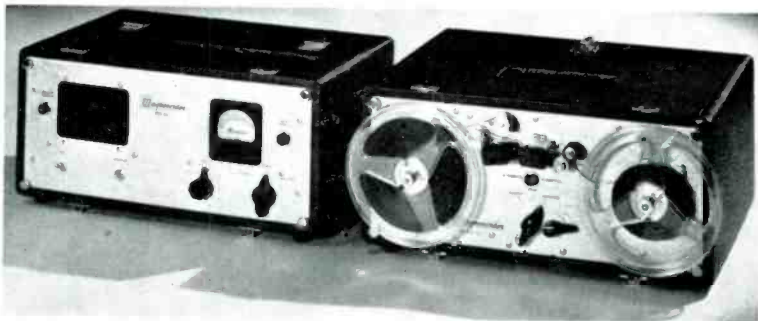

Fig. 1. The standard MagneCord units: amplifier and tape mechanism.

the excursion of the stylus within the
grooves of the record will not be so great
as to break through the walls between
grooves. At the other end of the frequency
spectrum, the loudness of the high fre-
quencies (again relative to the middle fre-
quencies) is increased so that these sounds
will override the background noise or record
hiss on the disc. Compensation for these
alterations in loudness of the original sound
is made when the record is played back
through the familiar preamplifier-equalizer.¹

This profile is shown, engineering-wise,
in Fig. 3. How high the hill is, and at
what frequency the precipice occurs, de-
pends on two (we're oversimplifying again,
but never mind!) factors: tape speed and
gap width. The latter is the amount of air
space between the north and south poles of
the magnet past which the tape passes.
The general rule holds that the smaller

¹For a complete discussion of this subject, see
HIGH-FIDELITY No. 3, p. 31 ff.

Fig. 2. The MagneCordette: tape mechanism with preamplifier, below.



the gap, the higher the frequency at which the precipice occurs and the faster the tape speed, the — ditto.

It is obvious that equalization or compensation must be employed so that we can get out of this hill-and-precipice country and into the flatlands of good frequency response. Because so drastic a change must be effected, it is frequently done in two steps: in recording, between microphone

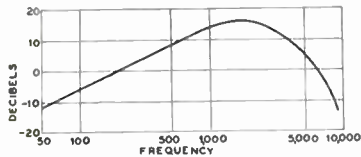

Fig. 3. Tape response without equalization.

and tape, and in playback, between tape and power amplifier. For instance, the record curve used by Magnecord is shown in Fig. 4; the playback curve, in Fig. 5. The final result is the "flat" standard of the National Association of Radio and Television Broadcasters, Fig. 6.

To accomplish this degree of equalization requires elaborate electrical circuits and careful engineering. Partial equalization may be achieved by quasi-mechanical methods. For instance, a loudspeaker deficient in high frequency response may be used in place of a high frequency attenuating circuit, or a microphone with excessive bass sensitivity may substitute for a low frequency boost circuit.

This point is brought out here, first, because we have had a number of reports from tape enthusiasts who have had unsatisfactory results due to recording on one machine and playing back on another. Frequently, the equipment is not to blame; rather, the method of equalization used by the two manufacturers did not match.

Basic Equipment

Further, an understanding of the equalization problem will help clarify what Magnecord has done in bringing out the Magnecordette. The basic Magnecord line includes two fundamental units (with several variations of each): the tape transport mechanism, erase and recording or playback heads are in one unit, at the right in

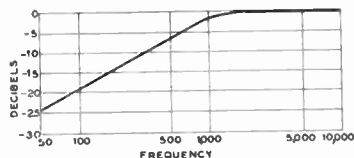

Fig. 4. Magnecordette record characteristic.

Fig. 1. The second, matching unit incorporates the equalization circuits plus a power amplifier and a monitor speaker.

For professional use, this arrangement was well thought out and is decidedly practical. A complete, yet easily carried, recording and playback system can be set up quickly wherever necessary.

Continued on page 98

And NOW...a complete Remote Control Audio

AMPLIFIER

by *Brociner*

Recent advances in loudspeakers, phonograph pickups and in the art of recording have placed more stringent demands upon the amplifier. Extended range in both bass and treble requires lower distortion, better transient response, faster recovery time and, perhaps most important of all, far greater flexibility in tone controls. In meeting these requirements, the Brociner Amplifier is truly a complete instrument.

Evolved after years of experience as the ideal amplifier for demonstrating high quality speaker systems, the Brociner Amplifier is now made available to discriminating listeners who demand the best. Technical specifications are impressive (they are outlined in our bulletin which is available on request), but more important still, comparative tests have proved its superiority in providing hours of musical enjoyment without ear fatigue.

BROCINER
ELECTRONICS LABORATORY
1546 SECOND AVENUE • NEW YORK 28, N. Y.

RECORD LOVERS—Send for FREE copy of "Record Compensators and Preamplifiers" by Victor Brociner.

(Producer of the widely acclaimed A-100 Preamplifier-Equalizer and Corner Reproducers)



Model UL-1 Power Amplifier, 20 watts, Ultra-Linear Williamson-type Circuit.



Completely independent, self-powered, remote control unit. Incorporates the famous Model A-100 Phonograph Preamplifier-Equalizer and the Model CA-2 Control Amplifier.

AVAILABLE SEPARATELY.

MANUFACTURERS OF PHONOGRAPH PREAMPLIFIER-EQUALIZERS • ULTRA-LINEAR POWER AMPLIFIERS • THE TRANSCENDENT HORN-LOADED CORNER REPRODUCER • THE MODEL 4 CORNER REPRODUCER • COMPLETE CUSTOM INSTALLATIONS

- Engineering and Designing to Individual Specifications

ALTEC
AUDAK
BROOK
BROWNING
CONCERTONE
CRAFTSMEN
GARRARD
GRAY
GROMMES
KLIPSCH
LANSING
LINCOLN
MAGNECORD
McINTOSH
PICKERING
REK-O-KUT
SCOTT
STEPHENS

CUSTOM ELECTRONICS
813 Chartres Street • New Orleans

Write for Brochure showing our Complete Services

STEPHENS

TRU-SONIC

INTRODUCES

The Finest Amplifier Ever Built

The NEW 500D DIRECT DRIVE AMPLIFIER



HERE'S WHAT MAKES IT GREAT!

- No output transformer
- Delivers 20 watts of audio
- Frequency response $\pm \frac{1}{4}$ db 20-70,000 c.p.s.
- Distortion less than $\frac{1}{2}$ of one per cent
- Phase shift less than 15° at 20 c.p.s.

Stephens is First Again to Raise the Standard of Excellence in Finest Quality Sound Systems

In fine sound systems the trend is away from use of transformers. The Stephens Tru-Sonic 500 D Direct Drive Amplifier is the first to successfully eliminate the output transformer. You get 20 watts of audio plus the elimination of all distortion introduced by transformers. There is less phase shift than ever experienced with a transformer—especially on the low end. What This Means To You...clarity of tone never before experienced in sound reproduction. Full rich tones without hum and noise. When used with matching Stephens speakers having 500 ohm voice coil impedance, you experience the ultimate in fine listening. These speakers which are specially wound for use with the 500 D Amplifier are unsurpassed in excellence of sound reproduction. The discriminating listener will find no equal to these companion developments which set a new high standard in listening pleasure.



The 5106AX, a new 500 ohm voice coil co-axial speaker. The perfect companion for the 500 D Amplifier

See your dealer for literature on this outstanding development or write direct today!

Those Who Treasure the Art of Listening Select

STEPHENS MANUFACTURING CORPORATION
TRU-SONIC
8538 WARNER DRIVE, CULVER CITY, CALIF.

TESTED IN THE HOME

Continued from page 97

However, for those who had high fidelity systems, the power amplifier and speaker equipment was superfluous because it duplicated the amplifier and speaker already existing in a home system.

In designing the MagneCordette, the manufacturer put the equalization and pre-amplification section into a small chassis which could be used in conjunction with the standard Magnecord tape transport units. Finally, for home use, attractive cabinets were designed to house the two units. Thus, in Fig. 2, the large upper unit is the standard Magnecord PT6-AH. At the bottom, below the two reels, is the equalization unit.

That, briefly and basically, is what Magnecord has done in bringing out its new line. How does it work? During the week we were in Chicago, back in May, for the Parts Show and Audio Fair, we used a

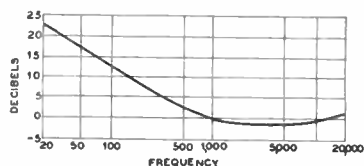

Fig. 5. MagneCordette playback response.

MagneCordette as part of our demonstration equipment in the HIGH-FIDELITY exhibit. We put it through most of its paces (we were not able to try it out with a microphone, though we did transfer records to tape). General verdict: a very neat, compact, and excellent piece of equipment.

Technical Description

Let's start with a technical description of the unit and its circuitry, with instructions on how to connect it into a home system, as written for us by the manufacturer:

"The MagneCordette features the same mechanical unit and recording mechanism used in Magnecord's broadcasting and professional models. It is designed for home,

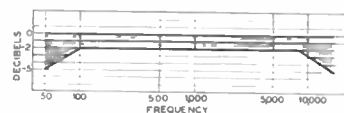

Fig. 6. NAB standard frequency tolerances.

office, school and church use, but meets performance standards of the National Association of Radio and Television Broadcasters.

The standard PT6-A mechanical part of the unit has separate erase and record-reproduce heads (either full or half track), and includes 7½- and 15-ips. tape speed capstans. The frequency response is from 50 to 15,000 cycles ± 3 db at 15 ips. The PT6-A is equipped with standard 7-in. reels, but may be adapted to 10½-in. reels. Rewind speed is 1800 ft. per second.

Continued on page 100

**HEAR THE
NEW**

**ALTEC
DUPLIX
SPEAKERS**



in...

KIERULFF'S

new

**Audio-ophile
Haven**

The only speakers in the world with *guaranteed quality*. Hear and compare these amazing new Altec "duplex" speakers in the most complete high fidelity center in the west. Expert or neophyte ... you'll enjoy visiting Kierulff's *Audio-ophile Haven*, an electronic dream. Let Kierulff solve all your sound problems with audio know-how backed by 30 years of experience.

KIERULFF
Sound Corp.

820-830 WEST OLYMPIC BLVD.
LOS ANGELES 15, CALIFORNIA

NEW PERFORMANCE STANDARDS
with the **WEATHERS FM CAPACITANCE CARTRIDGE**

20 to 20,000 Cycles Response

W-202 or
W-202-C
Cartridge
Set



DO YOU REALIZE WHAT LOWER
STYLUS PRESSURE CAN DO FOR
REPRODUCTION FIDELITY AND
RECORD LIFE?????

You can operate with stylus pressures
down to one gram with the new WEATH-
ERS Cartridge!

Get the NEW W-202-C Cartridge Set for your present
record player (automatic or manual to enjoy unex-
celled high fidelity reproduction).



For the ultimate in record reproduction, with
one gram stylus pressure, combine the standard
W-202 Cartridge Set with the new WEATHERS
W-12 or W-16 Reproducer Arm.



W-12
Reproducer Arm

Change to the WEATHERS Cartridge NOW and preserve
your records for the years to come.

See your dealer or
write for literature

WEATHERS INDUSTRIES

Box 531 66 E. Gloucester Pike
Barrington, N. J.

how to enjoy **NEW REALISM** from your
records or radio!



Shown are the McIntosh 50W-2
amplifier and AE2A remote controller.
Your dealer can help you make them
a part of your present system or
guide you in the selection of related
components. WRITE TODAY, for free
booklets and name of nearest dealer.

... from patient years of laboratory
research has come a basically new
audio amplifier—the McIntosh
50W-2. To you, this means new
heights of enjoyment—magnificent
realism of the music you treasure, on
records or tape. And the versatile
McIntosh brings "living presence"—
a new naturalness of sound to your
present radio or TV set.

Only McIntosh gives such distortion-
free performance over the entire
range of human hearing, with the
reserve of power essential for com-
pletely adequate reproduction.

McIntosh
LABORATORY, INC.

326 Water Street
Binghamton, N. Y.

LAFAYETTE Radio

HEADQUARTERS

High-Fidelity **FOR Music Lovers**

CUSTOM BUILT

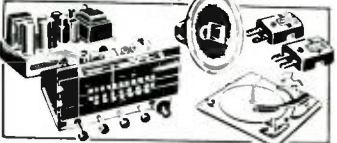

RADIO PHONOGRAPH EQUIPMENT

Come in and see how easy it is to own the finest in FM-AM Combinations. This is only one of hundreds of ensembles. T.V. can be included **1995**

HEADQUARTERS FOR HIGH-FIDELITY PHONO-EQUIPMENT

GENERAL ELECTRIC PICKERING JUDAK

3 SPEED RECORD CHANGERS

Garrard - VM Triomatic
Markel-Webster-Chicago



- Webster Model 701-1, with dual needle turnover crystal cartridge Net **37.24**
- Webster Model 101-270, as above, but with G.E. RPX-050 triple-play magnetic cartridge in standard tone arm. Less pre-amp Net **38.81**
- V-M Model 951, with turnover crystal cartridge and dual needles Net **29.62**
- V-M Model 951GE, with G.E. triple-play variable reluctance cartridge and dual needles, less base. Requires pre-amp. Net **32.80**
- Garrard Model RC-80 Changer Net **41.45**
- Markel Model 74 Changer Net **63.39**

GE Pre-Amplifiers

- Self powered preamp UPX003- NET **10.55**
- External powered preamp SPX001- NET **7.00**

CARTRIDGES AND STYLI

- G.E. RPX-041 Single-Play Cartridge LP \$ **5.85**
- G.E. RPX-040 Single-Play Cartridge Std \$ **5.85**
- G.E. RPX-050 Triple-Play Cartridge \$ **8.20**
- G.E. RPJ-010 Sapphire \$ **3.50**
- G.E. RPJ-007 Needle \$ **2.06**
- G.E. RPJ-003 Sapphire .001" Needle \$ **2.06**
- G.E. RPJ-001 Sapphire .003" Needle \$ **2.06**
- G.E. RPJ-004 Diamond .001" Needle \$ **16.17**
- NEW: G.E. RPJ-013 Triple-Play Needle Has .001" Diamond Tip and .003" Sapphire Tip \$ **18.23**
- NEW: G.E. RPX-052 Triple-Play Cartridge, 1 MIL Diamond and 3 MIL Sapphire Tips \$ **22.90**

COMING!!

THE GREAT NEW STROMBERG-CARLSON HI-FIDELITY LINE

Lafayette Custom Radio & Television

New York: 100 Sixth Ave. • RE 2-8600
Newark: 24 Control Ave. • MA 2-1661
Boston: 110 Federal St. • HU 2-7850

LAFAYETTE, Dept. W
100 Sixth Ave., N. Y. 13, N. Y.

Send FREE Hi-Fi Guide everything on high fidelity.

Name.....
Address.....
City..... State.....



TESTED IN THE HOME

Continued from page 98

The MagneCordette amplifier is designed to permit recordings to be made from a microphone or from the output of a radio tuner, crystal pickup, or from the output of a preamplifier used with magnetic cartridges.

Recordings may be played back through the PT6-G into any custom amplifier-speaker installation or into the "phono" connection of a radio or public address system.

Recording

The MagneCordette unit may be used to record direct from a microphone or may be connected to a tuner or phonograph to permit recording from radio or phonograph. If a microphone is used, it should be a high impedance type. Any high quality microphone meeting this condition may be used and should be purchased equipped with an Amphenol 75-MC-IF connector. The microphone connector on the amplifier is of the shorting type, thus silencing the microphone preamplifier when no microphone is used. When choosing a microphone, the best possible unit should be obtained. The microphone cable should be of a suitable low capacity, well shielded variety.

If it is desired to make recordings from a radio tuner, this unit should be connected to the PHONO input on the MagneCordette. The connector is the RTMA pin type, which is the industry standard for this type of connection. If the tuner used has several output connections, the one marked DETECTOR should be used. Well shielded low capacity cable should be used to connect the tuner to the MagneCordette and the pin plugs should be well soldered to the cable.

The output from almost any standard crystal pickup may be connected directly to the PHONO input of the MagneCordette.

In the case of a phonograph equipped with a magnetic or reluctance type pickup it will be necessary to use the preamplifier normally connected between cartridge and power amplifier.

A standard phone jack marked MONITOR is mounted on the front panel of the MagneCordette. Any high quality earphone may be plugged into this jack to permit monitoring while recording, or listening during playback. Like the main output connection, the monitor jack is connected at all times, both when recording and when playing back.

Output Connections

The monitor jack is electrically similar to the output jack and may be used as an alternate output connection if desired. However, the two connections are electrically separate, so the use of different types of earphones will in no way affect the response of the output.

Both the phono and mike inputs on the MagneCordette are disconnected entirely when the machine is set for playback, hence it is possible to connect the MagneCordette permanently to any point in an existing home installation without affecting the

Continued on page 101

THE AUDIO EXCHANGE

RETROSPECT and PROSPECTS

While we cannot take credit for having originated the idea of the trading post, we are pleased with ourselves for having established the first reliable agency through which new and used audio equipment may be bought, sold, and traded.

We began our operations on a very modest scale. But we had an idea of offering a new service which we felt was needed, and we went all out to give just that: service, service, and more service. Through the suggestions of our customers and friends, and through much self-analysis and self-criticism we have been able to develop an organization worthy of the patronage of a sizeable number of audiophiles, and to convince them that there is good reason for dealing with us. And in looking back upon the hardships of getting started it is a highly satisfying realization that a good idea, intelligently and faithfully executed is still capable of balancing a lever with some mighty weights on the other side of the fulcrum.

We have not only survived our first year, but have done better. We have just re-organized to give us three times the display space we had in the beginning, and we are now carrying an enlarged stock of new equipment in addition to a good-sized stock of used-guaranteed equipment, ranging from phono-cartridges to professional recorders. We also now have the famous English Hartley-Turner 215 speaker on display—another first for the Audio Exchange in this area.

For those of you who cannot visit us (and ours is one of the few places which welcomes your visit on any basis), we have periodic catalogues of used equipment and latest information on certain new items. Please write to get on our mailing list if you think you might be interested in availing yourself of our unique and comprehensive services:

- We will take the time to give you the personal service you need and want.
- We manufacture several items which are not available elsewhere, or not of the quality we want.
- We make it easy for you to improve your audio-system by taking your components in trade.
- We save you money with used-guaranteed equipment, sold at used equipment prices.
- We are primarily interested in music and regard audio-engineering as a means, not an end.

THE AUDIO EXCHANGE, INC.

159-19 Hillside Ave., Jamaica 32, N. Y.
OLympia 8-0445

the trade is invited to a showing of a new line of **the first and finest** completely packaged **high fidelity** radio-phonographs at the **1952 audio fair hotel new yorker** october 29, 30, 31 and november 1.



the sound workshop



modern modular arrangements match beauty with flexibility. pricings and details available immediately.

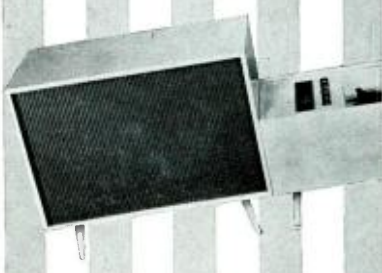

75 north eleventh street
brooklyn, new york

TESTED IN THE HOME

Continued from page 100

operation of other units. For instance, the phono input may be connected permanently to the output of a custom pre-amplifier without disturbing other connected amplifiers.

The MagneCordette may also be connected directly to the input of a power amplifier if desired. The output connector of the MagneCordette is the standard RTMA pin type.

The MagneCordette output impedance is approximately 100,000 ohms and the output voltage is sufficient to drive any power amplifier.

Flexibility of Equipment

So much for the general description of the unit. Since the heart of the MagneCordette is the basic tape mechanism, it would be well to review the various types of units available in this classification. The model PT6-AH is the basic recorder. Normally, these units are supplied with a single-speed motor and to change tape speeds from 7½ to 15 ips., the capstans and pressure rollers are changed. However, PT-6 recorders are also available with two-speed motors to permit operation at 3¾, 7½, and 15 ips.

The PT-6 units are equipped with an erase head, and a combination record-playback head. The PT-63 series are equipped with an erase head and separate record and playback heads. The three-headed MagneCordets are available with high speed forward (model PT-63-AH), and also with two-speed motors.

All of the above basic mechanisms can be purchased with either single or dual track heads.

The Need for Three Heads

The number of heads (two or three) is of importance from one point of view. Three heads permit recording and playing back simultaneously. Thus it is possible, with a three-headed machine, to monitor directly from the tape, a fraction of a second after the sound is recorded.

With two-headed machines, the same head is used for redording and for playing back. Hence, it is not possible to monitor from the tape, nor to listen to what is on the tape while a recording is being made. With tape recorders using only two heads, monitoring is accomplished by tapping in on the input side of the tape and listening in, so to speak, on what is going onto the tape.

The standard MagneCord playback amplifier can be used with three heads; the MagneCordette preamplifier can be used only with two-headed tape mechanisms.

The MagneCord units are designed for use with 7-in. reels of tape. They may be adapted for 10½-in. reels by the addition of two side arms. The reels, on the side arms, are then driven by belts from pulleys mounted on the original reel shafts. With the adapter arms in place, it is not possible to close the doors of the cabinet, Fig. 2.

Only 10½-in. NAB hub reels can be used on the arms. To go back to a 7-in. reel,

Continued on page 102

USING A WILLIAMSON?

Double Your Power Output and cut Distortion in Half by Converting to **ULTRA-LINEAR** Operation with **ACRO TO-300**

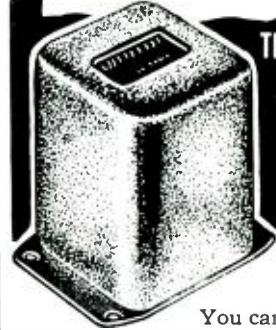

The World's Finest **AUDIO OUTPUT TRANSFORMER**

You can install an Acro Transformer, or have your custom builder install it for you. Only a few resistors and condensers are involved in converting to ultra-linear operation and the layout remains the same. Get more out of your Williamson by giving it the specifications listed below.

Specifications

- Response — 1 db 2 cps. to 200 kc.
- 30 watts of clean power within 1 db. 20 cps. to 30 kc.
- Less than 1% IM at 20 watts.
- Square wave transmission to 50 kc.

ACRO TO-300 \$24⁷⁵ net

ACRO TO-310 \$18⁷⁵ net

(TO-310 used to change over 6V6 amplifier to ultra-linear operation)

FREE Write for ACRO Catalog showing amplifier schematics and conversion information.

Radio Electric
SERVICE CO. OF PENNA., INC.

701 Arch St., Phila. 6, Pa.
Please ship Acro Transformer

TO-300 TO-310

Check or .MO. enclosed.

(Include postage. Shipping weight 7 pounds.)

Name

Address

City State

EASY LOW-COST WAY to own a

PROFESSIONAL QUALITY

DUAL SPEED—HIGH FIDELITY

tapeMaster

TAPE RECORDER



**PORTABLE
MODEL PT-125**

Use with Your Own Audio Amplifier, Radio or Radio-Phono Combination, or with new tapeMaster Model SA-13 Power Amplifier and Speaker.

For the first time, a completely-flexible professional quality tape recorder like this—at such economical cost! Advanced engineering and customized design make the tapeMaster a natural choice of recording enthusiasts everywhere. Can be carried anywhere and used with an existing audio amplifier or combined with the SA-13 to make a complete tape recorder and playback assembly far superior to other more costly equipment. Ideal for home, school or commercial use.

Complete with 5" spool of plastic tape and 7" empty take-up spool, in sturdy carrying case covered with waterproof leatherette, less audio amplifier and microphone. Size: 12½" x 12" x 9½" high.

Net Price **\$9950**

Built to RTMA Standards • Dual Track—Manual Reversal • Dual Speed—7.5" and 3.75" sec. • Single Knob Instantaneous Speed Change • Fast Forward and Rewind • "A" Wind Tape • Direct Threading of Tape • Push-Pull Supersonic Bias-Erase • Response 50-8000 cps. ± 3 db at 7.5 and 50-5000 cps. at 3.75 • Inputs for Radio, Phono and Mike • Outputs for Audio Amplifier and Headphone • Full Monitoring • Neon Record Level Indicator For 105-125 V. 60 cycle AC (Also available for 110-220 V 50 cycle AC) • Operates Vertically or Horizontally.

Send for FREE Bulletin 102-A



**MODEL SA-13
POWER AMPLIFIER
AND SPEAKER**

Portable companion to the PT-125 tape recorder. Combines a special type speaker, new amplifier design, and effective principle of baffling. Amplifier response ± 1 db 30-15,000 cps. Peak output 8 watts. Has separate bass and treble control. 12" x 9½" x 18½" high.
Net Price **\$7950**



FOR CUSTOM INSTALLATIONS

Model TH-25 Dual Speed Tape Transport Mechanism with Model PA-1 Matching Pre-Amplifier and Push-Pull Supersonic Bias-Erase Oscillator. Fully wired, ready to plug in. Without spool of tape, take-up spool and carrying case.
Net Price **\$8850**

Units may also be purchased individually (Prices Slightly Higher West and South)

TESTED IN THE HOME

Continued from page 101

the belts are removed, the pulleys are slipped off the regular reel drive shafts, and the small reels are then used in the normal fashion. (There is a way to use a 7-in. reel on the 10½-in. arms, in an emergency, but it is not recommended practice and shouldn't be discussed "in public".)

The Controls

Looking at Fig. 2, the controls on the pre-amplifier-equalizer unit are as follows, reading from left to right: phone jack for monitor connection (note that the unit illustrated is a two-headed variety, so the monitoring is done on the input); equalization switch, to compensate for 3¼, 7½, and 15 ips.; record level indicator (a blinking-eye type—very sensitive and active); combined on-off switch and volume control, which acts on both record and playback volume; and finally, at the extreme right is the record-playback switch. Professionals do not need to be told the danger of flipping this switch inadvertently into the record position, but for amateurs or those who use tape equipment only from time to time, we feel that some sort of a locking device would be advisable. During the week we used the MagneCordette in Chicago, thousands of visitors to our exhibit examined the recorder... and we had several minor heart attacks wondering if someone might flip that switch over to the record position without our noticing it!

Above the record level indicator is the tape transport control switch. The central position is stop; to the left is rewind and to the right is forward. The forward speed of the tape is controlled, of course, by the speed of the capstan. Drive shafts (or belts, when the 10½-in. reel adaptors are used) simply maintain tension of the tape. Just to the left of the tape transport control lever is a small button. This must be depressed before the control lever can be turned into the forward position. This serves as a safety catch to prevent switching from reverse to forward so suddenly that the tape would snap. When the machine is used primarily for playback, having to push this button is bothersome at first.

To the right of the tape transport control is the fast forward switch. Pushing it down brings it into action.

Above the transport control is a pilot light which goes on when the record-playback control is turned to its record position.

Easy Editing

The tape is threaded around two idlers, across the heads, and through the capstan and pressure roller to the takeup reel. A small hinged plate covers the tape as it passes across the record-playback head. This feature is of great convenience in editing, since the tape can be exposed and a mark made at the exact spot. Another feature, of importance in editing, is that the tape is in contact with the playback head even though the reels are not moving. Thus the

Continued on page 103

TESTED IN THE HOME

Continued from page 102

tape can be jockeyed back and forth by hand and the sound listened to over the speaker system. Some recorders use pressure pads to hold the tape in contact with the head and the pads exert pressure only when the tape is in motion. This makes "hand listening" difficult if not impossible.

Rewind can be accomplished by turning the tape transport control to rewind and letting the tape feed back past the heads and over the idlers, but this method is slow. Whiz-fast results can be secured by removing the tape and letting it run directly from takeup to supply spool. This is particularly true when 10½-in. reels and adaptors are used, since the torque required to turn the big reels is considerable.

Changing 7-in. reels is a simple matter of twisting a knurled knob a half-turn to release the spring pressure which it exerts. Changing 10½-in. reels is a more tedious process. A spring-pressure-fit hub is snapped into the reel. This is then held on the shaft by a threaded collar which is tightened up by means of a knurled knob. A little practice makes this a relatively quick job.

Conclusion

Sound-wise, the unit is excellent, as may be expected of equipment manufactured by an organization with Magnecord's repute. When 7-in. reels are used, the unit has the very real advantage of compactness and efficiency. Editing is particularly easy.

All in all, a most welcome addition to the tape recording field.

NOTED WITH INTEREST

Continued from page 88

books are already out, another is promised for late September, another for early Spring. The September release is to be Harold Weiler's "High Fidelity Simplified", which will sell for about \$2.50 and include thirteen or more chapters on basic principles and basic equipment. John Rider is publishing it; we hope to have a copy in time for review in our November issue. — C. F.

TRADER'S MARKETPLACE

Here's the place to buy, swap, or sell audio equipment. Rates are only 20c a word (including address) or \$20 an inch, and your advertisement will reach 20,000 to 40,000 audiophiles. Remittance must accompany copy and insertion instructions.

FOR SALE: Garrard RC-80 3-speed Record Changer, in mahogany cabinet. Perfect. Plug-in arrangement. \$85. Less Pickering Diamond Cartridge, \$60. Also will sell, buy, or exchange LP's. Private. G. Winn, 174 La Pier St., Glencoe, Illinois.

HIGH-FIDELITY EQUIPMENT AT BARGAIN PRICES. Free catalog. Box 5 High-Fidelity Magazine, Great Barrington, Mass.

BEAUTIFULLY built custom Ultra Linear Williamson Amplifiers-Dual Chassis—\$89.50. Dr. Nicely, Kenton, Ohio.



FAS Air-Coupler for Bass Reinforcement

Good News . . . The Dual Air-Coupler for bass reinforcement is in stock, ready for delivery. This is the improved model described in Radio Communication last October, and in the Winter Edition of High Fidelity.

As more and more of the most critical audio experts install Air-Couplers in extended-range systems, reports of remarkable performance continue to pour in. One of the most enthusiastic owners is Paul deMars, former chief engineer of the Yankee Network, and a pioneer in high-quality reproduction. He said: "I have never heard such magnificent tone from records and live-tape FM as I am getting from my Air-Coupler in combination with a dual speaker for intermediate and treble frequencies."

For your convenience . . . the Air-Coupler is available in both knock-down form, so that you can assemble it with a screwdriver, or completely assembled, ready to mount the speaker. Made entirely of first-quality ¾-in. plywood, with each piece cut to precision fit.

DUAL AIR-COUPLER, IN KNOCK-DOWN FORM . . . now only \$34.50
Every part is furnished, including the screws. Illustration shows assembled Air-Coupler, before front panel is mounted. Opening is cut for any 12-in. speaker, the recommended size.

DUAL AIR-COUPLER, COMPLETELY ASSEMBLED . . . now only \$47.50
If you haven't the time or the inclination to put the parts together yourself, then here is the Air-Coupler completely assembled and finished in a truly professional manner. Supplied as illustrated, with front panel in place, ready for the speaker.

MISCELLANY: we carry in stock . . . Altec 600-B 12-in. speaker for the Air-Coupler, \$46.50; Peerless S-230Q output transformer, \$26.00; Peerless R-560A power transformer, \$16.00; Peerless C-455A power choke, \$10.00; English KT-66 output tube, \$4.95; Recon CHU2 tweeter, \$23.10.

Crossover Networks for Any System of Two or More Loudspeakers

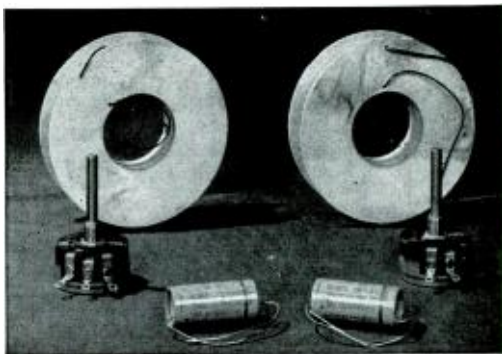

By a judicious selection of associated components, the three coil sizes on which G.A. has standardized enable our customers to secure low-cost crossover networks which will operate at 14 different crossover frequencies! For the experimenter, that means a wide range of choice without having to break the bank to buy dozens of coils. For the man who wants to install his system once and for all, it means money saved, because G.A. saves money by making only three coil sizes (10.2, 5.1, and 1.6 Mh) — and it passes on those savings direct to its customers.

If you want to use three speakers with crossover points at 350 and 1,100 cycles, for example, just order two of the networks listed above (for an 8-ohm system, with rapid crossover attenuation, it would be No. 6 and No. 8).

As most everyone has found out by now, G.A. is headquarters for crossover networks. As far as we know, we're the only organization stocking networks specifically designed for use with Air-Couplers.

If you are in doubt about the selection of a network for your particular speakers, send 10c for the G.A. Network Data Sheet, from which you can determine your requirements exactly.

RAPID ATTENUATION NETWORKS

12 db droop per octave. These networks use two inductance coils.

Impedance of low frequency speaker	Crossover Frequency	Order by Number	Price 2 Coils Only	Price Complete*
16 ohms	2,200	No. 1	\$7.00	\$11.50
	1,100	2	7.00	12.00
	700	3	12.00	16.00
	350	4	12.00	17.50
	175	5	20.00	24.00
8 ohms	1,100	6	7.00	12.00
	550	7	7.00	13.00
	350	8	12.00	17.50
	175	9	20.00	24.00
	85	10	20.00	26.50
4 ohms	550	11	7.00	13.00
	275	12	7.00	15.00
	175	13	12.00	19.00
	85	14	20.00	26.50

* Complete networks include necessary capacitors and level controls. Be sure to indicate whether you want just the coils or the complete network.

SAVE C.O.D. Charges! Send remittance with your order.

General Apparatus Co.

South Egremont, Massachusetts

Unparalleled
"PRESENCE"

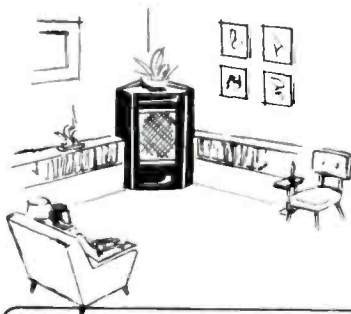

Famous
TANNOY
 DUAL CONCENTRIC
LOUDSPEAKER SYSTEMS

**NOW AVAILABLE
 IN AMERICA!**

Now experience the amazing listenability of wide range response in perfect balance. Hear the world famous Tannoy Dual Concentric Loudspeaker System, providing optimum fidelity at any level from the audibility threshold up to full room volume. Features of the Tannoy System include:

Substantially flat response from 40-20,000 cycles per second. Concentric sources for both HF and

LF components avoiding interference at crossover. HF horn formed by machined center pole and LF diaphragm, these combined with a special throat insure correct HF match. Intermodulation product less than two percent.

Hear it to appreciate it! Write for free brochure and name of nearest distributor today. 12" and 15" types, handling 15, 25 watts.

SOME DISTRIBUTORSHIPS STILL AVAILABLE

TANNOY
BEAM INSTRUMENTS CORPORATION
 350 FIFTH AVENUE NEW YORK 1 NEW YORK

**To hear TANNOY demonstrated
 visit the sound auditoriums
 of these eastern distributors:**

New York, New York
 Sun Radio & Electronics Co., 124 Duane Street

Washington, D.C.
 Shrader Manufacturing Co., Inc., 2803 M Street, N.W.

Philadelphia, Pa.
 Almo Radio Co., 509 Arch Street

Syracuse, New York
 Stewart W. Smith, Inc., 325 East Water Street

IMPORTANT BOOKS

Continued from page 95

changer is in an Aircastle Model 127084, the index shows that this radio-phonograph used a Milwaukee-Erwood model 10700 changer, which was "exploded" in Section 18 of Vol. 1. Or, if the equipment is more modern, say a Du Mont RA-109A, the index shows that in this case, Du Mont used a Webster-Chicago model 100, which is described in Section 143 of the latest volume.

This is a good book to own... even if all it does is to show, very clearly indeed, just how many parts there are in a changer and thus steers off the *would-be* tinkerer. For the man who has already removed the three nuts and had the unexpected spring pop onto the floor, the "Record Changer Service Manual" will help him to figure out just where that spring sprung from! — C. F.

Amplifiers: The Why and How of Good Amplification, by G. A. Briggs and H. H. Garner. 216 pages, 5½ x 8¾, 174 illustrations. Warfedale Wireless Works, England. 1952. \$2.95. HIGH-FIDELITY Book Department No. 100.

G. A. Briggs is fast becoming one of the best known popular writers on audio. Such popularity must be deserved; his latest effort — in which he combines forces with Major H. H. Garner — will add to his reputation because in a book of but little over 200 pages, he has covered, with astonishing success, the myriad considerations involved in amplifier design and construction. It seems as if almost every possible point had been touched upon, perhaps briefly, but nevertheless with an indication of the relative importance of each point and of the author's conclusion as to which method of achieving a certain end is best.

This discussion of points and conclusions may sound like bailllegab. The fact is that there always seem to be at least two ways of doing anything. When audio amplifiers are in question, there are umpteen things to be done, and almost as many ways of doing each one of them. Hence it is important to bring out that Briggs and Garner finish almost every major section of the book with a "final summary" or a "conclusion" which states the opinion of these two authorities on whatever facet of amplifier design they have been discussing. For instance, there is a chapter on cathode followers. Subheads in this chapter include: basic circuit, theory of operation, cathode follower output stage, practical design, comparable tetrode output, and finally, conclusion — which states, in part: "The use of the cathode follower in the output stage (of the power amplifier) is judged to be hardly worth-while, but a trial of the system may interest the experimenter". Thus, when the reader has finished this chapter, he will understand what a cathode follower is, why it is used, how it works — and be assisted to a conclusion.

"Amplifiers: The Why and How of Good Amplification" covers basic theory briefly and understandably, albeit with the use of a good many formulas. Then a chapter is devoted to each of the following subjects:

Continued on page 116

New Equipment

NOTE: Announcement in mid-summer by Altec-Lansing of two completely redesigned coaxial speakers has created considerable interest among audiophiles. Although we have not yet had an opportunity to do a *Tested in the Home* report on these units, we are glad to be able to publish the following description of the Altec 601-A and 602-A furnished by John K. Hilliard of Altec.

The Altec Lansing models 601A and 602A differ in the size of the low frequency cone and magnet structure. The 12-in. 601A (Fig. 1) has a 1.8 lb. magnet, whereas the 15-in. 602A has a 2.4 lb. magnet.

Low Frequency Unit

The complete assembly is mounted on a pressed steel frame. The magnet for the low frequency unit is of the center core type. The 3-in. aluminum ribbon voice coil has an impedance of approximately 8 ohms at 400 cycles. A cloth spider is used as a center suspension and the natural resonance is below 50 cycles. The outer edge of the seamless molded cone is treated with a viscous damping solution to absorb the reflections

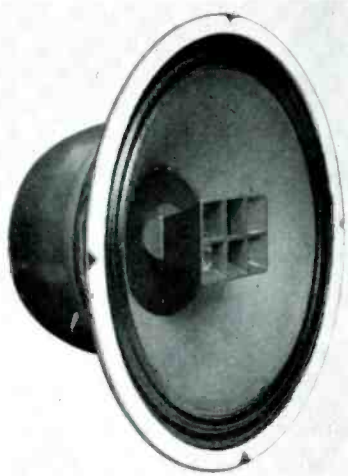

Fig. 1. The Altec-Lansing coaxial speaker.

at the clamping point. The properties and shape of the cone used in the low frequency unit are quite different from the one used for full range application. To insure good reproduction from the low frequency section, a stiff cone having a steep slope between the voice coil and the outer rim is used. This avoids any tendency to buckle.

High Frequency Unit

To insure optimum performance, the mass of the high frequency voice coil is about 1/100 of an ounce, as compared to the 1 1/2 oz. of the low frequency voice coil.

The high frequency unit is composed of a 1-in. diaphragm which has a rigid spherical center and a tangentially corrugated an-

Continued on page 106

Sun Radio of New York For the Best in High Fidelity

TANNOY



EXCLUSIVE with SUN RADIO in NEW YORK

You will experience for the first time the thrilling, unparalleled "room presence" when you hear the faithful reproduction of a Tannoy Speaker System. 12" and 15" types, handling 15, 25 watts. HF transducer inside magnet system, substantially flat response from 40 to 20,000 cps. Low "natural" crossover frequency. *Exclusive at Sun Radio, exclusively for your home.*

15-DCL 15" with crossover network **\$159.00**
12-DCL 12" with crossover network **\$130.00**

New! HIGH-FIDELITY by STROMBERG-CARLSON

Sun Radio proudly introduces Stromberg-Carlson to high fidelity enthusiasts. Now, there is no reason why you should procrastinate. Here is a complete, integrated high fidelity system you can afford. All components are designed to operate together as a complete, brilliantly designed system, or you can use any unit with your present set-up. Incorporating the latest engineering developments, Stromberg-Carlson combines quality with economy. Don't wait! Hear it now! Available at Sun Radio!

SR-401 AM-FM Tuner **\$139.95**
AR-410 10 watt amplifier **\$79.95**
RF-471 12" co-axial speaker **\$49.95**

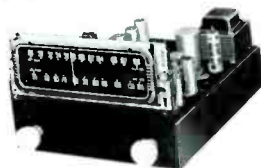
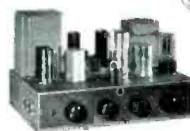
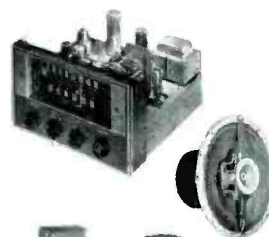

BOGEN R-604 AM-FM TUNER

A completely new tuner, remarkably versatile. Designed to operate with almost all high fidelity systems. The minimum of duplication of controls or circuits and maximum quality. Priced sensationally low but far outclasses more expensive units. Features AFC, temperature stabilized oscillator, phono input, permeability tuned. Write for complete specifications of this superb tuner. **R-604 AM-FM Tuner.... \$95.40**



GARRARD RC-80 RECORD CHANGER

Designed for those music lovers who demand the finest record performance. You can depend on Garrard for a constant, accurate speed turntable. Operates fully automatically at all three speeds, plays all records of all sizes. Automatic stop at end of last record.

RC-80 changer (less cart.) \$42.30

3-speed manual player for record enthusiasts who prefer to play one record at a time with foolproof performance.

Model "M" (less cart.) \$25.95

Mail orders promptly filled. Send 25% deposit with your order.

Write for your FREE copy of our "Audio Equipment Handbook". It contains 132 pages on "How To" assemble, install or improve music reproducing equipment in the home.

Sun Radio
& ELECTRONICS CO. INC.
122-F DUANE ST. NEW YORK 7, N. Y.
BARCLAY 7-1840



Model C Speaker
manufactured by
A.D.C., Ltd., London

SOUND SALES CORPORATION

Offers the best in ENGLISH AUDIO EQUIPMENT

A. D. C. SPEAKER: Rather than building a range of speakers, Audio Acoustic Diffusers, Ltd. of London has concentrated its engineering and production facilities on the design illustrated here, and identified as the Model C.

There is no equivalent to the A. D. C. speaker, for it is the result of completely original research, directed to the single goal of achieving superlative reproduction. Thus, in such details as the construction of the voice coil, the terminating periphery of the 12-in. glass fibre cone, the design of the 15-in. cone mounting, and the resistive damping at all frequencies, the Model C is unique among loudspeakers.

Basic specifications: Coil impedance is 22 ohms at 40 cycles, and 25 ohms at 10,000 cycles. Audio range is 30 to 18,000 cycles, with acoustic output response flat from 30 to 10,000 cycles, dropping less than 1 db per 1,000 cycles to 15,000 cycles. Weight is 19.75 lbs. Shipped from Seattle, Wash., \$125.00.

GOODSELL AMPLIFIERS: We have selected the Williamson-type KT66/DPS/CFB amplifier and the PFA preamplifier built by Goodsell, Ltd. of Brighton, England, because these units do full justice to the A. D. C. Model C speaker, or to any other high-quality speaker system.

The KT66/DPS/CFB is a 15-watt amplifier using the renowned Partridge hermetically-sealed transformers and chokes. It is flat from 20 to 96,000 cycles. Condensers are oil-impregnated and metal-cased; resistors are of noise free design. A separate power supply delivers 60 ma. at 250 volts for preamplifier or tuner. The chassis is 17¼ by 11 by 8 ins. high, weighing 55 lbs. Shipped from Seattle, Wash., \$225.00.

The PFA preamplifier meets all US specifications. A 4-position switch provides for two types of pickups, a radio tuner, and a tape recorder or TV sound. Six-position switches provide for record equalization, and for separate bass and treble controls. A 5-position switch cuts at 5, 7, 10, and 13 kc., or gives flat response. Shipped from Seattle, Wash., \$105.00.

CORRESPONDENCE AND ORDERS SHOULD BE ADDRESSED TO:

SOUND SALES CORP.
P. O. BOX 730, VANCOUVER, B.C., CANADA

NEW EQUIPMENT

Continued from page 105

nulus, and has a high area to stiffness ratio. No evidence of vibrating in other modes is shown in this structure below 22,000 cycles. The voice coil is wound with an aluminum ribbon. This small diaphragm is coupled to a rectangular horn which acts as an acoustic transformer to couple the diaphragm to the air. This exponential horn has a low frequency cutoff of approximately 2000 cycles, which is determined by the distance available between the center of the low frequency voice coil and the leading edge of the cone. The mouth of the horn is sufficiently small

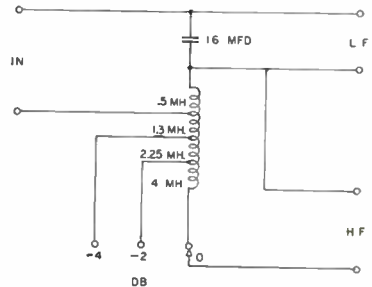

Fig. 2. Altec high frequency network.

so that it does not cast a shadow or obstacle in the path of the sound coming from the low frequency cone. The horn throat, which couples to the diaphragm, is mounted in close proximity so that no appreciable cavity appears between the diaphragm and throat. The loading factor or ratio of the diaphragm to throat area permits this small diaphragm to radiate the required acoustic power and not exceed its permissible amplitude. The horn creates a gain of 9 db.

The high frequency horn is mounted slightly off center. This is advisable since the cone which is back of it acts as a baffle, and lack of symmetry avoids cancellation effects.

Dividing Network

The crossover frequency of the dividing network is 3000 cycles. The schematic is shown in Fig. 2. It is a series type, 6-db-per-octave network and has an auto-transformer combined with the high frequency inductance which compensates for the difference in impedance between the low frequency unit (8 ohms) and that of the high frequency unit, which is 30 ohms. Taps are provided on this auto-transformer so that an attenuation of 0, -2, and -4 db can be obtained. Over the entire range of operation the loudspeaker has a safe carrying capacity of 20 watts. Its frequency range extends up to 22,000 cycles.

Program Distortion

When using a loudspeaker having this range, it is necessary to observe several precautions. Distortion originating in phonograph pickups, tuners, and amplifiers will be reproduced and cause undesirable and annoying results.

in music,
listening
quality

is everything...

".....during the last four years I bought several hundred dollars worth of pickups, purely on high kilocycle claims. Recently I acquired an AUDAX (diamond) CHROMATIC and now I know that Sarsar, the violinist (Toscanini's NBC Symphony), is so right.... listening quality IS everything...."..... from a letter.

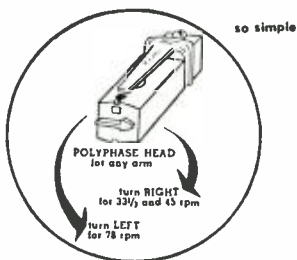

One single magnetic unit plays all home records—Sapphire or diamond styli

Available to fit the new Compass-pivoted Audax arms and to fit Record Changers.

Never before such LISTENING QUALITY such FAITHFUL REPRODUCTION, but... after all the reams are written about kilocycles and other laboratory data—when the chips are down—you and only YOU can decide what sounds best and most pleasing. Therefore... SEE and HEAR the AUDAX and—You be the judge.

Be sure to obtain a copy of PHONO-FACTS from your distributor

AUDAX COMPANY
500 Fifth Avenue New York 36

Creators of Fine Electro-Acoustical Apparatus for Over 25 Years

The Standard by which others are judged and valued

Create Your Own Hi-Fidelity tape library with...



Concertone

MAGNETIC TAPE RECORDER

Thousands of enthusiastic Concertone owners are now enjoying this delightful hobby.

Investigate the many professional features found exclusively in Concertone, recognized as the standard of High Fidelity performance in the tape recorder field. Write today for your free copy of Bulletin HF-1.



ONLY \$345⁰⁰
for basic recorder ready for custom installation.



Manufactured by

Berlant Associates



4917 W. Jefferson Boulevard Los Angeles 16, California

The High-Fidelity Bookshelf

HIGH-FIDELITY's Book Department carries a complete line of books on music, records, sound reproduction, and acoustics. They're ready and waiting for prompt shipment to you... just order by number from the list below. To save C.O.D. and postage charges, send your remittance with your order.

NO.	BOOK	PRICE	89	Listening to Music Creatively—Stringham	6.00
46	Recording & Reproduction of Sound—Read	\$7.95	90	Acoustics of Music—Bartholomew	5.00
53	Sound Recording—Frayne & Wolfe	9.50	91	Opera Lovers Companion	5.00
55	Pianos, Pianists & Sonics—Briggs	2.50	92	Our Musical Heritage	5.65
56	Loudspeakers—Briggs	1.25	93	An Introduction to Music—Bernstein	5.65
57	World Encyclopedia of Recorded Music	17.50	94	Williamson Amplifier Booklet	1.00
70	Make Music Live—Greene	4.50	95	Musical Engineering—Olson	6.50
73	Microphones—BBC	3.25	96	Audio Amplifiers Vol. III—Sams	3.95
74	Twentieth Century Music—Bauer	5.00	98	Sat. Rev. Bk. of Recorded Music	4.50
75	Music Through the Ages—Bauer	5.00	99	Record Changer Manual—Sams	3.00
76	What to Listen for in Music—Copland	4.00	100	Amplifiers—Briggs & Garner	2.95
77	The Concert Companion—Bagar	4.95			
78	The Complete Opera Book—Kobbe	6.00			
79	How Music Grew—Bauer	5.00			
80	Audio Amplifiers Vol. I—Sams	3.95			
81	Audio Amplifiers Vol. II—Sams	3.95			
82	Record Changer Manual Vol. I—Sams	4.95			
83	Record Changer Manual Vol. II—Sams	4.95			
84	Record Changer Manual Vol. III—Sams	4.95			
85	Selective Record Guide—Smith	4.50			
87	Guide to Musical Enjoyment—Marek	3.50			
88	Relax and Listen—Hallstrom	3.00			

DON'T FORGET A BINDER!!

Much to our embarrassment, our first announcement of binders for your copies of HIGH-FIDELITY resulted in so many orders that our stock was wiped out almost overnight. A new and large supply is now on hand. They're red leatherette, gold stamped on front and backbone, and hold four copies. Issues may be inserted individually. Cost is only \$2.75 each, postpaid and insured. Please specify if you want Vol. 1 or Vol. 2.

Book Department High-Fidelity Magazine Great Barrington, Mass.

THE HIGH FIDELITY SERIES

by SARGENT-RAYMENT

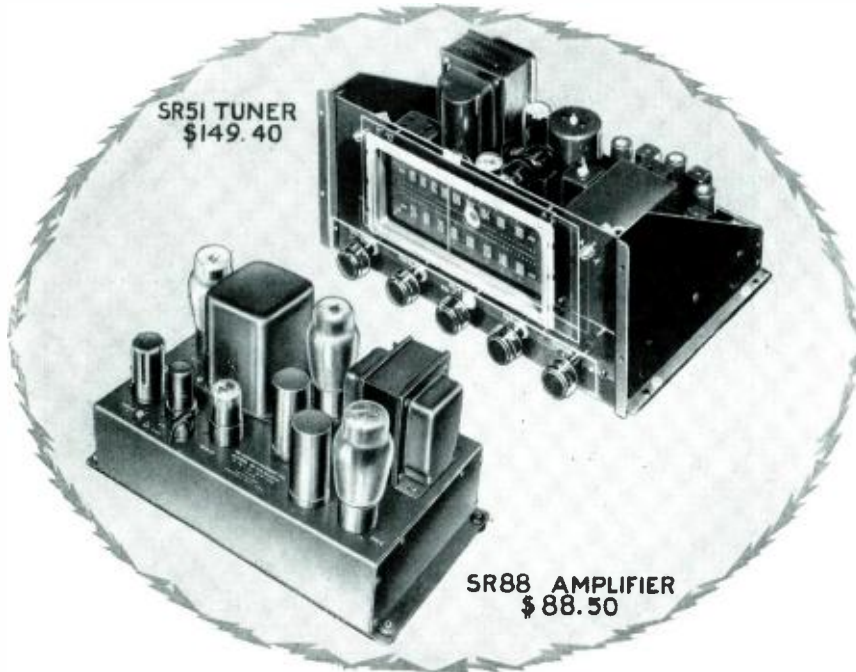

SR51 TUNER
\$149.40

SR88 AMPLIFIER
\$88.50

**the lowest
combined distortion available**

**AN UNPARALLELED TUNER, PRE-AMPLIFIER,
POWER AMPLIFIER COMBINATION.**

- The lowest distortion AM Detector in use today
- The sharpest and deepest 10 kc. filter.
- A two-stage FM Pre-amp affording an AFC controlled 5 MV sensitivity.
- Shock mounted feedback type reluctance Pre-amplifier.
- Amplifier harmonic distortion below .5% between 30 and 15K CPS at 15 watts

SEE AND HEAR THEM AT

HAL COX'S CUSTOM MUSIC

NORTHERN CALIFORNIA'S LARGEST HIGH FIDELITY DISTRIBUTOR

For Engineering Literature write:

Hal Cox Custom Music, 2598 Lombard St., San Francisco 23, Calif.

Tested in the Home

General Electric has been in the magnetic cartridge business for a long time and every couple of years the company redesigns its stylus, effecting a distinct improvement. About two and a half years ago, G-E introduced its "Baton" stylus; now, further improvements have been made by redesigning the method of damping the movement of the stylus shank. The new cartridge-with-stylus is not dignified with any special name — just a model number: RPX-052.

In the RPX-052, the innards of the cartridge itself remain unchanged; only the stylus is different. The new stylus is also available with cartridge in single tip design, and as a replacement for use in older cartridges, both single and dual tip.

As G-E said in a letter to us: "If you were to install a new RPJ-013 stylus in an old RPX-050 cartridge, you would have the equivalent of an RPX-052 cartridge."

Judging primarily by listening tests, we found that the new stylus achieved a definite and noticeable improvement. Frequency range has been extended so that the extreme highs, from about 8,000 cycles, seem



OLD: above

NEW: below



more apparent. This extension of frequencies, plus smoothing of response in the frequency spectrum below 8,000 cycles, gives greater clarity, particularly to orchestral works.

The frequency range is stated to have been extended from 50 to 10,000 cycles, ± 3 db, obtainable with the older stylus, to 30 to 15,000 cycles, ± 2 db.

The G-E units still suffer from a very low output, which is no drawback in itself, but which does necessitate careful preamplifier design to provide sufficient gain and at the same time introduce a minimum of hum.

The catalogue numbers assigned to the G-E cartridges and styli are more than slightly confusing. There are basically two types of cartridges, those designed for use with single styli and those which can accommodate dual styli. The styli, of which there are eleven different models, each with a different catalogue number, are available separately, but if the cartridge is furnished complete with a stylus, a new catalogue number is assigned.

The catalogue numbers for the new styli

Continued on page 110

**YOU'VE WAITED FOR THIS!
RADIO SHACK CORNER HORN**

licensed by **PAUL W. KLIPSCH**

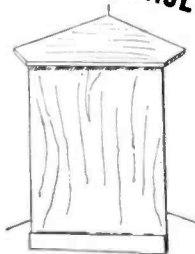

NET PRICE ONLY
\$132.50

Add \$15 for crating
for shipment

At last! A completely assembled folded corner horn enclosure at a price no higher than many 15" bass reflex cabinets! Ours alone! Licensed by Mr. Klipsch, under his original patent, when he was in Boston a short time ago. Built in Boston under rigid quality standards set up by Radio Shack's technical staff. Designed for 15" woofer and the utmost in low frequency response. Standard multi-plywood, stained dark mahogany brown. 45" H., 28" D., 38 1/2" W., 150 lbs. Radio Shack also supplies an optional complete speaker system.

RADIO SHACK
167 Washington St., Boston 8, Mass.

FREE! Radio Shack's new 1952 audio and electronics parts catalog, 192 pag. s. Profusely illustrated. A "must" for audiophiles. Write for your copy today!

FIRST AND ONLY LOW-COST

**G. E. Magnetic Cartridge
PLAYBACK EQUALIZER**

ORDER BY MAIL TODAY



TYPE HL-1-6
PRICE \$11.95

- For foreign, domestic discs
- For 78, 33 1/3, 45 rpm speeds
- A "must" for record lovers

Radio Shack's 6-step Playback Equalizer gives a professional touch to your audio system. Closely duplicates record manufacturers' original recording curve. Does what tone controls can't do! Designed for G. E. pickups using standard 500-cycle turnover preamp. Order now from Radio Shack Corp., exclusive national distributor. \$11.95.

RADIO SHACK
167 Washington St., Boston 8, Mass.

**TIME TO CHANGE
YOUR PHONO NEEDLE**

Replace it today with a...

**NEW
Jensen
NEEDLE**

Priced from 25c and up

• Your Favorite Record
and Service Dealer Has
Jensen Needles — Ask
Him About a Replacement
For Your Record Player!

- ★ Makes Your Old Records
Sound Like New—
- ★ Your New Records
Sound Better Than Ever!

Oldest Name in Sound Engineering

Jensen INDUSTRIES, INC., Chicago 12, Illinois

WHARFEDALE

SUPER 12 CS/AL

A single extended range speaker that outperforms many multi-speaker combinations!

A complete range of speakers is available for every application... all built by Wharfedale Wireless Works under the personal direction of G. A. Briggs, world-renowned audio engineer

Aluminum voice coil... extended range without "peaking"

Cloth suspension... reduced resonance — improved transients

Bakelized cone apex... amazingly clear "highs"

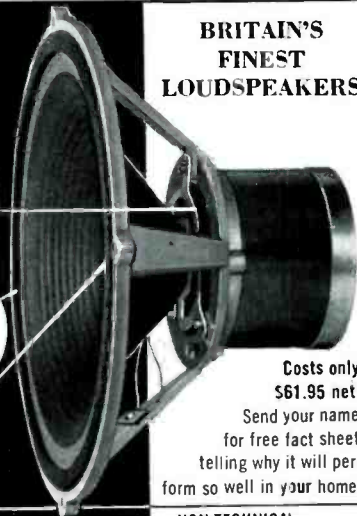

**BRITAIN'S
FINEST
LOUDSPEAKERS**

Costs only \$61.95 net
Send your name for free fact sheet telling why it will perform so well in your home.

Loudspeaker \$1.60 Amplifiers \$2.95 Piano, Pianists, Sonics \$2.50



Loudspeakers—Baffles Acoustics—Frequency response, etc.



Amplifiers—Phase Splitters—Push Pull—Negative Feedback—Tone Compensation—Circuits, etc.



Piano, Pianists, Sonics—Touch and tone—Tuning—Toning—Oscillograms of sounds, etc.

**NON-TECHNICAL
SIMPLE LANGUAGE**
Practical Informative
Only books of their kind written expressly for the layman. Simple, easy-to-understand language. Many illustrations and diagrams. At your jobber or send check or money order.

Dept. 3WF
BRITISH INDUSTRIES CORP.
164 Duane St., N. Y. 13, N. Y.

from now on . . .



nothing is beyond your control!

The controlling factor in the quality of your home music system . . .



The CRAFTSMEN® 300 Equalizer-Preamplifier

Combines in one central panel complete tone compensation, phonograph equalization, and control of all audio channel switching.

- Completely self-contained power supply permits flexibility for use with any audio power amplifier.
- Continuously variable loudness control correctly compensated at different listening levels for loss of response to low and high audio frequencies.
- Preamplifier for all popular magnetic phono cartridges, compensated exactly for all types of recordings.
- Bass and treble tone controls, continuously variable from attenuation to boost — flat clearly marked.
- Two 4-position filters: for reduction of noise and record scratch . . . for reduction of turntable rumble and hum.
- Cathode follower output permits extremely remote installations without loss of response.
- The first preamplifier performance matched to the Craftsman 500 Ultra-Fidelity audio amplifier.

HAVE YOU HEARD the C500? Williamson all-tube circuit. It's 99.99% distortion-free!



Write today for information

THE RADIO
craftsmen INC.

Dept. H-9, 4401 N. Ravenswood Ave.
Chicago 40, Ill.

TESTED IN THE HOME

Continued from page 108

are the same as the ones for the old, so there is no way to tell which is which without examining carefully the construction of the stylus. We illustrate herewith both single and dual tip styli of both old and new varieties. Note that in the old, single tip stylus, there is *one* damping block near the tip. In the new, there are *two* damping blocks near the tip plus another near the shank.

In the dual tip style, the distinguishing feature is the metal protective guard extending almost to the two tips. In the old style, the sides of the guard were solid; in the new, they are notched. The method of damping has been changed, of course, but it is hard to see this on casual inspection.



OLD: above

NEW: below

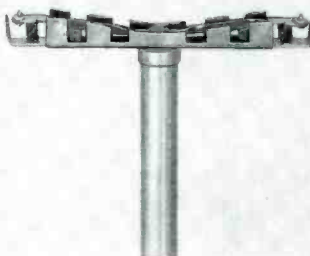

There are eleven styli now available, as listed below. The .0025 tip is intended principally for broadcast station transcriptions. The home user would do better to purchase the .003 tip for 78 rpm. macro-groove records. Note that the RPJ-013 is an addition to the regular line and combines, for the first time with G-E, a diamond .001 tip with a sapphire .003 tip.

SINGLE TIP STYLI

Cat. No.	Radius	Tip	Color Code
RPJ-001	.003	Sapphire	Natural
RPJ-002	.0025	Diamond	Yellow
RPJ-003	.003	Diamond	Violet
RPJ-004	.001	Diamond	Black
RPJ-005	.001	Sapphire	Red
RPJ-006	.0025	Sapphire	White

DUAL TIP STYLI

Cat. No.	Radius	Tip	Color Code
RPJ-007	.001	Sapphire	Red
	.0025	Sapphire	White
RPJ-010	.001	Sapphire	Red
	.003	Sapphire	Natural
RPJ-011	.001	Diamond	Black
	.0025	Diamond	Yellow
RPJ-012	.001	Diamond	Black
	.003	Diamond	Violet
RPJ-013	.001	Diamond	Black
	.003	Sapphire	Natural

A COMPLETE *High Fidelity* SERVICE

. . . from the supply of the individual components to the planning, installing and maintaining of the home music system.

Our living room sized audio room makes for the accurate selection of components. And when your choice is made our organization is at your service to render whatever assistance may be desired — technical advice, full or partial installation.

We maintain an electronic laboratory for the maintenance of all high fidelity equipment sold by us. Our customers know the satisfaction of dealing with an organization that takes a personal interest.

Perdue Radio Co. covers every phase of the home music and television field offering the finest complete instruments as Fisher and MP and carrying a wide selection of components featuring such names as . . .

Brook • Altec • Pickering
McIntosh • Magnecord
Jim Lansing • Newcomb
Rek-o-kut • and many others

**PERDUE
RADIO CO.**

8 S. PARK ST., MONTCLAIR, N.J.

MONtclair 2-0680

HIGH FIDELITY is here!

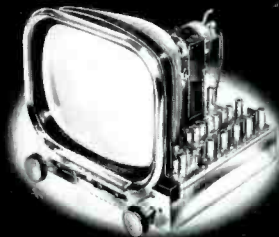

Finest made for your custom installation the CRAFTSMEN 202

ALL THE LATEST FEATURES

- **Cascade turret tuner.** Good news for fringe areas—sensitivity double that of earlier models!
- **Chassis accommodates** 21-in. cylindrical-face tube. Largest rectangular tube available, eliminates reflections. Also accommodates low voltage, electrostatic focus kinescope, permitting easier installation, focus adjustment, and maintenance of optimum focus, even with line voltage variations.
- **Push-pull audio** output provides 5 watts with less than 2% distortion. Frequency response: 20-20,000 cps.
- **Keyed AGC** prevents picture flutter due to outside interference.
- **Vertical retrace** line erase circuit.
- **Low distortion audio** channel uses double limiter and Foster-Seeley balanced discriminator.

All CRAFTSMEN TV chassis with turret tuners accommodate UHF simply by replacing tuner channel cartridges.

Write for information, or send 50¢ for instructions and schematics.

THE RADIO **craftsmen** INC.

Dept. H-9, 4401 N. Ravenswood Ave.
Chicago 40, Ill.

Tested in the Home

In HIGH-FIDELITY No. 3 we discussed the Brociner preamplifier-equalizer. In No. 5, we mentioned that a companion control unit had been announced. This report covers the Brociner CA-2 Control Amplifier.

As can be seen from Fig. 1, the CA-2 has four knobs which, reading from left to right, control the unit's basic functions: input selection, bass boost or droop, treble boost

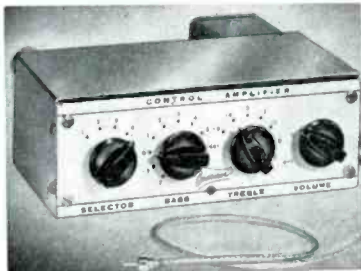

Fig. 1. Note the simplicity of controls.

or droop, and volume. An on-off switch is attached to the volume control, and a pilot light indicates whether the unit is operating.

In style and size, the panel is identical with the one used on the Brociner A-100 Preamplifier-Equalizer, making a neat pair of units which comprise that which, several issues ago, we called an audio nerve center.

As with the A-100, a good feature of the CA-2 is that the escutcheon is attached from the front with long screws, facilitating installation in panels having a wide range of thickness.

Looking at the back of the unit, Fig. 2, we can start at the upper left with a 110-volt outlet which is interconnected with the on-off switch on the volume control. Other equipment in the home music system, such as FM and TV tuners, preamplifiers and amplifiers, can be plugged into this outlet so that one master switch will control all the equipment.

Below the 110-volt outlet is an octal plug which is designed primarily to supply power to the A-100 preamplifier-equalizer. This plug provides 250 volts dc at 5 ma. maximum and 6.3 volts dc at 0.45 ma.

In the center is a single phono plug which provides a maximum of 10 volts output to a tape recorder. This output is not affected by the volume control setting; thus it is possible to attach, and have operating simultaneously, both the tape recorder (in record position) and the regular amplifier-speaker system. However, adjustment of bass boost or droop and of treble boost (but not droop) affects both tape and regular output.

This special tape output connection is a valuable feature. It is one which should be incorporated into more and more equipment, to meet the needs of the increasingly large number of people who are recording on tape.

Just below the tape output connection is a 6-ft. shielded lead, terminated in a standard phono plug, for connection to a power amplifier. Since the CA-2 is of cathode follower design, the length of this wire—and

Continued on page 112

The C-800 is here to bring you new record performance!

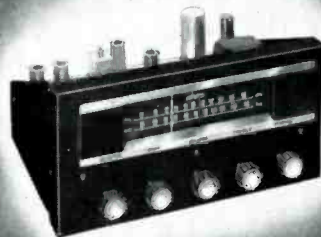

the new **craftsmen 800** FM-AM TUNER

with built-in phono preamplifier and record equalizer

Now—Craftsmen brings you a tuner that matches all your finest records... is setting new records for versatility, too. The C-800 is further evidence that Craftsman leadership in high fidelity is something you can put your finger on, something you can hear.

- **Front-panel-selected equalization** for AES, LP or European recording characteristics. Inverse feedback compensated dual-triode phono preamp for correct turnover and roll-off characteristics.
- **Improved AM reception.** Wider bandwidth for better fidelity, and sharper IF bandpass "skirts" for greater selectivity.
- **Double-shadow tuning eye** and AFC (no drift) on FM simplifies tuning. Front-panel AFC cut-out for tuning weak stations.
- **Efficient new layout.** Bottom plate, completely shielded chassis minimize oscillator radiation, assure tuner isolation.
- **Cathode follower** audio output for remote installations; 2 volts at less than 1/2% dist. Detector output also has cathode follower for recording applications.
- **Bass and treble** controls continuously variable from attenuation to boost—flat position clearly marked. Selector positions: FM, FM with AFC, AM, TV, LP, AES, EUR, and SPARE.
- **Mahogany-finish** wood cabinet available.

HIGH FIDELITY—LOW COST! C-400 audio amplifier offers 10 watts ± 1 db., 15—20,000 cps., less than 1% distortion. New streamlined chassis design.

Write today for information

THE RADIO **craftsmen** INC.

Dept. H 9, 4401 N. Ravenswood Ave.
Chicago 40, Ill.

Fine Music
Keyed to Modern Living

With
NOVA PRECISION-BUILT
wall units



for Radio,
 Phono and TV

**On Display for the First Time
 ONLY at Hudson!**

Here's the home installation that will make you STOP, LOOK, and LISTEN! Smart, modern NOVA Wall units designed to hold the High Fidelity Radio, Phono and TV of your choice. These beautifully styled, sturdily constructed NOVA Storage WALL UNITS save space, save money . . . add to your listening pleasure, and enhance the decor of any interior. Available unfinished, primed, or in fine furniture finishes.

See the complete line of NOVA storage wall units at Hudson, and select your High Fidelity equipment from the largest and most complete stock of all nationally famous makes at lowest money saving prices!

VISIT OUR SOUND STUDIOS

Dept. G9

HUDSON
 RADIO & TELEVISION CORP.

48 WEST 48th ST. • 212 FULTON ST.

New York 36, N. Y. New York 7, N. Y.

Circle 6-4060

- Please send FREE copy of 1953 Hudson Hi-Fi Catalog
- Please send details on NOVA Wall Units

Name _____

Address _____

City _____

Zone _____

State _____



FREE!

NEW 1953

HUDSON HI-FI CATALOG

Complete new buying guide . . . value-packed with the world's finest High-Amplifiers, Speakers, Tuners, Record-Fidelity and Audio Equipment . . . Changers, Recorders, Packaged Systems, Custom Furniture, etc. for professional and home installation.

Send for your FREE Catalog today!

Mail this handy coupon

TESTED IN THE HOME

Continued from page 111

hence the distance between the control unit and the main amplifier — may be increased to 50 ft. or more, provided the cables specified in the well-written instruction sheets are used.

In the lower right hand corner of the unit, as seen in Fig. 2, are four phono plugs. These are the input connections. All four are identical; into them should be plugged the output of such units as a phonograph preamplifier, tape recorder low level output, FM or TV tuner, crystal cartridge, etc.

Now let's turn the unit around and go back to the front panel, Fig. 1, to see just how much control we have over the frequency response characteristics.

The volume control and the bass boost control must be discussed all in one breath because they are tied together, electrically, so that the volume control becomes, in effect, a compensated loudness control insofar as low frequencies (only) are concerned. The volume control is continuously variable; the bass control is a step-type unit with



Fig. 2. Note tape output and four input jacks.

two positions of cut, flat, and five positions of boost. This is how the loudness compensation system works: if the bass control is turned to maximum boost, and the volume control is turned full on, the bass boost amounts to 20 db at 30 cycles. If the volume control is turned down 12 db from maximum, bass boost is 25 db. The volume control does not have any effect on treble response, similar to its interaction with the bass control.

At 30 cycles, the range of the bass tone control, with the volume full on, is from plus 20 db to minus 18 db.

The treble tone control has two positions of boost, flat, and five positions of cut. At 15,000 cycles, the range is from plus 9 db to minus 25 db. The treble control is of unusual design and is, in reality, a cut-off filter. It droops at a rate of 12 db per octave. The "3 db down points" — that is, the frequencies at which the droop is just perceptible — are 9,000, 7,000, 5,000, and 3,500 cycles. These are control knob positions -2 through -5; -1 provides a slow roll-off which is down 4 db at 10,000 cycles.

The overall gain of the unit is 10 db — enough to be of material help with sound sources which, previously, hadn't been quite loud enough.

These are the facts of the Brociner CA-2 Control Amplifier. It's a slick unit, well designed and well manufactured, and a fitting companion for the A-100 preamplifier. The two together make an attractive and efficient audio nerve center.

Why do you play your phonograph so LOUD?



Every music lover knows the answer to that question. It's because your phonograph just cannot reproduce the full range of your recordings at a normal listening level.

BUT... something new has happened in the sound world... and REK-O-KUT, manufacturer of recording and transcription equipment for the Broadcast Industry has done it. The new RHYTHMASTER and the RECITALIST WILL reproduce the full broad range of your recordings at any listening level.

REK-O-KUT'S exclusive POLYPHONIC SELECTOR accomplishes this by maintaining the proper relationship between the highs and lows when a record is played at any volume either very softly or very loud. Even with the volume turned down to a mere whisper, all the highs and the lows are reproduced clearly and without loss. Never before has anything like this been possible to achieve in a portable phonograph.

REK-O-KUT *Recitalist* featuring the POLYPHONIC SELECTOR



Plays all records, standard and microgroove, from 6" to 16" and broadcast transcriptions.

BOTH OFFER 3 INSTRUMENTS IN ONE

1. High-Fidelity Phonograph
 2. P.A. System (with microphone)
 3. Broadcast Receiver (with FM tuner)
- ★ RECITALIST (Illustrated) equipped with 3-speed turntable **229.95**
- ★ RHYTHMASTER, similar to Recitalist but with Continuously-Variable-Speed Turntable that plays records at ANY SPEED from 25 to 100 R.P.M. **269.95**

Ask for a demonstration at any music store audio visual dealer or radio parts jobber. Or write direct to Factory for complete catalog and descriptive literature.

REK-O-KUT CO.

38-01A QUEENS BOULEVARD
LONG ISLAND CITY 1, N. Y.

Professional Quality DIAMOND STYLI



By now it is a widely recognized fact that the Diamond is the only completely practical needle for LP's, if long record life and continuous high-fidelity reproduction are desired. To those who have not yet switched to Diamond or who may be waiting on the purchase of a new cartridge, we respectfully invite attention to the world's finest needles—Televox Professional Diamonds.

Custom-made to the highest standards of quality in the industry by skilled craftsmen with years of experience, the Televox Professional Diamond is the acknowledged leader in the field of phonograph needles. Used by the American Broadcasting Company and by leading record reviewers, musicologists, schools, colleges and libraries, it is also the first choice of discriminating music lovers the world over. And yet, despite its outstanding superiority, it is by no means the most expensive needle sold.



Every Televox Professional Diamond is fully and unconditionally guaranteed, and can be returned for free microscopic examination and report on its condition whenever desired.

If there is no music dealer in your locality as yet who stocks Televox Professional Diamonds, you can order direct from us. Single-tip replacements are \$15.75. Tandem-tip needles with LP Diamond, \$18.50; with two Diamonds, \$28.50. (All postpaid.) Be sure to enclose a used sample needle for identification purposes.

As a further service we can supply new cartridges already Diamond-equipped, and all other audio components. We have developed an exclusive line of conversion kits for Magnavox, Webster-Chicago and VM changers which offer the advantages of Professional Diamond styli plus the greatly improved tonal reproduction of higher-fidelity cartridge types. Many cartridge-stylus combinations available; also widest selection of preamps for magnetic cartridges.

TELEVOX

476 West 238th Street, New York 63, N. Y.

MAKE THE INCOMPARABLE LEAK "POINT ONE"

BRITAIN'S FINEST HIGH-FIDELITY AMPLIFIER

THE HEART OF YOUR MUSIC SYSTEM...

DISTORTION CERTIFIED TO BE ONLY

ONE TENTH OF ONE PERCENT!

COSTS ONLY \$192.00 NET

FOR AMPLIFIER

AND

PRE-AMPLIFIER



LISTEN... AND COMPARE!

EXAMINE TOP AND BOTTOM CRAFTSMANSHIP

BEFORE YOU BUY!

THERE'S A POWERFUL

DIFFERENCE!

MAIL THIS COUPON TODAY FOR INFORMATION ON
HOW TO CHOOSE AN AMPLIFIER, to
BRITISH INDUSTRIES CORP., Dept. 31F
164 Duane St., N. Y. 13

Name..... Address..... City..... State..... Zone.....

What Price Hi-Fidelity?

AT NEWARK

**IT'S AUDIO EQUIPMENT
HIGH IN PERFORMANCE**

YET LOW IN PRICE . . .

New Low Price for TAPEMASTER

For use with companion unit, Newark's System listed below, or your own system.



**TAPE
RECORDER
\$74.95**
**AMPLIFIER
and
SPEAKER
\$79.50**

TAPEMASTER PT-121 TAPE RECORDER. New low-cost basic recorder for use with external amplifier or radio. Dual track. Records at $7\frac{1}{2}$ " per second. Fast forward speed, 20:1 ratio. Flutter, less than 0.5%. Response, ± 3 db, 70-8,000 cps. Inputs for mike, tuner and phono. Blue-gray case, 12x12 $\frac{1}{2}$ x9 $\frac{1}{2}$ ". With tubes, 5" reel of "B" tape, 7" take-up reel, and 3-ft. cable with plug. Less amplifier (see below). 75F150. Shpg. wt., 21 $\frac{1}{2}$ lbs. **SPECIAL..... 74.95**

TAPEMASTER SA-13 AMPLIFIER AND SPEAKER. Companion unit for above. Response ± 1 db. 30-15,000 cps. Peak output, 8 watts. Less than 1% distortion at 5 watts. Bass control boosts 7 db, attenuates 12 db—at 30 cps. Treble control boosts 12, attenuates 10 db—at 15,000 cps; $7\frac{1}{2}$ " accordion type speaker with floating cone. Tubes: 5881, 6SN7GTA, 6C4, 5Y3GT. Size 9 $\frac{1}{2}$ x12x18 $\frac{1}{2}$ ". 75F153. Shpg. wt., 25 lbs. **NET..... 79.50**

Save on NEWARK'S Complete AM-FM Phono System

The Complete System...only \$82.50

Units can be purchased separately.



PILOT AF-605 HI-FI FM-AM TUNER. Save more than half the original price on this sensational hi-fi value! It's a deluxe FM-AM tuner chassis actually worth \$89.95—now selling, while they last, at \$42.95. Bandswitch has 4 positions: AM, FM, Phono and TV. Circuit includes 1-stage audio amplifier with flat response, ± 2 db, 20 to 15,000 cps. Has negative feedback for low distortion. Separate 3-gang tuning condensers and tuned RF stages on both FM and AM. FM section has temperature compensated oscillator for minimum drift; AM section has IF wave trap for rejection of signals in the IF passband. Sensitivity: FM, 20 microvolts for .3 volt audio output with quieting; AM, 3 microvolts for .3 volt output. With: 6-6SA6, 1-6BE6, 1-6AL5, 1-6AT6, 1-6X5GT. Self-contained power supply. Has built-in FM and AM antennas, plus provision for external antennas. Chassis size, 11 $\frac{1}{2}$ x6x9". 81F003. Shpg. wt., 8 $\frac{1}{2}$ lbs. **SPECIAL..... 42.95**

NEWARK LOW-COST AMPLIFIER. Compact 8-watt amplifier using 2-6V6 or 6K6 push-pull output tubes. Employs 6SN7 as Audio Driver and Phase Inverter; 5Y3GT is rectifier. Response, 50 to 12,000 cycles. Outlet for AC phono motor plug on back. Output impedance, 8 ohms. Chassis size, 6x8 $\frac{1}{2}$ x5 $\frac{1}{8}$ ". Shipping wt., 7 lbs. 81F001. Special Price **21.50**

G.I. 3-SPEED CHANGER. These units automatically play all 3 sizes of records—7", 10" and 12". Motor provides 3 constant speeds—33 $\frac{1}{3}$, 45 and 78 rpm. Tone arm uses crystal cartridge with single .002" needle to play both standard and microgroove records. Size: 12 $\frac{3}{4}$ x12x5-7/16". Requires 4-1/16" above 3 $\frac{1}{2}$ " below. Wt., 12 lbs. 81F000. Special Price **17.88**

NEWARK 12" SPEAKER. Designed for high-fidelity reproduction, this 12" PM speaker will handle 10 watts of audio power. Has heavy Alnico V magnet, 6-8 ohms voice coil. Less output transformer. Wt., coil, 5 lbs. 81F104. Special Price **6.95**

COMPLETE FM-AM SYSTEM.
81F010. Special Price..... **82.50**

Authorized Distributor of
MAGNECORDER
AMPEX
Professional Quality Recording
Equipment

Send for Complete Catalog
DEPARTMENT H-452

NEWARK
ELECTRIC COMPANY

223 WEST MADISON ST.
CHICAGO 6, ILLINOIS

Tested in the Home

It sometimes seems that high fidelity installations are characterized primarily by a mixture of equipment which, to those accustomed to purchasing complete packages under one manufacturer's name, is startling and certainly unorthodox. For the hobbyist, the admixture is much of the fun, but for others it is simply confusion worse confounded.

With the exception of Stromberg-Carlson, no company that we know of currently offers a complete line, from pickup to speaker. However, more and more are approaching this goal—and Sargent-Rayment, producing both tuners and amplifiers, is one of them.

This company has built a wide reputation on the West Coast for the excellence of its line. The reputation is, of course, spreading fast. So we are glad to have had an opportunity to put a matched pair—tuner and amplifier—through their paces and to report on them to readers.

The Tuner

Details of the SR-51 tuner, Fig. 1, are as follows: the FM section is of conventional design. It utilizes a ratio detector and, according to specifications, provides 70% noise reduction and 5 microvolt sensitivity.

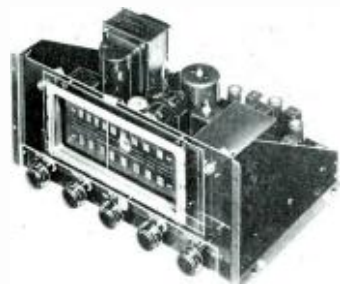

Fig. 1. FM-AM tuner has five controls.

Particular attention has been paid to the AM section, in a worthwhile and successful effort to insure minimum distortion and optimum fidelity. Another interesting feature of the AM section is an especially effective "whistle filter". When AM tuners are designed to cover the entire 10 kc. channel allowed to broadcasters, it is likely that interference from stations on adjacent channels will produce a high whistle. Since the frequency response of ordinary radios does not cover anything like the whole channel, they do not have this problem. The Sargent-Rayment filter has an extremely sharp drop (from zero db at 9 kc., to down 47 db at 10 kc.).

Controls on the front of the tuner are, from left to right: combined on-off and volume (not compensated), treble tone, input selector (FM, phono, TV, and AM), bass tone, and tuning. Tone control range is from plus 18 to minus 16 db at 40 cycles and from plus 13 to minus 22 db at 22,000 cycles.

Continued on page 115

TESTED IN THE HOME

Continued from page 114

Input and output connections are on the back of the chassis. A pair of screw-head terminals are provided for an AM antenna, another pair for an FM dipole. A nod is due manufacturer for its thoughtfulness in shipping with the tuner an FM dipole made of twin-lead, ready to be tacked to the picture molding or dropped under the rug. This would work satisfactorily in metropolitan areas, near the broadcast stations, but it was not adequate for fringe areas such as ours.

There are two outputs: one, marked DET, bypasses tone and volume controls and may be used for feeding direct to tape recorders or amplifiers which incorporate their own tone and volume controls. The second output is the normal one, for connection to a power amplifier. There are three input connections: TV and MAG being identical in response characteristics. The latter is for connection to the output of a preamplifier. The third, marked CRYSTAL, is compensated for crystal cartridge response characteristics.

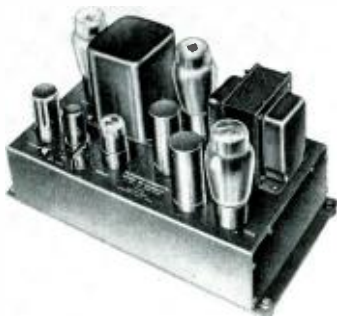

Fig. 2. Amplifier chassis includes pre-amp.

Also on the back of the chassis is a 110-volt AC outlet, controlled by the on-off switch on the volume control. On top of the chassis is an octal socket which supplies power for a Sargent-Rayment preamplifier unit, available separately if the power amplifier is not used. In this system, the pre-amp is built into the power amplifier chassis, not into the tuner. This is an important matter for anyone who wants to buy either unit separately.

We feel this is a highly commendable tuner, worthy of special attention from those wanting to improve the fidelity of their AM reception.

The Amplifier

The Sargent-Rayment SR-88 amplifier, Fig. 2, is a 15-watt, very low distortion power amplifier, with preamplifier built in, which utilizes a pair of 6L6's in the output and which incorporates 26 db of feedback into its design with complete stability.

Other tubes are one 6J5, one 6SN7, and a 6SL7 operating as the reluctance cartridge preamplifier stage. Distortion is stated to

Continued on page 118



Enjoy Music

**AS THE MASTERS PLAY
IN YOUR OWN HOME
WITH A High Fidelity CABINET**

**BEAUTIFUL CORNER CABINET
IN BLONDE OR MAHOGANY
IN KIT FORM AND PRICED
FOR EVERYONE TO ENJOY**

8" speaker cabinet size — 18" x 13" x 27"
THE MISSOURIAN (Mahog.) List Price — \$18.50
THE GLENDALE (BLONDE) LIST PRICE — \$21.50
 12" speaker cabinet size — 27" x 13" x 25"
THE MISSOURIAN (Mahog.) List Price — \$21.50
THE GLENDALE (BLONDE) LIST PRICE — \$24.50

For complete details, see your
Sound Dealer, or write:

Ozark

WOOD PRODUCTS COMPANY
311 Park Ave., Glendale, Mo.



Now you can have a quality, high-fidelity folded corner cabinet, at a fraction of the price you'd expect to pay — because you do the assembly work yourself! These kits contain only the best of materials, and include complete, easy-to-follow instructions that will enable you to assemble your unit in less than an hour!

Here's what the kit contains:

- Factory pre-cut finest quality mahogany plywood and fir
- Beautifully designed speaker grille and plastic grille cloth
- Plastic wood
- Complete assembly instructions including speaker hardware
- Wood screws and brads
- Glue

Audiophiles:

ATTEND PHILADELPHIA'S

SECOND ANNUAL HIGH FIDELITY CONFERENCE AND AUDIO SHOW

SEE AND HEAR DEMONSTRATIONS AND
LECTURES BY LEADING AUDIO EXPERTS

BROADWOOD HOTEL
CRYSTAL ROOM
Broad and Wood Sts.
Philadelphia, Pa.

OCT 8-9

Sponsored by

ALBERT STEINBERG & CO.
2520 N. Broad Street
Philadelphia, Pa.

ALMO RADIO CO.
509 Arch Street
Philadelphia, Pa.

RADIO ELECTRIC SERVICE CO.
7th and Arch Streets
Philadelphia, Pa.

**Free TICKETS OF
ADMISSION**

Available from these
Distributors and
their Branches

Brochure containing program and guide
for both days included with tickets.

Look to Leonard for Value!

A Leonard First!

**A Professional Type
Tape Recorder . . .
PREMIER No. 70
TAPE-SONIC***

Price: \$298.50 net
CASE INCLUDED



23 x 16 x 10 1/2
54 lbs. . . AC only
110 volts, 60 cycle

CHECK THESE FEATURES:

- ✓ 3 speeds: 3 3/4", 7 1/2", 15" per second . . . 2500 ft. per min. rewind and forward
 - ✓ Dual track . . . 4 hrs. on one reel; accommodates 10 1/2" NAB . . . 7" . . . 5" reels
 - ✓ Three dynamically balanced motors with electro-dynamic braking
 - ✓ 9 tube push-pull amplifier . . . 12 watt undistorted output . . . 8 inch extended range speaker
 - ✓ 4 inch calibrated V. U. meter
 - ✓ Controls: Separate bass & treble; special pad for controlling speaker level while recording; mixer-fader arrangement for external input
 - ✓ 2 outputs: 8 ohm for external speaker; Hi impedance for external amplifier
 - ✓ 2 inputs: Hi impedance mike w/mixing control; external hi impedance w/separate mixing controls
 - ✓ Completely fused for added safety
 - ✓ Frequency response: 3 3/4" . . . 40 to 7,000 cps; 7 1/2" . . . 40 to 12,000 cps; 15" . . . 40 to 15,000 cps
- *Reg.

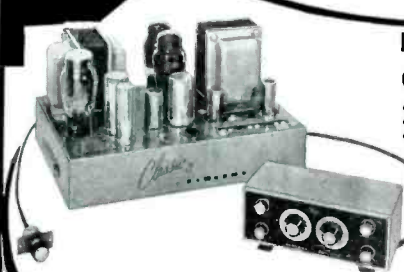

**Newcomb's New
CLASSIC 25**

- COMPLETE REMOTE CONTROL
- 25 WATTS PLUS RESERVE
- 10 TO 100,000 CYCLE RESPONSE

Here's Newcomb's priceless combination of absolute technical perfection and complete flexibility. You get remote control up to 100 feet . . . and the amazing new Audio-Balance* that permits anyone to achieve perfect balance of output tubes without meters. PLUS

every operational facility that electronic engineering can offer.
SPECIFICATIONS: 25 watts undistorted output. 6 input channels.
Flat below 10 to 30,000 cycles with extended response to 100,000 cycles. Pre-Amp remote control ± 1 db 10 to 30,000 cycles.

CLASSIC 15 (15 watt remote control amplifier with most of the above features) . . . \$179.50
* Patent Applied For

Mail and Phone Orders Filled 25% Deposit, Balance COD.

ACROSOUND Williamson-type output transformer, 20 watt TO-300 . . . 24.75
WEATHERS One Gram capacitance pick-up cartridge . . . 37.50
DUOTONE 14 power needle checking microscope50

LEONARD RADIO INC. 

69 CORTLANDT ST., NEW YORK 7, N.Y.
COrtlandt 7-0315 - 9 Dept. H19

The House Built On Service
Send For New 48 Page Hi-Fidelity Catalog

IMPORTANT BOOKS

Continued from page 104

amplifier quality, push-pull amplification, negative feedback, cathode followers, phase splitters, tone compensation, whistle and scratch filters, microphones and mixing circuits, power supplies, hum and noise in amplifiers, and distortion. Finally, details are given for the design and construction of a specific amplifier. How this fits into the overall picture is best described by Mr. Briggs himself: "My opinion is that the best way to obtain a first-class amplifier is to buy one of the reputable makes. I do not think it is possible to improve the standard of performance by home construction. But I also realize that many like to experiment and build at home, and it is necessary to round off [this] book by giving circuits which employ some of the prin-

Professional Directory

*High Quality
Custom Installations*
Featuring the Famous

**"CHILDS" CUSTOM-
BUILT AMPLIFIER**

As described in the July issue of
RADIO & TV NEWS

ULRIC J. CHILDS

Audio Engineer
1601 First Avenue, New York 28, N. Y.
TR 9-8290

In Southern California, it's

HOLLYWOOD ELECTRONICS

Distributors of high fidelity components exclusively

•
7462 Melrose Ave.
Hollywood, California

HEAR MORE - WITH THE SCORE!

Complete collections . . . the best editions . . . handy pocket format . . . only .98 each vol. . .

BACH: The Complete Organ Works (8 vols.)
Musical Offering & 3 Trio Sonatas (1 vol.)

BEETHOVEN: The 5 Cello Sonatas (1 vol.)
The 10 Violin Sonatas (2 vols.)

Free catalogue • At dealers, or from
Dept. Q, Box 138
LEA POCKET SCORES AudubonSta., NY 32, NY

SERVICE

FOR YOUR HI-FI EQUIPMENT

Specializing in Custom Equipment and Installations since 1947. Calls made in N.Y.C., Westchester, Long Island.

VECTOR LABORATORIES
217 3rd Ave., N.Y.C. GR-3-7686

IMPORTANT BOOKS

ciples which have been investigated." Schematics and a certain amount of discussion are provided for a "Garner" amplifier, preamplifier, TRF tuner, and superhet tuner. Mr. Briggs' tests (by the method described previously in HIGH-FIDELITY) show the Garner amplifier to be of top hi-fi quality.

"Amplifiers" is not for those still unfamiliar with schematics and at least some of the terminology of the engineer. But once it is known that a particular zig-zag line means a resistor, and curiosity is aroused as to why each component is used, then "Amplifiers" is must reading and re-reading. Since it is written as if the authors enjoyed collaborating and writing, this book is easy reading, yet worth careful study for the tremendous amount of information it contains. — C. F.

Professional Directory

CUSTOM INSTALLATIONS

Radio - Phonograph - Television

The best in fine cabinetry and electronic engineering

LOWE ASSOCIATES

167 Bay State Road
Boston, Massachusetts
Copley 7-6644

PROTECT YOUR INVESTMENT

CREATIVE AUDIO ASSOCIATES

Will Install and Service your
Home Concert System without charge
Home demonstration on request
Featuring the finest components available

CREATIVE AUDIO ASSOCIATES

Serving New York and New Jersey
150 South Harrison Street East Orange, N.J.
Write Dept. H2 for Literature Orange 6-5229

"EVERYTHING"

in high fidelity

From Primary Components
to Completed Custom Installations
VISIT OUR NEW "AUDIO-PHILE HAVEN"
or write to

KIERULFF

Sound Corp.

820 West Olympic Blvd. Los Angeles 15, Calif.
Richmond 7-0271 ZEnith 0271

CUSTOM SOUND

featuring

- Selected British & American units
- Special demonstration facilities
- Cabinets to your specifications

CRAIG AUDIO LABORATORY

12 Vine Street Rochester, N.Y.
BAker 1345

"a stylus to a Klipschorn"

SEE - HEAR - ENJOY - *The Newest and the Latest in*

HIGH FIDELITY

AT THE FOURTH ANNUAL

AUDIO FAIR

OCTOBER 29th, 30th, 31st and NOVEMBER 1st
HOTEL NEW YORKER—NEW YORK CITY

The AUDIO FAIR is the most important annual event in the high fidelity field. Every up-to-the-minute development in audio will be represented. Of utmost interest to high fidelity enthusiasts, government and military agencies, broadcast engineers, recordists, sound-

on-film and public address men, distributors and dealers.

Make your plans now to attend this — the largest and most concentrated exhibition of audio equipment under one roof. The general public is invited . . . no admission charge.



Sponsored by the AUDIO engineering society

FOURTH ANNUAL CONVENTION

Grommes Custom High Fidelity

Triode Amplifier



An all triode basic amplifier based upon the Williamson circuit . . . the last word in ultra high fidelity

Frequency response $\pm .5$ DB 10 to 100,000 CPS at 8 watts. Distortions at 15 watts .1% harmonic; I.M. .25% at 10 watts; 20 DB feedback from 2 loops; damping factor 20; cathode follower driver, 2 direct coupled stages; fixed bias.

The ideal pre-amplifier for the 215BA. Completely variable feedback type equalization for reproducing records exactly as recorded. Frequency response radio input $\pm .5$ DB. $\frac{1}{6}$ to 100,000 CPS. Step type bass and treble controls; 25 DB equalization down to 20 CPS. For magnetic or dynamic pickups.

Model
215BA
\$1250
NET

Model
210PA
\$9950
NET

PRECISION ELECTRONICS, INC.

641-43 MILWAUKEE AVENUE • CHICAGO 22, ILLINOIS

Custom Styled for Hi-fidelity

by **Cabinart**

MODEL 28
Equipment
Cabinet



MODEL 27
Loudspeaker
Cabinet

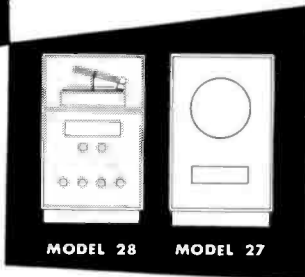

MODEL 28 **MODEL 27**

Designed for the audiophile, these handsome cabinets will accommodate any combination of high fidelity components. Panels are replaceable for future changes of equipment. The loudspeaker cabinet is acoustically correct, tuned for the average 12" or 15" loudspeaker, pre-cut as requested. Construction is of select birch, with a fine lacquer finish hand-rubbed to a high gloss. All joints are glued and screwed, and lock-joint miters are used throughout, affording utmost rigidity.

Dimensions:
35½" high, 23½" wide, 18" deep.

Finishes:
Bland Birch
Cordovan Mahogany on Birch.
Baffle Area: 6½ cubic feet.

Net Price
MODEL 27 . . . \$48.00
MODEL 28 . . . \$72.00

Sold through leading radio parts distributors.
Write for free catalog and nearest distributor.

G & H WOOD PRODUCTS COMPANY - 75 NORTH 11th STREET - BROOKLYN 11, N. Y.
Pioneers in radio furniture for high fidelity equipment.

RATING RECORDED MUSIC

Continued from page 21

8. **PERFORMANCE:** The quality of playing, interpretation of the score, and feeling.

9. **REMARKS:** There should be included an explanation of the rating and/or suggestions and recommendations by which the quality might be improved with re-recording corrections.

The reference to musical balance is particularly interesting because, on both records and radio programs, we have all heard the sad results when the control room operator undertakes to add his interpretation of the musical score via the microphone controls. Edward Uecke remarked: "Some of our best classical recordings gave the mixer operator a vacation." He probably referred to instances when, by careful preparation, exact microphone placement was achieved. But even then, if the operator cannot leave the mixer controls alone, he can ruin the recording.

Here, then, is an outline for record scoring that can be used by listening groups, not quite as precisely as by the Capitol judges who have the opportunity of comparing the original music with what comes from the records, but at least something that will serve as a practical, standard procedure for registering and comparing opinions.

TESTED IN THE HOME

Continued from page 115

be not over 0.5% harmonic at any frequency between 30 and 15,000 cycles, and 2.5% intermodulation (40 and 7,000 cycles) measured according to SMPE standards. Frequency response is ± 0.2 db from 20 to 20,000 cycles.

The amplifier is simple, straightforward, clean and crisp in sound, hum-free, and easy to connect. Having the preamp built into the power amplifier chassis (an unusual procedure) will be an advantage in many installations involving conversion from crystal to magnetic cartridges, since it will not be necessary to purchase and install a separate unit.

Chassis connections are: *in* to preamp, *out* from preamp (to tuner chassis, for instance, for volume and tone control), and *in* to main power amplifier section. A level control operates on the power amplifier input. These connections are all on top of the chassis. On the back is a 110-volt AC outlet and three screw-head terminals for speaker connections, matching either 8 or 16 ohm voice coils.

Sargent-Rayment is to be complimented, again, for small thoughtfulness: including with the amplifier package a couple of pieces of shielded cable, with phono plugs already soldered in place, and for providing four rubber shock mounts for the amplifier. We appreciate these gestures, because all too often we have been in the process of installing an amplifier or whatnot only to find we do not have the necessary shock mounts. Somehow, our tool box always has three mounts, never four!

All in all — fine equipment, with many features of special interest.

New
WILLIAMSON
TYPE

AMPLIFIER Features

- First Williamson Type Amplifier supplied with matching preamplifier.
- Uses Altec Lansing Peerless output transformer.
- Practically distortionless — Harmonic and intermodulation distortion both less than 1/2 of 1% at 5 watts output.
- Frequency response:
 - ± 1 db from 10 cycles to 100 kc.
 - ± 1 db from 10 cycles to 100 kc.
- Output impedance 4, 8, or 16 ohms.

The new Heathkit Williamson Type Amplifier kit is the best obtainable in amplifiers today — the choice of the really discerning listener. You can hear the difference and measurements actually bear out the superb performance. Frequency response ± 1 db from 10 cycles to 100 kc allow you to hear the highs and lows with equal crispness and clarity. Harmonic and intermodulation distortion both less than 1/2 of 1% at 5 watts output eliminate the harsh and unpleasant qualities which contribute to listening fatigue.

The circuit is similar to the one published in *Audio Engineering Magazine* for November, 1948, and is considered by engineers throughout the audio field as one of the best ever developed. The Main Amplifier (which may be purchased separately) consists of a voltage amplifier and phase inverter using a 6SN7, a driver stage using a 6BN7, and a push-pull output stage using a pair of 6AV6. The output transformer is manufactured by the Peerless Division of Altec Lansing and is built to their highest standards. Output impedances of 4, 8, and 16 ohms are available. The power supply uses a separate chassis with husky Chicago Transformer power transformer and choke, and 700V Mallory filters for long hum-free operation. 5V4G rectifier is used.

The main amplifier and power supply are each on a chassis measuring 7" high by 5½" wide by 11" long.

PREAMPLIFIER AND TONE CONTROL UNIT KIT

The preamplifier kit consists of: a 12AX7 (or 12AY7) dual triode first amplifier stage with a turn-over control for LP or 78 record tones, and a 12AU7 amplifier stage with individual bass and treble tone controls which provide up to 15db of boost or attenuation. A switch on panel selects either magnetic, crystal, or tuner inputs. Preamplifier also is well suited to custom installations — it will operate in either vertical or horizontal position, and special notched shafts of the controls and switches allow a variety of shaft lengths to be selected. Dimensions: 2½" high by 11¼" wide by 7¼" deep.

Heathkit
AMPLIFIER
KIT

WRITE FOR Free CATALOG

The
HEATH COMPANY
BENTON HARBOR 8,
MICHIGAN

Now SAVE BY ORDERING DIRECT

WA-A1 Amplifier kit — Combination 1 — (Main Amplifier and Power Supply) complete with WA-P1 Preamplifier kit. Total Ship. Wgt. 34 lbs. (Shipped Express only) **\$69.50**

WA-A1 Amplifier kit only — Combination 1 — (Main Amplifier and Power Supply). Less WA-P1 Preamplifier. Total Ship. Wgt., 29 lbs. (Shipped Express only) **\$49.75**

WA-P1 Preamplifier Kit only. (Less power supply). Total Ship. Wgt., 7 lbs. (Shipped Express or Parcel Post) **\$19.75**

ORDER BY MAIL
From "WHOLESALE"

America's Finest
HIGH FIDELITY
EQUIPMENT

Get High-Fidelity Music
At Minimum Cost

From "Wholesale Radio"

★ **HI-FI AMPLIFIERS**

GROMMES 50PG	\$55.00
CRAFTSMEN C-500	99.50
ALTEC LANSING Power Amp. A333A	111.00
ALTEC LANSING Remote Amp. A433A	75.00
Has operating controls for A333A	75.00
BELL Model 2122	50.46

High-Fidelity, Magnetic

★ **CARTRIDGES**

GE RPX-050 with dual reversible sapphire stylus	\$8.37
GE RPX-051 Same as RPX-050 (less stylus)	5.26
GE RPX-052 with combination diamond and sapphire stylus	23.37
GE RPX-040 with .003 sapphire	5.97
GE RPX-041 with .001 sapphire	5.97
GE RPX-042 (less stylus)	4.35
GE RPX-046 Professional type. (less stylus)	6.87
GE RPX-047 Broadcast type (less stylus)	9.27
PICKERING S120M Sapphire stylus	9.90
PICKERING D120M Diamond stylus	24.90
PICKERING S140S For microgroove. Sapphire	15.00
PICKERING D140S For Microgroove. Diamond	36.00

★ **GARRARD RC-80 RECORD CHANGER**

Model MB mtg. base—2.50 **\$42.30**
Model WB Wood base—5.95

SPECIAL! While They Last

★ **MEISSNER TUNERS**

Reg. 54.70	8C FM TUNER	\$39.95
Reg. 70.95	9AJ FM-AM TUNER	\$49.95

REK-O-KUT LP 743 **\$54.95**
3 speed, 12" turntable

Complete Line of High Fidelity
Equipment By The Famous Makers

- Electro-Voice
- Acro Sound
- Weathers
- Magnecord
- McIntosh
- Browning
- Partridge
- Jensen

A Practical Guide For Assembling
Your Own High Fidelity System

"MAKE MUSIC LIVE"

By Green, Radcliffe & Scharff **\$4.50**
First complete hi-fidelity handbook.

For Audio Values Write For Free F.Y.I. Bulletin
Address Orders to Dept. H.F. 9

WHOLESALE
RADIO PARTS CO., Inc.
311 W. Baltimore St.
BALTIMORE 1, MD.

ADVERTISING INDEX

Allied Radio Corp.	13
Altec Lansing Corp.	85
American Recording Society	67
Ampex Electric Corp.	16
Arrow Electronics, Inc.	90
Audak Co.	107
Audio Devices, Inc.	Inside Front Cover
Audio Exchange, Inc.	100
Audio Fair.	117
Audio Show	115
Bean Instruments Corp.	104
Bell Sound Systems, Inc.	83
Berlant Associates	120
Bonafide Radio & Electronics Co.	107
Book Department	109, 113
British Industries, Inc.	97
Brociner Electronic Lab.	17
Brook Electronics, Inc.	9
Browning Laboratories, Inc.	9
Capitol Records, Inc.	Back Cover
Childs, Ulric J.	116
Clarkston	84
Collaro	77
Collins Audio Products Co.	91
Columbia Records	65
Cook Labs., Inc.	71
Craig Audio Lab.	117
Creative Audio Associates	117
Custom Electronics	97
Duotone, Inc.	95
Electronic Workshop	101
Electro-Voice, Inc.	5
Espey Mfg. Co., Inc.	120
Fairchild Recording & Eqpt. Co.	79
Fisher Radio Corp.	86
G. & H. Wood Products Co.	118
Garrard Sales Corp.	2
General Apparatus Co.	103
General Electric Co.	80
Gray Mfg. Co.	10
Grayline Engineering Co.	88
Hallcrafters Co.	89
Harvey Radio Co.	93
The Heath Co.	118
High-Fidelity Magazine	107
Hollywood Electronics	94, 116
Hudson Radio & TV Corp.	112
Jensen Industries, Inc.	109
Jensen Mfg. Co.	1
Kierulff and Co.	99, 117
Klipsch & Associates	87
Lafayette	100
Lansing Sound Corp.	78
Lea Pocket Score, Inc.	116
Leak	113
Leonard Radio, Inc.	116
Low Associates, Inc.	117
Magnecord, Inc.	15
McIntosh Laboratory, Inc.	99
The Music Box	69
Network Electric Co.	114
Newcomb Audio Pths. Co.	8
Oxford Electric Corp.	7
Ozark Wood Products Co.	115
Pacific Transducer Corp.	84
Perdue Radio Co.	110
Permo, Inc.	76
Permoflux Corp.	11
Pfanztehl Chemical Co.	82
Pickering & Co., Inc.	18
Precision Electronics, Inc.	117
Prosto Recording Co.	92
R-J Audio Products, Inc.	81
Radio Craftsmen, Inc.	110, 111
Radio Electric Service Co.	101
Radio Shock Corp.	109
Rek-O-Kut Co.	96
Revere Camera Co.	14
Rockbar Corp.	77
Sams, Howard W., Co., Inc.	96
Sargent Raymont Co.	108
Schwann, W.	71
Scott, Herman Hasmer, Inc.	12
Sound Sales Corp.	106
Sound Workshop	101
Sounds of our Times	71
Stephens Mfg. Corp.	98
Stromberg-Carlson Sound Div.	75
Sun Radio & Electronics Co.	105
Tannoy	104
Tape Master, Inc.	102
Telex	113
Terminal Radio Corp.	Inside Back Cover
Traders Marketplace	103
Transcriber Co.	119
University Loudspeakers, Inc.	92, 95
Vector Laboratories	116
Weathers Industries	99
Webster-Chicago Corp.	6
Westminster Records	69
Wharfedale	109
Wholesale Radio Parts Co.	119

DIAMOND NEEDLES

\$10.50
PLUS POSTAGE

No doubt you have learned by now that the needle in your record player is not permanent. It is tipped with either sapphire or osmium metal which should be changed after about 20 hours of playing, in order to protect your valuable records.

This means that if you use your record player on an average of an hour a day these needles need replacing about every three weeks at a cost of between \$1.50 to \$3.50. Because of this frequent needle changing you have of course learned how to install a new one when required.

Why not, then, retip your present replaceable needle with a genuine diamond. One that will give you at least 1000 hours of high fidelity, distortion-free record playing pleasure with the comforting assurance that your costly records will remain undamaged — particularly those long-playing micro groove records, so finely grooved and sensitive to a worn stylus?

Send us your replacement needle assembly now—today. Let us retip it with the highest quality genuine diamond stylus—exactly the same kind that we make for leading radio stations the country over. Save the difference between \$10.50 for 1000 hours of playing and up to \$3.50 for 20 hours. And also save because you deal directly with a leading manufacturer of diamond styli for broadcast use who is in a position to offer the lowest price available for diamonds of this quality.

Our diamond tips are unconditionally guaranteed and are made for LP or standard records. Send check or money order for \$10.50 plus 25c for return postage with your needle assembly or complete cartridge if you cannot remove the replacement needle assembly (except Pickering non-replaceable type) to:

THE TRANSCRIBER CO.
Diamond Styli Manufacturers
172 Green St. Dept. H Boston 30, Mass.

FOR THE BEST BUY in HI-FI

Great Savings

BONAFIDE

Throughout Our Entire Sound Department

No. 1



Espey AM-FM
Tuner Chassis
512 C

No. 2



New V.M. Tri-o-matic
3-Speed Changer
Model 950

No. 3



Grommes
Custom Music Amplifier
50 PG

No. 4

Jensen
2-Way Hi-Fi
K-210



SAVE \$82.29 on this BONAFIDE Combo-Deal!

Everything you'd want for the very finest in High Fidelity... top quality—full guarantee—and BONAFIDE saves you plenty!

No. 1 Espey AM-FM Tuner Chassis 512 C

1. Espey Model 512C, AM-FM Tuner Chassis with Built-in Pre-amplifier. Rated "Best Buy" by independent consumer testing organization. Self-powered. FM circuit includes a tuned RF Amplifier stage, 2 stages of high gain Intermediate Frequency Amplification and an advanced design Ratio Detector circuit for low noise lever between stations, freedom from AM interference. AM circuit includes a tuned RF amplifier for improved selectivity. Top quality throughout! Net: \$99.50

2. New V-M Tri-o-matic 3-Speed Changer, Model 950-3GE with General Electric Magnetic Reluctance Cartridge, RPX-050; Records are lowered—not dropped, completely automatic, 33 1/3, 45 and 78 RPM, 7", 10" and 12" records, intermixes, automatic shut-off, completely jamproof. List: \$51.50

3. Grommes Custom Music Amplifier, 50 PG, hi-fi single unit amplifier with unusual performance. Features extended frequency response with low distortion and plenty reserve power. Ideal for conservative custom installations. 10 watts output, 20 watts peak distortion at 10 watts; 1% harmonic and 2% intermodulation—frequency response: $\pm .5$ db 20 to 20,000 cps. (± 1 db. 30 to 20,000 cps. at 10 watt level). List \$79.95

4. Jensen K-210, 2-Way Hi-Fi 12" Coaxial Speaker: Includes built-in frequency division system. List: \$39.50 Regular price for these four first quality units: \$270.45

BONAFIDE Combo-Deal for only \$188.16

Write today for our low-low prices on any and all Hi-Fi equipment.



FREE! Write today for 56 page booklet "Fundamentals of Magnetic Recording."

DISCS TO TAPES

Continued from page 34

On the next side, the same passage fades up from obscurity until, at a point presumably the same as that where the last side started to fade, its volume is again normal.

The trick is to find the spots on both record sides where the same note is recorded at the same volume, and to align them accurately enough so that the splice takes place without loss of rhythm.

First, the entire taping of the side-to-side transition should be played repeatedly until a note that seems to be of the same volume in both the fade-out and fade-in passages is found. The tape should be cut close to this point at the usual splicing angle. Then the trimming operation is repeated as before, the lengths from the faded passages being cut off until the ends of the tape, joined with a temporary splice, play through without disturbing the rhythm of the music.

Wherever there is a pause in the program, as between movements or acts of the recorded work, the period of unmodulated shellac surface noise should be cut out of the tape and replaced with enough unrecorded tape to give the pause a duration of about five seconds.

A much less conspicuous pause can be made by filling the intervening space with a length of tape on which has been recorded at very low level the rushing sound that comes from an FM receiver when it is not tuned to a station. The rushing sound resembles the surface noise from an extremely smooth shellac record, and its presence during the pause between records eliminates the startling silence that results when the surface noise from the discs is eliminated.

Conclusion

One inevitable result of making a tape from a familiar album of records is that, no matter how perfect the splices, they will continue to call attention to themselves for a considerable number of plays because the memory associates parts of the music with breaks in the continuity. Those who know the composition but are not too familiar with that particular version will, in most cases, be unable to point out the splices.

The taped albums can be played over and over without noticeable deterioration in quality. What little wear that does occur will not be heard as increased scratchiness or raggedness as in the case of discs that are on their last legs but will, instead, appear as an extremely gradual loss of high frequencies, occurring over such a long period of time that it will never be noticed until a direct comparison is made between the shellac originals and the taped version. If such a comparison does show a difference worth noting, the playback head should be suspected before the tape.

To bring about enough wear on the tape to cause any loss of high frequencies will require thousands of plays, while the original album, unplayed and unworn, adorns the library shelf, to be used once again if necessary to make a new taping.

At this rate an original Gieseking album of the piano music of Debussy can become a family heirloom, passing from generation to generation.



IT'S A SHAME

to throw away that beautiful old Console...replace the obsolete radio with a modern, easily-installed

ESPEY AM/FM CHASSIS

and your console is right - up - to - date



NEW FEATURES—Improved Frequency modulation circuit, drift compensated—12 tubes plus rectifier, and preamplifier 12AT7 tube—4 dual purpose tubes—High quality AM-FM reception—Push-pull beam power audio output 10 watts—Switch for easy changing to crystal or variable reluctance pickups—Multi-tap audio output transformer supplying 3.2—8—500 ohms.

Write Dept. HF-9 for literature and complete specifications on Model 511-C and others.

It is not necessary to spend a large sum of money to modernize your old radio or to become a "High Fidelity" enthusiast. ESPEY chassis provide the Highest Quality at moderate prices.

Fully licensed under RCA and Hazeltine patents. The photo shows the Espey Model 511-C, supplied ready to play. Equipped with tubes, antenna, speaker, and all necessary hardware for mounting.

Makers of fine radios since 1928.

ESPEY
MANUFACTURING COMPANY, INC.
528 EAST 72nd STREET, NEW YORK 21, N. Y.



HIGH FIDELITY 10-Watt AMPLIFIER

MODEL AR-410. Frequency response is from 20 to 20,000 cps flat within ± 1 db, with a hum level 70 db below its full rated output. Less than 1% total harmonic distortion. 5-position selector switch for: Phono, Radio, Microphone and auxiliary input. Separate bass and treble tone controls.

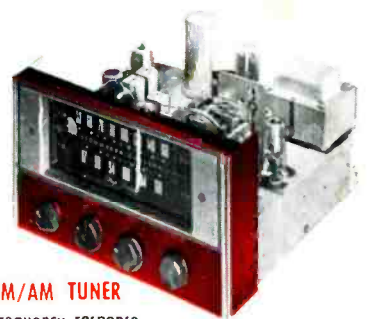

HIGH FIDELITY FM/AM TUNER

MODEL SR-401. FM frequency response of 20 to 20,000 cps, and from 20 to 7,500 cps on AM, both within ± 3 db. 5 microvolts sensitivity. 3 volts output across a 250,000 ohm load at less than 1% total harmonic distortion. AFC circuit eliminates drift.

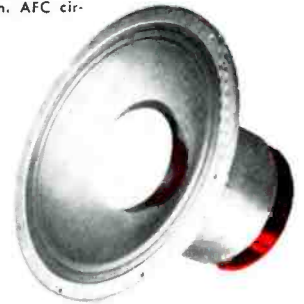

DeLuxe 15" COAXIAL SPEAKER

MODEL RF-475. The ultimate in quality loudspeakers with uniform response from 30 to 16,500 cps. 15" seamless cone with 3" voice coil for low frequencies, and 5" parametric horn with an acoustic corrective lens for high frequencies. Suitable for auditoriums, music halls, schools, and for the uncompromising music lover. Handles 40 watts.

TERMINAL
Cordially Invites You
TO SEE AND HEAR THE ULTIMATE IN
Home Music Reproducing Equipment
 featuring
STROMBERG-CARLSON
Custom Four Hundred
HIGH FIDELITY INSTRUMENTS

HIGH FIDELITY DeLuxe AMPLIFIER

MODEL AR-425. Brings concert-hall quality into your home. Distortion-free reproduction from 20-20,000 cps. Full 25-watt output. Separate tone controls. Input selector switch with variable record compensation. Pre-Amplifier in beautiful English Brown mahogany cabinet.



12" COAXIAL LOUDSPEAKER

MODEL RF-471. Employs the STROMBERG-CARLSON coaxial principle. 3 1/2" seamless tweeter suspended in Carpinchoe leather which smoothes response up to 15,000 cps. Tonal range down to 30 cps is reproduced through the 12" low frequency cone. Wide angle, correctly balanced sound dispersion. Power capacity 32 watts.

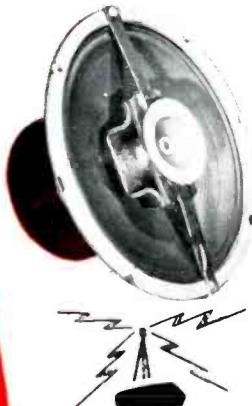

SPEAKER CABINET

MODEL RH-480. Exclusive STROMBERG-CARLSON exponential acoustical labyrinth incorporates a lined folded tube which removes all resonance down to 100 cps, absorbs back wave from the speaker. Principles used in modern broadcasting studios are now used to lend glorious reproduction to the finest high fidelity speaker system. Extends bass a full octave downward.

Take advantage of the liberal TERMINAL trade-in on your old standard-brand audio equipment. Send for "TERMINAL'S AUDIO DIGEST," a complete guide for True Sound Reproduction.

Terminal Radio Corp.

OPEN THURSDAYS TILL 9 P.M. ... AMPLE PARKING SPACE AFTER 6 P.M.

85 CORTLANDT ST., NEW YORK 7, N.Y.
 phone: WOrth 4-3311

HIGH FIDELITY NEWS:

These outstanding classics now available
on Full Dimensional Sound long-play recordings.

LATEST RELEASES

SUK:

Serenade For Strings

SMETANA-BYRNS:

Bohemian Dances

*Harold Byrns Conducting
The Byrns Chamber Symphony*

SHOSTAKOVICH:

Quintet For Piano and Strings
Victor Aller with

The Hollywood String Quartet

RICHARD STRAUSS:

Waltzes From "Der Rosenkavalier"

LISZT:

Les Preludes

*Franz André Conducting
The I.N.R. Symphony Orchestra, Brussels*

SIBELIUS:

Violin Concerto In D Minor

*Camilla Wicks, violinist—with Orchestra of Radio-Stockholm
Conducted by Sixten Ehrling*

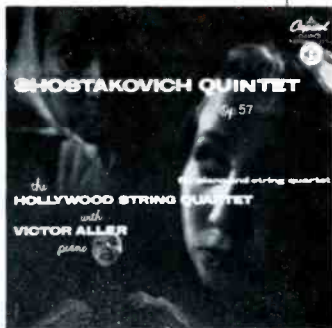

Coming in October • SPECIAL RELEASE

BRAHMS:

Liebesslieder Waltzes • German Folk Songs

Roger Wagner Conducting The Roger Wagner Chorale

No Lost Chords...with Full Dimensional Sound

For music connoisseurs, Capitol's Full Dimensional Sound is a development of supreme importance. FDS is *more* than high fidelity, *more* than full range. In addition to *these* qualities you will find in FDS recordings *balance and depth*, usually sacrificed for the sake of range alone. There is no "magic" to FDS. It results from the use of the most modern studio and recording equipment... painstaking care... plus a unique recording technique that permits maximum collaboration between artist, producer and engineer. As you will hear, this technique makes possible the reproduction of *all* tonal characteristics in the natural color and true perspective of the original live performance. Hear Capitol's current classical releases — identified by the FDS symbol — for recordings of great music, reproduced to the highest degree of *dynamic fidelity* made possible by the present state of the art. A completely rewarding musical experience awaits you.



CURRENT RELEASES

BEETHOVEN:

Symphony No. 6 (Pastorale)

SCHUBERT:

Symphony No. 8 in B Minor

(Unfinished)

Symphony No. 2 in B Flat Major

*Pittsburgh Symphony Orchestra
conducted by William Steinberg*

ARENSKY:

Variations on A Theme
by Tchaikovsky

GRIEG:

The Holberg Suite

*Harold Byrns conducting The
Harold Byrns Chamber Symphony*

PROKOFIEV:

The Love for Three Oranges
Suite from Lieutenant Kijé

TCHAIKOVSKY:

The Nutcracker Suite

Swan Lake

*Roger Désormière conducting
The French National Symphony*

RAVEL:

Daphnis et Chloe Suite No. 2
La Valse

*Franz André conducting The
INR Symphony Orchestra, Brussels*

BRAHMS:

Quartet No. 2 in A Minor,
The Hollywood String Quartet

RAVEL:

Introduction et allegro

DEBUSSY:

Dances Sacrée et Profane
*Ann Mason Stockton, Harp, and
The Hollywood String Quartet*

VILLA-LOBOS:

Bachianas Brasileiras No. 1
Choros No. 4 and Choros No. 7

HAYDN:

Horn Concerto in D Major
*Werner Janssen conducting
The Janssen Symphony Orchestra*

GLAZOUNOV:

The Seasons

RIMSKY-KORSAKOV:

Le Coq d'Or
Capriccio Espagnol
*Roger Désormière conducting
The French National Symphony*

RAVEL:

Miroirs
Gaspard de la Nuit
Leonard Pennario, Piano

Consult your record dealer
for complete repertoire
of Capitol FDS classics and
newest releases.

SEND FOR *Free*

"Playback Characteristics
Chart" of Capitol FDS
Records and F & O
Frequency Musical Scale —
Write:
Capitol Records Inc.,
Dept. 11-2
Sunset and Vine
Hollywood 28, California