

60 cents

high fidelity^{ICD}

JANUARY

THE MAGAZINE FOR MUSIC LISTENERS[®]

BRUNO WALTER

a complete discography of his work on records

REISSUES . . . introducing a new department: reviews of vintage recordings in new longplay editions

THRUST, DUST, AND FRICTION
a guide to the preparations and paraphernalia for cleansing and preserving your microgrooves

**Now even a professional
audio engineering journal
bows to the integrated,
all-in-one component**



...when it's the Fisher 500-C!

CIRCLE 36 ON READER-SERVICE CARD

Audio magazine was among the earliest apostles of the separate-component concept. But to the engineers who write and edit this professional publication, superior performance is superior performance, whether it comes on one chassis or a dozen. And here is what the "Equipment Profile" column of *Audio* has to say about the new Fisher 500-C: "The 500-C incorporates a 75-watt (IHF) stereo amplifier, an FM-stereo tuner and an audio control center, all on one 36.5-lb. chassis... The 500-C is a catalog of conveniences...

"The most convenient feature is automatic switching between stereo and mono FM reception; all one does is tune in an FM station and the 500-C does the rest: If the broadcast is monophonic, the receiver sets itself for monophonic playback; if the broadcast is stereo, the receiver automatically switches to stereo playback and turns on a light to tell you about it. No, the

500-C doesn't turn itself on and off, but once it's on...

"In addition to the usual complement of audio controls, the 500-C... permits two pairs of speakers to be operated simultaneously or either pair separately... With the center-channel output the 500-C enables the user to operate, and control, five speaker systems at the same time; truly an exciting prospect for audiophans who like to surround themselves with sound.

"... We found that the tuner drifted less than 0.01 per cent.

"The output transformers are quite husky (we have a strained back to document that)...

"... It is our opinion that one would have to pay considerably more to get performance equal to the 500-C in separate components.

"... The FM section pulled in 36 stations, loud and clear...

"Considering the performance, and

the many features, and the quality of the parts, we doubt that you could do better in separate components at anywhere near the price of the 500-C. Don't misunderstand us now, we firmly believe that it is the component design approach that makes such an excellent value possible. On the other hand it should be clear from the performance statistics that the Fisher 500-C is an excellent instrument by *any* standards.

"One thing more: the Fisher 500-C is an unusually fine sounding unit, a fact not necessarily revealed by statistics... We took an instant liking to it."

The price of the Fisher 500-C is \$389.50. The Fisher 800-C, with both AM and FM-Stereo but otherwise identical, costs \$449.50. Also available is the Fisher 400, an only slightly more modest receiver with FM-Stereo only, at \$329.50. Walnut or mahogany cabinets for all models, \$24.95. All prices are slightly higher in the Far West.

Mail this post card for the free 1964 edition of The Fisher Handbook.

FREE! \$1.00 VALUE! Just Published! Mail this post card for your free copy of the new 1964 Fisher Handbook, a lavishly illustrated 52-page reference guide to custom stereo. It includes complete data and specifications on all Fisher high fidelity components.



PLACE
4¢
STAMP
HERE

Name _____ State _____ 01101
 Address _____
 City _____

FISHER RADIO CORPORATION
P.O. BOX 6-C
 Long Island City 1, New York

Overseas residents write to Fisher Radio International, Inc., Long Island City 1, New York
 Canadian residents write to Tri-Tel Associates, Ltd., Willowdale, Ont.

**We begin this issue
of High Fidelity
with a quotation
from Audio:**

(For complete enlightenment, fold out this page.)

“By implication, and sometimes overtly, we have been led to believe that separate components are inherently better than integrated components. Well, ’taint necessarily so.”

—AUDIO magazine, December, 1963

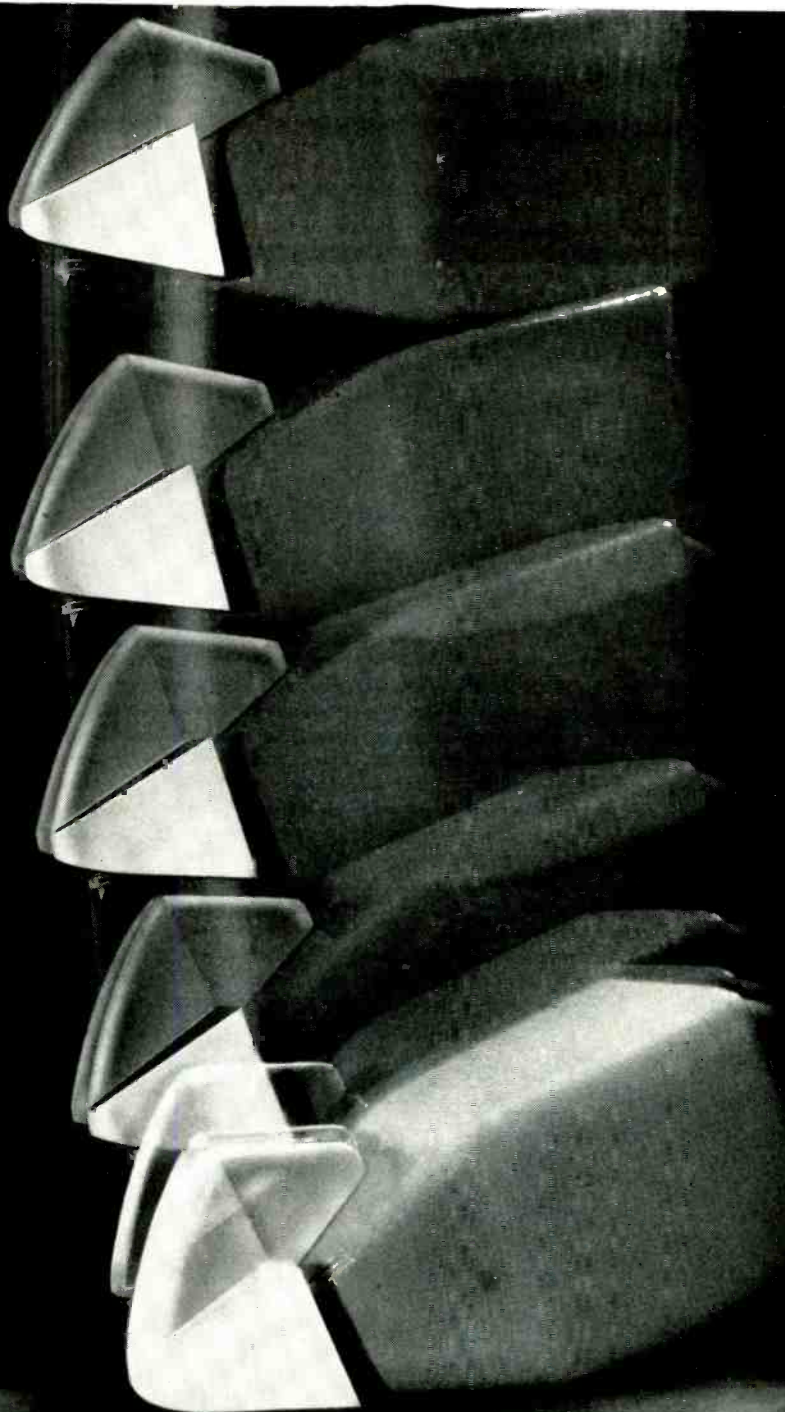

what makes
an automatic sound
like a turntable?

The U38!
expressly designed
for automatic
turntables

The new generation of automatic turntables tracking and tripping at lower and lower forces demands this new kind of cartridge. Demands a "floating stylus" that protects your diamond and record as it plays...demands complementary electrical characteristics which maximize the use of forward-looking circuitry whether vacuum tube or solid state. The U-38 meets these demands and makes your automatic **sound like** a turntable. With Pickering's famous plug-in replaceable stylus assembly you get a cartridge with a life-time of trouble free performance. Pickering and Company, Inc., Plainview, New York.

Pickering



U38 cartridge with
AT Stylus... 2-5 grams tracking force
ATG... 1-3 grams

CIRCLE 49 ON READER-SERVICE CARD



Plug-in head assembly for
Garrard Type A and Model ATG



Page 40

high fidelity



Page 53

Music and Musicians

- 39 Reissues: Introducing a New Department: an editorial
- 40 "An Education and a Joy": Bruno Walter at work *John T. McClure*
- 44 The Heritage of Bruno Walter: a discography *Robert C. Marsh*
- 53 A Soupçon of Vibrato *Denis Stevens*
- 28 A Change of Chairs: an interview with a & r men Leonard Burkat and Roger Hall *Shirley Fleming*
- 12 Notes from Abroad—Paris, London

Sound Reproduction

- 35 High Fidelity Newsfronts: distilled but not stilled *Norman Eisenberg*
- 49 Thrust, Dust, and Friction: record wear *Joseph Marshall*
- 57 Equipment Reports
 - United Audio Dual TG 12 SK Tape Recorder
 - Sherwood Model S-7700 Tuner/Amplifier
 - Dynakit Stereo-35 Basic Amplifier
 - Jensen TF-4 and X-11 Speaker Systems

Reviews of Recordings

- 65 Feature Record Reviews
 - Handel: *Samson* (Phyllis Curtin, Jan Peerce, et al.)
 - Saint-Saëns: *Samson et Dalila* (Rita Gorr, Jon Vickers, et al.)
 - "Bach in Swing" (Jacques Loussier Trio; Swingle Singers)
- 68 Other Classical Reviews
- 81 Reissues
- 85 The Lighter Side
- 90 The Sonic Showcase
- 93 Jazz
- 97 The Tape Deck

JANUARY 1964 • VOLUME 14 NUMBER 1

Published monthly at Great Barrington, Mass. by The Billboard Publishing Co. Copyright © 1963 by The Billboard Publishing Co. The design and contents of High Fidelity Magazine are fully protected by copyright and must not be reproduced in any manner. Second-class postage paid at Great Barrington and at additional mailing offices. One year subscription—anywhere on Earth \$7.00. Indexed in the "Reader's Guide to Periodical Literature." Change of Address notices and undelivered copies (Form 3579) should be addressed to High Fidelity, Subscription Dept., 2160 Patterson St., Cincinnati 14, O.



If you're willing to pay anything for professional quality.....but would rather not

The Concertone 605 is for the one man in several who can't stand less than perfection...but can't see why professional quality should cost so much. Never before have so many features and so much professional quality been available at this price. Read ahead carefully and see: Precision plug-in head assembly...includes four precision heads; Separate microphone and line controls (input can be mixed); Delay memory control circuit (never spill or break tape); Automatic glass tape lifters, including electric cue feature; Sound on sound and add sound; Solenoid operated brakes; Three motors, including 2-speed hysteresis synchronous drive; Automatic rewind; Exclusive Reverse-O-Matic®. Learn all about the 605 in complete detail. Ask your dealer for a demonstration or send for free literature today.



CONCERTONE 607

Broadcast version

The Concertone 607 with higher impedance is for the true professional or broadcaster. Remote control optional. This superb tape recorder is constructed to 19" x 14" dimensions, permitting it to be used as an exact replacement for old or outdated tape recorders.

CONCERTONE 400 COSMOPOLITAN

For people on the go...it's the Cosmopolitan - Combination Tape Recorder with AM Radio. A versatile companion and co-worker for business or pleasure travels. 5" reel capacity. Push-button operation. Amazing fidelity. Remote mike. Foot-pedal control. This all-transistorized recorder has big recorder features in miniature form.

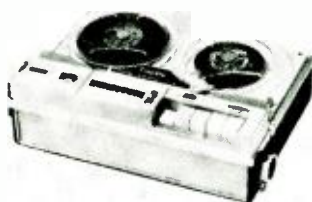

for further information write:



AMERICAN CONCERTONE, INC.
A DIVISION OF ASTRO-SCIENCE CORP.
9449 W. JEFFERSON BLVD. • CULVER CITY • CALIF.

Export: J. D. Marshall International, 170 W. Washington, Chicago, Illinois

HF-164

CIRCLE 6 ON READER-SERVICE CARD

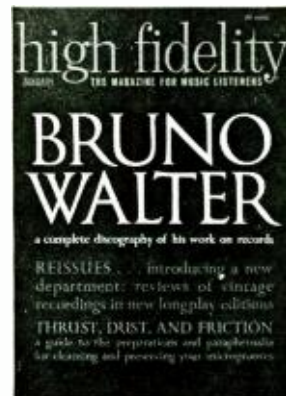

Cover Design: Lawrence Ratzkin

Roland Gelatt

Editor in Chief

Joan Griffiths
Executive Editor

Norman Eisenberg
Audio Editor

Sue Severn
Managing Editor

Shirley Fleming
Assistant Editor

H. C. Robbins Landon
European Editor

Roy Lindstrom
Art Director

Nathan Broder
John M. Conly
R. D. Darrell
Alfred Frankenstein
Robert C. Marsh
Contributing Editors

Claire N. Eddings
Director of Advertising Sales

Walter F. Grueninger
Circulation Director

Warren B. Syer
Publisher

ADVERTISING

Main Office

Claire N. Eddings, The Publishing House
Great Barrington, Mass., 01230
Telephone: 1300

New York

165 West 46th St., New York 10036
Telephone: Plaza 7-2800
Seymour Resnick, Andrew Spanberger

Chicago

The Billboard Publishing Co.
188 W. Randolph St., Chicago 60601
Telephone: Central 6-9818
Jerry Taylor

Los Angeles

434 So. San Vicente Blvd.
Los Angeles 90048
Telephone: Olympia 2-2100
Robert J. Friedman, Michael R. Simon



Dancing Allowed

...with the new Empire 488. You can Bossa, Cha Cha, two step and even twist with the new 488. Stability is assured under virtually any conceivable situation, with the exclusive *Dyna-Mount** (vibration absorbing multiple-floating-suspension system). Even the jars and jolts of children jumping or accidentally bumping into the cabinet will not discourage the tracking performance of the Empire 980 arm. As for levelness... the new Empire 438 Troubador with more perfect balance, tracks and plays even while turning upside down.

Not too long ago, Audio Magazine reported this about the Troubador... "We tried to induce acoustic feedback by placing the turntable on top of our large speaker system and turning up the gain—we were unsuccessful."

No larger than a record changer—every inch a Troubador. Minimum space requirements 15 $\frac{7}{8}$ " wide x 13 $\frac{1}{4}$ " deep... height required above mounting board 2 $\frac{3}{4}$ "; depth required below turntable base plate 3 $\frac{1}{2}$ ".

Famous Empire 398... *professionals' turntable*—too perfectly engineered for even a whisper of distortion... too handsome to hide behind cabinet doors.

That's why we're proud of the new Empire 488 & the 398... Look for the little sign in better showrooms across the country, that simply states "*Dancing Allowed with the new Empire 488.*"

TROUBADOR TABLE OF CONTENTS

Empire 3-speed "silent" turntable; 980 dynamically balanced playback arm with sensational Dyna-Lift; 880p mono-stereo cartridge featuring the virtually indestructible Dyna-Life stylus. 488 complete with walnut mounting board; \$192; walnut base optional (\$15); 398 complete with handsome walnut base: \$210.



EMPIRE

"World's Most Perfect Record Playback System"

Empire Scientific Corp. • 845 Stewart Ave., Garden City, L. I., N. Y. • Export: EMEC, Plainview, L. I., N. Y. • Canada, Empire Scientific Corp., Ltd., 1476 Eglinton West, Toronto

CIRCLE 34 ON READER-SERVICE CARD

COLUMBIA RECORD CLUB now invites new members to choose from this superb selection of

The Greatest Classical Recordings of our day!



"A mighty drama perfectly presented."—*St. Louis Globe-Democrat*

HANDEL
MESSIAH



MESSIAH
EUGENE ORMANDY
The Philadelphia Orchestra
THE MORMON TABERNACLE CHORUS
COLUMBIA

1107-1108. Two-Record Set (Counts As Two Selections.) "Zestful and gloriously recorded... a powerful, vital statement!"—*HiFi Review*

"America's most celebrated organist."
—*Newsweek*

MUSIC FOR ORGAN AND ORCHESTRA



E. POWER BIGGS
BERNSTEIN / ORMANDY

POULENC: Organ Concerto
BARBER: Toccata Festiva
STRAUSS: Festival Prelude
COLUMBIA

1268. E. Power Biggs plays three powerful works by Poulenc, Barber and Strauss in a truly "impressive performance."—*Am. Rec. Guide*

"The most dazzling technician ever."
—*Chicago Daily News*

VLADIMIR HOROWITZ



The Sound of HOROWITZ
COLUMBIA
SCARLATTI • SCHUBERT
SCHUMANN • SCRIBIN

1068. "The greatest of Romantic pianists... there is simply nobody else around who produces his kind of tone from a piano."—*HiFi Rev.*

"Will make your hair stand on end."
—*HiFi Stereo/Review*

SHOSTAKOVITCH
SYMPHONY No. 5



SHOSTAKOVITCH SYMPHONY No. 5
LEONARD BERNSTEIN
NEW YORK PHILHARMONIC
COLUMBIA

1288. "Leonard Bernstein at his best." — *Chicago Tribune*. "Truly memorable listening."—*New York Journal American*

BETHOVEN
"Emperor" Concerto
RUDOLF SERKIN
BERNSTEIN
N. Y. Philharmonic

1095. **SAINT-SAENS**
Organ Symphony (No. 3)
Philadelphia Orch. - Ormandy
E. POWER BIGGS
COLUMBIA ORGANIST

1076. **IVES**
Symphony No. 2
BERNSTEIN
New York Philharmonic

1094. **THE BLUE DANUBE**
A Johann Strauss Festival
PHILADELPHIA ORCH. • ORMANDY

MOZART
Concerto for Flute And Orchestra, K. 313
Concerto for Bassoon And Orchestra, K. 191
PHILADELPHIA ORCH.
ORMANDY
COLUMBIA

1078. **THE MUSIC OF ARNOLD SCHOENBERG**
Robert Craft Cond.
- Erwartung -
- Pierrot Lunaire -
- Die Glückliche Hand -
- Violin Concerto -
COLUMBIA

1273-1274. *Two-Record Set
TCHAIKOVSKY
THE SLEEPING BEAUTY
Ballet Suite
PHILADELPHIA ORCH.
EUGENE ORMANDY
COLUMBIA

1269. **The Cuckoo and the Nightingale**
Four Handel Organ Concertos
E. POWER BIGGS
SIR ADRIAN BOULT
LONDON PHILHARMONIC
COLUMBIA

LORD'S PRAYER
MORMON TABERNACLE CHORUS
COLUMBIA
BATTLE HYMN OF THE 2ND PUBLIC
THE LORD'S PRAYER - 9 CORE

1090. 

1279. **BERNSTEIN CONDUCTS COPLAND**
El Salon Mexico
Appalachian Spring
N. Y. Philharmonic
COLUMBIA

1104-1105. *Two-Record Set
BETHOVEN SYMPHONY No. 9 ("CHORAL")
Symphony No. 8
SZELL
Cleveland Orchestra
COLUMBIA

STRAVINSKY conducts
The "FIREBIRD" COMPLETE BALLET
COLUMBIA

1103. **RACHMANINOFF**
Piano Concerto No. 2
BERNSTEIN-ENTREMONT
N. Y. PHILHARMONIC

1101. **SVIATOSLAV RICHTER**
LISZT Concertos Nos. 1 & 2
Kondrashin
London Symphony

1286. 

Dances for Orchestra
DANSE MACABRE
HABANERA
POLOVTSIAN DANCES
4 more
COLUMBIA
ORMANDY • Philadelphia Orch.

1073. **PROKOFIEV:**
Alexander Nevsky
THOMAS SCHIPPERS
N. Y. PHILHARMONIC

1278. **Beethoven: Symphony No. 3 "EROICA"**
Philadelphia Orch.
ORMANDY
COLUMBIA

1106. **Stravinsky conducts LE SACRE DU PRINTEMPS**
"THE RITE OF SPRING"
COLUMBIA

THE FABULOUS VOICE OF RICHARD TUCKER
The Exodus Song - Tonight
The Sweetest Sounds - 9 more
COLUMBIA

1099. **BARTOK: CONCERTO FOR ORCHESTRA**
LEONARD BERNSTEIN
NEW YORK PHILHARMONIC
COLUMBIA

1271. **BACH MASS IN B MINOR**
Philadelphia Orchestra
ORMANDY
TEMPLE UNIVERSITY CHORUS
COLUMBIA

1086-1087-1088. **Three-Record Set
BACH BRANDENBURG CONCERTO No. 5
THREE CHORALE-PRELUDES
STOKOWSKI
Philadelphia Orch.
COLUMBIA

PERCUSSION SPECTACULAR
GINA STERA : CHAVEZ:
Cantata Para Toccata for America Magica : Percussion Instruments
COLUMBIA

1075. **ORFF: CARMINA BURANA**
THE PHILADELPHIA ORCHESTRA
soloists and chorus
ORMANDY conducting
COLUMBIA

1281. 

1272. **Zino Francescatti**
PAGANINI:
Violin Concerto No. 1
SAINT-SAENS:
Violin Concerto No. 3
COLUMBIA

BETHOVEN
Violin Concerto
ISAAC STERN
COLUMBIA
New York Philharmonic,
Leonard Bernstein, Cond.

1195. **Rimsky-Korsakov SCHEHERAZADE**
PHILADELPHIA ORCH.
COLUMBIA ORMANDY

1089. **Beethoven: PASTORAL SYMPHONY (No. 6)**
SZELL • Cleveland Orch.

1172. **CLAIR de LUNE**
A Debussy Piano Recital by PHILIPPE ENTREMONT
COLUMBIA

1100. (Stereo version is electronically re-channelled)

CIRCLE 23 ON READER-SERVICE CARD

AS A NEW MEMBER YOU MAY HAVE

ANY SIX

OF THE RECORDS SHOWN ON THESE TWO PAGES - IN YOUR CHOICE OF

REGULAR or STEREO

FREE

if you begin your membership by purchasing any one of these records—and agree to buy as few as six additional selections from over 400 to be offered in the next 12 months

VLADIMIR HOROWITZ Chopin · Liszt Rachmaninoff Schumann COLUMBIA 1067.	SWEET PIPES (5 Centuries of Recorder Music) COLUMBIA KRAINIS CONSORT and BARoque ENSEMBLE 1173.	BARTOK: BLUEBEARD'S CASTLE ROSALIND ELIAS JEROME HINES Eugene Ormandy The Philadelphia Orchestra COLUMBIA 1265.	ANDRE WATTS LISZT: Piano Concerto No. 1 BERNSTEIN NEW YORK PHILHARMONIC COLUMBIA 1074.
TCHAIKOVSKY Symphony No. 5 LEONARD BERNSTEIN NEW YORK PHILHARMONIC COLUMBIA 1069.	BRUNO WALTER MAHLER: DAS LIED VOM DIER ERDE Ludwig Strehl COLUMBIA 1266.	THE LORD'S PRAYER Volante II AVE MARIA HALLELUJAH, AMEN COME, SWEET DEATH COLUMBIA and others MORMON TABERNACLE CHOIR Ormandy - Philadelphia Orch 1091.	Bach Organ Favorites E. Power Biggs COLUMBIA 1097.
STRAVINSKY: CONDUCTS OEDIPUS REX COLUMBIA 1285.	MAHLER "Resurrection" Symphony (No. 2) BRUNO WALTER New York Philharmonic Westminster Choir COLUMBIA 1111-1112. *Two-Record Set	 THE BLUEBIRD SOUNDS OF MAHLER Philadelphia Orchestra COLUMBIA ORMANDY 1084.	TCHAIKOVSKY Symphony No. 7 World Premiere Recording COLUMBIA ORMANDY PHILADELPHIA DRCH. 1283.
BEETHOVEN Quartet No. 12 Budapest String Quartet COLUMBIA 1082.	FINLANDIA PHILADELPHIA ORCHESTRA MORMON TABERNACLE CHOIR EUGENE ORMANDY Plan - Tala Triola - Swedish Rhapsody - Rear Op. Suite No. 1 COLUMBIA 1096.	SCHUBERT: Symphonies Nos. 5 and 8 ("UNFINISHED") BRUNO WALTER conducting COLUMBIA 1287.	TCHAIKOVSKY CONDUCTS STRAVINSKY COLUMBIA PETROUSHKA 1093.
BACH: THE GOLDBERG VARIATIONS GLENN GOULD, piano COLUMBIA 1267. Regular Only	FOUR VIVALDI CONCERTI for Two Violins and Orchestra ISAAC STERN DAVID OISTRAKH EUGENE ORMANDY PHILADELPHIA ORCH COLUMBIA 1289.	CHOPIN: COLUMBIA 1109.	

HERE'S A TRULY WONDERFUL SELECTION OF CLASSICAL RECORDINGS that belong in any record collection! By joining the Columbia Record Club now, you may have ANY SIX of the superb records shown on these pages—FREE!

Simply write in the numbers of the SIX records you wish to receive FREE on the coupon below. Then choose another record as your first selection... for which you will be billed only \$3.98 (regular high-fidelity) or \$4.98 (stereo). In short, you will receive seven classical records for less than the price of one! Be sure to indicate whether you want your seven records (and all future selections) in regular high-fidelity or stereo.

HOW THE CLUB OPERATES: Each month the Club's staff of music experts selects outstanding records from every field of music. These selections are fully described in the Club's entertaining music Magazine which you will receive free each month.

You may accept the monthly Classical selection... or take any of the wide variety of other records offered in the Magazine... or take no record in any particular month.

Your only membership obligation is to purchase six additional records from the more than 400 to be offered in the Club Magazine during the coming 12 months... and you may discontinue membership at any time thereafter. If you continue, you need buy only four records a year to remain a member in good standing.

FREE RECORDS GIVEN REGULARLY. If you do wish to continue as a member after fulfilling your enrollment agreement, you will receive — FREE — a record of your choice for every two additional selections you buy.

The records you want are mailed and billed to you at the regular Club price of \$4.98 (Popular, \$3.98), plus a small mailing and handling charge. Stereo records are \$1.00 more.

MAIL THE COUPON TODAY to take advantage of this offer.

NOTE: Stereo records must be played only on a stereo record player.

*Two-Record Set Counts As 2 Selections *Three-Record Set Counts As 3 Selections

Chopin Polonaises
 ALEXANDER BRALOWSKY
 COLUMBIA
 1092.

Tchaikovsky - NUTCRACKER SUITE
 Prkofiev
PETER AND THE WOLF
 Leonard Bernstein
 N.Y. Philharmonic
 COLUMBIA
 1070.

Rhapsody in Blue
 An American in Paris
 Leonard Bernstein
 plays
 Gershwin
 COLUMBIA
 1098.

HEROIC MUSIC
 for Organ, Brass and Percussion
E. POWER BIGGS
 COLUMBIA
 1110.

BELA BARTOK
 PLAYING HIS OWN WORKS
 Excerpts from
MIKROKOSMOS
 COLUMBIA
 1270. Regular Only

Balalaika Favorites
 OSIPOV STATE
 RUSSIAN FOLK ORCH.
 COLUMBIA
 1079.

Beethoven
MISSA SOLEMNIS
 Leonard Bernstein
 New York Philharmonic
 Westminster Choir
 COLUMBIA
 1275-1276. *Two-Record Set

More than 1,750,000 families now belong to the world's largest record club
COLUMBIA RECORD CLUB
 Terre Haute, Ind.

COLUMBIA RECORD CLUB, Dept. 221-6
 Terre Haute, Indiana

I accept your special offer and have indicated at the right the numbers of the six records I wish to receive — FREE! I've also indicated the record I am to receive as my first selection, for which I am to be billed \$3.98 (regular high-fidelity) or \$4.98 (stereo), plus a small mailing and handling charge.

Send my 7 records and all future selections in (check one) REGULAR STEREO

Enroll me in the Classical Division, with the understanding that I may select any of the other records offered. I agree to purchase six additional records from the more than 400 to be offered in the coming 12 months, at the regular Club price plus a small mailing and handling charge. After fulfilling this agreement, if I wish to remain a member in good standing I need purchase only 4 records a year, and I will receive a 12" record of my choice FREE for every two such records I purchase.

Name..... (Please Print)
 Address.....
 City..... ZONE..... State.....
 Telephone Number.....

APO, FPO addressees: write for special offer
 CANADA: prices slightly higher; 1111 Leslie St., Don Mills, Ont.
 © Columbia Records Distribution Corp., 1964 726/S64

SEND ME THESE SIX RECORDS — FREE (fill in numbers below)

ALSO SEND ME THIS RECORD AS MY FIRST SELECTION

91-3E

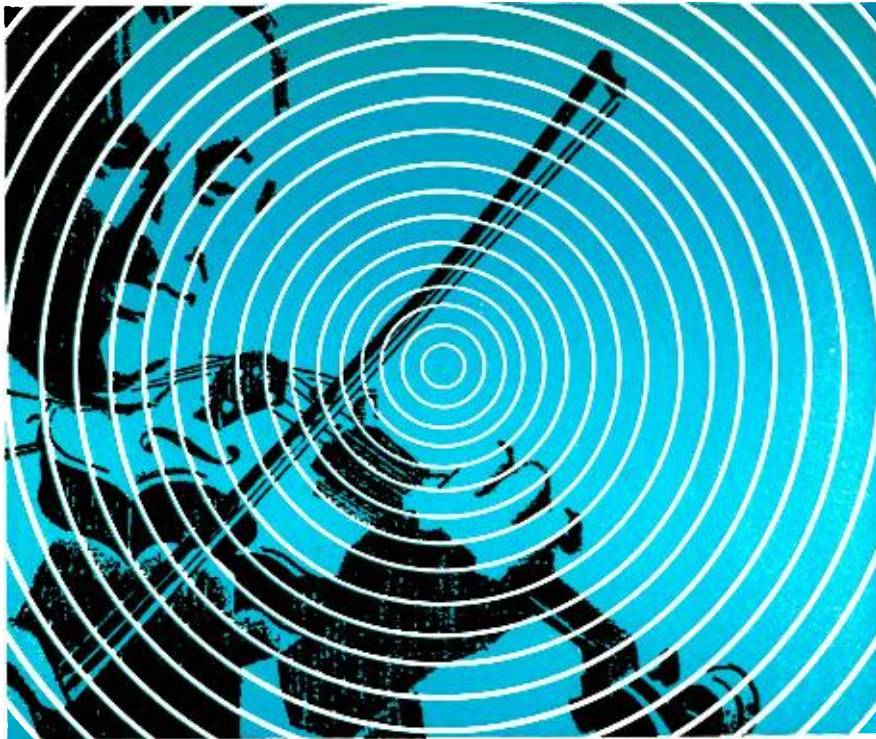

achieve THRILLING LIVING PRESENCE

WITH THE **FINCO**[®]
AWARD-WINNING FM ANTENNA

Broadcasting authorities agree that an outdoor antenna is absolutely essential for the reception of full quality monaural and multiplex FM sound.

A *FINCO* FM antenna will deliver a clean, undistorted signal and bring in more stations, regardless of location.

Guarantee yourself the best seat in the house for tonight's FM concert . . . install a fidelity-phased *FINCO* FM antenna.

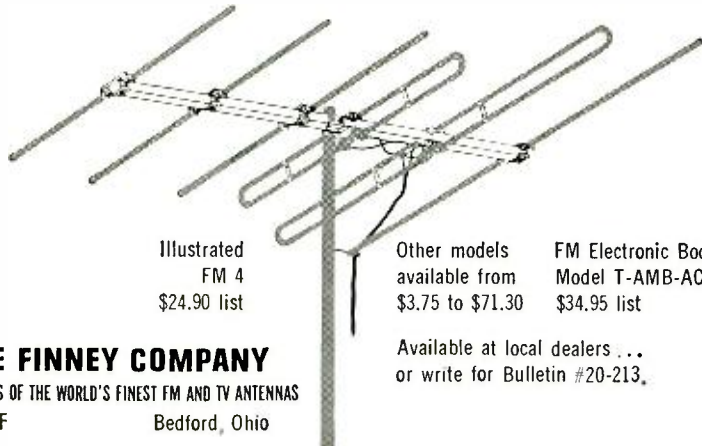

Illustrated
FM 4
\$24.90 list

Other models
available from
\$3.75 to \$71.30

FM Electronic Booster
Model T-AMB-AC
\$34.95 list

Available at local dealers . . .
or write for Bulletin #20-213.

THE FINNEY COMPANY
PRODUCERS OF THE WORLD'S FINEST FM AND TV ANTENNAS
Dept. HF Bedford, Ohio

CIRCLE 35 ON READER-SERVICE CARD

AUTHORitatively Speaking

John T. McClure, Music Director of Columbia Masterworks, was responsible for the Bruno Walter recordings in California from their inception in 1958 until the time of the late conductor's death. His recollections of those years form the substance of "An Education and a Joy" (p. 40), a memoir obviously written out of gratitude and affection. Since working with the late Maestro, Mr. McClure has gone on to supervise the recordings of many other distinguished artists, and in the time left from professional labors has established himself and his family in Valhalla (*sic*, a hilly town in Westchester, and no picturesque intimation on our parts of Wagnerian splendors). There he finds moments to play his harpsichord (half of them go to tuning, he says) and to indulge his enthusiasm for sailing, skiing, camping, and such equally nonsedentary pursuits as carpentry and stonemasonry.

With "The Heritage of Bruno Walter," p. 44, **Robert C. Marsh** has produced another of those discographies which have distinguished *HIGH FIDELITY*'s pages over a number of years. While Mr. Marsh has at diverse times in his career been a student of semantics, political economy, and mathematical logic (his book *Logic and Knowledge* is a critical edition of papers by Bertrand Russell), music has been his most enduring love and orchestral music his special forte. In this field he established his authority with *Toscanini and the Art of Orchestral Performance* and has maintained it with a succession of critical writings. The discography herein is based not only on many hours of listening to the Walter recordings but on personal conversations with Dr. Walter.

Joseph Marshall, author of "Thrust, Dust, and Friction" (p. 49), is a designer of electronic components and a professional audio consultant who, after more than thirty years' experience, still persists in describing himself as an amateur. We think he must have in mind the root meaning of the term, and in this sense we feel he has a right to his preference. Certainly, in the several books and hundreds of articles he has written on various aspects of sound reproduction there is in evidence that quality of dedicated personal involvement characteristic of the true high fidelity *aficionado*. Furthermore, Mr. Marshall has never lost sight of the ultimate aim, the music itself.

Giving the lie direct to that old saw that teaching and doing are quite incompatible, Britisher **Denis Stevens** has for fifteen years combined two careers—as musicologist and conductor. For part of each year he may be found in this country as a Visiting Professor (currently at Pennsylvania State University), for the rest of the year in Europe as director of the Accademia Monteverdiana and the Ambrosian Singers, both of which groups he was instrumental in founding. With his musicians Mr. Stevens appears frequently in concert and television performances—with programs ranging from Byzantine chant to contemporary motets—and is occupying an increasingly conspicuous place in the record lists. Presently engaged in compiling a one-volume *Concise Grove's Dictionary*, he has also found time to write for us an essay that is both *jeu d'esprit* and serious critique: see "A Soupçon of Vibrato," p. 53.



The lyric majesty of Sony sound



A magnificent new stereophonic high fidelity tape system; precise, versatile, complete in itself, the **Sony Stereorecorder 500**, with the revolutionary lid-integrating speakers, may be purchased for less than \$399.50 complete with two F-87 cardioid dynamic microphones.

Outstanding operational features distinguish the amazing new Sony Stereorecorder 500: ■ Acoustical cone suspension speakers ■ Speakers combine to form carrying case lid ■ 4-track stereo and monophonic recording and playback ■ Vertical or horizontal operation ■ Microphone and line mixing ■ Sound on sound ■ Two V.U. meters ■ Hysteresis-Synchronous drive motor ■ Dynamically balanced capstan flywheel ■ Pause control ■ Contour switch ■ Automatic shut-off ■ Automatic tape lifters ■ FM stereo inputs ■ Multiplex Ready!

SONY **SUPERSCOPE** *The Tapeway to Stereo*

Sony tape recorders, the most complete line of quality recording equipment in the world, start at less than \$79.50. For literature or name of nearest dealer, write Superscope, Inc., Dept. 1, Sun Valley, Calif. In New York, visit the Sony Salon, 585 Fifth Avenue.

CIRCLE 62 ON READER-SERVICE CARD



JANUARY 1964

9

This problem becomes most acute with increased stylus compliance. For, in reaching for higher and still higher compliance, it becomes necessary to reduce the dynamic mass of all the moving components of the stylus assembly to the lowest possible magnitude.

concerned primarily with improving cartridge performance. The ultimate objective was to achieve a cartridge without distortion, without crosstalk — a cartridge capable of reproducing a perfect waveform replica of the sound groove.

How close the Elac 322 has come to this

mono/stereo cartridge diamond stylus at \$39.50. At your hi-fi dealer. For further details, write to:

BENJAMIN ELECTRONIC SOUND CORPORATION
80 SWALM STREET, WESTBURY, NEW YORK
Sole U.S. distributor for Electroacoustic (Elac) ® Record Playing Components.

THE NEW ELAC MODEL 322 STEREO CARTRIDGE

BENJAMIN
ELAC

Every performance comes alive
on *allegra* by Grommes
... music you can almost see.

NOTES FROM

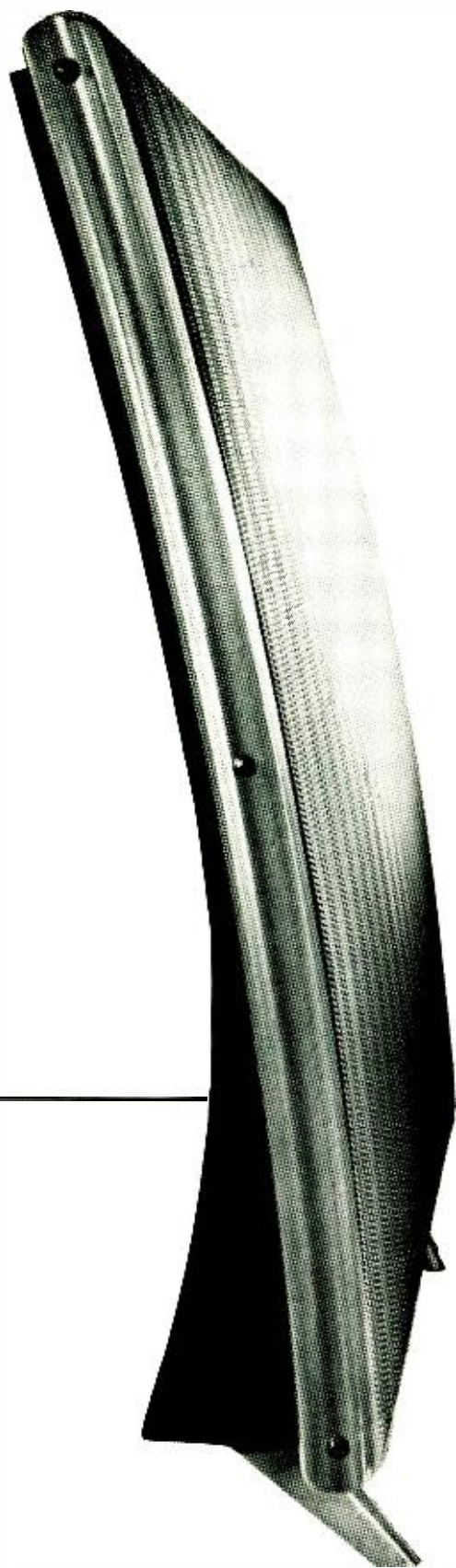

completely lacking in character?



The depth probing Ad-men will shudder at the use of such a title but we can think of no better description for a good loudspeaker.

Character in the music; character in the instruments; character in the artist—yes, but no character in the loudspeaker, please!

DEALERS ONLY. Specialist high fidelity dealers with demonstration and service facilities are still required in several areas for appointment as QUAD agents. Write for details of this interesting scheme.

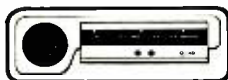

for the closest approach to the original sound.

WRITE FOR AN ILLUSTRATED LEAFLET AND THE NAME OF YOUR NEAREST QUAD DEALER TO ACOUSTICAL MANUFACTURING CO. LTD. HUNTINGDON, ENGLAND

CIRCLE 2 ON READER-SERVICE CARD

FREE record offer from **AF** Audio Fidelity!!!

BUY ANY **2** AUDIO FIDELITY ALBUMS AT \$4.98 (each), THIS STEREO DEMO LP IS YOURS

*(A \$20.85 VALUE FOR \$9.96)

FREE!



This is a limited time offer and may be withdrawn any time after January 31, 1964.

STEREO SPECTACULAR DEMONSTRATION & SOUND EFFECTS—Fast moving, exciting, narrated tour of dramatic situational stereo effects plus varied selections from Audio Fidelity's vast library. Cited for engineering excellence by the National Academy of Recording Arts & Sciences. The greatest stereo demonstrator ever created! DFS 7777

Audio Fidelity Records have always had a greater appeal to men. We don't know why exactly, except that they are a quality product. They sound better. Perhaps men are more "sound" conscious. We'll admit too that some of our material has

a predominantly male appeal. Mostly though, Audio Fidelity records are different, powerfully different. Men like them!

THESE ARE SOME TIME-TESTED AUDIO FIDELITY ALBUM FAVORITES!



THE BRAVE BULLS! Banda Taurina Music of the Bullfight Ring! El Relicario, Cielo Andaluz, La Virgen de la Macarena, etc. AFLP1801/AFSD5801



BAWDY SONGS and Backroom Ballads, Vol. 1. Oscar Brand—Lusty, spicy musical folklore. —Roll Your Leg Over, No Hips At All, Sam Hall, etc. AFLP1906



PORT SAID, Mohammed El-Bakkar—Tantalizing love songs, exotic dances. Haun Meelee, Bint II Geran, Al Jazayair, etc. AFLP1833/AFSD5833

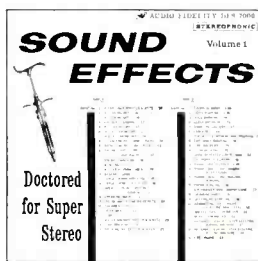

SOUND EFFECTS, Vol. 1—Perfect auditory images! Jets, Racing Cars, Crowds, Thunder, Heartbeats, Surf, Birds, Lions, etc. DFM3006/DFS7006



RAILROAD SOUNDS—Vanishing era revisited! Steam & diesel engines. Dynamic realism! Perfect model train background. AFLP1843/AFSD5843

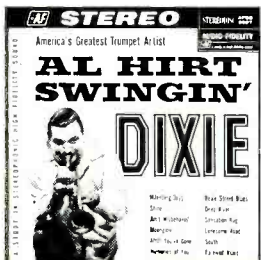

AL HIRT SWINGIN' DIXIE—Dynamic, distinctive trumpet talent, playing: Deep River, Moonglow, After You've Gone, etc. AFLP1927/AFSD5927



HITLER'S INFERNO, A shocking documentary in words and music. Hitler speaks, Nazi Storm Troopers sing, Nazi German marches. AR2445 (mono)



PATACHOU at Carnegie Hall—Her ebullient French charm was never more appealing. Ma Fetes A Moi, Que Reste-t-il, A Paris. AFLP2109/AFSD6109



MAGNIFICENT MANDOLINS, Dick Dia & Mandolin Orch.—Perhaps the finest mandolin sound on records! Summertime In Venice, Brasilia, etc. AFLP1963/AFSD5963

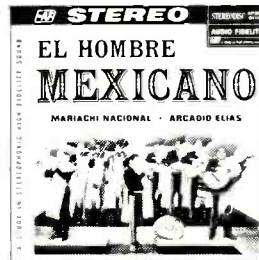

EL HOMBRE MEXICANO, Mariachi Nacional, Arcadio Elias—Guitars, Violins, Trumpets—Cowboy yells, Guadalajara, Soy Puro Mexicano, Paloma, etc. AFLP2116/AFSD6116



GREAT MOVIE THEMES—Inimitable Johnny Puleo treatment of: Moon River, Tonight, Never On Sunday, Exodus, Col. Bogey, etc. AFLP1969/AFSD5969



Big Top Carousel BAND ORGAN A majestic instrument recorded out-of-doors. An awesome musical sensation! Blue Danube, etc. AFLP 1987/AFSD 5987

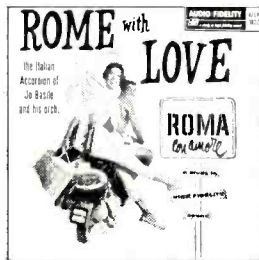

ROME WITH LOVE—Perennial favorite! Musical portrait of the Eternal City. Luna Rosa, Non Dimenticar, Tarantella, Arrivederci Roma, Torna a Sorrento. AFLP1822/AFSD5822

\$4.98—mono or stereo
AVAILABLE NOW AT YOUR LOCAL RECORD SHOP, OR WRITE DIRECT TO:
AUDIO FIDELITY RECORDS
770 Eleventh Avenue
New York 19, N.Y.
BIG
WRITE FOR FREE COMPLETE CATALOG.

*Until recently the Audio Fidelity Stereo disc suggested list price was \$6.95
AFLP, DFM denotes mono, AFSD, DFS denotes stereo.

CIRCLE 12 ON READER-SERVICE CARD

Continued from page 12

yelling and stamping their feet. Eugene wanted to take them with us just to be sure, but it turned out we didn't need them."

Question: "Have you had revelations in your repertory?"

Istomin: "Well, of course we were already very familiar with it all, but the Schubert E flat trio . . ."

Stern: "A private exaltation, difficult to play because you must not be sentimental . . ."

Rose: "Opus one hundred, like finding a diamond . . ."

Istomin: ". . . has become something special for us. We want to go further into it. We played it only once in public, since it is very long and people feel cheated if there are only two things on the program."

Question: "Any recording plans?"

Stern: "Nothing definite, but we certainly intend to make some records, and hope to get together in New York next spring."

Question: "Will that modify some of your interpretations? I mean, do you accept the theory that there are now two aesthetics—one for the concert hall and the other for recording?"

Stern: "I suppose we'll soon hear people saying that the sound engineer was in good form last night—adding perhaps that there was a musician around somewhere."

Question: "Did any of the critics over here bring up the alleged differences between the American sound and the traditional European sound?"

Stern: "A strong offense is the best defense."

Rose: "Great teachers create traditions, and our great teachers in America have been Europeans."

Stern: "In America we have all the European national traditions without their gaps. Anyway, we talk about traditional sounds when the truth is that orchestras have really been in tune for only about sixty years."

ROY McMULLEN

LONDON

In four and a half evening sessions at Kingsway Hall, Peter Pears, with his friend Benjamin Britten as accompanist, recorded for Decca-London the

Winterreise cycle of Schubert and the *Dichterliebe* cycle of Schumann, thirty titles in all. In *Gute Nacht*, first of the twenty-four Schubert songs, a dog was heard yapping during the closing couplet of Wilhelm Müller's fifth stanza: "*Lass irre Hunde heulen/ Vor ihres Herren Haus!*"—which, in effect, invites stray dogs to howl outside their own master's house.

Pears stopped singing, Britten stopped playing, and recording director John Culshaw in the control room stopped directing. In mingled consternation and

Continued on page 20

Command Performance at your fingertips . . .



... every time you capture the magnificent world of full fidelity sound on tape.

Taped sound retains full fidelity even after hundreds of playbacks . . . yours to enjoy always . . . on VIKING tape components, naturally.

A VIKING invests you with unlimited versatility to record live programs or off the air including F.M. multiplex, duplicate, put sound on sound and edit with perfect ease.

Retro-matic 220 — ultimate performance with tomorrow's features for discriminating audiophiles and professionals only.

Two-directional playback, quarter track stereo at two speeds. "Feather-touch" push buttons, remote control, 12 watt amplifier, simultaneous record/playback with 20-25,000 cps frequency response. Independent channel controls, "luma-touch" record buttons and illuminated VU meters. Photo electric run-out sensor, four heads, hysteresis capstan motor plus two reel drive motors and digital counter. Superbly styled with stainless steel face plate this compact operates vertically or horizontally.

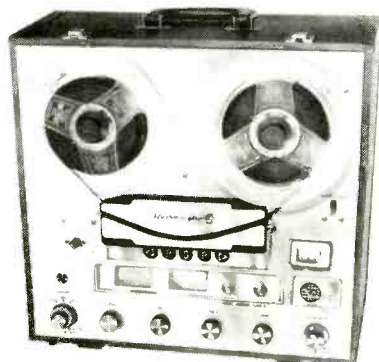

88 Stereo Compact—for connoisseurs of the fine things in high fidelity stereo sound.

Two speed tape recorder with choice of half or quarter track stereo. Three new type hyperbolic heads—no more old fashioned pressure pads. New design amplifier with excellent 30-18,000 cps frequency response, lets you monitor off the tape with "A-B" comparison switch. Independent channel controls and VU meters, two motors, record indicator light, counter, automatic tape shut-off. With its attractive, brushed aluminum face panel, the 88 Compact fits any installation for vertical or horizontal operation.

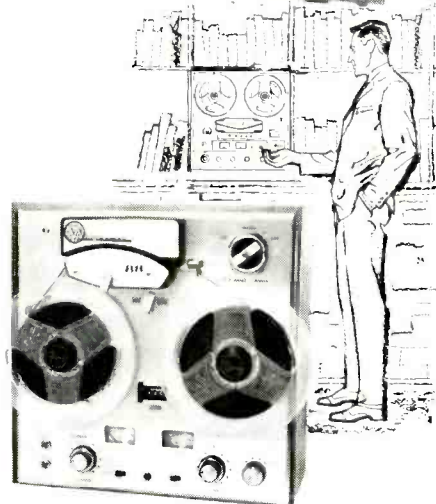

Put Command Performance at your finger tips with VIKING tape components — made by skilled American craftsmen.

Tape recorders, transports, cartridge players—even for your car or boat—at reputable high fidelity dealers most everywhere.



VIKING OF MINNEAPOLIS, INC.
9600 Aldrich Avenue South, Minneapolis, Minnesota, 55420

Your assurance of Quality in Tape Components

CIRCLE 69 ON READER-SERVICE CARD

CHOSEN BY *Popular Science* **AS THE BEST THAT MONEY CAN BUY**
(WITHOUT FRILLS)

This photo and caption (the price is an approximation) appeared in the September 1963 *POPULAR SCIENCE* as part of an article entitled "The Low-Down on Hi-Fi Stereo." It is a picture of those high fidelity components which, according to a panel of experts, provide the best sound possible today.

\$700



The panel carefully considered return-for-the-money, but "where there was a more expensive component that produced a detectable improvement in sound, it was chosen."

These components are recognizable to hi-fi enthusiasts as the AR two-speed turntable, the Dynakit PAS-2 preamplifier, the Dynakit Stereo 70 dual power amplifier, and the AR-3 loudspeakers.*

*They have been on demonstration as a system for several years at the AR Music Rooms, on the west balcony of Grand Central Terminal in New York City, and at 52 Brattle St., Cambridge, Mass. No sales are made there; you may ask questions if you like, but most people just come and listen.

More detailed information, including a list of dealers in your area, is available from:

ACOUSTIC RESEARCH, INC., 24 Thorndike Street, Cambridge, Massachusetts 02141
DYNACO, INC., 3912 Powelton Avenue, Philadelphia, Pennsylvania 19104
 CIRCLE 1 ON READER-SERVICE CARD

ON A DESERTED MOUNTAINTOP 10,000 FEET ABOVE THE CALIFORNIA DESERT THE SCOTT MONOPHONIC 310 IS ABOUT TO BE REPLACED... BY THE NEW TRANSISTOR 4312 STEREO TUNER



High atop Mount Santa Rosa, in California, the Palm Springs Television Company has been using monophonic Scott 310 broadcast monitors to relay FM programs from Los Angeles 105 miles away to the town of Palm Springs, directly behind the mountain. With the advent of stereo, new equipment was needed that would be as reliable as the 310, and provide the same performance . . . now in *stereo*. After an exhaustive study of available tuners, the brand new Scott 4312 transistorized tuner was selected for the job.

Like the 310's they are replacing, the new Scott 4312's will have to undergo a punishing ordeal on the mountaintop. Towering snowdrifts make these tuners completely inaccessible for many months of the year. There is no margin for error . . . these tuners have to work perfectly, with

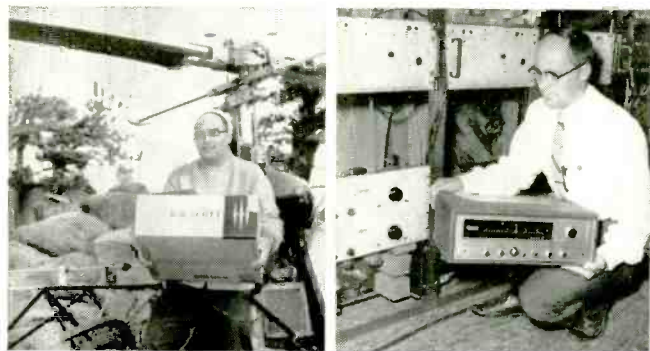

unvarying reliability. They cannot drift even slightly during the entire period.

Robert Beaman, Chief Engineer for Palm Springs Television Company, emphasized the two basic factors in the selection of the Scott 4312:

1. The radically new Solid State circuitry, designed by Scott, provides the optimum in stability and assures years of cool-running, trouble-free performance . . . a must for a remote location like Mount Santa Rosa.
2. New Scott transistor circuitry makes possible three-megacycle detector bandwidth which provides a new standard of stereo separation not previously achieved with vacuum tube tuners.



FOR NEW SCOTT CATALOG CIRCLE 100 ON READER SERVICE CARD

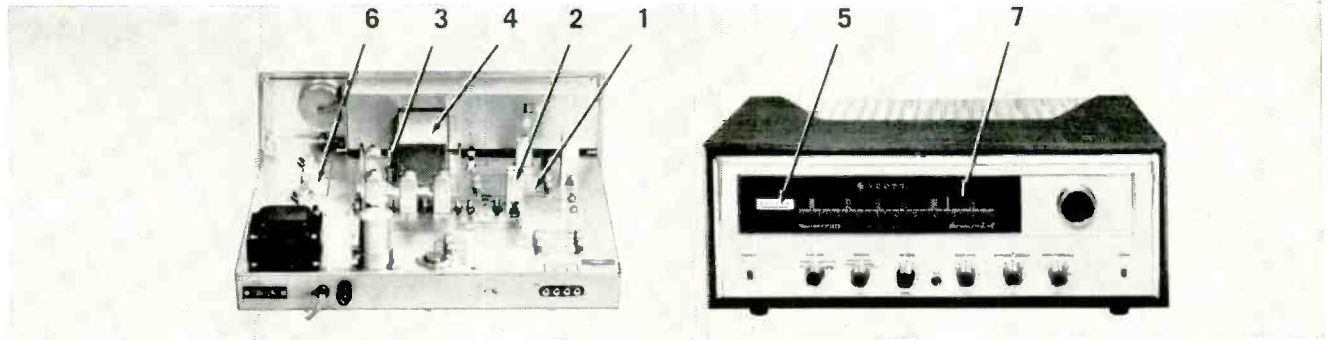

Here are the seven features that make the Scott 4312 the world's first truly reliable TRANSISTORIZED tuner.

1. Transistorized time-switching multiplex circuitry. Separation in excess of 35 db at 400 cps, a new industry standard.
2. 3-megacycle detector, widest of any tuner ever designed. Results in extremely good stereo separation, drift free performance, excellent capture ratio.
3. Nuvistor front end. Nuvistors chosen for their reliable performance and extremely low cross modulation, in excess of -65db. This outstanding design specification assures you that strong local stations show up only once on the dial.
4. Silver-plated RF circuitry. Assures sensitivity of 1.9 microvolts (IHF).

5. Sensitive tuning meter and antenna orientation indicator.
6. Transistorized Auto-Sensor circuitry instantly switches to stereo mode when stereo broadcast goes on the air.
7. Professional slide-rule tuning, with heavily weighted mechanism, and use of ball-bearings throughout. Assures true velvet-touch tuning. **\$365***



H. H. SCOTT INC., 111 Powdermill Road, Maynard, Mass.

*Slightly higher West of Rockies. Accessory cases extra. Export: Morhan Exporting Corp., 458 Broadway, N. Y. C. Canada: Atlas Radio Corp., 50 Wingold Ave., Toronto



NEW!

GRADO TRACER BEAM

STEREO CARTRIDGES

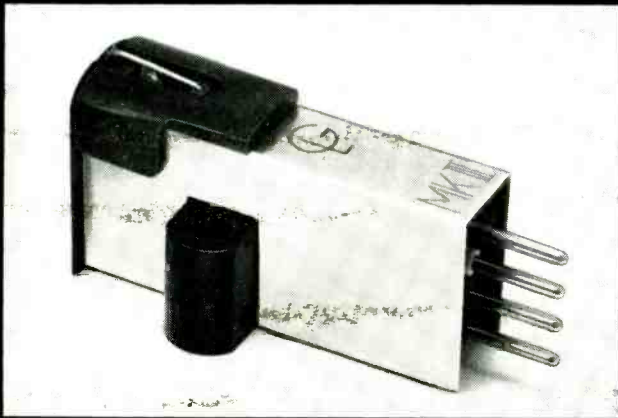

THE GRADO TRACER BEAM STEREO CARTRIDGES MEET ALL OF THESE REQUIREMENTS!

Eliminate inner groove distortion.

Eliminate completely "Shattering," and buzzing during playback.

Play both stereo and monaural records.

Be completely non-critical to installation problem and still perform superbly.

Track in a good tone arm at 1 gram or less (not just make sound but trace with low distortion!)

Work in all record changers and automatic turntables at up to 6 grams.

Have IM distortion of no more than 2% at the highest recorded levels and maintain 1% or less IM distortion for normal recorded levels.

Have a high frequency response to at least 24,000 CPS or better.

Have a FLAT frequency response down to 10 CPS.

STYLUS ASSEMBLY REPLACEABLE BY CONSUMER!

TRACER BEAM MK I STEREO CARTRIDGE \$75.00
TRACER BEAM MK II STEREO CARTRIDGE \$49.50
TRACER BEAM MK III STEREO CARTRIDGE \$37.50
TRACER BEAM MK IV STEREO CARTRIDGE \$27.50

For further information please write:

GRADO LABORATORIES, INC. 4614 Seventh Ave., B'klyn 20, N.Y.

CIRCLE 37 ON READER-SERVICE CARD

NOTES FROM ABROAD

Continued from page 16

amusement, everybody engaged in a hunt for the dog, which was finally found locked in the caretaker's quarters. Once rescued from duress, the poor animal fell silent—and as the playback finally revealed, the canine voice hadn't actually gotten on to the tape. In a way I was sorry. If trained to yap in the right key and rhythm, it might have added a touch of picturesque realism to the proceedings. The sessions ended on the eve of Britten's fiftieth birthday, by the way, in an atmosphere of bonhomie appropriate to such occasions.

Harps, Flutes, and Little Meringues. EMI's No. 1 studio at St. John's Wood recently presented a scene that was almost familial. Out on the studio floor, backed by the Bath Festival Orchestra, with Yehudi Menuhin on the podium, flutist Elaine Shaffer and harpist Marilyn Costello were playing Mozart's Concerto K. 299. Acquaintances for almost twenty years, these soloists had first played this work together as students at the Curtis Institute of Music, in Philadelphia, in 1945. On the present occasion they had an especially appreciative audience in the persons of Efreim Kurtz, the well-known conductor and husband of Miss Shaffer, and L. D. Dannenbaum, American businessman and husband of Miss Costello.

Mr. Dannenbaum told me how his wife nurses, coaxes, and retunes her Salzedo harp, positively mothering her highly temperamental instrument through vagaries of temperature and humidity and the ills attendant upon travel in ships' holds and gear-grinding trucks. When on tour she always carries a complete set of spare pedal rods, so as not to be caught out if they all break at once. Mr. Kurtz was similarly interested in *his* wife's instrument. Her flute, he said, is of 14-carat gold, the twenty-fifth and last instrument of its kind made by a noted American craftsman named Powell, now dead. It both looked and sounded as princely as such a provenance would suggest.

With the Mozart out of the way, Miss Shaffer and Menuhin launched upon John Philipp Telemann's A minor Suite for Flute and Orchestra. At both lots of sessions, Telemann and Mozart alike, Mr. Kurtz acted as *ex-officio* host. Every afternoon he brought in delicacies from Fortnums and presided over teatime feasts which included such confections as those marvelous morsels of chocolate-coated cream sold—when you can get them—as *petites meringues enrobés*.

Final playbacks left everybody content. Menuhin and his Bath players packed up and moved out. The Philharmonia Orchestra moved in. It was now Mr. Kurtz's turn to take the podium. From his labors two discs will result: one a selection of ten movements from the two concert suites which Prokofiev

Continued on page 24



PHOTOGRAPHED IN NEW YORK SHOWROOM OF DUK INCORPORATED

WHO WANTS TO
SEE A TAPE RECORDER
IN A LIVING ROOM

?

YOU DO
(if it's Miranda®!)



Two magnificent new stereo tape recorders featuring major electronic advances... plus the beauty of genuine teakwood cabinetry!

MIRANDA Sorrento Sophisticated solid-state circuitry, comprising an impressive array of 21 transistors and 19 diodes. Electronic matrix-type push-button switching positively and instantaneously controls every mode of tape transport. Tape-handling mechanism includes automatic tape lifters and tension bars. Other features include: built-in 4" x 6" full range dual speakers, automatic shut-off for motors and amplifiers, three motors plus servo motor for remote control, illuminated VU meters, pause switch, electronic switching delay, 3¾ and 7½ ips., records and plays 4-track stereo. *Priced at \$400.00*

MIRANDA Nocturne Hysteresis synchronous motor assures unflinching constancy in tape movement. Smoothly operating push-button controls make it a pleasure to operate. Each channel is provided with individual volume and tone controls, VU meter, two input jacks, output jacks for external speakers. Single switch allows the Nocturne to be used for either stereo or mono playback. Ten clean actual watts of audio power (5 per channel) plus matched 4" x 6" speakers give rich, full-bodied reproduction. The Nocturne records and plays 4-track stereo and mono in 1⅞, 3¾ and 7½ ips. *Priced at \$250.00*

SORRENTO REMOTE CONTROL: All tape transport controls plus separate channel volume controls, and 16 ft. cable. *Priced at \$35.00*

At last . . . the first truly practical design in tape recorders. Miranda is housed in genuine teakwood cabinetry that blends with and enhances any decor. No glaring chrome trim . . . no jagged outline disturbs its simple, classic elegance. More than a fine tape recorder, Miranda is also a fine piece of furniture that you can display with pride. Write for free literature to Dept. HF-1.



REGISTERED BY ALLIED IMPEX CORP., EXCLUSIVE U.S. IMPORTER
DALLAS 7, TEXAS * LOS ANGELES 16, CALIFORNIA

ALLIED IMPEX CORPORATION, 300 PARK AVENUE SOUTH, NEW YORK 10, NEW YORK * CHICAGO 45, ILLINOIS *
CIRCLE 4 ON READER-SERVICE CARD

CARNEGIE FREE PUBLIC LIBRARY
SIOUX FALLS, S. DAK.

YOU COULD SPEND \$100 MORE AND NOT GET BETTER PERFORMANCE

(or better features, or better quality.)

INTRODUCING the new Rek-O-Kut R-34 playback system—a complete 2-speed turntable, tonearm, and base unit, WITH A 5 YEAR WARRANTY ...unheard of in the audio industry! When we say our turntables are built to take it—we mean it.

INSTANT SPEED SELECTOR. A mere flick of your finger changes its speed from 33 $\frac{1}{3}$ to 45 rpm. An exclusive Rek-O-Kut feature.

HYSTERESIS SYNCHRONOUS MOTOR. Pabst is its name. Pioneered by Rek-O-Kut. For constant speed no matter what the variation in line voltage. It's the first time *this* motor (used in our higher-priced units) has been used in a system at *this* price.

ISOLATION SUSPENSION: Totally eliminates acoustic feedback. Makes vertical rumble a negative factor. No need for complicated spring devices to shock-mount your playback system. Ever.

S-340 TONEARM. A modified version of the S-320 professional tonearm. Tracks at less than one gram! Resonance factor is *below* 12 cycles. Ruggedly constructed, its removable cartridge shell handles any standard cartridge. Available separately at \$24.95.



SOLID OILED-WALNUT BASE. Fine furniture crafted.

SPECIFICATIONS. Noise and rumble: —60 db below average recorded level (@ 7 cm/sec. @ 1000 cps). Flutter & wow: .08% RMS. Dimensions: 15" x 14 $\frac{5}{8}$ " x 5 $\frac{1}{2}$ " (overall height, including tonearm).

ONE-PIECE CAST ALUMINUM TABLE. Full-size, 12 inch, professional quality. Dynamically balanced. Its weighted rim provides all the necessary flywheel motion for perfect rotation at constant speed.

EXCLUSIVE REKOTHANE BELT. Polyurethane. Individually ground to precision tolerances, this belt reduces noise and rumble *minus 6 db lower than any other belt.* And unless you actually cut or tear a Rekothane belt it should work for the life of the unit.

SIGNIFICANT PRICE. ONLY \$89.95!

A most modest price for such quality. See your dealer for a comparison demonstration. Only then will you know why you could spend \$100 more and not get better performance (or better features, or better quality).

REK-O-KUT, the world's largest manufacturer of turntables. 38-19 108 Street, Corona 68, New York

Export: Morhan Exporting Corp., 458 B'way, N.Y.C. Canada: Atlas Radio, 50 Wingold Ave., Toronto 19

CIRCLE 33 ON READER-SERVICE CARD

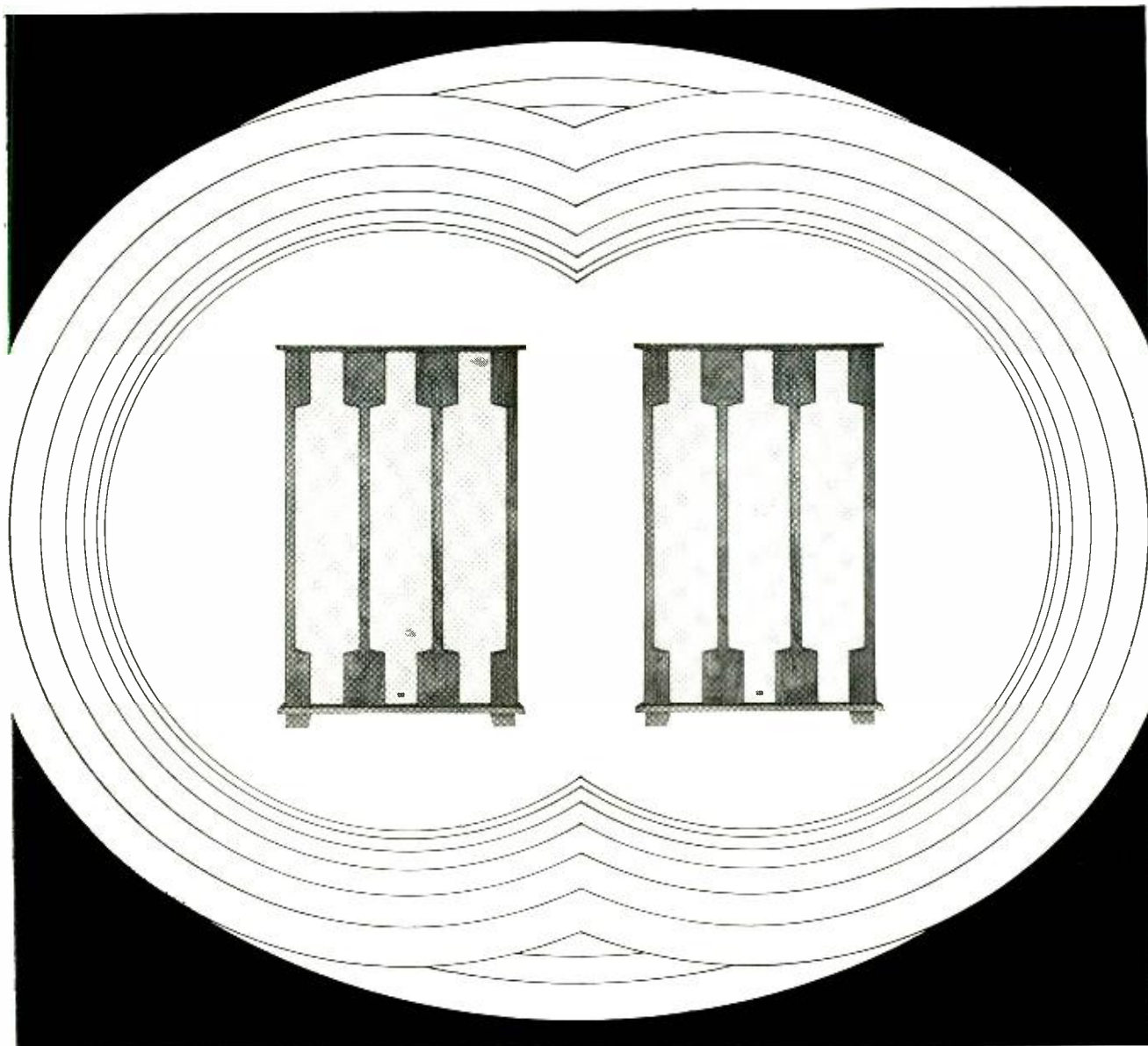

EXPRESSLY FOR STEREO

Symphony No. 1

The music is spacious, transparent, alive with detail in proper perspective — utterly faithful to the texture and dynamics of the original, as you expect from Bozak speakers. The B-4000, distinctively styled in mahogany or walnut, is surprisingly small for such big music. A pair are unobtrusive in even a modest living room. They are also available in kit form. Ask your Franchised Bozak Dealer, or write for catalog.



DARIEN/CONNECTICUT

CIRCLE 17 ON READER-SERVICE CARD

Continued from page 20

derived from his *Romeo and Juliet* ballet music and published in 1938; the other, a coupling of suites from two Rimsky-Korsakov operas—*Snowmaiden* and *Tsar Saltan*.

Prokofiev in the Direct Line. It was the Prokofiev sessions that particularly fascinated me. Not only was there the joy of hearing the Philharmonia players in music characterized by so much glitter, gold, and purple but there was also a feeling of main-line transmission behind Kurtz's conducting. Only nine years Prokofiev's junior, Kurtz was at St. Petersburg (Leningrad) Conservatory for an overlapping year with the composer before the Kaiser's War and vividly remembers his end-of-term performance of the Piano Concerto No. 1. It was this work that won Prokofiev the coveted Rubinstein first prize and, incidentally, the confirmed hostility of the Conservatory's all-powerful director, Alexander Glazunov. To Glazunov, young Prokofiev's stylistic levity and harshness—or what seemed harshness then—were anathema. Kurtz testifies that when, soon afterwards, Prokofiev gave a further performance of his concerto, this time under Tcherepnin, at the Conservatory graduation exercises, Glazunov got up and ostentatiously left the hall as soon as Prokofiev appeared on the platform. This detail seems new to the record, I do not, at any rate, see it in Prokofiev's autobiography or in the standard Soviet "life."

As a youngster in Tsarist Russia, Kurtz found Prokofiev's music enigmatic and disturbing. He did not really begin to fathom it until the Twenties, when he had become a free-lance conductor in Germany. Now, it is in his bloodstream, a segment of his life and mind. This was borne in upon me most emphatically during his section rehearsals and the ultimate shaping and reshaping of the scene of Tybalt's death. Upon this movement Kurtz spent a whole evening. Later, he talked with me: "The Philharmonia hadn't played *Romeo and Juliet* before, so to begin with I gave them a deliberately slow tempo and concentrated on the accents. All this was so they should get the 'feel' of the score. The last take of the day, when theoretically the men should have been stale, was the best. When you've conducted orchestras a hundred times a year for forty-three years, you know a trick or two."

CHARLES REID



CIPHER VII STEREO

In so many ways, the new Cipher VII stereo tape recorder is heads above the crowd: records and playback in 4-track, 3-speed stereo or monaural, records sound-on-sound, and its two full-range speakers are detachable for best positioning. Cipher VII can be played horizontally or vertically, or it can be installed into your present hi-fi system.

Other professional features of the Cipher VII include: separate volume and tone controls for each channel • 2 dynamic microphones • 2 VU meters • editing facilities • tape index counter • auto, reel-end shut-off • 10 watt output • two-tone cabinet with brushed aluminum control panel.

\$274.95



For brochure and name of nearest Cipher dealer, write to:
INTER-MARK CORP., Dept. HF, 29 West 36th Street, New York 18, N. Y.
 CIRCLE 41 ON READER-SERVICE CARD

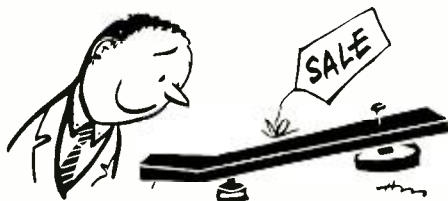

HOW FAR WRONG CAN YOU GO FOR \$1 A YEAR!

Eager to sell, buy or swap used high fidelity speakers, amplifiers, cartridges, turntables, tuners, records, etc.? Turn to our monthly bulletin: *The BUY-SELL-or-SWAP NEWSLETTER*.

If you want to **SELL**—classified listings of used equipment and records cost only \$1 per ad—limit 30 words including name and address. No dealer ads accepted.

If you want to **BUY**—lots of bargains offered in the 50 or more ads that appear here every month. Subscription price: only \$1 a year!

If you're audio-minded, how far wrong can you go for \$1? Fill in and mail the form below today!

HIGH FIDELITY, Dept. CE
 Great Barrington, Mass.

Start my subscription to your BSS Newsletter with the next issue. (Only \$1)

Name _____

Address _____

City _____ State _____

Enclosed is my payment for \$_____.

Insert the following 30-word advertisement (including name and address) in the next issue of the BSS Newsletter. (Type or print plainly.) (\$1)

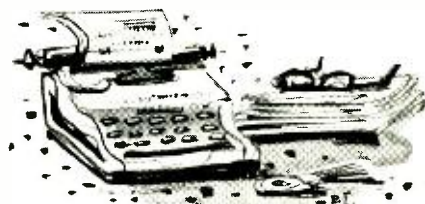

TUNER SECTION: In the kit, the two most critical sections—the front end and the IF strip—are supplied prewired and pre-aligned; and a high quality circuit board and pre-aligned coils are provided for the stereo demodulator circuit. The F strip has 4 amplifier-limiter stages and a wideband ratio detector for perfect limiting and flat frequency response. Sensitive bar-type electron-ray tuning indicator pinpoints the center of each broadcast channel for lowest distortion, and also serves as the stereo program indicator.

Antenna input: 300 ohms balanced □ IHFM usable sensitivity: 3 μ v (30 db quieting), 1.5 μ v for 20 db quieting □ Sensitivity for phase locking (synchronization) in stereo: 3 μ v □ Full limiting sensitivity: 10 μ v □ IF bandwidth: 280 kc at 6 db points □ Ratio detector bandwidth: 1 mc peak-to-peak separation □ Audio bandwidth at FM detector: flat to 53 kc □ IHFM signal-to-noise ratio: 55 db □ IHFM harmonic distortion: 0.6% □ Stereo harmonic distortion: less than 1.5% □ IHFM capture ratio: 3 db □ Channel separation: 30 db.

AMPLIFIER SECTION: High quality Baxandall bass and treble controls do not interact or affect loudness, permit boost or cut at extremes of range without affecting mid-range. Balance control is infinitely variable, permitting complete fade of either channel. Blend control is variable from switch-out, for maximum separation, to full blend. Tape Monitor switch permits off-the-tape monitoring with the Eico RP100 Stereo Tape Recorder.

Power: 36 watts IHFM music, 28 watts continuous (total) □ IM distortion (each channel): 2% at 14 watts, 0.7% at 5 watts, 0.2% at 1 watt □ Harmonic distortion (each channel): 0.6% at 10 watts, 40 cps to 10 kc; 0.2% at 1 watt, 30 cps to 20 kc □ IHFM power bandwidth at rated continuous power, 1% harmonic distortion: 30 cps to 20 kc □ Frequency response \pm 1 db, 15 cps to 40 kc □ Speaker output: 8, 16 ohms □ Inputs: Magnetic phono or adapted ceramic phono, tuner, tape auxiliary □ Sensitivity: 2.3 mv phono, 250 mv others □ Noise: -65 db at 10 mv, mag phono; -80 db others.

New Eico Classic 2536 Stereo FM Receiver

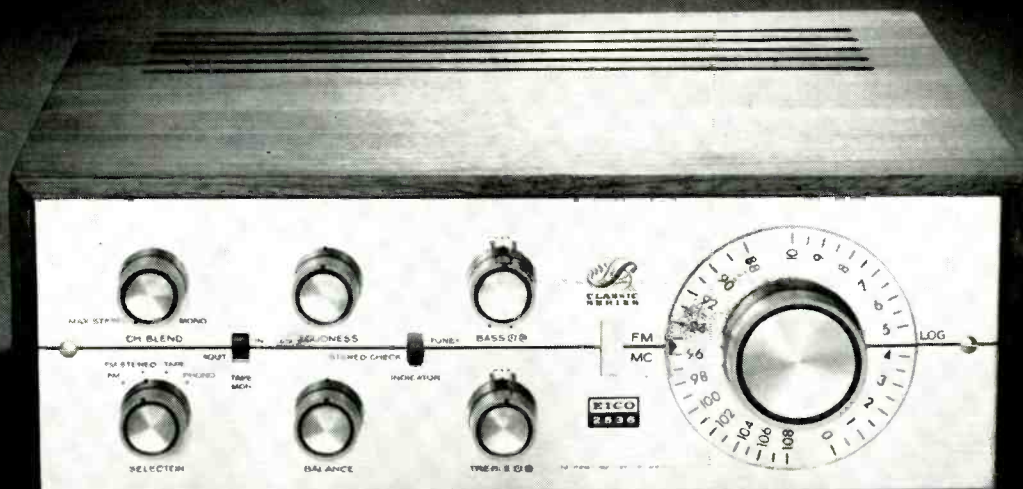

Now... every other stereo receiver seems overpriced

Take a superb stereo tuner, guaranteed stable under all conditions, and sensitive enough to give full stereo separation even on weak, fringe-area signals...

Add a virtually distortion-free 36-watt stereo amplifier with remarkable overload and transient characteristics...

Mount them on one chassis—effectively separated for the performance benefits of components plus the convenience of a single compact unit... Price this combination at \$209.95 factory-wired, and at \$154.95 in a new kit pack that makes building a delightful experience—and what do you have? The Classic 2536 Stereo Receiver, star of the new Eico Classic Series, and a component that matches or surpasses the performance of components selling at substantially higher prices. How? Simple. It's pure performance. Stripped of everything but the finest basic circuitry. Examine the specifications yourself. Compare them with those of more expensive units. Listen to the 2536—then to higher priced units. Can you see or hear a difference worth paying for?

If you're interested in building a fine stereo receiver, take a long look at our new kit pack, too. Note the logical, orderly arrangement of parts. How easily it sets up for work. How easily it closes down between work sessions—with no loose parts to go astray. Thumb through the 2-color Construction Manual. Ever see such graphic diagrams? Every step is clear and unmistakable—and no diagram shows more than 20 steps. Another thing the diagrams show you: how simple the wiring is. No tricky frills; no clutter; no confusion, even around switches and controls. Plenty of space to work in. And Eico has eliminated the most tedious part by pre-mounting jacks, sockets, terminal boards, and transformers.

Does any other kit give you more building ease, or assurance of success than the Eico Classic? See it at your hi-fi dealer. Optional Walnut Cabinet WE-73, \$19.95, Metal Cover E-12, \$7.50.

EICO ELECTRONIC INSTRUMENT CO. INC.
131-01 39th Avenue, Flushing, N. Y. 11352
Export: Roburn Agencies, Inc., 431 Greenwich St., N. Y. 13



CIRCLE 31 ON READER-SERVICE CARD

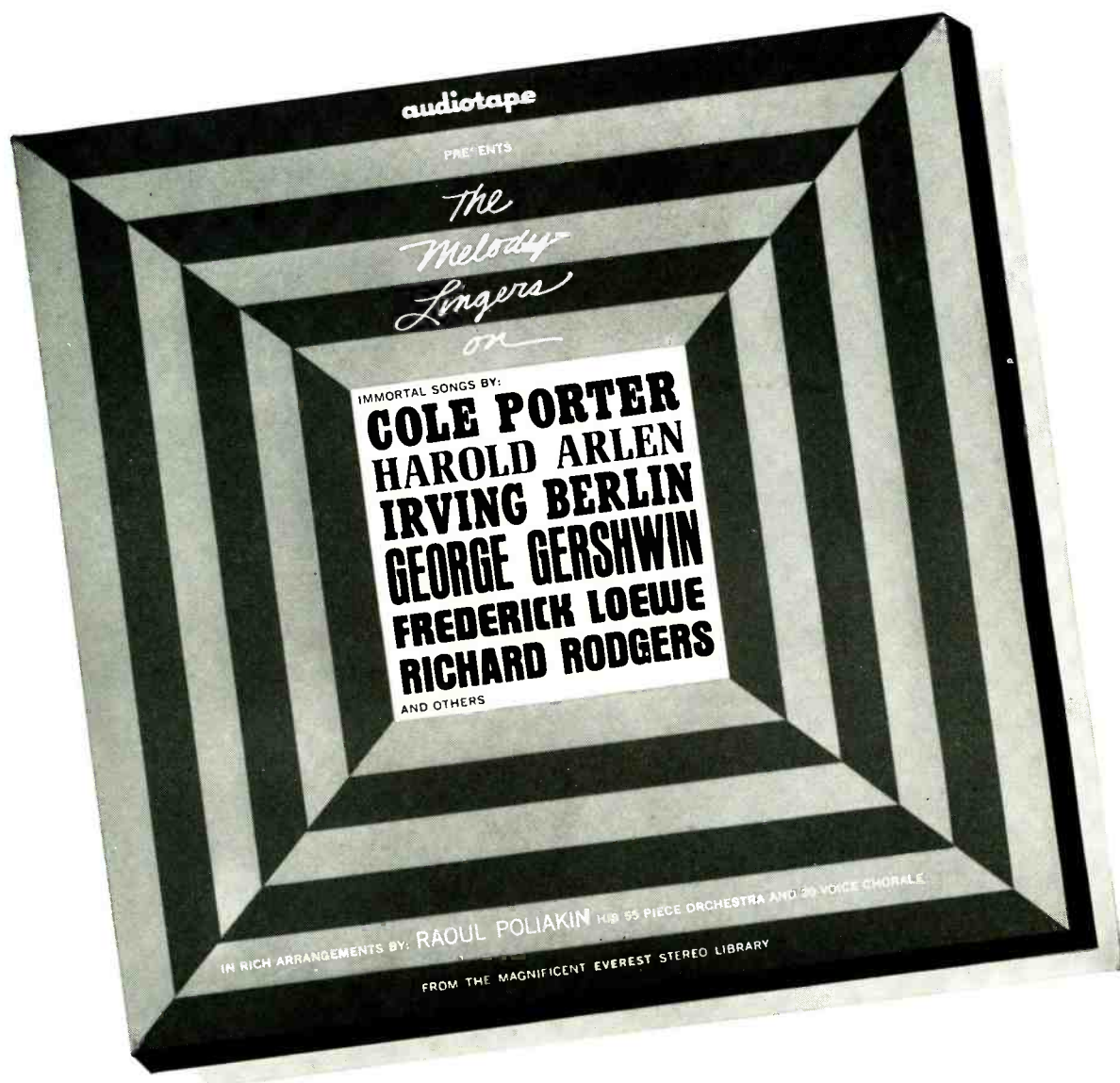

\$1.00

Who says Christmas is over? It isn't—not when you can get a superb recorded tape for a fraction of its actual cost just for trying a 7" reel of Double Recording Audiotape on Tempered "Mylar." (A great tape in itself: double length plus double strength.) ■ Just buy a reel of Double Recording Audiotape (Type 2431T) at the regular price, and for only \$1.00 additional come away with *The Melody Lingers On*—a magnificent 55-minute program of great popular standards. These unforgettable melodies are performed in luxurious arrangements from the Everest stereo library, long noted for the superb quality of its recordings. ■ The \$1.00 price tag is even more remarkable when you consider that the entire program is recorded on a reel of standard Audiotape which actually

sells for more than twice that price! So even if you erased the tape (heaven forbid!) you'd still be ahead of the game. ■ Go to any store that carries Audiotape products and buy a reel of Double Recording Audiotape, Type 2431T. Then add one dollar for *The Melody Lingers On*, a great tape that you and the women in your life will treasure. Available only in 4-track stereo.

AUDIO DEVICES, INC.
444 MADISON AVENUE
NEW YORK 22, NEW YORK



CIRCLE 9 ON READER-SERVICE CARD

**a 264 square-inch woofer
in a 3-way speaker system
only 1 3/4" thin!**

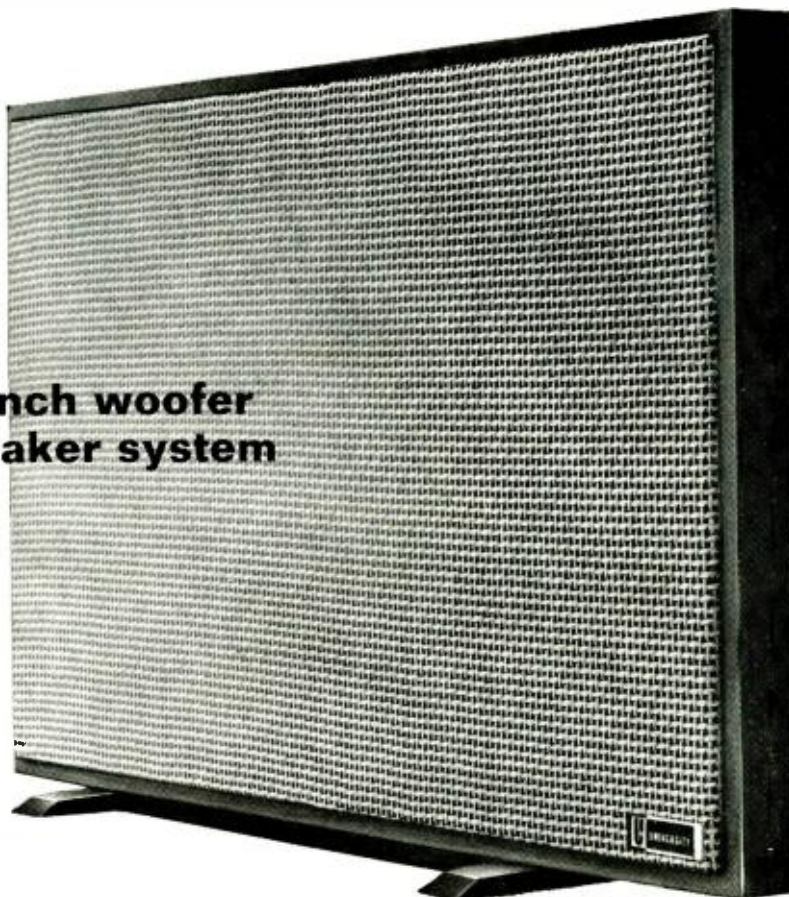

THE UNIVERSITY TRI-PLANAR SPEAKER SYSTEM. Here is the first speaker in which *thinness* is purely a functional matter. The unusually thin shape is actually dictated by its basic engineering design principle. In fact, you have to listen . . . and listen again . . . before you realize that the Tri-Planar's sound comes from a speaker system of such remarkably thin dimensions. The bass range is full and clean. The mid-range and highs are smooth and brilliant. And its balance over the entire range (45 to 18,000 cps) can only be achieved by considerably larger bookshelf systems. The woofer area, consisting of two panel radiators, with custom-matched voice coils, is larger than most speaker systems—264 square inches. And, there are many other features which depart from outworn traditional speaker designs . . . including the exclusive "push-pull" woofer configuration, the open back doublet system, and others. In oiled walnut, with cane grille, 15" x 23" x 1 3/4" thin. \$79.50. For more about the Tri-Planar and other University Loudspeakers, write Desk P-1.



SYL-J-ETTE — The ultra-thin 3-way system designed to look like a magnificent painting. Choice of Neo-Classic art, Decorator Cane or Petit Point floral grille. 40 to 20,000 cps. Oiled walnut. \$99.95. With Petit Point grille—\$109.90.



MINI—Big sound in a smaller speaker system measuring 18" x 13 3/4" x 2 1/4"! Utilizes many of the design principles found in the Tri-Planar. 50-17,000 cps. Oiled walnut. \$44.95.

UNIVERSITY LOUDSPEAKERS
Division of Ling-Temco-Vought, Oklahoma City, Oklahoma
CIRCLE 66 ON READER-SERVICE CARD

**GUARANTEED
FM and FM STEREO
Up to 200 Miles!**

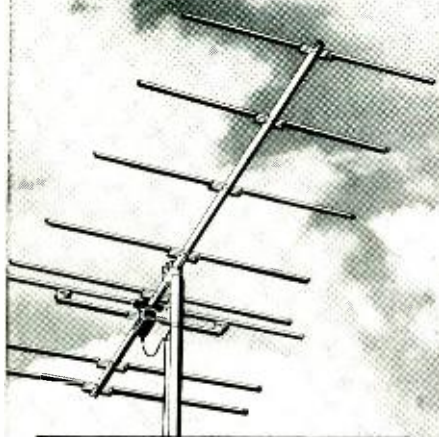

**NEW Winegard
STEREOTRON
FM ANTENNA
with Twin Nuvisator Amplifier**

The reception ability of *even* the most expensive FM or FM stereo outfit is restricted by the performance of the antenna to which it is connected. If you want to see what your equipment can *really* do, you need a new Winegard Stereotron.

The Stereotron antenna and twin nuvisator amplifier is the only antenna amplifier combination that can be used anywhere—responds to 1 microvolt of signal, yet takes up to 200,000 microvolts of signal without overloading. Antenna is GOLD ANODIZED, amplifier completely weather-sealed. Exceptionally high front-to-back ratio to prevent multi-path distortion. Antenna and amplifier are available separately.

We firmly believe that the Stereotron FM antenna is in a league by itself and therefore we make the following written guarantee:

1. We guarantee the Winegard Stereotron to be the most effective, sensitive, finest constructed antenna available.
2. We guarantee the Stereotron with Stereotron amplifier will pull in 85% of all FM stations in a 200 mile radius over average terrain.
3. We guarantee you will be 100% satisfied with a Stereotron or your money back.

STEREOTRON ANTENNA Model SF-8—\$23.65

STEREOTRON NUVISATOR AMPLIFIER Model AP-320 input 300 ohms, output 300 ohms—can be used with any FM antenna—\$39.95

Amplifier Model AP-375 for use with coax cable. Input 300 ohms, output 75 ohms—\$44.95

Write for technical spec's, gain charts, polar patterns, VSWR, etc., plus Free FM Station Log and Map.

World's Most Complete Line of FM and TV antennas, FM-TV Couplers and Amplifiers

Winegard
ANTENNA SYSTEMS

3014A Kirkwood Blvd. • Burlington, Iowa

CIRCLE 71 ON READER-SERVICE CARD



Leonard Burkat



Roger Hall

A Change of Chairs

**At Columbia and RCA Victor there are new skippers
in charge of classical repertoire.**

WITHIN RECENT MONTHS, the two largest record companies in America have taken under their respective roofs new managers of classical artists and repertoire. This fact in itself may appear no more than mildly coincidental, but on closer look the situation reveals an equation of almost algebraic neatness: Columbia has summoned to its service the former Music Administrator of the Boston Symphony Orchestra (an RCA Victor client), while RCA Victor has called in the former Manager of the Philadelphia Orchestra (a Columbia client). It's enough to make one begin pondering upon Destiny.

The two gentlemen in question are Leonard Burkat, whose new post brings him south from Boston to New York, and Roger Hall, whose duties bring *him* north from Philadelphia. Since record buyers will become the beneficiaries of the talents of Messrs. Burkat and Hall (it is, of course, the fundamental job of an a & r director to decide who records what), the time seems ripe for introductions all around.

COLUMBIA'S Leonard Burkat is a stocky man (he complains that his photographs make him look like a boxer) who has been a Bostonian all his life. He went to Harvard (where he studied orchestration with Walter Piston) and afterwards joined the music staff of the Boston Public Library. (It was at some time during this period that Mr. Burkat traded his saxophone for a cello, upon which he took three lessons. He has since passed the instrument on to one of his daughters.) When Tanglewood opened for its first postwar summer in 1946, he organized the school library—and thus began an association with the Boston Symphony which was to last for seventeen years. On

completing the Tanglewood assignment he was invited to take the next logical step—that of becoming librarian for the Symphony itself. Eventually he was appointed Music Administrator, “a musical arm of the management,” as he explains it, and in this position he collaborated with Charles Munch and Arthur Fiedler in planning repertoire for concerts and recordings by the BSO and the Boston Pops. “Altogether,” he told me, “I had a share in planning about 250 musical events a year. In a sense, my work at Columbia is quite similar—a record is, after all, a musical event. Only here there will be fewer of them—about eighty or ninety a year.”

As the guardian, so to speak, of three major orchestras—the New York Philharmonic, the Philadelphia, and Epic's Cleveland—Mr. Burkat seemed a logical person to ask about the problem of repertoire duplication. “It doesn't bother me at all,” he said. “There is no rivalry among these orchestras—they are all fine ensembles with large followings. If record audiences want a Beethoven Fifth from each of them, there is no reason why they shouldn't have it. And though there may be thirty Fiftys in the catalogue, there aren't thirty good ones.”

Of things to come, Mr. Burkat gave some enticing glimpses: a *Boris Godunov* with George London recorded in the Bolshoi Theatre, a Berlioz Requiem by the Philadelphia, a remake of the Bartók Quartets by the Juilliard, and a continuation of the Stravinsky-by-Stravinsky series, with *Orpheus*, *Agon*, and *Jeu de cartes* soon to come. “Another project dear to my heart,” he went on, “is to arrange for Stravinsky to conduct Tchaikovsky's Second Symphony. Stravinsky is strongly attracted to the music of his

Continued on page 30

HIGH FIDELITY MAGAZINE



“...by combining this unit, Citation A, with a *solid state basic amplifier* of comparable quality, a sound path could be set up that approaches the classic goal of amplifier design—a straight wire with gain.”

—HIGH FIDELITY MAGAZINE

THE NEW CITATION B

PROFESSIONAL 80 WATT SOLID STATE STEREO BASIC AMPLIFIER



Handsome front panel: facilitates custom installation. Features include current-adjustment meter, on/off switch with pilot light and low-cut filter. Removable bottom panel conceals idling adjustment controls.



Computer-grade silicon output transistors: heavy-duty, solid state devices, virtually impervious to abuse. Will take 100% more power than their use in Citation B will ever demand.

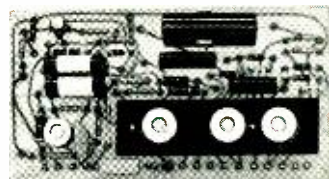

Driver stage: Wideband silicon driver transistors are mounted on rugged, military-type epoxy glass board. Board pivots for easy accessibility or removal.

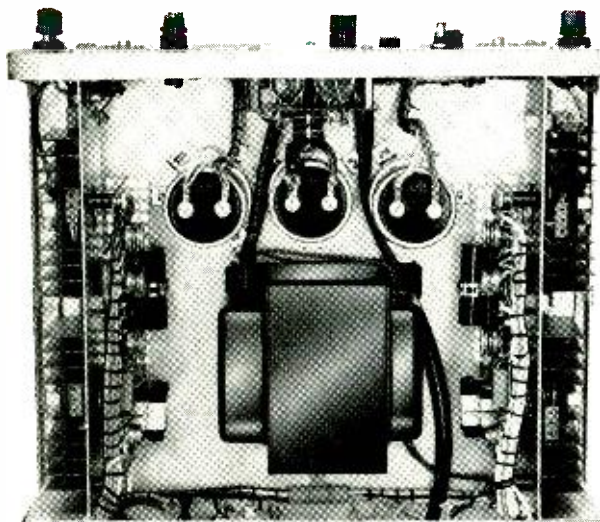

Top view of chassis: computer construction throughout. Five sub-assemblies assure easy accessibility and minimum operating temperature through efficient heat dissipation; laced military wiring harness couples each stage.



Electrolytic capacitors: engineered to computer-grade specifications for unlimited shelf life and consistent, long-term performance.



“Heat sink”: heavy-duty finned aluminum device which rapidly draws heat away from output transistors—insuring long life, fail-safe performance.

The “classic goal of amplifier design” is now reality. The big “B” is here. The Citation B. A power-packed “brute” loaded with 80 watts of flawless performance—a true product of the computer age. • The “B” has the widest frequency response of any basic amplifier—1 to 100,000 cps. • The “B” has the best square wave response—less than one microsecond rise time. • The “B” has the highest damping factor—50 to 1 at 10 cps. (No other power amplifier is even close.) • The big “B” is the only power amplifier completely free of hangover or clipping at full power output.

The Citation B reflects Harman-Kardon’s solid state leadership in every way—performance, design and construction. “A straight wire with gain” when matched with Citation A, the big “B” will also enhance the performance of any other high quality stereo preamplifier. For more information—write Citation Division, Harman-Kardon, Inc., Plainview, N.Y., Dept. HF-1.

harman kardon

A subsidiary of THE JERROLD CORPORATION

CIRCLE 38 ON READER-SERVICE CARD

If The Uher 8000 By Martel Did Not Feature:



AKUSTOMAT: You simply speak and the machine records . . . you stop speaking — machine stops. Audio Magazine reported . . . we know of no other machine which has this feature.

FULLY TRANSISTORIZED: Professional • 4 Speeds • 3 Heads • 2 VU Meters

DIA-PILOT: Built-in impulse transmitter for fully automatic control of slide projectors and animated displays.

ECHO EFFECTS

AUTOMATIC: End of reel shut-off disengages pressure roller.

MULTI-PLAY: Allows transfer of recording to a parallel track while simultaneously superimposing a new recording to the original track by the turn of a knob.

CONSOLE SOUND: Featuring two built in speakers for perfect separation.

4 TRACK STEREO — 4 TRACK MONO: With built in mixer control for both channels.

Audio Magazine Report: “. . . Practically any use that can be imagined is possible with the Uher 8000.”

Then It Would Be Just Like Any Other Tape Recorder.

By the way . . . it took Audio Magazine 1457 words to describe all the features on the Uher 8000 — for complete review write

**MARTEL
ELECTRONICS**

Hollywood
645 N. Martel Avenue
Phone (213) 938-2803

New York City
1199 Broadway
Phone (212) 684-0943

Chicago
1141 Merchandise Mart Plaza
Phone (312) 644-0430

CIRCLE 47 ON READER-SERVICE CARD

See What Robert C. Marsh Writes About

TAPES IN REVIEW: 1963 Edition

by R. D. Darrell

“. . . useful as a reference book and valuable as a guide. Rob Darrell is one who can size up both the musical and technical merits of a recording and give each its proper incentive in a concise review. In both instances his judgements are consistently trustworthy. I respect his opinions and found his book a useful overview of the considerable musical resources which tape offers the collector today.”

So writes Mr. Marsh in the Chicago Sunday Times. High praise, indeed.

TAPES IN REVIEW brings you in one convenient book about 500 pre-recorded tape reviews which appeared in HIGH FIDELITY during 1962 and 1961. All were written by R. D. Darrell, contributing editor

of HIGH FIDELITY, pioneer in the art of discography, author of The High Road to Musical Enjoyment and Good Listening and many, many articles.

If you buy pre-recorded tapes, this book will help you build a fine library of the music you enjoy. Mr. Darrell's interests range from Beethoven to romantic Italian songs. There's a handy index, too.

If you are not yet one of the HIGH FIDELITY readers who buys pre-recorded tapes, you will find TAPES IN REVIEW helpful as a guide to discs because performances on tapes are available, also, on discs. And the book will enlighten and entertain every musically minded reader. It measures 6½" x 9¾". Flexible cover.

Payment with order but satisfaction guaranteed or your money back. Use the handy order form below.

Wyeth Press, a Division of High Fidelity, Publishing House, Great Barrington, Mass., 01230 1-64
Send me a copy of TAPES IN REVIEW: 1963 Edition for the \$2.50 I enclose.

Send to

Name _____

Address _____

A CHANGE OF CHAIRS

Continued from page 28

youth, and he heard Tchaikovsky conduct the Second when he was a boy. I first heard Stravinsky conduct it in the late Thirties." Topping off the season's game of musical chairs is a Columbia recording—just out—of Charles Munch conducting the Philadelphia Orchestra. Mr. Burkat swears, "I had nothing to do with it."

A MILE OR SO downtown from Columbia's offices stands the yellow brick headquarters of RCA Victor, and here we found Roger Hall, tall, bespectacled, and genial. The Red Seal a & r manager acknowledged a strong bent for the piano (which he had studied at the Manhattan School of Music), but confessed that as a student he had been "interested in too many things" to devote himself to the instrument as a career. He majored in journalism at the University of North Carolina (Class of '46) and soon afterwards went to work for Columbia Artists Management in New York. Two years later he embarked upon a career of orchestra management which was to lead (by way of the Fort Wayne Philharmonic and the Erie Philharmonic) to the position of assistant manager of the Chicago Symphony in 1953—the year the late Fritz Reiner became music director. In 1956 he began a stint in the record business, heading sales for Angel and Capitol, and then returned to orchestral affairs as Manager of the Philadelphia.

Sitting in his still unfinished office, Roger Hall gave every appearance of being pleased to be where he was. "I'm old enough to have grown up with Victor records, and to me there is something intangible but very real about the RCA Victor legend. And I'm in love with the idea of the company's involvement with opera recordings." Mr. Hall sees his major task as that of planning "exciting repertoire and exciting collaborations," and though he was reluctant to make predictions so early in his tenure, it was not difficult to guess that plans to fulfill his expectations were already afoot.

SHIRLEY FLEMING

High Fidelity, January 1964, Vol. 14, No. 1. Published monthly by The Billboard Publishing Co., publisher of Billboard, Vend, Amusement Business, American Artist, Modern Photography, and the Carnegie Hall Program. Telephone: Great Barrington 1300. Member Audit Bureau of Circulations.

Editorial Correspondence should be addressed to The Editor, High Fidelity, Great Barrington, Mass., 01230. Editorial contributions will be welcomed. Payment for articles accepted will be arranged prior to publication. Unsolicited manuscripts should be accompanied by return postage.

Subscriptions: Subscriptions should be addressed to High Fidelity, Great Barrington, Mass., 01230. Subscription rates: Anywhere on Earth, 1 year, \$7; 2 years, \$13; 3 years, \$17. Single copies, 60 cents.

Change of address notices and undelivered copies (Form 3579) should be addressed to High Fidelity, Subscription Fulfillment Dept., 2160 Patterson Street, Cincinnati, Ohio, 45214.

Whether you use your Miracord...



as a manual turntable,



an automatic turntable,



or an automatic changer...

you have the same quality features working for you: hysteresis-synchronous motor with self-regulated speed accuracy, or high-torque, 4-pole induction motor, as you prefer, mass-balanced tone arm that provides tracking force without springs, and one-piece, dynamically balanced, die-cast turntable.

Quiet, smooth and gentle, the Miracord brings out the best in your records, and preserves their quality for long-lasting enjoyment. See and hear the Miracord at your high fidelity dealer. For complete details, write:

**BENJAMIN
MIRACORD**

BENJAMIN ELECTRONIC SOUND CORP., 80 SWALM ST., WESTBURY, N.Y. SOLE U.S. DISTRIBUTOR FOR MIRACORD TURNTABLES, E.A.C. CARTRIDGES AND OTHER ELECTROACOUSTIC RECORD PLAYING COMPONENTS.

CIRCLE 15 ON READER-SERVICE CARD

Who can build all this into a 6½" deep cabinet?



12" woofer with 6-lb. magnet structure, 2" voice coil, half-roll cotton surround, and 25 cps free-air resonance



5" midrange driver with Butyl-coated surround and sealed metal back

3" cone-type tweeter with 2-lb. magnet structure, hemispherical dome bonded directly to 1" voice coil, and sealed metal back

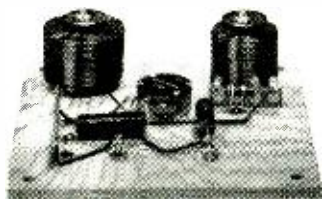

3-way inductive-capacitive dividing network with 1200 cps and 2800 cps crossovers, and continuously variable tweeter control



High-absorbency AcoustiGlas padding



You!

(with the Fisher KS-2 StrataKit)

You install the three drivers, wire them to the dividing network, put in the padding, complete the assembly of the cabinet—and you are the owner of the most advanced slim-line speaker system available today, only 6½" deep by 25" high by 20" wide. Despite its moderate dimensions, the Fisher KS-2 StrataKit has virtually uniform response from 35 to 20,000 cps and rivals the most advanced professional loudspeakers in clarity, transient response and over-all 'bigness' of sound. And —it is priced at only \$89.50.* The Fisher KS-1 StrataKit, a slightly smaller and even slimmer (5¾" deep) 3-way speaker system, costs only \$59.50.**

FREE! \$1.00 VALUE! The Kit Builder's Manual, an illustrated guide to high fidelity kit construction, complete with detailed specifications of all Fisher StrataKits.

The Kit Builder's Manual

Fisher Radio Corporation
P.O. Box 6-C
Long Island City 1, New York

Please send me the free Kit Builder's Manual.

Name _____

Address _____

City _____ State _____

03112

*In sanded but unfinished birch. Also available in unfinished walnut, \$94.50. Factory assembled, in finished birch, \$114.50; in oiled walnut, \$119.50.
**In sanded but unfinished birch. Also available in unfinished walnut, \$64.50. Factory assembled, in finished birch, \$64.50; in oiled walnut, \$89.50. All prices slightly higher in the Far West. Overseas residents write to Fisher Radio International, Inc., Long Island City 1, New York. Canadian residents write to Tri-Tel Associates, Ltd., Willowdale, Ont.

CIRCLE 36 ON READER-SERVICE CARD

a **marantz** owner

Forever

There is no such thing as a typical Marantz owner—unless one can say they are firmly devoted. Some may have determined at the outset that they would have only Marantz. For still others it may have been a matter of budgeting, with planned growth to a full Marantz system.

We have, however, been receiving an ever increasing number of letters from recent Marantz "converts", indicating surprise at the extent of the improvement obtained. They are now convinced of the difference, and are Marantz owners forever.

Whether one is buying soap or automobiles, it is difficult to evaluate conflicting claims and counterclaims of superiority. Yet, when it comes to stereo amplifiers and preamplifiers, almost anyone will acknowledge that Marantz is outstanding from any point—whether performance, precision, quality of construction, reliability, or sound quality.

Hear for yourself what the finest music reproduction sounds like—and you too will be a confirmed Marantz owner—forever!

another important message



Quality does not come easy. It takes hard work, know-how, craftsmanship and time. The introduction of the classic Model 7 Stereo console, if you remember, took time. Now, our Model 10 Stereo FM tuner again requires time. Those of you who have already received your Model 10 tuner can see that they are individually custom crafted with traditional Marantz quality. So, you who have ordered and are waiting delivery . . . please be patient. I assure you it is well worth waiting for.

S. Marantz President



Superb American Craftsmanship marantz
25-14 BROADWAY, LONG ISLAND CITY 6, NEW YORK

Model 7 Stereo Console • IM distortion @ 10V eq. pk. RMS, within 0.15%, 0.1% typical • Hum and noise, 80 db below 10 mv phono input • Sensitivity, 400 microvolts (0.4 millivolts) for 1 volt output • Equalizer and tone curves matched to better than 0.5 db • Beautiful precision construction • Price \$264 (Cabinet extra)

Model 8B Stereo Amplifier • 35 watts per channel (70 watts peak) • Harmonic distortion, less than 0.1% in most of range, less than 0.5% at 20 cps and 20 kc • Hum and noise, better than 90 db below 35 watts • Exceptional stability assures superb clarity with all types of loudspeakers • Price \$264.

Model 9 Amplifier—70 watt basic amplifier • Response at 70W, ± 0.1 db, 20 cps to 20 kc • Harmonic distortion, less than 0.1% in most of range, 0.3% at 20 cps and 20 kc. • Hum & noise, better than -90 db • Completely stable for smooth response • Built-in metered tests and adjustments • Price \$384 each. (higher in West)



CIRCLE 46 ON READER-SERVICE CARD

HIGH FIDELITY NEWSFRONTS

BY NORMAN EISENBERG

Distilled but Not Stilled. The conclave of engineers and acousticians that follows each year in the wake of the New York High Fidelity Music Show offers little in the way of visible or sonic display, but provides plenty of audiophilic sustenance nonetheless. At a five-day series of meetings arranged by the Audio Engineering Society, the technica underlying the products viewed a month earlier—to say nothing of new products and techniques not yet made public—was distilled and debated by the experts in sound recording and reproduction.

The air of sobriety characteristic of these sessions was enlivened at least twice during our visits. Dr. Harry F. Olson, of RCA Laboratories, was challenged by Dr. Benjamin B. Bauer, of CBS Laboratories, on—as you might guess—the Dynagroove record. After Dr. Olson had delivered a paper explaining the Dynagroove process, Dr. Bauer pointed out that the explication had omitted mention of studio monitors. He wanted to know whether RCA had done away with human monitors in favor of pure instrumentation. If so, concluded Dr. Bauer, “you simply can’t make records that way.” When the laughter had subsided, Dr. Olson explained that, of course, flesh-and-blood monitors were still employed and that he had assumed this would be understood as a matter of course. We then asked Dr. Olson, referring to a statement he had made earlier, whether the Dynagroove process was designed to make records sound good on an “average” level of playback equipment rather than on the best available playback equipment. Dr. Olson explained that they had “proved” Dynagroove discs on all manner of equipment and had found that the recordings sounded fine on low-cost playback systems as well as on high-quality systems.

Upon further questioning, Dr. Olson conceded that the “dynamic spectrum equalizer” (which automatically varies the depth of the cutting stylus in the interests of lessening playback distortion) is Dynagroove’s only significant departure from the conventional recording process; that, in general, the term “Dynagroove” summed up a cumulative series of improvements made over the years in the recording, cutting, and processing of discs. This was the convention’s most controversial session, and discussion of the issues between little knots of partisans continued long after the meeting. One engineer struck a mollifying note by pointing out that “things can’t be too bad between the two major record companies, since Jack Woodward of RCA did use a CBS test record to illustrate his talk on tracing distortion.”

More sparks flew at a symposium and

panel discussion on “Stereo and High Fidelity.” Anton J. Schmitt, of Harvey Radio, a New York dealer, flatly told the assemblage that he knows of some amateur audiophiles who build better equipment than some professionals—and was applauded for his barbs. Benjamin Bauer introduced a new test record designed to help a stereo listener adjust his system for variations not only in listening tastes and room acoustics but in normal manufacturing tolerances, thereby injecting a subjective note of “personal high fidelity” in an otherwise slide-rule and formula-minded orientation. A brief history of sound reproduction—from Berliner’s first disc to today’s stereo record—was given by Irving Joel, of Capitol Records. While not controversial, this talk, supplemented with examples of recordings made down through the decades, did point up that claims of lifelike performance were made and widely accepted at any given moment in the history of the art—despite the fact that noticeable improvements invariably followed shortly after.

Arnold L. Seligson, of Consumers Union, discussed the need for improved standards and for measurement methods to relate numbers to the subjective listening experience. He also hinted that audio engineers can learn a few techniques from the data-processing field to further the perfection of solid-state equipment and the continued reduction of distortion. Werner Freitag, of the Communications Arts Group at New York University, suggested that there is a need to define high fidelity, but that trade groups—such as the Electronic Industries Association and even the Institute of High Fidelity—“have vested interests” and therefore cannot be relied on to arrive at a completely satisfactory definition. He suggested that the Audio Engineering Society itself define, and set standards for, high fidelity sound.

C. G. McProud, publisher of *Audio*, set off some buzzing in the audience when he allowed that “the new is not necessarily better just because it is new. We can only judge innovation—in a product or a technique—on the basis of what now is accepted as good.” James A. Stark, of General Electric, offered a new concept of “packaged audio.” Cabinetry, pointed out Mr. Stark, “can move more equipment into rooms other than the ‘listening room’ or that room in the home originally taken to be the valid setting for music playback.” To illustrate his point, he mentioned the ordinary radio receiver and television set, both of which have stepped beyond their original “front parlor” environment into other parts of the home.

Perhaps the most challenging state-

ments were made by venerable Percy Wilson, the British engineer-editor of whom we wrote here last month. Mr. Wilson contended that the trouble with many engineers was that “they were afraid that music would get in the way of their hi-fi.” American technicians, he continued, were not sufficiently alerted to certain developments in audio because they either didn’t read, or didn’t care, about what was being done in Britain and in Europe. Specific issues he had in mind included the vertical-tracking-angle question and a definitive solution to the problem of dirt on records, both of which, he claimed, have been under more intensive study in Britain than in the U.S.A.

The assemblage either was mild-tempered or highly susceptible to these remarks for, although questions were asked, no one really disagreed with any of the speakers. On the way out, we overheard this exchange between two engineers:

“We’ve been told off, I guess.”

“But we haven’t been told how.”

“That’s up to us, isn’t it?”

Real Cool Stereo. It has long been known that the heat generated by tubes and transformers is a potential cause of malfunctioning or breakdown of audio gear. A husky amplifier, for instance, can run hot enough to fry eggs—and cook a few resistors at the same time. And the torrid zone set up by an amplifier can upset delicate adjustments in a nearby FM tuner. Although most of the heat in a music system is produced by power amplifiers, or the output stages of combination amplifiers, some also can be produced by preamplifiers or indeed by any electronic chassis. Careful design and construction of equipment help to reduce heat, but adequate ventilation during use remains a prime requirement. Even solid-state equipment, which itself produces little or no heat, can be affected by poor ventilation and ideally should be given some “breathing space.”

A step toward providing relief has been taken by Rotron, a new name in audio but an old hand at supplying fans to industry. Rotron’s aid for torrid stereo systems is a compact fan, encased in a black plastic frame that measures 4 11/16 inches square and 1 1/2 inches deep, is priced at \$14.95, and is supplied with mounting accessories and very clear instruction for installing it in different ways. The Rotron fan is rated to move 60 cubic feet of air per minute—and while we did not measure it, we were impressed with its ability to cool quietly and efficiently, a part of our own cabinet that had come to be known as the “hot box.” Kudos to Rotron.

Another SONY First



The TFM-116A — FM/AM/MARINE PORTABLE with "SNAP TUNING"

No more hunting for your program with the sleek new SONY TFM-116A. Its new system of "Snap Tuning" means the FM signal pops right into perfect tune without fuss and bother. And it stays, without fade or drift, thanks to Automatic Frequency Control.

The 11-transistor portable has other features you'll appreciate, too: Pushbutton band selection for FM, AM and Marine frequencies, tuning meter and continuous tone control. In bone white and silver, with batteries and earphone. \$99.95. Carrying case extra.

SONY®

RESEARCH MAKES THE DIFFERENCE

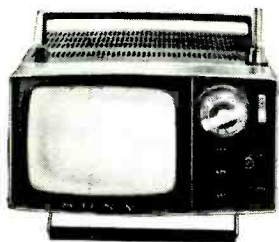

SONY Micro-TV — The remarkable truly portable all-transistor TV that goes with you practically everywhere. Only 8 lbs., it operates on rechargeable battery, auto/boat power and AC. With 25 transistors, it accepts transistorized UHF adaptor for channels 14-83. Only \$189.95. Case, UHF adaptor, battery pack, other accessories extra.

SONY CORPORATION OF AMERICA • 580 FIFTH AVE., N.Y. 36, N.Y. • REGIONAL OFFICES: LOS ANGELES • CHICAGO
CIRCLE 58 ON READER-SERVICE CARD



What went on in room 433 at the New York Hi-Fi Show?

The first solid state receiver... Bogen's RT1000 a superb instrument accorded the most enthusiastic response

The response was twofold. People responded to the Bogen technology which produced the FM-Stereo and FM/AM RT1000. And they responded to the understated elegance of design, to the hushed gold front panel. The RT1000 responded with pure performance. In high fidelity, transistors have just one reason for being . . . to make a component perform better. We knew the RT1000 was a milestone. Now all who saw and heard it in room 433 know it, too.

Here are but a few reasons why: 100 watts of exceptionally clean power (50 per channel). Distortion is practically extinct since transistors replace a major source, *output transformers*. The RT1000 is actually hum-free.

Cool. That's a good word for the RT1000. Transistors reduce heat markedly. That does away with enclosure vents ordinarily needed to cool the chassis.

Let's talk tuner, FM-Stereo and FM/AM that is. Separation, selectivity and sensitivity approach professional perfection. Flywheel tuning that sweeps the dial as effortlessly as moving your fingers. An FM-Stereo switch position automatically lights the Stereo Minder Indicator when mono transmission changes to stereo.

Summing up the responses, "there has never been a sound quite like it . . . clean, cool, pure performance." Check your own responses. Let us send you free, detailed literature on the RT1000 all-transistor receiver. Just mail the coupon below.



LEAR SIEGLER, INC.  BOGEN COMMUNICATIONS DIVISION
PARAMUS, NEW JERSEY

Please send me literature on the RT1000 and a catalog of all the 1964 Bogen Components.

Name.....

Address.....

City.....State.....H-1

BOGEN

CIRCLE 16 ON READER-SERVICE CARD

“my daddy
bought us a new car...
he says it's worth
\$7000”

“my daddy bought us
a Garrard Automatic
Turntable...he says
it's worth a million!”

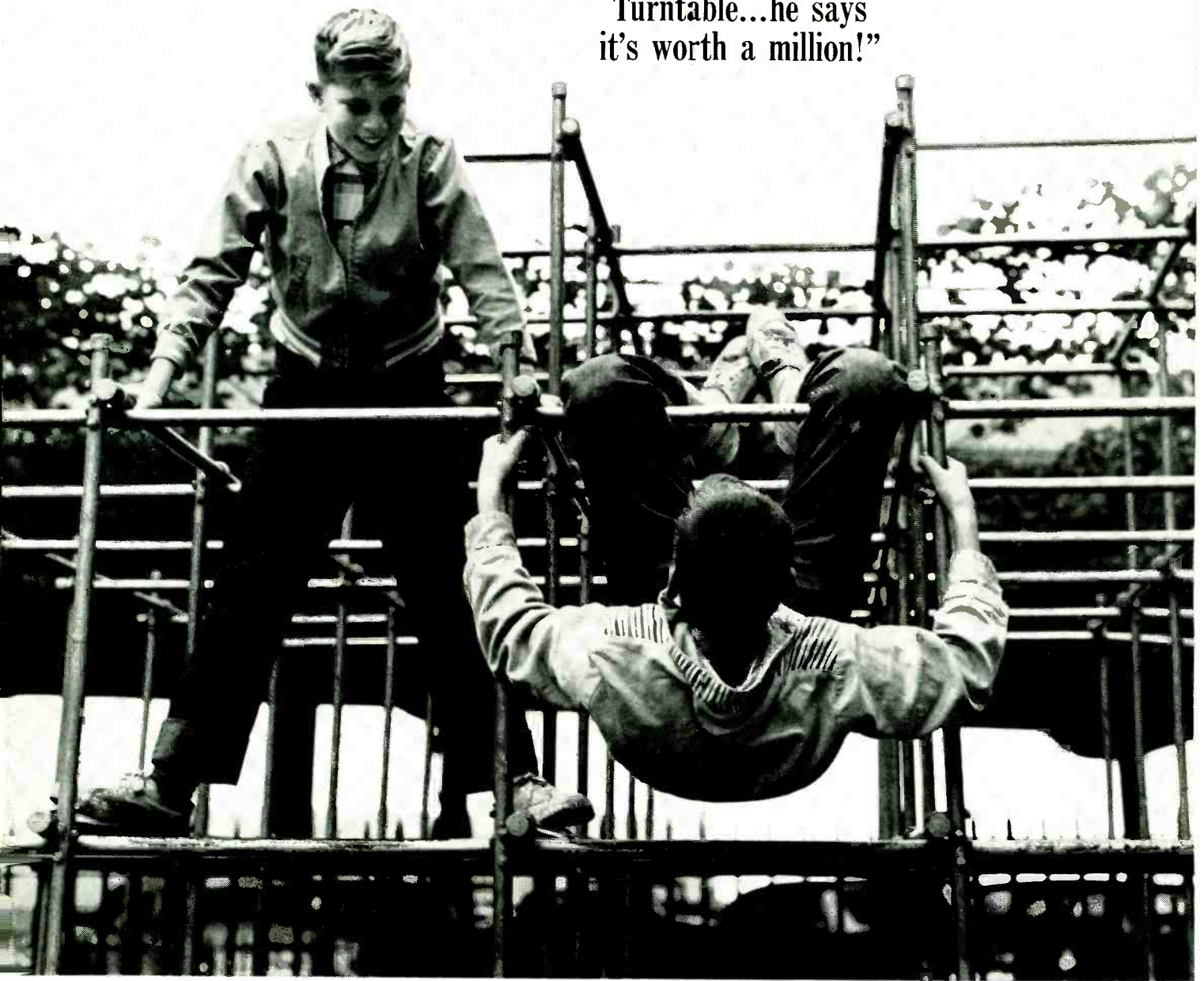

What makes a Garrard worth a million? Pleasure. The pleasure of an incomparable experience in sound. Why? Because the Garrard Automatic Turntable integrates a dynamically balanced tone arm, counter-weight adjusted...a full size turntable, cast, heavy and balanced...correct torque stemming from the Garrard Laboratory Series® motor. The Garrard arm takes your choice of cartridge... even the ultra-sensitive, high-compliance types labeled “professional”. This arm brings out the best in any cartridge...tracking and tripping at the lowest pressure specified by the cartridge manufacturer. The unit is quiet, speed even... sound pure, undefiled by rumble or resonance. Your Garrard plays records

one at a time or automatically, as you wish. In either case, it shuts off by itself after the last play. And, should your Garrard ever need maintenance, you will find that it is supported by the industry's best stocked, best trained, authorized service network. There is a Garrard for every high fidelity system. Type A, \$79.50; AT6, \$54.50; Autoslim, \$39.50. For literature, write Department GA-24, Garrard, Port Washington, N.Y.



Garrard[®]
WORLD'S FINEST

CIRCLE 18 ON READER-SERVICE CARD

www.americanradiohistory.com

Reissues: Introducing a New Department

WE LIVE in an age of waste: an age which nourishes itself from the throw-away container and demolishes celebrated architecture for the sake of "progress," an age in which we are exhorted not to repair but to replace, not to conserve but to consume. The effects of this profligate *Zeitgeist* are everywhere—and not least in the field of recordings. Schwann's black diamonds, those monthly marks of doom for discontinued discs, have become the symbol of an industry obsessed with obsolescence.

Too often that obsolescence has been purely fictitious. It is perhaps a cliché of record criticism to bewail the disappearance of an exemplary recorded performance and to fault its replacement by newer versions inferior in every respect save, possibly, that of engineering technique. But the cliché is founded on just cause, and we are not at all apologetic for having uttered it often in these pages.

Of late, however, the regrets and remonstrances have had to be repeated less often. Yesterday's recordings are no longer being discarded with the reckless abandon of yore. And many of those that were foolishly and prematurely supplanted are now being restored to circulation as reissues—usually in remastered and repackaged form, and sometimes at considerably reduced price.

The past several months have seen a near-deluge of reissues. RCA Victor has launched its welcome Victrola series, restoring to life a number of memorable productions from the recent past in particularly attractive new jackets. The burgeoning Victrola list already includes such prized fare as the Szeryng/Monteux Brahms Violin Concerto and the Gilels/Reiner Tchaikovsky Piano Concerto. From Capitol we have the new Paperback Classics line, which purveys the work of Erich Leinsdorf, William Steinberg, Leopold Stokowski, and other celebrated musicians who have figured at one time or another on this company's roster. London Records has brought many of its finest productions of the 1950s back to attention on the low-priced Richmond label, among

them some lavishly lauded opera recordings—the D'Oyly Carte's Gilbert and Sullivan, the Krauss-directed *Fledermaus*, the early Tebaldi sets of Verdi and Puccini. Angel is pressing ahead with its rehabilitation of the "Great Recordings of the Century" (this season has seen the long overdue return of Schnabel's Beethoven to the catalogue), and Westminster has embarked on its ambitious Collectors series, a major restitution of deleted discs by the Messrs. Scherchen, Janigro, Badura-Skoda, Cuenod, et al. Other noteworthy resuscitations have appeared on the Columbia, Lyricord, Vanguard, and Vox labels.

Undoubtedly the single largest salvo of reissues has been fired by Capitol Records International, which is now distributing on this side of the Atlantic literally hundreds of Odeon and Pathé discs imported from the factories of EMI affiliates in France, Germany, Great Britain, and Italy. While many of these recordings are new to this country, a large percentage of them have appeared here before, either as 78s or LPs, on the RCA Victor, Columbia, or Angel labels. The prewar Glyndebourne sets of *Don Giovanni* and *Così fan tutte* are now happily back in circulation thanks to these Odeon/Pathé imports. So are the Toscanini-BBC recordings of Beethoven . . . the Chopin series of Alfred Cortot . . . the Menuhin-Furtwängler versions (they made two) of the Beethoven Violin Concerto . . . and much, much more.

To give proper attention to these very welcome restorations, HIGH FIDELITY introduces this month in its review section a new department entitled "Reissues." Though—even with our full roster of reviewers contributing to these pages—it will not be possible to report on every item in the present inundation, we do intend to take note of all important revivals. The new department will continue as long as record companies continue to reissue notable material. Hopefully, both the phenomenon and our coverage of it should go on indefinitely. There is a lot of wonderful stuff to be mined.

AS high fidelity SEES IT



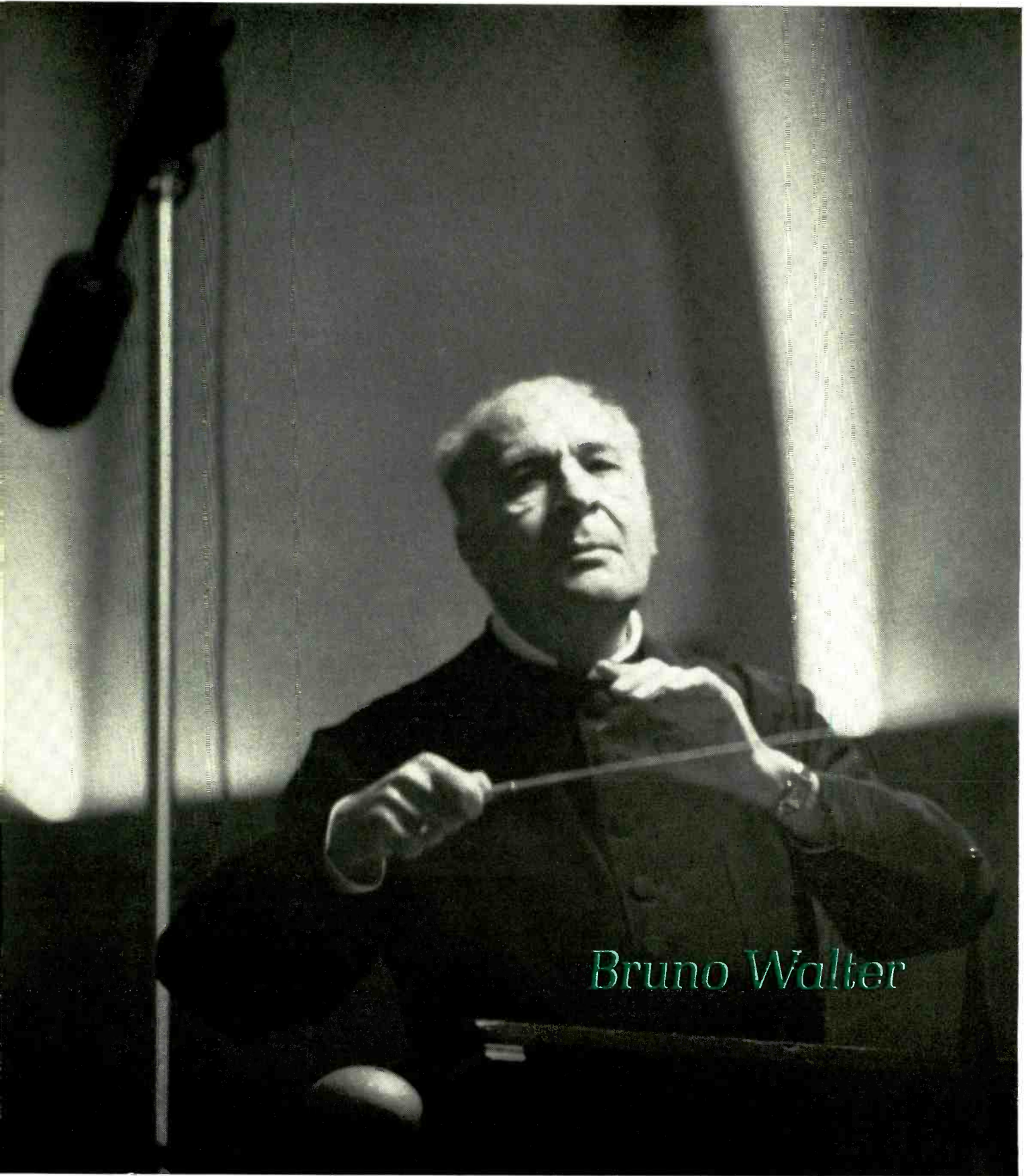

Bruno Walter

Bruno Walter's last years in
the recording studios, as a close working
associate remembers them.

“An Education and a Joy”

By John T. McClure

MY FIRST MEETING with Bruno Walter took place in the summer of 1957 amid the eerie moonscapes of Palm Springs where he had gone to recuperate from a heart attack. My mission was to find out how he was progressing and to discover under what circumstances he would be willing to resume recording, now that stereo was proving to be more than mere pitchman's hyperbole. The unlikely address he had given me over the phone, a motel owned by Horace Heidt (and his Musical Knights), added to a feeling of unreality that came from searching through this rich artificial oasis in the California desert for one of the last surviving representatives of high German culture. How had the land of Louella Parsons, Forest Lawn, and Mamie Van Doren attracted Dr. Walter? And not only Walter, but Thomas Mann, Igor Stravinsky, Aldous Huxley, and Arnold Schoenberg as well?

I found Dr. Walter seated near a tropical baroque rock garden, taking the sun in the manner of an older European generation: with topcoat, scarf, and cloth cap against the muscular desert heat. His greeting was subdued and rather shy, perhaps that of an alien to a native. The small stature he shared with many conductors was a surprise; his courtly and gentle manner was not. He asked about my drive from Los Angeles in a way that betokened real interest and invited me to a lunch and a talk. As we walked, I observed the tanned, unwrinkled planes of his face, his wide-ranging alertness, and the steady, deeply resonant voice which betrayed only sixty of its owner's eighty-one years. His dress was conservative, even drab, but his regular careful steps were made in cloth shoes with thick crepe soles—the only sartorial compromise with the West.

Over a salady lunch he recounted the qualities of California that had most captured his affection. The penetrating desert heat, at first like a physical blow, had so speeded his recovery that his doctor

was permitting him to resume work during the coming winter. He was presently making plans to reschedule several concerts canceled during his illness. I asked him if he were disposed to begin a large recording project using a new process called stereo. I explained that it was an advance in the recording art, but also an eventual threat to already existing records. He was unimpressed. Threats were for the young, he smiled. But certainly he would welcome another chance to redeem the interpretative sins of his past.

There were, however, some serious conditions attached. First: save for the rescheduled concerts, he considered himself retired from public life, and therefore all recordings would have to be made without benefit of performance. Second: his age and the misbehavior of his heart had earned him, he felt, the right to live the rest of his days in the California climate that he loved; we would have to come to him. Third: so that he could work for longer periods, he would record only every other day. Fourth: since there was the possibility (smile) that these might be his last musical statements, he would like a perfectly free hand with both orchestra and repertoire. All conditions I agreed to as uttered, cautioning him only that everything depended on finding a suitable recording hall in the Los Angeles area. If the search were successful, we could begin that winter. He thanked me for coming, made me a list of places to see before starting back, and wished me luck.

DURING THE WEEK FOLLOWING, I examined, notebook in hand, twenty-five buildings which our West Coast staff had selected as possible locales for our project. There were concert and convention halls, Masonic Temples, gymnasiums, vacant theatres, hotel ballrooms—and, for one reason or another, each had to be reluctantly disqualified. A good recording

hall is an Act of God, designed, as a rule, for anything but music: a finicky blend of accessibility, remoteness from traffic noise, clarity within reverberation, availability, and, if possible, atmosphere. Like a bad Hollywood script, the last hall on the list, a large concrete structure built in the 1920s as a meeting place for the American Legion, turned out to be ideal on every point. It "spoke" immediately with the music, surrounding each sound instantaneously with a natural aural bloom. The reverberation-decay was smooth and bright with no audible slap-back, and the sound of the diesel trucks laboring up the Cahuenga Pass to the San Fernando Valley never penetrated to its rather monastic interior.

Engineers were notified, a control room was built, and the job of distilling an orchestra out of the ample pool of fine musicians in the area began. For this job we picked Philip Kahgan, retired first violist of the Los Angeles Philharmonic, who knew Walter and had performed many times under him. Kahgan's work was so well done that the Maestro replaced only a few men during the next four years. Our goal was not to imitate any existing orchestra, but to select the best orchestral instrumentalists from the Philharmonic and the film studios, relying on Dr. Walter to create the necessary personality for the group. Subsequently, he was grateful for this "neutrality" since he could fashion with equal ease an appropriate style for Mozart or for Mahler. "It's better this way," he said. "They have not so many bad habits to overcome."

That busy summer and fall set a pattern for succeeding years. By letter and several more meetings we established the repertoire (in this case Beethoven Symphonies) for the winter following. Walter's extensive preparation involved hearing and criticizing his previous recordings, marking the scores page by page with his dynamics and bowings, correcting from his mind's ear the contours and balances of how many performances. These markings were then transferred into the orchestral parts by a copyist, saving us untold time and trouble at the sessions. Back in New York I underwent a similar though less intense process of familiarization, dividing each symphony into fragments of fifteen or twenty minutes, the most we planned to attempt in one day.

We all came nervously to the first session in January—Kahgan fussing over the orchestra; the musicians wondering how they would sound to the Maestro after Vienna, London, and New York; myself with fingers crossed for the hall; and Dr. Walter probably uncertain about the repairs so recently nurtured in the sun at Palm Springs. We talked beforehand in the control room, and I introduced him to the engineers. He looked smaller and older now in his old black rehearsal jacket, and I felt misgivings; but as we entered the hall to a standing ovation, his step became sure, the years dropped away like husks, and he almost sprang onto the podium. "So, gentlemen, thank you. It seems we will be seeing a lot of each other this winter and I hope we become a good working family. Today we

begin with" All under control. Three hours later we were veterans with all our fears unrealized. Dr. Walter was enthusiastic about the hall and the orchestra. A few seating changes and we were on the way.

TO ONE ACCUSTOMED to the pressure of recording established orchestras in already rehearsed repertoire, where the session moves with urgent speed, the calm and measured cadence of these Hollywood recordings was a dream come true. Here each work was rehearsed at the session itself until the Maestro felt it was quite ready to be taped. During these rehearsals we had ample time to set and adjust our microphones for the ultimate balance. Then a take was made and played back. Some further adjustment and rehearsal, perhaps, then we would record again, and again listen. Lots of time. Time even for the Maestro to enjoy an apple and a cup of coffee. We would remake a piece until we were both quite satisfied, and we often achieved our goal of a complete take with no splicing needed. In keeping with this goal, we were able ninety per cent of the time to leave our microphone levels untouched during the take in order that Dr. Walter's skill in molding dynamic outlines need not battle with less skillful, if well-intentioned, influences. Our sessions, averaging three hours each with several breaks to hear playbacks, allowed him to complete even the most turbulent movements of Mahler without suffering excessive fatigue.

During a session in 1959 (his eighty-second year) I met him at the control room door after two consecutive, stormy takes of the *Flying Dutchman* Overture. He was sweating and breathing heavily from the exertion, and I said with unfeigned concern that a rest was long overdue. He agreed: "Yes, the men are a little tired. No wonder." There was no trace of irony in his statement, nor did he seem aware that what he had just done would have prostrated many men of fifty.

Bruno Walter's rehearsals were an education and a joy. In the four years of our association I seldom heard his voice raised in impatience, and never in anger. The men came to the sessions as if to a master class. After tapping their music stands in tribute at the conductor's entrance, their tangibly receptive silence would be broken only by his exhortations or by music. Tension was minimal; concentration was absolute. Walter was an eminently articulate man, and his guidance—now spoken, now sung in that firm sixty-year-old voice—was colorful, warm, hortatory, and unfailingly pertinent. "Come, my friends," he would say, "once more: trumpets a little less, violins more singing, you know? It's much better but I do it again."

Although his patience was rarely tried by this responsive orchestra, he knew, from sixty-three years of conducting experience, just how each measure should sound, and there was no getting around him. I remember recording on four separate oc-

casions the first forty bars of the *Academic Festival Overture* because the accents weren't just the way he wanted them. Humor was always present at the sessions too, though never in the Beechamesque form of stories or jokes. During almost every recording something would happen to touch his funny bone, and a quiet remark would send the orchestra into ripples of laughter—leaving the control-room contingent feeling much deprived.

Week after week the members of our orchestra gave up more lucrative engagements to play with us for straight union scale. Even the more calloused and blasé among them were touched with awe, crowding into our control room to hear the playbacks and to observe the Maestro's every reaction. The problem of finding enough space for the eager auditors was just as acute the last year as the first. They realized that once this spring ceased its flow, a whole world of tradition would vanish with it.

As with many great musicians, Bruno Walter's nervous system was virtually helpless against musical magnetic fields. It was impossible for him to listen to a playback with quiet hands and feet. Heavily charged music would bring great slashing breaths and gestures from him at crucial downbeats. More than once I prudently relieved him of his glass of orange juice when I heard a climax approaching. "Isn't that *enorm*? Isn't that really someTHING?" he would say after it had passed.

IN THE YEARS we worked together we became as close as the fifty-four-year gap in our ages permitted. I would pick him up in my car each working morning, and no matter how early I came he would be out before me pacing slowly on his lawn. He was proud of having never been late to a concert in more than sixty years and insisted on being at the hall a full half hour before the session began. Our talk en route would circle around the day's objective: what to start with; where to break; how to bring out a problem passage; special instructions for the horns, etc. The trip home, however, was a reliving of the music just completed. Mozart *allegrettos* would provoke animation and sung snatches of themes from everywhere. Beethoven or Wagner might bring us careening dangerously near to metaphysics, while a great Bruckner adagio produced total silence punctuated by an occasional apostrophic sigh from the Maestro.

The Tudor-style house he shared with his daughter Lotte and her husband on a quiet palm-lined street in Beverly Hills was attractively furnished in no definite style. The living room was dominated by a grand piano and the Rodin bronze bust of Mahler which Lotte had somehow smuggled out of Vienna under her coat in the tense flight from the Nazis.

Meals had the European minimum of formality and conversation was easy and animated, especially when Lotte and I argued about politics—to the

great amusement of her father. At times the Maestro would reminisce about the past: his German premiere of the Shostakovich First Symphony, or the painful flight from Hitler, or meetings with Mahler and his family, or conducting Stravinsky with the composer as soloist. But Walter was not overly fascinated by the past. He lived in the present and was working hard. Lotte would chide me because her father would be up studying scores when she went to bed at night or when she got up in the morning.

Walter's speech was animated and "sung," with the vocal notes rising and falling. Even his mispronunciations (disease he pronounced *diss*-ease, in line with its archaic meaning) were based on an extensive knowledge of English word roots. He liked to use American slang and seldom had to resort to German for linguistic precision. In our endless discussions of music and musicians he did not make derogatory remarks about colleagues; only about a certain few he was silent. Toscanini, in the world's eye his greatest rival, was a household deity, and I once created a brief frost by making a negative remark about him. In the music world of ego rampant, this is indeed "someTHING."

Like his mentor Gustav Mahler, Walter enjoyed and sought contact with nature. His appreciation of California (the topography if not the *Geist*) was based on real knowledge from frequent explorations up and down the coast. He gave us countless sight-seeing suggestions based on his discoveries, and his enthusiasms covered a broad spectrum. Point Lobos and Big Sur were his special loves. With his old friend soprano Delia Reinhardt, he would stroll each afternoon along the Pacific palisades in Santa Monica, watching the seagulls ride the local updrafts and enjoying the sunset over the ocean.

If Bruno Walter's life had a rationale more formal than the discipline brought by music, it was his deep and deeply felt humanism. Goethe had a high place in his

Continued on page 105

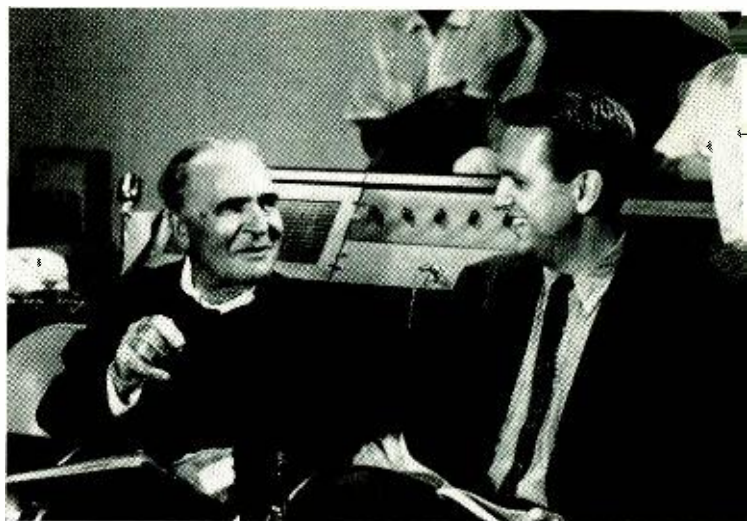

The Maestro with author: at almost every session "something would happen to touch his funny bone."

A Discography

The Heritage of Bruno Walter

By Robert C. Marsh

FROM HIS EARLIEST acoustical discs to the final multichannel recordings taped sixty years later, Bruno Walter's discography spans the greater part of twentieth-century phonographic history.

In chronology his recording activity may be divided into European and American periods, with the fatal year 1939 as the pivotal point. Two thirds of the time span falls before the outbreak of World War II, but the majority of records came later. The European series, which began during Walter's early years as an opera conductor in Berlin, continued in cosmopolitan fashion and presented him with the leading orchestras of Vienna and Paris as well as with a group of London ensembles. His work in the United States was at first mainly with the New York Philharmonic. Later, both in New York and Los Angeles, he worked with hand-picked groups engaged especially for his needs and given the *nom du disque* of the Columbia Symphony.

Bruno Walter left us one of the great legacies from the golden age of orchestral conducting. In one way it is even more impressive than that of Toscanini, since Walter remained active into years in which his music could be captured with the full possibilities of well-developed stereophonic techniques. Walter made a lot of records. Something over 150 different works of music went on discs under his baton, many of them in multiple versions. Yet Walter's records tend to be tightly focused in his areas of musical sympathy and strength. In all those recordings he drew upon the works of only twenty-two composers, and even that figure is misleading since roughly a third of the group are represented by only one or two titles.

The Walter legacy is one of Beethoven and Brahms, Mahler, Schubert, and, most of all, Mozart, whose cause is supported by more than thirty works in Walter-led recordings. It must not be thought, however, that he slighted certain composers because their music lay outside his talents. Walter was a wonderfully sympathetic interpreter of Tchaikovsky, for instance, as I discovered at one of the rare American concerts when the Russian master was represented on a Walter program. There is documentation for this in an ancient acoustical version of the *Pathétique* Symphony made in Berlin, but there is no Tchaikovsky in the later Walter discography, just as there is far less Schumann than one would expect from the conductor's deep sympathies for that composer. (More Schumann would have been forth-

coming, in fact, had Walter lived to complete his projected sessions for 1962.)

The present listing is selective and evaluative. No acoustical recordings are included, nor marginal items from the prewar period. Rather than offer completeness for completeness' sake, I have tried to concentrate on the Walter recordings as social and cultural documents, surveying them from the standpoint of present interest and future utility. All discs of the long-play era are cited under their current number or that carried when they last appeared in print. (Out-of-print records are identified by the customary OP designation after the number.)

The American Columbia company, for whom Walter made virtually all his recordings in the final twenty-one years of his life, has seen the wisdom of keeping certain of his earlier performances available even when there are later versions. For historic purposes a Bruno Walter Society edition may be in order some day to revive various notable performances presently deleted from the catalogue. Unless otherwise indicated, all numbers can be taken to refer to recordings released on the American Columbia label.

The majority of Walter's earlier discs were made for His Master's Voice or European Columbia. A few of them have appeared here or abroad in the Angel "Great Recordings of the Century" series, but much valuable material awaits restoration and re-issue in this fashion. Anything of this quality is included here.

Walter retained a certain nostalgic affection for some of his earlier recordings, which we discussed on various occasions, but largely he felt that his stereo productions were the true likeness of his musicianship and the primary documentation of his reputation for future generations, should they be interested. (Walter was never so ill-mannered as to suggest that he felt he was conducting for the ages.)

As the comment that follows will make clear, I do not always agree that Walter's final recording of a work was his most successful, but on the other hand I wish in this critique to reflect his opinions to the extent that I can presume to know them.

My selection of material for discussion was made from a complete listing of the Walter records compiled by Mr. Leo Goldstein of Chicago, and it is from his splendid private archive of historic recordings that I renewed my familiarity with most of the older items here discussed.

BARBER

Symphony No. 1, Op. 9
New York Philharmonic (1945). X 252 (78 rpm, OP).

Americans do not normally think of Walter as a champion of contemporary music, although his European years gave considerable evidence of his interests in this direction. In addition to his role as Mahler's leading advocate, Walter was the first conductor outside the Soviet Union to play the *Symphony No. 1* of Shostakovich, for example. It was quite in keeping with his past, therefore, that he should want to play and record a twentieth-century symphony by an American composer whom he admired. By showing us this facet of Walter, the album is unique in the conductor's discography, but its main attraction is a very strong and perceptive realization of one of the most important American works in symphonic form. The recorded sound is excellent for its vintage, and it takes only a rehearing of the records to make a positive case for their revival on microgroove.

BETHOVEN

Concerto for Piano and Orchestra, No. 5, in E flat, Op. 73 ("Emperor")
1) Walter Gieseking, piano; Vienna Philharmonic Orchestra (1934). M 243 (78 rpm, OP).
2) Rudolf Serkin, piano; New York Philharmonic (1941). ML 4004 (OP).

These two sets could be taken as paradigms for two familiar readings of this score, the one spacious, relaxed, lyric, and introspective, the other intense, almost Lisztian in its exhilaration, and always firmly propulsive in quality. In the former version the expressive force of the phrase, the refinement of nuance and color, dominate the pianist's attention, while the latter proceeds by sheer force of virtuosity, the sheer impact of the communicative statement. Gieseking and Serkin are caught in their artistic essence, and in both instances Walter surrounds them with an ideal orchestral framework. Gieseking offers the better account of the slow movement and the more artful passage of the bridge into the finale. The Serkin has the more vital recorded sound. Both editions are unquestionably landmarks in the history of the phonograph.

Concerto for Violin and Orchestra, in D, Op. 61
1) Joseph Szigeti, violin; British Symphony Orchestra (1932). M 177 (78 rpm, OP).
2) Joseph Szigeti, violin; New York Philharmonic (1947). ML 4012 (78 rpm, OP).
3) Zino Francescatti, violin; Columbia Symphony (1961). ML 5663 or MS 6263 (stereo).

My favorite is the first, but all three of these performances achieve greatness, and the stereo edition is so complete a success that it is the natural choice for the majority of Walter's public. The 1932 version has a sense of classic detachment, a serenity beyond all earthly cares, that is not duplicated in Szigeti's later version. (I actually find more of this feeling in the Francescatti, though his performance grows out of his own unique qualities as a re-creative artist.) Walter again pro-

vides a sense of ideal collaboration between peers. Engineering improves with each successive attempt, but even the first is quite good enough to please those whose primary interest is Beethoven.

Triple Concerto for Violin, Cello, Piano, and Orchestra, in C, Op. 56
John Corigliano, violin; Leonard Rose, cello; Walter Hendl, piano; New York Philharmonic (1949). ML 5368.

Walter is the dominant force here, with soloists drawn from the first chairs of the orchestra and the assistant conductor at the piano. This is the most difficult of all the Beethoven concertos interpretatively, because its strength lies in the ability to establish and develop a firm lyric line. Walter keeps everything thoroughly under control, and the blending of the solo voices in the slow movement is especially lovely. This is an important record, for it establishes a performance standard in a work where many musicians fail to find success.

Coriolan Overture, Op. 62
Columbia Symphony (1961). ML 5887 or MS 6487 (stereo).

Walter recorded this work previously in Berlin and London, but his final version is one of the greatest ever given us. We need look no further to learn what he saw in this music, for the vision is complete.

Egmont Overture, Op. 84
New York Philharmonic (1954). ML 5232.

The drive and sweep of this performance make it one of the finest recorded achievements of the score and a landmark in Walter's Beethoven recordings.

Fidelio Overture, Op. 72
BBC Symphony (1934). RCA Victor 11809 (78 rpm, OP).

Faded sonics make this disc of limited interest, but it is a performance too fine to forget.

Prometheus Overture, Op. 43
Symphony orchestra (London pickup orchestra) (1930). 68091 (78 rpm, OP).

Another lovely performance retained in rather ancient, but still pleasing, sound.

Leonore Overture No. 2, Op. 72a
Columbia Symphony (1961). ML 5887 or MS 6487 (stereo).

For comment on this recording, see "Records in Review," page 70.

Leonore Overture No. 3, Op. 72a
1) Vienna Philharmonic Orchestra (1936). RCA Victor M 359 (78 rpm, OP).
2) New York Philharmonic (1954). ML 5232.

The Vienna performance was a good one, but the Philharmonic is even finer and vastly superior in sound. Of the recordings which grow from German performance traditions, this is one of the very best we have ever had.

Symphony No. 1, in C, Op. 21
1) New York Philharmonic (1947). ML 4790 (OP).

2) Columbia Symphony (1958). ML 5398 or MS 6078 (stereo).

The 1947 performance is quite tightly structured, rhythmically strong, well paced, and, for its day, well recorded. I prefer it to the second, where the flexibility of pulse found in the Philharmonic version has been greatly expanded and the entire spirit of the work transformed by a romantic bloom. The touch of the poet is lovingly achieved, but I am more in sympathy with Walter's earlier concept. The differences in recorded sound are not so great as to overthrow the aesthetic balance in this case.

Symphony No. 2, in D, Op. 36
1) New York Philharmonic (1952). ML 4596 (OP).
2) Columbia Symphony (1958). ML 5398 or MS 6078 (stereo).

I have the impression that the Philharmonic was rushed to meet the Procrustean demands of a single long-play surface. In any case, the later version is more expansive as well as considerably better recorded, and the slow movement—the high point of this score for me—is far more splendidly realized.

Symphony No. 3, in E flat, Op. 55 ("Eroica")
1) New York Philharmonic (1941). M 449 (78 rpm, OP).
2) New York Philharmonic (1949). ML 4228 (OP).
3) Columbia Symphony (1958). ML 5320 or MS 6036 (stereo).

The *Eroica* was the best known of Walter's early efforts at recording in the United States. (Remember the red album cover with the Napoleon hat?) That initial performance was slightly slower than the two which followed, but all three were formed along the same interpretative lines. The stereo version is the obvious choice for the documentation of Walter's very extraordinary achievements with this music.

Symphony No. 4, in B flat, Op. 60
1) New York Philharmonic (1952). ML 4596 (OP).
2) Columbia Symphony (1958). ML 5365 or MS 6055 (stereo).

The later edition offers much the more effective performance and ranks among Walter's finest recordings. The older version, in contrast, is rather muddy in sound and without the firm control of line distinguishing its successor.

Symphony No. 5, in C minor, Op. 67
1) New York Philharmonic (1942). ML 4009 (OP).
2) New York Philharmonic (1950). CL 918.
3) Columbia Symphony (1958). ML 5365 or MS 6055 (stereo).

All three versions are substantially the same in approach. The first is a product of the war years, when this was the *V-for-Victory* symphony. The recording was moving then but shows its age badly. My own preference is for the second version, which has a solidity of registration which is lost in the long reverberation time of the stereo set. The third edition has the outstanding recording of the third movement, which is the portion of the score I admire the most. Walter, in his later years, was strongly opposed to repeats, and his disregard for double bars

was less defensible in this symphony than elsewhere.

Symphony No. 6, in F, Op. 68 ("Pastoral")

- 1) Vienna Philharmonic Orchestra (1936). Odeon QRX 9016 (Italian EMI import).
- 2) Philadelphia Orchestra (1946). ML 4010 (OP).
- 3) Columbia Symphony (1958). ML 5284 or MS 6012 (stereo).

Here a miracle has happened twice. The Vienna edition was one of the greatest things in the prewar Beethoven catalogue, a performance with the atmosphere of the *Wienerwald* and the sense of unbroken song which the composer must have intended. When the Philadelphia set arrived it was welcome, but it never quite claimed the heart the way the earlier one did. Vienna was rediscovered in California. Walter was relaxed and happy, lifting the music into lyric radiance, and the fine stereo recording captured it all with remarkable beauty and presence.

Symphony No. 7, in A, Op. 92

- 1) New York Philharmonic (1951). ML 4414 (OP).
- 2) Columbia Symphony (1958). ML 5404 or MS 6082 (stereo).

This is the most overplayed symphony in the repertory, but the second Walter recording belongs in the select group of performances in which temptations to extravagance have been resisted for the sake of greater musical principles. The fault of the older version was excessive reserve—metrical regularity carried to the point where the music became stiff in its movement and expression had to be imposed by heavy rhetorical devices. There is a light, bright quality in the new set, flexibility in pulse, and—especially in the finale—a sense of motion that sweeps the listener along.

Symphony No. 8, in F, Op. 93

- 1) New York Philharmonic (1942). ML 2001 (OP).
- 2) Columbia Symphony (1958). M2L 264 or M2S 608 (stereo).

The original Walter edition was not well recorded, and the second easily takes the dominant role. This is another case where the conductor's aversion to repeats seems to lessen the force of an otherwise distinguished performance, but even so the recording has a lilt and lively Viennese quality rarely found.

Symphony No. 9, in D minor, Op. 125 ("Choral")

- 1) Irma Gonzalez, soprano; Elena Nikolaidi, mezzo; Raoul Jobin, tenor; Mack Harrell, baritone; Westminster Choir; New York Philharmonic (1949). SL 156 (OP).
- 2) Frances Yeend, soprano; Martha Lip-ton, mezzo; David Lloyd, tenor; Mack Harrell, baritone; Westminster Choir; New York Philharmonic (1953). ML 5200.
- 3) Emilia Cundari, soprano; Nell Rankin, mezzo; Albert Da Costa, tenor; William Wildermann, baritone; Westminster Choir; Columbia Symphony (1958). M2L 264 or M2S 608 (stereo).

It should be noted that this is really only two and a half recordings, since all that is new in the second version is the final movement. Taking the whole of the

material, one can secure a very clear idea of Walter's achievement with this score. I would select for this purpose the 1949 version of the first movement, which is much more intensely controlled than the later version and so builds to dramatic effects not duplicated in the broader and more relaxed statements of the stereo set. The 1949 scherzo is quite fast, almost demonic in character, in contrast to the slower and more orthodox pacing of the new version. This is obviously a matter of taste, but if you play the earlier performance first, the latter comes as something of a letdown. There is no doubt, however, that the slow movement is best in the stereo version and that two-channel engineering is essential for the full effect of the last movement. The soloists are of about equal caliber in all the sets (good, but not good enough). Pressed for a choice, I would take the 1953 version of the finale on musical grounds, but the later one is of a very high standard.

BERLIOZ

Symphonic fantastique, Op. 14

Orchestre de la Société des Concerts du Conservatoire de Paris (1939). RCA Camden CAL 281 (OP).

Walter became a Berlioz enthusiast while a conservatory student in Berlin, and his townsmen heard this symphony from him when he gave his first concert there in the 1900-01 season. If we exclude his first recording (an acoustic version of the *Carmen* preludes), Berlioz is the only French composer to figure in the Walter discography; and if we pass by acoustic versions of three short concert pieces, the symphony is the only real documentation of Walter's approach to his music. The recording is a good deal short of high fidelity, but it reveals that Walter's performance is one of great refinement. In his final year we talked of this set, and he confessed a great fondness for it. Most conductors of today, he felt, were overly tempted by the possibilities of the work as a showpiece, and their results became somewhat crude. Walter's moral example rates reissue in Angel's "Great Recordings" series.

BRAHMS

Academic Festival Overture, Op. 80

- 1) Vienna Philharmonic Orchestra (1937). RCA Camden CAL 242 (OP).
- 2) New York Philharmonic (1951). ML 5126.
- 3) Columbia Symphony (1960). ML 5761 or MS 6361 (stereo).

Columbia has issued a number of these Brahms performances in alternate couplings and, in this case particularly, there are minor variations among editions. The performance to have is the last one, for only here does Walter relax and let the *gemütlich* quality of the music dominate. (The others, in contrast, are hurried, and in the first the conductor seems to be racing the time limitations imposed by two 78-rpm surfaces.)

Rhapsodie, Op. 53 ("Alto Rhapsody")

Mildred Miller, mezzo; Occidental College Choir, Howard Swan, dir.; Columbia Symphony (1961). ML 5888 or MS 6488 (stereo).

For comment on this recording, see "Records in Review," page 72.



In Munich, 1913: full court uniform for an officer of the Royal household.

Concerto for Violin, Cello, and Orchestra, in A minor, Op. 102

- 1) Isaac Stern, violin; Leonard Rose, cello; New York Philharmonic (1954). ML 5076.
- 2) Zino Francescatti, violin; Pierre Fournier, cello; Columbia Symphony (1959). ML 5493 or MS 6158 (stereo).

Quite apart from the advantages stereo provides in a work with two solo instrumentalists, I find the second performance immeasurably superior to the first. Both Francescatti and Fournier are of a mind that the work must be kept tightly focused with a firm propulsive thrust and no rhapsodizing. I am in sympathy with the aims of the stereo soloists, and they are achieved through playing of exceptional elegance. Walter, in both instances, is a vigorous ally.

Hungarian Dances: No. 1, in G minor; No. 3, in F; No. 10, in F; No. 17, in F sharp minor

New York Philharmonic (1951). ML 5126.

Hearing these familiar works in performances of this distinction serves as a reminder of what we miss by not having all of them, plus the *Slavonic Dances* of Dvořák, in Walter recordings. (Of the Dvořák we have only a 78-rpm disc of the Op. 46, No. 1, long out of print.)

Schicksalslied, Op. 54 ("Song of Destiny")

- 1) Westminster Choir; New York Philharmonic (1941). SL 156 (OP).
- 2) Occidental College Choir, Howard Swan, dir.; Columbia Symphony (1961). ML 5888 or MS 6488 (stereo).

The advantages of stereo in recording a work for chorus and orchestra make the choice between these editions obvious in favor of the new set.

Symphony No. 1, in C minor, Op. 68

- 1) Vienna Philharmonic Orchestra (1937). RCA Victor M 470 (78 rpm, OP).
- 2) New York Philharmonic (1953). ML 5124.
- 3) Columbia Symphony (1959). ML 5789 or MS 6389 (stereo).

The Vienna recordings are unable to re-

produce the effect of Brahms's *tutti* passages, and for present-day listening I am inclined to dismiss them. Unfortunately, neither of the later sets, as a whole, can be taken to represent Walter's skill in this music. Both suffer from overdistant microphone placement in the scherzo. The advantages of stereo are most apparent in the slow movement, which is far more beautiful in the two-channel version than ever before, but stereo cannot wholly compensate for the superior drive and majesty of the two outer movements in the New York recording.

Symphony No. 2, in D, Op. 73

- 1) New York Philharmonic (1953). ML 5125.
- 2) Columbia Symphony (1960). ML 5573 or MS 6173 (stereo).

Here there is slight basis for argument. The New York version is not especially well recorded (there is far too much reverberation), and the performance is overly tense. The second time around, Walter relaxed and sang with a ravishing Viennese quality that makes this edition one of the greatest on records. Happily, the especially good recorded sound caps the triumph.

Symphony No. 3, in F, Op. 90

- 1) Vienna Philharmonic Orchestra (1936). RCA Victor M 341 (78 rpm, OP).
- 2) New York Philharmonic (1953). ML 5126.
- 3) Columbia Symphony (1960). ML 5574 or MS 6174 (stereo).

I once talked with Walter about his omission of the repeat in the first movement. He listened patiently to my argument about structure and form and the greater effect of the double exposition, making no protest as to its validity. "But," he explained with a helpless gesture, "I cannot bring myself to go back. When the movement has advanced so far, I feel compelled to go on rather than return to what I have just said." This probably explains his general aversion to the double bar, and though I respect his feelings, this is another case in which I think the performance would be stronger with the repeat included. The New York Philharmonic version has more vigor and drama than the other two, and I prefer it on those grounds. On the other hand, the broader, more relaxed performance of the stereo set is probably more characteristic of Walter's approach to this music, and it contains some beautiful playing, well reproduced in the two-channel format.

Symphony No. 4, in E minor, Op. 98

- 1) BBC Symphony (1934). RCA Camden CAL 246 (OP).
- 2) New York Philharmonic (1951). ML 5127.
- 3) Columbia Symphony (1959). ML 5439 or MS 6113 (stereo).

The BBC Symphony recording sounds as if it had been personally made by Thomas Edison. Only a dim echo of what was obviously a very fine performance comes through, but there is enough of the final movement to be heard to make clear the degree to which Walter later changed his interpretation of these pages. I am more in accord with his earlier views. Perhaps Angel's "Great Recordings of the Century" technicians could manage a finer transfer of this

material than Camden secured. The Philharmonic set is lyric drama throughout, while the final one stresses the autumnal cast of the music. Both performances are consistent in the development of their individual approach and effective on that account. If I had to pick one of the three, it would be the Philharmonic set.

Tragic Overture, Op. 81

- 1) New York Philharmonic (1953). ML 5232.
- 2) Columbia Symphony (1960). ML 5573 or MS 6173 (stereo).

These are two quite different performances. The Philharmonic version is a heroic drama that marches resolutely to its denouement. The later edition is more introspective in mood and flexible in tempo, a drama of thought rather than action, and to my mind a less forceful work than that demonstrated before.

Variations on a Theme of Haydn, Op. 56a

- 1) New York Philharmonic (1953). ML 5076.
- 2) Columbia Symphony (1960). ML 5574 or MS 6174 (stereo).

Walter's first version is a good one, but hardly different from that of many another gifted conductor. The second is a far more distinctive performance, with delicate and unusual colorings, delightful and sometimes unexpected turns of phrase, and the unmistakable signs of a distinguished musician at work and play.

BRUCKNER

Symphony No. 4, in E flat ("Romantic")

- Columbia Symphony (1960). M2L 273 or M2S 622 (stereo).

Few performances of this music make sense of the descriptive title. Walter's does. As you get to know the score, you may prefer a more rugged account of it than this; but for those not yet convinced of Bruckner's stature, the Walter approach is probably the more persuasive. The recorded sound is spectacular.

Symphony No. 7, in E

- Columbia Symphony (1961). M2L 290 or M2S 690 (stereo).

For comment on this recording, see "Records in Review," page 72.

Symphony No. 9, in D minor

- Columbia Symphony (1959). ML 5571 or MS 6171 (stereo).

I do not think that Walter's success here is as great as that in the Fourth, but this is an important recording nonetheless and contains a great deal of very beautiful and expressive playing.

Te Deum

Frances Yeend, soprano; Martha Lipton, mezzo; David Lloyd, tenor; Mack Harrell, baritone; Westminster Choir; New York Philharmonic (1953). ML 4980.

"*Te deum laudamus*, the same what the birds sing every morning . . ." was Walter's description of this music in his recorded interview with Arnold Michaelis. This is the weakest of the Bruckner recordings, chiefly because it is the weakest of the scores, but also because of the obvious inadequacies of monophony in music of this complexity.

CORELLI

Concerto grosso No. 8, in G minor Op. 6 ("Christmas")

- London Symphony Orchestra (1938). RCA Victor M 600 (78 rpm, OP).

Music of the baroque is poorly represented in the Walter discography, the total absence of Bach being the most obvious omission. This Corelli set and a Handel concerto grosso (Op. 6, No. 12, made the following year in Paris) serve to remind us that Walter played music of this period with distinction and made use of a harpsichord continuo long before it became a matter of fashion to do so. A microgroove reissue of this lovely concerto from Angel would be welcome to many listeners.

DVORAK

Symphony No. 4, in G, Op. 88

- 1) New York Philharmonic (1947). ML 4119.
- 2) Columbia Symphony (1961). ML 5761 or MS 6361 (stereo).

No other conductor has ever given me the sense of complete fulfillment which I have found in Walter's reading of this score. The differences between the two performances are slight, and the lyric glory of the earlier version is all the more apparent in the second set, where stereo adds a further dimension. Most listeners will choose the new edition for that reason, and justly, but the New York performance is a little more tightly focused and thus gains effect in certain passages. Both editions are, however, distinguished additions to the Dvořák repertoire on discs.

Symphony No. 5, in E minor, Op. 95 ("From the New World")

- Columbia Symphony (1959). ML 5384 or MS 6066 (stereo).

This recording and Toscanini's are the two most satisfactory I know of this greatly overplayed work. Walter's has a freshness that testifies to his intention of playing everything as if for the first time. There is a sense of Bohemian song and Bohemian humor here that are quite lacking in the Toscanini, and I surmise that the Walter performance is probably closer to what the composer had in mind. This is one of the Columbia Symphony sets in which it is wise to use an un-

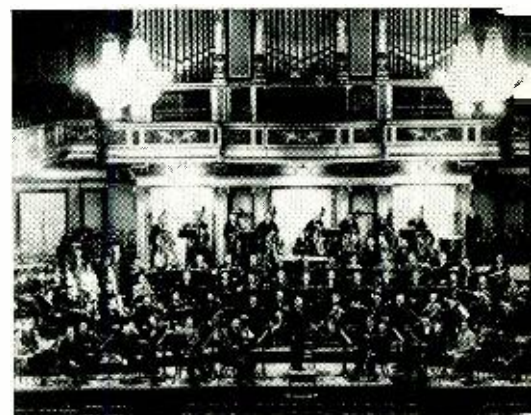

On stage at the Musikvereinsaal with the Vienna Philharmonic.

orthodox equalization curve and bring up the lower frequencies.

HAYDN

Symphony No. 86, in D
London Symphony Orchestra (1938).
RCA Victor M 578 (78 rpm, OP).

Symphony No. 88, in G
Columbia Symphony (1961). ML 5886
or MS 6486 (stereo).

Symphony No. 92, in G ("Oxford")
Orchestre de la Société des Concerts du
Conservatoire de Paris (1939). RCA
Camden CAL 257 (OP).

Symphony No. 96, in D ("Miracle")
1) Vienna Philharmonic Orchestra
(1937). RCA Victor LCT 6015 (OP).
2) New York Philharmonic (1954). ML
5059.

Symphony No. 100, in G ("Military")
1) Vienna Philharmonic Orchestra
(1937). RCA Camden CAL 257 (OP).
2) Columbia Symphony (1961). ML
5886 or MS 6486 (stereo).

Symphony No. 102, in B flat
New York Philharmonic (1953). ML
5059.

Discussion of Nos. 88 and 100 appears in the record review section elsewhere in this issue. Suffice it to say that the old *Military* betrays great age and hence is no rival for the new. Sensitivity and elegance are the primary features of Walter's Haydn, and these qualities are so conspicuously dominant throughout these performances that individual evaluations are not necessary. In Vienna, Walter's desires and the traditions of the orchestra could produce felicities in the old version of No. 96 that are not entirely duplicated in the New York performance, although it remains a good one. But it was in New York that Walter gave us one of his supreme achievements in the United States, No. 102, in a statement that is no mere show of ensemble finesse but gets to the heart of the humor and nobility marking one of Haydn's greatest scores. The two supreme triumphs of the European series are Nos. 86 and 92. Neither has ever been recorded with greater comprehension.

MAHLER

Kindertotenlieder
Kathleen Ferrier, contralto; Vienna Philharmonic Orchestra (1949). ML 4980.

This, more than *Das Lied von der Erde*, appears to me as the supreme collaboration between these two artists. It is, indeed, one of the greatest vocal records ever made, and a cornerstone of even a modest collection of music from the present century.

Lieder und Gesänge aus der Jugendzeit:
Ablösung im Sommer; Erinnerung;
Frühlingmorgen; Hans und Grete; Ich
ging mit Lust durch einen grünen
Wald; Nicht Wiedersehen; Scheiden
und Meiden; Starke Einbildungskraft
Desi Halban, soprano; Bruno Walter, piano (1947). SL 171.

None of these ranks among the most important Mahler songs, but several of

them are pleasant examples of his lighter, more romantic vein and of his taste for humor. They illuminate a side of the composer often overlooked, and the performances give us a last glimpse of Walter at the keyboard—this time as the mentor of a young soprano whose goal is to realize his interpretative desires.

Lieder eines fahrenden Gesellen
Mildred Miller, mezzo; Columbia Symphony (1960). ML 5888 or MS 6488 (stereo).

The vocal demands of these songs are quite extraordinary, and Miss Miller meets them with a thoroughly sensitive and musical performance. Walter's accompaniment is the best statement of the instrumental portion of the work to be heard on records.

Lieder von Rückert: Ich atmet' einen
linden Duft; Ich bin der Welt abhand-
den gekommen; Um Mitternacht
Kathleen Ferrier, contralto; Vienna Philharmonic Orchestra (1952). London 4212.

Ich bin der Welt abhanden gekommen
Kerstin Thorborg, contralto; Vienna Philharmonic Orchestra (1936). 4201 (78 rpm, OP).

These are all historic recordings, ranking among the best ever given us by three great artists. The impact of Ferrier's singing in *Um Mitternacht* is especially intense, but it is only one of several triumphant achievements here, with the Thorborg ten-inch 78 rpm not to be slighted among them. It certainly deserves reissue along with the 1936 *Lied von der Erde*.

Das Lied von der Erde
1) Kerstin Thorborg, contralto; Charles Kullman, tenor; Vienna Philharmonic Orchestra (1936). M 300 (78 rpm, OP).
2) Kathleen Ferrier, contralto; Julius Patzak, tenor; Vienna Philharmonic Orchestra (1952). London 4212.
3) Mildred Miller, mezzo; Ernst Häfliger, tenor; New York Philharmonic (1960). ML 5826 or MS 6426 (stereo).

All three performances are remarkable musically, while engineering techniques advance to the vivid stereo effects of the final version. The original recording—made at an actual performance—does no more than suggest the instrumental lines, but the singers are incomparable. Their contribution is more than acceptably reproduced, and it attains such a level as to make up for shortcomings elsewhere. A historic performance deserving of reissue. Ferrier is the principal asset of the second version, and hers is a noble performance. Still, I think that there is a tendency to allow extramusical considerations to make one sentimental about it, particularly to the disadvantage of Miss Miller, whose approach—less declamatory than Ferrier's—is also very moving. If I were to have only one edition of this music, I would choose the newer Columbia.

Symphony No. 1, in D ("Titan")
1) New York Philharmonic (1954). ML 4958.
2) Columbia Symphony (1961). ML 5794 or MS 6394 (stereo).

We have Walter recordings of five Mahler symphonies, and all are precious documents of the composer and his

closest disciple. It must be appreciated that Walter recorded only those Mahler scores which he played in concert, the ones which he regarded as the most fully realized of his great friend's artistic efforts. Thus he never performed the Tenth, because it was unfinished, and he apparently set aside the Third as an inconclusive effort towards the goal achieved in the Fourth. Similarly, he felt the Sixth, Seventh, and Eighth to be less than complete realizations of Mahler's genius, steppingstones leading up to his final testament: the Ninth. The First is a very Austrian symphony, and this is the quality uppermost in both of Walter's recordings. The earlier of the two no longer merits much attention, since the stereo is better in every way. I doubt if we shall ever hear a more completely sympathetic (or authoritative) recreation of this music.

Symphony No. 2, in C minor ("Resurrection")
Emilia Cundari, soprano; Maureen Forrester, contralto; Westminster Choir; New York Philharmonic (1957). M2L 256 or M2S 601 (stereo).

Even with stereo the full sonic scope of this score is attenuated, but the performance remains a landmark. This is the symphony in which the influence of Bruckner is most apparent, and I feel that Walter brings this out much more clearly than other conductors. Early Mahler and late Mahler are not the same. This is how early Mahler ought to go if the genius is to show.

Symphony No. 4, in G
Desi Halban, soprano; New York Philharmonic (1945). ML 4031.

This was, amazingly enough, the first recording of a symphony that is now a standard item in concerts and on recording schedules. For many music lovers it provided the first opportunity to become familiar with one of Mahler's finest achievements. Indeed, much of the present popularity of the work must be attributed to this set. The long-play transfer is a very fine one, and there is plenty to hear and cherish. If I could have only one Mahler Fourth on the shelf, this would still be it.

Symphony No. 5, in C sharp minor
New York Philharmonic (1947). SL 171.

The last time I talked with Walter, he was looking forward to making a stereo version of this symphony and showed me the final, revised score—with red-inked amendments in Mahler's own hand—which was to be the basis of the orchestral material. We were denied that recording, but in its current pressings the older version is quite good enough to prove that this is the most unjustly neglected of all the Mahler symphonies. The Adagietto gets extracted for concert purposes, but the entire score is worth knowing.

Symphony No. 9, in D minor
1) Vienna Philharmonic Orchestra (1938). RCA Victor LCT 6015 (OP).
2) Columbia Symphony (1961). M2L 276 or M2S 676 (stereo).

The Vienna set was made just a few

Continued on page 102

Thrust **DUST** and Friction

A short primer on record wear and its prevention.

THANKS TO the general excellence of today's records and playback equipment, the longevity of discs has been considerably increased: properly handled and stored, and played with correctly installed and adjusted equipment, they can continue to offer clean and faithful reproduction for many years. But to forestall the premature demise of disc recordings takes some understanding and effort.

Record wear, it is generally conceded, stems from two main causes: the very playing of the record, and the way in which it is handled and stored. The former involves a complexity of factors which specialists in the field are only beginning to understand and over which the user has limited control. The latter cause of attrition is more fully documented—chiefly in terms of the damage resulting from dirt and improper storage—and is much more susceptible to control by the user.

To examine the "playback problem" first: while most experts allow that there is a relationship between record wear and such factors as stylus size, vertical tracking force, cartridge compliance, and tone arm design, there is little agreement as to just what the relationship is in specific terms. Research continues, but so far no single claim or formula for reducing disc wear under a variety of playback conditions has been substantiated. But until further evidence is forthcoming, certain important general points can be made.

Inevitably, a record is subject to some wear when it is played. The stylus perforce sets up friction between itself and the walls of the record groove, and at the same time it exerts weight and pressure against those walls. The friction can become a source of long-term "smoothing," wearing away both the modulations in the groove and the stylus itself (not unlike the action of sandpaper on wood). The weight and pressure comprise a dynamic thrust that can gouge or deform part of the groove wall (as a chisel exercised on wood). These deformations, in turn, set up a vicious cycle: once a stylus tip develops a flat, it begins to grind and cut even more severely, thus producing additional and more intense groove deformations that will in turn rub more harshly on the

stylus. Similarly, a really bad gouge in a portion of the groove wall presents an obstacle to the stylus, which then reacts by flexing out of its correct alignment with respect to the cartridge body or by developing another flat, or both—and record wear and audible distortion are increased.

According to recent research done at the Royal Technical College in Salford, England, the principal effect of groove deformation is to indent into the groove a new set of wiggles representing harmonic distortion of the recorded waveform. This distortion can be expected to be as high as five per cent with the best of current pickups, and can exceed fifty per cent with poor pickups, or with improper adjustment of any pickup. One consoling feature is that practically all of the damage is done in the very first playing of such a record; subsequent playings do little additional harm and may even smooth out some of the initial damage.

At the 5- to 8-gram pressures required with most monophonic pickups a few years ago, a sapphire stylus would develop damaging flats in as few as fifty playings, and a diamond in several hundred. The only solution was to change the stylus, but even this did not eliminate all wear, for at these pressures the new, smooth stylus too would eventually wear the groove down.

Reducing the pressure of the pickup would seem, then, to be the logical way to reduce wear caused by rubbing. At pressures of 2 grams or less, rubbing wear on both the stylus and the groove becomes so nominal that, barring other causes of wear, both styli and records should have a virtually unlimited life. This will be true, however, only if the pickup is *tracking properly* at these low pressures. While reducing the pressure of a pickup that is itself designed for a higher pressure—for instance, using a tracking force of 2 grams for a pickup designed to track at 5 grams—may well lessen wear due to rubbing, it may cause far greater damage to the record by increasing the deformation of the groove through its dynamic thrust. Furthermore, some pickups simply won't track at very low pressures and will skip across the groove walls. For these reasons, operation at low



Among inexpensive cleaning items are applicator-and-detergent kits, "jockey cloth," dry brushes for clipping to a tone arm, and brushes for cleaning only the stylus.

pressures requires pickups and arms specifically designed for low pressures. Most of today's high compliance pickups and carefully balanced tone arms—available as separate components for use with manual turntables and in such improved automatic players as the Dual 1009, the Garrard Type A, and the Miracord—do permit tracking at pressures of 2 grams or less, and to minimize record wear due to friction the serious collector may wish to replace older equipment with more advanced types.

YET THE PROBLEM of damage through stylus thrust remains, and, ironically, it may be intensified if the equipment is not adjusted properly. Just as any sharp pointed instrument will indent a surface as it is pulled along under pressure, a stylus tends to act in a similar manner on a record groove as it traces. And in a modulated groove—where the stylus is vibrating from side to side at rates up to 15,000 times a second—the pickup can become a sort of jackhammer capable of doing considerable damage to the sides of the groove with its blows.

Because the behavior of a stylus moving in a modulated groove involves many factors, it has been difficult to obtain conclusive data on groove deformation through stylus thrust. The British researchers have been using an ingenious process of obtaining carbon film replicas of the groove and then examining these under electron microscopes at magnifications ranging from 5,000 to 50,000 diameters. An early indication from these studies is that the deformation—if the groove is not modulated—is proportional both to pressure and to stylus diameter. The smaller the stylus and the higher the pressure, the greater the deformation. Or to put it another way, reducing stylus pressure reduces deformation but

reducing stylus size increases deformation. Thus, if stylus size is reduced, stylus pressure must be reduced correspondingly. This is essential to the playing of stereo discs, which require a stylus no bigger than 0.7 mil. With a stylus of 0.7 mil, deformation becomes insignificant with pressures below 2 grams. With a 0.5-mil stylus, pressure should be reduced to 1.5 grams; and the use of a 0.3-mil stylus calls for pressure of 1 gram or less.

These figures, of course, apply to static deformation—that is, with reference to an unmodulated groove. With a modulated groove, things are less clear. It has been found that there is a limit to the reduction of stylus force. At too low a pressure the stylus no longer can maintain firm contact with the groove, especially during high level peaks. The result is an increase in audible distortion and probably in the damage done by the dynamic deformation—that "jackhammer" action of the vibrating stylus. Other, more complicated, factors are involved here too. One of the most important is the mass of the stylus tip. Just as a heavier hammer will drive a nail farther in a given number of blows of the same length, so a stylus with high tip-mass will do more damage than one with low tip-mass. Thus, it would seem that the smaller stylus which permits lower tip-mass would have a clear advantage.

On the other hand, the smaller stylus does not fit the groove as snugly; as a result, the play between stylus and groove walls in effect increases the length of the stroke at which the hammering action takes place. What's more, the smaller tip size gives the stylus a sharper point, which may increase the damage it can do. Finally, it must operate at lower pressure to keep down the static deformation but—because of this low pressure—a high velocity modulation tends to throw it out of the groove. Hence the

larger stylus has an advantage in these respects. The elliptical stylus (0.7 mil by 0.3 mil) recently introduced by Ortofon is designed to serve as an "ideal compromise." Its width is intended to permit it to maintain firm contact with more of the groove; its narrow depth is designed to follow very small high frequency indentations as faithfully as does the small round stylus.

In truth, there is so far no clear-cut solution to the problem posed by "larger" versus "smaller" stylus tips. Most recent products represent an optimum design in one direction or the other, with the determining factor being the actual performance of the pickup, or pickup-arm combination, as evaluated by measurements and listening tests. The present range, among pickups acceptable for stereophonic high fidelity reproduction, runs from perhaps just over 2 grams to below 1 gram, with stylus sizes correspondingly from the early 0.7 mil to recent models of 0.5 mil and smaller.

Whatever the pickup and the size of the stylus, the owner should remember that the lowest stylus pressure permitting undistorted playback of the highest amplitude on the record will probably result in the least deformation of the groove. On some records, with some pickups, pressures as low as ¼ gram may be sufficient; on other records, pressures as high as 2 grams may be needed with the very same pickup. Of course, few listeners will want to change stylus pressure for every recording, and for that matter few tone arms permit this adjustment to be made so easily that it can be repeated at frequent intervals. Most people will simply set a pressure suitable for use with most of their recordings.

My own procedure is to adjust a new pickup for the point at which the "buzz" on the loudest groove of a test record (any of several are suitable: see HIGH FIDELITY, December 1963, page 48) just disappears. I find that even with pickups of the very highest compliance and lowest tip-mass this results in a pressure between 1 and 1.5 grams—which I have found will provide good tracing on at least

ninety per cent of all monophonic and stereo records. Pickups not of the highest compliance or lowest tip-mass probably will require something closer to 2 grams—which still is on the safe side to avoid undue record wear. With these pressures, my own records, played hundreds of times over a period of years, still seem to deliver clean sound.

AT ALL EVENTS, the most serious threat to record life is dust, dirt, and grime. A stylus tracking at forces as low as 1 or 2 grams may itself be incapable of eroding a record significantly; but once it starts to push or drag an accumulation of dirt through the groove, it becomes—like the block of wood to which sandpaper is attached—an innocent instrument of erosion. Additionally, pickups operating at pressures in the 1-gram region—particularly those with small diameter styli—are extremely sensitive to foreign matter in the groove. Since they can respond to motions of only a few millionths of an inch, they will produce a loud "pop" on encountering a minute speck of dust. And, as the dust accumulates around the stylus, it lifts it out of contact with the groove. Consequently, keeping the disc and stylus clean of dust and grime has become even more important today than ever.

The oldest and simplest way to clean, or rather preen, a new record (or any record before playing it) is to wipe its surface with a moistened very soft cloth, piece of chamois or velvet pile, or very soft brush. In addition to these common household objects, there are also a number of inexpensive items commercially available.

One of these is the "jockey cloth"—a pad of chamoislike cloth impregnated with silicone dressing. Such cloths are easy to use and do an excellent job of picking up lint and dust and of destaticizing the record to render it less apt to attract dust. They do, however, have certain disadvantages. In the first place, not only do they pick up dust and grime but they also hold it firmly. Thus, once the cloth has

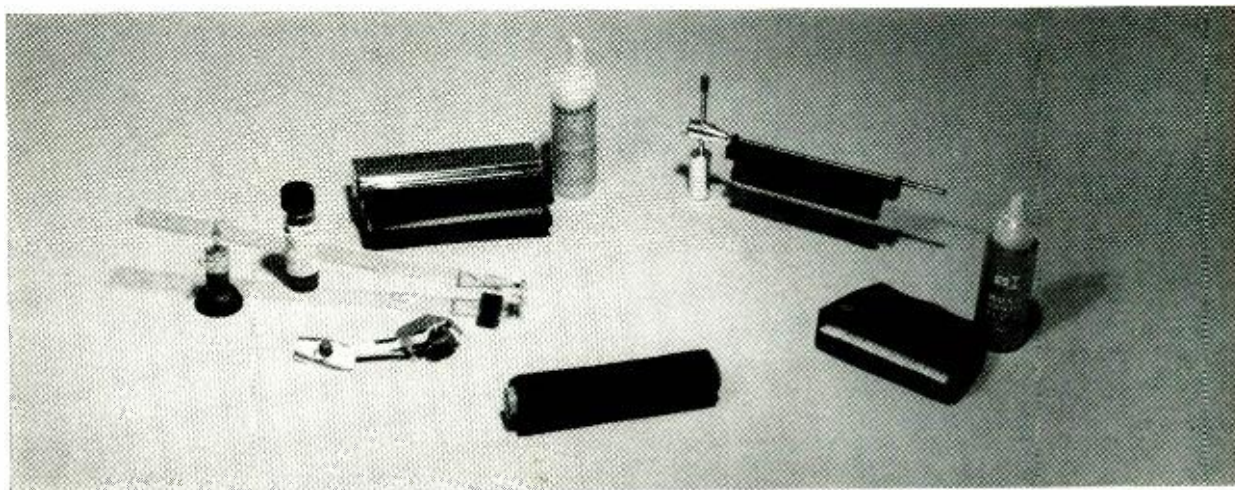

Newest devices include dust bugs in manual and changer versions, shown with Parastat above and Preener below. Upper right, Grado's Dustat; lower right, ADC Hush Brush.

accumulated dust, it may itself become a new source of record damage and must be replaced fairly often. Secondly, silicone is a type of grease. Some of it is transferred from the cloth to the groove, where it may push dust deeper into the groove and clog the finer wiggles. When this mixture of dust and grease is plowed up by the stylus, it acts as a sort of grinding compound. In general, the simple cloths are satisfactory for use on records played with the larger-size styli at pressures above 3 grams—which is to say, for service in monophonic systems—but they are less desirable for the lower pressures and smaller styli used in stereo.

More effective is a piece of velvet or mohair pile, or a brush whose bristles penetrate the grooves. One of the oldest of such record cleaners is the Lektrostat combination of a pad of sheared acetate velvet and an aqueous detergent solution. The pad is moistened with a few drops of the solution and the record is wiped, in a circular fashion, a few times. A stylus brush is included; similar kits are offered by several companies, including Audiotex, Beyland, Duotone, Lafayette, and Robins.

Cecil Watts—British engineer and writer—has been particularly concerned with record cleaning and has introduced several devices marketed here by Elpa. His most recent is the "Parastat"—a roller of very soft velvet pile which is kept slightly impregnated with a diluted detergent solution through an inner wick. The roller is pressed gently to the surface of the record as it revolves on the turntable for a revolution or two, picking up dust and at the same time applying a very thin film of the liquid.

The ADC Hush Brush is a somewhat more complicated device, employing a brush of sharply pointed nylon bristles and a velvet roller which is moistened by a liquid contained in the handle. As it is held on the record for a revolution or two, the brush sweeps the dust out of the groove and the roller picks it up and at the same time applies a film of the liquid. A two-sided brush that cleans both sides of a record at once and leaves a thin anti-static coating on them has been introduced by Corey of California.

Devices of this kind cover the entire radius of the record at once. Doing much the same job over a smaller part of the record (and thus necessitating its being used continuously during play) is Cecil Watts's famous Dust Bug. This is a velvet roller attached to a stand which is in turn fastened to the turntable base. The roller sweeps the grooves as it moves inward ahead of the stylus. It is also moistened occasionally with an antistatic and cleaning solution. Variants of the Dust Bug have now been put on the market by other manufacturers.

An alternate to the moistened brush is a dry brush which preens rather than cleans, and is effective for new records. A wide, soft, artist's brush can be used for this purpose, and there are also available several wide brushes fixed on stands to be attached to the turntable base; these sweep the record continuously as it revolves. One such is the brush

manufactured by Precision Manufacturing Company of Aurora, Indiana. Another is the Grado Dustat, similar in principle but using a fold of very soft velvet instead of a brush. Either the Elpa Parastat, or its simpler variant, the Preener, also may be used dry for this purpose.

The above devices—wet or dry—cannot very conveniently be used with changers because no one has yet devised one that will move aside during the change cycle. There is, however, a changer version of the Dust Bug as well as several dry brushes which can be clipped to the tone arm of a changer to sweep the groove during play, such as those offered by Audiotex, Duotone, Robins, and White Lion. These are quite satisfactory at tracking pressures between 3 and 5 grams, but not suitable for use in the most recent independent tone arms or at pressures below 3 grams with any tone arm. It is extremely difficult to adjust the pressure to allow for the stiffness of the brush—and even then the pressure tends to vary. Certainly, none of these brushes should be attached to any arm operating at 2 grams or less, unless one has the means and the considerable skill required to adjust the pressure so that the stylus itself is under proper pressure. This procedure usually requires a special type of pressure gauge, since the inexpensive balance-type suitable for most purposes does not do the job adequately.

Despite all measures to keep the record clean, the stylus itself will accumulate dust and grime and thus require periodic cleaning. The simplest and best procedure is to brush the tip of the stylus with a very soft brush every time a record has been played. An artist's small camel's-hair brush will do; but there are special brushes for this purpose, the most elegant of which is the fountain pen type such as the Duotone. The "lipstick" type of brush for cleaning camera lenses, obtainable at any camera store, is also very convenient and safe.

The stylus used in a record changer—which may run for hours without interruption—may accumulate dust and require cleaning while playing. A good substitute for hand brushing is a little brush that is fastened to the changer base in such a way that the arm, as it returns to its rest, pushes the stylus through the bristles. Suitable models are made by Audiotex, Duotone, Prosound, and Robins.

Several types of solvents and fluids are used for application to rollers, pads, or cloths to provide cleansing action and to neutralize the electrostatic charge which tends to build up on records. These can be divided into alcohols, glycols, detergents, and silicones. Alcohol in dilution with water of about the same proportion as in the standard drugstore "rubbing alcohol" appears to have no adverse chemical effect, is a good solvent, and leaves no residue. Ethylene glycol, most familiar to us as a type of automobile antifreeze, is also a good solvent with no apparent chemical effect and leaving little residue. It is used in the Dust Bug and Hush Brush. A solution of detergent in water is also an excellent solvent that has no

Continued on page 110

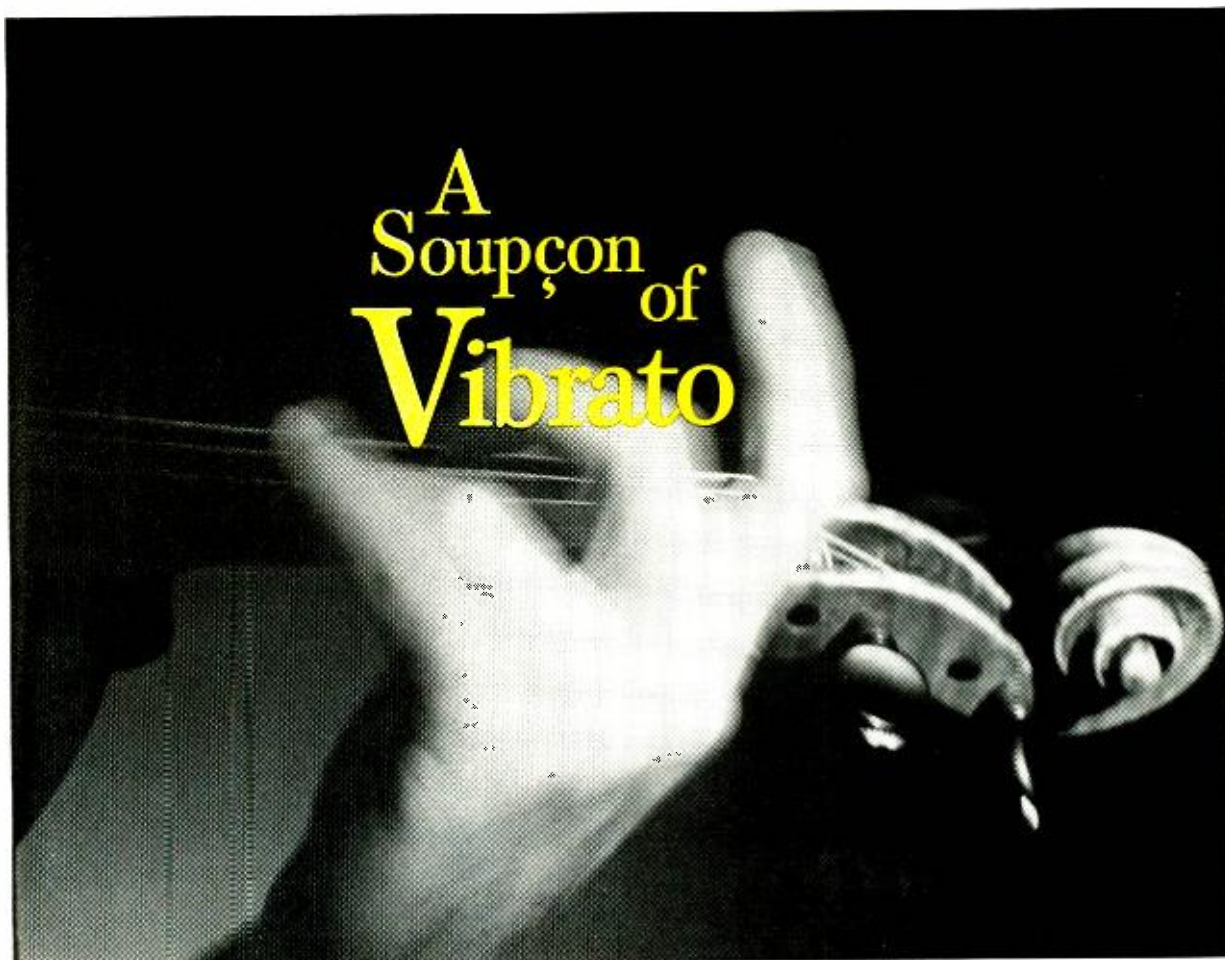

Between execrable and exquisite there's a delicate dividing line.

By Denis Stevens

“SHE’S NO GOOD,” said the a & r man, with that martyred look that comes so naturally to the species. “We’ll just have to find somebody else. She has a vibrato you could hang your hat on.” By which he meant to say, ungallant or no, that permanent waves in woman’s crowning glory are one matter: permanent wobbles in her voice, quite another.

The issue has been setting up critical vibrations for centuries. William Prynne, who had little use for music and none at all for singers, at any rate in ecclesiastical music, seized upon a diatribe penned by the twelfth-century Bishop Aelred to give us what is surely one of the earliest descriptions of the vocal disease or ornament called variously vibrato, trillo, tremolo, wobble, and judder: “The voyce is enforced into a horse’s neighings—writhed, and retorted with a certaine artificiall circumvolution.” In the 1920s a research team at the University of Iowa, under the direction of Carl Seashore (then Head of the Department of Psychology), launched a full-scale scien-

tific investigation of these “horse’s neighings” and published the results in a chart-packed volume of nearly four hundred pages. The phenomenon was examined under every conceivable light—physical, aesthetic, psychological, historical, and many more. Vibratos of singers, wind instrumentalists, violinists, were photographed and measured and studied. Amateurs, professionals, white men, colored men, old people, children—all passed before the tribunal at some stage or other, and vibratos calculated to decimal places resembled stock exchange ticker tape gone crazy.

Or perhaps not quite so crazy. Seashore and his associates discovered several truths and disposed of numerous fables relating to their strange subject. One was that a person possessing (or possessed by) a vibrato often did not know of its existence. Another stemmed from a group of intelligent and conscientious musicians who, on hearing the selfsame voice and vibrato, could not agree on the physical

A Soupçon of Vibrato



extent of the fluctuation, and even failed to distinguish between a change in pitch and series of changes in intensity. For vibrato is a complex attribute: in essence a variation in pitch, sometimes less than a semitone, sometimes more than a tone, it is also a series of variations in intensity, and both pitch and intensity are measurable. One of the most remarkable discoveries made was that the broad average of vibratos per second in fully developed voices was seven, a figure common also in wind and string vibratos. Natural or induced vibrations of the body also turned up the figure seven, that magical prime number beloved of witches and itches alike.

The conclusion drawn from these investigations was that vibrato is an undeniably common feature of artistic voice production, welling up from deep-seated emotional sources and allied to quintessential physical causes. Far from being despised, it should be welcomed with open ears. Moreover, distinction should be made between natural vibrato, capable of coloring and enriching a voice (provided the voice is worth listening to in the first place), and the tremolo or bleatlike sound which so often masquerades as its better half. Here, of course, terminology raises its tiresome head, for tremolo has for years been used in a nonpejorative sense to describe a rapid and deliberate alternation of two notes (any interval) in instrumental writing, also a rapid and deliberate to-and-fro motion of a string player's bow on the strings. In connection with a singer, however, referring to a tremolo can be tantamount to hurling an insult.

A trill is also recognized as a rapid alternation of two notes, either a semitone or a tone apart; and although instrumentalists usually have no difficulty in cultivating a good trill, vocalists may never capture it as long as they live. Terminology again: Caccini, in his *Nuove musiche* (Florence, 1602) calls our trill a "gruppo," and he describes and notates

a form of cadential ornament, closely resembling a highly sophisticated vibrato, under the name of "trillo." He even claims that this desirable addition to the vocalist's talents can be easily taught, citing the lady members of his own family, who acquired it in a matter of a week or two. If Caccini's boast resembles the Renaissance equivalent of those famous musical advertisements ("they laughed when I sat down to vibrate, but after two minutes . . ."), we must at least grant him credit for formulating its artistic use, and so confound the critics who blamed the tenor Giovanni Battista Rubini (1795-1854) for the "invention" of vibrato.

THERE ARE NO RECORDS of Rubini, not even a wax cylinder. But one who heard him managed to convey something of the nature of his vocal quality: "Rubini's voice, small in the beginning, developed marvelously in tone volume, and the swell and diminish of notes (*messa di voce*), called by Italians 'vibrato of the voice,' was characteristic of his style. This ebbing and flowing undulating wave of sound upon sustained notes was the source from which spring the modern tremolo and vibrato, which is so much in evidence among singers, and so offensive to all of really refined musical taste." This tendency to link crescendo and decrescendo with vibrato appears at first a case of mistaken identity. It has been proved, however, that vibrato almost disappears in very quiet singing, whereas in *fortissimo* passages a normal vibrato speed will increase its number of pulses, due to the air pressure on the vocal cords. Rubini was of course an exponent of *bel canto*; some modern tenors whose range of dynamics rarely passes below a healthy *forte* might suitably be referred to as exponents of "can belto." The size of the vibrato is sometimes in inverse proportion to the square root of brain size divided by extent of taste.

A century before Rubini's heyday, the violinist Geminiani gave a do-it-yourself account of vibrato (which he called "close shake") in his *Art of Playing on the Violin*: "To perform it, you must press the Finger strongly upon the String of the Instrument, and move the Wrist in and out slowly and equally, when it is long continued, swelling the Sound by Degrees, drawing the Bow nearer to the Bridge, and ending it very strong it may express Majesty, Dignity, etc. But making it shorter, lower, and softer, it may denote Affliction, Fear, etc. and when it is made on short Notes, it only contributes to make their Sound more agreeable and for this Reason it should be made use of as often as possible." Once again, vibrato is associated with crescendo; but even more important and indicative of modern trends is the statement that vibrato should be used frequently. The German school of violinists in the nineteenth century disagreed with this warm, sunny Italian disposition. Spohr advised extreme caution in its employment, and Joachim hardly ever used it at all. The great Russian teacher Leopold Auer said: "Only the most sparing use of the vibrato is desirable; the too

generous employment of the device defeats the purpose for which you use it. The excessive vibrato is a habit for which I have no tolerance, and I always fight against it when I observe it in my pupils—though often, I must admit, without success.” Naughty Heifetz, naughty Zimbalist, naughty Elman.

The change of fashion came in Germany and Austria with Kreisler’s rise to fame. His vibrato was well controlled, all-pervasive, musical, and lively. Carl Flesch summed up the Kreisler revolution in one cogent sentence: “He uses but little of the bow, strong pressure, and a continuous, most intensive vibrato (even during runs) when he plays, and with these most individual means achieves the highest measure of musical expression.” The sensuous French have been vibrato-conscious for centuries. As early as 1636, Marin Mersenne extolled the violin vibrato in his *Harmonie Universelle*: “The strokes of its bow are sometimes so ravishing that one can think of no greater dissatisfaction than to hear the end of them, especially when they are mingled with quiverings and gentle motions of the left hand, which constrain listeners to admit that the violin is the king of instruments.”

Alas, the gentle motions have on occasion given way to a highly charged, chromium-plated, twentieth-century tonal alternator. Sometimes we hear nothing but the ubiquitous vibrato permeating quicks, slows, louds, softs, passionates, lyricals, cools, and hots. One remembers the lunatic banging his head continuously against the wall because it felt so good when he stopped. But do these vibratoists ever leave off? Achille Rivarde, a New Yorker who became one of the Paris Conservatoire’s most brilliant students, wrote one of the wisest bits of advice any string player could adopt: “Never be dependent on vibrato for expression. Practice usually without it, and remember that the most wonderful effect of contrast can be made by avoiding it altogether.”

BUT DID Rivarde mean the “*non vibrato*” contrast of timbre asked for by Bartók in his string quartets and violin music, and by other moderns conscious of the emotional impact of tonal subtleties? Or did he mean the judicious use of “white” notes within a phrase, so beautifully exploited by such performers as Milstein, Szeryng, and Oistrakh? To hear these artists play a sonata or a concerto, to listen to their calculated or instinctive use of vibrato, is worth a dozen lessons in interpretation. Usually they color a cantilena by developing vibrato on harmonically or structurally important notes: the less important ones (passing-notes or auxiliary notes) are left white, the better to point up whatever melodic line is being dealt with. The slow movement of Milstein’s Mendelssohn Concerto (Angel 35730 or S 35730), Szeryng’s *Symphonie espagnole* passim (RCA Victor LM 2456, or LSC 2456), the lyrical passages in Prokofiev’s Violin Concerto No. 2 as played by Oistrakh (Angel 35714 or S 35714), all are sonorous embodiments of Rivarde’s contrast maxim. You can see it in

action, as well as hear it, when great cellists play in public. Their left-hand vibrato movements are more easily visible than those of violinists, and so it is that Rostropovitch’s Schumann (DGG 18674 or 138674) and Starker’s Dvořák (Mercury 50303 or 90303) enable the keen-eared listener to picture the soloist at work, making the very most of his tonal palette and musical sensitivity.

The finest singers today undoubtedly achieve some of their most memorable vocal effects by a subtle control of vibrato, and so of color and emotion. Two names that spring to mind at once are those of Victoria de los Angeles and Dietrich Fischer-Dieskau. Their voices would be immediately recognized among hundreds, even hundreds of years hence, and their repertoires range far beyond those of other singers only slightly less great. De los Angeles sings songs of all kinds to perfection: German Lieder, French *mélodies*, Spanish *villancicos*, and she ranges happily over six or seven centuries. At the other extreme is her high competence in opera, shared by Fischer-Dieskau, who is probably the greatest Lieder singer today—and no stranger to the French repertoire, as shown by DGG 18615 or 138615—as well as a highly sensitive interpreter of Heinrich Schütz. To cover successfully such a wide repertoire, the artist needs a thousand different shades of vocal timbre. Intelligent control of vibrato can and does contribute a great deal to interpretation, underlining the meaning of a word, the significance of a phrase, the finality of a cadence. Nowhere can this be heard to greater effect than in the delightful De los Angeles/Fischer-Dieskau collection of duets (Angel 35963 or S 35963). There are, of course, many singers today whose control of expressive means and musical ends adds up to a very high degree of artistry, just as there are others whose lack of control is sometimes disconcerting. Maria Callas, for instance, in her impressive “mezzo-soprano” record of French operatic arias (Angel 35882 or S 35882) indulges in more than one climactic cadential high note whose degree of deviation from pitch (combined with a really slow wobble) almost destroys the listener’s pleasure in what has gone before.

This type of ultraslow vibrato cannot be fused into one acceptable and recognizable pitch by the average musical ear. Quicker vibratos achieve this, just as the flicker of a projector shutter becomes invisible as it is speeded up. Even without the aid of complicated and expensive measuring apparatus, the owner of a four-speed record player can test this theory for himself. Play a 33-rpm disc at 45, and the Sextet from *Lucia* will begin to sound like the Chipmunks. Slow a 33 disc of a soprano down to 16 rpm and the vibrato suggests the torments of the damned. It is all a matter of degree, and the experience is in the ear of the hearer. When Galli-Curci first appeared in London, violent arguments between critics cast a temporary smog over her fair reputation. One found her concert “a sorry, sordid, and ridiculous business,” and then went on to speak satirically for her vibrato *Continued on page 110*

The sound from this new Shure cartridge is awesome in its vitality & clarity

A NIGHT-AND-DAY DIFFERENCE

From the very first prototype, the sound from the new Shure Series M44 Stereo 15° Dynetic Cartridge was incredible. Even skeptical high fidelity critics have expressed unconcealed surprise at the audible increase in brilliance, clarity, transparency, presence, fullness and smoothness of this amazing new Shure development. A close analysis of its performance reveals startling differences in this cartridge—although not extraordinarily improved in the “usual” areas of frequency response (still a virtually flat 20-20,000 cps) or in compliance (25×10^{-6} cm/dyne)—rather it is in the distortion measurements where Shure engineers have achieved a highly significant and dramatic reduction of 75% to 90% in IM and harmonic distortion from even such admirably distortion-free cartridges as earlier versions of the Shure Stereo Dynetic. Further, cross-talk between channels has been effectively negated in the critical low frequency and mid ranges . . . providing superior channel separation throughout the audible spectrum.

SCRATCH-PROOF RETRACTILE STYLUS

And, as if that were not enough, the new 15° cartridge incorporates a totally efficient retractile stylus that momentarily retracts whenever excessive forces are applied to the tone arm. This feature protects your records and prevents annoying “clicks.”

PERFECTION IS A MATTER OF DEGREE

It has been known for some years that a difference between the angle used to cut stereo records and the angle of the stylus of the cartridge used to play them would result in an increase in IM and harmonic distortion audible on certain records. With widely different cutting angles employed by the record companies, the effective angle of the playback cartridge stylus had of necessity to be a compromise so as to provide the best possible results from records of all makes.

Recently, industry attention was focused on this problem by a series of technical articles ascribing the difference in effective vertical angles between the cutter stylus and the playback cartridge stylus as a cause of distortion and urging the adoption of a standard effective angle to which records would be cut.

Major record companies have now begun to use an effective cutting angle of 15°, which is the proposed standard of the RIAA (Record Industry Association of America) and EIA (Electronic Industries Association).

With the emergence of the single standard effective vertical tracking angle for cutting records, Shure engineers immediately began what seemed on the surface the seemingly simple but in actuality the arduous and exacting task of converting their formidable Stereo Dynetic cartridge to the 15° effective tracking angle. It couldn't be done. So Shure designed this radically new moving-magnet cartridge that will track at an effective angle of 15°. Graphically, this is the kind of cartridge geometry involved in the new Shure Series M44 15° Stereo Dynetic Cartridge:

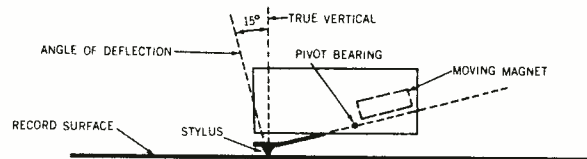

THE ULTIMATE TEST

You must hear this cartridge to appreciate the totality of the sound improvement. It will be instantly recognizable to the ear without the necessity for elaborate test instruments or A-B listening tests—although we assure you, instruments and A-B tests will more than substantiate our claims.

M44 SERIES SPECIFICATIONS

	M44-5	M44-7
Frequency Response:	20-20,000 cps	20-20,000 cps
Output Voltage at 1000 cps (Per Channel, at 5 cm/sec peak velocity):	6 millivolts	9 millivolts
Channel Separation (at 1000 cps):	Greater than 25 db	Greater than 25 db
Recommended Load Impedance:	47,000 Ohms	47,000 Ohms
Compliance:	25×10^{-6} cm/dyne	20×10^{-6} cm/dyne
Tracking Range:	$\frac{1}{4}$ to $1\frac{1}{2}$ Grams	$1\frac{1}{2}$ to 3 Grams
Inductance (Per Channel):	680 millihenries	680 millihenries
D.C. Resistance (Per Channel):	650 Ohms	650 Ohms
Stylus:	.0005" diamond	.0007" diamond
Stylus Replacement:	N44-5	N44-7

Monophonic Styli Also Available:

Model N44-1—For monophonic LP records, with .001" diamond
Model N44-3—For 78 rpm records, with .0025" diamond

SHURE

Stereo **15°** *Dynetic*®

**SERIES M44 SCRATCH-PROOF CARTRIDGE
WITH RETRACTILE STYLUS**

the new standard
in distortion-free
hi-fi cartridges

LITERATURE: Shure Brothers, Inc. 222 Hartrey Avenue, Evanston, Illinois

Manufactured under U.S. Patents 3,055,988; 3,077,521 and 3,077,522. Other Patents Pending



CIRCLE 56 ON READER-SERVICE CARD

*The consumer's guide
to new and important
high fidelity equipment*

high fidelity

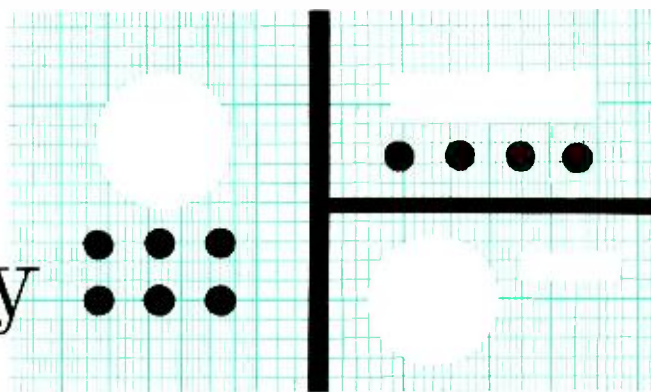

EQUIPMENT REPORTS



United Audio Dual TG 12 SK Tape Recorder

THE EQUIPMENT: United Audio Dual TG 12 SK, a three-speed, quarter-track stereo/monophonic tape recorder, with built-in power amplifier and speakers installed in removable covers for an integral carrying case. Over-all dimensions (closed): 11 3/16 by 16 by 14 3/4 inches (allowing for handle and feet). With the speakers removed, the deck is 6 3/4 inches high. Price: \$349.95. Manufacturer: Gebrüder Steidinger, St. Georgen/Black Forest, Germany. Distributed in the U.S.A. by United Audio Products, 12 West 18th St., New York 11, N. Y.

COMMENT: The Dual TG 12 SK offers the virtues of a completely self-contained tape recording and playback system that also may be easily adapted into a component music system. Mechanical performance and sound, in either use, are very commendable—especially in view of the compactness and cost of the unit. The operating controls and their markings may take some getting used to for most American users, but the instruction booklet with the Dual should help such orientation.

The entire equipment, when the speaker covers are clamped to the deck, forms a suitcase-like package. To use the recorder, the speaker covers are removed and the deck is revealed. The speakers then may be positioned at suitable distances from the deck. Alternately, the deck can be installed more permanently for wiring into an existing component system. Suitable input and output jacks, as well as the required cable connectors, are supplied. The extension speakers themselves—5-ohm units, fed by about 1.6 watts of audio power output

from the deck's built-in amplifier—sound surprisingly good. When the recorder is used in a high fidelity component system, its sound—on record/playback as well as playback of prerecorded tapes—is distinctly above average for its price class.

The recorder offers three speeds: 7½, 3¾, and 1⅞ ips. Its main operating functions are controlled by seven mechanically actuated push buttons, arranged across the deck just below the head assembly. To the left of this array are the speed selector and tape index counter; to its right are the recording level control and indicator. The recording level control adjusts the level in both channels simultaneously, and the level indicator (electronic beam type) indicates the total level of both channels together rather than separately. The versatility of the recorder is therefore somewhat limited for stereo recording in that individual channel fine adjustments cannot be made. However, the Dual makes up for this in other ways. For instance, it has a "dubbing" control which allows one to superimpose a new recording on an already existing one. It also has the extra slow speed of 1⅞ ips for extended recording time on voice; built-in amplifiers and extension speakers add to its versatility.

Electronic controls include volume, channel balance, and four positions of tone compensation. At the upper edge of the top panel, between the reels, is the track selector switch which can be set for stereo with both tracks, or for mono using either the upper or lower one. Electrical connections to the recorder are made through European-type 5-pin jacks at the rear of the

REPORT POLICY

Equipment reports are based on laboratory measurements and listening tests. Data for the reports, on equipment other than loudspeakers, is obtained by the United States Testing Company, Inc., of Hoboken, New Jersey, a completely independent organization not affiliated with the United States Government which, since 1880, has been a leader in product evaluation. Speaker reports are based on controlled listening tests. Occasionally, a supplementary agency may be invited to contribute to the testing program. The choice of equipment to be tested rests with the editors of HIGH FIDELITY. No report, or portion thereof, may be reproduced for any purpose or in any form without written permission of the publisher. No reference to the United States Testing Company, Inc., to its seals or insignia, or to the results of its tests, including material published in HIGH FIDELITY based on such tests, may be made without written permission of United States Testing Company, Inc.

United Audio Dual TG 12 SK Tape Recorder

Lab Test Data

Performance characteristic

Measurement

Speed accuracy at 7½ ips	4.6% fast at 117 volts AC 3.4% fast at 105 volts AC 5.4% fast at 129 volts AC
at 3¾ ips	2.6% fast at 117 volts AC 1.4% fast at 105 volts AC 3.9% fast at 129 volts AC
at 1⅞ ips	1.1% fast at 117 volts AC 0.85% fast at 105 volts AC 1.4% fast at 129 volts AC

Wow and flutter at 7½ ips	0.08% and 0.10% respectively
at 3¾ ips	0.08% and 0.12% respectively

Rewind time (7-inch, 1,200-ft. reel)	1.48 minutes
--------------------------------------	--------------

Fast forward time, same reel	1.52 minutes
------------------------------	--------------

NAB playback response (ref. Ampex test tape No. 31321-01), 7½ ips	left: +1.7, -2.5 db, 94 cps to 15 kc; slope to -6 db at 50 cps right: +1.2, -2 db, 50 cps to 15 kc
---	---

Max. output level (with 0 VU signal at 700 cps, as on test tape) with -10 VU signal	each channel: 1.15 volts each channel: 0.37 volt
---	---

Record/playback response (with -10 VU recorded signal) at 7½ ips	left: +1.5, -3 db, 68 cps to 17.5 kc; down to -7 db at 25 cps and at 19 kc right: +0.5, -3 db, 63 cps to 16 kc; down to -6 db at 25 cps, to -7 db at 18.5 kc
at 3¾ ips	left: +0.4, -3.5 db, 56 cps to 11 kc right: +0, -3.5 db, 52 cps to 6 kc; down to -6 db at 8.2 kc
at 1⅞ ips	left: +0.8, -5 db, 44 cps to 5.3 kc right: +1.2, -5 db, 35 cps to 3.5 kc

S/N ratio (re: 0 VU, test tape) playback	left: 52 db; right: 51 db
record/playback	left: 46 db; right: 46 db

Sensitivity for -10 VU recording level phono input	left: 0.08 volt; right: 0.08 volt
radio input	left: 1.4 mv; right: 1.4 mv

THD, record/playback (with -10 VU recorded signal) 7½ ips	left: under 2%, 58 cps to 15 kc right: under 2%, 45 cps to 15 kc
3¾ ips	left: under 2%, 64 cps to 6 kc right: under 2%, 50 cps to 7.2 kc

IM distortion, record/playback at -10 VU	left: 1.7%; right: 1.9%
at -5 VU	left: 4.3%; right: 3.6%
eye closure	left: 8.4%; right: 10%

Recording level for max. 3% THD	left: +3.5 VU; right: +3.1 VU
---------------------------------	-------------------------------

Power output at clipping	left: 1.56 watts; right: 1.6 watts
--------------------------	------------------------------------

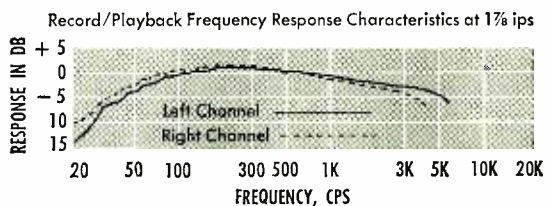
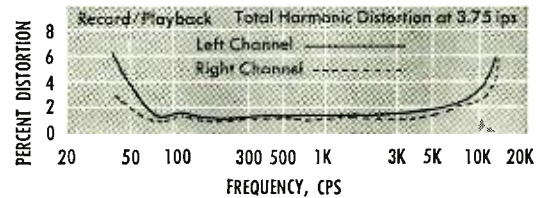
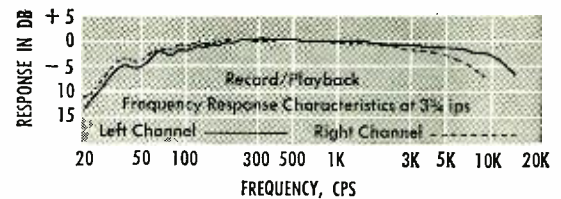
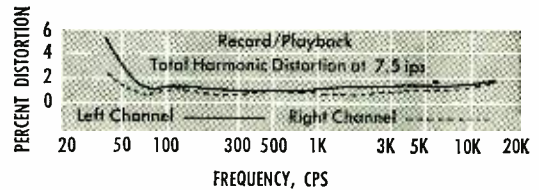
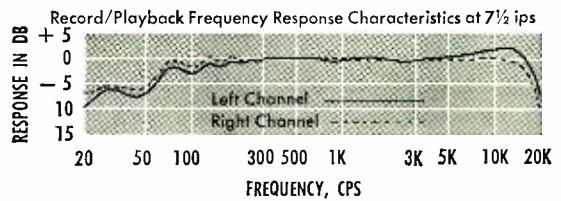
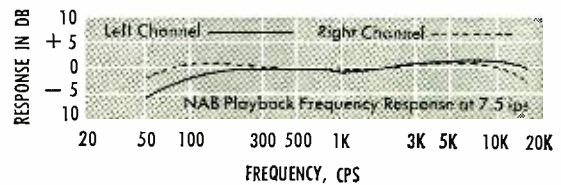

recorder, and inputs are provided for feeding signals from external program sources as well as microphones. A preamplifier output for playing the Dual through external amplifiers is also provided.

The recorder has two quarter-track stereo heads (erase and record/playback); and the electronic circuit contains two EF86 tubes, two ECC81 tubes, one ECC83 tube, three EM95 tubes, one EM84 tube, and three selenium rectifiers. It runs very quietly, and has an automatic shutoff switch to stop the machine at the end of the tape.

In tests conducted at United States Testing Company, Inc., the TG 12 SK acquitted itself handsomely. The recorder transported the tape well, and the change from one mode of operation to another was made very smoothly. Distortion, wow, and flutter all were very low, and the signal-to-noise ratio was favorable. Frequency response was very good to beyond 15 kc at the 7½-ips speed. While not as wide at the lower speeds, the response of the recorder still was relatively good at both 3¾ and 1⅞ ips. The Dual TG 12 SK, in sum, is one of the better tape recorders available today, and merits serious consideration in its price class.

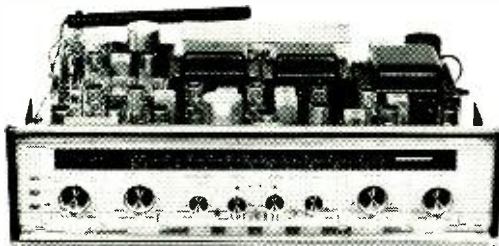

Sherwood Model S-7700 Tuner/Amplifier

THE EQUIPMENT: Sherwood S-7700, a combination AM, FM, FM stereo tuner and stereo preamplifier and power amplifier on one chassis. Dimensions: 16½ inches wide, 14 deep, 4½ high. Price: \$369.50. Walnut leatherette case, \$9.50. Manufacturer: Sherwood Electronic Laboratories, Inc., 4300 North California Ave., Chicago 18, Ill.

COMMENT: A full complement of controls, a high-performing tuner, and an amplifier capable of delivering 30 watts per channel are built—in the S-7700—onto a relatively compact chassis which may be fitted in its own attractive enclosure or may be panel-mounted in custom cabinetry. The main operating control knobs include a four-position input selector (tape head, phono, tuner, and auxiliary); a five-position stereo-mono function switch (“mix” for playing mono records, stereo reverse, stereo normal, FM, and AM); a phono gain control; concentric

bass and treble controls for each channel; a stereo balance control concentric with an FM interchannel hush (squelch) control; a loudness control combined with an off/on switch; and a tuning knob. In addition there are six slide-switches (for tape monitor, phase reversal, low-frequency filter, high-frequency filter, loudness compensation, and AM selectivity). Three source indicator lamps—marked for tape head, phono, and auxiliary—also are on the front panel. The station-tuning dial is long and clearly marked, and has a station-tuning eye as well as a stereo multiplex indicator. The rear of the set contains outputs for speakers of 4, 8, or 16 ohms; an unswitched AC convenience outlet; and signal input jacks for two low-level (phono and tape head) and two high-level (monitor and auxiliary) sources, and outputs for feeding a tape recorder.

Tests were conducted at United States Testing Company, Inc., on the tuner and amplifier sections of the S-7700. As the measurements indicate, the amplifier is a clean, medium-powered unit, capable of driving most speakers to more than ample volume. It has effective controls, very good playback equalization characteristics, adequate sensitivity for input signals, and favorable signal-to-noise ratios. As is typical of most integrated chassis components, the low-frequency (50-cps) square-wave response showed the effects of bass rolloff and phase distortion, although the high-frequency (10-kc) square-wave response had good rise-time and small overshoot, indicating good stability and transient response.

Measurements on the tuner section were made through the amplifier, supplying about one watt of audio output. FM sensitivity was very good across the band, and the set responded to stations cleanly and with very low distortion. The left and right channels were well balanced on stereo, and separation between them was very good. Distortion rose, as is usual, on stereo—but the distortion on mono was so low to begin with that the increase on stereo still was virtually insignificant. The stereo pilot and subcarrier signals were suppressed enough not to interfere with off-the-air tape recording.

The S-7700 includes an AM section which USTC found to have good sensitivity, fairly low distortion, and a respectable frequency response with the set used in its “wide” IF bandwidth mode.

With its low distortion, clean response, and well-mannered control features, the S-7700 could serve as the compact center of a high quality music system.

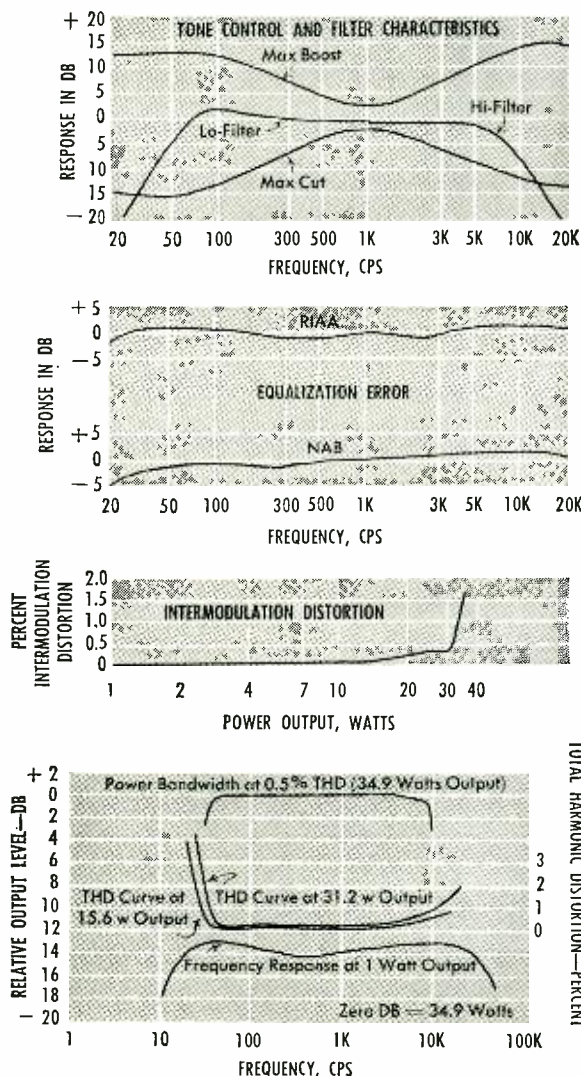

See next page for Lab Test Data

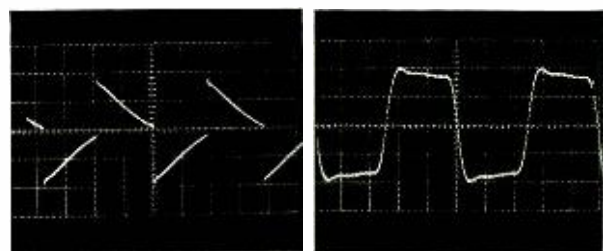

Square-wave response to 50 cps, left, and 10 kc.

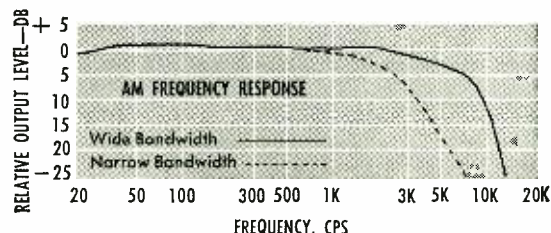
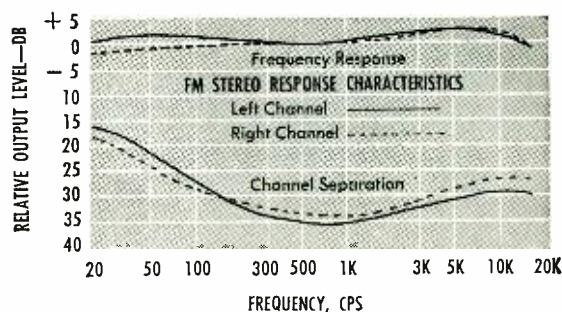
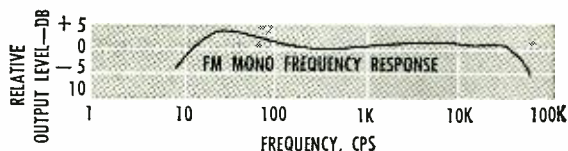
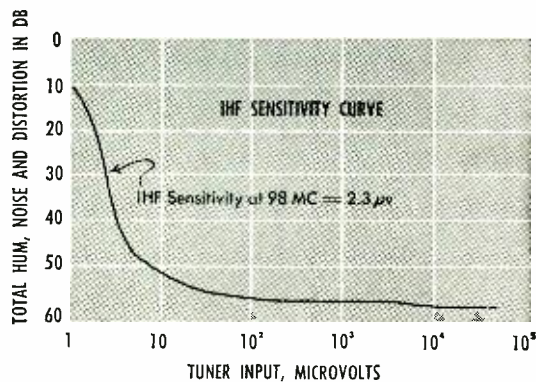

Sherwood Model S-7700 Tuner/Amplifier

Lab Test Data

FM Tuner Section

Performance characteristic	Measurement
IHF sensitivity	2.3 uv at 98 mc; 2.2 uv at 90 mc; 3.0 uv at 106 mc
Frequency response, mono	± 2 db, 9.5 cps to 50 kc, except for 3.5 db peak at 30 cps
THD, mono	0.13% at 400 cps; 0.13% at 40 cps; 0.17% at 1 kc
IM distortion, IHF method	0.08%
Capture ratio	2.5 db
S/N ratio	62 db
Frequency response, stereo	both channels: ± 1.5 db, 20 cps to 15 kc, with 2.5 db peak near 5 kc
Channel separation	left: 35 db at 1 kc; better than 20 db, 40 cps to 15 kc; 16 db at 20 cps right: 34 db at 1 kc; better than 25 db, 60 cps to 15 kc; 18 db at 20 cps
THD, stereo	left: 0.57% at 400 cps; 0.82% at 40 cps; 0.47% at 1 kc right: 0.67% at 400 cps; 0.90% at 40 cps; 0.54% at 1 kc
19-kc pilot suppression	-41.5 db
38-kc subcarrier suppression	-43 db

AM Tuner Section

IHF sensitivity	136 uv
THD	2.5% at 400 cps
Frequency response	wide IF bandwidth: +1, -3 db, 20 cps to 5 kc; down to -6 db at 8 kc narrow IF bandwidth: +1, -3 db, 20 cps to 2 kc; down to -6 db at 2.8 kc

Amplifier Section

Performance characteristic	Measurement
Power output (at 1 kc into 8-ohm load)	
left channel at clipping	31.2 watts with 0.13% THD
right channel at clipping	31.6 watts with 0.11% THD
left channel at constant 0.5% THD	34.9 watts
right channel at constant 0.5% THD	33.2 watts
both channels operating simultaneously at clipping	left: 26.3 watts with 0.25% THD right: 28.1 watts with 0.20% THD
Power bandwidth (for 34.9 watts at constant 0.5% THD)	30 cps to 10 kc
Harmonic distortion	for 31.2 watts output, under 1% from 34 cps to 11 kc; 1.8% at 20 kc; 4.2% at 25 cps for 15.6 watts output, less than 1% from 25 cps to 20 kc
IM distortion	0.15% at 10 watts 0.20% at 15 watts 0.40% up to 30 watts
Frequency response	± 1 db, 15 cps to 35 kc; down to -3 db at 11 cps and 49 kc
RIAA characteristic	± 1.5 db, 20 cps to 20 kc
NAB (tape head playback) characteristic	± 1 db, 40 cps to 20 kc; down to -5 db at 20 cps
Damping factor	5.3
Sensitivity, various inputs	phono, 1.52 mv tape head, 2.1 mv aux, 364 mv monitor, 340 mv
S/N ratio, various inputs	phono, 57 db tape head, 46.5 db aux, 72 db monitor, 72 db

Dynakit Stereo-35 Basic Amplifier

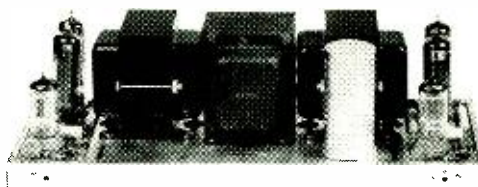

THE EQUIPMENT: Dynakit Stereo-35, a stereo basic amplifier. Dimensions: 13 by 5 by 4 inches. Price (in kit form): \$59.95; wired: \$79.95. Prices include cover. Manufacturer: Dynaco, Inc., 3912 Powelton Ave., Philadelphia 4, Pa.

COMMENT: The new Stereo-35 is one of the smallest, simplest amplifiers yet encountered, and also one of the most reliable and clean-performing. Although its power output places it in the "low-to-medium" class of amplifiers, its smooth response, low distortion, and stability under varying loads make it suitable for use with all but the very lowest efficiency speakers in very large rooms. It has no controls or preamplification-equalization circuits and so must be used with an external preamp-control unit, or with a program source that has its own level controls, such as a tuner or tape recorder on playback. The Stereo-35 does not even have an AC power switch, and so must be turned off and on by whatever other equipment it is connected to. Speaker taps are provided for 8- and 16-ohm speakers on each channel; no 4-ohm taps are furnished.

Results of tests of a kit-built Stereo-35 conducted at United States Testing Company, Inc., indicate that high

quality has been achieved with a disarmingly simple circuit design. Each channel uses only three tubes, and the power supply is built around two silicon diodes. With these relatively sparse innards, the Stereo-35 is able to produce surprisingly wide response with very low distortion. Its sensitivity is well suited to all preamps and tuners; its signal-to-noise ratio is very favorable at 82 db; and its damping factor of 10 indicates good control of most speakers. The amplifier remained stable under all conditions of loading and would be suitable for driving electrostatics. The square-wave response, for an amplifier of this size and price, was outstanding both at 50 cps and at 10 kc. All told, the Stereo-35 is a very worthy product for the budget-minded listener who is building a compact, but high-quality, music system.

How It Went Together

The Stereo-35 proved to be the fastest and easiest amplifier kit yet encountered. No ambiguities or errors were found in the instructions, and no adjustments were required after wiring and assembly. When completed, the unit simply worked—beautifully.

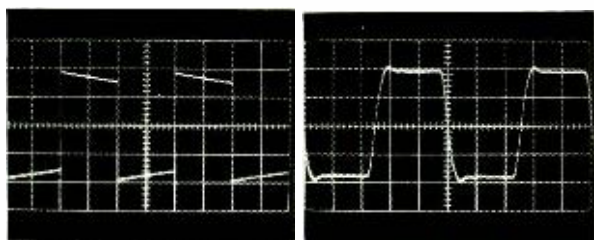
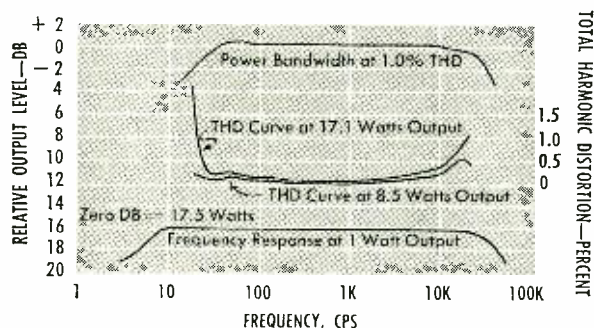
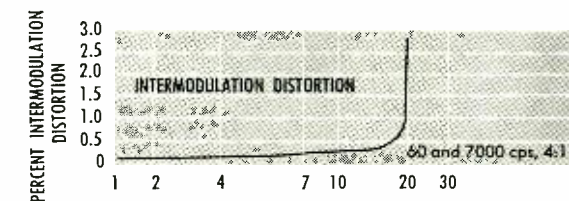

Square-wave response to 50 cps, left, and 10 kc.

Dynakit Stereo-35 Basic Amplifier

Lab Test Data

Performance characteristic	Measurement
Power output individual channels (8-ohm load)	
left, 1 kc clipping point	17.1 watts with 0.08% THD
left, 1% THD (roted dist.)	18 watts
right, 1 kc clipping point	17.1 watts with 0.08% THD
right, 1% THD (roted dist.)	18 watts
both chs operating together	
left, 1 kc clipping point	14.6 watts with 1.1% THD
right, 1 kc clipping point	14.3 watts with 1.3% THD
Power bandwidth, constant 1% THD	14 cps to 38 kc
Harmonic distortion	
left ch: 17.1 watts output	less than 1%, 23 cps to 18 kc
left ch: 8.5 watts output	less than 0.55%, 20 cps to 20 kc
IM distortion	less than 0.5% to 17.5 w
Frequency response	+0, -1 db, 8 cps to 34 kc; down to -3 db at 49 kc
Damping factor	10
Sensitivity for full output	0.97 volt
S/N ratio	82 db



Jensen Model TF-4 and Model X-11 Speaker Systems

THE EQUIPMENT: Jensen TF-4, a four-way speaker system in an integral enclosure. Dimensions: 16 by 25 1/2 by 8 1/2 inches. Prices: in walnut, \$114.50; in unfinished hardwood, \$97.50. The Model X-11 "Ultra-Compact" is a two-way system in an integral enclosure. Dimensions: 13 11/16 by 4 1/8 by 6 5/8 inches. Price: \$29.75. Manufacturer: Jensen Manufacturing Co., 6601 S. Laramie Ave., Chicago, Ill., 60636.

COMMENT: In the TF-4, Jensen's approach to full-range reproduction within compact dimensions is to use a modified air suspension system and split the audio spectrum among five drivers, two of which cover the same range, in a four-way system. The technique involves the use of a high-compliance, or "long-throw" 10-inch woofer for the bass response, which is aided by a ducted port on the front baffle. A dividing network feeds frequencies from 600 cps to 4 kc to an 8-inch midrange unit. Tones from 4 kc to 9 kc are handled by a pair of 3 1/2-inch tweeters, while the range above 9 kc is fed to a Model E-10 "ultratweeter" which uses a plastic domelike diaphragm to disperse the highest overtones. The network has a level control that adjusts the relative volume of frequencies above 4 kc. All five drivers and the network are housed in the integral enclosure and the system acts as a direct radiator. Input impedance is 8 ohms; screw terminals are marked for polarity.

The response of the TF-4 was estimated to extend from just above 30 cps to beyond audibility, with relatively few irregularities along the way. At normal listening levels, driven by a 25-watt amplifier, the bass showed signs of a gentle rolloff from about 45 cps and seemed to disappear at 34 cps. However, by raising the volume just the least bit, the roll-off tendency could be lessened, and the bass did respond to an indeterminate lower frequency. Driving the system a little "harder" could produce a response near to 20 cps, but with noticeable distortion and frequency doubling. The upper bass and midrange were satisfactorily smooth, except for a slight "brightening" at about 600 cps. With the high-frequency balance control turned to minimum, the system responded to about 11 kc; with this control turned to full, response continued to beyond audibility. Directivity was very moderate, and the highest tones could be heard fairly well off the nominal axis of the

system. White noise response was generally smooth, indicating very little undesirable coloration effects.

The TF-4, reproducing program material, gave a good account of itself. Transient response was crisp, the bass had impact, and the midrange and highs sounded well balanced and clean. The over-all acoustic presentation was somewhat "airy" with one TF-4 used monophonically, and amply spread out between a pair on stereo. The TF-4 is moderately efficient as speakers go, and will develop adequately loud sound levels with amplifiers rated from 10 to 25 watts. We tried it on a 40-watt unit and found that ample listening levels in a rather large room were reached with the volume control set between the "10 and 11 o'clock" positions. The TF-4 is only 8 1/2 inches deep and is nominally designed for positioning horizontally on a narrow shelf, although our experience indicates that it can be placed virtually anywhere—and in the vertical position too—for well-balanced, clean, full-range reproduction.

If the performance of the TF-4 is very creditable, the sound of the tiny X-11 is, for its size and price, astonishing. A five-inch woofer and a three-inch tweeter are housed, with crossover network, in a

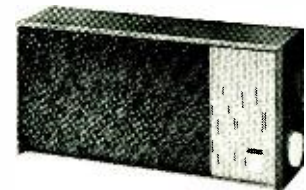

completely sealed, oiled walnut enclosure to produce musical response over most of the audio range. The bass began rolling off at about 70 cps and dropped markedly just above 50 cps. With the rising distortion attendant on driving any speaker "harder," the X-11 could be made to respond to test tones in the 30-cps region, incredible though this seems. Peaks were observed at 280 cps, 300 cps, and at 1 kc; and some distortion was heard at the 2-kc crossover point. The response rose slightly at 11 kc, then rolled off to beyond audibility. The X-11 was moderately directive at 2 kc, slightly more so at 5 kc, but not any more so at 10 kc. White noise response was surprisingly smooth. Obviously, the X-11 is not intended to project all the bass, or to provide the utmost in sonic transparency; however, for less critical use as an extension speaker, or for a "personal" music system in a small area, it represents good value vis-à-vis size and cost.

REPORTS IN PROGRESS

Fisher 500-C Tuner/Amplifier Leak Preamp and Power Amplifier



NOW THERE ARE TWO GREAT TAPES TO CAPTURE SOUND BRILLIANTLY

Two new magnetic tapes from Kodak—both with high-performance oxide layer that gives a new richness and brilliance to your recorded sound.

With new bases and oxide layer, KODAK Sound Recording Tape becomes a new standard of tape quality:

Two new bases. DUROL Base for Kodak tape is a new triacetate that is 40% stronger, yet breaks clean in case of accident. It permits splicing a break without loss of recorded sound. Kodak tape on 1½-mil DUROL Base can be your standard of tape excellence. For 50% longer play choose the 1-mil thickness. To double the recording time, get KODAK Sound Recording Tape on ½-mil Polyester Base.

New oxide layer. Kodak emulsion scientists have found a better way to disperse the recording oxide in a new, tougher resin binder. Result: a smoother oxide surface which reduces residual noise and recorder head wear, increases high-frequency response.

Exclusive backprinting. Kodak tapes are printed on the base side with our company name and manufacturing control number as your assurance of high quality.

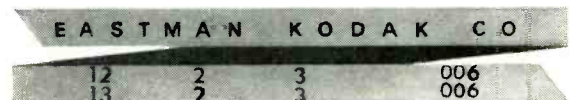

KODAK Thread-Easy Reel. Simply pull tape through the slot—it's loaded! Timesaving splicing jigs and index scales are on both sides of reel. Try all-new KODAK Sound Recording Tape soon. At your Kodak dealer's now!

Remember: You get each 7-inch roll of Kodak tape on the popular KODAK Thread-Easy Reel.

Kodak
TRADE MARK

EASTMAN KODAK COMPANY, ROCHESTER, N. Y.

CIRCLE 30 ON READER-SERVICE CARD

JANUARY 1964

63



Corelli is by turn exultant, despairing, dashing and menacing. He wears many faces, carries many roles. But above all he is Corelli—the artist and the man—captured in his many moods and roles at the peak of brilliance on Angel records.

There is the boy who listened to tales of Enrico Caruso and other great voices that first echoed in the hills of his native Italy. There is the youthful Corelli who astounded critics with his sparkling debut in Spoleto in 1952... and in 1954 opened the season at La Scala!

There is Corelli, the master tenor, whose electrifying 1958 American debut at the Met drew some of the most lavish praise ever bestowed by the press.

Corelli on Angel records... *I Pagliacci* (S) 3618 B/L; Operatic Arias from *Turandot*, *Manon Lescaut*, *I Puritani*, *Tosca* and others (S) 35918; *Cavalleria Rusticana* (S) 3632 B/L; *Norma* (S) 3615 C/L; *Neapolitan Songs*, volume I (S) 35852, volume II (S) 36126; for release in 1964: *Andrea Chénier*.



as Julius Caesar

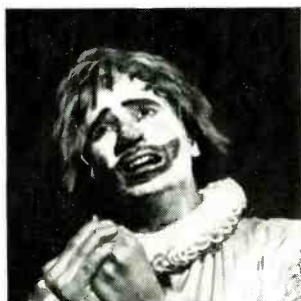

as Canio in *I Pagliacci*



as Calaf in *Turandot*



as Don José in *Carmen*

THERE IS ONLY ONE
**FRANCO
CORELLI**



as *Andrea Chénier*

CIRCLE 8 ON READER-SERVICE CARD

reviewed by
PAUL AFFELDER
NATHAN BRÖDER
O. B. BRUMMELL
R. D. DARRELL
SHIRLEY FLEMING

Records in Review

ALFRED FRANKENSTEIN
HARRIS GOLDSMITH
ROBERT C. MARSH
CONRAD L. OSBORNE
ERIC SALZMAN
JOHN S. WILSON



by Eric Salzman

A Samson from Handel . . .

ONE OF the great oratorios of Handel's maturity, *Samson* was written in 1741 and first performed, in a somewhat revised version, two years later. The work derives, rather remotely, from Milton's *Samson Agonistes*, and it is rather touching to remember that the composer of this epic of a blind hero, based on the verse drama of a blind poet, himself lost his sight only a few years later.

The libretto, arranged by a certain Newburgh Hamilton, manages, however, to reduce the Biblical and Miltonian epic to a kind of English Choral Festival Competition between the supporters of Jehovah and the adherents of great Dagon, apparently the local music director of the Philistine Choral Society. Any echoes of Milton still remaining in the verse are effectively stamped out by such poetic marvels as: "But who is this that so bedecked and gay/Comes this way sailing like a stately ship?/Tis Delilah, thy wife"; or "To man God's universal law/Gave power to keep the wife in awe./Thus shall his life be ne'er dismayed/By female usurpation swayed" (the latter the subject of a big Handelian contrapuntal choral treatment!).

Never mind. Handel's musical and dramatic conception makes up for all, and it is certainly Miltonian in its scope and power. *Samson* is one of those works in which Handel was adapting the forms of the old *opera seria* to the requirements of a religious-choral tradition and the dramatic impulse of the "modern" Italian style. There are, for example, few *da capo* arias; the "modern" types of motto and unison arias are common, and the new homophonic preclassical style of the elder Scarlatti and his Neapolitan successors is often suggested. The general shape of these arias often pivots around some kind of dramatic arrangement. The best example of this is the most famous: Samson's beautifully expressive "Total eclipse." But this is also true of the hero's first big aria, "Torments alas," with its impressive *largo e staccato* accompaniment, of Manoah's first aria with its unusual fast-slow format, and even of Samson's big display aria "Why does the God of Israel sleep?" The use of the chorus in the repeats of the middle and first sections of Micah's aria "Return, O Gods of Hosts" (a dramatic extension of the *da capo* idea) . . .

Delilah's melting unaccompanied phrases and the way they are extended in a ravishing duet and chorus . . . the A major duet between Samson and Delilah and the A minor duet between Samson and Harapha . . . the big double chorus at the end of the second act . . . the rushing, pleading chorus of the Israelites "With thunder arm'd" . . . the solo and chorus of the celebrating Philistines . . . the instrumental "sinfonia" depicting the fall of the temple and the transformation of that section into a pathetic chorus of the dying Philistines . . . the dead march and the various intertwined solo chorus and choral laments and celebrations at the end—all of these conceptions are, in origin, dramatic and theatrical. That final section—with the solemn procession, the catafalque strewn with flowers, laurel, and bay, the bright seraphim above streaming up to heaven blowing on their angel trumpets—is like a great baroque funeral monument patterned on some grand tableau complete with perspective and machinery.

AbraVanel and his Utah forces continue to produce exceptional recordings of the most varied sort of music, and

this one, like the others, is well done. The star of the show, for me, is Phyllis Curtin. She starts off singing well and gets better and better. Her wonderful cooing love song "With Plaintive Notes" (and shakes and divers ornaments as well) is exquisite. She is almost always pure and true and, as the work goes on, her expressive projection seems to get stronger. Peerce too is certainly impressive, although as Samson he is too Jan Peercean to come across as anyone but himself. Samuelsen is a resonant and powerful Manoah whose singing is very musical; Smith's contribution is almost of the same quality. Louise Parker, the other principal, sings very beautifully but lacks something in the way of incisiveness; vocal phrasing in this music needs some quality of crisp attack to get it flowing properly.

Abravanel makes a favorable impression as a baroque stylist; he has his orchestra playing extremely well and in character too. As for the chorus, its tone quality and expressive projection

lack a Handelian tone and measure, but it deserves to be commended for singing very accurately and in tune. A few small stylistic complaints: the organ and harpsichord continuo, though properly prominent, is a little too constrained in character; there is some inhibition on everybody's part about ornamentation; and more incisiveness would have been welcome (more vigorous instrumental and vocal attacks, double-dotting, etc.).

I am not conversant with the problem of editions in connection with *Samson* (there are always problems of editions in Handel), but Abravanel seems to have used a good, practical, workable version based on early sources. There are some considerable cuts: eight or nine arias (depending on which edition you go by), and big chunks of recitative (the latter, by the way, justified at least in part by early sources but productive nonetheless of some strange harmonic switches). The recorded sound is notable for its emphasis on separation. There is a lot of reverberation in the sound but

never so much as to obscure essential matters; however, in the lingering reverberation of the organ, sound sometimes seems to bounce back somewhat flat—an odd and disturbing effect that mars a couple of spots. But small flaws notwithstanding, it is indeed a pleasure to welcome not only a *Samson* into the catalogue but one well worth having.

HANDEL: *Samson*

Phyllis Curtin (s), Delilah, Philistine and Israelite Women: Jean Preston (s), A Maiden; Louise Parker (c), Micah: Jan Peerce (t), Samson; Kenley Whitelock (t), A Messenger; Roy Samuelsen (b), Manoah; Malcolm Smith (bs), Harapha. Alexander Schreiner, organ and harpsichord. University of Utah Symphonic Chorale and Utah Symphony Orchestra, Maurice Abravanel, cond.

• VANGUARD BG 648/50. Three LP. \$14.94.

• • VANGUARD BGS 5060/62. Three SD. \$17.94.

by Conrad L. Osborne

. . . and a Samson from Saint-Saëns



Gorr: "the grand line."

THE *Samson* of Camille Saint-Saëns has a good many things going against it. One is a rather peculiar dramatic construction, whereby the first act is devoted almost exclusively to a series of choruses, the second to arias and dialogues, and the third to ballet. Another is the improbability of an adequate stage representation, especially in the final tableau—everything points to Samson's destruction of the temple (a dramatic *idea*), but in the theatre this can hardly be accomplished except by means of a mere blackout or, worse, a half-hearted tugging apart of a couple of flats and platforms. And there is also the unfortunate fact, faced by other operatic composers, that the representatives of iniquity and decadence emerge, in the music, in a decidedly more attractive light than the nominal upholders of morality. The worship of Dagon certainly seems like a fun business, and the Philistine: a much healthier lot than the humorless mumbling Hebrews.

But there is much to admire in both the drama and the music of *Samson* (if one can, for purposes of discussion, separate them). The first act, where the

opera's initial conception as an oratorio especially shows through, is undoubtedly the weakest of the three: chorus follows chorus, and the formal organization of the numbers is rather too obvious. Moreover, the invention flags from time to time; unless the performance is galvanic, an air of futility is likely to invade the thudding rhythms of "*Israel, romps ta chaîne!*" and even the proclamatory "*Arrêtez, o mes frères!*" fine as this is. On the other hand, the opening chorus, theoretically sung before the rise of the curtain, is imposing and beautiful, as well as being a fine piece of mood setting and a very polished example of formal choral craftsmanship. And the plainsong-derived chorus for the Hebrew old men ("*Hymne de joie, hymne de délivrance*") is a simple, striking inspiration. With all this somewhat too lengthily developed setting out of the way (and it can be saved, in the theatre, by outstanding performance), the first act moves on to a startling and effective contrast: the entrance of Dalila and the chorus of Philistine women, with the accompanying sensuous opening out of the music. Then comes the trio "*Je viens célébrer la*

victoire" (so memorably recorded by Homer, Caruso, and Journet); the brief dance, badly needed to relieve the static impression of the first half-hour; and finally the ravishing contralto aria "*Printemps qui commence*."

The second act is splendid throughout, opening with that superb example of the French grand aria, "*Amour, viens aider ma faiblesse*"; continuing with the strongly written scene between the High Priest and Dalila (the High Priest's air "*La victoire facile*" is particularly good, though the duet "*Il faut, pour assouvir ma haine*" falls to a fairly trite level); and then the long scene between Samson and Dalila. From Dalila's "*Mon coeur s'ouvre à ta voix*" forward, this is surely as fine a piece of sustained writing as French opera can boast, with Samson's weakening determination, Dalila's intensifying urging, and the flashes of the approaching storm all woven neatly into the full-blooded, large-scale writing. Indeed, this act, with its focus on the personal drama of the central figures and its very compact setting forth of the conflicts, is a masterpiece of operatic writing.

The tableau of Samson, blinded, at the huge millstone, is an extremely moving one if the tenor is at all adequate as an artist, and most of the writing for the final scene is tremendously good fun (even if the Bacchanale has been rendered more hackneyed than Salome's Dance by the uses to which Hollywood has put it).

The work is, then, an interesting score, matched to a libretto that except for the first half of the first act accomplishes its functions cleanly and sharply with a minimum of waste motion. And the whole has a distinctive atmosphere, a flavor which, even after the first hearing, is remembered as belonging to *Samson* and to no other opera.

Its performance history of late has not been very happy. The opera seems almost totally dead in Europe, outside of France; at the Metropolitan it staggered through the Forties and Fifties, propped up by Risé Stevens and a succession of tenors—Maison, Vinay, Del Monaco. San Francisco and Chicago have seen it off and on since the Thirties. On records there has been only one complete version, dating back to 1946 (it featured Hélène Bouvier and José Luccioni, and has been long unavailable). There are two discs of excerpts, both Victor, both with Stevens, one with Peerce and the other with Del Monaco.

The new Angel recording is, then, the first complete edition technically up-to-date in stereo. Fortunately, it is, by and large, a satisfying performance. The acoustics are not unusually spacious or colorful—which is a bit of a shame, since the opening choruses could make considerable impact if the stereo sound were up to the very top level. On the other hand, it is a relief to find that Angel has not gone in for extraneous sound effects, and the sound is always clear and kind to the music (the triangle,

for instance, sounds like a musical instrument and not a percussive toy).

The singing might gain from a trace more of spontaneity, of passion. This is particularly true of Vickers, and especially with the opening address. Vickers is not what we call a "line" singer in the Italian sense; yet he isn't a vigorous declamatory one either. He is an interesting, thoughtful, and sometimes frustrating vocalist who suffers even more than most good artists when his singing is removed from the context of a total live performance. Here, most of his second-act work is musical and appealing, "*Vois ma misère*" honest and affecting. But there is not much ring, not much punch; he sounds most of the time as if he is concerned with saving his voice, with placing individual notes in their places. It is *too* thoughtful, too premeditated-sounding. But it is also sensitive and intelligent, and never stiff or steely.

Gorr is probably the only mezzo now active capable of taking the part of Dalila in hand and satisfying all the vocal requirements. Most of the music lies rather low—it is a contralto tessitura, not a mezzo one—and she has the easy fullness and sure legato called for. She also has the really secure, solid high B flat needed for the sudden cry of "*Lâche!*" in Act II, and a sure stylistic command. A bit more warmth and seductiveness would not be misplaced, but her Dalila has the grand line.

Blanc sings easily and beautifully—possibly his singing is almost too easy, or in any case not quite incisive enough. I miss some of the bite and very theatrical declamation of the text that Singher used to bring to this role at the Met. Still, here is a round, big voice, well used. Diakov is fine, but why could a second bass not have been found to avoid doubling in these roles? Variety is needed in Act I in any case, and

Diakov has a distinctive enough Slav-tinged timbre to make him recognizable.

The orchestral work is polished, and the chorus, happily, much above average; in fact, I do not remember hearing the choral sections this well done. I also like Prêtre's leadership—unecentric and controlled but vigorous and alive.

It is good to hear large, convincing voices applied to French opera again. The basic reason for the species' latter-day unpopularity is the absence of French singers of international caliber, plus the failure of foreign singers to take up the slack as they have in the Italian repertory. (This is not just a question of voice, or even of musical and linguistic accomplishments. It is a matter of conviction—it has been years since we have heard singers sink their teeth into French opera as if they believed in it and felt compelled to express themselves through it.) Even in this recording—possibly because it is a recording, studio-born and control-room-bred—there is sometimes not the fire, the urgency that separates the good performance from the inspired one. But it's an accomplished production, nonetheless, more than capable of restoring our faith in a work rapidly becoming unfamiliar to a whole generation of operagoers.

SAINT-SAENS: *Samson et Dalila*

Rita Gorr (ms), Dalila; Jon Vickers (t), Samson; Rémy Corazzo (t), Messenger; Jacques Potier (t), First Philistine; Ernest Blanc (b), The High Priest of Dagon; Anton Diakov (bs), Abimelech and An Old Hebrew; Jean-Pierre Hurteau (bs), Second Philistine. Choeurs René Duclos; Orchestre du Théâtre National de l'Opéra, Georges Prêtre, cond.

- ANGEL 3639. Three LP. \$14.94.
- • ANGEL S 3639. Three SD. \$17.94.

by John S. Wilson

For Bach—a Bacchanal in Swing

SUDDENLY, in France, there has occurred a rage to swing Bach. Now evidence of this bacchanal turns up on this side of the Atlantic in recordings which offer both instrumental versions, by the Jacques Loussier Trio, and vocal treatments, by the Swingle Singers.

Possibly because in its natural state Bach's music tends to swing (in the jazzman's sense), there has for years been an urge on the part of musicians interested in jazz to make the swinging a little more explicit. Back in the Thirties there was Alec Templeton's *Bach Goes to Town* as played by Benny Goodman's orchestra, and the New Friends of

Rhythm were trying out similar things about the same time. Later, George Shearing included in his repertory a number of Bachian pastiches which bore such titles as *Pardon My Bach*. And although the Modern Jazz Quartet has never made as open a declaration of its debt to Bach, many of its fugue-based arrangements are distinct modern descendants of Johann Sebastian.

The Modern Jazz Quartet, in fact, comes to mind again and again as one listens to the three discs by the Jacques Loussier Trio (Loussier, piano, Pierre Michelot, bass, and Christian Garros, drums). Loussier plays two long works

—Partita No. 1 and the *Italian Concerto*—and a variety of Preludes, Fugues, and Two-Part Inventions not simply as piano-with-rhythm-accompaniment performances but in arrangements in which Michelot's bass and his own piano are, much of the time, playing complementary lines with subtle coloring accents from the drummer's side equipment. (The taste and imagination in Garros' use of a brushed cymbal, a triangle, and even a tambourine are a consistent joy.) Only when Loussier moves into flat-footed 4/4 passages is Michelot apt to retire to a rhythm role.

It is part of Loussier's ingenuity in



developing his performances that he is restricted neither by the traditions of jazz nor the traditions of Bach but uses and mingles them with a painter's skillful eye for color. And it is in some of these mélanges that one hears reflections of the Modern Jazz Quartet, while, on occasion, his piano phrasing directly parallels that of John Lewis, the Quartet's pianist.

Far from being a quickly palling gimmick, this is delightful music—complimentary both to Bach and to jazz and, particularly, to the perceptive talents of Jacques Loussier. Even so, three full LPs may be too much of a feast; if you're dubious about acquiring the whole set, I'd suggest trying Volume 1 as a sample inasmuch as this disc is made up entirely of short pieces.

Ward Swingle's French singers have approached the Bach repertory in terms of scat singing over a four-beat rhythm set by string bass and drums. It's an amusing idea—and since these are singers who not only can really sing but who also know the scat singing idiom, it is carried off extremely well. Still, once the joke has been enjoyed, the constant recourse to a language consisting of "dabba-dabba-dah," "dooby-do," "bum-pah-dah," and "do-do-do" becomes monotonous. In fact, one finds it refreshing when these syllables occasionally give way to plain old humming or un-verbalized vocalizing—though, being beyond the normal realm of the scat singer, this amounts, in the present context, to downright cheating.

JACQUES LOUSSIER TRIO: "Play Bach Jazz," Vols. 1-3

Jacques Loussier Trio.

- LONDON LL 3287/89. Three LP. \$3.98 each.
- • PHILIPS 287/89. Three SD. \$4.98 each.

SWINGLE SINGERS: "Bach's Greatest Hits"

Swingle Singers.

- PHILIPS 200097. LP. \$3.98.
- • PHILIPS 600097. SD. \$4.98.



Ward Swingle, of the Swingle Singers.



BACH: Concerto for Two Harpsichords and Strings, in C, S. 1061— See Bach, Johann Christian: Duets for Two Performers on One Harpsichord, Op. 18: No. 5, in A; No. 6, in F.

BACH: Matthaeus-Passion, S. 244 (abridged)

Adele Addison, soprano; Betty Allen, mezzo; David Lloyd, tenor; Charles Bressler, tenor; Donald Bell, bass-baritone; William Wildermann, bass; Collegiate Chorale; Boys' Choir of the Church of the Transfiguration (New York); New York Philharmonic, Leonard Bernstein, cond.

- COLUMBIA M3L 292. Three LP. \$14.94.
- • COLUMBIA M3S 692. Three SD. \$17.94.

There is obviously a legitimate place in the catalogue for what the English call a potted version of an enormous work like the *St. Matthew Passion*. Purists will object that the present album (candidly described on the cover as "abridged") makes severe cuts—in Part One a short chorus as well as solos for the two female voices, and many pages of choruses, chorales, and solos in Part Two; that the work is sung in English; that it is realized with no more than a generalized idea of baroque performing style. In fact, this is a very decent reading which deserves to be treated seriously.

The production was originally given last season at Philharmonic Hall, and it is apparent that the determining factors were narrative and dramatic. This is a rich, exciting performance, not at all lush in the late romantic manner but far more restrained and direct in a gorgeous, striking way. The first revival performances of the work under Mendelssohn must have sounded much like this (give or take a harpsichord and an oboe d'amore or two). For some it will be a sore trial trying to anticipate which of the fermatas in the chorales will be observed and which will not. Some of the tempos and phrases are very straight; others are very free, in a sort of stylized, expressive way. At one moment there is a superb, flexible phrase; at another, an agonized *ritard-morendo* which straggles off ineffectively to nothing. There is, in sum, a great deal of beautiful playing and singing with richness, quality, and flexible clarity making for maximum dramatic effect. Bach should certainly get a flexible and poetic phrase style, and dramatic-theatrical gesture is not at all out of place in a work that so obviously draws on the great Italian baroque opera tradition. The point is that Bernstein is right about what he is trying to do; and if his particular musical decisions can be criticized, his approach still has a great deal of validity. Dramatic moments, such

THE SOUND OF GENIUS



ML 5773/MS 6373*



ML 5604/MS 6204*



ML 5379/MS 6062*



ML 5486/MS 6153*



ML 5415/MS 6093*

ISAAC STERN ON COLUMBIA MASTERWORKS



All Stereo albums are also available in Guaranteed High Fidelity (Mono). © COLUMBIA; MARCAS REG. PRINTED IN U.S.A.

*STEREO

THE JOY OF BEING ISAAC STERN

He brings the same enthusiasm to an impromptu recital for his children as to the concert stage. To a Brahms sonata or a discussion of politics or baseball. To reviving a neglected concerto or preserving Carnegie Hall. His exuberance and warmth are as distinctive in his music as in his personality.

He is the total musician. One critic described his playing like this: "Violinism that has everything—stupendous technique, infinite variety of tone, limitless dynamics and the intellect to apply them... architecture with a brain, with a heart."

His performances of the great violin masterpieces are universally acclaimed. Now hear his mastery bring new meaning to such favorite melodies as "Greensleeves" and "Clair de Lune" in his newest album, None But the Lonely Heart.

ISAAC STERN ON COLUMBIA MASTERWORKS

←STEREO→
NONE BUT THE LONELY HEART
ISAAC STERN PLAYS
GREAT VIOLIN FAVORITES
NONE BUT THE LONELY HEART
HUNGARIAN DANCE NO. 5
BESS, YOU IS MY WOMAN NOW
THE FLIGHT OF THE BUMBLEBEE
JEANNE WITH THE LIGHT BROWN HAIR
LOVE'S SORROW
GREENSLEEVES
HUMORESQUE
CLAIR DE LUNE
JAMAICAN RUMBA
AVE MARIA
HOE-DOWN
THE COLUMBIA SYMPHONY ORCHESTRA
MUTCH KATINS, CONDUCTOR

ML 5898/MS 5496*



DON HUNSTEIN

as the duet with chorus which forms the musical setting of the arrest of Jesus, are given a deeply effective expression, realized out of the music itself.

Of the vocal soloists Adele Addison and Betty Allen are superb. Both produce a rich and expressive sound and use it for clear, flexible, and poetic musical purposes. Among the men, Bressler is very fine and Wildermann (the Jesus) is sonorous and impressive. Bell's voice has a wiry, ugly sound, but his singing is clear in a bassoon-y sort of way. Lloyd, singing the Evangelist, is the weakest of the principals; in his desire to be dramatic, he pushes hard, losing the flow and producing a tight throbbing sound which is sometimes off pitch center.

The various instrumental soloists, mostly first-desk men from the orchestra, play beautifully, and the orchestra itself is in good form. The choral singing is exceptional. These singers are not merely accurate and disciplined; they are capable of producing an enormous range of expressive sounds and lines ranging from the supersweet (almost unctuous) to the most intense. The sense of line and phrase is extraordinary; contrapuntal lines are strong and clear, balances are fine, and the sound quality is always remarkable. The recorded sound is on the fat side but still clear.

A bonus comes with the album in the form of a little extra disc containing a brief talk on the Passion by Mr. Bernstein. For someone who already knows the work, this will not be much of an extra and, apart from everything else, some of the theological implications of the talk are hair-raising. But at any rate, the record provides quite a clear exposition of Bernstein's conception of the work as a big dramatic statement. E.S.

BACH: *Organ Works*

Toccatas and Fugues: in D minor, S. 565; in F, S. 540; in D, S. 538; in C, S. 564. Fantasias: in G, S. 572; in C minor, S. 562. Fantasias and Fugues: in G minor, S. 542; in C minor, S. 537. Passacaglia and Fugue, in C minor, S. 582.

Helmuth Walcha, organ.

- ARCHIVE ARC 3204/05. Two LP. \$5.98 each.
- ● ARCHIVE ARC 73204/05. Two SD. \$6.98 each.

One of the most impressive achievements in the Archive catalogue, which now numbers more than two hundred discs, has been its series of eighteen records containing most of Bach's organ music performed by Walcha on one or another of two baroque organs in North Germany. Those recordings were made between 1947 and 1952. Apparently, Archive felt it was time to start a new series, in stereo as well as mono. Disc 3204 (or 73204) contains S. 565, S. 540, S. 538, and S. 564; on 3205 (or 73205) are S. 572, S. 562, S. 542, S. 537, and S. 582. All are played on the fine old organ in St. Lawrence's at Alkmaar in the Netherlands. Most of the pieces were recorded in 1962, but the *Toccatas in D minor and C major* are dated 1956 (these last, then, may not be true stereo recordings).

The present performances do not seem drastically different from the older ones. Walcha is still dependable, intelligent, and musical; he may not be the most brilliant or exciting organist now recording, but he has a big technique (his pedaling in the difficult heel-and-toe solos of the *Toccatas in C* is unerring), he can

maintain momentum over long stretches, he has a good sense of color without being knob-happy, and his tempos most of the time are convincing. Miscalculations are rare: the only ones here occur in the G minor *Fantasia*, where a dramatic figure in the middle register does not come through clearly, and in its *Fugue*, where the pedal stops chosen do not have sufficient presence. But by and large these are distinguished and eloquent readings which wear very well. The sound is of course more imposing in these stereo versions than in the older recordings, and these are pressed at the proper pitch (the older Archive recordings of S. 540 and 538 are about three-quarters of a tone too high). N.B.

BACH, JOHANN CHRISTIAN: *Duets for Two Performers on One Harpsichord, Op. 18: No. 5, in A; No. 6, in F*

†Bach, J. S.: *Concerto for Two Harpsichords and Strings, in C, S. 1061*
†Bach, W. F.: *Concerto for Two Harpsichords*

Rafael Puyana, Genoveva Galvez, harpsichords; Clarion Concerts Orchestra, Newell Jenkins, cond.

- MERCURY MG 50322. LP. \$4.98.
- ● MERCURY SR 90322. SD. \$5.98.

Trust Mr. Puyana to stay off the beaten track. As in his solo appearances on discs, he has taken pains here to seek out worthwhile material that is practically unknown. John Christian's four-hand duet in F is orchestral in scope and style; the one in A has an engaging, easygoing melodiousness. One suspects that they would sound even better on a piano, for which they were more likely intended. Wilhelm Friedemann's Concerto is courtly and formal, relatively free of the subjective traits that color some of this composer's works. The playing is excellent much of the time, but in the second movement of John Christian's Op. 18, No. 6 it could have a little more grace, and the first movement of Father Bach's Concerto is made to sound rather hard-driven. The stereo is particularly effective in this last-named work, where the two harpsichords are well separated, but the miking seems a bit too close, especially on Side B. The order of the works on the A side is as given on the sleeve, not as printed on the label. N.B.

BACH, WILHELM FRIEDEMANN: *Concerto for Two Harpsichords—See Bach, Johann Christian: Duets for Two Performers on One Harpsichord, Op. 18.*

BARBER: *Andromache's Farewell, Op. 39—See Schumann: Symphony No. 8.*

BEETHOVEN: *Overtures: Coriolan, Op. 62; Leonore No. 2, Op. 72a*
†Brahms: *Academic Festival Overture, Op. 80*
†Wagner: *Meistersinger Prelude*

Columbia Symphony, Bruno Walter, cond.

- COLUMBIA ML 5887. LP. \$4.98.
- ● COLUMBIA MS 6487. SD. \$5.98.

It is obvious that even when Bruno Walter was well into his eighties, some recording sessions found him with the vigor

and drive of a man a half century his junior. Such was the case when he taped these two Beethoven performances, which for me rank among his supreme achievements with that composer. There is fire in them, and the wisdom of one of the greatest of theatre conductors. This *Coriolan* does not subordinate the secondary themes to the original motif. There is dramatic contrast, and the final effect is the more intense for it.

The second *Leonore* overture is a problem for many conductors primarily because they learn it as a variant of the third in the series and never puzzle out its individual structure. Walter obviously approached it as if its more famous successor had never been written, thought it through, and found the key to a magnificently clear and cogent statement of its problem passages.

Both the Brahms and Wagner have been released before. They are fine performances, worthy of their present company. The recorded sound is particularly good throughout. R.C.M.

BEETHOVEN: *Symphony No. 3, in E flat, Op. 55 ("Eroica")*

Pittsburgh Symphony Orchestra, William Steinberg, cond.

- COMMAND CC 11019. LP. \$4.98.
- ● COMMAND CC 11019SD. SD. \$5.98.

Boston Symphony Orchestra, Erich Leinsdorf, cond.

- RCA VICTOR LM 2644. LP. \$4.98.
- ● RCA VICTOR LSC 2644. SD. \$5.98.

Berlin Philharmonic Orchestra, Rudolf Kempe, cond.

- PAPERBACK CLASSICS L 9218. LP. \$1.98.
- ● PAPERBACK CLASSICS SL 9218. SD. \$2.98.

Happily, here is a case where the most vital performance is also the best recorded. I refer to the Steinberg edition, remarkable for its clean-cut registration and unimpeded dynamic range, and played in the spirit of today with a firm, fairly quick pulse and the absence of romantic malarkey.

Both Leinsdorf and Kempe offer variants on the same reading, the familiar Central European approach with considerable breadth of phrase, grave rhetorical stress, and much underlining of expression. We could accept this from an older generation, but from men so young it seems an anachronism or an affectation, for the *Eroica* belongs to the eighteenth century more than to the nineteenth. It is a revolutionary work with roots deep in the baroque tradition, and it is falsification to make it sound even remotely like Brahms.

The Steinberg performance is firmly propulsive. I approve. The lines are very open; one can hear everything. Bravo! It is eloquent but it lets the eloquence come out of the music; it is not applied like a sauce. Bravissimo! The cumulative effect is tremendous. Right!

The recording suits the performance in every way, indeed colors it. In the case of Kempe and Leinsdorf transparency is sacrificed to a mellow effect and dynamics are severely curtailed. The Leinsdorf is newer by some years and thus permits the listener to hear clearly some detail obscured in the Kempe—such as the juxtaposition of strings and horn at the first movement recapitulation—but the engineering philosophy is the same. In both cases the hall is too much of a personality, too much of a participant.

To go back to the Steinberg gives a refreshing sense of regaining direct contact with the orchestra.

None of the three sets avoids a break in the slow movement. Steinberg and Leinsdorf both make the same logical division. The Kempe gives us quite an awkward hiatus. R.C.M.

BEETHOVEN: *Symphony No. 6, in F, Op. 68 ("Pastoral")*

Chicago Symphony Orchestra, Fritz Reiner, cond.

- RCA VICTOR LM 2614. LP. \$4.98.
- RCA VICTOR LMD 2614. LP. \$15.00.
- • RCA VICTOR LSC 2614. SD. \$5.98.
- • RCA VICTOR LSCD 2614. SD. \$15.00.

Few members of the Chicago Symphony public will forget the grim autumn of 1960 when conductor Fritz Reiner was stricken with sudden and serious illness during the pre-season rehearsals. It was not until the twenty-fourth week of concerts, on March 30, 1961, that he appeared before an audience. It was a great evening, and Reiner crowned it with a performance of this symphony.

The recording, made shortly afterwards, has been in RCA's reserve stock, and its release now, soon after the conductor's death last November, makes it a kind of memorial volume. It comes to us in both standard and limited editions, the latter a richly conceived and costly package, extra illustrated with some well-selected art reproductions and containing a vest pocket anthology of prose and poetry on the subject of the terrestrial order. Whether a given collector will find this handsome piece of record packaging worth the very handsome price is up to him. The real issue is the music.

Reiner departs from convention in two obvious ways. He skips the repeat in the scherzo, bypassing a double bar which even such dedicated repeat-haters as Bruno Walter customarily observed. In concert we assumed Reiner did this to conserve his strength, but apparently he had other than practical considerations in mind. Further, Reiner allows himself considerable flexibility and individuality in matters of tempo. There are changes of pace, great and small, which are not indicated in the score, and one is often aware that Reiner is going quite a bit faster or slower than the present concert norms. This is, in short, no "standard reading."

The countryside we are shown is not the Viennese woodlands of Bruno Walter's ramble, nor the classical landscape of the Toscanini edition, but an austere northern European panorama where nature is severe in her demands. We may pause by the brook, but it is cold and deep. The country folk gather, and a storm arrives with sudden fury to put them to the test. And when, at last, a hymn of thanksgiving is sung, it comes from a fear that this time a harsh nature might perhaps have prevailed.

Beethoven's *Pastoral* is universal enough to be seen through many eyes, and Reiner's approach can be defended even if one prefers another. Certainly there is no question about the excellence of the playing nor about the very special beauty of the Chicago ensemble of the Reiner years. From the purely technical standpoint this is one of Victor's best Chicago sets. Only the best tone arms, however, will track the low bass without some breakup on the more heavily Dynagrooved notes. R.C.M.



Violinist Menuhin doubles as violist.

BERLIOZ: *Harold en Italie, Op. 16*

Yehudi Menuhin, viola; Philharmonia Orchestra, Colin Davis, cond.

- ANGEL 36123. LP. \$4.98.
- • ANGEL S 36123. SD. \$5.98.

Since the day Paganini saw the rests in the *Harold* viola part and told Berlioz that it "wouldn't do," few violinists of note have come near the work. Nor, for that matter, have many violin virtuosos within memory cared to be seen in public with an instrument traditionally regarded as the fiddle's poor relation. Menuhin is an exception to the rule (he has already recorded one of the solo viola parts in the *Brandenburg* No. 6), and it is indeed refreshing to find him taking Cinderella to the ball once again (or *Harold* to the mountains). His version is a worthy addition to the currently available *Harolds* of Primrose (two) and William Lincer, and it is in some ways the most personal of the four. Lincer's has always seemed to me a perfect musician's *Harold*—articulate, fluid, fairly straightforward, and superbly disciplined; Primrose's, particularly in the Royal Philharmonic version with Beecham, is bold and handsome, set forth in beautifully rounded tones which are particularly striking in the ringing high register. Menuhin's is introverted, the most intense of them all, the most emotionally emphatic, and at times somewhat unevenly projected. Menuhin does not sound so good as Primrose in the high passages (though the difference could conceivably lie in the character of the instruments), and he occasionally tends to accent the focal point of a phrase at the expense of the tail end of it, which gets lost in the surrounding orchestral scenery. But the latter idiosyncrasy strikes one not as a fault but simply as a stamp of Menuhin's attitude—which can be serene enough at times, as it is here when the Pilgrims approach in the second movement. (The famous arpeggios are positively scholarly, and very dutifully subordinated.)

Colin Davis leads the Philharmonia with tremendous vigor and attains huge climaxes, but relies more on sheer weight and even ferocity than on the kind of rhythmic vitality achieved by Munch, or by Toscanini in the old NBC version. Sound is expansive and clear in both versions; the advantages of the stereo are perceptible but hardly worth the extra price. S.F.

BIZET: *Carmen*

Joan Sutherland (s), Micaëla; Georgette Spanelys (s), Frasquita; Regina Resnik (ms), Carmen; Yvonne Minton (ms), Mercédès; Mario del Monaco (t), Don José; Alfredo Hallett (t), Remendado; Tom Krause (b), Escamillo; Claude Cales (b), Moralès; Jean Prudent (b), Dancaïro; Roberto Geay (bs), Zuniga. Chorus of the Grand Théâtre (Geneva); Orchestre de la Suisse Romande, Thomas Schippers, cond.

- LONDON A 4368. Three LP. \$14.94.
- • LONDON OSA 1368. Three SD. \$17.94.

Janette Vivalda (s), Micaëla; Vivette Barthelemy (s), Frasquita; Jean Madeira (ms), Carmen; Irène Sicot (ms), Mercédès; Nicola Filacuridi (t), Don José; Michel Hamel (t), Remendado; Michel Roux (b), Escamillo; Jean-Christophe Benoit (b), Dancaïro; Roberto Geay (bs), Zuniga; Daniel Marty (bs), Moralès; Paris Conservatoire Chorus, Padeloup Orchestra, Pierre Dervaux, cond.

- Vox OPBX 1593. Three LP. \$9.95.

Two new *Carmens*, and neither, alas, proves notable. The London set is the more disappointing, since on paper it has such exciting possibilities.

It does have things in its favor. One is its really luscious stereo sound (I have not heard the mono version). The acoustics are broad, spacious, and rich; instruments are beautifully true to their tone colors and very alive—the horns introducing "*Je dis que rien ne m'épouvante*" afford an excellent example. And in the main, Schippers' conducting is on the plus side. It has great verve and sharpness; orchestral attack is impressively vigorous and accurate, and some of the score's most difficult sections, such as the women's fight in Act I, come off stunningly. There is a tendency to overdo contrast and to whip up a superficial sort of excitement, too—the Act II dance is begun *very* slowly and finished *very* fast, the conclusion of the Smugglers' Quintet is pushed to distortion—but it only occasionally interferes with what is otherwise an admirable reading.

Among the soloists' performances, that of Sutherland is the most encouraging. Rhythm and pitch are more reliable than they have been in most of her recent recordings, and she seems to have realized that Micaëla, at least, need not be drenched in a somnolent-sounding *morbidezza*. Her recitative delivery tries at an offhand lightness and misses (her "*oui*" sounds unhappily like Olympia's), and her enunciation is not clear or meaningful. But the quality of voice is, as usual, round and lovely, and her mannerisms well enough under control to make her Micaëla a nice accomplishment.

Roberto Geay turns in a top-flight Zuniga, and Claude Cales is an adequate Moralès. The others? Well, there is much to admire and respect in Resnik's *Carmen*—the stylistic command, the sure and often subtle dramatic instinct, the grasp of what to do with the part to make it effective but not wild, the inventiveness that enables her to stay away from the worst-worn clichés. Musically, there are many fine moments: the piano opening of the *Séguirille*, which makes its return in more abandoned tones an effective contrast rather than a mere repetition; the very smart, careful building of the phrases at "*Je pense à certain officier*," etc.; and many more. But she is not at all in good voice. The tone spreads constantly, tends to settle around the pitch, and becomes unsteady at odd

moments. The transition between lower and middle registers is ragged indeed, and results in some precarious moments. And often the low chest tones have a dry, rather old sound. She has sung much better than this, and recently too.

Del Monaco as José flings his voice everywhere around and about the music, sloughing off entire phrases, maintaining a single dynamic level regardless of the score's instructions, and singing some extremely poor French to boot. There is not a legato phrase or a sweet sound from one end of the role to the other; it is, I should say, his worst recorded performance. As for Krause, he is a burly, thick-sounding Escamillo. Unless the sound and Sutherland, plus Resnik's approach to the music, will add up to *Carmen* for you, it's thumbs down.

Vox's entry, taken from an Aix-en-Provence performance of 1956, is no world beater either, but is competent in most of its elements and a sensible buy at its Vox Box price. The José is again a stumbling block, for Filacuridi reveals a thin, tight voice of small charm, and pedestrian ideas about phrasing and interpretation. Still, his voice is more flexible, his approach more musical, than Del Monaco's.

Madeira's *Carmen* has none of the interpretative originality or distinction of Resnik's and has one or two outlandish moments (here is another prima donna with a nerve-pulverizing laugh). It is, though, a good, solid job. I believe I have never heard this singer's voice as steady and full up and down the scale as it is here. It sounds secure, big, well focused, and she is knowledgeable enough in stylistic terms. Janette Vivalda, rather nondescript vocally, is nonetheless of approximately the right timbre for the role of Micaëla and is quite acceptable in a routine way. The fact that she is French gives her a certain stylistic head start over Sutherland; she is more cosily in the frame.

Roux is not a particularly lusty-sounding Escamillo, and seems to find high F the extremity of his range. But he has sure command of the role, and is as right in terms of style as toreadors come. The same might be said of the small-part players, who, except for the Zuniga (who is the same on both recordings, and more impressive on London's), are markedly superior to London's, not so much vocally as in terms of making proper, atmospherically right contributions to the general goings-on. Dervaux's conducting is lively—it lacks the excitement of Schippers' best moments, but is carefully proportioned, possibly a bit more honest. Vox's sound, mono only, is perfectly listenable. C.L.O.

BRAHMS: *Academic Festival Overture, Op. 80*—See Beethoven: *Overtures*.

BRAHMS: *Rhapsodie, Op. 53* ("Alto Rhapsody"); *Schicksalslied, Op. 54*
†Mahler: *Lieder eines fahrenden Gesellen*

Mildred Miller, mezzo (in the *Rhapsodie* and Mahler); Occidental College Choir, Howard Swan, dir. (in the Brahms); Columbia Symphony, Bruno Walter, cond.

- COLUMBIA ML 5888. LP. \$4.98.
- • COLUMBIA MS 6488. SD. \$5.98.

This is best taken as a sort of ancillary release to Walter's complete editions of the Brahms orchestral music. The read-

ings here are quite broad and lyrical, touched by sentiment, and rhapsodic as the occasion permits. This is not, I think, the strongest side of Brahms's nature, or Walter's, but, granted the approach, it's beautifully done and appropriately recorded. I protest only that the California collegians have trouble projecting the words of a German text.

The Mahler was issued before—in the two-record version of *Das Lied von der Erde*—but now that that set is down to one disc, the new coupling is welcome. It's a performance too good to lose. R.C.M.

BRUCKNER: *Symphony No. 7, in E*
†Wagner: *Lohengrin: Prelude; Siegfried Idyll*

Columbia Symphony, Bruno Walter, cond.

- COLUMBIA M2L 290. Two LP. \$9.96.
- • COLUMBIA M2S 290. Two SD. \$11.96.

If there is to be a Bruckner renaissance, and I think it is possible, it is recordings such as this that will bear much of the responsibility. In Walter's hands the apparent *non sequiturs* and raveled ends of thought regain some form and direction. Bruckner is made to sing rather than allowed to ramble, and there is no rhetorical elephantiasis to make pretentious what is, of itself, without pretensions. (Walter even denies himself the cymbal smash in the slow movement, feeling that it is not authentic.)

The obvious comparison is with the Klemperer set (which also provides baby Siegfried as the filler). Where Walter searches for song, Klemperer strives for drama. He crashes the cymbal, plays up the Wagnerian overtones, and brings a craggy monumentality to the outer movements. This is justified, and some listeners may even prefer it. But Walter's way is winning, and I take exception only to the *dolcissimo* approach to the trio of the scherzo.

The *Lohengrin* Prelude, which surprisingly enough Walter had never recorded before, is one of his best Wagner performances. It would have profited from a couple of additional violins, but there you are—recording is expensive. A small orchestra appears to have been used in the *Siegfried Idyll*. It's a good performance, much warmer than Klemperer's but surpassed as an interpretation by the best of Walter's earlier five versions.

The recorded sound is beautiful all-around. You may find that an 800-cycle turnover improves the Bruckner. R.C.M.

COPLAND: *Concerto for Clarinet and Strings; Old American Songs, Sets I and II*

Benny Goodman, clarinet (in the Concerto); William Warfield, baritone (in the Songs); Columbia Symphony Orchestra, Aaron Copland, cond.

- COLUMBIA ML 5897. LP. \$4.98.
- • COLUMBIA MS 6497. SD. \$5.98.

The Copland Concerto for Clarinet and Strings is interesting not only as a delightful piece of Copland Americana but as a rare and important attempt by the composer to write an extended instrumental work in the style of his popular ballets (most of Copland's big instrumental works employ much weightier materials and manner). From this point of view, the work, in spite of its many felicities, is only partly successful, and

THE SOUND OF GENIUS

STEREO

SCHUBERT: THE TROUT QUINCY
BEETHOVEN: PIANO QUARTET IN E-FLAT MAJOR



JOSEPH ROISMAN, BORIS KRÖTT, MISCHA SCHNEIDER
OF THE BUDAPEST STRING QUARTET
MIECZYSLAW BORSZOWSKI, PLARIT JULIUS LEVINE, HARRY

ML 5873/MS 6473*

STEREO

THE COMPLETE
STRING QUARTETS
OF JOHANNES BRAHMS
QUARTET IN E-FLAT MAJOR
Op. 33, No. 2 (The Angel)



A 2-record set
BUDAPEST STRING QUARTET
J. Rosman, J. Gombosi, V. Kovacs, V. Kovacs, C. Csik

SL 225

STEREO

Beethoven: The Middle Quartets
Op. 59, Nos. 1-3/Op. 74/Op. 95
The Budapest String Quartet



A 2-record set
BUDAPEST STRING QUARTET

M4L 254/M4S 616*

STEREO

Beethoven: The Early Quartets
(Opus 18, Nos. 1-6)
The Budapest Quartet



A 2-record set
BUDAPEST QUARTET

M3L 262/M3S 606*

STEREO

THE LAST QUARTETS
OF MOZART
QUARTET NO. 17 IN G MAJOR K. 428
QUARTET NO. 19 IN D MAJOR K. 464
QUARTET NO. 21 IN C MAJOR K. 476
QUARTET NO. 23 IN F MAJOR K. 499



THE BUDAPEST STRING QUARTET

A 2-record set (also available singly)

SL 228

ON COLUMBIA MASTERWORKS

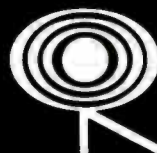

*Stereo

© COLUMBIA MARCAS REG. PRINTED IN U.S.A.

BEETHOVEN AND THE BUDAPEST

To most critics, musicians and concert-goers, there are two ultimates in chamber music—the late quartets of Beethoven and The Budapest String Quartet. To blend them together is to fashion one of the supreme musical experiences of all time. This new album marks the completion of the Budapest's third recording of the entire 16-quartet cycle. Their second recording was considered superb by critics and cognoscenti. So was their first. "They were the best we knew at the time," wrote High Fidelity. "But it is wonderful to sense how much their performances have gained through the years." Their technique has always been flawless. But there is a depth of understanding in their current reading that was not there before. Heightened insights gleam through the music like dark jewels. And improved recording techniques convey every nuance, every shading, with a fullness and fidelity never before possible.



**THE BUDAPEST
STRING QUARTET
ON COLUMBIA
MASTERWORKS**



it is probably not without significance that it has made its biggest impression in the theatre—as the music for Jerome Robbins' ballet *The Pied Piper*. Nevertheless, this seems to me a composition that has not really received its due.

The first movement probably comes off the best. It has the character of a long slow dance, derived ultimately perhaps from the Satie *Gymnopédies* but transformed into purest Copland; it is a unified and graceful conception. In this movement the clarinet is used quietly and unobtrusively but it comes to the fore in the big cadenza which follows and it dominates the second and final movement. The latter is another lively example of Copland Americana—South as well as North—and is closely related to the ballets. The movement is episodic, diffuse, and a little overinsistent, but Copland's invention in sound and rhythm and his unflinching taste and wit enable him to carry it off in fine fettle.

The work was commissioned by and dedicated to Mr. Goodman, who gives the piece a sense of his own style and projection. His sound in the upper registers (which are constantly exploited in that second movement) is very thin; for this reason especially I recommend the stereo version.

The *Old American Songs* are based on tunes, hymns, folk songs, and not-quite-folk songs from the early nineteenth century; most of these are unfamiliar little gems although one of the sets contains an attractive variant of the famous *Golden Vanity* and the other group contains a song quoted in *Appalachian Spring*. The latter, by the way, is a Shaker melody whose text begins with the words "the gift to be simple," a line that might stand as a motto for Copland's "American" style.

Copland has worked all this up into simple and delightful art settings, originally written for piano, later scored by the composer himself in a way that sets off and wittily comments on the melodic lines. A clever and typical characteristic of the settings is the way they go off-beat with the harmonies and rhythmic and instrumental accents in a kind of counterpoint to the melodic phrasing. The effect is wholly delightful. The slow tunes, in spite of their touching simplicity, are a little too naïve and sentimental for my taste (I suppose you have to be properly amused in a nostalgic sort of way to catch the right tone of these things) but the fast numbers—*The Dodger*, *I Bought Me a Cat*, *Ching-a-ring-chaw*—are charmers. In a way, the appeal of this music is like that of American "primitive" art, the semifolk art of the same period now so much in demand. The viewpoint is sophisticated; the delights are those of simple joy and uncomplicated sentiment.

Warfield is an excellent interpreter of the songs, and Copland directs his own music with style and humor. Recorded sound throughout is excellent. E.S.

DVORAK: *Concerto for Piano and Orchestra, in G minor, Op. 33*

Rudolf Firkusny, piano; Vienna State Opera Orchestra, Laszlo Somogyi, cond.
 ● WESTMINSTER XWN 19044. LP. \$4.98.
 ● ● WESTMINSTER WST 17044. SD. \$4.98.

As far as American audiences are concerned, this concerto is practically Firkusny's private property. He has played the work innumerable times, assisted by such luminaries as Sir Thomas

Beecham, Guido Cantelli, and George Szell, and he has previously recorded it (for Columbia) under Szell's direction. Indeed, the only other "name" pianist I know of who schedules the piece with any sort of regularity is Sviatoslav Richter, whose splendid performances with Ormandy and Kondrashin were highlights of his American and British tours a few years ago. Just how this splendidly tuneful concerto has missed becoming a "warhorse" is something I shall never be able to understand. To my mind, it is one of the finest, and most immediately accessible, works of this form in the entire romantic literature.

Its debut in stereo is an auspicious one in every respect. Firkusny's playing is architecturally lucid, technically brilliant, richly expressive. He shares with Richter a preference for incisive, forward-thrusting tempos, though he differs from the Soviet pianist in the area of tonal coloration—for whereas Richter favors a bright, linear sonority with sharply mercurial accentuation, Firkusny is rather less volatile, more sober and "Brahmsian." If his playing is slightly less arresting than Richter's, it could also perhaps be deemed more idiomatic.

As is standard practice these days, the Kurz revision of the piano part is utilized in the present recording, though in this instance Firkusny has reverted to Dvořák's original version in a few places.

The orchestral forces are smallish, but the Viennese players have a lovely expressive style here, and they are energetically conducted by Somogyi. Westminster's reproduction is brilliant in detail; and though the piano is close to the fore, the balance is exemplary. Stereophony pinpoints the orchestral instruments in a way that the monophonic disc cannot; the latter is beautifully engineered nevertheless. H.G.

DVORAK: *The Water Sprite, Op. 107; The Midday Witch, Op. 108; The Hussites, Op. 67*

Czech Philharmonic Orchestra, Zdenek Chalabala, cond.

● ARTIA ALP 201. LP. \$4.98.
 ● ● ARTIA ALS 7201. SD. \$5.98.

DVORAK: *The Golden Spinning Wheel, Op. 109; The Wood Dove, Op. 110*

Czech Philharmonic Orchestra, Zdenek Chalabala, cond.

● ARTIA ALP 200. LP. \$4.98.
 ● ● ARTIA ALS 7200. SD. \$5.98.

For most of his life Dvořák was an advocate of the Brahmsian ideal of "Absolute Music." He did, it is true, try his hand at opera (with variable success), and some of his earlier compositions do have some programmatic connotations. For the most part, however, his output was confined to symphonies, concertos, quartets, quintets, and the like. Then, suddenly, in 1896, immediately after his return to his native Bohemia, the composer addressed himself to the task of writing descriptive tone poems—and turned out four of them in a single year. Together with *The Hero's Song*, written in 1897, they constitute his last orchestral compositions, and indeed, his last major works in any form.

There have been many opinions expressed concerning the merit of the Dvořák tone poems. My own is that all of them contain lovely music, but that only *The Golden Spinning Wheel*, the most complex of the four here recorded, can rank alongside such other works in the genre as Smetana's *Vltava* or Strauss's *Don Quixote*. The work literally overflows with irresistible melody and vibrant Czech nationalism, but at the same time the development is splendidly symphonic. One gets the fulfillment at the end that could result only from a masterly compositional skill. *The Water Sprite* comes near to being on the same level save for a less impressive working out of its material; it too has a lovely, buoyant folk dance flavor. *The Wood Dove*, on the other hand, is rather static, while *The Midday Witch*, for all its bizarre pictorial imagery, is stiffly wooden. Indeed, many people who favor this last work above all the others probably do so just because of its peasant-like crudity.

In composing these works, by the way, Dvořák strictly followed the narratives of the poems by J. K. Erben on which they are based. These, despite their pastoral-sounding titles, are fairy tales in the macabre tradition of the Brothers Grimm. In some places Dvořák even went so far as to indicate lines of the text above the musical portrayal. (Where he did so, the music, I fear, suffers.) The composer also relies heavily on cyclic form, Leitmotive, and other such formulas of the Liszt-Wagnerian canon.

All four of the poems represented here have been recorded before, although none of them recently. Both Václav Talich and Sir Thomas Beecham had a go at *The Golden Spinning Wheel* on 78s, and the former's version was transferred to LP (first on a now defunct Urania disc, then later as one of the Supraphon releases imported here by Artia). Each of these was an excellent version, but both had cuts which were originally introduced by Josef Suk, the composer's son-in-law. Chalabala's new

NEXT MONTH IN
high fidelity

A Portfolio of Stereo Décor
 A look at some settings
 for sound.
 by John Anderson

The Hardy Independent
 Vanguard Records—
 an enduring success story.
 by John Tebbel

**The House
 That Wagner Built**
 The Bayreuth Festspielhaus
 still stands for artistic
 experiment.
 by Edward Downes

edition is more complete than either of its predecessors. Talich, a sacred name in matters Dvořákian, recorded Opp. 107, 108, and 110 as well, but only the final two were circulated here in his versions. (*The Witch*, in fact, is still available, and can now be found on Artia ALP 178 together with Talich's Dvořák G major Symphony.) There were also two Urania discs: a well-played but dully reproduced *Wood Dove* by the late Fritz Lehmann, and a drably played, though well recorded, *Water Sprite* led by Gerhard Weisenhütter. Both performances featured an aggregation referred to on the labels as "Symphony Orchestra of Radio Berlin"—presumably a *nom du disque* for the RIAS Symphony.

The present editions by Zdenek Chalabala, long-time director of the Prague National Theatre, were recorded just shortly before his death last year. Chalabala leads the works most creditably. Occasionally, he lets the theatrical elements of the writing take precedence over formal logic (as in the lyrical episodes of *The Golden Spinning Wheel*, which here sound a trifle sugary alongside the stirring and completely unsentimental Nationalist fervor that both Talich and Beecham conveyed), and the Czech Philharmonic, presumably greatly altered in personnel since the departure of Talich more than a decade ago, now produces a lighter and altogether less luscious sonority than it did in its golden days under that master. In the main, however, these performances are vibrantly alive, and brilliantly executed from the technical standpoint. Furthermore, the rasping emphasis and wide vibrato of the brass choir pays off in one instance: it imparts an altogether more menacing chill to the entrance of the *Midday Witch* than can be heard in the old Talich rendition. All told, then, what with the vastly improved recorded sound, the restored cut in *The Golden Spinning Wheel*, and the consistently lively and idiomatic interpretations throughout, Chalabala's cycle must be warmly endorsed.

The *Hussites Overture* was written in 1883 on the occasion of the rebuilding of the Prague National Theatre after a fire. Dvořák was, at that time, busily occupied with his D minor (Seventh) Symphony, and some of the tightly coiled symphonic developmental techniques used in that masterpiece inevitably extended to the present opus. It is one of the most exemplary overtures I know of, but Chalabala leads the work as if it were a Bohemian *1812*. To hear what a fine piece this really is, one has to go to the earlier Supraphon version (never issued domestically) by Sejna.

H.G.

HANDEL: *Samson*.

Phyllis Curtin, Jan Peerce, et al.; Maurice Abravanel, cond.

For a feature review of this recording, see page 65.

HAYDN: *Symphonies: No. 52, in C minor; No. 60, in C ("Il Distratto")*

Esterhazy Orchestra, David Blum, cond.
 • VANGUARD VRS 1105. LP. \$4.98.
 • • VANGUARD VSD 2143. SD. \$5.98.

I am delighted to see an edition at conventional prices of the Symphony No. 60,

for it is one of Haydn's most thoroughly original works and ought to be known by all who admire baroque music. Blum's performance is a very good one, matching, at moments even surpassing, Max Goberman's version for the Library of Recorded Masterpieces subscription series. I commend it, and the work, to your most serious pursuit of fun.

In No. 52, Blum has no American competition, although there is a Oiseau-Lyre edition by the Haydn Orchestra under Harry Newstone which may appear here momentarily. Newstone does a better job of pacing the Menuetto, but otherwise the two versions are on a level, and Blum's is not to be slighted, particularly since he has been given the better recorded sound. R.C.M.

HAYDN: *Symphonies: No. 88, in G; No. 100, in G ("Military")*

Columbia Symphony. Bruno Walter, cond.

• COLUMBIA ML 5886. LP. \$4.98.
 • • COLUMBIA MS 6486. SD. \$5.98.

Walter was one of the great Haydn conductors of his day, with a sure feeling for the elegance of expression and refinement of line which bring distinction in this literature. It is tragic, therefore, that this is all the Haydn we have from him in stereo, a token legacy where we could have been left riches. But I do not want to appear unappreciative. Both performances are deeply sympathetic and splendidly recorded, easily dominating the current stereo listings. The stress in both cases is on the long line rather than on detail, and the *Military* is intended as music, not as a "hi-fi" demonstration record. Let us accept this gift gratefully and not think of might-have-beens. R.C.M.

JANACEK: *Sinfonietta: Taras Bulba*

Czech Philharmonic Orchestra, Karel Ancerl, cond.

• PARLIAMENT PLP 166. LP. \$1.98.
 • • PARLIAMENT PLPS. 166. SD. \$2.98.

Like Dvořák, Smetana, Kodály, and Bartók, the Czech composer Leoš Janáček did much to exploit Slavonic music. This disc contains two of his most stirring orchestral works. The *Sinfonietta*, scored for an orchestra with an oversized brass section, is both brilliant and expressive. *Taras Bulba*, a rhapsody for orchestra in three sections, is a symphonic narrative of the deaths of the sixteenth-century Cossack hero and his two sons. Both works offer a blend of nineteenth- and twentieth-century musical elements, colored by Janáček's love of folk music and bright orchestral sounds. Ancerl's performances are big and broad, a proper match for the music itself, and except for a few unpolished woodwind passages the orchestra plays well. There is so much hall reverberation, however, that some of the sounds become muddy. P.A.

LALO: *Concerto for Cello and Orchestra, in D minor*—See Schumann: *Concerto for Cello and Orchestra, in A minor, Op. 129*.

MAHLER: *Lieder eines fahrenden Gesellen*—See Brahms: *Rhapsodie, Op. 53 ("Alto Rhapsody")*; *Schicksalslied, Op. 54*.

MASSENET: *Hérodiade* (excerpts)

Régine Crespin (s), Salomé; Rita Gorr (ms), Hérodiade; Albert Lance (t), Jean; Michel Dens (b), Hérode; Jacques Mars (bs), Phanael. Orchestre du Théâtre National de l'Opéra, Georges Prêtre, cond.

• ANGEL 36145. LP. \$4.98.
 • • ANGEL S 36145. SD. \$5.98.

HIGH FIDELITY recently expressed editorially its support for abridged versions of out-of-the-way operas, and here is a recording of just the sort the editors meant. *Hérodiade* is a work known by name to everyone interested in opera, and its principal airs—particularly "*Il est doux, il est bon*" and "*Vision fugitive*"—are familiar; yet it is almost never performed these days (even the Paris Opéra has not staged it since 1947). Although a complete version might not be expected to sell well, there must be a fair number of collectors curious enough at least to invest in a disc of highlights.

On the basis of what we can hear here (as well as what we can learn from scattered recordings of excerpts, most of them out of date) *Hérodiade* is by no means a great opera, or one that would wear well in the standard repertory; yet there seems to be enough interesting music in it to justify occasional revival when the right singers are available. "*Il est doux, il est bon*" is not really an outstanding piece of writing, but it is, as they say, easy on the ears, and melodically quite charming. "*Vision fugitive*" thoroughly deserves its standing as a baritone standby and the other principal baritone excerpt, "*Salomé, demande au prisonnier*" (memorably recorded about thirty years ago by John Charles Thomas), is also a very evocative piece of writing, which gains considerably from the surrounding context. The Salomé/Jean duet is only moderately interesting, and Phanael's "*Dors, o cité perverse*" is one of those pieces that makes good dramatic effect in the hands of an outstanding artist but almost none in the hands of a merely competent one. However, Hérodiade's plea to Hérode, "*Hérode, ne me refuse pas*," is distinctive—the preceding recitative, in fact, has a striking dark, dramatic quality—and both the second aria for Salomé and Jean's air "*Ne pouvant réprimer les élans de la foi*" are both more than respectable, if not very individual. Anyone who enjoys the Massenet of *Thaïs* should enjoy the Massenet of *Hérodiade*: in fact, on the basis of these excerpts, I should say that *Hérodiade* is the more distinguished score. Only one must not be put off by hindsight of the Wilde/Strauss version of the Salomé story, or by the occasionally saccharine orchestration, including the use of a saxophone in "*Vision fugitive*."

Crespin, Gorr, and Lance are all excellent here. Crespin manages to color her tone to a light, youthful tint, though of course, there is plenty of power for the climaxes. Gorr brings a lot of dramatic punch to her lines, but I must say the voice does not sound in its best condition—the top is rather edgy and sustained tones have a tendency to thin. Lance is most impressive—the voice is resonant and well focused, and his treatment of the music dignified. One could wish for a bit more animation and fervor, especially in the scene with Salomé, but offers little other ground for complaint.

Dens is, as always, vocally reliable, and he knows what to do with this music: the voice itself, though, is so dry and colorless as to rob his important role of

much of its potential effect. Mars is downright poor, limited of voice and unimaginative of style, with the result that his scene does not come off at all.

Although the accompaniments tend to spread and loosen, thus sometimes blurring the shape of the melodies, they are satisfactory enough. The sound is good, and there are extensive notes, texts, and translations. C.L.O.

MOZART: *Symphonies*

No. 35, in D, K. 385 ("Haffner"); No. 36, in C, K. 425 ("Linz"); No. 38, in D, K. 504 ("Prague"); No. 39, in E flat, K. 543; No. 40, in G minor, K. 550; No. 41, in C, K. 551 ("Jupiter").

Columbia Symphony, Bruno Walter, cond.

• COLUMBIA M3L 291. Three LP. \$14.94.

• COLUMBIA M3S 291. Three SD. \$17.94.

The product of Walter's final recording schedules, this album provides a comprehensive view of the last six Mozart symphonies as seen by the conductor in the ninth decade of his life. (There is, of course, no Mozart No. 37, the score thus designated being, in the greater part, the work of Michael Haydn of Salzburg.) Two of these performances—the first and last symphonies of the group—have been released before. Since they are the most completely satisfactory in the set, you may prefer to have them in the alternate one-disc version.

In general these are very lyric performances, with tempos on the slow side and ravishing, almost sensual beauty in the ensemble. Contours have been softened, and accents are rarely hard. Walter loved this music very deeply, and what he wanted to hear under his baton was the breathless wonder of it all.

This quality is uppermost in the recorded sound; and if you are sympathetic to such an approach, you will find the album a total success. If, however, you are still in the midst of life, you may feel that you want more vigorous Mozart, such as Walter gave us in his earlier years. The discography in this issue compares these releases with the conductor's previous versions. Every one of these symphonies is in print in another Walter performance, and some of those surpass the new versions in intensity of expression.

Take this set, then, as a lingering last look at one of the great Mozarteans of the day, and enjoy its beauties for their undeniable attraction. But for Bruno Walter's monument, you must look not only here but elsewhere. R.C.M.

SAINT-SAENS: *Samson et Dalila*

Rita Gorr, Jon Vickers, et al.; Georges Prêtre, cond.

For a feature review of this recording, see page 66.

SCHUBERT: *Sonatas for Piano: No. 21, in B flat; No. 14, in A minor*

Fou Ts'ong, piano.

• WESTMINSTER XWN 19038. LP. \$4.98.

• WESTMINSTER WST 17038. SD. \$5.98.

Fou Ts'ong's account of the great posthumous B flat Sonata exhibits tasteful reverence and a lovely singing tone.

Despite some rather fast tempos the pianist apparently feels no compulsion to drive the music vehemently and an appropriate spaciousness is preserved. Indeed, he even finds time to make the rarely heard repeat in the first movement (thereby permitting one to hear the starkly dynamic and completely original first ending).

But while the basic musicality of the performance is undeniable, this work has an impassioned power and breadth of emotion which Fou does not convey. His most serious failing is a pronounced tendency to soften contours unduly. In several places throughout this immense sonata Schubert has specified moments of pregnant silence, occasionally as long as two complete measures. Fou minimizes the impact of these dramatic pauses by easing the music into a retard before he comes to them. This happens at measure 88 in the slow movement and at measures 153 and 427 of the finale, thereby vitiating the effect that the composer so carefully planned: we should, ideally, always feel an active rhythmic pulse continuing in the void. There are also sundry other imprecisions in the playing. None of these little inaccuracies would seem, in itself, to be of great moment, but taken collectively they tend to dilute the immediacy and effectiveness of the interpretation.

Great music, as Artur Schnabel once noted, is always better than it can be played. It is, therefore, no great surprise to discover that all of the available recordings of the B flat Sonata are considerably less than perfect. Schnabel's memorable reading (now on Angel COLH 33) only serves to make his famous remark all the more poignant, since he clearly perceives subtleties which his own fingers often seem hard put to realize. (His labors on behalf of those treacherous dotted-note chords in the finale, for example, can only be described as "desperate.") If technique hampers Schnabel's reading, it also, remarkably, harms Leon Fleisher's performance (Columbia), but for a very different reason: Fleisher, a devout Schnabelian by training, views the sonata with an outlook expectedly similar to that of his illustrious mentor, but one feels that the very strength of his digital equipment—the knowledge, if you will, that he can handle the pianistic hurdles of the work with superefficiency—tends to take some of the adventurousness and spiritual grandeur away from his otherwise flawless reading. For years now, I have been constantly wavering between the near perfection of the Schnabel and Fleisher. At any rate, both are much to be preferred to Fou Ts'ong's lack of impact, Badura-Skoda's primness, Wührer's dry literalism, or Horowitz's hypertension. A new version of the B flat by Clara Haskil still awaits release (her old one, now withdrawn, was ascetic and probing). I also look forward to hearing the European editions by Adrian Aeschbacher (DGG) and Annie Fischer (HMV).

The A minor Sonata, formerly known as "Op. 143," is a fine little work in its own right. Following on the heels of the stupendous B flat, however, it is completely eclipsed by that score. Fou Ts'ong plays it nimbly, with cool objectivity and pleasing lyricism, although the old version by Solomon had more stylistic elegance.

Piano reproduction is superb, despite the very long sides. There is not much difference between the monophonic and stereo pressings, however. H.G.

SCHUETZ: *Weihnachtsbistorie*

Herta Flebbe (s), Angel; Hans-Joachim Rotzsch (t), Evangelist; Hans-Olaf Hudemann (bs), Herod; et al.; Instrumental soloists; Westfälische Kantorei, Wilhelm Ehmann, cond.

• CANTATE 640201. LP. \$5.95.

• CANTATE 650201. SD. \$6.95.

The *Christmas* Oratorio of Schütz is one of the most notable rediscoveries of this century. Although Schütz printed the recitatives in his own lifetime (he was especially proud of them as they were full of Italian techniques new to Germany), it was not until 1908, in Sweden, that the parts for the concerted numbers were unearthed. What then turned up turned out to be one of the great masterpieces of the seventeenth century. Most fascinating of all, this late work of 1664 proved to be a superb synthesis of German and Italian styles of the early and middle baroque.

Schütz is often said to have fused the old polyphonic style, still widely practiced in the conservative German tradition of his day, with the new baroque homophony and, especially, with the grand *concertante* style of the Venetians, often adopting massive instrumental techniques and colors to his exclusively vocal output. But in the *Christmas* Oratorio there is another element—the spirit of the new opera of Venice.

The scheme is basically dramatic with an alternating series of recitatives and set numbers, the whole, as in the Passions, framed by choruses. The Angel announces the birth of Christ, the heavenly hosts sing out, the Shepherds and the Wise Men come to find Jesus, the Priests prophesy to Herod, the Angel tells Joseph to flee to safety in Egypt. Perhaps the high points are the three exquisite songs for the Angel, but they are hardly more effective than the other solos, part songs, and choruses. Each section has its own definite character, and every quality of line and chord is set off by the use of characteristic instrumental timbres. All of this superb music is set into a wonderfully plastic recitative obviously derived from the Italian opera but with a shape of its own. Mere description unutterably fails to convey its charm, grace, and poetry.

This recording is really a model of its kind in performance and recorded sound. The instruments are old, correct, and played so that not only are they in tune (a thing in itself not always to be taken for granted) but so that they also sound out beautifully and sensitively. Vocally, the soloists are by no means remarkable if judged by ordinary standards of quality and projection. But their clear, focused voices assimilate remarkably well with the instrumental approach; indeed this is the old, pure, sweet instrumental style of singing and it works marvelously well here. E.S.

SCHUMAN: *Symphony No. 8*

†Barber: *Andromache's Farewell, Op. 39*

Martina Arroya, soprano (in the Barber); New York Philharmonic, Leonard Bernstein, cond. (in the Schuman), Thomas Schippers, cond. (in the Barber).

• COLUMBIA ML 5912. LP. \$4.98.

• COLUMBIA MS 6512. SD. \$5.98.

These two works were commissioned by the New York Philharmonic to celebrate

the opening of Philharmonic Hall in Lincoln Center in September of 1962. Since William Schuman is also director of Lincoln Center, he had it coming and going, as it were, and many persons expected the commemoration piece which he had been asked to write for the occasion to be a brilliant and festive affair. In fact, his Symphony No. 8 turns out to be one of the most somber, profound, monumental, and moving symphonies composed in recent years. Following none of the academicisms of contemporary music, this work is, like most of Schuman's music, ingeniously complex, altogether original in form, and wonderfully orchestrated. Conductor Bernstein and the men of the Philharmonic—as also Columbia's recording engineers—take the fullest advantage of the grandly dramatic virtuoso challenge which they have here been offered.

The Schuman is thirty minutes long, the Barber twelve minutes. Barber's text is taken from *The Trojan Women* of Euripides as translated for this particular setting by John Patrick Creagh. Andromache is saying farewell to her son Astyanax, who is about to be killed by the victorious Greeks immediately after the fall of Troy. The work sounds like the finale of *Elektra* sung by Madame Butterfly, and for once I will not protest the absence of words from the jacket notes. A.F.

SCHUMANN: Concerto for Cello and Orchestra, in A minor, Op. 129
 †Lalo: *Concerto for Cello and Orchestra, in D minor*

Janos Starker, cello; London Symphony

Orchestra, Stanislaw Skrowaczewski, cond.

- MERCURY MG 50347. LP. \$4.98.
- • MERCURY SR 90347. SD. \$5.98.

Starker's satanic virtuosity in itself would make these performances compelling; adding Skrowaczewski's equally disciplined but more pastoral and searching leadership makes them irresistible. These particular musical temperaments are ideally complementary to each other, and fortunate indeed is the record company that has both artists under contract. This team could give well-nigh ideal performances of Strauss's *Don Quixote* and Bloch's *Schelomo*. Won't Mercury please take the hint?

We have already heard Starker's performance of the Schumann (in an earlier Angel recording, with Giulini and the Philharmonia) and know of his ability to pull together all the loose ends of that sometimes rambling piece. This new version is even better, for while the rhythm in the finale is, if anything, even more buoyant than before, more of the underlying tragic drama and romanticism comes through. Only Rostropovich's more introverted and melancholy recording with Rozhdstvensky (for DGG) offers Starker-Skrowaczewski really serious competition.

The kinetic vehemence and delicate strength of the Lalo are superbly realized. While this music lacks the emotional impact of the Schumann, the present reading has such exemplary brilliance that the work appears to be a masterpiece.

The rhythmic finesse and internal clarity we recognize here are, of course, a tribute to the performing musicians, as

is the magnificent abundance of detail. These virtues, nevertheless, could never emerge with such immediacy were not Mercury's engineering outstandingly good. The sound has phenomenal presence and warmth. Place this disc on your turntable and you are magically transported to an ideally spacious concert hall. H.G.

VERDI: Aida (excerpts)

Birgit Nilsson (s), Aida; Grace Hoffman (ms), Amneris; Luigi Ottolini (t), Radames; Louis Quilico (b), Amonasro. Covent Garden Orchestra, John Pritchard, cond.

- LONDON 5798. LD. \$4.98.
- • LONDON OS 25798. SD. \$5.98.

The release of this record is timed to coincide with the Metropolitan's new production of *Aida*, starring Miss Nilsson. It gathers the principal soprano excerpts—the two big arias, the scene with Amneris, the Nile Scene duets, and the final scene—and will answer the needs of those who wish to supplement complete recordings with the Nilsson singing of the title role. As a highlights version of the opera, the record is less than satisfactory, since it concentrates so heavily on the soprano scenes.

Nilsson's voice easily encompasses the music, and there are points where the ease and balance of her voice make for stunning effects in passages usually prone to squalliness or gustiness. Certainly the piano ending of "O patria mia" is most beautiful, and there are other fine moments. But vocal beauty, power, and control notwithstanding, Miss Nils-

UNPARALLELED QUALITY

in a distinguished group of new releases from Westminster

Recordings as you have never heard them before, with surfaces so clean, and reproduction so true that concert hall presence becomes a living actuality. And the performances? Aahh!!!

On Westminster — Price \$4.98

RICHARD STRAUSS: Metamorphosen; Le Bourgeois Gentilhomme. Chamber Orchestra of Lausanne; Romascano, violin; Desarzens cond. **XWN-19026/WST-17026** ■ **CARLOS CHÁVEZ:** Piano Concerto. List, piano; Vienna State Opera Orch; Chávez cond. **XWN-19030/WST-17030** ■ **SCHOENBERG:** Verklärte Nacht, Op. 4; **ELGAR:** Introduction and Allegro, Op. 47; **BRITTEN:** Prelude and Fugue, Op. 29. Chamber Orch. of Lausanne; Desarzens cond. **XWN-19031/WST-17031** ■ **SCHERCHEN CONDUCTS CONCERTI FOR 1, 2, 3 and 6 TRUMPETS** — Telemann: Stöelzel: Corelli: Manfredini: L. Mozart. Delmotte, Haneuse, trumpets; Vienna State Opera Orch; Scherchen, cond. **XWN-19047/WST-17047** ■ **J. S. BACH:** The Great Organ Chorales. Carl Weinrich, organ; Organ of Vårfrukyrka in Skänninge, Sweden. Volume 1 (S. 651-S. 656) **XWN-19048/WST-17048**; Volume 2 (S. 657-S. 664) **XWN-19049/WST-17049**; Volume 3 (S. 665-S. 668 and Schüber Chorales) **XWN-19050/WST-17050** ■ **MILHAUD:** Sacred Service for the Sabbath Morning. Rehfuß, baritone; Choeurs de la Radiodiffusion-Télévision Française, Orchestre du Théâtre National de L'Opéra; Milhaud cond. **XWN-19052/WST-17052** ■ **CHOPIN:** Scherzi, Op. 20, 31, 39, 54; Berceuse, Op. 57; Barcarolle, Op. 60; Fantasia in F minor, Op. 49. Badura-Skoda, piano. **XWN-19053/WST-17053** ■ **GRIEG:** Sonata No. 3 in C minor, Op. 45; **FRANCK:** Sonata in A Major, Gertler, violin; Farnadi, piano. **XWN-19054/WST-17054** ■ **WAGNER:**

Rienzi Overture; Flying Dutchman Overture; Siegfried Idyll; Lohengrin Prelude. Munich Philharmonic Orch; Knappertsbusch, cond. **XWN-19055/WST-17055** ■ **W. A. MOZART:** Posthorn Serenade, k. 320; Serenata Notturna, k. 239. Chamber Grch. of Lausanne; Desarzens, cond. **XWN-19057/WST-17057**

On Music Guild — Price \$5.98

BUXTEHUDE: 5 Cantatas; Suite for organ. H. Cuenod, R. Conrad, tenors; M. Pearson, bass; Cambridge Festival Orch. Ensemble; D. Pinkham, dir. **M-45/ST-45** ■ **RAMEAU, Handel, Mozart, Scarlatti, Pachelbel, Mattheson** Balbastre: Variations for keyboard. VALENTI, harpsichord. **M-46/S-46** ■ **KRAUS, Lorenziti, Telemann, C.P.E. Bach, MONTEUX, flute; TRAMPLER, viola and viola d'amore. M-47/S-47** ■ **GRAZIANI:** Sonatas for violoncello and basso continuo, Op. 3. PARISOT, cello; Fernando Valenti and Italo Babini, continuo. **M-48/S-48** ■ **CHARPENTIER, Lully, de Laalande:** Symphonies, Royal Fanfares; **MOURET:** Suites. M. André, trumpet; P. Pierlot, oboe; Collegium Musicum de Paris; R. Douatte, cond. **M-49/S-49** ■ **HAYDN:** 3 concertos for flute, oboe and orchestra. J. P. Rampaal, flute; P. Pierlot, oboe; Collegium Musicum de Paris; R. Douatte, cond. **M-50/S-50** ■ **BÖCCHERINI:** Quartets, Op. 58, No. 5; Op. 64, Nos. 1 and 2; **CAMBINI:** Quartet in D Major. Quartet Carmirelli of Rome. **M-51/S-51** ■ **MOZART:** Symphonies K. 133 in D Major and K. 319 in B-flat Major; **STAMITZ:** Orchestral trio in C Major, Op. 1 Chamber orchestra of Prague. **M-52/S-52** ■ **BACH:** Goldberg Variations. DEMUS, piano, **M-53/S-53.**

Be sure to watch for the forthcoming additional releases in the new Westminster Collectors Series.



THE ABOVE RECORDINGS ARE CURRENTLY AVAILABLE AT ALL RECORD SHOPS
 If you are unable to find these albums locally, simply complete the coupon and mail.

WESTMINSTER RECORDING CO., INC.
 1501 Broadway, New York, N.Y. 10036

Enclosed find \$_____ Please send postpaid:

WESTMINSTER MUSIC GUILD _____

Name _____
 Address _____
 City _____ Zone _____ State _____ HF 164

CIRCLE 70 ON READER-SERVICE CARD



REVOLUTION in STEREO PHONES

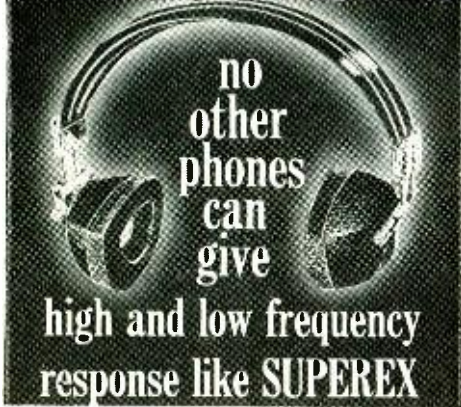

the only stereo phones with built-in woofer and tweeter in each phone

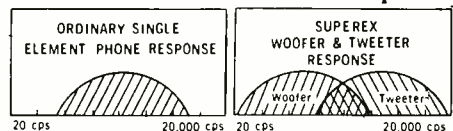

Obviously single element phones must compromise on high or low frequency
 Superex delivers the full range because of separate woofer and tweeter in each phone
 You deserve the most advanced phones... adjustable treble control in each phone... miniaturized cross-over network in each phone... single lead with stereo plug! For true stereo or monaural listening (full 20-20,000 cps range; 8-16 ohms impedance) get the most remarkably engineered stereo-phones ever built.
 Write for Free Valuable Handbook ST-M \$29.95

SUPEREX stereo-phones
 SUPEREX ELECTRONICS, 1 RADFORD PLACE YONKERS, N.Y.
 CIRCLE 61 ON READER-SERVICE CARD

son still does not impress me as a Verdi singer of consequence. I say this regretfully, as an admirer of her consistently satisfying work in the German repertory. But here one is all too aware of the lack of Italian line and color; the words go for little, the great moments pass shapelessly by. It is not that the singer is unmusical or insensitive, but her prime consideration here seems to be pure, centered tone—in greater or lesser volume, as marked. Wagner *si*, Verdi *no*.

The supporting artists are an oddly assorted bunch. Hoffman contributes very solid, not especially idiomatic or insightful singing. Quilico, remembered from some satisfying Germonts and Marcellos at the City Center (and more recently, for his Rigoletto), has opted for the dramatic baritone repertory. Much of the smoothness has departed from his singing, and the over-all effect is rather muddy and labored. But it is also strong and interpretatively vital; and when he sets his voice for it, he can still realize the long legato line, as he proves impressively at the end of the Nile Scene duet. Ottolini's voice is dry, sometimes reminiscent of Ramon Vinay's in its dark, pressurized quality, and his treatment of the music is fairly routine.

Pritchard's accompaniments are adequate. The sound is excellent. C.L.O.

WAGNER: *Lobengrin: Prelude; Siegfried Idyll*—See Bruckner: *Symphony No. 7, in E*.

WAGNER: *Meistersinger Prelude*—See Beethoven: *Overtures: Coriolan, Op. 62; Leonore No. 2, Op. 72a*.

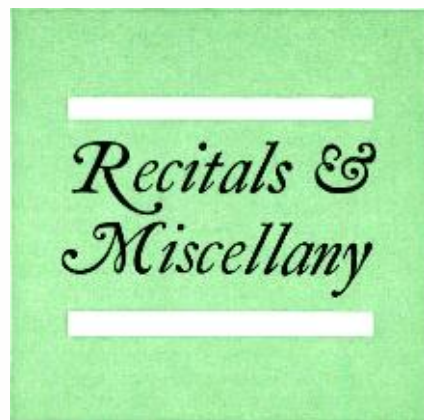

CATHERINE CROZIER: *Organ Recital*

Catherine Crozier, organ.
 • AEOLIAN-SKINNER A 315/16. Two LP. \$4.98 each.
 • • AEOLIAN-SKINNER AS 315/16. Two SD. \$5.98 each.

Miss Crozier, who was for years on the faculty of the Eastman School of Music, has taught and given recitals throughout the United States. To judge by these records, she is an artist with a big technique, good rhythm, and a nice taste in registration. Her choice of programs here, however, is not anything to cheer about. The disc labeled AS 315 and titled "Program I" consists mostly of what used to be called mood music and is now often designated "music to — by." You can fill in the blank with anything you like; the point is that you don't have to *listen* to these pieces. The longest work is the *Sonata on the 94th Psalm* by Julius Reubke, a Lisztian piece that is weak and repetitious but for some reason seems to be a favorite with organists. Also represented here are Jean Langlais (born 1907), Roger Ducasse, and Jehan Alain (1911-1940).

It may be that Miss Crozier deliberately chose such neutral stuff, because the main idea seems to be to display the qualities of the instrument, the Aeolian-Skinner organ at the Auditorium, World Headquarters, Reorganized Church of Jesus Christ of Latter-day Saints in Independence, Missouri. It is a splendid instrument with lovely flutes, characterful reeds, and rich mixtures, and it seems to be efficient in every division. It is given spacious recording here, with a wide dynamic range.

"Program II" contains some meatier items, including a rather charming and delicate Fantasy for Flute Stops by Leo Sowerby, a noble little Chaconne in G minor by Louis Couperin, Handel's Concerto in F, Op. 4, No. 5 (sounding pale without the orchestra), and Bach's Trio Sonata No. 5, in C, very well played. N.B.

GIUSEPPE DI STEFANO: *Operatic Recital*

Verdi: *Aida: Celeste Aida; Luisa Miller: Quando le sere; Otello: Dio! mi potevi scagliar: Niun mi tema*. Boito: *Mefistofele: Giunto sul passo*. Meyerbeer: *L'Africana: O Paradiso*. Ponchielli: *La Gioconda: Cielo e mar*. Puccini: *La Fanciulla del West: Or son sei mesi*. Cilèa: *Adriana Lecouvreur: La dolcissima effigie*. Leoncavallo: *La Bohème: Testa adorata*. Giordano: *Fedora: Amor*

ARTUR SCHNABEL / BEETHOVEN: The Complete Piano Sonatas
 A MILESTONE IN THE HISTORY OF RECORDED MUSIC—One of the most-wanted recordings of the century can once again be purchased by lovers of fine music. This is the definitive, authoritative interpretation by the artist who dedicated a lifetime to the study of these sonatas. A treasured possession... a distinctive gift.
 Great Recordings of the Century • Angel Album GRM 4005

CIRCLE 8 ON READER-SERVICE CARD

ti vieta. Pietri: Maristella: Io conosco un giardino. Pizzetti: Il Calzare d'argento: Davvero, quanto grande è la miseria.

Giuseppe di Stefano, tenor; Orchestra of the Maggio Musicale Fiorentino, Bruno Bartoletti, cond.

• DEUTSCHE GRAMMOPHON LPM 18827. LP. \$5.98.

• DEUTSCHE GRAMMOPHON SLPM 138827. SD. \$6.98.

One keeps hoping for a pleasant surprise from this singer—some evidence that the rapid deterioration of his splendid instrument has somehow been arrested. But there is no ground for encouragement here—not a note above the staff that does not bespeak ruinous pressure, not a high-lying phrase that is not a painful listening chore.

Two points of some interest: 1) though the *Otello* music is not suited to Di Stefano's voice, he does rather well with the opening part of the Monologue, which has clear projection of the words and some sensible phrasing. The Death Scene, though, is overdone and undignified. 2) Several of the Side 2 selections are unfamiliar. "*Testa adorata*" has been recorded before, but not recently; it is an effective number, though not, I find, a memorable one. The *Maristella* selection by Giuseppe Pietri is just bad music, from that cliché-inhabited province roamed by tertiary Italian composers who are somewhere between Mascagni and Martucci in manner.

The Pizzetti selection is somewhat more distinguished, providing at least a recognizable harmonic underpinning and some sequences of a certain intellectual interest. It rigorously avoids all suggestion of old-fashioned melodic line until it suddenly comes upon a trite post-verismo concluding progression. *Ecco* Italian opera since Puccini.

The accompaniments are quite good, and so is the sound, though it favors the singer. Text and translations. C.L.O.

GREGORIAN CHANT: "*Chants of the Church*"

Choir of the Abbey of Mount Angel and Mount Angel Seminary Choir (Oregon), Dom David Nicholson, O.S.B., cond.

• WORLD LIBRARY OF SACRED MUSIC WLSM 8. LP. \$4.98.

• WORLD LIBRARY OF SACRED MUSIC WLSM 8 S. SD. \$5.98.

Even among the many fine releases now available in the recorded plain song repertory, this disc makes two worthy claims to attention. One is as an example of how a gifted choirmaster (in this case, one well schooled in the Solesmes tradition) can train American singers to meet the highest European choral standards. While in Side A, the combined choirs, the somewhat too intent overcarefulness of the performance reveals the inclusion of less experienced singers (among the young Benedictine seminarians), in Side B, where the "Schola" Abbey Choir is heard alone, Father Nicholson's schooling in expressive sensitivity as well as in precision of rhythm and intonation is fully conveyed. The other special distinction here is the well-varied program's suitability as a general introduction to Gregorian Chant for listeners either unfamiliar with the medium or wanting something less than the complete Masses or other services most often featured nowadays in record

releases. There are no fewer than eight antiphons (including the *Alleluia*, *Lapis Revolutus Est* for Easter) and six communions; plus offertories, tropes, and hymns (two each); an introit (*Gaudemus*), sequence *Laeta Quies*, and the Advent chant *Rorate Caeli*. And all these are sung, as they should be, entirely unaccompanied.

My only, quite minor, complaints are that the otherwise informative jacket notes do not include Latin and English texts, and that the beautifully transparent stereo recording is so closely miked: especially on the B side, that the sound of the choristers' breathing is disconcertingly apparent. Even so, there is no loss of a warmly natural acoustical ambience, and the disc itself is also notable for its quiet surfaces and freedom from background noise. R.D.D.

RUGGIERO RICCI: "*The Glory of Cremona*"

Ruggiero Ricci, violin; Leon Pommers, piano.

• DECCA DXE 179. LP. \$4.98.

• DECCA DXSE 7179. SD. \$5.98.

Nobody who attended the session at which Ricci made this unusual recording is likely to forget the sight which greeted one on entering the studio: the long table, flanked by two pistol-packing Pinkerton detectives, bearing no fewer than fifteen of the world's highest-pedigreed violins. Six Stradivaris, an Andrea Amati and a Nicolo Amati, five Joseph Guarneris, a Gasparo de Salo, and a Carlo Bergonzi made up the \$750,000 collection. Past owners represented by this array included Vieuxtemps, Ole Bull, Kode, Ernst, and Hubermann. (The one owner present was Mr. Ricci himself, who owns the onetime Hubermann instrument.) The collection had been assembled by the late Rembert Wurlitzer, one of the country's leading dealers in rare instruments, and it was indeed a vision to warm the heart of any fiddle fancier.

Ricci took up the violins one by one, planted his feet firmly on the yellow chalk marks sketched at the prescribed distance from the microphones, and played on each instrument a selection chosen to show it to best advantage. For the sweet-toned and shy Andrea Amati (c. 1560—the oldest of the instruments on hand) there was a sinuous *Intrada* by Desportes; for the big, dark, almost violalike "Joachim" Strad (1714), the Brahms *Hungarian Dance* No. 20; for the huge and brilliant voice of the "De Beriot" Guarneri (1744), a stalwart and meaty composition by Hubay; for the powerful "Spanish" Strad (1677), a distillation of Russian yearning and passion by Kabalevsky. It was a fascinating parade of pieces that are fiddle music *par excellence*, and Ricci's masculine, unmincing approach suited most of them very well indeed.

There was a bonus yet to come. To pinpoint comparisons. Ricci cut a special 7-inch disc on which he played, on each instrument in succession, the opening solo statement of the Bruch G minor Violin Concerto. It is the closest most of us will ever come to a trip through the vaults of Wurlitzer's or Hill and Sons. For those who may yearn for such a trip it offers an unprecedented chance to ponder the mysteries of the craft of violin making. A lucid essay by Mr. Wurlitzer, compact notes on each instrument, and excellent sound complete a most attractive package. S.F.

Records at Cost!

through our Special Membership Plan

BUILD YOUR RECORD LIBRARY INEXPENSIVELY, QUICKLY, CONVENIENTLY NO "AGREE TO PURCHASE" OBLIGATION CHOOSE THE RECORDS YOU WANT

Citadel Record Club members purchase hi-fi and stereo albums at cost; classical, popular, jazz, show hits, folk, etc. There are never any "list price" purchases through Citadel.

CITADEL Membership —

The Proven Method Of Record Buying Used By Thousands Because . . .

- * **YOU DECIDE ON YOUR PURCHASES** — You are not obligated to purchase any particular quantity of records. Buy as few or as many records as you want . . . the choice is yours.
- * **YOU HAVE COMPLETE FREEDOM OF SELECTION** — Virtually any record or album, by any artist on any label is available including all major labels plus hundreds of smaller labels as well as most imports. Again, the choice is completely up to you.
- * **PROMPT SERVICE** — Many orders are shipped the day received, rarely later than the next several days. In the event of a delay, partial shipments are made and your order completed when available.
- * **PERIODIC SPECIALS** — Periodically you receive a list of hit albums from all categories of music at prices up to 55% off list. Again, you are under no obligation to purchase any of these specials.
- * **FREE! SCHWANN RECORD CATALOG** — With your membership you receive this quick reference to over 25,000 albums. This easy-to-use catalog contains separate sections for classical, popular, ballet, opera, musical shows, folk music, jazz, etc., and for all new releases.
- * **100% GUARANTEE** — If a damaged or defective record does get through our inspection, we shall immediately replace with a perfect copy.

Membership dues is \$3.00 a year . . . a nominal amount if you think of the prices you have paid within the past year. AS A CITADEL MEMBER BUYING RECORDS AT COST, YOUR DUES WILL BE PAID FOR WITH VIRTUALLY THE FIRST PURCHASE YOU MAKE THROUGH THE CLUB. Additional savings quickly mount up, permitting you to buy many more albums on your record budget.

May we suggest that you give Citadel an opportunity of proving its value to you. You enter no obligations, take no risks . . . simply complete the coupon below, include your \$3.00 yearly dues and upon receipt we shall immediately forward all membership material to you.

SATISFACTION GUARANTEED. Try membership for 30 days. If you are not completely satisfied, dues will be refunded immediately.

FREE! Act now. Fill out coupon, enclose your dues; we will include a free record cleaning cloth as a gift.

CITADEL RECORD CLUB

545 Fifth Avenue, New York 17, N. Y. H-14

Enroll me in Citadel for one year. I am under no obligation to purchase any particular quantity of records, but those that I do purchase will be at cost price . . . NEVER more. Send the current Schwann catalog and free record cloth immediately. I understand that if, after 30 days, I am not completely satisfied I can get my full membership dues back immediately. \$3.00 dues enclosed.

FULL NAME _____

STREET _____

CITY _____ ZONE _____ STATE _____

CIRCLE 20 ON READER-SERVICE CARD

McIntosh

PROMISES

YOU

- In every specification McIntosh makes a solemn promise. For 15 years McIntosh has made and kept such promises to you. We have guaranteed to equal or exceed our published specifications or refund our advertised price.
- McIntosh specifications hide no tricky evasions. For example, you need not fear fine print subtly limiting the specifications of our stereo amplifiers to one channel at a time.
- Nor will you find that McIntosh amplifiers are limited to 15 seconds at full treble power as are some of today's transistor amplifiers.
- You will not be oversold by McIntosh exaggerating the importance of square wave response or useless extension of high-frequency response.
- The promise to you in McIntosh specifications is not based on a single "LAB MODEL." The maximum realizable performance of a McIntosh instrument is well above the written McIntosh specifications.
For example, our MC 240 Stereo Amplifier which is rated at 40 watts per channel, both channels at the same time, will actually deliver 50 watts 20 cycles to 20,000 cycles at less than ½ of 1% harmonic distortion. There is no other commercial audio amplifier with this margin of performance above specifications coupled with such low power dissipation in its output tubes as the McIntosh MC 240.
- If you want stereo amplifiers and tuners in your home that give life-like pleasing sound, you can trust McIntosh to fulfill its promise to you.

McIntosh LABORATORY INC.

2 CHAMBERS STREET, BINGHAMTON, N. Y.

Phone—Area Code 607-723-5491

Zip Code 13903

CIRCLE 48 ON READER-SERVICE CARD

www.americanradiohistory.com

Reissues

BRAHMS: *Symphony No. 1, in C minor, Op. 68*

Pittsburgh Symphony Orchestra, William Steinberg, cond. [from Capitol P/SP 8340, 1959]

● PAPERBACK CLASSICS L 9203. LP. \$1.98.

● ● PAPERBACK CLASSICS SL 9203. SD. \$2.98.

This remains one of Capitol's best discs from a Pittsburgh series that was outstanding in its day. Technically, the newer version by these same artists has an advantage, but musically this is a comprehensive view of Steinberg's achievement with the score and, in some respects, a more powerful account of the music than the second try. The rich, mellow quality of the recording is also flattering. R.C.M.

BRAHMS: *Symphony No. 2, in D, Op. 73*

Vienna Philharmonic, Pierre Monteux, cond. [from RCA Victor LM/LSC 6411, 1960]

● RCA VICTROLA VIC 1055. LP. \$2.50.

● ● RCA VICTROLA VICS 1055. SD. \$3.00.

RCA Victor's publicity states that this performance, like the Monteux VPO *Eroica*, was never issued prior to this disc. That is not quite correct, for this Brahms No. 2 actually did appear—as part of a four-record set of the Brahms Symphonies as directed by Von Karajan, Monteux, Reiner, and Munch. (In England, the Monteux was also released as a single disc.) The company's statement does have some validity, however, in that it is doubtful whether Monteux's recording reached as many listeners as it should have in its obscure original state.

The list of names on the roster of bargain-priced Brahms Seconds—celebrities such as Furtwängler, Mengelberg, and Weingartner—looks impressive on paper. Actually, however, there is nothing remotely to compare with Monteux's splendid effort: Weingartner's is a fine reading hampered by primitive sound, while those by Furtwängler and Mengelberg, with even less acceptable sound, are both eccentric and willful interpretations.

There is, of course, a newer (full-priced) Monteux reading of the Symphony, with the London Symphony for Philips. The British orchestra plays more crisply and with cooler ensemble tone than their Viennese brethren, while Philips' stereo positioning is less conserv-

ative and, to my mind, more effective than Victrola's. I prefer the Philips version, especially as the price ratio is narrowed by the inclusion there of the *Academic Festival*. But everything about the Victrola edition—playing, engineering, and processing—is absolutely first-rate. (And if the stereo placement is rather unspectacular, it does at least offer a somewhat fuller sound than its monophonic counterpart.) H.G.

CHABRIER: *España; Joyeuse marche* †Ravel: *Pavane pour une infante défunte*

†Saint-Saëns: *Danse macabre, Op. 40; Le Rouet d'Omphale, Op. 31*

Orchestre de la Suisse Romande, Ernest Ansermet, cond. [from London LL 696, 1953]

● RICHMOND B 19097. LP. \$1.98.

Since only the Ravel *Pavane* is now available in a later, stereo edition, this program will be valued far above its modest price by every admirer of the Swiss conductor, who was at his very best in these superbly buoyant, exhilarating performances of the two Chabrier *jeux d'esprit*. And it well may be welcomed even more widely for its unfaded sonic appeal: if not quite as sonorously substantial as the finest mono recordings of today, this technical masterpiece of over a decade ago still boasts dazzling glitter as well as virtuoso-orchestral authenticity. R.D.D.

FALLA: *El Sombrero de tres picos*

Suzanne Danco, soprano; Orchestre de la Suisse Romande, Ernest Ansermet, cond. [from London LL 598, 1952]

● RICHMOND B 19100. LP. \$1.98.

Pardon my nostalgia, but ten years ago I spent the winter in the damp and foggy precincts of the University of Oxford, combating the ague as best I could with what the British would call a small gramophone and an electric fire. (In other words, I had a phonograph and a heater.) This recording of *The Three-cornered Hat* was then new, and its Latin warmth was just what I needed to raise my spirits and make the battle with the climate seem endurable. At the time, it was considered the ultimate in high fidelity engineering, and it still sounds fine to me. The performance is sensitive and idiomatic, and the effect of hearing it again was one of distinct satisfaction. Among current low-priced discs, this is a best buy. R.C.M.

GRIEG: *Concerto for Piano and Orchestra, in A minor, Op. 16*

†Schumann: *Concerto for Piano and Orchestra, in A minor, Op. 54*

Solomon, piano; Philharmonia Orchestra, Herbert Menges, cond. [from Capitol G/SG 7190, 1960]

● PAPERBACK CLASSICS L 9219. LP. \$1.98.

● ● PAPERBACK CLASSICS SL 9219. SD. \$2.98.

In its original American issue, the monophonic disc of this recording was less brightly focused in sound than its stereo counterpart. I cannot state whether the same holds true in this inexpensive reprint, since only the SD arrived for review, but the reproduction on that edition sounds fine—a bit subdued perhaps, but lucid and mellow.

Solomon's interpretations are a joy. The fine British pianist (who suffered a stroke shortly after this recording was taped) was not a stormy bravura player. His command over the notes here is effortless, complete, but always poetic, and the cantilena he produces in lyrical passages is of the loveliest, most ravishing quality imaginable. Menges leads the orchestra with fine discretion, and at times the two musicians appear almost to commune with each other in a chamber music framework. (The judiciously balanced engineering enhances that effect.)

In any price category, then, this disc is worthy of very serious consideration, and there is nothing remotely comparable in quality at bargain rates. It is to be gratefully welcomed back to the catalogue. H.G.

HANDEL: *Rodelinda* (abridged)

Friederike Sailer (s), Rodelinda; Hedwig Lipp (c), Edwige; Franz Fehringer, (t), Grimoaldo; Robert Titze (b), Bertarido; Walter Hagner (bs), Unulfo; Helmut Lips (bs), Garibaldo; Chorus and Orchestra of Süddeutscher Rundfunk, Hans Müller-Kray, cond. [from Period 589, 1954]

● LYRICHORD LL 115. LP. \$4.98.

Handel's operas are so meagerly represented on records that one is glad to welcome this disc back into the catalogue, even though it contains less than half of the score. It is an echo of the revival of Handelian opera in Germany in the 1920s. One of the chief figures in that revival was Oskar Hagen, and it is his version of *Rodelinda* that is the basis for the present recording. Hagen had cut

Handel's score considerably to make it viable for the contemporary stage, omitting a number of arias, mostly for the subordinate characters. He also shifted two principal parts, originally for *castrati*, to a baritone and a bass.

The present version deletes more than a third of Hagen's score, so that what we have here is "highlights" from the opera. There is some lovely stuff among them, such as the soprano arias "Ombre, piante" and "Ah! per che," the beautiful "Dove sei, amato bene" (here sung by the baritone), and the tender and affecting duet "Io t'abbraccio." The best singing by far is done by Miss Sailer, in the title role, who displays more spirit and variety here than I have heard from her on other occasions. Some of the other soloists sometimes reach her level. The orchestra is timid, but the sound acceptable. All in all, a case where a sampling is better than nothing. The Italian text and an English translation are provided. N.B.

HAYDN: Seven Last Words of Christ
Amadeus Quartet. [from Westminster 18055. 1955]

• WESTMINSTER COLLECTORS SERIES W 9029. LP. \$4.98.

Among the important Haydn works to have been written on foreign commission (in this case from Spain), these nine movements exist in four different versions, in vocal, piano, and orchestral forms, and the present text for string quartet. The latter, I think, is the most effective, and the present edition has had the field pretty much to itself for a dozen years. It is eloquent, well recorded, and a lesser classic of the LP era.

R.C.M.

OFFENBACH: Overtures (5)

London Philharmonic Orchestra, Jean Martinon, cond. [from London LL 350, 1951-52]

• RICHMOND B 19098. LP. \$1.98.

The once highly praised FFRR recording now seems somewhat constricted and at times even just a bit tubby, yet it is by no means lacking in strength and bright clarity. What makes this program a "must" (at least for everyone who doesn't own Scherchen's recent Offenbach Overtures from Westminster) is the controlled zestfulness of Martinon's performances. Seldom have the familiar *Orpheus in the Underworld*, *Belle Hélène*, and *Grande Duchesse de Gérolstein* been played without any suggestion of either slapdashness or sentimentalization; seldom have the less frequently heard *Barbe-bleue* and *Mariage aux lanternes* revealed more delectable piquancies and lyricism. For sheer listening pleasure, this bet at the \$2.00 window is a sure thing to pay off with daily-double munificence! R.D.D.

PROKOFIEV: Symphony No. 5, in B flat, Op. 100 (A); Scythian Suite, Op. 20 (B)

Minneapolis Symphony (in the Sym-

phony). London Symphony (in the Suite). Antal Dorati, cond. [(A) from Mercury MG 50258/SR 90258, 1960; (B) from MG 50157/SR 90006, 1958]
• MERCURY MG 50343. LP. \$4.98.
• • MERCURY SR 90343. SD. \$5.98.

These performances, not originally coupled, have just now been restored to the catalogue after a brief absence. The big attraction here is the *Scythian Suite*, that fine piece of early Prokofiev primitivism in a splendid reading under a conductor who knows his way around a ballet score. The Symphony gets a rough, driving performance whose every detail—good, bad, or indifferent—is mercilessly exposed in the glare of the dry, clear, close sound. Incidentally, the record jacket does not make clear which orchestra plays which piece, and the disc label itself incorrectly credits the Minneapolis with both performances. E.S.

RIMSKY-KORSAKOV: Le Coq d'or: Suite (A)

†Tchaikovsky: *Serenade for Strings, in C, Op. 48 (B)*

London Symphony Orchestra, Antal Dorati, cond. [(A) from Mercury MG 50122, 1957]; Philharmonia Hungarica, Antal Dorati, cond. [(B) from Mercury MG 50200, 1960]

• MERCURY MG 50344. LP. \$4.98.
• • MERCURY SR 90344. SD. \$5.98.

The *Coq d'or* concert suite here is accorded a brilliant performance, enhanced by very realistic sound. The Tchaikovsky *Serenade* appears in one of the very few uncut performances on discs, and the only one I know of that is complete on one uninterrupted record side. It is a very clean, forthright presentation by a superior group of strings. I would have liked less staccato playing and phrasing in the third and fourth movements, however. The stereo reproduction is splendid—fine, clear, and bright. P.A.

WAGNER: Siegfried (abridged)

Florence Easton (s), Brünnhilde; Nora Gruhn (s), Forest Bird; Lauritz Melchior (t), Siegfried; Heinrich Tessmer and Albert Reiss (t), Mime; Friedrich Schorr and Rudolf Bockelmann (b), The Wanderer; Eduard Habich (bs), Fafrer and Alberich. Symphony Orchestra of London and Orchestra of the Royal Opera House, Covent Garden, Robert Heger and Albert Coates, conds. [from RCA Victor M 83, 1930; M 167, 1933; M 161, 1940]

• ODEON 80744/45. Two LP. \$5.98 each.

There is only one valid criticism of these remarkable records, and that is that there is not enough of *Siegfried* on them. This fault cannot be entirely, or even largely, blamed on the current powers that be in the EMI organization. One of the great pities of recording history to date is that complete versions of all the Wagner operas were not inscribed thirty years ago, when the art of heroic singing had its most remarkable flower-

ing; in the case of *Siegfried*, lengthy passages were left unrecorded, so that we have had to wait for London's recent stereo version for a complete presentation of the opera.

Nonetheless, the HMV *Siegfried* recordings of the Thirties, which had currency here under the Victor label, contained a great deal more of the opera than is crowded onto these four generous sides. There were three of these Victor *Siegfried* albums: M 83, embracing twenty sides; M 161, embracing twelve; and M 167, embracing eight and duplicating some of the final duet music contained on M 83. All these albums starred Melchior as Siegfried, except that M 83 replaced him with Rudolf Laubenthal for the final duet with Frida Leider (commencing at "Heil dir, Sonne"). Odeon has taken these three sets and collated them, placing all the music in its proper sequence. It's an admirable plan, except that fairly sizable chunks of the music that was recorded have been left out.

The following passages from the indicated 78 sets have been omitted from the Odeon re-pressings: 1) the Prelude (M 167); 2) Mime's opening monologue "Zwangvolle Plage," up to the point of Siegfried's entrance (M 161); 3) the Act I passage between Mime and Siegfried, beginning at "Fühltest du nie in finstren Wald," and running to the beginning of Siegfried's Forging Song; 4) the entire Erda scene at the opening of Act III, beginning with the orchestral introduction, going on through Wotan's "Wache, Wald!," Erda's "Stark ruft das Lied," and the ensuing colloquy (M 83).

This adds up to seven or eight 78-rpm sides, and is easily enough to justify a third record, particularly when they can be acquired separately, as is the case here. The cuts are all real losses, not merely for the music, but for the performances. Tessmer and Albert Reiss were both splendid Mimes in very different ways. A graver omission is the Wotan/Erda scene, as sung by that extraordinary husband-wife combination, Emil Schipper and Maria Olszewska. It opened with a fine, thunderous performance of the orchestral introduction to Act III by the Vienna State Opera orchestra under Karl Alwin. Schipper was perhaps not a great dramatic baritone—a rung or two below the other Wotans heard here, Schorr and Bockelmann—but he was a very solid one, and would certainly be a welcome addition to the current crop. And since the retirement of Olszewska, there have been only one or two Erdas (Branzell comes to mind) whose names could properly be mentioned in the same breath with hers.

There might be some question in certain collectors' minds as to whether or not the Laubenthal/Leider version of the duet should not have been included, on the strength of Leider's contribution. Here, though, I think the correct decision has been made. To begin with, the Easton/Melchior version is complete (nearly twice as much music here as on the Leider performance). And while Easton is not quite up to Leider's standard either vocally or stylistically, she is extremely good; the voice is bright and full and

wide-ranging, capable of a true trill, and her interpretation has a direct, almost girlish flavor of its own that is quite interesting and appealing. Between Laubenthal and Melchior there cannot be any comparison; if Leider is somewhat more exciting than Easton, Melchior is several leagues removed from the constricted, strained vocalism of Laubenthal, however well routinized that is.

Enough of what there is not, or what there might have been. What have we here? In Volume 1, we have a healthy stretch of the Siegfried/Mime scene, from Siegfried's entrance through his dash off into the woods; then the Wotan/Mime scene from the point of Wotan's entrance ("*Heil dir, weiser Schmied*") through the end of Mime's three riddles (but not including Wotan's questions); then the finale of the act from the start of the Forging Song on. From Act II, there is the Forest Murmurs scene ("*Das der mein Vater nicht ist*") and the Siegfried/Fafner fight. In Volume 2, there is a portion of the Mime/Alberich quarrel, Siegfried's scene with the Forest Bird after the death of Fafner (we get a few of Fafner's lines and Siegfried's "*Da lieg auch du, dunkler Wurm*"); then, from Act III, the Siegfried/Wotan confrontation, starting at "*Kenntest du mich, kühner Spross*" and, occupying the entire final side, the concluding scene of the opera, beginning with "*Was ruht dort schlummernd.*"

This adds up to slightly less than half of *Siegfried*, which, however one may regret the excisions, is quite a good deal of music. Certainly no one who does not own the originals should have a moment's hesitation over the purchase, for the performances are incomparable—in fact, I think it is not unfair to say that there is not a moment of this performance (excepting a few purely orchestral passages or small portions of the soprano's music) that could be matched today. Melchior, of course, makes most of the difference. There is no other opera that depends so heavily on its tenor hero, and there is probably no other singer/role match more clearly superior to all competition, past or present, than Melchior as Siegfried. He is most obviously superior with the heroic side of the role. In the Forging Song and the final duet, it is really all most tenors can do to find ways of negotiating the music; Melchior throws himself into it with joy. Most of the negative feeling one hears voiced about the opera, its central figure, its music, have a way of disappearing when Siegfried sounds like a true hero. But there is more to Melchior's portrayal than the ring of a real *Heldentenor*, vital as that is. He could modulate his tone to any dynamic level, and to any of a wide variety of colors, and he was, for all the sloppy musicianship of his later years at the Met, an intelligent, sensitive interpreter. There is contemplativeness and tenderness in the *Waldweben* scene, and most particularly in the beautiful passage during which he speculates about the nature and fate of his mother. There is genuine innocence and humor—not beefy cuteness—in his "*Das tönt nicht recht*" when he fails to imitate the Forest Bird's

song on his pipe. And there is passion, longing, and urgency in the mounting climaxes of the last pages. This is one of the great vocal achievements on records, and will come as a revelation to those who may not have heard it.

Melchior's work alone would justify the re-release of these records, but fortunately there is much else besides. I have already spoken of Tessmer, Reiss, and Easton, each of whom is splendid. Then there are the two Wotans, Schorr and Bockelmann. It would be idle to claim that Schorr's top register was especially easily produced or ingratiating to the ear, at least at this stage of his career; high F is a strain, and the sound shows it. But the voice is so steady and warm, the phrasing so smooth and yet so sharp in attack, and the sense of style so secure, that a few top notes do not seem to matter. In his opening words to Mime there is a feeling of calm, of acceptance of all things, which immediately conveys the essential attributes of The Wanderer. (What perfect pages these are!) I would imagine that Schorr must have made Wotan's final moments, his capitulation to Siegfried, a very great theatrical experience.

Bockelmann is at his best here, as he is with his sturdy, resonant Kurwenal on the old Bayreuth *Tristan*. His voice, like Schorr's, was rock-steady, not so warm as Schorr's, but more at home in the upper part of the heroic baritone range, and a bit weightier. Like Schorr, he sang beautifully in this music—something that contemporary baritones, with an occasional exception like George London, seem to regard as irrelevant if not actually subversive. He does his one scene magnificently.

Heger and Coates were both front-rank Wagnerian conductors, and they had superb ensembles to work with. It is a bit difficult to objectify responses to performances that one has grown up with; I must have heard these *Siegfried* recordings fifty or sixty times before I heard anyone else conduct the music, or consulted the score. (I suppose this may be true, to some extent, with regard to the singing too—I just can't get used to the idea of artists not vocalizing well, even though they may get away with it in roles like Mime or Hunding.) Still, this seems to me like first-rate Wagnerian playing—uneccentric, straightforward, "in the blood," with nothing hard-driven or frantic about it, and with no special theories about inner lines or sonorities in operation.

The recorded sound, despite overaverage side length, is much above the norm for transfers, if not quite as clear or brilliant as that of the originals when heard on good equipment.

In sum: those who know these recordings, but do not own them, will not waver, however sorrowful they may be about the unfortunate and unnecessary cuts; those who have not made their acquaintance are under an imperative to do so—to find out how *Siegfried* can sound. C.L.O.



DAVID OISTRAKH: *Violin Recital*

Chausson: *Poème*, Op. 25 (A). Saint-Saëns: *Introduction and rondo capriccioso*, Op. 28 (B). Leclair: *Sonata for Violin and Piano*, No. 3, in D (C). Locatelli: *Sonata for Violin and Piano*, in F minor (arr. Ysaÿe) (D).

David Oistrakh, violin; Vladimir Yampolsky, piano (in C and D); Boston Symphony Orchestra, Charles Munch, cond. (in A and B). [(A) and (B) from RCA Victor LM 1988, 1956; (C) and (D) from LM 1987, 1956]

• RCA VICTROLA VIC 1058. LP. \$2.50.
• • RCA VICTROLA VICS 1058. SD. \$3.00.

These pieces represent David Oistrakh's very first American-made recordings, yet in one respect the reissue turns out to be better than the initial releases. The originals were recorded on both mono and stereo tapes but issued on discs in mono only. Now they are available both ways and sound excellent. Oistrakh moves along more swiftly and flowingly in the Chausson and Saint-Saëns than almost any other violinist, though he might have dug a little more deeply into the music. On the other hand, he is most expressive in the slow movements of the two sonatas. Victor has succeeded here in distilling the best material from the two earlier discs and combining it on an improved, lower-priced record. P.A.

FERNANDO VALENTI: *Spanish Keyboard Music*

Albéniz, Mateo: *Sonata in D*. Angles: *Adagietto in B flat*; *Sonata in F*; *Aria in D minor*. Casanovas: *Sonata in F*. Galles: *Sonatas: in F minor; in B flat*. Freixanet: *Sonata in A*. Rodriguez: *Rondo in B flat*. Cantallos: *Sonata in C minor*. Serrano: *Sonata in B flat*. Fernandez: *Sonata in C minor*.

Fernando Valenti, harpsichord. [from Westminster 18624, 1957]

• WESTMINSTER COLLECTORS SERIES W 9323. LP. \$4.98.

A charming collection of delightful eighteenth-century Spanish obscurities (with the exception of the piece by the "other" Albéniz, the warhorse, so to speak, of the collection). The music ranges in style from pure Scarlatti-ism to a highly developed classical manner with obvious derivations from Boccherini and Haydn. Oddly enough, nearly all of these composers were in orders; some of them are so obscure that not even their first names are known, but they all had art within a minor but charming tradition.

Valenti's performances are free, rich, and most attractive; the recorded sound holds up very well. A minor mystery: how was all the swelling and fading accomplished? Most of the time, this seems to come across as a result of an itchy finger on the controls. There certainly seem to have been musical reasons for much of the constant dynamic shifting, but a good deal of it is not very convincing. E.S.

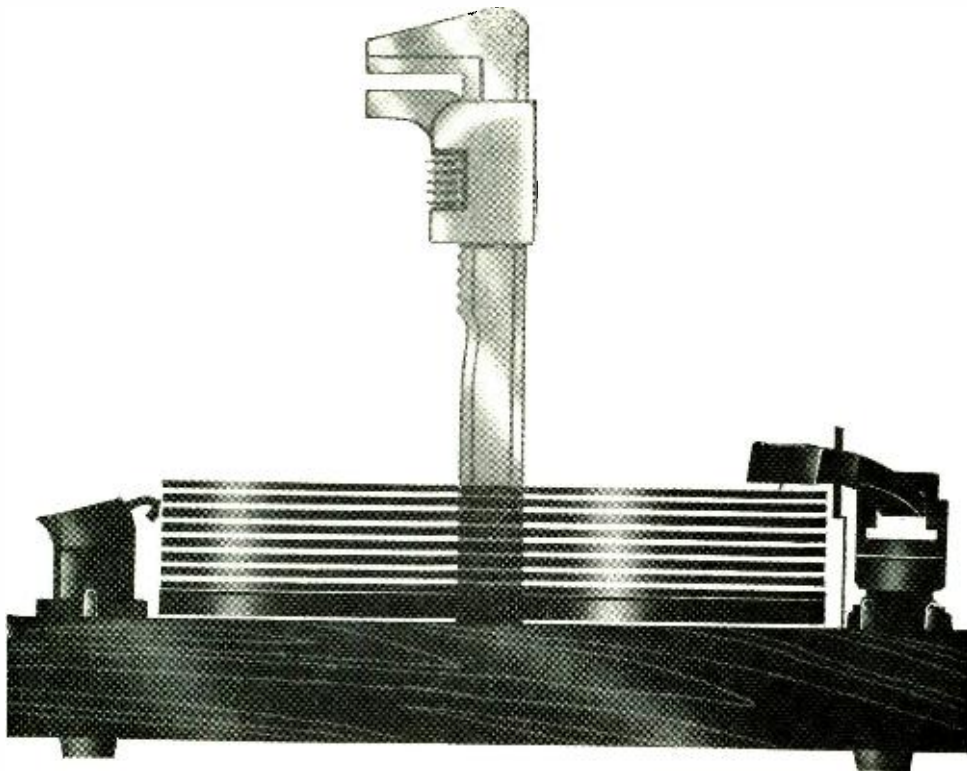

do you have a monkey wrench in your automatic turntable?

Any spindle that permits the stacking of records on a turntable throws a monkey wrench into the entire system.

The stacking of records varies the stylus angle – increases the load on the motor – creates flutter and wow – wears records – diminishes your listening pleasure. IS IT WORTH ALL THAT JUST TO CHANGE RECORDS?

*If you want a transcription turntable plus a changer . . .
working together properly . . . see the Thorens TD-224.
There's no other instrument like it in the world.*



THORENS

If your dealer cannot qualify for a Thorens Franchise—go to another one! ELPA MARKETING INDUSTRIES, INC., Dept. HF1, New Hyde Park, N. Y.

CIRCLE 45 ON READER-SERVICE CARD

The Lighter Side

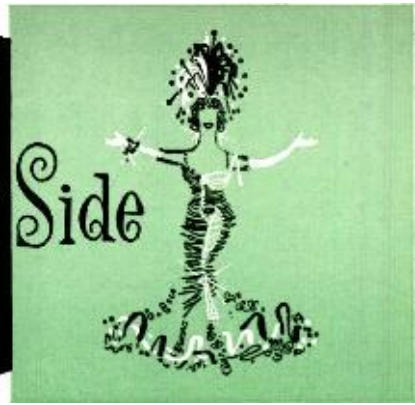

"Lady in the Dark." *Risë Stevens, Adolph Green, John Reardon, et al. Columbia OL 5990, \$4.98 (LP); OS 2390, \$5.98 (SD).*

WHEN *Lady in the Dark* opened in New York in January 1941, several new and decidedly special things arrived in the American musical theatre. Originally having in mind a play with a few incidental songs, Moss Hart set out to examine the complexes responsible for the conflict between the career and the love life of a successful magazine editor, Liza Elliott. As the project developed, Kurt Weill's music took on an increasingly important role, but the work was still far removed from the conventional "musical comedy" of the day.

Except for recurring fragments of what proves to be the climactic theme, *My Ship*, the music of *Lady in the Dark* is confined to four dream sequences in which Liza's fantasies on the psychoanalyst's couch reveal the inner motivation for her difficulties. By this means the boy-girl conflict seemingly essential to Broadway shows and usually presented in its shallowest form was, for the first time, placed in adult perspective. To celebrate this arrival of Sigmund Freud on the American musical stage, Kurt Weill turned away from the relatively conventional work he had been doing since his arrival in the United States six years previously and created a score that brilliantly captured the shifting moods and settings of Liza's dreams; and for Weill's highly melodic and frequently witty music, Ira Gershwin wrote a superb set of lyrics in which the scintillating talent



Miss Stevens, Mr. Green: now, a full-dress recording for Weill's witty music and Gershwin's bright lyrics.

evident in his earlier efforts came into full flower. To project all this, there was Gertrude Lawrence, giving as Liza the virtuoso performance of her career, and there was the explosive arrival of a previously unknown comedian named Danny Kaye.

The opening of *Lady in the Dark* anteceded the era of the original cast recording by about two years, although at the time Miss Lawrence and Mr. Kaye each recorded excerpts from the production for RCA Victor (these 10-inch 78-rpm discs were once available on LP reissues but have since disappeared from the catalogue). In the intervening years other pre-original-cast musicals have been given recorded documentations, but unaccountably, we have had to wait for a full-dress recording of *Lady in the Dark* until now. The present handsome, beautifully recorded album, for which Lehman Engel has wisely used Weill's original orchestrations, is a welcome remedy for this oversight.

A basic problem with any production of *Lady in the Dark* is that it must contend with long-time theatregoers' insistent memories of the performances by Miss Lawrence and Kaye. Happily, Columbia's version will quickly dispel whatever trepidations one may have on this count. Despite some erratic moments, Risë Stevens has realized the role of Liza unusually well. Most of her difficulties center on the spoken lines, which demand a sense of style that she is not always able to command. This affects her singing only once, however, in *The Saga of Jennie*, where her hurried and flat spoken introduction gets her off to a poor start on the song. And although Adolph Green has to strain to meet some of the singing requirements of the Danny Kaye assignment, he makes excellent use of his abilities as a mimic to give his lines crisp authority.

Unlike the scores of most Broadway musicals, *Lady in the Dark* has relatively few set pieces for the leads. The four dream sequences are beautifully woven patterns depending almost as much on the chorus and a variety of subsidiary solo voices as they do on Miss Stevens and Green. John Reardon sings *This Is New* with easy authority, and Stephanie Augustine is especially winning in a brief appearance.

Good use is made of the spread of stereo all through the recording and particularly in the exchanges in the courtroom sequence of the *Circus Dream*.
J.S.W.

4 NEW ALBUMS BY COMMAND

ELECTRIFYING PERFORMANCES
INCOMPARABLE ARTISTRY
INCREDIBLE RECORDING
BRILLIANCE

TORCH SONGS FOR TRUMPET

Doc Severinsen and His Orchestra



By Myself * I Got
It Bad * There Will
Never Be Another
You * Angostura
Suite * Born To Be
Blue * Yesterdays
* Stormy Weather
* Just One Of
Those Things *
Don't Worry 'Bout Me * Cry Me A
River * They Can't Take That Away
From Me * This Is All I Ask 859

LEE EVANS IN CONCERT

The concert touch in New and
Exciting popular piano arrangements



Brother Can You
Spare A Dime *
Kisses Sweeter
Than Wine * Porgy
And Bess Medley
* Midnight In Mos-
cow * The Simple
Joys of Maiden-
hood * Satin Doll
* Thou Swell * Body And Soul * The
Way You Look Tonight * If I Should
Lose You * Look No Further 858

VIRGIL FOX AT THE ORGAN PLAYS JOHANN SEBASTIAN BACH

The music of Johann Sebastian
Bach performed by Virgil Fox on
The Riverside Church Organ



Fantasy And Fu-
gue In C Minor *
Trio Sonata VI In
G * Prelude And
Fugue In D * All
Men Are Mortal
(Alle Menschen
Müssen Sterben)
11022

WAGNER, PRELUDES & OVERTURES

William Steinberg and
the Pittsburgh Symphony Orchestra



Die Meistersinger
(Prelude) * A
Faust Overture *
The Flying Dutch-
man (Overture) *
Rienzi, The Last Of
The Tribunes
(Overture) 11020

AVAILABLE AT YOUR RECORD DEALER'S IN
STEREO, MONAURAL AND 4-TRACK TAPE
Write for our FREE full-color brochure
of Command Releases

World Leader
in Recorded Sound
Command
records

1501 Broadway, New York 36, N. Y.

CIRCLE 25 ON READER-SERVICE CARD

Brigitte Bardot: "Sings." Philips PCC 204, \$4.98 (LP); PCC 604, \$5.98 (SD). Well, gentlemen, here it is. Brigitte Bardot sings, eh? We open a book-fold album. Pictures, possibly? Ah, yes, and we observe Miss Bardot—fully clothed, from neck to toe. What kind of a record is this? If one can disregard the disappointments of the sleeve-book and go on to play the record, one will discover that Miss Bardot has a great deal of unpretentious charm, even skill, as a singer. Her program is a mixture of French music hall songs and lighthearted evocation of the pop music of the 'Twenties, along with one venture into pseudo rock 'n' roll and a try at English on *Everybody Loves My Baby*. The latter turns out to be a winning effort simply on the strength of Miss Bardot's vocal charm. Vocal charm, in the final count, is what Miss Bardot has. No sex kitten stuff, either. She can keep her clothes on, breathe normally, and make it quite capably—just singing.

Danny Kaye: "The Best of." Decca DXB 175, \$7.98 (Two LP); DXSB 7175, \$9.98 (Two SD).

The myriad talents of Danny Kaye are offered in splendid cross section in this culling of his Decca-made recordings. Possibly even too much of Kaye is revealed—his blandness as a straight singer is exposed on *Anywhere I Wander* and, despite his usual ingenuity, he gets caught with almost nothing creative to contribute to such familiar songs as *St. Louis Blues* and *Ballin' the Jack*—but these evidences of human fallibility matter hardly at all in comparison with the sustained delights following one after another through most of the four sides of this album. Kaye is rowdily French in *Pigalle*, dramatically folk-Irish on *Molly Malone*, burringly Scottish on *I Belong to Glasgow*; he captures a variety of aspects of England on *I've Got a Lovely Bunch of Coconuts*, *Mad Dogs and Englishmen*, and the Gilbert and Sullivan patter of *The Policeman's Song* and *When I Was a Lad*; and he offers such Kaye classics as *Tchaikowsky* (from *Lady in the Dark*), *The Peony Bush*, *Anatole of Paris*, *The Lobby Number*, and an acquisition called *Triplets*. In fact, a great deal of the basic Kaye material—the songs on which his reputation is based—has been collected on these two discs, making the set as definitive as any Danny Kaye collection is likely to be.

Frank Cordell and His Orchestra: "Hear This." Capitol T 10346, \$3.98 (LP); ST 10346, \$4.98 (SD).

For a program made up primarily of Rogers hits (with touches of Kern, Porter, Arlen, and Ellington), England's Frank Cordell has created arrangements that are adventurous without ever becoming in any sense far-out. Essentially, what he does is to take such familiar material as *So in Love*, *I Didn't Know What Time It Was*, *My Funny Valentine*, *I'm Old-fashioned*, *Caravan*, and *Come Rain or Come Shine* and, by combining rich harmonies and an easy rhythmic flow, give them fresh vitality without re-

sorting to tricks. He turns *June Is Bustin' Out All Over*, for instance, into a delightfully airy tour de force for pizzicato strings; he gets unusual and interesting results from a combination of trombone and flute on *Come Rain or Come Shine*; and he shows the full body of his orchestra on *Caravan*. He makes especially effective use of strong, dark bottom sounds and spices his arrangements with short passages by several of Ted Heath's solo stars.

Patachou: "At Carnegie Hall." Audio Fidelity 2109, \$4.98 (LP); 6109, \$4.98 (SD).

Patachou's warm and engaging personality comes through strongly in this concert recording. She has a quality very much like Maurice Chevalier's—a beguiling charm particularly marked in her spoken introductions, which in their style, their inflection, and their humor are strikingly in the Chevalier vein. Though she is not a great vocalist, she is a superb showman and makes excellent use of the dark, sinuous, and sometimes throbbing qualities of a relatively limited voice. Her program projects the feeling of a French music hall with an admirable mixture of songs familiar on both sides of the Atlantic—*Que reste-t-il* (which in the United States is *I Wish You Love*), *Chanson d'Irma* from *Irma la Douce*, and *La Goulante de pauvre Jean* (she explains with great zest why the American title *The Poor People of Paris* is all wrong)—along with material that in its melodic lilt and dramatic flair is uniquely Parisian.

Antonio Carlos Jobim: "The Composer of 'Desafinado' Plays." Verve 8547, \$4.98 (LP); 68547, \$5.98 (SD).

Practically the patron saint of the bossa nova movement, Jobim is one of the prime sources of the wistfully haunting melodies typical of this music at its most appealing. As well as the initial bossa nova hit, *Desafinado*, he also wrote such popular examples of the genre as *One-note Samba*, *Meditation*, *Chega de Saudade*, and *Insensatez*. They are all included here, along with several other attractive Jobim compositions in a similar vein, played by a group in which strings and rhythm form a foundation over which Jobim's very simple, single-note piano patterns, and occasionally a flute or a soft trombone, carry the melody. The set is charming in its simplicity and complete lack of pretension, although the similarity in mode and interpretation from one piece to the next may make for monotony if taken all at once.

Charlie Cochran: "Presenting Charlie Cochran." Ava 25, \$3.98 (LP); S 25, \$4.98 (SD).

Cochran, a singer new to me, has a light, ingratiating voice which he uses extremely effectively in a group of low-keyed, well-chosen songs. He apparently is enjoying the sponsorship of Fred Astaire (to the extent that Ava is Astaire's company and Astaire has written the liner notes for this disc), and his singing style has a good deal in common with Astaire's—with the notable exception that he has

a bit more voice than Astaire had even in the latter's best days. The similarity is particularly noticeable on *A Lonely Old Song*, a number that Astaire could have done delightfully. The rest of the program leans towards a more deliberate tempo than Astaire might have chosen, but Cochran handles it well, assisted by quietly effective arrangements from Dick Hazard.

Lena Horne: "Lena Like Latin." Charter 106, \$3.98 (LP); S 106, \$4.98 (SD). Miss Horne's highly mannered style fits cozily into the sinuous strains of the various Latin rhythms used throughout this set. Sometimes she is completely involved in the special rhythms—as on the bossa nova-bred *Meditation* or on the bossa nova adaptation of *Night and Day*—and sometimes she imposes a relatively straight singing approach on the Latin beat, as in her very effective treatment of the coaxing *By Myself*. Along with songs that one might expect to find in such a program (*Old Devil Moon*, *Island in the West Indies*, and *Take Me*) there are occasional surprises such as *My Blue Heaven*, turned here into a jaunty bit of hip-swinging fun. On occasion Miss Horne's dramatic projection produces some battles between song and style, but it's a sporting proposition—the victory sometimes goes one way, sometimes the other. Always she is distinctive, and more often than not, a lot of fun.

Earl Grant: "Fly Me to the Moon." Decca 4454, \$3.98 (LP); 74454, \$4.98 (SD).

Grant has succeeded in avoiding both the limpness and the stickiness often characteristic of mood music programs played on the organ. With the help of unbilled guitar, bass, drums, and tenor saxophone, he manages to mingle the welling, flowing sound expected of an organ with vitalizing contributions from the guitarist and saxophonist. There are times when the combination of a particular tune with the organ makes for an inescapable commonplaceness—on *Over the Rainbow*, for instance—but in most cases Grant and his group have managed to provide a provocative and perky approach.

Til Dieterle: "Like Time on My Hands—A Tribute to Vincent Youmans." 20th Century-Fox 5020, \$3.98 (LP); S 5020, \$4.98 (SD).

While this is an album about which it is very easy to carp, it has points of interest. Youmans' songs are worthy parts of the great musical comedy flowering of the Twenties and Thirties and, even though illness cut short his active career, his work ranks deservedly with that of the giants of those days—Kern, Porter, Rodgers, and Gershwin. His music seems to flow gracefully almost by instinct, and it is therefore rather unforgivable that the performances in this collection are in several respects clumsy. Miss Dieterle is a stiff and starchy pianist, and the melodic level is not improved in the four selections on which she is assisted by Ashley Miller on organ. Instrumentally, the saving grace is the solo guitar of Al

VANGUARD

Current and Choice Recordings for the Connoisseur

Classical



BEETHOVEN:
The 10 Sonatas for Violin and Piano (Complete)
JOSEPH SZIGETI, violin
CLAUDIO ARRAU, piano
The legendary concerts of 1944 at the Library of Congress, Washington, D.C.
A Special Vanguard Anniversary Release. 4-12" discs boxed, with full analytical notes. Mfr's suggested list price \$11.90
VRS-1109/12

J. S. BACH:
The Musical Offering
Newly worked out, and performed by a Baroque chamber ensemble typical of Bach's day.
THE WIENER SOLISTEN
WILFRIED BÖTTCHER, conductor
Fritz Neumeier, harpsichord
BG-658 (Mono) BGS-5070 (Stereo)

HAYDN: *The Sturm und Drang Symphonies*
No. 44, *Trauersymphonie* & No. 45, *Farewell*. *VRS-1106
No. 46 in B major & No. 47 in G major. *VRS-1107
No. 48, *Maria Theresa* & No. 49, *La Passione*. *VRS-1108
Antonio Janigro conducting the Symphony Orchestra of Radio Zagreb.

MAHLER:
Des Knaben Wunderhorn
MAUREEN FORRESTER, contralto
HEINZ REHFUSS, bass-baritone
Symphony Orchestra conducted by Felix Prohaska. *VRS-1113

*Also on stereo

Folk & Popular



ODETTA—
"ONE GRAIN OF SAND"
Spirituals, work songs, love songs, traditional folk songs.
VRS-9137 (Mono)
VSD-2153 (Stereo)

SHOSHANA DAMARI—
"SHOSHANA"
A program of Israeli and International songs performed in Hebrew, Yiddish, Spanish, Rumanian, Turkish and Arabic.
VRS-9126 (Mono)
VSD-2144 (Stereo)

ERIK DARLING—
"TRAIN TIME"
VRS-9131

JIM KWESKIN and THE JUG BAND
VRS-9139 (Mono)
VSD-2158 (Stereo)

LIANE—
"APRIL IN PARIS" VRS-9129

Choice Releases



HANDEL: Music for the Royal Fireworks and Concerto a Due Cori in F.

Charles Mackerras conducting a Band of 64 Winds and 12 Percussion. BG-630 (Mono) BGS-5046 (Stereo)

"A magnificent display... what makes this such a stunning record is not just the breathtaking sound of all those winds, brasses and drums, but the stylishness of the interpretation."
I. Kipnis, HiFi/Stereo

"Stunning performance... superb, exciting, breathtaking, nerve-shattering... A truly outstanding record."
E. Helm, Musical America

GOTTSCHALK: Symphony—A Night in the Tropics

GOTTSCHALK-KAY: Grand Tarantelle

GOULD: Latin-American Symphonette

Maurice Abravanel conducting the Utah Symphony Orchestra; Reid Nibley, piano.

VRS-1103 (Mono)
VSD-2141 (Stereo)

"A Night in the Tropics... is evocative, romantic music by the most romantic of musical figures. The first movement is a most remarkably lush and sustained outpouring of gorgeous, sensuous melody the counterpart of which I cannot recall... Excellently performed and recorded."
E. Sutzman, High Fidelity

CIRCLE 68 ON READER-SERVICE CARD

WRITE FOR QUOTATION

ON ANY HI-FI COMPONENTS

DISCOUNTS:

QUICK SHIPMENT
FACTORY SEALED CARTONS
FRANCHISED DISTRIBUTOR

SOUND REPRODUCTION, INC.

34 New Street, Newark, N. J. (07102)

(201) Mitchell 2-6816

CIRCLE 59 ON READER-SERVICE CARD



Hail THE VICTORS!

Here is the magnificent music from the original sound track of Carl Foreman's explosive film "THE VICTORS". Recorded in Super Cine Sound. Composed and conducted by Sol Kaplan. In all your life, you have never heard an album like "THE VICTORS".

mono CP 516... \$4.98
stereo SCP 516... \$5.98



Jane Morgan sings twelve great songs from "THE VICTORS" including Bless 'Em All, Pennies From Heaven, Red Sails In The Sunset, Have Yourself A Merry Little Christmas, Glory Of Love, Let's Fall In Love. This is her most exciting album ever.

mono CP 460... \$3.98
stereo SCP 460... \$4.98



CIRCLE 22 ON READER-SERVICE CARD

TFM 3127 (Mono)

ART LINKLETTER
narrates the story of
WHERE DID YOU COME FROM

WHERE DID YOU COME FROM... The story of life, worded for small fry and sensitively related by Art Linkletter.

THE LITTLE DRUMMER BOY... The Harry Simeone Chorale presents songs of Christmas, festive and inspirational.

MY FAVORITE STORY... Told by favorite storytellers: Jack Benny, Bing Crosby, Bob Hope, Red Skelton and others.

presented by
20th CENTURY FOX RECORDS
The Ultimate in Entertainment

TFM 3100 (Mono)
TF5 4100 (Stereo)

The Little Drummer Boy
a Christmas Festival
the Harry Simeone Chorale

FAVORITE STORY
America's greatest performers

TFM 3106 (Mono)

3 Xmas Bellringers

CIRCLE 65 ON READER-SERVICE CARD

Valenti. To some degree, however. Miss Dieterle redeems herself as a vocalist despite a limited range. As long as she stays within her limitations, she sings quite effectively in French, Spanish, and German as well as English. Two little-known Youmans songs are included in the program—*Who Am I That You Should Care for Me*, which was dropped from the 1929 production of *Rainbow* before it reached Broadway, and *I Want a Man*, which remained in the same show. Both are interesting minor additions to the Youmans repertory.

"The New Moon": Gordon MacRae, Dorothy Kirsten, Roger Wagner Chorale. Capitol W 1966, \$4.98 (LP); SW 1966, \$5.98 (SD).

Sigmund Romberg's score for this 1928 musical is even richer and more melodic than most of those who think fondly of it may recall. It includes, of course, *Lover Come Back to Me*, *Softly as in a Morning Sunrise*, and *One Kiss*—all of them first-rank lyrical romanticism—and for sturdy operetta declarativeness there is *Stouthearted Men*. But there is still more to *The New Moon*—other songs that in a musical of less distinction would certainly have earned recognition. A merit of this disc is that it brings to attention *Marianne*, *Wanting You*, and the spritely *Try Her Out at Dances*. Unfortunately, however, the recording has to depend for its effectiveness more on the songs than on the singers. Miss Kirsten gives a sweet and amiable performance which is acceptable enough, but MacRae seems to be a victim of thickening vocal chords. His voice, which in other circumstances has had a fresh and vigorous quality, here takes on the wooden tone that was once Nelson Eddy's forte. Romberg's score has so much basic vitality that one would like to hear it treated in less pedestrian fashion.

Michel Legrand Big Band: "Plays Richard Rodgers." Philips 200074, \$3.98 (LP); 600074, \$4.98 (SD).

Legrand's tendency to be different simply for the sake of being different frequently gets in his way in the course of these performances. He leans heavily on unexpected phrasing, often blending several different types within a single selection. There is no denying that this gives one something to listen to—and to this extent it is preferable to the routine shimmering strings or mood music approach to Rodgers. But it is essentially a show-off approach in which the focus is Legrand rather than Rodgers, the basic quality of whose work is often lost in the shuffle. While this is not to say that there is not something profitable to be gained from an inquisitive and adventurous look at such familiar material as is involved in this disc, it is to say that Legrand could stand some editing. The best thing in this set is *The Lady Is a Tramp*, in which Paul Gonsalves on tenor saxophone and one of the three pianists involved in the proceedings get things going so firmly before Legrand starts constructing his personal edifices that the whole piece comes out quite satisfactorily.

JOHN S. WILSON

TAKE Heathkit's Deluxe Transistor Stereo Amplifier

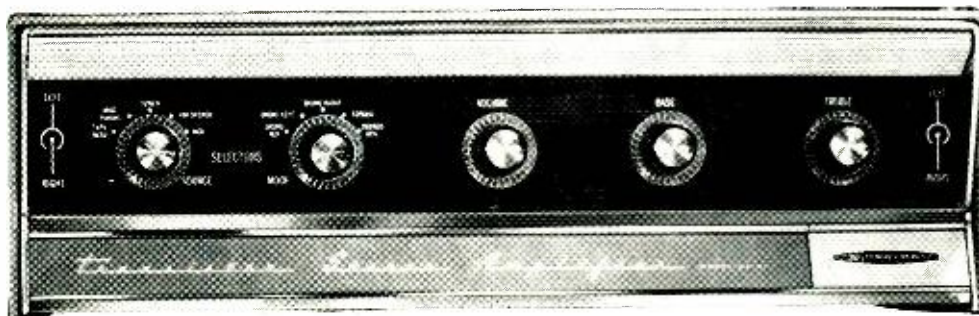

ADD the Deluxe Transistor AM-FM Stereo Tuner

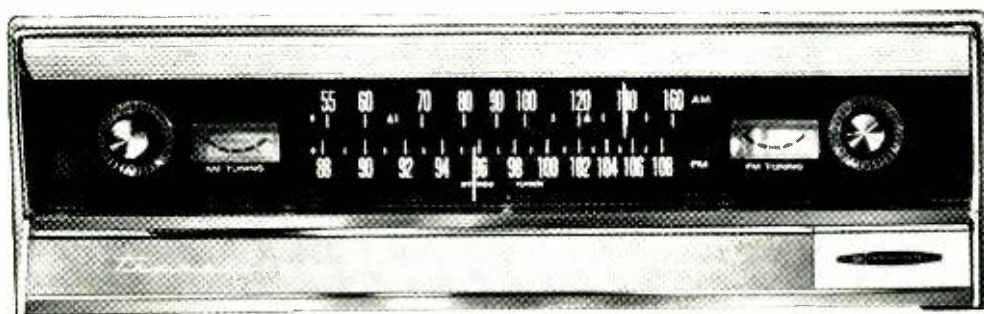

ENJOY Total "Transistor Sound" Performance

Each instrument with its characteristic sound reproduced realistically, faithfully, naturally. This is "transistor sound." No faltering, no fading, no compromising... just the quick, clean sound that only transistors can reproduce. You enjoy this totally different dimension in stereo listening with the *total* transistor performance of the Heathkit *deluxe* 70-watt Stereo Amplifier *and* matching AM, FM, FM Stereo Tuner.

Added performance features and luxurious decorator styling. You enjoy "extras" like the unique "push-push" off/on switch, concealed secondary controls to prevent accidental system changes, automatic switch-to-stereo feature of the tuner, and pre-built, prewired encapsulated component modules in the amplifier for quick, easy assembly. You enjoy handsome matched tan vinyl-clad steel cabinet styling with polished aluminum trim and soft refracted lighting... complements any decor! Both units are easy to build... easy to own! Just a few of the reasons why you should move up to this all-transistor duo. Consider the AA-21 Amplifier...

Full 70 watts of continuous power, 100 watts music power at ± 1 db from 13 to 25,000 cps. Additional features include 26-transistor,

10-diode circuitry for cool, "hum-free" operation, smooth power delivery, and fast effortless "transient response"; complete freedom from microphonics; front-panel mounted controls with 5-position dual concentric source switch, 5-position mode switch, and dual concentric volume, bass and treble controls; circuit breaker protection of output transistors and AC power; and encapsulated preamplifier circuits in 6 epoxy-covered modules, all factory wired and sealed, ready for easy installation. Check the AJ-43 Tuner...

Enjoy extra convenience. Automatic switching to stereo; automatic stereo indicator light; filtered stereo tape recorder outputs for direct "beat-free" recording; Stereo Phase Control for maximum separation and minimum distortion; Automatic Gain Control for constant volume; 25-transistor, 9-diode circuitry for lower power consumption and cool operation; individual AM & FM tuning meters for pin-point tuning; effortless fly-wheel tuning; transformer operated power supply; and preassembled FM tuning unit and 4-stage FM I.F. circuit board for fast assembly.

Experience the "transistor sound" of tomorrow, with the total transistor performance
CIRCLE 39 ON READER-SERVICE CARD

of Heathkit's Deluxe Transistor Twosome today! You'll be delighted with the advanced features, advanced styling, advanced sound... all at a typical Heathkit value price. Order both units now!

Kit AA-21, amplifier, 29 lbs.....\$139.95

Kit AJ-43, tuner, 18 lbs.....\$119.95

FREE 1964 HEATHKIT CATALOG

See Heathkit's complete line of advanced stereo/hi-fi equipment as well as color TV, electronic organ, radios, amateur radio, test & lab, marine, and educational equipment. Over 250 in all... the world's largest selection! Send for yours now!



HEATH COMPANY

Dept. 8, Benton Harbor, Mich. 49023

Enclosed is \$ _____, plus postage. Please send model (s) _____

Please send my Free 1964 Heathkit Catalog.

Name _____

Address _____

City _____

State _____

Zip _____



The SONIC SHOWCASE

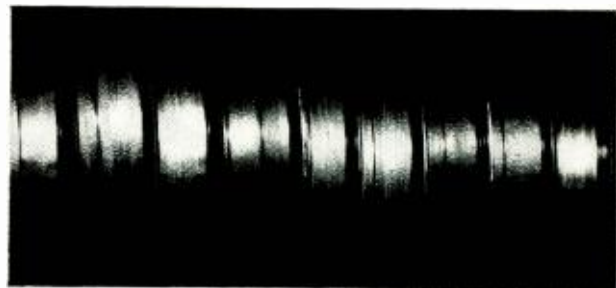

"The Big Band Sound of Sid Ramin." RCA Victor LPM 2716, \$3.98 (LP); LSP 2716, \$4.98 (SD).

"Politely Percussive." Dick Schory's Percussion Pops Orchestra. RCA Victor LPM 2738, \$3.98 (LP); LSP 2738, \$4.98 (SD).

"The Page 7." Page Cavanaugh and His Orchestra. RCA Victor LPM 2734, \$3.98 (LP); LSP 2734, \$4.98 (SD).

Controversy over the various techniques bundled together under the trade name of Dynagroove continues to flourish—and not without reason, since the flow of new releases provides ever fresh illustrations of its characteristics. I hope the time will soon come when a reviewer can forget all about the Dynagroove rubric on a label and simply evaluate a given disc on its individual merits! Meanwhile, one has to attempt to account for such contradictions as appear in the present pops examples of Dynagrooving.

Ramin's deliberately contrived "spectacular" is both the most technically ambitious and the most aurally excruciating of the discs at hand. I know of few releases that have risked such extreme dynamic contrasts; and while the recording and disc cutting accommodate them remarkably well, the explosive transients and ultrasharp *fortissimo* highs are earsplitting indeed. The mono edition is perhaps a bit less piercing than the SD, but neither can be heard comfortably except at drastically reduced volume. But before you seize upon all this as proof of inherently baleful consequences of Dynagroove technology, listen to the 4-track tape edition (FTP 1208, 33 min., \$7.95), which is processed at a considerably lower modulation level, with the high-end glitter reduced to a more tolerable brilliance yet with all the vivid presence of the midrange retained intact. There too you can form a better documented judgment of Ramin's desperately fancy scorings of such hits as *Blue Tango*, *Syncopated Clock*, *River Kwai March*, *Holiday for Strings*, *Never on Sunday*, etc.

Schory's no less virtuoso performances of more imaginative arrangements provide much more ingratiating entertainment, notably in the atmospheric *Summertime* and *Sleepy Time Gal*, piquant *Playboy's Theme* and *Quiet Bossa Nova*, and a propulsive *Night Train*. The strictly percussive elements are not excessively featured, except perhaps in drummer Joe Morello's showpiece *Shim-Wha*. For the most part they are discreetly exploited in delectable solos and antiphonal duos for vibes and tubaphone (a variety of marimba). Technically too, the recording itself is more satisfactory than Ramin's—

a fact I ascribe less to any possibly minimized application of specifically Dynagroove technology than to Schory's insistence on embodying (as in all his earlier releases) a generous measure of warmly natural Chicago Orchestra Hall reverberance. Again, though, highs tend to be overstrident: over-all spectrum balance and vividness, as well as the stereogenic scoring ingenuities, are best evident in the 4-track tape edition (FTP 1224, 30 min., \$7.95).

What Dynagroove claims to achieve in enhanced presence and freedom from groove-tracing distortion is more successfully demonstrated than in any previous pops release in the novel "Page 7 impact music" discs. The performances feature two trombones (or bass trumpets) playing sometimes in slippery floridities but more often in a vehemently staccato "shouting" style which provides some of the most startlingly steep-fronted waveforms I've ever heard so crisply recorded. The "presence" is possibly somewhat overemphasized by extremely close miking, but the acoustical ambience, while not as warmly expansive as Schory's, is certainly not artificially deadened. And there is no lack whatever of low-end sonic substantiality to balance what must be an ultrasonic extension of the high end to account for the fantastically clean transient response. In either edition the extraordinary technical qualities here demand every audiophile's admiration. Happily, there are also striking musical and executant attractions as well. Cavanaugh and his exuberant sidemen, playing mostly originals of their own devising, miraculously succeed in creating what is essentially a new instrumental style—involving elements of swing and Dixieland yet never falling into clichés. Their now jaunty, now hard-driving, but always immensely propulsive and bravura performances of such divertissements as *Pick Yourself Up*, *Barefoot Adventure*, *Down Home*, *Black Boots*, *The Swingin' Saints*, etc. provide electrifying listening.

"Mr. D's Machine"; "Hear That Whistle Blow." Mobile Fidelity MF 11/12, \$4.98 each (Two compatible discs).

The latest releases from the indefatigable Brad Miller's Mobile Fidelity Company flaunt a "Sonic-Seven" rubric, suggesting that still newer techniques have been added to the use of Polymax materials and Stereomonic cutting (which provides a disc compatible both to mono and stereo playback). Whatever the process involves, it achieves a clarity and realism that further strengthen Mobile Fidelity's reputation for uncommon technical excellence. The surfaces, as with all Poly-

max pressings I've heard, are extraordinarily quiet, even though this benefit exposes all the more candidly a continuous background hum apparently "built into" the outdoor recordings themselves. The present materials boast an interest which, in at least one case, transcends the normal specialized appeal to railroad buffs: the MF 11 program is the first, to my knowledge, to be devoted entirely to diesels (Southern Pacific EMD F-7s, SD-9s, ALCO DF 12-15s, and others). It is also one of the most impressive yet for its stereogenics, being recorded mainly near the famous Tehachappi Loop, where the tracks wind around a mountain—providing opportunities not only for pass-bys in both directions but also for distant circling effects.

MF 12 returns us phonographically to the vanishing world of the steam locomotive, featuring doubleheader trains on special buff-club trips on the McCloud River Railroad, Sierra Railroad, and Duluth & Northeastern, plus a couple of logging company geared locomotives and a Georgia Pacific Corporation Shay. It is notable for some fine examples of dramatic whistling.

"The Big Sounds of the Drags." Capitol T 2001, \$3.98 (LP); ST 2001, \$4.98 (SD).

Vehemently revved-up motors and razzing racing car pass-bys may be acquired sonic tastes, but apparently many race track *aficionados* and at least a substantial body of audiophiles can't get enough of them. Now Capitol invades what long has been Riverside's almost exclusive domain with an excellent general introduction to and dramatic documentary illustrations of drag racing and elimination trials at the winter meeting of the National Hot Rods Association on the Pomona and perhaps other Californian quarter-mile tracks. The jacket notes information is meager, but some details and background color are provided by a narrator, and information about the cars and their speeds may be gleaned from the public address announcements included—if not always with complete intelligibility. The materials are reasonably varied, none of the bands is extended to the point of complete monotony, and the recording itself is vividly authentic even in the mono edition. In stereo the inclusion of unambiguously directional motion makes for greater realism, but the effectiveness is somewhat flawed by a hole-in-the-middle jump—presumably resulting from too wide mike spacings.

R. D. DARRELL

what's new at Heathkit?



me!



Thirteen years ago we introduced the "Williamson Type Amplifier Kit". It represented a breakthrough in "do-it-yourself" high fidelity. For the first time a truly high fidelity amplifier was made available in kit form at an "easy-to-afford" price. The old WA-1 and its successors including the famous W-5 provided high fidelity listening pleasure to hundreds of thousands of music lovers across the nation. Ever since, Heath's history has been one of major advances in the hi-fi/stereo field. And now today, another first from Heathkit! Heath's newest... an all-transistor Stereo Receiver Kit, incorporating the latest in solid-state circuitry, at a price far below similar units... only \$195.00!

Now in one compact unit!...two 20-watt power amplifiers, two separate preamplifiers, plus wide-band AM, FM, FM stereo... all superbly engineered to give you the clean, uncompromising realism of "transistor sound". All with transistor circuitry... a total of 43 transistors and 18 diodes... to give you the coolest, fastest, most-reliable operation possible! All handsomely housed in a single, smart-looking walnut cabinet with a striking extruded gold-anodized aluminum front panel... fashioned in Heathkit's modern low-silhouette styling! This is the beautiful new AR-13. This is the first all-transistor, all-mode stereo receiver in kit form! Compact in size, compact in price!

Many advanced features have been incorporated to make possible the advanced performance of the AR-13. You'll like the way this unit *automatically* switches to stereo, and the stereo indicator light silently verifies that stereo is being received. For all-around versatility there are three stereo inputs (mag. phono and two auxiliary) plus two filtered tape recorder outputs for direct "off-the-air" beat-free recordings. Dual-tandem controls

provide the convenience of simultaneous adjustment of volume, bass, and treble of both channels. Balancing of both channels is accomplished by a separate control. The AM tuner features a high-gain RF stage.

Other quality features include an FM local-distance switch to prevent overloading in strong signal areas; a squelch control to eliminate between-station noise; AFC for drift-free reception; heavy die-cast flywheel for accurate, effortless tuning; pin-point tuning meter; and external antenna terminals for long-distance reception. For added convenience the secondary controls are "out-of-the-way" under the hinged lower front panel to prevent accidental system changes. The slide-rule AM and FM dial is fully lighted.

An exciting challenge for the more experienced kit-builder. Takes approximately 35 hours to assemble. The "front-end" and AM-FM I.F. strip are already preassembled and prealigned to aid construction.

Compare the new AR-13 Stereo Receiver with similar units. You'll agree that for advanced features, advanced solid-state engineering, advanced styling, and money-saving price, no unit matches the AR-13. Start enjoying the "transistor sound" of tomorrow, today, by ordering the AR-13 now!

Kit AR-13... 30 lbs. \$195.00

SPECIFICATIONS — Amplifier: Power output per channel (Heath Rating): 20 watts /8 ohm load, 13.5 watts /16 ohm load, 9 watts /4 ohm load. (IHFM Music Power Rating): 33 watts /8 ohm load, 18 watts /16 ohm load, 16 watts /4 ohm load @ 0.7% THD, 1 KC. Power response: ± 1 db from 15 cps to 30 KC @ rated output; ± 3 db from 10 cps to 60 KC @ rated output. Harmonic distortion (at rated output): Less than 1% @ 20 cps; less than 0.3% @ 1 KC; less than 1% @ 20 KC. Intermodulation distortion (at rated output): Less than 1%, 60 & 6,000 cps signal mixed 4:1. Hum & noise: Mag. phono, 50 db below rated output; Aux. inputs, 65 db below rated output. Channel separation: 40 db @ 20 KC, 60 db @ 1 KC, 40 db @ 20 cps. Input sensitivity (for 20 watts output per channel, 8 ohm load): Mag. phono, 6 MV; Aux. 1, .25 v; Aux. 2, .25 v. Input impedance: Mag. phono, 35 K ohm; Aux. 1, 100 K ohm; Aux. 2, 100 K ohm.

CIRCLE 39 ON READER-SERVICE CARD

Outputs: 4, 8, & 16 ohm and low impedance taps recorder outputs. Controls: 5-position Selector; 3-position Mode; Dual Tandem Volume; Bass & Treble Controls; Balance Control; Phase Switch; Input Level Controls (all inputs except Aux. 2); Push-Pull ON/OFF Switch. FM: Tuning range: 88 mc to 108 mc. IF Frequency: 10.7 mc. Antenna: 300 ohm balanced (internal for local reception.) Quieting sensitivity: 2½ uv for 20 db of quieting, 3½ uv for 30 db of quieting. Bandwidth: 250 KC @ 6 db down (full quieting.) Image rejection: 30 db. IF Rejection: 70 db. AM Suppression: 33 db. Harmonic distortion: Less than 1%. Multiplex: Bandpass: $\pm 1/2$ db, 50 to 53,000 cps. Channel separation: 30 db, 50 to 2,000 cps. 25 db @ 10 KC. 19 KC Suppression: 50 db down, from output @ 1 KC. 38 KC Suppression: 45 db down, from output @ 1 KC. SCA Rejection: 30 db. AM: Tuning range: 535 to 1620 KC. IF Frequency: 455 kc. Sensitivity: 1400 KC, 3.5 uv; 1000 KC, 5 uv; 600 KC, 10 uv—standard IRE dummy antenna. Bandwidth: 8 KC @ 6 db down. Image rejection: 30 db @ 600 KC. IF Rejection: 45 db @ 600 KC. Harmonic distortion: Less than 1%. Overall dimensions: 17" L x 5½" H x 14½" D.

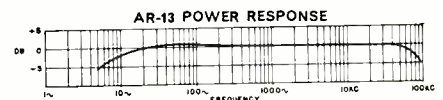

FREE 1964 CATALOG
See these and over 250 other exciting Heathkits available in easy-to-build kit form. Save 50% or more by doing the easy assembly yourself! Send for your free catalog today!

HEATHKIT
by Williamson

HEATH COMPANY
Dept. 8, Benton Harbor, Mich. 49023

Enclosed is \$195.00, plus postage. Please send model no. AR-13.

Please send my Free copy of the 1964 Heathkit Catalog.

Name _____

Address _____

City _____ State _____ Zip _____

HF-155

Perhaps its most important specification...

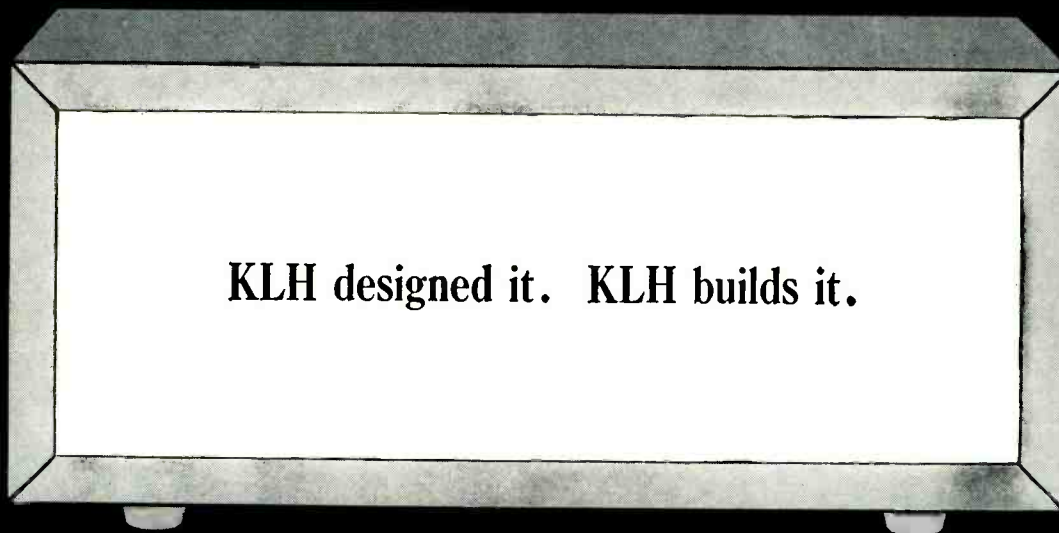

The KLH Model Sixteen Integrated Music Amplifier

This is a music amplifier,
not a 'hi fi' amplifier. For the difference,
ask your KLH dealer.

- The Model Sixteen offers a quality of performance which will satisfy every musical requirement of the educated home listener, even if he is quite willing to spend more
- 22 transistors, 8 diodes
- 70 watts steady state power, 35 watts per stereo channel (over 40 watts music power) into 8 ohms. (2 to 3 db less into 4 or 16 ohms.)
- Insignificant distortion levels from 20 to 20,000 cps
- Complete protection against accidental shorting or opening of speaker leads
- Controls: On-Off, Source, Volume, Balance, Bass, Treble, Loudness Compensation, Stereo-Mono, Tape Monitor, Filter, Speakers In-Out
- Inputs: Phono, Tuner, Tape, Aux. 1, Aux. 2
- Outputs: Speakers, Record, Headphone
- Guaranteed in normal use (parts and labor) for 2 years
- All you need is a sound source and speakers
- \$219.95. Oiled walnut cabinet—\$19.95

We set out to design an amplifying system which would satisfy, without compromise or quibble, the requirements of the great majority of music-lovers who want high quality music reproduction in their homes. It was our belief that such an amplifying system should be compact in size, simple to use, reliable, and moderate in price. Above all, it should sound, while playing music at the same relative levels heard in the concert hall, indistinguishable from the finest amplifiers available. The Model Sixteen is that amplifying system.

The Model Sixteen is fully transistorized, with the peak load performance and the trouble-free dependability that are now possible with the advent of solid state devices. It is no accident that the Model Sixteen was created by a company which has already made more high quality transistor amplifiers than all other component manufacturers combined.

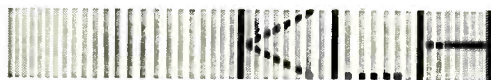

KLH RESEARCH AND DEVELOPMENT CORPORATION
30 CROSS STREET, CAMBRIDGE 39, MASSACHUSETTS

CIRCLE 43 ON READER-SERVICE CARD

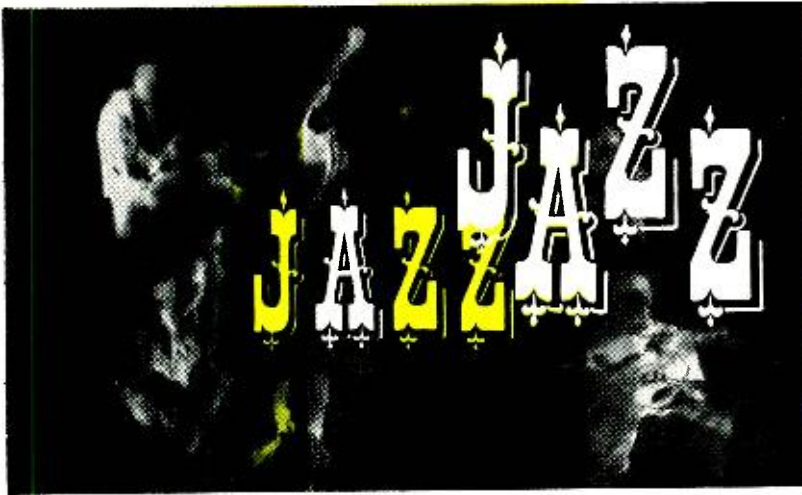

Charlie Byrd: "Once More!" Riverside 454, \$4.98 (LP); 9454, \$5.98 (SD).

Adding four cellos and a French horn to his regular group on some selections, and a trumpet and vibraharp on others, Byrd seems on the point of exhausting his association with bossa nova. It is a pleasant enough set, but neither material nor performances have the charm or interest of his earlier efforts in this vein. The cellos occasionally create a soft, warm cushion that is a satisfying complement to the sharp sound of Byrd's guitar, but they do not always swing as readily as they might. The trumpet-vibraharp pairing is less than satisfactory. Byrd plays well, but this is one of his less inspired sessions.

Bill Evans Quintet: "Interplay." Riverside 445, \$4.98 (LP); 9445, \$5.98 (SD).

Evans, whose piano work with his own trio leans towards a gentle, brooding probing of tunes, is heard in a very different context here. His quintet, which includes Freddie Hubbard, trumpet, and Jim Hall, guitar, attacks five standards and an Evans original. The medium-tempo, straight-ahead, swinging style might have developed into something interesting if the approach had not been so matter of fact. The three principals rattle off adequate solos in a manner that suggests very little apparent conviction or interest.

Erroll Garner: "A New Kind of Love." Mercury 20859, \$3.98 (LP); 60859, \$4.98 (SD).

One of the elements that has always been present in Erroll Garner's highly individual piano style is a large dollop of Hollywood romanticism. The climax of a Garner ballad often quivers with rich, slightly overripe harmonies straight out of a Hollywood background score. Because he has used this device with humor and for the pure dramatic pleasure of overplaying, it has become a strong and effective implement in his hands. But now Fate has caught up with Garner. He has written music for an actual movie score and, with a lush set of strings behind him, he plays it with his typical inimitable romanticism. There is, however, a bit of a difference here from the

generally lean, straight-ahead, melodic performances that Garner gives with his trio: with a whole Hollywood orchestra to carry the melody for him, he allows himself the luxury of lots of trickling decorative phrases. As a consequence, Garner tends to dilute himself in these performances. He has created a trio of pleasantly romantic tunes—*Fashion Interlude*, *Paris Mist*, and *Theme for "A New Kind of Love"*—and he fills out the disc with songs from old Chevalier movies—*Mimi*, *Louise*, and *You Brought a New Kind of Love to Me*.

Lionel Hampton: "On Tour." Gladhamper 1005, \$3.98 (LP).

For the past twenty years Lionel Hampton has led one of the most mysterious big bands in existence. It is constantly loaded with brilliant young talent, talent that usually shows its brilliance once it gets out of Hampton's seminary and goes on its own. For the most part the band has little opportunity to show its potential because it is either engaged in endless, routine riffs while Hampton jumps on his drums, or—in its calmer moments—it plays lulling backgrounds for Hampton's vibraphone solos. This disc, recorded before audiences at the Olympia Theatre in Paris and at the Metropole Café in New York, concentrates on Hampton's vibraphone to the exclusion of practically everything else. His suave talent on ballads and his wallowing momentum on faster tunes continue undimmed, but his choice of material, as exemplified in this program, has its ups and downs. On one selection he allows a sideman, a tenor saxophonist, Andrew McGhee, to have an unobstructed solo (the tune, after all, is called *McGhee*) and the saxophonist plays in such a delightfully soft, sinuous, and dancing a manner that one finds oneself wondering what other pleasures are perhaps being hidden in this band.

"A Jazz Salute to Freedom." CORE 100. CORE, 38 Park Row, New York 38, N.Y., \$5.00 (Two LP).

As a fund-raising device, the Congress of Racial Equality has put together a two-disc set of jazz performances drawn from the Roulette and Roost catalogues and including a number of memorable

recordings. At \$5.00, the album represents quite a bargain. There are a pair of classics from the bop era, Charlie Parker's *Klactoveedsedstene* (with Miles Davis), and the Parker/Dizzy Gillespie *Groovin' High*. There is Art Tatum's dazzling treatment of *Dark Eyes* with Slam Stewart and Tiny Grimes, the early and yeasty Erroll Garner playing *Love for Sale*, a joining of forces by Louis Armstrong and Duke Ellington on *Cotton Tail*, and a beautifully romping Stan Getz performance of *Strike Up the Band*. Other notable contributions come from Bud Powell, Count Basie, Sarah Vaughan, Joe Williams, the trombone duo of J. J. Johnson and Kai Windling, John Coltrane, and Woody Herman. As a sampling of post-World War II jazz, the set covers a broad middle area extremely well.

Curtis Jones: "Lonesome Bedroom Blues." Delmar 605, \$4.98 (LP).

Jones is a still vital exponent of the blues that flourished in the period when the focus was shifting from the country to the city. He is in the Big Bill Broonzy tradition without being merely an imitator. But more than that, he is also an excellent blues pianist who perceptively accompanies his own singing, often adding rolling, boogie-based keyboard passages to his vocal performances. Jones has been recorded frequently before, but this collection has particular value in revealing his piano work, which adds a very special flavor to his style.

Jacques Loussier Trio: "Play Bach Jazz," Vols. 1-3.

For a feature review including these recordings, see page 67.

Charlie Mariano: "A Jazz Portrait." Regina 286, \$3.98 (LP); S 286, \$4.98 (SD).

Charlie Mariano, after years of going along as one of the better Parker-derived alto saxophonists, has begun to show a strong individual personality since his return to the United States from Japan last year. There is an intensity in his playing that makes his performances consistently bristle with excitement

Continued on next page

What
do you hear
from your
FM?

Just as much as your FM
antenna lets you hear!

That's a fact.

The antenna built into your FM receiver can pull in only very close stations. And it may not do that with always complete clarity. If you'd like to tune in more (and more distant) FM stations clearly, you definitely need a high gain outdoor FM antenna. Kitchen table model or expensive stereo rig, the story's the same.

FM stereo, in fact, is a weaker signal than monaural FM; it "cries for" an antenna. A directional antenna, too, for clean FM stereo reception, since your built-in antenna pulls in signals from *all* directions and may lose your stereo effect.

Inexpensive, lasting solution! The totally new RCA 500 FM antenna just developed by experts with long, long electronics experience. This 8-element yagi-type antenna receives 88 to 108 MC, has a VSWR of 1.25:1 and a flat-frequency response across the entire band with an average 8 db gain. Acute directivity removes interference.

Your RCA dealer will happily explain in words of one syllable what better things you'll hear from your FM with an RCA 500 FM antenna.

Listen!

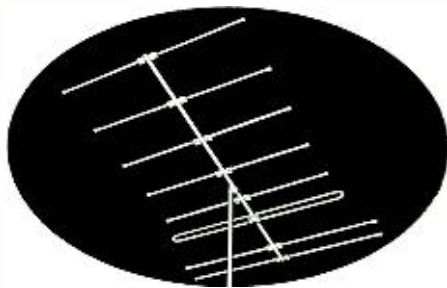

RCA Parts and Accessories



The Most Trusted Name
in Sound

CIRCLE 74 ON READER-SERVICE CARD

JAZZ

Continued from preceding page

whether he is using his phenomenal virtuosity on fast pieces or striking dark and passionate sparks from a slow ballad. This disc places him in three different settings—with an excellent big band, with strings, and at the head of a quintet made up of former Stan Kenton trumpeter Marvin Stamm and a rhythm section. Don Sebesky's arrangements for all three groups have been written with unusual skill and imagination, evoking the big, sweeping sense of excitement that can be drawn from a big band, giving the strings some validity in a jazz context, and filling out the sound of the quintet in amazing fashion. Within these settings Mariano plays a varied succession of strongly stated and beautifully balanced performances. Stamm has a better opportunity to show his potential in these surroundings than he did with Kenton; but while he has a clean, pungent manner and is a helpful secondary to Mariano, his own musical personality is still a bit diffuse.

Gerard "Dave" Pochonet: "Swingin' in Paris." Taureau 3301, \$4.98 (LP).

This is a real sleeper from France—a group of performances by varied groups of French musicians (plus the American saxophonist Lucky Thompson on two occasions) that are brimful of warmly expressed, rhythmic, and lyrical playing. There are reflections of Count Basie's style here, and there is a quintet that is pure Benny Goodman. But most of all there is the great sheltering shadow of the Duke Ellington band. The Ellington style has proved to be doggedly inimitable, but these French musicians, without going after the total Ellington ensemble sound, play very much in the Ellington manner with the help of a brilliant alto saxophonist, Michel Attenoux, who has absorbed Johnny Hodges' rich swinging tone and attack, and of a trombonist, Claude Goussert, who is expert at both the big, broad, singing tone of Lawrence Brown and Tricky Sam Nanton's growling use of mutes. Attenoux also plays excellent soprano saxophone (again, Hodges is the influence) on an interesting treatment of *Tin Roof Blues*. Thompson is in fine form in his two selections, on both of which pianist Martial Solal is also heard. A trumpeter, Sonny Gray, does splendid work, both muted and open, all through the set. Pochonet, the leader, is an unostentatious drummer (he does not take a single solo) now living in the United States.

Swingle Singers: "Bach's Greatest Hits." For a feature review including this recording, see page 67.

The Village Stompers: "Washington Square." Epic 24078, \$3.98 (LP); 26078, \$4.98 (SD).

Spike Jones: "Washington Square." Liberty 3338, \$3.98 (LP); 7338, \$4.98 (SD).

Something new called "folk-Dixie" is

introduced by the Village Stompers. As its name suggests, it is a mixture of folk music and Dixieland jazz, but since it's completely instrumental, it qualifies more as jazz than as folk music. The basic approach, as exemplified on the Stompers' disc, is to start a selection in a folkish manner with guitar or banjo playing the first chorus. Then, with a lusty trombone effusion, the feeling changes to Dixieland as trumpet, trombone, and clarinet come roaring in and everybody goes stomping off. It's a refreshing change from the stereotyped repetition of the same old tunes which most Dixieland programs have boiled down to. Using folk material and pseudo-folk opens up new avenues to the Dixielanders, and the inclusion in the group of two banjoists-guitarists (primarily for the folk feeling) gives the Dixieland segment a lot of added propulsion when these two performers add their driving momentum to the rhythm section.

So quickly has this new approach caught on through the tune *Washington Square* (for which both the style and the Village Stompers were invented by an astute team of arranger and music publisher) that Spike Jones has given up his twenty-five-year association with blurps, bleeps, shrieks, and hiccups to go into the folk-Dixie field. His disc includes a version of *Washington Square* virtually duplicating the Village Stompers' treatment. He also repeats from the Stompers' set *If I Had a Hammer*, *Blowin' in the Wind*, and *Green Green* and ventures out into other selections in the folk-Dixie mode with such ready facility that clearly the Stompers will keep no copyright on the style. Because of its essential simplicity and the rather restricted format it follows, folk-Dixie may be quickly done to death. But in this first flush of success, it is fun and a pleasing change.

Paul Winter Sextet: "New Jazz on Campus." Columbia CL 2064, \$3.98 (LP); CS 8864, \$4.98 (SD).

In a day when the emphasis in jazz falls almost completely on the solo virtuoso, Paul Winter provides a welcome and hopeful change. Winter is an organizer and a promoter in the sense that Duke Ellington is, for instance. He has assembled a group and kept it together without copying or following a fad (he has been in on the bossa nova wave, but he was one of the first to discover and use this Brazilian music). Nor has he depended on a solo personality. Winter himself is a very capable alto saxophonist, and his sextet has other able solo voices—Jay Cameron, baritone saxophone; Dick Whitsell, trumpet; and Warren Bernhardt, piano. But what impresses one on this disc is the group as a whole. It is an ensemble, not a set of soloists. The members listen to each other, complement each other, and build selections as a unit. The program is varied, spirited, and constantly interesting. All things considered, Winter's group constitutes as hopeful a sign for the future of jazz as has turned up in many years.

JOHN S. WILSON

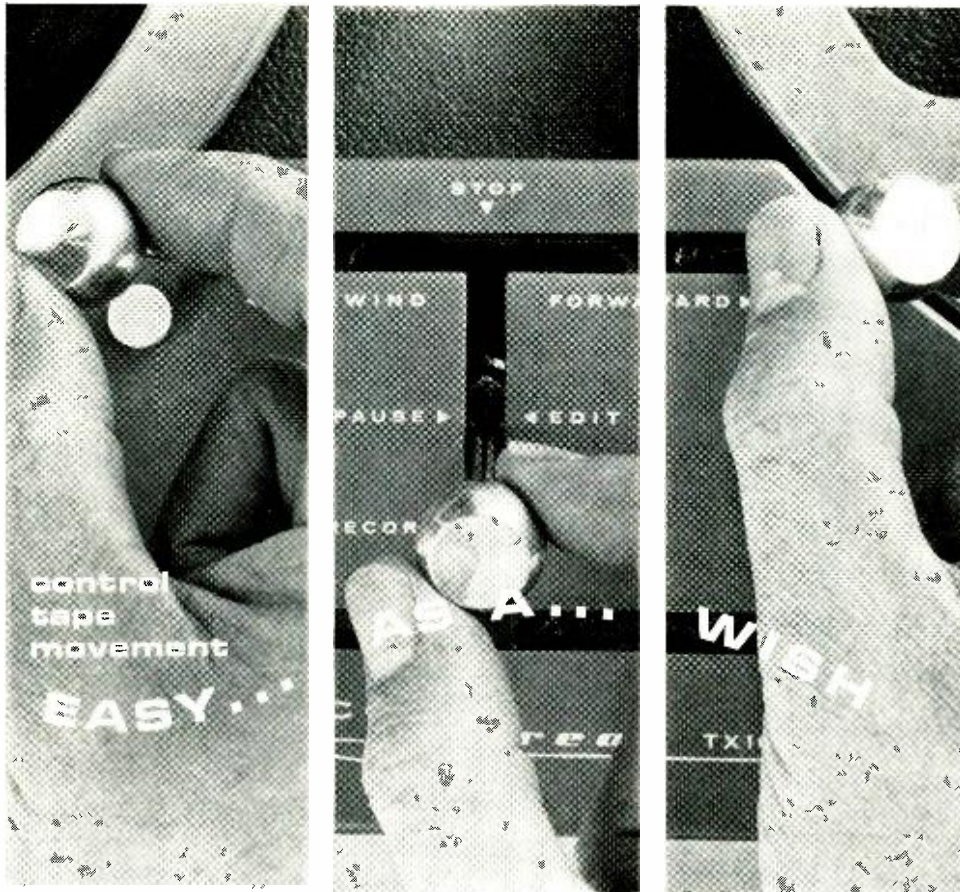

THE NEW **NEWCOMB** TX10 SERIES

STEREOPHONIC TAPE RECORDERS

SOUND ON SOUND UNLIMITED / HYSTERESIS SYNCHRONOUS MOTOR/MONITOR FROM TAPE OR PRE-AMP/TAKES 10½" REELS

Designed for instant, intuitive reaction to your thought, the Newcomb TX10 integrates all tape motion control through a single, central joystick. But this is only the beginning. The TX10 is outstanding for its simple, straightforward, dependable operation; exceedingly gentle tape handling; quietness; coolness. Small as a suitcase in size, big as a studio in scope, the TX10 has separate mixing controls for each channel. There is a separate knob for "Mike" and a separate—not concentric—knob for "Line" for each channel. Two recording-level/playback-volume meters are arranged pointer-to-pointer in the same illuminated window for ready stereo comparison. Plug-in transformers instantly convert mike channels for use with low impedance microphones. The TX10 has three heads, no pressure pads on heads. Major tape guides are stainless steel. To load the machine, tape is simply held in a straight line and dropped in the slot; automatic shut-off and supply reel take-up are automatically re-set. The new hysteresis motor is cool, quiet, unusually powerful. Differential braking on both reels and a unique tape tensioner provide non-spill, no-stretch, ever-so-gentle stops even with fully loaded 10½" reels rewinding at the rate of 2400 feet in 90 seconds—18 miles per hour! A four-digit counter gives accurate location even with a full reel of triple-play tape. You can record sound on sound, back and forth as many times as you wish, either channel serving as master. All TX10 models are two-speed machines. The push-push speed selector automatically supplies proper speed-frequency correction. There are four models in the series. Standard are 3¾-7½ i.p.s. recorders with either two or four tracks. On special order you can get 7½-15 i.p.s., two or four track. Throughout, the Newcomb TX10 is the instrument for the perfectionist—dedicated professional or amateur enthusiast. For a description in depth write for your free copy of the new TX10 brochure.

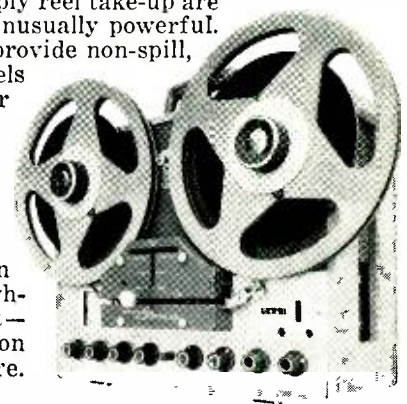

NEWCOMB AUDIO PRODUCTS CO., Department W-1, 6824 Lexington Avenue, Hollywood 38, California
CIRCLE 73 ON READER-SERVICE CARD

when will \$2.50* buy quality brand recording tape?

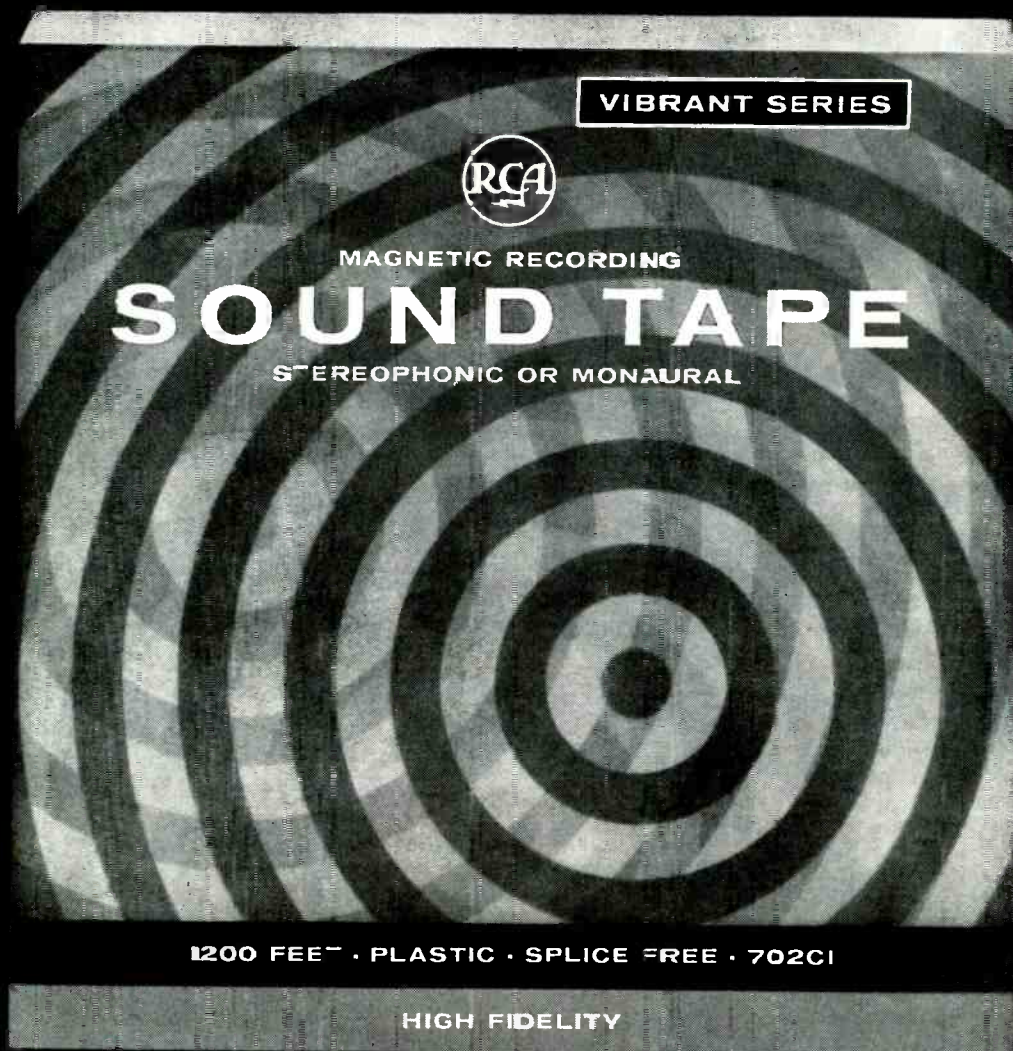

1200 FEET · PLASTIC · SPLICE FREE · 702CI

HIGH FIDELITY

TODAY!
... just ask for RCA VIBRANT

Yes, today a 1200-foot reel of RCA Vibrant Sound Tape costs you only \$2.50*! And you can be sure every inch will live up to RCA's world-wide reputation as "The Most Trusted Name in Sound." Use it to record everything—from musical performances and baby's first precious words to just-for-fun party conversations. The sound reproduction capability of RCA Vibrant Sound Tape actually exceeds that of most home recorders!

RCA "Vibrant Series" Sound Tape comes in all popular lengths, tape thicknesses and reel sizes. It is available in Acetate, Mylar or Tensitized Mylar.

Only \$2.50 for 1200 feet — it's the greatest value in *brand name* tape on the market! So be sure that you keep lots of extra tape on hand — now you can afford to!

Vibrant Series Sound Tape  **The Most Trusted Name in Sound**

*Manufacturer's nationally advertised price optional with dealer.

†Registered Du Pont Trademark

CIRCLE 51 ON READER-SERVICE CARD

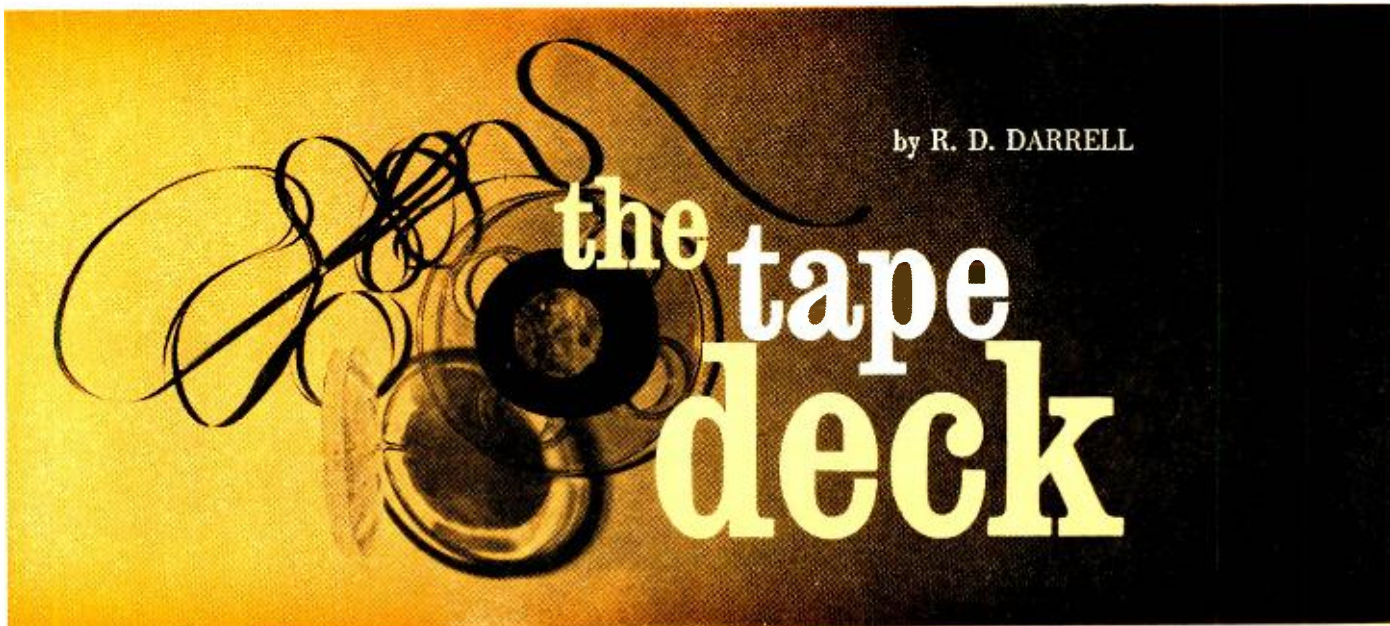

by R. D. DARRELL

the tape deck

The following reviews are of 4-track 7.5-ips stereo tapes in normal reel form.

BEETHOVEN: *Sonatas for Violin and Piano: No. 9, in A minor, Op. 47 ("Kreutzer"); No. 10, in G, Op. 96*

David Oistrakh, violin; Lev Oborin, piano.

• • PHILIPS (via Bel Canto) PT 900031. 62 min. \$8.95.

These latest Oistrakh-Oborin versions of the famous *Kreutzer* and the even more lyrical last Beethoven violin sonata are drawn from a European "Grand Prix" complete series not yet available in this country in its entirety. While the somewhat academic performances are not especially profound or subtle, they are admirably authoritative and straightforward. In any case, they are doubly welcome on tape: as the first examples of any Beethoven violin sonatas in the reel medium, and as models of well-nigh ideal stereo chamber music recording.

The miking is not too close, yet there is superbly natural presence both to Oistrakh's tautly spun (if sometimes a bit sticky) violin tone and to Oborin's more emphatic but gleamingly sonorous piano qualities. The unexaggerated stereoism itself is extremely effective not only in its differentiation and blend of the two instruments (with the violin slightly left of the well-centered piano) but also in preserving the acoustical warmth of a properly moderately small hall or studio.

The balances are fine, with the piano never relegated to the background but allowed to ring out boldly just as it would in a live concert. And, apart from a few slight preëchoes, the tape processing is first-rate (the trace of background hum in the quietest passages seems to have been built into the master recording rather than to stem from tape-surface noise).

MASCAGNI: *Cavalleria rusticana*

Victoria de los Angeles (s), Santuzza; Franco Corelli (t), Turiddu; Mario Sereni (b), Alfio; et al. Chorus and Orchestra of the Rome Opera, Gabriele Santini, cond.

• • ANGEL ZB 3632. 71 min. \$15.98.

The relatively short length of this favorite opera, which demands an awkward three sides in disc editions, fits neatly on a single reel midway between regular and twin-pack tape length. But for once the loss of the fourth-side disc "filler" is regrettable. Most reviewers of the disc edition found its supplementary excerpts from *Guglielmo Ratcliffe*, *Iris*, and *Le Maschere* more attractive than the main work, and I must agree that the present *Cav* is relatively colorless. There is of course the expectedly able vocalization by De los Angeles and Corelli (and better acting by Sereni), but in general both conductor and cast give a performance that suggests a self-conscious concert version rather than a genuine theatrical enactment.

While this is an exceptionally silent-surfaced and well-processed tape transfer, the recording itself is lacking in sonic depth and low frequency weight. A wholly satisfying *Cav* is still needed on tape—but if you just can't wait, London's 1961 version starring Simionato is less likely to disappoint you than this one.

OFFENBACH: *Overtures (6)*

Vienna State Opera Orchestra, Hermann Scherchen, cond.

• • WESTMINSTER WTC 162. 42 min. \$7.95.

Listeners who associate Scherchen primarily with modern music and serious classics (often played with unusual deliberation) should not fail to hear him kick up his heels in a holiday mood in some of the most effervescent musical

curtain—and spirit—raisers ever written! For all the exuberance of these performances there is never a lapse into slapdash playing—indeed the orchestra reminds us anew that Offenbach's gifts for piquant scoring were nearly as great as those for creating catchy tunes and rhythms. Of the six overtures here only that to *Orpheus in Hades* has been taped before, as far as I know. And while excerpts from some of the others (*La belle Hélène*, *La Vie parisienne*, and *La Grande Duchesse de Gérolstein*) may be familiar from *Gaîté parisienne* and other edited and reassembled Offenbachiana, *Barbe-bleue* and *Monsieur et Madame Denis* are sure to be novel even to connoisseurs. And what fun they are! This is a reel I can confidently recommend to all listeners. Even technical purists are not likely to be bothered by the fact that the brightly clean stereoism may have been processed with a slight channel-balance tilt towards the left, a few preëchoes, and perhaps just a bit more surface noise than in today's very best tapes.

RACHMANINOFF: *Concerto for Piano and Orchestra, No. 3, in D minor, Op. 30*

†Tchaikovsky: *Concerto for Piano and Orchestra, No. 1, in B flat minor, Op. 23*

Vladimir Ashkenazy, piano; London Symphony Orchestra, Anatole Fistoulari, cond. (in the Rachmaninoff), Lorin Maazel, cond. (in the Tchaikovsky).

• • LONDON LCK 80125 (twin-pack). 77 min. \$11.95.

No better vehicle than Rachmaninoff's Third could have been chosen for Ashkenazy's tape debut: the present performance reveals to perfection the young Russian's most characteristic qualities of searching musical intelligence, exquisite digital control, and distinctively fresh lyr-

Continued on page 99

“Gives a surprisingly well-rounded picture of what’s available on records.”

—*The Saturday Review*

RECORDS IN REVIEW: 1963 Edition, like its seven predecessors, brings you in one convenient book hundreds of reviews of records (stereo and mono) which appeared in HIGH FIDELITY MAGAZINE. This edition reprints reviews that appeared in 1962—classical and semi-classical music.

It will save you many hours in your dealer’s listening booth or earphone corner. And it will help you build a library of music YOU enjoy, for it is the most complete and authoritative book of its kind—the standard reference work that gains in value as the years roll by.

Each reviewer stands high in his field—Nathan Broder, for example, reviews Bach and Mozart, Alfred Frankenstein the moderns . . . Paul Affelder covers the romantics, Robert C. Marsh specializes in Haydn and Beethoven . . . Conrad L. Osborne writes on opera recordings. Forthrightly, they discuss the composition, performance and fidelity. And they compare new recordings with earlier releases.

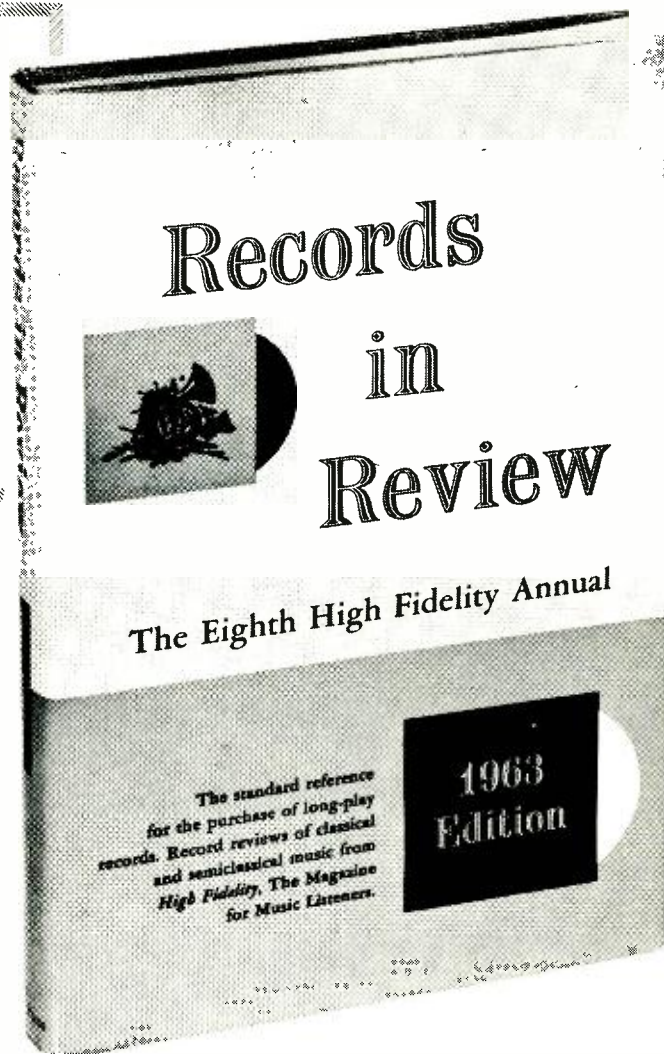

You’ll find the reviews organized alphabetically by composer for quick, easy reference—and in the case of composers frequently recorded, further subdivided by such categories as Chamber Music, Vocal Music, etc. You’ll find, too, a special section on Recitals and Miscellany. And an Artists’ Index, an Index of nearly 1300 Performers that many will find extraordinarily valuable.

Writing about previous editions, *The SATURDAY REVIEW* pointed out *RECORDS IN REVIEW* “gives a surprisingly well-rounded picture of what’s available on records and most reviews describe the work as well as the performance, providing each annual with a permanent use.”

The Pittsfield, Mass., *EAGLE* critic, Milton R. Bass, wrote “I have found the reviews in *HIGH FIDELITY* to be the most discerning and informative of any publication in the country . . . the book is a must for the serious record collector.”

This hardcover book of 555 pages is yours for only \$5.95 postpaid. Payment with order but satisfaction guaranteed or your money back. Convenient order form at left.

164

THE WYETH PRESS

A Division of High Fidelity
Publishing House

Great Barrington, Mass., 01230.

Send me *RECORDS IN REVIEW*
1963 Edition for the \$5.95 enclosed.

Name _____

Address _____

City _____ State _____

Foreign: 25c additional for shipping.

THE TAPE DECK

Continued from page 97

ical eloquence. Fistoulari's plastically contoured orchestral accompaniment ideally complements the soloist, and between them they reveal the felicities of details normally lost in one of Rachmaninoff's finest and most intricately woven scores. The Cliburn/Kondrashin live performance taping (RCA Victor, September 1960) was a good one too, if in a more overtly romantic vein, but it is surpassed here in interpretative subtlety as well as in sonic purity.

The Ashkenazy/Maazel Tchaikovsky, also included in this flawlessly processed twin-pack reel, boasts some fresh insights; but, with the exception of a truly electrifying finale, this performance is less decisively outstanding and less likely to displace the famous Cliburn/Kondrashin RCA Victor version in public favor. Yet no previous taping of the work matches the present one in recording attractiveness.

ROSSINI: *Il Barbiere di Siviglia*

Victoria de los Angeles (s), Rosina; Luigi Alva (t), Il Conte Almaviva; Sesto Bruscantini (b), Figaro; et al.; Glyndebourne Festival Chorus; Royal Philharmonic Orchestra, Vittorio Gui, cond. ● ● ANGEL ZC 3638. Two reels: approx. 93 and 48 min. \$21.98.

The taped repertory of complete operas is already so extensive that one is shocked to realize that this latest of four stereo *Barbers* on discs is the first to appear in reel form. Fortunately, the present Glyndebourne production is one of the best, as well as the most complete and authentic. The usual cuts and interpolations have been eschewed, Gui has gone back to the original manuscripts for many passages usually heard only in later revisions, and of course Rosina's part is sung—as Rossini intended—in the mezzo range rather than in an upward transposition by a coloratura soprano. Perhaps some listeners will miss the familiar virtuosic (if not necessarily more dramatic) approach, and the more slapstick comedy style which have become well-nigh traditional in this work. But more of us will welcome Gui's straightforward treatment and the less forced yet always sparkling humor and verve of the present performance. Miss de los Angeles' Rosina is piquantly girlish as well as vocally charming; Bruscantini's Figaro is robustly vivacious and conspiratorial without exaggerated bravura; and if Alva's Almaviva is more conventionally Italianate and less distinctive, all these and the other leading characters are superbly blended and differentiated in the great ensemble scenes (the Act II Quintet in particular) which represent the quintessence of Rossini's genius.

There is luminosity, buoyancy, and authentic tonal substance in Angel's recorded sonics, and the stereogenic stage spacings are theatrically appropriate. (Notes and libretto booklet are available

on request to tape purchasers.) The tape processing, too, is admirable: each of the two acts is complete on a single reel, and while there are a few very slight preëchoes, there is minimal surface noise and no spill-overs at all. Our long wait for a taped *Barber of Seville* has been well rewarded.

SCHUMANN: *Symphonies: No. 1, in B flat, Op. 38 ("Spring"); No. 3, in E flat, Op. 97 ("Rhenish")*

Detroit Symphony Orchestra, Paul Paray, cond.

● ● MERCURY (via Bel Canto) ST 90330. 63 min. \$8.95.

Although the present coupling appeared

on a single disc only recently (in Mercury's "Great Romantic Music" reissue series), the original recordings date back to 1958-59. Yet except for some slight low-end thickness, they sound much better now, thanks to a first-rate tape transfer, than they did then, when they were generally criticized as rather hard and dry. Paray's readings are characterized by more Gallic verve and briskness than romantic passion, and hence Schumann connoisseurs probably will cling to the Szell No. 1 for Epic (November 1962), despite its only so-so recording and processing, and to Bernstein's original score taping of No. 3 for Columbia (January 1963). The Mercury tape offers

Continued on next page

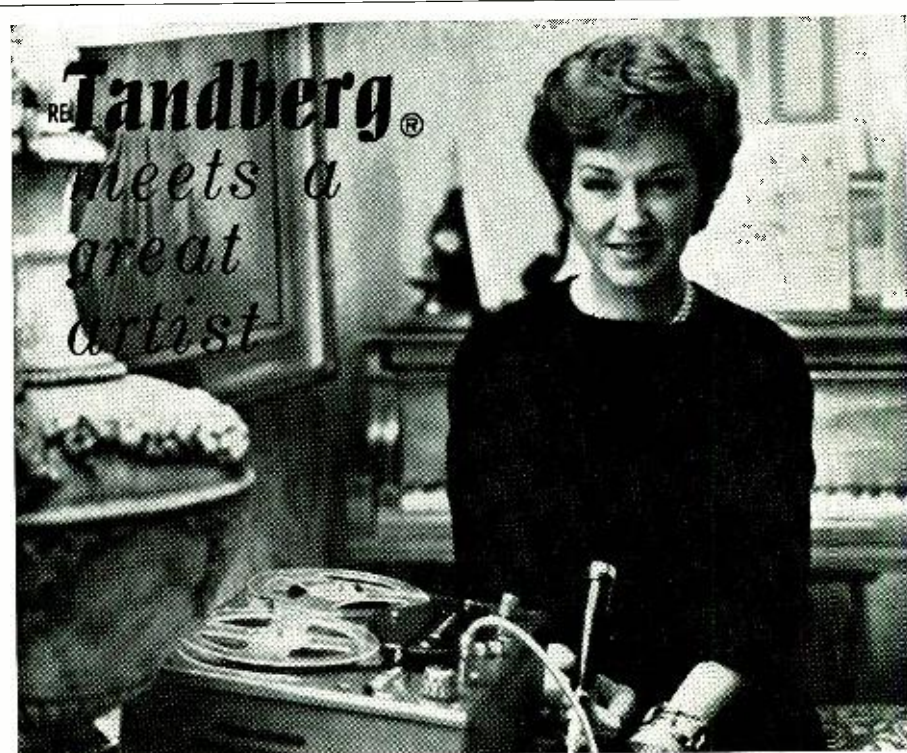

RISÈ STEVENS

Applauds the "Better, Clearer, More Natural Recording Quality" of ^{RE}Tandberg.

Model 74 $\frac{3 \text{ speed}}{4 \text{ track}}$

Complete Stereo Music System

The sheer brilliance of recording quality . . . from any source, is one of many reasons why the celebrated Miss Stevens favors Tandberg. Add to this the clean, crisp playback and such features as: FM Multiplex Filter, new pause control, "free" position tape threading, precision laminated heads, 4 pole asynchronous motor, lowest tape tension, and a virtual lack of wow and flutter. You, too, will then discover why Tandberg is rated the number 1 quality choice by everyone.

ONE YEAR GUARANTEE

AT FRANCHISED DEALERS EVERYWHERE . . . \$449.50

^{RE}Tandberg of America, Inc. P.O. Box 171, 8 Third Ave., Pelham, N. Y.
CIRCLE 63 ON READER-SERVICE CARD

**HERE'S ONE WAY TO
COOL A HOT AMPLIFIER**



but
here is a
BETTER WAY



Only
\$14.85

the **ROTRON**

Whisper Fan
KIT

Beat the heat that wrecks the set by installing a Rotron Whisper Fan Kit. Breathing 60 cubic feet of cool air over, under and around every heat-generating component, the Whisper Fan improves performance by minimizing drift due to temperature change within the enclosure. Requires only 7 watts, just pennies a week to operate. Measuring only 4 $\frac{1}{16}$ " square and 1 $\frac{1}{2}$ " deep, it can be set in a corner or mounted on the rear panel in minutes. Comes complete with mounting hardware, plug and cord for electrical connections and installation instructions.



Write for details
or see your local dealer.

ROTRON mfg. co., inc.
WOODSTOCK, NEW YORK
ORiolo 9-2401

CIRCLE 53 ON READER-SERVICE CARD

THE TAPE DECK

Continued from preceding page

the economy of both works on a single reel, however, and personally I enjoyed Paray's approach much more than I had expected.

TCHAIKOVSKY: *Capriccio italien*, Op. 45; *Marche slave*, Op. 31; *1812 Overture*, Op. 49

New York Philharmonic, Leonard Bernstein, cond.

•• COLUMBIA MQ 574. 41 min. \$7.95.

Hackneyed program though it contains, this reel offers multiple fascinations. Some are sheerly musical: the rhythmic precision, expressiveness, and enthusiasm Bernstein brings to the overfamiliar works. Others are technical: the subtle differences between recordings made in different locales (Brooklyn's Hotel St. George for the *Capriccio*, New York's Philharmonic Hall elsewhere); the solid impact of the electronic "cannon" in the *1812* finale—perhaps even more dramatic than the real guns sometimes featured; the slight but felicitous sonic improvements which this tape transfer reveals when A/B'd against the disc edition (reviewed last October). Apart from slight preëchoes, the tape processing itself is very good, partially reducing the background noise or hum I noted in the stereo disc. Even more interesting is that the not unusual high-speed dubbed-tape softening of the extreme highs is actually beneficial here—eliminating most of the pinched tone qualities of the disc's *fortissimos* yet with no loss of real brilliance and indeed a considerable gain in sonic lucidity and more equable spectrum balance.

In short, no matter how many other versions you may already have of these Tchaikovsky showpieces, you will still find profitable rewards in the present editions—not least that of hearing the often erratic Bernstein at the top of his form. And at this best there have been few conductors since Koussevitzky in his prime who can generate more thrilling listening excitement.

VERDI: *La Traviata*

Joan Sutherland (s), Violetta; Carlo Bergonzi (t), Alfredo; Robert Merrill (b), Germont; et al. Chorus and Orchestra of the Maggio Musicale Fiorentino, John Pritchard, cond.

•• LONDON LOG 90069. Two reels: approx. 62 and 71 min. \$19.95.

This latest *Traviata* was analyzed in such detail by Conrad L. Osborne in the disc review and Verdi discography appearing in this journal last October that only a few supplementary notes are needed for the particular consideration of potential reel-edition purchasers. As far as the tape layout and processing are concerned, I can have nothing but praise: the former eliminates some of the mid-side breaks in the earlier RCA Victor taping by conveniently presenting

Acts I and III each complete on a single reel side; the latter boasts extremely quiet surfaces (a faint trace of background hum in the quiet beginning of the Act III Prelude is probably built in the master recording) and complete freedom from preëchoes and spill-over.

Where the comparative attractions of the present and the earlier tape versions are concerned, a choice isn't easy. Although the London recording is admirable for its luminosity, purity, and unexaggerated stereoism, that by RCA Victor easily surpasses it in sonic body and impact as well as in a wider dynamic range. And while I didn't find Miss Moffo's acting entirely convincing when I first listened to her performance (August 1961), she now strikes me—at least in comparison with Miss Sutherland's vocally beautiful but dramatically languid Violetta—as considerably more spirited. The London version has the advantages of consistently fine singing and genuine score completeness (even if the restoration of conventional cuts is of no special musical value); RCA has those of richer sound and a generally livelier performance. In the end the decisive factor is likely to be the individual listener's soprano preference between Sutherland and Moffo.

"Artistry in Bossa Nova." Stan Kenton and His Orchestra. Capitol ZT 1931, 37 min., \$7.98.

"Lotsa Bossa Nova." Kenny Burrell Octet. Kapp KTL 41060, 35 min., \$7.95.

The prime appeal of Kenton's program, which includes many of his old hits in new arrangements, lies less in their considerable effectiveness as big-band bossa nova performances than in their welcome revelations of the pianist-leader and his usually blustering winds in relatively relaxed and often richly poetic moods. The scorings are beautifully done, and although there are still occasional moments when the brasses roar or scream a bit, there are many more of expressive and colorful sonic enchantments—especially in the bouncy title piece (by Pete Rugilo), the haunting *Kentonova* and *Concerto*, a catchy *Loco-Nova*, and a surprisingly delicate *Opus in Chartreuse*. Glowing stereoism and flawless tape processing add a final polish to the often sumptuous sonorities here.

There are still further sonic charms, of a quite different nature, in the vibrantly expressive playing of Kenny Burrell. He is backed by two other guitarists, a rhythm section starring two very fine and subtle bossa nova percussionists, occasional rhapsodic trumpet solos by Clark Terry, and sax or flute solos by Jerome Richardson. *Different Worlds* is a seductive charmer; *The Lamp Is Low*, *Song of Delilah*, *One Mint Julep*, *Tin Tin Deo*, and *Star Eyes* are outstanding in their blend of lyricism and rhythmic verve. Burrell provides liting performances throughout. This tape too is admirably recorded (a bit more crisply and less reverberantly than Kenton's),

NEW!

ROBERTS PROFESSIONAL "455"



A professional solution to your most rigorous recording problems
Roberts "455" is a complete, self-contained recording studio. Three separate heads for faultless record, erase and playback. Monitor both input and output signal. Three motors; dynamically balanced flywheel for unwavering smoothness. Touch-button solenoid operation for instant response. Speeds, 3 $\frac{3}{4}$, 7 $\frac{1}{2}$ i.p.s.

A COMPLETE RECORDING STUDIO UNDER \$600.00

With Roberts "455" you get sound-over-sound, 4 separate mixing inputs and outputs. Multiple sound-on-sound recording. Built-in "echo effect" circuit. Fast rewind—45 seconds for 1200 feet of tape—and instant braking. Self-contained 5" x 7" stereo elliptical speakers. New solid state power amplifiers (12 transistor). 10 $\frac{1}{2}$ " Reel Adapters; touch button Remote Control available. The Roberts Model "455," \$599.95

SEE AND HEAR ROBERTS TAPE RECORDERS AT BETTER PHOTO AND SOUND CENTERS — FROM \$269.95.



FREE BOOKLET! "40 and more ways to use a Roberts tape recorder."

Roberts Electronics, Inc.
5978 Bowcroft, Dept. HF-117.
Los Angeles 16, Calif.
Please send free booklet
Please send details on Roberts '455'
Please send me complete information about Roberts Tape Recorders
Name _____
Address _____
City _____ State _____

IN CANADA: J. M. Nelson Electronics Ltd., 2149 Commercial Drive, Vancouver 12, B.C. (Prices slightly higher in Canada)

CIRCLE 52 ON READER-SERVICE CARD

and it is processed with, if anything, even quieter surfaces. and with the same freedom from preëchoes and spill-over.

"Tony Bennett at Carnegie Hall." Orchestra, Ralph Sharon, cond. Columbia C2Q 568 (twin-pack), 75 min., \$11.95.

This twin-pack documentation of a live concert (June 9, 1962) reveals—more candidly than any carefully controlled studio session—the pop star's vocal limitations, yet it also demonstrates more vividly his remarkable magnetism. The cleanly transparent recording has an authentic "live" quality, if no great sonic weight, and the miking seems considerably more distant than is customary nowadays. While all this may cut the soloist's voice down to life-size and expose some of his weaknesses, it makes his eventual triumph all the more genuinely earned. Especially effective here is the long but well-varied *Glory Road*; there are also fine performances of *Love Is Here To Stay*, *Anything Goes*, *Blue Velvet*, *What Good Does It Do?*, etc. The deft orchestral accompaniments (occasionally featuring Candino's bravura percussion solos) are a model of their kind. Bennett's informal spoken commentaries are good too. My only objection concerns the excessive audience applause.

"Five Feet of Soul." Jimmy Rushing; Orchestra, Al Cohn, cond. Colpix CXC 605. 32 min., \$7.95.

The blues-shouting and jazz-charged ballad styles of the exuberant and ageless Rushing are perhaps not to everyone's taste, but what a welcome contrast they provide to the limpness of most pops—and even jazz—vocalists of today! Even in his great years with the Basie and Moten bands, Rushing never sang better than in the present *My Bucket Has a Hole in It*, *Please Come Back*, *Did You Ever?*, etc. The strong, vibrant recording and live acoustics do full justice both to the soloist and to Cohn's animated, if sometimes almost too sophisticated, accompaniments. Several top-rank jazz soloists are starred; most effective of all is pianist Patti Brown.

Lynn Gold. Warner Brothers WSTC 1495, 34 min., \$7.95.

"Such Interesting People." Steve Adliss and Bill Crofut. Verve VSTC 294, 30 min., \$7.95.

Two exceptionally arresting debut programs by fresh pop-folk talents. Miss Gold is as yet a minor league Baez with much to learn about enunciation, relaxation, and projection of personality, but she is already a charmer—especially in the tender lullaby *Sweet Potatoes*, the touching *I Once Loved a Boy*, and the more vivaciously lilting *Katie Cruel*. Her future releases are to be anticipated, but I hope they will provide better information on the program materials. It is not even stated here whether the soloist plays her own attractive accompaniments—a single guitar (sometimes rather disconcertingly separated from the voice itself) except in the Spanish-American

Continued on next page

NEW!

TRUE HIGH-FIDELITY STEREO AT 1 $\frac{1}{8}$ SPEED

ROBERTS CROSS FIELD "770"



Roberts "770," with its revolutionary CROSS FIELD HEAD provides incredibly magnificent, full-range, high-fidelity stereo at 1 $\frac{1}{8}$ i.p.s. . . . record 12 hours of stereo or 24 hours of monaural on one 7" reel (3600') at an average tape cost of less than 33¢ per album. The CROSS FIELD "770" has an exclusive patented "third head" separating recording and biasing functions. You record a full octave higher than ever before possible (at 7 $\frac{1}{2}$ i.p.s., from 40 to 22,000 c.p.s.), preserving the harmonics that add brilliance to music playback. Highest resolution head (gap-width of only 40 millionths of an inch) available, assures undestroyed full-range high frequency playback—and is protected by wear-resistant nickel-chrome alloy NC-88. Other features: 2-speed electrically switched hysteresis synchronous motor; minuscule wow and flutter; automatic total shut-off; 12-watt amplifier; self-contained 7" extended-range Alnico V-magnet speakers; 1 $\frac{1}{8}$, 3 $\frac{3}{4}$, 7 $\frac{1}{2}$ i.p.s. speeds. 15 i.p.s. speed optional. \$499.95

SEE AND HEAR ROBERTS TAPE RECORDERS AT BETTER PHOTO AND SOUND CENTERS — FROM \$269.95.



FREE BOOKLET! "40 and more ways to use a Roberts tape recorder."

Roberts Electronics, Inc.
5978 Bowcroft, Dept. HF-118.
Los Angeles 16, Calif.
Please send free booklet
Please send details on Cross Field '770'
Please send me complete information about Roberts Tape Recorders
Name _____
Address _____
City _____ State _____

IN CANADA: J. M. Nelson Electronics Ltd., 2149 Commercial Drive, Vancouver 12, B.C. (Prices slightly higher in Canada)

CIRCLE 52 ON READER-SERVICE CARD

**Who has
Sutherland,
Baez,
The Duke,
Ansermet,
Mantovani,
and a thousand
other
stereo tape
selections?**

The pick of 16 major recording companies—featuring Peter, Paul & Mary, Stan Getz, Stokowski, Monteux, Sutherland, the D'Oyly Carte—in short just about everybody who is anybody in the popular, jazz, folk, classical, opera and oratorio fields.

**Your Ampex
Master Tape Center**

- | | |
|--|--|
| CALIFORNIA
BEVERLY HILLS
Discount Record Center, Inc.
8484 Wilshire Blvd | MICHIGAN
DETROIT 24
Pecar Electronics, 11201 Moreang |
| GARDENA
Stereo Hi Fi Center
13986 S. Crenshaw Blvd | MINNESOTA
MINNEAPOLIS 8
Audio King Co., 313 West Lake St |
| HOLLYWOOD
Wallachs Music City
Sunset and Vine | MISSOURI
KANSAS CITY 6
Bunsten-Applebee Co
1012 1014 McGee St |
| LOS ANGELES 6
California Music Co
2933 W. Pico Blvd | NEW YORK
BUFFALO 3
Purchase Radio Hi Fi, 747 Main St |
| MENLO PARK
McDaniels Hi Fi, 935 El Camino Real | NEW YORK 7
Hens and Bolet, 68 Cortlandt St
Leonard Radio, 69 Cortlandt St |
| OAKLAND
Starway to Music, 4150 Broadway | NEW YORK 22
Liberty Music Shop
450 Madison Ave |
| SAN FRANCISCO
Lakeshore Hi Fi, 222 W. Portal
Walter Willey, 691 Market St | NEW YORK 17
G. Schirmer, 609 5th Ave |
| COLORADO
DENVER
Empire Radio & TV, 1100 Broadway | OREGON
PORTLAND 4
Oregon Hi Fi, 340 S W 5th |
| DISTRICT OF COLUMBIA
WASHINGTON
Commissioned Electron cs
1776 Columbia Rd N W
Electronic Wholesalers, Inc
2345 Sherman Ave N W | PORTLAND 15
One Radio & Hi Fi,
3190 S E Hawthorne Blvd |
| ILLINOIS
CHICAGO
Allied Radio, 100 N. Western Ave | WASHINGTON
SEATTLE
Electri-craft, 1408 6th Avenue |
| MASSACHUSETTS
CAMBRIDGE 38
Minute Man Radio, 28 Boylston St | Hess Recorders
650 S W 152nd Street
Tulle Camera Supply
1415 3rd Avenue
Wesfields, Inc
800 So Michigan St |
| WELLESLEY
The Music Box, 58 Central Ave | |

For a catalog of the complete selection of tapes, write Ampex Stereo Tapes, 401 Broadway, Redwood City, California. In Canada, Ampex of Canada Ltd., Rexdale, Ontario.



CIRCLE 72 ON READER-SERVICE CARD

THE TAPE DECK

Continued from preceding page

ballad *Plane Wreck at Los Gatos*, for which two guitars are used in somewhat excessive spacing.

Addiss and Crofut are more assured than Miss Gold and choose more varied materials. They sing with an infectious verve, humor, and vocal appeal that remind me (different as the individualities concerned may be) of Josef Marais' first recorded appearances many years ago. The new duo is very amusing in the name-dropping title song, and the only too topical *Missile Song* and *Twelve Days with Khrushchev*, but I liked even better the chanting of such magnificent tunes as the familiar *The King Went Forth* (Agincourt Song) and a *Coulter's Candy* (Australian?) that is brand-new to me. There are also a lilting Elizabethan *I Saw Her*; a buoyant *Whale and Back Band*; a fresh and surprisingly un-sentimentalized *Goin' Home*; and one of the very few performances I know that does full justice to Ann Ronell's *Willow Weep for Me*. Quite closely miked but with good acoustical warmth, this well-recorded and immaculately processed tape is a real discovery. Only its annotations are deficient: background information on the program material would be much more useful than an account of the duo's concert successes.

"On Tour." University of Michigan Band, William D. Revelli, cond. Vanguard VTC 1667, 46 min., \$7.95.

I praised warmly both the recording and performances of this fine concert band program in its disc edition (February 1963). The playing again is impressive here, the sonics are even better: for once a tape version boasts not only more substantial lows and superior channel differentiations but a slightly brighter high end and more equable spectrum balance. (There are, however, some pre-echoes and one slight suspicion of spill-over in the quiet-surfaced tape processing.) Perhaps the big showpieces here (*The Great Gate of Kiev* from Musorgsky's *Pictures and Elsa's Procession* from *Tannhäuser*) are works best left to orchestras, but Bonelli's *Symphonic March*, Rachmaninoff's surprisingly jaunty if almost vulgar *Italian Polka*, Bilik's *American Civil War Fantasy*, and Lecuona's *Carnival Procession* are all ideal for band. And for sheer virtuosity few concert bands—even professional—could top the present performance of the *Polacca* from Weber's *Second Clarinet Concerto* (with the collegians' full clarinet choir playing in perfect unison) and Agostini's *Divertissement for Three Trumpets*, in which four different cornet and trumpet trios are featured.

"The World of Miriam Makeba."

Miriam Makeba; Orchestra, Hugh Masekela, cond. RCA Victor FTP 1227, 34 min., \$7.95.

Miriam Makeba's one world is unified by the infectious warmth and conviction of a protean artist, equally at home in African dialects, Portuguese, English—

and probably other languages as well. Particularly appealing here are *Little Boy*, *Amampondo*, and *Dubula*, among others. My only critical reservation is over an occasional slight commercialization (the hint of Lena Horne mannerisms in *Wonders and Things*; the emotionalization of *Where Can I Go?*). And I would have enjoyed more frequent occurrences of Masekela's extraordinary muted-trumpet solos over these intoxicatingly rhythmed and colorfully scored orchestral accompaniments. The stereo recording is extremely vivid and broadspread (with the soloist well centered and apparently not too close). It is one of the best examples of Dynagroove technology in the nonclassical repertoires, a happy state of affairs perhaps resulting from a combination of some natural reverberation with a few discreet touches of echo-chambering.

Ampex Standard Reproduce Alignment Tape. Ampex 31321-04, 7 min., \$21.95 (on special order only).

Here is an invaluable tool of the highest professional caliber for technicians and experienced audiophiles who own and know how to use proper auxiliary response measuring devices. I single it out for attention here as a sort of postscript to my test record article of last month. In that survey I had originally hoped to include test tapes too, but there proved to be none in print which is primarily designed for general amateur use at home. Indeed, apart from two RCA Victor test tapes in 3.75-ips "cartridge" form, the present 31321-04 reel seems to be the only means available today of making accurate dynamic tests of 4-track playback operations and of making optimum vertical adjustments of 4-track playback heads. Its high cost is substantially justified by the exceptional care with which it has been prepared and processed at one-to-one 7.5-ips speed on lab-calibrated and standardized equipment. It includes (recorded on tracks 1 and 3 only) spoken directions on procedure and announcements of the frequency runs: one minute of 0-db 3-kc tone for vertical head adjustments (which may be checked by turning the reel over and testing for complete absence of spill-over into the blank tracks 2 and 4); thirty seconds of -10-db 15-kc tone for making optimum azimuth adjustments of the playback head; ten seconds each of nine frequency spots at -10-db (12 kc to 50 cps) for checking frequency response and preamp equalization; and fifteen seconds each of 700 cps at -10-db and 0-db levels for setting VU meter levels.

The Audio Division of Ampex Corporation, Sunnyvale, California, also offers a considerable variety of full-track lab-standard alignment tapes for special professional purposes, including flutter measurements and level-set calibrations, CCIR and AME (as well as NAB) equalizations, at 15 and 3.75 (as well as 7.5) ips. A descriptive price list is available on request.

THE HERITAGE OF BRUNO WALTER

Continued from page 48

weeks before the Nazi *Anschluss* and, like *Das Lied von der Erde*, was recorded in concert "with coughing and banging of seats," to use Walter's deprecatory description. Fred Gaisberg of HMV, who directed the recording, called it "the swan song" of Mahler's own orchestra, sung in the historic Musikverein. Surely it was the swan song of Walter's career in Central Europe until after World War II. Perhaps for this reason, perhaps for others, he never was very enthusiastic about the set, and I think it is now beyond question that he would want it put aside for the stereo version. I would be fully in agreement.

MENDELSSOHN

Concerto for Violin and Orchestra, in E minor, Op. 64
Nathan Milstein, violin; New York Philharmonic (1945). ML 4001 (OP).

In view of his rapport with the early romantics, Walter strangely neglected their music on records. There is an unimportant Philharmonic disc of the *Midsummer Night's Dream* Scherzo (plus a couple of acoustics), but this is really the sole Mendelssohn document of any stature. Milstein never made a finer concerto album. The gypsy quality in his playing is firmly controlled, perhaps through Walter's influence, and the dancing lyricism of the music beautifully set forth. A new edition ought to be forthcoming.

MOZART

La Clemenza di Tito, K. 621: Overture
Vienna Philharmonic Orchestra (1937). RCA Victor 12526 (78 rpm, OP).

There is plenty of sound on this disc, and Walter's gift for capturing a sure Mozartean pulse was never better displayed. In the absence of a later recording, this score is badly missed. A "Great Recordings" reissue is in order.

Concerto for Piano and Orchestra, in D minor, K. 466
Bruno Walter, piano; Vienna Philharmonic Orchestra (1937). Odeon COLH 36.

This is the supreme documentation of Walter as a pianist, as well as one of the finest recorded statements of this score. I do not understand why the new edition has never been released in this country, but happily the importers can supply the European "Great Recordings" issue on the Odeon label. No collection of Walter records is comprehensive without it. The general character of the performance is romantic, with a Chopin-esque cadenza by Reinecke that would seem rather out of place were the manner of interpretation more austere in character. But the concerto lends itself to this approach, and Walter carried it through with a degree of consistency in artistry and style that makes this performance a lasting memorial to the grand manner of the past century.

Concertos for Violin and Orchestra: No. 3, in G, K. 216; No. 4, in D, K. 218
Zino Francescatti, violin; Columbia Sym-

phony (1958). ML 5381 or MS 6063 (stereo).

Francescatti and Walter were an ideal combination in the concerto literature, and we must be grateful that they included these lovely and too frequently neglected works in their recording schedule. As in the concerto above, the lyric emphasis is uppermost, and it leads to some beautiful playing.

Così fan tutte, K. 588: Overture

- 1) New York Philharmonic (1945). 12901 (78 rpm, OP).
- 2) Columbia Symphony (1954). ML 5004.
- 3) Columbia Symphony (1961). ML 5756 or MS 6356 (stereo).

I omit discussion of an acoustic version of this score, and the first two of the electrical recordings can be set aside. The number of editions, however, attests to Walter's affection for the music. I think that the final try, which was expertly captured in stereo, has all the felicity he was hoping to realize in these grave and witty pages.

Deutsche Tänze, K. 605

- 1) Vienna Philharmonic (1937). RCA Victor 4564 (78 rpm, OP).
- 2) Columbia Symphony (1954). ML 5004.

Distinctly entertainment music, but charming, these three dances (the last is the famed sleigh ride) are best heard in the second version.

La finta giardiniera, K. 196: Overture
(First movement only)
Vienna Philharmonic (1937). RCA Victor 12526 (78 rpm, OP).

The absence of a later version makes this performance more than worthy of reissue. (I would even like a refurbished edition of Walter's *Idomeneo* Overture, ancient and acoustic though it be.)

Maurerische Trauermusik, K. 477

- 1) Columbia Symphony (1954). ML 5004.
- 2) Columbia Symphony (1961). ML 5756 or MS 6356 (stereo).

Walter loved this music and, as will happen in his Mozart, was sometimes carried away by the sheer beauty of it. I detect no self-elegizing in the second version, though it comes from his final recording sessions, but the earlier set offers a more tightly focused and direct performance.

Minuets: in C, K. 568; No. 12, in F, K. 599, No. 5
Columbia Symphony (1954). ML 5004.

More entertainment music, again achieved with charm and grace.

Le Nozze di Figaro, K. 492: Overture

- 1) British Symphony Orchestra (1932). 68133 (78 rpm, OP).
- 2) Columbia Symphony (1954). ML 5004.
- 3) Columbia Symphony (1961). ML 5756 or MS 6356 (stereo).

Again, there is an even earlier acoustic



means the beat of
sound wizardry

Sound all around. Crystal clear. Compelling. Mood setting... such is the magic of Utah's compact Sorcerer. This 2-speaker system brings BIG, full, distortion-free sound into reality. It performs this electronic magic better than many larger and more costly systems. Here is wizardry developed from Utah electronic ingenuity, and found exclusively in the Sorcerer.

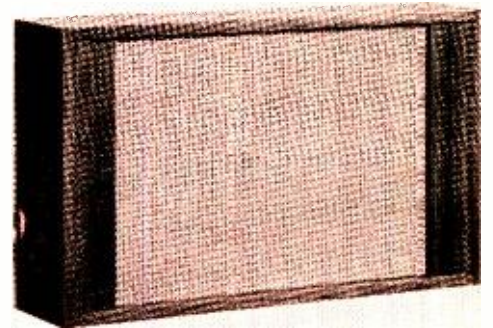

- Styling — fits Early American through Modern decor.
- Components — Two Utah Speakers, an 8" Woofer, 5" Tweeter, Crossover.
- Cabinet — Hand-rubbed, oiled walnut veneer, applied to 1/2" plywood, a standard for fine furniture.
- Location — Wall, bookshelf, floor, table-top.
- Dimensions — 20" in length, 12" high, 5" deep.
- Power rating — 12 watts.
- Uses — Hi-Fi or Stereo, as extension speakers for record player, radio or TV.

\$29.97 Net SH4-W



HUNTINGTON, INDIANA

"Unequaled"

New Yorker



JOAN
SUTHERLAND
as *Elvira* in
BELLINI'S
I PURITANI

Joan Sutherland, Pierre Duval,
Renato Capecchi, Ezio Flagello
and other soloists—Chorus and
Orchestra of the Maggio Musicale
Fiorentino—Richard Bonyngé
Stereo OSA-1373 Mono A-4373

ROBERT
MERRILL
OPERATIC
RECITAL

Arias from *Otello*, *Un Ballo in Mas-
chera*, *Il Trovatore*, *La Forza del
Destino*, *I Pagliacci*, *Don Carlos*,
Andrea Chénier—The New Sym-
phony Orchestra—Edward Downes
Stereo OS-25833 Mono 5833

RÉGINE
CRESPIN

Ravel
SHÉHÉRAZADE
Berlioz
LES NUITS D'ÉTÉ

L'Orchestre de la Suisse Romande
—Ernest Ansermet
Stereo OS-25821 Mono 5821



version, which can be forgotten along with the 1932 effort. If you prefer a very fast, brilliant performance of this music, the first of the Columbia Symphony editions is the one to have. I am, however, charmed by the effects secured by the slightly slower pace and more flexible breadth of phrase in the second American version, and the advantages of stereo are not to be dismissed either.

Requiem Mass, in D minor, K. 626
Irmgard Seefried, soprano; Jennie Tourel, mezzo; Léopold Simoneau, tenor; William Warfield, baritone; Westminster Choir; New York Philharmonic (1936). ML 5012.

In his performances of this music in the later years of his career, Walter finally took the steps to revise Süssmayr's "routine" instrumentation of Mozart's unfinished score, particularly the excess use of trombones which had, for Walter, a "tiring effect on the ear" and lacked the authority of having been included in the composer's sketches. The present recording is thus of value as a document of a great conductor's editing of a masterpiece, but of course its primary effect is that of an exceptionally fine performance. The reverberation time is longer than I normally approve (the sessions were held in Carnegie Hall), but it does not seem to do any harm. The chorus is especially fine, and the solo quartet is made up of four individually notable singers, though Touré does not seem to match the others in her interpretative approach.

Der Schauspieldirektor, K. 486: Overture
1) Columbia Symphony (1954). ML 5004.
2) Columbia Symphony (1961). ML 5756 or 6356 stereo.)

Once more the second version is somewhat more broadly stated than the first. In this case I find the earlier performance to be wittier and more gallant.

Serenade for Strings, No. 13, in G, K. 525 ("Eine kleine Nachtmusik")
1) British Symphony Orchestra (1931). X 19 (78 rpm, OP).
2) Vienna Philharmonic Orchestra (1936). Odeon COLH 36.
3) Columbia Symphony (1954). ML 5440.
4) Columbia Symphony (1958). ML 5756 or MS 6356 (stereo).

The fallacy of talking about "Walter's Mozart" as if it were a fixed thing is nowhere better demonstrated than in his four versions of this serenade. It was always one of his favorite works, and his affection always shows; but the manner of performance ranges from a very fast, tightly stated version at first to a rather loose and, regretfully, ineffectual account at the end. I am most in agreement with Walter's tempo here when it is quick, which is to say the first, second, and final movements from 1931 and the third from 1954. However, the recording of the British Symphony set is very antiquated, and only serious Walter students will find it of interest. The second edition has a big orchestra in a highly resonant hall (the Grosser Musikvereinsaal). The performance is as full of *Schlagobers* as a Viennese sweet shop. This leaves us with the third, which offers very pleasing high fidelity sound and the best of the recorded performances of the past thirty years.



A pianist too, in the grand manner.

Symphonies: No. 25, in G minor, K. 183; No. 28, in C, K. 200
Columbia Symphony (1954). ML 5002 (OP).

This was one of Walter's recordings for the Mozart bicentennial in 1956. If you don't have a copy, start hunting while some are still around, for the performances have a robust, youthful quality that is a delight and the recording is quite good enough to make its deletion seem premature.

Symphony No. 29, in A, K. 201
Columbia Symphony (1954). ML 5375.

This is one of the most difficult Mozart symphonies to pace. Under Walter's direction it fairly glows. The control is sure, the urges to sentimentality well disciplined, and the work unfolds with all its *brío* intact.

Symphony No. 35, in D, K. 385 ("Haffner")
1) New York Philharmonic (1953). ML 4693.
2) Columbia Symphony (1959). M3L 291 or M3S 691 (stereo); ML 5655 or MS 6255 (stereo).

Both of these performances are filled with lovely things, but the first seems to be just a little too tight. When Walter made the second version he was more relaxed, and this sense of being at ease shows in a delightful lilt that transforms many a phrase into something more beautiful than he was able to bring us before.

Symphony No. 36, in C, K. 425 ("Linz")
1) Columbia Symphony (with rehearsals) (1955). DSL 224.
2) Columbia Symphony (1960). M3L 291 or M3S 691 (stereo); ML 5893 or MS 6493 (stereo).

This is the score that provided what Walter called "The Ambush," the sessions in which both rehearsals and performance were recorded—unbeknownst to the participants. Since then we have had other glimpses of Walter in rehearsal, but none so extensive, so personal, nor so valuable to those who wish to rediscover what he was like in the "workshop." The DSL album must therefore remain the more important one in

any historical approach, and I think it is also the better realization of the music.

Symphony No. 38, in D, K. 504
("Prague")

- 1) Vienna Philharmonic Orchestra (1937). Odeon COLH 37.
- 2) Columbia Symphony (1959). M3L 291 or M3S 691 (stereo); ML 5894 or MS 6494 (stereo).

There is no comparison in sound between these editions, but the Vienna performance appears to me to be the stronger of the two musically. Both show a tendency to slow tempos, but in the Vienna performance there is a little more sense of drive.

Symphony No. 39, in E flat, K. 543

- 1) BBC Symphony (1934). RCA Camden CAL 237 (OP).
- 2) New York Philharmonic (1956). ML 5014.
- 3) Columbia Symphony (1960). M3L 291 or M3S 691 (stereo); ML 5893 or MS 6493 (stereo).

The British set has a very beautiful, romantic statement of the slow movement and deserves to be remembered on that account. Taking performances as wholes, the second is probably the most consistently successful (it certainly is best in the final two movements). On the other hand, if the first movement is your favorite, the stereo edition dominates, because here Walter obviously achieves all he has been trying to say in these pages. Unfortunately, he then allows the slow movement to become somewhat lush and the pulse to grow less emphatic elsewhere.

Symphony No. 40, in G minor, K. 550

- 1) British Symphony Orchestra (1930). M 182 (78 rpm, OP).
- 2) New York Philharmonic (1953). ML 4693.
- 3) Columbia Symphony (1959). M3L 291 or M3S 691 (stereo); ML 5894 or MS 6494 (stereo).

Walter has said that he was overcome with the "feeling of responsibility" in performing this work, and it was not until quite late in his career, when he was about fifty years of age, that he added it to his repertory. Walter was fifty in 1926, and by the time he made his initial recording the basic outlines of his performance were established, though they were still to achieve full refinement. The Philharmonic version best represents that peak, I think. It is a tighter, more expressive, more forceful statement than the later one, and better exemplifies the vigor Walter could achieve in Mozart's most eloquent pages.

Symphony No. 41, in C, K. 551 ("Jupiter")

- 1) Vienna Philharmonic Orchestra (1937). Odeon COLH 37.
- 2) New York Philharmonic (1945). ML 4880 (OP).
- 3) New York Philharmonic (1956). ML 5014.
- 4) Columbia Symphony (1960). M3L 291 or M3S 691 (stereo); ML 5655 or MS 6255 (stereo).

Of the four recordings of this work, no two are alike. The Vienna set is very sentimental, and I find that quality alien to this music. The first New York

Continued on page 106

"AN EDUCATION AND A JOY"

Continued from page 43

personal pantheon, and Goethe's concept of "natural man vs. corrupting society" probably reinforced Walter's strong anti-mechanistic tendencies. He was suspicious of anything containing more working parts than a baton. Gadgets were personal enemies, and the looming world of the computer and the electronic-mathematical composer filled him with despair. Despite this, he was genuinely enthusiastic about stereo if someone would subdue for him the treacherous phonographic beast. He confessed that our "new records" had advanced so far he no longer got pleasure from hearing his old ones.

His antipathy to gadgets extended even to his glasses, whose perpetual opacity I struggled to overcome with ineffectual Kleenex on those rare occasions when he needed them. Lotte catalogued his attempts to abandon them in all restaurants and dressing rooms of the Western world, and added that certain Hollywood waiters were now trained to recover and return the leather case upon departure as a matter of routine. Walter enjoyed this kind of teasing immensely and told her she was lucky he didn't feel the same way about his children.

A close association with Bruno Walter was necessarily a rich one. Defined by music, it was also constructed with kindness, humor, and morality in its profoundest sense—all measured in the different life pulse of a now vanished world, a world of savored time where a Bruckner symphony was a pleasure too quickly spent.

It is still very difficult to recall the list of projects planned and never now to be completed: the Schumann Symphonies, the Brahms Requiem, the Mahler Fourth and Fifth Symphonies, *Fidelio*. Each of these unfertilized seeds brings its own peculiar pain. The only anodyne is a group of records occupying eight inches along a library shelf: the legacy of one hundred unforgettable sessions of music making, and a treasure worthy of its creator.

are
you
ready
for
low C

(32.7 cps)



but
clean?

■ Perhaps you've heard it from a small box with a frantically flailing small cone. But wait until you hear it from this large box with a big cone as relaxed as a baby's breathing. Write for free information on the Klipsch Cornwall loud-speaker system. And, if you wish, send 25¢ for Paul W. Klipsch's paper "The Eight Cardinal Points of Sound Reproduction."

KLIPSCH & ASSOCIATES, Inc.
P. O. BOX 96H • HOPE, ARKANSAS
CIRCLE 13 ON READER-SERVICE CARD

AMPEX-UST-4

4-track stereo

tape recorder

\$299.00

with introductory offer of \$50.00 worth of UST 4-track stereo tapes. Brochure and list of free tapes sent by return mail!

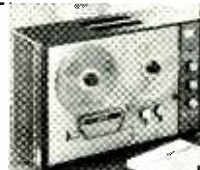

SAXITONE RECORDING TAPE

275' plastic, 3 inch35
225' MYLAR, 3" (in mailable box)39
600' acetate (plastic), 5 inch75
600' MYLAR 5 inch reel85
900' MYLAR (Polyester), 5 inch89
1200' MYLAR, 1/2 mil, 5 inch reel1.18
1200' MYLAR, tensilized, 5 inch1.59
1200' acetate (plastic), 7 inch1.15
1200' MYLAR, 1 1/2 mil, strong1.29
1800' acetate (plastic), 7 inch1.39
1800' MYLAR 1 mil, thick, 7 inch1.89
2400' MYLAR, untensilized, 7 inch2.59
2400' MYLAR, tensilized, 7 inch2.89

Plus Postage (Greater discounts to quantity buyers.)

SAVE 30-60%

4-track stereo music on tape
FREE 50-PAGE CATALOG



1776 Columbia Road, N. W., Washington 9, D. C.
division Commission Electronics, Inc.

CIRCLE 26 ON READER-SERVICE CARD

get a reliable

Hi-Fi

Quotation from

ALLIED

save big money—
get the services
and guarantees of
America's Largest
Hi-Fi House...

write today—tell us what
you want, or ask for our
expert recommendations.

DO IT NOW...

ALLIED RADIO

100 N. WESTERN AVE., Dept. HF,
CHICAGO 80, ILL.
Area Code 312 • HAYmarket 1-6800

CIRCLE 5 ON READER-SERVICE CARD

SAVE OVER 40% ON HI-FI

Write for our price now. You'll be glad
you did.

EASY-PAY-PLAN. Up to 24 mos. to pay.

- ★ 15 Day money-back guarantee.
- ★ Full 2 yr. Warranty-Parts & Labor.
- ★ Factory Franchised all lines. We ship
from stock.
- ★ Trade-Ins Highest Allowance—Send your
list.
- ★ 19th year of reliable service—world-wide.
- ★ We guarantee "WE WILL NOT BE
UNDERSOLD".

Call us. We pay first 3 min. any part of
U.S.A. if your order exceeds \$100.00. Best
Buy Hi Fi List Free.



1797-AP, 1st Ave.
New York, N. Y., 10028
(212) EN-9-3700

CIRCLE 40 ON READER-SERVICE CARD

FAST SHIPMENTS

COMPONENTS • KITS

RECORDERS • TAPES

- BEST-BY-COMPARISON PRICES
- FACTORY SEALED CARTONS
- SEND FOR "QUOTES" ON PACKAGE
DEALS AND SAVE MORE



WRITE FOR MONTHLY SPECIALS
VISIT OUR STORE
CARSTON Studios
125-F East 88 St., New York 28, N. Y.

CIRCLE 19 ON READER-SERVICE CARD

THE HERITAGE OF BRUNO WALTER

Continued from page 105

version has a wonderfully quick finale which is never duplicated, while the new Columbia Symphony set has an equally effective realization of a much slower approach. The second Philharmonic edition is outstanding for its minut. The first two movements are the key to the score, however, and here the fourth version appears greatly superior to its predecessors.

Die Zauberflöte, K. 620: Overture

- 1) Mozart Festival Orchestra, Paris (1928). 67660 (78 rpm, OP).
- 2) Columbia Symphony (1954). ML 5004.
- 3) Columbia Symphony (1961). ML 5756 or MS 6356 (stereo).

For Walter this opera was Mozart's "spiritual testament," and it is tragic that we do not have the entire work from him on records. There is a great sense of nobility in his final version of the Overture, enhanced by the stereo engineering, but there is greater musical force in the performances of earlier years. My choice would be the initial Columbia Symphony version.

Vocal Accompaniments

If we do not have a complete Mozart opera from Walter, we do at least have a substantial quantity of Mozart's vocal music, sung by leading singers of Walter's American years with orchestras under his direction. The discs in question are, naturally, more likely to be of interest for the singing than for the conducting, but I list them in compact form with the suggestion that a rather interesting historical set could be assembled from these materials.

Così fan tutte, No. 25, "Per pietà ben mio," Eleanor Steber, ML 4694 (OP).

Don Giovanni, No. 4, "Madamina, il catalogo. . .," Ezio Pinza, ML 5239; No. 23, "In quali eccessi . . . Mi tradi," Eleanor Steber, ML 4694 (OP); No. 25, "Cruelle! . . . Non mi dir," Eleanor Steber, ML 4694 (OP).

Die Entführung aus dem Serail, No. 6, "Ach, ich liebe," Lily Pons, ML 4217 (OP); No. 10, "Welcher Kummer . . . Traurigkeit," Eleanor Steber, ML 4694 (OP); No. 12, "Welche Wonne," Lily Pons, ML 4217 (OP); No. 19, "Ha! wie will ich triumphieren," Ezio Pinza, ML 4036 (OP).

Le Nozze di Figaro, No. 3, "Se vuol ballare," Ezio Pinza, ML 5239 and George London, ML 4699 (OP); No. 4, "La vendetta," George London, ML 4699 (OP); No. 9, "Non più andrai," George London, ML 4699 (OP); No. 11, "Voi che sapete," Lily Pons, ML 4217 (OP); No. 17, "Hai già vinta . . . Vedrò mentr'io sospiro," George London, ML 4699 (OP); No. 19, "E Susanna non vien . . . Dove sono," Eleanor Steber, ML 4694 (OP); No. 26, "Aprite un po'," Ezio Pinza, ML 5239 and George London, ML 4699 (OP).

Il Re pastore, No. 10, "L'amerò, sarò costante" (Saint-Saëns cadenza), Lily Pons, ML 4217 (OP).

Der Schauspieldirektor, No. 2, "Bester Jüngling!" Eleanor Steber, ML 4694 (OP).

Die Zauberflöte, No. 14, "Der Hölle Rache," Lily Pons, ML 4217 (OP); No. 15, "In diesen heiligen Hallen," Ezio Pinza, ML 4036 (OP); No. 17, "Ach, ich fühl's," Eleanor Steber, ML 4694 (OP).

Concert Arias

Mentre tu lascio, o figlia, K. 513. Ezio Pinza, ML 5239 (OP); George London, ML 4699 (OP). *Rivolgete a lui lo sguardo, K. 584.* George London, ML 4699 (OP).

Church Cantatas

Exsultate, jubilate, K. 165: No. 3, "Alleluja," Lily Pons, ML 4217 (OP).

SCHUBERT

Rosamunde, Op 26: Overture (Magic Harp); No. 5, Entr'acte No. 3; No. 9, Ballet, in G
Columbia Symphony (1955). ML 5156.

Rosamunde, Op. 26: No. 2, Ballet, in B minor; No. 9, Ballet, in G
London Symphony (1938). RCA Victor 12534 (78 rpm, OP).

These two records document Walter's performances of the best-known sections of the *Rosamunde* score, with the spirit of the playing unchanged and the quality of sound always good enough to please the ear. Walter succeeds with the light, romantic Schubert more consistently than with the heroic Schubert of the C major Symphony. These are important items in his discography.

Symphony No. 5, in B flat

- 1) Columbia Symphony (1955). ML 5156.
- 2) Columbia Symphony (1960). M2L 269 or M2S 618 (stereo).

The differences between the two performances are slight, but the recording of the second is so much clearer and more refined that it easily takes precedence. The first movement might benefit from a faster tempo, but this is a very beautiful and sensitive performance.

Symphony No. 8 in B minor ("Unfinished")

- 1) Vienna Philharmonic Orchestra (1935). RCA Victor G 9 (78 rpm, OP).
- 2) Philadelphia Orchestra (1947). ML 4880 (OP).
- 3) New York Philharmonic (1958). M2L 269 or M2S 618 (stereo).

The Vienna set is surpassed by the two later ones, in which finer engineering adds to the impact of even stronger performances. I have a great deal of affection for the Philadelphia edition, which well conveys the characteristic sound of that ensemble. However, as a whole, the newer version must be regarded as the more important document. Stereo adds a great deal, and the performance seems to sum up everything Walter wished to achieve with this music. No other conductor gives the *Unfinished* quite the same romantic quality while retaining the same sense of control, nor has anyone else achieved an equivalent balance between lyric and dramatic elements.

Symphony No. 9, in C

- 1) London Symphony Orchestra (1938). RCA Camden CAL 195 (OP).
- 2) New York Philharmonic (1946). ML 4093 (OP).
- 3) Columbia Symphony (1959). M2L 269 or M2S 618 (stereo).

I am forced to conclude that this work never was one of Walter's great achievements. Of his contemporaries, Toscanini and Furtwängler both easily surpassed him, primarily because of their greater ability to cope with its problems of form. Among Walter's recordings, the one from London provides the most tightly focused statement of the score. The sound is not very pleasant, however, and it may go into the discard as a result. The third version, in contrast, has quite lovely sound, and I would take it over the Philharmonic version on that account, even though it provides virtually the only instance in the Columbia Symphony series where I feel I am hearing an old man's performance of a work.

SCHUMANN

Concerto for Piano and Orchestra, in A minor, Op. 54

Eugene Istomin, piano; Columbia Symphony (1960). ML 5494 or MS 6159 (stereo).

There is no sentimentality in this performance, which achieves a warm, romantic quality while remaining brisk in tempo and very much to the point. If you agree that sensitivity sometimes benefits from a degree of emotional reserve (which is to say, emotional control), you will find this a particularly satisfying statement of the score. The orchestral playing under Walter is obviously a complete fulfillment of his wishes, and this (coupled with stereo) makes the set the finest documentation we have of the conductor's approach to Schumann.

Dichterliebe; Frauenliebe und-leben

Lotte Lehmann, soprano; Bruno Walter, piano (1941). ML 4788.

Although more important in the Lehmann discography than in the Walter, the collaboration of these artists gave us one of our few real glimpses of Walter's pianism in his later years. The



Also a master in three-quarter time.

performances are historic and acceptably recorded, the value of the disc hardly open to dispute.

Symphony No. 3, in E flat, Op. 97

("Rhenish")
New York Philharmonic (1941). ML 4040 (OP).

At the time of his death Walter was just about to turn to the task of re-recording the orchestral music of Schumann, and we shall be forever the poorer that this project went uncompleted. Apart from a Berlin acoustic recording of the *Manfred* Overture, we have only dated editions of two symphonies to represent his work in this literature. The *Rhenish* is the better of the pair, both in performance and sound. Broadly romantic, with more than a touch of rhetoric, it still creates a feeling of romantic bravura—and manages to sustain it even in passages that are slower than the present-day norms for this work.

Symphony No. 4, in D minor, Op. 120

- 1) Mozart Festival Orchestra, Paris (1928). M 106 (78 rpm, OP).
- 2) London Symphony Orchestra (1938). RCA Victor M 837 (78 rpm, OP).

Neither performance, I feel, preserves Walter's best work in this music, and neither is particularly well recorded. The primary difficulty in both cases resides in excessive variation of tempo—some passages sounding rushed, others slack. The London version is the better, but it omits the repeat in the finale which Walter provided in the earlier set.

SMETANA

My Country; No. 2, Vltava (Moldau)
New York Philharmonic (1941). ML 2075 (OP).

Walter had a gift for Bohemian music, first revealed to American listeners with a now ancient-sounding London Symphony disc of the *Bartered Bride* Overture. For years this *Moldau* held high favor in the domestic catalogue, and its charm remains, though the registration of the ensemble appears severely faded by contemporary standards.

STRAUSS, JOHANN II

Emperor Waltz, Op. 437; Die Fledermaus: Overture; Gypsy Baron: Overture; On the Beautiful Blue Danube, Op. 314; Tales from the Vienna Woods, Op. 325; Vienna Life, Op. 354

Columbia Symphony (1956). ML 5113.

Roses from the South, Op. 388

Berlin Philharmonic (1930). 9081M (78 rpm, OP).

American audiences almost never associated Bruno Walter with light music, though Berlin audiences could recall that one of his first great successes in his native city was a production of *The Mikado*. The seven works listed above comprise his entire recorded repertory of Johann Strauss. If his older versions from among the first six listed above had come from Vienna, their interest might be sustained; but only one of them (that of the *Emperor Waltz*) was Viennese in origin, and indeed the *Blue Dan-*

portable
perfection
for
hi-fi fans



From Denmark comes this aristocrat of portables. Superb AM-FM-Shortwave performance with all the features you can imagine in a high quality portable: one full watt push-pull output and a 5" x 7" speaker, flywheel tuning with slide-rule dial, full range independent tone controls, pushbutton band selection, tuning meter and battery indicator, loudspeaker-earphone output and separate tuner output, plus plug-in connection for an auto antenna and accessory mounting bracket for over-the-road hi-fi.

Write for detailed specifications and test reports.



By appointment
to the Royal Danish Court

DYNACO

DYNACO, INC.
3912 Powelton Ave., Phila. 4, Pa.

CIRCLE 29 ON READER-SERVICE CARD



**YOUR FAVORITE TAPES ...
AS YOU DRIVE WITH A
TERADO POWER INVERTER
for any tape recorder!**

If your tape recorder fits into your car, you can hear your tapes wherever you travel. A Terado power inverter changes the direct current from your car battery to 60 cycle, 110 volt alternating current, stable within 1/2 cycle, in spite of changing input or load. Will also operate other equipment . . . amplifiers, TV, small power tools, etc. Inverter sizes from 15 to 600 watt capacity.

See your tape recorder dealer or electronic parts jobber, or write:

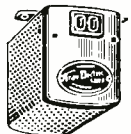

terado

CORPORATION

1067 Raymond Avenue, St. Paul, Minnesota 55108
In Canada, Atlas Radio Corp. Ltd.—Toronto, Ont.
CIRCLE 64 ON READER-SERVICE CARD

DIXIE

HIGH FIDELITY WHOLESALE

Largest discount High Fidelity component distributors in the South. Wholesale prices on package or individual components. Latest models in factory sealed cartons.

Are prices too high?—Write:

DIXIE HI-FI

703 Horton Drive Silver Spring, Md.

CIRCLE 27 ON READER-SERVICE CARD



Storage cabinets available or do-it-yourself

Eliminates visibility problem of edge-stacked albums, stops jacket-bottom wear. Installs anywhere in five minutes with 4 screws. Sturdy welded steel construction, ball-bearing tracks, balanced suspension, 9 models for LP's & tape, hold to 125 albums; Brass Finish, \$7.95 up. Write for brochure Dealer inquiries invited

KERSTING MFG. CO., 504-N S. DATE, ALHAMBRA, CALIF.

CIRCLE 42 ON READER-SERVICE CARD

ube remained unrecorded until the 1956 Columbia album. In terms of style and grace, there is little to distinguish between the new and the old interpretations, while the American set not only benefits from superior engineering but offers authentic touches (such as the zither solo in *Tales from the Vienna Woods*) missing from the European efforts. I would like for the sake of completeness to have *Roses from the South* available again, but apart from this Walter's skill in three-quarter measures is splendidly represented on the Columbia microgroove. Few other conductors I know of endow this music with the nostalgia of the Hapsburg days and turn its strains into dance poems from the vanished past.

STRAUSS, RICHARD

Don Juan, Op. 20

- 1) Royal Philharmonic Orchestra (1928). 67386, 87 (78 rpm, OP).
- 2) New York Philharmonic (1952). ML 5338.

Walter's first version of this music was considered outdated long before the advent of high fidelity, and we can let it pass. The second is much the better performance, a *Don Juan* that is essentially lyric and amorous rather than a reflection of the pessimistic side of Lenau's hero. It is the best document we have of Walter as a Strauss conductor. There is no doubt that Walter respected Strauss the composer and played his music with the conviction born of these feelings, but during the Nineteen Thirties and Forties there were complications resulting from the activities of Strauss the man. To Walter one of these was the painful memory of 1933, when the Nazis forced the cancellation of his concerts and Strauss willingly stepped in to fill a Berlin engagement from which Walter, in his own words, "had been forcibly removed." With such thoughts in his mind as he left the city of his birth, it is not strange that Walter usually chose other composers for his recording activity.

Der Rosenkavalier: Waltzes and Act II Finale

- Berlin Philharmonic Orchestra (1930); a London pickup orchestra with Anny Andrassy and Richard Mayr, vocal soloists (1929). 67892D/9087M (78 rpm, OP).

In the great absence of operatic recordings by Walter, the lack of a Strauss opera—especially *this* Strauss opera—is conspicuous. With the exception of an inferior Berlin recording of *Salome's Dance* (67814D OP), this is all we have of Walter playing music of the operatic Strauss. Mayr also sings the Act II Finale in the somewhat later Heger set (GRB 4001) in Angel's "Great Recordings of the Century" series, but the Walter is worth recalling.

Tod und Verklärung, Op. 24

- New York Philharmonic (1952). ML 5338.

Walter was present when Strauss directed the Berlin premiere of this work in the 1890-91 season. He reports in his autobiography, *Theme and Variations*, that he felt "perplexingly overwhelmed" by it, an emotion that may have led to the decision to make this the first of

the Strauss recordings—an acoustic production of the early Nineteen Twenties with the Royal Philharmonic. The New York recording is not notable for its engineering, but it is thirty years closer to us in time, even though the music struggles against the bonds of medium-fi monophony. When I reviewed this disc I remarked that "the sense of attending on the conductor and his art is real." I find that still true, and this quality of immediacy makes up for a great deal of sonic deficiency.

WAGNER

Der fliegende Holländer: Overture

- 1) Royal Philharmonic Orchestra (1928). M 68 (78 rpm, OP).
- 2) Columbia Symphony (1959). ML 5482 or MS 6149 (stereo).

At the age of thirteen, as a student in Berlin, Walter heard a performance of *Tristan und Isolde*, and for the rest of his young manhood was a champion of Wagner. (With greater age and experience he turned to Mozart, whom he began to view in a new, and more realistic, light as the greatest of all the operatic composers.) In time more than two dozen Wagnerian selections went on discs under Walter's baton, but many are even earlier than the 1928 set listed above, and replaying them conveys only a shadowy sense of the originals. It is interesting to note that Walter's approach to the *Dutchman* remained basically unchanged over the three decades spanned by these two recordings. The new version is an excellent performance; the recorded sound can be improved by a roll-over point at 800 cycles.



Lohengrin: Prelude to Act I

- Columbia Symphony (1959). ML 5907 or MS 6507 (stereo).

For comment on this recording, see "Records in Review," page 72.

Die Meistersinger: Prelude

- Columbia Symphony (1959). ML 5482 or MS 6149 (stereo).

Walter first recorded this work with a British pickup orchestra, but there is no point in comparing the two. The new version is much the finer performance, full of the magic of being in love, and recorded with splendid use of stereo technique.

Die Meistersinger: Prelude Act III

- British Symphony Orchestra (1931). X 43 (78 rpm, OP).

Surprisingly rich in sound for all its three decades, this is a reading filled with a

sense of noble sorrow and dismay at human folly, not ill suited to the state of man and Europe in that fateful year. I take it as a very personal document of Walter's heart, and as such it deserves rehearing. From the same period and orchestra, but less interesting as performances, are recordings of the *Dance of the Apprentices* and *Entrance of the Mastersingers*, originally issued in this same set.

Parsifal: Prelude and Good Friday Spell
Columbia Symphony (1959). MS 5482 or MS 6149 (stereo).

Walter made an extended series of *Parsifal* discs with the Royal Philharmonic in the Nineteen Twenties, some of them among the very first electrical recordings put out by English Columbia. I find them technically inferior and musically less impressive than the Bayreuth Festival series of 1927 under Karl Muck and Siegfried Wagner. There is as much of the sensual as the spiritual in *Parsifal*, and in his 1959 performance Walter brings out the warm, fleshy quality of the music, producing religious art more in the style of Rubens than of El Greco. For me this is in no way disconcerting, and with rehearing I am increasingly of the opinion that Walter's is one of the greatest of all recorded statements of these familiar extracts from the score.

Der Ring des Nibelungen

Die Walküre: Act I (complete); *Act II, Scene 3* (Siegmond-Sieglinde duet); *Scene 5* (Conclusion)

Lotte Lehmann soprano; Ella Flesch, soprano; Lauritz Melchior, tenor; Alfred Jerger, baritone; Emanuel List, bass; Vienna Philharmonic Orchestra (1935). Act I only, Angel COLH 133; Act I and scenes from Act II, Odeon 80686/88.

Apart from some private off-the-air recordings of performances from his Metropolitan period, this is the nearest thing we have to a complete opera recorded under Walter's direction. It also documents, in a way, his last post as artistic head of an opera house, for Walter became director of the Vienna State Opera in 1936 and remained there until Hitler's "liberation" of 1938. Thus these records give us not merely a great conductor and orchestra working with singers of the highest artistry, but they preserve the flowering years of a theatre which was about to become the victim of war and Nazi *Kultur*. It is unfortunate that Angel did not see fit to include the Act II scenes in its "Great Recordings" transfer, but happily the complete recording is available through import channels on Odeon.

Götterdämmerung: Siegfried's Rhine Journey and Funeral Music
British Symphony Orchestra (1931). 68101/68044 (78 rpm, OP).

There are acoustical versions of both these works and an even earlier electrical attempt at the *Rhine Journey*, but if Walter's performances of this music are to be recalled, the above-mentioned are the only valid means. Despite dated sonics, the basic substance of two powerful readings is preserved. The *Rhine Journey*, incidentally, begins with the dawn music, thus offering a somewhat fuller text than one normally hears (except in the Toscanini version).

Siegfried Idyll

- 1) Royal Philharmonic Orchestra (1924). L 1653/54 (acoustic 78 rpm, OP).
- 2) Royal Philharmonic Orchestra (1928). M 68 (78 rpm, OP).
- 3) Symphony Orchestra (London pickup orchestra) (1930). X 26 (78 rpm, OP).
- 4) Vienna Philharmonic Orchestra (1935). RCA Victor G 12 (78 rpm, OP).
- 5) New York Philharmonic (1952). ML 5338.
- 6) Columbia Symphony (1959). M2L 290 or M2S 690 (stereo).

Since Walter recorded this work more times than any other, I feel obliged to cite all six versions, though the first three of them can be quickly dismissed. I take them as stages in the development of a great performance which is finally heard, with full beauty and richness of concept, in the Vienna edition of 1935. This is one of the basic documents of Walter's art, and its revival is overdue. The New York Philharmonic performance is of comparable stature, though quite different both in detail and in approach. Tempos are faster and the line more tightly drawn, rather as if Walter were momentarily under the influence of Toscanini. It too remains a lasting document. The final version is not as unified in its interpretative viewpoint, and for this reason I find it less satisfactory despite the beauty of many passages as heard in stereo.

Tannhäuser: Prelude and Venusberg Music

Occidental College Concert Choir, Howard Swan, dir. Columbia Symphony (1961). M2L 273 or M2S 622 (stereo).

This is perhaps the most perfect, certainly the most atmospheric, of Walter's Wagner recordings. For all its familiarity the opening theme of the prelude has a mystical quality that excites the imagination, and even the somewhat coarse tunes which follow have freshness, indeed refinement, quite unexpected. Even more impressive is Walter's skill in pacing the work, which here moves through a succession of well-prepared climactic passages to a final sense of resolution. Generally, the Venusberg music gets off to such a wild start that the quiet close fails to make much of an impression, even with a choral assist. Walter manages it in such a way that the whole performance moves towards those quiet pages; rather than providing a lessening of tension, here they impose a mood that actually serves to heighten the effect. The recording is one of the best technically, with particularly fine brass registration.

WEBER

Der Freischütz: Overture
Orchestre de la Société des Concerts du Conservatoire de Paris (1939). HMV DB 3554 (78 rpm, OP).

One of the disappointments in the Walter discography is the lack of representation of Weber, for he was unsurpassed in this literature. The only thing he recorded was the *Freischütz* Overture, but the disc cited (which replaced an acoustic one) is certainly better than nothing. The performance is a highly atmospheric one, beautifully played except for some faulty horn notes. Certainly, it ought to be available somewhere in a "Great Recordings" collection.

YES, WE HAVE THE "CONCORD 880"

three speed, three heads, 4 track
complete stereo record/playback
tape recorder



Write for full specifications
and our free mail order
DISCOUNT CATALOGUE

SAXITONE TAPE SALES

div. of

Commission Electronics, Inc.

1776 Columbia Rd., N.W., Wash. 9, D.C.

CIRCLE 26 ON READER-SERVICE CARD

Pre-recorded 4 Track Stereo Tape at Cost!

Through Our Special Membership Plan
Citadel Membership — Proven by thousands
of satisfied club members because . . .

- YOU DECIDE ON YOUR PURCHASES — Buy as few or as many tapes as you want .
- FREEDOM OF SELECTION — Virtually any tape, on any label, by any artist is available.
- FREE! COMPLETE TAPE CATALOG — With membership you receive this current catalog of all 4-track stereo tapes.
- PROMPT SERVICE — Many orders are shipped the day received . . . rarely later than the next several days.
- 100% GUARANTEE — All tapes are guaranteed factory fresh and free of defects.

(Special! All LP records also available under your Citadel Tape membership.) Membership dues is \$4.00 a year . . . a nominal amount when you consider that as a CITADEL MEMBER BUYING TAPES AT COST, YOUR DUES WILL BE PAID FOR WITH VIRTUALLY THE FIRST PURCHASE YOU MAKE THROUGH THE CLUB. Additional savings quickly mount up, permitting you to buy many more tapes on your tape budget. Try membership for 30 days. If not completely satisfied, your dues will be refunded immediately. Complete the coupon below, include your \$4.00 yearly dues and upon receipt we shall forward all membership material to you.

CITADEL TAPE CLUB

division Citadel Record Club HT-14
545 Fifth Ave., New York 17, New York

Name _____
Street _____
City _____ Zone _____ State _____

CIRCLE 21 ON READER-SERVICE CARD

PURCHASING A HI-FI SYSTEM?

TRADE-INS OK—TIME PAYMENTS
Up to 2 years to pay!

Send Us
Your List of
Components
For A
Package
Quotation

**AIREX WON'T
BE UNDERSOLD**

All merchandise
is brand new,
factory fresh &
guaranteed.

Visit our N. Y. Showroom.
Free cabinet brochure
& Hi-Fi Catalog

**AIREX
RADIO**
CORPORATION

85-HF Cortlandt St., N. Y. 7, WO 4-1820

CIRCLE 3 ON READER-SERVICE CARD

Jim Lansing*
Aitec Lansing
Electrovoice
Jensen-Hallicrafter
Hartley* • Gonset
USL Citizen Band
Texas Crystals
Internat'l Crystals
University
Acoustic Research
Janszen • Viking
Wharfedale
Concertone
Bell • G.E.
Weathers
Harman-Kardon
Eico • Pilot
Sherwood*
Tandberg*
ESL • Frazier
Superscope
Dual Changer*
Bogen • RCA
Dynamik • Fisher
H. H. Scott • Leak*
ECL • Roberts
De Wald • National
Sony • Challenger
Browning
Garrard
Miracord
General Radio
Rek-O-Kut
Polytronics
Norelco • Finco
Fairchild
Pickering • Sonar
Audio Tape
Magnecord*
Rockford Cabinets
KSC Speaker
Systems*
* Fair Traded

A SOUPCON OF VIBRATO

Continued from page 55

and lack of steadiness in tone. Another commended her for the beauty of her "steady, clean vocal tone."

Presumably, instruments imitated vocal vibrato in the remote past, and they have gone on doing so with unabated enthusiasm. Wind players can produce vibrato by superimposing an artificial pulse upon the stream of air before it reaches embouchure or reed, enriching and delicately ornamenting the frequently deadpan "basic" sound of the instrument. In the hands of Léon Goossens, the oboe so flourished, though not without opposition. When Goossens joined the London Philharmonic as first oboe, at Beecham's request, the story goes that prior to the first rehearsal Sir Thomas asked for the customary A, and Goossens obliged. "Take your choice, gentlemen," said Beecham, and the rehearsal (as so often with him) began on a merry note. Flutists can produce a vibrato fairly easily (Mr. William Kincaid, former first flute with the Philadelphia Orchestra, had a beauty), but clarinetists, with the exception of Reginald Kell and one or two others, find it difficult. Listening to the Philadelphia recently at a concert, I noticed the odd effect produced in the Waltz from Tchaikovsky's Fifth Symphony when clarinet and bassoon play that angular and syncopated phrase in octaves: the clarinet sounded straight as a rod, but the bassoon vibrated passionately, and all I heard was a series of augmented and diminished octaves in rapid succession. Before microgroove, I owned a recording by Albert Wolff and (I think) the Lamoureux Orchestra of Paris, playing Méhul's Overture *Le jeune Henri*, and for the first time in my life I heard a French horn vibrato—a cornucopial introduction to other brass vibratos in which French orchestras seem to specialize.

Keyboard instruments have by no means been immune, for the organ has had its *Vox humana* stop from very early

times, caused then as now by two ranks of pipes slightly out of tune with each other. The more vulgar tremulant, over-ripe fruit of a mechanically interrupted air supply, has been so long abused in the cinema organ that the instrument has died of the complaint. So far only the electronic experts can make a mere piano vibrate, far surpassing the efforts of a John Cage or a Henry Cowell to modify the timbre of that noble instrument. But the clavichord: this has a built-in vibrato, called "*Bebung*" in all the old treatises, and of all such effects one of the most intimate and lovely. For some reason, the clavichord has so far resisted all attempts to record it successfully, but the day may dawn when the phonograph will present this highly expressive sound in all its quiet glory. By pressing a key, and (while maintaining enough pressure to keep the string vibrating) moving it very slightly and quickly up and down, the most exquisite vibrato can be produced by a skilled and sensitive player. The notes are made to "sing," just as stringed instruments "sing" at the behest of a chromatically minded conductor.

First and foremost an attribute of the singing voice, vibrato has enjoyed a difficult and at times confused career. Even if Leopold Mozart and others felt it to be the almost exclusive property of circus clowns, there are fine artists today who will see to it that the vibrato is used intelligently, ornamentally, and above all in a way that does not prevent it from being turned off once in a while. They have only to watch a bird flying through the air, moving its wings to gain speed and height, and then stopping their motion altogether, gliding without effort, gracefully, gently, noiselessly, like some celestial body devoid of all need for propulsion. As Carl Flesch said, quoting a French epigram: "There is something even more agreeable than beauty, and that is change."

THRUST, DUST, AND FRICTION

Continued from page 52

chemical effect and leaves little residue. (Detergents, by the way, may have more effective antistatic action than the alcohols or glycols.) Silicones, as already indicated, are greases, and are suitable for use only with 1-mil and 0.7-mil styli operating at pressures above 2 grams.

MY OWN FEELING is that with the small styli operating at pressures of 1 gram or thereabouts, it is safest to use a dry brush or velvet pad to keep the record free of dust, and to use a liquid only occasionally. When records are handled carefully so that greasy fingerprints are avoided, there will be little need for a solvent. If records have become very dirty and marred with fingerprints, they

can be washed in a very clean dishpan in lukewarm water in which a little household detergent has been dissolved. With a very soft, clean cloth or a piece of velvet pile wipe the record lightly with a circular motion along the grooves. After rinsing in clean water, dry with a very soft piece of moist chamois, and touch the edge of the record to the sink faucet to dissipate its static charge.

The modern plastic record, incidentally, is very prone to acquiring an electrostatic charge. In playback this charge produces pops and crackles. It also attracts dirt and dust. The tendency is greatly increased if the records are stored in a very dry room or rubbed with a dry cloth. The several liquids mentioned above minimize the building up of a

LEARN WHILE YOU SLEEP
Headquarters
EXPERIMENT in this fascinating, educational new field. Use your phonograph, recorder or amazing new Electronic Educator endless tape recorder. We carry a full line of endless repeating tape cartridges for all makes of standard tape recorders plus automatic timers, pillow speakers and complete outfits. Also over 400 strange, unusual educational, self-help courses on tape and record for sleep-learning and hypnosis experiments. Includes Personality Improvement, Self-Confidence, & Memory courses, languages, sales, speech, Sex, Yoga, Hypnotism, business, health improvement courses, etc. Write for free 500 items catalog and full details.
Sleep-Learning Research Association
P.O. Box 24-F, Olympia, Washington
CIRCLE 57 ON READER-SERVICE CARD

LEARN WHILE YOU SLEEP

**SAVE MONEY ON
HI-FI COMPONENTS**
TAPE RECORDERS
TAPES, ACCESSORIES
SLEEP LEARN KITS
—MERITAPE—
Low cost, high quality recording
tape, in boxes or cans.
FREE CATALOG
1523 JERICHO TPKE.
DRESSNER
NEW HYDE PARK 19, N.Y.

CIRCLE 28 ON READER-SERVICE CARD

static charge and will also discharge one that has been built up. For a very highly charged record, I have found the most effective treatment is washing in detergent as detailed above. Incidentally, a simple way to verify whether a record is heavily charged is to tear up a bit of newsprint into confetti-sized pieces, place them on a very clean surface, and then bring the record close to them. If the pieces of paper jump, rise, or cling to the record, it is heavily charged.

Actually a record is not likely to pick up much dust from the air in a reasonably clean home in the brief time it is being played. Unfortunately, in many installations records are exposed to a very high concentration of dust and dirt by the owner's failure to keep the turntable itself clean. A turntable left uncovered when it is not in use will accumulate a layer of dust even in a few days, and in homes where the kitchen is not vented with a fan, it may be contaminated by grease from cooking vapors. Placed on such a turntable, the record picks up this dirt either by direct contact or by electrostatic attraction. For this reason, every record player should be covered with a dust-tight shield when it is not being used. If your model is not supplied with such a cover, a suitable one can be purchased at a record shop or audio supply house.

In addition to being covered, the turntable should frequently be wiped clean. Indeed, wiping the turntable may minimize the need for wiping the record itself and thus the danger of scratching it. If the turntable has a rough surface, it may be cleaned with the nozzle of a vacuum cleaner.

Among further hazards to records is the danger of their developing minute scratches when they are removed from or inserted into their sleeves. During playback, a larger stylus tracking at pressures above 2 or 3 grams has enough force to smooth out the burrs formed by a scratch, and is large enough to glide over its indentation. But, again, the smaller stylus tracking at lower pressures can neither "de-burr" nor glide over the scratch as readily, and will produce an audible pop or crackle—often incorrectly ascribed to a static charge. To avoid such scratches, the greatest care should be taken in handling your records. A procedure I follow is to brace the sleeve against a surface (cabinet top or my own hip!) with enough pressure to open the sleeve into an oval. I then remove the record by holding it only at the rim with a light pinch of the fingers. In this way, only the rim, and not the surface, rubs against the sleeve. To guard against acquiring a record badly scratched through careless initial insertion into its sleeve at the factory, while I am still in the record shop I very carefully inspect the surface for visible scratches before making my purchase.

Yet another possible source of pops, crackles, and distortion is the imprinting on the record surface of irregularities on the surface of the sleeve or, worse yet, the wrinkles in the very light plastic inner envelopes used for some records. If the records, or the cartons containing

them, are stacked horizontally in a hot warehouse, the imprint can make the record almost unplayable. My own rule is to dispose of these thin transparent sleeves immediately. And, again, at purchase time, any record that shows a pattern on its surface other than the pattern of the grooves should be rejected.

Correct storage also is germane to record longevity, and is related chiefly to warping. Warping in records is caused by unequal pressure on the surfaces, or unequal exposure to the drying or moistening effect of the air, or by any condition which releases the tensions established in the record during its molding process. There is only one safe way to store records. They should stand vertically without leaning against adjacent records or surfaces and without being subjected to too much pressure. The simplest way to insure this is to stand the records on shelves in compartmented sections snugly but not too tightly packed, so that the records are always vertical but no force is necessary to pull them out or replace them in the stack.

As for drying or humidity effects, records like pretty much the same air conditions as people do—temperature in the region of 70 degrees, and humidity from 25 to 50 per cent. However, even in a home in which both temperature and humidity are carefully controlled, records can be exposed unwittingly to adverse conditions. They should not, for instance, be stored near sources of heat, such as ducts or radiators. The summer sun hitting a record for an interval can raise the temperature to a point where the inner strains are released and the record warps severely. Warping is also encouraged by a cycling of temperature such as would occur in a room which is heated by day but permitted to become quite cold at night. There is no effective cure for a warped record. One proposal is to place the record under a concentrated weight, such as a pile of telephone directories, and then subject it to the same conditions of heat and/or humidity that caused it to warp. This technique sometimes has been known to flatten a warped record, but the pressure exerted against the groove can do further harm.

A final possible cause of damage to the record is the growth of fungi. Vinyl itself is quite resistant to fungi, but the paper labels and the sleeves permit their growth and in extreme cases the record can be etched by the acid excretions of such colonies. In a very moist environment where fungus growth is known to be a problem in general, records should be examined frequently for evidence of fungus growth, which of course should be cleaned off immediately.



Why?

DO THOUSANDS OF HI-FI ENTHUSIASTS BUY FROM AUDIO UNLIMITED

It's Obvious!

- LOWEST PRICES
- FAST SERVICE
- FACTORY SEALED UNITS
- FULLY INSURED SHIPMENTS
- UP TO 2 YEAR MANUFACTURERS' WARRANTY
- TIME PAYMENT PLAN
 - only 10% down
 - up to 36 months to pay
- FRANCHISED DISTRIBUTORS

Write for FREE Catalog Today

SEND US YOUR LIST FOR OUR AIR MAIL QUOTE TODAY

Visit Our Showroom and Warehouse

 **AUDIO** unlimited, inc.
715-F, Second Ave. (N.Y. 38), New York City, N. Y.
3 blocks from the U. N.

CIRCLE 14 ON READER-SERVICE CARD

ROCK BOTTOM PRICES

GET OUR QUOTE

STEREO • HIGH FIDELITY

PLUS THESE RABSONS EXTRAS

- Established 1905 58 Years of Reliability
- Franchised Protection Plus
- Rabsons Special Two Year Guarantee
- Easy Payment Plan Up to 24 Months to Pay Each Component Double Packed to Insure Safe Arrival . . . At no extra charge
- Rabsons Sells ONLY Factory Fresh Merchandise in Original Factory Sealed Cartons

SO WRITE RABSONS

Whatever your HI-FI requirements and receive

FREE A \$1.00 genuine Miracle Record Cleaning Cloth with EVERY Quotation from Rabsons on a component or system of your choice.

RABSONS 57 ST. INC.
119 West 57th St., New York 19, N.Y.
Area Code 212 Circle 7-0070
Diagonally opposite Carnegie Hall

CIRCLE 50 ON READER-SERVICE CARD

BUYER'S GUIDE TO COMPONENTS TRADING

TUNERS, RECEIVERS & AMPLIFIERS... all leading makes and models. WHY BUY? When you can TRADE... and receive the highest trade-in allowance from the country's original and largest audio trading organization, Audio Exchange.

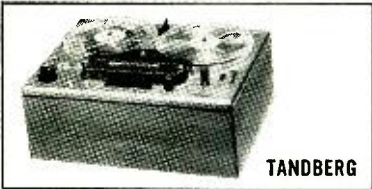

TANDBERG

RECORD PLAYBACK SYSTEMS, AND TAPE RECORD/PLAYBACK... all leading makes and models... The Hi Fi/Stereo components your ear is yearning for will not only cost you less when you trade by mail with Audio Exchange (or in person at our New York area showrooms), it's SAFER. Unmatched guarantees: free parts and labor within 90 days... 75% allowance in trade-back within 6 months... plus a 10-day money-back guarantee on USED components.

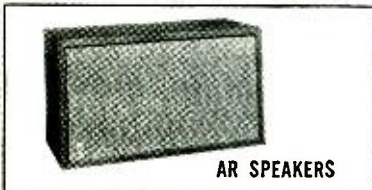

AR SPEAKERS

SPEAKER SYSTEMS, Wall, Large Enclosure and Bookshelf... all leading makes and models...

■ **FREE—"TRADERS HANDBOOK"**—a colorful 16-page booklet that explains everything about trading by mail. New components from over a hundred manufacturers, and guaranteed used equipment by the carload. All at lower cost because of higher trade-in allowances. Write for your free copy.

audio exchange 

WORLD'S FIRST AND FOREMOST HI FI STEREO TRADING ORGANIZATION
PLEASE MAIL ALL ORDERS AND INQUIRIES TO JAMAICA
193-21 Hillside Ave., Jamaica 32, N. Y. Dept H J AX1E1 7-7577
WHITE PLAINS, N. Y. BROOKLYN, N. Y. MANHASSET, N. Y.
203 Mamaroneck Ave. 1065 Flatbush Ave. 451 Plandome Rd

PLEASE SEND ME FREE BOOKLET

NAME _____

ADDRESS _____

CITY _____ STATE _____

ADVERTISING INDEX

Key No.	Page	Key No.	Page
1	Acoustic Research, Inc. 17	40	Hi-Fidelity Center 106
2	Acoustical Manufacturing Co., Ltd. 14	41	Inter-Mark Corp. 24
3	Airex Radio Corp. 110	42	Kersting Mfg. Co. 108
4	Allied Impex 21	43	KLH Research & Development Corp. 92
5	Allied Radio 106	13	Klipsch & Associates, Inc. 105
6	American Concertone, Inc. 4	16	Lear Siegler, Inc. 37
72	Ampex Stereo Tapes 102		London Records 104
8	Angel Records 64, 78	46	Marantz 34
9	Audio Devices, Inc. 26	47	Martel Electronics 30
10	Audio Dynamics Corp. 10, 11	48	McIntosh Laboratory, Inc. 80
11	Audio Exchange 112	73	Newcomb Audio Products Co. 95
12	Audio Fidelity Records 15	49	Pickering & Co., Inc. 2
14	Audio Unlimited, Inc. 111	7	Precision Electronics, Inc. 12
15	Benjamin Electronics 13, 31	50	Rabsons-57 St., Inc. 111
16	Bogen Communications Division 37	74	RCA Parts & Accessories 94
17	Bozak, R. T., Mfg. Co. 23	51	RCA Tape 96
18	British Industries Corp. 38	33	Rek-O-Kut 22
19	Carston Studios 106	52	Roberts Electronics, Inc. 101
20	Citadel Record Club 79	53	Rotron Mfg. Co., Inc. 100
21	Citadel Tape Club 109	26	Saxitone Tape Sales 105, 109
22	Colpix Records 88	100	Scott, H.H., Inc. 18, 19
23	Columbia Record Club 6, 7	55	Sherwood Electronics Cover IV
24	Columbia Records 68, 69, 72, 73	56	Shure Brothers, Inc. 56
25	Command Records 86	57	Sleep-Learning Research Association 110
26	Commissioned Electronics, Inc. 105, 109	58	Sony Corporation of America 36
27	Dixie Hi-Fi 108	59	Sound Reproduction, Inc. 87
28	Dressner 110		Stereo 1964 Edition 32
1	Dynaco, Inc. 17	61	Superex 78
29	Dynaco, Inc. 107	62	Superscope, Inc. 9
30	Eastman Kodak Co. 63	63	Tandberg of America, Inc. 99
31	Eico Electronic Instrument Co., Inc. 25	64	Terado Corporation 108
32	Electro-Voice Inc. Cover III	45	Thorens Division 84
45	Elpa Marketing Industries, Inc. 84	65	20th Century-Fox Records 88
34	Empire Scientific Corp. 5	72	United Stereo Tape 102
35	Finney Company, The 8	66	University Loudspeakers 27
36	Fisher Radio Corp. Cover II, 1, 33	67	Utah Electronics Corp. 103
18	Garrard 38	68	Vanguard Records 87
37	Grado Laboratories, Inc. 20	69	Viking of Minneapolis, Inc. 16
7	Grommes 12	70	Westminster Records 77
38	Harman-Kardon, Inc. 29	71	Winegard 28
39	Heath Co. 89, 91		Wyeth Press 30, 98

CIRCLE 11 ON READER-SERVICE CARD

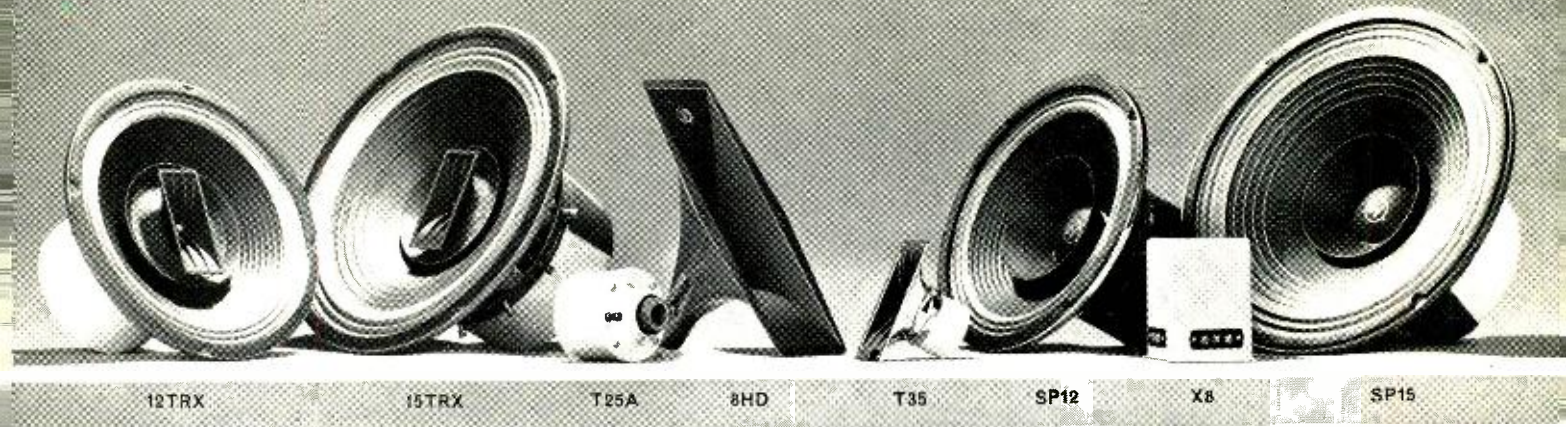

A Return to the Fundamental Concept of High Fidelity: SOUND OF UNCOMPROMISING QUALITY!

Before you make the final choice of speakers for your high fidelity system, take a moment to review your goals. What comes first—size, cost, or performance? If performance is of prime importance, then you owe it to yourself to look at—and listen to—Electro-Voice Deluxe component speakers. Granted, they are not the smallest or the least expensive speakers you can buy, but their design is predicated on the need for quality reproduction above all other considerations.

Your ear is the final arbiter of speaker system quality, but it may help you to know what's behind the unequalled popularity of E-V in the component speaker field. It begins with the finest engineering laboratory in the industry, finest not only in equipment, but also in the size of its staff and in its creative approach to electro-acoustics.

The basic design for E-V Deluxe components was laid down over a decade ago, and, despite numerous detail improvements, this approach is just as valid today. It begins on a firm foundation: the rigid die-cast frame that provides a stable basis on which this precision instrument can be assembled. It is this frame that assures that each E-V Deluxe speaker will forever maintain its high standard of performance by maintaining perfect alignment of all moving parts.

Added to this is a magnetic assembly of generous proportions that provides the "muscle" needed for effortless reproduction of every range at every sound level. In the case of the SP15, for example, four pounds, ten ounces of modern ceramic magnet (mounted in an efficient magnetic assembly weighing even more) provides the force needed for perfect damping of the 15-inch cone.

Within the gap of this magnetic system rides the unique E-V machine-wound

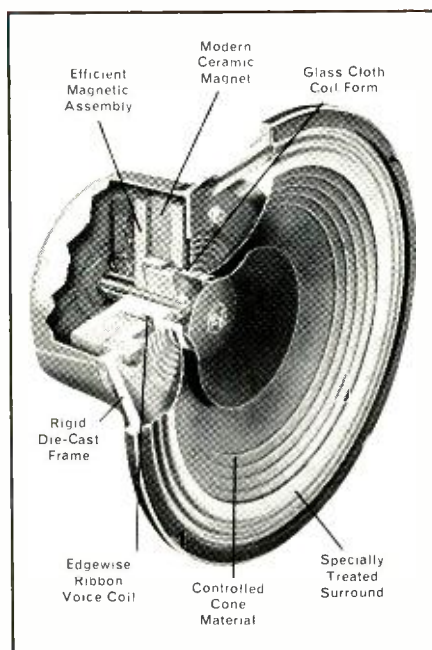

edgewise-ribbon voice coil. This unusual structure adds up to 18% more sensitivity than conventional designs. Production tolerances on this coil and gap are held to $\pm .001$ inch! The voice coil is wound on a form of polyester-impregnated glass cloth, chosen because it will not fatigue like aluminum and will not dry out (or pick up excess moisture) like paper. In addition, the entire voice coil assembly can be made unusually light and rigid for extended high frequency response.

In like manner, the cone material for E-V Deluxe components is chosen carefully, and every specification rigidly maintained with a battery of quality control tests from raw material to finished speaker. A specially-treated "surround" supports the moving system accurately for predictably low resonance, year after year, without danger of eventual fatigue. There's no breaking-in or breaking down!

Now listen—not to the speaker, but to the music—as you put an E-V Deluxe component speaker through its paces. Note that bass notes are neither mushy nor missing. They are heard full strength, yet in proper perspective, because of the optimum damping inherent in the E-V heavy-magnet design.

And whether listening to 12-inch or 15-inch, full-range or three-way models, you'll hear mid-range and high frequency response exactly matched to outstanding bass characteristics. In short, the sound of every E-V Deluxe component speaker is uniquely musical in character.

The full potential of E-V Deluxe component speakers can be realized within remarkably small enclosure dimensions due to their low-resonance design. With ingenuity almost any wall or closet can become a likely spot to mount an E-V Deluxe speaker. Unused space such as a stairwell can be converted to an ideal enclosure. Or you may create custom cabinetry that makes a unique contribution to your decor while housing these remarkable instruments. The point is, the choice is up to you.

With E-V Deluxe component speakers you can fit superlative sound to available space, while still observing reasonable budget limits. For example, a full-range speaker such as the 12-inch SP12 can be the initial investment in a system that eventually includes a T25A/8HD mid-range assembly, and a T35 very-high-frequency driver. Thus the cost can range from \$70.00 up to \$220.00, as you prefer—and every cent goes for pure performance!

Write today for your free Electro-Voice high fidelity catalog and list of the E-V audio specialists nearest you. They will be happy to show you how E-V Deluxe component speakers fulfill the fundamental concept of high fidelity with sound of uncompromising quality!

ELECTRO-VOICE, INC.
Dept. 144H, Buchanan, Michigan



CIRCLE 32 ON READER-SERVICE CARD

www.americanradiohistory.com

should Sherwood increase its prices by 20%



the superlative new S-8000 III FM stereo receiver priced at \$319.50



Years ago, Sherwood high-fidelity tuners and amplifiers were evaluated by highly-respected, totally-impartial research companies as either the finest designed or the best valued on the market. ■ Although we were pleased by such endorsements of pure quality in design and performance, the really significant fact was that *other leading components carried higher price tags.* ■ *Subsequent Sherwood components have received ratings indicating features and performance equal or superior to brands carrying price tags at least 20% higher.* ■ A current example of Sherwood design superiority is our new S-8000 III receiver. Sensitivity is rated at *1.8 microvolts.* Capture effect is an *outstanding 2.4 db.* ■ No other FM receiver can claim the 80-watt music-power rating of the S-8000 III, and only one other (priced \$50 higher) offers the professional D'Arsonval zero-center tuning meter that's standard with Sherwood. ■ We still believe that our old-fashioned policy of superior engineering and realistic prices is best for both you and Sherwood.

SOME OF THE S-8000 III FEATURES THAT MAKE THE DIFFERENCE

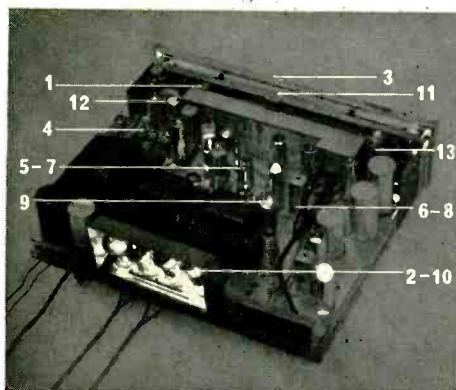

1. Zero-center tuning
2. 80-watt music power
3. Complete stereo control center
4. 1.8 μ v. (IHF) sensitivity
5. Wide-band 3-mc. gated beam limiter
6. 1-mc. band pass balanced ratio detector
7. 2.4db. capture effect
8. 1/3% distortion at 100% modulation
9. Interchannel hush
10. Long-life Novar output tubes
11. 8-inch professional-type tuning scale
12. Silk-smooth flywheel tuning
13. Positive stereo broadcast identification

For your free copy of our complete catalog, write Dept. H-1
SHERWOOD ELECTRONIC LABORATORIES, INC.
4300 North California Ave. Chicago 18, Illinois

Sherwood
HIGH FIDELITY

STEREO RECEIVERS ■ TUNERS ■ AMPLIFIERS ■ STEREO INDICATOR LIGHTS ■ SPEAKER SYSTEMS ■ CONTEMPORARY CABINETRY

CIRCLE 55 ON READER-SERVICE CARD