

JANUARY/FEBRUARY-1971  
VOLUME 2 - NUMBER 1

\$1.00



# RECORDING engineer/producer

*relating recording science • to recording art • to recording equipment*

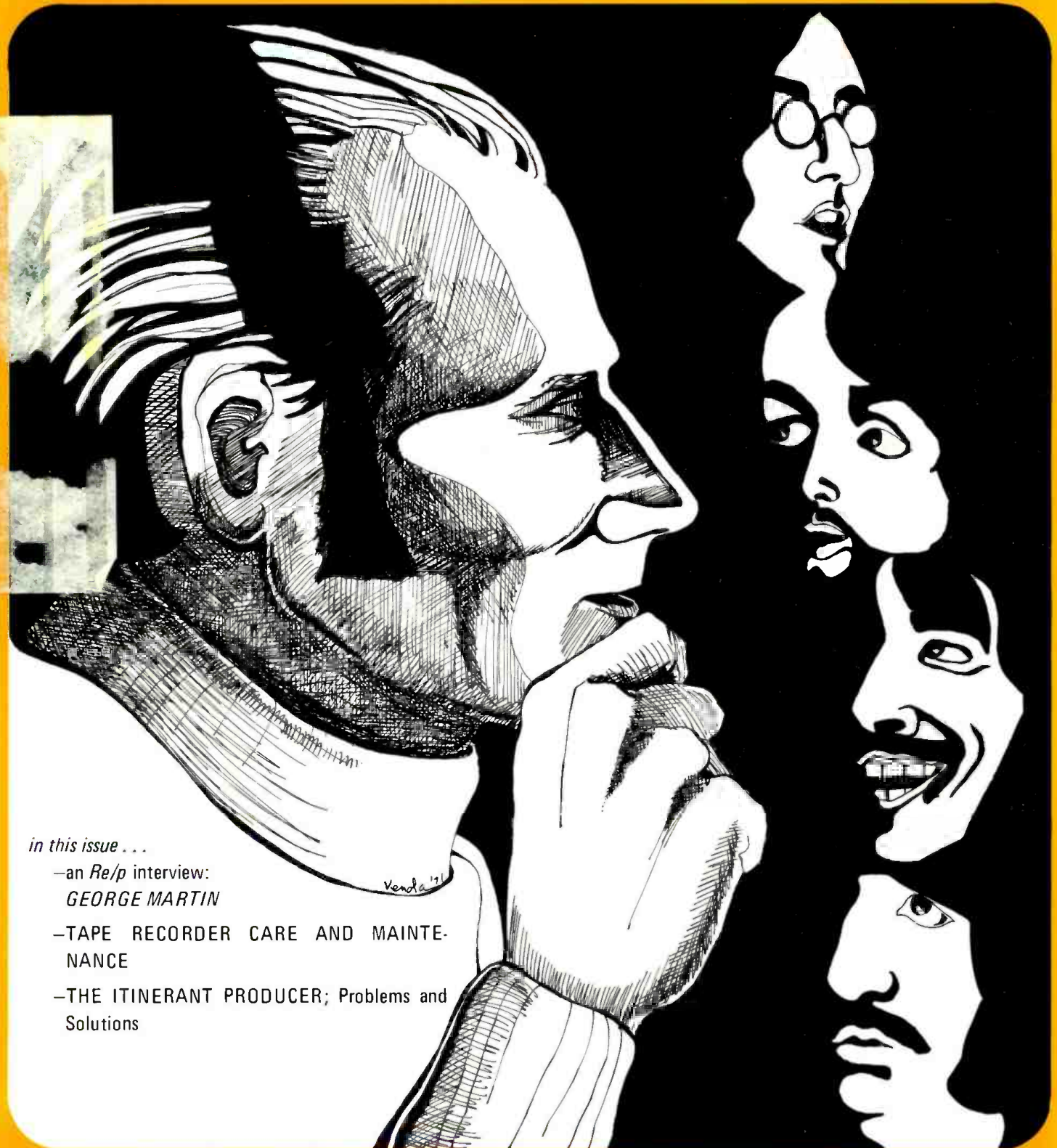

*in this issue . . .*

—an *Re/p* interview:  
**GEORGE MARTIN**

—TAPE RECORDER CARE AND MAINTENANCE

—THE ITINERANT PRODUCER; Problems and Solutions

# Crown

## PROFESSIONAL STUDIO EQUIPMENT

| Specs        | 15ips         | 7 1/2ips      |
|--------------|---------------|---------------|
| w. & fl.     | 0.06%         | 0.09%         |
| f resp. +2dB | 40Hz to 30kHz | 20Hz to 20kHz |
| S/N          | -60dB         | -60dB         |

3 speeds - 15, 7 1/2 & 3 3/4ips; hysteresis synchronous drive motor

computer logic controls for safe, rapid tape handling and editing; full remote control optional

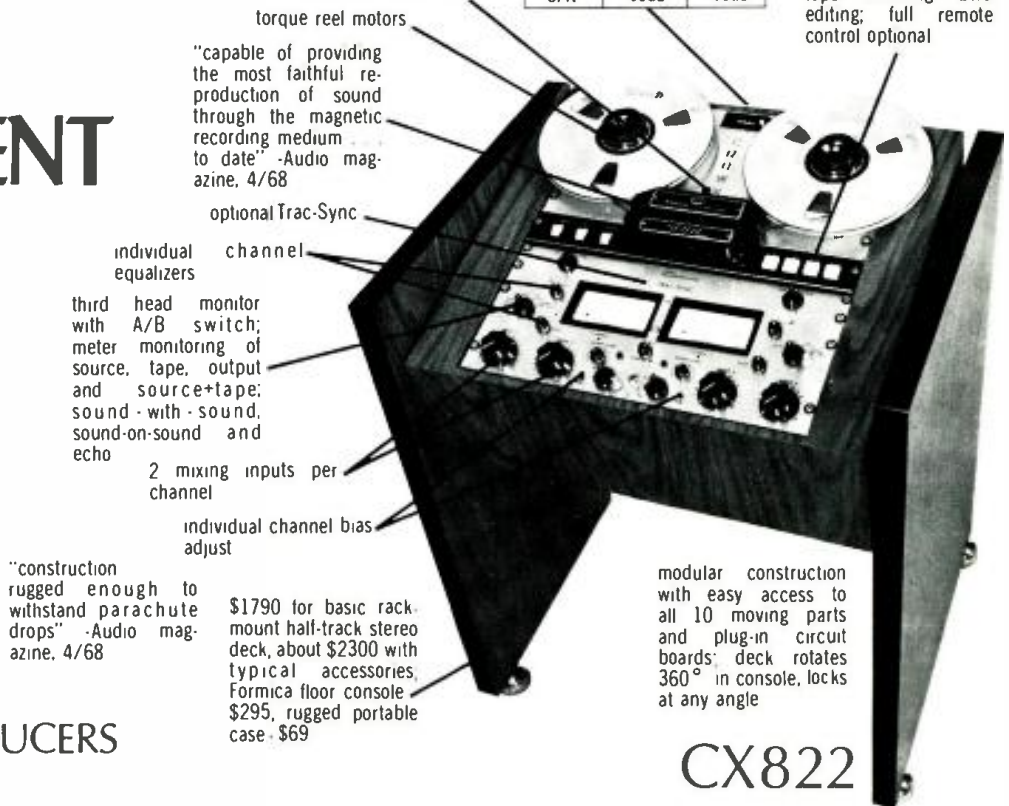

torque reel motors  
"capable of providing the most faithful reproduction of sound through the magnetic recording medium to date" -Audio magazine, 4/68

optional Trac-Sync

individual channel equalizers

third head monitor with A/B switch; meter monitoring of source, tape, output and source+tape; sound-with-sound, sound-on-sound and echo

2 mixing inputs per channel

individual channel bias adjust

"construction rugged enough to withstand parachute drops" -Audio magazine, 4/68

\$1790 for basic rack-mount half-track stereo deck, about \$2300 with typical accessories, Formica floor console \$295, rugged portable case - \$69

modular construction with easy access to all 10 moving parts and plug-in circuit boards; deck rotates 360° in console, locks at any angle

### CX822

## RECORDERS & REPRODUCERS

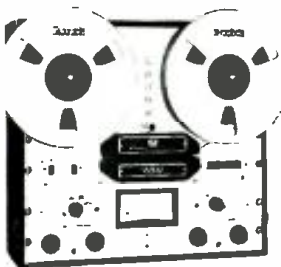

**SX711** Claimed by its pro audio owners to be the finest professional tape recorder value on the market today - price versus performance  
 ■ Frequency response at 7 1/2ips ±2dB 20Hz-20kHz, at 3 3/4ips ±2dB 20Hz-10kHz ■ Wow & flutter at 7 1/2ips 0.09%, at 3 3/4ips 0.18% ■ S/N at 7 1/2ips -60dB, at 3 3/4ips -55dB ■ Facilities: bias metering and adjustment, third head monitor with A/B switch, sound-with-sound, two mic or line inputs, meter monitoring same as CX822, 600Ω output ■ Remote start/stop optional, automatic stop in play mode  
 ■ \$895 for full-track mono deck as shown, \$995 for half-track stereo deck

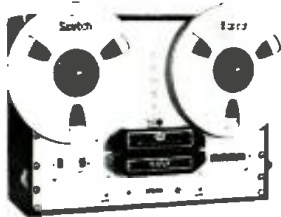

**SP722** Ideal reproducer for automation systems  
 ■ Meets or exceeds all NAB standards  
 ■ Remote start/stop optional, automatic stop in play mode  
 ■ \$595 for half-track stereo reproducer

**Crown tape recorders and reproducers** are available in 42 models, with almost any head configuration, including 4 channels in-line. Patented electro-magnetic brakes maintain ultra-light tape tension and never need adjusting. They are made by American craftsmen to professional quality standards, with industrial-grade construction for years of heavy use.

**All Crown amplifiers** are warranted three years for parts and labor. They are 100% American-made to professional quality standards. All are fully protected against shorts, mismatch and open circuits. Construction is industrial-grade for years of continuous operation.

For more information, write CROWN, Box 1000, Elkhart, Indiana 46514

## STUDIO MONITOR AMPLIFIERS



### D40

Delivers 40 watts RMS per channel at 4Ω ■ Takes only 1 1/4" rack space, weighs 8 1/2 lbs. ■ IM distortion less than 0.3% from 1/10w to 30w at 8Ω ■ S/N 100dB below 30w output ■ \$229 rack mount



### D150

Delivers 75 watts RMS both channels at 8Ω ■ IM distortion less than 0.1% from 1/10w to 75w at 8Ω ■ S/N 100dB below 75w output ■ Takes 5 1/4" rack space, weighs 16 lbs. ■ \$439 rack mount



### DC300

Delivers 300 watts RMS per channel at 4Ω ■ IM distortion less than 0.1% 1/10w-150w at 8Ω ■ S/N 100dB below 150w output at 8Ω ■ Lab Standard performance and reliability ■ "As close to absolute perfection as any amplifier we have ever seen" - Audio magazine, 10/69 ■ \$685 rack mount

Circle No. 101



**RECORDING**  
engineer/producer

—the magazine to exclusively serve the recording studio market . . . all those whose work involves the recording of commercially marketable sound.

—the magazine produced to relate . . . RECORDING ART to RECORDING SCIENCE . . . to RECORDING EQUIPMENT.

*Editor/Publisher* MARTIN GALLAY  
*Engineering*

*Editor* . . . WILLIAM ROBINSON  
*Associate Editor* . . . PETE SENOFF  
*Business/Circulation*

*Manager* . . . . . V.L. GAFFNEY  
*Art Director* . . . . . G.J. SADOWSKI

RECORDING engineer/producer is published bi-monthly and is sent free to qualified recipients in the United States. Subscriptions for other than qualified individuals or companies may be purchased at \$5.00 per year. (All foreign subscriptions: \$6.00 per year.) Material appearing in Re/p may not be reproduced without written permission of the Publisher. Copyright © by RECORDING engineer/producer 1971.

Controlled circulation postage paid at Los Angeles, California.  
RECORDING engineer/producer  
6430 Sunset Boulevard  
P.O. Box 2287  
Hollywood, CA 90028  
(213) 461-7907

*an Re/p interview*  
GEORGE MARTIN  
at A.I.R. Studios, London 11 *william wolf*

the RING MODULATOR 23 *brian ingoldsby*

a care package for AUDIO RECORDERS 25 *gene titterington*

THE ITINERANT PRODUCER  
his problems and a solution or two 29 *charles 'bud' dant*

LETTERS 8

MAKER OF MIKE AWARD 9

SPRING '71 AES CONVENTION 23

NEW PRODUCTS 34

CARTOON 39

credits — cover: TRICI VENOLA  
cartoon: WAYNE YENTIS  
Allison Research

**A new 16-track,  
2" pro recorder  
for \$13,750.  
You're putting  
me on,  
right?**

**It was really  
the hit of the  
AES Show?**

Wrong.

You'd better  
believe!

**The Scully  
Series 100 really  
out-performs  
recorders  
costing \$10,000  
more?  
They're truly  
innovative, not  
warmed-over  
something  
else?**



You heard  
it  
right.

I'm sold.  
When can  
I get a 100?  
How can  
I learn more  
about it?

Check.  
And, you can order  
from your favorite  
Scully distributor  
or directly  
from a Scully  
regional office.

Man, that 100  
will really swing  
with my console.  
I can buy only  
the basics I  
need. Add  
others later.

You can get  
the 100 next  
month.  
You can get  
all the facts  
by writing  
Ham Brosious  
at  
**▶ Scully**  
480 Bunnell Ave.  
Bridgeport,  
Conn. 06607  
or call him at  
203 335-5146



# Play at 15 i.p.s.

## Yamaha C7 Grand.

When you're laying down the master, you'd better be sure your piano is air quality. That's what the Yamaha C7 Grand is all about. It's a 7'4" concert instrument that ranks among the world's great pianos. Just ask the talent at your next session.

## Yamaha U1-D Upright.

The closest you can come to a grand piano without a grand piano. Four feet high and nearly five feet wide, it has full, rich tone and response crisp enough to please the most finicky talent. It stays that



way through month after month of masters, rehearsals and spilled drinks, too.

## Yamaha Electone

E-3. It's a symphony orchestra in a box for just \$2,395. With fewer controls, the E-3 gives you more

sounds, more music than organs costing as much as \$8,000. What's more, it's a regular sound effects machine. Think about *that* the next time you have to synthesize some sounds.

## Letters

*From: Charles F. Swisher  
Christopher Jaffe & Assoc.  
San Francisco, CA.*

An important consideration appears to have been overlooked in the series of short discussions regarding drum recording techniques. My experience indicates that it is essential to properly shock mount microphones in order to prevent low frequency mechanical energy from coupling into the microphone via the supporting stand and cable. It is most critical when resonant floor systems, such as those in typical performing arts spaces are involved, but I think good recording and sound reinforcement practice dictates attention to this detail in any case.

Complete elimination of mechanically induced energy has made a dramatic improvement in the timbre of low frequency musical energy in my experience on a number of occasions in sound reinforcement work with The New York Philharmonic and other symphony orchestras.

I also find it hard to believe that condenser microphones are not generally considered essential when used for drum miking. Reference is made to an article titled, "A Self-Contained Condenser Microphone with Improved Transient Response" which appeared on page 464 of *The Journal of the Audio Engineering Society* Volume 16 Number 4, October 1968. Since we are dealing with instruments producing steep wavefronts with critical damping in drum miking (along with every other instrument one would mention for that matter) use of a condenser microphone should be considered essential where one desires to reach quality levels presently possible to achieve. The availability of condenser microphones with 10 to 20 dB pads between the capsule and electronics can be employed to prevent condenser microphone electronics overload. Use of omnidirectional microphones and/or equalized cardioid condenser microphones can control low frequency proximity effects. This in conjunction with proper microphone shock mounting techniques will help provide improved reproduced transient wavefront impact and make it possible to reproduce a more realistic effect from musical instruments.



# YAMAHA

YAMAHA INTERNATIONAL CORPORATION  
P.O. Box 54540 • Los Angeles, California 90054

Send for complete specifications and dealer information.

- C7 Grand Piano      Name \_\_\_\_\_
- U1-D Upright Piano      Business \_\_\_\_\_
- E-3 Organ      Address \_\_\_\_\_
- Other \_\_\_\_\_      City \_\_\_\_\_ State \_\_\_\_\_ Zip \_\_\_\_\_

Attention must also be given to the console input stage overload characteristics by understanding that the short time base transients produced by musical instruments can be as much as 20 dB over VU meter readings and can cause subtle input overload distortion in many conventional circuit designs. A solution to this problem can be found in circuits such as the Spectra Sonics 101 amplifier which has the ability to clip inaudible transient peaks, accurately preserving the steep wavefront (which is really what we want to hear and feel) without causing overload distortion.

I believe that those who would argue that the foregoing comments yield results that cannot be heard as improvements might re-examine their monitor loudspeaker techniques. A growing number of us are realizing that the use of bi- and tri-amplification techniques with electronic filters in lieu of built-in passive loudspeaker crossover networks opens up a new realm of loudspeaker performance characteristics especially with regard to their ability to reproduce high energy density wavefronts.

*From: Art Williams  
Independent Producer  
New York, NY*

Your recent issue on drum recording was truly informative and I consider it a valuable document in the history of sound recording. The article by George Klabin was obviously the "piece de resistance". It was, in a sense, a milestone in recording history. Finally, an article which explains in factual, intelligent, logical and unbiased terms, how to record the modern drum sounds. I believe that the "hats" of the entire recording industry should be off to Mr. Klabin for finally telling it as it is.

Since reading the article I have visited Mr. Klabin's studio and found that the sound was truly incredible (not only the drums). As an active record producer I am happy to have found a studio like Sound Ideas where people like Mr. Klabin and Mr. Daking make the process of recording sounds on tape a great art, and a thoroughly delightful educational experience.

### CANADA HONORED WITH "MAKER OF THE MICROPHONE" AWARD



*Canadian record industry historian Ed Manning (right) looks on as Oliver Berliner points out a feature of the Maker Of The Microphone trophy to Dr. Guy Sylvestre who accepted the award in behalf of the Government of Canada.*

For the first time in its 8 year history the respected "Maker Of The Microphone Award" has gone out of the United States, the trophy having just been presented to the National Library of Canada where Dr. Guy Sylvestre, National Librarian, accepted it from Oliver Berliner, grandson of the inventor of the microphone.

Presented annually in memory of Emile Berliner, who also invented the disc record and player plus the method of mass producing discs from a single master, the trophy, showing 3-dimensional replicas of the original Berliner gramophone,

disc record and microphone, is presented annually for an outstanding contribution to the world of sound. The Bibliotheque Nationale de Canada, in addition to having one of the world's outstanding archives of recorded sound, will be the depository of reference copies of all commercial records released in Canada, by recent government edict, a "first" for such requirements in the world. Emile Berliner himself manufactured discs in Canada more than 75 years ago, and originated the famous "His Master's Voice" trade mark there in 1900.

# AKG

Where  
superior  
microphones  
originate.

We research and design . . . and build microphones exclusively.

Surely you will want to keep abreast of the technical developments which make AKG the leaders in microphone developments. Research and modern technology in both microphones and headphones have resulted in recent breakthroughs. Current data on products will be sent you regularly without obligation.

Register via the coupon below and receive our latest 50 pages treatise on the concept and technology of the modern cardioid dynamic microphone . . . complete with technical data. Do it today!



Yes, add my name to AKG's Professional Engineers' Mailing List. Also send me a complimentary copy of—AKG's history of the cardioid dynamic microphone.

AKG-34

NAME \_\_\_\_\_

TITLE \_\_\_\_\_

FIRM \_\_\_\_\_

ADDRESS \_\_\_\_\_

CITY \_\_\_\_\_

STATE \_\_\_\_\_

ZIP \_\_\_\_\_



**MICROPHONES • HEADPHONES**

DISTRIBUTED BY  
NORTH AMERICAN PHILIPS CORPORATION  
100 EAST 43RD STREET, NEW YORK, NEW YORK 10017

AKG CANADA - DIVISION OF DOUBLE DIAMOND ELECTRONICS - SCARBOROUGH, ONTARIO

Circle No. 104

Re/p 9



## Bill Porter and friend.



"We are using nothing but Shure SM53 microphones—at my request." That's Bill Porter, master sound engineer for his *United Recording Corp. of Nevada* out in Vegas, telling us about a recent series of live concerts at which he officiated as the man in charge of sound. "I've been using Shure microphones in recording sessions for quite a few years. We used SM60's for Buddy Rich's 'Mercy, Mercy' live recording at Caesar's Palace . . . and have had numerous comments on the drum sound. We use the 545 and 546 on all live and recording sessions for guitar, drums, and piano." We're proud of the fact that with all the equipment from which he can choose, Bill calls on his "tried and true" friends from Shure.

Shure Brothers Inc.,  
222 Hartrey Ave., Evanston, Illinois 60204.



Circle No. 105



*bw: What do the letters "A.I.R." stand for?*

gm: Associated Independent Recordings.

*bw: Has A.I.R. done any independent production—locating the talent, etc.—as yet?*

gm: Yes, but not much. We left our respective companies just over five years ago—three of us left EMI and one left Decca—and we had to do a deal with EMI which lasted five years in fact; it ended about a month ago. This was basically an independent deal but it also covered the servicing of artists that were contracted to the company anyway. Obviously the Beatles came under that, and other artists that we handled—there were quite a few. So we had to maintain those artists and so our time for finding other artists was obviously limited. But at the same time, as the years went by it became more and more difficult to get new artists—not because they weren't there but because the deal that we had with EMI was limited to an overall royalty which gradually became—well, in fact, very quickly became out of date. So that by the time the contract ended we couldn't possibly hope to secure any artists because we couldn't offer them any money. We were bound by that and we couldn't do anything about it. Now that we're free we can really look around—sniff the air—which is what we intend to do. But we decided, in fact, before we did that, to build a studio.

# GEORGE MARTIN

at A.I.R. STUDIO  
LONDON

by  
William Wolf



*bw: Several of the studios I've visited in England are equipped, as is A.I.R., to handle visual material as well as audio. Do you feel that there is a potential in integrating the pop music field with visual technology?*

gm: Actually there aren't all that many studios here that also do visuals. There are far more—fewer sound ones. But the tendency is, of course, to open up the visual side—mainly because, I think, this is inevitably the future. You're bound to have video recordings—they're on our doorstep.

*bw: What are your feelings about four channel sound?*

gm: We haven't built it into our boards mainly because it's a very new development and most people in this country don't know anything about it. We know about it because we go to your country. I honestly don't believe it's a very important development. It's quite nice; it's pleasant; it's a very nice gimmick, but I can not imagine the average person going to the elaboration of fixing up four speakers in their room so that they can hear the ambiance of the concert hall behind them . . . You could have circular sound, of course, but when I was introduced to quadrasonic sound my comment was that if you're using four speakers the ideal is not one in each corner of the room, but it is three in an equilateral triangle below you and one above you so that you're in the center of a tetrahedron. Then you've really got all around sound, in all manners—you've got up and down as well. But this is being idealistic and I really don't think it's for the average man. It's very nice, but I can't imagine Mrs. Jones of Wiggum or in your case Mrs. Bloomfield of Connecticut taking the trouble of fixing up her drawing room or . . . whatever you call it . . . the lounge with four speakers.

# DOLBY AND MULTITRACK IN LONDON

With the increasing sophistication of pop and rock recording, quality conscious London studios are finding the DOLBY SYSTEM essential in preventing the noise problems which are otherwise inherent in multi track recording. In London's rapidly expanding network of 16-track studios, 19 of the 20 recorders currently in use are fully equipped with Dolby noise reduction units

Robin Cable at Trident Studios  
23 Dolby A301 units,  
including 16 on two 16-track recorders

Mike Claydon at I.B.C. Recording Studios  
fully Dolby equipped 16-track installation

Frank Owen at Island Studios  
30 Dolby A301 units,  
including 24 on three 16-track recorders

top right:  
One of the Dolby installations at Olympic Studios  
London's first multi-track studio to use  
noise reduction throughout

## DOLBY LABORATORIES INC

333 Avenue of the Americas New York NY 10014  
telephone (212) 243-2525 cables Dolylabs New York

UK and international:

346 Clapham Road London SW9 England  
telephone 01-720 1111 telex 919109 cables Dolbylabs London



Circle No. 106

*bw: Is there stereo radio transmission in England?*

gm: Yes, there is, but it's very limited. It's third programme stuff; that is, you get classical concerts occasionally broadcast in stereo and occasionally you get stereo record broadcasts. I should think the number of people in England who listen to it is about .001 per cent. And also, people don't listen to radio much anyway. The average man in this country is glued to the television set.

*bw: Would you describe what you feel the responsibilities of the producer are on a "rock" date?*

gm: Yes. I'm glad you defined that because a producer's responsibilities do vary an awful lot. For a rock date I think he's got to get to know the group musically and obviously psychologically he's got to know the people. He's got to get into their minds and he's got to try to find out what they're trying to express and if he can find out, it's then his job to realize it in terms of sound. So, his function is not to impose his will upon the group and produce *his* sound using the group as his puppet, but more to draw out from the group the best sound he can possibly get, and get them to play the best possible music.

*bw: Then you feel that sound, as well as music, is a major responsibility of the producer?*

gm: Yes. That's the way I see it. It's also psychological. I think you've got to learn how to get the best out of people—find out when they're going past it and so on.

*bw: How would these responsibilities vary for a CLASSICAL MUSIC session?*

gm: Well yes, they vary enormously. To begin with in the classical session, unless it's chamber music, you've only really got one person's ideas to deal with, and that's the conductor; and then, from the amount of classical recordings that seem to take place today, it's more a question of the diplomatic handling of that conductor and trying to get the best out of him rather than the technical details of a good sound. The classical producers of today, and I'm not calling myself a classical producer, seem to leave everything to the engineer and just act like a kind of . . . what shall I say . . . host to the conductor. I don't think they interfere too much musically, which I think is a pity. I think that classical music could be in fact improved by adapting certain pop techniques to it. I wouldn't mind having a go at recording something classical in a different way.

*bw: Would you, for example, use close miking?*

gm: Yes. Most classical records are made like photographs of concerts, if you know what I mean—aurally speaking. The ultimate aim is to reproduce as naturally as possible the sounds of the orchestra as created in the concert hall. Now I think this is terribly limiting. I mean it's been done, and it continues to be done better and better because engineers and acoustics and recording techniques have advanced enormously. But I think we're missing out on something. I think that if Beethoven or Bach were alive today, they would call that a very timid approach, and I think they would go back to first base and say, "You've got tremendous tools here; let's use them." And I think if you go back to the actual music and adopt, really, very modern recording techniques and produce a work of art which is different from what you hear in the concert hall, and not necessarily inferior which most people might think.

*bw: Then the rock producer presently has more room for creativity?*

gm: Unquestionably. That's what appeals to me.

*bw: (Before AIR Studios were built) Your responsibilities also include selection of the studio and engineer?*

gm: Yes.

*bw: In recording a rock group, will you attempt to capture a "live" studio performance, or will you construct a recording using, for example, overdubbing.*

gm: I'm afraid the latter is true. One doesn't go for a performance as such in the studio because you know darn well that if you do that there are going to be shortcomings in various other departments. You might get a great vocal performance, and the bass line may not be so great. So, there are various things that you can do—you can go and overdub the bass line if you've got good enough separation. You've seen us working recently . . . what I was trying to do yesterday, in fact, with Peter, with the whole group, was to try to concentrate on Peter's performance trying to get something out of him, and then worrying about the rest of it. But in fact we've reversed the process today because we've decided that Peter will probably do as good a performance by overdubbing anyway. So we're going back to first base and concentrating on the actual sound. It doesn't seem to impair the total result. Most rock recording is done that way today. You obviously get a much better sound on everything; you are able to pay much more attention to detail.

*bw: You mentioned before the importance of psychologically understanding the group. Could you be more specific?*

gm: It's just instinct really—a kind of sixth sense you build up. You've got to get to know people and sense what's happening.

*bw: Would you say that a sense of humor is important?*

gm: Oh yes, a sense of humor is terribly important. Absolutely. If you didn't have a sense of humor on rock dates, then everybody would go sour. I can't bear people who take themselves too seriously, including rock musicians.

*bw: Do you find that you do a lot of producing during the mixdown stage as well as during the recording stage?*

gm: It depends on the artist and the record you're making, and what techniques you're using. If you're making a record like Sgt. Pepper, for example, the mixdown is just as complicated, in fact more so, than the original recording because you're painting a picture in sound and you're using extra things: you're bringing in sound effects, you're distorting sounds, you're playing with them, you're sort of shaping them—sculpting them, if you like—and mixing them down at the same time. So that kind of production is probably more complicated and more important in the mixing stage than at any other time. But if you did that all your life, you'd be spending all your time mixing and none of it recording.

*bw: Then it varies greatly from group to group?*

gm. Very greatly, yes.



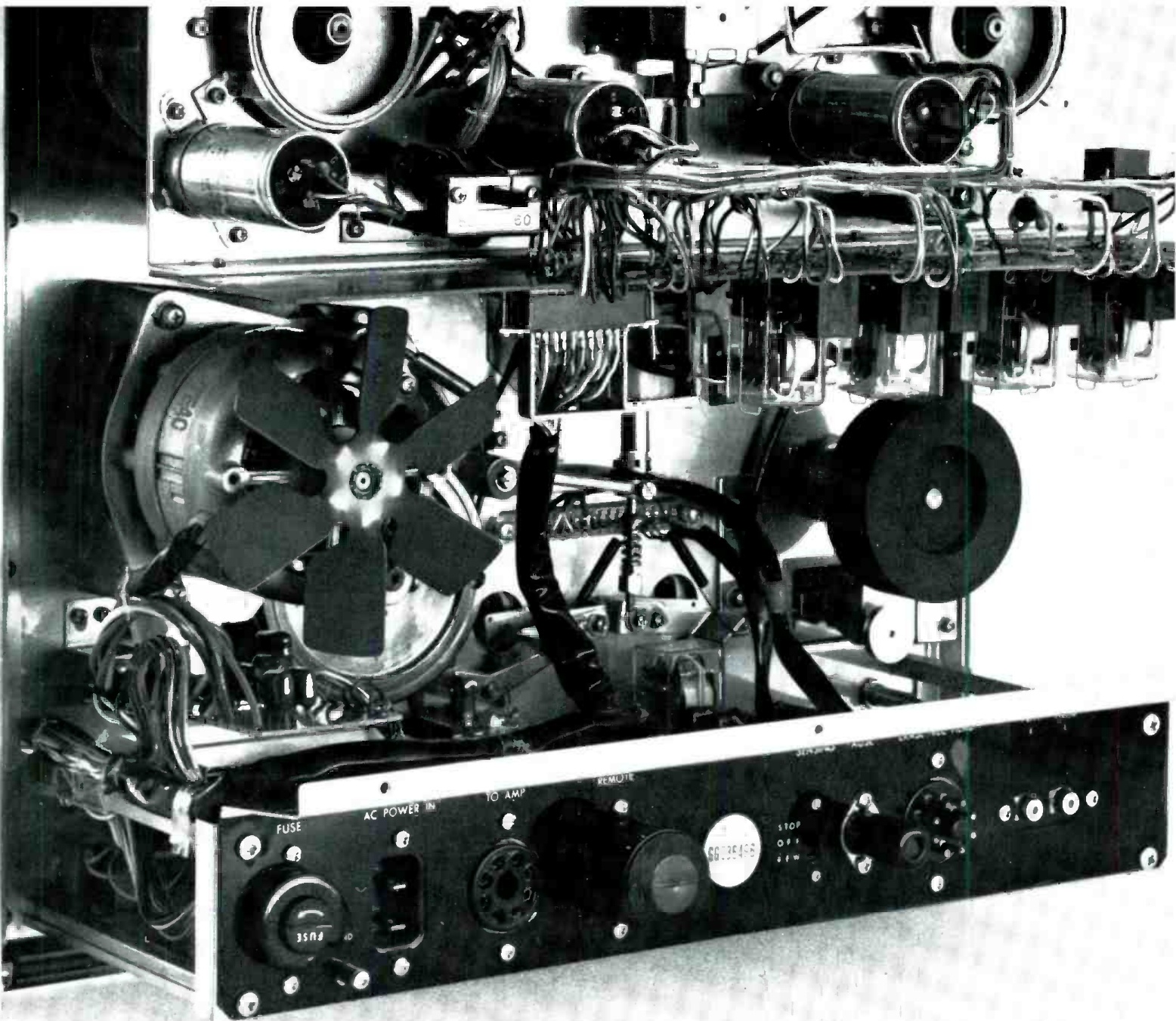

# BACK TALK

When it comes to building sound equipment from the inside out, you could call us the component company. You see, we're one of the few tape deck manufacturers who make all our own critical components – from heads to motors and most of the electronics. After all, who knows better than we do what it takes to make a TEAC?

For instance, our heads are hyperbolic, not conventionally rounded. This means more intimate tape contact, less tape tension, better sound reproduction. Hyperbolic heads are the shape of things to come – and the only kind we'd think of using.

Meanwhile, we still buy outside parts for certain purposes. The ones we buy, we buy because they're the best. The ones we make, we make because they're the best.

And most of the time, we've got it made.

## TEAC

TEAC Corporation of America • 2000 Colorado Avenue • Santa Monica, California 90404



Circle No. 107

*bw: When mixing down, do you physically operate the console, or do you direct an engineer?*

gm: Like most producers I like to get my hands on the controls, and it's wrong. Sometimes I do—sometimes you have to—because sometimes the mixes are so complicated that one pair of hands won't work. In fact, on many Beatles mixes, we would have the engineer sitting in the middle, me sitting on the right, and one of the guys on the left. It depends whose song it was—it might be Paul or John or George. And we would all be playing with the faders, the three of us; we would actually be playing a sort of triple concerto. But the snag with that is that you still need someone else to listen because when I'm controlling the controls on a mix, I'm listening for certain things that I'm controlling and I don't have that essential requirement of being able to listen to the whole thing with absolute impartiality. So nowadays I tend to get out of that scene and say, "This is wrong. You shouldn't be handling the controls. You should be standing back and telling people what to do, and listening to the whole thing." It's only by being free that you can really see the whole picture.

*bw: What qualities do you look for when selecting an engineer?*

gm: Oh, that's a big question. First of all, he's got to be an enthusiastic engineer. I'm very fortunate with Bill (Price); he really is a dedicated engineer. He must be keen on his job, keen on sound, and preferably—and there will be many people who will quarrel with this—preferably without the ambition to be a record producer, because I think that gets in the way of good engineering.

*bw: Why is that?*

gm: Well, there are an awful lot of engineers who become record producers, which is fine; I've got no gripes against that. But I don't think you can do two jobs at the same time. And there's always the transition period when the engineer tries to do a bit of production, or goes back to doing a bit of engineering after he's been a producer. And I think that they lose out because of that. They are two separate jobs and they need detached minds.

*bw: Anything else?*

gm: He's got to be good at his job; he's got to know a lot about recording—that goes without saying. He's got to know the board, and he's got to have a good ear. He's got to have a personality where, without being servile, he makes it plain that he is there, in fact, to serve the group. He doesn't have to be a humble person. On the contrary, he must be a person of some authority and some spirit; but he must always give that impression, that he is there to get the best sounds out of people, just as the producer should give that effect.

*bw: So you don't care if the engineer has a musical background?*

gm: No, not really; not personally because that should be the job of the producer.



George Martin and engineer Bill Price

*bw: What kind of language do you use to communicate with your engineer? You mentioned to me before that you were non-technical, therefore I assume that you do not communicate in technical terms.*

gm: Well, in fact, I do. I'm non-technical, but I still say to him, "I think we need a bit of top at 4,000 (Hz) on that, or try it a little lower down." When I say I'm not technical, I mean I haven't any technical training. But you can't grow up in the recording industry, and go from mono recording through stereo and multi-track, working all the time on boards, without picking up a little knowledge.

*bw: Then you feel that the producer should be able to operate the console himself—at least in his head?*

gm: I think it helps—anything that gives a greater understanding between people. I think that if my engineer knows that I know what's going on, then he will respect me more and he'll work more closely with me. If I don't know what I'm talking about and I ask him for something that is patently impossible, I'll lose his respect, and he won't work so well with me.

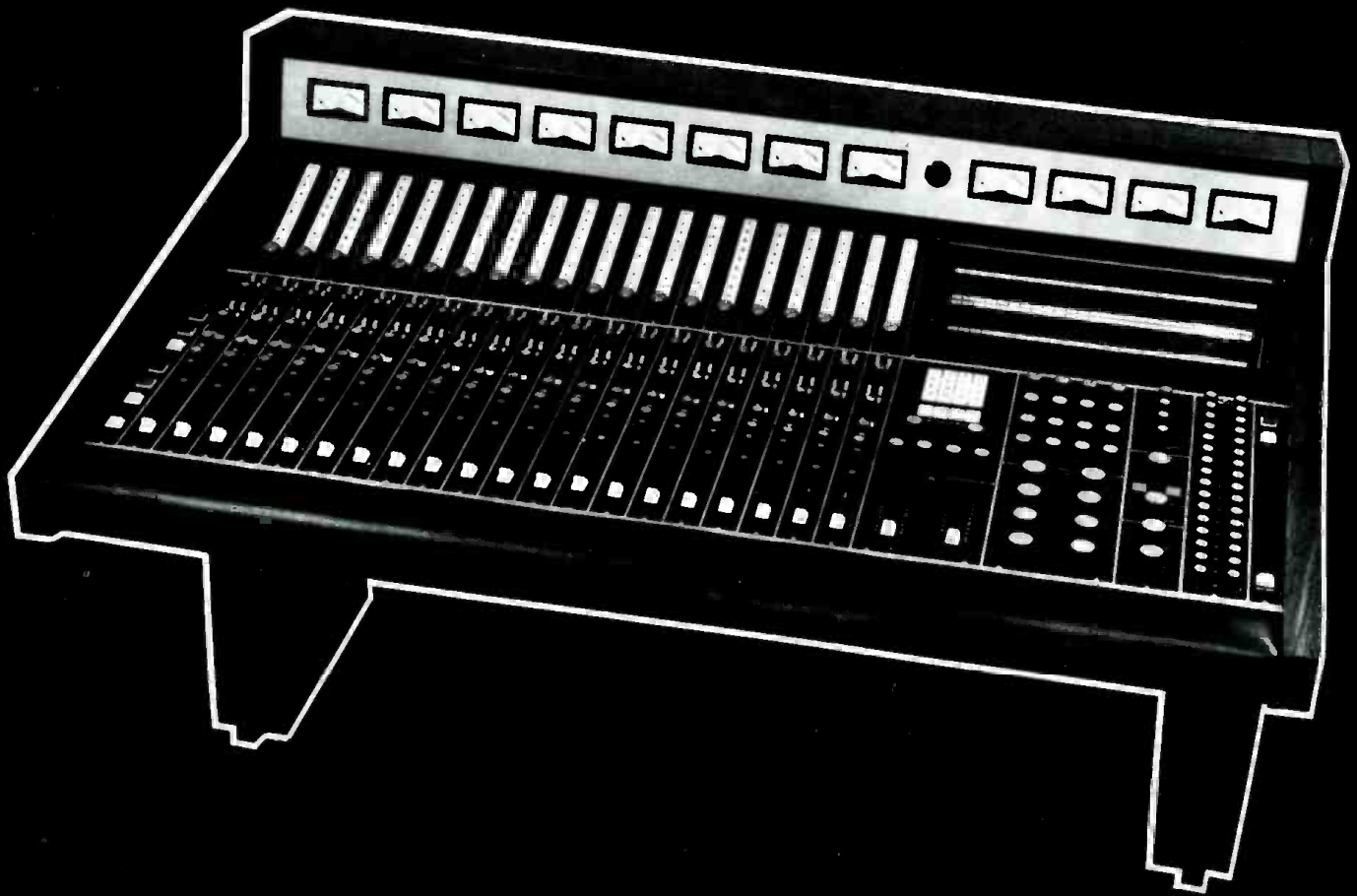

SPECTRA SONICS is pleased to announce that new "Beyond the State of the Art" audio control consoles are now in production. First exhibited to the professional audio industry at the Spring Audio Engineering Society Convention in Hollywood, these SPECTRA SONICS consoles have become, overnight, the ultimate standard to which all electronic performance is compared. Already installed and in operation at the RECORD PLANT WEST, LARRABEE SOUND STUDIOS, and MGM RECORDS in Hollywood, the SPECTRA SONICS Audio Control Console Model 1020-8/16 has received such immediate industry acceptance and acclaim, that continuous production of this console has been initiated.

Like the Model 101 Audio Amplifier (the basis of the console electronics) these SPECTRA SONICS Consoles are guaranteed to outperform any console in the world in distortion, noise, frequency response, square wave response, and peak overload! For detailed specifications, and immediate delivery on "Beyond the State of the Art" audio control consoles, contact SPECTRA SONICS at 770 Wall Avenue, Ogden, Utah 84404 (801-392-7531) or at 6430 Sunset Blvd., Hollywood, California 90028 (213-461-4321).

# SPECTRA SONICS

LEADER IN ADVANCED TECHNOLOGY



*bw: Do you prefer to work straight through with one engineer?*

gm: I prefer to work with one engineer for a particular job, but I don't want to work with that engineer all my life.

*bw: Many Beatles recordings employ techniques or tricks such as phasing very tastefully. Did the ideas for these techniques come from engineers? Or, to put it another way, do you encourage your engineers to make suggestions?*

gm: I certainly would encourage engineers to make suggestions. But in fact, all the techniques we used that you've described have come about not because the engineers made suggestions, but because we actually asked for particular sounds. Phasing came about as a result of experimenting with the automatic double tracking, ADT, which was, in fact, suggested by an engineer, who strangely enough wasn't a balancing engineer. He was a backroom boy who came forward with this idea. He was an EMI bloke; he's now in fact running EMI studios, which is nice. And so phasing came about as a result of that—playing with ADT. In most other cases they've been a result of personal experimentation in the studio. My experience with spoken word recordings—building up sound pictures without music—was invaluable in that respect.

*bw: Are there any special considerations that you keep in mind when producing a 45 rpm single release?*

gm: Obviously it's got to be a little more concise than an album track. There are a lot of things which you put on an album, which stand up on an album because they are part of a long scene, which obviously wouldn't mean anything on a single. In any case, you are making records to a certain extent for a particular market. One is well aware of the nature of the music that is played on the top 100 in the "states", so you're obviously thinking of that when you select your single.

*bw: Is there any instrument, or instruments, that you consider particularly important, especially with regard to singles?*

gm: No, I don't honestly consider any one thing to be particularly important—I think they're all important. When I'm doing a recording of a rock group, I do actually, mentally, go through every sound that I'm hearing, saying, "Is that the right sound?" I apply the same devotion to each one. If you miss out on one, you're not doing your job.

*bw: Is it true that the early Beatles records were remixed by Capitol for release in the states?*

gm: They weren't *remixed* by Capitol; they might have been re-equalized by Capitol. Yes, in fact, I'm sure they were. The story was in those days that

American record players were different from English record players, and therefore they had to cut their own masters to suit their own tastes. And they did that; and I didn't like the results, but I couldn't do anything about it.

*bw: Could you describe the differences in sound between the American and British releases?*

gm: I didn't think they (U.S. releases) were as good. It's difficult to get a good answer to that one because I was hearing their records on my machine and I don't know what they would have sounded like if I had heard them on their machines. They may have been alright, but they generally sounded much thinner and harsher than our sound, and less bass certainly.

*bw: Early Beatles records were characterized by a particular vocal sound which has been very influential on pop music in general. How did this come about?*

gm: Because we had particular kinds of vocalists, really.



*bw: You mentioned ADT.*

gm: That was a particular sound we put on. You know, once we got over the first hurdle of being a success, they were always looking for something new. They were continually coming to me and saying, "Do something different." They were always prodding and trying to push some things out a bit further. John hated the sound of his own voice, which I personally thought was a great voice, and quite often he would come to me and say, "Can't you do something with my voice; it sounds terrible." He'd say "I know it *is* terrible, but let's do something about it. Don't make it sound like me," which was worrying in a way because he expected magic. I don't know quite what he was expecting to hear, but it wasn't what he was producing and consequently we did play about with the voices quite a bit. Sometimes, I think the results weren't very good, but in a lot of cases they were.



bw: *Is it true that Sgt. Pepper was recorded on four-track machines?*

gm: Yes, absolutely true. It was done four to four.

bw: *Who did the engineering on Sgt. Pepper?*

gm: Geoff Emerick, I think he did all of it.

bw: *What other Beatles records has he worked on?*

gm: I couldn't give you a catalog—there are quite a few. When we started out, the engineer we had was a guy by the name of Norman Smith. I can't give you which record he stopped on, but we could find that out easily—the facts are there. But he came to me one day and said he wanted to be a producer . . . he was an EMI engineer . . . and did I mind. And I said, "No, fine. Off you go." He said, "The only thing is, I want to go on engineering the Beatles." And I said, "Well, now, I don't think you can do that." I was very firm, but quite polite, and I said, "If you want to be a producer, that's one thing and that's fine. Go and make some good records. I'm sure you can, but I don't think you can go on engineering at the same time," which comes back to your previous question. So he made the plunge and he left and became a producer, and he's done some extremely good stuff. He made all of the Pink Floyd's early records. He's now a staff producer for EMI. But then I had to find another engineer. Now there were lots of engineers senior to him at EMI, but I decided at that time that I wanted someone very new and young. I'd been looking around—looking for talent, so to speak, and I decided to give the chance to Geoff Emerick, who in fact had done very little recording before. He'd been balancing for six or nine months before I gave him the job with the Beatles. He jumped at that and it was really tossing him over the deep end; but he was marvelous—he came out with colors flying. And after Geoff we used other people as well, but in fact, we brought Geoff back for *Abbey Road*.

bw: *He didn't, then, work on the Beatles white album?*

gm: No, he didn't.

bw: *Would you describe some of the techniques used on Sgt. Pepper, for example on "For The Benefit of Mister Kite"?*

gm: That's really quite simple when you know about it. John wanted a calliope kind of sound. He wanted to get the impression of a fair ground and he played me this song that he'd written, and asked what I could think up to give it that kind of fair ground atmosphere. And I thought a lot about it, and I decided the best way to do it was to use some of the techniques I'd done with spoken word records. I decided that to get the kind of swooping, steam organ noise he wanted, I got him on one Hammond organ

and me on another; actually I think he was on a Lowry and I was on a Hammond. And we recorded some half speed organ, and I did some chromatic runs with the tremelo on fairly fast over two octaves and then sped them up to double speed. That was one of the things—the swooping noises. But for the background mush, I got lots of steam organ tapes, genuine fair ground organ recordings of all sorts of pieces of music—"Stars and Stripes Forever" and those kinds of things—and cut them into short lengths (of tape) and threw them up in the air, literally, and just told the engineer to pick them up again and join them all together. He thought I was mad. We played it and of course the result was very cacaphonic. We used that as just a general background, mingling mush, which gave the required effect . . . all kinds of funny jumping—some of it was backwards—but it worked.

bw: *Beatles records are also characterized by constructive use of echo effects. Do you pay particular attention to echo on your recordings?*

gm: The right kind of echo, yes. There's a tendency these days to use plates an awful lot, in fact exclusively. We have plates here but we also have an echo chamber, which I must confess I haven't used a great deal yet. But I believe that a good chamber can beat a plate any day. I used chamber mainly on Beatles records. Actually, we used a combination of chamber and tape, which we called "steed"—I don't know why we called it "steed"—but it was basically sending the delayed signal by means of tape into the chamber.

bw: *Why weren't any of the engineering teams credited until Abbey Road?*

gm: EMI policy, and they didn't like it even then. (*Abbey Road*)

bw: *Beatles records, especially since Sgt. Pepper, have caused a rekindling of interest in the electric bass. Was bass a particular problem in recording the Beatles?*

gm: Paul was always worrying me to get more bass on the records, certainly, and it was my job to try and get that bass on, true. Probably it was the single most worrying factor, of any sound that we produced, because Paul is a perfectionist and even when we got a great bass sound he didn't think it was very good. Now, you say that we got some great bass sounds, which is nice to know. I'd like you to relay that information to Paul.

bw: *I'd be glad to.*

bw: *Could you describe a technique you used on the bass on Abbey Road, say, for example, "Come Together"?*

gm: I think on that particular one we used a combination of direct injection and live sound.

*Continued on page 33*

# 9 out of 10 ears prefer 3M professional audio recorders.

3M professional audio recorders provide outstanding features you can hear as well as see.

Our line includes 16, 8, 4, 2 and full track recorder/reproducers. Remote overdub units for the 16 and 8 track models provide individual mode selection of any or all tracks and duplicate transport controls. Designed for the professional studio, all models occupy only about 2' by 2¼' of floor space and provide better performance, more convenient operation and higher quality than any other recorder.

The entire line uses the same unique 3M transport and the same sophisticated electronics, so tape and signal handling is as convenient, gentle and precise on our full track

model as it is on our 16 track model.

The tape drive is our own Isoloop®. Low scrape flutter, improved timing accuracy, and constant tape tension are all products of this unique system.

Compare and you will agree as these professionals do, that the 3M professional audio recorder is outstanding in its field.

Mincom Division, 3M Company, 300 South Lewis Road, Camarillo, Calif. 93010. Telephone 805/482-1911.

SCOTTY MOORE  
Music City Recorders

LEE HERSCHBERG  
Warner Bros. Records

BRENT ALBRIGHT  
MCA Recording Studios

AARON J. BARON  
Location Recorders

PROFESSIONAL AUDIO PRODUCTS

Mincom Division **3M**  
COMPANY



**BOB DOHERTY**  
United Recording  
Corp.



**ARMIN STEINER**  
Sound Recorders



**MARTIN FELDMAN**  
Paragon Recording Studios, Inc.



**DAVE CLARK**  
Holland-Dozier  
Holland



**WALLY HEIDER**  
Wally Heider Recording



**THE TENTH EAR**  
Genuine Tin

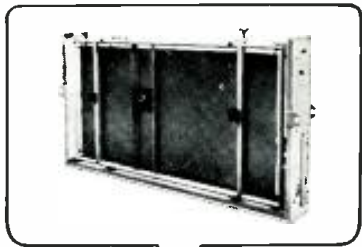

# At Gotham Audio, we have a lot to talk about.

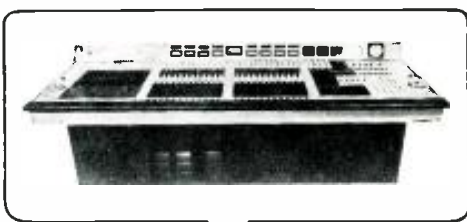
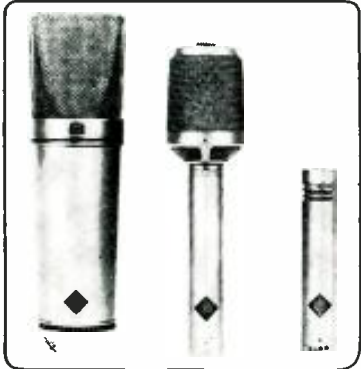
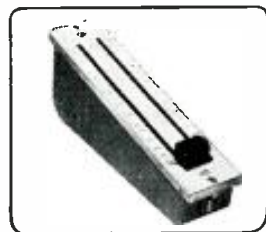
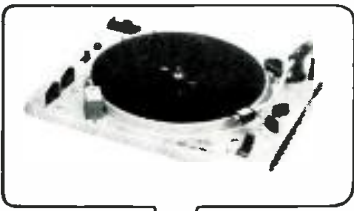
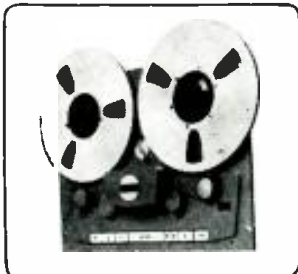

You're looking at only a few of our conversation pieces.

Altogether, we have about 300 different kinds of professional sound products. Ranging from microphones to tape timers. Reverberation units to tape recorders. Loudspeakers to flutter meters. And even \$70,000 studio consoles.

The names on all this equipment? They're worth *shouting* about. Because, they're without question the top manufacturers in their fields — companies that have consistently led the advancement of the state of the art.

We speak — with pride — of such companies as Beyer. EMT. Studer. And, of course, Neumann. (Gotham has been the sole U.S. distributor of Neumann microphones for more than a decade.)

If it's delivery and service you want to talk about, we have happy words for you there, too. Words like *quick. When promised. And — on time.*

Try us. You'll see. We're not talking through our hat.

**GOTHAM**  
AUDIO CORPORATION  
2 West 46th Street, New York, NY 10036 (212) CO 5-4111  
1710 N. LaBrea Avenue, Hollywood, CA 90046 (213) 874-4444  
In Canada: J-Mar Electronics Ltd.

# THE RING MODULATOR

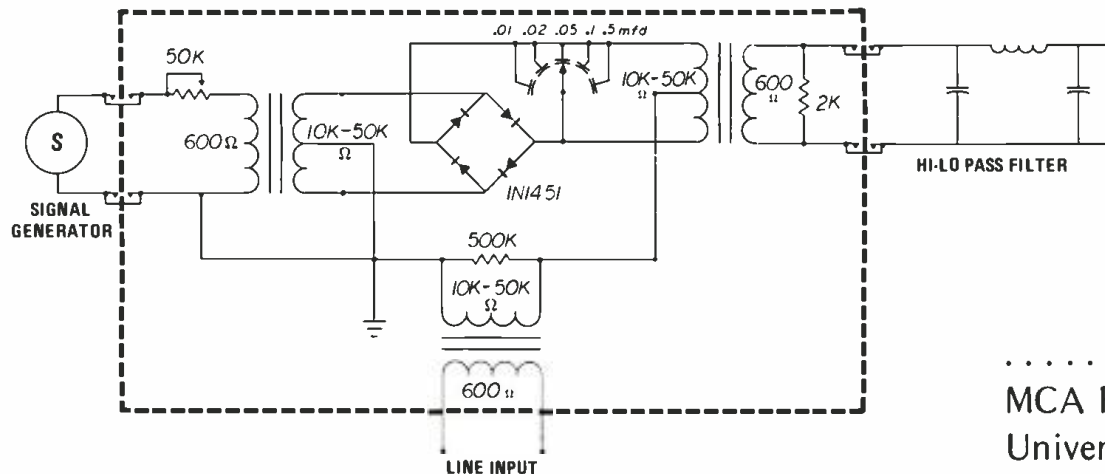

... by Brian Ingoldsby  
MCA Recording Studios  
Universal City, Calif.

The Ring Modulator, a major sound processing component of all music synthesizer systems, is a mighty handy, easily built, signal processing device to have available for producing a broad range of unusual synthesizer type audio effects. The design described here makes use of two pieces of studio equipment almost universally found in recording studios: a signal generator, and a hi-low pass filter.

Both input transformers, the one from the signal generator, and the one from the program source (line or microphone), are ordinary inexpensive 600Ω in, 10K-50KΩ out, center tap transformers. The same transformer is used for the output to the hi-low pass filter. The important thing about the selection of the transformers is that the input impedences should be the same for all three.

The few resistors needed do not have to be better than 20% resistors.

The four 1N4151 rectifiers ought to cost in the neighborhood of 50¢ apiece. Care should be taken to assemble the rectifiers as correctly shown in the circuit. Do not confuse this part of the circuit with a full wave bridge.

The ability to switch from one capacitor value to another capacitor value, over the range of .01, .02, .05, .1, .5mfd, at the output of the rectifier ring varies the resonant frequency range of the output

transformer. This is one of the two means for varying the characteristics of the ring modulated sound.

If the design is built-up on one or another of the breadboard systems (unhoused) the capacitance selection device is obviously unnecessary, as the various value capacitors can be easily spliced in and out of the circuit.

Additional variation of the sound output is achieved by varying the frequency of the sine wave from the signal generator, as it is tuned to any frequency within the full audio range, at +8 to +10dB.

The program input should, of course, be at +4dB.

The suggested method of operation of the unit is to find the resonant frequency which most complements the line input signal from the audio generator. The hi-low pass filter is then adjusted to the nearest frequency to the fundamental of the audio generator. Further adjustment to the audio generator is then made until beat frequency (harmonics) are heard.

By experimenting; no just down right playing around with the unit, a wide array of very useful effects can be 'discovered.' For example, one of the first things you might try with the ring modulator is the conversion of the conventional piano sound to that of an electric piano, or even a harpsichord ... and on from there.

## SPRING 'AES' CONVENTION AND EXHIBITION: APRIL 27-30, 1971: LOS ANGELES HILTON HOTEL.

Under the general chairmanship of AES Western V.P. Bill Brandt (ALTEC LANSING) and convention manager Bill Robinson (SUNSET SOUND) the 1971 edition of the Western (Spring) 'AES' Meeting will, in something of a departure from previous practice, open in mid-week on Tuesday, April 27, 1971. The meeting will again be quartered at the Los Angeles Hilton Hotel, in an expanded area, being prepared to accommodate another record attendance by AES members, visitors and

exhibitors.

Attendees with a mixed communications media interest will be able to also attend the SMPTE convention being held on the same dates across town in the Century Plaza Hotel.

Session subjects with the session chairmen line-up as follows:

TRANSDUCERS Austin Brouns  
BROADCASTING, AM-FM-TV Donald C. McCroskey  
SOUND REINFORCEMENT & ARCHITECTURAL ACOUSTICS Charles Standiford  
DISC RECORDING & REPRODUCTION Steven A. Guy

MAGNETIC RECORDING & REPRODUCTION Keith Johnson  
MOTION PICTURE SOUND TECHNIQUES Walter K. White  
AUDIO AND MEDICINE David Annett  
ELECTRONIC MUSIC Paul Beaver  
MEASUREMENTS, THEORY, STANDARDS & PRACTICES John K. Hilliard  
SIGNAL CONTROL-SYSTEMS Shelley Herman  
SIGNAL CONTROL-CIRCUITRY Robert A. Bushnell  
AUDIO INSTRUMENTATION Bob Beavers  
STUDIO RECORDING TECHNIQUES TODAY Hugh P. Stark  
ACOUSTICAL NOISE AND NOISE CONTROL Charles Horton  
RECORDING STUDIO WORKSHOP William Robinson



**The best  
microphone money  
can buy.**

The Sony C-500 Studio-Standard Condenser Microphone is the only studio microphone able to surpass the technical capabilities of all other equipment in today's advanced recording studios. Its dynamic range—in excess of 130 dB—permits distortion-free recording of extremely dynamic works of music. No other microphone even approaches its distortion-free performance—less than 0.1% (I.M. or T.H.D.) at or below 134 dB SPL, and its maximum sound pressure level is a devastating 154 dB, without significant increase in distortion. All other performance characteristics are equally impressive, thus justifying the C-500's title: STUDIO-STANDARD. \$395.00.

**The best  
microphone buy  
for the money.**

Now Sony enhances studio capability with the new incredibly low-priced ECM-377 cardioid condenser microphone—the outstanding successor to the popular Sony C-37A. The ECM-377 surpassed the performance of all existing condenser microphones except Sony's new C-500. It is compatible with all "phantom power" systems or may be powered by an internal battery. You can use it anywhere. Outstanding performance at a remarkably low price—\$195.00—The Sony ECM-377.

The Sony ECM-377 and the Sony C-500 are available at select Sony/Superscope dealers. For their names, as well as complete details and specifications, please write Special Application Products Division, Sony/Superscope, 8132 Vineland Ave., Sun Valley, Calif. 91352. **SONY SUPERSCOPE**

a Care package for

# AUDIO RECORDERS

by Gene Titterington  
Field Service Engineer  
Ampex Corporation

Recognizing that instructions for the care of magnetic tape recorders are indelibly imprinted on the memory of every recording engineer, we are nonetheless persisting in our belief that somewhere, somehow, these instructions should be restated. For those who have but recently joined us, of course.

Here, then, is a review of the professional audio recorder—what it is supposed to do, what care it should receive, some tips on checking up on it, plus a few casual indicators of trouble for engineers willing to frown knowingly at some point prior to total disintegration of the recorder in service.

Simply put, the professional magnetic audio tape recorder is a system in which signals in the frequency spectrum to which the human ear is tuned are recorded on magnetic tape for later reproduction. The name of the game is “what goes in should come out!” The fact that what comes out is remarkably similar to what goes in is what makes the magnetic tape recorder the useful tool that it is. In calling it a “professional” recorder we are simply defining the category of recorder used by the professional recording or broadcast engineer in the normal course of his day to day activities. But . . . if the professional wishes to apply the same care to his home recorder, we have no objections.

There are some peculiar twists to the process, though. Sometimes more comes out than expected. Noise, for example. And a surplus of low frequencies. At the same time *less* comes out. High frequencies get lost in the shuffle of loading signals on tape and getting them off again.

Some of this gaining and losing is cancelled out by some pretty nifty adjustments made by the manufacturer and recording engineers operating as a team. But there are some residual effects which are undesirable and these are the ones we'll attempt to thwart herein.

Mind you, we're not going to solve all of your problems, we'll just tell you some of the things to do to avoid some of them. And maybe point you in the right direction.

## PREVENTIVE MAINTENANCE . . . Three Easy Steps

First, let's assume immediately that all professional audio recorders perform as specified and that performance as specified is satisfactory. Our job: to unseat those malevolent forces which suddenly appear to upset our assumptions.

Most readers will recognize three basic principles right off:

1. A recorder with clean heads, guides, capstan and surfaces is less susceptible to problems caused by dirt and oxide than a dirty recorder.
2. Proper and regular demagnetization of all elements in the tape path is quite likely to eliminate problems caused by magnetized heads, guides, etc.
3. A properly lubricated transport will not be over-lubricated or under-lubricated. It has also been known to run better as well.

When analyzed, these three basic statements will reveal one startling fact: together they constitute the entire preventive maintenance routine. Anything above

or beyond this constitutes inspection, checking or troubleshooting.

This in no way implies that inspection, checking and trouble-shooting are not to be indulged in—not at all. It just pays dividends to know where one leaves off and the others begin. And while the preventive maintenance routine can be delegated to an assistant, the really careful engineer will do the next step himself: the inspection.

## TAKE A LONG HARD LOOK

You'll get no quarrel from anyone by claiming that a good visual inspection can reveal many, many little pieces of information that together tell a significant story about the condition of the recorder.



While there is no way to describe it adequately, a properly adjusted tape transport literally sings a song of well-being. You can feel it. By the same token, an ailing recorder can cause the hackles on the back of your neck to stand out straight. You're uncomfortable being in the same room with it.

The well-behaved transport on close inspection will be passing tape in an absolutely flat path—flat in that motion is nearly imperceptible. It is this comfortable sensation of the rightness of things plus the beautiful, smooth flow of tape that encourages the engineer to proceed knowing that *today* things will go well.

At this point, the engineer can check the braking system. Two successful smooth stops in a row signifies that, by golly, he might have it made. And so he continues to exercise the transport through all of its modes and in the several speed ranges involved.

Note that the engineer in checking "stops" is also checking "starts" in approximately a 1:1 ratio. In both cases, the stop/start times can be checked against the manufacturer's spec. Again, the well-adjusted transport will be a delight to behold.

Satisfied that the transport functions are just short of perfection, the engineer can now continue his inspection by removing the tape from the machine and preparing for a thorough examination of the entire transport.

Two tools are helpful. Good light and a man sized magnifying glass. There need be no shame connected with the use of the glass. After all, the idea is to see what's going on.

From the engineer's vantage point all manner of wonderful things show up in the glass. (And you thought you cleaned the system, didn't you?)

Dirt and oxide particles stare balefully back from hidden corners. Here's a piece of torn tape tucked away. Safe enough where it is, but what if it should move and lodge itself smack dab against a head at a critical instant?



Get rid of it! And any others you may find.

And while you are getting rid of the scrap of tape, you've a perfect right to ask where it came from. One scrap could be a piece knocked off the end of a tape during a fast rewind—several pieces of similar size and shape *could* indicate a burr on a contact surface somewhere—missed at the last inspection.

And that oxide—where did *it* come from? Poor cleaning? Or is it newly shed—a sign of trouble?

Now the value of the glass really shows. A careful check of stationary guides and the heads will reveal any signs of wear. If slot-wear is present yet recorder performance is satisfactory, there may be no cause for alarm. Leaving well-enough alone applies. It may be sufficient simply to make a note that the wear *is* taking place and watch for further developments. But if the engineer is contemplating a change in head alignment, those wear slots will present some real problems.

Tapes will not track smoothly through the misaligned slots. Buckling, bowing or warping of the tape could result with an attendant loss of intimate tape-to-head contact. High-frequency response drops off quickly and physical tape damage is a good possibility.

Under the assumption made in the beginning, the recorder under survey is in decent condition. We have observed no signs of wear. But we're not through yet. Some additional checks should be performed.

Head alignment and electronics are still unknown quantities. While these items appear to be in proper working trim, the "let's make sure" checks are not difficult to perform, nor need they require much of your valuable time.

#### TEST TAPES . . . Your Best Friends

Select the proper test tapes needed (reproducer alignment tapes recorded at the proper speeds). Ideally, you should use test tapes with track configurations matching that of the recorder. You're already aware of the fringe-effect that occurs when using full-track tapes to check multitrack recorders. Low frequency response is magnified and it is next to impossible to equalize for a flat response. (Remember even with the right format tapes the "bumps" will still be there.)

Thread the alignment tape carefully and follow the voice instructions on the tape. In most test tapes, signals are provided for checking head azimuth, frequency response and the operating level, not necessarily in that order. Make the essential adjustments for both speeds, using the tape made for each speed. (Although the NAB equalization curves are identical for 15 ips and 7½ ips, the frequency response adjustments must be

made with separate tapes to assure accuracy.)

In using test tapes, the confident voice on tape may sound more authoritative than the condition of the tape warrants. *Know your test tape.*

#### TENDER LOVING CARE FOR TEST TAPES

While test tapes are masters so far as the recorded signals are concerned, they are fragile things. Once they leave the environment in which they were made, they are susceptible to the same damage as any other tape. They not only wear out in use, but even deteriorate magnetically on the shelf. Shelf deterioration can be minimized by proper storage, but only care in use can successfully combat physical damage to test tapes. Manufacturers are cautious in expressing life-expectancy figures. Fifty to a hundred plays seems to be a safe figure. Losses as high as 5 dB have been noticed at the hundred play mark. Offsetting this are tests where tape life has been extended well beyond one-hundred plays when normal clearing and degaussing routines are followed. Professional quality heads generally will extend the life of test tapes. This would indicate the need for caution in using test tapes on heads of doubtful quality—at least those test tapes you depend on for use with your professional gear.

Under no circumstances should a test tape be used on a machine prior to cleaning and degaussing. Remember that short wave-length flux literally rides on the oxide surface. Wear it thin and you've lost the high frequencies. Even if no wear occurs, dirt causes loss of intimate contact and again, there go the highs.

Running test tapes on magnetized surfaces offers more trouble. You can erase the highs and replace them with noise rather easily.

A word about the efficiency of head degaussers should be dropped in here.

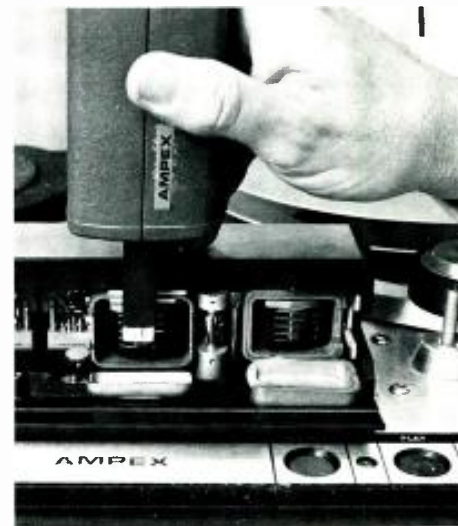

New AMPEX HD-16 Degausser



With the wide availability of low-noise tapes, noise reduction systems, and 16 channel (or more) recording systems, noise or signal damage caused by magnetized elements in the tape path is more than ever noticeable. Tests have shown that the old familiar head degausser is not doing the job adequately. Special, more effective degaussers will undoubtedly reach the market in the near future. Until they are available, the professional must use what he has. Multi-channel head systems that can be removed from the transport should be degaussed with the more powerful bulk degaussers. Even the handheld bulk degaussers will do a better job of degaussing parts such as capstans and guides.

In storing your test tapes, rewind them carefully and store them in a magnetically secure environment—away from speakers, microphones and other magnetic devices (including magnetic latches on cabinet doors!).

Since test tapes represent one of your primary reference standards, they should be treated as precision tools. You can be sure that's how the manufacturer treats them.

Once you have checked the recorder by means of the reproducer alignment tape, you will have established several points: the azimuth of the reproducing heads is correct, the frequency response has been equalized at each operating speed and you have adjusted the output to the standard operating level.

With all these good things done you can carefully rewind the test tapes at play speed (or store them tail out) and put them away in a secure storage.

#### IT'S THE SIMPLE THINGS THAT COUNT

See how conveniently our assumption has served us? Since your recorder was assumed to be in good working order, all you've had to do is to perform three simple preventive maintenance steps, a visual inspection (*thorough* visual inspection), and a check of the system using properly configured alignment tapes.

Together, these routines comprise the basic care package for your recorder. Because they are simple routines, they can be repeated often. Others must be performed too, and these routines will generally be spelled out by the manufacturer in the instruction manual.

Since most of these more specialized checks and adjustments are peculiar to the machine involved, we won't detail them here.

Instead, we'll make a list of the routines, suggesting the frequency of application, and give the reasons why they should be done. This, then, is a more complete "care package for the magnetic audio recorder."

## Universal Audio Plug-in Amplifier 1109

# high headroom for heavy sounds (+27 dBm)

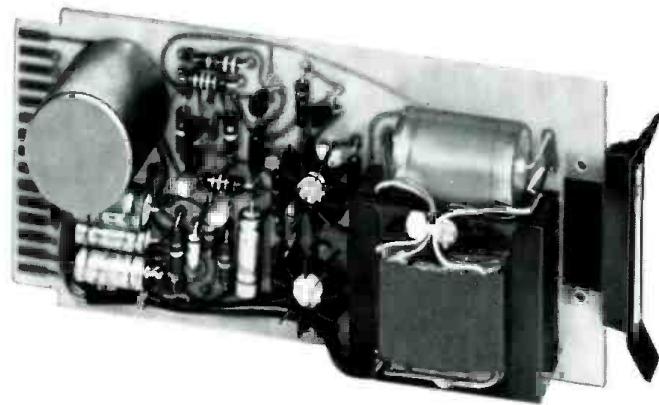

### all purpose amplifier mike, booster, or line

Now a preamp with a full half watt output. A truly interchangeable card amplifier for studio console applications. Impedance-matching and gain now strappable at the card tray connector, making all console amplifiers interchangeable (think of the reduction in back-up amplifiers). Extremely low noise (within 2 db of theoretical limits). May be operated optionally from +24-30 vdc or  $\pm 15$  vdc.



**Remote Equalizer Model 509** provides flexible "envelopmental equalization" **at the lowest cost in the industry.** Equalizer can be panel mounted up to 25 feet away from amplifier tray. Size compatible with contemporary vertical faders. (1½" x 5½" x 5½").

Send for complete specifications, today!

11922 Valerio Street, No. Hollywood, California 91605  
(213) 764-1500

Exclusive export agent:  
GOTHAM AUDIO DEVELOPMENT CORP., NEW YORK, N.Y.

# URi

Circle No. 113

# Total Tape Dup'cat'ng with "Building Block" Simplicity

## CASSETTE TO CASSETTE, REEL TO CASSETTE, REEL TO REEL

The Telex series 235-1 is more than just another tape duplicating system. It is a concept based on modular "building blocks" which complement each other and provide total flexibility for tape duplicating. It solves the problems of interfacing between open reels and cassettes. It is a system designed for future expansion. Engineered to make tapes of true, professional quality. And it's priced within your budget.

The Telex system consists of only five basic units.

1. Solid state modular electronics containing amplifiers, meters and controls. This unit works with any combination of ten cassette or reel slaves.
2. Cassette master play transport.
3. Open-reel master play transport.
4. Cassette slave record transport. Records three cassettes simultaneously.
5. Open-reel slave record transport.

The five units are totally compatible. Intermix cassette and open-reel master or slave transports to suit your duplicating requirements; cassette to cassette, reel to cassette, reel to reel, or even cassette to reel. All units fit into table top consoles of uniform size so when your requirements change, you just add more units. It's that simple. Telex series 235-1 is heavy duty equipment with hysteresis synchronous motor tape drives, momentary push button controls and time delay circuits for smooth, positive tape handling. Selected premium grade duplicator heads provide long life and excellent frequency response. And fail safe, automatic features enable non-technical personnel to operate the system efficiently. Telex "building blocks" make a totally flexible and complete duplicating system. It's the sensible approach, designed to meet your needs today, next month and in the years to come. Made in the U.S. to professional standards. Systems start at \$1860.



Solid State Electronics. Bias oscillator module and two or four channel amplifiers.

Open Reel Slave, 7.5 - 15 IPS. Full track. Half track 1 or 2 channel. Quarter track 2 or 4 channel.

Cassette Slave, 3.75 - 7.5 or 7.5 - 15 IPS. Half track 1 or 2 channel. Quarter track 2 or 4 channel.

Open Reel Master, 7.5 - 15 IPS. Full track. Half track 1 or 2 channel. Quarter track 2 or 4 channel.

Cassette Master, 7.5 - 15 IPS. Half track 2 channel. Quarter track 2 or 4 channel.

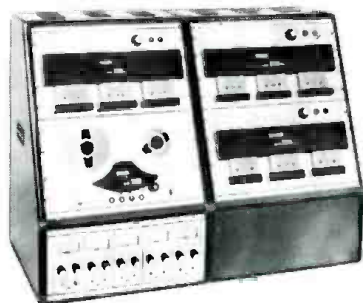

PRODUCTS OF SOUND RESEARCH  
**TELEX**<sup>®</sup>  
COMMUNICATIONS DIVISION

9600 ALDRICH AVE. SO. • MINNEAPOLIS, MINN. 55420

Export: Royal Sound Company, Inc., 409 North Main Street, Freeport, New York 11520 USA. Cable: Royalsound Freeportnry

Circle No. 114

# AUDIO RECORDER SCHEDULE OF ROUTINE INSPECTION AND MAINTENANCE

| ROUTINE   | HOW OFTEN   | WHY   |
|---|---|---|
| 1. Cleaning   | As often as desired but certainly no less often than once every eight operating hours.  | Clean recorders eliminate a lot of possible problems. Dirt and oxide accelerate wear and degrade performance.   |
| 2. Demagnetizing  | Should be considered as part of the cleaning routine.   | Magnetic cleanliness is as desirable as physical cleanliness. Stray fields can rob you of the quality you put in so carefully.  |
| 3. Lubrication  | As recommended by the manufacturer. No more, no less. This is no place to exercise creativity.                                    | No one likes a squeaky wheel. Too much lubrication attracts dirt, destroys components.  |
| 4. Visual Inspection  | Follow your own time-table. In practice the careful engineer is <i>always</i> inspecting.   | Observation of normal behavior can tune the eye to abnormal conditions. Also, some problems can be observed in development, and corrected before catastrophe.   |
| 5. System Check Out (using alignment tapes)                                 | After cleaning and demagnetizing, generally prior to an important session. As the commercial says, "once in the morning does it." | Test tapes are a primary reference and remove any doubts you might have.  |
| 6. System Check Out (using manufacturer's check list and flutter test tape) | Follow the manufacturer's instructions. Use flutter test tape after all adjustments to the tape handling system.                  | These checks determine whether or not adjustments should be made in brake or hold-back tensions, capstan idler pressures, etc. Flutter test checks adjustments in reproduce modes and is a comfortable reassurance that tape is being handled properly. |

Obviously there isn't much glory in doing these things. But keeping accurate records is one way to get some satisfaction out of doing them. The neat columns of figures should give you some pride of accomplishment and, when the records grow in number, consistent readings will give you the comforting knowledge that you're getting the most out of your recorder—regardless of make or age.

Please note that we have resisted the urge to discuss the routines in detail. No two makes or models of recorders are alike in all respects. Our purpose here is to remind you that following the basic procedures is the best way to avoid serious problems.

The pleasure of tracking down prob-

lems and successfully correcting them we leave in your capable hands. You may, however, want more information on some of the points we've made, particularly those dealing with test tapes and degaussing. Four worthwhile papers are available.

1. "Reproducer Test Tapes: Evolution and Manufacture," Robert K. Morrison. Presented October 12, 1966, to the 21st Convention of the Audio Engineering Society, New York.

2. "Tape Reproducer Response Measurements with a Reproducer Test Tape," John G. McKnight. Presented October 12, 1966, to the 31st Convention of the Audio Engineering Society, New York.

3. "Flux and Flux-Frequency Meas-

urements and Standardization in Magnetic Recording." John G. McKnight. Published June 1969 in the Journal of the SMPTE, Vol. 78.

4. "Remanence and Demagnetization Problems in Magnetic Recording Heads" by Avner Levi (originally presented at the 1970 International Telemetering Conference.)

Papers #1, #2, and #4 are available from Ampex Corporation, M.S. 7-13, 401 Broadway, Redwood City, California 94063. Ask for A-223, "Test Tape Applications," and TIP #11 (Demagnetization). Paper #3 may be obtained from the Society of Motion Picture and Television Engineers, Inc., 9 E. 41st Street, New York, N.Y. 10017.

# Altec introduces a 4-foot control console with up to 28 inputs and 16 outputs.

It's built to your specs...delivered ready to use.

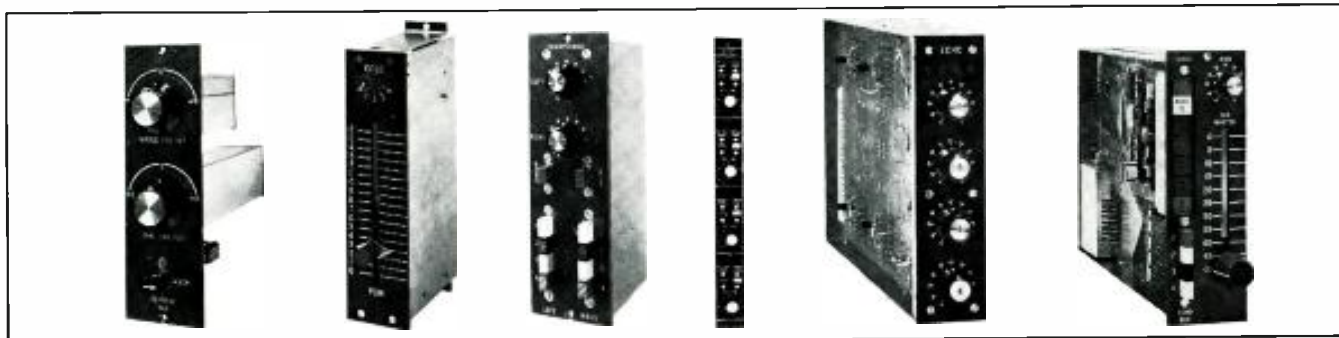

It's the all-new, all-solid-state Altec 9300A control console. Only 51½ inches long, it features direct-plug-in modular construction that lets you custom tailor your own board by simply selecting the specific modules you need.

The new Altec 9300A gives you up to 28 inputs and up to 16 outputs. And any input may be connected to any output by means of a switching matrix on each input channel.

Here are some exclusive features designed into the new Altec 9300A.

- Channel Check provides an individual instant check of all input lines without interrupting the program.
- A Pre Cue pushbutton transfers signals from the output buss to the cue buss.
- A Modulite<sup>®</sup> Visual Volume Level Indicator on each module tells exactly how much level is being fed to tape machines.
- Echo Facilities permit selection of internal or external reverb devices and a bright or soft timbre.
- Color-coded knobs enable fast and easy matching of input channels with correct output selector modules.
- 22 dB of headroom.

Mail this coupon for all the details on the new Altec 9300A console.

To: Altec Lansing, 1515 South Manchester Ave.  
Anaheim, California 92803.

Please send me all the details on the all-new Altec 9300A control console—including information on how its unique modular design will let me simply plug in different modules as I need them.

I'd like to hear more. Please get in touch with me.

Name \_\_\_\_\_ Phone \_\_\_\_\_

Position \_\_\_\_\_ Studio \_\_\_\_\_

Address \_\_\_\_\_

City \_\_\_\_\_ State \_\_\_\_\_ Zip \_\_\_\_\_



Circle No. 115

# THE ITINERANT PRODUCER

his problems . . . and  
a solution or two . . .

by Charles 'Bud' Dant  
itinerant producer

The itinerant independent producer is faced with several unique problems not shared with other producers who are able to confine their activities to a single studio or locale, and one set of engineers (mixers) for, at least, the duration of a particular production.

The essential problem is that no two studios have the same acoustics, equipment, engineers or psychological feel. The producer is the one constant factor in the mix of different men, machines and environments.

In an effort to share some of my experiences with producers who may be faced with the problems of 'moving' tapes from studio to studio, and also in an effort to achieve a better understanding with the engineers who may wonder sometimes at the seemingly strange requirements of itinerant producers, this article is built around our recent experience producing the Pete Fountain album 'DR. FOUNTAIN'S MAGICAL LICORICE STICK REMEDY FOR THE BLUES' (Coral 757513).

A combination of factors, the program material, time and geography pretty much dictated that we would have to do the album in at least a couple of locations. The program material emphasizes a good part of the problem. All of the songs selected for the album were related to each other by their happy-feel, although they were in diverse musical idioms.

The title song; DR. FOUNTAIN'S LICORICE STICK REMEDY FOR THE BLUES and LICORICE STICK RAG were a couple of original New Orleans Jazz type tunes. Gordon Jenkins wrote and arranged SOMEWHERE for Pete's great tenor man, Eddie Miller. We had some ballads, a bit of the country sound, a touch of rock . . . a really mixed bag of happy tunes.

SIDE ONE: DOCTOR FOUNTAIN'S  
MAGICAL LICORICE  
STICK REMEDY FOR THE  
BLUES  
MISSISSIPPI  
BRIDGE OVER TROU-  
BLED WATERS  
LICORICE STICK RAG  
SOMEWHERE  
SULPHUR AND MO-  
LASSES

SIDE TWO: EVERYTHING IS BEAU-  
TIFUL  
I'M IN LOVE WITH NEW  
ORLEANS  
APPLAUSE  
PASSPORT TO THE FU-  
TURE  
HEY MR. SUN

From my headquarters in Los Angeles and Pete's at his saloon in New Orleans we agreed that there were better players in Los Angeles for some of the tracks, and better players in Nashville for other of the tracks. The album was produced, except for Pete's solo on APPLAUSE, at BRADLEY'S BARN in Nashville, and at the MCA-DECCA STUDIO at Universal City in L.A.

Before heading for Nashville we did the rhythm tracks for the three more contemporary songs; MISSISSIPPI, the tune written by Lauraine Goreau, the talented New Orleans columnist, I'M IN LOVE WITH NEW ORLEANS and HEY MR. SUN, at the MCA STUDIO. With engineers Terry Brown and Brian Ingoldsby we put a really exceptional drum track down in stereo on two channels, with the

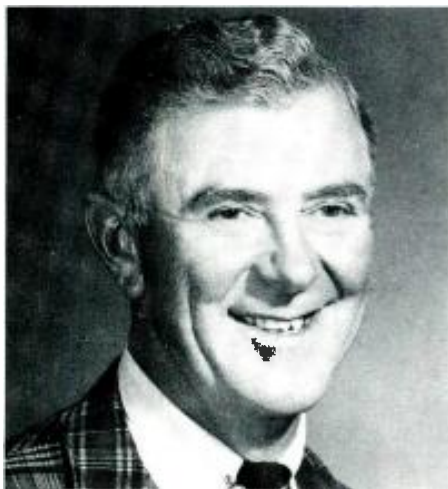

## CHARLES 'BUD' DANT

*If all of his accomplishments in the music world were properly listed, there would not be room for the article which follows. Perhaps, recount of only one story from the beginnings of his music career tells of the roots from which this important career as player, writer, conductor, arranger, producer springs.*

*The place: Indiana University, Bloomington, Indiana*

*The time: 1928*

*A fellow player asked Bud to 'write-down' a tune as he played, sang and whistled it.*

*Bud did.*

*The tune published four years later in 1932 with only slightly changed lyrics . . . STARDUST.*

*Bud's good friend, among many, then . . . and now . . . HOGIE CARMICHAEL*



## Creative engineers make hits at our place

We've got 36 inventive geniuses between here and New York whose primary job is to create the unique sounds that make hit records. They'll help you get just the sound you're looking for when you do your session at Capitol. What's more, we can wrap up your *entire* sound package — from recording to pressing to a HIT!

For the most professional and complete deal anywhere...bring your sound to Capitol.

Circle this ad number on the reader service card and we'll send you our rate card.

**CAPITOL CUSTOM SERVICES, A Department of the Special Markets Division.**



**Hollywood:** 1750 N Vine  
Hollywood, Calif 90028  
(213) 462-6252

**New York:** 151 W 46th  
New York, New York 10036  
(212) 582-8040

Circle No. 116

*continued!*

electric and acoustic guitars and the Fender bass each on another individual track, with the bass being taken direct.

Next stop for the tapes, Pete and me was BRADLEY'S BARN 20 miles outside Nashville in that beautiful Tennessee countryside.

We did all the recording in Bradley's large room, originally a big old hay barn, but rebuilt into a fine large studio, affording great sound separation. During two live sessions we made the rhythm tracks for the balance of the tunes. We used drums, Dobro or steel guitar, acoustic and electric bass, piano and four voices.

As we began our work in Nashville we were faced with one of the foremost problems of the traveling producer; becoming accustomed to the different environment and acoustics when working in a new control room, after having become accustomed to the sounds and levels of the system in the room in which we had recorded the previous tracks.

### MONO MONITORING OF THE TRACKS

We think that an excellent answer to this problem, with the concurrence of Jim Williamson, Bradley's chief engineer, is to rely, in good part, on monitoring mostly in 'mono.'

Why? Because, 'mono' monitoring affords a truer basic picture of the tracks than the sound you may get from even a truly well engineered multi speaker monitoring system.

What we are suggesting is that you will be under no false delusions concerning the sound you are getting, or how much, when monitoring on one speaker.

There is no question that if we were working in the same studio every day, and we knew the monitor sound and range intimately, then we could rely on multi speaker monitoring to a much greater degree.

During the third session we sweetened where necessary with brass and strings. (Although not a factor at Bradley's, let me suggest that if the studio in which you may be doing the sweetening with strings doesn't have good single ear earphones for the players, you, or the lead violin, might consider 'conducting' the fiddles without phones, rather than risk leakage due to the traditional 'one ear on, one ear off' wearing of conventional earphones.)

Finally, we recorded all of the solos, Pete, and Pete with Eddie Miller on SOMETHING, on the last two tracks. We had saved the two tracks for the solos so that we could put them down twice . . . which gave us a choice of using either in the dub-down.

### THE DUB-DOWN

We had two objectives as we began to dub-down. Both are relevant to the itinerant producer problem. First, we wanted to produce a real natural, rounded, sound from all of those tracks recorded in the two studios, which used as much separation as possible, in sessions done at four different times. Second, we needed as near perfect balance as we could possibly get on all the tunes.

### THE ROUND SOUND

We achieved a great 'round' sound using a technique involving reversal of the echo returns from each side.

The sounds which were placed on the left would sound 'dry' there, but the return from the echo chamber would sound (echo) on the right. The sounds on the right would remain 'dry' there, but on return from the assigned echo chamber would sound on the left. The center solo (Pete) had his own chamber.

In the dub-down, on the basis of the philosophy that a good mono mix will always sound better in stereo, to achieve the balance we wanted, we again relied heavily on the alternate use of mono-monitoring . . . at low levels this time on an inexpensive small speaker.

It has been my experience that the higher instruments, trumpets, fiddles and the like, seem to be harder to place in the proper range at higher play back volumes on big speakers.

In mixing down 16 tracks, without being very familiar with the acoustics of a particular control room or monitoring system it seems impossible using two or more large speakers to be able to get proper balance and equalization of the combined tracks. The reflexes of the large powerful speakers seem, unless you can afford the time to study them very carefully to know exactly what they are doing, they seem to superimpose on the ear, the illusion of the system or that of the control room. Consequently, you may not have what you think you have heard.

On one small speaker, the acoustics of the room have practically no effect.

It's probably not unique, but we always 'prove' the stereo dub-down on at least three different sound systems. First, we play back on the big speakers, at volume, in the control room. Then, on another big professional system . . . and, last, perhaps the ultimate test of the mix down is the listening we do on a medium quality consumer type playback system.

One additional factor we must emphasize as it particularly assists the traveling producer, is the need for a really impeccable log of procedures and settings used throughout the production.

*continued on page 39*

GEORGE MARTIN  
Continued from page 19

*bw: And limiting/compression?*

gm: Yes, of course, and also a little bit of echo too. But each sound is treated on its own merits. That's why we, in fact, got lots of varied sounds, some of which were not so good as others.

*bw: The instruments and voices on Abbey Road have a particular clarity and presence that seem to be derived from close-miking or similar techniques. Was this your aim?*

gm: I was aiming for clarity, but oddly enough, it isn't very necessarily close-mike techniques that provide this. The essence of that clarity that you talk about is the ability to differentiate one sound from another; so that if you get a bass drum sound that is interfering with your bass, for example, then you do something about it. You change it. And I think the clarity comes from having distinguishable sounds anyway.

*bw: Then from a production standpoint, if you're going to have two sounds in the same frequency range, they should be playing approximately the same part, or else they will muddle each other?*

gm: That's right.

*bw: Did you do all the horn and string arrangements for the Beatles?*

gm: Yes, with one exception. Oh, I certainly didn't do the *Let It Be* one, which Phil Spector did. I was quick to disown that. There was one exception; it was one of the string ones, which an English arranger did. He gave us the score because I wasn't around at the time and Paul wanted it done very quickly. Mike Leander it was on one title. He gave us the score and I directed it in the studio. Everything else was mine.

*bw: Do you think that you'll work with the Beatles again, or any of the Beatles?*

gm: In answer to the first question, I think it's possible if the Beatles ever work together again. As to the individual Beatles, I don't know. Each one of them is very talented, two of them in particular, in fact George, John, and Paul are obviously more talented than Ringo. All four of them are very talented anyway, but none of them is as strong as the four of them together. The four individual parts were not as great as the entire whole. The Beatles, four people together, did something that nobody else had ever done before, and the fact that they're not together I think is a terribly sad thing.

END

\*\*\*\*\*

**MUSIC INDUSTRY?**

★ A & M RECORDS ★ MERCURY ★ MOTOWN  
★ COLUMBIA ★ RCA ★ FANTASY · GALAXY ★

**FILM SOUND?**

★ RYDER SOUND ★ MANHATTAN SOUND ★ MGM  
★ CINESOUND ★ COLUMBIA ★ WALT DISNEY ★

**KEPEX™ users are EXPANDING**

Allison has released her new hit 45 RPM record, A KEPEX DEMONSTRATION  
Write for your free copy to

**ALLISON RESEARCH, INC.**  
**7120 SUNSET BOULEVARD ★ ★ HOLLYWOOD, CALIF. 90046**  
**(213) 874-6615**

\*\*\*\*\*

Circle No. 117

# NEW PRODUCT NEWS

**THREE RANGE EQUALIZER FROM SPECTRA SONICS.** A new Microphone/Program Equalizer, the Model 502, provides simultaneous selection of equalization for low, mid, and high frequencies with a separate in/out switch for each range. Five separate frequencies are available in each range:

- Low: 50Hz, 100Hz, 200Hz, 300Hz, 400Hz.
- Mid: 500Hz, 800Hz, 1.2KHz, 1.6KHz, 2KHz.
- High: 2.5KHz, 3.5KHz, 5KHz, 7.5KHz, 10KHz.

Reciprocal Gaussian curves (graphic type) for each frequency are selectable in 2 dB steps for a total of 12 dB of boost or attenuation. Low and high frequency shelving curves, adjustable in 2 dB steps, are also provided. Utilized in the feedback loop of any Model 101 Audio Amplifier, this versatile equalizer has zero insertion loss and is less than 1½" wide x 6½" high by 2-7/8" deep. Distortion is unmeasurable (less than 1/100th of 1% measurable residual) under any condition of boost or cut. The units are already in use throughout the country and available at \$240. for custom mounting. Sale is through specially franchised dealers from coast to coast. SPECTRA SONICS, 770 WALL AVENUE, OGDEN, UTAH 84404, or 6430 SUNSET BLVD., HOLLYWOOD, CALIF. 90028.

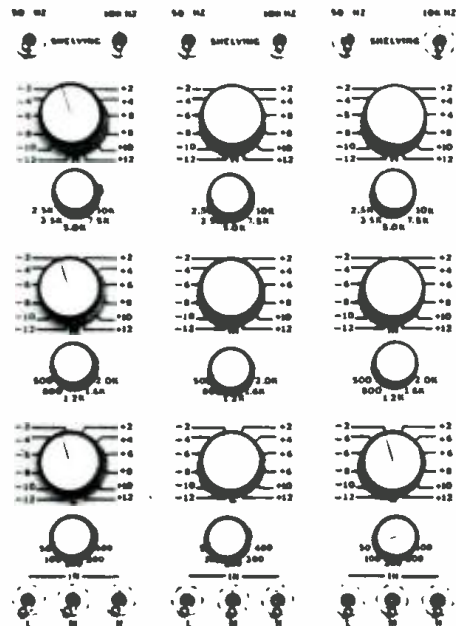

Circle No. 118

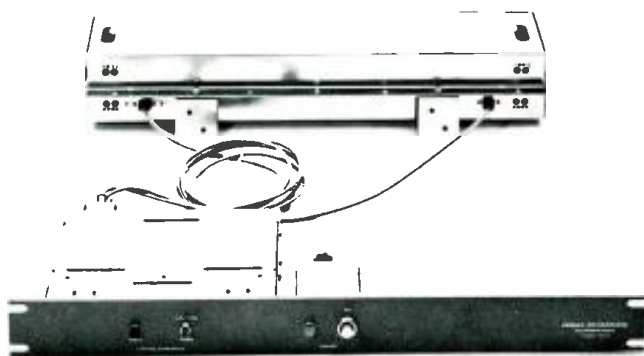

Circle No. 119

PARASOUND, INC. of San Francisco, Calif. announces the availability of the new Orban/Parasound Reverberation unit, engineered by Robert Orban of Menlo Park.

The O/P Reverberation is designed for use in professional recording studios who wish a substantial improvement in the sound quality obtainable from a spring. Flutter is reduced in the conventional way—by using multiple springs, while noise is kept below audibility by means of correct design of the pickup amplifier.

The O/P Reverberation also includes a floating threshold peak limiter which greatly reduces objectionable noises in the form of popping "sproings" on transients.

The unit is available in console and rack mount, with or without power supply. PARASOUND, INC., 680 BEACH ST., # 495, SAN FRANCISCO, CALIF.

**ISOLATION AMPLIFIERS FROM COUNTRYMAN.** These new units are available in two models. The Type 80 microphone level output isolation amplifier allows musical instrument pickups and other high-impedance signal sources to be patched into audio systems without loading. The Type 80 is basically a low noise FET-input preamp with a balanced output designed to drive standard microphone inputs. \$80.00 each.

The Type 82 is a switch selectable microphone level or line level output isolation amplifier. Both outputs are balanced isolated lines. \$100.00 each.

Technical specifications include distortion of less than .25% at .5v. p-p. A clipping level of 20dB above reference Frequency response of ±.5dB 20Hz-2KHz. Noise: 1.5 microvolts equivalent input noise voltage. COUNTRYMAN ASSOCIATES, 424 UNIVERSITY AVE., PALO ALTO, CALIFORNIA 94302.

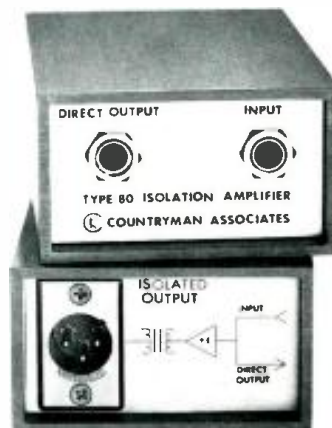

Circle No. 120



**HANDSCAN.** New device locates any desired wire in a bundle. HANDSCAN lets you locate the right wire in a matter of minutes even if the wire is not color coded or identified in any other way, whether terminated or loose, stripped or not. The device is also used for rapid sure isolation testing of transformers, capacitors, semiconductors, coaxial cable, etc.

By connecting the alligator clip to one end of the wire you want, or to its connector terminal, then running the fingertips over the other end of the wire bundle, an audible tone is produced when contact with the right wire is made.



In a large bundle of wire a check is made of a handful of wires at a time. As soon as the tone is produced the right wire is known to be in that handful. By touching just a few more of the wires in that handful identification of the proper wire is made. Power comes from two 1.5 volt D-cells; the circuitry is designed so that only miniscule amounts of current are used to complete the circuit. Should the alligator clip be connected inadvertently to a wire or terminal that is plugged into a 115 volt outlet, an alarm sounds immediately to warn the operator.

Measuring only 5x4½x3½ inches, the unit is fully portable and self contained. Price \$129.50. HANDSCAN IS AVAILABLE FROM ELECTRONIC TOOLS DIV. OF C.H. MITCHELL CO., 18531 VENTURA BL., TARZANA, CALIFORNIA 91356.

*Circle No. 121*

**OPAMP MODEL 440 DIFFERENTIAL D.C. OPERATIONAL POWER AMPLIFIER** consists of an OPAMP 4009 driving a dual class AB power amplifier. There is no crossover distortion. This amplifier is intended for use as a servo motor or D.C. thru audio power amplifier. It may be used in audio applications with either a single polarity or bipolar power supply. It has an output capability of 50 watts RMS. The entire amplifier is constructed on the octal plug-in heat sink. The circuitry is isolated from the case.

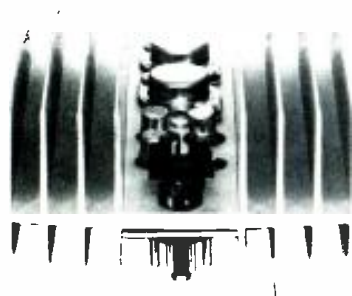

This unit can be ordered in kit form (\$35.00) or factory wired and tested (\$60.00). OPAMP LABORATORIES, 172 SOUTH ALTA VISTA BL., LOS ANGELES, CA. 90036.

*Circle No. 122*

# It's MCI's new total-logic JH10.

The logic is so total, not even a power failure (much less an engineer failure) can break or spill the tape.

"Sudden" is the most accurate word we can find for JH10's acceleration from "Stop" to any commanded tape function.

And for its conversion time from one- to two-inch, and vice versa.

Practically everything is plug-in for fantastically simplified maintenance and expansion from, say, 8 to 24 tracks.

Constant, electronic (not mechanical) tension control sensing reduces head wear, wow, flutter and speed variations.

Prices start at \$3,500.

Write: MCI, 1140 N. Flagler Dr., Ft. Lauderdale, Fla. 33304 • 305/524-3318. Distributed West of Rockies: Westlake Audio, 1047 Twinfoot Court, Westlake Village, California 91361 • 805/497-7924 **MCI**

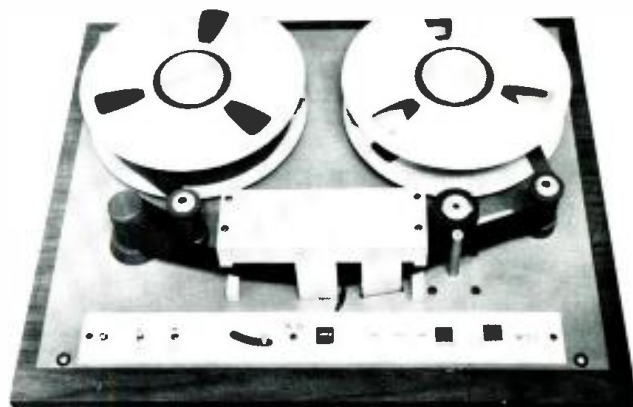

*Circle No. 123*

AMPEX INTRODUCES A NEW MASTER REPRODUCER designed for rapid duplication of cassette, cartridge and reel-to-reel audio tape recordings.

The new Model RR-200 reproducer can drive up to 10 Ampex Model 3400 slave units and can duplicate as many as 200 copies of a 30-minute-per-side tape in one hour on a 10-slave line. It is designed for use by master recording studios and in educational and industrial applications where large numbers of tape copies are required. The fully-transistorized RR-200 replaces the tube-type 3000 Series of duplicators in the Ampex line.

It features selectable speeds of 30/60 and 60/120 inches-per-second; plug-in head assemblies for format selection; automatic tape tension control and master transport tape widths from 1/4-inch to 1-inch.

The RR-200 uses reel-to-reel master tapes recorded on Ampex MM-1000 or AG-440 master recorders, or similar models, to produce tape copies in cart-



ridge, cassette and reel-to-reel formats.

The RR-200 is available in 4-track and 8-track versions. It is capable of duplicating programs for 8-track stereo cartridges, 4-track stereo cartridges, 2-track stereo or 4-channel stereo tapes.

The master reproducer has a frequency response equivalent to 50Hz-15KHz at 7 1/2 ips; a flutter and wow of less than 0.15%, and independent switching is provided for both master and copy equalization.

Dimensions for the RR-200-4 are 26 inches wide, 30 inches deep and 61 inches high. The RR-200-4 weighs 200 pounds. The RR-200-8 is 26 inches wide, 30 inches deep and 70 inches high. It weighs 230 pounds.

RR-200 pricing begins at \$11,000. Delivery is within 30 days. AMPEX CORPORATION, 401 BROADWAY, REDWOOD CITY, CA. 94063.

Circle No. 124

## ADVERTISERS INDEX

|                                  |                    |
|----------------------------------|--------------------|
| AKG .....                        | 9                  |
| ALLISON RESEARCH .....           | 33                 |
| ALTEC-LANSING .....              | 30                 |
| CAPITOL RECORDS .....            | 32                 |
| CLARK BROWN AUDIO .....          | 39                 |
| CROWN INTERNATIONAL .....        | INSIDE FRONT COVER |
| DOLBY LABORATORIES .....         | 12                 |
| ELECTRO-VOICE INC. ....          | BACK COVER         |
| GOTHAM AUDIO .....               | 22                 |
| MCI .....                        | 35                 |
| MINCOM DIV 3-M CO. ....          | 20-21              |
| MOSER DEVELOPMENT .....          | 39                 |
| OPAMP LABORATORIES .....         | 39                 |
| SCULLY RECORDING EQUIPMENT ..... | 6-7                |
| SHURE BROTHERS .....             | 10                 |
| SPECTRA SONICS .....             | 17                 |
| STEVENS ELECTRONICS ...          | 39                 |
| SUPERSCOPE .....                 | 24                 |
| TEAC CORP. OF AMER. ....         | 15                 |
| TELEX .....                      | 28                 |
| U.R.E.I. ....                    | 27                 |
| YAMAHA INTERNATIONAL ..          | 8                  |



“... and what does this green button do?”

GATELY ELECTRONICS announces the introduction of its Stereo Echo Mixer EM-7S. This unit is similar to the EM-7 unit presently widely used in recording and broadcast studios as well as sound re-enforcement applications except that it incorporates slide controls for all program gain controls and incorporates panning on mixing channels rather than fixed channel assignment.

The EM-7S Mixer handles up to eight inputs, 4 line and 4 mike level, switch selectable from the front panel. Any input can be assigned to either program or echo output channel in any proportion by means of the four pan pots standard with the unit. These units are stackable allowing additional inputs to be added at any time. All mixing circuits are of the active type using Integrated Circuits. Output is rated at +28 dbm and mike input noise is below -127 dbm referred to the input. The EM-7 is 19" wide by 7" high by 8" deep.

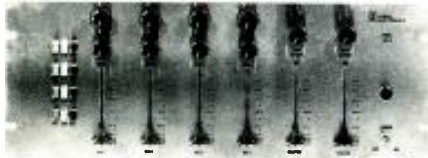

The Gately EQ-7B Integrated Circuit shelving type equalizer or the Gately PEQ-7 Integrated Circuit peaking type equalizer plug directly into the EM-7S.

These new mixers may be used as the basic building block in the Gately Audio systems 1, 2, 3 or 4.

Additional information on this new mixer may be obtained by contacting John Buffington at GATELY ELECTRONICS, 57 WEST HILLCREST AVENUE, HAVERTOWN, PA. 19083.

Circle No. 125

**EASE... ACCURACY... SPEED**

Two-inch tape editing block, hard anodized aluminum with satin finish, straight or angular cuts of 15° and 30°, 7 3/4" long and 1/2" high, in stock for immediate delivery, \$55.00 per block, post paid.

Make checks payable to:  
**Stephens Electronics, Inc.**  
 3513 Pacific Avenue  
 Burbank, California 91505

## CLASSIFIED

Send for **FREE Catalog and Audio Applications**

**OPAMP LABS**  
 172 S. Alta Vista Blvd.  
 Los Angeles, Calif. 90036  
 (213) 934-3566

Circle No. 126

### EQUIPMENT AVAILABLE

**Complete Tape Duplicating System**

Convertible 8-track/4-track.  
 1" Master and Bin with Ten  
 3/4" Slaves. Reliable, Trouble-free Operation. Some Support Equipment Available.  
 Greatly Reduced Price.

P.O. Box 65856 Los Angeles, Calif.  
 90065 Stn. 967

SCULLY 8-track 18 mos. old. Complete with sync-master, remote control, etc. \$8500.00 (612) 521-7631

PLAN NOW...

ATTEND THE SPRING 'AES'  
 LOS ANGELES... APRIL 27-29

#### NOTICE

INDIVIDUALS seeking employment in the recording industry may submit their qualifications for FREE publication in *RECORDING engineer/producer*.

Listings will be limited to 30 words, and will be limited by available space. Listings will be selected for publication on the basis of earliest postmark. Listings will not be automatically repeated or carried over to the succeeding issue.

#### PERSONNEL AVAILABLE:

CHIEF ENGINEER previous experience with major 16 track studio ... all phases of Maintenance ... Studio Design ... Mixing ... Production. All replies in strictest confidence. Dept. CE, R-e/p, P.O. BOX 2287, HOLLYWOOD, CA. 90028

DANT continued from page 32

For accuracy in this article we must also add that the tune APPLAUSE was originally recorded earlier in Nashville without Pete, on eight track. When we decided to include the number in the album we took the tracks of APPLAUSE to New Orleans and put Pete on at the fine JAZZ CITY STUDIOS there. The tape was returned to Nashville for transfer to 16 track sweetening with brass and voices.

**THE NEW MOSER ATTENUATOR:**

**"THE QUIET ONE"**  
 No noise ever / Smooth operation—no drag / Infinite resolution / No sliding contacts / Negligible insertion loss / No frequency discrimination / Non microphonic / Any curve possible / Standard mounting / Standard panel size / No cleaning ever required / Two panel configurations available—conventional or recessed / Multiple ganging available from 2 to 24 independent channels, all tracking within .5db, on 1 1/2" wide x 1 1/4" long panel for master control, or multi channel controls may be remotely located.

**MOSER DEVELOPMENT CO.**  
 10751 Chandler Bl., No. Hollywood, CA. 91601  
 (213) 769-0283

Circle No. 127

**sound is guaranteed at CBA**

**RECORDING ENGINEERING is CBA.**

We have an 8 Track Studio and an ∞ track service ...

**PROFESSIONALLY ENGINEERED**  
 sound studio • recording sessions  
 mix down sessions • equipment calibration

J. B. LANSING • GATELY • AMPEX • McINTOSH  
 TELEFUNKEN • SHURE • RCA • VEGA • STEINWAY

**call 296-0352**  
**clark brown audio**

3210 West 54th St.  
 Los Angeles, California 90043

Circle No. 128



Further proof...  
sound has never  
been in better shape!

## RE55 OMNIDIRECTIONAL DYNAMIC MICROPHONE

There are plenty of good, functional reasons behind the new look of Electro-Voice professional microphones. Reasons dramatically proved by the rapid success of the Model 635A and the RE15. Now we've added the RE55 to this handsome group.

The RE55, like its predecessor the 655C, is an extremely wide-range omnidirectional dynamic. And in most electrical particulars it is not greatly different. RE55 frequency response is a bit wider, and perhaps a trifle flatter. An impressive achievement when you consider that the 655C has been extensively used as a secondary frequency response standard. Output level is 2 db hotter, and the exclusive E-V Acoustalloy® diaphragm of the RE55 can provide undistorted output in sound fields so intense as to cause ear damage.

The biggest changes in the RE55 are mechanical. For the microphone is even more rugged than the 655... long known as one of the toughest in the business. There's a solid steel case and new, improved internal shock mounting for the RE55. Plus a fawn beige Micomatte finish that looks great on TV long after most microphones have been scarred and scratched almost beyond recognition.

For convenience we've made the barrel of the RE55 just 3/4" in diameter. It fits modern 3/4" accessories. It also fits the hand (and its length makes the RE55 perfect for hand-held interviews). We also provide XLR-3 Cannon-type connectors to help you standardize your audio wiring. Detail refinements that make the RE55 more dependable, easier to use.

Finally, the RE55 has the exclusive Electro-Voice 2-year *unconditional* guarantee. No matter what happens, if an RE55 fails to perform during the first two years — for any reason — we'll repair it at no charge.

Try the Electro-Voice RE55 today. The more you listen, the better it looks!

ELECTRO-VOICE, INC., Dept. 211RP, 674 Cecil St., Buchanan, Michigan 49107

high fidelity systems and speakers • tuners, amplifiers, receivers • public address loudspeakers  
• microphones • phono cartridges and styli • aerospace and defense electronics

# Electro-Voice®

a GULTON subsidiary

Circle No. 129

[www.americanradiohistory.com](http://www.americanradiohistory.com)