

# the TAPE RECORDER

PRICE 1/6

NOVEMBER 1962  
Vol. 4 No. 10

INCORPORATING "SOUND AND CINE"

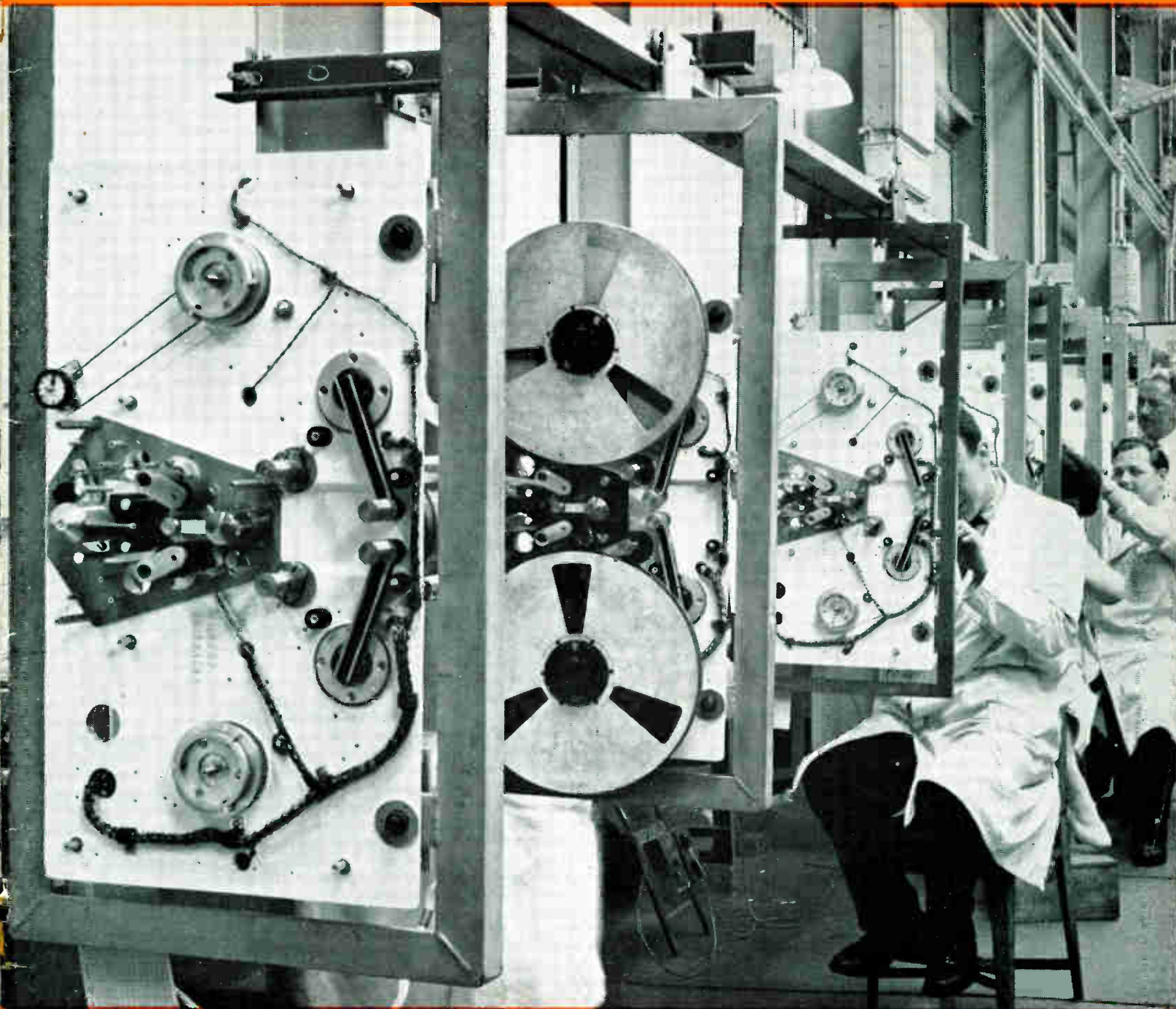

## IN THIS NUMBER

- Garrard Battery Tape Deck Report
- Our Readers Write
- Puppetry and Tape
- Tape Recorder Workbench
- Details of New Products
- Tape Recorder Service—Grundig Models
- Readers' Problems
- Sound and Cine
- News and Pictures from the Clubs
- Equipment Reviewed

# 4 REASONS THAT MAKE THE **Garrard** TAPE SYSTEM SO SIMPLE



13

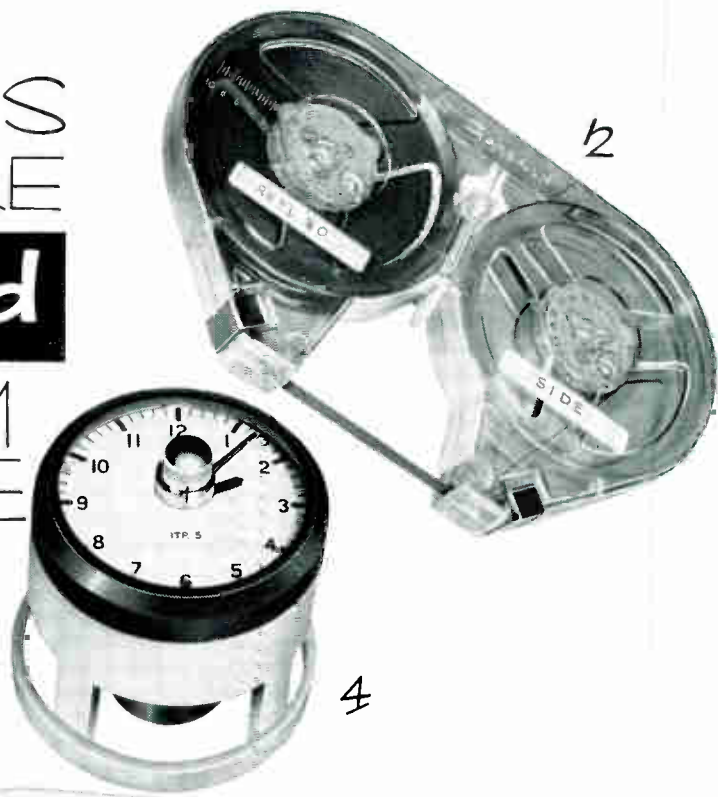

12

4

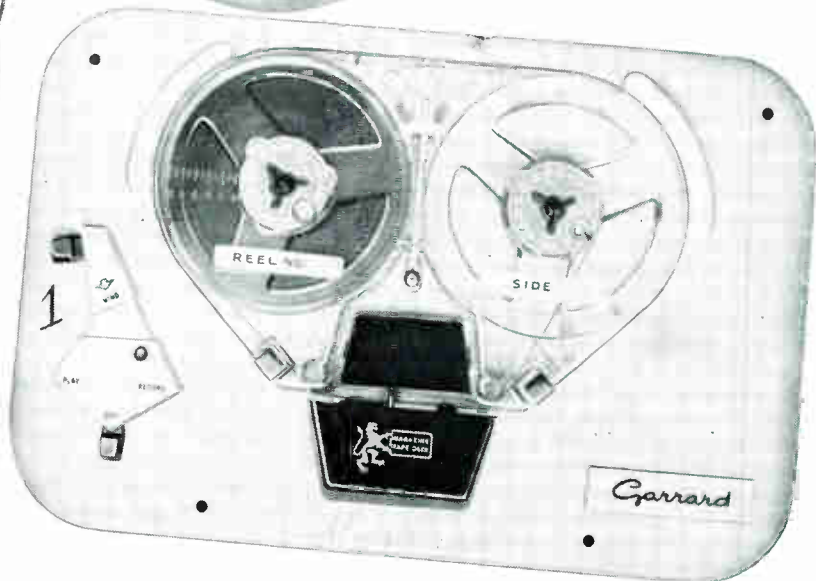

## 1 SIMPLE TO OPERATE

Anyone can operate the Garrard system. Controls have been simplified. There are three positions only—PLAY—RECORD—WIND.

## 2 MAGAZINE LOADING

No tape threading. No spilling. No anchoring of tape. Just place the magazine on the deck and it is ready to operate.

## 3 EASY STORAGE

The Magazine is the same size as an average book. It fits neatly on a bookshelf using the Library Storage Unit.

## 4 GARRARD TAPE POSITION INDICATOR

Gives precise and accurate indication of recordings on the tape.

## CONTINUOUS-EASY TAPE RECORDING & PLAYBACK WITH THE GARRARD MAGAZINE METHOD

### MAGAZINE TAPE DECK ACCESSORIES

	£	s.	d.
Magazine containing 650 ft. Double Play Tape in container	1	13	4
Magazine only with one empty spool	8	0	
Reel of 650 ft. Double Play Tape	1	4	0
Garrard Spool only	3	3	
Library Storage Magazine Container	3	6	
Tape Position Indicator	1	19	6

**THE GARRARD ENGINEERING & MANUFACTURING CO. LTD.**

SWINDON WILTSHIRE

# 2 YEARS FREE SERVICING!!

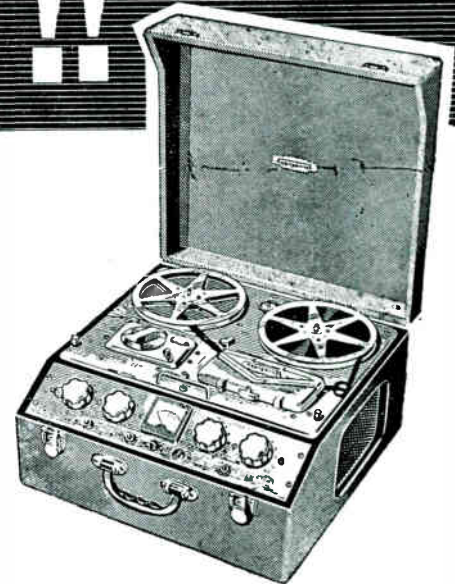

## FREE HOME DEMONSTRATIONS!!

So great has been the demand for Home Demonstrations that we have decided to extend the scope of these to all prospective customers residing in the Greater London Area, and its immediate suburbs. To avail yourself of this wonderful opportunity simply cut out and fill in the form below and upon the date requested, we will demonstrate, in the comfort and convenience of your own home, the recorders you wish to see, hear and compare. Our City Manager, Mr. Wells, who is well known as the Chairman of the famous Walthamstow Tape Recording Club, will personally supervise each demonstration. You may therefore be assured of expert technical knowledge and experience, plus a personal interest being shown. Alternatively a personal visit to our showrooms will enable you to see the finest and largest selection of both new and secondhand tape recorders on display in this country. All new recorders carry our unique **TWO YEARS FREE SERVICING GUARANTEE**, ensuring two whole years of worry-free, trouble-free and above all cost-free servicing.

### Specialists in

BRENELL · REFLECTOGRAPH  
 FERROGRAPH · VORTEXION  
 GRUNDIG · REPS · REVOX · ETC

- ★ OVER 250 NEW AND LOW PRICED SECONDHAND RECORDERS ON DISPLAY ★
- ★ GENEROUS PART EXCHANGES ★ CASH and H.P. TERMS OVER 9-24 MONTHS ★

## Free Home Demonstration Application

NAME..... ADDRESS.....  
 ..... TELEPHONE No.....  
 DATES CONVENIENT (ALL DEMONSTRATIONS ARE AFTER 7 P.M.).....  
 RECORDERS YOU WISH TO HEAR. (Max. 3).....  
 IF YOU WISH TO PART EXCHANGE STATE DETAILS BELOW.....  
 MAKE..... TYPE..... AGE..... CONDITION.....  
 ADDRESS FORM TO: Mr. B. Allerhand, City & Essex Tape Recorder Centres, 2 Maryland Station, Stratford, E.15

### SHOWROOMS

228 BISHOPSGATE, E.C.2    BIS 2609  
 OPPOSITE LIVERPOOL STREET STATION

2 MARYLAND STATION, STRATFORD, E.15  
 ADJOINING MARYLAND STATION    MAR 5879

205 HIGH ST. NTH., EAST HAM, E.6  
 OPPOSITE EAST HAM STATION    GRA 6543

## CITY & ESSEX TAPE RECORDER CENTRES

# WORLD RECORD CLUB OFFERS YOU THE CHOICE OF ANY 3 PRE-RECORDED TAPES

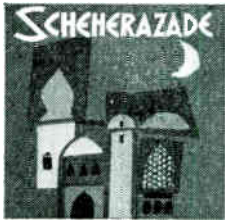

31. Rimsky-Korsakov: Scheherazade. Sir Eugene Goossens conducts the LSO in a breathtaking performance of this rich and exotic masterpiece. Also on disc: mono/stereo



32. Star cast and orchestra stage all the famous songs: Getting to Know You, Hello Young Lovers, I Whistle a Happy Tune, Shall We Dance, etc. Also on disc: mono/stereo



53. These two suites, containing some of Bizet's most thrilling music, are given magnificent performances by the Sinfonia of London under Muir Mathieson. Also on disc: mono/stereo

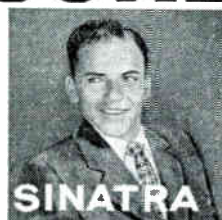

19. Look Over Your Shoulder, My Lean Baby, White Christmas, Don't Worry About Me, Melody of Love. 12 top numbers sung by the fabulous Sinatra. Also on disc: mono only

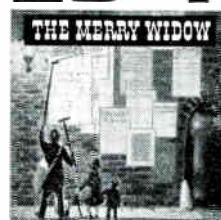

56. All the magic of old Vienna! starring Jacqueline Delman, John Larsen, Linden Singers and Sinfonia of London conducted by John Hollingsworth. Also on disc: mono/stereo



33. Beethoven 5th, plus Egmont, Josef Krips and LSO in a titanic interpretation which matches the tremendous power of this celebrated music. Also on disc: mono/stereo



30. Ian Carmichael, Joyce Blair, star cast/orchestra. As Long as He Needs Me, Consider Yourself, all the hit numbers from Lionel Bart's great show. Also on disc: mono/stereo



39. Great ballet conductor John Hollingsworth and the Sinfonia of London in a sparklingly fresh interpretation of Tchaikovsky's famous Ballet. Also on disc: mono/stereo

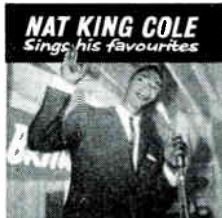

20. Answer Me, Nature Boy, Ruby and the Pearl, these plus 8 more favourites sung especially for you by the unique Nat King Cole. Also on disc: mono only



40. Superb singing by Bruna Rizzoli and Giuseppe Savio with the chorus of the Teatro Nuovo di Milano and Orchestra conducted by Napoleone Annovazzi. Also on disc: mono only



29. Me and My Shadow, Among My Souvenirs, Mean to Me, How About Me... the fabulous Judy Garland sings 11 of her greatest songs. Also on disc: mono only



25. Ian Wallace, Joyce Blair and chorus. Some Enchanted Evening, I'm In Love With a Wonderful Guy, and all the unforgettable songs from this great musical. Also on disc: mono/stereo



34. Stardust, How High the Moon, Nearness of You, Round Midnight, King David—eight numbers by the vibraphone genius, Lionel Hampton. Also on disc: mono/stereo



48. Deep in My Heart, Drinking Song, Serenade—all the old favourites fresher than ever with Marion Grimaldi, Linden Singers and Orchestra. Also on disc: mono/stereo



37. Revolutionary Study, Polonaises A and A. Flat, Fantaisie-Impromptu—12 favourites in all played by the pianist of Dirk Bogarde's 'Song Without End'. Also on disc: mono only



22. 12th St. Rag, Isle of Capri, Smile, Blue Moon, Bunny Hop Mambo, Sailing Doll. 12 top numbers played in characteristic style by the Duke and his band. Also on disc: mono only



2. Grieg Piano Concerto, Alexander Jenner in an electrifying performance with the Bavarian State Radio Orchestra conducted by Odd Gruner-Hegge. Also on disc: mono only

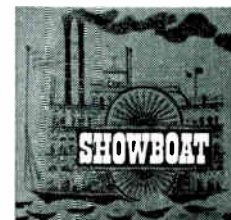

35. O! Man River, Bill, Make Believe, many more well-loved numbers from this famous musical memorably sung and played by full star cast. Also on disc: mono/stereo

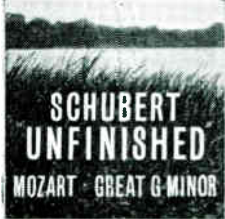

44. Leopold Ludwig and LSO combine brilliantly in an exciting 'double'; two of the world's greatest symphonies receive vivid new interpretations. Also on disc: mono/stereo

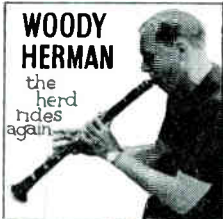

45. Crazy Rhythm, Bijou, I Cover the Waterfront, Northwest Passage, Blowin' Up a Storm, etc. The master clarinetist plays 12 numbers in great style. Also on disc: mono/stereo



38. Hervey Alan, Ian Wallace, Marion Grimaldi and chorus sing the immortal favourites: 'Cobbler's Song', 'Robbers' Chorus, 'Chu Chin Chow', etc. Also on disc: mono/stereo



14. Tchaikovsky Symphony No. 5. Sir Malcolm Sargent and LSO combine to give this famous symphony a dramatic and colorful rendering. Also on disc: mono/stereo



43. Andy Cole, Barbara Leigh, Mike Sammes singers: High Society, Three Coins, Harry Lime, Gigi, The High and the Mighty, 11 top film hits. Also on disc: mono/stereo

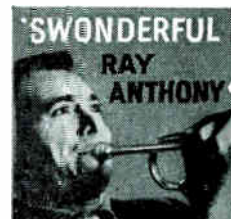

41. Night and Day, King Porter Stomp, Pennies from Heaven, Christopher Columbus, Don't Be That Way, with the top American bandleader/trumpeter. Also on disc: mono only

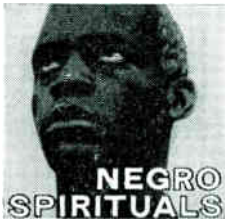

42. Jericho, Swing Low, Shadrak... 12 of the best loved Negro Spirituals movingly sung by George Browne, Isabelle Lucas and Linden Singers. Also on disc: mono/stereo

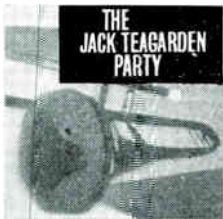

36. Beale Street Blues, After You've Gone, The Sheik of Araby, My Kind of Love, 12 tremendous hits by one of the world's greatest jazz trombonists. Also on disc: mono only

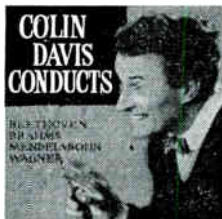

49. Beethoven's Fidelio Overture. Brahms' St. Anthony Vars, Mendelssohn's Hebrides, Wagner's Siegfried Idyll, All under Britain's greatest young conductor. Also on disc: mono/stereo

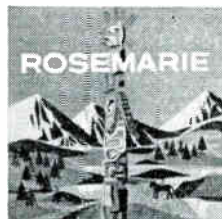

50. David Hughes, Barbara Leigh, Andy Cole and chorus sing Indian Love Call, Rose Marie, and all the other tunes from Friml's well-loved musical. Also on disc: mono/stereo



47. Brahms Violin Concerto. Superb playing by Endre Wolf and Sinfonia of London under the baton of Anthony Collins makes this a truly memorable performance. Also on disc: mono/stereo



46. Elizabeth Larner, Andy Cole, Peter Knight singers. Exciting 'double' featuring highlights from two famous shows by Frederick Loewe and Cole Porter. Also on disc: mono/stereo

# FOR ONLY 30/-

## THE GREATEST BREAKTHROUGH SINCE TAPE RECORDING!

Here is the greatest World Record Club introductory offer ever made . . . a unique offer never before matched by any record club or company anywhere in the world!

EVERY ONE OF WORLD RECORD CLUB'S UNRIVALLED RELEASES AS 12" LPs IS NOW AVAILABLE ON 3 3/4 ips TAPE!

Now you have the opportunity to play any WRC release on your tape recorder. Each of these 'tape records' runs at 3 3/4 ips, mono, on 5" spools and can be played on either 2 or 4 track recorders. New electronic techniques of tape-to-tape transfer give these 3 3/4 ips WRC pre-recorded tapes a standard of reproduction unattainable previously at less than 7 1/2 ips.

### WORLD RECORD CLUB 7-POINT PLAN MEANS BETTER LISTENING FOR YOU!

#### 1. AN UNPARALLELED INTRODUCTORY OFFER.

Choose now, any three of the superb 3 3/4 ips pre-recorded tapes shown here, for only 10/- each and number them on the attached coupon. (If you wish, of course, you can choose 12" LPs instead. Both disc and tape are the same price.) Please send no money until after you have received, played and approved them. We want you to prove to yourself, before paying, that our tapes are equal to the world's best.

#### 2. THE OPPORTUNITY TO BUILD A UNIQUE TAPE COLLECTION.

The WRC plan offers you an exciting and varied annual repertoire of more than 60 selected tape releases, covering classics, jazz, shows, ballet music, light music and 'pops'. Every one is a superlatively recorded 3 3/4 ips mono tape (or 12" LP—mono and stereo). Each is offered to you at the

privilege club price of 29/- (plus a small charge for post and packing)—much less than you would pay elsewhere for recordings of anything like this quality. Your only obligation, as a Club member, is to agree to buy four more tapes (or 12" LPs) over the year. Beyond this, there is no subscription or membership fee.

#### 3. A PLANNED PROGRAMME.

Every World Record Club release is hand-picked by an independent panel of Britain's top musical authorities. The Countess of Harewood, Lord Montagu of Beaulieu, Sir Arthur Bliss, Richard Attenborough, Cyril Ornadel, Ray Ellington, Leon Goossens, Malcolm Arnold, Steve Race, John Hollingsworth, Antony Hopkins—and, as special adviser on tape, Miles Henslow.

#### 4. FREE MONTHLY MAGAZINE.

A monthly magazine, packed with fascinating musical articles, reviews, news and pictures, is issued free to all members.

#### 5. SPECIAL CONCERT PRICE CONCESSIONS.

Many concert halls and theatres throughout the country (including the Royal Festival Hall) allow special concession rates to club members for many performances.

#### 6. FREE BONUS TAPES.

The more you buy, the more you save! After fulfilling the minimum membership obligations, you earn another tape of your own choice free for every extra three you buy!

#### 7. EXCLUSIVE EXTRA RELEASES.

In addition to the regular monthly selections, the club offers members exclusive extra tapes at the standard Club price.

World Record Club is unique—the first and greatest Record and Tape Club in Britain, with the largest show catalogue (on tape and mono/stereo disc) in the world. No other method of tape—or record-buying offers you so many additional benefits, so much freedom and variety of choice, with no 'high-pressure' selling. And, of course, there are no subscriptions or membership fees of any kind—only a small deposit of £1 (later refundable) when you become a tape member.



... AND IF YOU OWN A STEREO TAPE RECORDER hear the fantastic reproduction of **STEREO 21** THE NEWEST, TRUEST SOUND ON TAPE TODAY!

Revolutionary new STEREO 21 pre-recorded tapes (7 1/2 ips twin-track) are issued exclusively by World Record Club. But they are offered without membership commitments of any kind. The first list of all new STEREO 21 releases is now available. It features 30 superb stereophonic tapes ranging from Beethoven's *Eroica* with Josef Krips conducting the LSO, to a lavish full-cast production of *Oklahoma*.

As always, WRC prices present unparalleled value—all STEREO 21 releases cost either 50/- or 60/- depending on playing time (up to 50 minutes). STEREO 21 tapes are now obtainable through leading retailers or direct by post from World Record Club. Send for full catalogue now—STEREO 21 must be heard to be believed!

Don't miss this great opportunity. Send off the coupon today, for your 3 introductory selections for only 30/-

## 7-DAY FREE TRIAL OFFER—POST TODAY!

## STEREO 21 FREE BROCHURE

To WORLD RECORD CLUB (Dept TRR6)  
PARKBRIDGE HOUSE, RICHMOND, SURREY.

SEND NO MONEY NOW

3 3/4 ips pre-recorded tapes	12" LPs
------------------------------------	---------

Tick which you want

Please send me, without obligation, on 7-day free trial, the three selections indicated. (Your 3 selections must be either all tape or all disc.) If satisfied, I will pay you 30/- plus 3/- postage, packing and insurance. Only at that stage may you enrol me as a full member of World Record Club, entitled to all the benefits described. My only obligation as a member would be to agree to purchase 4 more top quality 3 3/4 ips tapes (or 12" LPs) over a 12-month period at the special club price of 29/- each. If I am not completely satisfied with my 3 selections, I will return them to you within 7 days, in good condition, and owe you nothing.

NOTE I understand I will be asked to pay £1 dep sit when I become a tape member (this does not apply to disc members). This deposit is refundable.

Signed.....  
this offer applies in Gt. Britain and N. Ireland only.

### MY 3-SELECTION 'PACKAGE' COMPRISES

Choice No. 1 Choice No. 2 Choice No. 3



(place tape/disc key numbers only in the circles)

Tick here if stereo 12" LPs are required where available

Mr/Mrs/Miss .....  
(BLOCK CAPITALS PLEASE)

ADDRESS .....

To WORLD RECORD CLUB (Dept TRR6)

Box 11 PARKBRIDGE HOUSE, RICHMOND, SURREY.

Please send me your free colour brochure, showing the full range of your new STEREO 21 releases.

NAME .....

ADDRESS .....



**ZONATAPE LEADS THE WAY WITH**

# **COLOURED SPOOLS**



Zonatape embodies all the professional know-how of great sound-film recordings such as *Ben Hur*, *Guns of Navarone*, *West Side Story* and *South Pacific*. It is this professional difference you will immediately recognise in your first recording on Zonatape. The various Zonatape grades are further distinguished by coloured spools: CLEAR for Diacetate, RED for PVC and GREEN for Polyester. Ask your dealer about this very different tape and send for Zonatape booklet—"The Basis of Every Good Magnetic Recording".

**ZONAL FILM(MAGNETIC COATINGS)LTD, ZONAL HOUSE, WESTFIELDS ROAD, W.3 ACORN 6841**

PD 82 twin-track  
£42

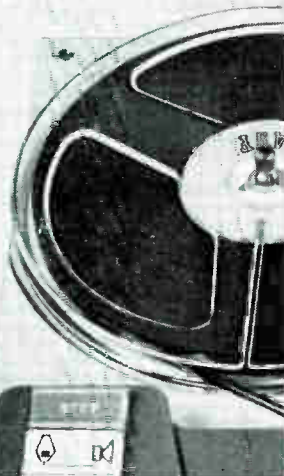

PD 86 Stereo  
quarter-track £63



PD 83 Professional  
twin-track  
£48 10 0

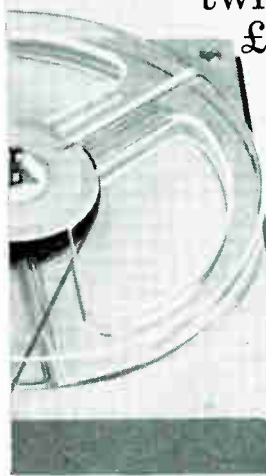

PD 84 four-track  
£46

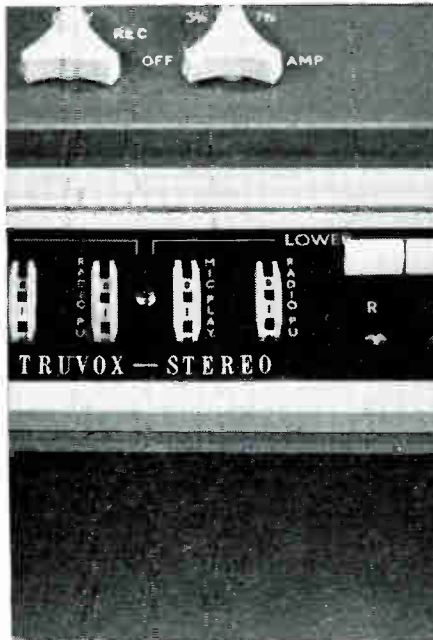

PD 87 Stereo  
half-track £63

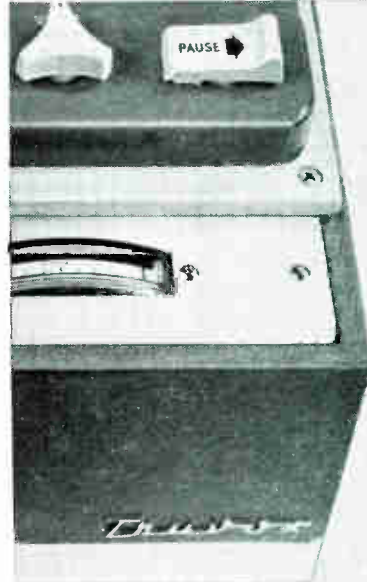

PD 85 Professional  
four-track  
£52 10 0

## *six variations on a Hi-Fi theme*

'SERIES 80' TAPE UNITS BY TRUVOX ■ The heart of this series is the Truvox 80 tape deck—fast becoming recognised as a classic of modern audio engineering. Smooth, silent and certain in operation. Crisply precise and alert to the touch. Ruggedly built for a long, tough and active life. And as reliable as Big Ben. ■ Truvox tape units offer—in all six variations—a fine array of features. A hysteresis capstan motor by Papst provides three speeds ( $7\frac{1}{2}$ ,  $3\frac{3}{4}$  and  $1\frac{1}{2}$  ips) constant to within  $\pm 1\%$ , and changeable while running, with two independent motors to ensure a 60-second

fast rewind for a full 7" reel. The braking is positive and efficient and the autostop operates both at the tape end or in case of tape breakage (no foil required!). All versions are self-powered and housed in an attractive wooden plinth ready for easy connection to existing hi-fi installations. (No matching problems!) ■ Inspect the Series 80 at your Truvox Dealer. When you see, hear and handle these fine instruments for yourself you'll recognise, too, what we mean by the Truvox Touch—the extra, *subjective* factor, beyond the specification, that is engineered into every Truvox tape recorder.

Send now for leaflets showing *all* the tape recording equipment with The Truvox Touch:—  
TRUVOX LTD. Neasden Lane, London, N.W.10

TR

## THE TRUVOX TOUCH

*starts where the specification leaves off*

**MORE GOOD  
NEWS FROM  
GRUNDIG!**



Here it is—not just the finest, widest range of tape recorders in the world but a superb collection of radios, radiograms and office equipment too.

This coupon will bring you a selection of leaflets covering this fabulous Grundig range for home and office use. Post it today!

Please send me leaflets of the Grundig Range.

NAME.....

FULL POSTAL ADDRESS.....

GS/TR 1309

**GRUNDIG**

World Radio History





# KEEP YOUR EYE ON GRUNDIG

- |                 |                            |                             |                           |                                       |
|-----------------|----------------------------|-----------------------------|---------------------------|---------------------------------------|
| 1. TK1 29 gns.  | 6. TK46 99 gns.            | 11. Trans-world 72 gns.     | 16. Memorette* 65 gns.    | 21. Stereo Microphone GDSM202 14 gns. |
| 2. TK14 35 gns. | 7. President 165 gns.      | 12. Party Boy Luxus 36 gns. | 17. } 70 gns.             | TM45 (Not shown here) 70 gns.         |
| 3. TK23 45 gns. | 8. Hamilton 117 gns.       | 13. Steno-Twin* 57 gns.     | 18. } Triumph Typewriters | *Includes Basic Accessories           |
| 4. TK40 75 gns. | 9. New Marlborough 55 gns. | 14. Stenorette* 61½ gns.    | 19. }                     |                                       |
| 5. TK41 75 gns. | 10. Centurion 59 gns.      | 15. Stenomatic* 75 gns.     | 20. Yacht Boy 52 gns.     |                                       |

**GRUNDIG (GREAT BRITAIN) LTD**  
 NEWLANDS PARK, SYDENHAM, LONDON, S.E.26. TEL: SYD 2211

**THE FINEST, WIDEST RANGE IN THE WORLD!**



## Emitape reels off bright ideas for merry Christmas!

Something for everyone — or everything for someone!

You can *give* Emi-presents for Christmas. You can *keep* Emi-presents for yourself. Or you can do both (the more the merrier). Anyway, there are stacks of things to choose from. Here are four suggestions:

### EMITAPE—FOR FUN AND GAMES!

With every pack of Emitape you buy this Christmas, you get instructions for eight hilarious party games (to be played with tape and recorder). Devised by John Borwick, specially for Emitape, they're printed on the inside of every Christmas wrapper.



### EMITAPE PARTY TAPE

Here's something new and exciting! Forty minutes of entertainment to get your party swinging—party music, games, jokes and quizzes — introduced by Dick Emery. And a section by John Borwick on 'How to get the best from your tape recorder at party time'. On a 5 1/2" reel. 37/6.

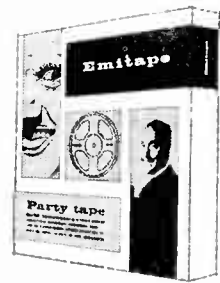

### EMITAPE ACCESSORIES ARE NECESSARIES!

The Emitape Accessory Kit's got everything. Three reels of leader tape. One reel of metallic stop foil. One reel of jointing tape. Jointing block. Two tape cutters. And a special Emi-tray container. The complete box of tricks costs 37/6. But get them separately if you like.

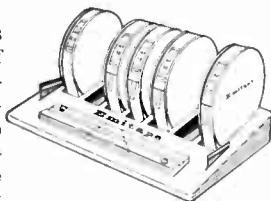

### AN EXPERTISE OF EMIGUIDES

The most exciting way to learn about sound is through sound — through Emiguide. Getting the quality right. Microphone technique. Tape editing. Outdoor recording. Trick recording and sound effects. Producing feature tapes . . . They're a gift! 8/6 each or 51/- the set.

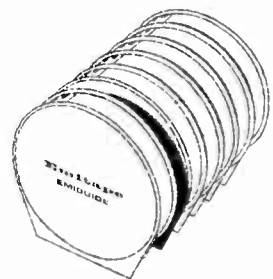

ET66

**Emitape**

E.M.I. TAPE LIMITED · HAYES · MIDDLESEX

# the TAPE RECORDER

Editor ----- MILES HENSLOW  
 Advertisement Editor ----- Julian Berrisford  
 News Editor ----- Alan Lovell  
 Editorial Offices - - - 99 Mortimer Street, London, W.1  
 Telephone - - - - - MUSEum 3967 to 3969



★  
 EDITORIAL

MEMBER OF THE  
 AUDIT BUREAU  
 OF CIRCULATIONS

SOME months back, in this column, we suggested that there was a great deal of overlap in the range of facilities offered on tape recorders, and that the whole position of manufacture might be considerably simplified if recorders and/or players could be designed and produced to do more definite jobs. Our remarks brought quite a few interested replies from manufacturers who thought that the idea was a good one, given this and that, and some very caustic retorts from others who said, more or less, that until people knew what they really wanted there was not much hope of anyone making any particularly specialised product. From reader users, on the other hand, we had numerous letters in complete agreement with our point, and in several of them the writers said that they would far sooner buy and use two recorders for specialised jobs than make do with one that did neither job really adequately.

It is of course natural that a tape recorder manufacturer should try to make his product do as many jobs as possible. for in this way he has a better chance of appealing to a wider range of potential customers—as things are at the moment; but it does not seem an extravagant thought to imagine that, given a more specialised product in each case, a range of two such products could be made better and, in terms of value for money, less costly. Nevertheless, the manufacturer must need to know, at least approximately, what he has to cater for; and the whole field of "tape and recorders" is most certainly a very unknown quantity today. What is wanted can only be gauged from the analysis of what is being bought—and that cannot result in more than good guesswork when it comes to assessing what the public might buy, were it available.

With all this in mind, and with the one certain fact available—that only the tape and recorder buying public can provide the answer—we have prepared a questionnaire of some fifty questions which we propose to submit to our readers for their kind co-operation. The questions cover a very wide range of points, and if the response is a big one our analysis of the answers could be of very great interest to all manufacturers and distributors in the tape field. The questionnaire forms are now being printed, and we hope to include them with the next number of the *Tape Recorder*. In this connection we emphasise one very important point: in no circumstances will the names and addresses on the forms be passed on to anyone, or to any organisation outside this editorial office; and the forms have been designed with this in mind. Readers who may be kind enough to co-operate with us by providing the information we seek may thus be quite confident that the source will remain private.

We do not imagine that the resulting information will be translated into action overnight, but we are most hopeful that

NOVEMBER - - - - - 1962  
 VOL. 4 - - - - - No. 10

## CONTENTS

	Page
News from the World of Tape .....	425
News and Pictures from the Clubs .....	426
Modifications for the Collaro Studio Deck	
By F. K. Rawson .....	429
Our Readers Write .....	433
Sound and Cine	
By Richard Golding .....	435
Tape Recorder Service	
Grundig Models Part 4.	
By H. W. Hellyer .....	438
Puppetry and Tape	
By Roger Stevenson .....	441
Garrard Battery Tape Deck Report	
By H. W. Hellyer .....	443
Tape Recorder Workbench	
By A. Bartlett Still .....	447
Details of New Products .....	449
Equipment Reviewed .....	451
Readers' Problems .....	457
Classified Advertisements .....	460
Advertisers' Index .....	462

we shall obtain sufficient data to provide interested manufacturers with much to consider for their forward planning. The questionnaire is not confined to tape recorders alone, but also concerns tape, recorded tapes, accessories, and the uses of all these things. The results—if the replies reach the volume we hope for—will be freely available to all manufacturers on request, either in analysis form or in actual copies of questionnaire reply forms, if, as and when these are sufficiently useful and interesting.

One of the sidelines of manufacture and distribution which might well be affected by a better knowledge of the user's requirements is the matter of stocks carried and sold by different retail outlets; and this, of course, could be of very direct benefit to purchasers and dealers alike. Anyway, enough on this subject for this month. In the number containing the questionnaire—December, if all goes to plan—we will give more details and make several detailed requests.

## COVER PICTURE

BRITAIN'S new equipment for detecting nuclear explosions in other countries recently came into use at Eskdalemuir, Scotland. This equipment uses Emidata instrumentation tape decks, manufactured by E.M.I. Electronics. These are of a similar type to those being used at the detecting station at Laramie in the United States. Other uses include industrial and medical research and recording data telemetered back to earth from rockets.

The front cover photograph shows an assembly line of these decks at E.M.I. Electronics' plant at Treorchy, South Wales.

## SUBSCRIPTION RATES

The subscription rate to *The Tape Recorder* is 21/- per annum (U.S.A. \$3.00) from The Tape Recorder, 99 Mortimer Street, London, W.1. Subscription + Index, 24/- (U.S.A. \$3.25).

The subscription rate to *Hi-Fi News* is 27/6 per annum (U.S.A. \$4.00) from Hi-Fi News, 99 Mortimer Street, London, W.1. Subscription + Index, 30/- (U.S.A. \$4.25).

the  
originators  
of  
tape recording  
—top their  
new range

with the fabulous **85** de luxe



Magnetophon 85 de luxe (shown above). New styling, new 'magic-eye' recording level indicator. New mixing facilities. Speeds: 7½ ips: 3½ ips. Frequency response 30-20,000 cps ± 3dB; 30-15,000 cps; DC heated pre-amplifier valves. 83 GNS (excl. microphone)

# TELEFUNKEN

Hear this! The signal to noise ratio achieved in the magnificent new Magnetophon 85 de luxe is  $\geq 50$ dB! And this remains constant throughout its life, unaffected by ageing valves! This is a remarkable achievement in a domestic tape recorder. An achievement in keeping with all the other outstanding advances of technique and design that have kept the name Telefunken Magnetophon in the fore-front of tape recording since the first tape recorder in the world carried the name, way back in 1935!

Now—a Telefunken to suit every tape recording need! Ask your dealer for a demonstration.



**Magnetophon 95**

Twin-Track—Speeds 7½, 3½, 1½ ips 7" spool. Frequency response 30-18,000; 30-16,000; 30-9,000 cps. Facilities for superimposition and "straight through" amplifier. 59 GNS (excl. microphone)



**Magnetophon 96**

Four-Track—Speeds, spool size and frequency response as Magnetophon 95. Superimposing intertrack, transcription and straight through amplifier facilities. Ideal recorder for cine enthusiasts. 69 GNS (excl. microphone)

GET THIS **NEW**  
**TELEFUNKEN**  
BROCHURE **FREE**

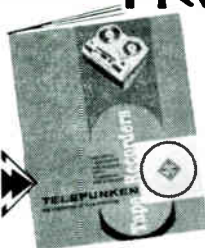

6433

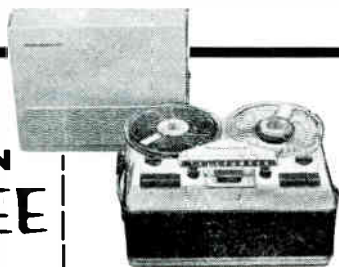

**Magnetophon 97**

For the stereo enthusiast. Four-Track—full stereo recording and playback as well as all the unique features of the Magnetophon 96. Extra speaker in lid for Stereo playback.

95 GNS (excl. microphone)



**Magnetophon 'Automatic'**

The world's first Automatic Tape Recorder. Eliminates almost all controls. You merely switch on and press recording button. Running time 3 hours with 5½" DP tape.

50 GNS (excl. microphone)



**Magnetophon 75K-15**

Tape Speeds 3½ ips and 1½ ips with frequency response of 60-16,000 cps and 60-9,000 cps. Playing time of 6 hours on 5½" DP tape. Tone control. Extension speaker socket.

50 GNS (excl. microphone)

(Write now) to Dept TR Welme Corporation Ltd, 147/8 Strand, London WC2

# NEWS FROM THE WORLD OF TAPE

## £300,000,000 a Year Spent on Do-it-yourself

The tremendous interest in do-it-yourself continues to grow and it is estimated that the market for do-it-yourself materials, tools and equipment now amounts to £300,000,000 a year, and the readership of the various journals dealing with it is 8,196,000 per month, of which 40 per cent. are women.

It was only ten years ago that the first exhibition for the home handyman and woman was started. In the first year it was attended by only 60,000. Now the International Handicrafts and Do-it-yourself Exhibition at Olympia is thronged by around 200,000 each autumn.

At this year's exhibition, which was held from September 7th-22nd, do-it-yourselfers found that things have been made even more easy for them. In addition to the many practical demonstrations of every facet of do-it-yourself, as a novel service the organisers staged a special 3,500 square foot Instruction Centre. Here, free of "sales talk", unbiased experts gave continuous demonstrations of some of the more difficult sides of do-it-yourself including home plumbing, safe home electrics, tiling of walls and floors, the modernising of kitchens and bathrooms.

\* \* \*

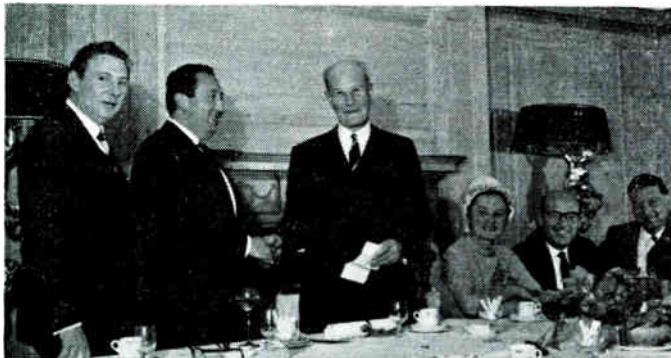

During September, Elizabethan (Tape Recorders) Ltd. held an exhibition at which visitors were invited to spin a roulette wheel. The winner, Mr. S. R. Parkes of Trulite Ltd., Birmingham, is seen here being presented with the prize, a cheque for 200 guineas.

## Tellux Move to Romford

TELLUX LTD., have moved to Romford. They have a new and spacious factory, in which a large section is being prepared for the home production of new merchandise, to be marketed under their own name. They will continue to market and service the range of Sony tape recorders and radios.

Complete reorganisation now allows an "off-the-shelf" service on Telefunken semi-conductors and valves, Isophon speakers and Sennheiser microphones. The new address is: **Tellux Limited, Avenue Works, Galleons Corner, Colchester Road, Romford, Essex.**

\* \* \*

## Heathkit Exhibition

DAYSTROM LTD. of Gloucester are giving a special demonstration of Heathkit Audio Equipment at the Russell Hotel, London, on November 3rd, 4th, 5th and 6th from 11 a.m. to 8 p.m.

\* \* \*

## Mullard Limited Technical Information Department

A NEW organisation has been established to deal with the growing volume of published data and applications information on Mullard products.

Known as the Technical Information Department, it assumes all the functions previously carried out by the Company's Data and



A bank of eight Wyndor "International" tape recorders being used in the television programme "Out of this World".

Publications Section. These include the preparation of data sheets for the Mullard Technical Handbook, now grown to five volumes: the production of Mullard Technical Communications, of which the 50th issue was published last year; and the provision of applications information in various forms.

The services given by the department now extend to all the commercial divisions of Mullard Ltd. Manager of the Technical Information Department is Mr. H. P. White, B.Sc.

\* \* \*

## Ampex Demonstration Week

FOR the second year in succession Nusound Recording Co., 35 Craven Street, London, W.C.2., will be holding a demonstration of Ampex equipment from the 5th November to 11th November inclusive. On display will be the 300 Series Professional recorders, Mixers, 500 Series Tape and associated equipment. Demonstrations will be given throughout the week to dealers and the general public. Tickets are not required.

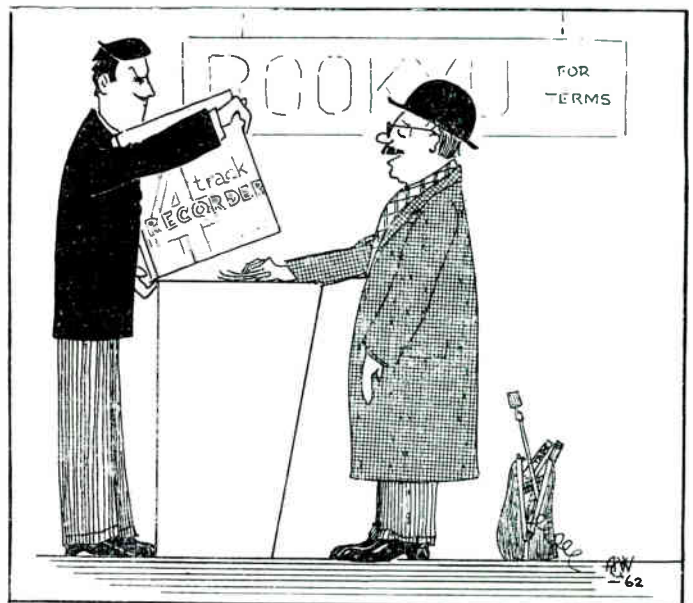

"Do you accept luncheon vouchers?"

# NEWS AND PICTURES FROM

MANY people regard tape recording as a winter activity, but the members of the **South Devon Tape Recording Club**, have been far from inactive during the summer months.

Member D. Judd and chairman G. Furneaux attended a couple of local garden fetes to help raise money for charity. Two items were featured at the club stand, for a small charge persons could either record and hear their voices played back to them or try to "Double their Money" by guessing some everyday sounds.

Dick Judd has also been keeping the club flag flying by going along to a local holiday camp to record some professional entertainers. Copies of the recordings were sent abroad and the entertainers subsequently obtained an offer to tour India and the Lebanon on the strength of them.

When one of the founder members Ken Rowe was married on September 1st, all the evidence was taken down by members David Pletts and Jeff Brooke-Stewart with the aid of a mains machine and a battery portable.

Details can be obtained from: *G. Furneaux, c/o 9 Enfield Road, Babhacombe, Torquay.*

ON Thursday the 13th of September members of **The Thornton Heath Tape Recording Club** were given a demonstration of Truvox tape recorders. Mr. K. C. Smith, a member of the technical staff of this company assisted by Mr. Freeman, demonstrated three of the recorders from the 60 and 80 ranges. Next month there will be a demonstration by Grundig (Great Britain) Ltd.

On the 8th of September two club members were married in St. Augustine's Church, South Croydon, and the chairman was invited to record the service.

At the last committee meeting it was decided that the club should hold an Audio Fair, in December, and the plans for this venture are well under way, further details will be announced at a later date.

Anyone wishing to become a member of the club should write to *E. J. Bashford, 4 Dunheved Road North, Thornton Heath.*

TWENTY-ONE people attended the inaugural meeting of a proposed Tape Recording Club held at Bury House, Gosport. It was agreed that there were enough interested people to start a club, and due to the fact that people came from Portsmouth, Fareham, Gosport and Lee-on-Solent, it was agreed to call the club **The Solent Tape and Audio Club**.

Aims and objects were discussed and a temporary committee was formed to serve for a period of two months so as to enable the club to get started and to allow the members to get to know one another. A set of rules was also agreed upon in principle.

At the first general meeting a demonstration was given by Mr. Watts of various types of recorders and microphones. Also various tapes were played including one on microphone techniques and one on stereo, and also a tape from Radio Barnsley.

It is proposed to start recorded programmes for local hospitals, old people's homes and blind homes in the very near future. Meetings are held on the 2nd and 4th Thursday of each month at the Gosport Community Association headquarters.

Further details available from *R. V. W. Temlett, 30 Blake Court, South Street, Gosport, Hants.*

THE two-day Enfield Show in the Enfield Town Park, with its marquees housing dozens of display stalls of local associations, clubs and horticultural societies, gave the **North London Tape and Hi-Fi Club** an excellent opportunity of showing on its own stand the many possibilities of tape recording.

Through headphones visitors could hear a dummy run of the club's newstape for the Enfield blind, the first of which is being

prepared for distribution later in the month, and a four-minute programme of interviews and sounds, recorded at the Forty Hill Rose Fayre in Enfield during June.

Over a loudspeaker recordings were played at regular intervals of programmes showing how to get the best out of a tape recorder by using external loudspeakers. A comparison of the internal speaker of a Brenell Mark 5M with two different external speakers was also made. A tape of sound effects recorded on the 24 guinea Philips portable proved very successful in drawing attention to the many uses of battery machines. A third five-minute programme gave the before and after of an editing session. The BBC granted permission earlier this year for the club to record and edit one of the regular half-past-the-hour, 60 second news summaries.

The tape to be used in this particular demonstration was chosen from a batch of entries in a recent competition, where members were each given a copy of the same news summary and asked to splice it into the most original and humorous shape they could. The winner was member Ray Maslin who spent more than six hours creating a news summary which caused much amusement to visitors to the stand.

Live demonstrations were given of mixing music and voice, splicing and editing and one member, David Scott, spent about seven hours building a mains operated valve-voltmeter, at the stand.

While some members manned the stand, those members with portable machines were touring the other marquees at the show to get interviews with club secretaries, sound effects and the general atmosphere, and on the second day visitors could hear items about the show itself. These have been edited into a tape programme, excerpts from which will be used on the newstape for the blind. Recordings were also made of local brass bands, a firework display and the choosing of the first "Miss Enfield"—Miss Anita Chance—who was also interviewed for the newstape. A recording of the announcement that she had been picked was rushed back to the club's stall at the other end of the park for playback through two loudspeakers for those who missed the contest. The club's stand aroused a great deal of interest and among the many items on display were tape recorders, an amplifier, a pre-amp, and an echo-chamber, an audio oscillator and various microphones.

Further details are available on request from *R. Collinson, 30 Ridler Road, Forty Hill, Enfield, Middlesex.*

A NEW development in the history of the **Cotswold Tape Recording Society (Cheltenham)** took place on September 13th, when Peter Duddridge and Peter Turner visited the Oakridge Women's Institute to give an illustrated talk on the society's hospitals' service. Peter Duddridge gave the lecture, and played excerpts from material which he had recorded during the previous year for inclusion in "Hospital Roundabout". The programme was loudly applauded and pronounced "too short".

On October 4th, the society welcomed Mr. A. C. Griffith, of World Record Club, who gave a short talk on the policy of the club he founded, with particular reference to tape as a source of recorded music alongside disc. Members were astonished to hear of the vast number of musical tapes which have now been issued by the club.

The first half of the programme consisted of a demonstration of mono tapes at 3½ i/s. These were played on a Simon SP4 machine, using the Cotswold loudspeaker system which has just been acquired by the society. In the view of most members, these mono tapes have been greatly improved since their first introduction, and now give a standard which provides perfectly acceptable listening even to one habituated to high fidelity

# THE CLUBS

reproduction. One cannot expect the wide frequency response which is obtainable at the higher speeds; but these tapes are well balanced within their range, and do give great pleasure.

After an interval during which members retired to the recently-built Royal Well Tavern for refreshment, Mr. Griffith went on to demonstrate the 7½ i/s stereo tapes also issued by the World Record Club, though not on a club basis. For this, equipment loaned by E.M.I. was used: a professional stereo recorder, E.M.I. power amplifier, and two H.M.V. speaker systems. The result can best be described as "terrific": at least one member had never heard quality like this from so-called pre-recorded tapes.

Further details can be obtained from *P. D. Turner, Pike Cottage, Frampton Mansell, Stroud, Glos.*

\* \* \*

**T**APE Clubs are not usually formed with the knowledge they will be dissolved within the week. This has happened to one successful club. It was formed on the educational ship m.v. "Devonia" on the return voyage from West Africa: formed by 16 and 17-year-old boys in one of the dormitories: headed by Alan Newman, Robert Chase and Andrew Davis: using a Philips transistor battery portable.

A 15-minute programme of a day on board the ship was recorded, and as no editing facilities were available everything had to be done in the correct sequence, from just before reveille to just after lights out, with the recording spread over four days. After one or two attempts to "fake" items at the wrong time or the wrong place, it was realised that the realism and topicality of a genuine recording just could not be beaten. As this was the case, the captain was interviewed on the bridge, the splash of someone falling in the swimming pool was real, the cries of protest from the girls who got splashed were quite genuine too: so were the groans when the Master at Arms came around in the morning with his characteristic "Let's have you, get you feet on the floor".

Before the ship docked at Tilbury the completed programme was broadcast over the ship's loudspeaker system: and the **Columbus Dormitory Tape Club** dispersed to various schools around Britain.

\* \* \*

**M**EMBERS of the **Dartford and District Tape Recording Club** and the **Dartford Co-op Cine Club** combined forces for a sound and cine visit to the Bluebell Railway in Sussex recently.

Mr. George May, general manager of the Bluebell Railway, was contacted and permission was given for a Sunday visit. The two clubs left Dartford in cars and a mini bus early and made their way to Sheffield Park Station, Uckfield, in Sussex. Members had the pleasure of meeting Mr. Martin, of Zonal Films (Magnetic Coatings), Ltd., on the station who had visited the clubs earlier in the year.

Cameras were put on the footplate of the engines which were at each end of the train, and members of the tape club were in the coaches next to the engines. Two trips were made.

Further information can be obtained from *E. Foreman, 117 Westgate Road, Dartford.*

\* \* \*

## A New Club

**T**HE formation of a new club called the **Sound and Cine International Tapesponding Club** has been announced. The aim is to improve the knowledge of members in the art of cine and sound through tape exchanges. Details are available from: *V. Bull, 21 Chippenham Road, Harold Hill, Romford, Essex.*



*Three members of the Ipswich Tape Recording Club seen during their visit to a local dairy.*

**A**T the Annual General Meeting of the **Dundee Tape Recording Club** on September 10th, 1962, D. B. Smith was elected President and R. Taylor was elected Secretary.

It was also decided at the meeting that the club should make a start on a recording about "Dundee" which will include interviews with members of the City Council, Local Personalities and members of the public. The club meeting dates are as follows: October 29th, November 12th, 26th and December 10th.

Details are available from *R. Taylor, 9 Baffin Street, Dundee, Angus.*

\* \* \*

**T**HE weekly meeting place of the **Howard Wall and Bethnal Green Tape Recording Society** has been changed to:—Bethnal Green Town Hall, Cambridge Heath Road, E.2. (5 minutes from Bethnal Green Tube Station).

The evening has also been changed from the Friday to the Wednesday of each week.

Further details are available from *R. Gentle, 24 Hyde Road, Hoxton, London, N.1.*

## Minivox Service

**T**HE Challen Instrument Co. has stopped producing Minivox tape recorders and can no longer undertake servicing as they have vacated their premises. Arrangements for servicing can be made with **Sheppard Services (Tape Recorder and Hi-Fi), 11a Upper Tulse Hill, Brixton Hill, London, S.W.3.**

## Tape Clubs in Other Countries

**W**E would like to point out that this magazine cannot be responsible for the authenticity of these clubs but we print them as a service to our readers. Further names and addresses will be printed from time to time.

The New Zealand Tape Recording Club, Kenneth M. Tuxford, P.O. Box 7060, Auckland, W.I., New Zealand.

Indiana Recording Club, Mazie Coffman, Secretary, 3612 Orchard Avenue, Indianapolis 18, Indiana.

Magneto-Vox Club, J. M. Roussel, Secretary, 7915 Des Erables, Montreal 35, Que., Canada.

Organ Music Enthusiasts, Carl Williams, Secretary, 152 Clizbe Avenue, Amsterdam, New York.

Stereo International, O. B. Sloat, Director, 1067 Flatbush Avenue, Brooklyn 26, N.Y.

The Voicespondence Club, Charles Owen, Secretary, Noel, Virginia.



*is that  
really ME..*

*on a  
VOICE  
LETTER?*

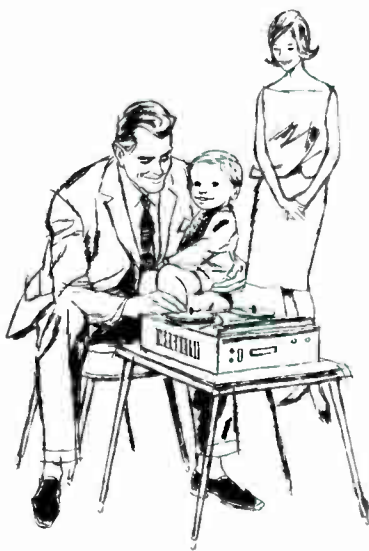

More and more people are getting their letter writing 'taped' with the Mastertape Voice Letter. Anywhere in the world far away friends and relations can receive and exchange a living, spoken message which can include the whole family—even down to the baby! Giving 20 minutes playing time at 3½ i.p.s. on a twin-track recorder, the Mastertape Voice Letter, complete with box and ready-to-address envelope weighing only 2 oz., costs only 5s. 3d.

**British Mastertape  
Makes Sound Sense**

# **Mastertape voice letter**

*obtainable from stockists everywhere*



M.S.S. RECORDING CO. LTD., COLNBROOK, BUCKS. Tel.: Colnbrook 2431

A Member of the **BICC** Group of Companies



# MODIFICATIONS FOR THE COLLARO STUDIO DECK

By F. K. RAWSON

A NUMBER of servicing points not covered in the previous article in "Tape Recorder Service No. 2. The Collaro Studio Deck"—by H. W. Hellyer, are offered. The author of the present article, whilst agreeing with the statement that the present Collaro Studio Deck is a "masterpiece of streamlining", from the design point of view, cannot add the same compliment to the execution of the design into a working product.

A number of versions of the Collaro Studio Deck exist fitted with different heads, etc., and it may well be that you may own a deck which differs considerably in detail to models which the writer has serviced. Additionally, some tape recorder manufacturers carry out quite considerable modification to the deck before fitting it into their own equipment.

## Record/Playback Heads

The record/playback heads fitted to many Collaro Studio Decks and, incidentally, to some of the older Transcriptor Decks, have the appearance as shown in fig. 1, when the Mu-Metal screening cover is removed.

Two packs of laminations are held together by means of pressed brass clamps to form the magnetic circuit of the head. The front record/playback gap between the pairs of laminations is of small dimensions (quoted in some of the manufacturers

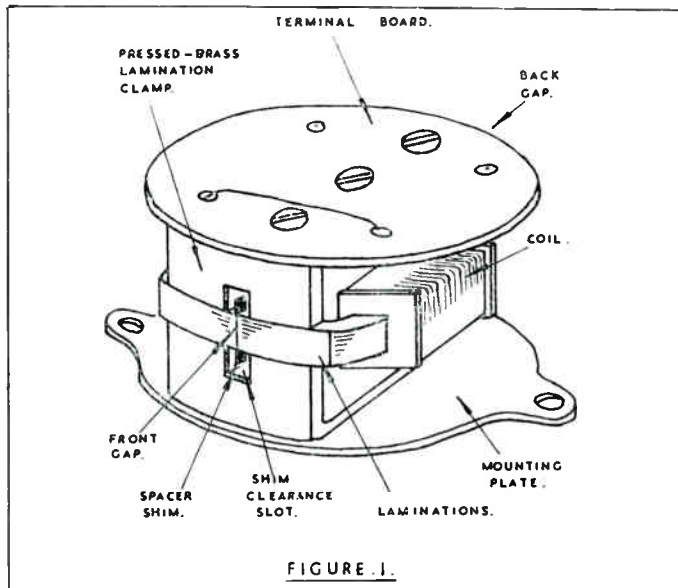
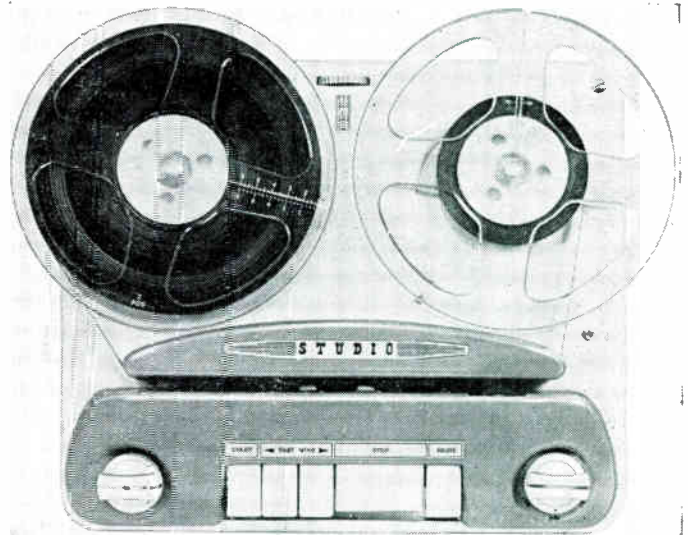

FIGURE 1.

literature as 0.00025 inch) and the back gap, which ensures the required magnetic characteristics, is of larger dimensions. Depending on the particular head, the windings which are supported on the laminations may or may not be wax impregnated.

The shim clearance holes in the brass lamination clamps may fill with oxide from the tape with serious consequence to the



frequency response and dynamic range of the head system. The sharp edge of the clearance hole can also act as a very efficient cutter which, in some cases, can cause the oxide to pile up to such an extent that the tape is held away from the defined recording gap in the magnetic circuit. The effect is further aggravated by the completely different wear properties of the laminations and the brass clamps, which, after a year or two of use, may present a surface to the tape which is anything but flat.

The gap shunting effect, together with the tape hold-off effect, can in combination reduce the overall frequency response of the record/playback system by more than one octave. The playback output voltage will be similarly effected and in one case was found to be 15 dB below the expected level.

## Removing Oxide Residues

Some relief can be obtained by very carefully removing the oxide residues from the clearance holes in the clamps by means of a piece of fine copper wire followed by cleaning the gap and surrounding surface with a fluffless rag on to which the minimum of carbon tetra chloride (CTC) has been applied. On no account should steel wire be used. *If the operation is carried out quickly the CTC will not harm the head.* The repair can be made more permanent if the holes in the clamps are filled with an epoxy resin of the Araldite type after cleaning. It is necessary to remove the head or heads from the deck if this is carried out as the resin must normally be heat cured. This can be achieved by placing the complete head overnight on a warm shelf. All resin residues should be removed from the head before the resin is allowed to cure. This can best be achieved by removing the excess with strips of clean smooth paper. A low-power magnifying glass is a great help in the service procedure. On no account should metal implements be used near to the recording head or its surface may be irreparably damaged.

Great care should be exercised in replacing the heads in exactly the same position from which they were taken and on no account should the azimuth setting screw be touched. If a test tape is available it is advisable to check the head adjustment before putting the recorder back into use.

## Mu-Metal Screening Cans

The screening can on the type of head shown above is press fitted on to the head-mounting base. A rotational adjustment of the can is possible. If the can is removed for servicing its replacement in the incorrect position can cause cross-talk from the recording on the bottom track during playback. This is mainly in the form of low frequency components (playing backwards) from the adjacent track to the one being used.

Exact centring of the can, which should be well pressed down on to the mounting base, will alleviate this difficulty. A little trial and error is usually required. (Continued on page 431)

# Taped sound breaks through the price barrier

## NEW FERGUSON 4-TRACK RECORDER GIVES YOU MORE FEATURES FOR LESS MONEY

How is it possible for the price? The answer lies in the years of designing and engineering effort that Ferguson have spent in producing a tape deck of their own. This recorder is *all* Ferguson. That's why it cost less to build. The cost saving has been passed on to you first by lowering the price, and then by cramming it with all those features you never dared hope to afford. Sceptical? There's only one cure for your scepticism. See the new Ferguson recorder at your dealer's. Trust to the evidence of your own eyes—and ears. Trust to the reputation of Ferguson. And finally, trust to your own instinct for value.

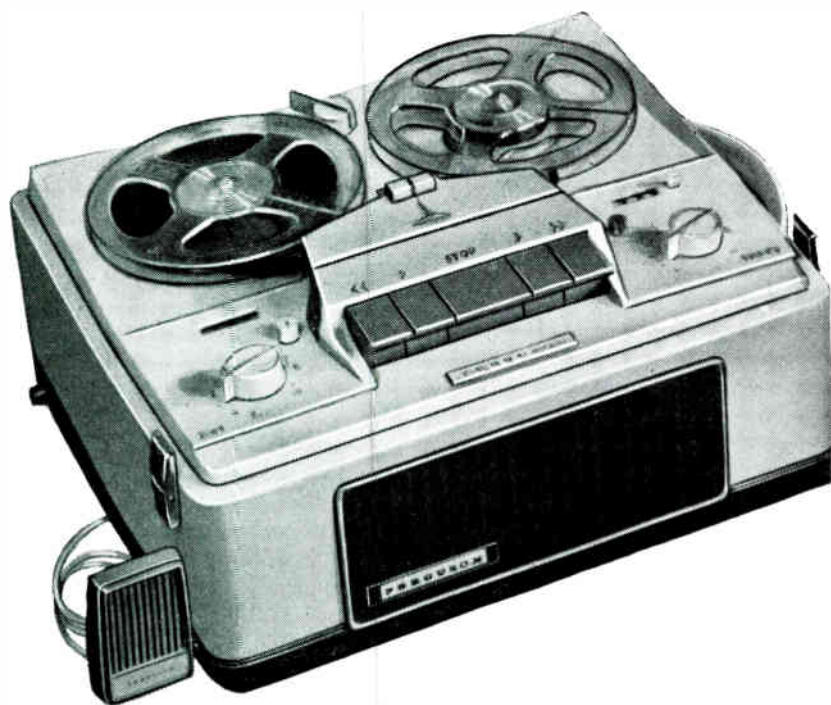

- *Piano Key controls*
- *Tape "inching" facility*
- *Four-track, two speeds:*  
*3 3/4" per sec., 1 7/8" per sec.*
- *Reel diameter: 5 3/4"*
- *Fast spooling in both directions*
- *Pause control*
- *'Play-through' / Superimpose Button*
- *Press-button reset for tape position indicator*
- *Automatic stop operates at both ends of tape*
- *Electron beam recording level indicator*
- *Weight 19 lbs.*

Complete with microphone (incorporating remote control switch), 850' long play tape, take up spool, connecting leads. Powered accessories socket, using suitable attachments, enhances scope of recorder with playback of stereo tapes, track to track recording synchronization, automatic stop/start by voice or signal, synchronized slide projector/recorded commentary operation, etc. etc.

**33** MODEL 3202  
**GNS**

A new twin-track single-speed Ferguson, too! Incorporates almost all the features of the four-track model, yet the Ferguson 3200 costs only **26 GNS**

# FERGUSON



THORN ELECTRICAL INDUSTRIES LTD., THORN HOUSE, UPPER SAINT MARTIN'S LANE LONDON, W.C.2

430

Pinch wheel eccentricity has been found to give high "wow" levels on this deck. An investigation traced the trouble to rubber swelling cause by overoiling of the central oil retaining bearing bush. The wheels (as spares) appear to be despatched by the manufacturer with excess oil. It is suggested that all visible free oil be removed by tumbling the replacement wheels

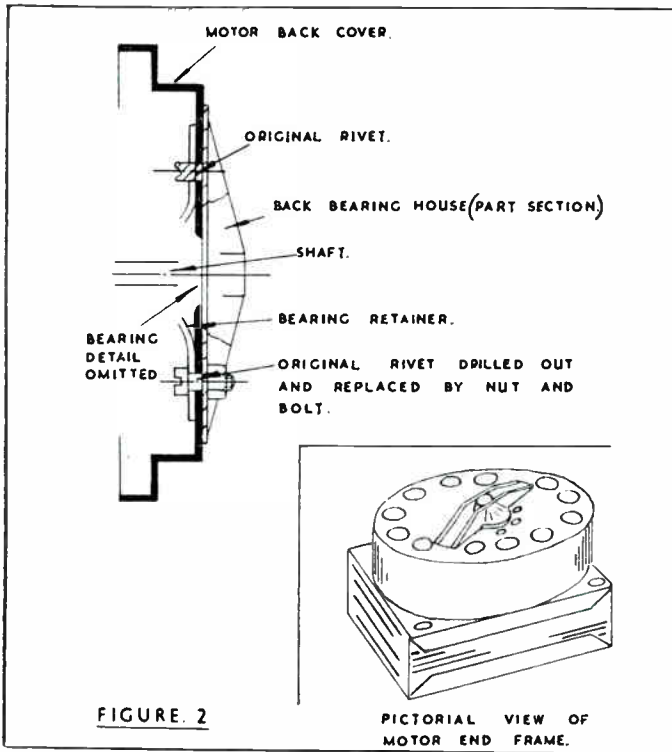

in an absorbent material, such as french chalk or sawdust. Needless to say, all the absorbent material must be cleaned off, including inside the bush, before replacing the wheel. The oil retained within the porous metal of the bush will still result in quite efficient lubrication.

**Noisy Motors**

After some use the motors may become intolerably noisy with a sound rather like a vibrating transformer core. It may

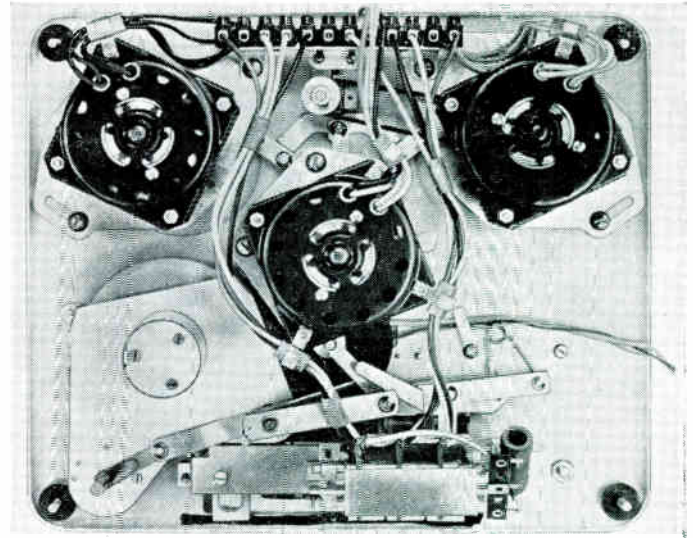
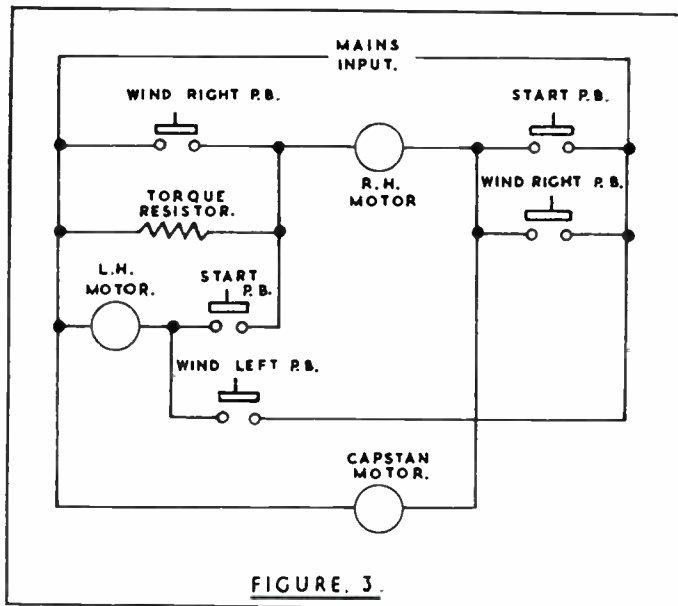

The underside view of the Collaro Studio Deck

be possible that the stator lamination clamping screws in the motor have become loose, in which case the remedy is obvious—tighten them.

Another cause of noise experienced by the writer on two motors, is that the whole back bearing assembly of the motor may come adrift due to inadequate riveting of the die cast back bearing. It should be pointed out here that the rivets are cast into the bearing and are an integral part of it. Repunching the rivets can hardly be regarded as a permanent cure for this trouble. The answer here is to drill the rivets out and replace with nuts and bolts as shown in fig. 2. Some skill is required in drilling out the bearing and its replacement in exact alignment. It is not an operation to be carried out by the mechanically inexperienced, who are well advised to return noisy motors to the manufacturers or their dealers for correction.

**Control Circuit**

For completeness in this article, the motor control circuit is given in fig. 3. During recording and playback the two winding motors are run in series, the back torque on the left-hand motor being regulated by resistor *R* which parallels its windings. The resistor may become open circuited in which case the back torque is too high relative to the winding torque and consequently increased "wow" results. The fact that the resistor has gone open circuit is not obvious since the machine continues to operate in an apparently satisfactory manner. A check that the resistor is of the correct value can be carried out during the service by means of an *Avometer*.

**PLEASE MENTION "THE TAPE RECORDER" WHEN REPLYING TO ADVERTISEMENTS.**

**HOW TO SPLICE TAPE**

★ If you use tape, sooner or later you will need to know how to splice tape—how to repair simple or complicated breaks—how to edit your material—how to cut out words or syllables, etc.

All this is described in a well-illustrated booklet, in which stage-by-stage photos and text provide the complete answer to professional tape splicing.

Price 2/6 . . . Postage paid

**THE TAPE RECORDER**  
99 Mortimer Street, London, W.1

# More Top Stars and Shows on E.M.I. $3\frac{3}{4}$ I.P.S. TWIN TRACK Tape Records



EM.I  $3\frac{3}{4}$  I.P.S. TWIN TRACK TAPE RECORDS CAN BE  
PLAYED ON MOST HALF OR QUARTER TRACK TAPE  
REPRODUCERS!  
ASK YOUR USUAL RECORD DEALER FOR A FREE  
LEAFLET OR WRITE FOR A COPY TO THE ADDRESS BELOW

**ALREADY AVAILABLE:**

BIG BEN BANJO BAND · SEMPRINI  
TEMPLE CHURCH CHOIR · PEGGY LEE & GEORGE SHEARING  
HELEN SHAPIRO · ADAM FAITH · GIGI · BOBBY VEE · JUDY GARLAND  
MICHAEL FLANDERS & DONALD SWANN · PEGGY LEE · CAROUSEL · SHIRLEY BASSEY  
VICTOR SILVESTER · JOE LOSS · ELLA FITZGERALD · INSTRUMENTS OF THE ORCHESTRA  
H.M. ROYAL MARINES BAND PORTSMOUTH · IVOR NOVELLO  
DUKE ELLINGTON & JOHNNY HODGES · NAT KING COLE · JIMMY SHAND  
THE TEMPERANCE SEVEN · CONNIE FRANCIS · JOHNNY BURNETTE · MR. ACKER BILK  
HANK WILLIAMS · FRANK SINATRA · THE KING AND I  
THE MERRY WIDOW · ORPHEUS IN THE UNDERWORLD  
THE SOUND OF MUSIC · THE SHADOWS · BLITZ

E.M.I. RECORDS LTD., E.M.I. HOUSE, 20 MANCHESTER SQUARE, LONDON, W.1



THE GREATEST  
RECORDING ORGANISATION  
IN THE WORLD

# our readers write . . . . .

## . . . about using a mixer

From:—J. H. Kitto, 249 Barton Road, Stretford, Manchester.

Dear Sir:—I was interested to read the letter from N.C.B. of Harrow in the September issue of *Hi-Fi News* with reference to the Mullard Type "C" Tape Pre-amp. His second point about using a mixer in place of the first valve is very similar to a query I wrote in on July 10th and to which Mr. Graham Balmain gave me a very useful and detailed reply. Because of this, I too, gave up the idea of turning the first stage into a mixer, but I have developed a solution which so far has given excellent results.

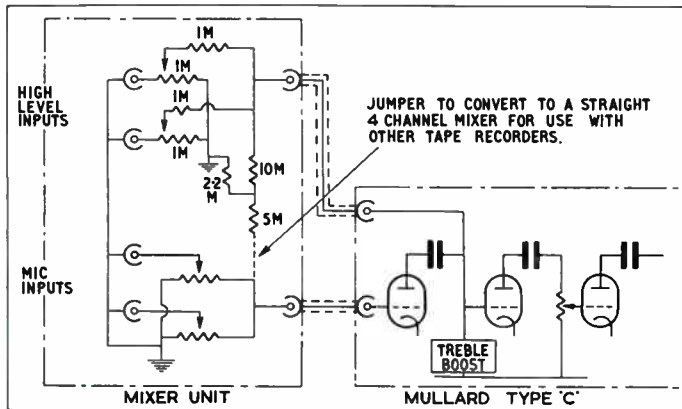

I have made up the mixer detailed by A. Bartlett Still in No. 28 of *Tape Recorder Workbench*, but with one important modification. I have two microphone inputs and two high level inputs for tape, gram, etc, but in my set up for recording the two microphones mix into one output, which goes to the first valve of the Type "C" whilst the two high level channels go to a separate high level output which goes to the second stage.

The abovementioned unit is to be used for building up the soundtrack of a 16 mm film, mixing pre-recorded sounds and microphone comments on a second tape recorder. I find this infinitely better than superimposition, which blurs the original sound very badly.

Yours faithfully,

\* \* \*

## . . . about a club demonstration

From:—T. Robinson, 17a St. Anne's Road, Whitstable, Kent.

Dear Sir:—At the invitation of a neighbouring club, several members attended a demonstration which was to be given by a well-known firm of tape recorder distributors. Some of the details of this demonstration may be of interest and amusement to other tape club secretaries and members.

The show was supposed to have started at 8 p.m. but as the representative had forgotten some important parts of his equipment, and had to return to London to get them, it was not until nearly 9.30 p.m. that things got under way. After spending the next 10 minutes or so unpacking boxes etc. the expert commenced his address with these monumental words: "I had better preface my remarks by saying that all of you here probably know much more about tape recorders than I do. . . . I usually have more to do with hearing aids". After showing us some of the controls of the three machines on display, he went on; "There is not very much else I can tell you about them, but if there are any questions I shall try to find the answers in these leaflets . . . (produced a few leaflets) . . . I am sorry there are not very many leaflets to give you, but we are very short of them at the moment. . . ."

The machine which attracted most interest was a recent battery/mains model, and this was used to play back a pre-recorded tape on mains power. When I asked to hear the machine working with its batteries I was told that it was unfortunate, but there didn't happen to be any batteries in it, but I was assured that

it did work very well with them! The weight of the machine? "Just a minute and I will look it up". Some microphones were on display also, including one priced at over £20. Was it a moving coil or a ribbon? "It says a ribbon in the leaflet, so I am pretty sure that is what it is". There was also a good-looking extension speaker. Could we hear it working? "Well unfortunately I have not brought the right plug to fit it".

And this sort of thing went on until mercifully the "demonstration" ended. It was all very embarrassing, and the club who were unfortunate enough to have staged it, and who had been good enough to invite us along, had my sympathy.

For the sake of tape clubs everywhere, and the peace of mind of their secretaries I hope this was an isolated example—surely a firm such as this could not afford to put on such a dreadful show more than once!

Yours faithfully,

\* \* \*

## . . . about entering the Common Market

From:—C. Braddock, The Tape Recorder Centre (Blackpool), 266 Waterloo Road, Blackpool, Lancs.

Dear Sir:—Should the U.K. decide to and are accepted into the Common Market I dread to think of the havoc that will be reaped amongst many, very many of our tape firms also Hi-Fi or so-called audio firms.

Although there are a great many poor manufacturers on the Continental market, I feel sure that they cannot equal our own, please manufacturers in the U.K. how about a tape recorder under £40 with at least two "workable" speeds, if three, do let the third, at least accept speech, without objectionable flutter, if not please go bankrupt, voluntarily, before the Continentals put you into disgrace. Recently I had occasion to test not one but two samples of a British make under £40, with multi-speeds and all the usual features one becomes accustomed to seeing on the cheaper type of machines. At 1 7/8 i/s I actually could detect quite audible flutter of a severity to be expected on the early cheap machines of 7 or 8 years ago.

However not wasting any time I ordered a replacement, which if anything was far worse, not only was the flutter there again, but without an earth, which let's face it the majority of the general public do not use. Although I agree to the safety factor, a machine even so, should not have such inherent noise/hum level as to make a recording sound as though it was made "20 fathoms down".

On writing to the manufacturer concerned I was told that I was expecting too much, it was not in the £90 class and furthermore it was not I assure you.

Now this last remark is typical of many of our manufacturers and certain importers of foreign machines, "Take it or leave it". I maintain that a machine even under £40 should be of reasonable quality and although the Grundig TK 14 and similar machines have only one speed I dare anyone to detect by ear any serious flutter, provided always that the machine is within the specified limit. Isn't it about time that something was done to combat this type of shoddy practice which if we go into the Common Market will get short shrift indeed.

The firm concerned, which unfortunately must be nameless, are advertising nationally on a large scale and must I feel sure be selling many machines, but I feel that before long they will die a natural death, I hope so. I think when shopping for a tape recorder or anything of a specialist nature one can judge its potential quite easily. If it is in the shops which sell everything from ordinary electrical appliances to soft furnishings, etc., "but not in the tape specialists" and I use the latter advisedly it can, I think, safely be neglected, without the slightest qualm.

As has been pointed out many, many times before, "go to a specialist" if you can find or live near to one. Finally, you would not go to a tape shop for a suite of furniture.

Yours faithfully,

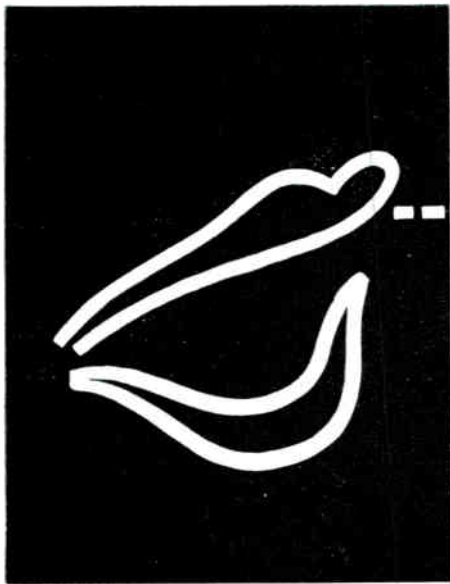

connoisseurs

say

**SIMON**



... the connoisseur with an eye for a bargain chooses the **SIMON SP5** because no other tape recorder in the price range gives him so much at professional standards!

Unrivalled facilities of the **SIMON SP5** include uni-directional twin track recording, two speeds, 7-inch spools, dual channel mixing, master fader, monitoring through loudspeaker and level setting, controlled echo, track to track recording, controlled bias, recording level meter.

\* You can buy the **SIMON SP5** as a stereo recorder, or in a monaural version ready wired and fitted for easy conversion to stereo.



**SIMON SP5**  
Price from 93 gns  
"Tape recording in the new age"



... the connoisseur with an ear for performance chooses the **SIMON Cadenza Ribbon Microphone** because he gets studio class results in the middle price range.

The **SIMON Cadenza Ribbon Microphone** is a popular and successful conception of ribbon and magnet arrangement... output is flat to close limits over the very wide range 50-12,000 c.p.s., new shell design eliminates resonant peaks and troughs—especially the "bass hump". Can be used in LZ or HZ condition... though the ribbon area is four times the normal size, dynamic impedance is negligible.



**SIMON Cadenza Ribbon Microphone**  
Price 10 gns  
"Makes a piano sound like a piano"

For full technical details of **SIMON** tape recorders and microphones, consult your dealer. In case of difficulty please write to:

**SIMON EQUIPMENT LIMITED**  
48 GEORGE STREET LONDON W.1

# SOUND and CINE

AN interesting comment by Richard Bird (producer of "Adamu Comes to London"—an amateur informational 16 mm optical sound film for use in Nigeria) was "if anyone wants an exercise in recording, try taping a 'High-Life' band on a domestic recorder with only one microphone and the drums never less than thunderous!" Finally, and to do justice to the talented music students in his cast, he had to go to the extra expense of recording his music sequences in a professional sound studio.

## Furthering Anglo-African Relations

As a film maker who had never tackled anything more than a four-minute travel film, Richard Bird was anxious to find some subject that would extend his range; one that had never been done before and of a type that would be useful to an audience wider than the ordinary club show could offer. He found his purpose when he learned that African students were coming to Britain ill informed of the conditions that they would find here and, in consequence, were suffering unnecessary humiliation. These students, eventually returning disillusioned to Africa with the feeling that the British Commonwealth Ideal was only something to be found in school books. His object, then, once that he had decided that he could further better Anglo-African relations in this way, was to provide a truthful account of what it would be like for a Nigerian in his first few days or weeks of student life in London. The film would explain what the Nigerian would see, what would surprise him, and what he could do here that he could not or would not do at home.

The production proved less difficult than he had at first expected for through the Nigerian authorities he was able to find a clever and enthusiastic cast. He also found, and this gave his soundtrack planning greater scope, an African jazz composer who could play both authentic non-Westernised "High-Life" and also "blow blues like Miles Davis". The writing of the script, however, held several problems uncommon to the usual documentary. How, for instance, do you describe the size of Greater London to someone who has never left his village in the bush, and who may never have heard of the Underground Railway? Richard, who is a journalist, settled for—"it would take two days to walk across London". The commentary, throughout, is spoken by an African and the track contains a fair amount of music plus one lip-sync sequence. This last sequence does not really come off for although, technically, it is reasonably done, it does tend to make this small insert over-important and so breaks the unity of the film at this point. Even so, Adamu is a very workmanlike film with a sincere wish to do something worthwhile.

## Shortage of Suitable Films

When talking about Nigerian film outlets Richard said "African Television welcomes quality material but apparently there is a great shortage of suitable films. Some stations pump out a stream of gangster films and old Westerns inter-laced with commercials. It is said that at one time, for many Africans, the image of the white man was conditioned by seeing only the trader, the missionary and the District Officer. Now, thanks to



*The author discussing the problem of camera soundproofing with Alan Cohen.*

TV, the image is changing to that of the sheriff who's quick on the draw especially when dealing out summary justice to the Indian. In some areas, too, no differentiation is made between one white race and another and this is quite understandable. Would we know a Fulani from a Yoruban, an Ashanti from an Ibo? Yet their religion, languages and ways of life are usually more different than, say, the English are to the Germans, or the French to the Americans. Nor is there any conception as to time or place in these films; TV Westerns are often assumed to be happening now—in England! Education, however, is accelerating as never before, and an emergent middle and ruling class will require a diet considerably more palatable and edifying than 'The Lone Ranger'. The television companies are unlikely to meet the demand because there is no money in it for them. I believe, however, that the Americans are beginning to show interest and I am pleased to note that the Nuffield Foundation is to provide suitable educational films."

Richard has taken his film up to the point where the student is ready to begin his studies and it seems to me that if any reader is looking for a subject he could well start where this film leaves off. I know that Richard Bird is not contemplating another film on this subject at the moment and in view of what he says about film outlets the market seems wide open.

## Film Titles

Meanwhile, on the home front, the late autumn brings its usual spate of holiday films to be sat through, to be complimented upon, and upon which to offer unwanted advice on cutting. This year, at least, the wholesale use of the new Arrowtab 8 mm animated titles has given unexpected punch to both beginnings and endings of this type of film. These titles, for those of you who have yet to see one screened, last about eight seconds, which is long enough for the normal straight title, main or end, and are quite superb. The Technicolor prints (reduced from 35 mm originals) are of good quality and the artwork and animation is extremely well done. From the 24 titles on the market I particularly like "Italy", "The Riviera", and the three "End" titles. At 3s. 6d. each they seem good value especially when you consider the time and trouble involved in filming such a title for yourself.

## The "Touring" Film

It is surprising just how many holiday/documentary films there are about. By this I mean a film showing the family on a touring holiday and bringing together two different themes, i.e. the family following the normal holiday pursuits plus camera exploratory work on various architectural features of the manor houses and castles visited during the tour. Where importance is given to the family, this type of film can be very successful as a pleasant holiday memory, but too much prominence given to the documentary side can put the film completely out of balance especially if it is desired to show the film to audiences

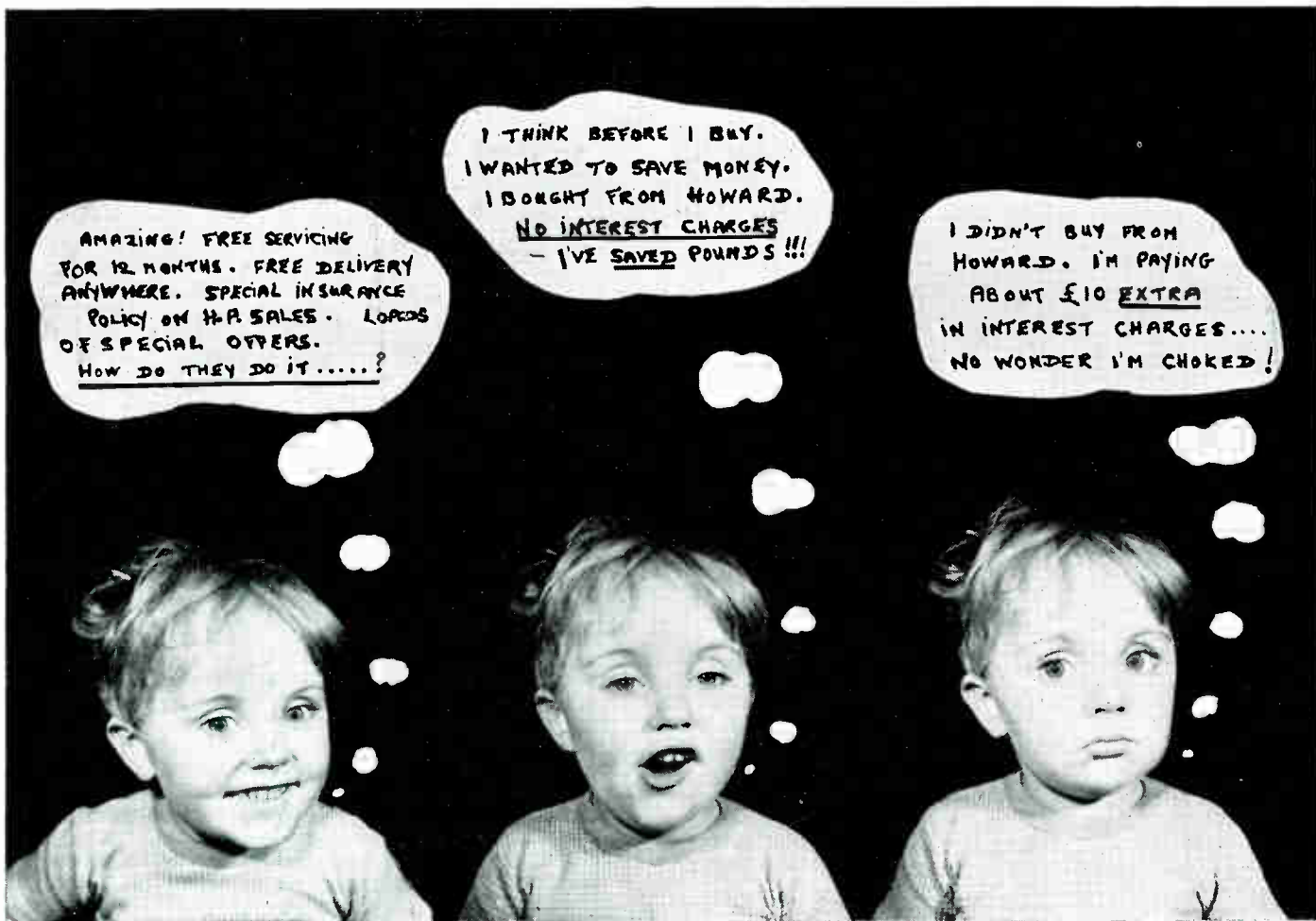

## 3 HEADS ARE BETTER THAN 1

If you are only blessed with the normal number, don't give up! One brain is quite sufficient to work out that if you are going to buy a Tape Recorder, and want the maximum value for your money, you must buy from HOWARD.

We have 10 years' experience as the biggest Specialists in the British Isles to place at your disposal—for nothing. It is a fact that you will pay less than if you buy anywhere else. *Think we are shooting a line?* Then write, phone or call us—we will prove it with an ease that is both the envy and despair of our competitors.

**HOWARD**  
**TAPE RECORDERS**

**218 HIGH STREET,  
BROMLEY, KENT**

RAVensbourne 4000 & 4477





# TAPE RECORDER SERVICE

GRUNDIG MODELS, PART 4

By H. W. HELLYER

THE more elaborate machines in the Grundig range have been left (like the small boy's birthday cake) until last. One advantage of this is the reference to previous features on machines described in earlier articles of the series. For example, both the TK55 and TK60 employ a drive system that is similar to the TK35. A diagram of the belt system has already been given; see page 339 of the September 1962 issue of *The Tape Recorder*. Clutches are of the simple, felt pad type.

Brakes on both these models are of the simple, pad on angle-piece variety. They are applied by the de-energising of a relay, as described in the last article of this series. Although there are slight differences between the shape of pivoted arms and angle pieces that bear the actual brake pads, the system on both TK55 and 60 is similar. On each, a common tension spring is stressed between the main arms, hooked into a series of holes, selection of exact position providing fine adjustment of return tension.

## Pressure Roller Assembly

The pressure roller assembly is also applied by a combination of mechanical linkage and the energising of a solenoid. A lock-nut and setting screw enables exact throw to ensure the correct pressure. An eccentric screw at the right-hand end of the pressure arm gives coarse adjustment, and should be set to allow an 18 ounce pull with motor running. The inward pressure of the felt pad to the Record/Playback head should then be one ounce. Fig. 1 should make these remarks clearer and also show that there is no separate pressure pad for the erase head. This is to eliminate as much friction as possible, the configuration of the complete assembly being such that the tape, aided by a highly polished pin on a guide bracket, has a partial wrapping action around the erase head.

Note, in fig. 1 the two steel balls and the spring blade, lettered S-S and P. If there is any necessity to dismantle the assembly, take care to reassemble correctly with these in place and the fixing screw at the left-hand end made secure. Other symbols are: R; Pressure roller, with screening piece and

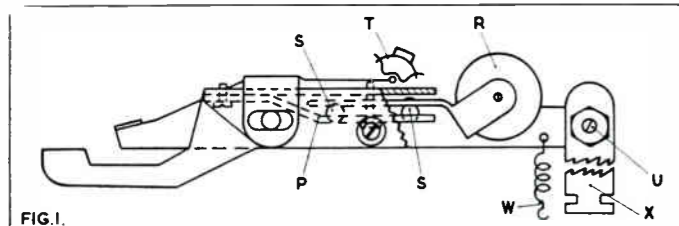

cotter pin, T; eccentric screw, U; return spring, W. This last is used to assist the action of the relay arm, X, not as a primary force for returning the whole bracket to neutral. A small return lever assembly, mounted on a pivot on the head plate, regulates the bracket travel. Grit and oily deposits beneath these moving parts can cause erratic action. Indeed, in machines of this type, where the action is finely balanced, such small discrepancies should be checked before suspecting a more serious fault. Ironically, it is the cheaper machines which have positive engage and disengage movement, strong spring action, etc., but which are not so delicately adjusted.

Head mounting on both these machines is two-screw, with one spring-loaded. The R/P head screws are at each side of the head mounting, and the erase head is clamped in a mounting with a screw across the top and mounting screws front and rear. There

are slight physical differences between the models, but the azimuth alignment procedure is similar, and should be carried out as follows.

Record a constant tone of 6-8 Kc/s, preferably on a known good machine. Play this back with a valve voltmeter connected to each high impedance output in turn. Adjust the head mounting screws for maximum output on one channel, invert the tape and carefully readjust for an equal output on the other track. Some patience is needed, for the maxima should coincide. But note that discrepancies in the replay channels can affect actual readings. In this case, adjust for maximum output on each channel, rechecking the head setting, and look further for the loss in the appropriate channel. Reference to fig. 2, and fig. 3, and further notes on the adjustment shown in these block diagrams of the two models should be of assistance to those readers able to make this sort of test. But please note that setting up of bias, frequency response, etc., needs good instruments plus experienced care: hit-or-miss adjustments should never be made. The following notes are aimed to give more knowledgeable readers a rough guide to checking their machines, and others who may be interested a demonstration of the exact standards required of a good-class stereo machine.

## Valve Line Up

First, an explanation of the block diagrams. The TK55 is a monophonic recorder, but with facilities for playing back stereo tapes. On *Record*, the left-hand channel is employed: V1 is the microphone amplifier. V2 and V3 are two halves of an ECC81, double triode, the equalisation circuits being shared between these two sections, and the resultant signal passed to the R/P head. Bias is supplied from the oscillator valve, V5, an EL95, which also provides the erase current, at a frequency of 78 Kc/s. The EM84 modulation level indicator, V9, is connected to the L.H. channel output.

On playback, the left-hand channel is fed from the upper gap on the R/P head, the conventional track. The signal on the tape is fed, via the head, to the grid of the first amplifier, V1, the EF86 valve. The two stages of the ECC81, V2 and V3, now shape the playback characteristic and the signal is passed to the output stage, V4, which is a single EL84 valve. High and low impedance outputs are available at the appropriate socket, from intermediate points on the circuit. The output from the ECC81 stages is also taken, via a relay and a switched changeover contact, to the stereo output socket.

The right-hand channel is fed from the lower head gap to V6, another EF86, thence to V7 and V8 for a similar characteristic shaping and amplification as in V2 and V3. From this point, the amplified signal is taken to the stereo socket. Thus, there is no output stage for stereo reproduction, and it is necessary to provide either a matched pair of output stages from the stereo socket, or a single stage and loudspeaker for the right-hand channel. The oscillator is rendered inoperative.

## Equalisation Circuits

Equalisation circuits on the TK55 are more complicated than on the TK60, and switching differs considerably. This is because the TK55 has an additional  $1\frac{1}{2}$  i/s speed. Although the speed change arrangements on the two machines are similar, as described before, for the two upper speeds,  $7\frac{1}{2}$ ,  $3\frac{1}{2}$  i/s, the selection of  $1\frac{1}{2}$  on the TK55 switches the motor to a 177 volt tapping on the mains transformer, inserts a 20 ohm resistor and 1 micro-

farad condenser in the motor circuit and shunts the field connections, as well as changing the equalisation circuits. The faster speeds utilise the 165 volt tapping on the mains transformer.

The TK60, however, is a completely stereo machine, even to the extent of having both loudspeakers as separate, detachable assemblies in matching cabinets. Fig. 3 shows that the two channels are similar from input to output, except in one respect. This is the oscillator circuit, where bias and erase current is supplied

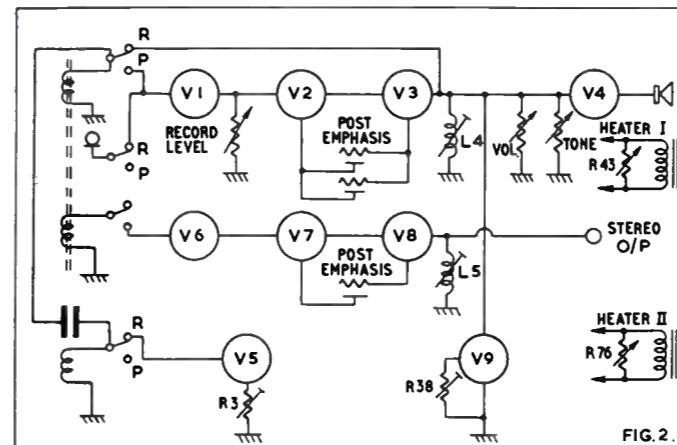

(at 40 Kc/s) to the left-hand channel directly from V5, but through a buffer amplifier V6 to the right-hand channel. The numbering of preset controls on these diagrams is taken from the Grundig service manual.

It is worth noting here that the manufacturers have marketed a self-contained deck, with pre-amplification and equalisation, to load any suitable stereo amplifier. This is the TM60, which may be taken as that part of fig. 3 which lies on the left of the chain-dotted line.

## Adjustments

**TK55.** Bias current. Insert 200 ohm resistor in the return lead of the R/P head. With the machine switched to *Record*, but no input signal, the reading across this resistor should be 220 mV. This measurement is taken with a valve voltmeter, and has a tolerance of ten per cent., and represents a bias current of 1.1 mA. Adjustment for optimum conditions, R3.

Erase current. Across a ten ohm resistor in the erase head return (chassis) lead, a reading of 440 mV, should now be obtained.

Recording current should read 14 mV, across the 200 ohm resistor with a 1,000 c/s input giving full modulation, with the bias inoperative. (Remove the EL95 oscillator and temporarily load the h.t. with a 12,000 ohm resistor, to simulate the loading effect of the oscillator.)

To check the modulation level, with conditions as above, i.e., oscillator inoperative, machine switched to *Record*, 1,000 cycles input, first set the recording level control to maximum. Then adjust the input level until a reading of 630 mV, is obtained at the high impedance output. This input should be  $1.5 \text{ mV} \pm 2 \text{ dB}$ . This should also give the measurement of 14 mV, across the 200 ohm resistor, detailed above. The setting of the Magic Eye, which should just close at this input, may be adjusted by R38.

Next, replace the oscillator—not forgetting to remove the 12 K ohm dummy load resistor—and check that a 20 mV, input from

a high impedance source to the diode socket also fully modulates the recording amplifier. To test the frequency response, it is now necessary to reduce this input by 20 dB, (to approximately one-tenth), and record signals of 60, 333, 1,000, 4,000, 8,000, 10, 12 and 15,000, at a speed of  $7\frac{1}{2}$  i/s. With a valve voltmeter connected to the High Impedance Output, the output level over the whole of this recorded range should be within plus or minus 3 dB, with reference to the reading obtained for the 1,000 cycles tone. To check at  $3\frac{1}{2}$  i/s, use frequencies up to 10 Kc/s and to 6 Kc/s for the slowest speed.

The two remaining variables are R43 and R76, which are used to reduce the Hum level. First make a full level recording, as before, at 1,000 c/s, 20 mV, to the diode input. Check the level at playback, remove the tape and note that the residual noise should not exceed -43 dB of the previous (recorded) level. Adjust R43 for minimum on the left-hand channel, and R76 on the right-hand channel.

**TK60.** Bias current. Across 200 ohms, as before, 200 mV. Adjust C102 on L.H. and C215 on R.H. channels.

Erase current. Across 10 ohms, as before, 380 mV. Adjust R111 on L.H. and R207 on R.H. channels.

Recording current. Remove oscillator and amplifier valves. Set machine to *Record* and *Stereo*. Feed a 1,000 c/s signal into diode input of each channel consecutively, and set the input to produce a 16 mV, reading across the 200 ohm resistor. Adjust R9 to close Magic Eye on L.H. and R243 on R.H. channels. R3 should be adjusted on *Record* to produce 16 mV, at both channels for equal inputs. R4 is similarly adjusted for equality on Playback.

The playback response is adjusted by L5 and L6, on left and right channels respectively to obtain a 7 dB lift for the frequency range 1-15 Kc/s, with maximum response at 16.5 to 19 Kc/s. This is done at  $7\frac{1}{2}$  i/s.

Similarly, at  $3\frac{1}{2}$  i/s, adjust R135 and R235 for a 13 dB lift for the frequency range 1-10 Kc/s, with maximum response between 10.5 and 13.0 Kc/s.

Frustrated readers who do not own the necessary test equipment to make these adjustments, please bear with the author. Service work is not always a matter of carrying out mechanical and electrical repairs. Often it is necessary to run through the specified tests to find out what is wrong with any particular

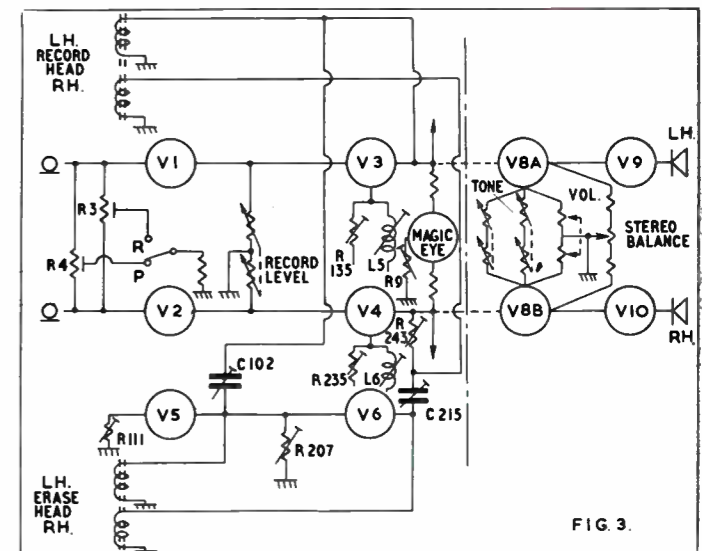

machine, noting discrepancies with the published figures. The more high class the tape recorder, the more serious are those small errors that will only show up when good standards of testing are applied. Adjustments should never be made as a "trial-and-error" test.

However, in the next issue, we shall revert to practical matters, describing the rather complex mechanics of the Brenell Three-Star and Mark V tape recorders. Several enquiries have been made about these popular decks, and it is hoped to cover them fully if space is available.

# THE SOUND OF SONY... A WONDERFUL SOUND



## The SONY 521 Stereophonic Tape Recorder

Here is brilliant engineering in sound. The Sony 521. Here is perfection in dimensional recording and reproduction. The Sony 521. Here are the many extras usually reserved for professional instruments—built-in amplifiers and speaker units, two and four track play-and-record features and trouble-free synchronous motor drive. The Sony 521. Here are sensitive level meters and split-second stop lever, assuring true fidelity, precise cueing and editing. The Sony 521.

**124 gns.** including 2 dynamic microphones and all accessories

- \*  $7\frac{1}{2}$  +  $3\frac{3}{4}$  tape speeds
- \* tape index indicator
- \* instant stereo/mono switch
- \* tone control
- \* automatic cut-off
- \* additional line outlet
- \* headphone monitor jack
- \* professional mixing

# SONY

RESEARCH MAKES THE DIFFERENCE

Detailed specifications on the range of Sony tape recorders are available from the

Sole U.K. Distributors: **TELLUX LIMITED** A member of the K.G. (Holdings) Group of Companies  
AVENUE WORKS, GALLOW'S CORNER, COLCHESTER ROAD, ROMFORD, ESSEX. Telephone: Ingrebourne 43971

## SOUND AND CINE — cont.

outside one's immediate circle. The balance can be restored, to a certain extent, by a commentary but, it is much better, where there is enough material, to make two films—one of the family relaxing in the sun, swimming, on the beach and at a picnic etc., and the other of the visits to these well-known places of interest.

### Plan Before Travelling

The ideal plan is to work out some linked theme before the holiday is begun. If the route is known then this can be fairly straightforward and guide books can be consulted well in advance. Manor houses, castles, pretty little villages and landscapes with exciting associations can be chosen for the documentary side of the holiday and a complete itinerary worked out so as to include the most rewarding. Where the film has already been shot, providing that there is quite an amount of material to choose from, it can be saved to a certain extent by extra cut-ins specially filmed for the purpose. By this I mean taking the existing scenes of, say, a beautiful old manor house, assembling them into some agreeable and logical order, and then, fitting into the commentary some interesting little tale taken from the history of the house, adding the cut-in as a climax. The cut-in could be either a short "live action" cameo acted out by a small group of players or a filmed photograph or drawing brought to life by the "stillie" technique.

### The "Stillie" Technique

This form of cartoon film making, rather favoured by producers of stained glass window films, can be very pleasant to carry out for all it consists of is an endless flow of camera tricks. A drawing of the situation is placed in the titler and camera movement, plus panning of the drawing itself, is used to unfold the story. Any effect that can be thought of is quite within the rules, providing that it furthers the story and is not just used for its own sake.

The same technique can be used in the scripted film but with so much more ease. A basic theme that could be linked quite successfully in planning a film on Manor Houses in the Midlands and the West Country is the Civil War. There are many dramatic stories to be found of conflict within the great families—of father against son—of brother against brother etc. To assist in the later filming of the cut-ins are the many reproductions of paintings that exist today of the Civil War. The possibilities are quite without limit.

The theme that interests me is that of the Devil and his followers and their place in the Folk-Lore of the West Country and, in just a little research on a very rough line from London to Land's End, I have found some gems. These I pass on for your own consideration.

### Commencing in London

Starting from outside London there is the mystery of the feasts of the Franciscan Club conducted by Francis Dashwood, who was said to indulge in devil worship at Medmenham Abbey. From here a short drive to the Wiltshire Downs will find dozens of stories of sheet-bedecked, ghostly, titled ladies to choose from. Further on through Wiltshire, one hears of headless swordsmen and horrible floating monks. At Sutton Montis church there is the phantom procession every Christmas Eve of King Arthur and his men down the King's Causeway and the silver horse-shoes which are sometimes found at this spot on Christmas Day. There is the flying dragon of Cadbury Castle. There is the story of how the Devil tempted St. Dunstan at Glastonbury by appearing to him in the guise of a beautiful woman and how the good saint caught the temptress by the nose in his red-hot tongs. There are the Three Spinsters of South Devon, the choosers of the slain who rode the battle plain to call doomed warriors to Odin (these appear again as the three weird sisters in Macbeth), and of course the Devil at Widdicombe Church and how he destroyed the steeple. For an illustration

of how the cut-in could work this last folk-tale may be a good example:

Visuals	Commentary
Parchment containing the spoken words is filmed in close-up.	"Wounded, Scorched, and stupefied In that so strange a storm, Which those who had seen would say Twas hard to have preserved a Worm". (Trad.)
Mix from parchment to distant shot of Widdicombe Church.	This tranquil spot called Widdicombe once had dealings of its own with the Devil. One day during the good summer of 1638 when the villagers were at service a storm blew up within seconds.
Zoom in. Cut to some exploratory camera work.	The steeple was suddenly shattered by a flash of lightning and the stained glass windows came showering down on the worshippers followed by a cascade of stones and what seemed to be a great ball of fire. There was no doubt in anyone's mind just who the author of this outrage really was, and later an old woman, who kept an inn on the outskirts of the moors, remembered that just as the villagers entered the church for their service, a tall, dark man, riding a black and powerful horse, called for some cyder and asked the way to the church. As he drank the cyder, it hissed and bubbled, and to her horror, when he mounted his horse, she could see quite plainly that a cloven hoof protruded from his trouser leg. Half an hour later, this gentleman in black had flung his fireball into the church at Widdicombe.
Mix to cut-in which could be a "stillie" of the Devil sitting on his horse etc. Pan down to cloven hoof, etc.	

This, of course, is a simple illustration of the technique and there are many, many better to be found. These I leave to those of you who may be interested in working out your own themes. This type of film is quite exciting to make and the soundtrack can include quite an amount of local material. In this respect alone it is useful to have contacts with tape recording societies in the areas concerned, for it is often surprising to see what they can come up with or, indeed, will produce specially to meet a given need, and for those of you for whom I have started something new, I add some addresses of West of England recording clubs.

**Reading Tape and Cine Club, Secretary: D. M. Noyes, 4 Froxhill Avenue, Reading, Berks.**

**Swindon Tape Recording Club, Secretary: V. Riechman, 31 Downs View Road, Swindon, Wilts.**

**Bath Tape Recording Club, Secretary: K. W. J. Gingell, 9 Norfolk Crescent, Bath.**

**Bristol Tape Recording Club, Secretary: M. Hollier, 27 Dean Lane, Southville, Bristol.**

**Bridgwater Tape Recording Club, Secretary: Miss J. Sharman, 34 Lakeside, Taunton Road, Bridgwater, Som.**

**Taunton Tape Recording Club, Secretary: Paul Gray, 80 Wordsworth Drive, Holway, Taunton.**

**South Devon Tape Recording Club, Secretary: G. Furneaux, c/o 9 Enfield Road, Babbacombe, Torquay.**

**Cornwall Tape Recording Club, Old Church Cottage, Mount Hawke, Truro.**

# PUPPETRY AND TAPE

by ROGER STEVENSON

★THIS short article, by an amateur puppeteer, offers an interesting and unusual Christmas idea for homes where children are to be entertained—or, if they are of the necessary age and inclination, wish to create entertainment for others. The age-old art of puppetry, and the modern addition of recorded sound, blend excellently together and greatly simplify the production of shows in the miniature theatre. The author has developed his stage productions into quite large-size works, and his gear and props take a lot of organising and transport; but it is the idea behind the art which will be of appeal here, and home puppetry can easily be planned on a scale that will suit the space available.

THE auditorium lights begin to fade and the orchestra strikes up a lively beat. A second later the curtain rises, revealing a wonderland of lights, colours and costumes and presenting the possible with the fantastic. This is the theatre, but not the conventional theatre. This is the Marionette Theatre—a world of its own, which can express the puppeteer's view on life and show how he sees various incidents as his "actors" perform them on stage. Behind the footlights are all the emotions found behind the live theatre, except that the actors themselves are immune to them. They wait quietly in their dressing rooms, namely a hook on the wall or part of a long rail, until the time comes for them to enter from the wings and present their own inimitable style of acting.

Before the finished show, there are of course many things to do. The act must be thought out and all the designs made, even before any of the characters are created. A marionette may take several days or many weeks to make, and can be constructed from a large collection of materials including paper, plastic, rubber, felt and wood. A large elephant that I once made had an inside consisting of a metal can covered in grey felt.

After the marionettes come the scenery and all the other props that may be required; and then the marionette is made along with the control. The next stage is where the marionette is "strung



up"; and after this all his movements are checked and, if necessary, some more strings are added to provide additional movement.

A tape recorder now plays a vital part of the sound system for my theatre, and its uses in any such theatre are almost limitless. Plays may be recorded on tape, including sound effects; and this saves the cast travelling with the theatre. The soundtracks for my shows are made on two tape recorders, the main one being a *Simon SP 4 Automatic*, chosen for its ten watt ampli-



fier, automatic deck and built-in mixer unit, and the second recorder is a *Ferrograph Model 4A/N*. Most of the soundtracks are made at home, in the room which contains all the equipment and marionettes.

Normally all the props, marionettes and stages are transported to the theatre, hall or hotel the evening before the show, and here the question of transport alone poses quite a problem. The stage is so large that on occasions it will not fit into a private car and so a furniture van has to be used. On arrival at the place of the show everything is fitted up and, if possible, I run through the complete show. Lights are adjusted, scenery set, and the extension speaker is placed in front of the stage, with the volume corrected so that everyone in the auditorium can hear perfectly.

A device that has been of tremendous use is the remote control for the "Simon". The recorder is normally placed under the stage or in some other out of the way place, as the back of the stage is full of props and marionettes, so a remote control unit is used. This can stop, start and track-change the machine from almost any distance and is used when I am working on stage and wish to pause the recorder.

I always begin the show with introductory orchestral music. While this is conditioning the audience I am able to prepare the final details. Behind the stage, marionettes are taken from their hooks and brought on to the stage to present their act. They enter from the wings into an area ablaze with light, and face the awaiting audience. Their limbs move backwards and forwards and if the act is first rate and interesting, as it should be, then the audience should forget that these creatures are not of flesh and blood. They see them as real little people in this world of fantasy. Some acts do create this impression, some acts don't, but it is up to the puppeteer to strive for an entertaining act and so keep the show alive.

Under the stage the tape recorder's spools keep turning so providing breath for the theatre, and only occasionally are the spools stopped when an extra pause is needed. One thing is certain and that is that the tape recorder has added enormous potentials to the theatre. Its uses are limitless and accordingly it is playing a leading role in the marionette business. Since the introduction of the tape recorder my own show has been greatly streamlined; and, of course, I have been able to dispense with several assistants and a live cast.



Every tape recorder, no matter how good, needs repairing and servicing at some time or other. For this you need a dealer who is ready and *able* to give a delicate machine the specialised attention it needs. Here is the solution to your problem. Study the list to see who is the nearest dealer who can help with a top line repair service for top line machines, at reasonable cost\*.

#### **Birmingham Area**

##### **REG. WARD & CO. LTD.,**

229 Heath Road, Bournville, Birmingham, 30.  
5 Alvechurch Road, West Heath, Birmingham, 31.  
21c Alcester Road, Studley, Warwicks.  
21 The Square, Alvechurch, Worcester.

#### **Glasgow Area**

##### **CLYDE ELECTRONICS,**

4 Maule Drive, Glasgow, W.1.

##### **J. JOHNSTON & SON (ELECTRONICS) LTD.,**

61 Kilbowie Road, Clydebank, Dunbartonshire.

#### **Liverpool Area**

##### **WM. E. POTTER LTD.,**

64 Dale Street, Liverpool, 2.

##### **E. A. STEVENSON (ELECTRICAL) LTD.,**

178 Oakfield Road, Liverpool, 4.

122 Widnes Road, Widnes, Lancs.

La Scala Building, High Street, Runcorn, Cheshire.

##### **SIDON (G. F. & E. Sims),**

10 Greenway Road, Higher Tranmere, Birkenhead,

Cheshire.

Electric House, Market Hall, Birkenhead, Cheshire.

#### **London (North-West) Area**

##### **SIGNAL SERVICE (WEMBLEY) LTD.,**

461 Uxbridge Road, Hatch End, Middlesex.

454 High Road, Wembley, Middlesex.

2 Station Approach, Carpenders Park, South Oxhey,  
Herts.

## \*YOU CAN INSURE YOUR TAPE RECORDER WITH Telesurance

Telesurance can help you with a fully comprehensive insurance policy for your machine if it is less than twelve months old. The policy protects your tape recorder against the risks of Fire, Theft, Accidental Damage or Breakdown. There are no repair bills to

worry about—Telesurance takes care of them. Ask your local Telesurance Agent for details or write to

Telesurance Limited, 14 Windmill Street,  
London, W.1. (Telephone: MUSEum 8584).

# A REPORT ON THE GARRARD BATTERY DECK

THE term "portable" has been used to describe anything that has a handle. In the tape recorder market, the euphemism has even been applied to those steel-clad monsters with steam-roller flywheels and traction-engine drive, firmly anchored to the site by Laocoon cables; monsters which develop a case of the yaws if the operator as much as leans sideways as he punches the keys.

The true portable, battery operated, shoulder-slung and simple to use, has been developed along specialist lines. Partly because of its price, it is a toy or a tool for the enthusiast—who usually employs it only for recording, transferring his tape to a more ambitious rig if he wants a playback of any quality. The ordinary tape recorder user bypasses it, or tries it for a short time then becomes dissatisfied at having to replenish batteries.

At the 1962 Radio Show, however, considerable public interest was shown in the newest model of the battery operated tape decks, the two-speed, half-track *Garrard Magazine Deck*, which is likely to be seen in a number of future machines made expressly for the "popular" market.

## Conventional Styling

Cause of this breakthrough will undoubtedly be the retention of conventional styling. The battery version is remarkably similar in appearance to the proven and familiar Garrard Magazine Deck, but has been streamlined in both size and weight. Its overall measurements are just 9 in. × 6½ in. × 1½ in. above and 2¼ in. below the mounting board. It weighs three pounds.

The advantage of magazine loading, which may not be so important with a mains-operated, table machine, becomes obvious when the battery version is considered. It takes only a second to change magazines, needs no fiddling, and can be done in the dark. When removed, the magazine holds its spools locked by the sprung brake, so that recording or playback can be continued from the same point: moreover, the complete magazine can be transported without fear of damage to the tape. There is no need to spool off and rethread.

These points, which may cause a frown on the purist's brow, and are certainly not novel to *Tape Recorder* readers, are worth re-stating, if only because they will be important selling factors on many future machines. Just as this year at Earls Court brought a revival of the truly portable gramophone—transistorised, battery driven radiograms to add to the worries of the Noise Abatement Society in our parks and on our beaches—so next year may see an increase in the companion instrument, the tape recorder. And with popularisation, the magazine deck will score. Having said as much, let us examine the model we have before us already.

## Standard Spools May Be Used

It should first be stated that this deck is not restricted only to magazine operation. Normal spools, up to 4 in. diameter, can be mounted in the ordinary way. The magazine contains two such spools with 650 ft. of double-play tape. As a small bonus, two spool retainers (rubber) are supplied, stored on the lower pair of the top-plate fixing screw heads. With these in position, the deck will operate in any position, although on test I found it objected to a swinging movement when held vertically.

This deck is a basic transport mechanism, plus record/play head and erase head. It has two speeds, 3¼ and 1½ i/s, with fast wind in each direction; both these points are an improvement on the mains version. The motor operates on 9 to 7 volts, D.C., a standard transistor portable battery. In fact, I tested this model on batteries down to 5½ volts as well as fully powered, and found very little variation of speed or regularity, which

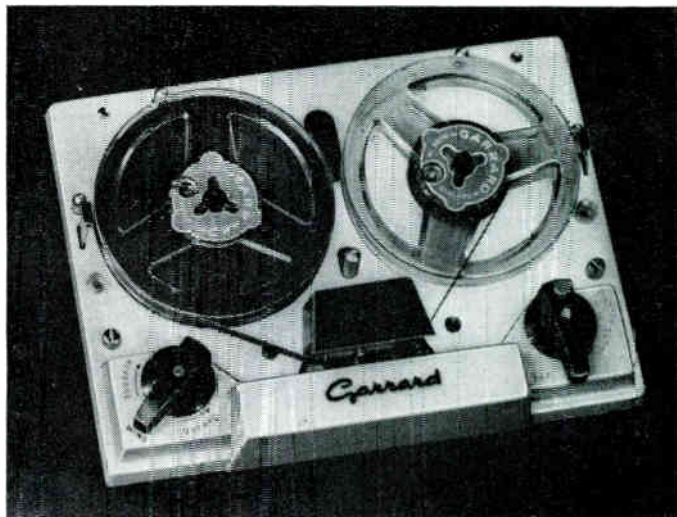

indicates that the maximum life will be obtained from batteries. Constructors should note that it is advisable to employ separate batteries for motor drive and amplifier unit, as the consumption rate varies differently for each purpose: segregation is both more efficient and more economic.

Consumption did not exceed the 200 mA maximum (during rewind), but the quoted currents for record/play at the two speeds were obtained on the machine I tested when the supply was 7½ volts. With a full 9 volts input, the current consumption was approximately ten per cent. higher.

## Removable Head Cover

Despite its small size and lightness, the Garrard Battery Deck is a well-engineered job, in the manner we have come to expect from this company. The knobs mount solidly on square spindles, lever action is unequivocal, the drive is firm, via well-sprung rubber pulleys and the brass flywheel is of generous dimensions for such a small deck. Removal of the two knobs and four screws enables the top cover to be taken off, exposing the main deck plate and head assembly. (The rear head cover is removable for cleaning purposes.) The driving components, beneath this deck plate, are protected by an angled plate, through which only the switch spindle and motor mounting protrude. The spindle is extended to carry a wafer switch; Messrs. Garrard suggest the Plessey Type GA1, Size II as a suitable switch.

This spindle is turned by movement of the R/P knob when the red Record button (integral with this knob) is depressed. Thus, the machine is electrically set to Playback during normal functions. Mechanically, the R/P knob selects Off, Pause and record/playback. The Pause position switches on the motor, via the single-pole leaf switch, but the pressure roller is not engaged and the brakes remain on. Movement to R/P turns a cam in which is set a locknutted screw, engaging a flange on the pressure arm. Extension of this screw allows adjustment of roller pressure. Pressure pads are felt on blocks of foam rubber, light and self-adjusting. It is noteworthy that the selection of the 'Pause' position with the red Record button pressed allows a single movement of the switch spindle. This enables circuitry to be incorporated for checking Record level before tape movement commences.

A stepped pulley on the motor spindle engages a rubber idler which in turn engages the flywheel for tape transport. This main

BIG  
TAPE-RECORDER HIT  
FROM HITACHI

**SMALLEST PORTABLE**  
GIVES BIG-MODEL PERFORMANCE!

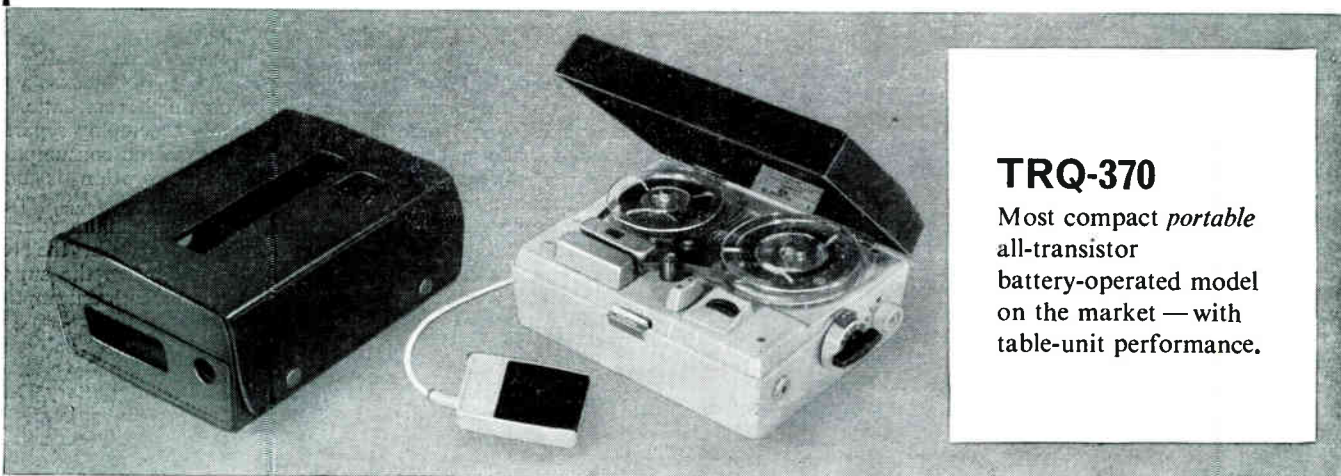

**TRQ-370**

Most compact *portable*  
all-transistor  
battery-operated model  
on the market — with  
table-unit performance.

*Note these features* — remarkable for a portable:

- \* 7 Transistors — 500 mW output.
- \* Undistorted reproduction.
- \* *Two* recording speeds —  $3\frac{3}{4}$ " / sec.  $1\frac{7}{8}$ " / sec.
- \* Accurate recording meter — also indicates battery level.

- \* Built-in remote control switch in microphone.
- \* Single control knob for record, play-back, erase and rewind.
- \* monitoring earphone.

Retail price **52 gns.** Includes heavy hide carrying case with strap, also separate leather case for microphone and accessories.

ORDERS AND ENQUIRIES TO: **LEE PRODUCTS (G.B.) LTD.**,  
10/18 CLIFTON STREET, E.C.2. TEL: BIS 6711. (Distributors for U.K.)

 **Hitachi, Ltd.**  
Tokyo Japan

## GARRARD DECK REPORT—cont.

idler is raised and lowered by the slide action of the speed-change selector, to engage different diameters of the motor pulley. A further idler, mounted on a sprung swivel, engages the flywheel and clutch-drum (right-hand) for fast forward wind. Thus the speed selector has an effect on forward wind speed, because of the intermediate flywheel drive. Fast rewind, however, is obtained by a swivel movement of the motor, engaging the rubber intermediate wheel of the left-hand spool, on which the spool carrier is directly mounted.

### A.C. Erase Head

Take-up drive is via a spring belt from a subsidiary pulley on the flywheel spindle to the right-hand clutch-drum. The clutch is a thin plastic disc, with the lower section of the drum spring-loaded lightly on the carrier spindle. This is mounted in a bearing and held by a 4 BA screw, allowing some adjustment of spool level. Spool brakes are applied by a central bracket, sprung on,

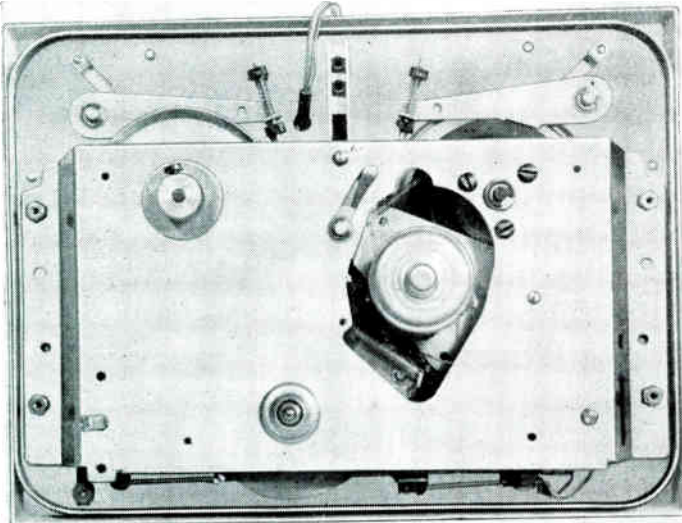

with two rods which have terminal locknuts and light adjustor springs. A similar plastic "nut" is fitted to the on/off switch operating rod, allowing fine setting. These small refinements are certainly worthy of praise. Another point worthy of note is the provision of an AC erase head. This is a 300 ohm impedance type, with a required 20 volts at 50 Kc/s.

I have now ascertained the following performance figures: Wow and flutter—better than 0.2 per cent. *r.m.s.* Recording current (at 50 Kc/s)—30-100  $\mu$ A high impedance head; 60-200  $\mu$ A medium impedance head. Output (2 Kc/s at  $3\frac{1}{4}$  i/s)—3 mV high impedance head; 1.5 mV medium impedance head; (3 Kc/s at  $7\frac{1}{2}$  i/s)—5.3 mV high impedance head; 2.7 mV medium impedance head; (1 Kc/s from EMI test tape T.B.T.I.)—1.1 mV high impedance head; 0.55 mV medium impedance head. The performance of this little deck was far above expectations, and at its price, £10 15s., it is a definite asset to the constructor.

**Manufacturer's Specification:** Tracks: Two. Direction: left to right. Sense: Top Track Recording. Speeds:  $3\frac{1}{4}$  and  $1\frac{1}{2}$  i/s. Supply voltage: 7 to 9 volts DC. (Other voltages available). Current consumption:  $3\frac{1}{4}$  i/s, 95 mA average.  $1\frac{1}{2}$  i/s, 70 mA average. Fast Wind, 200 mA maximum. Spool Size: 4 in. (650 ft. double play tape). Playing time:  $3\frac{1}{4}$  i/s, 35 min. per track, total 1 hr. 10 min.,  $1\frac{1}{2}$  i/s, 70 min. per track, total 2 hr. 20 min. Rewind time: 2 min. for 650 ft. spool. Fast forward:  $3\frac{1}{4}$  i/s selector setting, 3 min. average. R/P head inductance: at 1 Kc/s, 450 mH or 110 mH. Erase Head impedance: 300 ohms. Erase voltage: 20 volts, A.C. Bias Frequency: 50 Kc/s. Weight: 3 lbs. Size: 9 in. x  $6\frac{1}{2}$  in. x (+  $1\frac{1}{8}$  in. -  $2\frac{1}{4}$  in.) Manufacturers: Garrard Engineering and Manufacturing Co., Ltd., Newcastle Street, Swindon, Wilts.

## RAPID RECORDING SERVICE

78s and L.Ps. from your own tapes. (48 hour service).

Master Discs and pressings.

Recording Studio.

Mobile Recording Van.

Associated Company:

### EDUCATIONAL RECORDINGS LTD.

Specialists in Sleep-learning and Audio-learning. Tapes on Mind Management; Positive Personality; Memory Training; How to Pass Examinations.

Manufacturers of the "Sleep-o-matic Unit" to be used with our Sleep-learning tape.

Foreign language courses available for Sleep-learning.

Brochures on request from:

RAPID RECORDING SERVICE, Dept. TR,

21 Bishop's Close, Walthamstow, E.17. COP 3889

YES!  Tapes  
are records too!

THEY used to be called tape-recorders; but now they are called tape gramophones. If you are a music lover whose ears are *truly sensitive* you will find your tape gramophone a more refined, a more responsive, above all a better gramophone. SAGA TAPE-RECORDS are tomorrow's records. They are on sale at your nearest record retailer. SAGA TAPE-RECORDS are made on SCOTCH brand tape exclusively.

Ask for  by name

SAGA RECORDS LTD., 127 KENSAL RD., W.10

## BRAND NEW FAULT FREE 100% TESTED TOP QUALITY RECORDING TAPE

(As supplied to the Far East Broadcasting Corp.)

### WHY PAY MORE?

Polyester Long Play. Super Quality			P.V.C. Standard		
Size	Length	Price	Size	Length	Domestic Price Super
3"	220'	3s. 0d.	3"	160'	2s. 3d. 2s. 6d.
5"	900'	11s. 6d.	5"	600'	8s. 6d. 9s. 0d.
5 $\frac{1}{2}$ "	1200'	16s. 0d.	5 $\frac{1}{2}$ "	900'	10s. 9d. 11s. 6d.
7"	1800'	23s. 0d.	7"	1200'	15s. 3d. 16s. 0d.

REFUND GUARANTEE (Never requested)

N. WALKER, 28 Linkcroft Avenue, Ashford, Middlesex

you'll be glad you chose  
**gevasonor**  
magnetic tape

Ask your dealer for free descriptive leaflet

**GEVAERT**

GEVAERT LIMITED  
BRENTFORD · MIDDX.

# Two Years Guarantee

NOT MASS PRODUCED BUT VIRTUALLY HAND-MADE FOR RELIABILITY  
AND CONSISTENTLY HIGH STANDARD OF PERFORMANCE

**R10 SPECIFICATION: 2 or 4 track version. 10 watts push/pull output.**

Record Replay Responses—

7 $\frac{1}{2}$  ips. 40-16,000 C.P.S. }  $\pm 3$  dBs.  
3 $\frac{3}{4}$  ips. 40-10,000 C.P.S. } At optimum  
1 $\frac{7}{8}$  ips. 50- 6,000 C.P.S. } bias setting.

Signal/Noise ratio—

half track 50 dBs at 3 $\frac{3}{4}$  ips.  
quarter track 45 dBs at 3 $\frac{3}{4}$  ips.

Modified Collaro Studio Deck. Microphone and Radio/Gram inputs each with separate gain controls for mixing. Separate bass and treble controls.  $\pm 12$  dBs at 50 cycles and 12 k/cs. Adjustable monitor volume control independent of record level. Peak signal lever meter 2 $\frac{1}{4}$  in. square. Bogen heads. Record safety device. 600 ohms Cathode follower output. Two per cent total harmonic distortion on peaks. 200/250 volts 50 cycles or 100/120 volts 60 cycles. Valve line up: 3 EF86, 2 ECC83, 1 ECC82, 2 ECL86. Metal rectifier, contact cooled.

Prices: 2 Track 7" spools ... .. 59 gns.  
4 Track 7" spools ... .. 69 gns.



Fully illustrated literature available on request to—  
**REPS (TAPE RECORDERS) LTD.**  
118 Park Road North, South Acton,  
London, W.3 Phone: Acorn 4141

## J. J. FRANCIS (WOOD GREEN) LTD.

ALL  
MAKES  
OF  
RECORDERS

★  
AUDIO  
EQUIPMENT

★  
SPEAKERS

★  
MIKES

★  
TAPE

★  
AND UNUSUAL EQUIPMENT

### NEW RECORDERS AVAILABLE FROM STOCK

BRENELL MK. 5.M.  
SONY 521.  
AKAI M.6.  
REVOX E.36.  
FERROGRAPH 4.A.N.  
TELEFUNKEN M.24.  
PHILIPS EL.3541/2.  
REFLECTOGRAPH "A".

### QUALITY MACHINES BOUGHT FOR CASH

(All goods bought MUST be free of H.P. and credit agreements).

J. J. FRANCIS (WOOD GREEN) LTD.,  
123 Alexandra Road, Hornsey, N.8.  
Bowes Park 1662.

Write—Phone—Call (all letters answered).

### USED MACHINES

AMPEX 961 (as new)	...	...	...	£150
FERROGRAPH SERIES 4	...	...	...	£75
VORTEXION W.V.A.	...	...	...	£65
VORTEXION W.V.B.	...	...	...	£60
FERROGRAPH 808	...	...	...	£75
FERROGRAPH 88	...	...	...	£55
FERROGRAPH 4.A.S.	...	...	...	£68
M.S.S. PERFECT	...	...	...	£45
GRUNDIG TK.60 (new)	...	...	...	£89
GRUNDIG TK.55.	...	...	...	£50
FICORD IA.	...	...	...	£35
PHILIPS STEREO	...	...	...	£60
ELIZABETHAN "ESSEX"	...	...	...	£25
TELEFUNKEN "77"	...	...	...	£35
TELEFUNKEN "85 KL"	...	...	...	£55
ROBUK	...	...	...	£25

MANY OTHERS TOO NUMEROUS TO LIST

## WE SPECIALISE IN PART EXCHANGE!



# ... tape recorder workbench

## No. 40. AN A.C. VALVE MILLIVOLTMETER

by A. Bartlett Still

LAST month I promised to give some hints on the construction of the A.C. Valve millivoltmeter that I have been using for several years. In fact, two or three other units have been built, to my knowledge, using an entirely different mode of construction and presentation. Incidentally their success serves to point out that the construction is not at all critical providing certain basic rules are followed.

The photograph will give a fairly good general idea of the arrangement I used. You may notice an additional selector switch. This was arranged to by-pass the amplifier so as to use

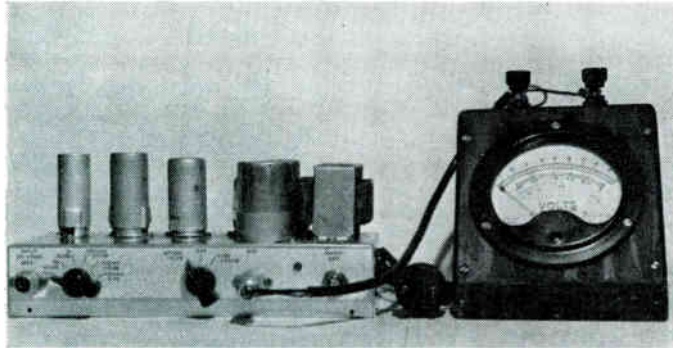

the attenuator only, with Cathode follower input and output. One of those bright ideas to increase the flexibility of the equipment, but I do not think I have used it once!

I give a list of suitable components, most of which, however, have appropriate replacements from other manufacturers. Quite a number of high stability resistors are used, both to ensure stable gain and to keep down the noise level. The 100K and 150K resistors used in the attenuator should all be 1 per cent. tolerance, remember that it is on the accuracy of this item that the whole unit depends. Those used elsewhere need only be of 5 per cent. accuracy.

The attenuator components should be mounted directly on to the rotary switch, keeping the leads reasonably short but, with this in mind, keeping each resistor as far from its neighbours as possible. This will keep the capacity shunting to a minimum and help to keep the top cut-off frequency as high as possible. It will be apparent from the photograph that all the valve holders have been placed in a straight line, and I believe this to be best. To avoid any possibility of oscillation the input and output should be kept apart, and this is the simplest way of doing it.

Having made a chassis to suit the components to be used, and aluminium is a good choice—it is easily worked and has the right electrical characteristics, the major components should be assembled. In order to avoid the undesirable effects, poor signal/noise ratio, that can arise if signal currents return through the chassis, an earth bus-bar should be used. This should be put in first and will consist of a length of stout, bare, copper wire mounted on, and soldered to, the central "pips" on each valve base. If the valve bases you are using do not have these pips, the wire should be anchored to a pin that needs to be earthed, such as the suppressor grid or a shield connection. The bus-bar will be joined to chassis as close as possible to the first valve base, one of the mounting screws is usually ideal. All components on each valve that go to earth can now be taken to this bus-bar, with the exception of decoupling or smoothing capacitors, which go directly to chassis.

I would suggest that the heater wiring is put in at an early stage. The two wires should be tightly twisted together and tucked down into the corner of the chassis remote from as many other components as possible, particularly the input socket (which should be in its own screened compartment)

and the attenuator. Components that go between one valve and the next can be mounted directly between the two tags. It is true that this will not give you the tidy assembly that would result if a tag board were used to mount all the components, but it is probably the safest, simplest, way of ensuring stability.

The two preset controls should be arranged so that they are covered up when the bottom is put on, this will prevent their being altered by accident. The setting of the calibration control was dealt with last month, setting the output to be the same as the input when the attenuator is all "in". This will, of course, represent the 10V range. While the unit is used solely as a meter, the setting of the humdinger will be relatively unimportant. If used as an amplifier, however, the hum level will need to be as low as possible, and this control will be found to give quite a distinct minimum.

Now for my list of components, and let me say once more that these are suggestions, suitable replacements can be used instead.

Resistors	
1 820Ω ... ..	Erie Type 109
1 1.5 K ... ..	" " 9
1 2.2 K ... ..	" " 9
1 2.2 K ... ..	" " 8
1 4.7 K ... ..	" " 9
1 10 K ... ..	" " 9
2 22 K ... ..	" " 9
1 33 K ... ..	" " 9
1 100 K ... ..	" " 9
8 100 K ... ..	" " 109
5 150 K ... ..	" " 109
7 200 K ... ..	" " 109
1 220 K ... ..	" " 9
1 330 K ... ..	" " 109
1 560 K ... ..	" " 9
2 1 M ... ..	" " 9
Capacitors	
1 .01 Mfd ... ..	TCC Type 383
4 .1 " ... ..	" " 346
1 1 " ... ..	" " 345
3 4 " ... ..	" " CE18L
1 8-16 " ... ..	" " CE27L
1 25 " ... ..	" " CE31B
1 32-32 " ... ..	" " CE27LE
2 Clips ... ..	" " S3372
Valves	
2 EC91 or L77	2 EF86 or Z729
Miscellaneous	
1 100 Ω Potentiometer Colvern CLR 1106.	
1 25 K Potentiometer Egen Type 170.	
1 S.P. 6-way Switch N.S.F. Type DM.	
1 S.P. S.T. Switch Bulgin Type S295.	
1 Rectifier S.T.C. C2D.	
1 Transformer 200-250V 25mA. 6.3V 1A Gardner Type MR 200	

One final point, it is better to fit a two-core mains lead, and not to earth the unit directly. An earth might be made, via the screen of the input cable and any equipment to which it is connected, thus forming a "ring". This could introduce mains hum and affect the reading on the more sensitive ranges. If a reliable double-wound transformer is used, such as the one I have suggested, the unit should be quite safe. However, an earth wire can always be clipped on with a crocodile clip.

# Armstrong Quality Tuners

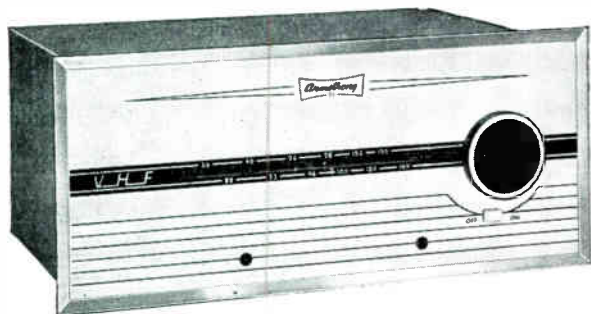

- T4B FM TUNER (illustrated) £21.18.0  
 T4C FM TUNER (without case) £19.19.0  
 ST3 Mk 2 AM/FM TUNER £27.16.0

We also make a wide range of high fidelity amplifiers and tuner-amplifiers, both mono and stereo, all of which offer top quality performance at reasonable prices.

Write for free descriptive literature to

**ARMSTRONG** (DEPT. TTN), WALTERS ROAD, HOLLOWAY, LONDON, N.7.

**NORTH 3213**

## Designed to match any amplifier or tape recorder

The T4B model (and uncased version—T4C) is a self-powered high fidelity FM Tuner. Automatic frequency control ensures complete stability and the cathode follower stage, together with the variable output control, enables it to be used with any amplifier or tape recorder. All these features are to be found also in the ST3 Mk. 2 AM/FM Tuner together with coverage of the medium and long wavebands. The AM section includes a ferrite aerial and two IF stages ensuring good Continental reception, and there is a miniature bright-line indicator for easy tuning.

For first class recordings from radio with absolute stability, there is nothing better than an Armstrong tuner and we confidently assert that there is no better value on the market.

**AVAILABLE FROM LEADING HIGH FIDELITY AND TAPE RECORDER DEALERS THROUGHOUT THE COUNTRY**

### 18 Months to Pay

	Deposit	18 Monthly	Cash
	£ s. d.	Payments	Gns.
	£ s. d.	£ s. d.	Gns.
<b>MAINS 2-TRACK</b>			
Truvox R82 ...	5 15 6	2 17 9	55
Brenell 3 Star ...	6 2 0	3 0 11	58
Reps. R.10 ...	6 4 0	3 2 0	59
Brenell Mk. 5 ...	7 2 0	3 6 10	64
Grundig TK41 ...	8 0 0	3 18 8	75
Telefunken 85 de Luxe			
Brenell 5 Type "M"	9 5 0	4 12 5	88
Veritone 16 ...	9 13 0	4 15 6	91
Simon SP/5 ...	9 16 0	4 17 8	93
Reflectograph "A"	11 5 0	5 10 0	105

#### 4-TRACK MONAURAL

Grundig TK23 ...	4 15 0	2 7 3	45
Brenell 3 Star ...	6 2 0	3 0 11	58
Truvox R.84 ...	6 4 0	3 2 0	59
Philips EL3549 ...	6 12 0	3 5 0	62
Reps. R.10 ...	7 5 0	3 12 6	69
Grundig TK40 ...	8 0 0	3 18 8	75

#### 4-TRACK STEREO/MONAURAL

Philips EL3534 ...	9 16 0	4 16 6	92
Telefunken 97 ...	10 0 0	4 19 9	95
Grundig TK46 ...	10 12 0	5 3 9	99
Akai M.6 ...	13 13 0	6 16 6	130

## THE RECORDER CO.

presents a NEW MODEL

**PHILIPS EL3534 de Luxe Stereo**



**PRICE 92 GNS.**

Up to 32 hours Mono Recording on one tape. All transistor amplifier.

Four speeds: 15/16, 1 1/4, 3 1/2 and 7 1/2 i.p.s. Complete with Stereo Microphone and two 5" x 7" loudspeakers.

We will be pleased to demonstrate this remarkable model, send for full details.

- \* INTEREST FREE terms
- \* FREE INSURANCE COVERING YOUR PAYMENTS IN THE EVENT OF SICKNESS OR UNEMPLOYMENT
- \* FREE DELIVERY
- \* PART EXCHANGES

### 12 Months to Pay

	Deposit	12 Monthly	Cash
	£ s. d.	Payments	Gns.
	£ s. d.	£ s. d.	Gns.
<b>MAINS TWIN-TRACK</b>			
Elizabethan LZ30 ...	3 7 3	2 10 5	32
Grundig TK14 ...	3 13 6	2 15 2	35
Reps. R.10 ...	6 3 11	4 13 0	59
Telefunken 95 ...	6 3 11	4 13 0	59
Ferrograph 5A/N ...	8 19 0	6 13 10	85
<b>4-TRACK</b>			
Philips "Scar Maker"	2 16 9	2 2 7	27
Philips EL3541 ...	3 15 8	2 16 9	36
Elizabethan LZ29 ...	3 15 8	2 16 9	36
Truvox R64 ...	4 2 0	3 15 0	39
Grundig TK23 ...	4 15 0	3 10 10	45
<b>BATTERY</b>			
Grundig TK1 ...	2 13 0	1 15 0	23
Philips EL3585 ...	2 10 5	1 17 10	24
Stella ST470 ...	2 15 0	1 19 2	25
Optacord 412			
Battery/Mains	4 15 0	3 10 10	45
Stuzzi Magnette ...	6 4 0	4 12 11	59
Butoba MT5 ...	7 0 0	5 3 10	66
Ficord 202 ...	7 0 0	5 3 10	66
<b>TRUVOX HI-FI TAPE UNITS</b>			
Twin-Track			
PD.82 Standard ...	4 4 0	3 3 0	42
PD.87 Stereo ...	6 6 0	4 14 6	63
4-Track			
PD.84 Standard ...	4 12 0	3 9 0	46
PD.86 Stereo ...	6 6 0	4 14 6	63

Open all day Saturday—  
Friday 6.30 p.m.

# THE RECORDER CO.

If unable to call, write for free brochure or send deposit now for quick delivery.

(Dept. R) 188, WEST END LANE, WEST HAMPSTEAD, LONDON, N.W.6.

Telephone: SW1 4977

# TAPE, RECORDERS & ACCESSORIES

## FIRST DETAILS OF NEW PRODUCTS

● We remind our readers that notices of equipment listed and illustrated in this monthly feature are in no sense reviews. When figures, specifications and diagrams are published, these data are extractions from manufacturers' lists. When samples of this equipment are submitted for test, they are passed to our technical contributors, whose reports are published in a separate section.

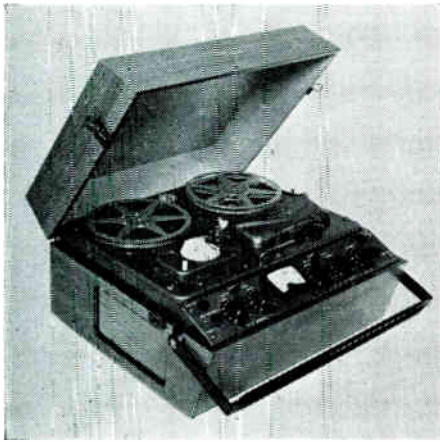

★  
**CLARKE  
 AND SMITH  
 TR 634 and TR 635  
 TRANSISTORISED  
 TAPE  
 RECORDERS**

FOR over twelve months, Clarke and Smith Manufacturing Co. Ltd., have been making an intense study of the use of tape recorders in schools. The outcome of their survey has been the development of the TR 634 and TR 635 transistorised tape recorders.

Each machine is fitted with two completely transistorised amplifiers, one for record and the other for playback. The basic difference between the two machines lies in the choice of tape deck. The type TR 634 uses the latest Wearite model and the TR 635, the Truvox D 82 deck, with push button controls. Both the recorders are housed in robust lockable, light oak cabinets, fitted with specially-designed carrying handles. Deliveries start in November.

The specification supplied is common to both machines; Speeds:  $7\frac{1}{2}$  and  $3\frac{1}{2}$  i/s. Wow and flutter: 0.2% at  $7\frac{1}{2}$ ; 0.3% at  $3\frac{1}{2}$  i/s. Track width: .095 in. Frequency response: 50 to 15,000 c/s ( $7\frac{1}{2}$ ); 50 to 9,000 c/s ( $3\frac{1}{2}$ ) both  $\pm 3$  dB. Distortion of power amplifier less than 1% at 1 Kc/s at 10 watts. Signal to noise ratio: 50 dB ( $7\frac{1}{2}$ ), 48 dB ( $3\frac{1}{2}$ ). Inputs:  $1\frac{1}{2}$  mV, 15  $\mu$ V, and 60 mV. Outputs: 15 ohm, 70 volts line, and 1 volt at 5,000 ohms. A 9 x 5 in. speaker is fitted. Other facilities provided include Recording meter, Tone controls, and Mixing. The price of the TR 634 is £108 3s. and the TR 635 £90 6s. Manufacturers: Clarke and Smith Manufacturing Co. Ltd., Melbourne Works, Wallington, Surrey.

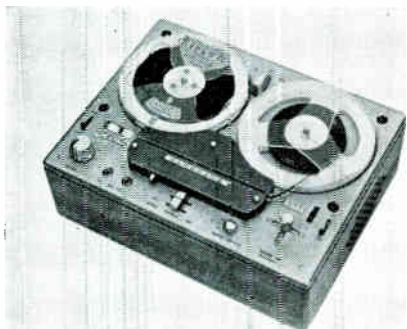

★  
**TANDBERG  
 SERIES 7  
 TWO AND FOUR  
 TRACK  
 TAPE  
 RECORDERS**

THE introduction of the Tandberg Series 7 has been announced by the distributors in this country, Elstone Electronics Ltd. Two versions are available, the Model 72 (two track) and Model 74 (four track). Three speeds are provided,  $7\frac{1}{2}$ ,  $3\frac{1}{2}$  and  $1\frac{1}{2}$  i/s. The claimed frequency response is 30-20,000 c/s at

$7\frac{1}{2}$  i/s; 30 to 14,000 c/s at  $3\frac{1}{2}$  i/s; and 50 to 7,000 c/s at  $1\frac{1}{2}$  i/s. Wow and flutter figures quoted are within 0.15%; 0.2% and 0.3%.

Two Goodman 7 x 4 in. speakers are fitted, and output speaker sockets allow external speakers to be used if required. The power output is 3 watts. Dual volume controls and two recording level indicators are provided. Other facilities available are monitoring on one track whilst recording on the other, automatic stop, digital revolution counter, pause control and bass switch.

Both models are supplied in teak cabinets measuring  $15\frac{1}{2}$  x  $11\frac{1}{2}$  x  $6\frac{1}{2}$  in. The weight is  $27\frac{1}{2}$  lbs. Price £97 13s. A carrying case is available as an optional extra at £7 1s. 8d. The distributors are Elstone Electronics Ltd., Edward Street, Templar Street, Leeds, 2.



★  
**SOUND  
 ADDON  
 STEREO  
 UNIT**

A STEREO Addon Unit designed to operate with any of the Sound 4 track, 1963 model recorders has been introduced by Tape Recorders (Electronics) Ltd. This will enable 4-track stereo tapes to be played. The unit is supplied ready wired for connecting to the recorder and the mains. The controls situated on the front panel are for volume, tone and on/off switch. The amplifier has an output of 3 watts and will operate from 200 to 250 volts A.C. 50 or 60 c/s. The price is £14 14s. Manufacturers Tape Recorders (Electronics) Ltd., 784-788 High Road, Tottenham, London, N.7.

### Gevasonor Triple-Play Tape

THE range of Gevasonor Magnetic Tapes has been extended by the addition of Triple-Play Tape. Using a tensilised polyester base, the thickness of this tape is 17 microns, or only one-third of their standard tape, type M.

Gevasonor Triple-Play Tape, is available in the following sizes: 3 in., 450 ft. Priced at 21s. 6d. 4 in., 900 ft. Priced at 38s. 6d. 5 in., 1,800 ft. Priced at 65s. 6d.

Further information can be obtained from the manufacturers Gevaert Ltd., Great West Road, Brentford, Middlesex.

### Grundig TM45 Tape Deck

SPECIALLY designed for incorporation into Grundig radio-grams is the company's Model TM45 tape deck. It is a stereo recorder and reproducer with all mechanical controls and components for tape handling. It has its own power pack, pre-amplifier, oscillators, recording level indicator, etc., but there are no output stages or loudspeakers and it is not contained in a case. The TM45, a four-track machine, is almost identical to the TK46 tape recorder. Price is £73 10s., excluding microphone. Microphones available for use with this machine are the GDM18 at £7 7s. and a special stereo microphone, the GDSM202, priced at £14 14s.

Manufacturers: Grundig (Great Britain) Ltd., 40 Newlands Park, London, S.E.26.

For highest  
quality equipment



at lowest  
possible prices

**HI-FI FM TUNER, Model FM-4U**

Available in two units which for your convenience are sold separately: Tuning unit (FMT-4U—£3 2s. incl. P.T.), despatched wired and tested, and I.F. amplifier (AFM-4U—£12 5s.). Printed circuit for I.F. amplifier and ratio detector. Built-in power supply; 7 valves. Tuning range 88-108 Mc/s. (Illustrated bottom right).  
Total price **£15.8.0**

**HI-FI AM/FM TUNER, Model AFM-1**

Also available in two units as above: Tuning heart (AFM-TI—£5 5s. 6d. incl. P.T.) and I.F. amplifier (AFM-AI—£20 13s.). Printed circuit board; 8 valves; consecutive FM limiting and ratio detector. Tuning range FM: 88-108 Mc/s; AM: 16-50, 200-550, 900-2,000m. Switched wide and narrow AM bandwidth. Built-in power supply. Total price. **£25.18.6**

**TO ALL MUSIC LOVERS AND  
HI-FI ENTHUSIASTS**

Our wide range does not permit adequate coverage here of all models. A FREE CATALOGUE and full specifications of any particular model will be gladly sent on request without obligation on your part. **ASSEMBLED MODELS NOW AVAILABLE, PRICES ON REQUEST.**

All prices include free delivery in U.K. Deferred terms available on orders over £10.

**Tape Recording and Replay Hi-Fi Amplifiers  
Models TA-IM (Mono) and TA-IS (Stereo)**

For use with most tape decks. Thermometer type recording indicators, press-button speed compensation and input selection, 3-position bias level and printed circuit construction.

TA-IM ...	£19.2.6
TA-IM and Collaro "STUDIO" ...	£30.10.0
TA-IM and Truvox D83 ...	£47.2.6
TA-IM and TRUVOX D84 ...	£45.5.0
TA-IS (illustration Centre) ...	£24.10.0
TA-IS and Collaro "STUDIO" ...	£35.14.0
TA-IS and TRUVOX D83 ...	£52.6.0
TA-IS and TRUVOX D84 ...	£50.9.6

A WHOLE RANGE OF PACKAGED DEALS (INCLUDING "CONNOISSEUR CRAFTSMAN" TURN-TABLE and DECCA fess PICK-UP) NOW AVAILABLE TO SAVE YOU FURTHER MONEY.

**HI-FI EQUIPMENT CABINETS**

A range of equipment cabinets is now available to meet the differing needs of enthusiasts. All are accurately machined for ease of assembly and left "in the white" for finish to personal taste. Designed for maximum operating convenience or for where room space is an overriding consideration, this range has at least one model to meet your requirements. Why not send for full details?



THE "MALVERN"

**£11.12.6 to £18.10.0**

**"COTSWOLD" HI-FI FREE SUSPENSION  
SPEAKER SYSTEM**

This is an acoustically designed enclosure 26 in. x 23 in. x 14½ in. housing a 12 in. bass speaker with 2 in. speech coil, elliptical middle speaker, together with a pressure unit to cover the full frequency range of 30-20,000 c/s. Capable of doing justice to the finest programme source, its polar distribution makes it ideal for really Hi-Fi Stereo. Delivered complete with speakers, cross-over unit, level control. Tygan grille cloth, etc. All parts pre-cut and drilled for ease of assembly and left "in the white" veneered for finish to personal taste. Can be easily assembled in an evening and you then have a system fully comparable with any in the £40-£75 class. Assembled weight 61 lb. **£23 4s. 0d.**



COTSWOLD

**Here are some other easy-to-build Heathkit Models for you:**

**HI-FI SPEAKER SYSTEM Model SSU-1.** This kit is easily assembled. It contains twin speakers and balance control in its direct ducted port reflex cabinet. It is equally suitable for stereo or mono in average room. (Legs 14/6 optional extra). **£11 5s. 0d.**

**HEATHKIT ELECTRONIC WORKSHOP KIT, Model EW-1.** This new kit will help your boy to understand electronics, by making at least 20 exciting experiments, including Transistor Radios, Intercom Sets, Burglar Alarm, Electric Eye, etc. **£7 18s. 0d.**

**HI-FI STEREO 6-WATT AMPLIFIER Model S-33.** Attractively styled, completely self-contained. Printed circuit makes it easy to build. Only 0.3% distortion at 2½ W/chal. U/I output, ganged controls. **£13 7s. 6d.**

**AUDIO SIGNAL GENERATOR Model AG-9U.** Delivers up to 10 volts pure sine-wave (less than 0.1% distortion, 20 c/s to 20 kc/s). Decade switch-selected frequencies from 10 to 100,000 c/s. Internal 600 Ohm N/I load, or external. **£21 9s. 6d.**

**POWER AMPLIFIER 12-WATT Model MA.12.** Single channel, ideal for stereo conversion. **£10 19s. 6d.**

**LOW INPUT HI-FI STEREO PRE-AMPLIFIER Model USP-1.** An input of 2-20 mV will produce an output adjustable from 20 mV to 2 volts. This enables low-input p.u.'s, etc., to load fully subsequent amplifiers of medium sensitivity. Negligible distortion. **£7 7s. 6d.**

**COLLARO "STUDIO" TAPE DECK.** Two tracks. "Wow" and "flutter" not greater than 0.15% at 7½ p.s. Long Term Speed Stability better than 0.5%. **£17 10s. 0d.**

**SUGDEN MOTOR UNIT "CONNOISSEUR CRAFTSMAN".** Heavy duty motor, operating at 33½ and 45 r.p.m. Very heavy 12" turntable. **£18 3s. 6d.**

**VARIOUS AUDIO ACCESSORIES** such as Speakers and Microphones etc. available. List sent on request.

**HI-FI STEREO 18-WATT AMPLIFIER Model S-99.** Within its power rating, this is the finest stereo amplifier available, regardless of price. U/L push-pull output. Printed circuit construction. **£27 19s. 6d.**

**TRANSISTOR INTERCOM. Models XI-1U and XII-1U.** Ideal for office or home. Each Master operates up to five Remotes. 9v battery operated. **XI-1U £10 19s. 6d. XII-1U £4 7s. 6d.**

**STEREO CONTROL UNIT Model USC-1.** A deluxe stereo control unit with variable filter, switched rumble filter, printed circuit boards and many other refinements. Operates direct from tape heads. **£19 10s. 0d.**

**TRANSISTOR PORTABLE RADIO Model UXR-1.** Superbly styled hide case, with golden relief and crystal easy-to-tune dial; this completely self-contained 6-transistor dual-wave set performs brilliantly everywhere, even in a car. Reproduction is exceptionally good. Printed circuit. **£14 3s. 0d.**

**SHORTWAVE TRANSISTOR PORTABLE Model RSW-1.** Four wave-band seven transistor portable with telescopic and ferrite aerials, slow-motion tuning. Covers Medium, Trawler, and 6-26 Mc/s in four switched bands. Uses printed circuit board and latest circuit technique. Superbly styled leather case. **£22 8s. 0d.**

**TRUVOX D83 AND D84 TAPE DECKS.** High quality mono/stereo Tape Decks. **D83 2-track for highest-fidelity. £31 10s. 0d. D84 (identical presentation) 4-track for most economical use of tape. £29 8s. 0d.**

**"MOHICAN" GENERAL COVERAGE RECEIVER Model GC-1U.** Fully transistorised. Four piezo-electric transmitters. To overcome the problems of alignment, etc., the R.F. "front end" is supplied as a pre-assembled and pre-aligned unit. **£39 17s. 6d.**

**GOLDRING-LENCO TRANSCRIPTION RECORD PLAYER Model G.L.58.** Fitted with the G.60 pick-up arm, it has infinitely variable speed adjustment between 33½ and 80 r.p.m. and four fixed speeds. 3½ lb. turntable to reduce rumble, "wow" and "flutter". **£19 12s. 6d.**

**SOME OTHER HEATHKIT MODELS AVAILABLE**

World's largest-selling VALVE VOLTMETER ...	Model V-7A	£13.18.6
G/P OSCILLOSCOPE (5 in. Flat-face screen) ...	Model O-12U	£38.10.0
"HAM" TRANSMITTER ...	Model DX-40U	£31.19.0
VARIABLE FREQUENCY OSCILLATOR ...	Model VF-1U	£11.17.6
TRANSISTOR RADIO for the youngsters ...	Model UJR-1	£2.13.6
RESISTANCE/CAPACITANCE BRIDGE ...	Model C-3U	£9.5.0
AUDIO VALVE MILLIVOLTMETER ...	Model AV-3U	£14.17.6
AUDIO WATTMETER ...	Model AW-1U	£15.15.0

**DAYSTROM LTD. DEPT. HT11  
GLOUCESTER, ENGLAND**

A member of the Daystrom Group, manufacturers of  
**THE LARGEST-SELLING ELECTRONIC KITS IN THE WORLD**



SSU-1

S-33

AG-9U

MA-12

USP-1

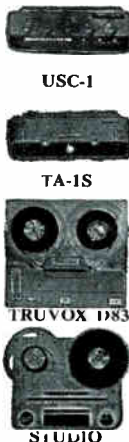

USC-1

TA-IS

TRUVOX D83

STUDIO



S-99



RSW-1



UXR-1



GL-58



F.M. TUNER

JUST POST THIS COUPON FOR FURTHER INFORMATION

Without obligation please send me

★ **FREE BRITISH HEATHKIT CATALOGUE . . .**

FULL DETAILS OF MODEL(S) .....

Kindly write below in BLOCK CAPITALS

NAME .....

ADDRESS .....

TICK  
HERE

\_\_\_\_\_

HT11

# EQUIPMENT REVIEWED

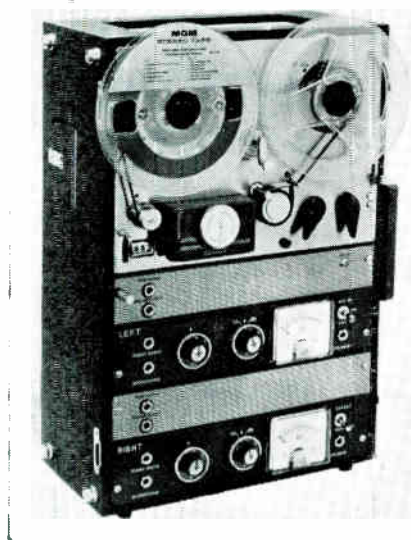

★  
AKAI M6  
TWO- AND  
FOUR-TRACK  
RECORDER  
★

**Manufacturer's Specification:** Frequency response: 30-20,000 c/s at  $7\frac{1}{2}$  i/s. 40-14,000 c/s at  $3\frac{3}{4}$  i/s. Tested with Scotch tapes 190A and 200. Head frequency response: 20-20,000 c/s at  $7\frac{1}{2}$  i/s, 30-15,000 c/s at  $3\frac{3}{4}$  i/s. Tape speeds:  $7\frac{1}{2}$  i/s,  $3\frac{3}{4}$  i/s and 15 i/s for dubbing only. Recording system: In line 4-track stereo records and 4-track monaural records. Heads: In line 4-track stereo record/playback head; 4-track monaural record/playback head; 2-track stereo playback head; separate 4-track erase head. Power sources: A.C. 100, 117 and 240 volts 50 or 60 cycles. Power consumption: 100 volt amps. Motor: Hysteresis synchronous motor. Output power: 6 watts each channel. Wow and flutter: Under 0.07% r.m.s. at  $7\frac{1}{2}$  i/s. Cross talk: 80 dB at 1,000 c/s -3V.U. Signal noise ratio: More than 45 dB. Fast forward and rewind time: 2½ minutes for each operation. Valves used: 2-EF86, 2-12AX7, 2-6BQ5, 2-6X4, 1-6AR5. Weight: Terecorder Model M-6, 46.5 lbs. Stereo Hi-Fi speaker system Model SS-50, 23 lbs. Accessories: 2.5 lbs. Dimensions: Recorder 14 × 20½ × 8½ in. Speaker system: 8½ × 14 × 20½ in. Accessories case 4½ × 9 × 4½ in. Price: M-6 recorder £136 10s. Speaker system £31 10s. Submitted by R. Marking and Co. Ltd., 197 Streatham Road, Mitcham, Surrey. Importers: Northgate (Cameras) Ltd., 119-125 Wardour Street, London, W.1.

THIS is a Japanese made recorder with American connections. It is sold under the name of Roberts in the U.S.A. and its appearance and styling is typical of a number of American

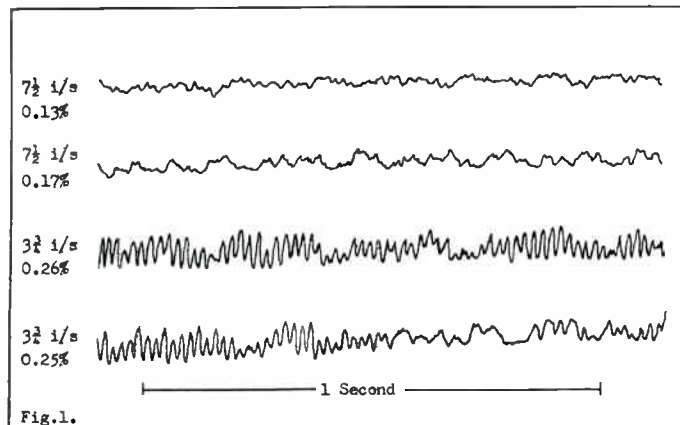

Fig.1.

machines. A thin walled capstan sleeve is fitted to bring the tape speeds to exactly  $7\frac{1}{2}$  and  $3\frac{3}{4}$  i/s on our 50 cycle mains, and a panel pre-set alters the motor phasing condenser to suit the lower mains frequency. A nominal 15 i/s capstan sleeve is supplied for tape dubbing at twice the normal speed, but on 50 cycle mains this gives a tape speed of only  $12\frac{1}{2}$  i/s and cannot therefore be used for this purpose in this country.

The most impressive feature of this machine is the Track Selector Control which switches, and mechanically moves, the heads to suit the chosen track configuration. Although the specification may give the impression that a number of heads are fitted there is in fact only a two track record-play head, with 43 thou' wide poles, and a matching erase head. The various track combinations are obtained by moving the heads relative to each other, and to the tape, and electrically switching the head connections. For example, for playing two track tapes, the R/P head is moved down so that the 43 thou' poles scan the centre of the 90 thou' tracks; for stereo four track recording the erase and R/P heads are in line to erase and record on tracks 1 and 3 simultaneously; for monaural recording on tracks 1 or 4 the erase pair are raised so that the bottom one scans the top (No. 1) edge of the tape and the upper erase head is off the tape altogether; in the same way for recording tracks 2 or 3 the erase head is lowered so that the bottom head is off the tape

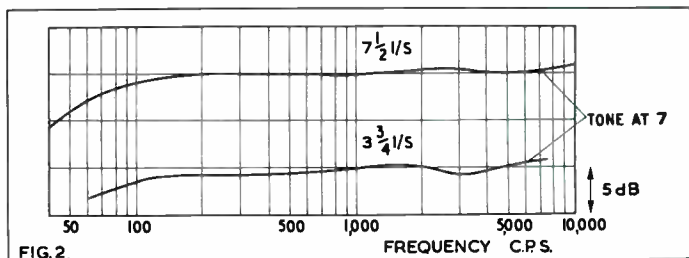

FIG.2.

and the top one scans track 3. In this way both erase heads are powered during recording but the unwanted one is moved off the tape; this obviates electrical switching of the erase heads and maintains a constant load on the bias and erase oscillator.

Standard ball and sleeve jacks are provided for microphone and loudspeaker inputs and outputs, and preamplifier and head outputs are also available for feeding power amplifiers or equalised preamplifiers. No pressure pads or guide rods are used; the mounting for the head is semi-circular and the tape tension is maintained at a constant value by careful braking of the supply reel.

## Speed Wow and Flutter

The tape speeds were checked and found to be within 1% of the nominal speeds from beginning to end of the largest reels. Wow and flutter figures were reasonably low at the higher speed as shown by my fluttergrams in fig. 1. There is a slight trace of capstan wow at about 6 c/s. The r.m.s. readings were 0.13% and 0.17% for the best and worst readings and this does not meet the specification figure of 0.07% r.m.s. The increased reading is probably due to the fitting of the capstan sleeve for 50 cycle operation; to meet the specification the fit and concentricity of the sleeve would have to be accurate to about a tenth of a thou'.

At  $3\frac{3}{4}$  i/s the combined wow and flutter reading remained nearly constant at around 0.25% with most of the reading due to 50 c/s flutter from the drive motor. The bottom pen recording shows that this flutter cancels from time to time as the recorded and playback flutters come in and out of phase. This reading and fluttergram look much worse than they sound, as the ear is less sensitive to high frequency flutter and is only conscious of the light capstan wow.

C.C.I.R. 100 and 200 microsecond test tapes were played and the tone control adjusted for the most level response in each

# PROFESSIONAL TAPES

by



DIVISION OF

**COLUMBIA BROADCASTING SYSTEM**

*for  
all  
who want  
better  
recordings*

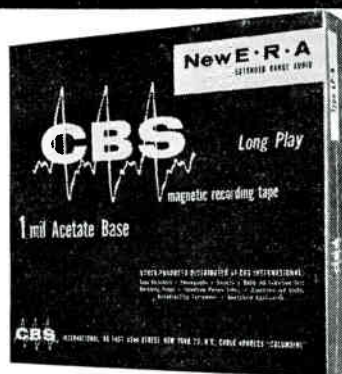

Specially prepared fine magnetic iron oxide dispersion; precision and uniformity in processing with quality control at all stages—these are some of the features that result in C.B.S. Tapes giving you extended frequency range, better wearing; better transients and the chance to make magnificent recordings from all sources even on quarter track machines at  $3\frac{3}{4}$  i.p.s.  
In all sizes—standard, long play and double play.  
Particularly recommended for  $\frac{1}{4}$  track and stereophonic uses.

See report, *The Tape Recorder* September issue, page 359.

## BETTER QUALITY FOR LESS COST

		5"	5 $\frac{1}{2}$ "	7"
Standard	1 $\frac{1}{2}$ Mil	600' 17/6	900' 23/-	1,200' 27/6
Long Play	1 Mil	900' 21/-	1,200' 25/-	1,800' 35/-
Double Play	$\frac{1}{2}$ Mil	1,200' 34/-	1,800' 45/-	2,400' 56/-
Standard Mylar		600' 21/-	900' 28/-	1,200' 35/-
Long Play		900' 25/-	1,200' 32/-	1,800' 47/-
Double Play 10 (Tensilised)		1,200' 42/-	1,800' 55/-	2,400' 68/-

- ★ With leaders and stop foils
- ★ Superb quality at  $3\frac{3}{4}$  i.p.s.
- ★ Long wearing
- ★ Recommended specially for four track instruments
- ★ Consistently high quality in all grades

**CBS TAPES**

12-16 WATLING ST., LONDON, E.C.4  
CITY 2238

# This is the LUSTRAPHONE 'Micridyne'

## MICRO-MINIATURE RIBBON MICROPHONE

*Another  
outstanding  
contribution  
to microphone  
progress*



Of the many advancements in microphone design made by LUSTRAPHONE the VR/70 "Micridyne" micro-miniature ribbon must be one of the most outstanding yet. This amazingly small instrument incorporates a completely new conception of magnetic design to enable the smallest-ever ribbon microphone to be produced. Improvements of many kinds are incorporated. The head, which has a volume of less than 1 cu. in., permits unobstructed air flow all round, thereby achieving extended frequency response. Substantial blast screening and entirely new anti-vibration mounting technique are used. 3-pin plug and socket connections permit the microphone to be used on its own base, held in the hand or mounted on a stand. The microphone is complete with stand and appropriate cable in high, line or low impedances.

### ● BRIEF TECHNICAL DETAILS

- Sensitivity—  
Low 1 amp. 90 dB below 1V/dyne/cm.  
High 1 amp 56 dB below 1V/dyne/cm.
- Response—  
Substantially flat from 50-14,000 c/s.
- Pattern—  
Figure of 8.
- Head Dimensions  $2\frac{1}{8}$  in.  $\times$   $\frac{11}{16}$  in. wide  $\times$   $\frac{1}{2}$  in. (Height of microphone unit to plug, 6 in.)
- Overall Height on base,  $7\frac{1}{2}$  in.
- Base diameter,  $5\frac{1}{2}$  in.
- Finish. Satin chrome and black with rubber cushioned legs.
- Weight (complete),  $6\frac{1}{2}$  ozs.

Price: Low impedance **10 gns.**

### KEEPS FAITH WITH SOUND

Descriptive literature on application.

**LUSTRAPHONE LTD.**

ST. GEORGE'S WORKS,  
REGENTS PARK ROAD, LONDON, N.W.1  
Phone: PRImrose 8844.



## EQUIPMENT REVIEWED — continued

case. These responses are shown in fig. 2. Top and bottom tracks were tested on the same tapes and the responses and tone control setting were virtually identical. Noise and hum were 42 dB below test tape level. The tone control gave a range of +8 dB to -15 dB at 10,000 c/s.

### Record Replay Responses

The record/play responses were equally satisfactory and these are shown by fig. 3. It will be seen that a level playback response is now obtained with the tone control at 5 instead of 7.

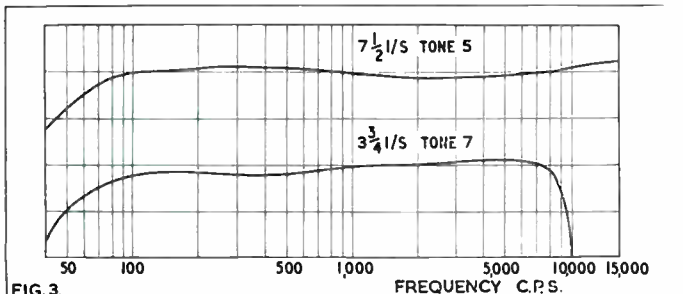

This shows that the recorded response at  $7\frac{1}{2}$  i/s is to the N.A.R.T.B. 50 microsecond characteristic. The recording characteristic for the lower speed remains at 200 microseconds to the C.C.I.R. recommendation.

Test tape level in each case was obtained at a V.U. meter reading of -6 dB. A recording at full scale deflection of the meter showed no distortion, and the level could be increased to 12 dB above test tape level with just perceptible distortion of the reproduced signal on a C.R.O. Erase and bias noise did not raise the tape noise above the -42 dB measured on a bulk erased tape.

### Signal Noise Ratio

Peak recording at 500 c/s, as indicated by full scale reading of the V.U. meter, was erased on the machine and the ratio measured at 50 dB. Plus 12 dB on test tape level, or tape peak recording level, would thus be 54 dB above noise.

### Acoustic Response

A white noise test tape was played with the tone control set to 7 to feed a level electrical input to one of the SS-50 stereo speakers, and the acoustic output measured on the speaker axis with a calibrated microphone. The resultant overall response is shown by fig. 4.

The high note response is smooth and level and the low note response is well maintained down to 100 c/s. Subjective listening tests showed a forward unobstructed quality with a slight lack

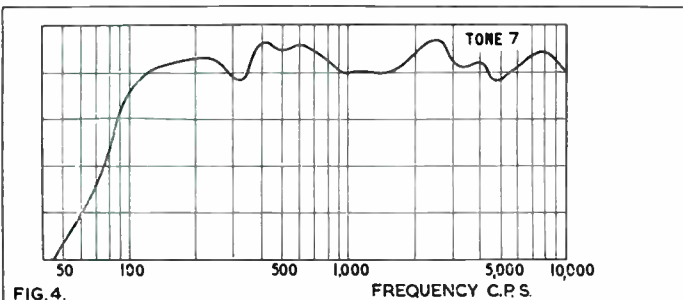

of body when compared directly with a larger wide range speaker. Placing the speaker in a corner of the room helped the low note response somewhat, and the two speakers in opposite corners gave very satisfying quality, especially on stereo tapes, with the impression of a larger spread out source.

### Microphone Response

Two moving coil microphones were provided with this equip-

ment but I am not sure whether the price quoted in the specification includes microphones with the recorder. One of the microphones was measured using the white noise technique and the response is shown in fig. 5. The slight bump at 3 Kc/s adds "presence" to voice reproduction and the well maintained response to 10 Kc/s adds a silky quality without risk of sibilant emphasis.

The dotted response can be obtained by blocking the outlet of the bass equaliser tube at the rear of the microphone case. When used for stereo live recording I found that the slight bass cut was an advantage with my particular room acoustics, but no doubt the full bass response would be an advantage for music recording in a larger hall or room.

### Comment

Plus points for this outfit are: extremely good signal to noise ratio; exact equalisation of pre-recorded tapes; wide range record/play response; excellent stereo speaker response; good microphones.

The only minus point of any consequence is the slightly inferior wow and flutter performance at  $3\frac{1}{4}$  i/s, although as

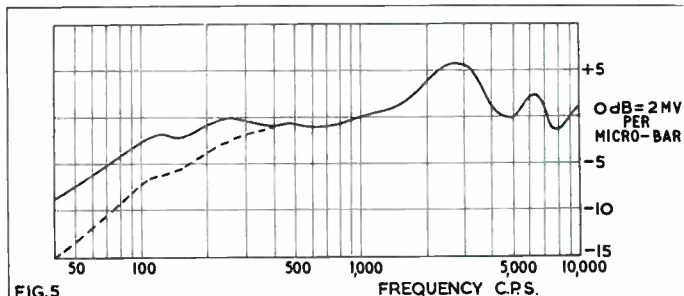

mentioned earlier the ear does not necessarily agree with the meter reading.

The severely functional appearance of the recorder will appeal to the engineer and technical enthusiast, but the lady of the house may object to the array of meters, knobs, levers, jacks and leads sprouting from the front panel of this machine. The deck however works equally well upright or on its back, so that it can be installed at almost any angle in a cabinet, cupboard, or shelf, so that the mechanics are not too obvious. A. Tutchings.



★  
WHARFEDALE  
PST/8  
SPEAKER

★  
★  
★  
**Manufacturer's Specification:** Damped reflex, forward facing. One 8 in. drive unit. **Recommended units:** Super 8/FS/AL or Bronze FS/AL. **Response:** 60-14,000 c/s. **Size:** 24 x 12 x 12 ins. **Weight:** 17 lbs. **Price:** without unit £7 10s. whitewood, or £10 10s. veneered and polished. **Manufacturers:** Wharfedale Wireless Works Ltd., Idle, Bradford.

In the instruction books and leaflets sent out by manufacturers of tape recorders the following sentence can often be seen— This recorder is fitted with a high-quality x by x in. speaker. (continued on page 455)

## HI-FI FOR BEGINNERS

This is the first title in a long-awaited series of Hi-Fi books, and we recommend it thoroughly to every enthusiast. PRICE 7/6d., plus 9d. postage.

Available from:  
MILES HENSLAW PUBLICATIONS LTD, 99 MORTIMER STREET



1



2



**PHILIPS**

T A P E R E C O R D E R S

at the

# CHELSEA RECORD CENTRE

and all records and equipment

203 KINGS ROAD LONDON SW3 FLA 2596



3

1 The brilliant new battery-operated mobile recorder  
**24 GNS**

2 The professional recorder at YOUR price  
**59 GNS**

3 The Family Tape Recorder! Four Tracks! Super-imposing facilities  
**36 GNS**

## Most Important Announcement!

Ferrodynamics

**"BRAND FIVE"**

Recording Tape

NOW EVEN BETTER THAN EVER!

- NEW!** Improved exclusive dry synthetic lubricant—no squeal, no gumming of heads, vastly reduced head wear.
- NEW!** Harder scratch-resistant formulation—no flake-off, peeling or deposit on guides and heads.
- NEW!** Increased output—reduced distortion at same recording level.
- NEW!** Improved frequency response—sharper, brighter recordings.
- NEW!** Improved uniformity—lower modulation noise.
- NEW!** Sturdy one piece quick threading reel-stable, warp-free operation.
- NEW!** Complete with leader. Cellophane wrapped.

**WARRANTY:** Ferrodynamics magnetic recording tape is manufactured by a pioneer in the industry utilizing the most modern precision equipment. Strict quality control of the materials and processes is exercised by engineering personnel to assure consistent high quality.

**AT YOUR USUAL STOCKIST NOW!**

Wholesalers apply to:  
**V. L. Dewitt Ltd., 24-26, Hampstead Road, N.W.1. EUS 5533.**  
Manufacturers apply to:

**Electro-Techno-Dynamics Ltd.,**  
101, Leadenhall Street, London, E.C.3. AVE 6982.



## NUSOUND RECORDING Co.

35 CRAVEN STREET, W.C.2.

TELEPHONE TRA 2080

# Ferrograph

(Appointed Dealer)

The new SERIES S Tape Recorder is on permanent demonstration, in addition to the 420 STEREO SERIES. Hear these recorders linked with QUAD Amplifiers and TANNOY Speakers.

See the range of accessories we carry:

Mixers—Tapes—Microphones—Stands—Tuners, etc.

OUR TECHNICAL AND PRACTICAL EXPERIENCE IS AT YOUR DISPOSAL

**IT PAYS TO DEAL WITH A SPECIALIST**

The 'NUMIX 2' is a two-channel unit (Mic. and other source) low- or high-impedance feeds. The 'NUMIX 2' can be used with ANY TAPE RECORDER WHICH WILL ACCEPT A HIGH-Z MICROPHONE. Near professional results are guaranteed.

Price: £6.10.0. complete.



Write for leaflet on 'NUMIX 1', 'NUMIX 2' and 'MONITOR' UNITS.

The 'NUMIX Mk. 3' (fully transistorised) 2-channel Microphone Mixer is now available, price: £8-19-6

**NUSOUND RECORDING COMPANY**



### THE ONLY REALLY SAFE SCIENTIFIC CLEANING METHOD!

Recommended by leading manufacturers

Many tape recording faults are due to oxide deposits from the tape on the record and erase heads.

You can overcome these by using ...

# KLENZATAPE

A completely safe cleaning method developed by sound engineers, to clean delicate and inaccessible surfaces. You merely play through the KLENZATAPE (supplied on two spools) using the special KLENZATAPE cleaning fluid.

**IT'S QUICK—IT'S EASY—IT'S KLENZATAPE!**

Available at leading dealers. If you have any difficulty, write to...



**METRO SOUND**  
METRO-SOUND MFG. CO. LTD.  
19a BUCKINGHAM ROAD,  
LONDON, N.1.  
Telephone: CLIssold 8506/7

Look for the bright red pack with the polythene storage wallet. Price 12/6d



## EQUIPMENT REVIEWED — continued

This may be quite true, but the efficiency of the speaker is determined by the design of the cabinet to house that particular speaker. And, as tape recorders are complicated pieces of equipment, comprising tape decks, record and playback amplifiers and power packs, the fitting of the speaker depends upon the amount of space left after these items are fitted. Several other things must also be taken into consideration. Ventilation of motors and valves must be carefully studied to prevent overheating of the recorder. This is provided by cut-outs either at the rear of the recorder or underneath. Very good for the motors, but very bad for the loudspeaker! Finally, whilst on this subject, most recorders have an output of between 2 to 3 watts, which is ample for the average size living room. (A little too much for flat dwellers!) However, with the increasing use of plastics in the production of tape decks and cabinets, it has been found that at certain frequencies cabinets and the deck covers resonate. Again, not in keeping with high quality!

### Recommended Unit

Having looked on the bad side, there are, however, two good points on the reproduction side of the tape recorder. The first is that extension speaker sockets are fitted to 99 per cent of the recorders available at present, and the second is that when an extension speaker is fitted the internal speaker is disconnected, allowing a larger speaker to be used in a properly-designed cabinet. These speakers can cost between ten and sixty pounds, but even an inexpensive unit such as the *Wharfedale PST/8* cabinet, fitted with a *Bronze FS/AL*, will produce quality far in excess of that obtainable through the machine's own loud-speaker. The *PST/8* takes up very little space (size 24 x 12 x 12 in.). It can be used upright in a corner or longwise on a shelf or table. Its handling capacity is 4 watts; ample for the domestic range of recorders. The output impedance varies from recorder to recorder, but a fair, average guide the rating is 3 ohms in the cheaper price range, and in the higher price bracket 15 ohms. *Wharfedale* will supply speakers to customer requirements in both ranges. They have also taken care of do-it-yourself enthusiasts who are interested in finishing cabinets to their own design.

A *PST/8* speaker has been used during the past year at demonstrations to tape recording clubs and has always created a great deal of interest. We think this is because very few recorder owners use an extension speaker at all, let alone one of high quality. With such a speaker there is no reason why anyone should continue to listen to recorders with that "boxed-in" sound.

A.J.L.

### Comment

The manufacturers advise us that the latest version of the Super 8 is the *Super 8/RS/DD* at £7 9s. 5d. including purchase tax, and this is very suitable for use in the *PST/8* cabinet. The *Super FS/AL* is still available at £6 16s. 5d. including purchase tax.

FOR BEST RESULTS USE  
**ferrania**  
MAGNETIC RECORDING TAPE

## hi-fi books

### HI-FI YEAR BOOK . . .

The 7th edition of this world renowned annual publication has been enlarged and now contains 272 pages and includes articles by leading authorities. The disc Stereo Picture and Microphones by Stanley Kelly; New developments in Transistor Amplifiers by George Tillett; Radio Tuners by Arthur Wayne; The Dynamic Decibel and Time on Tape by Graham Balmain. Loudspeakers for 1962-3 by Ralph West. Technical specifications are given of over 1000 items of Hi-Fi and Tape Equipment, and over 500 of these are photographically illustrated. Price 11s 6d post free.

### CINE YEAR BOOK . . .

For the first time ever, a comprehensive survey in one complete volume of the cine market for the cine user. The new reference book for the professional, the enthusiast, and the photo dealer. This valuable book follows the unique pattern set and maintained by the "Hi-Fi Year Book"—separate and detailed directories for every product group—Cameras, Lenses, Exposure Meters, Lighting, Film Stock, Screens, Projectors, etc. Some 200 photographic illustrations, Suppliers' addresses, product specifications, Library lists, Cine services are all included in this hard bound book. Price 11s 6d post free.

### HI-FI FOR BEGINNERS . . .

This work is thoroughly recommended to every enthusiast; it has been acclaimed from all sides as being the ideal book for everyone who has just started or is about to start their hobby. Those whose particular interest lies in tape will find that Chapter 7 alone will make this book worthwhile.

Price 8s 3d post free.

### EXPERIMENTAL RECORDING . . .

This book presents in convenient form the series of articles by A. Tutchings on "Twenty Practical Experiments in Magnetic Recording" and full introductions for "Building a Fully Portable Recorder", using a clockwork motor and transistor amplifier.

Price 5s 9d post free.

### HOW TO SPLICE TAPE . . .

If you use tape, sooner or later you will need to know how to splice tape, how to repair simple or complicated breaks, how to edit material, how to cut out words or syllables, etc. All this is described in this well-illustrated booklet.

Price 2s 6d post free.

### BOUND VOLUMES . . .

We have available copies of Tape Recorder Volumes 2 and 3. These are covered in black buckram, and hand stitched and gold blocked in spine. Special presentation volumes bound in real leather are also available, details on request.

Price (standard binding) 52s 6d post free.

### In preparation . . .

Sound and Cine by Richard Golding  
Cabinets for Beginners by Wheeler Smith  
Stereo for Beginners by B. J. Webb

**MILES HENSLOW PUBLICATIONS LTD.**

99 MORTIMER ST., LONDON, W.1

**BUILD-IT-IN OR  
CARRY-IT-AROUND!**



**Tandberg**  
SERIES 7

4track model 74 93 gns.  
(available October 1st)

2track model 72 93 gns.  
(available December 1st)

(Luggage type carrying case £71.8. extra.)

▷ new  
**Tandberg**

**SERIES 7  
STEREO TAPE RECORDER  
VERSATILE — COMPACT — COMPLETE**

In teak case 15 $\frac{3}{8}$ " x 11 $\frac{3}{8}$ " x 6" Weight 27 $\frac{1}{2}$  lbs.  
Records and Plays Mono or Stereo

- 3 speeds 7 $\frac{1}{2}$  - 3 $\frac{3}{4}$  - 1 $\frac{7}{8}$
- 2 Indicators
- 2 Record, 2 Playback and 2 Power amplifiers (3 watts per channel)
- 2 Monitor Speakers
- 2 outputs for additional speakers or Hi-Fi

A WORTHY COMPANION TO TANDBERG SERIES 6

THE DOMESTIC DECK WITH PROFESSIONAL PERFORMANCE

**Tandberg** GB ELSTONE ELECTRONICS LTD., EDWARD ST., TEMPLAR ST., LEEDS 2. Tel: 3-5111

**BRITAIN'S LARGEST TAPE RECORDER AND HI-FI  
PART EXCHANGE  
SPECIALISTS**

**MAIL ORDER EXPERTS**

If you have outgrown your present tape recorder or hi-fi equipment and would like to own a more advanced machine, as used by professional and serious tape recorder enthusiasts. Contact us today !!!

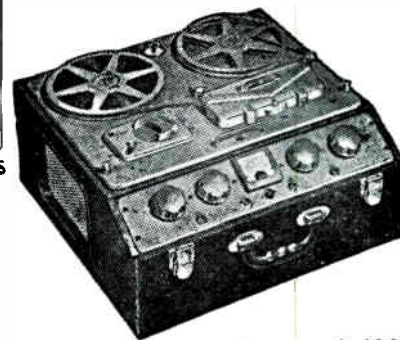

Ferrograph 4AN

AND APPOINTED AGENTS FOR

- Ferrograph 5AN ... 85 gns.
- Wyndor International 75 gns.
- Ferrograph 422/4 ... 110 gns.
- Reflectograph 'A' ... 105 gns.
- Tandberg 6 Stereo ... 110 gns.
- Vortexion WVA ... £93.13.0
- Brenell Mk. 5 'M' ... 88 gns.
- Simon SP.5 ... 93 gns.
- Brenell Mk. 5 ... 64 gns.
- Akai M6 Stereo ... 130 gns.
- Philips Stereo ... 92 gns.
- Sony 521 Stereo ... 124 gns.
- Reps R10 ... 59 gns.
- Ampex Stereo 971 ... 225 gns.
- Revox Stereo ... 110 gns.

ALL ABOVE RECORDERS AVAILABLE FROM STOCK

WE HAVE THOUSANDS OF SATISFIED CUSTOMERS THROUGHOUT THE BRITISH ISLES

TRANSISTOR-BATTERY

- Grundig TK1 ... 29 gns.
- Optacord 412 ... 45 gns.
- Butoba MT5 ... 69 gns.
- Fi-Cord 202 ... 69 gns.
- Philips EL3585 ... 24 gns.
- Stuzzi Magnette ... 59 gns.
- Uher 4000 ... 93 gns.

Complete High-Fidelity systems supplied in parts or built to customers' requirements. The latest equipment and cabinets in stock.

Large stocks of new and used tape recorders at bargain prices. Ask for list. 30% to 60% reductions on original price.

ALL GOODS AVAILABLE ON OUR FAMOUS  
**NO INTEREST TERMS**

10% deposit, balance 12 months. 18 to 24 months terms available

FREE SERVICING — FREE DELIVERY — 300 MACHINES ON DISPLAY — OUR MAIL ORDER DEPARTMENT WILL DEAL WITH YOUR ENQUIRY BY RETURN. WRITE—PHONE—CALL FOR A QUOTATION ON YOUR MACHINE. A LARGE SELECTION OF USED TAPE RECORDERS. HOME DEMONSTRATIONS IN THE LONDON AREA.

**REW**

EARLSFIELD LTD., 266 UPPER TOOTING ROAD, LONDON, S.W.17  
Telephone: BALHAM 7710

100 yards from Tooting Broadway underground station; opposite Tooting Market



Tape recorders

## READERS' PROBLEMS

★ Readers who encounter snags, or who run into trouble with their tape recording equipment, are invited to write to this editorial office for advice, marking the envelopes "Readers' Problems—Tape". Replies will either be sent direct by post, or published in this column if the subject is of general interest. However, we must emphasise that this advisory service cannot include requests for information about manufacturers' products when such information is obviously obtainable from the makers themselves. It is also essential to keep the queries reasonably short and to the point, and to limit them to one specific subject if at all possible. And, please, in no circumstances confuse such letters with references to other matters which may have to be dealt with by other departments in our office.

### Coupling Heads

Dear Sir:—On reading one of your recent articles headed "Tape Recorder Service", I note you invite readers to discuss problems regarding other decks. Could you help me with the following. I am using the "Collaro Studio" deck coupled to the "Mullard Type C" pre-amp. There appears to be two separate windings on the "Studio" rec/rep head.

Which is the best way of coupling this head to the Type C pre-amp?

Also, can you suggest any method to enable the correct alignment to be obtained on the spool motors to ensure nice even spooling of the tape?—*Yours faithfully, E.A.S., Darford.*

If, as you say, there are two sets of leads from the R/P head, we can only suggest that this must be a 4-track version. Normally, there are two unscreened wires, red and green, from the erase head, and a screened wire from the R/P head, with two connections. If, however, a different type of head has been fitted, it may be one of the two-track versions with four wire pins for connection. This type requires a link between a top pin and the bottom pin at the opposite corner, the connections being taken away from the other two pins. Ultimately, the pre-amp is fed with the normal two-wire input.

Remember, when connecting up in this way, that a bias voltage has to be supplied to the head from the main amplifier, during Record, as well as the erase voltage necessary for this kind of deck. Without knowing more about your overall equipment, we cannot advise in greater detail. There is a publication by Messrs. Mullard, obtainable from their Torrington Place, W.C.1. headquarters, plus a number of leaflets dealing with the audio equipment they have designed specifically for tape recording.

Regarding the spooling of the "Studio" deck. This is one of the features of the deck which may cause bother. The high speed of rewind may cause looseness, and a little vibration may be experienced. It has been found the latter point can be overcome by fitting some form of hub-cap—a simple rubber cap, even the lid of a toothpaste tube!

\* \* \*

### Soundproofing

Dear Sir:—I have a problem regarding the soundproofing of rooms. I live in a solidly-built semi-detached house and wish to cause as little annoyance as possible with my equipment. For selfish reasons my desire is even greater to insulate the sound from my neighbour's wireless, etc., from reaching one of my rooms which has a common wall with theirs. The floors are timber with cellars. Can you give me any advice on construction, materials and methods with regard to this problem? As a



**VENNER**  
14 DAY  
CLOCKWORK  
TIME SWITCHES  
Ideal for Tape Recorders  
**29/6** P & P  
3/-

KINGSWOOD SUPPLIES (T.R.2), 4 Sale Place, London, W.2. PAD 8189

AUTOMATIC CONTROL over radio and/or tape recorder. Will switch ON/OFF or OFF/ON once every 24 hours at any manually pre-set time. Minimum time lapse 30 minutes. It has a current rating of 1 amp sufficient to carry radio and/or tape recorder. Complete with key and mounting bracket. Used but in perfect condition. Fully guaranteed.

## YOUR TAPE DEALER

Specialists in Hi-Fi Equipment and Tape Recorders

### CHELSEA RECORD CENTRE

203 KINGS ROAD, S.W.3 FLA 2596

Open till 8 p.m. (except Thursdays)

Disc and Tape Reproducing Equipment and Tape Recorders  
by Leading Manufacturers

CUSTOM BUILT INSTALLATIONS  
All High Fidelity Requirements and Services Available

Estimates Free

Personal Service

### Custom High Fidelity

371 Green Lanes, Palmers Green, London, N.13

Tel. PALmers Green 5228

# hifi

FOR ALL LEADING  
AUDIO EQUIPMENT

call, write, or telephone

**hampstead HIGH-FIDELITY**

91a Heath Street, Hampstead, London N.W.3 Telephone HAMpstead 6377

ENGLAND'S BIGGEST SPECIALISTS:

# HOWARD

218 HIGH STREET, BROMLEY RAV 4000

## LASKY'S RADIO

ALL LEADING MAKES IN STOCK

Cash or Easy Terms

LONDON'S FINEST SERVICE

207 EDGWARE ROAD, W.2

PAD 3271/2

33 TOTTENHAM COURT ROAD, W.1 MUS 2605

## SHEEN TAPE RECORDER CENTRE

SPECIALISTS IN TAPE RECORDERS, ACCESSORIES, HI-FI EQUIPMENT  
YOUR CENTRE FOR FRIENDLY HELP—SALES AND SERVICE

8 STATION PARADE  
SHEEN LANE, SHEEN  
LONDON, S.W.14

Showrooms Open until 7 p.m.  
PROSPECT 0985  
(Opposite Mortlake Station S.R.)

## Country and Provincial

BOURNEMOUTH

### NATIONAL RADIO SUPPLIES

66 Holdenhurst Road,  
Bournemouth

Tape, Hi-Fi & components

Tel. 25232

# AMPEX SPECIAL WEEK at NUSOUND

from 5th - 11th November, inclusive

On display will be the 350 Series Professional Recorders, Mixers, 500 Series Tape, and associated equipment.

YOU are cordially invited.



## 500 SERIES TAPE

TRADE AND ALL ENQUIRIES INVITED

	Standard Play Tape	Long Play Tape	Standard Play Tape Mylar	Long Play Tape Mylar	Double Play Tape Mylar
5"	15s.6d.	£1. 2s.6d.	£1. 1s.0d.	£1. 6s.6d.	£2. 2s.0d.
5½"	£1. 2s.6d.	£1. 10s.0d.	Not available	£1. 13s.6d.	£2. 16s.0d.
7"	£1. 6s.6d.	£1. 19s.6d.	£1. 12s.6d.	£2. 5s.0d.	£3. 12s.6d.

Cash with order for immediate goods by return, post free

**NUSOUND RECORDING COMPANY**

35 CRAVEN STREET, W.C.2.

TELEPHONE TRA 2080

## USE YOUR TAPE RECORDER FROM ANY D.C. SUPPLY

You can operate your recorder from a car, caravan or boat battery, or from any D.C. mains supply with a VALRADIO D.C. CONVERTER. These D.C. converters enable you to operate T/RECORDERS, etc., for play-back music, telephone conversations and reports whilst on long journeys, in addition to making outside recordings.

Electronic types of converters are also available for 200/250 D.C. with outputs up to 200 watts 50 c/s. from ships' supply or D.C. mains.

Available for practically all makes of recorders, record players, radiograms, amplifiers, etc., with prices ranging from £7.3.0., VALRADIO D.C. CONVERTERS add versatility to your equipment.

For further details just post coupon below to:



**LIMITED,**  
Browells Lane,  
Feltham, Middlesex.  
Tel. Feltham 4242 & 4837



Valradio and Stereosonoscope are the registered trade marks of Valradio Ltd.

Please send me fully descriptive leaflet, ref: TR on D.C. CONVERTERS for tape recorders and other equipment.

NAME .....  
ADDRESS .....  
Make and type of equipment:.....  
D.C. volts in:..... A.C. watts out:.....

## TAPE RECORDER COVERS



Smart waterproof cover to give complete protection to your tape recorder. Made from rubberised canvas in navy, wine, tan, grey and bottle green with white contrasting pipings, reinforced base, handy zip microphone pocket and name panel.

Philips EL3536	...	70/-
.. EL3515	...	57/6
.. FL3541/15	...	57/6
.. Starmaker	...	66/-
Cossor 1602	...	57/6
.. 1601	...	63/-
Stella 5T455	...	63/-
.. ST454	...	57/6
Saja MK.5	...	57/6
Stuzzi Tricorder	...	58/-
Saba	...	63/-
Wyndors Viscount	...	55/-*
.. Victor	...	60/-*
Elizabethan Princess	...	60/-
.. Avon	...	60/-
.. Escort	...	57/6*
.. Major	...	63/-
.. FT.1	...	66/-
.. FT.3	...	75/-
Fj-Cord	...	52/6
Korting (4 track stereo)	...	63/-
Harting Stereo	...	66/-
Fidelity Argyle	...	55/-*
Simon SP4	...	63/-*
Clarion (with strap)	...	52/6
Brenell Mk.5	...	77/-
.. 3 star	...	69/-
Minivox C	...	61/-
Robuk RK.3	...	67/6
Ferroglyph	...	80/-
Sony 521	...	90/-
Grundig 1 N.1	...	49/6
.. TK.5	...	55/-
.. TK.8	...	63/-
.. TK.14 & 23	...	59/6
.. T.K.20	...	52/6
.. TK.24	...	55/-
.. TK.25	...	55/-
.. TK.30	...	60/-
.. TK.35	...	63/-
.. TK.40	...	60/- †
.. TK.50	...	60/-
.. TK.55	...	63/-*
.. TK.60	...	75/-*
.. TK.830/3D	...	63/-*
.. Cub	...	35/-*
Telefunken 85	...	60/-
.. 85	...	65/-
.. 75/15	...	55/-
.. 76K	...	55/-
.. 95	...	69/6
Philips 8108	...	57/6
8109	...	63/-
.. EL3538	...	63/-
.. EL3542	...	63/-

\*Without pocket. †Price to be announced.

**A. BROWN & SONS LTD.**

24-28, GEORGE STREET, HULL Tel: 25413, 25412

## tape accessories

IN A PRESENTATION GIFT SET



**KLENZATAPE** The approved method for cleaning playing and erase heads.  
KLENZATAPE KIT 12/6, FLUID REFILLS 3/11.  
TAPE REFILLS 5/-.

**METRO-SPLICER** For both recording tape and 8 mm. cine film.  
SPICING KIT 15/-, SPARE CUTTING UNITS 2/6,  
SPARE FILM EMULSION SCRAPER 1/-.

**METRO-TABS** For QUICK, POSITIVE identification of recorded passages.  
PRICE PER SET 3/11 INCLUDING INDEX.

**METRO-BRUSH** For cleaning, tape decks and cine equipment.  
PRICE 2/6.

★ ALL THE ABOVE, PLUS MANY SPARES, CAN NOW BE OBTAINED IN THE METRO-SOUND TAPE ACCESSORIES GIFT SET (AS ILLUSTRATED) PRICE £2.0. COMPLETE.

**NEW! METRO-STOP** Used as normal stopfool. Easy to apply and remove. PRICE 17/6.

Available all leading dealers, if any difficulty write to:



**METRO-SOUND MFG. CO. LTD.**

19A Buckingham Road, London, N.1.  
Tel: CLIssold 8506/7

**READERS' PROBLEMS—(continued)**

matter of fact I am about to move into the house which I have just described and would like to undertake any structural alterations before it is decorated, etc. *Yours faithfully,* S.W., Stockport.

*We regret that your query is a little outside our normal field of interest, but we have been advised that a degree of sound insulation can be carried out reasonably simply and successfully by the use of "Celotex" boarding. This is a soft fibre-like board available in sheets of similar sizes to hardboard and about 1/2 in. thick. The great thing is not to face the wall directly with this boarding but to stand it off leaving an air space of about a quarter of an inch.*

*We would, however, suggest that you get in touch with a local architect or good builder and decorator since they may be able to offer a cheaper solution. I think that you will have to understand that soundproofing an existing building cannot be carried out for a matter of a few shillings only.*

\* \* \*  
**Television Whistle**

*Dear Sir:*—I have a Telefunken 85 KL recorder, and can connect same (via an Isolating transformer) to a Philips television set for the purpose of recording.

The television output is wired to the transformer from the loudspeaker, and then to a switch and two external lead sockets. What I cannot understand is that the recorder picks up the "whistle" of the television line transformer, even though it is only connected to the loudspeaker of the television. This naturally spoils any recording, as on playback (through my external 12 in. loudspeaker system) this noise is continuous and loud in the background, and if the treble response is turned up on playback the noise becomes almost deafening in its "whistle".

It makes no difference at 3 1/2 or 7 1/2 i/s speeds, and the input level does not affect it either except that obviously the lower the input level is the lower the sound is therefore the noise seems louder. I am connecting television to the recorder via standard co-axial cable, and the recorder is approx. 6 ft. from the television set.

There are two alternative inputs on my recorder—Radio and Direct, and except for the strength of the input altering, the noise comes exactly the same on both inputs.

I shall be most grateful if you can advise me why I pick up this noise, and any suggestion how it can be prevented.

*Yours faithfully,* D.S., Chesham.

*The whistle that you are experiencing on your tape recorder is almost certainly a "beat" not produced by interaction between the line oscillator of the television set and the bias oscillator of the recorder. An experiment will show whether this whistle is still present when the two units are not connected together, it may be fed through the mains input wiring. The most likely way, in our opinion, of overcoming the trouble would be to slightly alter the bias frequency on the tape recorder. This would not remove the signal but could well render it sufficiently high in frequency to be inaudible.*

*However, since this means an adjustment inside the tape recorder we would strongly suggest that you consult your dealer and seek his advice.*

TRI-COLUMN REPRINTS NOW AVAILABLE. PRICE 2/-

**Stereo hi-fi is cheaper than you think ●**

a postcard will bring you IDEAS IN HIGH FIDELITY  
LISTEN — LOOK — COMPARE — good sound and good looks — NEW SCANDINAVIAN LINE FURNITURE  
10 a.m. to 10 p.m. daily (Sundays from 6 p.m.) Closed Thursdays. MA1 8B55  
**STUDIO 99** 57, FAIRFAX ROAD, SWISS COTTAGE LONDON  
HAMPSTEAD · N.W.6

**— YOUR TAPE DEALER —**

**H. D. KIRK**  
*Stereolectrics*  
Specialists in High Fidelity  
150 HIGHER BRIDGE STREET  
Phone: 23093  
**BOLTON**

**R.E.S. (COVENTRY) LTD.**  
**SPECIALISTS IN HIGH FIDELITY**  
and all makes of Tape Recorders  
All leading makes of High Fidelity Equipment stocked and demonstrated under ideal conditions. ★ *The Best Selection—Terms and After Sales Service in the MIDLANDS.*  
R.E.S. (Coventry) Ltd. 128 Far Gosford St. Coventry 28781/2

**FARNHAM, SURREY**  
★ Stockists of all the leading makes of High-Fidelity Equipment  
★ Comparative Demonstrations  
★ Cabinet Manufacturers and Designers  
★ Personal service and satisfaction guaranteed  
★ Specialists in custom-built Hi-Fi Equipment  
**LLOYD & KEYWORTH LTD, The Record Shop**  
26/7 Downing Street, Farnham, Surrey. Telephone: Farnham 5534  
SURREY AND HAMPSHIRE'S HI-FI DEALERS

**TAPE RECORDER CENTRE (HALIFAX)**  
Stock all the best Tape Recorders; Hi-Fi Equipment; Tape; L-P Records, etc.  
DEMONSTRATIONS DAILY BY EXPERT STAFF  
2 years FREE SERVICE ON NEW RECORDERS over £35  
30 King Cross Street, Halifax. 'phone 66832

**MANCHESTER**  
**Tape Recorder Specialists**  
**DIXONS ELECTRONIC (Sales and Service)**  
proprietors: Lancs Hi-Fidelity Ltd.  
**8 DEANSGATE next to Grosvenor Hotel**

**LEICESTER**  
**ALL YOUR HI FI REQUIREMENTS**

Speakers by:	H.M.V.	QUAD	LEAK	ROGERS	
	TANNOY	MORDAUNT	LOWTHER	W.B.	
	WHARFEDALE	GOODMANS.			
Tape:	FERROGRAPH	REFLECTOGRAPH	GRUNDIG		
	SIMON	BRENELL.			
Record Department:	ALL LABELS-PARASTAT SERVICE.				
<b>LEICESTER CO-OPERATIVE SOCIETY LIMITED, High Street, Leicester.</b>					<b>Tel: 20431</b>

**TAPE RECORDERS and HI-FI**

The Largest Electrical store in the North

**Fenham Radio**

158, NEW BRIDGE STREET, NEWCASTLE UPON TYNE 1  
Telephone: 29866

**WESTWOOD'S** of **OXFORD**

46 GEORGE STREET  
PHONE: 47783

## — YOUR TAPE DEALER —

PETERBOROUGH, NORTHANTS

Tel: 5545

### CAMPKINS RECORD SHOP

RECORD TAPE AND HI-FI EQUIPMENT SPECIALISTS

NEW ADDRESS

15 LONG CAUSEWAY  
(IN CITY CENTRE)

LARGE STOCKS

### HAMILTON ELECTRONICS

HIGH FIDELITY TAPE RECORDERS 35 LONDON ROAD

TEL. 28622

SOUTHAMPTON

SOUTHAMPTON—SALISBURY

- ★ All the best makes of Tape Recorders
- ★ Hi-Fi Systems and Records
- ★ Expert knowledge and advice

The West of England High Fidelity Specialists

J. F. SUTTON 421 SHIRLEY ROAD, SOUTHAMPTON  
15.18 QUEEN STREET, SALISBURY

WORTHING, SUSSEX

We stock Hi-Fi Equipment by Leak, Quad, Goodsell, RCA, Acos, Garrard, Collaro, Tannoy, Wharfedale and Goodman and give fully comparative Demonstrations

### BOWER & WILKINS LTD.

1 Becket Bldgs., Littlehampton Road Worthington 5142

## — TAPE TO DISC SERVICES —

The following are members of the Association of Professional Recording Studios who can be relied on to give satisfaction

### MJB RECORDING & TRANSCRIPTION SERVICE

specialise in the production of microgroove records from Professional and Amateur recordings (Acetate copies; Processing Masters and Pressings at 16 $\frac{1}{2}$ ; 33 $\frac{1}{3}$  & 45 r.p.m.) Extended playing times achieved by controlled cutting. Editing, Label printing, Mobile and "Off the Air" Services.

7 HIGH STREET, MAIDENHEAD (Tel: 230)

TAPE RECORDERS · AUDIO EQUIPMENT · DISC CUTTING STD & LP FROM TAPE · STUDIO FACILITIES · HIRE SERVICE · SALES · EXCHANGES

### MAGNEGRAPH

1 Hanway Place, London, W.1

Tel: LAN 2156

THE WAL D-MAG, head demagnetiser, long nylon covered probes. £2.10.0

WAL GAIN transistorised pre-amplifiers, Mono £5.10.0, Stereo £7.10.0 and Hi-Gain (latter CCIR equalised). £7.16.0

THE WAL BULK ERASER. £7.18.6

Available from all leading dealers. (Wholesale include T.D. & B., London, and A. C. Farnell, Leeds).

WELLINGTON ACOUSTIC LABORATORIES LTD.  
Farnham, Surrey (6461)



## CLASSIFIED ADVERTISEMENTS

Advertisements for this section must be pre-paid and accompanied by a postal order, money order, or cheque. The rate is 6d. per word with a minimum charge of 7/6d. Box numbers may be used for an extra charge of 1/6d. The trade rate is 9d. per word, plus 2s. for a box number, conditions on application. Send replies to box numbers, c/o "The Tape Recorder", 99 Mortimer Street, London, W.1.

No responsibility will be accepted by the editor, the publishers, or the printers of The Tape Recorder for the quality of any goods offered, bought, or exchanged through the medium of these columns, or for any failure in payment, etc., though the greatest care will be taken to ensure that only bona fide advertisements are accepted.

All advertisements for the December issue must arrive not later than November 5th.

### For Sale

Pre-recorded tapes. Unique complete catalogue listing all makes, mono, stereo. 7 $\frac{1}{2}$  and 3 $\frac{1}{2}$  i/s including World Record Club tapes. Call for free copy or send 1s. mailing fee. Dept. T.R.3 Teletape Ltd., 33 Edgware Road, W.2 PAD 1942.

Ask your dealer for American Ferrodynamics "Brand Five" recording tapes. The best tape value!

Find that review you want—get a copy of the index for "Tape Recorder", volumes 1, 2 and 3. Price 2s. each volume, post free.

Use up those odd lengths of tape, splice them together professionally after reading "How to Splice Tape", price 2s. 6d. posted, from The Tape Recorder, 99 Mortimer Street, London, W.1.

All makes of tape recorders repaired or modified. Miniflux heads supplied. "Audiomaster" equipment serviced. Audio installations built to your specification by John C. Latham, Deimos Ltd., 8 Corwell Lane, Hillingdon, Middx.

Lee Electronics offer famous manufacturer's zipped waterproof canvas Tape Recorder Covers, complete with microphone compartment at half retail prices. Send for comprehensive lists: 400 Edgware Road. Tel.: PADDington 5521.

Tape Recorders. Save from 30 per cent. to 60 per cent. on the original price. Large stock of secondhand, new, shop soiled machines. All guaranteed. Obtainable on our No Interest Terms. Best part exchange allowances on your existing equipment. Call, write, 'phone today for free list. Quotation and details. Our mail order covers the whole country. R. E. W. Earlsfield Ltd., 266 Upper Tooting Road, London, S.W.17. Balham 7710.

Ferrograph 422 and 4 A/N always in stock ready for immediate delivery and demonstration. City & Essex Tape Recorder Centres. See page 415.

Your choice of tape equipment, or pre-recorded tapes offered in exchange for items connected with pre-1929 motoring books, magazines, photographs, accessories, even complete cars. J. Berry, 88 Westfields Avenue, London, S.W.13.

Full building instructions for the remarkable "Tricolumn" loudspeaker are available in reprint form from Hi-Fi News, 99 Mortimer Street, London, W.1. Price 2s. 6d. post free.

### BUILD A HIGH QUALITY TRICOLUMN LOUDSPEAKER FOR UNDER £5

using the Elec 8N/148 drive unit.

Full building instructions are available in reprint form for R. N. Baldock's remarkable Tricolumn loudspeaker.

In February 1962 Ralph West wrote: "They were even subjected to A-B tests against other speakers of considerably greater cost. Quite unfair really, but the results were most surprising . . . To round off, this is in no way a mere gimmick, but a serious loudspeaker design of very reasonable performance."

Can be built by any average handyman, easily in an evening. Send 2s. 6d. for complete instructions.

Hi-Fi BOOKS, 99 MORTIMER ST., LONDON, W.1

# Alive to every sound



Like the ears of this wary fox, the Grampian DP4 microphone is sensitive to an extremely wide range of sounds. With its uniform frequency response from 50 to 15,000 c/s, the reliable, medium-priced DP4 will greatly improve the standard of your recordings.

## Grampian DP4

— also for broadcasting, public address and call systems.

Low impedance microphone, complete with connector and 18 ft. screened lead . . . . . **£8.0.0.**  
Medium and high impedance models . . . **£9.0.0.**

A complete range of stands, swivel holders, reflectors and other accessories is available.

**GRAMPIAN—sounds like the real thing!**

Write or phone for illustrated leaflets:

**GRAMPIAN REPRODUCERS LTD**  
Hanworth Trading Estate, Feltham, Middlesex. Feltham 2657



# FRANCIS OF STREATHAM

## ● TAPE RECORDERS

Akai M6 ½ & ¼ Tr. St. . . . .	130 gns.
Akai de luxe 69 . . . . .	79 gns.
Brenell Mk. V Model M . . . . .	88 gns.
*Brenell Mk. V . . . . .	64 gns.
Brenell 3 star . . . . .	58 gns.
Cossor 4 Tr. 1602 . . . . .	38 gns.
Cossor 4 Tr. 1601 . . . . .	59 gns.
Cossor 1603 4 Tr. . . . .	28 gns.
Elizabethan 200 . . . . .	32 gns.
Elizabethan 2230 . . . . .	32 gns.
*Ferrograph 5AN . . . . .	85 gns.
*Ferrograph 422 or 424 . . . . .	110 gns.
*Ferrograph 4AN . . . . .	81 gns.
*Ferrograph 4AN/S . . . . .	88 gns.
Fidelitty Minor . . . . .	22 gns.
Grundig TK14 . . . . .	35 gns.
Grundig TK 23 4 Tr. . . . .	45 gns.
Grundig TK40 4 Tr. . . . .	75 gns.
*Grundig TK60 Stereo . . . . .	128 gns.
Loewe Opta 404 2 sp. 4 Tr. . . . .	53 gns.
Loewe Opta 403 . . . . .	45 gns.
Philips 4 Tr. 3541 . . . . .	36 gns.
Philips 4 Tr. 3542 . . . . .	59 gns.
Philips 3514 4 Tr. . . . .	27 gns.
*Reflectograph 'A' ½ Tr. . . . .	105 gns.
*Reflectograph 'B' ½ Tr. . . . .	115 gns.
Robuk . . . . .	36 gns.
*Simon SP5 . . . . .	93 gns.
Sony Stereo 462 4 Tr. . . . .	75 gns.
Sony 521 Stereo . . . . .	124 gns.
Stellaphon 4 Tr. 454 . . . . .	39 gns.
Stellaphon 4 Tr. 455 . . . . .	59 gns.
Stellaphon 456 . . . . .	28 gns.
Stuzzi 4 Tr. Junior . . . . .	26 gns.
*Tandberg Series VI Stereo ½ or ¼ Tr. . . . .	110 gns.
*Tandberg Mono, 3B . . . . .	76 gns.
*Telefunken 85 De Luxe . . . . .	83 gns.

*Telefunken 95 . . . . .	59 gns.
*Telefunken 96 4 Tr. . . . .	69 gns.
*Telefunken 97 Stereo . . . . .	95 gns.
Truvox 60 2 or 4 Tr. . . . .	39 gns.
Truvox Series 80/2 Tr. . . . .	55 gns.
Truvox Series 80/4 Tr. . . . .	59 gns.
Truvox R7 . . . . .	82 gns.
Uher Universal . . . . .	83 gns.
*Vortexion WVA . . . . .	£93.13.0
*Vortexion WVB . . . . .	£110.3.0
*Vortexion C Stereo . . . . .	£148.10.0
*Vortexion CBL Stereo . . . . .	£160
Wyndor International . . . . .	69 gns.

## BATTERY PORTABLES

Cossor 1620 . . . . .	25 gns.
Grundig Memorette . . . . .	55 gns.
Philips Portable . . . . .	24 gns.
Loewe Opta 412 . . . . .	47 gns.
(Mains/Battery/Car)	
Butoba . . . . .	66 gns.
Grundig TK1 . . . . .	29 gns.
Clarion Phonotrix . . . . .	39 gns.
Fi-Cord 202 . . . . .	66 gns.
Stella . . . . .	25 gns.
Stuzzi Memo-Cord . . . . .	25 gns.

\*Microphone extra

Mains Power Pack for Philips or Stella . . . . .	£5.0.0
Grundig Mains Power Pack . . . . .	8 gns.
Truvox Decks with Pre-Amps . . . . .	
PD 82—Standard Twin Tr. . . . .	£42.0.0
PD 85—Professional 4 Tr. . . . .	£52.10.0
PD 86—Professional 4 Tr. Stereo . . . . .	£63.00.

Tape Decks by Brenell, Wright & Weaire.  
Tape to disc and copy service

## LEADING STOCKISTS OF EQUIPMENT FOR TAPE and HI-FI . . . and NO EXTRA FOR CREDIT TERMS

- ★ Minimum Deposit
- ★ No Interest or Service Charges on H.P. up to 18 months
- ★ Free Service during Guarantee Period

Prices subject to alteration as announced by manufacturers.

Grampian Reflector . . . . . £5.15.0

## ● MICROPHONES AND MIXERS

Grampian GR/2 as advertised . . . . .	
Grampian DP/4 Dynamic . . . . .	£8. 0.0
Lustraphone VR/70 as advertised . . . . .	
Lustraphone VR/64 . . . . .	
Ribbon . . . . .	£7.17.6
Lustraphone LFV/59 . . . . .	£7.17.6
Dynamic . . . . .	£8.18.6
Simon 'Cadenza' Ribbon . . . . .	£10.10.0
Reslo Ribbon or Dynamic . . . . .	£9.12.6
Reslo Cardioid . . . . .	£9.12.6
AKG Stereo D.88 . . . . .	£19.19.0
TSL 3 Channel Mixer . . . . .	£2. 7.6
Grundig Mixer . . . . .	£16.16.0
AKG K 50 Headphones . . . . .	£7.10.0

Also in stock microphones by ACOS, FILM INDUSTRIES, TELEFUNKEN, A.K.G.

## ● ALL WALGAIN PRODUCTS

- Stands of all types and accessories
- TAPES by all leading makers in all grades and sizes as advertised.
- Pre-recorded by Columbia, H.M.V., Saga, Music-on-Tape.

AT OUR HI-FI DEPT. Now next door to Recorders

## ● STEREO AND MONO AMPLIFIERS

Quad . . . . .	Chapman Rogers	
Leak . . . . .	Dulci . . . . .	Armstrong
Tripletone . . . . .		

## ● TUNERS

Quad . . . . .	Rogers . . . . .	Pye
Leak . . . . .	Dulci . . . . .	Armstrong
Chapman . . . . .		

## ● LOUDSPEAKERS by

Quad . . . . .	Kelly
W.B. . . . .	Wharfedale
Goodmans . . . . .	Tannoy
Mordaunt . . . . .	Leak

## ● MOTORS, PICKUPS

Garrard . . . . .	Tannoy	EMI
Goldring . . . . .	Lenco	Shure
Connoisseur Decca Stereo . . . . .		
Decca Deram . . . . .	Mk. II	
Philips . . . . .	Ronette	
All-Balance. B&O . . . . .		
Ortofon . . . . .	SME Mk. II	
Acos . . . . .		

All types of Diamond and Sapphire styli, stereo and mono. Microlifts, Garrard SPG3. Acos Dust Bug.

## CABINETS

Record Housing  
Leak 'Southdown'

**169-173 STREATHAM HIGH ROAD, LONDON, S.W.16**

Between St. Leonard's Church and Streatham Station

STReatham 0466/0192

Please note this is our only address

**CLASSIFIED ADVERTISEMENTS**

**For Sale (continued)**

**Tape Bargains in all sizes.** Example: Top Brand 5½ in. 1,200 ft. 19s. 6d., P. & P. 1s. 3d. S.A.E. for list. Large choice of new and used recorders.—E. C. Kingsley & Co., 132 Tottenham Court Road, London, W.1. EUS 6500.

**Grundig MA 1 Transistor tape pre-amplifiers** suitable for use as microphone transformer, pick-up and tape head booster. Listed at 4½ gns. offered at £2 17s. 6d. Send for full details and free lists.—Lee Electronics, 400 Edgware Road, W.2. Paddington 5521.

**1,800 ft. Branded Tapes, 30s. each.** Sound News, 10 Clifford Street, London. W.1.

**Tape and gram equipment repairs/mods.**—Harding Electronics, 120A Mora Road, Cricklewood, N.W.2.

**"Brand Five" American Tape, long play 5 in. (900 ft.) 18s. 6d.;** 5½ in. (1,200 ft.) 23s. 6d.; 7 in. (1,800) 35s. sent by return. Post free Watts Radio, 54 Church Street, Weybridge, Surrey.

**L. Bishop Ltd., Tape Recorder Services, 1708 Bristol Road South, Rednal, Birmingham.** Tel.: Rubery 2709. Grundig Specialists.

**All American pre-recorded stereophonic tapes supplies.** Send 4s. 6d. for complete catalogue, all makes.—Imported Records, 42 Broadway, London, S.W.1.

**Bradford Readers**—Visit your Sound Centre at Brighter Homes Building, 16 Ivetgate, Bradford, 1, Yorks. Tape recorder specialists available every Friday for skilled advice on a choice of your new recorder. Guaranteed first-class after-sales service by expert engineers.

**Reflectograph Special Stereo/Mono Recorder** equivalent to two Model "A" machines without speakers incorporating one new-type deck. In professional metal case on trolley for vertical or horizontal operation. Used only 20 hours. Sole reason for disposal—too large for built-in fitment. Cost £250, price £120. Seen Gerrards Cross, Bucks, or London. Write R.A.. Multicore Works, Hemel Hempstead, Herts. Phone: Boxmoor 3636.

**Brenell Mark 5, three heads, £36;** Stuzzi battery-portable, £32.—Conway, SPRing Park 3152 (London).

**Languages by Tape Recorder.** Individual Postal tuition. No tape to buy. Details, Linguatape, Cheriton Fitzpaine, Crediton, Devon.

**Gramplan DP4/M microphone** with matching unit and 18 ft. cable. As new £9 10s.—12 Maxwell Court, Lordship Lane, S.E.22.

**Bargains, Ferrograph Model D,** recently overhauled £36 with tape also 2B with 3 heads is a special model. £47 10s. Both are perfect.—M. LeVene, 1 Bushy Road, Plaistow, E.13.

**Sony 521 stereo tape recorder** with two Sony loudspeakers. Just as new, cost £174, accept £120. Good reason for sale.—Powell, c/o Richards, 6 Douglas Road, Coseley, Near Bilston, Staffs.

**Easysplice Tape Splicer** makes accurate splicing easy, guaranteed, 5s. 6d.—Easysplice, 30 Lawrence Road, Ealing.

**Three complete volumes "Tape Recorder"** in binders with indexes. First-class condition. What offers?—W.B., 9 Briarwood Road, Clapham, London, S.W.4.

**Liquidators Stock.** Comprehensive stock of National Tape Recorder Manufacturers for sale. Enquiries to Francis McIlwee, 75b High Street, Ruislip, Middx.

**Manchester and the North West:** enjoy trouble-free recording; purchase your equipment from an old-established recording studio: we cover recording for all purposes, professional, technical and domestic. All Ferrograph Models, Stuzzi, Brenell, etc., Armstrong Amplifiers, Tuners, Mics., Tape, battery mains recorders, etc. Everything for quality recording with sound advice from practical experience. Recorders built for special requirements. "Eroica" Recording Studios (registered 1949), Peel Street, Eccles, Manchester, ECCles 1624 (STD Code 061). Studio Director: Thurlow Smith, A.R.M.C.M. Special facilities for languages and music. Studio near M.62 and A.57.

**Wanted**

**Fi-Cord, Mark 1A Wanted.** State condition and price.—Box No. 300.

**Tape Exchanges**

**Armchair Travel!** Join exciting "Worldwide Tapetalk", 35 The Gardens, Harrow. S.A.E. for particulars.

**Tape to Disc**

**Tape to Disc Recordings.** Finest professional quality, 10 in. L.P. 35s. (32 mins.); 12 in. L.P. 40s. (45 mins.); 7 in. E.P., 17s. 6d, 48-hour Postal Service. S.a.e. for leaflet to: Deroy Sound Service, 52 Hest Bank Lane, Hest Bank, Lancaster.

**Tape to Disc service, editing, and dubbing, all speeds.** Studio available for musical groups. Outside recordings our speciality. Ilford Sound Recording Service, 63, Aintree Crescent, Barkingside, Ilford, Essex. Telephone: CRE 8947 and GRA 5107.

**FOR ONLY £8  
YOU CAN BUY A PROFESSIONAL  
RIBBON MICROPHONE  
COMPLETE WITH  
DESK STAND**



The M8A is a new ribbon microphone from Film Industries; it employs the highly successful ribbon assembly that is used by recording and broadcasting studios throughout the world. By improved manufacturing methods we are now able to make these available at a price within the reach of all serious enthusiasts.

**PRICE £8**

All impedances and complete with desk stand and 12ft. screened cable.

Get the best from your recorder—  
**BUY A FILM INDUSTRIES MICROPHONE,**  
send for full details:

**FILM INDUSTRIES LTD.**  
90 BELSIZE LANE, N.W.3

Tel: HAM 9632

**ADVERTISERS' INDEX**

Armstrong Wireless & T.V. Co. Ltd. ...	Page
B.A.S.F. Chemicals Ltd. ...	448
Brand Five Tapes ...	464
A. Brown & Sons Ltd. ...	454
C.B.S. Tapes ...	458
Chelsea Record Centre ...	452
City & Essex Tape Recorder Centres ...	454
Elstone Electronics Ltd. ...	415
E.M.I. Records Ltd. ...	456
E.M.I. Tape Ltd. ...	432
Ferrania Magnetic Recording Tape ...	422
Film Industries Ltd. ...	455
Francis of Streatham ...	462
Gevaert Ltd. ...	461
Gramplan Reproducers Ltd. ...	443
Grundig (G.B.) Ltd. ...	461
Heathkit ...	420
Hitachi Ltd. ...	450
Howard Tape Recorders ...	444
J. J. Francis (Wood Green) Ltd. ...	436
Kingswood Supplies ...	446
Lustraphone Ltd. ...	457
Metro-Sound Mfg. Co. Ltd. ...	452
M.S.S. Recording Co. Ltd. ...	454-458
Northgate (Cameras) Ltd. ...	428
Nusound Recording Co. ...	463
Rapid Recording Service ...	454-458
R. E. W. Earlsfield Ltd. ...	443
Reps Tape Recorders Ltd. ...	456
Saga Records Ltd. ...	446
Simon Equipment Ltd. ...	443
Studio 99 ...	434
The Garrard Engineering & Manufacturing Co. Ltd. ...	459
The Recorder Co. ...	414
Thorn Electrical Industries Ltd. ...	448
Telesurance Ltd. ...	430
Tellux Ltd. ...	442
Truvox Ltd. ...	440
Vairadio Ltd. ...	419
N. Walker... ...	458
Welme Corporation Ltd. ...	443
Wellington Acoustic Laboratories ...	424
World Record Club ...	460
Zonal Film (Magnetic Coatings) Ltd. ...	416-417
	418



# U.S.A.'s 3rd LARGEST SELLER NOW ARRIVES IN BRITAIN!

## AKAI *Terecorders*

*for those who expect the earth in a world of sound*



### MODEL 69 'DE-LUXE'

Wide Frequency Range: Equipped with a record/play head which consists of specially treated core-materials being imported from West Germany.  
Output Power: 6 watt, can drive larger size extension speaker up to 12 in. Self contained speaker is 6½ in. in diameter.  
7 in. Reel Capacity: Accepts 3 in. and 5 in. reels as well.  
Level meter: with pilot lamp for easier determination of correct volume control setting when recording.  
Index (Revolution) Counter.  
Instant Stop Control: Spot editing and momentary stops are easily accomplished by use of the Instant Stop Lever.  
Monitoring and better reproduction: Monitoring of your recording may be accomplished by plugging a crystal earphone into the recorder's Output Jack. Superb reproduction can be obtained by operating a large Hi-Fi speaker direct from the Output Jack. Also your existing power-amplifier that does not have a pre-amplifier of its own may be driven from the same Jack.  
Head Output and three position Power Switch: If desired, the tape transport mechanism (tape deck) of the recorder can be operated independently of the built-in amplifier and speaker. The Head Output Jack and the three-position Power Switch are provided to make this special function possible.

Retails at 79 GNS.

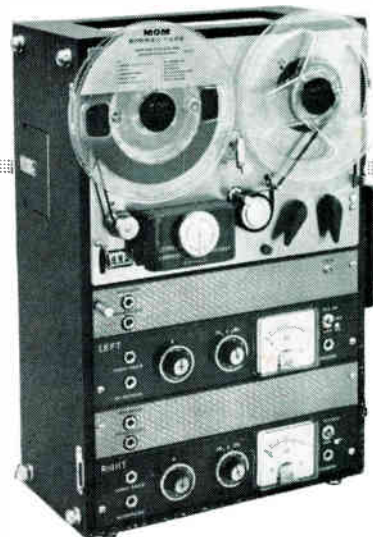

### MODEL M6

Records and plays back either 4-track stereophonically or 4-track monophonically and also plays back 2-track prerecorded stereo tapes. Hysteresis Synchronous Motor always ensures constant tape speed. Designed for vertical or horizontal operation. Two inline and accurate VU-Meters reads recording and playback levels.  
A precision index Counter. Recording/play head consists of specially treated core-materials which are being imported from West Germany. Maximum output power of the built-in amplifier is 6 watt on each channel (total 12 watt) which can drive up to 12 in. extension speaker system. Dual Head and Preamp Outlets are provided for connection direct to any other pre-amplifiers or stereophonic amplifier.  
Instant Stop Lever. All operating controls are interlocked. Automatic stop device.  
The pinch wheel is always automatically released from capstan which protects it against a "spot" on the soft rubber surface causing uneven running.

Retails at 130 GNS.

### HI-FI WIDE RANGE STEREO SPEAKER SYSTEM MODEL SS-50

Matched with the Model M-6 in styling and size, complete with connecting cables.  
Speakers: Two 8-inch mechanical 2-way (with built-in coaxial tweeter) speakers in a dividable carrying case.

Retails at 30 GNS.



Akai's new modern factory in Japan where the finest equipment is produced under the most up-to-date conditions.

Akai\* is the most important contribution that has been made to first-class tape recording equipment for years. In a comparatively short time, they have established themselves in a leading position in the American Tape Recording Field.

Now they have come to Britain and one has only to examine them to see why they are going to prove serious competition to those European manufacturers, who have led the field for so long. You find this hard to believe? Then see the Akai Terecorders for yourself, contact your usual dealer or the sole importers.

\*Due to trade agreements Akai are sold under the name of Roberts in the U.S.A.

For descriptive literature and full information of the Akai Terecorders contact your usual dealer or **NORTHGATE (CAMERAS) LIMITED**, 119/125 Wardour Street, London, W.1  
Tel.: GERrard 7030, 7038, 7939.



## BASF tape library boxes in smaller sizes

These exciting swivel-open storage boxes, now available for the smaller spools, are supplied complete with three BASF Double Play Tapes—for the price of the tapes only!

Made in tough rigid plastic, they provide the perfect quick reference library and protect your tapes from dust and damage. In three sizes, pre-packed with  
 Three 3" BASF Double Play Tapes for 42/-  
 Three 4" BASF Double Play Tapes for 75/-  
 Three 4½" BASF Double Play Tapes for 90/-

# NEW

*for portable users!*



## BASF triple play tape

Yes, *triple* play—an hour and a half of recording time on a 3" spool to give your twin-track portable a big-machine capacity. BASF Triple Play Tape has treble the playing time of Standard Tape, yet retains all the outstanding BASF qualities—

full frequency response, negligible print-through, dimensional and magnetic stability. Available from your dealer on 3", 4" and 4½" spools, holding 450, 900 and 1200 feet of tape respectively.

with  you get more for your money

BASF CHEMICALS LIMITED 5A GILLESPIE ROAD LONDON N5