

# the TAPE *price 2/-* RECORDER

NOVEMBER 1963  
VOL. 5 NO. 10

INCORPORATING "SOUND AND CINE"



## THOUGHTS ON DESIGN



## PHILIPS TAPE

GREEN  
for standard  
RED  
for longplay  
BLUE  
for doubleplay  
GREY  
for tripleplay



Capture a sound on Philips Tape and it's yours for ever—yours to play back and enjoy whenever you like. Available in all current reel sizes of standard, longplay, doubleplay and tripleplay, Philips Tape gives you all these advantages: great sensitivity, wide frequency range, low noise level, high resistance to stretching or breakage, powerful adhesion of the magnetic coating. And of course, they're colour-packed for easy identification. Whatever tape recorder you own, get the best out of it—with Philips Tape.

**FINE PRODUCTS FROM PHILIPS—THE FRIEND OF THE FAMILY**

PHILIPS ELECTRICAL LTD., ELECTRO-ACOUSTICS DIVISION, CENTURY HOUSE, SHAFTESBURY AVENUE, LONDON WC2 (PTA4314)

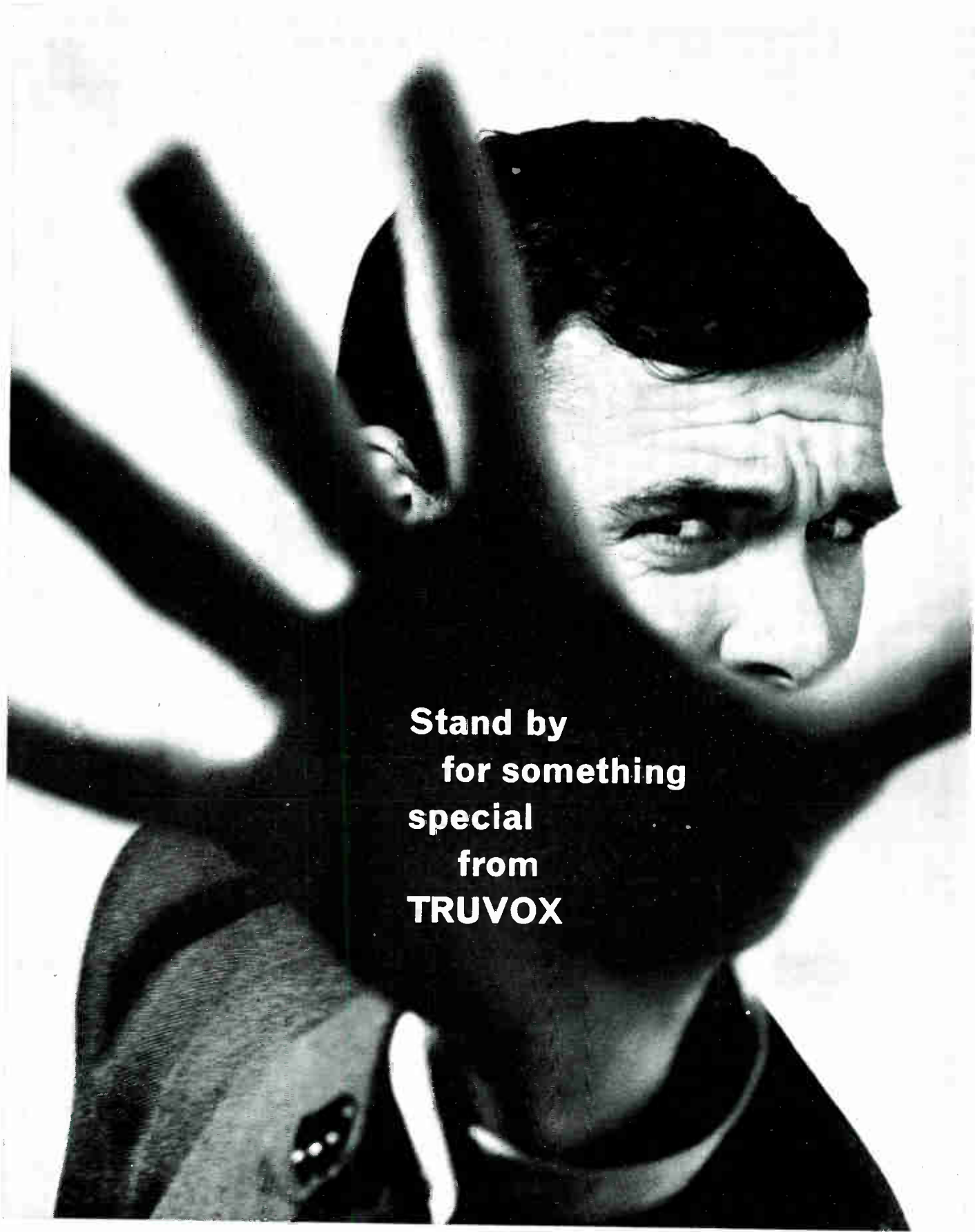

**Stand by  
for something  
special  
from  
TRUVOX**



# introducing the TRUVOX 90

## A NEW THOROUGHbred SERIES FROM A FAMOUS BRITISH MARQUE

Clinically professional in every line. Crisply precise in operation. Full and faithful in reproducing sound . . . this sums up the new Series 90—the finest yet from Truvox.

No concessions here to mass-market "styling". No fancy plastic moulding; no pretty-pretty cover fabrics. No "cosmetics" at all. Instead—clean, rugged and functionally austere, the new Truvox looks every inch what it is . . . a thoroughbred instrument for the enthusiast.

For the man who wants a *real* tape recorder; not a gilded toy on the one hand, nor a status symbol on the other.

Among the outstanding features of the Series 90 are:

- \* "Piano Key" operation.
- \* A cathode follower output.
- \* Recording level meter.
- \* Positive lock reel carriers.
- \* 4 digit counter — instant reset button.
- \* Hinged editing panel.
- \* 'No-tape' autostop.
- \* Mixing facilities.
- \* Superimposition.
- \* Forward facing Rola-Celestion loudspeaker.
- \* 3 tape speeds— $7\frac{1}{2}$   $3\frac{3}{4}$   $1\frac{7}{8}$  ips.
- \* 3 motor drive — Papst capstan motor.

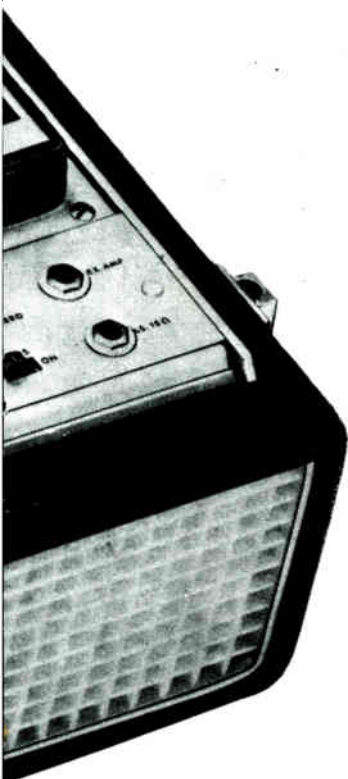



**PD.93 2-track mono tape unit.**  
**PD.95 4-track mono tape unit.**  
Each 59 gns. (U.K. only)



**PD.97 2-track stereo tape unit.**  
**PD.99 4-track stereo tape unit.**  
Each 79 gns. (U.K. only).

These handsome self powered tape units, in superb Afrormosia plinths, polyester finished, provide an ideal means of adding tape to the existing Hi-Fidelity system at a very economical price. They can be used with any amplifier at present available and be operated horizontally, vertically or any angle between.

To enable purchasers to make their own personal choice of microphone and tape, we do not supply these items with any tape unit.

**R.92 2-track recorder**  
**R.94 4-track recorder**  
Each 69 gns. (U.K. only)  
Complete with moving coil microphone and first-class reel of tape.

**For highest  
quality equipment**

**Heathkit**  
DAYSTROM

**at lowest  
possible prices**

**HI-FI FM TUNER, Model FM-4U**

Available in two units which for your convenience are sold separately. Tuning unit (FM-4U) - £2 15s. 0d. incl. P.T.E., despatched wired and tested, and I.F. amplifier (MA-4U) - £12 6s. 1d. Printed circuit for I.F. amplifier and ratio detector. Built-in power supply; 7 valves. Tuning range 88-108 Mc/s. (illustrated bottom right). Total price £15 1s. 0d.

**HI-FI AM/FM TUNER, Model AFM-1**

Also available in two units as above. Tuning heart (AFM-1) - £4 13s. 6d. incl. P.T.E. and I.F. amplifier (AFM-A1) - £20 13s. 1d. Printed circuit board, 8 valves, consecutive FM limiting and ratio detector. Tuning range FM: 88-108 Mc/s., AM: 16-50, 200-550, 900-2,000m. Switched wide and narrow AM bandwidth. Built-in power supply. Total price £25 6s. 6d.

**HI-FI EQUIPMENT CABINETS**

A range of over a dozen equipment cabinets is now available to meet the differing needs of enthusiasts.

Designed for maximum operating convenience or for where room space is an over-riding consideration, this range includes kits, accurately machined for ease of assembly and "left in the white" for finish to personal taste, ready assembled cabinets or assembled and fully finished cabinets, and has at least one model to meet your requirements. Why not send for full details? Prices from £6 19s. 6d. - £29 8s. 0d.

ALL BRITISH MODELS AVAILABLE ASSEMBLED.

PRICES ON REQUEST.

Deferred terms on orders over £10.

**NEW: GUITAR/P.A. AMPLIFIER**

Model PA-1. 50 watts r.m.s., 100 W pk. output. 4 inputs for guitars, mic., record player etc. Many features incl.: 2 heavy duty speakers. Vol. indicator, variable tremolo, 2 channels. Full specification sent on request. Available now: £54 15s. 0d.

**NEW: "OXFORD" DELUXE TRANSISTOR DUAL-WAVE PORTABLE RECEIVER Model UXR-2**

Ideal for use in the home, car or as a personal portable receiver. Features: - Solid leather case. Slide-rule tuning scale. Printed circuit board: 7 transistors, 3 diodes. 7" x 4" Loudspeaker. Full details available on request. £14 18s. 0d. incl. P.T.

**Tape Recording and Replay Hi-Fi Amplifiers Models TA-IM (Mono) and TA-IS (Stereo)**

For use with most tape decks. Thermometer type recording indicators, press-button speed compensation and input selection, 3-position bias level and printed circuit construction.

TA-IM	£19 2s. 6d.
TA-IM and Collaro "STUDIO"	£30 10s. 6d.
TA-IM and TRUVOX D83/2	£47 2s. 6d.
TA-IM and TRUVOX D83/4	£45 5s. 0d.
TA-IS (illustration Centre)	£24 10s. 0d.
TA-IS and TRUVOX D83/2	£52 6s. 0d.
TA-IS and TRUVOX D83/4	£50 9s. 6d.

A WHOLE RANGE OF PACKAGED DEALS (INCLUDING "CONNOISSEUR CRAFTSMAN" TURNTABLE and DECCA BISS PICK-UP) NOW AVAILABLE TO SAVE YOU FURTHER MONEY.



"Malvern"



MFS

**COTSWOLD HI-FI SPEAKER SYSTEM**

This is an acoustically designed enclosure 26" x 23" x 14 1/2" housing a 12" bass speaker with 2" speech coil, elliptical middle speaker, together with a pressure unit to cover the full frequency range of 30-20,000 c/s. Capable of doing justice to the finest programme source, its polar distribution makes it ideal for really Hi-Fi Stereo. Delivered complete with speakers, cross-over unit, level control, Lygan grille cloth, etc. All parts pre-cut and drilled for ease of assembly and left "in the white" veneered for finish to personal taste.

**"COTSWOLD" MFS SYSTEM**

Similar performance to standard "Cotswold" but designed for the smaller room. Size 36" high x 16 1/2" wide x 14 1/2" deep. Filter model. £23 1s. 0d.

Here are some other easy-to-build Heathkit Models for you



S-33

MA-5

SSU-1

AG-9U

MA12

**MONO CONTROL UNIT Model UMC-1.** Designed to operate with the MA-12 or any amplifier requiring 0.25v or less for full output. Suitable for cabinet mounting or free standing. Size 10" x 7" x 4". Available shortly. £8 12s. 6d.

**DELUXE 6 WATT STEREO AMPLIFIER Model S-33H.** A stereo/mono amplifier with the high sensitivity necessary for light-weight ceramic pickups (e.g. Decca Deram). Deluxe version of the S-33. £15 17s. 6d.

**HI-FI STEREO 6 WATT AMPLIFIER Model S-33.** Attractively styled, completely self-contained. Printed circuit makes it easy to build. Only 0.3% distortion at 2 1/2 W/chal. U/I output, ganged controls. £13 7s. 6d.

**HI-FI MONOURAL AMPLIFIER Model MA5.** An ideal general-purpose reasonably priced mono amplifier. 5 watts output at only 0.5% distortion, has inputs for Gram. Radio. Printed circuit board. Size 11" x 6 1/2" x 4 1/2" high. £10 19s. 6d.

**HI-FI SPEAKER SYSTEM Model SSU-1.** This kit is easily assembled. It contains twin speakers and balance control in its direct ducted port reflex cabinet. It is equally suitable for stereo or mono in average room. 11 cgs. 14/6 optional extra. £10 17s. 6d.

**AUDIO SIGNAL GENERATOR Model AG-9U.** Delivers up to 10 volts pure sine-wave (less than 0.1% distortion, 20 c/s to 20 kc/s). Decade switch-selected frequencies from 10 to 100,000 c/s. Internal 600 Ohm N/I load, or external. £21 9s. 6d.

**POWER-AMPLIFIER 12-WATT Model MA.12.** Single channel, ideal for stereo conversion. £11 9s. 6d.

**COLLARO "STUDIO" TAPE DECK.** Two tracks. "Wow" and "flutter" not greater than 0.15% at 7 1/2" p.s. Long Term Speed Stability better than 0.5%. £17 10s. 0d.

**SUGDEN MOTOR UNIT "CONNOISSEUR CRAFTSMAN".** Heavy duty motor, operating at 33 1/3 and 45 r.p.m. Very heavy 12" turntable. £16 6s. 6d.

**HI-FI STEREO 18-WATT AMPLIFIER Model S-99.** Within its power rating, this is the finest stereo amplifier available, regardless of price. U/I push-pull output. Printed circuit construction. £27 19s. 6d.

**TRANSISTOR INTERCOM. Models XI-U and XIR-U.** Ideal for office or home. Each Master operates up to five Remotes. 9s. battery operated. XI-U £10 19s. 6d. XIR-U £4 7s. 6d.

**STEREO CONTROL UNIT Model USC-1.** A deluxe stereo control unit with variable filter, switched rumble filter, printed circuit boards and many other refinements. Operates direct from tape heads. £19 10s. 0d.

**TRANSISTOR PORTABLE RADIO Model UXR-1.** Superbly styled hide case, with golden relief and crystal easy-to-tune dial, this completely self-contained 6-transistor dual wave... performs brilliantly everywhere, even in a car. Reproduction is exceptionally good. Printed circuit. £12 11s. 0d.

**SHORTWAVE TRANSISTOR PORTABLE Model RSW-1.** Four wave-band seven transistor portable with telescopic and ferrite aeraids, slow-motion tuning Covers Medium, Frawler, and 6-26 Mc/s in four switched bands. Uses printed circuit board and latest circuit technique. Superbly styled leather case. £19 17s. 6s.

**TRUVOX D83/3 AND D83/4 TAPE DECKS.** High quality mono/stereo Tape Decks. D83/2 2-track for highest-fidelity. £31 10s. 0d. D83/4 (identical presentation) 4-track for most economical use of tape. £29 8s. 0d.

**GARRARD AUTO/RECORD PLAYER Model AT-6.** A 4-speed stereo/mono unit with manual or fully automatic record selection; adjustable counter-balanced arm. Fitted with Decca Deram ceramic cartridge £14 6s. 1d. or Ronette 105 mono/stereo cartridge. £13 12s. 1d.

**GOLDRING-LENCO TRANSCRIPTION RECORD PLAYER Model GL.58.** Fitted with the G.60 pick-up arm and Ronette 105 mono/stereo cartridge, it has infinitely variable speed adjustment between 33 1/3 and 80 r.p.m. and four fixed speeds. 3 3/4" lb. turntable to reduce rumble, "wow" and "flutter". £18 19s. 2d.



S-99



RSW-1



UXR-1



GL-58



AM/FM TUNER

JUST POST THIS COUPON FOR FURTHER INFORMATION

Without obligation please send me

★ **FREE BRITISH HEATHKIT CATALOGUE.**

FULL DETAILS OF MODELS(S).....

Kindly write below in BLOCK CAPITALS

NAME.....

ADDRESS.....

Tick  
HI FI

HT11

INTERNATIONAL MAIL ORDER SCHEME COVERING THE AMERICAN HEATHKIT RANGE OF OVER 250 MODELS. For direct delivery from the U.S. plant to your U.K. address. Illustrated American Catalogue and full details of the scheme can be obtained from us at the nominal charge of 1/- post paid.

**DAYSTROM LTD. DEPT. HT11 GLOUCESTER, ENGLAND**

A member of the Daystrom Group, manufacturers of

**THE LARGEST-SELLING ELECTRONIC KITS IN THE WORLD**

**This beats everything !**

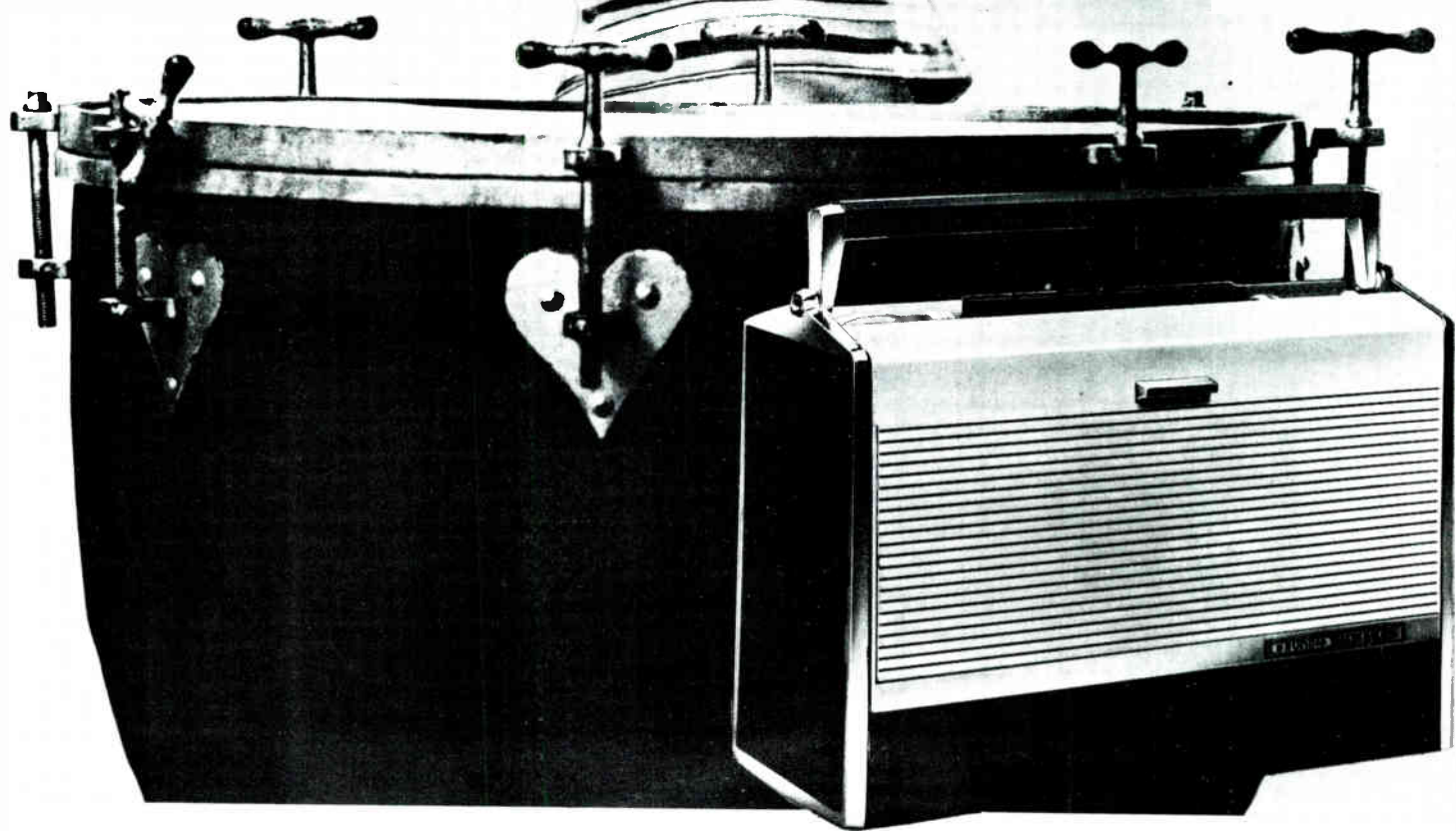

THE SUPERLATIVE

**TK6**

A new-era Grundig. No machine like it anywhere. Mains-operated transistorised portable tape recorder. Own built-in battery or car battery operated. Next-century design. Concert hall quality. Two speeds. Four hours play-back. Ask your Grundig Dealer for a demonstration of this brilliant new model. 65 gns. including microphone and triple play tape.

**SPECIFICATION**

- Speeds  $3\frac{1}{2}$  and  $1\frac{1}{2}$  i.p.s. • Frequency Response up to 13,000 c/s • 13 Transistors and Diodes
- Revolutionary HF controlled and transistor stabilised motor • Recording Level Meter—Battery indicator
- Tape Canister • Fast forward, rewind, stop, start, temporary stop and recording by press buttons
- Highly sensitive dynamic moving coil microphone • 1,200 feet of triple play tape supplied
- Auto adaptor available • Extra large loudspeaker • Dimensions  $12\frac{1}{2}$ " x  $5\frac{1}{2}$ " x  $9\frac{1}{2}$ " • Separate bass and treble controls.

**GRUNDIG**

**GRUNDIG (Great Britain) LIMITED**

Newlands Park, Sydenham, London S.E.26 SYD 2211

Please send me the exciting TK6 leaflet

NAME .....

ADDRESS .....

TR 11

# WORLD RECORD CLUB OFFERS YOU THE CHOICE OF ANY 3 PRE-RECORDED TAPES



**58** The fabulous dynamic Duke Ellington himself in eight great numbers including Stomping at the Savoy, In the Mood and Honeysuckle Rose



**1** Tchaikovsky Swan Lake, John Hollingsworth conducts the Symphony of London in a great performance of this well-loved ballet music. Also in stereo.



**59** The silken voice of Nat King Cole in Walkin', Because You're Mine, You'll Never Grow Old, Baby Won't You Say You Love Me and 8 more



**30** Lin Colmichael Joyce Blair star cast and orchestra. As Long As He Needs Me Consider Yourself, all the hit numbers from Lionel Bart's great show. Also in stereo.



**49** Beethoven Fidelio Overture, Brahms St Anthony variations, Mendelssohn Hebrides Overture, Wagner Steiefeld Idyll. Superb interpretations. Also in stereo.



**50** David Hughes, Barbara Leigh, Andy Cole and chorus sing Indian Love Call, Rose Marie, and all the other tunes from Friml's well-loved musical. Also in stereo.



**61** The world's 3 greatest sonatas - Beethoven's Moonlight, Pathetique and Appassionata, superbly played by famous TV pianist Joseph Cooper.



**71** The smooth sound of the Neilson Riddle Orchestra in Touch of Your Lips, Body and Soul, The Tender Touch, As You Desire Me. 11 favourites in all.



**44** Leopold Lindog and LSO combine brilliantly in an exciting double. Two of the world's greatest symphonies receive vivid new interpretations. Also in stereo.



**63** Cuban Carnival Yesterday - Blues in My Heart and eight more great numbers played by George Shearing with vocals by Dakota Station.



**48** Deep in My Heart, Drink Song, Serenade - all the old favourites fresher than ever with Marion Grimaldi, Linden Singers and Orchestra. Also in stereo.



**53** Bizet's thrilling music magnificently performed by Symphony of London under Muir Matheson. Also in stereo.

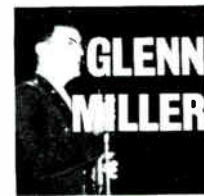

**77** In the Mood, Bugle-Call Rag, Chattanooga Choo-choo, Serenade in Blue. 9 original tracks by the immortal Glenn Miller and his band.



**14** Tchaikovsky Symphony No. 5. Sir Malcolm Sargent and LSO combine to give this famous symphony a dramatic and colourful rendering. Also in stereo.



**35** Of Man River, Bill, Make Believe, many more well-loved numbers, from this famous musical, memorably sung and played by full star cast. Also in stereo.



**11** Dvorak Symphony No. 5. From 'The New World' Leopold Lindog conducts the London Symphony Orchestra in a dramatic and moving performance. Also in stereo.



**32** Star cast and orchestra stage all the famous songs: Getting to Know You, Hello Young Lovers, I Whistle a Happy Tune, Shall We Dance, etc. Also in stereo.



**69** The exquisite playing of the Virtuoso Ensemble matches the beauty of Schubert's celebrated Trout Quintet, which contains some of his most famous melodies.



**40** Bruna Rizzoli and Giuseppe Savino with the chorus of the Teatro Nuovo di Milano and orchestra conducted by Napoleone Annuzzi.



**52** Gracie Fields sings her favourite songs for you, including In My Little Bottom Drawer, Sally, Song of the Mountain and ten others.

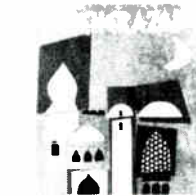

**31** Rimsky-Korsakov Scheherazade, Sir Eugene Goossens conducts the LSO in a breathtaking performance of this rich and exotic masterpiece. Also in stereo.



**90** Fbb Tide, Waterfront Blues, When the War breaks out in Mexico, Carolina in the Morning, and many more by Jerry Colonna and his Dixieland Band.



**2** Grieg Piano Concerto. Alexander Jenner in an electrifying performance with the Bavarian State Radio Orchestra conducted by Odd Gruner-Hege.



**76** Inimitable Art Tatum in person plays Tenderly, Body and Soul, Without a Song, Begin the Beguine. 12 superb numbers from the greatest ever jazz pianist.



**74** Superb Sarah Vaughan in ten great numbers. If I Loved You, Saturday It's Delovely, You'll find me There, etc. Every one a hit.



**38** Hervey Alan, Ian Wallace, Marion Grimaldi and chorus sing the immortal favourites: Cobbler's Song, Robbers' Chorus, Chu Chin Chow, etc. Also in stereo.



**34** Stardust, How High the Moon, Nearness of You, 'Round Midnight, King David and eight numbers by the vibraphone genius, Lionel Hampton. Also in stereo.



**54** Tchaikovsky's last and greatest symphony, is here given a splendid moving rendering by the Symphony of London conducted by Muir Matheson. Also in stereo.



**65** Our Love is Here to Stay, The Nearness of You, Gaily, and nine more great hits, all with America's top vocal group, the fabulous Four Freshmen.



**81** Song of Chopin's beloved melodies, magnificently played by world-famous pianist Fou Ts'ong. The Four Ballades Nocturne in F Sharp Major, etc.



# FOR ONLY 30/-

## THE GREATEST BREAKTHROUGH SINCE TAPE RECORDING!

Here is the greatest World Record Club introductory offer ever made . . . a unique offer never before matched by any record club or company anywhere in the world!

EVERY ONE OF WORLD RECORD CLUB'S UNRIVALLED RELEASES AS 12" LPs IS NOW AVAILABLE ON 3 3/4 ips TAPE!

Now you have the opportunity to play any WRC release on your tape recorder. Each of these 'tape records' runs at 3 3/4 ips, mono, on 5" spools and can be played on either 2 or 4 track recorders. New electronic techniques of tape-to-tape transfer give these 3 3/4 ips WRC pre-recorded tapes a standard of reproduction unattainable previously at less than 7 1/2 ips.

### WORLD RECORD CLUB 7-POINT PLAN MEANS BETTER LISTENING FOR YOU!

#### 1. AN UNPARALLELED INTRODUCTORY OFFER.

Choose now, any three of the superb 3 3/4 ips pre-recorded tapes shown here, for only 10/- each and number them on the attached coupon. (If you wish, of course, you can choose 12" LPs instead. Introductory discs and tapes are both the same price.) Please send no money until after you have received, played and approved them. We want you to prove to yourself, before paying, that our tapes are equal to the world's best.

#### 2. THE OPPORTUNITY TO BUILD A UNIQUE TAPE COLLECTION.

The WRC plan offers you an exciting and varied annual repertoire of more than 70 selected tape releases, covering classics, jazz, shows, ballet music, light music and 'pops'. Every one is a superlatively recorded 3 3/4 ips mono tape (or 12" LP—mono and stereo). Tapes are offered to you at the

privilege club price of 29/- (plus a small charge for post and packing)—much less than you would pay elsewhere for recordings of anything like this quality. Your only obligation, as a Club member, is to agree to buy four more tapes (or 12" LPs) during your year of membership. Beyond this, there is no subscription or membership fee.

#### 3. A PLANNED PROGRAMME.

Every World Record Club release is hand-picked by an independent panel of Britain's top musical authorities. The Countess of Harewood, Lord Montagu of Beaulieu, Sir Arthur Bliss, Richard Attenborough, Cyril Ornadel, Ray Ellington, Leon Goossens, Malcolm Arnold, Steve Race, John Hollingsworth, Antony Hopkins—and, as special adviser on tape, Miles Henslow.

#### 4. NEW CLUB MAGAZINE.

The new club magazine contains 48 pages, many in colour. Packed with fascinating features, information, competitions and special offers, it comes free to all WRC members.

#### 5. SPECIAL CONCERT PRICE CONCESSIONS.

Many concert halls and theatres throughout the country (including the Royal Festival Hall) allow special concession rates to club members for many performances.

#### 6. FREE BONUS TAPES.

The more you buy, the more you save! After fulfilling the minimum membership obligations, you earn another tape of your own choice free for every extra three you buy!

#### 7. EXCLUSIVE EXTRA RELEASES.

In addition to the regular monthly selections, the club offers members exclusive extra tapes at the standard Club price.

World Record Club is unique—the first and greatest Record and Tape Club in Britain, with the largest show catalogue (on tape and mono stereo disc) in the world. No other method of tape—or record-buying offers you so many additional benefits, so much freedom and variety of choice, with no 'high-pressure' selling. And, of course, there are no subscriptions or membership fees of any kind.

Don't miss this great opportunity. Send off the coupon today, for your 3 introductory selections for only 30/-

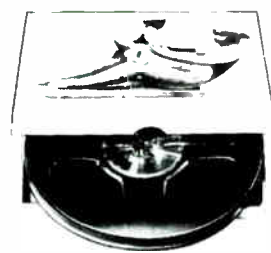

... AND IF YOU OWN A  
STEREO TAPE RECORDER  
hear the fantastic reproduction of

## STEREO 21

THE NEWEST,  
TRUEST SOUND  
ON TAPE TODAY!

Revolutionary new STEREO 21 pre-recorded tapes (7 1/2 ips twin-track) are issued exclusively by World Record Club. But they are offered without membership commitments of any kind. The first list of all new STEREO 21 releases is now available. It features 30 superb stereophonic tapes ranging from Beethoven's Eroica with Josef Krips conducting the LSO, to a lavish full-cast production of Oklahoma.

As always, WRC prices present unparalleled value—all STEREO 21 releases cost either 50/- or 60/- depending on playing time (up to 50 minutes). STEREO 21 tapes are now obtainable through leading retailers or direct by post from World Record Club. Send for full catalogue now. STEREO 21 must be heard to be believed!

## 7-DAY FREE TRIAL OFFER—POST TODAY!

## STEREO 21 FREE BROCHURE

To WORLD RECORD CLUB (Dept. TRR 12) Box 11  
PARKBRIDGE HOUSE, RICHMOND, SURREY.

SEND NO MONEY NOW

3 3/4 ips pre-recorded tapes	<input type="checkbox"/>	12" LPs	<input type="checkbox"/>
------------------------------------	--------------------------	---------	--------------------------

Tick what you want

Please send me, without obligation, on 7-day free trial, the three selections indicated. Your 3 selections must be either all tape or all disc. If satisfied, I will pay you 30/- plus 3/- postage, packing and insurance. Only at that stage may you enrol me as a full member of World Record Club, entitled to all the benefits described. My only obligation as a member would be to agree to purchase 4 more top quality 3 3/4 ips tapes over the next year at the special club price of 29/- each (or 12" LPs at 26/6) plus a small charge for post and packing. If I am not completely satisfied with my 3 selections, I will return them to you within 7 days, in good condition, and owe you nothing.

Signed \_\_\_\_\_  
this offer applies in Gt. Britain and N. Ireland only.

MY 3-SELECTION  
'PACKAGE' COMPRISES

Choice No. 1 Choice No. 2 Choice No. 3



(place tape/disc key numbers only in the circles)

Tick here if stereo 12" LPs are  
required where available

Mr/Mrs/Miss \_\_\_\_\_  
(BLOCK CAPITALS PLEASE)

ADDRESS \_\_\_\_\_

To WORLD RECORD CLUB (Dept TRR 13)  
Box 11 PARKBRIDGE HOUSE, RICHMOND, SURREY.

Please send me your free colour brochure,  
showing the full range of your new  
STEREO 21 releases.

NAME \_\_\_\_\_  
(BLOCK CAPITALS PLEASE)

ADDRESS \_\_\_\_\_

Pick of the **WORLDS** best!..

a new class  
**SIEMENS**  
**TAPE RECORDER**  
 for the connoisseur



**SIEMENS NORGE Model 12**  
**4 TRACK STEREO/ALL TRANSISTOR**  
**HIGH FIDELITY TAPE RECORDER**

The world's most experienced professionals have made this brilliant newcomer for you. You will immediately appreciate the technical perfection and ingenuity of this incomparable tape recorder. There are 3 Tape Speeds, 3 Heads-Record, Playback and Erase—with Sound-on-Sound trick recording and many other facilities. The Model 12 has two Hi-Fi speakers built in. Rewind time is 2 mins. for 1,200 ft. of tape. Weight 35 lbs. Strongly made and finished. Beautiful to hear and see.

The **SIEMENS** Range comprises

Model 10, 89 gns. Model 12, 94 gns. Model 14, 87 gns.



**DENHAM & MORLEY LTD.**  
**DENMORE HOUSE**

173/175 Cleveland Street, London, W.1 Tel: EUSton 3656-7

The leading portable  
**TAPE RECORDERS**



**BUTOBA MT7 & MT7R**

Battery operated with Mains performance

If you're looking for a multi-purpose tape recorder buy a "Butoba." This range of battery operated machines is outstanding for purity of reproduction and is ideal for recording music, speech and bird-song. Easily transportable, "Butoba" will help to make your holiday memorable. You can have the music of your choice wherever you go and, together with your camera, you can bring home tapes which have captured forever the sounds and scenes you have selected to record. The "Butoba" is truly economical on batteries and there is a mains converter available for home use. High Fidelity range 6 in. oval speaker. Good output. (1 watt.) The MT7R is available with remote control facilities, ideal for dictation in office or car.

The prices of the range are attractive

Model MT7 38 gns. MT7R 43 gns. MT5 66 gns.

Please send me details of the Butoba/Siemens Tape Recorders.

NAME .....

ADDRESS .....

# the TAPE RECORDER

Editor - - - - - MILES HENSLOW  
 News Editor - - - - - Alan Lovell  
 Advertisement Editor - - - - - Julian Berrisford  
 Editorial Offices - - - - 99 Mortimer Street, London, W.1  
 Telephone - - - - - MUSEum 3967 to 3969



## ★ EDITORIAL

MEMBER OF THE  
 AUDIT BUREAU  
 OF CIRCULATIONS

THIS month we are using the "editorial column" as a medium for a request, rather than a discussion. Ever since we first published the *Tape Recorder*, nearly five years ago, our post bag has increased steadily. This is in itself not surprising, because the sales of the magazine have also increased regularly, but what has been puzzling us for the last two or three years is the fact that such a small percentage of all the letters we receive fall under the heading of "readers' letters". Most of them are technical queries, which are dealt with (as their writers know) by our team of advisers, and although a few of these are published monthly, together with their replies—when they represent problems that are likely to be of general interest—they do not reflect the views, opinions or ideas that normally make up an interesting and lively Correspondence Feature. We have often tried to stimulate interest in this direction, and each stimulus has brought about an increase of letters—but not of the type we seek. So this time, in this column, we are not merely asking for the basis of a bright "readers' letters" page, but we are appealing point blank to those of our readers who are in touch with "tape" and some of the lesser known uses of "tape" to give us a lead, and to let us read about the other side of the picture. We have been surprised, during the past few months in particular, to discover how many unusual jobs that tape and tape recorders are doing in various trades and industries; and as a result of these discoveries we have briefed a member of our editorial staff to prepare a series of articles around the more interesting of these tape applications. The first of these articles will appear very shortly, and it will probably act as a stimulus for correspondence of the type we want in at least one direction. But what we believe is that quite a large slice of our readership is made up of people who work with tape in jobs which are, to them, very ordinary and routine, but which would prove to be extremely interesting to almost every other reader. We do not intend to give any leads, other than to say that we know that vast quantities of magnetic tape are used by science and industry each month—a tape total that makes the whole of the quite large domestic and semi-professional market look really small by comparison. We are quite certain that—can they be stirred to write to us about it—the people who help to use this tape have a lot to write about—excluding those people who would like to write, but who are naturally not allowed to do so because of defence or design secrecy.

It has always been a sore point with us, that we have so far failed to create for this magazine one of its most interesting features. It has also been a real mystery to us, because all the rules and laws of average which brush the publication of periodical journals indicate that the flow of correspondence increases in direct proportion to readership increase. If we do anything wrong or unpopular, then we are immediately told about it—by postcard, letter and telephone. We are constantly asked for advice about potential purchases. And, as we have already said, our requests for technical information increase steadily. But the type of reader's letter that we eagerly await—the letter that is so interesting that we can barely wait to have it set in type for publication—comes so rarely that it is a real event when it arrives. The reason for this is probably a

NOVEMBER - - - - - 1963

VOLUME 5 - - - - - No. 10

## Contents

News from the World of Tape	401
Test Tapes and Their Uses By Gordon J. King	403
Tape Recorder Service No. 23. Simon Recorders By H. W. Hellyer	405
Readers' Problems	409
Sound and Cine By Richard Golding	411
Recording in Switzerland By Bob Danvers Walker	414
Fundamental Building Acoustics (Part 3) By M. F. Woodward	417
Readers' Letters	421
Book Reviews	421
Tape Records Reviewed	423
Thoughts on Design By Rafe Seabrook	425
Details of New Products	427
Equipment Reviewed	429
Classified Advertisements	436
Advertisers' Index	438

result of our own shortcomings: if so, let us hope that we soon find out what it is! On the other hand, putting the cart before the horse, possibly the building-up of the feature that we so sincerely wish to create will itself point the way for us, showing us what we have to do to get the cart rolling—pulled or pushed by the afore-mentioned horse!

Before closing this subject (and this column) for the month, let us make a practical plea. Letters intended for publication should not exceed 200 to 250 words. Broadly speaking they should deal with tape or tape recorder subjects of general interest. They should *not* be a synopsis of what the average tape recorder owner does with his or her machine. They should not comprise a series of complaints about this, that and the other (we receive plenty of letters of that type! We refer them directly to the parties to whom they should originally have been directed!). They may deal with novel ideas, in which case a rough sketch should come with them.

## Cover Picture

OUR cover photo this month was taken behind the scenes at Shepperton Studios, during the shooting of a musical, *It's all Happening*. The electronics, including professional and sound mixing equipment, is mainly from the EMI stable, and will be recognised from the various pictures that have accompanied reviews and reports of developments in this magazine.

## SUBSCRIPTION RATES

The subscription rate to *The Tape Recorder* is 27/6 per annum (U.S.A. \$4.00) from The Tape Recorder, 99 Mortimer Street, London, W.1. Subscription + Index, 30/- (U.S.A. \$4.25). The same rates apply to *Hi-Fi News*.

- strictly for the connoisseur



## MAGNETONBAND True Fidelity Recording Tape

Capture it completely. Capture every fragment of the living sound. From the full diapason of the cathedral organ to the resonant bite of the brass. Omit nothing. The touch of the bow on the strings or the lightest breath of the spoken word. Capture it all truthfully and for ever on Agfa Magnetonband, the tape of the connoisseurs.

### A UNIQUE COMBINATION OF TECHNICAL QUALITIES

**Pre-stressed** to have maximum tensile strength and resist further stretching. This ensures accurate reproduction of musical pitch.

**Unaffected by heat or moisture.** Tape can be subjected to alternating temperatures  $-100^{\circ}\text{C}$  to  $+100^{\circ}\text{C}$ , without affecting in any way the tape or the recording. Polyester tapes are completely resistant to water and chemical solvents.

**Specially made to take considerable overloading** without affecting the quality of the recording. The distortion factor and the signal/noise ratio are such that reproduction shows a clarity of sound that is quite remarkable.

**Unrivalled resistance to abrasion.** The special iron oxide is not coated to the base but BONDED to it so that recording heads remain clean. Even with long periods of use no iron oxide deposits spoil the recording and play-back characteristics.

**Agfa tapes are specially polished** to provide the minimum wear on magnetic heads. Also, the *flexibility* of these tapes allows intimate contact between tape and head—thus ensuring the maximum frequency response. This is why home recordings can be of a high fidelity comparable in quality with professional recordings.

as used by professional studios

AGFA LTD DEER PARK ROAD · LONDON SW19 · CHERRYWOOD 1121

400

# NEWS FROM THE WORLD OF TAPE

## Strictly for The Birds

**A**N "audible poster" was heard in London recently, claimed to be the first in England. A tape recorder was used to relay the sounds of screaming birds to speakers placed behind an advertising poster in Shaftesbury Avenue, W.C.2. The gimmick was part of an advertising campaign by the Rank Organisation for Alfred Hitchcock's latest film about our feathered friends "The Birds". The tape was switched off however when complaints were received from the council, the Noise Abatement Society, and the police.

★ ★ ★

## Long Play for Tannoy

**T**HOSE of us who imagine our domestic tape recorders are over-worked by Junior's interminable "pops" may take heart from the figures quoted recently by Tannoy, who have now bought RE301 machines from EMI, to meet their expanding requirements. Several of their regular machines, EMI TR51s, TR52s and TR90s have been in use for an average of 14 hours a day, six days a week, all the year round.

The RE301 machines were used for the first time at a large international congress at the Royal Albert Hall, this summer. About 33 hours of recording were made, in two languages. This was edited to six hours of special features and copied 100 times. The copies were flown to 56 different countries, re-edited to a 3-hour tape, copied many hundreds of times and now distributed on a world-wide basis.

★ ★ ★

## Fi-Cord at Business Efficiency Exhibition

**M**AGNETIC recording tape cut by Miss Caroline Maudling, daughter of the Chancellor of the Exchequer, made an original slant to the traditional opening ceremony of the Fi-Cord stand, at the Business



Efficiency Exhibition in London. Miss Maudling later examined a version of the Fi-Cord 101 portable dictating machine which was made of 24 carat gold.

★ ★ ★

## Hi-Fi Division for Sony

**T**HE name of *Sony*, which has jumped to prominence in the world of tape recorders during the past two years is now to be linked more



Lists of "Talkative Types" which will end up in the homes of Worldwide Tapetalk members all over the world. Mrs. Florence Towers prepares for a big stamp licking job!

emphatically with the Hi-Fi scene. We have just heard from *Telux* that they have formed a Hi-Fidelity division for the development of the sales of *Sony* products in the United Kingdom. These products include semi-professional and professional tape recorders and hi-fidelity equipment, including amplifiers and microphones, as well as tuner units, etc., of other manufacture.

We understand that a statement of the marketing policy and special promotional activities, to be undertaken by the new division, will be made at a later date.

The new division will be under the supervision of Mr. D. K. Perry, *Telux* General Sales Manager. The offices of this division will be at Avenue Works, Romford. (Telephone No.: Ingrebourne 43971) where Mr. W. J. Evans will deal with trade enquiries and sales information.

★ ★ ★

## Northern Audio Fair is Off

**D**UE to lack of support from manufacturers the Northern Audio Fair will not be held after all. The organiser, Mr. Cyril Rex Hassan explained that for the exhibition to pay its way at least 30 exhibitors would be needed. Only 22 firms had agreed to provide support. The fair was to be held at Harrogate.

★ ★ ★

## Running a Tape Exchange

**W**E all have our problems in life, but Mr. Charles L. Towers of Harrow, Middlesex, must have felt life was treating him a little too lightly when, in June 1961, he formed the tape exchange *Worldwide Tapetalk*. Since then, every four months, he and his wife Florence have the arduous task of sending address lists and news to a membership which has now exceeded 600. On top of this each day brings dozens of letters and tapes from members throughout the world.

★ ★ ★

## Price Reduction for Butoba MT7

**D**UE to increased production and greater demand for the Butoba MT7 transistorised battery portable tape recorder, the retail price has been reduced from £46 4s. to £39 18s. The reduction took effect from the 9th September.

★ ★ ★

**Index to Volume 4 of THE TAPE RECORDER Available now - - - Price 2s. 6d.**



TCHAIKOVSKY PIANO CON. NO.1  
H.M.V. TA-ALP1991

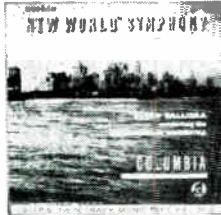

NEW WORLD SYMPHONY  
COLUMBIA TA-333X1025



MADAM BUTTERFLY  
H.M.V. TA-CLP1334



MORE BEECHAM LOLLIPOPS  
H.M.V. TA-ALP1862



SWAN LAKE  
H.M.V. TA-CLP1018

# THE BIGGEST CHOICE IS ON E.M.I. 3 3/4 I.P.S. MONO TWIN TRACK TAPE RECORDS



CONNIE FRANCIS  
M.G.M. TA-MGM-C 930



THE MERRY WIDOW  
H.M.V. TA-C-PI226



CALL ME MISTER  
COLUMBIA TA 333X1522



DANCING PARTY  
H.M.V. TA CLP1-97



BOBBY DARIN  
CAPITOL TA-11791



THE KING AND I  
CAPITOL TA-W740



ELLA swings brightly with NELSON  
Fitzgerald-Decca  
ELLA SWINGS BRIGHTLY WITH  
NELSON VERVE TA 3-19511



FRANK SINATRA  
CAPITOL TA-W1491



SHIRLEY BASSEY  
COLUMBIA TA-333X1178



THOSE LAZY-HAZY-CRAZY DAYS OF SUMMER  
NAT KING COLE  
CAPITOL TA-T4932

**MUSIC FOR LEISURE**  
36  
TAPE RECORDS IN THE  
NEW ENCORE SERIES  
available now!  
only 30/- each



SUMMER HOLIDAY  
COLUMBIA TA-333X1472



BEYOND THE FRINGE  
PARLOPHONE TA-PMC1145



THE SHADOWS GREATEST HITS  
COLUMBIA TA-J33X1522



GIGI  
M-G-M TA-MGM-C770



PLEASE PLEASE ME  
PARLOPHONE TA-PMIC1202



CLEOPATRA  
STATESIDE TA-SLI-044



FERRANTE AND TEICHER  
UNITED ARTISTS TA-ULP1010

**FROM ONLY 30/- EACH**

Ask your dealer for  
FREE leaflet giving  
full details of the  
many other tape  
records available, or  
write to the address  
below



THE GREATEST RECORDING  
ORGANISATION IN THE WORLD

E.M.I. RECORDS LTD., E.M.I. HOUSE, 20 MANCHESTER SQUARE, LONDON, W.1

# TEST TAPES AND THEIR USES

By: GORDON KING

A PERFECT tape recording system can be defined as one where the sound waves created by the speaker are identical in every way to the sound waves which activated the microphone in the first place.

The sound from the microphone has to be amplified and then stored in terms of magnetic patterns on the tape. Then the patterns have to be converted back to the electrical equivalent of the original sound, amplified a second time and then fed to the speaker. One of the big problems in the overall recording system is to ensure that the change of the signal from electrical to magnetic and then from magnetic back to electrical is performed with the least distortion.

To help us decide whether or not this conversion is happening as it should—or as we should like it to—there are available a number of test tapes. These are recorded to a high degree of accuracy under exacting technical conditions and contain various items of signal to reveal weak points in the tape mechanics and in amplifier equalising, as well as other things.

## Frequency Response

Let us take frequency response first of all. If we have a good quality amplifier, replace the speaker with a non-inductive resistive load, across which is connected a voltmeter suitable for indicating audio voltages, and feed into the amplifier a signal from an audio generator we should expect to achieve a fairly constant voltage reading as a constant-level generator signal is varied from about 20 c/s to 15 Kc/s. On a hi-fi amplifier we should get the same results at fairly high power level, depending upon the rating of the amplifier.

This is all very well for amplifiers alone, but it does nothing to assess the performance of the tape section. Here, then, the idea would be to apply the generator signal—correctly matched—to the input of the record amplifier and make a recording of the constant-level audio over the required spectrum. The system would be good if now the voltmeter reading was constant (as connected across a loaded replay amplifier, as detailed above) when the tone-recorded tape was replayed.

To save all the trouble and pit-falls of creating one's own pure-tone test tape a number of firms are producing such tape records at CCIR characteristics mainly for  $3\frac{1}{2}$  and  $7\frac{1}{2}$  i/s.

When a recording is made over the audio spectrum with pure tone at constant level the various frequencies fail to be recorded at equal intensity. The peak occurs around about 4 Kc/s, depending upon tape speed, rising to this value from low frequencies and falling consistently afterwards until very little signal is recorded beyond about 15 Kc/s on the average recorder.

The tape itself has no inherent frequency characteristics of its own. Tape speed influences frequency response—the higher the recording speed the higher the upper limit of recording. The theoretical limit is reached when the wavelength of the sound signal being recorded approximates the width of the gap in the head.

## Correction Standards

To secure a flat output when such a recording is replayed, therefore, the lower and higher frequencies need to be boosted, and slightly different boosts are required for different tape speeds. This is called frequency correction.

Equalising or filter circuits are employed for the boosting process, as these let through more signal at certain frequencies than at others. In Great Britain the correction is to a standard established by the International Radio Consultative Committee, called the CCIR standard. In America a slightly different standard is sometimes used—called NARTB.

The correction for different tape speeds is often given in terms of time, since the filters themselves are really time-constant networks; by defining in time engineers can design to a definite standard. Thus, test tapes may be signified in microseconds of time as well as in frequency and tape speed.

Some of the more expensive tape recorders feature pre-set adjustments for correcting the equalisation. These adjustments are established by the use of a test tape in conjunction with an output-meter. The pre-sets should be adjusted on *replay* to give a specific output at a specific fre-

quency, as indicated in the instruction book. 4 Kc/s is a value sometimes chosen for equaliser adjustment, and some test tapes thus feature a band of such recording.

Clearly, the CCIR characteristic embraces the replay channel as well as the record channel. Indeed, most of the correction is done in the replay channel, as intimated above. The tape is CCIR-recorded if a flat output is obtained when the tape signal is fed through a replay amplifier with the CCIR correction. In practice, some HF boost is given during the recording process.

Another important use of a test tape is in the setting of the azimuth or tilt angle of the replay head. The high-frequency performance of any tape recording depends very much upon how well the oxide side of the tape is in contact with the working surface of the replay head. If only a portion of the tape is in contact with the gap, both the sensitivity and treble response will be poor. Likewise, if the length of the gap differs in *angle* from a line drawn at right-angles between the parallel sides of the tape, there will be a loss of high frequency output.

By running through a 6-8 Kc/s test-tape, the azimuth angle is in perfect line with the recorded 'magnets' when the adjustment gives maximum output. The ear is insufficiently sensitive to aid much with this adjustment, and an audio output meter (or record-level meter if this can be arranged or switched to respond on replay) should be used to tell of slight differences in level as the adjustment is made.

"Wow" and "flutter" are other shortcomings that test tapes can highlight. Wow is produced by cyclic changes in speed up to about 10 c/s, and rapid wow produces an effect not unlike the tremolo features of a singer's voice. Flutter is caused by faster speed changes, up to about 100 c/s. It tends to "roughen" the reproduction and can make listening a fatiguing business, especially when the flutter frequency is high.

The effects show up most on sustained frequencies between 2 and 5 Kc/s, and test tapes recorded within this range are available. These, of course, must themselves be perfectly free from the effects, and the *EMI* test tape SRT13, for example, has wow and flutter contents below 0.08%.

Wow and flutter increases as the tape speed is decreased, and while a good deck may not produce the effects in excess of about 0.15% at  $7\frac{1}{2}$  i/s, the same deck at  $1\frac{1}{8}$  i/s may give up to 0.3% wow and flutter.

White-noise can be used instead of pure tone. White noise is the "hiss" that is present on hi-fi equipment when the gain is turned right up and no signal applied. Actually, white noise should contain all frequencies from zero to top audio. Such signals applied to any audio system will tend towards coloration as the result of peaks and resonances (if any) in speakers, transformers, inductors and filters. This in rather the same way as "residual noise" is coloured by holding an ear close to a sea-shell. The shell acts as a resonator and frequencies to which it is tuned are picked out of the residual noise background which is for ever present around us (especially by the sea).

## White Noise Tapes

White noise is interesting to play with, but this is really another story . . . apart from saying that some nice white noise recordings are available from *Tutchings Electronics Limited*. This firm also has a tape giving full-range unfiltered noise.

Other uses for test tapes include speed checking, as, for instance, the *EMI* SRT13 which has strobo markings, background noise and bias checking, using a section of clean tape and for checking the general health of any recorder along the lines suggested in these notes.

For those of our readers who play tape records, test tapes are really essential to ensure that the machine is responding to recordings made on equipment other than that which is used for replay. While good treble may be attainable from a machine which replays the material it actually recorded, poor treble may be forthcoming when a tape record is played because of an incorrect azimuth. Remember that the azimuth is highly important on tape records. Maladjustment is barely revealed when the misaligned head both records and replays, for relatively the azimuth is correct even though the length of the gap in the-head is at an angle across the width of the tape; for the angle remains the same on both record and replay.

Probably the most useful of all the test tapes is *EMI* TBT1, a CCIR tape at  $7\frac{1}{2}$  i/s covering the range 40 c/s to 10 Kc/s.

# CHRISTMAS!



## GIVE **Scotch** MAGNETIC TAPE IN THIS **GAY** WRAPPER

Scotch Magnetic Tape is the perfect present for anyone who owns a tape recorder. And all the 5", 5 $\frac{3}{4}$ " and 7" boxes are packed in colourful seasonal wrappings. New lower prices, too!

**3M** MINNESOTA MINING AND  
 MANUFACTURING CO., LTD.  
 3M HOUSE · WIGMORE STREET · LONDON W.1

### SPOKEN CHRISTMAS "CARDS" FOR FARAWAY FRIENDS

Why not send truly personal greetings to faraway friends on a Scotch "One Five Special" Inexpensive, at only 5/3 per reel. Runs 15 mins. at 3 $\frac{3}{4}$  i.p.s. Packed in a box designed to be sent through the post.





# TAPE RECORDER SERVICE

## NO. 23. SIMON RECORDERS

By H.W. HELLYER

JUST lately, there has been an increase in what my wife calls, condescendingly, "our fan mail". This is very welcome, for, pro or con, all letters from readers are appreciated. Nothing is more dispiriting to the technical writer than an apparent indifference. And even those who omit the courtesy of including a stamped-addressed envelope receive an eventual answer. Between the urgent chores—bathing the dog, pruning the roses, earning a living—we manage to squeeze in a few researches and offer a little advice.

But occasionally the letter arrives which taxes our literary powers, such as that from H. G. J. of Edware, who asked baldly: "Could you give me a description of the various machines produced by Messrs. Simon Equipment Ltd., and indicate which you prefer?"

The latter part of the question is the easiest to deal with. Like the actor whose latest play is always indisputably the best, most of us would plump for the Simon SP5. As my colleague A. Tutchings observed in



his review which appeared in May 1962, this tape recorder can be warmly recommended. It is not cheap—but quality seldom is cheap. It has many original features, but before discussing them, let us look at the rest of the field, and answer the first part of H. G. J.'s question.

In July 1955 the SP2 was marketed. Again, it was not a cheap machine at 75 guineas, but the good amplifier, with its 10W. output, which made it a useful piece of PA equipment, justified the price. And the 2-speed, 3-motor, EMI deck with 7-in. spools ensured mechanical reliability.

Frequency response is from 50 c/s to 12 Kc/s  $\pm 3$  dB at  $7\frac{1}{2}$  i/s. This is not particularly impressive by modern standards, but a look at the overall response characteristic shows that from 40 c/s up to nearly 20 Kc/s the variation lies within a  $+3$  and  $-5$  dB limit at  $7\frac{1}{2}$  i/s. Better still, at  $3\frac{3}{4}$  i/s the quoted response extends to 7 Kc/s but the overall curve takes up to well over 10 Kc/s, with similar limits to those stated above.

★ ★ ★

The circuit consists of an EF86 microphone pre-amplifier, an ECC83 two-stage amplifier (with a feedback loop over the two stages) followed by a comprehensive equalising and tone control circuit. This has separate bass and treble controls, providing a 15 dB swing at each end of the frequency spectrum, operable on playback. On some machines, an even more stable arrangement was incorporated, with variable feedback between the output of the second half of the ECC83 and the input of the first half, consisting of a 30-pF preset capacitor, with a neutralising circuit effected by 30 mfd. decoupling of the first cathode. In this circuit, the earthy end of the grid circuit of the 2nd half ECC83 is taken to a tap on the cathode bias—putting a 33 ohm resistor in series with the bottom end of the 2.2K. cathode resistor—and the anode load is reduced from 150K. to 100K. This is the sort of "quality" modification that could usefully be carried out by the experimenter, not only on this machine, but on many other less ambitious models.

From the equalising circuits the signal passes to the first triode of an ECC81 and is then directly coupled to the second triode, which acts as

paraphase amplifier, splitting the signal for the two EL84 output valves, which are in push-pull. A feedback loop from the secondary of the output transformer is applied to the cathode of the 1st half ECC81. On Record, the output to the R/P head is taken from the transformer secondary, as is the monitor signal (with a separate control) and the signal that powers the EL34 magic eye.

Of especial interest is the oscillator circuit of the SP2, reproduced in fig. 1. The valve is an EL89, and both the anode and the grid circuits are tuned, but not directly coupled, except by inter-electrode capacitances. The procedure for setting up is for the anode circuit to be adjusted to give maximum output (valve-voltmeter across R/P head) while an oscillator is used to inject 55 Kc/s at the grid. Normally, the impedance of the oscillator (signal generator) and its attenuator is sufficient to damp the grid circuit, but in some cases it may be necessary to provide a lower impedance with an external shunt. After the anode circuit has been adjusted for maximum output, the signal generator and shunt are removed, then the grid circuit tuned for maximum output. The 10K preset in the grid circuit is factory-adjusted and should not be altered unless major repairs have been carried out. Its purpose is to adjust for minimum second-harmonic output—not for maximum oscillator output. This latter adjustment is made with the 25K variable resistor which is the screen grid voltage control. Normal setting is for a reading of 145V R.M.S. across the head.

Note that this screen voltage is interrupted by two switched points. S1 is on the deck, and closes when the motor control is in the Play position. S2 is the amplifier selector switch, and the H.T. circuit is made when it is in the Record position. There is one disadvantage with this type of circuit: it is necessary to allow the bias voltage to decay gradually when the machine is switched from Record to any other function, to prevent magnetisation of the heads. Therefore, normal operation is to switch the motor control to the brake position before switching the selector to Playback, from Record.

Inputs are: Mic., 1 megohm, 1.5 mV; Radio,  $\frac{1}{2}$  megohm, 150 mV. P.A. inputs are: Mic., 2 mV; Rad., 200 mV.

Outputs: Monitoring via the internal 10-in. 3-ohm loudspeaker; high impedance headphones; or external 15-ohm loudspeaker.

When the amplifier is used for public address purposes a level response is obtained with the treble control advanced and bass control at zero.

Dismantling is straightforward, and the amplifier can be removed to the extent of its leads and operated remotely if turned on its side with the valves toward the open end of the cabinet so that the 5-pin and octal plugs can be re-inserted, and pins 3 and 4 of the 4-pin plug shorted (or the lead extended and plug re-inserted into the socket at the side of the amplifier). Remember, however, that a load must be provided under these conditions, and either the internal loudspeaker re-connected or a 15-ohm resistor connected across a jackplug inserted into the Phones/Ext. LS

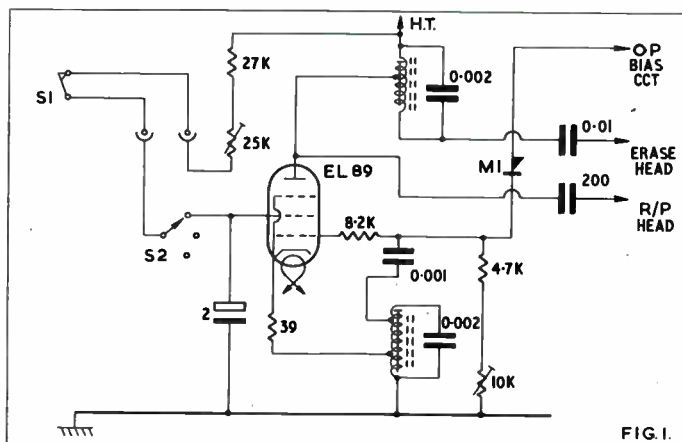
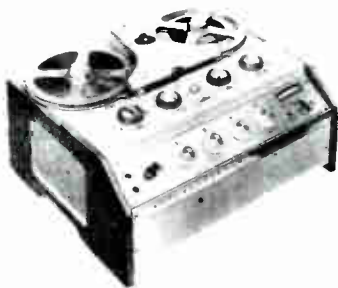

FIG. 1.

# ● UNRIVALLED PART EXCHANGE FACILITIES FOR TAPE ENTHUSIASTS

A friendly welcome awaits you at our bright new showroom extension. Here you will find a lavish array of equipment at every price level... make your choice for immediate delivery or if you cannot visit us, the fast and friendly R.E.W. Mail Order Service makes it easy for you to enjoy the professional results only possible with an advanced Tape Recorder. Get in touch with us now. We have thousands of satisfied customers and a reputation for generous part exchange, reliability and specialist service.

## MACHINE OF THE MONTH



### PAMPHONIC

#### REFLECTOGRAPH Type A 105 gns.

A new machine with a redesigned amplifier giving improved frequency response at all speeds on both record and playback.

- 2 speeds: 3 $\frac{1}{2}$  and 7 $\frac{1}{2}$  i.p.s.
- Separate playback amplifier.
- V.U.M. Meter Semi-prof.

No interest terms, £11.5.0. deposit and 12 monthly p'ments of £8.5.0. Also available on H.P. Terms, 18-24 months to pay.

## Bargain Basement!

We have an unrivalled stock of leading makes of new and used machines at unbeatable bargain prices—(30%-60% reductions on original prices! Make a point of asking for our Special Bargain List.

### \* CASH FOR YOUR TAPE RECORDER or HI - FI.

Highest cash offers for good equipment... get in touch today!



## 300

### MACHINES ON DISPLAY!

Call, see, hear and choose the Tape Recorder you've always wanted from one of the biggest ranges anywhere. Just about every model—for off-the-shelf delivery—in-

5AN 85 gns, Brenell Mk. 5/2 69 gns, Brenell Mk. V "M" 88 gns, Revox Stereo 110

Type "A" 105 gns, Grundig TK46 99 gns, and hundreds of others.

You're guaranteed maximum satisfaction with the R.E.W.

## "PLUS FIVE" SERVICE

- Generous part exchange allowances.
- No interest terms—lowest deposits.
- Off-the Shelf delivery from the biggest range under one roof.
- Free servicing and free delivery.
- Optional personal insurance.

## NO INTEREST TERMS!

Take your pick from our wide range and have any machine you want for 10% deposit, balance twelve months and no interest charged. (18-24 months H.P. terms also available).

Home demonstrations in the London area gladly arranged. By return enquiry service Agents for all makes.

## R·E·W

(Earlsfield) Ltd.

Mail Order Department  
264/266 (TR) Upper Tooting Road,  
London, S.W.17.  
Telephone: BALham 7710



MARK 5 Series 2

## Spotlight on quality...

The Mark 5 Series 2 tape recorder is a high quality machine capable of making outstanding recordings.

It is tastefully finished in medium grey with chromed fittings, and designed not only for use as a complete portable recorder but for incorporation into a Hi-Fi installation. (Deck, amplifier and power unit are available as separate items). A low level compensated output socket is provided for driving an external Hi-Fi amplifier.

### Specification:

4 speeds 1 $\frac{1}{2}$ , 3 $\frac{1}{2}$ , 7 $\frac{1}{2}$  and 15 ips • frequency correction at all 4 speeds • 3 independent motors • exceptionally low wow and flutter content • double-gapped ferrite erase head to minimise erase noise • narrow-gapped record/playback head to give extended frequency response • pause control • superimpose control • recording level indicator (meter extra) • takes 8 $\frac{1}{2}$  in. dia. reels • fast rewind (1200 ft. in 45 seconds) • digital rev. counter.

## Brenell

**BRENNELL ENGINEERING CO., LTD**  
1a DOUGHTY STREET, LONDON W.C.1.  
Telephone: HOLborn 7356/8

## Tape Recorder Service — *Contd.*

socket. The one awkward part about the dismantling and re-assembling operation is the handling of the compensating switch bracket, secured by 4 BA nuts.

Two machines in a lower price bracket, using the Garrard Magazine Deck, are the *Cymbal* and the *Minstrelle*. The former, at 24 guineas, has an output of 3W. and a frequency response of 70 c/s—9 Kc/s. It was obviously produced for the competitive low-price market, and is completely conventional in design. Certainly, it compares very favourably with anything else in a similar price range, both as regards construction and styling.



The *Minstrelle* is rather more ambitious, and is produced in 2- and 4-track versions, with the addition of a matching amplifier. The 4-track version costs 41 gns. and the stereo amplifier 22 gns. With their attractive shaping and Spanish Blue Hide finish, they make a tasteful piece of home equipment, and the stylish *Cadenza* microphones, made in crystal and ribbon versions, are equally fetching. The Garrard magazine deck has already been dealt with in this series, and it is not proposed to waste space in discussing the quite conventional circuitry of these models. They present few servicing problems.

One model that was produced during the tape recorder "boom" period, 1958/9, but which is not in very wide employment, was the SP/4. Messrs. Simon used their own deck on this machine, playing in both directions with automatic reversal. At 7½ and 3½ i/s. The specifications are much the same as the SP2, except that a push-pull oscillator was used, and two loudspeakers fitted (a 4-in. high frequency unit, with diffuser, added to the 10 x 6 main speaker). Here I must be honest and admit that I have never had the opportunity of taking one to bits! Considering the wide range of machines that have landed on my bench during the past seven years or more, this admission must be a recommendation in itself! Therefore, if any well-breeched reader has one of these models tucked away in the lumber room, I would be glad of the chance to handle it.



The star machine of this month's round-up is the SP5. There is so much that could be said about the original points of design, construction and performance, that it becomes necessary to omit the specifications, and refer readers to the May 1962 review of the machine.

Servicing can be done at two levels, and it is certainly not advisable to tackle the more delicate adjustments. But in answer to several queries on the basic points of dismantling and setting up, the following notes have been prepared.

**Head cover:** the rear part of the plastic cover is removed by inserting a small screwdriver blade at the one end, near the tape slot, and levering gently upwards, then repeating at the other end. Do not attempt to prise directly upward until this easing process has been done, or you will simply break off the fixing pieces.

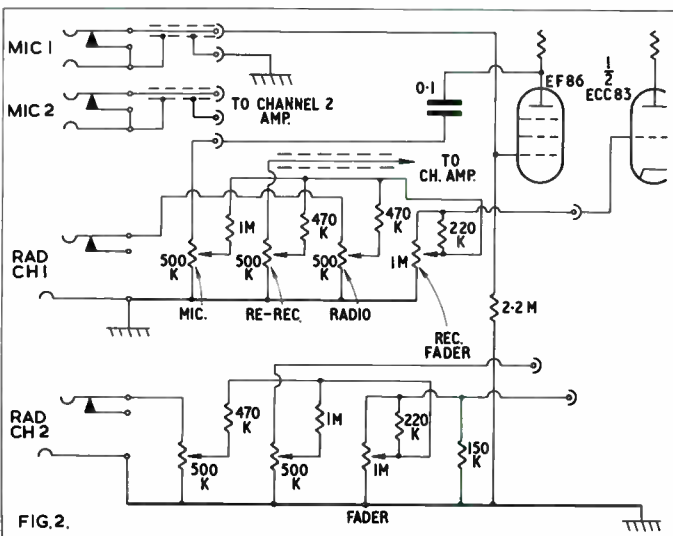

FIG. 2.

**Base:** when removing the base, tip the machine on to the back of the speaker enclosure, remove the wood-screws around the base and gently lower it to a horizontal position.

**Power pack:** after removing the four corner 4-BA nuts, this can be taken out, but care must be exercised to avoid straining the connections to the silicon rectifiers. Similarly, when removing the oscillator assembly, first take out the 9-pin plug, then remove the three 4-BA nuts and the assembly is free. The cable to the plug should be handled carefully, to avoid breaking off the fine inner conductors of the twin-screened cable.

**Power amplifier:** the plug on the printed panel must be removed by sliding off in a side-to-side movement, not by pulling up. The underside of the panel is accessible when the three 6-BA nuts holding it to the heat sink are removed.

**Replay Pre-amp:** one small catch here is the metal standoff pillar, which must always be returned to the same position on re-assembly; this

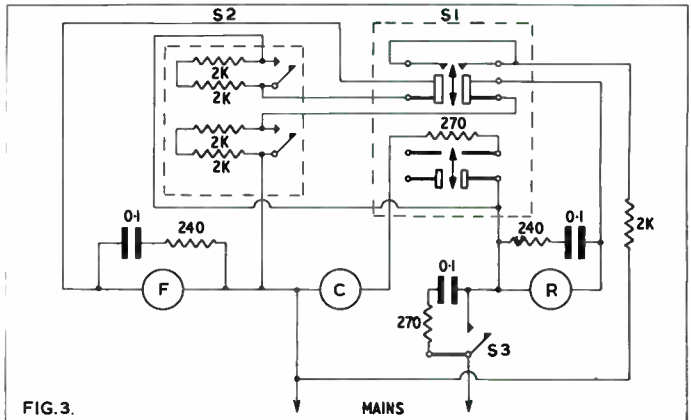

FIG. 3.

acts as the chassis return connection for the printed circuit. Similarly, the screws holding the Record Amplifier panel act as earthing points, and must be fully tightened before operation.

**Meter:** a short 6-BA box spanner is needed to get at the nuts counter-sunk in the loudspeaker baffle.

**Normal replay, normal modulation, but poor or no recording:** check the micro-interlink deck switch for poor contact and note that the end contact of the socket on the Record Amplifier panel may not be "making" properly. See that the end preset of the trio on the right-hand flanking panel is not shorting to adjacent capacitors.

**Blown fuse:** a rather tricky fault, persistent blowing of the 2A fuse in the 17.5V. supply line can be caused by earthing of the speaker system. Check that the leads are not touching the speaker frame, nor the metal gauze under the power amplifier shorting to the power transistor heat sink. If the meter is reading forward and cannot be zeroed, this may be due to blowing of the FS1 fuse. The FS3 fuse, if blown, will prevent fast winding, and this can be caused if the 2K resistors beneath the deck touch each other.

**Intermittent replay:** check the Phillips screws on the tone control panel and make sure the fixing tag is well soldered.

**Instability at maximum treble:** move the cables at the output sockets as far as possible from the track switch wiring. These may easily move during transit.

**Bias adjustment:** screwing the "set bias" trimmers anti-clockwise increases the bias. Take care not to overdo this, as it is possible to blot out the recording altogether in certain circumstances.

**Intermittent Record:** check the connections and circuitry of the input mixer network, shown in fig. 2. Pay especial regard to the plug and socket connections, and check earth returns.

**Deck faults:** the deck used on this model is the EM1 Basic 2-speed, which is worthy of more detailed description at a later date. The motor circuit, however, is given in fig. 3.

## HI-FI FOR BEGINNERS

This was the first title in our Hi-Fi Books series and has already sold over 5,000 copies . . . "Recommended thoroughly to every enthusiast."

Price 7s. 6d. plus 9d. postage

Available from  
MILES HENSLow PUBLICATIONS LTD., 99 MORTIMER STREET

# WHATEVER YOUR ASSIGNMENT—GET THE FI-CORD 202

PORTABLE BATTERY/MAINS RECORDER—  
*so much in so little space*

Another assignment for Fi-Cord Fred, safely stowed under his belt, thanks to the compact versatility of the Fi-Cord 202. The Fi-Cord 202 caters for the most exacting professional and for the enthusiastic amateur. Whether you are in a sound-proof studio or perched on a rocky ledge, the Fi-Cord 202 gives you high-fidelity recording at your fingertips. And with this wonderful, lightweight machine you have all the practical advantages of a full-size recorder.

**The Fi-Cord 202 offers all these features:**  
2 speeds— $7\frac{1}{2}$  and  $3\frac{3}{4}$  · Standard 4" spools  
Vu-meter · Fast forward wind · Fast rewind  
Resettable counter · Manual volume control

Built-in loudspeaker · Sockets for microphone, extension speaker and remote control · Safety record switch · Easy-load battery cassettes · Battery warning lamp · Mains input optional.

**ACCESSORIES INCLUDE:** Carrying case, choice of microphones, power packs for mains and car.

There is a full range of Beyer microphones, from general purpose to ultra-studio quality, to cover every use of the Fi-Cord 202.

Price: 66 guineas, including long life mercury batteries and tape.

Write for fully illustrated brochure and address of nearest stockist to:



**FI-CORD INTERNATIONAL** 40A, DOVER STREET, LONDON, W.1. HYDe Park 3448



# Readers' Problems

★ Readers who encounter snags, or who run into trouble with their tape recording equipment, are invited to write to this editorial office for advice, marking the envelopes "Readers' Problems - Tape". Replies will either be sent direct by post, or published in this column if the subject is of general interest. However, we must emphasise that this advisory service cannot include requests for information about manufacturers' products when such information is obviously obtainable from the makers themselves. It is also essential to keep the queries reasonably short and to the point, and to limit them to one specific subject if at all possible. And, please, in no circumstances confuse such letters with references to other matters which have to be dealt with by other departments in our office.

## Motor Vibration

DEAR SIR, I purchased a Harting HM5 some five years ago, and the instrument has been in constant use since. Your advice on the following points would be very welcome:

(a) Mechanical noise and hum have always been disappointingly high, but motor noise has considerably increased recently. I have lubricated the bearings with no effect as the noise appears to be produced by the motor laminations. The idler wheel for  $7\frac{1}{2}$  i/s has also defied my attempts to quieten it.

(b) I suspect that the head may now need replacement and would be glad for advice on the type and make. (I have recently acquired an S99 amplifier and GL70 player which, when used with my Paraline speakers makes my recordings sound very poor.

(c) Finally, are you able to recommend a reliable maintenance and repair firm for the Harting?

Yours faithfully, L. G. S., Reading.

*As you are experiencing motor vibration on your Harting HM5, which lubrication has failed to cure, you are probably correct in assuming the laminations are the source of the trouble. If you have tightened them as much as possible, there is little else that can be done, short of stripping the motor and re-assembling the stack. Even a minute particle of grit between two laminations, or a poor electrical joint causing a high resistance instead of a short-circuit between adjacent strips can give rise to this.*

*Replacement heads depend on the physical mounting, and you would probably find either Bradmatic or Miniflux would be able to supply a suitable type at a cost of about £2, if you quote the machine type when writing for their sales literature.*

*The agents for Harting are: Technical Suppliers Ltd., Goldhawk Road, London, W.12. They would probably be happy to advise you of a local repair firm for your machine.*

★ ★ ★

## Pre-Amp for a Portable

DEAR SIR, I have built a portable tape recorder using a Garrard battery deck. I have had a lot of trouble with noise from the motor, picked up by the amplifier. This is a pre-amp only, and uses an OC45 and two OC71 transistors. I wrote to the makers of the deck about this and they sent me a paper on this kind of thing. However I have tried the circuit they recommend, and some of my own, using TV chokes, but with only 50% success.

I found that about 25% noise gets in through the face of the tape head, so I cured this by fixing a mu-metal screen to the pressure pad. The amplifier and deck motor have separate nine-volt batteries. Please can you suggest anything to suppress the rest of the noise?

Yours faithfully, D. A. T., Nottingham.

*As you have discovered, the problem is acute, and no hard-and-fast rules can be quoted. So much depends on the relative positions of the parts of the equipment, length and routing of leads, etc. The pamphlet from Garrard, which I return to you herewith, gives most of the routine points, but, rather curiously, omits mention of the head leads and their screening.*

*First, a few comments on the Garrard recommendations, which you say you have followed with only moderate success. Note the ferrite beads. There is usually a tendency by constructors to leave these out. They are important, however, as a means of concentrating the field in the short length of unscreened lead between connections. Next, the soldered joints, especially those to the motor casing, should be impeccable. A dry joint here is a perfect noise pick-up device. Routing of cables, even when screened, is important, and you may try the device of running cables along the length of the motor before taking off to battery. Again, a screened cable touching chassis points along its length provides unwanted earth loops, and I find it advisable to use either insulated screened leads, or fit sleeving over the cable.*

*Head leads are also screened, but you may find it useful to experiment with the earth point of this screening. Take the screening right up to the*

*head, as far as possible, but earth it only at the amplifier end. Watch the routing of amplifier leads, and if you are utilising the switch, keep all leads as direct as you can.*

*Finally, try screening your pre-amplifier completely in a tin box, returning all chassis points to a common tag riveted or soldered to a point on the inner face, and earth the outer to the deck-plate.*

★ ★ ★

## Track Conversion

DEAR SIR, I own a PAR tape recorder which is fitted with a two track Collaro Studio Deck. I have acquired another Collaro Studio Deck which is fitted with a four track head. Could you please give me details of how to modify my recorder to accept the four track deck.

Yours faithfully, G.W., Hemel Hempstead.

*Conversion of your PAR tape recorder, with Collaro Studio Deck, from two-track to four-track should entail very little alteration. The track switch need only be a two-pole, two-way type, with the common return leads of the heads earthed and the "live sides" taken through the appropriate contacts. You may need to increase the series capacitance of the network supplying the audio signal to the head. Usually a resistor with a small capacitance across it. Increase this latter to about 100 pf. It may be an advantage to stabilise the erase feed, too, by inserting a 330 ohm 1 watt resistor in the feed from the oscillator coil, to the erase head.*

*This is largely a matter for experiment, and no strict rules need be made. Your greatest problem will be the physical mounting and adjustment of the heads, and I would urge you to follow the advice on four-track head alignment that has been given in the Servicing articles several times.*

★ ★ ★

## Faulty Erase

DEAR SIR, I have an Elizabethan FT1 recorder which, of late, has not been making a clean erasure when recording over old material or cleaning a tape in the approved manner, i.e. all controls to zero and the machine on "record". I have tried aligning the erase head but this made no improvement. A would-be tape recorder expert tells me that a valve is the cause of the trouble but as I am not very well versed in electronics I thought I would check with you first.

Yours faithfully, E. H., Swansea.

*The problem of incomplete erasure on your Elizabethan FT1 tape recorder could be caused by one of several faults.*

*Your adviser who stated that a valve was probably the trouble was only guessing, and although it is possible that the ECL82 oscillator is faulty, this is not the prime suspect. Generally, when an oscillator valve fails, oscillations cease, and the resultant distortion due to lack of h.f. bias is very apparent. You can prove this by recording on a section of clean tape and noting whether the signal is distorted. If not, you should rule out the oscillator valve.*

*A possibility is that the head facing has gathered a slight coating of foreign matter (tape oxide, dust, etc.), and the obvious cure is cleaning. Use only methylated spirit or a proprietary tape cleanser, and do not employ any metallic instrument, or for that matter, anything sharp or too hard.*

*Another cause could be failure of the erase head feed capacitor. This component should be a good quality one, and the value may need to be increased to 0.003 mfd to obtain the current feed you require. You may have noted an exchange of correspondence in the April and May issues of this magazine. Reader A. H. S. had a similar problem with his Elizabethan LZ29, and Messrs. Elizabethan stated in the following issue that our diagnosis of possible head misalignment was "a little misleading". They suggested using a replacement feed capacitor. I would advise you to try a similar cure—this component is a popular culprit on many machines.*

# Brilliant

# 6!

The tape recorder  
you're looking for is  
in the Philips range

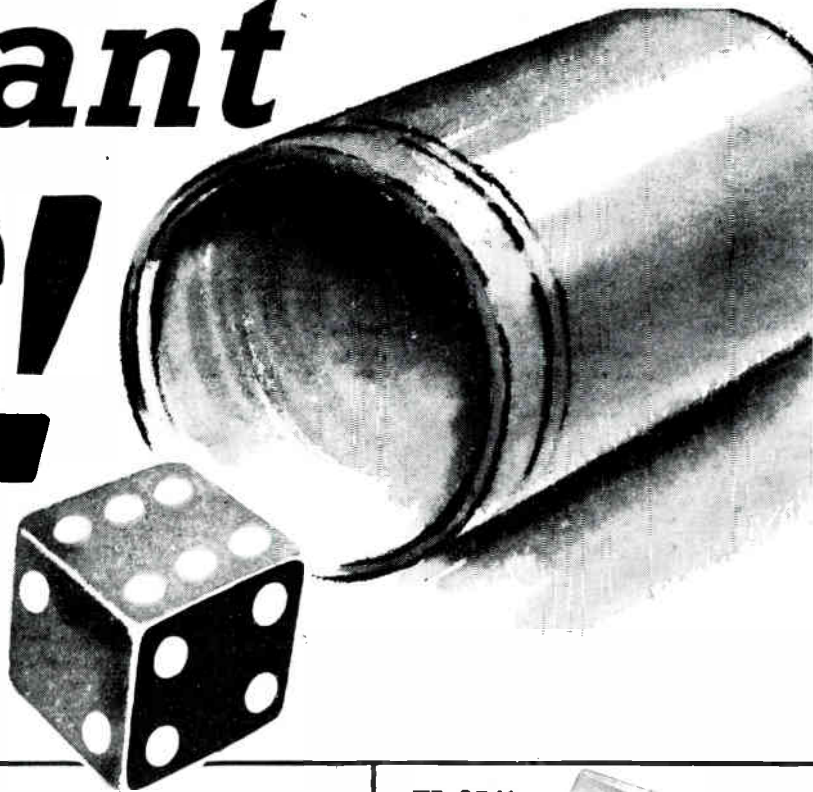

 <p><b>EL 3586</b> PHILIPS NEW BATTERY TAPE RECORDER</p> <p>Records and plays back anywhere, any time—even while being carried. All transistor for economical running and lightweight portability.</p> <p><b>25 gns.</b> <small>Carrying case and mains unit available as optional extras</small></p>	 <p><b>EL 3514</b> PHILIPS STARMAKER MAINS TAPE RECORDER</p> <p>The first mains tape recorder ever to feature the new, space-saving upright styling. Four-track recording and playback.</p> <p><b>27 gns.</b></p>	 <p><b>EL 3541</b> PHILIPS FAMILY TAPE RECORDER</p> <p>This truly remarkable four-track tape recorder incorporates many advanced features. The ideal instrument for the family man.</p> <p><b>36 gns.</b></p>
<p><b>PHILIPS EL 3541/H</b> FAMILY DE-LUXE TAPE RECORDER</p> <p>Has all the features of the EL3541 plus the important added advantage of a leathercloth-covered, wooden cabinet.</p>  <p><b>42 gns.</b></p>	<p><b>PHILIPS EL 3549</b> 4-SPEED HI-FI TAPE RECORDER</p> <p>This all-transistor, 4-track, 4-speed tape recorder has no equal in the medium price class. Many professional features.</p>  <p><b>62 gns.</b></p>	<p><b>PHILIPS EL 3534</b> 4-SPEED HI-FI STEREO TAPE RECORDER —WITH MULTIPLAY</p> <p>Impeccable stereo and mono sound plus <i>multiplay</i>—the feature that permits the combination of many monitored recordings on one track.</p>  <p><b>92 gns.</b></p>

See the complete range at your Philips dealer's

ALL BEAUTIFULLY  
MADE BY



# PHILIPS

—THE FRIEND OF  
THE FAMILY

PHILIPS ELECTRICAL LIMITED, CENTURY HOUSE, SHAFTESBURY AVENUE, LONDON, W.C.2 (PTR 4332)

by Richard Golding

# SOUND AND CINE

A LOOK AT ANGLIA TELEVISION

WHEN Anglia Television took over the old Agricultural Hall in the centre of Norwich in 1959 they were more than set on just converting one big building for use as another, they were about to supply one of the most valuable regional services that radio or television had ever known.

The task of conversion alone was interesting, for it consisted of placing an entirely new block of studios and offices inside the shell of the old building without altering the appearance of the exterior.

In the Agricultural Hall, there were originally two smaller halls. At the front, sideways to the main road, was an assembly hall and behind it a larger exhibition hall. The former assembly hall now contains the reception centre and three floors of offices. The old exhibition hall at the rear now houses four studios under one structural re-inforced concrete frame which never touches the original walls. Sound insulation of this frame is effected by covering the walls both inside and outside with acoustic tiles, and by making all entrances into "wind lobbies" (recesses with two doors which act as wind buffers).

★ ★ ★

The first thing to be seen when entering the ground floor reception is "TOPSIE" or, in other words, the Tape Operated Programme Switching and Indicating Equipment. Through a huge plate glass window all the master engineering controls can be seen which can be operated automatically by punched tape if the need arises.

In the same room, but not visible from reception, is the Telecine and the Ampex VTR. Telecine is a word used to refer to television-film operations and includes film projectors, slide projectors, special television cameras in circuit directly with the projectors, and television shading control units. The Anglia Telecine consists of four channels of Rank Cintel Flying-Spot Telecine, each capable of handling 16 mm. or 35 mm. material with all classes of married and unmarried sound. Two channels are also capable of handling slides.

Telecine operations can be explained by describing the production of a typical television news programme. In this the news reader and the weather reporter are live, but all news inserts are on film and are projected from the Telecine room on cue from the producer. When slides are employed they are projected in the same way.

★ ★ ★

The Ampex Videotape Recording machine is a permanent fixture (there is a mobile Ampex for O.B. work) and is used mainly for recording television programmes off the air and to retelecast them at a more appropriate hour, for repeats and for location inserts in plays. The basic principle of VTR is much the same as ordinary tape. The magnetic head places the electronic impressions on the tape and the programme is produced by reversal of the electronic process. High head-to-tape velocity is required, however, to record the high-frequency signals of the television picture. This is achieved by using a 2 in. wide tape moving at 15 i/s together with four switched magnetic heads mounted on a single revolving disc. The signal is thus recorded vertically rather than horizontally, resulting in a series of 120 degree arcs transversely across the tape. This is made possible by the heads being mounted each with microscopic precision at 90 degrees from the next head on the disc. With a disc diameter of about 2 in. and a rotational rate of about 240 r/s the writing speed or relative head-to-tape velocity is about 1,500 i/s.

The Video tape contains three other synchronised magnetic tracks: the normal sound track that accompanies the picture; the control track which comprises a record of the alternating currents which feed the rotating-heads motor during the recording and which acts as a reference point for editing; and the cueing track. This last track is used by the producer to indicate points at which he requires the various camera positions to be edited in and so on.

★ ★ ★

From this master control room the studios are reached by corridors running down either side of the building and when one is walking through

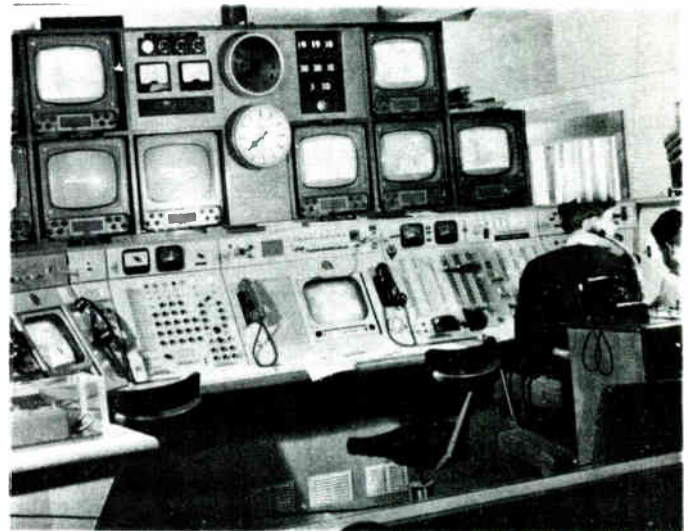

The Master Control Panel. First to be seen when entering Anglia House.

these corridors the architectural effect is quite dramatic. On one side, the offices, on the other side, the concrete, brick and tile box of the new studios towering up to the very roof of the old building without actually touching it. In between, all the services that a busy television centre needs—the biggest and bulkiest being the great runs of trunking required for air-conditioning—with six huge fans to maintain the different circuits.

Inside the studios the ceilings have a specially designed lighting grid made up of a slotted steel platform. This enables lighting and scenery to be fixed up and to be moved about with complete flexibility. The four production studios are as follows: Studio A, 52 x 62 ft. (3,224 sq. ft.); Studio B, 25 x 41 ft. (1,031 sq. ft.); these two studios can be operated singly or as one unit; Studio C, 18 x 13 ft. (231 sq. ft.) for continuity, news, weather bulletins and talks; and Studio D, 9 x 6 ft., for commentaries. The two main studios are equipped with Pye 4½-in. Mark V Camera Channels and the latest sound and lighting equipment.

Both Studio A and B have control rooms on the first floor, with soundproof double-glazed windows. The corridor which gives access to them is the gallery of the old exhibition hall and here again old and new are juxtaposed in an exciting fashion. Rearing up every few feet are the girders of the Victorian roof, resplendent in blue and gold, the elegant ironwork frills contrasting with the modern, direct extract trunking. Finally, as not an inch of space could be wasted, the area above the studios contains production offices under the redesigned roof of the old hall.

In that, Anglia employs around 350 on the regular staff, with many more under contract for particular programmes. For news coverage of East Anglia, there are two permanently attached film units consisting of 100 correspondents, 25 free-lance cameramen and the usual news-room production staff and copy takers. The Natural History Film Unit travels the world obtaining information for *Survival* programmes and has been associated with two of the World Wildlife Fund's most important rescue operations. The first of these was the classic removal of the few remaining white rhino in Uganda to an area of safety in a National Park. The second was the rescue of thousands of flamingo fledglings trapped in the soda crust of Lake Magadi.

In addition to a wide variety of local programmes produced in the studios for East Anglia's 2½ million viewers, Anglia dramas and documentaries are frequently transmitted nationwide on the ITV network and have a high reputation as serious quality productions. The latest development from the Drama Department is the 30 minute "quickie"

(Continued on page 413)

COMPLETE  
AUDIO  
REALISM

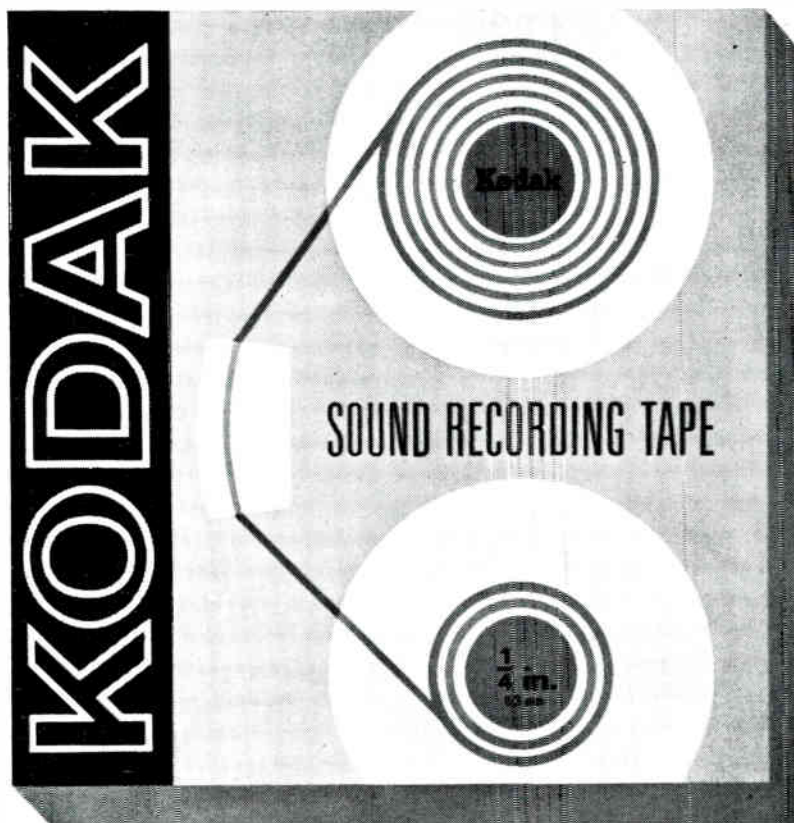

## —from new Kodak Sound Recording Tape

*There's never been a tape so sensitive as new Kodak Sound Recording Tape. For the first time you can capture complete audio realism. Sound so true you'll hardly believe it's recorded.*

- ▶ High output sensitivity
- ▶ Low noise performance
- ▶ Full audio frequency range response
- ▶ Double-lubricated for smooth transport
- ▶ Low bias adjustment

New Kodak Sound Recording Tape is manufactured to the same super-critical standards as Kodak film. Standards that have never been excelled in any coating process. Standards that give a coating uniformity that never varies more than plus or minus 20 millionths of an inch.

There are four types of new Kodak Sound Recording Tape to suit all requirements: standard, long play, double play and triple play—the extra strong tape with the extra long playing time.

Each reel is wrapped in a polythene bag and packed in a sturdy box. A form for recording data is printed on the back of the box. Each reel incorporates a special clip which eliminates tape spillage.

Write for further details of this new tape, to Dept. T2, Kodak Ltd., Kodak House, Kingsway, London, W.C.2.

KODAK LTD.

**Kodak**

DEPT. T2, KODAK HOUSE, KINGSWAY, LONDON, W.C.2.



## SOUND AND CINE — continued

play exchange between regional companies pioneered by Anglia and now gaining network distribution. With the half-hour drama, the writer has to develop character and plot much earlier and this calls for a different writing technique. It allows, however, the smaller television companies the opportunity to produce their own plays in their own way and to co-operate in producing a high quality series.

★ ★ ★

I was present at the first Ampex run through of a new 30 minute drama which had just been edited together. This was *The Simple Truth* starring Renee Asherson as the frustrated and unhappy wife of a naval officer on Gibraltar. I won't tell you the plot as this would spoil the whole effect should you see it but it has an exceedingly clever twist halfway where the Commercials fit in and a surprise ending giving lead to much conjecture on what could happen afterwards.

Another thirty minute drama in this series had been shot almost entirely on location by the Outside Broadcast unit. The O.B. unit is in constant demand and carries two Pye 4½-in. Mark V Camera Channels and the Mobile Ampex VTR machine. The play—*They Don't Make Summers Like They Used To*—is the story of two people caught up in a threatened transport strike and who take time off to cycle into the countryside on a sentimental journey. The sequences were shot around the picturesque countryside of Norfolk and Suffolk and much of the play was actually taped on the move as the Ampex trailed behind the cyclists! The production unit was lucky to have the only two weeks of fine weather that this last summer had produced, for as soon as the shooting was finished the weather reverted to normal, thus, for the unit, giving an extra truth to the title of the play.

★ ★ ★

Anglia Television is a most progressive company, always alert for the new idea and, of course, the new writer. Drama material required is for 30, 60 or 90 minute plays in *script* form. Outlines of ideas are not acceptable unless submitted by authors who have had previous experience in television writing. All submissions should be sent to the Drama Department which is located at the London office at Brook House, Park Lane, W.1, but must be handled through a recognised literary agent.

A limited number of tickets are available for audiences at certain shows, the maximum capacity for Studio A being 200. Applications,



Production still of a Magazine programme on East Anglia. Here we see Oscar Heidenstam demonstrating how to keep fit to women.



Studio A Control Room

enclosing stamped addressed envelopes, should be made to: "Audiences", Public Relations Department, Anglia Television, Anglia House, Norwich 07A. No audiences are admitted to drama productions or to "About Anglia".

★ ★ ★

### Cinematography Course

For London readers I have details of what appears to be a most interesting course of lectures. The lecturer is Gerald Wooller-Jennings, MBKS, author of the Introduction to Projectors in the 1963 *Cine Year Book*, and the venue is at the Stanhope Institute, Queen Square, W.1 (5 minutes from Holborn Underground). The purpose of the series of lecture-demonstrations is to provide the amateur film-maker with a clear understanding of the basic principles of cinematography, to explain, and advise on, the operation of equipment, to discuss students' difficulties in the use of 8 mm. and 16 mm. cameras and projectors and to provide facilities and help in the construction of simple but useful accessories. Individual assistance will be given and the class will have opportunities for general discussion.

Studio, darkroom and workshop facilities will be available at certain times during the course and several visiting lecturers will speak. Times: Mondays—6.30 to 8.30 p.m.

This course is intended for those who have already attended the introductory course on *Filming for Pleasure* at the Stanhope Institute, Stanhope Street, N.W.1 (Fridays—6.30 to 8.30 p.m.) but others who have the requisite experience, and access to the required equipment, may be admitted.

PLEASE MENTION "THE TAPE RECORDER" WHEN REPLYING TO ADVERTISEMENTS.

## PERMANENT BINDING

We can undertake the permanent binding of all volumes of *The Tape Recorder*. Send your copies to us, the price is 36s. which includes index and postage. They are individually hand stitched and covered in black buckram, gold block on spine. Other colours and leather bindings are also available, details on application.

**Index to Volume 4 of THE TAPE RECORDER**  
**Available now - - - - Price 2s. 6d.**  
**99 Mortimer Street · London · W.1**

# RECORDING IN

★ *Another contribution from Bob Danvers-Walker, whose missions abroad to record material for broadcast programmes frequently involve him in high adventure. In this issue he recalls recent visits to Switzerland and Sardinia.*

THE ratchet railway slowly climbed its way from Grindelwald, the "village of the glaciers" in the Bernese Oberland, to Kleiner Scheidegg 6,800 ft. up in the heart of the Jungfrau group. This was to be an important day for me during this visit commemorating the Centenary of the first conducted tour of Switzerland. Two remarkable demonstrations were to be given; a "cannon" would fire ten rounds to produce echoes off the 13,449 ft. face of the Monch, and an alhorn would attempt to bounce its note off the North face of the Eiger.

I arrived at the terminus of the Wengernalp line to see a fine old piece of field ordinance shining brightly in the brilliant sun and manned by two artillerymen dressed in uniforms of the period. Beside them, in costumes of a hundred years ago, stood the party of excursionists simulating in excellent detail the experiences of the original travellers who came here with a Mr. Thomas Cook of Leicester exactly a century before. The purity of the air, the almost audible silence of alpine regions and the fantastic distance over which noise can be heard, were factors to be considered in attempting to record such contrasting sounds.

I stationed myself a hundred yards from the field gun, which was as far as I could go and still keep the gunners in sight so as to observe

their signals to fire. To my Fi-Cord 202 I connected the M.219 Beyer omni-directional microphone in preference to the M.66, as I wanted to capture the omnipresential characteristic of sound in this environment.

Right from the first shot my problem was to stop down low enough on my volume control for the sharp detonation, then to fade-up to almost three-quarters open to catch the thunderstorm effect of the explosion reverberating off the snow and ice-clad peaks of the Junfrau massif. I experimented with every one, not knowing with what success, as the shots were fired in varying and unexpected intervals permitting no time to make quick playbacks. I could tell well enough that during the six second gap between the shot being fired and the ensuing echo I would not escape recording the giggles and chatter of the spectators. And indeed it was this that spoilt nearly all the takes, since I could not escape them as they merged into the rumble coming to me like the sound of an avalanche.

According to my log Take 9 is the best. On this I turned away from the gun for the shot, delayed fade-up until the last moment, and for some reason no one spoke. I don't like that momentary fade-down because it loses atmosphere.

★ ★ ★

As a Travel Correspondant it is my job to encourage people to go abroad. But how I wish they were not there when I am recording bird-calls, cattle-bells, babbling brooks and . . . alphorns. Seeing my three alhorn players positioning themselves for the experiment to record their music off the Eiger face, people jangling with cameras and binoculars bore down on us. And why is it that as soon as I level my microphone and make a signal for silence, someone in the crowd says "Oh look, Television"? It happens time and time again. Three 15 ft. long horns valued at about £50 each reached out from the lips of the three skilled players. The horn ends resting on the ground were directed towards the granite face of the cruelest mountain in Europe. I switched on and waited for them to start. The slow, measured notes droned out and diffused themselves in the distance. Like bagpipes and shepherds flute, the alhorn is an instrument for the mountains and the still places of nature.

The air they played was the same as the one I recorded at 4.28 a.m. on another day when an alhornist on the Rigi Kulm played to welcome the dawn. The echoes were lost to me. Maybe they stayed and died on the North face of the Eiger which has claimed so many human lives.

I left Switzerland with what I would claim to be an extremely rare if not unique tape recording of a sound which has never happened before nor is ever likely to happen again. This was made in Lausanne beside the 700 year old Cathedral. For 300 years it has been the custom every night for a watchman to deliver his cry of "Eleven o'clock and all's well" from the belfry. On the night I was there, in commemoration of the Centenary celebrations, he made his cry in English—the only time it has ever been done and unlikely ever to be repeated again.

★ ★ ★

DIRECTOR/CAMERAMAN Martin Rolfe and I had flown to Sardinia by BEA "Vanguard" on the direct flight to Alghero. Fertilia Airport is only three hours away from Heathrow, so the day lay before us as we dumped all his camera gear and my recording equipment on to the car which we use when Martin goes colour film gathering and I go in search of sound for radio broadcasting. Martin's working "payload", comprising 35 mm. camera, film, battery, tripod and reflector boards, weighs about 250 lbs., while mine is an all-up weight of 8 lbs. concentrated into a Fi-Cord 202, Carrying case, two 4 in. tape spools and a microphone plus tripod. I am not saying which of us actually carries the most, but I am thinking of getting some shoulder pads made up.

Just outside Alghero at Capo Caccia is Neptune's Sea Grotto where one may penetrate deep into the great cliffs and walk along passages and galleries festooned with stalagmites and stalactites (tites hang down and mites stick up). There are two ways of getting there—road or boat. If one takes the land route one has to descend the cliff-face by what is known as the "Goat's Stairway"—hundreds upon hundreds of precipitous steps. Martin's keen eye for a picture determined which route we would take. So I heaved the camera tripod on to my shoulder, waved



# SWITZERLAND



goodbye to the boatload of passengers far below and we made for the stairway comforted by Martin's encouraging remarks about the sea bird cries I could record on the way down.

Those who suffer from fallen arches, smokers cough or are prone to dizzy spells at heights should never attempt the Goat's Stairway route. Twenty feet down the cliff face I popped the wind filter over the microphone and knocked off sixty seconds of new seagulls for the BBC. The entrance to the Grotto is through a gash in the sheer hump of rock sticking 500 ft. out of the dark blue sea. Surging against the red stone, its depth at one point is said to be four and a half miles.

Once inside I was on my own. Although electrically lit, the galleries need extra illumination when filming for the cinema. So I slithered my way along the timbered cat walks deep into the interior and recorded the marimba-like notes given off when the various carbonate formations resembling velvet drapes and organ pipes are struck carefully with the flat of the hand. From these notes I have recorded a scale which anyone like Jack Jackson could make into a recognizable tune.

Towards the end of our stay in Sardinia we found ourselves in the fabulous town of Nuoro and based at the Ortobene Hotel which literally adheres to the mountainside in the Gennargentu massif overlooking the town 3,300 ft. below in the wild country known as the Barbagia. During the night and early morning a violent thunderstorm put the whole electrical system out of action. The extraordinary thing was that it was all happening below us. Martin and I had our breakfast in sunshine on the roof terrace while thunder banged and clattered among the foot hills below and clouds scudded under foot.

Incidentally, rain, waterfalls, rivers and sea effects are among the hardest things to record; they all sound like wind blowing through trees. A tinkling brook or stream gives one the only truly watery sound.

The next day we set off for Orgosolo, notorious for its evil reputation. For hundreds of years this region has been the centre of banditry,

briggandry, feuds and vendettas. At one time the names of locals due for liquidation would be chalked up on the wall of the church. The inhabitants still wear traditional costume and the scenery and buildings are all made for filming. In fact it was here that the Venice Festival award-winning film "Bandits at Orgosolo" was shot. Most of the villagers dislike cameras, believing them to be possessed of an evil eye. Furthermore, since they detest all forms of control or discipline, they associate them with police photos and react angrily, sometimes violently, when confronted with one.

★ ★ ★

My particular search was for someone who could play the curious triple-shanked pipes known as the launeddas, the only existing instrument of its kind in Europe. It must have been the combination of microphone and cine camera which suddenly triggered off a woman working with a pick-axe on some sort of demolition work. Before you could say "Take to the hills men" she had swung round and came at me brandishing her pick.

Now there are two things I always count on in situations abroad where emergencies crop up: a packet of English cigarettes and a show of impassiveness. "This won't do at all my old darling" I said as I whipped out a packet of twenty (the great thing is to keep talking—say anything, and above all communicate a sense of friendliness). "Here, have a snout you old battleaxe" I said, thrusting the packet towards her and looking as sexy as my advancing years would permit. Disarmed by my attitude and won over by a filter tip, the red mist seemed to clear from her brain and she lowered her weapon. Not wishing to push my luck further, I slipped the fags into her hand and wrote the incident off as "experience". Funny how a thing like this can happen on an island which is trembling on the brink of becoming one of the most favoured holiday spots in the Mediterranean.

EMITAPE  
COATING ROOM

TABOO!

## The coating rooms at Emitape—strictly taboo for dirt, dust and photographers!

We wanted to show you a picture of the clinically clean conditions under which Emitape is made. But we couldn't get a photographer anywhere near the tape. 'Operators Only' is the rule in Emitape's coating rooms.

**WHY THE VETO?** Unless your tape is free of foreign particles it won't travel smoothly over the recording head of your tape recorder—and sound quality suffers. Eventually the recording head itself will show signs of premature wear. That's why Emitape are so careful about cleanliness.

**EVEN THE FILTERED AIR IS FILTERED.** The coating rooms themselves are pressurised with filtered air, which is again filtered before being drawn into the coating machines. It's in this rarefied atmosphere that Emitape makes its reputation for cleanliness.

**CELLOPHANE WRAP TAKES THE RAP—NOT THE TAPE.** And it's a reputation that has nothing to fear from travelling or storage. Each reel of Emitape is cellophane wrapped. A centre tear-strip keeps the wrap intact until it reaches you—*factory fresh*. Always. And sealed against dust. That's why people who care about performance *and* their equipment use Emitape. Why not come clean and join them?



*Cellophane wrap keeps dust at bay*

**Emitape** is 'factory fresh'

E.M.I. TAPE LIMITED · HAYES · MIDDLESEX

# FUNDAMENTAL BUILDING ACOUSTICS

*The last articles have considered general principles of sound propagation, this one applies them to specialised applications.*

## Rooms for Speech

These include Lecture Theatres, Courts of Law, Debating Chambers, where intelligibility of the spoken word is paramount. The fundamental question to be answered is firstly, whether the speaker is to be placed at one position (Lecture Theatre) or to be placed anywhere (Debating Chamber, Courts of Law).

Human speech is a delicate aspect of sound, involving subtle inflexions and transients, quite apart from the fact that the majority of people have no idea of speaking up, or perhaps as in Law Courts, have no intention!

Thus the prime requirement is: (1) a quiet situation with no intrusive external sound, (2) the suppression of unnecessary internal noise such as the shuffling of feet, (3) the avoidance of over long excess paths for reflected sound, and the encouragement and reinforcement of direct sound wherever possible. All this produces a room of small volume (100 cub. ft. per person) with a low ceiling, soft flooring, upholstered seats set at a substantial rake so that each row can see the speaker(s) clearly and, in the case of a lecture hall, hard reflective and diffusing surfaces over and on each side of the speaker.

Debating Chambers on the other hand need their reflectors and diffusers set for speakers at any place in the room.

Rooms as described above should be satisfactory without additional acoustic treatment, if however the reverberation period exceeds the recommended maximum then absorption should be placed where excess paths for secondary sound might cause echoes such as the rear wall or a balcony front and not please note, necessarily on the major part of the ceiling which can act as a useful reflector of secondary sound over the floor area.

The audience accounts for much of the absorption in a speech room and precautions must be taken, by the use of well upholstered chairs so that when partly empty the room has adequate absorption (when the room is full of course, the audience largely blankets the chairs and thus cancels out their absorption.)

## General Purpose Rooms

General Purpose Rooms are a compromise requiring very close study. I feel that if, as in the case of a School Hall, speech is at certain times all important then the design should veer as far as possible towards the requirements of rooms for speech. This means a short reverberation period not entirely suitable (but tolerable) for music. To err on the other hand and to have too long a reverberation will make the room more attractive for music but quite intolerable for speech. Thus one should watch very carefully for any implied paramount requirement for a "General Purpose Room".

The G.P.R. will be used for dances, stage plays and may even have a stage. The floor must be flat for the most part thus sight lines (and therefore "sound lines") to a stage require careful consideration. The stage proscenium and wings should be splayed and reflective to encourage reinforcement of direct sound from the stage. Many G.P.R.'s have hardwood floors and temporary seating which will be light in weight and non-absorbent. Thus there is a risk, especially with a small audience present, of "flutter" echoes occurring between floor and ceiling, this should be guarded against by avoiding a wholly flat ceiling (not necessarily by placing absorbents on to it). If absorbents are required then they should go on the end wall opposite the sound source, the ceiling perimeter or upper parts of the side walls.

Of all G.P.R.'s the church poses the greatest problem. Speech must be heard, the building must be a good one in which to sing, and organ music requires to be heard, all in a building which must be big enough to hold a congregation for an Easter Mattins or a wet Winter Evensong. What a hope of getting a successful compromise! A large building is the least difficult, for there, a proper time delay amplification system for reinforcement of the voice, will almost inevitably be installed and thus



the reverberation period can be biased in favour of music. Where the spoken part of the Service is all important nothing can be done for music and the design must be based upon Speech Room principles, and music lovers must go elsewhere.

Note the effect which large projecting galleries have upon sound quality. All the principles contained in these notes assume an acoustically simple space, however a wide gallery on three sides of a church has a considerable effect on the indirect sound pattern and consequently the reverberation period. High naves and low aisles also complicate matters. Choirs and Clergy benefit from reflecting surfaces around and over them, whilst organs should have ample height and speaking room and should preferably stand in the Nave, not be bottled up in a tiny chamber speaking across the Choir. The average Continental Church with its "West" end organ or the average English Non-Conformist Church with the organ spread out across the "East" end are examples of good placing.

## Halls for Music

Halls for music are once again fruitful fields for compromise, requirements varying from Chamber music where a crisp precise effect is required to romantic organ music and Wagnerian opera where a long reverberation is desirable.

As halls for music are generally of some size, apart from the basic requirements of the reverberation period, attention must be given to adequate reinforcement of direct sound by strong secondary reflections beamed into the furthest corners of the hall, and the attainment of a smooth well diffused die-away of sound.

Other problems are associated with the size of the sound source, an orchestra, choir and organ can sometimes occupy 2,000 sq. ft. and over, and careful design is needed to blend the individual sound sources into one, and to avoid a ragged effect.

*Continued on page 419*

## Stereo hi-fi is cheaper than you think ●

a postcard will bring you IDEAS IN HIGH FIDELITY

**LISTEN — LOOK — COMPARE — good sound and good looks — NEW SCANDINAVIAN LINE FURNITURE**  
10 a.m. to 10 p.m. daily (Sundays from 6 p.m.) Closed Thursdays. MA1 8B55

**STUDIO 99** 57, FAIRFAX ROAD, SWISS COTTAGE  
HAMPSTEAD · N.W.6 **LONDON**

# GREAT NEW SONY SOUND!



## SONY TC. 500

TO THE SERIOUS AMATEUR COME THE LATEST, THE FINEST TECHNICAL ADVANCEMENTS IN STEREPHONIC TAPE RECORDING AND PLAYBACK. THE SOUND IS SONY, THE VERSATILITY IS SONY, THE QUALITY IS SONY. THIS IS FOR THE CONNOISSEUR — THE SONY TC. 500

**106** GNS with 2 Sony F87 Cardoid Dynamic microphones and all accessories.

**SONY**<sup>®</sup>  
RESEARCH MAKES THE DIFFERENCE

*Detailed specification of this tremendous Sony tape recorder freely available from the Sole U.K. distributors:*



## EXTRACTS FROM SPECIFICATION:

Full stereo facilities with independent recording and playback amplifiers, providing professional mixing facilities. Manual cueing, digital tape counter, instant stop, automatic tape lifter. Instantaneous selection of  $7\frac{1}{2}/3\frac{3}{4}$  ips. Response — 30-18000 cps at  $7\frac{1}{2}$  ips. Harmonic distortion — less than 2% at 3 db below rated output. Detachable speakers for stereo separation.

## TELLUX LIMITED

High Fidelity Division  
GALLOWS CORNER, ROMFORD, ESSEX

418

## FUNDAMENTAL BUILDING ACOUSTICS—Continued

The audience provides a considerable amount of absorption in Music Rooms, thus to obtain a reasonable reverberation period it is essential to have a fairly large volume, and figures from 200 up to 300 cub. ft. per person are needed. A volume of this size means a large building and can result in possible risks of echo due to excess paths for indirect

Current Reverberation Periods (in seconds)  
of Broadcasting Studios (at 1 Kc/s)

1	Small talks studios	0.20-0.23
2	Medium talks studios	0.23-0.35
3	Medium general purpose studios	0.26-0.54
4	Medium music studios	0.60-1.00
5	Large music studios	0.80-1.80

Information supplied by Engineering Information  
Department of the BBC.

sound. This is generally combatted at the sound source by a large reflector set directly over it, carefully designed so that sound is reflected forthwith into the furthest seats. Further use is made of reflecting surfaces below balconies and on the main ceiling to reinforce sound where it is needed.

Sight lines (and thus "sound lines") are once again of paramount importance, and a substantial rake must be given to all seating to obtain this.

Surfaces surrounding the sound source should be hard and reflective, and every care should be taken to ensure good diffusion of sound and avoidance of flutters by splaying and breaking up wall surfaces, such as incorporating projecting boxes, all of which helps in addition to attain that rather ephemeral musical quality which marks a good hall. It is of course absolutely essential to avoid intrusion of sound from without and great efforts are made by screening lobbies, even discontinuous construction to attain this ideal. When, as at the Royal Festival Hall, London, external sound includes nearby electric trains crossing a steel girder bridge, the size of the problem can be gauged.

Before leaving Concert Halls I am going to stick my neck out and pass the opinion that too many Concert Halls have been built recently with too short a reverberation period, clarity is all very well but the effect of much music can be very satisfying when heard in a 2 to 3 second reverberation period (even more for organ music), and will not be heard as "mush" if properly played. Perhaps the pendulum has swung too far away from the long "Wagner" reverberation period.

### Cinema Acoustics

Cinema acoustics are concerned chiefly with the avoidance of resonances, echoes, flutter or a reverberation period of significance. In other words, the deader the better and turn up the volume control! One of the least satisfactory artistic experiences of this life is to hear a live performance of orchestral or piano music in a well damped cinema.

### Small Rooms

The acoustics of small rooms (under say, 5,000 cub. ft.) depend more on judgement and less on science than larger ones. Apart from studios, this sort of room exists acoustically as small classrooms or domestic living rooms used for high fidelity playback.

Due to hard floors and desks, and areas of hard plaster and glass, classrooms can have an overlong reverberation period, making the spoken word indistinct. Principles outlined earlier in "Speech Rooms" should be applied, modified as necessary (no raking of desks!) and a reverberation period of .5 seconds aimed at.

Flutters must be guarded against, and where acoustic absorption is required it is best applied to the rear wall, (opposite the speaker in other words), the perimeter of the ceiling, and the upper 2 ft. of the walls. Beware the destructive tendencies of little boys however and use indestructible materials, or keep the materials well away from boy level (I once saw the walls of a telephone booth lined with fibre acoustic tiles—

very effective acoustically but the temptation was just too much for the Great British Public who in a short time decorated and damaged the tiles beyond repair).

Domestic rooms for high fidelity playback are generally well damped by carpets and furnishings and the reverberation period can well, as a consequence be negligible. For stereophonic playback there is everything to be said for a "dead" acoustic, in fact over reverberant rooms should be acoustically treated, (generally once again, on the wall opposite the speakers). I feel personally, that monaural playback realism is aided by a little reverberation, say up to .3 seconds. Such a time cannot be easily calculated or measured with accuracy, and the only thing to do, if the room sounds too dead, is to roll back the carpet and see how that sounds. If acceptable audio-wise, but not wife-wise fill the cracks between the floor boards with filler or mashed-newspaper-and-glue mix then borrow a Power sander and sand the floor boards smooth. Stain the whole lot black, seal it with a polish then scatter a few coloured rugs about—the result is quite nice.

Sound insulation can be important in playback rooms,—for the neighbours' welfare—not the occupants!

Finally, that very specialist subject of recording studios. There appears no doubt for monaural recording that the reverberation period should be shorter than for equal speech or music heard live. The reason for this is that the ears and eyes join together in a live performance to discriminate against random reverberant sound, and tend to prefer direct sound from the original source. When both direct and reverberant sound come however from one speaker the eyes cannot help the ears so to discriminate.

Typical studio reverberation periods are given in table 1, and if you propose to calculate the very short reverberation periods required for some studio work, Eyring's modification of Sabine's formula should be used, this formula, given at the end of the article gives much more

### Modification of Sabine's formula

Eyring's formula:

$$R = \frac{0.049V}{S [- \log_e (1 - \bar{\alpha})]} + (\alpha V)$$

Where:

R = Reverberation period (seconds)

V = Volume (cub. ft.)

S = Total surface area of particular absorbent (sq. ft.)

log<sub>e</sub> e = Napierian or hyperbolic logarithm

$\bar{\alpha}$  = Average absorption of coefficient (Sabins)

(obtained by working out the total absorption coefficient of all surfaces and dividing by the total surface area) i.e.:

$$\bar{\alpha} = \frac{\sum S_1 \alpha_1 + S_2 \alpha_2 + \dots + S_m \alpha_m}{S}$$

$$\alpha = \frac{S}{S}$$

$\alpha$  = Absorption coefficient for air (Sabins)

accurate results when a lot of absorption is required, but requires more maths!

Drama Studios may require to be very live and reverberant for certain work, yet at the same time may need to be "dead". The question of adjustable acoustics is often raised, but as any given effective absorption needs roughly to be doubled to make a significant aural difference it will be appreciated that difficulties exist here. Quite a useful way is to start off with a "live" studio and to make a "gadget" out of framework 8 ft. high by say 4 ft. x 4 ft., clad on three and a half sides by highly absorbent material facing inwards. This sarcophagus like object can be used when a "dead" effect is needed, the characters and microphone working inside. This is just a basic idea, and any fertile mind can develop it to have different sizes and functions, and by hinges and wheels to have more flexibility.

Studios more than any other subject need to be absolutely free from intrusive noise; aircraft, traffic, trains, footsteps, dogs, insects, plumbing and afar off flushing W.C's can all ruin a recording, thus every care must be taken to cover every eventuality. This brings us conveniently to the subject of sound insulation which, in theory and practice is a most interesting matter and is in fact dealt with in the next article.

# SPECIAL STEREO OFFER!!

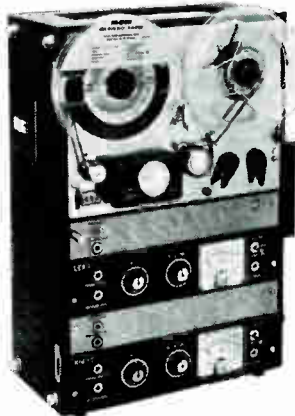

**89** GNS.

Never before have we or any other Company been able to make such an outstanding offer!!! Due to our ability to purchase large quantities of recorders direct, we are able to pass on to you the tremendous reduction in prices thus achieved. Here are just two of our fabulous offers!!! The world acclaimed AKAI M6 rated as being the finest professional type stereo/mono recorder available, coupled with the equally world famous SONY make this an offer that we or anyone else will never be able to repeat. Every recorder is absolutely BRAND NEW in sealed manufacturer's carton complete with full maker's Guarantee. PART EXCHANGES welcomed. Very limited number only available. Write to our MAIL ORDER DEPT. at Stratford, enclosing S.A.E. for illustrated literature and information on this and other wonderful offers.

We are also stockists of every leading make of tape recorder and have on display at our Showrooms over 250 new and secondhand models. HIRE PURCHASE TERMS available to suit every pocket.

## AKAI-M6

Offered at the unbelievable price of 89 Gns. (less microphones) they show a tremendous saving on the official LIST PRICE of £136, making these recorders an unrepeatable bargain!!! There is little need for us to detail this amazing recorder's performance, it is universally accepted as being the finest recorder in its class bar none. Look at the fabulous specification and judge for yourselves. Used by many leading recording studios throughout the world and accepted as a standard by which to judge others. The superb Freq. response ensures that every recording is a masterpiece and the 12 watts undistorted output enables you to enjoy to the full this recorder's amazing capabilities.

### TECHNICAL SPECIFICATION

Frequency Response at  $7\frac{1}{2}$  i.p.s. 30-20,000 c.p.s. Frequency Response at  $3\frac{3}{4}$  i.p.s. 40-14,000 c.p.s. 3 Speeds  $3\frac{3}{4}$ ,  $7\frac{1}{2}$  and 15 i.p.s. Wow and Flutter under .07 R.M.S. 7" tapes, Automatic tape stop. Operates vertically or horizontally, Hysteresis Synchronous Motor. Two inline. 100% accurate V.U. meters. Precision position indicator. Direct from Head and pre-amp outlets. 4 or 2 track stereo/mono record/playback at turn of tape selector control. Completely independent record/replay amplifiers on each channel. Out-put 6 watts per channel 12 watts total. Will fully drive 12" speakers. Signal to Noise ratio better than 45 dB. Cross channel separation better than 80 dB. Dimensions  $14" \times 20\frac{1}{2}" \times 8\frac{1}{4}"$ .

★★★ Special Offer. AKAI Dynamic Moving Coil Microphones. Superlative Performance. 7 gns. each, 10 gns. pair.

**23** GNS.  
OUR PRICE

### HI-WIDE RANGE STEREO SPEAKERS

Another wonderful offer are the two perfectly matched speaker enclosures containing in each one 8" super high fidelity wide range speaker together with 3" co-axial tweeter. Perfect for either the AKAI or SONY. Speakers in one divisible cabinet matching style and size of AKAI. LIST PRICE £31 10 0. our SPECIAL OFFER PRICE 23 Gns. or individually £12 10 0. Overall frequency response 40-16,000 c.p.s. Handling capacity 16 Watts.

## SONY 464 CS

This fabulous 4 track Stereo recorder recently introduced by SONY incorporates every latest development. Listed at £99 we are able to offer a limited number at the amazingly low price of 69 Gns. (Less Microphones). Look at the impressive Technical Specification. One of the few recorders offering special inbuilt facilities for Sound on Sound. There is no other comparable recorder available today at under £100 and once our existing stocks are exhausted we shall be unable to repeat this offer.

★ Special Offer:- Superb Sony dynamic microphones 4 gns each, 6 gns. pair.

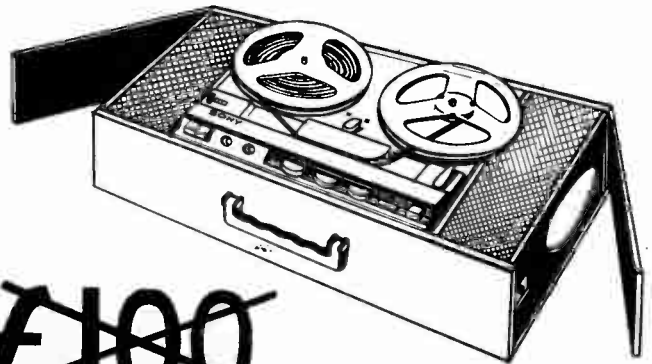

~~£100~~

### TECHNICAL SPECIFICATION

4-Track-Stereo/Monorecord Replay. Sound on sound enabling new recording to be made whilst listening to other through either internal speakers or headphones. Ideal Cine use. 2 high-flux density speakers. Frequency response 40-15,000 cs. 2 magic eyes. Independent volume controls for record/replay. Tone control. 2 speeds  $7\frac{1}{2}$ " and  $3\frac{3}{4}$ ". Signal to noise ratio 45 dB. Weight  $37\frac{1}{2}$  lb. Superb mono and stereo reproduction.

**69** GNS.

CITY & ESSEX

T A P E

RECORDER CENTRES

Note.—Our city shop open Mon.—Fri. 9 a.m.—6 p.m. Closed all day Saturday. Open Sunday 9.30 a.m.—2 p.m.

228 BISHOPSGATE, E.C.2 OPP. LIVERPOOL STREET STATION. BIS 2609  
2 MARYLAND STATION, STRATFORD, E.15 (ADJ. STATION). MAR 5879  
205 HIGH STREET NTH. (OPP. EAST HAM STATION), E.6. GRA 6543



## our readers write . . .

. . . about the causes of flutter

From: Dr. J. D. Poldy, 37 Queen's Road Central, Room No. 1102, Hong Kong.

DEAR SIR, Allow me to take up the point of "flutter" with Mr. R. J. Crome, following his article in your magazine of August 1963. Needless to say, all his practical advice is much appreciated, especially, I imagine, by certain readers who would otherwise not get over their first small troubles with tape and might give up.

One cause of flutter was not mentioned, perhaps because it is not so prominent in a cool climate; a deteriorated belt causing slippage was mentioned, but not the uneven motion due to a belt that is clean, but "cooked" or over-aged. The symptom is more akin to flutter than to wow, the cause apparently being a belt between the motor and the capstan.

From most annoying experience I have come to rule out for purchase any machine that has such a belt, and these are unfortunately by far the majority of the medium priced, and otherwise very good makes. The glorious exception, as far as I know, being the whole range of "Sony".

If to replace a belt were a quick and easy job, one would not mind. However with most machines the motor-to-idler or motor-to-flywheel belt is very hard to extricate and replace, not a job for the average user to do at home.

Rubber is probably most suitable for all manner of friction drive but only while new. If it is loaded for stretch it deteriorates very quickly. If loaded for compression, as on idler wheels, this deterioration is so slow that no extra trouble results during the life of the magazine.

I can therefore not understand why manufacturers do not concentrate on the elimination of these belts. Since the interest of the user is also that of the industry, I think Mr. Crome would contribute significantly to progress in this field if he wrote an article on this point only.

Yours faithfully, Dr. J. D. Poldy, Hong Kong.

★ ★ ★

. . . about the Audio Festival

From: Mr. G. L. Court, 313 Upminster Road, Rainham, Essex.

DEAR SIR, I was interested in your remark in the editorial of the August issue of "The Tape Recorder" about the Audio Festival. I do not think Olympia would be as favourable as you suggested as, when I visited the Do-It-Yourself Exhibition there, two years ago, there was not much room to move about. The best place, in my opinion, would be Earls Court, where the Radio Show is held. It would be as a separate exhibition of course. There would be a lot of work involved, I know, as sound-proof rooms would be needed but it should be possible to pre-fabricate such rooms that could be used every year. If more Hi-Fi firms would exhibit their equipment at the Radio Show this would get people interested in sound who, as yet, have given very little thought to it. This would, in turn, benefit trade.

Yours faithfully, G. L. Court, Rainham.

★ ★ ★

### STOLEN RECORDERS

Between the hours of 8.00 p.m. on September 4th and 6.00 a.m. on September 5th a delivery van belonging to Robuk Electrical Industries Ltd. was stolen from the junction of Fortress Road and Raveley Street, N.W.5. An Austin Mini-Van, registration number 348 CXX, it contained fourteen tape recorders all in cartons bearing the company's name.

The serial numbers of these machines are as follows:

Grey & White (R.K.4)	Pink & Buff (R.K.3)
44220	40637
44237	40792
44163	40861
43608	30984
43787	41957 <i>Numbers in italics</i>
44010	35945 <i>not new machines,</i>
50559	33615 <i>ex-service dept.</i>

Any readers who comes across one of these machines should get in touch with *The Station Officer, Kentish Town Police Station, Holmes Road, London, N.W.5.*

## BOOK REVIEWS

**Modern Tape Recording and Hi-Fi**—by Ken Peters. 247 pages, illustrated. £1 10s. Published by Faber & Faber.

THIS is one of the most comprehensive books for the beginner I have ever read. It deals with everything from acoustics to tape-spondence, hi-fi to fireside plays. Unlike the majority of books written for "beginners", the author does not assume that because his readers are new to tape recording they are therefore ignorant. He takes the reader, in straightforward non-technical language, into the complexities of microphone technique, recorder maintenance, editing, and so on. Several chapters are devoted to the uses to which a tape recorder can be put: recording humorous skits, exchanging tapes with other recordists both in England and overseas, and joining in the activities of local tape clubs. The author has devised a number of games that can be played in conjunction with a recorder. For those who would like the ability to understand and converse in "technical jargon" a sound vocabulary is given. I fully recommend this book, a complete course in tape recording and hi-fi, to beginners and semi-technical readers.

D. K.

★ ★ ★

**Magnetic Sound Recording**—by D. A. Snel. 230 pages, illustrated. £1 6s. 6d. Published by Philips Technical Library.

THIS book is an enlarged edition of the popular original by Snel. Written for the enthusiast as well as the expert, it contains a great deal of useful information laid out in a pleasant, easily understood, manner. The author gives a detailed explanation of the theory of magnetism, recorder design, tape, amplifiers, loudspeakers and microphones. He describes how the recorder can be used in education as well as an entertainer in the home. This book deserves a place on every enthusiast's shelf.

★ ★ ★

PLEASE MENTION "THE TAPE RECORDER" WHEN REPLYING TO ADVERTISEMENTS.

Now... you can order  
direct from Hi-Fi News  
**AUDIO**  
Read the original magazine about high fidelity every month. Use convenient order form.

Hi-Fi News

99 Mortimer Street

London, W.1., England

I enclose 42 - for a 1 year subscription to AUDIO which is to be mailed post-free from the U. S. (Please print or type name and address)

Name \_\_\_\_\_

Address \_\_\_\_\_

*The Incomparable*  
**Ferrograph**



for  
the man  
who  
demands  
**HARMONY**  
IN THE  
**HOME**

Post this coupon today for full details

NAME.....

ADDRESS.....

T2.

**THE FERROGRAPH COMPANY LTD**

84 BLACKFRIARS ROAD LONDON S.E.1. Tel: WATerloo 1981



for the professional

# IRISH

—the recording tape that gives the finest fidelity possible. How? Through the unique Ferrosheen process. Exclusive to Irish tape, this process produces a mirror-smooth surface to a magnetic tape with distinct technical advantages to satisfy even the most meticulous professional. The Ferrosheen process makes for exceptional high frequency response (due to precise perfection of tape/head contact) . . . head wear is minimal . . . external lubrication unnecessary—less oxide abrasion, no lubricant build-up on recorder head . . . minimum drop out . . . maximum reduction of background noise. Your Irish Tape stockist, and other details including technical data, from A. C. Farnell Ltd. Hereford House, Vicar Lane, Leeds 2 Tel: 35111.

'IRISH', 'FERROSHEEN' and 'Signature Binding' are registered trade marks of Orradio Industries Inc., Opelika, Alabama.

# TAPE RECORDS REVIEWED



THIS month we have half a dozen 3 1/4 i/s mono tapes, covering modern Russian ballet, ballroom dance music, pop songs, jazz, Viennese and Czech Operettas, and German Lieder.

Starting in Russia, there is a suite of pieces from the ballet *Gayaneh* by Khachaturian. This is performed by the London Symphony Orchestra under Anatole Fistoulari on *World Record Club TCM 41*. The suite commences with the well-known *Sabre Dance*, made popular through innumerable performances in various arrangements by Western bands and orchestras. The rhythmic impact of this piece is typical of Khachaturian's wilder moments, but the music is colourful and lively throughout, with bright rhythmic sections interspersed with quieter passages on the strings. Much of the material is based on Armenian Folk music.

The whole tape is delightful, and one is constantly impressed by the fact that good modern ballet music can be so very tuneful, rhythmic and pleasant. The recording is very clear and clean.



We now move from the studied choreography of the stage to the informality of *Come Dancing*, with Joe Loss and his Orchestra on *HMV TA-CLP 1370*. This tape is simply what its title implies: an invitation to dance. There are six quicksteps, four waltzes and two foxtrots, all played very clearly in a good, lively, foot-tapping style. This is excellent stuff in the Joe Loss tradition, and many well-known tunes from the Shows have found their way into his arrangements. The recording is bright and crisp.



A smaller group of players provides some good listening on a tape called *Jazz Giant*. This is *Saga STG 8062*, with Coleman Hawkins (the "giant") on tenor saxophone, Wendell Marshall (string bass), Eddie Bert (trombone), Earl Knight (piano), Ernie Royal (trumpet), Sidney Gross (guitar) and Osie Johnson (drums).

This is fine modern jazz, comprising eight items which give the various soloists their chance. But Hawkins is obviously the cornerstone of the group with his outstanding saxophony; in the item *I'll String Along With You* his expressiveness is so fine that one is brought very near to the sound of a voice. The recording brings the sax appropriately near, and our one objection is to the use of the worst type of electronic organ tone as a background fill-in at times.

For a big contrast we move from the modern improvised chamber music called jazz to the tuneful sparkle of Viennese Operetta in the form of *The Chocolate Soldier* by Oscar Straus (unrelated to the Strauss family). On the same tape, *WRC TT 210*, is *The Firefly* by Rudolf Friml, who came from Prague. The performers in both are Laurie Payne, Stephanie Voss, Barbara Ely, Pauline Stevens and the Linden Singers.

Five items and an overture are included from each work, and performances are competent though lacking the zest of a stage production. These two Operettas are full of memorable tunes and will probably have a nostalgic appeal for some older folk. The *Soldier*, believe it or not, is based on G. B. Shaw's *Arms and the Man*, and *The Firefly* includes that famous piece known as the *Donkey Serenade*.



From pop music of yesterday to that of today. On *Liberty TA-LBY 1006* a pop singer puts over his dozen best pieces in *Johnny Burnette's Hits and other Favourites*. Johnny is supported by a chorus and instrumentalists (mainly guitar) in songs which are all tuneful, lively and sentimental. A fine tape if you like this sort of thing.



Solo singing of an utterly different kind is found on our last tape as a *Lieder Recital* by Matti Lehtinen (baritone) accompanied by Hubert Giesen (piano), on *WRC TCM 37*. Lehtinen sings seven songs by Schubert, two each by Brahms, Schumann and Richard Strauss, and four by Hugo Wolf.

This is fine, well-controlled singing with a good feel for the music's mood. The piano is also very well played, providing a suitably dramatic accompaniment at times. Schubert was, of course, the song writer of all time—oh that we had an equivalent to set the English poets so sublimely as he did the German! This tape would be worth buying for the Schubert alone. Just try *Am Meer*, to learn how profoundly sad and moving a song can be when well sung.

Really one needs the equivalent of a disc record's sleeve notes on a tape such as this, especially when a foreign tongue is involved. Indeed one misses the extensive programme notes on all tapes when compared with discs; perhaps the tape people could think of a solution to this which does not involve great expense. There is a bare expanse inside the lid of all tape boxes which could be utilised.





## MONEY TO BURN ? . . .

Then you won't want to know about us. Go somewhere else, where they charge you high H.P. rates, charge for delivery, charge for servicing, have little stock and even less knowledge and experience of Tape Recorders. *And the best of luck!*

On the other hand, if you want to save money (or are even downright mean and stingy), HOWARD is for you—Free H.P.—UP TO 18 MONTHS NO INTEREST CHARGES \* Free Delivery anywhere \* Free servicing \* Special Cash Terms Special H.P. Insurance \* 500 machines in stock, 70 different models on show \* 10 years' experience as the biggest Tape Recorder Specialists in the Country \* In short—OUR TERMS ARE THE BEST YOU CAN GET ANYWHERE.

Cameras, Hi-Fi equipment and Dictating Machines, too!

*Write, phone or call in for catalogue and brochures (Free, but of course!):*

218, HIGH ST.  
BROMLEY  
KENT

RAVensbourne 4000

# HOWARD

CAMERAS · TAPE RECORDERS · HI - FI

# THOUGHTS ON DESIGN

THESE are, broadly speaking, four main groups of tape recorders. Professional, or studio instruments, plus their portable counterparts; semi-professional recorders which, in good hands, can do all but the most exacting work; domestic models for record and replay; and small battery portables. Of all these, only the first and the last groups can be said to be "ideal" for their respective jobs. Professional recorders are as near perfect as they can be because they are the result of a pooling of ideas—a combination of what users want and what tip-top designers and engineers are able to create. Small battery portables are relatively simple machines without the many frills that so often breed troubles. In the middle two groupings, "semi-professional" and "domestic", there are many fine instruments but, in my personal view, there are none that are truly "ideal". In these articles I intend to mention a few well-known names, primarily for the purpose of illustrating good points. If I omit to mention other names in those same connections, no offense is intended.

The semi-professional machine is in a difficult category, so far as its manufacturers are concerned, and I would not like to try to fix the boundaries in terms of specifications. From the user's point of view, however, the division is quite clear. He wants a machine that is out of the normal run in terms of quality, and his upper limit is fixed by the amount he can afford to pay for what he wants—plus, of course considerations of size, weight and mobility, and the senselessness of paying for facilities that he does not need. Semi-professional machines are used in large numbers by many people and numerous firms for very "professional" work. For example, a studio which is only interested in first-class speech recording and reproduction can get all it wants from such a machine, costing perhaps £200. It would be pointless to spend £600 on a more "professional" model.

From a quick glance at the instruments which are usually grouped as "semi-professional", and memories of handling most of them, there are a host of fine features to be found. Some possess more than one; none have all, and I am still waiting—and hoping—for the "ideal" semi-professional recorder to come along. The argument against such hopes being realised (always assuming that my "ideal" would be that of everyone else!) is that the money which would have to be spent upon its development would demand far greater sales than the "semi-professional" market could promise. I do not agree with that argument, for two very good reasons. First, I am very confident that there is a large and rapidly growing potential market for better quality recorders; second, the machine that I have in mind, in outline, could automatically be priced by its purchasers, according to needs of the moment.

Vortexion (I believe) were the first to introduce a bias adjuster on their recorders, enabling the level meter to be used for this adjustment when using different types of tapes. Bradmatic pressure pad arrangements facilitated editing, and this firm offered electromagnetic button control. Wearite, Brenell and Bradmatic decks make provision for extra heads. All these features would be part and parcel of my ideal, which would also have tape tension arms to isolate both spools from capstan and heads. EMI went a long way towards my ideal, in one direction, and then stopped short of it in others. The EMI TR52 has some really excellent features, and its electronic arrangements are exceptionally good—five slide-in units, replaceable in a matter of a minute, fitted with plug connections—2 record amplifiers, 2 replay and 1 monitor. If one of either of the record or replay units develops a fault it can be swapped round, pending a re-conditioned one's arrival.

But how about a deck, as the basis for the "ideal", with plug-in positions (or bayonet lock-in) for full track, half track and quarter track heads, for record, replay and erase—a deck with isolating tape-tension arms, (or hubs), with rheostat control to govern fast wind speed in either direction, with electromagnetic controls and indicator lights, and a

positive tape position indicator driven by the tape as it travels. The EMI professional TR90 has the last 4 items.

Such a deck would naturally be expensive—but not prohibitive. It would be advantageous to have the capstan motor running at constant speed, for instant stop and re-start of tape, and tape hub spacing should be sufficient to accept NAB spools. 2-speeds would suffice.

To accompany this "ideal" deck would be a standard series of tape heads and a series of electronic units, slide-in, plug-in, on the EMI principle. The user who merely wanted a good deck, plus full-track mono record and replay facilities, could thus buy the deck and frame and power pack, together with 3 full-track heads and 2 amplifiers. The user who wanted half-track facilities would buy them instead. He could later convert to stereo replay at the cost of one more head and one amplifier. Another stereo head and record amplifier would give him full stereo. He could then, if he wished, complete the outfit by using a stereo erase head, instead of full-track.

There could be more advantages in such an "ideal" combination than are immediately apparent. The ability to purchase a fairly simple set-up, with the knowledge that its future usefulness and potentialities and elaboration were assured at the time of buying, would certainly be a very great attraction. Servicing of all electronics would be tremendously simplified, and it would be reasonable to imagine that dealers handling such equipment would also carry "one each" of the standardised electronic units. With a careful control of all heads, so that their characteristics were within the range of the adjustments on the amplifier units, the setting-up of the recorder after any change would be a simple matter.

However, so much for a lovely pipe dream. It will take more than a few dozen "hear-hears" to encourage any manufacturer to produce such an outfit, however much he might like the idea. Even less would he like the task of adding one final master touch, which might open the doors to the very interesting small-gauge cine market—making provision for a sprocket attachment to replace the normal capstan/pinch-roller drive, so that perforated tape could be recorded for the dubbing of smack-on sound to edited, magnetically striped films! But even though we may still be a long way from such things, there are surely one or two items from all the above that could be incorporated into decks, or recorders in the "semi-professional" category.

*Fast Wind* should be really fast, but it should be controllable. The rheostat form of control used on professional machines is a relatively simple idea. At central, or "zero" position the voltage on both rewind motors is balanced, and the tape is held stationary. According to the direction and degree that the control knob is turned, so are the voltages varied, giving a free swing from full ahead to full astern.

Electromagnetic controls, operated by finger-light push buttons, are not an extravagance to ask for in a mains-operated machine. These, coupled with control of fast wind speed, make serious working with tape a pleasure, and they save hours of time in a busy week. Also, as users of professional machines know well, the only accurate method of place-finding involves the use of an indicator driven by the moving tape—not by the spool hub.

A capstan motor that runs continuously when the recorder is switched on, and which does not stop when the tape transport system is switched off, makes certain of clean stops and starts in recording. It cannot be a very costly facility, for it only involves a change of switching. The provision of a pair of sprung arms with rollers, one on each side of the head assembly, would take away many "wow" headaches that are caused by sticking tape or uneven spools.

Perhaps, somewhere, someone is at work on the drawing board, planning a deck as the basis for next year's "semi-professional" model. Perhaps, if so, he may be tempted to add in one or two of the above features? Perhaps all of them. I can promise him one customer if he does!

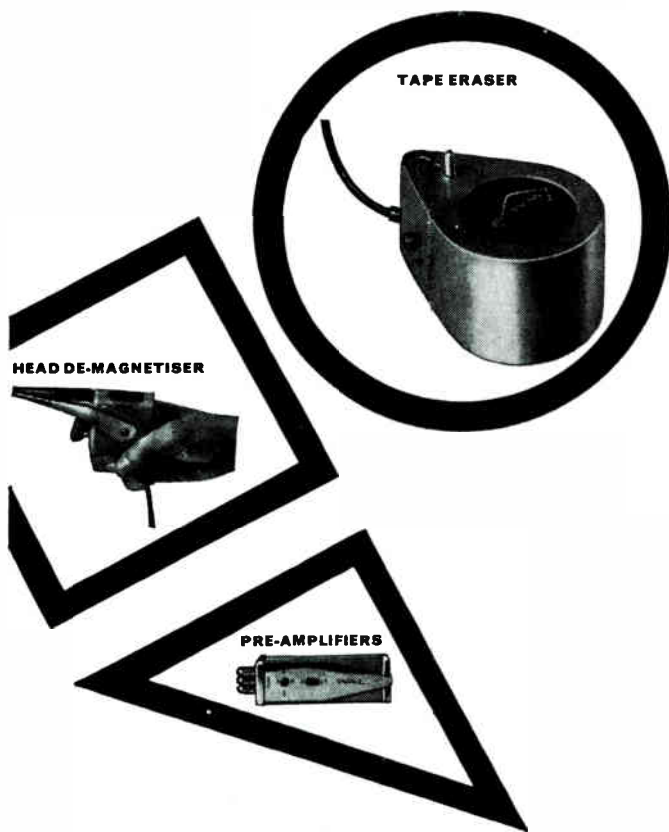

## Three basic essentials for the recording enthusiast

### Tape Eraser

Erases both sides of a 7" tape reel in 30 seconds and positively removes even the very low frequency portions of a recording. Use the WAL Tape Eraser, the only way to ensure an *absolutely* clean tape—quicker

and better. Mains operated. Also erases sound from 16 mm. film, 10" aluminium reels. Professionally designed for professional recording engineers. £6.18.6.

### Head De-magnetiser

De-magnetises tape heads quickly and simply. Also for pin-point erasing on striped film and tape recordings—removes local unwanted noises without detriment. Has nylon-cushioned

twin probes with a concentrated demagnetising field in the 1/8" gap between the arms. Pistol grip. A.C. mains. Professionally designed for professional recording engineers. £2.10.0.

### Pre-amplifiers

WAL pre-amps are made for every purpose. Fully transistorised, battery-operated, give high gain, completely hum-free. Laboratory built and fully tested. Professionally designed for professional recording eng-

ineers. Ask for details of WAL-GAIN Mono £5.10.0. STEREO WAL-GAIN £7.10.0. and the superb WAL HI-GAIN with built-in switched equalisation for monitoring, dubbing etc. etc. £7.16.0.



Free leaflets available on these professional aids to perfection . . . please write:

## ELSTONE ELECTRONICS Ltd

Edward Street, Templar Street, Leeds 2.

## A NEW RANGE OF TUNERS by...

# Armstrong

### 224 FM TUNER

Self powered with full provision, including space on the chassis, for simply plugging in an Armstrong Stereo Multiplex Decoder when regular stereo transmissions begin. Featuring precision tuning meter, dual audio outputs with pre-set gain control on each, and exceptional sensitivity. The styling is similar to the 223 Tuner as illustrated. Price **£22.10.0**

**SPECIFICATION**  
 Coverage 87—108 M/cs.  
 Sensitivity 1.5  $\mu$ V for 20 db quieting.  
 Output 0—2 volts variable to match any amplifier or tape recorder.  
 Stages R.F. Stage, Two IF Amplifiers, Limiter Stage and Foster Seeley Discriminator.

### 223 AM-FM TUNER (illustrated)

Identical in performance to the 224 above but with the addition of the Medium waveband. Price **£28.15.0**

**FM Band** as the 224 above.  
**AM Band**  
 Coverage 180—600 metres.  
**SPECIFICATION**  
 Sensitivity 5  $\mu$ V for 20 db quieting.  
 Automatic Variable  
 Selectivity 2 to 8 K/cs. depending on signal strength.  
 Filter Built in Heterodyne rejection filter.

The new 224 FM Tuner and 223 AM-FM Tuner are designed to provide outstanding facilities and performance with any tape recorder or amplifier.

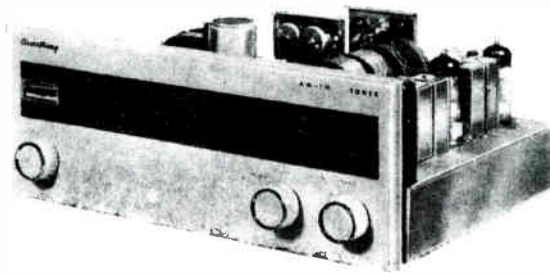

Optional cases of teak and vinyl-hide are available for all models.

**222 STEREO-AMPLIFIER**—a new Integrated Stereo Amplifier matched in styling and performance to the NEW Armstrong Tuners. Price **£27.10.0**

Full descriptive literature available from Dept. No. RNT.

## ARMSTRONG AUDIO LTD. Warlters Road, London, N.7. Telephone: NORth 3213

# TAPE, RECORDERS & ACCESSORIES

## FIRST DETAILS OF NEW PRODUCTS

● We remind our readers that notices of equipment listed and illustrated in this monthly feature are in no sense reviews. When figures, specifications and diagrams are published, these data are extractions from manufacturers' lists. When samples of this equipment are submitted for test, they are passed to our technical contributors, whose reports are published in a separate section.

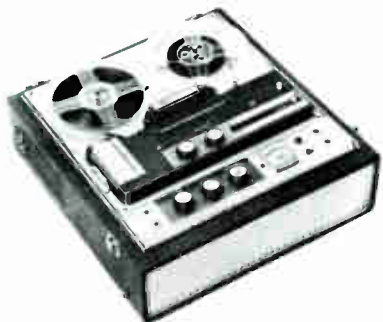

★  
Truvox R.92  
★

THE TRUVOX R.92 is one of the latest recorders to be introduced in the Series 90 range. It is available with two or four tracks. Recording level is shown by a meter and mixing facilities allow simultaneous recordings to be made from microphone and radio. The machine has three speeds:  $7\frac{1}{2}$ ,  $3\frac{3}{4}$  and  $1\frac{7}{8}$  i/s. Wow and flutter is claimed at  $-1\%$ ,  $-15\%$  and  $-25\%$  respectively. Spools of up to 7 in. diameter can be used and fast-wind speed is sixty seconds for 1,200 ft. Frequency response at  $7\frac{1}{2}$  i/s is given as  $40 - 17$  Kc/s  $\pm 2$  dB. The price of the R.92, and its four track equivalent the R.94 is £72 9s. Manufacturers: Truvox Limited, Neasden Lane, London, N.W.10.

★ ★ ★

### The Nusound "Nukit"

NUSOUND have just announced a cleaning kit designed for use with domestic tape recorders, the *Nukit*. They claim that 60% of tape recorder faults could be avoided by regular cleaning and lubrication. To this end they have formulated a hypodermic motor-oiler, a bottle of cleaning oil, a cleaning agent for neoprene capstans, a fluffless cleaning cloth, a head cleaning brush, and three soft-wood cleaning sticks. The price of the complete outfit, packed in a transparent plastic case, is £1. They can be obtained, post free, from: Nusound Recording Company, 93 Mortimer Street, London, W.1. (Note change of address).

★ ★ ★

### Universal Mains Plug

ONE of the greatest problems experienced by recorder owners is the fuss and difficulty which occurs when machines are taken to club meetings or friends who, invariably, have different mains plugs and sockets. A universal mains plug is the only satisfactory solution to this annoyance and it is surprising that such a gadget was not invented long ago. Now, however, such a plug, the *Fitall* has been introduced which is easily adjustable to fit 13A square-pin, 5A three-pin, 15A three-pin, 15A two-pin, and 5A two-pin sockets. Incorporating a built-in fuse, the



plug is adjusted by means of a selector lever which ensures the selection of the correct pins for the particular socket required. Available only in white, the *Fitall* costs 11s. 6d. plus 1s. postage. Details are available from the suppliers (send stamped addressed envelope): J. L. Tofts, 305 High Street, Ponders End, Enfield, Middlesex.

★ ★ ★

### S. T. C. Microphone

A NEW microphone recently brought out by Standard Telephones and Cables is designed for the recording enthusiast of limited means who nevertheless wants to improve the performance of his equipment. The new microphone, the *STC 4118* is a moving coil "stick" type available at 200 ohms and 50,000 ohms impedances. Frequency response is claimed at 100 c/s to 10 Kc/s  $\pm 4$  dB and the list price is £4 19s. 6d. Manufacturers: Standard Telephones and Cables Limited, Connaught House, 63, Aldwych, London, W.C.2.

★ ★ ★



★  
Telefunken Portable  
Tape Recorder  
★

THE latest recorder to be announced by Telefunken, the *Magnetophon 300*, is claimed to be the smallest amateur battery portable manufactured in Germany. Measuring approximately  $11 \times 10\frac{1}{2} \times 3$  ins. it has a maximum spool size of five ins. An unusual feature is the location of the pause and gain controls in the handle. Frequency response is specified as 40 c/s to 13 Kc/s at the single speed of  $3\frac{3}{4}$  i/s. The distributors of this recorder, the price of which has not been given, are: Weltec Corporation Limited, Lonsdale Chambers, 27 Chancery Lane, London, W.C.2.

★ ★ ★



★  
Weircliffe Bulk Eraser  
★

DESIGNED for professional and semi-professional recordists, the *Weircliffe Bulk Tape Eraser* is designed to remove all recorded matter from tape reels and cassettes. Two standard models are available. *Model 6* taking spools up to  $8\frac{1}{4}$  in. diameter, and *Model 7* taking cassettes up to  $6\frac{3}{4} \times 8$  ins. Both models are housed in mahogany cases with perspex panels. Dimensions are  $11\frac{1}{2} \times 12\frac{1}{2} \times 7\frac{1}{2}$  ins. and the weight is 33 lbs. Current consumption is approximately 14A. The price of the eraser is £29 and the manufacturers are: Amos of Exeter Ltd., Weircliffe Court, Exwick, Exeter.

# TAPE RECORDER COVERS



Smart waterproof cover to give complete protection to your tape recorder. Made from rubberised canvas in navy, wine, tan, grey and bottle green with white contrasting pipings, reinforced base, handy zip microphone pocket and name panel.

Grundig TK.1	49.6	Philips EL3536	70
.. TK.5	55	.. EL3515	57.6
.. TK.8	63	.. EL3541 IS	57.6
.. TK.14 & 23 & 18	59.6	.. 3541H	
.. TK.20	52	.. Starmaker	66
.. TK.24	55	Cossor 1602	57.6
.. TK.25	55	.. 1601	63
.. TK.30	60	.. 1605	84
.. TK.35	63	Stella ST455	63
.. TK.40 & 41	66	.. ST454	57.6
.. TK.46	82	.. ST459	84
.. TK.55	63	Saba	63
.. TK.60	75	Wyndor Victor	60
.. TK.830 3D	63	Elizabethan Princess	60
.. Cub	35	.. Escort	57.6
Telefunken 85	65	.. Major	63
.. 75 15 & 76K	55	.. FT.1	66
.. 95	69.6	.. FT.3	75
Philips 8108	57.6	.. LZ29	75
.. 8109	63	Fi-Cord IA	52.6
.. 3534	87	Fidelity Argyle	55
.. 3459	79.6	Clarion (with strap)	52.6
.. EL3538	63	Brenell Mk.5	77
.. EL3542	63	.. 3 star	69
		Minivox C	61
		Robuk RK.3	67.6
		Ferrograph	80
		Sony 521	90
		Revox	84
		Optacord 414	412

\*Without pocket.

**A. BROWN & SONS LTD.**

24-28, GEORGE STREET, HULL TEL: 25413, 25412

YOUR  
RECORD  
& EQUIPMENT  
SHOP

# CHELSEA RECORD CENTRE

203  
KINGS  
ROAD  
CHELSEA  
SW 3  
FLAXMAN 2595



## The Grampian Ribbon Microphone

Exceptionally wide frequency response — virtually level from 40 c/s to 15 Kc/s—combined with excellent transient response, makes this the ideal instrument for the studio and wherever a high standard of fidelity is essential. Two models are available, each in three impedance sensitivities.

**Model GR. 1**, having a semi-cardioid response, gives approximately 10 db suppression to high frequencies at the rear face. It is ideal for overcoming problems of feed-back between microphone and speakers.

**Model GR. 2**, having a bi-directional "figure of eight" sensitivity pattern, discriminates against unwanted side noise both in the vertical and horizontal planes.

Supplied in attractive, padded instrument case, complete with 18 ft. screened lead, swivel holder and connector. £11.10.0.

**Grampian**

30 years' experience in  
the manufacture of high-  
quality microphones

A full range of accessories is available. Please send for illustrated leaflet. Enquire too for details of the famous Grampian DPA range of Moving Coil Microphones

**GRAMPIAN REPRODUCERS LTD**  
Hanworth Trading Estate, Feltham, Middlesex. FELtham 2637

# Lee Electronics

TAPE RECORDER & HI-FI AUDIO SPECIALISTS

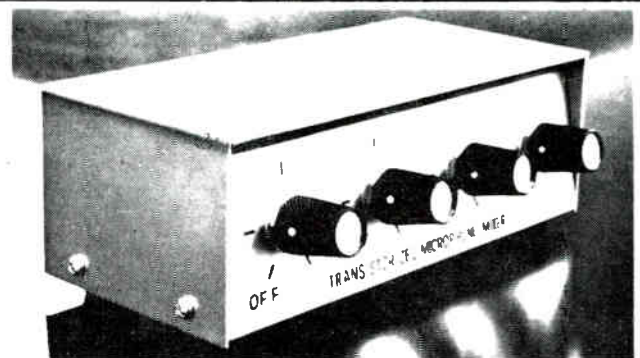

AT LAST A 4-CHANNEL TRANSISTORISED MICROPHONE  
MIXER AT A REASONABLE PRICE

Four high impedance inputs, e.g. four mics  
or two mics, one gram and one radio. Out-  
put gain approximately 6dB. Inputs, standard  
jack sockets. Battery PP3.

Price complete with PP3 circuit diagram, instructions etc

**£3 - 19 - 6**

TRADE SUPPLIED

Details of this, and other offers, available on request.

400 Edgware Road, Paddington

PAD 5521



# EQUIPMENT REVIEWED

★  
MICROKIT  
CONDENSER  
MICROPHONE  
★

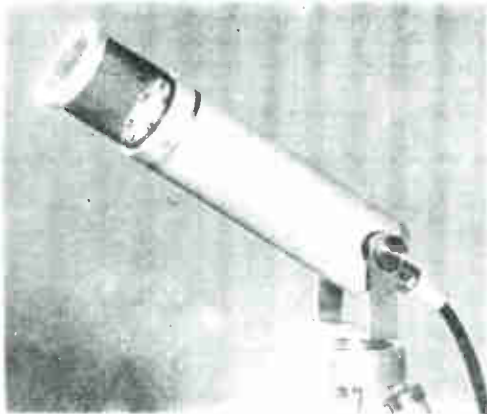

**Manufacturer's Details:** Condenser microphone with precision capsule. **Directional properties:** Substantially omni-directional but cardioid on axis of capsule. **Output impedance:** 600 ohms cathode follower. Available in kit form or assembled and tested. **Price:** Kit, 20 gns.; assembled, 25 gns. **Distributor:** Chateau Productions Ltd., 25 Denmark Street, London, W.C.2.

THE description in the February and March issues of our sister publication *Hi-Fi News* of the Microkit Condenser Microphone (which must surely be the world's first "do-it-yourself" microphone) aroused considerable interest (and a little envy) on the part of your reviewer. The articles showed that considerable thought and ingenuity had been expended in producing a complex and precise piece of electro-acoustic engineering.

The condenser microphone is as old as the art of sound reproduction and examples were produced during the 19th century; but it was not until 1919, when Wente and Thuras produced their famous Condenser Transmitter at the Bell Telephone Laboratories in the United States, that a workable Condenser Microphone was produced. This microphone was the first high fidelity unit to be produced anywhere and, it is suggested, owes much to the inherent basic simplicity of the condenser microphone (which consists of nothing more than a thin diaphragm supported at a suitable distance from an insulated backing plate which forms the live electrode). I said "nothing more" with my tongue in my cheek because the diaphragm itself must be perfectly flat, perfectly stretched and of only a few microns in thickness. The separation between the diaphragm and the backing plate is usually of the order of a thou' or so and the system must obviously be of extreme mechanical rigidity and stability.

The original Wente microphone underwent a number of changes and the reviewer is still using one Western Electric microphone produced according to the Wente philosophy in the early '30s. It is rather a large beast, about 3½ inches in diameter, with a diaphragm resonance at about 6 Kc/s but a rather large cavity resonance at 2½ Kc/s. These were originally equalised by means of electrical circuits and for the last 15 years it has worked as a master transducer in a standard artificial ear. Periodic checks of the microphone show a long-term stability better than 1 dB!

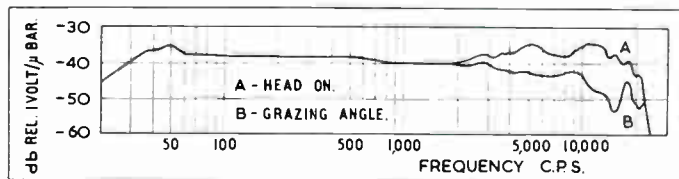

Condenser microphones have been extensively used in the past, particularly in film recording studios where the magnetic shielding of dynamic microphones can be difficult, but they never caught the fancy of either the broadcasting authorities or the general British public until recently, with the advent of Neumann and, later, the

A.K.G. microphones. These are beautiful instruments but are completely out of the range of the pocket of the average home recording enthusiast. Whilst the performance of the best ribbon and moving coil microphones is beyond reproach, this performance is obtained by various artifacts and not from an inherently resonant-free system. As mentioned before, the condenser microphone should only have one fundamental resonance, usually in the 7 to 10 Kc/s region. This resonance can be damped until it is aperiodic by means of acoustic damping provided by small diameter holes in the back plate, after which the pressure response drops at -6 dB per octave. The response is, however, maintained to about 20 Kc/s due to the "obstacle effect" of the microphone diaphragm and housing.

The response curve shows that the microphone is sensibly flat from 30 c/s to 20 Kc/s in the 'head-on' position. The two peaks at 5 Kc/s and 11 Kc/s are due to the diaphragm resonance and the first mode resonance of the front case respectively. At grazing angle, the response drops 2 or 3 dB at 10 Kc/s and then dies rather rapidly, apart from the peak at 18 Kc/s. The result is that when the microphone is used under studio conditions, the response is substantially flat to a limiting frequency of 18 to 20 Kc/s, and this, ladies and gentlemen, is no mean feat in a microphone selling for £20; it would do credit to microphones costing five times that amount. The measured distortion is less than 0.5% over the whole frequency range at a level of 100 phons, rising to 7% at 30 c/s at a level of 140 phons. As the loudest orchestral crescendo is never likely to be more than 105 to 110 phons, the distortion introduced by the microphone is negligible compared with that of other links in the recording and reproducing chain.

When Mr. Morris delivered the microphone to me, he brought with him a tape produced by an amateur at a rehearsal of a midlands Symphony Orchestra. The balance was extremely good, the string tone having a 'bite' that one expects from an excellent transient response and smooth frequency characteristic. Not having the resources of a Symphony Orchestra, your reviewer had to make do with piano and voice recordings. A TR 52 Recorder was used and we met some matching problems. A 600 ohm/25 ohm matching transformer was, however, completely satisfactory and no trouble whatever was experienced due to magnetic hum pick-up or earth loops. (It should be noted in parentheses that the output of the microphone is taken through a normal coaxial audio socket of the power supply, the ground of which is isolated from the power supply carcass. The only earth used on the system was taken from the Recorder, no earth being used on the microphone directly.) The second test was used with the Revox Tape Recorder E 36, the output of the microphone being connected directly to the microphone input of Channel One. The sensitivity was more than adequate and the background noise to all intents and purposes negligible.

My wife's lounge doubles as a studio for these experiments and is about 18×15×10 ft. A 7 ft. 6 in. Bluthner piano is the source of sound, and in my opinion (hotly disputed by the distaff side) due to

## COMPLETE "SLEEPOMATIC" UNIT FOR ONLY £20

Comprising transistorised tape machine, auto time-switch, microphone, batteries, and under-pillow speaker.

### INTERESTING FREE BOOKLET

and details of our range of tapes, discs, and equipment gladly sent on receipt of postcard.

(We are the pioneers of Automated Sleep-learning in Gt. Britain.)

**EDUCATIONAL RECORDINGS LIMITED**  
(Dept. TR) 21 Bishops Close, Church Lane, London, E.17.

# THE RECORDER CO.

for best machines on advantageous terms

	Deposit £ s. d.	12 Monthly Payments £ s. d.	Cash Price Gns.
<b>4-TRACK STEREO/MONAUROL</b>			
Akai M6	13 13 0	10 4 9	130
Ferrograph 424	11 12 0	8 13 2	110
Grundig TK46	10 12 0	7 15 7	99
Telefunken 97	10 0 0	7 9 7	95
Sony 464 CS	10 0 0	7 7 10	94
Siemens Mod. 12	9 16 0	7 9 5	93
Philips EL3534	9 16 0	7 4 8	92

	Deposit £ s. d.	12 Monthly Payments £ s. d.	Cash Price Gns.
<b>2-TRACK STEREO/MONAUROL</b>			
Brenell STB 1	12 0 0	9 0 0	£120
Ferrograph 422	11 12 0	8 13 2	110
Telefunken 98	10 0 0	7 9 7	95

	Deposit £ s. d.	12 Monthly Payments £ s. d.	Cash Price Gns.
<b>MAINS TWIN-TRACK</b>			
Brenell 5 Type "M"	9 5 0	6 18 7	88
Ferrograph SA/N	8 19 0	6 13 10	85
Telefunken 85	8 15 0	6 10 8	83
Grundig TK41	8 0 0	5 17 11	75
Brenell 5/2 (Meter)	7 15 6	5 16 7	74
Brenell 5/2	7 5 0	5 8 8	69
Reps R10	6 4 0	4 12 11	59
Telefunken 95	6 4 0	4 12 11	59
Truvox R82	5 15 6	4 6 8	55
Grundig TK18	4 2 0	3 1 5	39
Truvox R62	4 2 0	3 1 5	39
Grundig TK14	3 13 6	2 15 2	35
Wyndors Trident	3 10 0	2 11 11	33
Elizabethan LZ30	3 7 3	2 10 5	32
Ferguson 3200	2 16 6	2 0 10	26

	Deposit £ s. d.	12 Monthly Payments £ s. d.	Cash Price Gns.
<b>4-TRACK MONAUROL</b>			
Grundig TK40	8 0 0	5 17 11	75
Reps R10	7 5 0	5 8 8	69
Fidelity Major De Luxe	3 13 6	2 15 2	35
Philips EL3549	6 12 0	4 17 6	62
Truvox R84	6 4 0	4 12 11	59
Grundig TK23	4 15 0	3 10 10	45
Philips EL3541/H	4 12 0	3 5 10	42
Truvox R64	4 2 0	3 1 5	39
Elizabethan LZ29	3 15 8	2 16 9	36
Philips EL3541	3 15 8	2 16 9	36
Ferguson 3202	3 10 0	2 11 11	33
Philips "Star Maker"	2 16 9	2 2 7	27

	Deposit £ s. d.	12 Monthly Payments £ s. d.	Cash Price Gns.
<b>BATTERY</b>			
Uher 4000S	9 16 0	7 6 5	93
Ficord 202	7 0 0	5 3 10	66
Butoba MT5	7 0 0	5 3 10	66
Stuzzi Magnette	6 4 0	4 12 11	59
Optacord 414 Bat./Mains	4 19 0	3 14 0	47
Grundig TK6	6 17 0	5 2 4	65
Philips EL3586	2 12 6	1 19 5	25

	Deposit £ s. d.	12 Monthly Payments £ s. d.	Cash Price Gns.
<b>TRUVOX HI-FI TAPE UNITS</b>			
<b>TWIN-TRACK</b>			
PD.82 Standard	4 4 0	3 3 0	42
PD.87 Stereo	6 6 0	4 14 6	63

	Deposit £ s. d.	12 Monthly Payments £ s. d.	Cash Price Gns.
<b>FOUR-TRACK</b>			
PD.84 Standard	4 12 0	3 9 0	46
PD.86 Stereo	6 6 0	4 14 6	63

H.P. also over 18 and 24 months.

Open Saturday until 6.0 p.m. Friday 6.30 p.m.

If unable to call, write for free brochure or send deposit now for quick delivery.

## INTEREST FREE TERMS

Agents for FERROGRAPH, VORTEXION, REFLECTOGRAPH, SONY, GOODMAN'S, ETC.

Whatever the time—  
Wherever you are—  
you're completely  
independent  
with the NEW

## UHER 4000 S

4 speeds, 7 $\frac{1}{2}$ , 3 $\frac{3}{4}$ , 1 $\frac{1}{2}$  and  $\frac{1}{4}$  i.p.s. Reel size up to 5 in. Push button controls. Remote Control. Combined Record Level/Battery Meter Indicator. Operated from rechargeable "Dryfit" storage Battery, or 5U2 batteries, or Mains operated Power Unit. Complete with Dynamic Remote Control Microphone and 5 in. Tape.

Price 93 gns.



Ever-ready  
leather carrying  
Case—9 gns. extra

We will be pleased to demonstrate  
this fine model or send full details.

# THE RECORDER CO.

(Dept. R) 188, WEST END LANE, WEST HAMPSTEAD, LONDON, N.W.6. Telephone: SW1 4977

Nearest Station: West Hampstead, Bakerloo Line

FREE DELIVERY · PART EXCHANGE

# FRANCIS OF STREATHAM

*Akai M6 $\frac{1}{2}$ & $\frac{1}{4}$ Tr. St.	89 gns.
* Brenell Stereo STB 1	£120
* Brenell Mk. V Model M	88 gns.
* Brenell Mk. V Series 2	69 gns.
Cossor 1603	28 gns.
Cossor 4 Tr. 1604 2 sp.	39 gns.
Cossor 4 Tr. 1605 4 sp.	62 gns.
Elizabethan "Popular"	22 gns.
Elizabethan LZ30	32 gns.
Elizabethan LZ29	36 gns.
Ferguson 3200	26 gns.
Ferguson 3202 4 Tr. 2 sp.	33 gns.
* Ferrograph 422 or 424	110 gns.
* Ferrograph Series 5	85 gns.
Fidelity Argyll Minor	22 gns.
Grundig TK14	35 gns.
Grundig TK18 "Magic Ear"	39 gns.
Grundig TK23 4 Tr.	45 gns.
Grundig TK40 4 Tr.	75 gns.
Grundig TK41 2 Tr.	75 gns.
* Grundig TK46 4 Tr. St.	99 gns.
Loewe Opta 403	45 gns.
Philips 4 Tr. 3541 H	42 gns.
Philips 4 Tr. 3549	62 gns.
Philips 4 Tr. stereo 3534	92 gns.
Philips Starmaker 4 Tr.	27 gns.
* Reflectograph "A" Tr.	105 gns.
Robuk	36 gns.
* Simon SP5	93 gns.
Sony Stereo 462 4 Tr.	75 gns.
Sony 521 Stereo	89 gns.
Stella 458 4 Tr.	39 gns.
Stella 459 4 Tr.	62 gns.
Stella 456	28 gns.
* Tandberg Series 6	110 gns.
* Tandberg Series 7	93 gns.
* Telefunken 85 de luxe	83 gns.
* Telefunken 95	59 gns.

* Telefunken 96 4 Tr.	69 gns.
* Telefunken 97 Tr. Stereo	95 gns.
* Telefunken 98 Tr. St.	95 gns.
Truvox Series 80 2 Tr.	55 gns.
Truvox Series 80 4 Tr.	59 gns.
Truvox 60 Series $\frac{1}{2}$ & $\frac{1}{4}$ Tr.	39 gns.
* Vortexion WVA	£93.13.0
* Vortexion WVR	£110.3.0
* Vortexion C Stereo	£148.10.0
* Vortexion CBL Stereo	£160.0.0
Wyndors Trident	33 gns.

BATTERY PORTABLES	
Cossor 1620	25 gns.
Philips Portable	24 gns.
Loewe Opta 414	47 gns.
(Mains, Battery Car)	
* Butoba	66 gns.
Clarion Phonotrix	19 gns.
* Fi-Cord 202	66 gns.
Stella	25 gns.
Stuzzi Memo-Cord	25 gns.
Uher 4000S	93 gns.

Mains Power Packs	
Philips, Stella or Cossor	£5.0.0
Grundig	8 gns.
Butoba	11 gns.
Fi-cord	£7.10.0
<b>TRUVOX DECKS with PRE-AMPS</b>	
PD 82—Standard Twin Tr.	£42.0.0
PD 83—Pro. 2 Tr.	£48.10.0
PD 84—Stand. 4 Tr.	£46.0.0
PD 85—Professional 4 Tr.	£52.10.0
PD 86—Pro. 4 Tr. St.	£63.0.0
PD 87—Pro. 2 Tr. St.	£63.0.0

Tape Decks by Brenell, Wright & Weaire.  
Tape to disc and copy service

LEADING STOCKISTS OF EQUIPMENT FOR

## TAPE and HI-FI

... and NO EXTRA FOR CREDIT TERMS

- ★ Minimum Deposit
- ★ No Interest or Service Charges on H.P. up to 18 months
- ★ Free Service during Guarantee Period

### MICROPHONES, MIXERS, ETC.

Grampian Reflector	£6.0.0
Grampian Ribbon	£11.10.0
Grampian DP 4 Dynamic	£8.0.0
Lustraphone VR 64	£7.17.6
Lustraphone LFV 59	£8.18.6
Simon "Cadenza" Ribbon	£10.10.0
Reslo Ribbon	£10.2.0
Reslo Cardioid Dynamic	£10.15.6
AKG Stereo D.77	£17.10.0
AKG D.19C	£17.10.0
TSL 3 Channel Mixer	£2.7.6
Grundig Mixer Stereo	18 gns.
AKG K 50 Headphones	£7.10.0

Also in stock microphones by ACOS, FILM INDUSTRIES, TELEFUNKEN, etc.

### All WALGAIN PRODUCTS

- STANDS OF ALL TYPES
- TAPES & ACCESSORIES
- Standard, Long, Double, Triple Play in all sizes by all leading makers.
- DEFLEXERS BY WEARITE, WALGAIN
- Pre-recorded Tapes by Columbia, H.M.V., and all E.M.I. Labels. Saga, Tatar-tape, etc.
- Bib. Bond and E.M.I. splicers. Matching transformers. Plugs, sockets, etc.
- Prices subject to alteration as announced by manufacturers.

### HI-FI DEPT.

- STEREO AND MONO AMPLIFIERS—
- Quad, H.M.V., Pye, Rogers, Leak, Avey, Armstrong, Tripletone, Scott, B & O, Chapman, Eagle
- TUNERS
- Quad Rogers Pye H.M.V. Leak Avey Armstrong Chapman B. & O. Tripletone
- LOUDSPEAKERS
- Quad Pye Rogers W.B. Kef Wharfedale Goodmans Tannoy Colrad Lowther Mordaunt Leak Lockwood
- MOTORS, PICKUPS
- Garrard Tannoy EMI Goldring Lenco Shure Connoisseur Decca Stereo Decca Deram Pickering Philips Ronette B & O Acos SME Mk. II Thorens ADC BSR
- All types of Diamond and Sapphire stylis, stereo and mono, Microlifts, Garrard, Goldring and Acos Pressure Gauges, Disc Preener, Acos Dust Bug Cabinets by Record Housing and G.K.D.

169-173 STREATHAM HIGH ROAD, LONDON, S.W. 16

Between St. Leonard's Church and Streatham Station

STReatham 0466/0192

Please note this is our only address

## EQUIPMENT REVIEWED—(continued)

inadequate drapes and furnishings, the room is live and reverberant; additionally, due to the Aliquot tuning of the Bluthner the two top octaves have a 'live' singing quality. This makes it a most difficult instrument to record satisfactorily, although when conditions are right it sounds magnificent.

The microphone was tried in various positions of the room, and eventually the optimum position was found in the open doorway facing the open lid of the piano, situated about six feet away. Balance was good, the sound was not too reverberant, and the bass response was well maintained. The results were replayed through an EMI TR 135, Quad 22 Amplifier, and my own Loudspeakers, and A/B changing from recorded to live showed a high degree of realism, especially when one listened through the open door in the hall.

Voice is especially good, there is no chestiness sometimes found with ribbon microphones used at close distances, and due to the omnidirectional sensitivity, positioning of the speaker or singer is not important; although in some circumstances the bidirectional characteristics of a ribbon can be helpful.

The microphone was delivered for review completely assembled and was, I believe, assembled by the manufacturer of the kit. The finish is well up to semi-professional standards, the microphone in particular having a strong family likeness to the studio condenser microphone currently being used professionally. I understand that the microphone capsule itself is now being supplied as the complete unit rather than risk damage to the foil diaphragm at the hands of those not quite as skilled as should be in the mechanical arts. Having had considerable experience in the production and use of thin metallic films I heartily applaud this step and add a word of warning to any purchasers of this unit: Do not, under any circumstances, approach the diaphragm with index finger, screwdriver, or other instrument. If the diaphragm is touched it will most probably be damaged beyond repair! The connecting cable between the microphone and pre-amplifier power supply was very flexible, considering the five conductors, shielding, etc., and of adequate length (in this case, 15 feet).

I have two criticisms. The power supply case is sand-blasted aluminium and because of the handling it received during these tests the surface has become dirty and rather scratched and now looks somewhat scruffy. Doubtless either anodising the case or a coat of lacquer would obviate this particular point. The other criticism is a little more serious. When the plug is inserted in the bottom of the microphone housing it is not possible to put the microphone in a vertical position. It can, of course, be argued that no one wants the microphone in a vertical position, but a swivel is provided to allow for adjustment of the operating angle—if it is made about an inch longer all will be well.

To summarise: The performance of the microphone is excellent, the sensitivity is more than adequate for all normal domestic recording situations. It is mechanically robust and stable and the components are of excellent quality. In common with all other pressure microphones in which polar response is omnidirectional, care must be exercised in correct placement of the microphone, but when used properly the results are certainly as close to professional standards as make no matter. Taking into account the minor mechanical criticisms, this microphone is excellent value for the money and can be confidently recommended to the enthusiast who wants something better than the 'run of the mill' dynamic microphone at present offered to the recording enthusiast.

Stanley Kelly.

★ ★ ★

### TRU-CORD R 119K PORTABLE TAPE RECORDER

**Manufacturer's Specification:** Tape speed:  $3\frac{3}{4}$  i/s. International double-track. Frequency range: 60-10,000 c/s. Wow and flutter: Better than 0.5%. Dynamic range: Better than 50 dB. Rotary switch for start, stop, fast rewind, off. Three push-buttons for recording, playback, quick stop. Tone control. Volume control: Pre-set recording level and monitoring. Recording control by magic line DM70. Transistors: 3 OC75, 2 OC74, 1 OC79T, 2 2M3 diodes. Connections for dynamic microphone, radio, phone, earphone, external loudspeaker. Recording time: 1 hr. each track. Spool diameter: Max.  $4\frac{1}{4}$  in. Power supply: 4 U2 cells. Dimensions:  $9\frac{1}{4} \times 4 \times 9\frac{3}{4}$  in. Weight with batteries: 6 lb. Price: with tape, microphone, radio lead, batteries, instruction book and circuit diagram, £34 13s.

AC adapter NCI £4 4s. Distributed by C. Braddock Ltd. The Tape Recorder Centre (Blackpool) Ltd., 266 Waterloo Road, Blackpool, Lancs.

REGULAR readers will know of my interest and enthusiasm for portable tape recorders. I think they offer a challenge to the designer which is much more difficult to satisfy than that of a static home recorder where weight, size, power supply, etc. are not limited.

I also find that most of the events I want to capture in sound occur well away from mains supplies, or would be lost if time were spent in locating a mains point, changing plugs, etc. With a good portable recorder you are as free as the air. In a glider or down a coal mine you can record comments or sound pictures which could not be obtained in any other way. This is not to say that the static mains recorder does not have a place in the scheme of things. It can be used to play recordings made on the

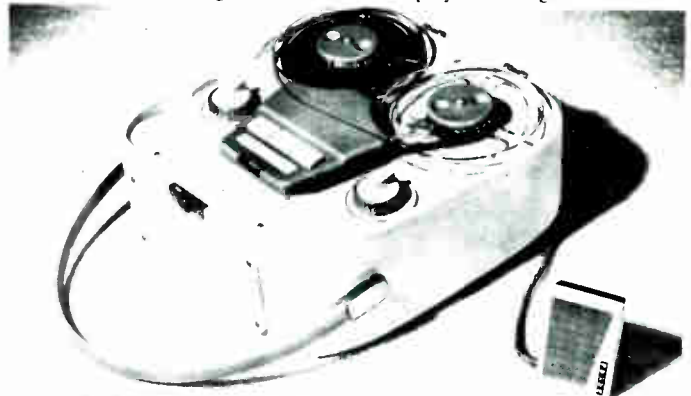

portable recorder, or to re-record sounds recorded on the portable machine together with a linking commentary to join the fragments of sound into a coherent pattern.

The second machine allows copying, dubbing, re-recording with different levels and frequency balance, etc., and can save an enormous amount of tedious tape editing. Not all portable recorders are suitable for this work; these must be a constant tape speed so that recorded tapes can be played on the static recorder; dynamic range must be high so that the minimum of noise is added to duped recordings; and a wide range of tone control is desirable so that recordings made in different locations, or at different times with various types of microphone, may be blended without obvious and annoying changes of quality.

The reason for all this preamble is that the machine under review does all these things extremely well, as can be seen by the following tests.

Combined wow and flutter remain constant at between 0.2 and 0.25% RMS (fig. 1). Wow is extremely low due to the use of a fairly large diameter capstan which runs true to fine limits. Flutter at 50 c/s

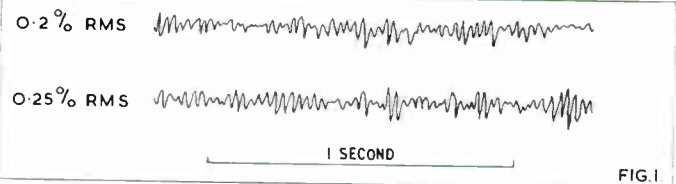

### BRAND NEW TOP QUALITY 100% TESTED RECORDING TAPE

(As supplied to the Far East Broadcasting Corp.)

All English tapes now P.V.C. All American tapes now Acetate and Mylar.

	Size	Length	ENGLISH	AMERICAN
STANDARD PLAY ...	3"	150'	2/6	
	5"	600'	9/-	8/-
	5½"	900'	11/6	10/9
LONG PLAY ...	7"	1200'	16/-	15/-
	3"	220'	3/-	
	5"	900'	11/6	11/-
DOUBLE PLAY ...	5½"	1200'	16/-	15/-
	7"	1800'	23/-	19/-
	5"	1200'	21/-	16/-
	5½"	1800'	24/-	19/-
	7"	2400'	39/-	26/-

Post and Packing 1/- per Spool, 4 or more post free

Money refunded in full if not delighted (refund still never ever requested)

**SPECIAL OFFER. Brand New 2 and 4 track Recorders.**

Retail price £40, our price £18.10.0. Further details: Phone Ashford 53020.

**N. WALKER, 28 Linkscroft Avenue, Ashford, Middlesex**

The universally acknowledged leader—that's the Tandberg Series 6 stereo tape deck. Three speeds, three heads, four amplifiers. Four-track and two-track models. High and low level mixer inputs and cathode follower outputs. On and off the tape' monitoring. Sound-on-sound simultaneous record and playback. Fully professional performance in every respect, beautifully made—unsurpassed precision engineering—strictly for the connoisseur.

**TANDBERG SERIES 6 STEREO TAPE DECK 110 gns**  
 Model 64 (4 track)—Model 62 (2 track) *illustrated; plan view of top plate—15f. x 11½"*  
*Illustrated leaflet and Booklet of Technical Reviews on request from*

ELSTONE  
 ELECTRONICS  
 LIMITED  
 EDWARD STREET  
 TEMPLAR STREET  
 LEEDS 2  
 Tel. Leeds 35111 (7 lines)

**TURN TO Tandberg**

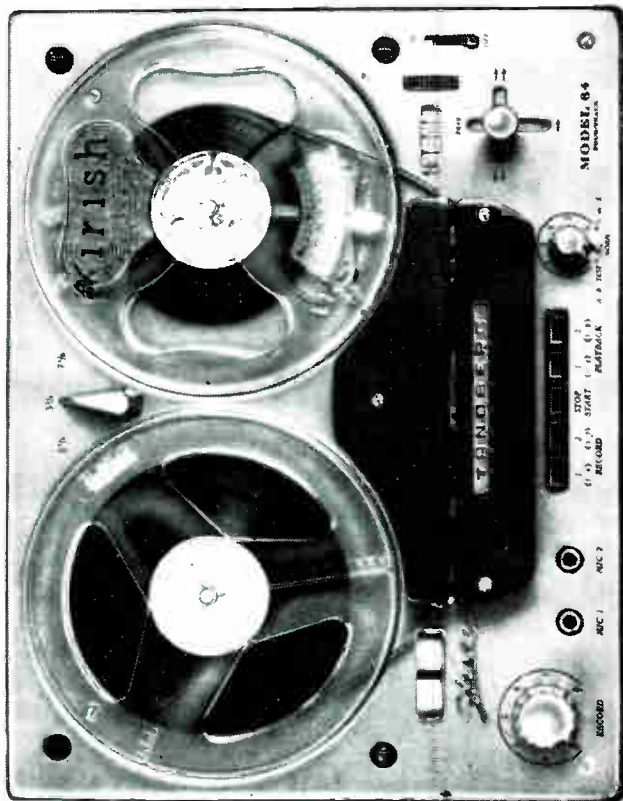

**TURN**

Don't let

*hiss-s-s*

spoil your recordings

The recording head of any Tape Recorder tends to become magnetised in use. Small at first but gradually building up, this residual magnetism can seriously affect the quality of your recordings by progressively increasing the hiss level. It can also impart a noisy background—which can never be removed—to any pre-recorded Tape *at the first time of playing.*

Fortunately, residual magnetism can be instantly removed with the Ferrograph De-fluxer. Get one to-day and, if you use it from time to time, you'll always enjoy tape recordings with a background as silent as the night.

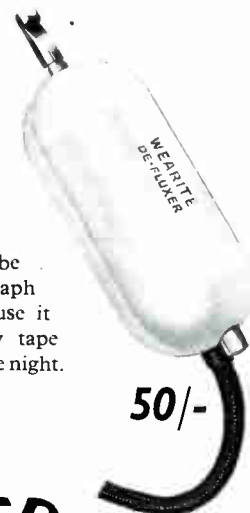

Get a Ferrograph  
**DE-FLUXER**

*Sold by all Hi-Fi Dealers and made by*

**THE FERROGRAPH COMPANY LTD.**

84, Blackfriars Road, London, S.E.1.

Telephone: WATerloo 1981

**DO YOU SPLICE TAPE?**

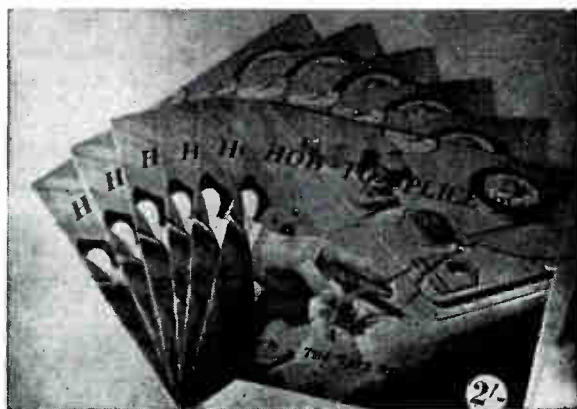

**HOW TO SPLICE TAPE**

★ If you use tape, sooner or later you will need to know how to splice tape—how to repair simple or complicated breaks—how to edit your material—how to cut out words or syllables, etc. All this is described in this well-illustrated booklet, in which stage-by-stage photos and text provide the complete answer to professional tape splicing.

Price 2/6 . . . Postage paid

**THE TAPE RECORDER**

99 Mortimer Street, London, W.1

accounts for most of the combined reading, and this occurs at the drive motor speed of 3,000 r.p.m. As mentioned in other reviews, the ear is very tolerant to high frequency flutter, and the amount measured on this recorder is not audible on most programme-content. This is all the more remarkable when one realizes that there is literally no flywheel in this unit; the high speed rotor of the motor does the main smoothing; the disc attached to the capstan is used as a speed reduction device and has little mass. If it had, it would be more of a liability than anything else as the machine would be much more sensitive to movement.

**Playback only Response**

A CCIR 200 microsecond  $3\frac{1}{2}$  i/s test tape was loaded on the machine and the response measured at the line output at various settings of the tone control (a word of explanation of the arrow markings on fig. 2 is

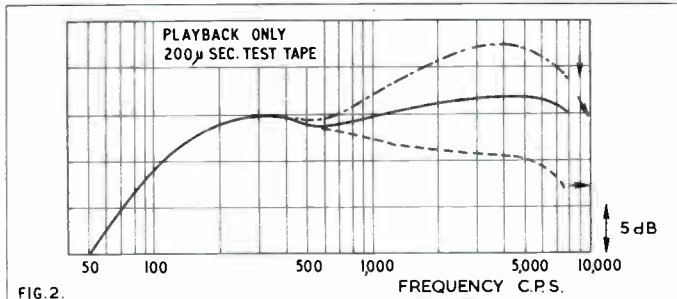

FIG. 2.

called for here. The tone control ring knob, which is coaxial with the volume control knob, has no calibration markings, but, on my machine, the grub screw was at 6 o'clock when the ring was turned fully clockwise). It will be seen that this is rather more than a simple top-cut control, it does in fact vary the time-constant in a feed-back circuit so that it can be used for fairly accurate matching of various recording time-constants. The range of control shown on fig. 2 is covered by a quarter turn of the knob; turning the knob further in an anti clockwise direction tilts the response even further in the direction of the lower curve.

**Record Play Responses**

Fig. 3 shows the overall record replay response from radio input to line output. The tone control arrows have the same meaning as in

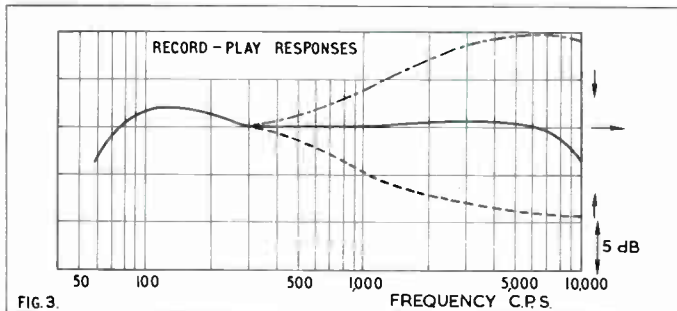

FIG. 3.

fig. 2. As the most level response, indicated by the solid line, is obtained with the playback tone control at 3 o'clock, corresponding to the lower curve of fig. 2, it can be deduced that the recording characteristic is close to the 100 microsecond characteristic favoured by many Continental designers.

Indicated peak-recording level, with the magic line beam just extinguished was 10 dB above test-tape level, but the level could be increased a further 3 dB without noticeable waveform distortion.

**Signal-Noise Ratio**

System noise, with no tape running, was 45 dB below test-tape level or 57 dB below peak recording level. Bulk erased tape noise was 40 dB below test-tape level or 52 below peak, and tape erased on the machine with the gain control at zero was 38 dB below test-tape or 50 dB below peak. With system noise so low, tape noise becomes the limiting factor and readers can see why I can recommend this little machine for dubbing or copying tapes.

*Continued on page 435*

**— YOUR TAPE DEALER —**

Specialists in Hi-Fi Equipment and Tape Recorders

**CHELSEA RECORD CENTRE**

203 KINGS ROAD, S.W.3 FLA 2596

Open till 8 p.m. (except Thursdays)

Disc and Tape Reproducing Equipment and Tape Recorders by Leading Manufacturers  
Custom Built Installations

All High Fidelity Requirements and Services Available

Estimates Free

Personal Service

**Custom High Fidelity**

371 Green Lanes Palmers Green N.13 PALmers Green 5228

**hifi**

FOR ALL LEADING AUDIO EQUIPMENT

call, write or telephone

**hampstead HIGH-FIDELITY**

91a Heath Street, Hampstead, London N.W.3 Telephone HAMpstead 6377

ENGLAND'S BIGGEST T/R SPECIALISTS

**HOWARD**

218 HIGH ST. - BROMLEY - RAV. 4000

**LASKY'S RADIO**

ALL LEADING MAKES IN STOCK

Cash or Easy Terms

LONDON'S FINEST SERVICE

207 EDGWARE ROAD, W.2

PAD 3271/2

152-153 FLEET STREET, E.C.4. FLE 2833

33 TOTTENHAM COURT ROAD, W.1. MUS 2605

★ PART EXCHANGES WELCOMED ★

- ★ ALL MAKES Hi-Fi and Tape Recorders supplied
- ★ PART EXCHANGES. Terms 12, 18 or 24 months
- ★ SONY Specialists. Full Range Stocked
- ★ GUARANTEED Recorder Repair Service

**MAC'S CAMERA SHOPS LIMITED**

250-252 KING STREET, HAMMERSMITH, LONDON, W.6  
RIV' 8581-2 Hours 9-6 Thursday 9-1

**SHEEN TAPE RECORDER CENTRE**

SPECIALISTS IN TAPE RECORDERS, ACCESSORIES, HI-FI EQUIPMENT  
YOUR CENTRE FOR FRIENDLY HELP—SALES AND SERVICE

8 STATION PARADE,  
SHEEN LANE, SHEEN,  
LONDON, S.W.14

Showrooms Open until 7 p.m.

PROSPECT 0985

(Opposite Martlake Station S.R.)

**CROYDON'S TAPE RECORDER CENTRE**

All leading makes in stock, Hi-Fi equipment, cabinets, etc.  
Service agents for AKAI Tape Recorders

**SPALDING ELECTRICAL LTD.,**

352, 354, Lower Addiscombe Road,  
CROYDON.

ADDiscombe  
1231/2040

# hi-fi books

## CINE YEAR BOOK . . .

The only comprehensive survey in one complete volume of the cine market for the cine user. The reference book for the professional, the enthusiast, and the photo dealer. This valuable book follows the unique pattern set and maintained by the "Hi-Fi Year Book"—separate and detailed directories for every product group. **Price 11s 6d post paid.**

## HI-FI FOR BEGINNERS . . .

The ideal book for everyone who has just started, or is about to start the hobby. The various chapters deal with Loudspeakers, Amplifiers, Pickups, Turntables, Radio Tuners, Stereo and Installing Hi-Fi. Readers whose particular interests lie with tape will find that Chapter 7 alone will make the book worth while. **Price 8s 3d post paid.**

## EXPERIMENTAL RECORDING . . .

This book presents in convenient form the series of articles by A. Tutchings on "Twenty Practical Experiments in Magnetic Recording" and full introductions for "Building a Fully Portable Recorder", using a clockwork motor and transistor amplifier. **Price 5s 9d post paid.**

## SOUND & CINE FOR BEGINNERS . . .

An up-to-date guide for the beginner by Richard Golding with an introduction to some advanced methods including the latest means of producing experimental soundtracks. Contents include making up separate tape tracks; sound stripe; optical sound-on-film; special recording apparatus; recording sessions; with photographs and line illustrations. **Price 8s 3d post paid.**

## CABINET MAKING . . .

This book gives you all the necessary information for building your own Hi-Fi cabinet. Subjects covered include designing, timber, marking out, tools, materials, joints and finishes. The many photographs and diagrams help to make this book indispensable not only for Hi-Fi applications but also for general cabinet work. **Price 8s 3d post paid.**

### AVAILABLE SHORTLY

## STEREO FOR BEGINNERS . . .

For those who are confused or not wholly converted by Stereo reproduction this book gives all the answers. The author, B. J. Webb, explains in clear language what Stereo is, and how best to obtain it, whether from disc, tape or radio. Advice and guidance on the purchase, installation and maintenance of suitable equipment; a six page glossary, many illustrations and special drawings are included. **Price 8s 3d post paid.**

**MILES HENSLOW PUBLICATIONS LTD.**  
99 MORTIMER ST., LONDON, W.1

# GOODMAN SPEAKERS

12 inch HI-FI BASS

New and Guaranteed

Impedance . . . . . 15 ohms  
Power Rating . . . . . 10 watts  
Frequency Range . . . . . 45-5000 c.p.s.  
Fundamental Resonance . . . . . 55 c/s  
Flux Density . . . . . 11,000 gauss



**UNREPEATABLE LIMITED QUANTITY 1/2 OFFER PRICE 4 GNS. ONLY**



## SUPER SOUND

**AMERICAN HI-FI RECORDING TAPES**  
(made by C.B.S.)  
NEW, BOXED AND GUARANTEED

5 Ins.	600 ft.	13/-
5 Ins.	900 ft.	17/6
5 Ins.	1,200 ft.	30/-
5 1/2 Ins.	900 ft.	16/-
5 1/2 Ins.	1,200 ft.	19/6
5 1/2 Ins.	1,800 ft.	35/-
7 Ins.	1,200 ft.	21/-
7 Ins.	1,800 ft.	28/-
7 Ins.	2,400 ft.	45/-



## GRUNDIG GCM3

CONDENSER MICROPHONE

New & Guaranteed

**UNREPEATABLE LIMITED QUANTITY 1/2 OFFER PRICE 3 GNS. ONLY**

SUITABLE FOR ALL MAKES OF TAPE RECORDERS and AMPLIFIERS

CASH WITH ALL ORDERS - BY RETURN - ALL POST FREE  
ALL CALLERS WELCOMED - TRADE SUPPLIED

**K. & K. ELECTRONICS LTD.**

Dept. TR. 39 ROMAN ROAD, LONDON, E.7 Tel: ADVance 1936

Set it . . . then forget it!

# 24 HOUR TIME SWITCH

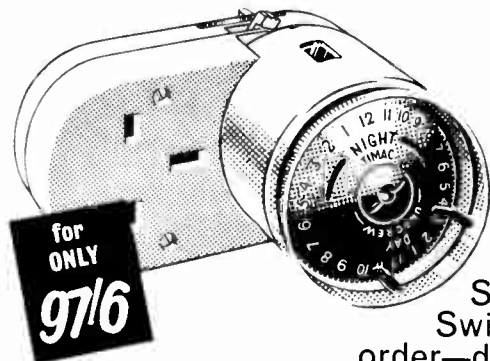

Switches on,  
Switches off to  
order—day or night!

Whether it's recording in your absence, waking you with music, or simply turning off a light, you'll find—as an audiophile—dozens of jobs for the Timac 24-hour time switch.

The compact little Timac fits into a wall socket just like an ordinary power plug. You set the precision-built electric clock and your appliance — maybe a fire, the lights, the radio or TV, a recorder, the cooker—goes 'on' and 'off' at your pre-selected times . . . and repeats this every 24 hours without further adjustment! A locking device prevents accidental time-changes after setting and a bypass switch cuts out the timer at will. The Timac is handsomely finished in sturdy cream plastic and is available at 97/6 post free.

**POST THIS COUPON NOW!**

To Chalfont Marketing Ltd.,  
Dept. TR1, 115, Bayham Street,  
London, N.W.1.  
Please send me \_\_\_\_\_ Timac  
24-hour time switches at £4.17.6. each  
I enclose cheque/P.O./M.O.

for \_\_\_\_\_  
Tick plug fitting 15 amp   
13 amp

NAME  
(BLOCK CAPITALS)

ADDRESS

## EQUIPMENT REVIEWED—Continued

### Acoustic Responses

The combined responses of the electronics and loud speaker were measured by recording bands of filtered white-noise and measuring the sound output on replay with a calibrated microphone. Fig. 4 shows the response with the tone control fully advanced for maximum top response.

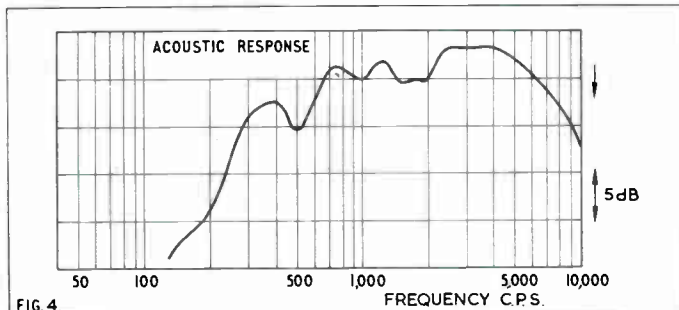

FIG. 4.

The microphone response was also measured in a white-noise sound field and its response is shown in fig. 5.

Mechanical motor noise was very low indeed and the microphone could be held in the same hand as the recorder with practically no indication of their close proximity on the recorded tape.

### Circuit Notes

An unusual feature in transistor circuits is that the input stage is connected as an emitter-follower during recording so that the input impedance is quite high. The microphone supplied is a dual impedance model, but the 50K output is the one used with this machine. A crystal microphone can be used, although the input impedance is not really high

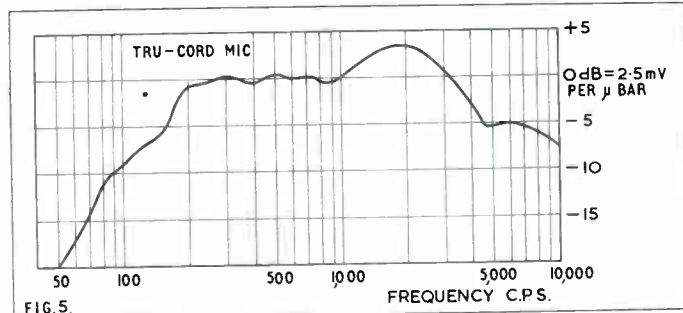

FIG. 5.

enough to record a level response from such a high impedance device. Nevertheless the wide-range playback tone control can be set to give excellent speech quality from such a microphone.

Motor speed control is effected by the OC79T transistor, and efficient filtering accounts for the very low electrical motor noise in this machine.

### Comment

A versatile and extremely well designed little recorder, ideal as a "number two" for the enthusiast who wants to extend the scope of his recording activities as suggested in my opening paragraphs. On the other hand, it gives an extremely good account of itself when powered from the AC adapter type NCI as a semi-static main recorder.

I was very intrigued to find that the adapter plug could be removed or inserted into the recorder socket, to change over from battery to mains or vice versa, with no break in a recording, or playback of a recorded tape.

I did find it essential to press the playback key *before* the R.H. knob is turned to put the tape into motion. If it is pressed after the tape is started, a low frequency "bonk" is added to the recording which will only be noticed when the tape is replayed on a later occasion. **A. Tutchings.**

**CITY & ESSEX** BRITAIN'S FINEST  
TAPE Recorder Repair Specialists  
**RECORDER CENTRES** See Page 420

## — YOUR TAPE DEALER — — Country and Provincial —

**BOURNEMOUTH**  
**NATIONAL RADIO SUPPLIES**  
66 Holdenhurst Road,  
Bournemouth  
Tape, Hi-Fi & components Tel. 25232

**H. D. KIRK**  
**Stereolectrics**  
LIMITED  
Specialists in High Fidelity — Phone: 23093  
150 HIGHER BRIDGE STREET **BOLTON**

**COVENTRY & DISTRICT CO-OPERATIVE SOCIETY LTD.**  
HIGH FIDELITY SOUND EQUIPMENT TASTEFULLY DISPLAYED FOR YOUR "BROWSE AROUND" ENJOYMENT  
All leading makes Amplifiers, Control Equipment, Loudspeakers, Cabinets, Tuners, Microphones, Tape Recorders and Ancillary Items in stock or quickly obtainable.  
Coventry & District Co-operative Society Ltd., High Fidelity Sound Section, Electrical Dept., First Floor, Central Premises, Corporation Street, Coventry Tel. Coventry 24031-10 lines

**R.E.S. (COVENTRY) LTD.**  
**SPECIALISTS IN HIGH FIDELITY**  
and all makes of Tape Recorders  
All leading makes of High Fidelity Equipment stocked and demonstrated under ideal conditions. ★ *The Best Selection—Terms and After Sales Service in the MIDLANDS.*  
R.E.S. (Coventry) Ltd. 128 Far Gosford St. Coventry 28781/2

**FARNHAM, SURREY.**  
★ Stockists of all the leading makes of High-Fidelity Equipment  
★ Comparative Demonstrations  
★ Cabinet Manufacturers and Designers  
★ Personal service and satisfaction guaranteed  
★ Specialists in custom-built Hi-Fi Equipment  
**LLOYD & KEYWORTH LTD, The Record Shop**  
26/7 Downing Street, Farnham, Surrey. Telephone: Farnham 5534  
SURREY AND HAMPSHIRE'S HI-FI DEALERS

**TAPE RECORDER CENTRE (HALIFAX)**  
Stock all the best Tape Recorders; Hi-Fi Equipment; Tape; L-P Records, etc.  
DEMONSTRATIONS DAILY BY EXPERT STAFF  
2 years FREE SERVICE ON NEW RECORDERS over £35  
30 King Cross Street, Halifax. 'phone 66832

**LEICESTER**  
**ALL YOUR HI FI REQUIREMENTS**  
Speakers by: H.M.V. QUAD LEAK ROGERS  
TANNOY MORDAUNT LOWTHER W.B.  
WHARFEDALE GOODMANS.  
Tape: FERROGRAPH REFLECTOGRAPH GRUNDIG  
SIMON BRENELL  
Record Department: ALL LABELS-PARASTAT SERVICE  
LEICESTER CO-OPERATIVE SOCIETY LIMITED, High Street, Leicester. Tel: 20431

**STOCKPORT**  
**FAIRBOTHAM & CO. LTD.**  
47 LOWER HILLGATE STO 4872  
FERROGRAPH, REVOX, TANDBERG, BRENELL,  
SIMON, TRUVOX, SONY, PHILIPS, MAGNAVOX  
All models on comparison demonstration  
Evening demonstrations by appointment

— YOUR TAPE DEALER —

**MANCHESTER**  
**LANCASHIRE HI-FI Limited**  
and now incorporating  
*The Tape Recorder Specialists*  
**DIXONS ELECTRONIC** (Sales and Service)  
8 DEANS GATE - - - next to Grosvenor Hotel

**TAPE RECORDERS and HI-FI**

The Largest Electrical Store in the North



**Fenham Radio**  
158, NEW BRIDGE STREET,  
NEWCASTLE UPON TYNE 1  
Telephone 29866

**WESTWOOD'S** of **OXFORD**  
46 GEORGE STREET  
PHONE 47783

PETERBOROUGH, NORTHANTS Tel: 5643/5644

**CAMPKINS RECORD SHOP**  
RECORD TAPE AND HI-FI EQUIPMENT SPECIALISTS

NEW ADDRESS **15 LONG CAUSEWAY** LARGE STOCKS  
(IN CITY CENTRE)

**HAMILTON ELECTRONICS**  
HIGH FIDELITY TAPE RECORDERS **35 LONDON ROAD**  
**SOUTHAMPTON**  
TEL. 28622

18 QUEEN STREET **SALISBURY**  
**J. F. SUTTON**  
RECORDS — RECORDERS — HI-FI  
421 SHIRLEY ROAD **SOUTHAMPTON**  
111 EAST STREET

**Audio Electronics (Midlands) Ltd.**  
Specialists in Dictation Mcs., Tape Recorders, Inter-Com., Tapes and Accessories  
Full After Sales Service on all Equipment  
PHILIPS, GRUNDIG, TRUVOX, UHER, ETC

**203 STAFFORD STREET WALSALL** Tel.: 21086

WORTHING, SUSSEX  
We stock Hi-Fi Equipment by Leak, Quad, Goodsell, RCA, Acos, Garrard, Collaro, Iainoy, Wharfedale and Goodman and give fully comparative Demonstrations

**BOWER & WILKINS LTD.**  
1 Becket Bldgs., Littlehampton Road Worthington 5142

**CLASSIFIED ADVERTISEMENTS**

Advertisements for this section must be pre-paid and accompanied by a postal order, money order, or cheque. The rate is 6d. per word with a minimum charge of 7s. 6d. Box numbers may be used for an extra charge of 1s. 6d. The trade rate is 9d. per word, plus 2s. for a box number, conditions on application. Send replies to box numbers, c/o "The Tape Recorder", 99 Mortimer Street, London, W.1.

Advertisements for the December issue must arrive not later than November 4th.

**SITUATIONS VACANT**

**Test Engineers required by Truvox** to check and adjust to professional standards complex and comprehensive Stereo Tape Units for Home and Overseas markets. Excellent working conditions and pay for first-rate men. Tape experience preferred, good audio knowledge essential. Staff positions after short proving period. Phone or write for interview: Mrs. Smith, Truvox Limited, Neasden Lane, London, N.W.10. Phone: Dollis Hill 8011.

**Middlesex County Council—Education Dept.** Laboratory Assistant Req'd. at Ealing Technical College, St. Mary's Road, Ealing, W.5, for Language Laboratory. Should be qualified by training and/or experience in electrical maintenance and interested in tape recordings, projection equipment and organisation of tape library. Salary Misc. III £590-£665 (rising to £730 by 1965) plus London Weighting up to £40, commencing according to qualifications and/or experience. Prescribed conditions. Write with names of two referees to Principal immediately. (Quote O.160TR).

**Mobile Mechanic required** to repair 8 mm. Cine Sound Projectors. Write or phone Mayfair Photographic Suppliers, 166 West End Lane, London, N.W.6. Phone: SW1. 5671.

**FOR SALE**

**Connoisseur Varigroove, Disc Recording Unit Three Speed.** As New Less than one days use. £150. Also EMI L2 Recorder £55. Box No. (Essex) 353.

**Revox F.36 Stereo tape recorder.** Boxed as new hardly used. Perfect Guaranteed. £88. Watson, Eagle House, Sandhurst, Camberley, Surrey.

**Vortexion WVA Tape Recorder, Ribbon Microphone** very little used. London Area, £50 o.n.o. Box No. (London) 354.

**TRADE**

**Ferrograph 5A/N, 422 and 424, Revox F36, etc.,** always in stock. City and Essex Tape Recorder Centres (see page 420).

**Cinesmith Depolariser** demagnetizes your record/playback heads in situ. Use occasionally for better recordings without hiss and with background silent as the grave no matter how often played. From your dealer or Cinesmith Products, Regent Street, Barnsley, £2 5s. Write for leaflet.

**Pre-recorded tapes.** Unique complete catalogue listing all makes, mono, stereo. 7½ and 3½ i/s including World Record Club tapes. Call for free copy or send 1s. mailing fee. Dept. T.R.3 Teletape Ltd., 33 Edgware Road, W.2. Phone: PAD 1942.

**A Unique Buy!** Recording tape top brand, 5½ in. 1200 ft. 19s. 6d.; 7 in. 2400 ft. D.P. 28s. 6d. P. and P. 1s. 6d. per spool. Bargains in all sizes. S.A.E. for list. E. C. Kingsley & Co., 132 Tottenham Court Road, London, W.1. Phone: EUSton 6500.

**Tapes post free.** High quality with leader and trailer at low price. Long play (P.V.C.), 4 in. 450 ft. 8s. 6d.; 5 in. 900 ft. 12s. 6d.; 5½ in. 1200 ft. 16s.; 7 in. 1800 ft. 22s. 6d. Double play (Polyester), 3 in. 400 ft. 20s.; 5½ in. 1800 ft. 28s.; 7 in. 2400 ft. 20s.; 5½ in. 1800 ft. 28s.; 7 in. 2400 ft. 36s. Discount on four or more, refund guarantee. M. S. Recording tapes (Dept. F.R.), 7 Moorside Road, Tottington, Bury, Lancashire.

**Recording tape, top quality, brand new, boxed.** 5½ in. 1200 ft. 19s. 6d.; 5½ in. 1800 ft. 30s.; 7 in. 1200 ft. 19s. 6d.; 7 in. 1800 ft. 22s. 6d.; 7 in. 2400 ft. 39s. 6d. P & P 1s. Fenham Radio, 158 New Bridge Street, Newcastle-upon-Tyne, 1.

**Truvox Stereo Tape Unit, 4-track Model PD.86.** One only, reduced to £46, shop soiled, but new and unused. Lancs. Hi-Fi 8 Deansgate, Manchester.

Continued on page 438



# LUXOR

A BRILLIANT NEW HI-FI

## STEREO TAPE RECORDER

FROM SWEDEN

The first completely self contained 4-track, 3-speed mono-stereo Recorder on the British Market at a price below anything comparable with it in performance. Built-in stereo speakers and amplifiers as well as all connectors and leads for record and play-back through external equipment.

Also MP 424 in two-tone portable case with carrying strap ... .. 77 Gns.

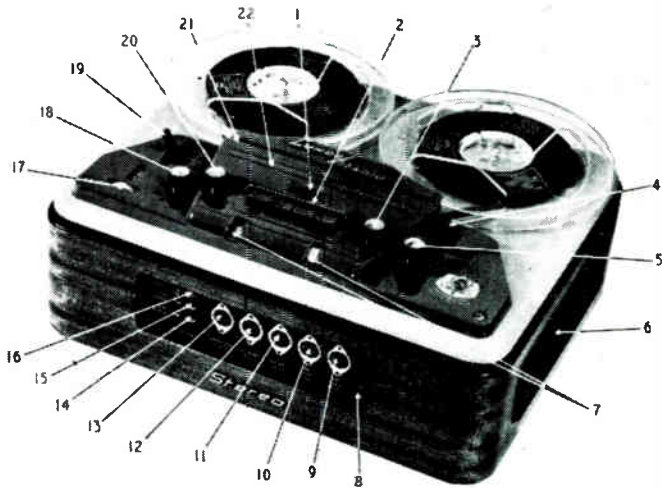

- |   |   |
|---|---|
| 1 Track selector                                | 12 Radio input, and external amplifier output |
| 2 Pushbutton panel                              | 13 Earphones                                  |
| 3 Master volume control                         | 14 Socket for external loudspeaker (mono)     |
| 4 Standby-play-fast forward-fast reverse        | 15 Socket for external stereo loudspeaker     |
| 5 Individual volume controls for stereo balance | 16 Socket for external stereo loudspeaker     |
| 6 Speaker enclosures (only right visible)       | 17 Tape-consumption indicator (cuemeter)      |
| 7 Recording level indicators (magic eyes)       | 18 Loudspeaker switch                         |
| 8 Ground  | 19 Power on/off and speed selector switch     |
| 9 Microphone (stereo) input                     | 20 Tone switch                                |
| 10 Microphone (mono) input                      | 21 Tape guide                                 |
| 11 Phonograph input                             | 22 Splicing groove                            |

PRICE ONLY 74 gns. MODEL M.P. 423 (in teak)

Particulars and address of nearest stockist from sale Concessionaires in U.K.:-

16-22 GREAT RUSSELL ST., LONDON, W.1. Phone: MUSEum 7600

## BRITIMPEX LTD

U.K. DISTRIBUTORS OF TELEFUNKEN VALVES AND COMPONENTS

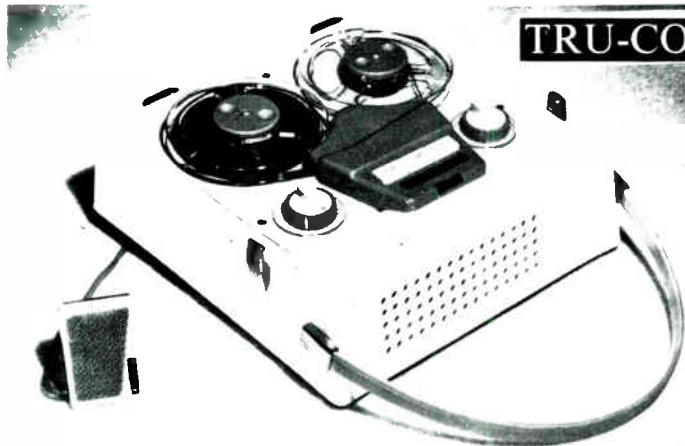

### TRU-CORD PORTABLE ALL-TRANSISTOR TAPE RECORDERS

Type 203 in a modern vacuum formed plastic carrying case. Price 34 gns. complete.

Type R119K in a fashionable leatherette-covered wooden case. Price 33 gns. complete.

Two high performance tape recorders for everybody independent of the mains, operated by batteries or accumulator.

A tape recorder for car, weekend and camping with additional AC power adapter operated by mains.

A tape recorder for the home and for parties, light, small and handy, easy to operate.

Ready for use everywhere at any time and in any position.

High performance of speech and music.

203 can be used as dictating machine.

Both machines are supplied complete with 600 ft. tape, empty spool, radio lead, battery, instruction book, circuit diagram and dual mike of 50 K or 200 ohms for use with line transformer,

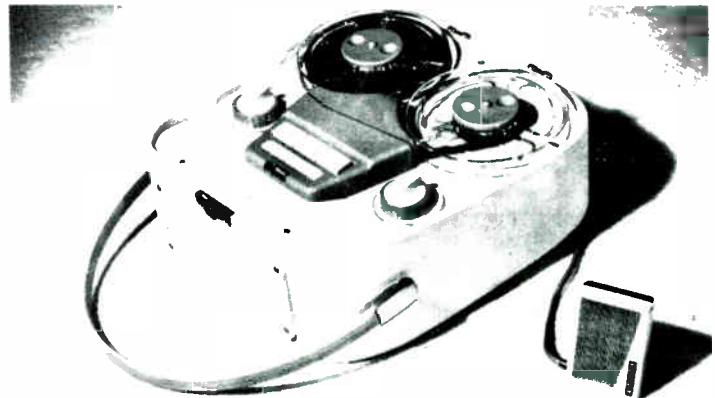

#### TECHNICAL DATA:

Tape speed  $3\frac{1}{2}$  i.p.s. · International double track · Frequency range 60—7,500 c/s  $\pm$  3 dB · Wow and flutter < 0.5% · Signal to noise > 50 dB · Rotary switch for START, STOP, FAST REWIND, OFF · 3 Push buttons for RECORDING, PLAY-BACK, QUICK STOP · Tone control, Volume control · Pre-set recording level and monitoring · Recording control by magic line · Connections for dynamic microphone, radio, phone, earphone, external loudspeaker · Recording time 2 x 1 hour · Spool diameter max.  $4\frac{1}{4}$  ins. · Power supply: Type 203 = 4 dry mono-cell batteries (4 x 1.5V) or 6V accumulator which can be recharged by means of the AC adapter or car battery (6V or 12V), or AC power adapter · Type R119K = 4 dry mono-cell batteries (4 x 1.5V) or car battery (6V and 12V), or AC power adapter · Weight: both types approx. 5 lbs. without batteries · Measurements: Type 203 =  $10'' \times 4'' \times 10\frac{1}{2}''$

Enquiries to: C: BRADDOCK LTD., 266 WATERLOO ROAD, BLACKPOOL, LANCs. Trade Enquiries Welcome

CLASSIFIED ADVERTISEMENTS

If quality matters consult Audio Supply Association for better terms. 60 page photographically illustrated Hi-Fi catalogue 4s. 6d. Part exchange, servicing. Your precious tapes transferred to unbreakable LP-s by specialists. Specify requirements; 10 Clifford Street, London, W.1.

**Summer Sale bargains!** up to 50 % price reductions! Every machine brand new, fully guaranteed. Send S.A.E. for complete list. Special sale discount on every order placed during sale period quotations on request. Mail-order specialists. Tape services Library House, Lossiemouth, Moray-shire.

Tape 7 in. 2400 ft. Mylar, 27s. 6d. David Cavalier, 17 Leigh-on-Sea.

Sound effects 45 r.p.m. EP Castle and Contrast trade disc records. 7s. 6d. + 6d. stamp each. Mixed effects, Animals, Trains, Electronic Sounds and Music, etc., 3d. stamp for list to: Sound Recording Ltd., 174 Maybank Road, South Woodford, London, E.18.

WANTED

Good Cash prices for tape recorders. Phone: Maryland 5879 (see page 420)

Highest cash prices offered for good quality Tape Recorders and Hi-Fi. See our ad. page 406 this issue. R.E.W., 266 Upper Tooting Road, London, S.W.17.

Bradmatic Tape Deck—Model 5DF: or deck of similar specifications. Phone: Bristol 682778. Box No. (Bristol) 352.

Lee Electronics, The Tape Recorder and Hi-Fi Specialists wish to purchase good quality Tape and Hi-Fi Equipment for cash. 400 Edgware Road, W.2. Phone: PADDington 5521.

Autoba transistor tape recorder wanted, preferably model M.T.5. Please send age, condition, model, and price to Box No. (Ireland) 356.

Tired of the same old Jazz/Classics? Free advertising of your unwanted discs. Join Atlas X change-A-Disc Club. S.A.E. Details of Membership. A.X.D.C. P.O. Box 51, William Road, London, N.W.1.

TAPE EXCHANGES

Open up your own Tape Station and speak to the world! Send S.A.E. for particulars: Worldwide TapeTalk, 35 The Gardens, Harrow.

STUDIO FACILITIES

New intimate recording studio, 15 minutes west end. All facilities. Same Day disc service. Refreshment Bar. Easy free parking. Dubreq Studios. 15 Cricklewood Broadway, London, N.W.2. Phone: Gladstone 0047.

Tape to Disc service, editing, and dubbing, all speeds. Studio available for musical groups. Outside recordings our speciality. Ilford Sound Recording Service, 63 Aintree Crescent, Barkingside, Ilford, Essex. Phone: CRE 8947 and GRA 5107. S.A.E. for list.

Rapid Recording Service, 78s and L.Ps. from your own tapes. (48-hour service) Master Discs and pressings. Recording studio. Mobile recording van. Manufacturers of the Sleep-o-matic Unit. Foreign language courses available for sleep-learning. Brochures and price lists on request from: Dept. T.R.21 Bishops Close, London, E.17.

Tape to Disc Recordings. Finest professional quality, 10 in. L.P. 35s. (32 min.); 12 in. L.P. 40s. (45 min.); 7 in. E.P. 17s. 6d. 48-hour Postal Service. S.a.e. for leaflet to: Deroys Sound Service, 52 Hest Bank Lane, Hest Bank, Lancaster.

TAPE EXCHANGES

Autumn . . . a cosy fire . . . and Armchair Travel with Worldwide Tape-talk! S.A.E. for particulars: WWTT(1), 35 The Gardens, Harrow, Middlesex.

— TAPE TO DISC SERVICES —

The following are members of the Association of Professional Recording Studios who can be relied on to give satisfaction

**MJB RECORDING & TRANSCRIPTION SERVICE**  
*specialise in the production of microgroove records from Professional and Amateur recordings (Acetate copies; Mono and Stereo pressings). Extended playing times achieved by controlled cutting techniques. Studio, Mobile. "Off the Air" and all recording services. Detailed booklet available.*  
**7 HIGH STREET, MAIDENHEAD (Tel: 25630)**

**TAPE RECORDERS - AUDIO EQUIPMENT - DISC CUTTING STD & LP FROM TAPE - STUDIO FACILITIES - HIRE SERVICE - SALES - EXCHANGES**  
**MAGNEGRAPH**  
**1 Hanway Place, London, W.1. Tel: LAN 2156**

**NUSOUND RECORDING Co.**  
 35 CRAVEN STREET, W.C.2. TELEPHONE TRA 2080



**New Series 5**  
**now on demonstration**  
**also Models 422-424**

Accessories, Mixers, Tuners Microphones, Stands, by leading manufacturers.

ADVERTISERS' INDEX

	Page
Agfa Ltd. ....	400
Armstrong Audio Ltd. ....	426
B.A.S.F. Chemicals Ltd. ....	440
Braddock, C. ....	437
Brenell Engineering Co. Ltd. ....	406
Bricimpex Ltd. ....	437
Brown, A. & Sons Ltd. ....	428
Chalfont Ltd. ....	434
Chelsea Record Centre ....	432
City and Essex Tape Recorder Centres ....	420
Denham and Morley Ltd. ....	398
E.M.I. Records Ltd. ....	402
E.M.I. Tape Ltd. ....	416
Educational Recordings Ltd. ....	429
Elstone Electronics Ltd. ....	432
Farnell, A. C. Ltd.—Irish Tape ...	422
Fi-cord International ....	408
Francis of Streatham ....	430
Francis, J. J. (Wood Green) Ltd. ....	430
Grampian Reproducers Ltd. ....	428
Grundig (Great Britain) Ltd. ....	395
Heathkit ....	394
Highgate Acoustics Ltd. ....	439
Howard Tape Recorders ....	424
Jeffreys, G. Ltd. ....	434
K & K Electronics Ltd. ....	412
Kodak Ltd. ....	428
Lee Electronics ....	438
Nusound Recording Co. ....	390, 410
Philips Electrical Ltd. ....	430
Recorder Co. ....	439
Reps Tape Recorders Ltd. ....	406
R. E. W. Earlsfield Ltd. ....	404
Scotch Magnetic Tape ....	418
Tape Recorder Centre ....	422, 432
Teleradio (1943) Ltd. ....	391, 392, 393
Tellux Ltd. ....	431
The Ferrograph Co. Ltd. ....	426
Truvox Ltd. ....	431
Walker, N. ....	426
Wellington ....	431
Wharfedale Wireless Works Ltd. ....	396, 397
World Record Club ....	396, 397

# Two Years Guarantee

NOT MASS PRODUCED BUT VIRTUALLY HAND-MADE FOR RELIABILITY  
AND CONSISTENTLY HIGH STANDARD OF PERFORMANCE

**R10 SPECIFICATION: 2 or 4 track version. 10 watts push/pull output.**

Record Replay Responses—

7½ ips. 40-16,000 C.P.S. } ± 3 dBs.  
3¾ ips. 40-10,000 C.P.S. } At optimum  
1¾ ips. 50- 6,000 C.P.S. } bias setting.

Signal/Noise ratio—

half track 50 dBs at 3¾ ips.  
quarter track 45 dBs at 3¾ ips.

Modified Collaro Studio Deck. Microphone and Radio/Gram inputs each with separate gain controls for mixing. Separate bass and treble controls. ± 12 dBs at 50 cycles and 12 k/cs. Adjustable monitor volume control independent of record level. Peak signal lever meter 2¼ in. square. Bogen heads. Record safety device. 600 ohms Cathode follower output. Two per cent total harmonic distortion on peaks. 200/250 volts 50 cycles or 100/120 volts 60 cycles. Valve line up: 3 EF86, 2 ECC83, 1 ECC82, 2 ECL86. Metal rectifier, contact cooled.

Prices: 2 Track 7" spools ... .. 59 gns.  
4 Track 7" spools ... .. 69 gns.



Fully illustrated literature available on request to—  
**REPS (TAPE RECORDERS) LTD.**  
118 Park Road North, South Acton,  
London, W.3 Phone: Acorn 4141



LOEWE OPTA

# Hi-Fi Tape Recorders

**FOR PERFECTION IN SOUND**

**THE LATEST ADDITION  
TO THE  
OPTACORD RANGE**

## OPTACORD 414

With the first ever high frequency motor ensuring long life and constant speeds. Unsurpassed for a portable tape recorder. For use on mains, batteries and car batteries.

**47 Gns.**

Ask our Representative to call, or see the complete range at our Showrooms.



**HIGHGATE ACOUSTICS**

71/73, GT. PORTLAND STREET, LONDON, W.1

Telephone: MUSEum 2901/6

Box 47



YOU CAN TALK TO YOUR FRIENDS ANYWHERE IN THE WORLD



ON **BASF** LETTER TAPES SPECIALLY PACKED FOR MAILING



**BASF** LETTER-TAPE enables you to talk to relatives and friends anywhere in the world. **BASF** insistence on highest quality production makes the Letter-Tape extra sensitive to capture every shade of expression. Delight your friends far away—let them *hear* your news on the 150 feet long-play tape specially made for mailing. The lightweight **BASF** Letter-Tape comes complete with mailing carton and reply labels, and costs only 5/6d.



—SYMBOL OF AUTHENTIC SOUND

**BASF CHEMICALS LIMITED**, 5a GILLESPIE ROAD, LONDON, N.5. TEL: CANonbury 2011