

February 1972 25p

# studio sound

LIMITERS AND COMPRESSORS  
Their application and  
operation

---

DOLBY 361 REVIEW

---



# MEET THE FAMILY.

We've been in the microphone business for over 40 years now.

And in all that time we've built up quite a family.

Ribbon mikes, moving coil mikes, headphones, stands, accessories, the lot.

Over 50 in fact.

All these products, made to the

same high acoustic quality that has set standards all over the world.

All these products are shown and explained in detail in the Beyer Dynamic Catalogue.

Which, if you are at all interested in better equipment, is something you should send for.



To: Beyer Dynamic (GB) Ltd., 1 Clair Road,  
Haywards Heath, Sussex.  
Telephone Haywards Heath 51003

Please send me full particulars and illustrated  
brochure of the Beyer Dynamic products.

Name .....

Address .....

**BEYER DYNAMIC**

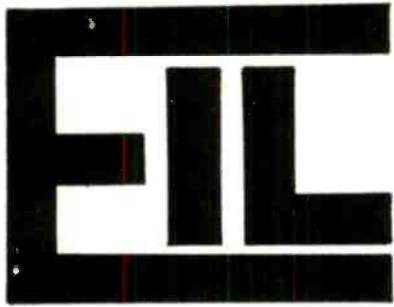

**ELECTROCRAFT  
INSTRUMENTS  
LIMITED**

MANUFACTURERS OF A COMPLETE RANGE OF TELEVISION TEST EQUIPMENT, VIDEO & PULSE DISTRIBUTION AMPLIFIERS, VISION MIXERS & EFFECTS UNITS, ANCHOR THE B.B.C. DESIGNED ALPHA-NUMERIC CHARACTER GENERATOR AND NOW A

**NEW** RANGE OF COLOUR EQUIPMENT:—

- SINGLE TUBE VIDICON CAMERA
- P A L ENCODER
- COLOUR BAR GEN. & SUB-CARRIER OSC.
- SYNC. PULSE GENERATOR

SALES OFFICE: LISS MILL, LISS, HAMPSHIRE.

TELEPHONE LISS (073082) 3444

**NEW**  
AVAILABLE IN  
MATT BLACK FINISH

**WHEN YOU NEED IT  
WHERE YOU NEED IT  
——— FAST!**

**KMAL FLOOR STANDS FINE FROM EVERY ANGLE**

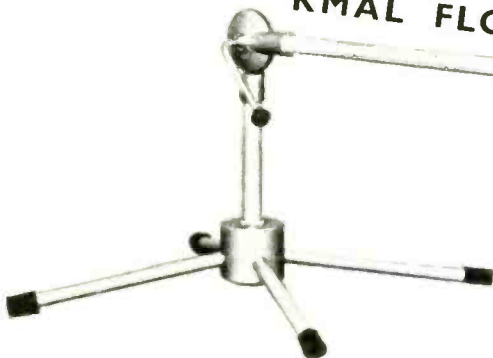

KMAL BOOMS, FLOOR STANDS, CLAMPS, ADAPTORS, MELODIUM MICROPHONES, SWAN NECKS AND A WIDE RANGE OF ACCESSORIES FOR ALL USERS

**KEITH MONKS (AUDIO) LIMITED**

26-30 READING ROAD SOUTH, FLEET, HAMPSHIRE

Tel. Fleet 7316

# J. J. Francis

## THE PROFESSIONAL FOR PROFESSIONALS



# NAGRA

**NAGRA III's  
URGENTLY REQUIRED  
FOR CASH**

We are the acknowledged off-the-shelf stockists of NAGRAS and accessories for immediate delivery

## Sennheiser, A.K.G. and Audio Radio Mikes



We carry an extensive range of SENNHEISER, A.K.G. and Audio Radio microphones and have knowledgeable sound sense and are ready to give unbiased advice on every aspect of sound recording and reproduction. If you want to talk professional — come to the professionals.

**IMMEDIATE  
DELIVERY  
ON ALL  
PRODUCTS**

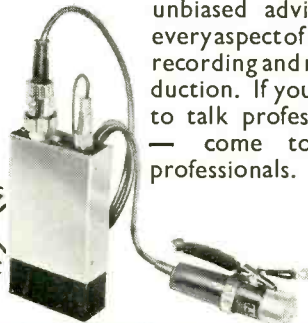

The professional equipment stockist for  
SENNHEISER, A.K.G., BEYER, AUDIO-RADIO  
MICROPHONES, PERFECTORS, etc.

**J. J. FRANCIS** (WOOD GREEN) LTD  
123 ALEXANDRA RD., HORNSEY, LONDON N.8. Tel: 01-888 1662

# Heco P.6000. the professional one.

### SPECIFICATION

Frequency Response: 20-25,000 Hz.

Power Handling: 60 watts RMS.

Impedance: 8 ohms.

Cross-over Frequency: 250/800/3,000 Hz.

Speaker Assembly: One 12" woofer.

One 5" mid-range speaker. One upper

mid-range hemispheric dome radiator.

One ultra-high hemispheric dome radiator.

Recommended Retail Price:

£110.00 in Teak. £115.00 in white.

Stand extra.

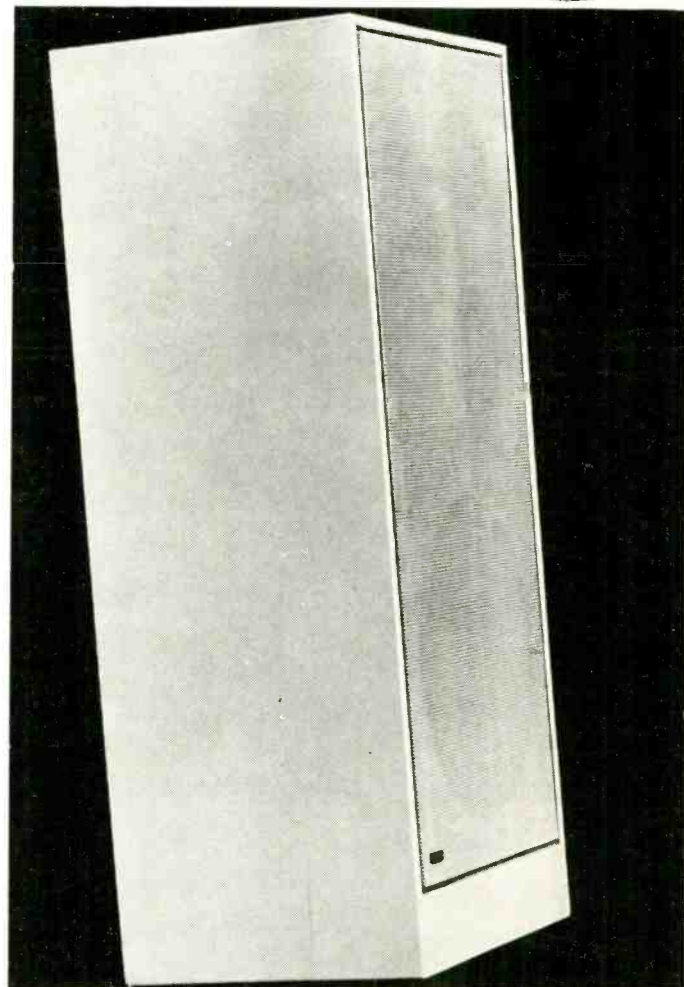

NAME .....  
ADDRESS .....

Please send me full colour literature and test reports on Heco Speakers.

Send to: Dept. SS, Acoustico Enterprises Ltd, 6-8 Union Street,  
Kingston-upon-Thames, Surrey Tel: 01-549 3471/3 (3 lines)

# BE CAREFUL

**IF YOU ARE ANTICIPATING BUYING A 16 TRACK PROFESSIONAL TAPE RECORDER ON 2" TAPE OR AN 8 TRACK TAPE RECORDER ON 1" TAPE**

**THEN CONSIDER A 16 TRACK TAPE RECORDER ON 1" TAPE AND AN 8 TRACK ON  $\frac{1}{2}$ " TAPE, ESPECIALLY WHEN THE RESULTS ARE AT LEAST AS GOOD**

**ARE YOU CONSIDERING THE INEVITABLE PROGRESSION TO 32 TRACK TAPE RECORDING?**

If so you may wish to view our own 16 Track Tape Recorder on 1" tape at our own Studios. This good looking and good sounding machine is our pre-production model and has been working faultlessly for the past 4 months, during this period our Studio has been virtually fully booked, being used almost exclusively by top British Producers — all of whom have been very impressed with the results. Our Production Model 16 Track will be unveiled at the Frankfurt Fair at the end of February and our 32 track will follow shortly afterwards.

*Write now for further details to: —*

**ORANGE (AMITY - SHROEDER RECORDING LTD.)**

**Recording Development Division,  
3-4 New Compton Street, W.C.2.**

**Telephone 01-836 7811**

# TELEFUNKEN M28A £633

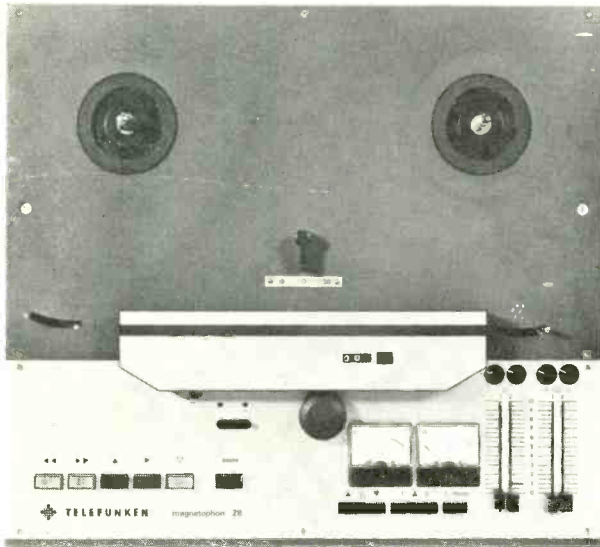

**MAGNETOPHON M28A** professional tape recorder by Telefunken, the company who made the world's first tape recorder.

- **Three-motor tape transport** at  $3\frac{3}{4}$  and  $7\frac{1}{2}$  ips ensuring maximum speed constancy.

Fully comprehensive mixing facilities.

- **Solid state electronics** are used throughout Modular construction ensures trouble-free maintenance and replacement of parts.

- **Relay operated transport control** operated by illuminated push buttons requiring only fingertip operation.

- **Two-channel monitoring and VU-meter amplifier** can be switched to two modes. In the 'before-tape' mode the amplifier is connected to the output on the mixer, while in the 'after-tape' mode it is connected to the output of the replay amplifier. Two large VU-meters calibrated to international standards are provided.

- **Interchangeable head assembly** comprising half-track, stereo, erase, record and playback heads, is mounted on a single rigid plate fixed to the main chassis. It is normally not necessary to replace or adjust heads during the normal life of the machine.

*Broadcast studio versions. Models 28B and 28C are provided with tape speeds of 15 and  $7\frac{1}{2}$  ips, but have no mixing or monitoring and VU-meter amplifier. Model 28B is equipped with full-track heads.*

*Model 28C has two-track heads and track selector switch.*

**A.E.G. Telefunken**  
A.E.G. House  
Chichester Rents,  
Chancery Lane,  
London WC2  
Tel: 01-242 9944

## WOW and FLUTTER METERS

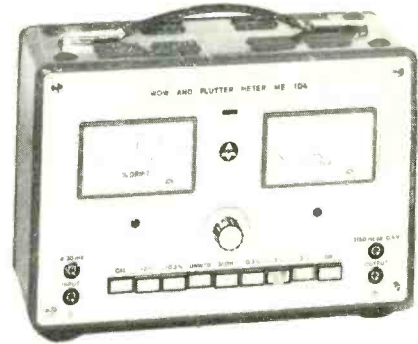

Illustrated is the ME 104, one of the three types of Wow and Flutter Meters distributed by us exclusively in the U.K. It is widely used by all the leading Broadcast, TV and Recording Studios, manufacturers of tape-deck-tape recorders, turntables, record-changers—in fact by anyone concerned with the accurate measurement of drift and wow and flutter. Fuller details on application.

**LENNARD DEVELOPMENTS LTD.**  
LOCKFIELD AVE., BRIMSDOWN, ENFIELD,  
MIDDX.  
Tel. 01-804 8425

## High speed, high quality cassette and reel to reel duplicating

### AUDIONICS

160 Ewell Rd Surbiton  
Surrey Tel: 01-390 0291

WE SPECIALISE IN BRAND NEW

**TOP QUALITY BRITISH P.V.C. MYLAR & POLYESTER  
RECORDING TAPES WITH FITTED LEADERS, Etc., EX 3"**

Thanks to bulk purchase we can offer tensilised HI-FI tapes, manufactured by a British firm of world repute. All boxed individually (sealed if required) in polythene. Our tapes are not to be confused with imported sub-standard or used tapes. Full money refund if not delighted.

This month:- "DRY SPLICE" (19p) given FREE with every order.

Std.		L.P.		D.P.		Boxed
Length	ea. 3 for	Length	ea. 3 for	Length	ea. 3 for	empty spls
3"	150' 10p 29p	3"	220' 12½p 35p	3"	400' 22½p 65p	3" 3p
4"	300' 20p 50p	4"	450' 25p 70p	4"	600' 34p 97½p	4" 8p
5"	600' 30p 87½p	5"	900' 40p £1.17½	5"	1200' 62½p £1.85	5" 9p
5½"	900' 35p £1.02½	5½"	1200' 52½p £1.52½	5½"	1800' 85p £2.50	5½" 9p
7"	1200' 45p £1.27½	7"	1800' 65p £1.92½	7"	2400' £1.05 £3.05	7" 10p

All orders despatched by return.

Postage and Packing 9p per order

**STARMAN TAPES, 421 Staines Road, Bedfont, Middlesex**

Be Safe in Sound with TRANSCO

THE QUALITY  
RECORDING  
BLANKS

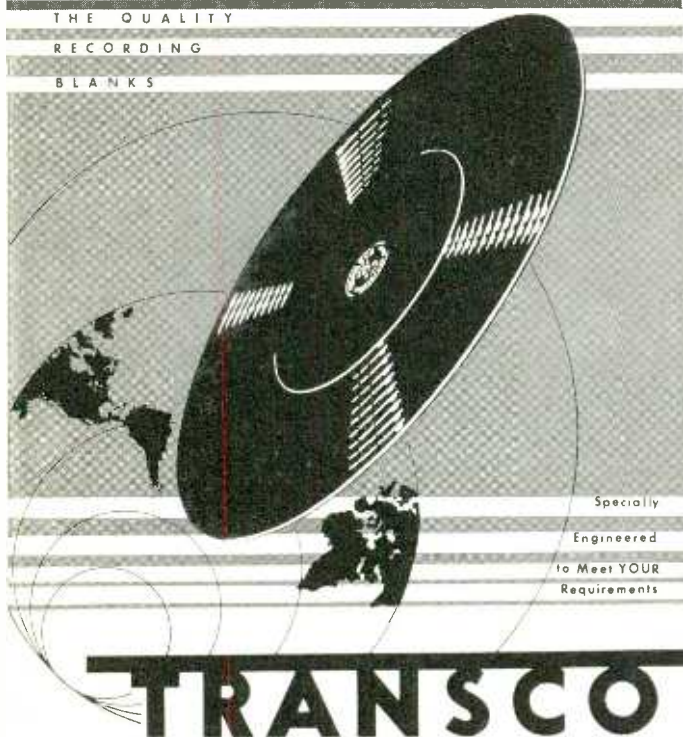

Specially  
Engineered  
to Meet YOUR  
Requirements

# TRANSCO

Everybody has problems with recording blanks, we do not kid ourselves (or our customers) that our blanks are perfect — however, they are very good.

**TRANSCO** are today the largest Manufacturers in the world *exclusively* engaged in the production of recording blanks. We do try harder and we do succeed in producing blanks of *consistent unsurpassed* quality.

Full range of Masters and Acetates stocked in London.

## Leonard Wadsworth & Co. Ltd.

(ELECTRONICS)

BROADWAY HOUSE,  
BROADWAY,  
WIMBLEDON, S.W.19

Telephone 01-542 4258

Telex 264028

# Are you MIXING with the right people?

## THEN SOUND US OUT

### INPUT MODULE A/1

£25.00 The basic system module for both stereo and multi-track mixers.

Input 200 ohms balanced or 100K ohms unbalanced for levels—65dBm to +10dBm. Sensitivity adjustable by stepped gain switch.

**Equalisation** Treble, Mid, Bass at selected frequencies, offered continuously variable lift and cut.

**Auxiliary Outputs** Prefade foldback or cue send and post fade echo controls to feed external mixing networks.

**Main Outputs** Linear fader buffered, and followed by low impedance panpot, connection directly to main mixing busses, or to routing control.

Provision is made for inclusion of channel or EQ cut, prefade listen etc. To individual specification.

We build sound mixers by incorporating modules from our range in whatever configuration may be desired, from permanent studio installations through a variety of mobile applications.

Please write or phone for complete system specification.

**ALLEN & HEATH LTD.**

Drummond House  
203-209 North Gower Street  
London NW1

Phone: 01-387 9611



## numbers

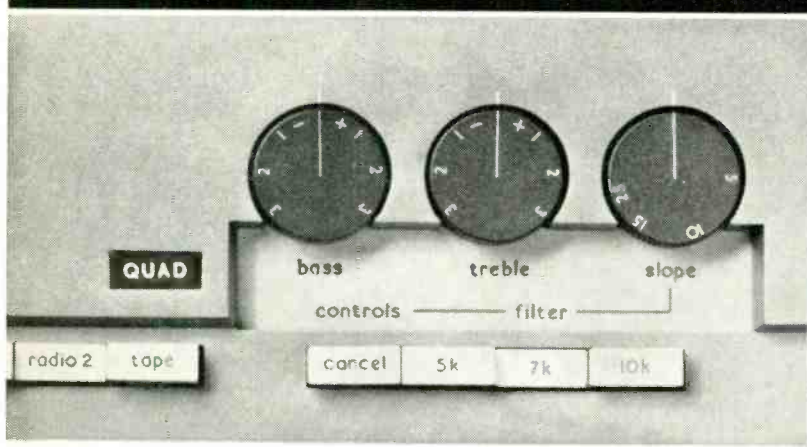

Set up a QUAD 33 with +1 on the treble control, and you will obtain a response precisely defined; readily and accurately repeatable. This response has a shape rather different from most run of the mill tone controls and there are, as you may guess, good reasons for this.

Then as the listener is not expected to know just what a given response curve does to the signal off the record, we provide a button marked 'cancel'. This enables him to make a direct comparison with the original and so learn just which recording defects need what correction. A QUAD user gets the best out of every record – every time – and enjoys the music to the full.

# QUAD

for the closest approach to the original sound

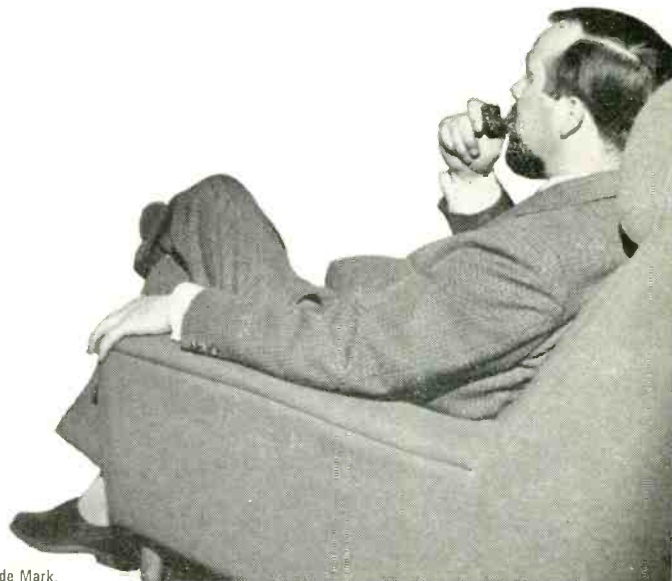

Send postcard for illustrated leaflet to Dept. S.S.T.R., Acoustical Manufacturing Co. Ltd., Huntingdon, Tel: (0480) 2561. QUAD is a Registered Trade Mark.





FEBRUARY 1972 VOLUME 14 NUMBER 2

EDITOR DAVID KIRK

CONSULTING EDITOR JOHN CRABBE

ADVERTISEMENT MANAGER TONY NEWMAN

AUDIO GROUP ADVERTISEMENT MANAGER ROBIN WELLS

Editorial and Advertising Offices: LINK HOUSE, DINGWALL AVENUE, CROYDON CR9 2TA. Telephone: 01-686 2599

© Link House Publications Ltd 1972. All rights reserved.

A SUCCESSFUL LEGAL action brought against his employer by a pneumatic drill operator raises the most unpopular subject in the audio business: deafness. The plaintiff in question received financial compensation for hearing damage incurred by prolonged exposure to the noise of his employer's tools. We are not being entirely sarcastic in suggesting that deafness was itself ample compensation for such an environment.

The public ear is subjected to an increasing barrage of acoustic sewage, varying in substance from so-called 'entertainment' to so-called 'information'. Motorists cover the roar of their engines in a veil of distorted music from car radios. Dine out and your conversation is drowned by the one-note bass and uniform tizz of a juke box. Travel by railway and you meet that standing joke, the British Rail PA system. The speciality at Tunbridge Wells Central is to run two separate announcements simultaneously.

Cold Pop was introduced into supermarkets in the hope of enlivening the perpetual wet Monday morning atmosphere. This backfired to the extent that Cold Pop is now associated with wet Monday mornings.

Last Christmas, a BBC acquaintance was asked to provide background music for a drinking party. Having experienced similar functions, he decided to install himself beyond earshot of his programme. This created a problem: as more visitors arrived, and as more guests drank, the music level would need increasing. Rather than oscillate between the two rooms, he decided to conceal a microphone among the guests and use the overall room noise level to modulate the background music level by means of a voltage controlled amplifier. Whether this succeeded or went unstable we have yet to hear.

The fact that an Italian company should find it necessary to produce amplification devices for drums, which in days gone by were loud enough to fill the largest hall, suggests that many Pop musicians have finally lost all sense of musical balance: a factor which in studios is left largely to engineers. The purpose of loud music is obviously to excite the listener and what more exciting than 60 minutes at 110 dB? Obvious answer: 60 minutes at 115 dB. Less obvious answer: contrasting dynamics. It is taking the Pop industry inexcusably long to discover the techniques of musical contrast employed by the very appropriately termed 'serious' composers. Even these gentlemen, by courtesy of Radio Two, frequently find their work compressed into a musical mush that contributes as much to the enjoyment of life as dehydrated potato.

A German harpsichord builder once suggested that human hearing in the 15th and 16th centuries was more sensitive than it is today. This, he claimed, explained the need to amplify harpsichords electronically in 20th century concerts. He was wrong, his reasoning being based on the very low volume produced by his instruments which had literally more in common with dining tables than with traditional harpsichords. The point is worth noting, however. At the present rate of artistic and industrial development, 21st century man looks like being chemically more polluted, mentally more stultified, and harder of hearing than even the smoking, telly-watching Pop fan of today. Unhappy future.

FEATURE ARTICLES

- 19 DESIGNING A STUDIO MIXER Part Seven By Peter Levesley
28 LIMITERS AND COMPRESSORS By Michael J. Beville
35 SURVEY: AUDIO PROCESSORS
43 A VERSATILE RECORDING AMPLIFIER Part Two By L. Hayward

REGULAR COLUMNS

- 10 PRECIS
12 NEWS
15 PATENTS REVIEW
17 LETTERS
23 STUDIO DIARY By Keith Wicks

EQUIPMENT REVIEWS

- 45 DOLBY 361 By Angus McKenzie
50 FERROGRAPH RTS 1 By Hugh Ford

CORRESPONDENCE AND ARTICLES

All STUDIO SOUND correspondence should be sent to the address printed on this page. Technical queries should be concise and must include a stamped addressed envelope. Matters relating to more than one department should occupy separate sheets of paper or delay will occur in replying.

Articles or suggestions for features on all aspects of communications engineering and music will be received sympathetically. Manuscripts should be typed or clearly handwritten and submitted with rough drawings when appropriate. We are happy to advise potential authors on matters of style. Payment is negotiated on acceptance.

SUBSCRIPTION RATES

Annual UK subscription rate for STUDIO SOUND is £3 (overseas £3.80, \$8 or equivalent). Our associate publication Hi-Fi News costs £3.12 (overseas £3.66, \$8.64 or equivalent). Six monthly home subscriptions are £1.50 (STUDIO SOUND) and £1.56 (Hi-Fi News).

STUDIO SOUND is published on the 14th of the preceding month unless that date falls on a Sunday, when it appears on the Saturday.

PAST ISSUES

A small number of certain past issues may still be purchased from Link House, price 31p each including postage.

Photostat copies of any STUDIO SOUND article are available at 25p including postage

BINDERS

Loose-leaf binders for annual volumes of STUDIO SOUND are available from Modern Bookbinders, Chadwick Street, Blackburn, Lancashire. Please quote the volume number or date when ordering.

## ARTICLES PRINCIPAUX

### 19 AFFECTANT UN MELANGEUR DE STUDIO

Partie 7. Les problèmes pratiques de la pose des fils sont détaillés par Peter Levesley avec une référence particulière à la stabilité du circuit.

### 28 AUDIO PROCESSEURS

Par Michael J. Beville

### 35 EXAMEN : AUDIO PROCESSEURS

Compresseurs, limiteurs, expandeurs, et les systèmes pour la réduction du bruit, disponible pour les applications de studio dans Royaume Uni.

### 43 UN AMPLIFICATEUR DE MAGNETOPHONE

Partie 2

Par L. Hayward

## RUBRIQUES REGULIERES

### 12 INFORMATIONS

### 15 REVUE DE FABRICATIONS BREVETEEES

### 17 LETTRES

### 23 JOURNAL DES STUDIOS

Par Keith Wicks

## REVUE D'EQUIPMENT

### 45 DOLBY 361

Par Angus McKenzie

### 50 FERROGRAPH RTS 1

Par Hugh Ford

## SPEZIALARTIKEL

### 19 ENTWURF EINES STUDIOMISCHERS

Teil 7. Praktische bedrahtungs probleme in Einzelheiten von Peter Levesley, mit besonderem bezug auf die stromkreis-stabilisierung.

### 28 TONFREQUENZBEARBEITER

Von Michael J. Beville

### 35 UBERLICK : TONFREQUENZBEARBEITER

Kompressor, begrenzer, expander und geräuschunterdrückungsverfahren, die für die anwendung in studios in Grossbritannien zue verfügung stehen.

### 43 EIN BANDVERSTARKER

Teil 2

Von L. Hayward

## STANDINGE RUBRIKEN

### 12 NEUIGKEITEN

### 15 PATENT RUNDSCHAU

### 17 BRIEFE

### 23 STUDIO TAGEBUCH

Von Keith Wicks

## REVUE D'EQUIPMENT

### 45 DOLBY 361

Von Angus McKenzie

### 50 FERROGRAPH RTS 1

Von Hugh Ford

## ARTICOLI SPECIALI

### 19 PROGETTAZIONE DI MISCELATORE DA STUDIO

Parte 7. Vari problemi pratici vengono dettagliati da Peter Levesley con riferimento particolare alla stabilità del circuito.

### 28 COMPRESSORI DO LIMITATORI

Di Michael J. Beville

### 35 INCHIESTA SU PROCESSATORI AUDIO

Compressori, limitatori, espanditori e sistemi di riduzione rumore ottenibili per applicazioni studio nell UK (Regno Unito)

### 43 UN AMPLIFICATORE A NASTRO D'ALTA QUALITA Parte 1

di L. Hayward

## ARTICOLI REGOLARI

### 12 NOTIZIARIO

### 15 RIVISTA DEI BREVETTI

### 17 LETTERE

### 23 DIARIO STUDIO

## RIVISTA

### 45 DOLBY 361

Di Angus McKenzie

### 50 FERROGRAPH RTS 1

Di Hugh Ford

## ARTICULOS SELECCIONADOS

### 19 DELINEACION DE UN MEZCLADOR PARA EL ESTUDIO

7. Los problemas practicos de las conexiones, con los detalles y con la referencia especial de la estabilidad de los circuitos

Por Peter Levesley

### 28 LOS AUDIOPROCESOS

Por Michael J. Beville

### 35 EVALUACION : LOS AUDIO-PROCESOS

Los compresores, limitadores y expandores, así como los sistemas para la disminución del ruido, disponibles en Gran Bretaña, para el uso de los estudios.

### 43 UN AMPLIFICADOR DE CINTA DE ALTA CALIDAD Parte 1

Por L. Hayward

## ARTICULOS DE SERIE

### 12 NOTICIAS

### 15 REVISTA DE LOS PATENTES

### 17 CARTAS

### 23 DIARIO DE LOS ESTUDIOS

Por Keith Wicks

## CRONICA DE EQUIPO

### 45 DOLBY 361

Por Angus McKenzie

### 50 FERROGRAPH RTS 1

Por Hugh Ford

## Metric/Imperial Equivalents

### Tape speed

centimetres/second	inches/second
38	1.5
19	0.75
9.5	0.375
4.75	0.1875

### Tape width

millimetres	inches
50	2
25	1
12.5	0.5
6.25	0.25

## Distance

1 metre (m)	—39.370113 inches
1 centimetre (cm)	—0.393701 inches
1 millimetre (mm)	—0.039370 inches
1 kilometre	—0.6214 miles

## Weight

1 kilogram (kg)	—2 pounds 3.75 ounces
1 gram (g)	—15.432 grains or 0.564383 drams
1 Tonne (metric ton, 1,000 kilogrammes)	= 2204.6 pounds

## Temperature

n° Celsius—(n + 32)° Fahrenheit

## AES European Convention

THE BRITISH Section of the Audio Engineering Society hope to organise a visit to the AES European Convention in Munich. This opens on March 14 at the Holiday Inn Hotel. A two or three day trip is envisaged, travelling by air from Gatwick. AES members would have priority for places but non-members would be welcome if seats are available. The cost depends on numbers and the trip can only take place if sufficient bookings are made. Interested readers are invited to write to the secretary, AES British Section, 10 Museum Street, London WC1, marking their envelope 'Munich' in the top left corner and enclosing a stamped addressed envelope.

# When it comes to the test... this is it!

Now, for the first time, all the major parameters of a magnetic recording system can be measured on a single, inexpensive instrument. The Ferrograph RTS1 Recorder Test Set.

Consisting of 4 basic sections—variable frequency audio generator, millivoltmeter with associated attenuator, peak-to-peak wow and flutter meter, and distortion measuring network—this instrument will measure frequency response, distortion, crosstalk, erasure, input sensitivity, output power and signal/noise ratio.

Completely solid state and lightweight, it may be used in the field as well as the laboratory,

operating on voltages of 100-120, 200-250 volts at 50 or 60 hz.

It is developed specially for those people who have to operate, maintain or service all types of tape recorders, sound-on-film equipment and audio apparatus.

The Ferrograph RTS1.  
Made to stand the test.  
Why not write for further details?

## FERROGRAPH SOUNDS GOOD



Please send me a leaflet on Ferrograph tape recorders or Ferrograph amplifiers  
or Telephone 01 205 2241 Telex 21774

NAME \_\_\_\_\_  
ADDRESS \_\_\_\_\_  
\_\_\_\_\_

The Ferrograph Company  
Limited The Hyde,  
Edenware Road,  
Colindale,  
London  
NW9. SS2

## APRS 72

THE DATES OF their fifth annual exhibition of professional recording equipment have been announced by the Association of Professional Recording Studios. APRS 72 will be held on June 23 and 24 at the Connaught Rooms, Great Queen Street, Kingsway, London WC2.

## APAE Exhibition '72

THE ASSOCIATION of Public Address Engineers will be holding their 1972 exhibition, 'Sound '72 International,' at the Bloomsbury Centre Hotel, Coram Street, London WC1. This new venue will afford a total stand area of some 500 m<sup>2</sup>. The last APAE exhibition was held at Camden Town Hall, which has an area of 232 m<sup>2</sup>. The 1972 exhibition will run from Tuesday March 14 until Thursday March 16, and will have a full supporting programme of lectures and seminars.

The following is a list of companies who have already given a firm undertaking to exhibit: CTH Electronics, Shure Electronics, Fane Acoustics, Beyer Dynamic, Astronic, Westrex, Millbank, SNS Communications, Keith Monks Audio, S. B. Davenport, Goldring, Grampian, Eagle International, Trusound Manufacturing, AKG, MacInnes Laboratories, Rupert Neve, Pye and Hayden Laboratories. Highgate Acoustics may also exhibit. Further details may be obtained from APAE Head Office, 394 Northolt Road, South Harrow, Middlesex HA2 8EY.

## Hayden Address Change

HAYDEN LABORATORIES have moved to Hayden House, 17 Chesham Road, Amersham, Buckinghamshire. The telephone, telex and cable addresses remain the same. The move is part of a general expansion of the company's activities as an agent for home and overseas manufacturers.

## New Millbank Mixer

THE 'DISCO Three' stereo three channel sound mixer is now available from Millbank. It is self-powered and has been designed for use in custom built discotheque units. Millbank consider it suitable for use in small continuity studios and local broadcasting stations. The unit features full audio and visual prefade and postfade monitoring (except on the microphone input), switchable limiting, twin vu meters, automatic or manual music/microphone fade to any selected level, fully floating outputs, and twin switched ac outputs at the rear. Inputs are two stereo gram (magnetic or ceramic), one stereo tape (unequalised), 'jingle' machine (again stereo, which overrides the other tape input) and one mono microphone input, low or high impedance. The unit may also be operated in mono.

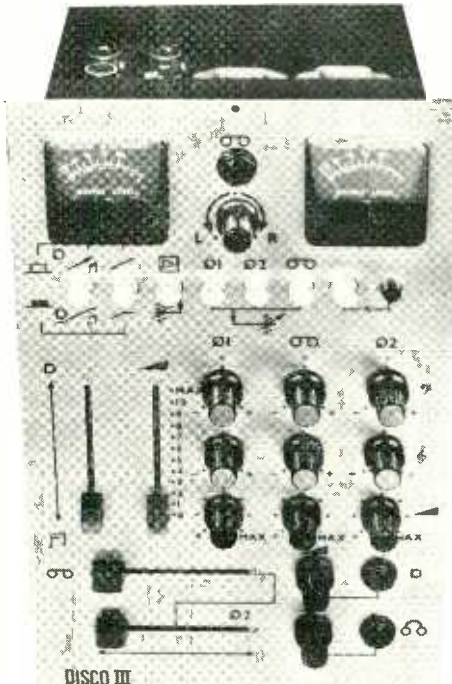

Further information may be obtained from Millbank Electronics Group, Bellbrook Estate, Uckfield, Sussex.

## Surrey University appoint recording techniques lecturer

JOHN BORWICK has been appointed by the Department of Music, University of Surrey, as senior lecturer in recording techniques. The appointment is a further step in the develop-



ment of the University's 'Tonmeister' course. According to the University's definition, a 'Tonmeister' is responsible for the success, both musical and acoustic, of an original transmission or a recording.

John Borwick began his career at Edinburgh University, where he gained a B.Sc in physics, and went on to join the RAF as a signals officer. After four years, he joined the BBC. His activities there included production (as a studio manager) on a wide range of transmissions, lecturing on the technical side of broadcasting at the BBC Engineering School, the development and expansion of the training studio of the Corporation's Central Programme Operations Department, and the beginning of the Radiophonic workshop. He left the BBC in 1958 and is at present Technical Editor of *The Gramophone*.

## Prowest win German order

PROWEST ELECTRONIC Ltd of Maidenhead have been awarded a large contract to supply Zweites Deutsches Fernsehen with one of the largest colour mixing systems in the world. The equipment has 12 inputs and is suitable for both colour and monochrome. It is based on a new modular concept and will be made to the requirements of the existing studio at ZDF. Prowest were formed only five years ago and can already boast a £400,000 annual turnover, with exports accounting for 30 per cent of the total.

An announcement was later made to the effect that a recently formed company, Broadcast Systems Ltd, had taken over the majority interest in the company, previously held by the two commercial television companies Grampian and Westward. The entire former board of the Prowest company has resigned and their positions have been taken over by executives of Broadcast Systems. The new managing director, Erian Pover, was formerly Controller of Engineering at London Weekend Television. His former deputy and Head of Planning at LWT is also on the newly formed board.

London Weekend Television have retained Broadcast Systems Ltd as managing consultants on the construction and technical installation of their new South Bank television studio complex until the completion of the project at the end of 1972.

## Ampex supply Harlech

HARLECH TELEVISION have accepted delivery of a £70,000 Ampex mobile recording unit. The unit includes a VR2000B video tape recorder, suitable for colour or monochrome, and a signal distribution and synchronising system. The unit is fully air conditioned and heated, and was custom built by Dell Coach Builders of Southampton. It measured 6.25 by 3.28 by 2.29 m.

# Can you guess which Sansui deck gives you the better than 56dB S/N ratio?

If you guessed Sansui's SC-700 stereo cassette deck, you're right. That's what it gives you using a chromium dioxide tape and with its built-in Dolby Noise Reduction System\* employed. (Over 4KHz., the S/N ratio is better than 58dB).

The larger Sansui SD-7000 and SD-5000 open reel decks give you S/N ratios of better than 60dB.

The point is that no matter which Sansui deck you choose, you get one that offers performance figures few other decks can match.

Starting with the SD-7000 and ending with the SC-700, frequency response figures for these decks are 15 to 25,000Hz, 15 to 25,000Hz and

40 to 16,000Hz, respectively.

Wow and flutter figures are 0.06%, 0.08% (both measured at 7 1/2 ips) and 0.12%.

Anyway you care to interpret these figures, you know you're getting performance measurements that are way above the mean.

So that all that remains for you to do is to discover the advanced tape protection, operating ease and versatile features these decks offer.

Which is as easy as stopping in and talking to your nearest authorized Sansui dealer.

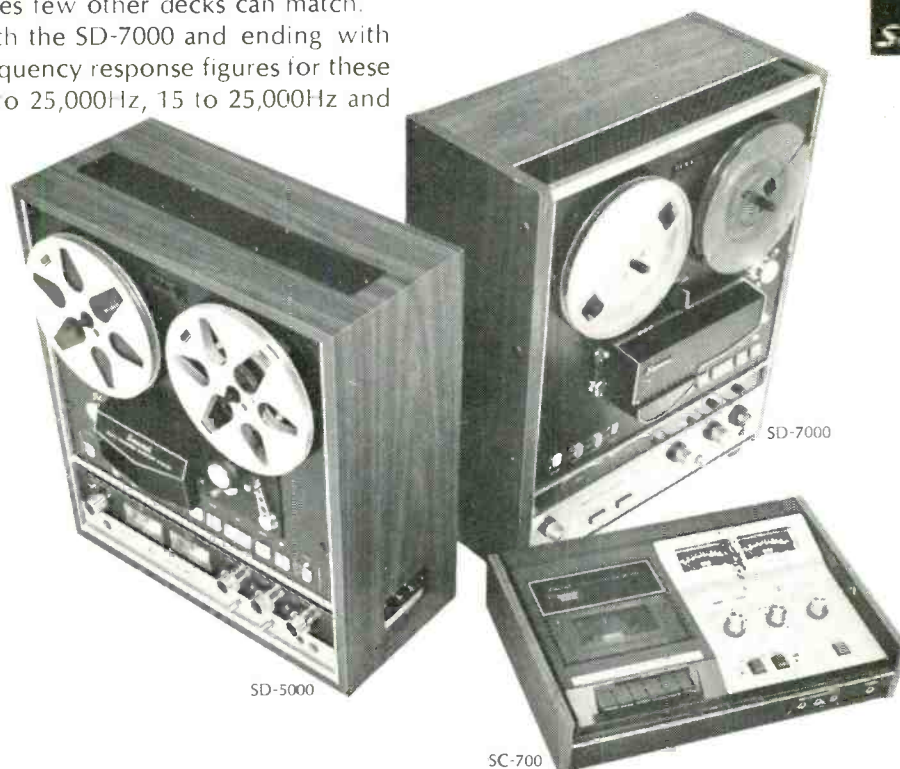

\*Manufactured under license from Dolby Laboratories Inc. Dolby is a trademark of Dolby Laboratories Inc.

England: VERNITRON (UK) LTD. Thornhill Southampton SO9 5QF Tel: Southampton 44811 / Ireland: INTERNATIONAL TRADING GROUP LTD. 5 Cope Street, Dame Street, Dublin 2 / West Germany: COMPO HI-FI G.M.B.H. 6 Frankfurt am Main, Reuterweg 65 / France: HENRI COTTE & CIE 77, Rue I.-R. Thorelle, 77, 92-Bourg-la-Reine / Luxembourg: LUX Hi-Fi 3, rue Glesener, Luxembourg / Austria: THE VIENNA HIGH FIDELITY & STEREO CO. A 1070 Wien 7, Burggasse 114 / Belgium: MATELECTRIC S.P.R.L. Boulevard Leopold II, 199, 1080 Brussels / Netherlands: TEMPOFOON N.V. Tilburg, Kapitein Hatterasstraat 8, Postbus 540 / Greece: ELINA LTD. 59 & 59A Tritis Septemvriou Street, Athens 103 / Italy: GILBERTO GAUDI s.a.s. 20121 Milano, Corso Di Porta Nuova, 48 / South Africa: GLENS (PTY) LTD. P.O. Box 6403 Johannesburg / Cyprus: ELECTROACOUSTIC SUPPLY CO., LTD., P.O. Box 625, Limassol / Portugal: CENTELEC LDA. Avenida Fontes Pereira de Melo, 47, 4.º dto., Lisboa-1 / Malta: R. BRIZZI 293, Kingsway, Valletta / Canary Islands: R. HASSARAM Calle la Naval, 87, Las Palmas / SANSUI AUDIO EUROPE S.A. Diacem Bldg., Vestingstraat 53-55, 2000 Antwerp, Belgium / SANSUI AUDIO EUROPE S.A. FRANKFURT OFFICE 6 Frankfurt am Main, Reuterweg 93, West Germany / SANSUI ELECTRIC CO., LTD. 14-1, 2-chome, Izumi, Suginami-ku, Tokyo 168, Japan

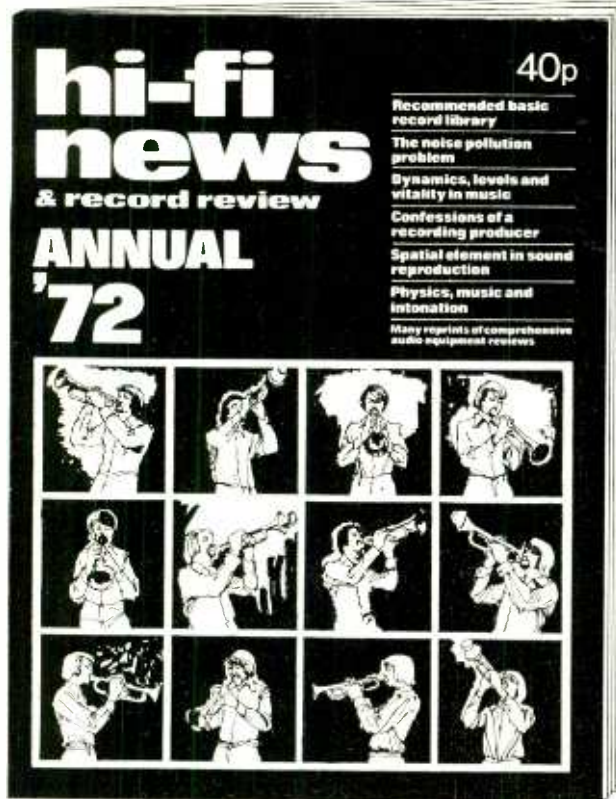

A Link House Group Publication.

# A sound investment.

Hi-Fi News & Record Review Annual.

Just published is the 1972 Hi-Fi News & Record Review Annual. There's lots of interesting features on sound, equipment and recordings. 'Confessions of a recording producer' looks at the role of the producer in classical recordings. Plus special articles on noise pollution, music levels, sound in space—the alternatives for domestic use, and physics, music and intonation.

There's a brand new feature giving recommended classical stereo recordings, on which a basic library collection can be started. Along with a number of equipment reviews from the preceding year's issues of Hi-Fi News & Record Review. In fact Hi-Fi News & Record Review Annual is a reference book you should never be without.

**hi-fi  
news  
& record review  
ANNUAL '72**

Available at bookstalls. 40p.

You taught **AUDIO DEVELOPMENTS** how to make mixers by telling us what was needed.

If you would like to find out what we have learnt, write, telephone, or better still, come to see us — the coffee pot is always on. Information and quotations are yours for the asking.

*Factory :*

HALL LANE  
WALSALL WOOD  
STAFFORDSHIRE

Telephone: 05433 5351

Ask for PETER LEVESLEY

*Agent in South East :*

TECHNOMARK  
STATION YARD, BOROUGH GREEN  
SEVENOAKS, KENT

Telephone: Borough Green 3669

Ask for PETER COXHILL

# Patents Review

BP 1,254,875 describes a process for the production of, and apparatus for producing, an optically readable pattern corresponding to a magnetically recorded pattern. The Marconi Company Ltd have developed methods of overcoming the information density limit set by the gap in a conventional replay head.

In fig. 1, prerecorded magnetic tape 1 coated with a uniform layer of photo-resist such as Kodak KPR is drawn from a reel or other supply 2. After passing over a brush or other suitable surface cleaner 3, it is passed through a suspension of magnetic particles, for example  $Fe_3O_4$ , in container 4. A polarising magnetic field is provided perpendicular to the surface of the tape by coil 5. The magnetic particles adhere to the tape in a pattern corresponding to the information recorded on the tape. The effect of the field produced by the coil is to increase edge contrast and resolution of the magnetic pattern. The suspension of particles may be in water, in which case the tape is dried by drier 6 on emerging from container 4.

After the drying stage, the tape is illuminated by lamp 7 which emits light of a wavelength which chemically changes the photoresist where it is not masked by magnetic particles. A further surface cleaner 8 then removes the magnetic particles and the tape passes through bath 9 where the light-exposed portions of the photoresist are developed, next through etching bath 10 where etching may be regulated to remove to any desired depth the surface of the tape in the unmasked areas corresponding to the information on the tape. The emerging tape carries a pattern which corresponds to the magnetic pattern previously recorded on the tape. The tape is washed and dried by passing through bath 11 and drier 12, and the recorded information may then be read from the tape by a suitable optical device such as a photocell.

Ray Dolby has taken out a patent (1,253,031) detailing the improvement of compressors and expanders for use in both audio and video systems. The existing Dolby principle is outlined in fig. 2. Dolby has investigated other approaches and the rearranged scheme of fig. 3 is the result.

Fig. 4 shows how each works. Line a is the unmodified input signal to both types of device and b is the characteristic of the further path in fig. 2. Thus low level signals will be compressed, after a and b are added to form d, before being passed on to the tape recorder or transmission system. At the other end, or on playback, the same characteristic, b, is subtracted from the output signal by the further path (14) and the original signal obtained.

The modified system shown in fig. 4 allows simpler layout and less expensive circuitry in the expander (output) stage, while the application of closed loop control theory to the input makes for greater stability. To achieve the same compressor or expander transfer charac-

teristic in the type two system as in type one, it is necessary to use a slightly different further path characteristic and this is shown in fig. 3c. It has a somewhat higher threshold and a flatter characteristic.

Subtraction is achieved by adding the inverted output of the further path to the system output. As with the previous invention, each further path divides its input into four bands, processes them and adds them together before passing them on to the adder or subtractor. The processing for each band involves a filter, linear limiter and nonlinear limiter.

The patent goes on to explain various ways of applying the system to noise reduction of audio and video signals and to compression and expansion of signals in general.

The BBC have patented a method of analogue to digital conversion. The heart of the invention (BP 1,251,967) is an electronic approximation of the vernier scale. The analogue signal to be converted is compared to a sawtooth. When the sawtooth reaches the amplitude of the analogue signal, a square pulse (started at the beginning of the ramp) ends. The length of each pulse thus formed is directly proportional to the amplitude of the analogue signal.

The way in which the length of each pulse is measured is that a train of pulses is generated at the beginning of each ramp of the sawtooth. When a comparator detects equality between signal and sawtooth, a multiples counter operated by the above train of pulses is stopped before the next pulse occurs and a second train of pulses is initiated at a different frequency. According to the relationship between the two frequencies of the pulse trains, they will coincide some time later, thus stopping a second clock and indicating when, between pulses, the parity occurred. The method used is similar to the vernier method of measurement. The analogue signal is measured with the sawtooth by a sampling circuit. Digital to analogue conversion is effected by holding the value of a similar sawtooth at the moment when the time interval ends, until the end of the next time interval.

(continued over)

FIG. 1

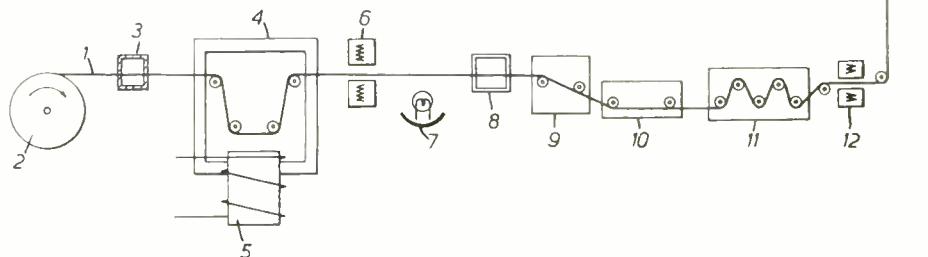

FIG. 2

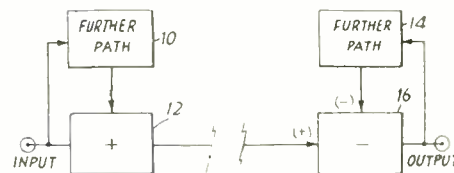

FIG. 3

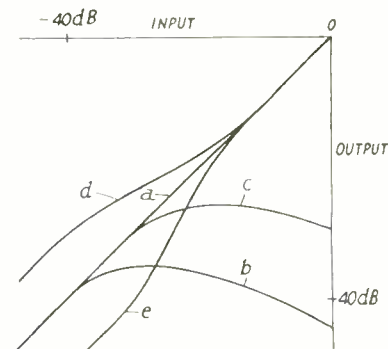
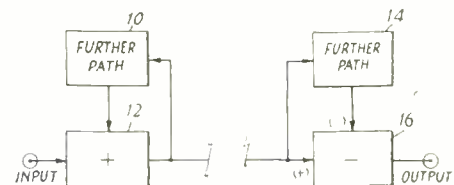

FIG. 4



## PATENTS REVIEW

continued

**THE FOLLOWING** list of complete Specifications Accepted is quoted from the November issues of the Official Journal (Patents). Copies of specifications may be purchased at 25p each from The Patent Office, Orpington, Kent BR5 3RD.

### November 3, 1971

**1,256,676**  
Brown Boveri & Cie AG  
Arrangement for testing the charge condition of accumulators  
**1,256,685**  
Sony Corporation  
Television cameras comprising an automatic gain control system  
**1,256,789**  
RCA Corporation  
Video amplifier circuit  
**1,256,809**  
Commissariat A L'Energie Atomique  
Difference amplifiers  
**1,256,831**  
International Business Machines Corporation  
Frequency analyser  
**1,256,862**  
British Broadcasting Corporation  
Television-signal equalisation  
**1,256,902**  
Eastman Kodak Co  
Web handling apparatus, for example a motion picture projector.  
**1,256,926**  
RCA Corporation  
Apparatus for previewing slides  
**1,256,955**  
Burnside, M. (Marantz Co Inc)  
Tuning control for radio sets  
**1,257,009**  
Philips Electronic & Associated Industries Ltd  
Binary storage circuit arrangement  
**1,257,019**  
Plessey Co Ltd  
Push-pull transistor output circuits  
**1,257,028**  
Matsushita Electric Industrial Co Ltd  
Magnetic tape cartridges and recording and reproducing apparatus for use therewith  
**1,257,036/7**  
Kuibyshevsky Nauchno-Issledovatel'sky Institut Neftyanoi Promyshlennosti  
Method and apparatus for generating vibrations in the sonic and ultrasonic frequency ranges  
**1,257,067**  
North American Rockwell Corporation  
Multiple phase clock signal generator  
**1,257,116**  
Conruyt, P. and Serrand, J.P.  
High speed logical gates  
**1,257,140**  
Siemens AG  
Drive for a recorder for recording on a lengthwise moving band  
**1,257,146**  
Multicore Solders Ltd  
Splicer for magnetic recording tape

**1,257,170**

International Business Machines Corporation  
Colour video recording and playback system  
**1,257,187**  
Cartridge Television Inc  
Apparatus for tape recording and/or reproduction  
**1,257,209**  
Burroughs Corporation  
Differential amplifiers  
**1,257,211**  
Kombinat Zentronik Veb  
Circuit arrangement for producing any desired code combinations  
**1,257,222**  
Telefunken Patentverwertungs GmbH  
Recording and/or reproduction equipment for fast-running flexible foil recording-media  
**1,257,289**  
Dolby, R.M.  
Signal compressors and expanders  
**1,257,306**  
Agfa-Gevaert  
Method of measuring the resistance of electrically conductive materials  
**1,257,311**  
Parsons & Co Ltd, C.A.  
Signal monitoring systems  
**1,257,319**  
General Electric Co Ltd  
Circuits for determining or responding to time displacements between signals  
**1,257,366**  
Varta AG  
Cadmium nickel storage battery  
**1,257,383**  
Soc De Recherches En Matiere De Micro-Moteurs Electriques  
Electric motor with a plurality of radially arranged 'bridge-type' magnetic circuits  
**1,257,398**  
International Standard Electric Corporation  
Tuner device for use in cassette tape recorders

### November 10, 1971

**1,257,504**  
North Western Specialities Ltd  
Coaxial cable and plug assemblies  
**1,257,528**  
Thomson-CSF  
Device for compensating the terrestrial magnetic field in colour television tubes  
**1,257,542**  
General Electric Co Ltd  
Variable attenuation circuits  
**1,257,550**  
Marconi Co Ltd  
High frequency transistor power amplifiers  
**1,257,584**  
Philips Electronic & Associated Industries Ltd  
Transmission of intelligence by means of scrambled audio signals  
**1,257,622**  
Mastertape (Magnetic) Ltd  
Apparatus for producing plated magnetic tape.  
**1,257,625/8**  
Post Office  
Time division multiplex telecommunication systems.  
**1,257,674**  
Lahmer, A.A.  
Illuminated push-button display

**1,257,729**

American District Telegraph Co  
Electrical protection systems  
**1,257,793**  
British Insulated Callender's Cables Ltd  
Apparatus for use in paying out a cable or the like from a drum  
**1,257,924**  
Twinlock Fidgeon Ltd  
Tape storage racks  
**1,257,977**  
Blackstone Corporation  
Ultrasonic transducer assembly  
**1,257,997**  
Gilmore Enterprises Ltd, Joseph  
Stand for film splicers  
**1,258,034**  
Bunker-Ramo Corporation  
Tuning forks and oscillators embodying the same  
**1,258,117**  
Decca Ltd  
Phase locked oscillators  
**1,258,131**  
Western Electric Co Inc  
Distortion correction  
**1,258,205**  
Ampex Corporation  
Manufacture of thin magnetic films  
**1,258,210**  
Gulton Industries Inc  
Rechargeable sealed battery cell of the button type  
**1,258,221**  
Dow Chemical Co  
Electric cable having resistance to moisture

### November 17, 1971

**1,258,280**  
Multicore Solders Ltd  
Cutting and splicing magnetic recording tape  
**1,258,384**  
General Motors Corporation  
Electric storage battery cell groups and their manufacture  
**1,258,436**  
Avions Marcel Dassault  
Method of and means for noise attenuation  
**1,258,445**  
Philips Electronic & Associated Industries Ltd  
Push-button unit for tape recording and/or playback apparatus  
**1,258,464**  
Olympia Werke AG  
Hand microphone  
**1,258,465**  
Lundgren, C.E.B. and Lichtneckert, I.J.A.  
Communication to a remote centre of the response of a group of the population to a question presented via a mass medium  
**1,258,466**  
Fernseh GmbH  
Method and circuit arrangement for generating a pulse  
**1,258,480**  
Telefunken Patentverwertungs GmbH  
Pulse generator  
**1,258,482**  
Maudech, R.  
Coders employing amplitude compression  
**1,258,486**  
Matsushita Electric Industrial Co Ltd  
System for use in a colour television system for producing a continuous signal in synchronous phase with a reference signal

**1,258,524**

Fernseh GmbH  
Arrangement for converting a television signal into binary form  
**1,258,630**  
Western Electric Co Inc  
Acoustic devices  
**1,258,638**  
Sony Corporation  
Electret and methods of making the same  
**1,258,689**  
Hitachi Ltd  
Method of manufacturing a multilayer printed circuit board  
**1,258,702**  
Hughes Aircraft Co  
Flexible flat conductor cable of variable electrical characteristics  
**1,258,712**  
Hoshidenki-Seizo KK  
Electrical jack socket  
**1,258,778**  
Marconi Co Ltd  
Modulating circuit arrangements  
**1,258,853**  
Allen, J.S.  
Electronic musical apparatus  
**1,258,854**  
TRW Inc  
Electrical filters

### November 24, 1971

**1,258,954**  
Margutti, V.L.A.  
Manufacture of composite still or motion picture films  
**1,259,056**  
Memorex Corporation  
Method and apparatus for certifying magnetic recording tape  
**1,259,087**  
Maier & Co, Charles  
Control circuit for reversing motors  
**1,259,193**  
Sydney, University of  
Noise attenuators for use in air ducting  
**1,259,315**  
Teijin Ltd  
Electrically conductive fibres  
**1,259,358**  
GTE Laboratories Inc  
Impedance-controlling circuit  
**1,259,419**  
PIV SA  
Devices for controlling the tension of belts in mechanical speed changers  
**1,259,458**  
British Radio Corporation Ltd  
Current-limiting circuits  
**1,259,512**  
Philips Electronic & Associated Industries Ltd  
Electro-acoustical transmission system  
**1,259,517**  
Hoshidenki-Seizo KK  
Earphone  
**1,259,526**  
North American Rockwell Corporation  
Low power output buffer circuits for multiphase systems  
**1,259,529**  
Western Electric Co Inc  
Time division multiplex arrangements  
**1,259,638**  
International Standard Electrical Corporation  
Stabilised signal generator  
**1,259,650**  
Standard Telephones & Cables Ltd  
Loop current detector



## Commercial radio

Dear Sir, I would like to make comment on Keith Wicks's informative articles on commercial radio. These articles, coupled with press reports of the Government's intentions in this field, have given me a fair basis on which to conclude that the whole endeavour isn't worth it. Not that I am against commercial radio. It is just that the manner in which the government is going about it leads me to believe that it would be best to let things be.

When anyone mentions commercial radio, I immediately conceive a pattern of individual radio stations which are owned lock, stock and barrel by some local enterprise. These individual stations may be fully independent or affiliated with a network to share news costs or programmes, whatever they prefer or can afford.

I have read that studies have shown any city or town of 50,000 or more can support a radio station of this nature. I think this is over cautious. It depends of course on how much profit the owners want—the bigger the desired profit, the bigger the community must be to pay for it.

From a technical viewpoint, the biggest stumbling block is the allocation of frequencies. The vhf band should present little difficulty—but one must remember that a vast number of listeners still have medium wave receivers only and, until the shift to VHF is complete, there is little profit in trying to sell to a minority.

If the technicalities are solved there is the bugaboo of programmes. Is it going to be solid diet of pop, inter-mixed with chats from the man in the street, punctuated by news on the hour, half hour, and as it happens, pock-marked or graced by commercials (depending on who is paying)?

There is the continuing fear that commercial local radio will take the form suffered by the North American public. There is some justification for this fear. The pop pirates gave us all an inkling of what American radio is like and I for one don't like it a bit. But it needn't be quite that way.

I remember before the last war that American radio was extremely enjoyable. Commercials were unobtrusive, the network programmes were good, professional stuff. A lot was worth staying in for. The local stations were truly local. They were concerned with local problems, giving outlet to amateur talent, and local advertisers were keen to support them. When the station ran out of local talent, they plugged into the network and the world was theirs.

What killed radio in America was, of course, television. Like to anything new, the American turned with great respect to the new medium and he liked it. Radio was abandoned overnight. To survive, radio in desperation turned to what was called 'formula' radio and the disc jockey was born. The packaged half hour programmes sponsored by large commercial

interests with well known stars disappeared. After television little on radio was sponsored, just pop music interspersed with spot ads. It still made money but the world of sensible commercial radio collapsed.

I lived in Ottawa, Canada, for five years up to 1965. There the state-owned Canadian Broadcasting Corporation had a local station with the call sign CBO. Although Ottawa and its sister city Hull together approximates the population of Croydon, there was one French-speaking and three English-speaking commercial stations. I liked to listen to CBO; they had low key commercials and a mature approach. But they weren't involved. I ran a one-man survey of my friends and anyone else I could pin down. 'What,' I asked them, 'would you consider the local station most likely to deserve the title "Radio Ottawa"?' Inevitably the reply would be either CFRA, CKEY or CKPM, the three commercial stations. CBO is local in the same sense as Radio Brighton, but the local population would not accept it because it was part of the nationwide nationalised CBC, and to them the CBC is indivisible. Yours faithfully, J. Moffat, 24 Greenacres, Great Bookham, Surrey.

## AKG microphones

Dear Sir, I find it difficult to reconcile the following conflicting statements regarding AKG D202 and D224 microphones made in the December issue of STUDIO SOUND.

Page 641, column one: 'The polar pattern is well maintained over a wide range of frequencies . . . the microphones produce very pleasant stereo when crossed.' (John Fisher)

Page 645, column two: 'Because of the off-axis fall-off of high frequency response, this microphone (D202E1) is quite unsuitable for use in a stereo pair.'

Page 645, column three: 'I consider (the polar response) nowhere near good enough to be used as a stereo pair.'

Page 647, column three: '. . . and for this reason (lack of good high frequency response) the D202 and D224 should definitely be avoided (as a stereo pair).' (Angus McKenzie)

This discrepancy of view between two of your contributors is of considerable practical interest as far as I am concerned since for some time now I have been getting what seemed, to my amateur and untutored ears, pretty good stereo recordings with a pair of D224 and a high speed A77. The fact that AKG and John Shuttleworth's (August 1971) review of the D202 both publish polar graphs which fail to bear out Mr McKenzie's statements only adds to my bewilderment.

If I have to accept that my D224 aren't much use for crossed pair stereo, where do I go from here? Elsewhere in his review, Mr McKenzie remarks that 'Almost all capacitor microphones also show a reduction of extreme top response considerably off axis' and implies

that only a pair of C12A à la BBC can adequately fill the bill. I feel that I ought to sign myself 'Worried Blue Eyes' but remain Yours faithfully, R. P. Everest, 124 Julian Road, West Bridgford, Nottingham.

*I am sorry to have puzzled you—never let it be said that STUDIO SOUND is guilty of dull uniformity! However, to your points:*

*I have the greatest respect for Angus McKenzie's views though one does not always necessarily agree with them entirely. One has only to recall the coincident/multi arguments about stereo microphone placing that have adorned these pages, and the coincident/spaced mic arguments that preceded them, to appreciate that you will not always find agreement on technique and taste. Similarly, assessments of the sound quality from loudspeakers and microphones vary, and the final choice is still to some degree a matter of personal taste and choice.*

*If you will pardon my saying so, I do not think my statement and Mr McKenzie's are wholly incompatible. He said a pair of D202 would not work satisfactorily back-to-back. I said a pair of D202 mics produce very pleasant stereo when crossed; I did not suggest they should be used back-to-back—relatively few cardioids are good enough to be used in this manner without some lack of definition over the centre of the image. Nevertheless, coincident cardioids are frequently used, as you must be aware, at intermediate angles between 90 and 180 and I know a number of people who use or have used a crossed D202 pair for stereo and have been well satisfied. I have made recordings myself using a borrowed pair of D202s, crossed at about 130°, and to my ears—and incidentally those of most people who have heard the recording—the stereo is very pleasant.*

*I quite agree with Mr McKenzie that at 90° to the axis (centre of image for back-to-back cardioids) there is a loss of high frequencies and also the response becomes less smooth. Nevertheless, if you will refer to the D202 review in the August 71 issue, where curves for 60°, 90° and 180° are given, the response curve at 60° to the axis is quite respectable, indicating the possibility of using a pair crossed at 120°. The 90° curve is much better than with perhaps the majority of moving coil cardioids. I think you must agree that the polar response is well maintained over a wide range of frequencies, even if it is not up to the best capacitors.*

*As to your final point, whether 'a D202 can in fact be used for stereo recordings', the simple answer is no, you need a pair! Given a pair, my view remains yes, if the microphones are crossed at about 120° and appropriately positioned. This is, however, a matter of taste and technique; for many purposes I would rather use a pair of C451s, if available. Probably the only way to satisfy your own curiosity is to borrow a demonstration pair, which AKG are always happy to arrange.*

**John Fisher**

**R.E.W. Bring you professional quality on a budget!**

**HARMAN-KARDON**

R.E.W. have been appointed Sole London Agents for this outstanding American Equipment. Models now on demonstration include the **CAD 5 Stereo Cassette Tape Recorder** with built-in Dolby System and the **Citation Stereo Amplifier**

**IMF R.E.W. REFERENCE STANDARD Studio Monitor Speakers**

R.E.W. have been appointed exclusive U.K. Distributors for the top IMF Monitor Loudspeaker. This Speaker has previously been reserved specifically for critical professional markets. It features improved low frequency stability and increased power handling capacity. Send for detailed specifications.

**ACOUSTIC RESEARCH LOUSPEAKERS**

Come and hear all the models from this famous American Manufacturer in our new Professional Showroom. These Speakers are equally suitable for studio monitoring or top Hi-Fi systems.

**Ferroglyph TAPE RECORDERS**

**NOW ON DEMONSTRATION**

New models with built-in Dolby System, available from stock. ALSO—the superlative new Ferroglyph Speaker at Charing Cross Road Showrooms now.



**Shure, Beyer, AKG MICROPHONES**

Ask our advice on the model to suit your requirements from these famous makes. Over 150 microphones in stock, from £7 to £170. Also boom arms, stands, windshields, etc.



*Now on demonstration*

**NEW ROGERS BBC MONITOR**

In our opinion the best compact monitor speaker available today

**Price £95 complete with stand**

**MIXERS**

We now have in stock a limited supply of the Sony MX 12 and Uher A 121 in our range of less expensive mixers. Also available, mixers in the higher price bracket.

**REVOX, B. & O., SONY Full ranges in stock**

**R.E.W. AUDIO VISUAL CO**

**PROFESSIONAL SHOWROOMS:**  
146 Charing Cross Road, London W.C.2.  
Telephone: 01-836 3365

**S. LONDON SHOWROOMS:**  
266-8 Upper Tooting Rd., London S.W.17.  
Telephone: 01-672 4471/2 and 9175

Please send me full details of your services

NAME .....

ADDRESS .....

The World's Finest **POWER AMPLIFIER DC300**



DC-coupled throughout, the DC300 offers unequalled reproduction of frequencies from DC to 20,000 Hz. Users in the UK include The Post Office, C.E.G.B., C.E.R.L., National Physical Lab., Road Research Lab., Queen Mary College, Universities at Bath, Salford, Manchester and Southampton, and the Institute of Sound and Vibration. Laboratory uses include driving Vibrators, Stimulators and Motors, Servo loops, and many more. Full data available on request.

- Frequency Response** ±0.1 db Zero 20 KHz at 1 watt into 8 ohms. ±0.6 db Zero-100 KHz.
- Phase Response** Less than 5° 0-10 KHz.
- Power Response** ±1 db Zero-20KHz at 150 watts RMS into 8 ohms.
- Power at Clip Point** Typically 190 watts RMS into 8 ohms, 340 watts RMS into 4 ohms per channel.
- Total Output (IHF)** Typically 420 watts RMS into 8 ohms, 800 watts RMS into 4 ohms.
- T.H.D.** Better than 0.03% at 1 KHz at 190 watts level.
- I.M. Distortion (60-7 KHz 4:1)** Less than 0.1% from 0.01 watt to 150 watts RMS into 8 ohms, typically below 0.05%.
- Damping Factor** Greater than 200 (Zero to 1 KHz into 8 ohms at 150 watts RMS).
- Hum and Noise** 100 db below 150 watts RMS output (unweighted, 20-20 KHz)
- Slewing Rate** 8 volts per micro-second. S-R is the maximum value of the first derivative of the output signal.
- Dimensions** 19in standard rack mount (W.E. hole spacing), 7in height, 9½in deep (from mounting surface).
- Weight** 40 pound net weight.
- Finish** Bright-anodised brushed aluminium front panel with black-anodised front extrusion, access door and chassis.

**PRICE £360**

Sole Agents: **MACINNES LABORATORIES LTD**  
71 Oakley Rd., Chinnor, Oxon. Tel. Kingston Blount (0844) 52061

**AUDIO CONNECTORS**

BROADCAST PATTERN JACKFIELDS, JACKCORDS PLUGS & JACKS. QUICK-DISCONNECT MICROPHONE CONNECTORS. AMPHENOL (TUCHEL) MINIATURE CONNECTORS WITH COUPLING NUT. HIRSCHMANN BANANA PLUGS & TEST PROBES. XLR COMPATIBLE IN-LINE ATTENUATORS. LOW COST SLIDER FADERS BY RUF.

**FUTURE FILM DEVELOPMENTS LTD.**

38 Hereford Road, London W2 5AJ

01-229 8054 or 01-229 9111

**High-speed Tape Copying Equipment**



**fpa** Fraser-Peacock Associates Limited  
94 High Street Wimbledon Village London SW19  
01-947 2233

sole UK distributors of Infonics

# Designing a Studio Mixer

## Part Seven by Peter Levesley

WE have now completed our consideration of microphone amplifier and mixer amplifiers, and methods of routing the signals between the two have been touched on in the first article. I want to say a few words about some of the methods of connecting up the wiring which may assist in the construction of a mixer. Unless some careful forethought is given to the subject, the sheer bulk of wiring behind the mixer panel can grow to horrifying proportions. By the application of some simple techniques it is possible to reduce substantially this wiring without making any sacrifices in system noise.

### Connection of channels to mixer amplifier

If there are only a small number of channels to be wired to the mixing amplifier, say less than five, it will probably be better to wire all the way from each channel in screened wire. Fig. 1 shows the way in which five channels should be wired to a simple mixer. Five microphone amplifiers are shown, each with its gain control and fader. No routing switching has been shown for simplicity at this time. We have found that if all kinds of peculiar problems are to be avoided the earth wiring, that is the power supply 0V connection, must be made as shown. It will be seen that a separate wire is taken from each preamplifier all the way back to a common earth point at which the power supply connection is also made. It is definitely not advised that the 0V wiring be looped from one channel to the next. You may save on wire but it is highly probable that trouble with instability will be experienced. In a very small mixer—physically small that is—it is less likely due to the short runs of wire, but it is still good practice to make these separate feeds. The reason that the problems arise is that the actual wire that is used for making the connections has resistance and inductance. Not very much, but enough to cause trouble.

Fig. 2 shows the arrangement redrawn to show the non-advised method of connections.

It can be seen that the currents from each of the channels labelled  $I_1$  to  $I_5$  all eventually flow together down the one piece of wire. These currents will contain some proportions of signal currents being handled by the amplifier and some ripple current from the power supply. The decoupling capacitors in the amplifiers are responsible for the presence of these ripple currents. If the wire had no resistance we would have no problem. In fact, the currents produce slight voltage drops along the wire in accordance with Ohm's Law and these small potentials can appear as additional input signals to the amplifier. When this happens, due to the high gains that are present in the system, the ripple currents appear on the signal lines and interaction between channels takes place. I have had the problem that having discovered trouble due to power supply ripple getting on to the signal line, an attempt has been made to improve the decoupling at the amplifier by increasing the value of the decoupling capacitor. Increasing the capacitor value produced a worsening of the trouble.

much to my amazement. Analysis of the wiring gave the solution, however, and the suggested method cured matters. At high frequencies, say several megahertz, the inductance of the wiring becomes significant. Transistor amplifiers still have useful gain at these frequencies and if precautions are not taken oscillations can occur. One precaution is to ensure that the amplifier gain is reduced by suitable addition of capacitors. The other is to re-route the wiring as indicated.

Returning now to fig. 1, note that the earth return from the bottom of the channel fader is also taken from its own channel 0V. Do not be tempted to loop this wiring from one fader to the next, no matter how convenient it may seem. The screened wires from the sliders of the faders are taken to the mixing amplifier, which also has its 0V returned to the common earth point. Another important thing to note is that the shield of the screened wire should be earthed at one end only. Finally, the group fader is earthed to the mixing amplifier 0V or back to the common point if more convenient.

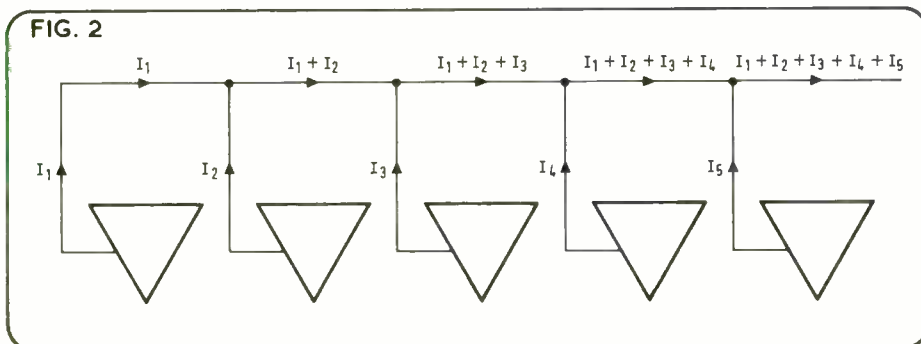
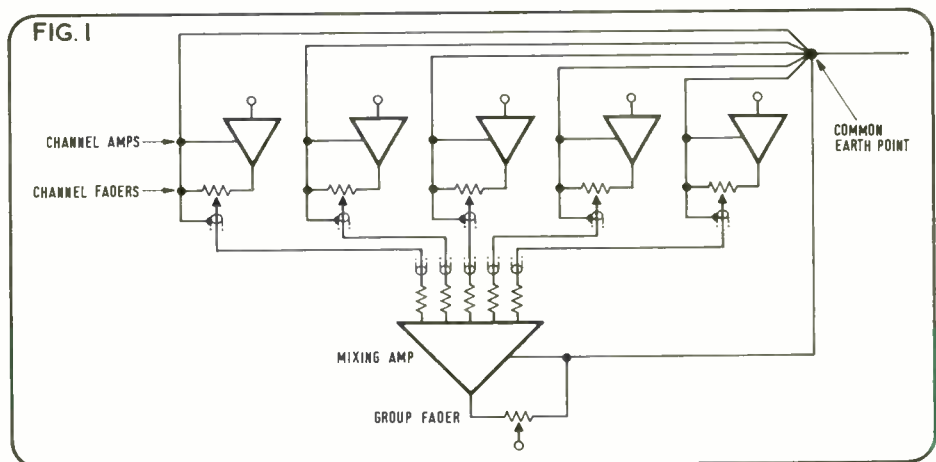

These arrangements are quite manageable for a small mixer as described but things become much more complicated if the number of channels and the number of groups increases. It then becomes necessary to adopt a different system of which we at Audio Developments now make very wide use. The method becomes possible due to the very low impedance at the virtual earth point of the mixing amplifier. Provided that suitable shielding is employed, the mixing resistors can be mounted, not adjacent to the mixing amplifier but on the channels themselves. This means that only one

(continued over)

continued

wire has to be run to each mixer rather than one for each channel. The mixing node is extended as a bus rail along the row of channel amplifiers as shown in fig. 3.

It will be immediately apparent how this system simplifies the complexity of the wiring. In order to bring out the mixing node from the mixing amplifier it is simply necessary to short circuit one of the Rin positions on the GPA as described last month. The mixing node will then be available on the connector pin associated with the shorted position.

The other Rin positions on the GPA can have the normal resistors fitted for injection of additional signals. It is sometimes convenient to be able to inject a calibration oscillator direct to the groups and this can be conveniently done here. This enables the setting and matching of the group outputs to be carried out. From fig. 3 we can see that it is very little extra trouble to expand the system by simply adding more switches. These switches are the routing switches and they can either take the form of a rotary switch or a push-button bank. The rotary switch takes up less room but we can only route to one group at a time. The push button on the other hand is likely to be more bulky and expensive but by depressing several buttons at once it is possible to route to several groups at the same time. It is, of course, necessary to ensure that the output amplifier of the channel is capable of driving the whole number of group mixing resistors selected. Since the group's mixing resistors are 47kΩ each, the load resistance experienced by the channel amplifier will be equal to 47 kΩ divided by the number of groups selected. If we selected ten groups simultaneously—admittedly an unlikely procedure—the load on the amplifier would be

$$\frac{47k}{10} = 4.7 k\Omega.$$

In the circuit arrangement in fig. 1 of the first article of this series the channel amplifier shown as Channel 1 sent its output from the slider of the channel fader. This is acceptable if a rotary switch is used as the routing medium because there can only be one load at a time.

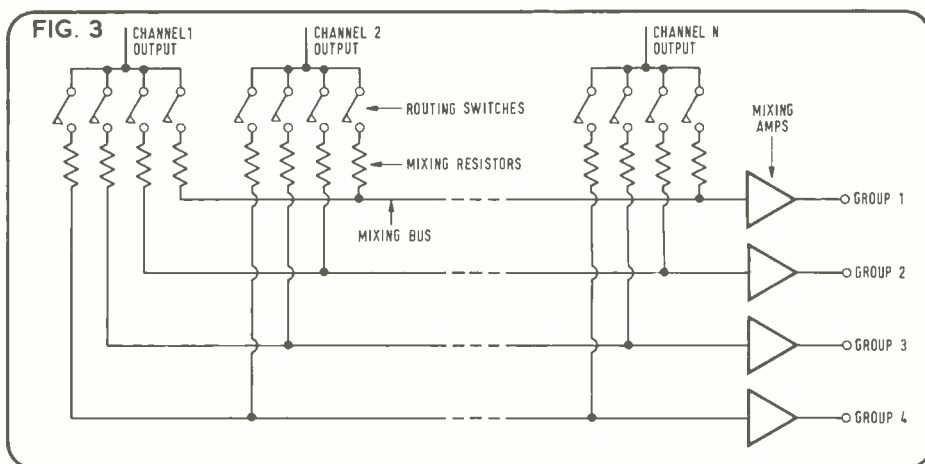

Under the worst case conditions, if the fader is a 10 kΩ unit as has been recommended previously, the output resistance of the channel will be 2.5 kΩ, this being one quarter of the resistance of the total fader. With ten channels connected, we would lose signal level relative to the open circuit condition. Let the output signal be 1V with no load connected. With the 4.7 kΩ load, the output will fall to

$$\frac{1 \times 4.7}{2.5 + 4.7} \text{ volts} = 0.653 \text{ volts}$$

This represents a loss of 3.7 dB which is clearly unacceptable. The solution suggested in fig. 4 is to connect a Buffer Amplifier between the fader and the output, the signal to the routing system now being taken from point Y. The buffer should have a high input impedance so as not to load the fader and a low output impedance with good power capability to drive the routing system. It should also have unity gain and very low internally generated noise. This latter point is most important because even with the channel fader set to minimum, this amplifier will still be giving an output—its own noise. Since there will still be some 20 dB of gain to follow, it is clearly necessary that the buffer should add as little as possible. Another point to bear in mind is that if all the channels are routed to one group, all the buffer amplifier noises will be present at the same time on the

group output. An emitter follower stage seems a suitable choice for this duty since it fulfils all the requirements.

You can't use just any old emitter follower though. Fig. 5 shows a typical emitter follower. The base is biased to half way between the supply rails and the emitter voltage will therefore be about 15V. If we connect an oscilloscope across R<sub>L</sub>, we can observe the waveform as the output of the signal generator is increased. While the output is small, it will be a faithful replica of the input as shown at a. At b the output has increased and some distortion of the negative half cycle is observed. The effect is worse at c where the amplitude is even greater. This trouble always occurs on the negative half cycle (with NPN transistors) and is not affected by frequency or the value of the output coupling capacitor. Why does it happen? The explanation is that on positive half cycles the transistor is able to charge C<sub>2</sub> as shown on the diagram. At low amplitudes, the value of R<sub>e</sub> is low enough so that it can discharge the capacitor during the negative half cycles. As the amplitude increases, the charge on the capacitor is such that on the negative half cycles the emitter of the transistor is held more positive than its base, R<sub>e</sub> being unable to supply the current needed to discharge the capacitor. At this point, the output impedance of the amplifier rises rapidly and the signal voltage fed to the load partially collapses. The

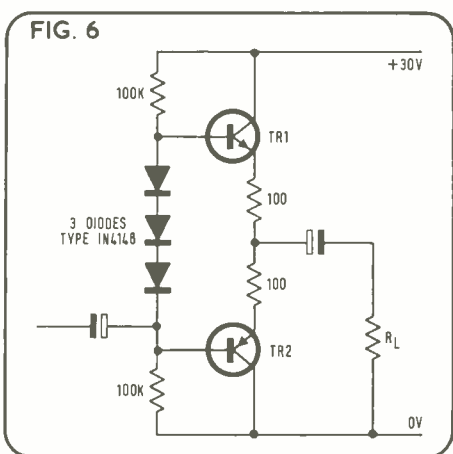
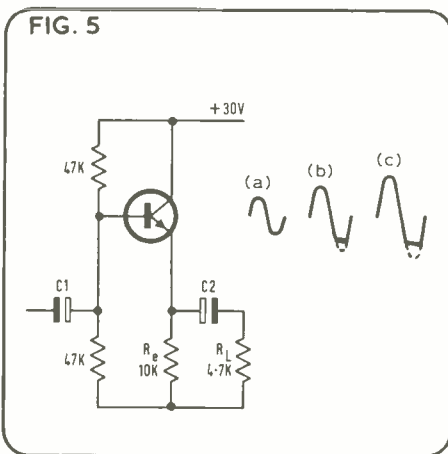
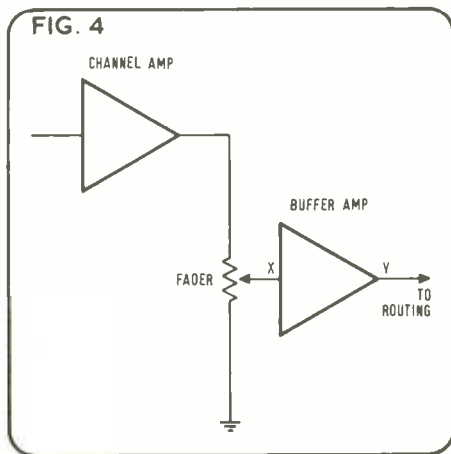

...ets worse as the amplitude increases, an t e value of  $C_2$  has nothing to do with it. This only controls the actual time that the condition takes to establish itself after the commencement of the signal input. A possible cure would be to raise the standing current through the transistor by reducing the value of  $R_e$  which would speed up the negative half cycle discharge. Such a cure would increase the permissible amplitude before the onset of distortion but if the value of  $R_e$  were made low enough to ensure no distortion under all expected load conditions, we would probably have to fit a heat sink to the transistor to get rid of the heat generated. This is a very wasteful solution. A better one is to use a complementary pair of transistors as shown in fig. 6. Here we have the advantage that under no-signal conditions a small current to overcome cross-over distortion is all that flows in the circuit. On positive half-cycles the load current is supplied by  $TR_1$ . The accumulated charge on the coupling capacitor is discharged by  $TR_2$  as the signal executes its negative half cycle, and since the circuit is symmetrical the capacitor shows no tendency to charge in either direction. Thus the output is a faithful copy of the input at all levels up to the limits imposed by the supply rails. The  $100\Omega$  resistors limit the output current in case the output is accidentally short circuited and they define the output resistance of the amplifier at about  $100\Omega$ . The circuit shown can easily be wired on to a GPA board by rearranging the component positions.

Referring once again to fig. 1 of the first article, it will be seen that we have already introduced the idea of the buffer amplifier to isolate the Pan Pot from the slider of the main fader (see Channel 2). This is to avoid distorting the law of the fader. The use of the Pan Pot was described and here I want to discuss some practical points. It has already been said that the Pan Pot consists of two potentiometers wired back to back so that as the output of one increases, the output of the other reduces. One of the potentiometers is logarithmic and the other is anti-logarithmic, and there is considerable difficulty in obtaining good ganged controls of this type. The reason is that it is very difficult to match the tracks accurately and well matched controls cost a lot of money and are hard to find. I offer here a solution that has been tried and that works very well in practice.

PERCENTAGE ROTATION	$R_1$ $\Omega$	$R_2$ $\Omega$	$R_3$ In Parallel with $R_2$ $\Omega$	$V_{out}$ Volts	dB	dB Intervals
100	0	10	1.80	1	0	3.9
90	1	9	1.77	.64	-3.9	2.8
80	2	8	1.72	.462	-6.7	2.2
70	3	7	1.67	.358	-8.9	2.3
60	4	6	1.61	.277	-11.2	1.4
50	5	5	1.53	.234	-12.6	1.7
40	6	4	1.42	.192	-14.3	2.0
30	7	3	1.27	.153	-16.3	2.8
20	8	2	1.02	.111	-19.1	4.6
10	9	1	.069	.065	-23.7	—
0	10	0	0	0	.00	—

We start from the proposition that it is much easier and cheaper to make—and therefore to buy—good linear potentiometers. It is also much easier to get a respectable match between two sections of a ganged potentiometer if they are both linear law. The trick is to make a linear control give a logarithmic output or sufficiently near to it for practical purposes. This can be done by distorting the law of the control with a low value load resistor. We went into all this in the sixth article when we talked about 'Law Distortion' and what a terrible thing it was. Here, we are going to rehabilitate it and use it as a virtue.

In the circuit of fig. 7 we have a potentiometer loaded by a resistor. Let us measure a table of output voltages keeping the input voltage constant at 1 volt and making  $R_1 + R_2$  equal  $10\text{ k}\Omega$  and  $R_3$   $2.2\text{ k}\Omega$ .

The test to see if we have a respectable logarithmic law is to look at the last column and see if all the intervals are equal. We can judge that these intervals are equal enough for practical purposes and the system is sound. We have thus made ourselves a logarithmic law from a linear law but the most important advantage is that it is just as easy to make an antilogarithmic law. This is done by wiring the loading resistor from the centre to the top instead of the other way round (see fig. 8).

Fig. 9 shows the method of wiring the control. At the centre setting both outputs receive the

same signal which can be shown to be  $-2.3\text{ dB}$  relative to the input. If the spindle is rotated anticlockwise (i.e. to the left of centre), the A output will increase and the B output will reduce. The labelling of these outputs was reversed in error on the original drawing in Part One.

The opposite will happen when the spindle is rotated to the right. 9a shows the circuit and b shows the actual wiring arrangement. The final point to be considered is the output resistance and input resistance of the Pan Pot. The signal input to the Pan Pot will be derived from an amplifier with a low output impedance such as that shown in fig. 6. The minimum load resistance that the Pan Pot will present to the amplifier will be at either extreme of rotation. Under these conditions, we can see from the table associated with fig. 7 that we have two resistances in parallel of  $1.8\text{ k}\Omega$  and  $10\text{ k}\Omega$ . The total load thus works out to be  $1.52\text{ k}\Omega$  which should not worry an amplifier with an output resistance of  $100\text{ ohms}$ . The source resistance seen by the Routing System is greatest when the slider of the Pot is at its mechanical centre. The maximum value that this can take is equal to one quarter of the total potentiometer resistance in parallel with the loading resistor, assuming that the amp. output resistance is negligible as it is in this case. The value works out as  $1.17\text{ k}\Omega$ . For  $0.5\text{ dB}$  drop from minimum

(continued on page 27)

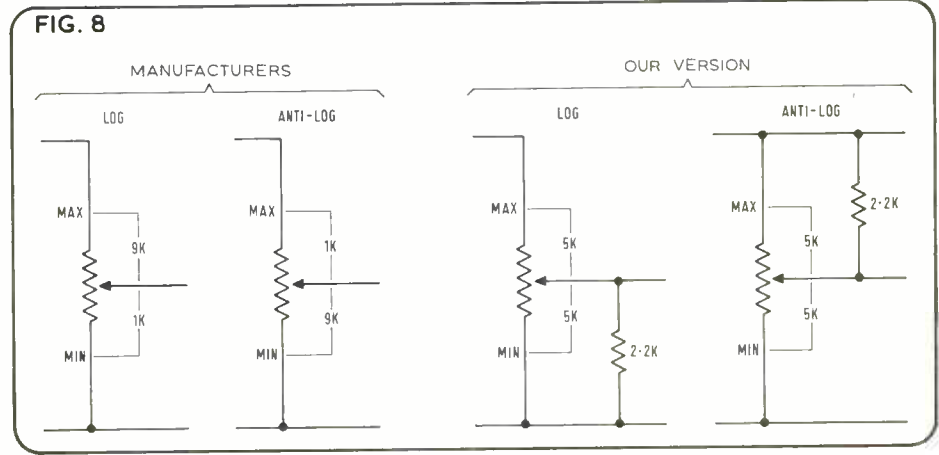
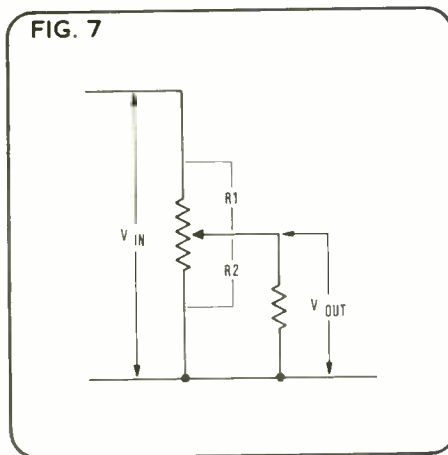



# SAIT SOUND MIXERS

## ALLOTROPE LIMITED

5B, Thame Industrial Estate, Thame Oxon. Sales Office Tel. 01-229 4965

# INDIGO

Sound Studios Ltd

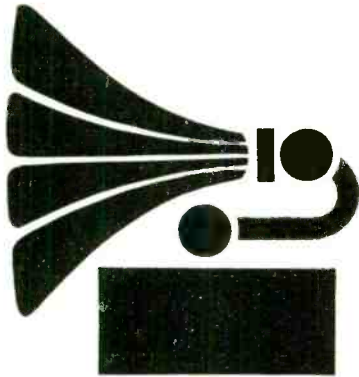

# 061-834 7001

# Multitrack in

# Manchester

72 Gartside Street Manchester M3 3EJ

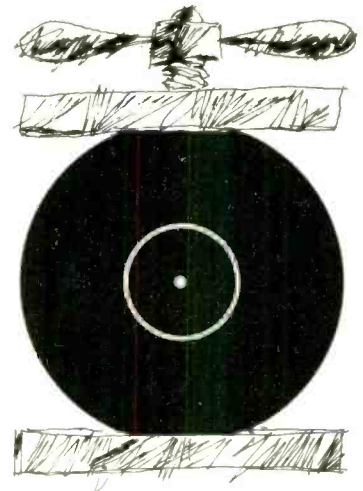

**for all Professional,  
Custom, & Trade Pressings**

C. H. Rumble Ltd., Benedict Wharf, Benedict Road,  
Mitcham, Surrey. Telephone: 01-648 5106

COMMAND Studios' 'Rock Box', opened last November, provides virtually infinite separation between instruments without confining each musician to a separation booth. The Rock Box appears to work so well that it is certain to be copied by other studios, and considering that a similar system was used with great success by Tamla Motown several years ago, it is surprising that the idea took so long to reach London.

Command's managing director, John Mosely, after one of his periodic visits to the States, reported that he had seen a studio of this kind in Los Angeles. The other Command directors liked the idea, and studio three, previously used for rehearsals, was converted to the Rock Box.

Around the sides of the studio are four booths, each big enough to house the largest guitar amplifiers or Leslie speakers. The piano

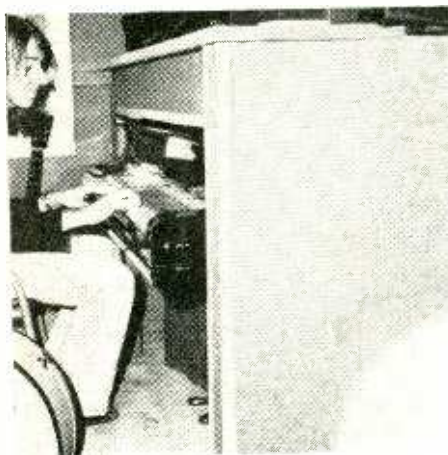

is boxed in leaving just the front exposed. For the drummer, there is a booth with a transparent roller blind which assists in separation without cutting him off completely. Apart from the drummer, all the musicians play in the main body of the studio, the basic idea being to provide separation between instruments, not between players. After miking up, the booths and piano box are closed and the group play together in the studio, using headphones for monitoring. Working in this way, the musicians avoid the remote feeling often experienced when using conventional booths, so better results are likely to be obtained.

John Jones, formerly with Anno Domini and now leader of the group Jonesy, told me after a session in the Rock Box that he thought some amazing sounds would be created there. His group consists of himself on piano and lead guitar, brother Trevor on piano and bass guitar, drummer Terry Cutting, and saxophonist Bernie Hagley. An electric pickup was used

on the tenor sax, the sound being modified at times by an octave doubler and supplemented by a tone generator, both these units being attached to the player's belt. In spite of using 100W amplifiers at a high level, the separation was found to be extremely good. 'A great step forward' was John Jones's description of this studio, and the customer is always right.

The cost of using the Rock Box is £24 per hour for up to four track, £26 for eight track, and £28 for 16 track.

Orange Recording Studios in New Compton Street also have a facility provided by no other London Studio. Sixteen track recording at only £16 per hour, day and night. The Orange 16 track machine was designed and built by the studio engineers, and is non-standard in that it uses 25 mm tape.

It seems likely that 16 track on 25 mm will become standard if and when 32 track recording on 50 mm tape becomes popular. At the moment, Orange are in the process of designing a 32 track 50 mm machine but it was chance rather than foresight that initiated the Orange mini 16 design.

The story begins in an Edgware Road electronics shop, where studio manager Brian Hatt found a 16 track 25 mm Epsilon recorder. The old machine, which had been built for a government department, was fitted with audio heads. Realising the possibilities, Brian purchased the recorder for around £160 and, with the other Orange engineers, started building amplifiers and experimenting with the machine. It originally ran at 152 and 76 cm/s so the

capstan was ground down to provide speeds of 38 and 76 cm/s. There had been no provision for an erase head as the tapes were intended to be bulk-erased after use. It was not possible to add an erase head to the existing system. The tracks covered by the record head were too close together to be erased individually without affecting adjacent tracks, so three new heads were built by Gresham. The pressure pads were abandoned for an electronically controlled back tension system, new motors were fitted, and the braking system changed.

In the end, the deck had been modified so much that it was no longer up to the standard they wanted. It was scrapped and replaced by an old Ampex 6.25 mm deck, suitably modified. The guides and pulleys were turned down to accept 25 mm tape, and Branch & Appleby heads were fitted to a new headblock. The existing tape-lifting system, consisting of a solenoid-lift and spring-return, was replaced by a two solenoid system. Around £3,000 had been spent on the project by the time the final modifications had been completed. The machine had many faults, as one would expect. Ventilation had to be increased to prevent overheating; the studio-designed power supplies proved inadequate so were replaced by Advance Industrial Electronics units. Some time was spent in declicking the machine. The result was a 16 track recorder that has been in great demand for the last few months.

The disadvantage of the system is that a 16 track tape recorded at Orange must be reduced  
*(continued on page 25)*



**Left:** Command's rock-boxed piano.

**Right:** Terry Hewitt and the Orange 16 track 25 mm recorder.

# ONE OF OUR WINNING CARDS

Chadacre Electronics Limited present a new concept in Audio Modules

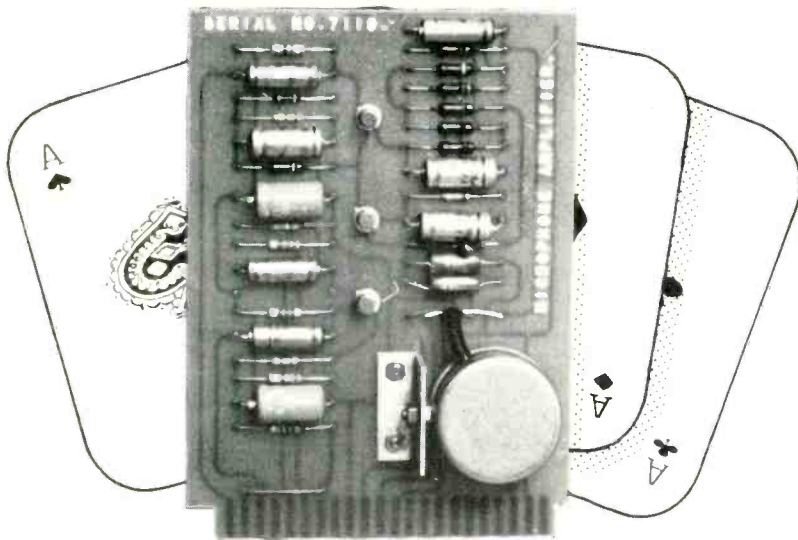

All modules are polarised, and terminated by a twenty two way gold plated edge connector. They are built on fibre glass boards, and include metal oxide resistors for low noise operation where necessary. They require twenty four volts D.C. for optimum results.

## From Stock

- Microphone amplifier 4310
- Equalizer amplifier 4311
- Stereo output amplifier (unbalanced) 4312
- Stereo magnetic cartridge amplifier 4313
- Stereo tape replay amplifier 4314
- Stereo vu meter driver amplifier 4315
- Mixing amplifier 4316
- Stereo high impedance headphone amplifier 4317
- Phasing simulator 4300

## Available Shortly

- I.C. ring modulator (with high carrier rejection)
- Frequency doubler
- Quadraphonic pan-pot
- Digital read out Oscillator

TRADE ENQUIRES WELCOMED

For further details please write to

chadacre  
electronics  
limited

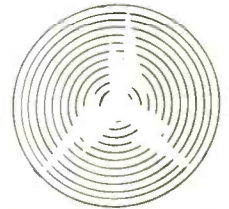

AUDIO DIVISION

43 CHADACRE AVE CLAYHALL ILFORD ESSEX TELEPHONE 01 550 7119

## SONIFEX SOUND EQUIPMENT

93 STANWELL WAY  
WELLINGBOROUGH

Telephone Redwells 2142



- ★ Portable six channel monophonic studio mixer type B1000

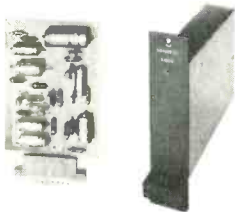

- ★ Amplifier assemblies providing microphone to line amplification, equalisation, virtual earth mixing, and high level output functions.



- ★ Studio intercommunication units and systems designed and manufactured to specific requirements.



- ★ Broadcast type jackfield assemblies.

- ★ Specialised sound equipment designed and manufactured to individual requirements.

## HIGH-SPEED TAPE & CASSETTE COPYING

large and  
small runs

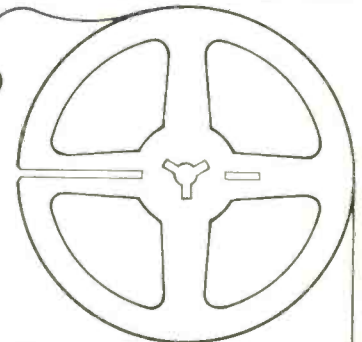

Fraser-Peacock  
Associates Limited

94 High Street Wimbledon Village  
London SW19 01-947 2233

## STUDIO INSTALLATIONS

T. B. Technical, Audio Systems Consultants, can provide engineers for planning, installation, and maintenance of all professional audio equipment.

Also

Audio Test Equipment Hire

**T. B. TECHNICAL LTD**  
38 HEREFORD ROAD, LONDON, W.2

01-229 8054



continued

on the same machine. However, there are several advantages, the most significant being the relatively low operating cost, a reel of 25 mm tape being about £10 cheaper than 50 mm. The low hourly rate of £16, coupled with the smaller outlay on tape, allow a customer recording 16 tracks to save hundreds of pounds in a week. Another advantage is that a group with a full eight track tape recorded at another studio can add up to another eight tracks using the Orange machine to replace half of each original track with a fresh one. It is unlikely that anyone would want to add another eight tracks but the facility is useful where a client wants to double-track vocals on a full standard eight track tape. Work of this kind has in fact been carried out at the studio.

Orange expect to move to bigger and better premises soon and are currently building new equipment in preparation for the change over.

Heckmondwike, situated in Yorkshire between Huddersfield and Leeds, now has a four track studio. Operated by Bill Clarke's Box Music Service, it is known as **Box Recording Studio** and is equipped with Scully recorders, a Calrec desk, Lockwood monitors, and microphones by AKG and Calrec. Four track facilities are quite rare in that area so business should be good unless musicians are equally rare. Anyone interested in using this studio should contact Bill Clarke on Heckmondwike 5681.

Coming a little further south, **Strawberry Recording Studios** in Stockport, Cheshire, are equipped with a Scully eight track recorder, a Helios desk, EMT plates, and J. B. Lansing speakers fed by HH amplifiers. Recent work at the studio has included a second album for Hot Legs and album tracks for Granada featuring Ken Goodman, star of the *Comedians* television series. The Strawberry engineers designed and built a special 14 channel mixer in four weeks, and this was used in conjunction with J. B. Lansing speakers and HH amplifiers on a Moody Blues tour. The most interesting feature of the system was the foldback circuit, an induction loop driven by two 50W amplifiers.

This allowed the group to pick up the foldback signal on small magnetic earpieces connected to nothing! I am amazed that there were no problems of unwanted pickup on the microphones or guitars but I am assured that the system works well and is so convenient that a similar foldback system may be incorporated in the studio. I'll stick my neck out and forecast that it will present too many problems for use in the studio, although I may have to eat my words.

At Wembley's **Intersound** studio, Greg Lake of ELP fame produced album material for the Visual Music Entertainment Company. Vic



French engineered sessions for Robin Goodfellow and cover work continued for Avenue and Pickwick.

Talent wanted. At **Pan Sound Studios** in Hampstead, would-be recording artists have the chance of proving their worth and joining a new record production company. On Fridays until the end of February, the studio will audition and record demo tapes for any singers, instrumentalists or groups interested in signing a recording contract. There is no charge for this service, the tapes being retained at the studio for consideration. It is expected that a large number of artists will be signed up so, if you think you stand a chance, telephone 01-328 7222 for further details.

Dave Hadfield has been working on another

Manfred Mann album at **Maximum Sound** and recently finished an album of the Crescendo steel band which has been doing very well on Hughie Green's talent show. Hog Back Pig have been in for Instant Sound Productions, Kenny Lynch produced Hocus Pocus and Elephant's Eye, and Mike Hugg completed his album.

**Sarm** (Sound And Recording Mobile) is a company established last October by Barry Ainsworth and Garry Lyons, formerly engineers at Command Studios. In Finchley, Sarm have a small studio suitable for speech and vocal overdubbing and equipped with Revox machines for mono, stereo and 6.25 mm four track work. The services offered include studio and mobile recording, production work, editing, tape copying, publicity photography, and album sleeve design. The emphasis is on providing a personal service at reasonable price. For example, tapes are copied for a charge of £4 per hour which includes collection and delivery within 24 hours in the Greater London area. Music publishers and record companies with no studio of their own are finding the Sarm service most useful. Recording costs £5 per hour and a variety of instruments are available to clients.

Barry Ainsworth supervises disc cutting and recently managed to get five titles on one 18 cm side for Avenue Recordings, one of Sarm's regular clients. Johnny Hackett's *On The Western Front* was produced by Des Champ for Sarm's subsidiary company, Sonar Productions, recorded at Chalk Farm Studios and mixed at Polydor. The B side was mixed at Tin Pan Alley Studios.

Sarm may possibly have a hit with an EP featuring hypnotist Edwin Heath talking persuasively about giving up smoking. On one side of the record, there is information on the harm that smoking does and statistics of deaths from lung cancer. Side two helps the listener relax without smoking, and should be played regularly if it is to have a lasting effect. Barry Ainsworth, who normally smoked about 20 a day, found that he smoked only one cigarette during the recording session. As he didn't listen to the record for some time, his smoking soon increased, but when he started the editing session, he stopped smoking altogether.

Sarm, who recorded this material, designed the sleeve, and are now organising the pressing and distribution, think it stands a reasonable chance of selling a million.

Further information on Sarm, Sonar and the prevention of smoking can be obtained by phoning 01-346 0209.

**Marquee** clients this month have included Mick Audsley, David Bedford, Candlewick Green, Hookey, Performin Lees, Medicine Head and Gentle Giant. A live Black Widow performance was recorded from the adjoining Marquee Club, a TV link making club recordings like this almost as easy for the engineers as ordinary studio sessions.

**Mayfair** taped the stage musical *Vanity Fair* for possible album use when the show has been  
(continued over)



**Above:** Vic French at the Intersound desk.

**Left:** Topol post-syncing English dialogue for the film *The Boys'll Never Believe It* at World Wide Pictures, St. Anne's Court.

# CTH TM 50 MK2 SERIES AUDIO MIXERS

Single or multi-output mixers with up to 40 input channels made to professional standards and incorporating the following features:

- 'XLR' input connectors
- Prefade listening
- 180° self-evident dials
- Back contacts
- 'Channel on' lamps
- Peak programme meter
- +12 dBm floating output
- 0-30-60 dB input attenuators
- 0-30 dB preset channel gain
- 30Hz-20KHz  $\pm 2$  dB

## OPTIONAL FEATURES INCLUDE:

- Tone Controls
- Extra P.P.M.'s
- V.U. meters
- Disc and tape inputs
- Limiter/compressors
- Battery operation
- Portable field units
- Rack mounting units



TM 52/5  
5 channel mixer.

CTH also manufacture a range of modular mixing units, consoles, distribution amplifiers, studio disc player units, speaker amplifiers, cable drums and many other items of studio equipment.

## CTH ELECTRONICS

Industrial Estate, Somersham Road, St. Ives, Huntingdonshire, PE17 4LS Telephone: St. Ives 64388 (0480 64388)



PORTABLE AND STATIC MIXER DESKS IN MODULAR OR NON-MODULAR FORM

CALDER RECORDINGS LTD., REGENT ST., HEBDEN BRIDGE, YORKS HX7 7DG. Phone 042-284 2159  
SOUTHERN AND SCOTTISH DISTRIBUTORS  
BEYER DYNAMIC (G.B.) LTD., 1 CLAIR ROAD, HAYWARDS HEATH, SUSSEX. Phone 51003.

### EST. 12 YEARS BRAND NEW—SUITABLE FOR ALL MACHINES RECORDING TAPES & CASSETTES

ALL TOP QUALITY 100% TESTED  
BY SUPERIOR AMERICAN AND BRITISH MANUFACTURERS  
GENEROUS QUANTITY DISCOUNTS

BASE—TENSILISED POLYESTER and PVC  
EXTRAS—NO CHARGE—FITTED LEADERS EX 3"

FREE ROLL OF LEADER WITH ALL TAPE ORDERS  
24 HOUR DESPATCH SERVICE

	St'rd Play	Long Play	Double Play	Empty Spools
3"	150' 10p	210' 11p	320' 20p	4p
4"	300' 20p	420' 24p	550' 30p	9p
5"	600' 30p	900' 40p	1200' 56p	10p
5 $\frac{3}{4}$ "	900' 37p	1200' 49p	1800' 78p	11p
7"	1200' 44p	1800' 64p	2400' 95p	12p

3" and 4" APPROX LENGTHS

### CASSETTES MANUFACTURED by EMI MASTERTAPE ALL IN PLASTIC LIBRARY CASES

C60 EMI PLAYRITE	34p	3 for £1	} 10p P/P on all orders
C90 MASTERTAPE	50p	3 for £1.45	
C120 MASTERTAPE	65p	3 for £1.90	

If any goods are found at fault in any way money refunded in full.

**SPECIAL OFFER**—EMI AFONIC LOW NOISE REEL TAPES  
and PRE-RECORDED CASSETTES AT LESS THAN HALF PRICE

CALLERS WELCOME

## WALKERS

16 WOODTHORPE ROAD, ASHFORD, MIDDLESEX  
ASHFORD S2136

**STUDIO DIARY**

continued

established in this country. Phil Coulter produced more material by the Dubliners, this time for an album, and Mike Leander produced Marianne Faithful.

**Craighall Recording Studios** of Edinburgh have gone eight track with the installation of a Studer A80 recorder, and now claim to be 'the most comprehensive studio north of the Midlands'. Local group Christyan have been in for Decca with producer Ray Horricks, and Iron Claw are completing an album for release in the spring.

Slightly closer to London, Malcolm Jackson reports from Rickmansworth that he has been organising a monster conference for Faberge. The **Jackson Recording Company** now have a complete organisation for dealing with all aspects of conferences: lighting, tape/slide presentations, film, videotape, presentation gifts, everything.

In the studio, newcomer Dave Meadows, 'a good looking lad with a strong voice,' has been laying down big rock ballads. In preparation for the Eurovision Song Disaster, music publishers have been recording demonstration tapes for submission to the Music Publishers' Association. In one week, 45 hours were spent recording material of this kind at the Jackson studio. Get well soon, Malcolm.

Engineers from the **Tooting Music Centre Studio** hired a van, installed their control room equipment, and drove to the Montague Arms in New Cross. This pub has earned a reputation for providing good entertainment and the Tooting Music Gang were there to record a



The new control room at De Lane Lea, Wembley.

blind organ player called Peter London, landlord Peter Hoyle on drums, and compere Jimmy Jones who supplied bluish jokes. When the customers found that a recording was being made, they ordered lps there and then.

Tooting are soon to install a Kellar **KDB2** Dolby B system, which will be used for recording and reducing four track tapes, but not for stereo or mono. It will be interesting to see the reaction of the Dolby A brigade.

**Atlantic Recording Studios** now operate at their new and larger premises in Marlborough Street, Dublin, and Tony Russell informs me that they hope to install four or eight track equipment fairly soon. Atlantic customers have included Horslip, WE 4, Burnett Jenkins, Fantasy, the Wheels, and the Gentry.

In Nashville, Tennessee, Jack Clement has been working in his new studio, an expansion

of the **Jack Clement Recording Studio** complex in Belmont Boulevard. In order to get a different feel about the studio, and to get away from the 'cold, efficient, recording studio look', JC brought in Jim Tilton who designed the sets for the Broadway production of *Oh Calcutta*. The studio was divided into several different areas with their own individual moods, and the control room was furnished with an assortment of antiques and other fixtures ranging from a turn-of-the-century pierced teak Indian sofa, to a marble fireplace, an antique gas chandelier, various carvings and other furniture.

The studio is acoustically dead, and suitable for small group recording. The desk has been designed for quadrasonic working and each microphone channel has been provided with a 360° panning control, rather than having panning on just the four master channels.

**STUDIO MIXER**

continued

load to full load we must restrict the maximum number of 47 kΩ resistors to four. This is not such a terrible drawback as might be thought at first. Bearing in mind that it is unusual to route to more than one group at a time anyway, we can make use of the fact that we never want to route Pan A and Pan B to the same group simultaneously. It is not an onerous restriction

to limit the two Pan outputs to alternate groups as shown in fig. 10.

We customarily route Pan A to odd-numbered groups and Pan B to even-numbered and in this way we do not seriously restrict the number of output groups that can be driven by this means. Personally, I would be quite prepared to use such an arrangement to operate 16 groups because the likelihood of wanting to route the same Pan output to more than four

groups at any one time is very small.

This completes what we need to say about the mechanics and electronics of routing, and in next month's article we shall go on to consider the great PPM versus VU controversy and deal with other aspects of the monitoring of output signals.

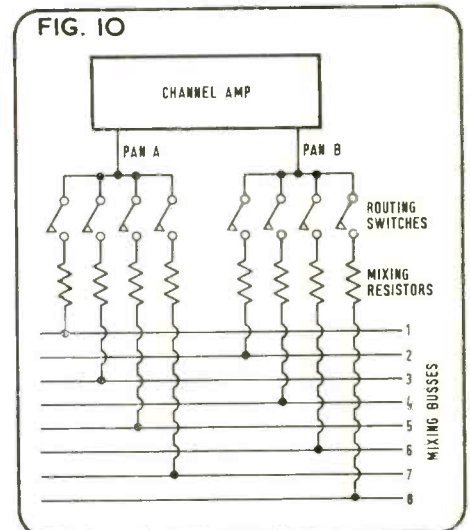
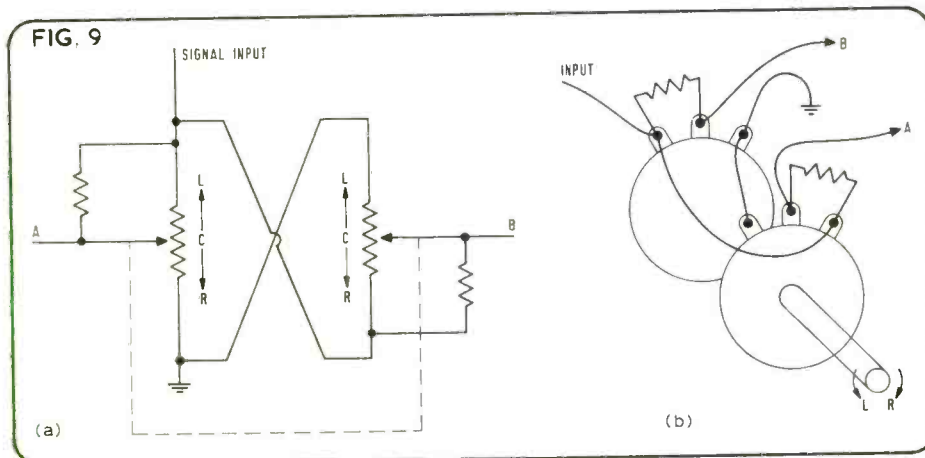

# LIMITERS

## THEIR APPLICATION by Michael J. Beville\*

**L**IMITING, compressing and expansion form part of a wide and ever increasing field of level control techniques. These techniques play vital roles in telecommunications, broadcasting, sound reinforcement and our own special area of interest, that of sound recording on tape, disc and film. Until recently such techniques have been exclusively used by the professional engineer; now increasingly we are finding such systems applied to the domestic equipment scene, notably noise-reduction techniques spearheaded by Ray Dolby. Automatic gain control (agc) is increasingly found on domestic recorders, both mains and portable. This is not new to the business world; dictation machines have been equipped with this facility for many years.

The purposes of level control systems may be summarised under the following headings:

1. *Overload protection:* In order to optimise signal-to-noise ratio and maintain the widest possible dynamic range on a given recording medium, a limiter can be inserted to operate just prior to the onset of significant distortion. Thus the necessity to maintain large overload margins is obviated, enabling a more efficient use of the material plus the added protection from accidental overload.

2. *Increased loudness:* While the ear has a dynamic range of nearly 120 dB, this is a far cry from the capabilities of audio recording and reproducing systems. These probably vary from about 10 dB for a car radio (taking into account high ambient noise) to 60 or 70 dB in a high quality channel reproduced under ideal conditions. While wide dynamic range may be an essential requirement for the enjoyment of orchestral music, it would be undesirable in areas where the ambient noise is by comparison

considerable (e.g. in factory, restaurant, cinema and public address situations). Under such conditions the signal must be compressed so that the quietest level is audible above the background noise without the loudness of reproduction being unacceptable for the given situation. Background music, for example, must be reproduced quietly yet should at all times be audible enough to be intelligible. The key to the success of the Pop industry lies in an ability to engineer loudness and impact. The limiter compressor has made this possible.

3. *Automatic gain control:* This is used in business and domestic recording systems where wide changes of input level must be accommodated. Such devices are normally relatively slow acting with longish release times.

4. *Noise-reduction systems including compander, expander and noise-gates:* Such devices provide attenuation of low level noise, including print-through and crosstalk, and in some cases, increase dynamic range.

5. *Special effects:* Devices such as de-essers (for reducing sibilants); 'voice-over' and 'ducking' (as favoured by the disc-jockey); peak-inverters and dynamic equalisers (for optimising loudness in the broadcast medium). Such specialised devices evolved to meet the varying individual problems in the field.

A short period of operational experience in sound recording is enough for one to realise the essential nature of level control equipment, particularly in the form of the limiter and compressor. Few would dispute that the evolution of the Pop scene has been responsible for the phenomenal growth of the recording industry, or indeed that it was to a great extent the recording engineer, whose skilled use of such devices enabled sounds of considerable

impact to be cut on to disc. It is ironic that there has developed a sort of 'feedback' situation where fans and performers, perhaps even producers, are having their hearing impaired through getting a kick out of sound; then demanding a higher sound level as their hearing deteriorates in order to achieve the familiar thrill. And it is the balance engineer, to whom sensitivity of hearing is so vital, who too often must submit to dangerous monitoring levels.

With a limiter in the chain, the disc-cutting engineer can relax; the film recordist can be confident of a usable first take; in the tv studio the sound engineer can handle unpredictable live shows with more certainty, the transmitter engineer can take his eye off the ppm, and the balance engineer achieves remarkable and impressive sounds, especially since he doesn't have to watch all 24 meters at once.

### Design basics

The limiter-compressor is primarily a linear audio amplifier with a variable voltage controlled attenuating element. In the past, this element was the variable mu valve, a balanced diode bridge, or even the photocell. Currently the most favoured is the field effect transistor. The modern equivalent of the photocell is the photo diode. All these devices have a non-linear voltage resistance relationship, which means that units are mostly designed as feedback systems (the control voltage derived from the output, rather than 'feed forward' derived from the input). Non-linearities are thus automatically corrected within the feedback loop and accurate control of various slopes is possible.

Distortion is largely second-harmonic and naturally this is very dependent on signal level

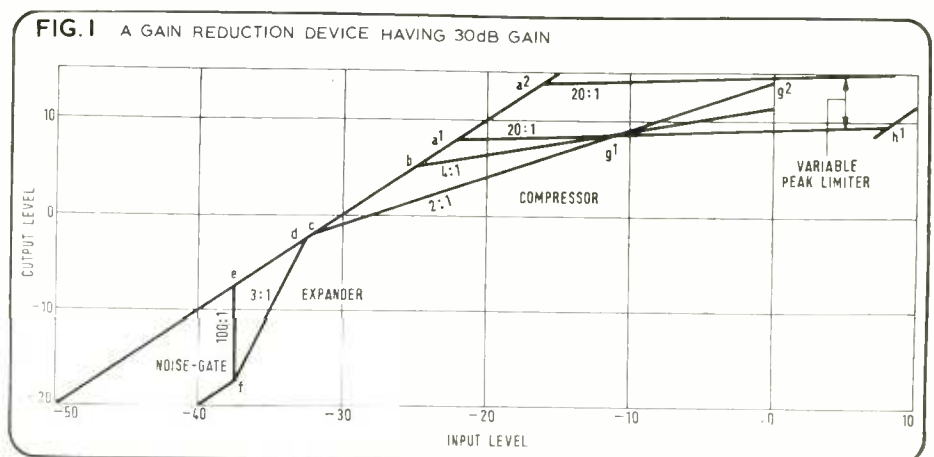

\*In 1956, Mike Beville formed his own recording business, specialising in disc cutting. He was elected to the APRS Executive Committee in 1958 and has remained a committee member since that date. He has been actively engaged in the production of limiters and compressors since 1965 and is currently managing director of Audio & Design (Recording) Ltd.

# S & COMPRESSORS

## ND OPERATION

across the device. With the fet, selective feedback enables this distortion to be reduced by as much as 20 dB, to around 0.1 per cent with good signal-to-noise ratio.

If the amplifier is designed purely as a limiter, it could have unity gain, but amplification will be essential if compression is required.

### Definitions

At this point it may be as well to agree upon and define the terms used in describing limiting and compression.

*Gain reduction* (often referred to as *compression*) is the amount of attenuation occurring at any given moment. This is usually indicated by meter calibrated in dB.

*Control range* (or *compression range*) is the amount of attenuation possible in a given condition prior either to the onset of a different action (e.g. with a peak limiter) or the return to a linear slope. In fig. 1, a<sup>1</sup>-h<sup>1</sup> shows a control range of 30 dB prior to return to a linear slope; c-g<sup>1</sup> shows a control range of about 26:13 (i.e. at a slope of 2:1), 13 dB gain reduction, prior to the operation of the peak-limiter along the slope a<sup>1</sup>-h<sup>1</sup>.

*Compression ratio* or *slope* describes the degree of attenuation for a given input signal level. Thus a 2:1 slope indicates that the output rises at half the rate of the input. An increase in input level of 20 dB will thus appear at the output as 10 dB. A ratio of 20:1 is clearly a 'tighter' slope since the output only rises by 1 dB for every 20 dB increase at the input. This would normally be referred to as a limit slope.

*Threshold* is the point at which gain reduction begins to occur and, for convenience of measurement, this is usually said to be the point at which an attenuation of 0.5 dB has taken place. It is clear from fig. 1 that the 2:1 threshold must be lower than 20:1 threshold; it will also be noted that the amount of gain reduction is determined by the threshold points relative to the required output level on a given slope.

*Attack time* is the duration taken to control/attenuate an input signal which exceeds the threshold level of the selected compression slope. It can otherwise be described as the 'overshoot duration', or how much the device lets through prior to bringing it to either its proper static level or within a defined point of the static level. For example, the CCITT definition quoted in BBC *Monograph No. 70* is for a given threshold overshoot at the input (12 dB in the BBC tests), to be attenuated by 4 dB. This is chosen since, on the linear scale of an oscilloscope, 4 dB represents a point midway between the initial and final amplitudes.

Some manufacturers qualify their attack time by stating it referred to frequency (e.g. 20 dB overload at 20 kHz is controlled within one cycle to its final static output). Fig. 2 shows waveform envelopes of attack effects.

*Release time* is the duration taken for the device to recover to its quiescent linear slope with no gain reduction occurring. For convenience this is usually stated as the 'CR' time, or where the gain has recovered to within 4 dB of its unattenuated state. When a release network involves a complex series of release-times, in one position, this is sometimes described as 'programme controlled', 'automatic' or 'multiple network'. The release time varies with the period of gain reduction. This often involves quite fast release times on top of slow recovery (sometimes described as a 'platform'). Release greatly affects the moment to moment gain reduction characteristic and thus overall mean programme level (see fig. 3, referred to later). The speed of fall of the gain reduction meter usually gives a visual indication of release time.

*Tracking* refers to the matching or otherwise of gain reduction characteristics when linked for stereo operation. Each controlling element must have identical or similarly shaped voltage/resistance characteristics. If this is not the case, one channel could attenuate the other to below its proper level, giving worse image shift than with unlinked units.

*Limiting* implies the use of a level control unit as an overload protection device: its purpose being to limit transients which exceed the predetermined level (peak output). It will not markedly affect the dynamic range of the input signal since gain reduction, when it does occur, will be momentary and of a relatively

low order of magnitude. Fast release times will be used so that transients are punched down without apparently affecting programme content. A tight compression ratio greater than 10:1 would be used.

*Compression* is used in describing conditions of continuous gain reduction; thus the dynamics of the original material are said to be 'compressed'. The compression ratio selected may be anything from the 'softest' to the 'tightest' slope, dependent on the effect required. When it is desired to preserve some reasonable relationship with the original, dynamics ratios of 2:1 or 3:1 might be used. In the production of Pop, tighter ratios are often preferred along with fast release times and considerable gain reduction in order to obtain higher mean levels approaching 100 per cent continuous modulation.

*Peak clipping* is used in some systems whereby initial transients are actually clipped without gain reduction taking place. A limiter just under the clipper is meanwhile beginning to operate and transients exceeding, say, 1 ms cause gain reduction to occur.

*The peak limiter* is designed specifically to handle transients. It would have fast attack and release times and may operate on top of a compressor.

*Compressor-limiter*. Such a term would probably describe a unit providing a range of compression ratios from 2:1 or less to 20:1 or greater. The latter ratio would provide the limit slope.

*Compressor*. This would probably be a unit having a fixed slope or attack characteristics which were unsuitable for limiting.

*Expander*. In the context of limiter-  
(continued on page 31)

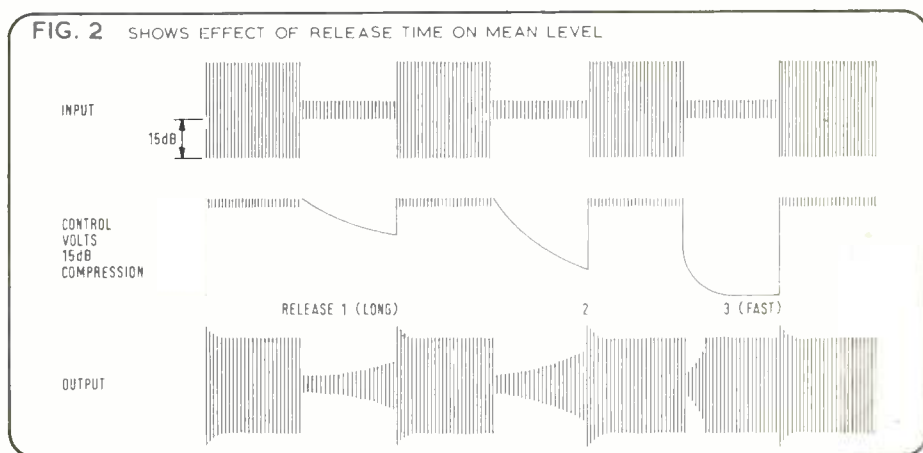

Ambiophonic Unit

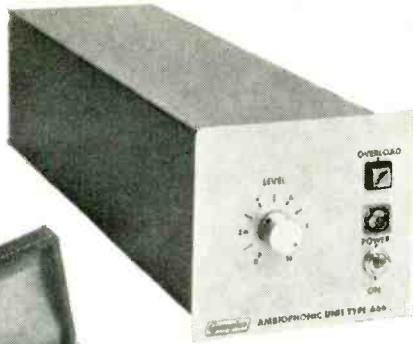

Studio Ribbon Microphone

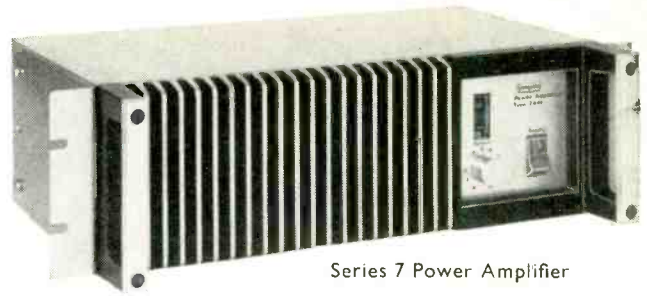

Series 7 Power Amplifier

## Three Units of Distinction by

# Grampian

These and many others manufactured by the company with forty years experience in sound products.

**Grampian**  
SOUND EQUIPMENT

**GRAMPIAN REPRODUCERS LIMITED**  
Hanworth Trading Estate, Feltham, Middlesex.  
Telephone: 01-894 9141.

JACW/X.138

(AMA1)

## APOLLO ELECTRONICS

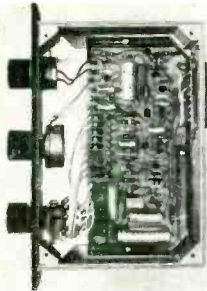

COMPRESSOR-LIMITER  
plug-in unit  
model CL 36

- ★ 36 DB COMPRESSION CAPABILITY  
No meter can read that much compression  
Virtually impossible to overload the input
- ★ SMOOTH AND NOISELESS ADJUSTMENT OF THE COMPRESSION RATIO CONTROL  
It can be adjusted during recording session
- ★ WIDE RANGE OF THRESHOLD LEVELS  
To meet every possible application
- ★ VERY LOW OUTPUT NOISE AND DISTORTION  
They are measurable but not audible
- ★ UNITY GAIN FOR SIGNALS BELOW THRESHOLD  
It will not affect your noise reduction system because it does not expand below threshold
- ★ VERY SENSIBLE PRICE  
To meet everyone's pocket
- ★ AND THERE ARE TEN MORE PLUG-IN UNITS TO MATCH WITH IT IF YOU WANT TO BUILD A MIXER

**96 MILL LANE, LONDON N.W.6**  
Telephone: 01-794 8326

## DISTORTION METER

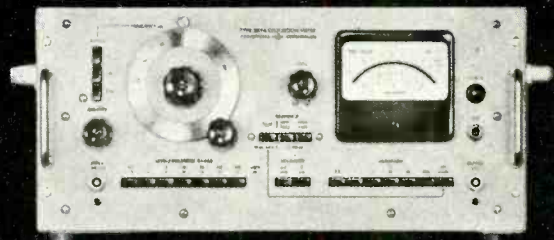

The **RADIOMETER** Type BKF6 Distortion Meter provides a simple but highly accurate means of measuring the percentage distortion of signals within the audio-frequency range. The fundamental frequency range is 20 Hz to 20 kHz, but the range of the amplifier and rectifier circuits extends from 10 Hz to 300 kHz, so that all frequency components within these limits are included in the distortion measurement. The built-in rms meter ensures that all measurements are to CCIF standards and it indicates the distortion directly in percentage figures. Readings from 0.01% to 100% are readily obtainable and at £286 this instrument must represent exceptional value to all quality conscious design engineers. For further information contact:—

**ALLIED INTERNATIONAL CO. LTD**  
59 Union St. London. S.E.1. Tel. 01 407 4567

continued

compressors, this would refer to low level expansion where gain reduction takes place at low levels increasing in attenuation as the input level reduces. Fig. 1 (d-f) shows that, as the input falls from -32.5 dBm to -37.5 dBm, a 5 dB change, the output level changes by 15 dB. Below f the slope is linear and 10 dB of attenuation is maintained. The purpose of this is to reduce apparent noise level on the input due to compression. The threshold point d would be variable along with the amount of attenuation. The slope shown is 3:1 but a softer slope would produce a more subtle effect.

**Noise-gates.** These are switched attenuators operating at a pre-determined low threshold. The operation time can be varied but in practice they do not seem to be popular with engineers nor as satisfactory as the expander with its softer slope (see fig. 1 (e-f)).

**De-essing.** The use of a limiter dynamically to attenuate sibilant transients. This is usually achieved by special equalisation in the side-chain of the unit.

**Side-chain.** That part of the limiter/compressor which amplifies, rectifies and produces the dc control voltage from the audio signal. This in turn determines the operation of the gain controlling element. The side-chain also determines compression ratio and threshold levels.

In selecting a limiter-compressor or any other level control device, the prime consideration must be whether it works well without audible side-effects. Since these are dynamic devices, no specification can inform you exactly how it is going to behave in operation. Fig. 3 shows various attack characteristics. It is probably the way in which a device handles initial transients more than any other aspect which determines the acceptability and effectiveness of a given unit. Thus we have the idea that the only way to choose a unit is to have it on trial for evaluation in service. In fig. 3, a and b show good waveform envelopes; 3a with the longer attack is likely to sound slightly fuller than 3b, which will give a tighter sound. Fig. 3c, d and e are examples of poor attack which will be apparent to the ear as a constricted sound (c and d) and odd effects will occur with e.

The next consideration will probably be simplicity of operation: if it does what we want, can the engineer, once familiar with it, use it quickly with a minimum of knob twiddling? In designing units it is easy to get carried away and produce a comprehensive unit that fulfils every function under the sun. When it is finally in operation, it more likely remains in one place with one setting, those involved never really having time to master it. With 16 and 24 track 32 channel desks, engineers have enough to handle without an extra ten variables per channel. At the other extreme, one can find units with fixed everything. In general, considerations of capital expenditure dictate reasonable versatility, especially in choice of insertion points.

In most arrangements, gain reduction equipment operates at line levels, i.e. between -10 and +10 dBm, units being inserted between mixer and recorder or on individual channels or groups. Usually the level in a desk prior to

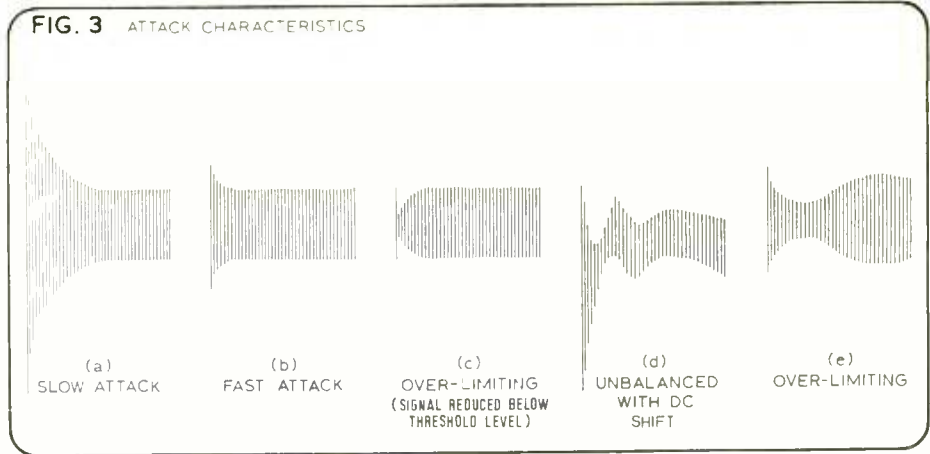

mix will be about -10 to 0 dBm. From the point of view of obtaining compression it will be seen that, in order to have gain reduction of 15 dB from a level of -10 dBm, the compressor will need 33 dB of gain in a unit designed to operate at +8 dBm output. Most devices must operate at this sort of output level (even if they are attenuated after) in order to maintain optimum signal-to-noise ratio. Gain therefore is a vital factor in selecting a device.

Units evolved for film and broadcast work have an arrangement whereby the output is attenuated as the input is increased. There is a common threshold point for the different compression ratios. While below threshold the output is maintained at unity gain. As gain reduction takes place, the output level will change with different ratios and some adjustment may be necessary.

An alternative arrangement (shown in fig. 1) has proved popular with recording studios. In this, compression threshold is switched with the ratio so that, for 12 to 15 dB of gain reduction, the output levels remain constant when ratios are changed, the output attenuator having been set up on limit level to suit the following equipment. In this way, besides being more convenient, an optimum noise-to-distortion compromise is maintained on all ratios. Thus the operator has only to select the ratio and increase the input gain control until the amount of compression required is indicated. If the unit is switched out of circuit, the uncompressed signal remains peaking to the same level.

While variable attack time may be considered something of a luxury (and perhaps an added complication by some) it can be extremely useful to be able slightly to increase attack-time when using tight limit ratio, coupled with high gain reduction and fast release time (the worst combination). By being able to increase the attack time, one can obviate transient distortion and extend the usefulness of the device. Interesting effects such as 'pumping' can also be obtained in the above condition, with slow attack.

Distortion at low frequencies is a function of release-time. Where the frequency is such that the unit is attacking and releasing on each cycle, some flattening of the cycle will be visible. This will be worst, again, in settings of high gain reduction coupled with fast attack and

release along with a tight limit slope. On most units release times range from about 50 ms to 3s. Some units provide a 'programme controlled' or 'automatic' position. In order to obtain high mean programme level, fast gain change is essential. Fig. 2 shows the effect of release time on mean level, or loudness. Fig. 2a shows the input which is being periodically increased by 15 dB. Fig. 2b shows the control voltage, the falling curve being the recovery time. During this period, the gain of the unit will be increasing by up to 15 dB when fully recovered. In fig. 2c the output is shown. With 15 dB compression, the lower signal level can be brought up to peak modulation when the compressor is fully recovered, and it can be seen how the release time determines the moment to moment gain changes, and therefore effective loudness. In an 'automatic' release position, the moment to moment gain change may be fast over about 6 dB whereupon it changes to a longer recovery time. This is sometimes more acceptable to the ear, reducing modulation and 'breathing' effects.

Where a unit incorporates a range of compression ratios with a separate limiter operating above them (fig. 1, a<sup>1</sup>-h<sup>1</sup>), while this may be preset at +8 dBm, useful additional coverage can be moved relative to the compressor a<sup>1</sup>-h<sup>1</sup> to a<sup>2</sup>-h<sup>2</sup>). (h<sup>2</sup> is a point where the line from h<sup>1</sup> and that from a<sup>2</sup> intersect.) Not only is the range of compression control extended on any one slope, but higher mean levels can be obtained by using slow attack times on the 2:1 or 3:1 slopes with peak limiter high above it.

Thus it is my opinion that there is a necessity for input gain control, compression/threshold control, release and attack, an output control (which could be preset) and, with peak limiter-compressor, a limiter threshold control.

From the point of view of minimal noise, it is preferable for compression to be effected on a direct signal prior to going on tape. The reason for this is that compression worsens the signal-to-noise ratio of the signal being processed. For every dB of gain reduction, the noise level on the input signal is brought a dB higher (with reference to peak output level) when the device recovers. Signal-to-noise on a good mic channel can be from 75 to 85 dB and can afford some deterioration; whereas tape starts off some 10 to 15 dB worse than  
(continued on page 33)

# Audio Engineering for Professionals

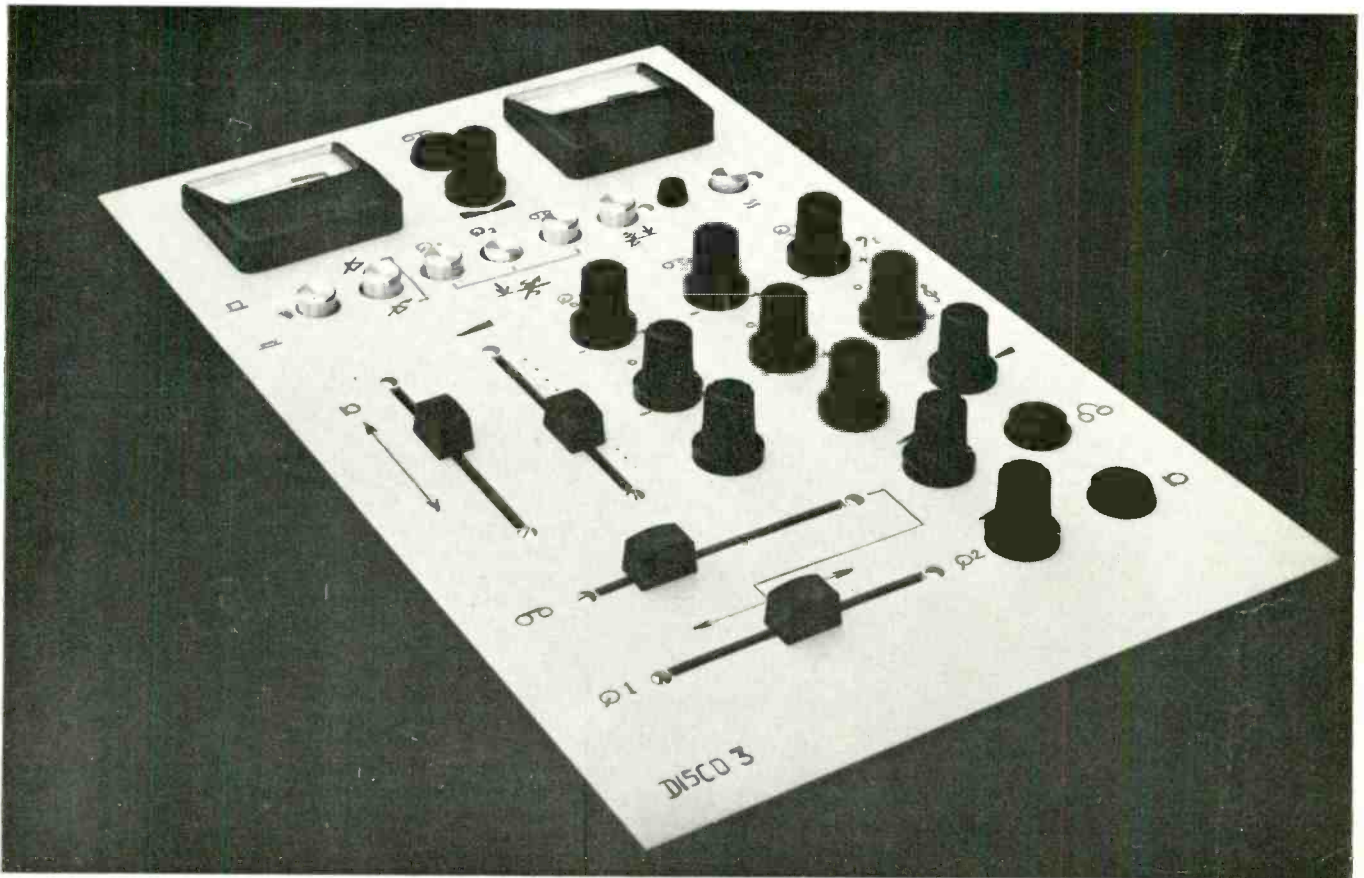

Four years ago, only a handful of people had heard of the Millbank Electronics Group. Today, our equipment is operating in 25 countries and is specified by most major professional users of audio and communications equipment in the United Kingdom.

Why?

We think the simple answer is that we give our customers exactly what they want. And we're just as anxious to satisfy the small firm round the corner as we are to help the big company.

When Millbank Electronics was formed, but before it started to make anything, we took the trouble to talk to professional sound and recording engineers, and DJ's and listen to their problems. They told us exactly what they wanted; we went away and made it. And that's precisely what we've been doing ever since.

Everything we make is carefully engineered to give a specific performance—and meet a definite need. Take, for example, our new Disco 3 professional sound mixer. It is based on our very successful Disco 2 model, but incorporates several major new refinements. For instance, it offers stereo reproduction, as well as mono, and has full audio/visual monitoring, pre-fade and post-fade, of all inputs and outputs, except microphone. That's something many sound engineers and DJ's have wanted for years.

These are some of Disco 3's other important new features:

- \*Switched audio limiters
- \*Twin peak reading VU meters
- \*Brand new styling—vapour blasted stainless steel fascia with matt black knobs and fittings
- \*Automatic or manual music/microphone fade to any selected level
- \*Compact, rugged printed circuit construction
- \*Low distortion, high signal-to-noise ratio, wide frequency range and full bass and treble tone correction
- \*Fully floating outputs, free of earth, to avoid hum loops
- \*Front panel microphone input mutes rear connected socket
- \*"Jingle" tape input on front panel mutes rear connected socket
- \*DIN standard construction and terminations
- \*Twin AC switched outlets for turntables, amplifiers, etc.
- \*Stabilised power supply.

Disco 3 has been designed and manufactured specifically for professional sound engineers—the people we're in business to help. For a full technical specification of this new development in sound mixers, please telephone or write to our General Sales Manager, Bernard Skinner.



Millbank Electronics Group,  
Bellbrook Estate, Uckfield, England.  
Tel: Uckfield 4166 (0825-4166)



continued

this, and more than 10 dB of gain reduction is likely to be noticeable.

Where the degree of compression required exceeds say 10 dB, it is essential to select carefully instruments grouped through any one compressor. In a complex of instrumental sounds it will be noticed, as gain reduction is increased, that a dominant instrument will modulate the rest of the signal, and the compression is easily detected. By separately compressing each sound source, or by grouping similar sounding sources, considerable compression is possible without being apparent. Any mixer design must therefore provide various insertion points along each channel and group, at a level of around 0 dB to ensure maximum gain reduction potential.

Compressors can be used before or after equalisation. Since limiters are used to provide overload protection, any equalisation boost following would alter the peak output at those frequencies. Filtering or attenuation of frequencies is in order since this would reduce level below the limit output.

If vu's are used for recording level indicators in association with a limiter, it will be noticed that, if lined-up for 0 vu from a tone at limit level, subsequent programme level is likely to appear some 6 dB lower on the meter, even with some limiting taking place. As one increases the amount of gain reduction and shortens the release time, so the vu will come closer to the 0 vu point. Viewed on a ppm or oscilloscope, it would be clear that in fact the output level is actually reaching and probably slightly exceeding the steady state 0 vu indicated on the line-up tone. If you were to observe your normal peak level when recording to 0 vu without a limiter in circuit, you may be surprised to see that peaks are exceeding the steady-state line-up tone by anything from 10 to 15 dB.

If you have a calibrated input control to the recording amplifier, or have the equipment to make such a calibration, this would enable you really to know what level you are putting on tape, irrespective of the vu's antics. With a distortion measuring unit, establish for yourself the levels of distortion with the given tape combination you are using. Let us assume you discover that an increase of 6 dB over 0 vu represents three per cent; and 8 dB is five per cent. Line up on 0 vu, then increase your calibrated recording amplifier input by 6 dB. You will now know that peak level is three per cent distortion, whatever happens in front of the limiter. Experiment with differing programme material and increasing amounts of gain reduction. You may find that the limiter can be operating at the five per cent level without any problem; of course if gain reduction is considerable at this point (using the limiter as a compressor) then a greater proportion of the signal will be reaching the higher distortion levels. This will also apply if the input signal is already well compressed. However, with experience it is a simple matter to lower the recording input level to a different distortion setting.

The net outcome of this should be the maintenance of good recording level without

distortion, coupled with improved signal-to-noise and a real certainty about what is happening. As a rough guide one should be able to reach 0 vu on programme material without any difficulty with the limiter in circuit.

*Voice-over or ducking:* There are several methods of effecting 'voice-over' music but the optimum is what I have called 'music-to-voice ratio control' which consists of a standard limiter amplifier with a second lower voice-operated threshold. The position of the lower threshold is predetermined (say 15 dB below the normal peak limit threshold). The music channel will normally be peaking to the limit level (+8 dBm) or may even be more extensively limited. When the announcer speaks, the limiter switches to its lower threshold level and gain reduction increases by 15 dB, the output now being -7 dBm. The advantage of this method over others is that, if the operator were fading the music or it was fading at the end of a track, when the voice threshold operated it would only attenuate the music further by the amount it exceeded the -7 dBm threshold. If below that level, it would not be further affected. Thus an optimum music-to-voice ratio can be established. With the unit continuously in circuit, it would be automatically maintained whatever the operator did.

Another method of obtaining 'voice-over' is by the use of a double compressor where the control voltages are linked. Music is fed through one, peaking to limit threshold. Announcer's voice is sent to the other (the output from this unit is not necessarily used for transmission or the final mix). The voice is compressed by say 15 dB. When the two units are linked via their control volts, attenuation is of the same order effected on the music channel (if reasonably matched). If one is able to accept the announcer's voice compressed by the amount required (e.g. 15 dB) then it is possible to use one unit. Music is fed through the limiter peaking to threshold and the announcer's voice then mixed at the input to a level 15 dB higher than the music. Limiting occurs and the voice is attenuated to limit output level, the music being reduced by the same amount beneath the voice.

The slight drawback of both these methods is that, if music is being faded or is fading naturally, this is not taken into account and the full amount of attenuation is always applied reducing it at times below audibility.

In compressing stereo signals, the gain must change identically on both channels, otherwise the sound picture will shift continually by an amount dependent on the degree of compression and the inherent difference between the channel signals.

To provide matched reduction on both channels, it is usual to link units by their control voltages. Tracking of the gain reducing elements within their own feedback loops must effectively be identical with respect to the common link point of the two units. Any difference here could result in one unit being attenuated below its proper level, giving image shift.

One method of reducing the effect of slight tracking errors is to matrix the signals as sum and difference before compression. Any tracking error will then appear as varying width rather than image shift.

While one can get away with unlinked stereo

limiting by only operating on fast transients with a fast release time, one should ensure that for serious stereophonic work the two units are well matched over a range of 15 dB or so. The way to check a pair for matching is as follows:

Insert identical input signals below threshold level (mono sine wave is best). Check that output levels are identical (it is probably best to open fully any input or output attenuators and control signal level from the generator). The output can be monitored on a double beam oscilloscope and a millivoltmeter which could be switchable to either channel. Ensure that the same compression ratio is selected on both units along with similar attack time. Release times can be identically set, although the mean CR time operates where there are differences of setting on linked units. Having established stereo gain compatibility, increase the signal output to a point where gain reduction commences. The voltage control circuits of both units should have been linked and, as one increases the input signal and gain reduction, the output of both units should remain identical throughout the required range of control. Any deviation or difference will reflect mismatch of tracking. A tolerance of  $\pm 1$  dB would probably be considered acceptable. Greater deviations can be due to differences of threshold point, of compression slope as well as the control elements.

For simple stereo use, threshold level and compression slope must be switched to make for accurate operation. The availability of ganged input and output attenuators would also be an advantage.

Modulation effects can easily be produced by a control voltage derived from a unit compressing another sound. This could be voices, instruments, sine wave or square wave; the possibilities are almost infinite. Equalisers of unity gain can be inserted in the side chains to alter dynamically the balance of certain frequencies. In an age where producers are looking for that something 'different', compressors still hold the key to many interesting possibilities.

### Summary

Limiters and compressors are vital tools in the recording industry. While in some contexts (e.g. broadcasting), a case can be made for designing 'operator-proof' units, this greatly reduces flexibility and is quite unacceptable in the recording studio. Here the purpose may be the creation of new musical experience. Versatility in equipment is essential, along with increased operator responsibility necessary to work it properly. Achieving the best from these devices is very much dependent on operator skill, based on a firm understanding of what is required in a given situation along with an ability to visualise how the unit can best be applied. It is well worth spending some time looking over the principles involved in gain reduction, relating the unit one has to these, and familiarising oneself with all aspects of operation on a wide range of programme material. In doing this, visualise what is happening technically and associate this with changes in audible effect. Such initial efforts will pay off handsomely in the subsequent ease and skill of operation that is the hall-mark of the virtuoso balance engineer.

# LEVEL CONTROL EQUIPMENT

The F600—one of the finest LIMITERS ever . . .

The F700—a superb COMPRESSOR second to none . . .

NOW WITH THE BEST OF BOTH . . .

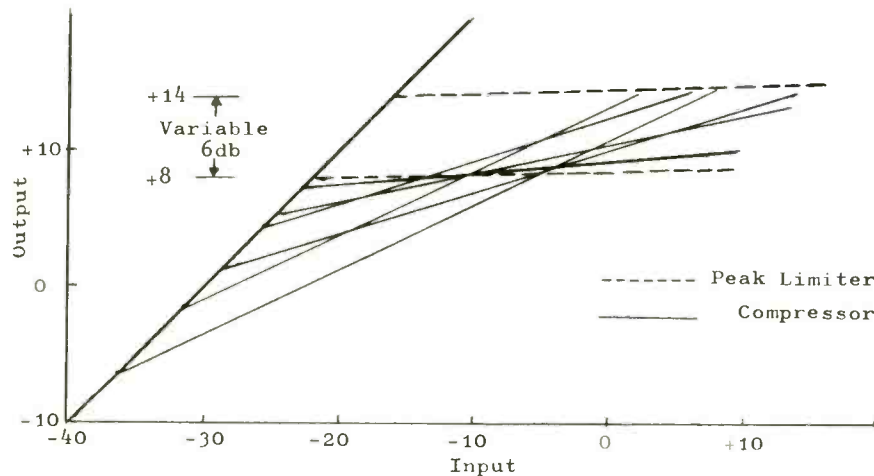

## The DYNAMIC F760 PEAK-LIMITER COMPRESSOR

- ★ FAST PEAK LIMITING—*Variable Threshold* over
  - ★ SMOOTH ACTING COMPRESSOR—*Switch Ratios from 2:1 to 10:1*—*Switched Attack from 250μS to 25mS* with
  - ★ RELEASE-TIME *from 50mS to 3.6S plus* AUTOMATIC PROGRAMME CONTROLLED *position, reducing modulation effects on high gain reduction,* and of course
  - ★ LOW DISTORTION—EXCELLENT SIGNAL-NOISE RATIO
- = HIGHER MEAN SOUND LEVELS *with transient control and minimal side-effects.*

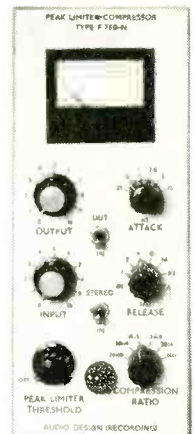

F760-N

STANDARD FORMATS

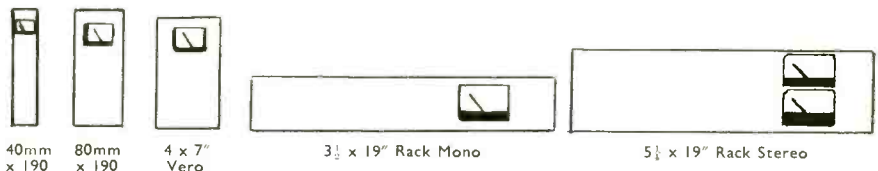

- ★ STEREO & QUADRAPHONIC MATCHING *available to close tolerances.*

## AUDIO & DESIGN (RECORDING) LTD

St Michaels, Shinfield Road, Shinfield Green, Reading, Berks. Tel: 0734 84487 (Reading)

# Survey: Audio Processors

## ALICE ELECTRONICS BD6 LINE LEVEL PEAK LIMITER

**Input:** Unbalanced 10 k $\Omega$ . Nominal 0 dBm. Threshold normally set at -8 dBm.  
**Output:** Unbalanced 5 ohms. Nominal 0 dBm. Maximum gain 26 dB.  
 Input and output suitable for 600 ohm bridging.  
**Controls:** Input gain (threshold); Output level; Release time pot.; Illuminated meter measuring compression in dB, 30 dB max; Illuminated pushbutton limiter in/out sw.  
**Connections:** Gold plated 16 way Cannon plug and socket.  
**Mounting:** Push/twist fastener for mounting rail provided. 483 mm rack mounting chassis available to take up to nine modules.  
**Power requirement:** 24V neg. earth stabilised.  
**Frequency response:** 30 Hz to 30 kHz  $\pm$  1 dB.  
**Noise level:** Approx 74 dB below 0 dBm (20 Hz to 20 kHz).

**Distortion:** within 0.25% at 10 dB limit, 1 kHz.  
**Attack time:** within half a cycle at all frequencies.  
**Release time:** Variable from 0.1 to 3s.  
**Limit ratio:** approximately 25:1.  
**Stereo matching:** Stereo linked pairs are available.  
**Dimensions:** 47 x 152 x 152 mm.  
**Price:** £78.

## ALICE ELECTRONICS BD7 COMPRESSOR/LIMITER/NOISE GATE

**Input:** Unbalanced 10 kohms.  
**Output:** Nominal 0 dBm unbalanced. 5 ohms impedance.  
**Controls:** Input level (threshold); Release time; Ratio sw.; Noise gate in/out sw.; Suppression depth control; Illuminated meter measuring gain reduction in dB up to 30 dB fsd.  
**Connections:** Gold plated 16 way Cannon plug and socket.

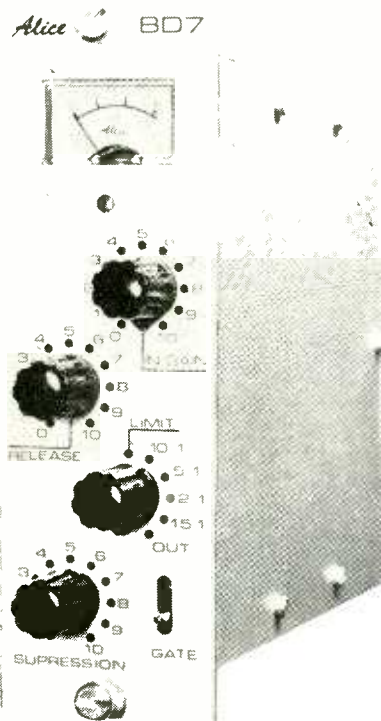

**Mounting:** Push/twist fastener for mounting rail provided. 483 mm rack mounting chassis available to take up to nine modules.

**Power requirement:** 24V neg. earth stabilised, 70 mA.

**Frequency response:** 30 Hz to 30 kHz  $\pm$  dB.

**Noise level:** -70 dB relative to output (20 Hz to 20 kHz).

**Distortion:** Less than 0.15% for all degrees of compression and at all ratios, at 1 kHz. 0.08% at 10 dB, 1 kHz.

**Attack time:** Within half a cycle at all frequencies.  
**Release time:** Variable from 0.15 to 3s. Transients within 0.1s.

**Compression ratio:** (nominal) 1.5:1, 2:1, 5:1, 10:1, limit 20:1.

**Stereo matching:** Stereo linked pairs are available.  
**Dimensions:** 47 x 152 x 152 mm.

**Price:** £125 ex works.

## ALICE ELECTRONICS CROSSTALK and NOISE SUPPRESSOR

Reduces the level of residual noise between instants of high level programme. The noise under the high level signal is effectively masked by the signal, thus improving the apparent signal-to-noise ratio.

**Input:** Unbalanced to 10 kohm (suitable for 600 ohm line bridging) Input variable from -20 dBm (100 mV).

**Output:** Nominal 0dBm unbalanced 5 ohms (Suitable for 600 ohms line bridging) Maximum overall gain 26 dB. Max output before clipping -18 dBm.

**Controls:** Input gain, (linear fader); suppression depth (4 way pushbutton sw. Settings—bypass, 1 to 9 dB max, 2 to 14 dB max, 3 to 22 dB max); illuminated VU meter. 0 VU=0 dBm output sinewave.

**Connections:** Gold plated 16 way cannon plug and socket.

**Mountings:** Push/twist fastener for mounting rail provided. 483 mm rack mounting chassis available to take up to four modules.

**Power requirements:** 24V neg. earth stabilised 70 mA.

**Frequency response:** 20 Hz to 20 kHz  $\pm$  1 dB.

**Noise level:** 70 dB below nominal output (20 Hz to 20 kHz).

**Distortion:** Within 0.08 thd at 1 kHz at rated output.

**Stereo matching:** Not required.

**Dimensions:** 92 x 152 x 152 mm.

**Price:** £93 ex works.

**MANUFACTURER & DISTRIBUTOR:** Stancoil Ltd., 15 Sheet St., Windsor.

## ALLEN & HEATH A34 LIMITER MODULE

**Input:** Continuously variable from -30 dBm at 10 k $\Omega$ .

**Output:** Cont var from -6 dBm at 1 k $\Omega$ .

**Attack:** Cont var from less than 5 ms.

**Release:** Cont var from greater than 1.5s.

**Distortion:** Less than 1% at all levels.

**Limiting action:** Holding greater than 30 dB within 3 dB.

**Indication:** Forward reading moving coil meter.

**Frequency response:**  $\pm$  2 dB, 20 Hz to 20 kHz.

**Noise:** Less than -65 dB with reference to limit level.

**Supply:** 20V positive rail 20 mA.

**Construction:** Standard 'A' module (320 x 36 mm) McMurdo PP8 connector.

**Price:** £25.

**MANUFACTURER:** Allen & Heath Ltd, Drummond House, 203-209 North Gower Street, London NW1.

## ALLISON RESEARCH GAIN BRAIN LIMITER

**Gain reduction range:** 30 dB.

**Noise level (20 Hz to 20 kHz):** At least 83 dB below threshold of peak limiting.

**Distortion:** thd less than 0.3%, 40 Hz to 15 kHz.

**Attack time peak section:** less than 1.5 dB overshoot 1  $\mu$ s after application of 50 kHz tone burst exceeding the threshold of limiting by 15 dB.

**Attack Time rms section:** 7 ms to 40 ms for 90% of ultimate gain reduction. Dependent on waveform complexity amount of limiting and position of function control.

**Release time—peak section for transients of less than 50  $\mu$ s duration:** Less than 1  $\mu$ s. For other peak signals: Variable by release control 50 ms to 5s.

**Release time—rms section:** Variable 250 ms to 5s.

**Limiting ratio—peak section:** Approx 50:1.

**Limiting ratio—rms section:** Approx 40:1.

**Limiting thresholds:** With function control at peak position (CCW) all thresholds are at -20 dBm with input level control fully clockwise, variable to +30 dBm (CCW).

**Separation between thresholds:** Rotating function control from peak to rms position raises peak thresholds 6 dB while lowering rms threshold

(continued over)

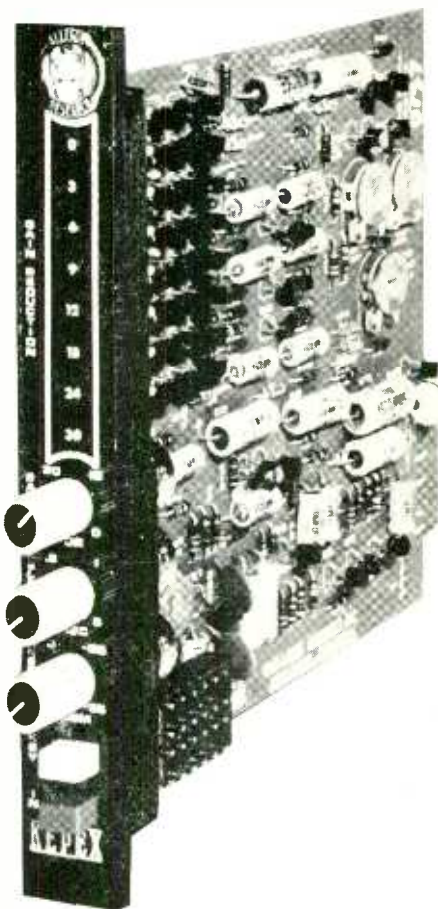

## AUDIO PROCESSORS

continued

6 dB. This allows a separation of thresholds which is continuously variable from 0 dB (peak position) to 12 dB (rms position).

**Frequency response:** 25 Hz to 80 kHz  $\pm 1$  dB.

**Output Level:** Up to +18 dBm into 150 ohms or higher (-24 dBm may be obtained by using a 150 ohm to 600 ohm output transformer).

**Multiple limiter coupling:** Connection provided for tandem limiting functions.

**Front panel controls:** Input level, output level, release time. Function (peak/rms) in/out switch.

**Power requirements:** Regulated 24V to 28V negative ground at 70 mA.

### Metering Specifications

**Gain reduction:** 7 increment sequential light-emitting-diode array indicates gain reduction from 2 dB to 24 dB.

**Accuracy:**  $\pm 1$  dB (2 dB to 12 dB gain reduction),  $\pm 2$  dB (18 dB to 24 dB gain reduction).

**Speed:** Virtually instantaneous. Permits accurate reading of short term, fast release limiting.

**Peak limiting indicator:** Light emitting diode indicates when peak limiting is taking place.

**rms limiting indicator:** Light emitting diode indicates when rms limiting is taking place.

**700 module dimensions:** 178 x 25 x 165 mm.

**Price:** £170.

**Manufacturer:** Allison Research Inc. 7120 Sunset Boulevard, Hollywood, California 90046.

**DISTRIBUTOR:** F.W.O. Bauch Limited, 49 Theobald Street, Boreham Wood, Herts.

### ALTEC LANSING 1591A COMPRESSOR AMPLIFIER

**Gain:** Mic: 90 dB with 1588A plug-in preamplifier. Line: 40 dB with 15095 transformer bridging 600 ohm line.

**Frequency response:**  $\pm 1$  dB, 20 Hz to 20 kHz.

**Power output:** -18 dBm as straight amplifier.

**Harmonic distortion:** At +18 dBm, less than 0.5% thd, 30 Hz to 20 kHz. At 25 dB of compression, less than 1% thd, 40 Hz to 20 kHz. At 35 dB of compression, less than 2% thd, 40 Hz to 20 kHz.

**Noise level:** -120 dBm equivalent input noise from microphone input. Output noise with gain controls at minimum is 70 dB below full output.

**Source impedance:** Mic: 150/250 ohms with 1588A plug-in preamplifier. Line: Up to 15 k $\Omega$  with 15095 transformer (Microphone input may use a 1579A Equalized amplifier for 47 k $\Omega$  magnetic phono pickup).

**Load impedance:** 150 and 600 ohms (Transformer isolated output).

**Maximum compression:** 35 dB.

**Attack time:** 30 ms (63%).

**Release time:** Selectable, 0.5 or 1.5s (63% recovery).

**Threshold:** Selectable, 0 dBm or +8 dBm output.

**Compression ratio:** Selectable, 10:1 at 0 dBm; 10:1 or 5:1 at -8 dBm.

**Controls:** Mic gain, Line gain, release time, compression ratio and threshold, power switch 12V/24V dc power transfer switch on chassis rear 120/240V ac, 50/60 Hz at 10W 12V dc at 0.16A or 24V dc at 0.17A Ground negative.

**Dimensions:** 90 x 480 x 146mm.

**Colour:** Dark Green.

**Weight:** 4 kg.

**Accessories:** 1588A plug-in transformer isolated microphone preamplifier. 1578A plug-in unbalanced input microphone preamplifier. 1579A plug-in RIAA equalised amplifier for magnetic phono pickup. 15095 plug-in transformer for line bridging. 15356 plug-in transformer for line matching.

**Price:** £141.25.

### ALTEC LANSING 9473A LIMITER AMPLIFIER

**Gain:** 50 dB.

**Frequency response:**  $\pm 1$  dB, 20 Hz to 20 kHz.

**Power output:** +24 dBm maximum output level.

**Distortion:** Less than 1% at 20 dB compression, 32 Hz to 20 kHz (Typical 0.5%).

**Noise level:** 74 dB below rated output.

**Source impedance:** 150 or 600 ohms.

**Load impedance:** 150 or 600 ohms.

**Maximum compression:** 40 dB.

**Attack time:** 10  $\mu$ s.

**Release time:** 0.4s above 250 Hz, 3.6s below 250 Hz, or 0.4s Single Band, or 3.6s Single Band, or dual interlocked 20:1, 12:1, 4:1 power switch.

**Threshold:** +15 dBm with output level control at maximum.

**Compression ratio:** Selectable 4:1, 12:1 or 20:1.

**Controls:** Input level control, 20 step attenuator (2 dB per step). Output level control, 20 step attenuator (2 dB per step). Dual band dual release, single band dual release, single band 0.4s release. Single band 3.6s release. Compression ratio interlocked 20:1, 12:1, 4:1 power switch.

**Power supply:** 120/240V ac 50/60 Hz at 15 watts.

**Dimensions:** 134 x 483 x 183 mm.

**Colour:** Green.

**Weight:** 6.3 kg.

**Price:** £285.75.

**Manufacturer:** Altec Lansing, 1515 S Manchester Avenue, Anaheim, California 92803, New York.

**DISTRIBUTOR:** Ling Dynamic Systems Limited, Royston, SG8 5BQ.

### APOLLO ELECTRONICS CL36 COMPRESSOR LIMITER

**Frequency response:** ( $\pm 0.5$  dB): 20 Hz to 20 kHz.

**Input impedance:** 600 ohms unbalanced.

**Maximum input level:** +19 dBm (7V rms).

**Output source impedance:** 50 ohms unbalanced.

**Terminating impedance:** 600 ohms or higher.

**Maximum output level:** -19 dBm (7V rms).

**Gain, below threshold:** 0 dB  $\pm 1$  dB (unity).  
**Unweighted output noise level:** -80 dBm (80  $\mu$ V rms).

**Maximum compression:** 36 dB.

**Total harmonic distortion, for 36 dB compression:** 1.5%<sub>rms</sub> for 30dB compression; 0.5%<sub>rms</sub>

**Threshold level control, in steps of 3 dB:** -18 to -6 dBm  $\pm 1$  dB (100 mV  $\dots$  1.5V rms).

**Compression ratio control (continuously adjustable):** 1:1 limiter.

**Attack time:** Automatic.

**Release time control (for 12 dB compression):** 2 to 50s.

**Operating voltage:** 24V dc.

**Current consumption:** 35 mA approx.

**Dimensions:** 190 x 45 x 142 mm.

**Weight:** 0.63 kg.

**Connector:** 16 way DIL plug with gold-plated contacts.

**Price:** £38.20.

**DISTRIBUTOR and manufacturer:** Apollo Electronics, 96 Mill Lane, West Hampstead, London, NW6.

### AUDIO & DESIGN F600 SERIES LIMITER

**Input (as supplied):** Unbalanced. Input impedance 10 k $\Omega$ . Sensitivity for limit threshold -25 dBm Gardner MU 7530 for balanced operation.

**Output (as supplied):** Unbalanced. Source Impedance less than 1 ohm. Normally +2 dBm into 600 ohms (-8 or +10 dBm to order). Balanced operation with MU 7524 or MU 7544 provides 6 dB gain in transformer.

**Maximum compression:** Not less than 25:1.

**Overload Range:** In excess of 30 dB gain reduction.

**Attack time:** Faster than 20  $\mu$ s (variable to 20 ms).

**Release time:** 25 ms to 4.0s: Multiple network.

**Distortion:** 0.1% thd for 20 dB gain reduction at 1 kHz.

**Signal-to-noise ratio:** Better than -70 dB below threshold level (bandpass restricted -3 dB at 25 kHz).

**Frequency response:** 30 Hz to 20 kHz, -0.5 dB (10 Hz to 50 kHz -3 dB).

**Meter Range:** Indicates 25 dB gain reduction.

**Power requirements:** Rack units 220-250V ac; fuses 100 mA A/S. Type 'C' modules +30V dc (rough) or -24V dcs tabilised. Type 'N' modules +24V dc stabilised.

**Connections:** Rack units: Mains plug—Cannon XLR Audio Gauge 'B' jacks t-r-s or XLR sockets to order. Type 'C' module: Painton 10-way plug/socket. Type 'N' module: Tuchel 13-way plug/socket.

**Dimensions:** Rack-mounting stereo 'RS' unit: 133 x 483 x 140 mm. Rack-mounting mono 'R' unit: 133 x 483 x 140 mm. Type 'C' module: 102 x 178 x 267 mm. Type 'N' module: 80 x 190 x 110mm.

**Stereo units:** Matched within 1 dB over a gain reduction range of at least 20 dB. Quadraphonic matching recently introduced.

**Price:** On application.

### AUDIO & DESIGN F700 SERIES COMPRESSOR-LIMITER

**Input (as supplied):** Unbalanced. Input impedance 10 k $\Omega$ . Sensitivity for compression threshold: -40 dBm for 2:1 and -26 dBm for limit. Gardner MU 7530 for balanced operation.

**Output (as supplied):** Unbalanced. Limit slope 8 dBm. Output source impedance less than 1 ohm. Gardner MU 7524/7544 for balanced output.

**Gain:** Normally 30 dB plus 4 dB in output stage.

**Compression ratio:** 2:1 (40:20 max), 3:1, 4:1, 5:1, 8:1, limit (20:1).

**Distortion:** 0.1% thd at 1 kHz for 15 dB gain reduction.

**Release time:** 25, 50, 100, 200, 400, 800, 1600, 3600 ms and a 'multiple' position.

**Attack time:** 0.1 ms for maximum reduction. Switched positions 'F', 0.25, 1.0, 2.5, 10, 25 ms.

**Signal-to-noise:** Better than -75 dB below limit threshold (-8 dBm).

**Frequency response:** 30 Hz to 30 kHz  $\pm 0$  dB; -0.5 dB.

**Meter range:** Meter indicates 20 dB gain reduction fsd.

**Power requirements:** Rack units: 220-250V ac, fuses 100 mA A/S. Type 'C' modules: +30V dc or -24V dc. Type 'N' modules: +24V dc stabilised.



**Connections:** Rack units: Mains plug—XLR Cannon Audio—Gauge 'B' jacks t-r-s or XLR sockets to order. Type 'C' module: Painton 10-way plug and socket. Type 'N' module: Tuchel 13-way plug and socket.

**Dimensions:** Rack-mounting stereo 'RS' unit: 133 x 483 x 229 mm. Rack-mounting mono 'R' unit: 89 x 483 x 229 mm. Type 'C' module: 102 x 178 x 267 mm. Type 'N' module: 80 x 190 x 110 mm.

**Stereo units:** Matched within 1 dB over a gain reduction range of at least 20 dB. Quadraphonic matching recently introduced.

**Price:** On application.

**Also available:** The F700—R/DS, which features a de-esser, and the F690 versions, which offer noise gate and 'voice-over' facilities.

#### AUDIO & DESIGN F760 SERIES PEAK LIMITER-COMPRESSOR

**Input** (as supplied): Unbalanced. Input impedance 10 k $\Omega$  sensitivity of threshold level for: 20:10 -32 dBm, 30:15 -38 dBm, 24:8 -28 dBm, 15:5 -26 dBm, 20:4 -26 dBm, 16:1 -23 dBm. Balanced operation using Gardner MU7530 Tr. (no provision for transformers on Type 'N' unit).

**Output** (as supplied): Unbalanced. Source impedance less than 1 ohm, variable +8 dBm to -18 dBm 10 dB gain in output stage. Balanced operation with Gardner MU7524 or MU7544 (no provision on Type 'N' mod).

**Gain:** 30 dB in compressor. 10 dB in output stage.  
**Compression ratio:** 2:1 (30:15 and 20:10), 3:1 (24:8 and 15:5) 5:1 (20:4), 10:1 (limit). Peak limiter: greater than 25:1.

**Distortion:** Better than 0.5%, at 1 kHz at maximum output.

**Release time:** Compressor: 0.05, 0.1, 0.2, 0.4, 0.8, 1.6, 3.2s Multiple position.

**Attack time:** Compressor: from 0.2—20 ms. Peak limiter: Better than 20  $\mu$ s.

**Signal-to-noise ratio:** -80 dB referred to -8 dBm.  
**Frequency response:** 30 Hz to 30 kHz  $\pm$ 0 dB;  $\pm$ 0.5 dB.

**Meter range:** Compressor: Indicates 20 dB reduction. Peak limiter: Bold illumination.

**Power requirements:** Rack units: 220 to 250V ac. Type 'N' module: 24V dc stabilised. Type 'C' module:  $\pm$ 24V dc stabilised.

**Connectors:** Rack units: mains plug XLR Cannon. Audio: Gauge 'B' jacks. T-r-s or XLR sockets to order. Type 'N' module: 13-way Tuchel plug/socket. Type 'C' module: 10-way Painton plug/socket.

**Rack unit dimensions:** 'RS' stereo—133 x 483 x 229 mm. 'R' mono—89 x 483 x 229 mm.

**Stereo units:** matched within 1 dB over 20 dB reduction range. Quadraphonic matching recently introduced.

**Price:** On application.

**MANUFACTURER:** Audio & Design (Recording) Ltd, St. Michael's, Shinfield Road, Shinfield Green, Reading, Berks.

#### DOLBY A 301 NOISE REDUCTION UNIT

**Layout:** Two independent signal processors per A301 unit; each may be switched into either record mode or playback mode.

**Signal Connections:** One XLR input and output for each processor (Tuchel connectors optional).

**Inputs:** 10 k $\Omega$  balanced bridging transformers accepting all normal line levels. Provision made for addition of termination resistors, if required, to match line impedance.

**Outputs:** Balanced levels and impedances to order. Normal options are: 0VU ( $\pm$ 4 dBm), 600 ohms (US standard) 1.55V ( $\pm$ 6 dB) 30 ohms (Continental standard)  $\pm$ 8 dBm peak, 600 ohms (UK broadcasting standard). Output termination switches provided on 600 ohms units.

**Overall (record playback) frequency response:** Better than  $\pm$ 1 dB, 20 Hz to 20 kHz.

**Overall total harmonic distortion:** At  $\pm$ 8 dBm,

less than 0.1% at 1 kHz; less than 0.2% from 40 Hz to 20 kHz.

**Output clipping point:** Better than -18 dBm.

**Noise reduction:** 10 dB from 20 Hz to 5 kHz, rising to 15 dB at 15 kHz; with noise reduction switched off, system becomes unity-gain line amplifier.

**Overall Noise Level:** Better than 80 dB (unweighted) below  $\pm$ 8 dBm.

**Crosstalk:** Better than 80 dB, processor to processor 20 Hz to 20 kHz.

**Matching between units:** Better than 1 dB at any level and any frequency.

**Stability:** System is highly stable—does not require routine alignment.

**Operating temperature:** Up to 45 $^{\circ}$  C.

**Operating controls:** None.

**Panel meters:** NAB and DIN level setting meters for recorder gain calibration.

**Construction:** Modular, eight plug-in circuit modules together with plug-in chassis module for power supply and audio transformers. Fibreglass printed circuits, solid state devices throughout (103 silicon transistors including stabilised power supply).

**Finish:** Anodized aluminium case, front panels dark grey with white characters.

**Size:** 225 x 483 x 270 mm.

**Weight:** 13 kg.

**Power requirements:** 100-125V and 200-250V voltage selector 50-60 Hz single phase, 22VA.

**Price:** £560.

**DISTRIBUTOR and manufacturer:** Dolby Laboratories Inc., 346 Clapham Road, London, SW9.

#### DOLBY 360 SERIES NOISE REDUCTION UNIT

One signal processor, which can be set for either record mode or play mode. Control by illuminated push-button switches on front panel.

**Signal connections:** XLR input and output.

**Signal levels:** Input and output levels adjusted by multi-turn potentiometers accessible from front of unit. Minimum input 350 mV for Dolby Level, 600 mV for DIN level. Maximum output level  $\pm$ 22 dB into bridging load;  $\pm$ 21 dBm into 600 ohms;  $\pm$ 20 dBm into 200 ohms.

**Overall frequency response:**  $\pm$ 1 dB from 30 Hz to 20 kHz.

**Overall total harmonic distortion:** At  $\pm$ 8 dBm, less than 0.1% at 1 kHz, less than 0.2% from 40 Hz to 20 kHz.

**Noise reduction:** Dolby-A Type professional characteristic providing 10 dB of noise reduction from 30 Hz to 5 kHz, rising to 15 dB at 15 kHz. With noise reduction action switched off, unit becomes unity-gain line amplifier.

**Overall noise level:** Record-playback, 80 dB (unweighted) below Dolby level.

**Matching between units:**  $\pm$ 1 dB at any level and any frequency, 30 Hz to 20 kHz.

**Stability:** System is highly stable—does not require routine alignment.

**Operating temperature:** Up to 45 $^{\circ}$  C.

**Construction:** Plug-in noise reduction module (Cat. No. 22) removable through panel. Fibreglass printed circuits, solid state devices throughout.

**Finish:** Steel case, grey stoved plastic textured finish; front panel clear anodized with black characters.

**Size:** 44 x 483 x 250 mm.

**Weight:** 5.5 kg.

**Power Requirements:** 100-130V and 200-260V 50-60 Hz single phase, 14 VA.

**Price:** £240.

**DISTRIBUTOR and manufacturer:** Dolby Laboratories Inc., 346 Clapham Road, London SW9.

#### DOLBY B320 NOISE REDUCTION UNIT

**Layout:** Two independent signal processors per unit; each may be switched into either record mode or playback mode.

**Signal connections:** One XLR input and output for

each processor (Tuchel connectors optional).

**Inputs:** 10 k $\Omega$  balanced bridging transformers accepting all normal line levels. Provision made for addition of termination resistors, if required, to match line impedance.

**Outputs:** Balanced, levels and impedances to order. Normal options are: 0VU ( $\pm$ 4 dBm) 600 ohms (US standard) 1.55V ( $\pm$ 6 dB), 30 ohms (Continental standard)  $\pm$ 8 dBm peak, 600 ohms (UK broadcasting standard). Output termination switches provided on 600 ohms units.

**Meters:** Front panel meters for level standardisation. Dolby level corresponds to 185 pWb/mm (Ampex operating level) on open reel duplicates and 200 pWb/mm on cassettes.

**Overall record-playback Frequency response:** Better than  $\pm$ 1 dB, 20 Hz to 20 kHz.

**Overall total harmonic distortion:** At  $\pm$ 8 dBm (600 ohms); less than 0.1% at 1 kHz.

**Output clipping point:** Better than -18 dBm (600 ohms); better than -16 dB (30 ohms).

**Noise reduction:** B-type characteristics 3 dB at 600 Hz, 6 dB at 12 kHz, 10 dB from 15 kHz upwards.

**Overall noise level:** Better than 80 dB (unweighted) below  $\pm$ 8 dBm (600 ohms) or  $\pm$ 6 dB (30 ohms).

**Crosstalk:** Better than 60 dB processor to processor 20 Hz to 20 kHz.

**Matching between units:** Better than 1 dB at any level and any frequency.

**Stability:** System is highly stable and does not require routine alignment.

**Operating temperature:** Up to 45 $^{\circ}$  C.

**Construction:** Modular, five plug-in circuit modules together with plug-in chassis module for power supply and audio transformers. Fibre glass printed circuits, solid state devices throughout.

**Finish:** Anodized aluminium case, front panels dark grey with white characters. Module handles clear anodised.

**Size:** 225 x 483 x 270 mm.

**Weight:** 13 kg.

**Power requirements:** 100-125V and 200-250V, voltage selector 50-60 Hz single phase, 18 VA.

**Price:** £390.

**MANUFACTURER:** Dolby Laboratories Inc., 346 Clapham Road, London, SW9.

#### EMI 8025 COMPRESSOR

**Power supply:**  $\pm$ 24V.

**Input impedance:** No: less than 10 k $\Omega$  in parallel with 50H.

**Output impedance:** Input and output transformers are incorporated.

**Voltage gain below knee:** Adjustable from 0 to 20 dB by means of the compression range control.

**Compression:** Range variable from 0 to 20 dB; ratio is selectable to 1:1 (linear), 2:1, 3:1 and 5:1 by a switch.

**Knee point:** This is automatically adjusted when the required compression ratio and compression range are selected, so that the peak output levels, under maximum compression, all coincide at the same selected level.

**Output level:** Level of maximum compression is adjustable from 0 dBm to  $\pm$ 24 dBm.

**Sensitivity:** Peak input level, to give full compression is adjustable from  $\pm$ 16 dB to  $\pm$ 24 dB relative to 775 mV.

**Attack time:** 1 ms.

**Recovery time:** Selectable to 125 ms, 250 ms, 500 ms, 1s, 2s, or 3s by means of a front panel switch.

**Frequency response:** Within a 1 dB envelope from 60 Hz to 8 kHz and within a 2 dB envelope from 40 Hz to 15 kHz.

**Distortion:** Harmonic distortion is less than 1% at 40 Hz with a recovery time of 500 ms or more, and less than 0.25% at 1 kHz under all conditions.

**Signal-to-noise ratio:** Better than 60 dB over the band 40 Hz to 15 kHz.

**Temperature range:** 0 $^{\circ}$  C to  $\pm$ 50 $^{\circ}$  C.

(continued on page 39)

For a long time you've been asking us for a variable ratio compressor.

Simple and quick to operate and beautiful to listen to.

Here it is—

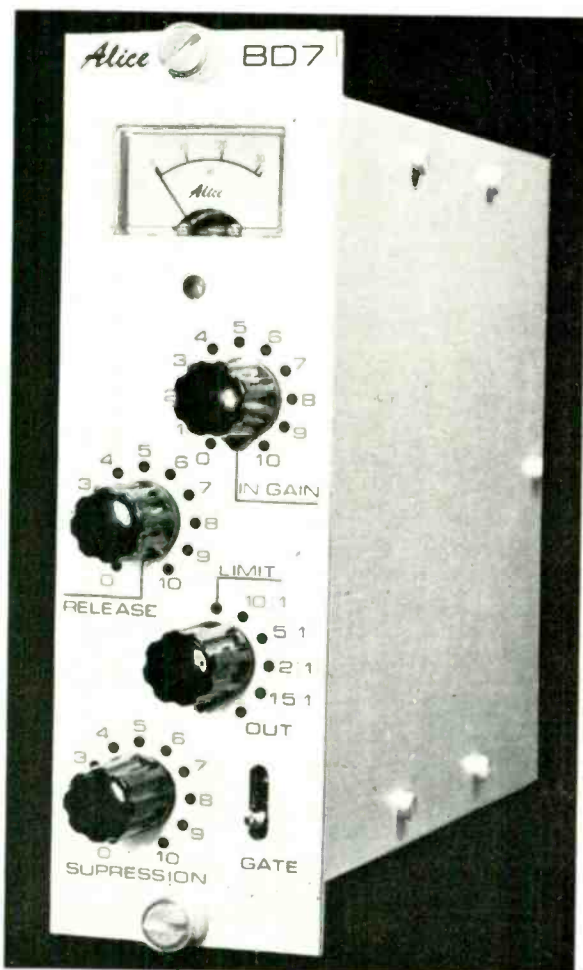

By the way—

You may notice the variable suppression noise gate we have added.

You can use this compressor where before you would never have dared.

*Alice* (Stancoil Ltd)

15 Sheet Street, Windsor, Berks.  
Tel. Windsor 61308

# We'll turn you on gently.

With our linear motion studio faders. Our faders use mirror finish conductive plastics, together with multiple finger precision metal wipers to give superb reliability and noise-free output.

They give infinite resolution, last for years, have built-in switching, and work silently.

Still want convincing?

Clip the coupon and we'll tell all.



To: Penny & Giles Conductive Plastics Ltd.,  
Newbridge Road Industrial Estate,  
Pontllanfraith, Blackwood, Monmouthshire.

I just might be in the market for a linear motion studio fader. Convince me please.

Name \_\_\_\_\_

Position \_\_\_\_\_

Company \_\_\_\_\_

Address \_\_\_\_\_

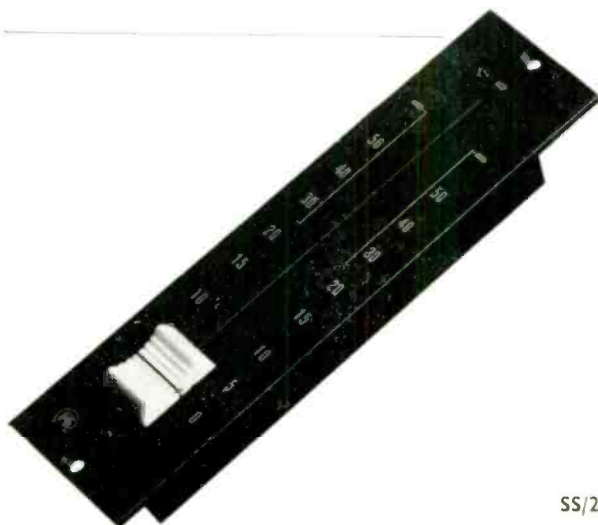

SS/2

## AUDIO PROCESSORS

continued

Price: £167.00.

**MANUFACTURER:** EMI Electronics Limited, Hayes, Middlesex.

### EMT 156 STEREO COMPRESSOR LIMITER

**Inputs:** Two for stereo, balanced and floating.

**Input impedance:** 5 k $\Omega$  minimum.

**Input level:** Continuously adjustable within the range +4 dBm (1.2V) to +15 dBm (4.4V).

**Maximum input level** (Independent of nominal level setting): +24 dBm (12.3V).

**Outputs:** Two for stereo, balanced and floating.

**Output level** Adjustable in fixed steps: +4 dBm (1.2V) +6 dBm (1.55V) +8 dBm (2V) +12 dBm (3V) +15 dBm (4.4V).

**Output source impedance:** 15, 20, 30, 40, 50 ohms.

**At output level of:** +4, +6, +8, +12, +15 dBm.

**Total distortion** at 1 kHz: 0 dB gain, 0 dB internal level: 0.6% max. In the working range of the compressor (automatic release time): 0.6%. In the limiter range (automatic release time): 1%.

**Frequency response** referred to 1 kHz: 30 Hz to 10 kHz  $\pm$ 1 dB. At 15 kHz -1.5 dB.

**Signal-to-noise ratio** (unweighted) R source = 200 ohms R term = 600 ohms: At 0 dB gain 70 dB rms. At 18 dB gain 68 dB rms.

**Signal-to-noise ratio** (weighted). R source = 200 ohms, R term = 600 ohms: At 0 dB gain 70 dB rms 65 dB peak, At 18 dB gain 68 dB rms 63 dB peak.

#### Crosstalk

Between channels 1-2 and 2-1 at 1 kHz and nominal level: greater than 35 dB.

With input level of -20 dB absolute (limiter operation) greater than 35 dB.

**Maximum gain control range of compressor and limiter:** 40 dB.

#### Limiter

**Threshold:** -2dB to 7.5 dB\*.

**Maximum input level,** independent of nominal level setting: +24 dBm (12.3V).

**Attack time:** max 100  $\mu$ s.

**Release time** with 10 dB jump in level: with manual selection 0.25 to 2.5s: Automatic, programme controlled.

#### Compressor

**Compressor gain,** adjustable: 0 to 18 dB.

**Compression ratio:** 1.5:1 to 4:1.

**Rotation point,** adjustable: -6 dB to -1.5 dB\*.

**Attack time,** internally adjustable 1 to 4 ms. Set at factory for 2 ms.

**Release time** for 10 dB gain variation: Manually adjustable: 5 to 3.5s: Automatic, programme controlled.

#### Expander

**Expansion ratio,** Selectable with push buttons: 1:1.5/1:2.5.

**Exp. rot. point,** adjustable: -35 dB to -55 dB\*.

**Attack time,** coupled with compressor release time: programme controlled.

**Release time** for 10 dB gain variation: Manually adjustable: 1.5 to 7.5s. Automatic approximately 4.5s.

**AC power line voltage ranges:** 100 to 130V, 200 to 250V.

**AC power line frequency:** 50 to 60 Hz.

**Power consumption:** 40 VA.

**Insulation resistance** AC power line/housing: 100 M $\Omega$ .

**Weight:** 13.3 kg.

\* referred to an internal 0 dB reference level.

**Price:** £1,185.

### EMT 256 COMPACT COMPRESSOR

Smaller compressor developed from the EMT 156. Designed for use in microphone channels of mixing consoles.

**Power supply:** 24V dc  $\pm$ 1V constant current consumption 160 mA, constant power consumption approximately 3.8W. Operation from

higher dc voltages possible by series connection of an external resistor.

**Input and output:** balanced, floating.

**Input Level:** -20 to +22 dB.

**Output Level:** -20 to +22 dB.

**Connection:** 13 pole T2706 on rear.

**Dimensions:** 190 x 40 mm.

**Price:** £310 (approximately).

**Manufacturer:** EMT Wilhelm Franz KG, D-7630 Lahr/Schwarzwald, Postfach 1520, West Germany.

**DISTRIBUTOR:** F.W.O. Bauch Limited, 49 Theobald Street, Boreham Wood, Herts.

### JBL 7124 AGC AMPLIFIER

**Signal Channel:** -20 dB with no sensing signal.

**Gain:** 0 dB with full sensing signal.

**Input impedance:** 600 ohms unbal/bal w/5195. 50 k $\Omega$  balanced w/5195.

**Output impedance:** 600 ohms balanced w/5195. 50k  $\Omega$  balanced w/5195.

**Maximum signal handling capacity:** -10 dBm.

**S/n ratio:** -65 dB below +10 dBm with 0 dB gain. -60 dB below -10 dBm with -20 dB gain.

**Distortion:** less than 1.0%, 600 ohms terminated. Less than 0.25%, 600 ohms bridged not terminated.

**Frequency response:** 20 Hz to 20 kHz  $\pm$ 1 dB.

**Sensing channel sensitivity:** -85 dBm for 0 dB gain on signal channel at sensing microphone input (w/5901) 8 mV for 0 dB gain on signal channel at sensing microphone input (Z in = 1 M $\Omega$ ).

-25 dBm for 0 dB gain on signal channel at bridging input (15k ohms w/5195). -35 dBm (600 ohms w/5195). 150 mV for 0 dB gain on signal channel at 50 k $\Omega$  unbalanced bridging input.

**Attack time:** 1s for 10 dB increase. 3s for 20 dB increase.

**Decay time:** 1s for 10 dB decrease. 3s for 20 dB decrease.

**Power supply:** 120V ac, 50/60 Hz, fused.

**Controls:** Sensitivity control, power on-off switch.

**Dimensions:** 89 x 483 x 152 mm.

**Finish:** Non-glare baked enamel, light gray.

**Accessories:** 5901 Universal microphone matching transformer, plug-in 5905 matching or bridging transformer plug-in.

**Weight:** 4.5 kg.

**Price:** On application.

**Manufacturer:** J. B. Lansing Sound Inc., 3249 Casitas Ave., Los Angeles, Calif 90039, USA.

**DISTRIBUTOR:** Feldon Audio Limited, 126 Great Portland Street, London, W1.

### KEPEX MODEL 500 KEYABLE PROGRAMME EXPANDER

**Attack time** (Time required for gain to increase from -60 dB to -1 dB after the application of a control signal whose level exceeds threshold): less than 20  $\mu$ s.

**Release time** (Time required for gain to decrease by 30 dB after removal of a control signal): Variable from 50 ms to 6s.

**Active expansion ratio:** 2:1 from 0 dB to 15 dB expansion; increasing to 4:1 at 60 dB expansion.

**Threshold of expansion** (magnitude of control signal in dBm required to cause Kepex to reach unity gain): Variable from -35 dBm to 20 dBm.

**Insertion loss:** 0 dB, internal control provides up to 20 dB gain.

**Frequency response:** 20 Hz to 40 kHz  $\pm$ 1 dB.

**Distortion:** less than 0.5% thd under normal operating conditions. (Measured distortion may exceed this figure if very short release times are used. The design allows operation in this region in order to take advantage of the special effects produced by such operation.)

**Signal to noise ratio:** 85 dB min below rated output.

**Input impedance:** 3 k $\Omega$  in normal exp mode.

**Output impedance:** 600 ohms (emitter follower).

**Maximum input and output levels:**  $\pm$ 17 dBm.

**Power requirements:** +24V dc at 75 mA. +100V dc at 3 mA. Ground negative.

**Price:** £170.

**Manufacturer:** Allison Research, Inc., 7120 Sunset Boulevard, Hollywood, California, USA.

**DISTRIBUTOR:** F.W.O. Bauch Ltd., 49 Theobald Street, Boreham Wood, Herts.

### KLARK TEKNIK COMPRESSOR/LIMITER MODULES

A new range of gain control equipment will be available in February 1972, comprising two compressor/limiters in mono and stereo versions, a noise gate and a voice operated switch. There will be a choice of rack mounting or modular construction. The instruments will include some of the following features:

**Attack speed:** Variable to faster than 50  $\mu$ s.  
**Release time:** Variable from 50 milliseconds to 1.5 seconds.

**Input and output** gain controls, ratio switch, stereo link switch, calibrated meter; Separate peak limiter controlling the limit level completely independently from the compression curve.

The compression threshold is determined by the input level, the main features being the very fast attack time, devoid of overshoot, and the separate compression and limit thresholds. All transient breakthrough has been eliminated. All the units use the same basic attenuation stages—only the control section varies. The noise gate/expander can be incorporated with the compressor/limiter in one unit. This will give complete control over low level and high level signals.

Prices start at £100.

**MANUFACTURER:** Klark Teknik, MOS Industrial site, Summerfield, Kidderminster, Worcs.

### MACINNES 1A865 and 9A1195 COMPRESSOR MODULES

**Frequency response:** 20 Hz to 20,000 Hz  $\pm$ 0.5 dB.

**Distortion** (thd): Less than 0.5% at all frequencies.

**Equivalent input noise:** -122 dBm.

**Attack time:** 10 ms (fixed), 10 to 100 ms (adjustable).

**Release time:** 200 ms (fixed), 200 to 1000ms (adjustable).

**Compression range:** 30 dB.

**Compression ratio:** 10:1.

**Input impedance:** 1000 ohms (mike input), 270 ohms (interstage).

**Insertion loss:** 0 dB.

**Gain:** 45 dB (1A 865 preamplifier only), 14 dB (after isolation).

**Controls:** Threshold (external). Gain Adjust (optional). Attack Time (optional). Release Time (optional).

**Power required:** 55 mA (maximum) at 24 volts dc.

**Size:** Two 70 x 83 mm plug-in printed circuit cards.

**Price:** on application.

**DISTRIBUTOR:** Macinnes' Laboratories, 71 Oakley Road, Chinnor, Oxon.

### NEVE 2254A LIMITER COMPRESSOR

**Input:** 10 ohms bridging earth-free.

**Output:** Source impedance 80 ohms balanced and earth-free Maximum output -26 dBm into 600 ohms.

**Gain:** 0 dB (preset).

**Noise:** -75 dBm in the band 20 Hz to 20 kHz for the Linear and Limit modes rising, in the Compression mode with an increase 'make up gain' to a maximum of -60 dBm at 6:1 ratio.

**Frequency response:** 20 Hz to 20 kHz  $\pm$ 1 dB.

**Distortion:** Typical results measured at +8 dBm out and with 800 ms recovery times are: Residual, linear mode 0.05%. Compression mode, 6:1 ratio 0.2%. Limiting mode at 20 dB input 0.4%.

**Limit ratio:** Greater than 100:1.

**Level:** -8 dBm within 0.5 dB on preset, adjustable from -4 dBm to -12 dBm in steps of 0.5 dBm.

**Attack time:** 5 ms.

(continued over)

## AUDIO PROCESSORS

continued



**Recovery time:** 100 ms, 200 ms, 800 ms, and 'auto' 50 ms/5s.

**Compression ratio:** 1.5:1, 2:1, 3:1, 4:1, 6:1.

**Threshold:** 0 dBm, within 0.5 dB on preset, adjustable from -20 dBm, to +10 dBm in 2 dB steps.

**Attack time:** 5 ms.

**Recovery time:** 400 ms, 800 ms, 1500 ms and 'Auto' 50 ms/5s.

**Gain:** 0 dB below compression threshold, adjustable 'gain make up' available from 0 dB to -20 dB.

**Meter:** Switched to indicate either gain control up to 16 dB or signal level from -12 dBm to +12 dBm. Action approximates that of a ppm.

**Prices:** On application.

### NEVE 2257 BACKGROUND NOISE SUPPRESSOR

Attenuates audio signals below a predetermined level; variable attenuation depth and recovery time. For use in film dubbing or music mixdown operations to remove unwanted noise from prerecorded tapes.

#### CONTROLS

**Threshold:** sets level of input signal below which attenuation occurs. 0 to -40 dBm in 2 dB steps. Lamp indicates when threshold is exceeded.

**Attenuation depth:** Selects degree of attenuation of the unwanted signal. 3 to 33 dB in 3 dB steps.

**Recovery:** Recovery time of 100 ms, 270 ms and 1s. The unit may be switched in and out of circuit by operation of the key.

**Gain:** 0 dB (preset on rear panel).

**Frequency response:** 20 Hz to 20 kHz  $\pm 0.5$  dB.

**Noise:** with attenuation depth set to -3 dB, less than -85 dBm measured wideband 20 Hz to 20 kHz.

**Distortion:** +20 dBm into 600 ohms, less than 0.03% at 1 kHz, less than 0.05% at 10 kHz, less than 0.1% at 100 Hz.

**Maximum output:** -26 dBm into 600 ohms.

**Input:** 10 k $\Omega$  bridging, balanced and earth free.

**Output:** 80 ohms source impedance, balanced and earth-free.

**Power Requirements:** 24V dc (negative earth) 60 mA.

**Mechanical:** Unit housed in a Neve size DL1 module assembly.

**Dimensions:** 222 x 46 x 273 mm.

Unit can be supplied as part of a Neve sound control console or in a Neve 483mm rack assembly, complete with suitable psu. Up to five Type 2257 units can be mounted in one 222mm high rack unit and run from a single psu.

**Price:** on application.

**MANUFACTURER:** Rupert Neve & Co, Cambridge House, Melbourne, Royston.

### NTP LOGARITHMIC AMPLIFIER TYPE 178-200.

**Supply voltage:** 220V ac 50/60 Hz 17 watts.  
**Output for instrument lamp:** 6V 2.5 amps ac.  
**Temperature range:** -20 to +60°C.  
**Frequency range:** 20 Hz to 20 kHz,  
**Input impedance** within frequency range: 22 k $\Omega$   $\pm 10\%$ . Balanced floating.  
**Input voltage** (0 dB deflection): -6 dB (1.55V rms sine).

**Input overload level:** +21 dB (8.6V).  
**Input current** (according to input voltage DIN 45406): 0 dB 1.44 mA, -20 dB 2.64 mA, -40 dB 3.34 mA.

**Output impedance:** Approx. 300 ohms.  
**Indicating errors:** (+5 to -10 dB; below -10 dB); 1 kHz steady signal at room temperature:  $\pm 0.5$  dB;  $\pm 1$  dB.  
 Within frequency range:  $\pm 1$  dB;  $\pm 2$  dB.  
 Polarity shift of an unsymmetrical waveform:  $\pm 1$  dB;  $\pm 2$  dB.

10% change of supply voltage:  $\pm 0.3$  dB;  $\pm 2$  dB.  
**Integration time:** 10 ms (DIN 45406).  
**Fallback time:** Approx. 1.5s per 20 dB.  
**Additional amplification controllable from front panel:** +40  $\pm 0.5$  dB.

**Noise level:** -105 dB (input load 200 ohms).  
**Dimensions:** 120 x 45 x 250 mm.  
**Connector:** Tuchel T 2008/12.  
**Price:** £143.

### NTP LOGARITHMIC AMPLIFIER TYPE 178-100

**Supply voltage:** 24V dc  $\pm 10\%$ .  
**Current consumption:** Approximately 60 mA.  
**Temperature range:** -20 to +60°C.  
**Frequency range:** (0.5 dB points): 20 Hz to 20 kHz.  
**Input impedance** within freq. range: 22 k $\Omega$   $\pm 10\%$ . Balanced floating.  
**Input voltage** (100% deflection): To be specified.  
**Input overload level:** -21 dB (8.6V).  
**Output current according to input voltage:** To be specified.

**Output impedance:** Approx. 300 ohms.  
**Indicating errors:** (+5 to -10 dB; below -10 dB); 1 kHz steady signal at room temperature:  $\pm 0.5$  dB  $\pm 1$  dB.

Within frequency range; +0, -1 dB; -0, -2 dB.  
 Within temperature range; +1 dB; +3 dB.  
 Polarity shift of an unsymmetrical waveform:  $\pm 1$  dB;  $\pm 2$  dB.  
 10% change of supply voltage: +0.3 dB;  $\pm 2$  dB.  
**Integration time:** 10 ms (EBU standardisation).  
**Fall-back time:** Approx. 1.5s per 20 dB.

**Additional amplification** by shorting terminals 9 and 10: +40  $\pm 0.5$  dB.  
**Noise level:** -105 dB (input load 200 ohms).  
**Dimensions:** 190 x 40 x 105mm.  
**Standard colour:** Dull Black.  
**Connector:** Tuchel T 2700.  
**Price:** £116.

### NTP COMPRESSOR AMPLIFIER TYPE 179-100

**Supply voltage:** 24V dc  $\pm 10\%$  - common.  
**Current consumption:** Approx. 80 mA.  
**Temperature range:** -20 to 60°C.  
**Frequency range:** (0.5 dB points) 20 Hz to 20 kHz  
**Input impedance** within freq. range: 22 k $\Omega$   $\pm 10\%$  balanced floating.

**Output impedance** within freq. range: less than 20 ohms balanced floating.  
**Output overload level:** +21 dB (8.6V).  
**Minimum load impedance:** 200 ohms.  
**Basic amplification:** +15 dB  $\pm 1$ .  
**Preamplifier adjustable:** 0 to +24 dB in 3 dB steps.

**Compression ratio** adjustable: 2:1 3:1 5:1.  
**Threshold of compression 2:1:** -24 dB input.  
**Threshold of compression 3:1:** -17 dB input.  
**Threshold of compression 5:1:** -13 dB input.  
**Input level for unity gain:** +6 dB.  
**Maximum gain reduction:** 20 dB.  
**Attack time:** Less than 75  $\mu$ s.  
**Blocking time:** 50 ms.  
**Recovery time adjustable:** 4—2—1—0.4—0.2—0.15  
**Distortion:** Less than 0.5%.

**Signal-to-noise ratio:** At compression threshold -80 dB (weighted A curve). At 15 dB compression -85 dB (weighted A curve).

**Dimensions:** 190 x 80 x 105 mm.  
**Standard colour:** Dull Black.  
**Connector:** Tuchel T 2700.  
**Price:** £207.

### NTP 179-120 COMPRESSOR AMPLIFIER

**Supply voltage:** 24V dc  $\pm 10\%$   
**Maximum ripple voltage:** 0.1V p-p.  
**Current consumption:** approximately 90 mA.  
**Temperature range:** -20 to +60°C.  
**Input impedance** within frequency range: 5.6 k $\Omega$ , and 15.6 k $\Omega$  and 20 k $\Omega$  bal.  
**Output impedance:** Three, two bal one unbal. all less than 2 ohm.

**Frequency range** (0.5 dB points): 20 Hz to 20 kHz.  
**Minimum load impedance:** 100 ohms.  
**Compression ratio:** adjustable 1:1 2:1 3:1 5:1 20:1.  
**Attack time:** adjustable 100  $\mu$ s /20 dB to 200 ms /20 dB. (11 steps).

**Recovery time:** adjustable 60 ms/20 dB to 4s/20 dB and one 'Auto' position (11 steps).  
**'Auto' dual time constants:** 200 ms upon 15s.  
**Recovery delay:** switchable 0 or 50 ms.  
**Distortion** under static conditions: less than 0.5%, up to 20 dB gain reduction.

**Signal-to-noise ratio** at compression threshold: 80 dB A-curve.  
**Instrument output:** 0 to 1 mA for 0 to 20 dB compression Linear dB scale.

#### Limiter function

**Attack time:** 1.5 ms combined with a full-wave logarithmic clipping circuit.

**Recovery time:** following the recovery time set for the compressor.

**Limitation threshold 'normal':** +9 dBu output with any of the three output terminations.

**Limitation threshold 'high':** -19 dBu output when using the 0.7:1 output transformer.

**Price:** On application.

### NTP LIMITER AMPLIFIER TYPE 179-210

**Supply voltage:** 24V dc  $\pm 10\%$ .  
**Current consumption:** Approx. 50 mA.  
**Temperature range:** -20 to +60°C.  
**Frequency range** (0.5 dB points): 20 Hz to 20 kHz.  
**Input impedance** within freq. range: 22 kohms  $\pm 10\%$  Balanced floating.

**Output impedance** within freq. range: Less than 20 ohms Balanced floating.

**Minimum load impedance:** 200 ohms.  
**Input overload level:** -21 dB (8.6V).

**Signal-to-noise ratio** at limiting. Threshold: 80 dB (weighted A curve).

**Basic amplification:** 0  $\pm 0.5$  dB.  
**Preamplifier adjustable:** 0 to -24 dB in 3 dB steps.

**Limiting threshold:** +6 -0.5 dB (1.55V).  
**Limiting range:** More than 35 dB.

**Variation in output voltage through limiting range:** Less than 0.5 dB.

**Pre-emphasis** (control circuit): 50  $\mu$ s

**Attack time:** Less than 50 microseconds.

**Recovery time T<sub>1</sub>:** adjustable: 0.1-0.2-0.4-1-2-4 seconds.

**Recovery time T<sub>2</sub>:** adjustable: 1-2-4-10-20 seconds.

**Distortion:** 40 Hz to 200 Hz. Less than 0.8% 200 Hz to 20 kHz. Less than 0.3%.

**Dimensions:** 190 x 40 x 105 mm.  
**Standard colour:** Dull Black.  
**Connector:** Tuchel T 2700.  
**Price:** £135.

**Manufacturer:** NTP N Tonnes Pedersen A/S, Copenhagen, Denmark.

**DISTRIBUTOR:** Feldon Recording Ltd, 126 Gt. Portland St., London, WIN 5PH.

### PYE TVT COMPRESSION UNITS 5752 & 5753

**Gain:** 0 dB  $\pm 0.5$  dB (with no compression).  
**Frequency response:** -0.5 to -1 dB, 30 Hz to 15 kHz. -0.2 to -0.5 dB, 60 Hz to 8 kHz. (in all compression and limiting conditions).



**Output level:** +24 dBm max.  
**Input level:** +24 dBm max.  
**Signal-to-noise ratio:** s/n weighted to DIN 45405 from threshold setting -16 dB to -1 dB. Better than 68 dB. At threshold setting -24 dB. Better than 65 dB.  
**Compression ratio:** 1:1, 2:1, 3:1, 5:1, switched. The linear position is provided for setting up associated equipment in the system.  
**Limit range:** For an increase of input level of 20 dB above the threshold output level increase less than 1 dB.  
**Attack time:** Compression, less than 0.5 ms. Limiting, 1 ms to 0.5 ms.  
**Decay time:** Switchable: 100 ms, 200 ms, 400 ms, 800 ms, 1600 ms, 3200 ms.  
**Threshold level:** Control calibrated in 2 dB steps. Compression: 24 dBm to -16 dBm. Limiting -6 dBm to -24 dBm (8 dBm relative to indicated threshold level).  
**Distortion:** With 600 ohms load, less than 1% measured at 30 Hz, 1 kHz and 8 kHz.  
**Input impedance:** Greater than 10 k $\Omega$  at 60 Hz, 1 kHz and 8 kHz.  
**Output impedance:** Less than 50  $\pm$  7.5 ohms at 60 Hz, 1 kHz and 8 kHz.  
**Isolation input:** Greater than 50 dB.  
**Isolation output:** Greater than 50 dB.  
**Temperature range:** -10 $^{\circ}$  C to +55 $^{\circ}$  C (ambient operating).  
**Supply requirements:** 110V-220V, 50 Hz -60 Hz 3W approx (one amplifier).  
**Dimensions:** 89 x 480 x 380 mm.  
**Weight:** 845751/01: 1.9 kg. 845754/03: 14 kg. 845753/01: 13 kg.  
**Part Numbers:** 845751/01: Basic Compression Amplifier with noise gate. 845753/04: Rack mounting frame including power unit to take two 845751/01 or one 845751/01 and one AG28881. AG28881: Blank panel.  
**Price:** £210.00. (rack & psu £60).  
**MANUFACTURER:** Pye TVT Limited, Cambridge, CB1 3JU.

#### SPECTRA SONICS 601 COMPRESSOR LIMITER

**Gain:** Below threshold, 20 dB. Threshold to 30 dB comp, 20 dB to -10 dB respectively.  
**Compression/limiting ratio:** Continuously Variable or fixed from approximately 1.1:1 to greater than 100:1.  
**Attack time:** Automatically variable.  
**Limiters:** 100 ns to 2.0 ns.  
**Compressor:** 100 ns to 1.2 ms.  
**Release time for 90% recovery; Limiter:** Less than 90 ns; **Compressor:** Continuously variable from 50 ms to  $\geq$  10 seconds.  
**Frequency response:** Within 1 dB from 20 Hz to 50 kHz (-1 dB at 10 Hz and 100 kHz).  
**Maximum undistorted output:** +12 dBm.  
**Total harmonic distortion:** Not over 1/10th of 1%, typically less than 5/100ths of 1% (up to 30 dB comp. 20 Hz to 20 kHz).  
**Signal-to-noise ratio:** Better than 80 dB below compressor/limiter output (-40 dBm input signal, 20 Hz to 20 kHz).  
**Source impedance:** 50 ohms to infinity.  
**Input impedance:** 600 ohms (10 k $\Omega$  available on request).  
**Output impedance:** Less than 6 ohms.  
**Output loading:** 600 ohms to infinity.  
**Power requirement:** 24V at approx 40 mA.  
**Dimensions:** 64 x 126 x 19 mm.  
**Weight:** 0.1 kg.  
**Price:** £61.

#### SPECTRA SONICS 610 COMPRESSOR LIMITER

**Input impedance:** 600 ohms floating.  
**Output impedance:** less than 6 ohms floating.  
**Output loading:** 600 ohms to infinity balanced or unbalanced.

**Maximum gain:** 56 dB.  
**Input level:** Typically -50 dBm to +10 dBm.  
**Threshold attack level:** -40 dBm.  
**Output level:** Typically +4 dBm or +8 dBm.  
**Signal-to-noise ratio:** Not less than 80 dB below -4 dBm output with -40 dBm input (threshold), 20 Hz to 20 kHz, unweighted.  
**Frequency response:** +1 dB 20 Hz to 40 kHz at -16 dB (High Z load)  $\pm$  5 dB 20 Hz to 20 kHz at -16 dBm (600 ohms load).  
**Harmonic distortion:** Less than 1/10th of 1% 30 Hz to 20 kHz at -16 dBm, up to 30 dB compression, with release time such that attack and release does not occur on successive peaks of the lowest frequency utilized (typically less than 5/100 of 1%).  
**Compression/limiting ratio:** continuously variable from approximately 1.1:1 to 100:1.  
**Attack time:** Automatically variable.  
**Limiters:** 100 ns to 2.0  $\mu$ s.  
**Compressor:** 100 ns to 1.2 ms.  
**Release time:** for 90% recovery.  
**Limiters:** Less than 90 ns.  
**Compressor:** Continuously variable from 50 ms to  $\geq$  10s.  
**Maximum temperature:** 140 F.  
**Power requirement:** 105 to 125V, 60 Hz, 6W.  
**Dimensions:** 89 x 483 x 216 mm.  
**Weight:** 4.3 kg.  
**Stereophonic interconnection:** two units are easily coupled. Requires model 610 SI Accessory.  
**Price:** £318.75.  
**Manufacturer:** Spectra Sonics, 770 Wall Ave., Ogden, Utah 84404.  
**DISTRIBUTOR:** Feldon Audio Limited, 126 Great Portland Street, London, W1.

#### STUDER COMPRESSOR-LIMITER (Professional Specifications)

Two separate channels for mono operation, which can be coupled for stereo work.  
**Input:** Balanced and free from earth  
**Input impedance between 30 Hz and 15 kHz:** 10 k $\Omega$ .  
**Nominal input level:** -15 dB (0.14V).  
**Source impedance nominal:** 200 ohms (0 to 1 k $\Omega$ ).  
**Max input level:** 15 dB (4.4V).  
**Output:** Balanced and free from earth.  
**Load impedance:** 600 ohms min.  
**Distortion:** between 100 Hz and 10 kHz: 0.5% max.  
**Frequency response:** 30 Hz to 15 kHz  $\pm$  0.5 dB.  
**Signal-to-noise ratio:** Referred to an output level of -15 dB: 70 dB min.  
**Crosstalk ratio:** 75 dB min.  
**Max compressor gain:** 30 dB.  
 Gain before reaching threshold: variable 0-20 dB.  
**Limit Mode:**  
 Threshold level: -15 dB.  
 Compression ratio: 25:1.  
 Attack time constant: 50  $\mu$ s approx.  
**Compressor mode**  
 Threshold level: -15 dB.  
 Compression ratio: selectable 1.5:1, 2:1, 3:1, 5:1  
 Attack time constant: 2.5 ms.  
**Release time** (after a gain reduction of 20 dB selectable in four steps): 0.3s, 0.75s, 2s, 5s.  
**Position auto:** release time programme content controlled.  
**Stereo operation:** The control circuits of the two channels are electrically coupled for stereo operation (or gate function). The two af channels are now governed by the same control signal.  
**Price:** £270.00.  
**Manufacturer:** Studer (Gotham Audio Corp., 2 W46 St., New York, NY 10036, USA)  
**DISTRIBUTOR:** F.W.O. Bauch Ltd.

#### TELETRONIX LEVELLING AMPLIFIER LA-3A

**Input impedance:** 600 ohms (floating).  
**Maximum input level:** +20 dBm (30 dB gain position) 0 dBm (50 dB gain position).

**Output load impedance:** 600 ohms (floating), Damping factor 8.  
**Maximum output level:** +24 dBm ( $\pm$  27 dBm on peaks).  
**Gain:** 50 dB or 30 dB ( $\pm$  1 dB). Switching at rear panel.  
**Frequency response:**  $\pm$  1 dB 20 Hz to 20 kHz.  
**Signal-to-noise ratio:** Greater than 80 dB at threshold of limiting (30 Hz to 15 kHz bandwidth).  
**Threshold of limiting:** -10 dBm at 30 dB position, -30 dBm at 50 dB position.  
**Distortion:** Less than 0.5% thd from 30 Hz to 20 kHz.  
**Attack time:** Less than 250  $\mu$ s to 0.5 ms depending on programme material.  
**Release time:** Varies from 500 ms to 5.0s depending on the duration of the peak causing the onset of limiting.  
**External connections:** Jones barrier terminals at rear.  
**Stereo interconnection:** Terminals at rear of chassis.  
**Power requirements:** 110-125V 50/60 Hz, 6 watts. Switch provided for 220-250 V, 50/60 Hz.  
**Environmental:** Max ambient operating temperature 160 F.  
**Dimensions:** 89 x 216 x 235 mm.  
**Weight:** 2.9 kg.  
**Price:** £228.  
**Manufacturer:** United Recording Electronics Industries, 11922 Valerio Street, No. Hollywood, California 91605.  
**DISTRIBUTOR:** F.W.O. Bauch Ltd.

#### UNIVERSAL AUDIO 1176 LN LIMITING AMPLIFIER

**Input impedance:** 600 ohms, bridged T control (floating).  
**Output load impedance:** 600 ohms, floating damping factor 20.  
**External connections:** Jones barrier terminals at rear.  
**Frequency response:** -1 dB 20 Hz to 20 kHz.  
**Gain:** 45 dB  $\pm$  1 dB.  
**Distortion:** Less than 0.5% thd from 50 Hz to 15 kHz with limiting at 1.1s release setting (as with all limiting devices, distortion of low-frequency peaks increases as release time is shortened). Output capability is -24 dBm.  
**Signal-to-noise ratio:** Greater than 81 dB at threshold of limiting, 30 Hz to 18 kHz.  
**Attack time:** Less than 20  $\mu$ s for 100% recovery. Adjustable to 800  $\mu$ s with front panel control.  
**Release time:** 50 ms minimum, 1.1s maximum (for 63% recovery). Adjustable with front panel control.  
**Threshold vs Output Level:** (sinewave signal). Compression ratio setting 20:1, 12:1, 8:1, 4:1. Input level at minimum limiting threshold -2 dB, -19 dBm, -20 dBm, -21 dBm, -26 dBm respectively. Relative output: +12 dBm, -11 dBm, -10 dBm, -9 dBm respectively.  
**Stereo interconnection:** Pin jacks at rear of chassis. Requires 1176SA Network Accessory to couple two units.  
**Power requirements:** 110-130V 50/60 Hz, 6 watts. Strapping provided for 220-260V, 50-60 Hz.  
**Environmental:** Max ambient operating temperature 160 F.  
**Dimensions:** 89 x 483 x 204 mm.  
**Weight:** 5 kg.  
**Price:** £298.  
**Manufacturer:** United Recording Electronics Industries, 11922 Valeriox Street, No. Hollywood, California 91605.  
**DISTRIBUTOR:** F.W.O. Bauch Limited, 49 Theobald Street, Boreham Wood, Herts.



# Background Annihilation with KEPEX

The new electronic sensor :: the wide range gain expander, absorbing any background or low-level noise :: soaking up all tape hiss, instrument hum and amplifier noise :: separates tracks, eliminates studio noise, removes unwanted sounds. In short, the simple way to obtain perfect tracks without impairing the original.

Fitted with range, release and threshold controls to give a wide range of controlled application, plus simple visual gain display in digital form. The instrument for the professional recordist, the multi-track studio engineer and the broadcasting technician. Supplied in modular form for ready integration into existing consoles, or as racked and mounted units for up to 16 channels. Write now for details.

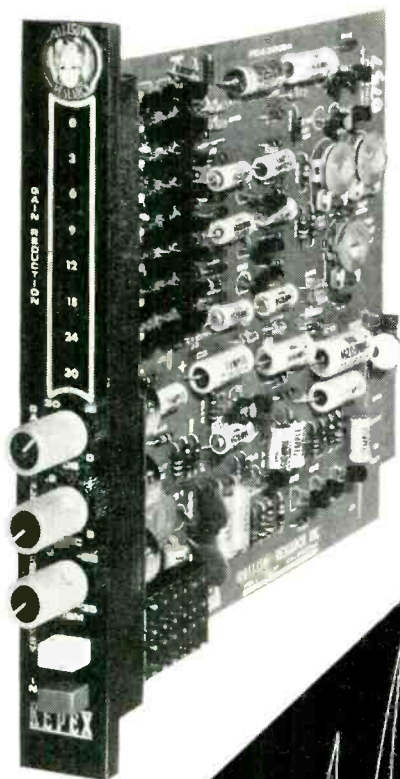

**F.W.O. BAUCH LIMITED**  
 49 Theobald Street,  
 Boreham Wood, Herts.  
 Tel: 01-953 0091 Telex: 27502

## It's back again!

Beautiful 

# Shamrock

FERRO-SHEEN  
 POLYESTER BASE  
*recording tape*

Once again this top quality recording tape is coming in from the USA and is being made available at a price all can afford. Do not confuse SHAMROCK Ferro-Sheen with cheap tape, it is a quality product made by AMPEX, America's largest producer of high quality tapes for industrial, entertainment and domestic use.

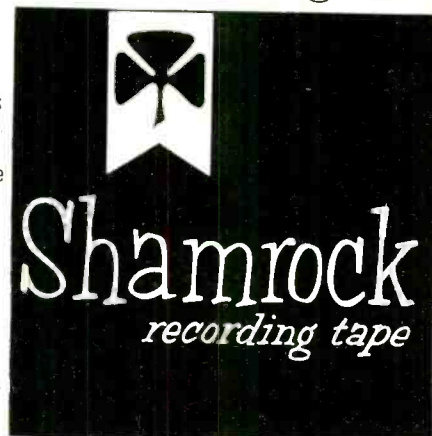

**TOP QUALITY AT THE LOWEST PRICE**  
 SHAMROCK Ferro-Sheen has always been difficult to get, over here, but with a special arrangement with AMPEX G.B., our continuity of supplies is assured. SHAMROCK Ferro-Sheen is a superior product.

### THE GREATEST VALUE IN RECORDING TAPE

You get more good clean sound for your money with SHAMROCK Ferro-Sheen than with any other tape anywhere near the price...

SHAMROCK Ferro-Sheen is extensively used by Educational Authorities, Universities, Language Laboratories and Tape Recording Clubs.

SHAMROCK Ferro-Sheen recording tape is available in L.P. and D.P. grades. 7" 1800ft. L.P. 3 for £2.25, 6 for £4.45, 12 for £8.85. 5 1/4" 1200ft. 3 for £1.95, 6 for £3.75, 12 for £7.65. 5" 900ft. L.P. 3 for £1.30, 6 for £2.55, 12 for £5.05. 7" D.P. 2400ft. 3 for £3.40, 6 for £6.75, 12 for £13.45. Add 5p PER REEL p & p on all orders under £5

#### Guarantee

*If, for any reason you think your SHAMROCK Ferro-Sheen tape does not come up to your expectations, send it back to us and we will either replace it FREE or refund your money whichever you select.*

### POST THIS COUPON TO DAY

Music Tapes Mail Order,  
 36 High Street,  
 Salisbury, Wilts.

Please mail to me at the address below, the following reels of Shamrock Ferro-Sheen recording tape.

7" L.P. .... @ £.....  
 7" D.P. .... @ £.....

I enclose 5p per reel for P & P if my order totals less than £5.

Name .....

Address .....

(Offer available in U.K. and Northern Ireland only.)

# A Versatile Recording Amplifier

Part Two

By L. Hayward

THIS article deals with what is often the weakest link, the bias and erase oscillator. No originality is claimed for this circuit; most engineers will be familiar with it, at least in valve form. Transistors lend themselves well to this type of multivibrator; this circuit has the advantage of simplicity and is easily designed to meet the power required for erasure. Although the system is to some extent self-stabilising, if half-track operation is required it is advisable to load the erase winding with the equivalent loss resistance of the unused part of the erase head. For the Bogen *UL290*, this works out at 10 kΩ. The best situation for good results is of course a full-track erase head, mono recordings being made using both half-tracks. If editing is to be carried out this is necessary in any case and leads to a much simpler construction.

The power developed in the heads will depend upon the power supply voltage, and this may require increasing if heads other than the *UL290* are used. To obtain sufficient erasure with a Leever-Rich full-track erase head it was found necessary to increase the supply to 13.5V. It is unadvisable to increase this beyond 15V, however, since the peak collector voltage of the transistors may be exceeded. Where more or less volts are required for heads of an impedance other than the types specified, the secondary turns may be adjusted as required. As a guide, the *UL290* requires 70V rms. This is provided by 100 turns. It should be remembered that head manufacturers' specs regarding bias current often require updating, since the high output tapes in common use normally require a little more bias for 1 dB overdrop than earlier tapes. Where very low impedance heads are used it will be necessary to increase the gauge of wire used to accommodate the increased current. The operating frequency is set by  $C_x$  in conjunction with the total inductance, and in this case is set just over 100 kHz.

It is not advisable to run the oscillator unloaded, due to the high peak voltages produced. It is quite possible to obtain an RF burn if fingers are placed across the secondary windings whilst operating in this mode!

The 500 μF capacitor is not included for decoupling but to ensure a gradual decay of oscillations when the oscillator is switched off. Its inclusion is therefore essential if magnetised heads are to be avoided. Bias amplitude control is effected by adjustable series capacitors feeding the heads, and the setting up of these will not shift the operating frequency to any great extent.

The pot-core assembly used here is, again, the Mullard *LA2208*. Thus the three circuits described in the series are standardised on this component. This was selected because its construction allows dismantling as often as

required, making turns adjustment quite simple. The primary winding of the transformer should be bifilar wound. This is most easily accomplished by finding the length of wire required for one half of the primary, cutting two lengths, and then winding these on together. One start and one finish are now connected together to form the centre tap. The secondary windings may be pile-wound; one over the primary, the other in the spare half of the bobbin.

The complete oscillator should be built in a screened box to prevent radiation. Preferably the head feed resistors are also included in this box to improve bias rejection. These components were designated R12 in the record amplifier, and for the *UK202* head should be reduced to 82 kΩ. It is not advisable to use the higher impedance *UK200* with this circuit, as the required voltage leads to a rather large bias secondary. It can be accommodated, how-

ever, if the bias winding is connected in series with the erase winding.

It is advisable to use cooling clips of a minimum area of 25 cm<sup>2</sup> to mount the transistors, especially if greater output is required.

Either end of the power supply may be used as earth, since the transformer provides complete isolation.

Tests with the prototype have been most satisfactory. Using EMI *815* tape, adequate erasure was obtained with a variety of heads, including some 'difficult' types. Noise from the erased tape generally was no greater than 1-2 dB above virgin tape level, indicating a low distortion level from the oscillator.

Next month the concluding article in the series will feature a design for a high performance playback amplifier, as well as giving details of the power supply requirements for the set of three circuits.

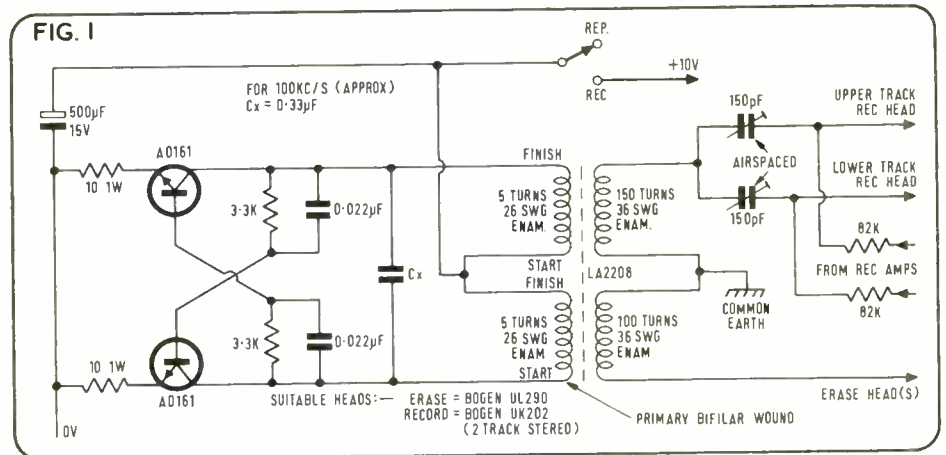

## Component specification

Z1	24V zener diode, 250 mW
TR1	BC 183 L
TR2	BF179
TR3	BF179 With cooling clip
VR1	10 kΩ potentiometer
R2	33 Ω 10% 1/8W
R3	6.8 kΩ 5% "
R4	7.5 kΩ 3W wire wound
R5	1.2 kΩ 5% 1/8W
R6	120 kΩ " "
R7	15 kΩ " 1/2W
R8	1 kΩ " "
R9	1.5 MΩ " "

R10	330	10% 1/8W
R11	6.8 kΩ	5% 2W
R12	150 kΩ or less	depending on head
R13	100 kΩ	10% 8W
C1	50 μF	25V Electrolytic
C2	4,700 pF	polyester
C3	2 μF	polyester or tantalum
C4	250 μF	15V electrolytic
C5	82 pF	5% silver mica
C6	27 pF	" "
C7	0.33 μF	polyester
C8	1 μF	250V polyester

Transformer. Gardners type *MU7524*, and international octal base.

# The big new name to trust. Sharp.

We're one of the biggest names in world electronics.

Our record is one of 50 years of technological achievement; from the first ever radio and television sets manufactured in Japan, right up to today, when Sharp, in conjunction with the North American Rockwell Corporation have commercially developed the microcircuitry that helped put Apollo on the moon.

This technical experience is built into all our products. Sharp audio equipment is some of the finest available today.

Now, British connoisseurs of fine sound can enjoy the excellence of Sharp.

1. Whenever you buy a piece of Sharp equipment you are buying Sharp's high standard of design, performance and technology.

A standard backed by Sharp's special one-year guarantee covering not only parts but all labour costs too.

2. To ensure that our fine equipment gets the best service possible, Sharp's specially equipped service centre is

manned by the same efficient team of experts that designed and made it originally.

3. When you buy Sharp audio equipment, you're buying the results of the most up-to-date technology.

Sharp sets new standards — depend on it.



For a free Sharp catalogue showing the complete audio range write to:— Sharp Electronics (UK) Ltd., Dept U 48 Derby St., Manchester M8 8HN. Tel: 061 832 6115

Name \_\_\_\_\_  
 Address \_\_\_\_\_  
 \_\_\_\_\_  
 \_\_\_\_\_

Walton & Gordon Ltd., 38a/40 Queen St, Belfast BT1 6EX. Tel: 20656. Peter Dand & Co. Ltd., 111 Clonskeagh Rd, Dublin 6. Tel: 694433.



**RD 712D**  
 Solid state x 3 speed stereo tape deck.  
 Circuit 11 transistor, 5 diode. Type 7" reel,  
 4 track, 2 channel, stereo/monaural,  
 vertical/horizontal operation  
 DIN Jack. Output Line (-6dB 3K ohm) £72.30

\*recommended U.K. retail price

**STA 32L**  
 Solid state stereo tuner/amplifier.  
 Circuit 42 transistor (including 3 FETs)  
 1-1c, 28 diode. Type MW/LW/FM  
 multiplex 3 band superheterodyne stereo  
 tuner/amplifier. Tuning range 525-1605kHz,  
 LW 150-370kHz, FM 88-108 MHz.  
 Output 80W (40W + 40W) max. music power £115.00



**RD 423E**  
 Solid state cassette  
 tape deck  
 (standard cassette).  
 Circuit 18 transistors,  
 11 diode.  
 Stereo/monaural  
 4 track, 2 channel,  
 DIN jack, output  
 (-2dB 50K ohm).  
 £57.50

# Equipment Reviews

## Dolby 361 Noise Reducer

IN the July 1970 issue of *STUDIO SOUND* I wrote the first technical review of the Dolby A noise reduction system, based upon the A 301 unit submitted by the manufacturers. The actual working of the system with the results that could be obtained at different speeds was explained, and it is therefore not intended that this review should cover these technicalities.

The model 361 has been justifiably nicknamed the 'slimline' Dolby. Two units are necessary for stereo, but nevertheless these occupy only a third of the space taken by the stereo A301 as well as being slightly shorter back to front. Each unit measures 480 mm wide x 230 mm deep x 38 mm high. All the normal functional controls are available on the front panel, and each unit has sockets on the rear for mixer input, output to tape recorder, tape recorder playback and monitor output. A remote control socket is also provided to change the unit over remotely from the normal replay function to the record function. The provision of this facility overcomes one of the drawbacks of the A301 system in which it was necessary to carry out switching on the rear of the unit; this could be very awkward when several units were mounted in a rack, necessitating the use of an expensive remote control device which required semi-permanent installation.

Dolby Laboratories have also included a Dolby tone push button which injects an 880 Hz signal with 1.5 Hz frequency modulation on to the audio circuit so that the tone can be recorded on to a tape for alignment checking on playback. Five coloured, illuminated push buttons are used for the different functions: the left hand one shows white when depressed to switch the noise reduction circuits in; the next, for the record function, shows red when depressed, and its partner shows green for playback or remote functions. The final two select either normal or check tape functions and are blue and yellow respectively. In the normal position the monitor output is connected through to the mixer input whereas in the check tape position the monitoring circuits are switched to the tape monitoring in the Dolbyed state, since a single 361 unit can only be switched into one mode at a time. Input and output gain controls are accessible behind a screw-on panel to the right of the push buttons, thus allowing the 361 to be operated at any of the more usual studio peak working levels. This facility is most useful as it allows Dolbyed tapes having a Dolby tone at the beginning to be set up accurately to Dolby level. This can be done by adjustment of these pre-sets avoiding the necessity of touching other pre-sets which may be difficult to get at—in the tape recorder for instance. In prac-

tice a Dolbyed tape recorded at the correct Dolby levels on a two track head with a wide guard band between the tracks can replay nearly 3 dB down in level on a stereo playback head having a narrow guard band, as explained in a recording studio techniques article. Thus the input levels on the 361 can easily be lifted by the required amount, allowing the programme material to be presented to the Dolby at the correct level. In the same way, if the tape recorder replay channel has been accurately calibrated the Dolby tone oscillator can be used in conjunction with the output level controls to check that the right Dolby level is recorded onto the tape, allowing it to play back correctly. Within a studio it is envisaged that the input and output controls would be set for the same peak level corresponding to Dolby level.

Many engineers will remember that the A301 had an output impedance of approximately 600 ohms and therefore the output level could drop noticeably if two or more tape recorders having an input impedance of 10 k $\Omega$  were connected to the output. For this reason the 361 has been designed to have the extremely low output impedance of approximately 20 ohms at 1 kHz, this being an approximate dc resistance on the output transformer winding. This allows the equipment to be bridged by a resistive load as low as 600 ohms without any

bridging on the replay side the unit will require modification. This can be done by the manufacturers. The standard model is supplied with XLR connectors at the rear, but I understand that certain other types of connectors are available to special order. The same type of non-reversible mains socket is provided as on the A301, and the equipment is designed specifically to enable it to be easily rack mounted.

Two 361s were submitted for review and were connected so that the record output of the first circuit fed the playback input of the second unit. All input and output controls were adjusted on both units so that a level of +4 dBm corresponded throughout to Dolby level. The overload margin was checked and it was found that the clipping point was considerably better on the 361 than on the A301, the output into 10 k $\Omega$  being of low distortion up to +23.5 dBm, clipping being immediately noticeable at only a fraction of a dB above this point. The clipping point with the 600 ohm load connected was at +22 dBm, and +18 dBm with a 200  $\Omega$  load connected. This is still better than for the A301 measured 18 months ago.

Some engineers have claimed in the past that under operational conditions the A301 system clipped noticeably before tape distortion became apparent to them. Some tapes used under these circumstances can produce tape distortion at the point of clipping on the A301

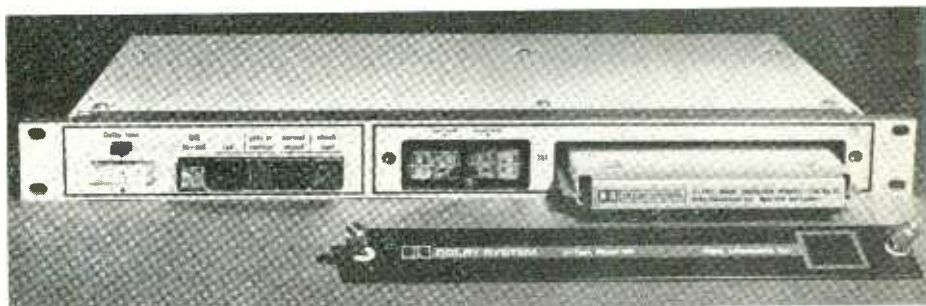

voltage change being noticeable under normal conditions. The input impedance has been increased to approximately 19 k $\Omega$  bridging for normal operation, allowing greater versatility. A switch is provided for loading the input with 600 ohms for circuits requiring loading. Under these circumstances, with the push button in the normal position, should the monitoring circuit also be 600 ohms it will be appreciated that a 300 ohm load could therefore appear on the mixer, and to obviate this in this switched position the internal 600 ohm load is disconnected. It should be mentioned here that in installations requiring 600 ohm load termination on the record side and

as high as 10 per cent. It is however important to have as good an overload margin as possible, and the 361 will prove to have a more suitable overload margin for engineers wishing to drive their tape very hard. The clipping points were tested across the entire audio bandwidth and only a very marginal fall off of  $\frac{1}{2}$  dB was noticed at the extreme ends of the frequency spectrum.

The frequency response of the two units connected back to back was checked with both the noise reduction circuits in and out of operation. In addition, each unit was tested individually to check that the compression and

(continued on page 47)

# FRANCIS OF STREATHAM

## DECKS WITH PRE-AMPS

(Microphone extra)  
 Akai 8 Tr. Cartridge CR.800  
 Akai 4000D Stereo  
 Brenell Mk.6 Stereo  
 Ferrograph 702/4  
 Philips N.4500 3 sp. 4 Tr. Stereo  
 Revox 1102/4 2 sp. Stereo  
 Sharp RD 712D 3 sp. 4 Tr. Stereo  
 Sony 366D 3 sp. 4 Tr. Stereo  
 Sony 630D 3 sp. 4 Tr. Stereo  
 Sony 266D 3 sp. 4 Tr. Stereo  
 Sony 255 Stereo  
 Tandberg 1800 4 Tr. Stereo  
 Tandberg 3000X 3 sp. 2/4 Tr. Stereo  
 Tandberg 6000X 3 sp. 2/4 Tr. Stereo  
 Telefunken 205 3 sp. 4 Tr. Stereo  
 Telefunken 203 Studio

## KELLAR BLACK BOX Dolby Unit

## MAINS SPOOL RECORDERS

\*Akai 1710L 2 sp. 4 Tr. Stereo  
 \*Akai 4000 3 sp. 4 Tr. Stereo  
 \*Brenell Mk. 6  
 \*Ferrograph 713  
 \*Ferrograph 722/4  
 Grundig 141 4 Tr. Mono  
 Grundig TK.121 2 Tr. Mono  
 Grundig 146 4 Tr. Mono Auto.  
 \*Grundig TK248 2 sp. 4 Tr. Stereo  
 Philips 4307 4 Tr. Single Speed Mono  
 Philips 4308 2 sp. 4 Tr. Mono  
 Philips Stereo 4404 2 sp. 4 Tr.  
 Philips 4407 3 sp. 4 Tr. Stereo  
 \*Revox 1222/4 Stereo  
 Sharp 708 3 sp. 4 Tr. Stereo  
 Sharp 711 3 sp. 4 Tr. Stereo  
 Sony 630 3 sp. 2/4 Tr.  
 Sony 540 3 sp. 4 Tr. Stereo  
 Sony 252 3 sp. 4 Tr. Stereo  
 \*Tandberg 15 2 or 4 Tr./3 sp./Mono

\*Microphones extra

\*Tandberg 4000 3 sp. 2/4 Tr. Stereo  
 \*Telefunken M207 2 sp. 4 Tr. Stereo  
 Telefunken 203 Stereo/Mono 2 sp. 4 Tr.  
 Telefunken 201 Mono 4 Tr.  
 \*Uher 714 4 Tr. Mono  
 \*Uher Royal de Luxe 4 Tr. 4 sp. St.  
 \*Uher Varicord 263 Stereo  
 \*Uher 724 4 Tr. 2 sp. Stereo

## MAINS CASSETTE MODELS

\*Philips RH882 Stereo Tuner/Amp  
 \*Sony HST399 Stereo Tuner/Amp  
 Sony TC 330 Stereo Cass./Spool

\*Rank Wharfedale Dolby Stereo  
 Philips 2400 Stereo  
 Philips 2401 Autochange w. ski-slope

\*Sony TC 127 Deck and Pre-amp  
 \*Sony TC 122 Deck and Pre-amp  
 \*Philips 2503 Deck and Pre-amp

## BATTERY MAINS CASSETTE

Philips 2204 Sony TC. 80  
 Philips 2205 Sony TC. 100  
 Sony TC. 60  
 Philips TT 392 with AM/FM  
 Philips RR 290 with AM  
 Sony CF 100 with AM/FM  
 Sony CF 200 with AM/FM

## BATTERY CASSETTES

Philips EL3302 Sony TC. 40  
 Philips N2202 Sharp 418  
 Sony TC. 12 Grundig C.200

## BATTERY SPOOL MODELS

\*Tandberg Series 11-2  
 Sharp 514 2 Tr 2 sp (BM)  
 Sony TC. 800 B 2 Tr 4 sp (BM)  
 Telefunken 302 4 Tr 2 sp  
 \*Uher 4000L 4 sp 2 Tr  
 \*Uher 4200/4400 4 sp Stereo

FOR A FAIR AND DEPENDABLE DEAL IN

## TAPE and HI-FI

- ★ NO INTEREST OR SERVICE CHARGES ON H.P. UP TO 18 MONTHS
- ★ Free Service during Guarantee period
- ★ Fair Part Exchange Allowance on your old Recorder
- ★ Reconditioned Recorders available to personal shoppers only

## AMPEX TAPE OFFERS

(P—Polyester; M—Mylar; A—Acetate)  
 Compact Cassettes C.60—53p; C.90  
 —75p; C.120—£1.05 (pp 3p each).  
 7" D.P. 2400 ft. (P) ... £1.50  
 7" L.P. 1800 ft. (P) ... £1.05  
 5 1/2" I.P. 1150 ft. (M) ... 88p  
 5 1/2" L.P. 1150 ft. (A) ... 75p  
 5 1/2" Standard 850 ft. (A) ... 63p  
 5" D.P. 1200 ft. (P) ... 88p  
 5" L.P. 900 ft. (P) ... 63p  
 5" Standard 600 ft. (P) ... 50p  
 Postage on orders under £3 add 10p,  
 orders over £3 sent post paid U.K.

Splicers, Defluxers, Bulk Erasers,  
 Accessories of all kinds.

## MIXERS by

Uher, Eagle, Sony, Grundig, etc.

● MICROPHONES by AKG, Gram-  
 pian, Reslo, Acos, Beyer, Sennheiser,  
 Telefunken, etc.

● HEADPHONES by AKG, Nikko,  
 Philips, Koss, Eagle, TTC, Beyer,  
 Akai.

● MUSICASSETTES. All leading  
 makes. Pre-recorded 8-track car-  
 tridges and tapes.

BASF Chromium Dioxide Cassettes.  
 TAPES and CASSETTES by TDK  
 and all leading makes.

## HI-FI DEPT.

### AMPLIFIERS

Quad, Rogers, Arena, Philips,  
 Goodman, Nikko, Armstrong,  
 Leak, Tripletone, Tandberg,  
 Teleton.

### TUNERS

Quad, Rogers, Leak, Arm-  
 strong, Tripletone, Arena,  
 Nikko, Goodman, Huldra.

### LOUDSPEAKERS

Quad, Rogers, Kef, Wharfe-  
 dale, Goodman, Tannoy,  
 Lowther, Leak, Tandberg,  
 Arena, Celestion, Kelestron.

### MOTORS, PICK-UPS

GARRARD inc. S.P.25 Mk. III  
 Goldring BSR  
 Connoisseur Thorens  
 Audiotec Shure  
 Neat Sonotone  
 Acos SME  
 Dual Pickering

Diamond styli, Microlifts, Pressure  
 Gauges, Cleaning Accessories,  
 Cabinets, etc.

169-173 STREATHAM HIGH ROAD, LONDON, S.W.16

Between St. Leonard's Church  
 and Streatham Station

01-769 0466: 01-769 0192

Please note this is our only address. Free parking Prentis Road, 2 mins away  
 OPEN ALL DAY SATURDAY—CLOSED ALL DAY WEDNESDAY

# studio sound

THE MOST EFFECTIVE WAY OF BUYING STUDIO SOUND IS BY DIRECT SUBSCRIPTION

## ANNUAL RATES

Australia	7 Dollars	Denmark	60 Krone	Italy	5,000 Lire	Spain	560 Pesetas
Austria	200 Schillings	France	44 Francs	Japan	2,850 Yen	Sweden	41 Kronor
Belgium	400 Francs	Germany	28 Marks	Norway	57 Krone	Switzerland	33 Francs
Brazil	42 Cruzeiro	Greece	240 Drachma	Portugal	230 Escudos	United Kingdom	£3.00
Canada	8 Dollars	Holland	28 Guilders	South Africa	5.75 Rand	United States	8 Dollars

To Studio Sound, Link House, Dingwall Avenue, Croydon CR9 2TA, England

Please enter my subscription for one year, commencing with the ..... issue. I enclose payment .....

Name .....

Address .....

continued

expansion characteristics were up to specification. For this measurement a B & K 1022 oscillator was used with an automatic frequency response tracer using the 50 dB pot position. The response at all levels was within the manufacturer's tolerance of  $\pm 1$  dB, from 20 Hz to 20 kHz and indeed at almost all dynamic levels measured  $\pm 0.5$  dB with reference to 1 kHz. The response checks were carried out in 10 dB steps from  $\pm 14$  dBm in down to  $-56$  dBm in.

It was decided that a large number of readers would be interested in a back to back check of the 361 with the A301 in both the record and replay modes, and this was done over the same range. The largest error found was a shelf of just under  $+1$  dB at the lower frequency end which was reduced to half this value when the A301 was checked back to itself. This error in fact was due to the slight change between NAB and DIN levels on the A301 and the equivalent positions on the 361. The difference between the two positions on the A301 measured only 4 dB, whereas on the 361 the difference measured 4.8 dB. This change was due to the remeasurement of the Ampex operating level standard which was found to be 185 pWb/mm and not 200. Dr Dolby decided therefore to make the Dolby level position 0.4 dB below the NAB position of the A301 and the DIN position of the 361 0.4 dB higher than the DIN position of the A301. This error of 0.4 dB therefore accounts for the minute difference of frequency response at certain levels, a difference which is nevertheless completely inaudible.

As a further check of compatibility between the two types of unit, frequency modulation was applied to the 1022 oscillator such that this modulation was switching at a high speed approximately 200 Hz either side of a band overlap. A probe tone at varying levels was then mixed in with the frequency modulation tone and it was found that not only did the probe tone always come out at the correct level after de-Dolbying, but, no matter what its intensity was, the frequency modulated tone was also extracted at the same level as its input level, using a  $\frac{1}{3}$  octave filter. This measurement was found to be extremely difficult, but should be regarded as very worthwhile since it is in effect testing the Dolby system in dynamic frequency shift conditions which would show up faults in every other type of compander known to the writer.

I have also used the two new units several times on mobile sessions and on sessions in my own studio, and operationally I have found

them to be considerably more convenient than the A301. No snags in operation have been encountered although one or two rather surprising points have arisen as a result of further measurements carried out. In the response checks it was decided to check the performance well outside the normal audio band of 20 Hz to 20 kHz, and it was found that a very considerable boost of 8 dB was noticeable at frequencies between 4 Hz and 8 Hz when the response was taken at a level of  $-56$  dBm. This was found to be due to a resonance between the output transformer and its feed capacitor which completely disappears at levels higher than approximately  $-35$  dBm, and is only just noticeable at a level of  $-40$  dBm. This resonance is quite common when a very low output impedance transistor stage is connected via a capacitance to an output transformer. It will be found that if the output is loaded, the resonance is considerably reduced and in practice will be inaudible under all conditions. However, the symptoms can be noticed if the noise reduction switch is momentarily pushed in and out, the circuit taking approximately a second to stabilise, but the effect should not be confused with motor boating, which is completely absent in the equipment under review.

Above 21 kHz the response falls very rapidly, being 3 dB down at 24 kHz and 6 dB down at 26 kHz. The filter is set at a slightly lower frequency than that originally designed for the A301. This filtering is specifically designed to prevent any forms of bias or very high frequency signals from interfering with operation and no trouble in this respect has ever been reported by users known to me.

In the record mode the noise level on the review samples was not considered quite good enough, the measurements being  $-62.5$  dBm and  $-65$  dBm on the two units respectively.

The noise produced was almost entirely 50 Hz, although small components of 150 and 250 Hz were noted. No hum was apparent at 100 Hz since the 18 volt stabilised rail is extremely well smoothed. The 50 Hz hum present is mainly induced into the audio wiring by the ac current feeding the bulbs behind the front panel switching, but modifications have now been carried out by the manufacturer to improve the figure; a later sample tested just before sending in this report measured  $-68.5$  dBm. This hum level is of course only noticed in the Dolbyed state, and after de-Dolbying the overall hum level of the two units in series is  $-72$  dBm, i.e. 76 dB below Dolby level and 84 dB below the peak level used by studios operating their tapes to 510 pwb/mm. Although the hum level measured is therefore appreciably worse than that of the A301, in practice it is very considerably lower than that found on any commercial tape recorder, and would not normally be noticed unless multitrack recordings were repeatedly Dolbyed and unDolbyed with 361 units after many mixes in making a master.

Since a very small number of professional engineers are still insisting that they can hear the A system operate, I measured the distortion of the two 361s in series at different frequencies. The distortion levels of the 361 were in all cases considerably lower than the low distortion levels of the A301. The pre-distortion techniques used appeared to work very accurately and at Dolby level the distortion at 1 kHz measured below 0.02 per cent. I decided to look for the level at which the worst distortion was noticeable, and under the worst conditions. At 25 dB below Dolby level the second harmonic distortion of 1 kHz was considerably below the noise level of the system; below 0.01 per cent with the two units in phase. Since it

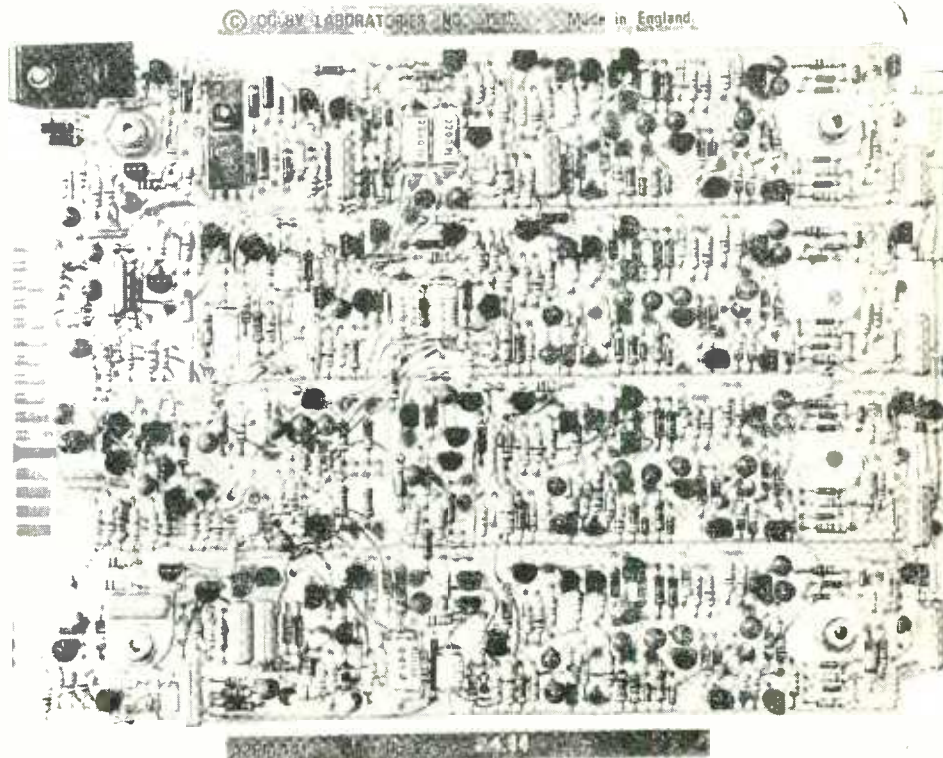
*(continued on page 49)*

**Right:** Virtually every component of the 361 is mounted on this one circuit board.

# Product Manager for sound career.

One of Europe's leading audio and electronic companies – Eagle International, are looking for a man they can train to be an aggressive Product Manager who, by the end of 1972, will head up their entire Public Address division.

After training, the job will demand responsibility for sales and advertising targets, budgets and policy.

You must have a good knowledge of professional standards in the industry or have relevant experience in the entertainment, stage or studio worlds.

If you're around 24-34, earning good money now and prepared to learn how to earn even more, write to David Harris, Eagle International, Precision Centre, Heather Park Drive, Wembley HA0 1SU.

## 0.1% Distortion at full RMS power rating.

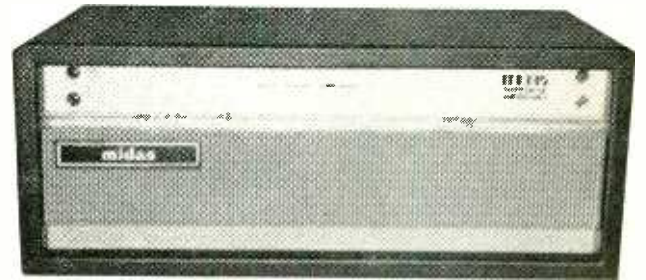

Is just part of the specification that proves the Midas Hi Fi 100 Slave above all its contemporaries. 100 watts plus into 8 OHMS. Frequency range, 20 c/s to 20 K c/s. Fully protected against short and open circuit conditions. Clean limiting under high signal overdrive, with no recovery problems.

Midas Professional Amplification,  
128 High Road, East Finchley, London, N.2.  
Telephone: 444 7707.

**The JBL D140F Speaker in this horn loaded cabinet will handle 150 watts RMS continuous power, will reproduce frequencies as low as 30 c/s and is guaranteed to do so for two years.**



What could be more useful in the same unit than an amplifier of 100 watts RMS with less than 0.1% distortion, and guaranteed to give this over a frequency range of 20 c/s to 20 K c/s. Vitavox Horns crossed over at 850 c/s are used to complete a balanced P.A. Stack.

Midas Professional Amplification,  
128 High Road, London, N.2. Telephone: 444 7707.



continued

was apparent that the distortion might have been cancelling between the two units a phase reversal was inserted, the distortion then measuring 0.2 per cent—on the fringe of the manufacturer's specification. To measure distortion at higher levels I had to go to considerable lengths to find the one small range in the equipment where the distortion was of this order. Thus the overall performance should be considered as highly satisfactory. The difficulty of measuring distortion at these low levels is not inconsiderable but nevertheless I managed to measure the third harmonic distortion of 30 Hz at the same level. This measured only 0.15 per cent, the measurement being unaffected by phase. The second harmonic was of course extremely close to the mains hum, and since the distortion was at a fairly low level I managed with difficulty to check that it was not worse than 0.2 per cent, and probably better than 0.1 per cent when the units were in phase. It may interest readers to note that at this level the distortion was of the order of only 15 dB above the noise level produced in a 10 Hz bandwidth, and quite frankly I cannot imagine that it could possibly be noticeable in operation by anyone.

#### 'Hearing the action'

It must be assumed that where engineers have said that they have heard the action of the Dolby either the noise reduction system or the tape recorder in use must have been out of alignment in response or level. For example, should a tape recorder have a fall off at high frequencies but have the levels adjusted correctly at middle frequencies the Dolby action will produce a reduction of quiet, high frequency sound, giving the effect of a rather dull balance. Conversely, a high frequency boost in the recording system will make a tape sound rather too close and brittle. Therefore the Dolby system should not be used as it has been by some users—as a means of avoiding frequent maintenance of professional machines. With these factors in mind, most engineers agree that accurate frequency response alignment becomes more important rather than less so when Dolbys are in use.

Distortion measurements were also taken up to the clipping point. At 1 kHz with the units in phase the total harmonic distortion measured only 0.09 per cent even at +23 dBm, and at all levels below +20 dBm the distortion was lower than 0.05 per cent. At Dolby level the distortion was 0.02 per cent. It was noted that with the two units out of phase the distortion figures were usually worse, but with the exception of the -21 dBm figures referred to the distortion was always lower than 0.1 per cent below +20 dBm. It should not be assumed that a tape recorder has its input in phase with its output relatively speaking, although of course all tracks should be in phase with one another. It is possible that in any particular installation therefore the machines in de-Dolbyed playback may have slightly higher second harmonic distortion measurable than would occur if all the playback leads were reversed in phasing, but such improvement as might be gained would be highly unlikely to be

noticeable under even the most stringent conditions.

The range of the input sensitivity control was checked, and when set at maximum a signal of -7 dBm can be brought up to Dolby level so that the lowest signal that can be brought up to a recorded flux of 510 pWb/mm on the input to the Dolby becomes +1 dBm. Since there might be studios that have a standard 0 dBm = maximum peak programme level a slight increase in available sensitivity might be welcomed in general. I understand that the manufacturers can supply a higher sensitivity version to meet special orders for larger installations. The maximum output level that can be achieved for Dolby level is +16 dBm, this being considered more than enough for any possible contingency since clipping would then occur at only 450 pWb/mm. Both input and output controls are capable of being turned down to zero. These, incidentally, are multiturn potentiometers which can be set with great accuracy and are not likely to drift even when in transport. The input impedance of the 361 was found to be 19 kΩ over almost the entire audio bandwidth, falling only slightly at 20 kHz. The equipment is therefore suitable for use with sources of considerably higher impedance than 600 ohms. It would for instance be satisfactory for use with the Revox 736 which is otherwise unsuitable for driving normal professional equipment bridging 10 kΩ, bass loss being apparent at this loading on replay. The 361 will not in any way be harmed even when driven at high level into a short circuit, since current limitation is applied to the output amplifier circuit. The output transformer has in fact a 6 dB voltage step up and since the rail voltage available is only 18 volts the output stage is exceptionally well designed, giving approximately six volts before clipping. The output impedance only rises slightly to 27 ohms at 20 Hz, due to the very high value of electrolytic capacitor used for the coupling to the output transformer.

#### Dolby's tests

Quite recently I had the opportunity of seeing 361s being manufactured, and I was particularly struck by the exhaustive way in which all parts of the equipment are tested, both mechanically and electronically. Nevertheless to check that the circuit is working correctly a special test meter is available into which the *Cat 25* module can be plugged. The meter is also connected in place of the module to the 361 framework. This checks the laws and gains of all the compressor circuits and both the unregulated and regulated dc supplies. The 361 meter and Dolby tone oscillator can also be checked for calibration in addition to the gains of the input and output amplifiers. This useful test meter is therefore recommended for users having a large number of 361s. The actual *Cat 25* module contains the entire electronic circuitry of the input and output amplifiers, control and compressor circuits, Dolby tone oscillator in, meter circuit, and ht rail regulator and smoothing circuits. Although the module only measures 190 mm x 155 mm x 17 mm it nevertheless contains approximately 500 components tightly packed on a printed circuit board. Very close tolerance components are used wherever necessary, and a few are adjusted on test at the factory, but it is noteworthy that no presets are provided, which

frankly stops unqualified engineers from making adjustments which might not be correct—unfortunately this has happened frequently in the past with the *A301*. I am told that very considerable attempts were made to use integrated circuits in an effort to further miniaturise the board, but none could be found which had a performance as good as the circuits finally employed. The module alone is also available and can be installed in custom built equipment, thus lowering the cost in some circumstances. Some tape recorder manufacturers have already announced equipment with these modules built in. It seems quite remarkable that the entire circuit in the module contains no inductances, since all the filters are now designed around active circuits employing only resistive and capacitive components, apart from transistors, FETs and diodes.

Jack sockets are available for linking the Dolby tone oscillator to different 361 units allowing one Dolby tone oscillator to control a bank of units giving tone on all channels. The remote control facility allows any number of units to be controlled from a mixing desk and the illuminated push buttons can be seen clearly from a distance showing the operational positions of the different units.

#### Mains lead

The mains lead has a moulded plug fitting the special socket and has been designed specifically to meet very stringent American and Canadian standard specifications. It is available only from one American manufacturer who always uses the standard American colouring of green for earth, white for live and black for neutral. Despite the fact that the user's attention is drawn to this in the manual, I feel strongly that the manufacturer should provide the internationally agreed colour coding, and that pressure should be applied for this widely recognised standard to be adopted in the States.

Although the 361 has in general much lower distortion than the *A301* at the levels where distortion would be most apparent the noise level, as explained, is noticeably inferior as far as hum is concerned. Hiss level is only slightly inferior to the earlier model but in any case is almost 20 dB better than the hiss produced by any tape machine. It is felt in practice that only operational advantages are gained by the use of the 361 over the *A301*, and tapes made on either equipment can be regarded as completely compatible with either system.

I would finally like to make a plea for the Dolby noise reduction system to be used to lower tape distortion in addition to reducing the effect of tape noise by a general reduction of peak recording levels on tape. I can see no reason whatsoever why studios should not limit their peak recording levels to a maximum of 3 or 4 dB above 320 pWb/mm, rather than striving to get the ultimate in signal to noise ratio whilst still peaking as high as eight per cent distortion in some cases. This will allow a far flatter power response to be obtained over the audio bandwidth and hence a far superior transient response. Tapes I have heard recorded at these lower levels sound very much cleaner in climaxes, particularly when played on loudspeaker systems having both low distortion and low coloration.

Angus McKenzie

# Ferrograph RTS I Test Set

## MANUFACTURER'S SPECIFICATION

### Audio Frequency Generator Section

- Frequency coverage:** 15 Hz to 150 kHz in four ranges.
- Distortion:** less than 0.025% at 1 kHz; less than 0.08% over the range 100 Hz to 20 kHz.
- Frequency response:**  $\pm 0.2$  dB over the range 15 Hz to 150 kHz.
- Output level:** maximum 3V into open circuit;  $\pm 8.5$  dBm into 600 ohm load.
- Output attenuator:** coarse: six 10 dB steps. Fine: continuous over approximately 15 dB range.
- Output impedance:** dependent on attenuator setting: maximum 450 ohms.

### Millivoltmeter

- Indication:** average reading meter calibrated in rms for sinusoidal inputs.
- Ranges:** 11 ranges in 10 dB steps from 1.0 mV to 100V FSD.
- Input impedance:** 2 megohms (no D.C. path).
- Accuracy:** within  $\pm 2\%$  FSD over the range 30 Hz to 20 kHz.
- Frequency response:**  $\pm 0.2$  dB over the range 10 Hz to 150 kHz.

### Wow & Flutter Meter

- Wow & Flutter measurement using a carrier frequency of 3.15 kHz provided by an internal oscillator.
- Frequency response:** weighted to DIN 45507. Maximum response at 4 Hz (3 dB points 1.2 Hz and 12 Hz).
- Meter response:** average reading calibrated in peak values for approximate sinusoidal wow & flutter waveforms.
- Input requirement:** 35 mV to 5V.
- Sensitivity:** 2 ranges of 0.3% and 1% peak wow & flutter FSD.
- Drift measurement:** centre zero for mean frequency as internal oscillator. Scaled  $\pm 2\%$  for measurement of speed changes in a recording and responding to slow speed cyclic wow rates (peak reading under 1 Hz).
- Oscilloscope output:** provided for visual examination of wow wave-form or for connection to external analyser.

### Distortion Section

- Total harmonic distortion measurement by rejection of a fundamental frequency in the range 500-1500 Hz.
- Second harmonic rejection:** less than 0.25 dB.
- Bandwidth of harmonic measurement:** 15 Hz to 20 kHz with optional If cut (turnover 400 Hz approximately) for rejection of hum or If noise components.
- Minimum reading:** less than 0.05% from distortionless source.
- Minimum input signal:** 100 mV (smaller inputs may be used with increased minimum distortion reading).
- Input impedance:** 100 k $\Omega$ . Oscilloscope output provided for visual examination of distortion wave-form or for connection of external filters. Provision for use as variable sensitivity meter with bandwidth of 100 kHz by use of 'set level' control e.g. for frequency response measurements where no external gain controls exist.

### General

- Power supply:** 105-120V 50-60 Hz. 200-250V 50-60 Hz.
- Dimensions:** 441 x 254 x 143mm.
- Weight:** 6.4 kg.
- Price:** £250.
- Manufacturer:** The Ferrograph Company Limited, The Hyde, Edgware Road, Colindale, London, NW9.

The idea of a good audio oscillator, a millivoltmeter and a distortion meter in one portable case has crossed my mind many times over the years; now Ferrograph have produced such an instrument, with the additional feature of an inbuilt wow and flutter meter.

Whilst the Ferrograph instrument was specifically designed for testing and aligning tape recorders, it obviously has applications in measuring the performance of many types of audio equipment, but it will be seen that there are certain limitations. This is not surprising when one does a little mental arithmetic and adds up the cost of individual instruments of comparable performance which would replace the Ferrograph RTS I.

However, Ferrograph tell me that they are designing an auxiliary unit incorporating various features which are the results of comments from professional users and reviewers. Such additions as a higher oscillator output, bias rejection filters, balanced output and possibly even a small monitor loudspeaker are likely facilities in the auxiliary unit.

The mechanical design of the present unit is very good, the unit being housed in a strong case with two substantial handles which protect the front panel knobs from damage. A lowerable foot is fitted for tilting the instrument when it is placed on the bench. All normal controls and inputs and outputs are on the front panel, which is very clearly laid out.

A great feature of the instrument is that there are only three connections to be made, an input from the unit on test, an output to the unit on test and a monitoring connection to an oscilloscope if required. All three connections are to the reliable BNC type, and two BNC to standard 6 mm jack plug leads are supplied ready made to connect to Ferrograph tape recorders, as well as a spare BNC plug for the monitoring connection.

The function of the instrument is determined by a row of push-buttons on the front panel, which are suitably interlocked and clearly identified, so that anyone used to operating testgear will have mastered the operation of the instrument in only a few minutes. There is also pushbutton selection of internal calibration for the millivoltmeter section and for the wow and flutter meter section.

The instruction manual supplied with the instrument is sensibly comprehensive so far as tape recorder measurements are concerned, and gives some valuable guidance for the newcomer, but it does not include any service information on the instrument or even a circuit . . . I feel that the inclusion of this information is only right and proper for a 'professional' piece of testgear.

Because of the comprehensive nature of the instrument it is not possible to adequately describe its performance as a whole without first investigating the performance of each individual section and then piecing together the results to give an overall impression of the potential of this most exciting piece of equipment.

### The Oscillator Section

The left hand part of the front panel houses the oscillator controls, which consist of four interlocked pushbuttons for selecting the frequency decades in the sequence 15 Hz-150 Hz -1.5 kHz-15 kHz-150 kHz, a variable control covering intermediate frequencies within a decade without range overlap, a six position attenuator covering 10 dB steps from 10 mV to 3V and a variable output control.

Oscillator output may be measured by directly connecting the millivoltmeter section to the oscillator section by means of a push-button; thus the output voltage accuracy is the same as that of the millivoltmeter section.

The maximum obtainable oscillator output voltage at 1 kHz was found to be 3.228V into an open circuit, or 2.722V into 600 ohms, which is adequate for measurements on domestic audio equipment but insufficient for measurements on professional equipment using 600 ohm lines. On the other hand, the minimum useful output voltage is in the order of 2 mV, which is too high for sensitivity and frequency response measurements on high sensitivity microphone and magnetic pickup inputs, where it would be essential to use an additional external attenuator.

Internal attenuator accuracy was excellent over 20 dB steps, being better than one per cent. There was a constant five per cent error between the 10 dB steps leading to an overall attenuator accuracy of  $\pm 0.25$  dB, but this is reasonable.

Oscillator frequency response was within  $\pm 0.1$  dB over the range 15 Hz to 100 kHz, falling to -0.2 dB at 150 kHz, which is an excellent standard of performance. Furthermore, amplitude bounce when sweeping the oscillator frequency was sensibly small on all except the highest frequency decade between 15 kHz and 150 kHz. The first unit examined suffered from oscillator instability at just below 150 kHz, in the form of 250 Hz amplitude modulation to about 30 per cent depth; however, a second unit promptly supplied by Ferrograph did not exhibit this fault.

The accuracy of frequency calibration was found to be plus four per cent, minus nought per cent, which is perfectly adequate for most audio frequency applications, and the oscillator frequency was insensitive to loading or attenuator setting showing a shift of less than 0.01 per cent between open circuit and a 600 ohm load.

Similarly, distortion appeared to be independent of loading and was outstandingly low at all frequencies with the following total harmonic contents:

### The Oscillator Section

Frequency	Total Harmonic Distortion
100 Hz	0.064%
1 kHz	0.018%
10 kHz	0.022%
50 kHz	0.058%
100 kHz	0.150%

<b>Second Harmonic Distortion</b>	0.002%
<b>Third Harmonic Distortion</b>	0.009%
<b>100 Hz Hum</b>	-78 dB
<b>50 Hz Hum</b>	-80 dB

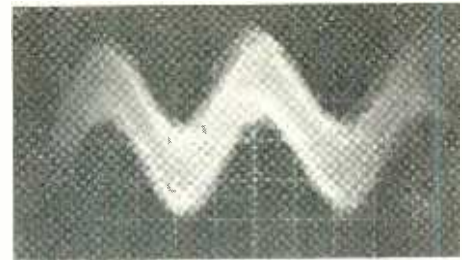
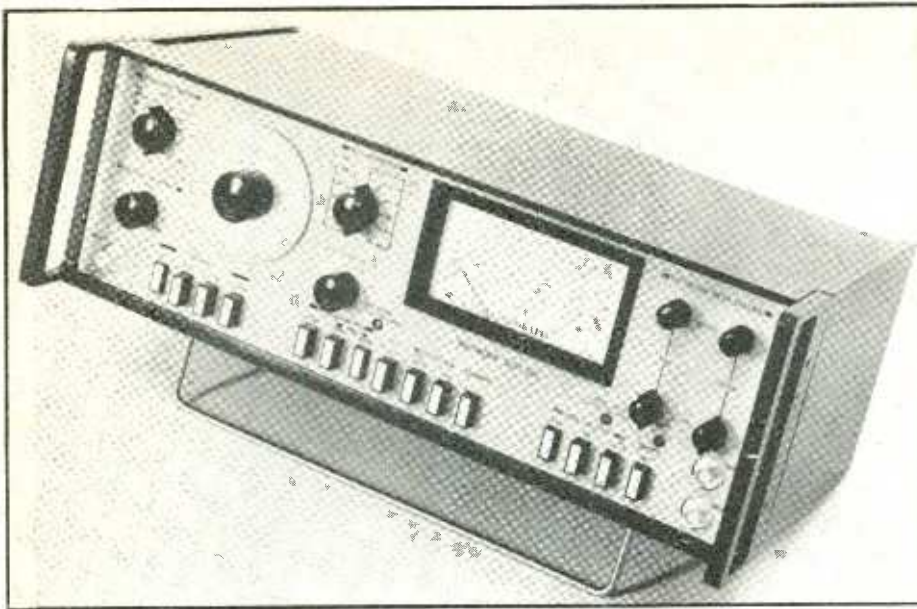

The measured distortion and mains frequency components about a 1 kHz signal to 3V output gave the excellent results shown in the table.

To summarise the oscillator section, the performance is really outstanding, but the attenuator could do with at least 20 dB more attenuation for some measurements and at least +12 dBm output would be nice for studio equipment maintenance.

#### The Millivoltmeter Section

The millivoltmeter comprises an easily read, illuminated meter movement scaled in volts and also dBm (as well as a drift scale for the wow and flutter meter section) which may be switched by push buttons to read either the input voltage or the oscillator voltage, as well as other functions to be mentioned later. The basic sensitivity of the meter is 1 mV full scale deflection, matched to an attenuator in 10 dB steps permitting readings up to 100V with a specified accuracy better than plus or minus two per cent of full scale deflection between 30 Hz and 20 kHz, or a frequency response of  $\pm 0.2$  dB over the range 10 Hz to 150 kHz.

Our measurements of the meter accuracy on all attenuator settings at 50 Hz showed that the basic metering was to an accuracy better than plus or minus one per cent of full scale deflection, and frequency response measurements showed that the specified accuracy held over the frequency range 10 Hz to 200 kHz.

Unfortunately the meter response extended to above 1 MHz, with a rising sensitivity on some attenuator settings. Such a characteristic can lead to misleading results when measuring signal to noise ratios, particularly where there is a possibility of bias breakthrough in tape recorders.

Whilst the instrument does not include an 'A' weighting network for measuring signal to noise ratios, it does have a high pass filter with a 6 dB per octave cut below 400 Hz which is useful for rejecting mains hum and its harmonics. As is common with instruments of this class the meter is average reading, cali-

brated rms, which may lead to minor errors when measuring noise.

The millivoltmeter section certainly does all that may be expected for an instrument of this class, and has an adequate maximum sensitivity of 1 mV full scale deflection and very good mechanical damping of the meter movement.

A useful facility, associated with the distortion measuring section, is that the input to the millivoltmeter may be fed via a variable attenuator by pressing the 'set distortion' button. This facility can save a lot of time when measurements are required relative to a given reading which does not coincide with a convenient point on the meter scale.

#### The Distortion Measuring Section

The distortion section consists of a fundamental rejection circuit, which is used in conjunction with the millivoltmeter section to reject the fundamental frequency and measure total harmonic distortion. The residual harmonic content is available at the 'scope' output of the instrument for visual examination or further analysis.

In order to simplify the design of this section, Ferroglyph have limited the frequency of the fundamental rejection circuit to a specified range of 500 Hz to 1,500 Hz which covers the normal measurements on amplifiers and high speed tape recorders, but does not cover the conventional measuring frequency of 333 Hz used with tape recorders operating at 9.5 cm/s

and 4.75 cm/s or the American standard measuring frequency of 400 Hz.

The specified minimum input for measuring distortion down to the limit of 0.05 per cent is 100 mV, but with the review instrument we found that we could use any signal level above 87.2 mV with no practical upper limit.

Tuning of the rejection circuit is accomplished by four controls, two coarse controls for frequency and phase balance, each with its associated fine control. To accomplish the specified 0.05 per cent (76 dB) fundamental rejection, or anything near it, was a work of art because not only are the knobs on the balance controls too small, but the ratios of the coarse and fine controls are most inconvenient. It was also found that if one happened to leave the oscillator section running near its maximum frequency there was severe breakthrough into the distortion section when on the most sensitive range. The accompanying photograph shows this breakthrough superimposed on a 1 kHz signal giving a reading of 0.1 per cent distortion.

As with the millivoltmeter, the 400 Hz high pass filter may be introduced to attenuate low frequency hum components from the distortion measurements, giving an attenuation of 22.5 dB at 50 Hz and 14 dB at 100 Hz. This is a very valuable facility, but in the first sample of the Ferroglyph the insertion of the high pass filter led to a 0.5 dB error in distortion measurement; the second review sample did not exhibit this fault.

Investigation into the frequency response of the distortion section when rejecting a 1 kHz fundamental showed less than 0.2 dB attenuation of the harmonics up to the fifth harmonic, which is an extremely high standard as demonstrated by the accompanying frequency response plot with the high pass filter inserted.

Caution is required when measuring power amplifier distortion with the Ferroglyph RTS 1, for two reasons—firstly it must be remembered that the earthy input to the distortion meter is directly connected to the earthy output of the oscillator; thus the instrument cannot be used when an amplifier does not have an output

*(continued over)*

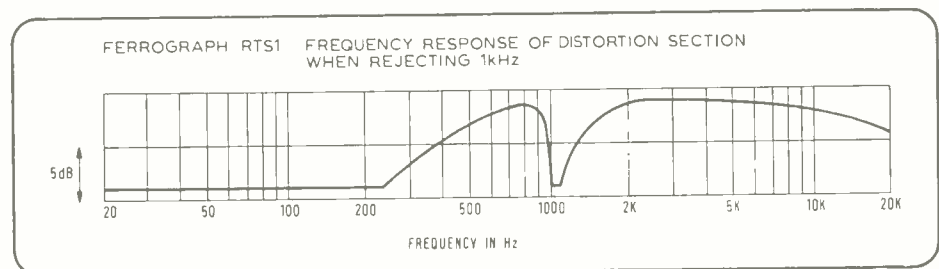

continued

terminal directly connected to its chassis or the amplifier output stages will be upset. Secondly, when an amplifier does have an output terminal directly connected to its chassis, great care must be exercised to avoid feedback loops via the testgear.

**Wow and Flutter Section**

The wow and flutter section is in two parts, a fixed frequency oscillator operating at a nominal 3,150 Hz (with a 3,000 Hz model available) which is used for measuring tape speed drift, and calibration of the wow and flutter metering section which operates with a nominal input frequency of 3,150 Hz to the DIN requirements.

Reverting to the oscillator section, this provides a nominal 3,150 Hz output at 350 mV for feeding to the recorder under test for measurement of drift and wow and flutter. It is therefore essential that the frequency should be stable, particularly because the oscillator is also used for calibration of the drift meter.

Investigation into the oscillator drift at normal room temperature with a constant 240V mains input yielded the following figures:

Time from switch-on	Frequency	Per cent error
0 mins	3,120 Hz	-0.97
10 mins	3,135	-0.48
30 mins	3,147	-0.1
45 mins	3,150	+0.19
100 mins	3,156	+ 0.19

The above figures mean that the drift meter and the oscillator should not be used for measuring drift until at least 30 minutes after switch-on, and even then the frequency stability leaves something to be desired.

Calibration of the drift meter is accomplished by pressing a 'calibrate' button on the front panel, then adjusting a screw-driver operated control for an indication of zero drift on the meter, which is calibrated for plus or minus two per cent drift.

Measurement of the meter accuracy at the one per cent and two per cent points after careful calibration with an external oscillator showed the indications to be absolutely exact, but it must be remembered that the calibration procedure normally relies on the frequency of the internal fixed oscillator.

**Wow and Flutter Measurements**

Now to the actual wow and flutter measurement; the *RTS 1* is designed to measure quasi-peak weighted wow and flutter to the DIN requirements so far as frequency weighting is concerned. No facilities are provided for measurement of unweighted wow and flutter or for the measurement of rms wow and flutter, neither of which can be correlated with quasi-peak measurements. However, because the quasi-peak weighted measurement is likely to become an international standard this factor is of little disadvantage from a long term point of view.

Wow and flutter measurement is in two pushbutton ranges of one per cent full scale and 0.3 per cent full scale, with provision for

internal calibration of the meter by means of a screwdriver adjustment and setting the instrument to 'calibrate' and '0.3 per cent wow and flutter' by means of pushbuttons. The wow and flutter waveform may be examined during measurement at the 'scope' output of the *RTS 1*, but it was found that this output corresponded to the weighted wow and flutter waveform which could well lead to confusion when analysing the relative magnitudes of the various component wow and flutter frequencies.

Investigation into the accuracy of the weighting curve showed that it was within the limits specified in DIN 45507 at all frequencies, and accuracy of indication was in the order of plus or minus five per cent of full scale indications as compared with the DIN requirement of plus or minus ten per cent.

The instrument operated satisfactorily with 60 mV input, and was completely free from any reasonable amplitude modulation of the incoming signal at the specified input requirement of 75 mV. Whilst the wow and flutter measurement does not claim to meet the DIN standard it should be mentioned that the input impedance and voltage requirements are not compatible with DIN, and that no attempt was made to check the effective meter time constant against the DIN 45507 standard.

**Calibration Tape**

Supplied with the *Ferrograph RTS 1* is a 180 mm *Ferrograph* type metal spool containing a calibration tape for use at 19 cm/s. Sensibly, the inner part of the tape is made up of leader to enlarge the core diameter of the spool, so that a machine is aligned at the proper operating tensions.

While the tape box did not indicate the recorded characteristics of the tape, it was a pleasure to find a recorded announcement at the beginning to the effect that the tape was recorded to the 50  $\mu$ S and 3,180  $\mu$ S characteristic for use at 19 cm/s, and a warning that the recorder heads should be de-gaussed before the tape was played any further.

Following this are clearly announced sections of tape containing sequences of tone as follows:

- 20 seconds of 320 pWb/mm reference level
- 40 seconds of 14 kHz for azimuth alignment
- 20 seconds of each of the following frequency response checking tones, in the sequence 1 kHz, 16 kHz, 12.5 kHz, 10 kHz, 8 kHz, 6.3 kHz, 4 kHz, 1 kHz, 250 Hz, 125 Hz, 63 Hz, 31.5 Hz and 1 kHz.

With the exception of the 125 Hz and 250 Hz tones all sections were within better than  $\pm 0.5$  dB of the author's calibration tapes, but a 0.2 dB change in level was noted on the reference level section and rather undue cyclic uniformity problems appeared at 16 kHz and 12.5 kHz, being in the order of 1 dB at 16 kHz. Both the 125 Hz and 250 Hz tones on the *Ferrograph* showed a level 1 dB above the *BASF DIN 19H* calibration tape, but such a variation is within normal professional calibration tape specifications.

The duration of all sections is ideal for meter measurement and it is also very nice to have the high frequency sections adjacent to the 1 kHz mid frequency reference, as this saves much time in the alignment of playback equalisation.

After the above measurements the calibration tape was rewound with the most electrifying results—yes, two inch long sparks from the metal spool. Oh Mr *Ferrograph*, non-conducting spool hubs with metal flanges make a lovely *Wimshurst* machine!

**In Conclusion**

The *Ferrograph RTS 1* is something completely new in terms of a versatile piece of testgear, so I have been intentionally highly critical and searching when investigating its performance and pointing out its limitations. This is perhaps a little unfair to *Ferrograph*, who designed the *RTS 1* for servicing tape recorders of their own manufacture, but to review it in this context would be ridiculous because it has so much potential as a maintenance tool for studios and service workshops, with a reasonable price tag.

As an audio frequency oscillator it has outstandingly low distortion, low noise and hum, and a nice flat frequency response. On the debit side, the output voltage is not high enough for professional use with 600 ohm lines, and does not go low enough for the measurements on high sensitivity amplifier inputs.

As a millivoltmeter it is competitive in performance with the majority of instruments to be found in workshops and studios. It does not have a low pass filter for rejecting tape recorder bias frequencies, and it does not have an 'A' weighting network: both these would be useful additions, but they are certainly not found in all but the most expensive millivoltmeters. The high pass filter is however a very good addition, not to be found in most instruments, and useful for measuring noise without mains frequency and its harmonics.

Given time and patience, the distortion measuring section is perfectly adequate for measuring mid-frequency distortion around 1 kHz in tape recorders and amplifiers. But it does not cope with the standard measuring frequencies of 333 Hz for low speed tape, or 400 Hz which is commonly specified in America.

All too often wow and flutter meters are thought of as an expensive luxury, but really they are an essential piece of test gear for tape recorders and turntables. The *RTS 1* wow and flutter section does all that is required for the measurement of quasi-peak wow and flutter, but lacks the refinements associated with meters costing over £100, and does not measure rms wow and flutter. Probably the least satisfactory part of the *RTS 1* is the drift meter and its associated oscillator—30 minutes warm-up time is too long, and even then the stability of the oscillator is not ideal.

The calibration tape was a nice little bonus, sensibly arranged, and to the correct time constants for domestic machines. It would however be a good idea to add a pre-recorded wow and flutter section to this tape.

For £250 the *Ferrograph RTS 1* is very good value for money, provided that its specification meets your requirements, which is virtually certain to be the case for the routine maintenance of domestic equipment—furthermore it only weighs 6.3 kg and is fully portable.

In the case of professional use there may be limitations, but *Ferrograph* do realise this, and I look forward to seeing the add-on unit which will be available with special professional features.

**Hugh Ford**

# Classified Advertisements

Advertisements for this section must be pre-paid. The rate is 6p per word, minimum 60p. Box Nos. 20p extra. Semi-display £3.00 per inch. Copy and remittance for advertisements in MARCH 1972 issue must reach these offices by 18th JANUARY 1972 addressed to: The Advertisement Manager, Studio Sound, Link House, Dingwall Avenue, Croydon CR9 2TA.

**NOTE:** Advertisement copy must be clearly printed in block capitals or typewritten.

Replies to Box Nos. should be addressed to the Advertisement Manager, Studio Sound, Link House, Dingwall Avenue, Croydon CR9 2TA, and the Box No. quoted on the outside of the envelope. The district after Box No. indicates its locality.

## FOR SALE—TRADE

**Lancashire.** Tandberg, Ferrograph Tape Recorders, etc. Plus over 10,000 high fidelity systems. After-sales service. Holdings Photo-Audio Centre, 39-41 Mincing Lane, Blackburn BBA 2AF. Tel. 59595/6.

**Tame those dB's . . .** Plug in professional quality FET compressor module £15.50. For the 'slick operator' . . . 'Voice over' module £15.50. S.A.F. details. Cathedral Sound SS, 'Fourways', Morris Lane, Halsall, Lancs., L39 8SX.

**Copyright Free Sound Effects Discs.** 7" E.P.'s and 12" L.P.'s. Catalogue from Rapid Recording Services, 21 Bishops Close, London, E.17.

## RAC MIXERS

Join other satisfied customers. Build a mixer using our printed circuit modules—prices from £1.75. Or let us custom build a unit to your exact requirements—ask for a quote. Export enquiries welcome.

**RUGBY AUTOMATION CONSULTANTS**  
220 ALWYN ROAD, RUGBY 0788-810367

If quality matters consult first our 105-page illustrated Hi-fi catalogue with technical specifications (60p). Members enjoy unbiased advisory service, preferential terms. Membership (40p) p.a. Our associates also manufacture records from your own tapes, or record the Master at our studios (Steinway Grand). Bulk terms for choirs, fund-raising. Please specify requirements. Audio Supply Association, 18 Blenheim Road, London, W.4. Tel. 01-995 1661.

**Professional tape only 35p.** 1200ft. Agfa on hubs, no joins (p. & p. one box 20p, each additional box 8p). We handle 99% of all s/h professional recording equipment. Send for list. Jackson Studios, Rickmansworth, Herts. Tel. Rickmansworth 72351.

## UNIMIXER 4S

Mixing unit for professionals in studio and on location. (1 stereo pair and 2 pan controlled mics.) Any input imp. 25-600 ohms. S/n ratio greater than 55 dB with an input signal of 180 µV at 200 ohms or 70 µV at 30 ohms. Individual test certificate. Price £45, Power Pack £8.75. Recent reviews from leading hi-fi magazines available on request from:

**SOUNDEX LTD**  
18 Blenheim Road, London, W.4. Tel. 01-995 1661

**Bealieu R16 Electric** complete with 9.5-95 Angenieux; Shoulder Pod; 100ft. Mags; 2 Battery Packs; Pistol Grip; Sync Unit, etc., £400. Aricon Pro 600 as new. Complete with 10-1 Angenieux; Mags; Filters; Shoulder Pod; Sound Channel; Changing Bag, etc., £1,250. Nagra 111 1/2" Deck £190. Nagra 111 Neopilot Recorders from £275. J. J. Francis (Wood Green) Ltd., 123 Alexandra Road, Hornsey, London, N.8. Tel. 01-888 1662.

**Complete 805 Outfit** including case. Normal price £250. Special offer £180. Sennheiser MD211 Microphone, new and boxed. Normal price £44. Special offer £32. AKG D109 Microphone, special offer £9. AKG D119C Microphone, special offer £12. J. J. Francis (Wood Green) Ltd., 123 Alexandra Road, Hornsey, London, N.8. Tel. 01-888 1662.

## STUDIO FACILITIES

### EDEN STUDIOS LTD

QUALITY recording, tape to disc and pressing services, all at very sensible rates. Please write or 'phone for leaflet.

11 EDEN STREET, KINGSTON, SURREY  
01-546 5577  
Affiliate Assoc of Professional Recording Studios

**J & B Recordings.** Tape to disc—latest high level disc cutting, all speeds. Mastering pressings, studio, mobile. 14 Willows Avenue, Morden, Surrey. MITcham 9952.

**Graham Clark Records.** Tape to disc pressings. P. F. A. House, 182A Station Road, Addlestone, Weybridge, Surrey. Tel. Weybridge 43367.

**Fanfare Records.** Tape - disc pressings, demo's, masters, any quantity. Studio/mobile. Neumann disc cutter. S.A.E. brochure. 1 Broomfield Close, Rydes Hill, Guildford. Telephone 0483-61684.

**County Recording Service,** Demos, mono and stereo pressings. 7" vinyl discs pressed on our own plant, delivery approx. 14-21 days. S.A.E. for leaflet and price list. Tel. Bracknell 4935. London Road, Binfield, Berks.

## mjb recording and transcription service

Vinyl pressings and acetate demosciscs. Limiting, compression and equalisation facilities; high undistorted cutting levels with feedback cutter heads. Booklet available.

ST. MICHAEL'S, SHINFIELD ROAD,  
SHINFIELD GREEN, READING, BERKS.  
Reading (0734) 84487 Member A.P.R.S.

## MISCELLANEOUS

**Tape and Cassette Recorder Repairs** by Specialists. The Tape Recorder Centre, 82 High Holborn, London, W.C.1.

**Repairs.** Our modern service department equipped with the latest test equipment including a wow and flutter meter and multiplex stereo signal generator is able to repair hi-fi and tape recording equipment to manufacturer's standards. Telesonic Ltd., 92 Tottenham Court Road, London, W.1. Tel: 01-636 8177.

## WANTED

**Lee Electronics.** The Tape Recorder and Hi-Fi Specialists wish to purchase good quality Tape and Hi-Fi equipment for cash. 400 Edgware Road, W.2. Phone PAD 5521.

**Highest possible cash prices** for Revox, Ferrograph, Brenell, Vortexion, Tandberg, Akai, B. & O., Sanyo, Sony, Uher. 9.30-5.00. Tel. 01-242 7401.

**All types of Nagra Recorders.** Immediate cash settlement. Tel. 01-888 1662.

**Complete Recording Studios** purchased for cash. Also all types of Professional Recorders and associated equipment. J. J. Francis (Wood Green) Ltd., 123 Alexandra Road, Hornsey, London, N.8. Tel. 01-888 1662.

To Studio Sound, Classifieds, Link House, Dingwall Avenue, Croydon CR9 2TA

Please publish the advertisement indicated below for ..... insertion/s under the heading .....

Name.....

Address.....

Cheque/P.O. enclosed £..... Is a Box No. required Yes/No. If no please include remittance to cover name and address and/or Tel. No. Please write in block capitals.

Professional and quality tape recorders and accessories, also hi-fi equipment purchased for cash. R.E.W. Audio Visual Co., 146 Charing Cross Road, W.C.2. Tel. 01-836 3365. 266/8 Upper Tooting Road, S.W.17. 01-672 4472, 01-672 9175.

**Wanted. Grampian feedback cutter-head.** also TRD tape deck, must be good condition, Box No. 620 (Lancs.).

## SITUATIONS WANTED

**Audio engineer (39)** seeks position in radio, T.V. or recording studios (preferably London area). Past experience with B.B.C. radio and commercial T.V. in both operational and maintenance capacities.

## FOR SALE—PRIVATE

**Unimixer 4S** in extended case with additional pair of panpot inputs. £40. Matheson, 13 Ailsa Drive, Glasgow. 041-632 2468.

**Allen & Heath Mixer (Studio)** six to eight channels stereo or mono line and mic., meters, limiters, two track, model in current production. No offers. Little used. £300. Phone 01-688 8605.

**Fi-Cord (Model 1a) Tape Recorders.** New 2-volt Dry Accumulators (batteries available shortly). Until now unavailable in U.K. (modest charges—inc. postage). Contact Intermark, c/o C. St. M. Thorp, 119 High Street, Eastfield, Scarborough, Yorks. Set of four—£1.40. Set of eight—£2.70.

# INDEX TO ADVERTISERS

Acoustical Manufacturing Ltd. .. ..	8	Francis, J. J. (Wood Green), Ltd. ..	4
Acoustico Enterprises .. ..	4	Francis of Streatham .. ..	46
AEG .. ..	6	Fraser-Peacock Associates Ltd. ..	18, 24
Alice (Stancoil) Ltd. .. ..	38	Future Film Developments Ltd. ..	18
Allen & Heath Ltd. .. ..	7	Grampian Reproducers Ltd. .. ..	30
Allied International Co. Ltd. .. ..	30	Hi-Fi News and Record Review Annual ..	14
Allotrope Ltd. .. ..	22	Indigo Sound Studios Ltd. .. ..	22
Apollo Electronics .. ..	30	Lennard .. ..	6
Audio Developments .. ..	14	Macinnes Labs Ltd. .. ..	18
Audio & Design (Recordings) Ltd. ..	34	Monks, Keith (Audio) Ltd. .. ..	3
Audionics .. ..	6	Midas Professional Amplification ..	48
Bauch Ltd. .. ..	42	Millbank Electronics Group .. ..	32
Beyer Dynamic Ltd. .. ..	2	Music Tapes Mail Order .. ..	42
Calder Recording .. ..	26	Neve & Co. Ltd., R. .. ..	56
Cave, F., hi fi .. ..	55	Orange .. ..	5
Chadacre Electronics Ltd. .. ..	24	Penny & Giles Ltd. .. ..	38
C.T. Electronics .. ..	54	R.E.W. Audio Visual Co. .. ..	18
CTH Electronics .. ..	26	Rumble, C. H., Ltd. .. ..	22
Eagle International .. ..	48	Sansui .. ..	13
Electrocraft Instruments Ltd. .. ..	3	Sharp Electronics (UK) Ltd. .. ..	44
Ferrograph Co., The .. ..	11	Sonifex Sound Equipment .. ..	24
		Starman Tapes .. ..	6
		T.B. Technical Ltd. .. ..	24
		Wadsworth, L., & Co. Ltd. .. ..	7
		Walker, N. .. ..	26

## C.T. ELECTRONICS

**COMPONENTS**  
Carbon Film. 1%, 2%, 5% Tol. Resistors in stock. E24 range 1% 6p each, 2% 5p each, 5% 2½p each. Also in stock many non-preferred values, useful for meters, etc.

**Metal Oxide Resistors.** 2% ½ watt. TR5. Complete range always in stock. 1 off 5p each; 100 off 3½p each.

**Mullard Electrolytic Capacitors.** Complete range always in stock.

**Mullard Polyester Capacitors.** Complete range always in stock.

**Lemco Silver Mica Capacitors.** Complete range always in stock.

**Polystyrene Capacitors.** Complete range always in stock.

**Wirewound Resistors.** 1W, 3W, 6W, 12W, 15W, 30W. Complete range always in stock.

**Semiconductors.** Transistors, Diodes, Rectifier Blocks, Thyristors, U.J.T.s., Diacs, Triacs, F.E.T.s., Zeners, Photocells, etc.

**AUDIO PLUGS AND SOCKETS**  
D.I.N. 2 pin L.S. Chassis Skt. ... 10p  
2 pin L.S. Plug ... 12p  
3 pin 180° Plug 15p Skt. ... 12p  
5 pin 180° Plug 11p Skt. ... 15p  
5 pin 240° Plug 17p Skt. ... 15p  
Jack Plugs ¼" Plastic 12p Screened 16p  
Stereo ¼" Plastic 22p Screened 28p  
Jack Sks Mono open ... 14p  
Mono switched ... 18p  
Stereo open ... 20p  
Insulated type. 2 contact 38p  
3 contact 40p

**MULTIPIN PLUGS AND SOCKETS**  
Painton/Jones 2/4/6/8/12/18/24/33-way. P.E.T. B.N.C. Amphenol, Cannon, D.I.N., Plessey, E.M.L.

**PUSH BUTTON SWITCHES**  
Multibank Push Button Switch assemblies now in stock. Any combination. latching, non-latching, push-push, push to change over, push to hold, etc.

THIS LIST REPRESENTS A FRACTION OF OUR COMPONENT RANGE. WE HAVE HUNDREDS OF BARGAIN ITEMS FOR THE PERSONAL CALLER.

**C.T. ELECTRONICS** 267 ACTON LANE, LONDON, W.4 01-994 6275

Nearest Underground—Chiswick Park (District Line): Acton Town (Piccadilly Line). Bus Routes: 53, 88, 207, 15, 7, 260. Please Note: As yet we do not have a catalogue available. Any queries please phone or call at the above address. Business Hours: MONDAY to SATURDAY 9.30 a.m. to 6 p.m. WEDNESDAY 9.30 a.m. to 1 p.m.

2p. C/o 20p per button } P. & P. 10p  
4p. C/o 30p per button } per bank  
6p. C/o 40p per button }

Buttons available white, grey, black, silver, red.

**STUDIO MONITOR LOUDSPEAKER SYSTEM**  
E.M.I. 5 speaker system. Complete with 3-way Variable Crossover Network. 1 only ... £55

### TRANSFORMERS

**Mains Transformer.** Pri 0-240V. Sec. 250-0-250V. 75mA. 6.3V. 3.5A ... £1.75 each. P. & P. 30p  
**Parmeko E.H.T. Transformer.** Type P.66890A. Pri-240V. 1A. Sec. 10kV. C.T. 20mA. Enclosed in metal case. 5" x 4½" x 4½". Weight 11lb. £4.50 each. P. & P. 75p

**D. C. Tibbles & Co.** Pri. 0-100-110-220-240V. Sec. 12V. 20A. ... £6.50 each

**Miniature Transformers.** 2in x 1½in x 1½in. Pri. 240V. Sec. 12V. 100mA } All types  
Pri. 240V. Sec. 0, 20V, 30V, 100mA } 65p  
Pri. 240V. Sec. 0, 18, 36, 0, 18, 36, 100mA } each

**Shrouded Transformers**  
Pri. 0-120-240V. Sec. 24V. ½A ... £1.25 each  
Pri. 0-240V. Sec. 26V. 1A ... £1.60 each

**C-Core Transformers.** Pri. 240V. Sec. 0, 7½, 15V. 1A ... £1.20 each

**Heater Transformers.** Pri. 0-110-200-220-240V. Sec. 6.3V. 3A ... £1.00 each

### RELAYS

**Siemens Varley Plug-in.** Complete with transparent dust cover.  
4p c/o 15,000Ω; 5,800Ω; 2,500Ω; 700Ω; 240Ω  
50p each P.P. 5p

2p c/o 700Ω; 430Ω; 230Ω; 52Ω 35p each P.P. 5p.  
**P. Clare Miniature Sealed**  
2p c/o 110Ω; 675Ω; 9,100Ω 70p each. P.P. 5p.

**S.T.C. Sealed Relays**  
2p c/o 2,500Ω; 700Ω; 170Ω; 45Ω 60p each. P.P. 5p.

**G.P.O. Relays**  
2p c/o H.D. 2,000Ω; 4,000Ω; 6,000Ω  
50p each. P.P. 8p.

4p on-off H.D. 500Ω; 2,000Ω; 6,000Ω  
50p each. P.P. 8p.  
2p on-off 20,000Ω  
40p each. P.P. 8p.  
**Latching Relays.** B & R Type H02/JT.498 2p c/o 380.  
98p each. P.P. 8p.

### SOLENOIDS

12V DC Operation 2½" x 2½" dia. 50p each. P.P. 10p.  
**ILLUMINATED PUSH-BUTTON SWITCHES**  
2p c/o. Non-locking only. 35p each. P.P. 5p.

**WIRE-WOUND POTENTIOMETERS**  
Colvern, Reliance. All values from 1Ω-100KΩ  
19p each. P.P. 5p.

360 wire-wound pots. Colvern. ... £1.50 each  
CLR/6605/18 100KΩ ... £1.50 each  
CLR/6605/18 100KΩ ... £1.50 each

10-turn pots. Bourns. 10KΩ+5% Lin. 0.25%  
£1.98 each

360 Precision Servo Potentiometers. Either type 400417.500Ω. 3" dia. ½" spindle, ½" spindle £4.00 ea.

**PRINTED CIRCUIT EDGE CONNECTORS**  
15-way Electro-Methods Ltd. KKM 155 0 156 pitch.  
40p each. P.P. 5p.  
20p each. P.P. 5p.

6-way 0.125" pitch. KKM.65  
20p each. P.P. 5p.

**EDGE CONNECTORS SUITABLE FOR VEROBOARD ETC**

0.1" pitch 0.15" pitch  
24 way 32p 8 way 20p  
36 way 42p 16 way 24p } P.P. 5p.  
24 way 32p

**VEROBOARD COPPER STRIP**  
1" pitch · 15" pitch  
2½" x 3½" 25p 17p  
2½" x 5" 30p 50p  
3½" x 5" 35p 30p  
3½" x 3½" 30p 30p  
17" x 2½" 82p 70p  
17" x 3½" 97p 85p

**PLAIN DRILLED**  
2½" x 3½" 15p  
2½" x 5" 18p  
17" x 2½" 50p  
17" x 3½" 72p  
17" x 5" 85p

**LOW DEPOSIT CREDIT**  
ASK FOR DETAILS!  
**PAY BONDS**  
NO DEPOSIT CREDIT  
**Diners Club & BarclayCard**

**DEMONSTRATIONS**  
OF ALL KINDS OF  
EQUIPMENT & SYSTEMS  
**Maker's Guarantees**

**FOR THE WIDEST CHOICE of**  
**Tape Recorders & HiFi**  
**at much LOWER PRICES!**

**AMPLIFIERS**

C ALPHA F212	£29.40
D F200	£23.50
D FA300	£31.50
D AMSTRAD 8000	£16.94
D 2000	£32.22
D ARD 2000	£37.95
D DUETTE SA400	£26.50
D SA500	£32.95
D F/GRAPH F307 Mk2 C	£47.95
D F307 Mk2 Ch	£45.95
D LEAK DELTA 30	£49.95
D DELTA 70	£62.95
D LUX 77T	£54.00
F 1220	£79.50
D METROSOUND ST20E	£27.95
D PEAKSOUND 840A	£38.95
D 870A	£47.50
D PIONEER SA700	£78.40
E SA800	£87.35
E SA900	£107.00
F QUAD 303/33	£95.50
D ROGERS R/BROOK Mk2 C	£41.95
D R/BOURNE C	£47.95
D ROTA 2200	£24.95
D 1500	£17.95
D ROTEL RA310	£37.95
D RA610	£59.60
D SANSUI AU101	£31.95
D AU555A	£69.50
E AU666	£87.95
D SINCLAIR 2000 Mk2	£25.95
D 3000	£32.95
D TELETON 206B	£18.50
D WHARFEDALE LINTON	£44.95

**TUNERS**

D ALPHA FT150	£36.95
D LEAK DELTA FM	£60.50
D DELTA AM/FM	£71.25
D ROGERS R/BOURNE FM C	£55.50
D R/BROOK FM C	£41.95
D ROTEL RT320	£45.50
E SANSUI TU666	£76.95
D TU555	£67.95

**TUNER AMPS**

G AKAI AAB500	£180.00
AA6600	£111.50
AA6300	£100.75
E ALPHA R150	£48.95
E FA3000	£70.75
E FA4000	£80.75
E DUETTE SAT260X	£63.70
E SAT460X	£83.50
E SAT4370X	£41.75
E GOODMAN'S MODULE 80	£75.00
E GRUNDIG RTV400	£142.50
E RTV650	£197.95
F LEAK DELTA 75	£135.00
F PIONEER SX440	£86.43
F SX770	£115.50
F LX440	£93.60
E ROTEL RX150	£57.95
E RX200	£72.50
E RX400	£82.95
E 130	£57.50
G SANSUI 600L	£146.95
G 2000X	£157.50
G 200	£60.95
F 300	£73.50
E TANDBERG 1171	£83.25
E 1172	£94.50
E HI FI FM	£63.90
E TR200 MPX	£88.75
D TELETON CR10T	£19.95
D F2000	£28.75
D TFS50	£58.95
F TFS50LA	£61.50
F WHARFEDALE 100.1	£102.50

**T. RECORDERS**

E AKAI 1720L	£62.50
F X1800SD	£117.85
F X200D	£112.50
E 4000D	£65.95
G M10L	£175.95
H GXC220D	£162.40
H GXC220	£214.40
H GXC280D	£218.00
H FERROGRAPH 713	£174.90
H 702/4	£192.95
H 702HS	£201.40
H 722/4	£224.75
H 722HS	£233.20
H GRUNDIG TK121	£47.50
E TK141	£51.25
E TK146	£55.95
D TK3200	£118.00
D TK124	£31.00
E TK144	£33.50
E TK149	£41.50
D PHILIPS N4303	£33.75
E N4307	£39.75
E N4308	£48.60
F N4407	£88.45
F N4404	£76.30
F N4500	£101.20
F N4408	£111.65
F N4450	£232.95
H REVOX 1102/4	£188.95
H 1102/4 HS	£227.50
H 1122/4	£218.95
H 1122/4 HS	£253.50
H 1222/4	£227.50
H 1222/4 HS	£262.25
E TANDBERG 1541	£79.20
E 1542	£89.30
E 1741	£62.60
F 4041X	£145.00
F 4021X	£145.00
F 64X	£119.50
F 3041X	£89.50
F 3021X	£89.50
F 6041X	£158.00

**SONY TAPE RECORDERS & CASSETTES**  
COMPLETE SONY RANGE. SPECIAL PRICES ON APPLICATION.

**8 TRACK STEREO**

D AKAI CR80D	£76.95
D CR80	£61.50
C LEAR JET LJ71	£28.50
C LJ277/Radio	£46.95
C P550	£44.50
C METROSOUND 448	£46.16
D Mk3	£39.95
C SS30	£69.75
C SATELITE	£37.95
D 1080	£69.75
E TELETON STP800	£41.95
E STP801	£43.95

**CASS. RECORDERS**

E AKAI CS50	£91.75
E CS50D	£76.95
D GXC40D	£67.50
D GXC40	£80.85
C WHARFEDALE DOLBY DC9	£94.95
C GRUNDIG C200SL	£28.95
C 222/224	£47.35
C PHILIPS RN702	£88.20
C N2600	£21.65
C EL3302	£17.50
C N2202	£19.95
C N2205	£34.60
D N2400	£72.15
D N2401	£64.95

**SPEAKERS**

E AR4X	£33.95
E 6	£59.45
D B&W DM1	£33.50
F DM3	£48.50
X SERIES 70	£124.95
H CAMBRIDGE R50	£80.95
G R40	£53.50
G DITTON 44	£44.50
D 120	£23.95
E 15	£30.50
G 25	£55.25
E GOODMAN'S MEZZO 2	£22.50
E MEZZO 3	£25.50
F MAGNUM	£32.90
E DBLE MAXIM	£25.95
E HAVANT	£22.00
E MINISTER	£20.14
H MAGISTER	£49.95
G DIMENSION 8	£51.50
D KEF CRESTA	£21.95
E CELESTE	£24.50
E CHORALE	£28.00
E CADENZA	£34.00
F CONCERTO Mk3	£49.50
E KELETRON KN600	£10.05
E KN800	£11.90
F KN1000	£13.75
E LEAK MINI SANDWICH	£19.95
E 200	£20.50
E 300	£26.90
F 600	£39.95
E 150	£19.50
E 250	£25.95
F QUAD ELS	£62.95
D RICHMOND Mk1	£19.95
E 350	£19.95
E 350S	£22.95
D 450	£13.50
E TANNOY 111LZ Mk2	£33.95
F 12" LANC. RECT.	£53.50
F 15" LANC. RECT.	£57.95
G 15" YORK	£73.50
G WHARFEDALE ROSEDALE	£48.50
E TRITON 1	£26.50
D TRITON 2	£15.75
E LINTON 2	£19.75
E TRITON 3	£26.50
E MELTON 3	£28.00
F DOVEDALE 3	£33.50
E TANDBERG TAN7	£24.50
E TAN10	£16.65
E TAN12	£18.40

**HEADSETS**

B AKAI ASE9S	£4.85
B ASE20	£6.75
B ASE22	£8.25
B AKG K120	£8.50
B K150	£9.75
B K60	£12.75
B BEYER DT48	£28.50
B DT48S	£28.95
B DT100	£11.85
B DT480	£22.95
B EAGLE SE21	£8.70
B SE30	£6.25
B PIONEER SE50	£15.85
B SE30	£10.40
B SE20	£6.20
B SE2P	£5.60
B ROTEL RH711	£7.60
B RH700	£7.95
B SANSUI SS2	£6.20
B SS20	£14.20
B SS10	£10.70
B SENNHEISER HD110	£19.55
B 414	£8.35

KOSS HEADPHONES... SPECIAL PRICES ON APPLICATION.

**MAIL ORDERS** GOODS SENT BY BRS OR SECURICOR ARE INSURED. PLEASE SEND ALL ORDERS AND ENQUIRIES TO RICHMOND

WE ARE STOCKISTS OF **UHER!** THESE PROFESSIONAL RECORDERS AND CASSETTE MACHINES

**MICROPHONES**

A AKAI DM13	£5.95
A ADM11	£4.35
A ADM10	£4.35
B AKG DST11/41	£17.00
B D11-DHL	£9.35
B D11S	£8.95
B D58E	£14.45
B D 109	£12.35
B BEYER M55HL	£8.75
B M64	£9.75
B M81HL	£11.05
B M818HL	£23.95

RESLOSOUND MICROPHONES IN STOCK. PRICES ON APPLICATION.

A TANDBERG TM3	£7.00
A TM4	£11.45

**TAPE & CASSETTES**

BASF LOW NOISE	
5.75"	1200' £1.43
7"	1800' £2.04
8.75"	2400' £2.68
10"	3280' £3.65
10.5"	4200' £4.52
5.75"	1800' £2.04
7"	2400' £2.50
8.75"	3600' £3.10
EMI APHONIC	
5.75"	900' 90p
7"	1200' £1.10
5.75"	1200' £1.20
7"	1800' £1.50
5.75"	1800' £1.35
7"	2400' £1.90
SCOTCH DYNARANGE	
5.75"	900' £1.13
7"	1200' £1.40
5.75"	1200' £1.40
7"	1800' £1.95
8.75"	2400' £2.74
10.5"	3600' £4.11
5.75"	1800' £2.06
7"	2400' £2.90

BASF & SCOTCH CASSETTES	
C60	46p
C90	65p
PHILIPS LN CASSETTES	
C30	45p
C60	50p
C90	70p
C120	100p

P&C TAPE	
3" -5"	EACH 5p
5.75" -8.75"	7p
10"	10p
P&C CASSETTES	
EACH 3p	6's 10p 10's 15p

CARRIAGE CHARGES			
A 12p	D 50p	G 125p	
B 25p	E 75p	H 175p	
C 40p	F 100p	X 250p	

ALL PRICES SUBJECT TO CHANGE WITHOUT NOTICE E&OE SS272

**F.CAVE TOP DISCOUNTS**

WEST END 21 Old Compton St W1 01-734 5606  
RICHMOND SY 5 Bridge St 01-948 1441  
KINGSTON SY 27 Eden St 01-546 7845  
ROMFORD ESSEX 84/86 South St



WEST END STORE Close to Tottenham Ct. Rd. Leicester Sq. & Piccadilly Circus Stations

**BIG NEW MONEY SAVING CATALOGUE!** SEND 9p STAMPS or let us quote for the system of your choice

## RCA (Records) New York choose



Photo by Glenn B. Ward Co., Glendale 5, California

One of two 32-input comprehensive multi-track sound control consoles designed and built for RCA (Records) New York and installed in their Hollywood studios. These consoles incorporate many unique facilities and are another example of Neve ability to satisfy customers' exacting requirements.

*The sound of Neve is worldwide*

# Neve

**Rupert Neve & Company Ltd.**

**Rupert Neve Inc.**

**Rupert Neve Of Canada Ltd.**

Cambridge House, Melbourn, Royston, Herts, SG8 6AU, England  
Telephone: Royston (Herts.) 60776 (STD 0763) 10 lines Telex 81381

Berkshire Industrial Park, Bethel, Connecticut 06801, U.S.A.  
Telephone: (203) 744 6230 Telex 969638

P.O. Box 182, Etobicoke, Ontario, Canada. Telephone: (416) 677 6611

