

studio sound

AND BROADCAST ENGINEERING

THE TEMPEST GOES QUADRAPHONIC

A REMOTE CONTROL FOR THE REVOX 77

RANK-KALEE AND WOELKE FLUTTERMETERS REVIEWED

THE WORKS OF
OF
WILLIAM SHAKESPEARE.
THE TEMPEST.

DRAMATIS PERSONÆ.

Antonio, King of Naples.
Sebastian, his brother.
Prospero, the rightful Duke of Milan.
Antonio, his brother.
Ferdinand, son to Alonso.
Gonzalo, an honest philosopher.
Alonso, King of Naples.
Francisco, a gentleman of the court.
Caliban, a sorcerer.
Trinculo, a clown.

Stephano, a drunken Butler.
Trinulo, a Fool of a Ship.
Antonio, the Merchant of Venice.
Antonio, the Merchant of Venice.

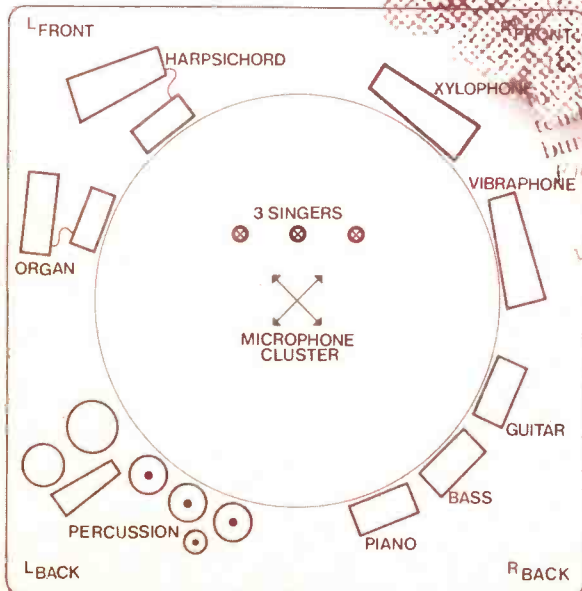

Making a Big Decision?

We are always pleased when engineers compare consoles critically instead of blindly accepting what the manufacturer promises; who form their own opinions instead of following others; who make a cool assessment of systems engineering and cost; who know what they want precisely.

A good look at Cadac makes the choosing easy.

cadac

The established leaders in music recording
consoles and techniques.

← Cadac (London) Ltd.

141, Lower Luton Road Harpenden Herts AL5 5EL

☎ Harpenden (STD 05827) 64351 Telex 826323

EDITOR DAVID KIRK
DEPUTY EDITOR MICHAEL THORNE
EDITORIAL PRODUCTION DRUSILLA DALRYMPLE
ADVERTISEMENT MANAGER RICHARD WESTBROOK
MAGAZINE SALES MANAGER DON BAILEY



THE LINK HOUSE GROUP

Editorial and Advertising Offices: LINK HOUSE, DINGWALL AVENUE, CROYDON CR9 2TA. Telephone: 01-686 2599

© Link House Publications Ltd 1974. All rights reserved.

CONTENTS

FEATURES

THE TEMPEST By Adrian Revill	32
CONSTRUCTING A REVOX REMOTE CONTROL By Angus Robertson	42
SURVEY: DC/AC CONVERTERS	46
ELECTRONICS IN MUSIC BIBLIOGRAPHY By R. M. Youngson	48

COLUMNS

NEWS	24
PATENTS	26
CLEANFEED	30
PLAYBACK	36
FIELD TRIAL: Brenell IC2000 By Hugh Ford	64

REVIEWS

RANK KALEE 1742, AENGUS EQUALISER, WOELKE ME105, BRENNELL IC2000 By Hugh Ford	52
---	----

SUBSCRIPTIONS

STUDIO SOUND, published monthly, enables engineers and studio management to keep abreast of new technical and commercial developments in electronic communication. The journal is available without charge to all persons actively engaged in the sound recording, broadcasting and cinematographic industries. It is also circulated by paid subscription to manufacturing companies and individuals interested in these industries. Annual subscription rates are £3 (UK) or £3.30 overseas.

CORRESPONDENCE AND ARTICLES

All STUDIO SOUND correspondence should be sent to the address printed on this page. Technical queries should be concise and must include a stamped addressed envelope. Matters relating to more than one department should occupy separate sheets of paper or delay will occur in replying.

BINDERS

Loose-leaf binders for annual volumes of STUDIO SOUND are available from Modern Bookbinders, Chadwick Street, Blackburn, Lancashire. Price is £1 (UK) or 95p (overseas). Please quote the volume number or date when ordering.

AUGUST 1974 VOLUME 16 NUMBER 8

SO-AND-SO has come a long way since its first development in whenever it was. A sentence of this kind can be applied as an introduction to almost any aspect of technology, particularly in the sphere of electronics. When one examines the rate of progress in electrical storage systems, however, one faces an unhappy scene of technical stagnation. The lead-acid car battery remains supreme.

One of the few original ideas to emerge in this field during recent years related to the storage of hydro-electric energy. Water released during peak daytime periods was pumped back uphill in the small hours of night, ready for release the following morning. All very elegant but even less portable than a lead-acid car battery.

In recent years, the fuel cell has shown promise as a potential successor to lead-acid and dry-cell batteries—even to the extent of rendering the electric car a practical possibility. Long recharge times would be eliminated, it was claimed, by the simple process of pumping in fresh chemicals to replace those exhausted by the power-generation process. Whatever happened to that?

The location sound recordist, whether he arrives on the scene by combustion engine, by milk float or on foot, requires a stable form of electrical energy supply to operate his equipment. This is most commonly obtained from Ever Ready U2 cells or their commercial equivalents; alternatively from nominally rechargeable nickel-cadmium batteries. These latter have much to commend them, being substantially cheaper energy sources than conventional dry batteries. Unhappily, nickel-cadmium devices tend to be variable in behaviour from one 'new' specimen to another, a characteristic perhaps connected with their tendency to deteriorate when left in a state of low charge.

It is not widely appreciated that U2-style dry cells are themselves rechargeable though admittedly on a somewhat haphazard basis since the zinc battery casing—dissolved by the electrolyte during discharge—reforms at random during the recharge process. Sooner or later, the casing is penetrated and sal ammoniac jelly emerges to eat away the local wiring.

A year or so ago, when electrical blackouts looked like becoming part of the regular winter pattern, we pondered surveying manufacturers of fossil-fuel powered emergency mains generators. Since that time, however, the cost of these fuels in general and of fuel oil in particular has risen so substantially that the advantages of such machinery barely outweigh their attendant smell, noise and expense.

Hence, a survey of direct-to-alternating current converters. These at least have improved since the days of vibrators, when output waveforms were usually far from sinusoidal even if accurate in frequency. It is amusing to speculate on the number of converters that must have been used in the past year or two to raise 12 or 24V dc up to 240V ac to be transformed back down and rectified for a 12 or 24V dc rail.

STUDIO SOUND is published on the 14th of the preceding month unless that date falls on a Sunday, when it appears on the Saturday.



Total average net circulation of 7,641 per issue during 1973.

ELECTROSONIC:

BOSSE

... a powerful partnership

Electrosonic have manufactured lighting control systems for the Rolling Stones, The Who, Pink Floyd, Deep Purple, King Crimson, Yes, Uriah Heep and other top names, plus large scale professional sound systems throughout Britain. With our recent appointment as Main Distributor for Bose Professional Products we offer on any scale, from the smallest band rig to the largest Auditorium installation.

TOTAL SYSTEM DESIGN CAPABILITY FOR SOUND AND LIGHTING

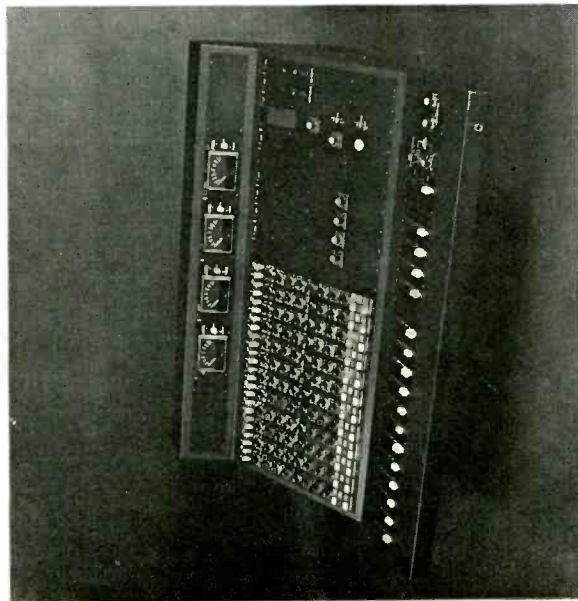

Sound Control Electrosonic design and manufacture complete sound control systems, including the ES1230 Series Modular Studio Mixer. Custom-built to any format with a wide range of control facilities, the ES1230 is available in Console form suitable for the small studio, or fully portable built into specially designed shock-resisting transit cases for the touring band or recording outfit. It forms the heart of the ideal rig: Electrosonic ES1230 Modular Mixer, Bose 1800 Power Amplifiers, Bose 800 Loudspeakers with AKG Professional Microphones.

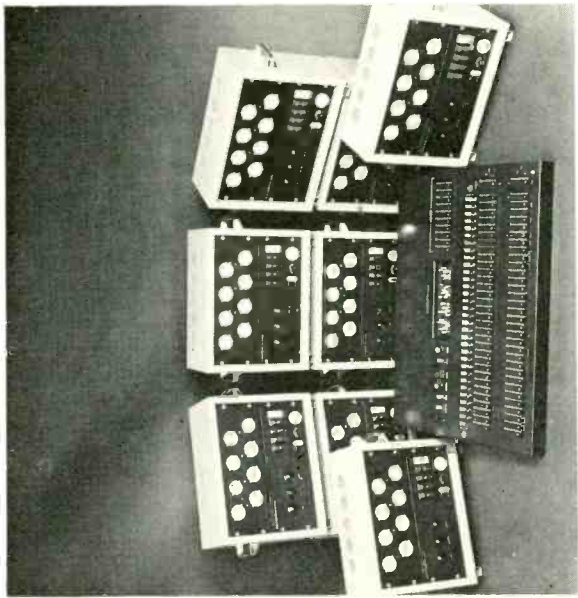

Lighting Control Professional specialist control equipment designed for any application from the small band to the largest auditorium. The Electrosonic ES6000 Series of multichannel dimmers form the basic modular dimmer pack range, coupled to custom control boards, available in designs for permanent installation or for touring portability. A wide variety of special effects controls may be inbuilt in addition to the usual manual presets. Illustrated is the 128 kilowatt 32-channel 2-preset portable control system supplied to ESP - the band lighting system consultants - for URIAH HEEP.

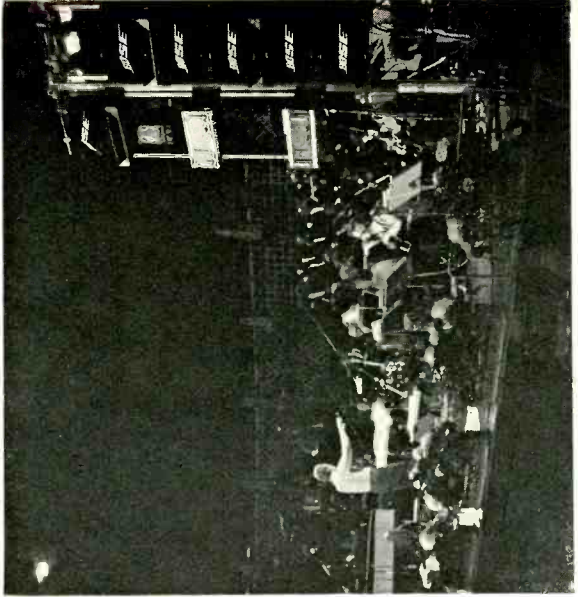

The Bose System A total reappraisal of the design requirements for a high power sound system. No longer need the artist be obscured by a huge wall of giant cabinets. Each Bose 800 Loudspeaker, whilst only 19" x 15" x 13" one-handed size, is fully capable of handling 270 Watts rms! Each Bose 1800 Power Amplifier is capable of a power output of 250 + 250 Watts rms into 8 ohms! The use of Bose Loudspeakers and Amplifiers enabled two Electrosonic engineers to install the BERT KAEMFERT 4kW sound system for his World Premiere at the Royal Albert Hall in just 1 1/2 hours - the complete system having been delivered in a 35 cwt Ford Transit Van!



ELECTROSONIC

Electrosonic Limited Electronic Control and Audio Systems
815 Woolwich Road London SE7 8LT Phone: 01-855 1101
Telex: 896323 (ESMX London) Cables: Multiplex London SE7

REVOX

REVOX A77 SERIES

Available in a wide variety of configurations, inc. $\frac{1}{2}$ track, full track, $\frac{1}{4}$ track. Choice of tape speed.

Backed by ITA Service

**IMMEDIATE DELIVERY—
ALL MODELS**



THE NEW REVOX A-700 SERIES

3 tape speed configurations
Full deck logic
Four inputs
Crystal servo control
Tape footage counter
Servo tape tension

Write for full information

**IMMEDIATE DELIVERY—
ALL MODELS**

Scotch 207 LOWEST UK PRICES

NOTE NEW ADDRESS~

Industrial Tape Applications

5 Pratt Street, London NW1 OAE. Tel: 01-485 6162 Telex: 21879

this is Otari

Europe's
largest
choice of
Broadcast
Recorders
—off the
shelf !!

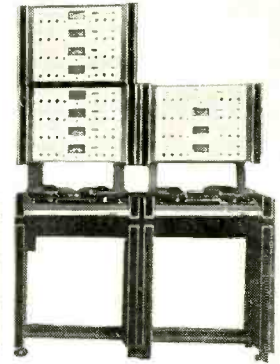

Multitracking
Mastering or
Duplicating.
OTARI
Broadcast
Equipment

OTARI

NOTE NEW ADDRESS-

Industrial Tape Applications
5 Pratt Street, London NW1 OAE. Tel: 01-485 6162 Telex: 21879

ITA

NEW equipment for the professional sound-recording studio from *brenell*

DESIGNED AND MADE IN THE U.K.

MULTI-CHANNEL EQUIPMENT

We have set a new price/performance standard with our 4, 8 and 16 channel studio recorders offering full facilities for the production of master recordings. PPM or VU meters on each channel. Equalisation to CCIR, NAB and IEC characteristics. Remote control for tape transport and record functions. The equipment is in full production and studio use in both U.K. and overseas.

STUDIO RECORDERS

for 2-channel reducing, field recording and full track mastering.

TAPE TRANSPORTS

We offer a widened range of 2 speed and 4 speed modules from 15/16 to 60 IPS, $\frac{1}{8}$ " to 1" tape width, with heavy duty solenoid operation and remote control facilities.

brenell

BRENELL ENGINEERING CO LTD

231-5 Liverpool Road, London N1 1LY Tel. 01-607 8271 (5 lines)

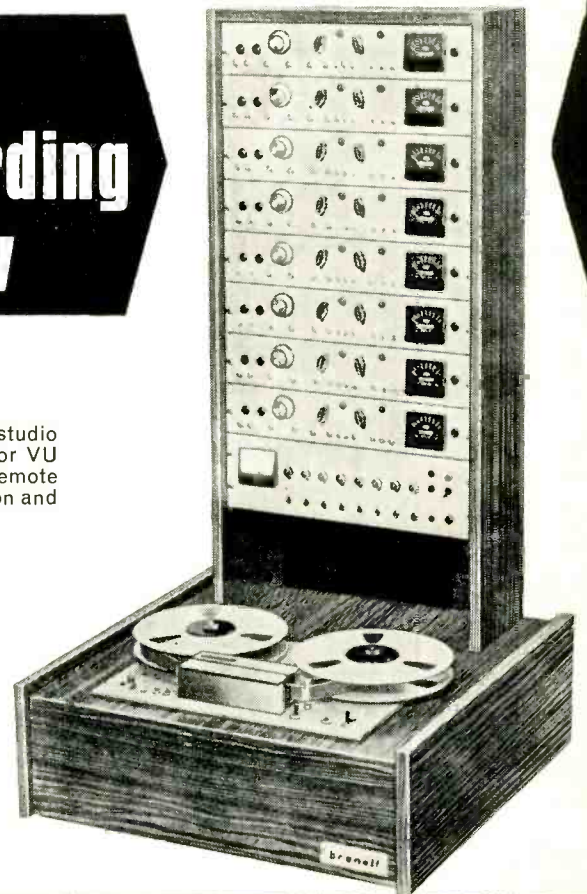

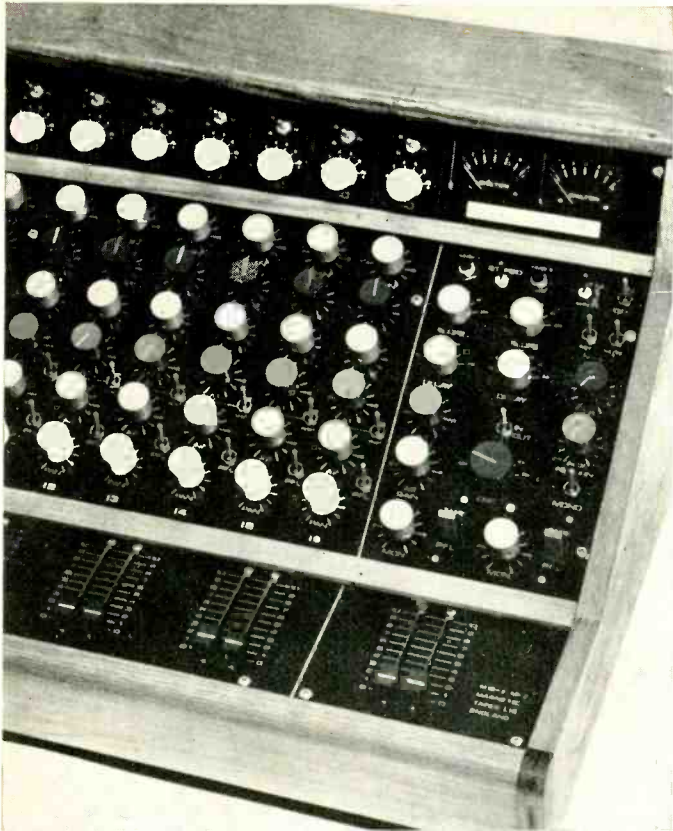

WHY CHILTON MIXERS?

We are manufacturers in the true sense of the word; producing Teak Cabinets, Sheet Metal Work, Tooling, Front Panel and Printed Circuit Artwork etc., our products are accurate with an attention to detail that is second nature to us.

The popular M10/2 (10in 2out) portable mixer shown is supplied as a basic unit with 10 Line inputs inc PPM, Oscillator, LF/HF Equalisers, 1 Aux and PFL. You choose the number of Microphone or Gram inputs, the channels to have Presence, Switchable HF/LF Filters or Ducking. In addition a 2nd Aux channel, Talk-Back, and/or Compressors can be fitted.

Ring or write for full information, if however our standard range is unsuitable it may be possible to modify one to suit your requirements.

M10/2 Mk3 BASIC £295.00+ VAT
16 input version £455.00+ VAT
12 in 4 out £515.00+ VAT

**MAGNETIC TAPES Ltd., Chilton Works,
 Garden Rd., Richmond, Surrey, TW9 4NS**

Telephone 01-876 7957

Voucher

for free copy of the
 advance catalogue

Detach and send by postcard or
 letter to "photokina" D-5 Cologne
 1, P.O.B. 210760, West Germany.

Don't forget the address

» The new "photokina"
 A film and photo
 festival is now devel-
 oping into an optimum
 trade fair for
 information and buying



Products presented by 800 (eight hundred!)
 firms from 26 countries at "photokina"
 1974. That is the world's biggest cine,
 photo and accessories fair ever.

Important for you

The experts are on their own at "photokina" 1974:

- Everyone interested in photography and cinematography
- All trade outlets, professional users and consumers

German amateur photographers are not invited to attend because the World Fair of Photography is not a festival but a matter-of-fact information centre. There you can compare, study, negotiate and buy at your leisure—without any crowding. A week-long world market.

photokina

World Fair of Photography

Cologne 1974 — September 27 to October 3

Tickets and Information:

H. E. Melsom, M.B.E.
 Cologne International Trade Fairs,
 Lufthansa House, 10 Old Bond Street, London W1X 4EN
 Telephone: 01-409 1436

Ireland:

H. Clissman, Jr., 44 Dartmouth Square, Dublin 6
 Telephone: 65729

Mixing with the best

In order to fill the need for a small versatile truly professional mixer, Stellavox have designed the ultra modern Mixer type AMI 48. Using the same principles as the well known Stellavox professional tape recorder type SP7, the AMI 48 is : very rugged, with a die-cast chassis; very light and small, but with perfect operational comfort; battery operated, for use anywhere.

Being comprehensive, it offers not only the classical facilities of conventional big studio consoles, but many exclusive circuits : *powering for any condenser microphones* (parallel or phantom fed 12 V, phantom fed 48 V); very accurate *880 Hz tuning fork reference oscillator*; and the new *limiting circuits type SIL on all inputs and outputs*, allowing easy use of STELLAMASTER technology for extremely low noise recordings.

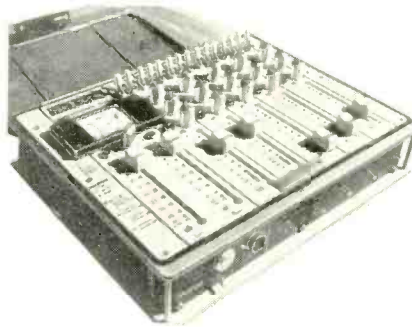

STELLAVOX

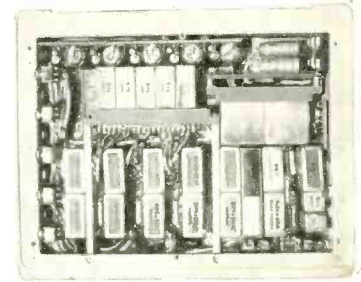

A. V. Distributors (London) Ltd.
26 Park Road, Baker Street,
London NW1 4SH.
Tel.: 01-935 8161.

Please send me further Stellavox details.

Name

Address

.....

.....

.....

SS 8



SESCOM'S NEW CABLE TESTER

TESTS FOR:

- Continuity
- Opens
- Shorts
- Phasing

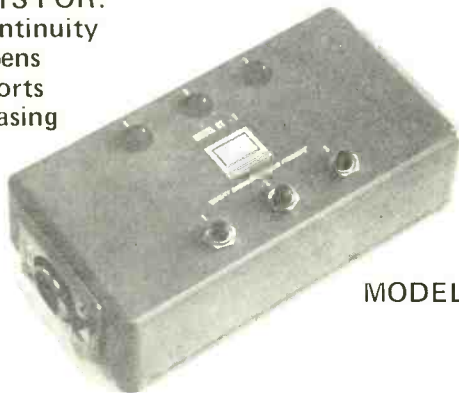

MODEL CT-1

Just plug a standard cannon type 3 pin male to female extension cord into box, depress three push buttons. Compact cast aluminum box. Uses standard 9V transistor battery. Professional Net \$20.50.

Send for Spec Sheet



QUALITY ENGINEERED SOUND PRODUCTS
SESCOM, INC.
P. O. Box 4155, Inglewood, Ca 90309, U.S.A.
Telephone (213) 678-4841

0.002% THD 100 watt per channel power amplifier

0.002% THD at all levels up to 10 watts and all audio frequencies. Less than 0.02% THD at all frequencies and all levels up to 50 watts, typically 0.004% at 1kHz and 50 watts. Intermodulation distortion is less than 0.03%.

The amplifier is unconditionally stable and does not ring even into a 2µF capacitor.

The two channels are power limited at 120 watts rms and a tracking short-circuit cut-off protects each of the four power supplies. There is also a thermal cut-out.

Both channels will deliver continuously more than 100 watts into a 4 ohm load or 70 watts into an 8 ohm load.

The frequency response is within 1dB from 10Hz to 20kHz and the noise is more than 100dB below 70 watts into an 8 ohm load.

The case size is 430mm x 300mm x 76mm.



naim audio

The price of the NAP200
Amplifier is £172 + VAT.

15 CHURCHFIELDS RD · SALISBURY · WILTS · SP2 7NH · Tel: 3746

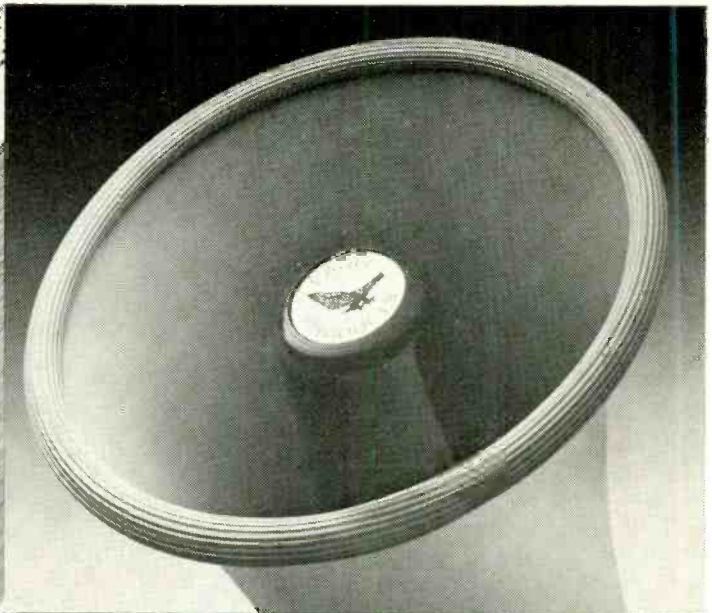
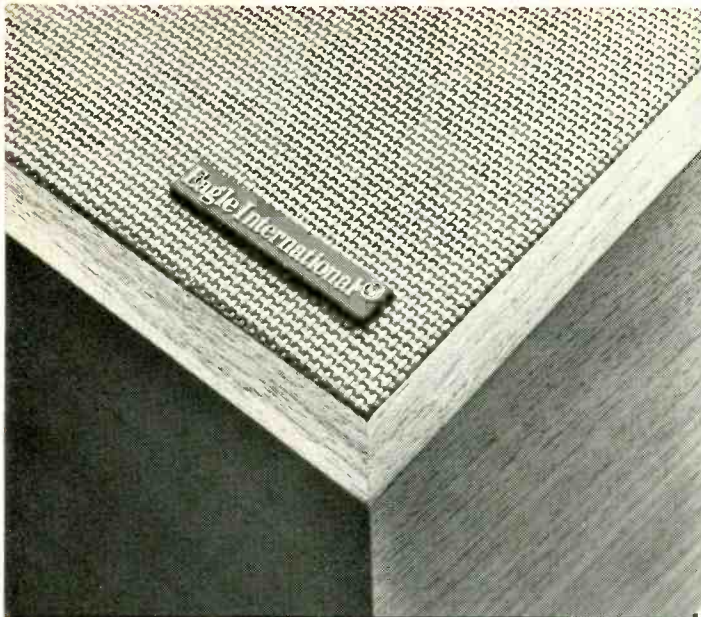

If you install PA equipment with our name on it, it guarantees yours.

One of the best ways to pick up more business is through a satisfied client.

For your part you know you'll do a good job.

You also need to know the equipment you use won't let you down.

Over the years we've listened to professionals to tell us what people want.

Amplifiers with an RMS output of 120 watts. Or 65 watts. Or our 35 watt mains/mobile model.

Omni-directional and uni-directional mikes. Our PRO 25 boom-arm. The extra light PRO M5 with a special tie-clip and jack plug.

Thirty five different kinds of speakers. Megaphones. Headphones.

Everything down to microphone stands and 100 volt line matching transformers.

We're confident enough to put a two year guarantee on anything we make.

But if something goes wrong we have parts here to get

things back in working order without wasting time.

That's how Eagle PA got its name for reliability.

To keep your clients satisfied.

Eagle
International

The name on Britain's widest range of electronic equipment.

Please send me the Eagle 1974 PA Brochure and your latest Electronics Range Catalogue.

Name _____

Address _____

SS 1

Eagle International Precision Centre Heather Park Drive
Wembley HA0 1SU Telephone 01-903 0144

We never heard of you, either!

But DUPLITAPE would like to. We specialise in the duplication of recordings on magnetic tape. Our newly equipped plant with its clinical atmosphere reflects our dedication in offering the finest and most competitive duplication service currently available.

DUPLITAPE
5 PRATT STREET
LONDON NW1
Tel: 01-485 6162
Telex: 21879 Amstelco ITA

Please send full information on
TAILORED BLANK CASSETTES
C. ZERO CASSETTES
DUPLITAPE FACILITIES

Name

Address

Altec Sound Equipment by Theatre Projects



9846B Bi-amplifier Studio Monitor Speaker System

For further information on the Altec range of sound equipment please fill in the coupon below and return to:

Theatre Projects/Sole UK Agents
10 Long Acre London WC2E 9LN
Telephone 01-240 5411

ALTEC **THEATRE PROJECTS**

Please send me further information on the Altec range

Name:

Address:

Telephone Number:

I am particularly interested in:



In the wrong hands it's wasted.

This is the Triad 'A' Series.

A supremely sophisticated, all capable sound mixing console.

But, like any such equipment it must be handled by someone who knows what he's about.

An artist.

Someone with that almost indefinable something that sorts the men from the boys in sound engineering.

People will say we're cutting down our market saying things like this.

We think not.

Because if you are one of the best you deserve one of the best.

And this precisely is what we have to offer.



More than most guys can handle.

Trident Audio Developments Limited, 4-10 North Road, London N7 9HG. Telephone: 01-609 0087. Telex: 27782.

WHY WE BOUGHT BIAS



John Lumsden, Chief Engineer of Radio Clyde, says: "We bought the BE1000 for Radio Clyde because we were impressed by the excellent construction and ease of operation, and BIAS could offer the performance and facilities required at a very reasonable price.

"Since the opening of Clyde on the 1st January, 1974, the machines have been in operation almost 24 hours per day and, apart from some minor teething troubles, our original opinion has been confirmed by their excellent reliability and ability to withstand the demands placed upon them.

"Congratulations BIAS on an excellent example of British engineering, skill and know how."

BANK ON BIAS — A SOUND INVESTMENT

BIAS ELECTRONICS LIMITED
572 KINGSTON ROAD, LONDON SW20 8DR
Telephone 01-540 8808

Grampian

Series 7 Modular Sound Systems



Manufacturers also of the most comprehensive range of Amplifiers, (including Mains/Battery types) Microphones and ancillary items, Ambiophonic and Reverberation Units and all types of loudspeakers for sound systems.

GRAMPIAN REPRODUCERS LTD
HANWORTH TRADING ESTATE,
FELTHAM, MIDDLESEX.
TELEPHONE: 01-894 9141
GRAMS. REAMP FELTHAM



F760X-N
module
(80 x 190mm)

F760X Limiter-Compressor Expander

A truly remarkable little package; ideal for reduction work. Any function can be used independently or a combination of all three functions can operate simultaneously. Technically superb: physically compact and financially attractive. Who wants more?



AUDIO DESIGN RECORDING
St. Michaels, Shinfield Road, Shinfield
Green, Reading, Berks.
Tel: (0734) 84487

“Gee TEAC – what big reels you have!”



“All the better to play up to six hours of uninterrupted music with.”

“And Gee TEAC, what big recording features you have.”

“All the better to turn this A-3300 into a professional stereo tape deck with.”

Not only does the deck accept long playing 10½ inch reels, but it also improves your recording technique. It features TEAC's unique Edi-Q electronic record pause control which eliminates the clicks and snaps that can upset your recordings when you pause and then restart. Then there's the front panel bias switch for the proper selection of bias current. It assures the best possible performance from all the new tapes on the market.

Attach the powerful 210 watt TEAC AG-6500 stereo receiver and you're in for more enjoyment, because it has the most exclusive FM front end around. The kind you would find on highly complex communications equipment. A special feature of the AG-6500 is that it offers almost any combination of copying and monitoring facilities. For example, while dubbing you can listen to either AM, FM or the record player without interfering with your copying. Enjoy the next chapter of this story in sound. Listen to TEAC's A-3300 and AG-6500. Can you think of a better way to hear happily ever after?

TEAC
The sound of perfection



Sole UK Distributors

**ACOUSTICO
ENTERPRISES
LTD** *The Hi-Fidelity People*

Unit 7, Space Way, North Feltham Trading Estate,
Feltham, Middlesex. Tel. 01-751 0141 (4 lines)



Macinnes Driver Jon Dooley is going pretty well with his Macinnes Sponsored Alfa Romeo in the Triplex Championship for production saloon cars. Currently lying 2nd in class behind a 6 litre Camaro Jon has been going well with his 1800 cc car.

C.T.S. DRIVERS ARRIVE!

CTS loudspeakers of Paducah have appointed Macinnes as exclusive agents for their range of Driver speakers. CTS speakers are used in more guitars, Bass Guitars, and Electric Organs than any other brand of speaker. The musical Instrument range covers 10", 12", 15", and 18" models for Lead Guitars, Bass Guitars, and Organ and even has a 100 watts 10" model available.

- ★ Voice coils made with CTS Aluminex Bobbin
- ★ Barium-ferrite magnets for high efficiency
- ★ Vented Aluminium dome to relieve air pressure
- ★ 8 ohms nominal voice coil impedance
- ★ Individually packed for maximum protection

model 12G54L

100 watts lead guitar



MACINNES LABORATORIES LTD.

**MACINNES HOUSE, CARLTON PARK INDUSTRIAL ESTATE,
SAXMUNDHAM, SUFFOLK IP17 2NL
TEL: (0728) 2262 2615**

Condenser Microphones... at greatly condensed prices

Yes it's true! Unisound Electret Condenser Microphones are capturing the sound and the interest of the amateur and professional recordist, for at last the condenser microphone price barrier has been shattered and without any loss of performance.

The range includes Omni and Uni-Directional as well as Tie-Tack lapel models. The unique design employs a tiny UM-3 battery making bulky power packs obsolete yet providing sufficient power to maintain high sensitivity and a wide response ratio.

Get to know more about Unisound Electret Condenser Mikes - we have a very interesting technical leaflet available on request.

Condor

The fastest bird in the business

Condor Electronics Limited,
100 Coombe Lane, London, SW20 0AY
Telephone: 01-946 0033 (4 Lines)

Distributors of cartridges, styli, condenser microphones and headphones. Guaranteed 24-hour dispatch service

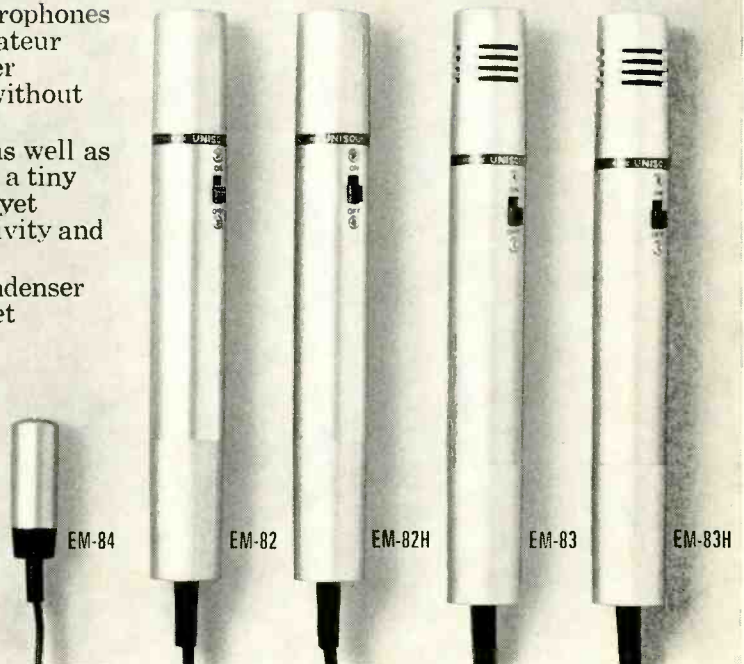

Take a Quad 50E Amplifier

(a good start for any installation)



plug it into your monitor system and it bridges 600Ω lines to drive your speakers.

Take that same amplifier and, without changing it in any way, plug it into another installation to deliver 50 watts into 100 volt line * from a 0.5 volt unbalanced source. This versatility and its attendant easing of stocking and maintenance problems is one reason why large organisations use the Quad 50E.

* or indeed any other impedance from 5 to 250 ohms.

Other advantages appropriate to users of all

sizes include: Excellent power and frequency response (-1dB).

Low distortion (0.1% at 1kHz at all power levels).

Low background (better than 83 dB referred to full output).

Pre-set level control adjustable from front panel.

Unconditionally stable with any load.

Proof against misuse including open or short circuited output.

Small size (4 $\frac{3}{4}$ " x 6 $\frac{1}{4}$ " x 12 $\frac{3}{4}$ ") - (120mm x 159mm x 324mm).

QUAD
Products of
The Acoustical Manufacturing Co. Ltd.
for the closest approach to the original sound
QUAD is a Registered Trade Mark

Send for details to Dept SS, Acoustical Manufacturing Co Ltd,
Huntingdon PE18 7DB Tel: (0480) 52561

QRK

IS THE STANDARD EQUIPMENT OF THE AMERICAN BROADCAST AND RECORDING INDUSTRY. THERE IS NO EQUAL. CHECK OUR HIGHLY COMPETITIVE PRICES.

this is QRK

Broadcast Equipment



QRK 12C BROADCAST TURNTABLE

QRK STEREO CARTRIDGE BROADCAST RECORDER

ITA

Industrial Tape Applications

5 Pratt Street, London NW1 OAE. Tel: 01-485 6162 Telex: 21879



"sounds perfect"

AT LAST your search is over. If second best just will not do, you should be using our range of high reliability equipment which includes power amplifiers, 100v. line transformers, microphone transformers, rack cabinets, and some superb electronic lighting control units. Delivery—usually ex-stock.

Write now for the full details.

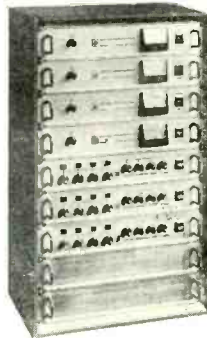

MUSTANG COMMUNICATIONS

NELSON STREET · SCARBOROUGH
YORKSHIRE · YO12 7SZ

Telephone (0723) 63298

*** Dolby A361 for hire ***

- * REVOX A77 Mk III Recorders, standard and high speed model in stock. Sel-Sync model available.
- * New REVOX A700 1372 and 1374 now available.
- * NEAL 102 professional cassette deck from stock.
- * All leading equipment at competitive prices including A.K.G., Beyer, Ferrograph, Teac A3340, Quad, Tannoy, Spondor, Uher 4000/4200/4400, Report IC, and CR210 cassette recorder with facility for chrome tape.

131 The Parade, High Street, Watford WD1 1NA
Tel. Watford 34644

BAILEYS

AUDIO CONNECTORS

BROADCAST PATTERN JACKFIELDS, JACKCORDS PLUGS & JACKS, QUICK-DISCONNECT MICROPHONE CONNECTORS. AMPHENOL (TUCHEL) MINIATURE CONNECTORS WITH COUPLING NUT. HIRSCHMANN BANANA PLUGS & TEST PROBES. XLR COMPATIBLE IN-LINE ATTENUATORS. LOW COST SLIDER FADERS BY RUF.

FUTURE FILM DEVELOPMENTS LTD.
90 Wardour Street W1V 3LE

01-437 1892/3

Flexibility en route.

The Philips MP4 portable 4 channel mixing unit has been specially designed for flexible operation on location.

If you are looking for studio quality and a reasonably-priced, small flexible unit that complies with professional specifications, then the MP4 is what you need.

Not only can the MP4 be used as a portable unit but it can also be integrated in existing studio-installations.

You need more information? Contact Mr. Jan Gerrits or Mr. Bram Potappel, N.V. Philips' Gloeilampenfabrieken Electro-Acoustics (ELA) Division, Broadcast Equipment, Building SAQ II, Eindhoven - The Netherlands.

Tel. 040-733793 or 732646, Telex 51121.



PHILIPS

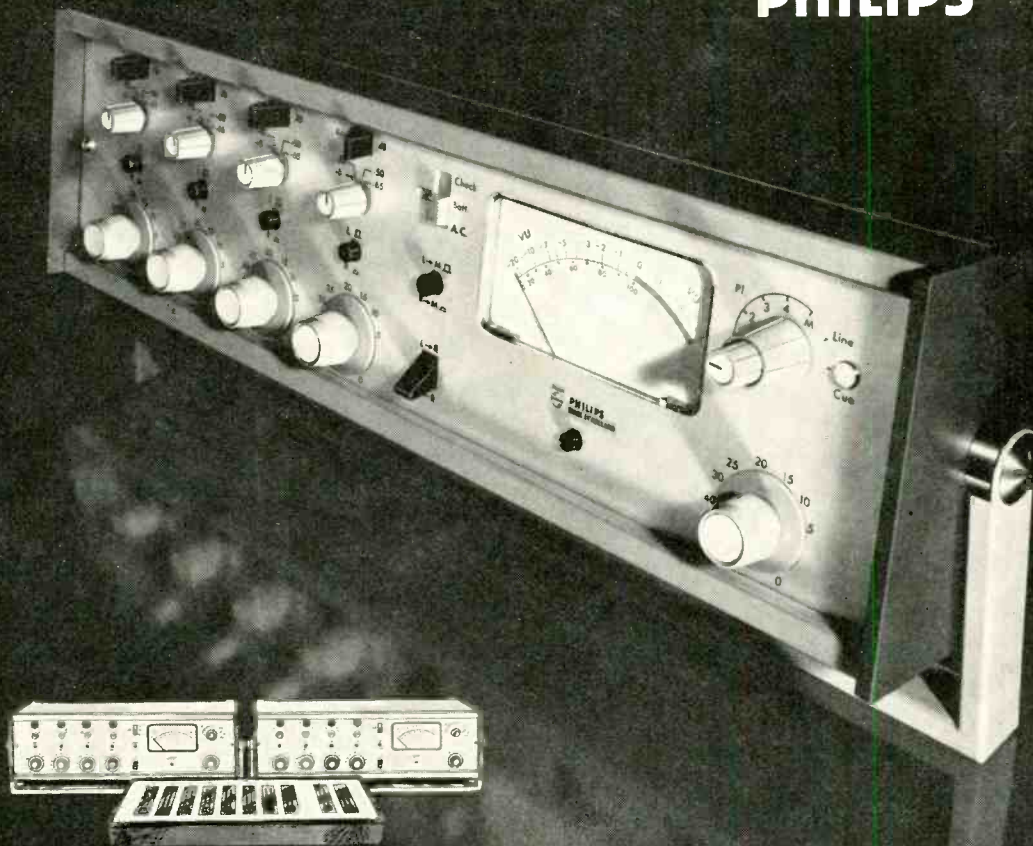

THE PROFESSIONAL—

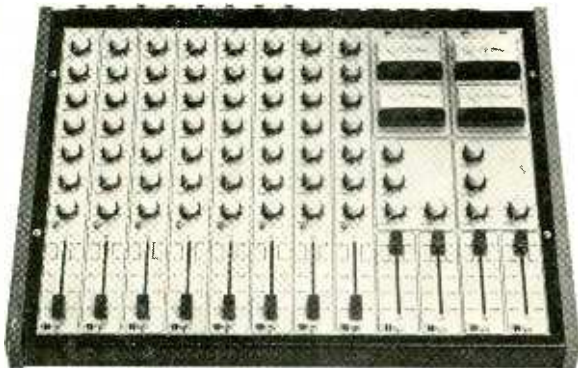

**AT A NON-PROFESSIONAL
PRICE**



ALLEN & HEATH LTD.

PEMBROKE HOUSE, CAMPSBOURNE ROAD, HORNSEY, LONDON N8. Tel: 01 340 3291

THE QUASI 4 OUTPUT MIXER
12 MODULE CAPABILITY IN EITHER 8x4
OR 10x2 FORMAT
XLR OR JACK SOCKET TERMINATION
LOW OR HIGH IMPEDANCE MIC INPUTS
CONTINUOUSLY VARIABLE SENSITIVITY
THREE BAND EQUALIZATION
ECHO AND FOLDBACK OUTPUTS
LINEAR FADER
4 TRACK ROUTING SWITCH AND PAN POT
ON EACH CHANNEL
EQUALIZED ECHO RETURN, MAIN OUTPUT
FADERS AND VU METERS
SIZE 16"x14½"x1½" WEIGHT 15 lbs

KEEP IN TOUCH WITH STUDIO SOUND 25p

Place a regular order
with your Newsagent or take
advantage of a POST FREE
Annual Subscription.

NOW UNDER ONE ROOF!

- ★ Audio Cassette Duplication Services
- ★ Tape and Cassette Recorder Rentals
- ★ Professional Equipment Mart
- ★ Video Cassette Equipment Rentals

MAGNEGRAPH Recording Co. Ltd.,
8 Hanway Street, London, W.1. (junct. Oxford
Street/Tottenham Court Road) Tel. 01-323 0888

WOW and FLUTTER METERS

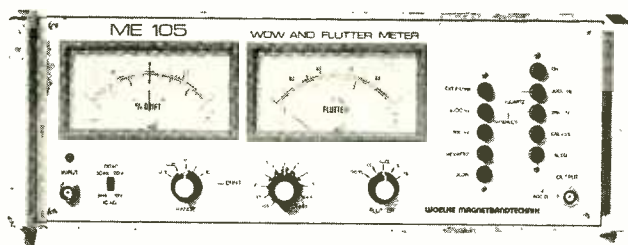

Illustrated is the ME 105, the very latest type of Wow and Flutter Meters manufactured by Woelke Magnet-technik, Munich, Germany, and distributed exclusively by us in the U.K. Anyone concerned with the most accurate measurement of drift (down to plus/minus 0.1%) and wow and flutter (down to plus/minus 0.03%) will be interested in the ME 105. Fuller, final details on application.

LENNARD DEVELOPMENTS LTD.

206 CHASE SIDE, ENFIELD, EN2 0QX
MIDDXX.

Tel. 01-363 8238

It needn't break the bank.

The Philips MD is a range of high performance standard mixing desks at realistic prices.

They have been used all over the world for years and years, which just proves their reliability and excellent quality.

A kind of all risks insurance. So keep it in mind.

You need more information? Contact Mr. Jan Gerrits or Mr. Bram Potappel, N.V. Philips' Gloeilampenfabrieken Electro-Acoustics (ELA) Division, Broadcast Equipment, Building SAQ II, Eindhoven - The Netherlands. Tel. 040-733793 or 732646, Telex 51121.

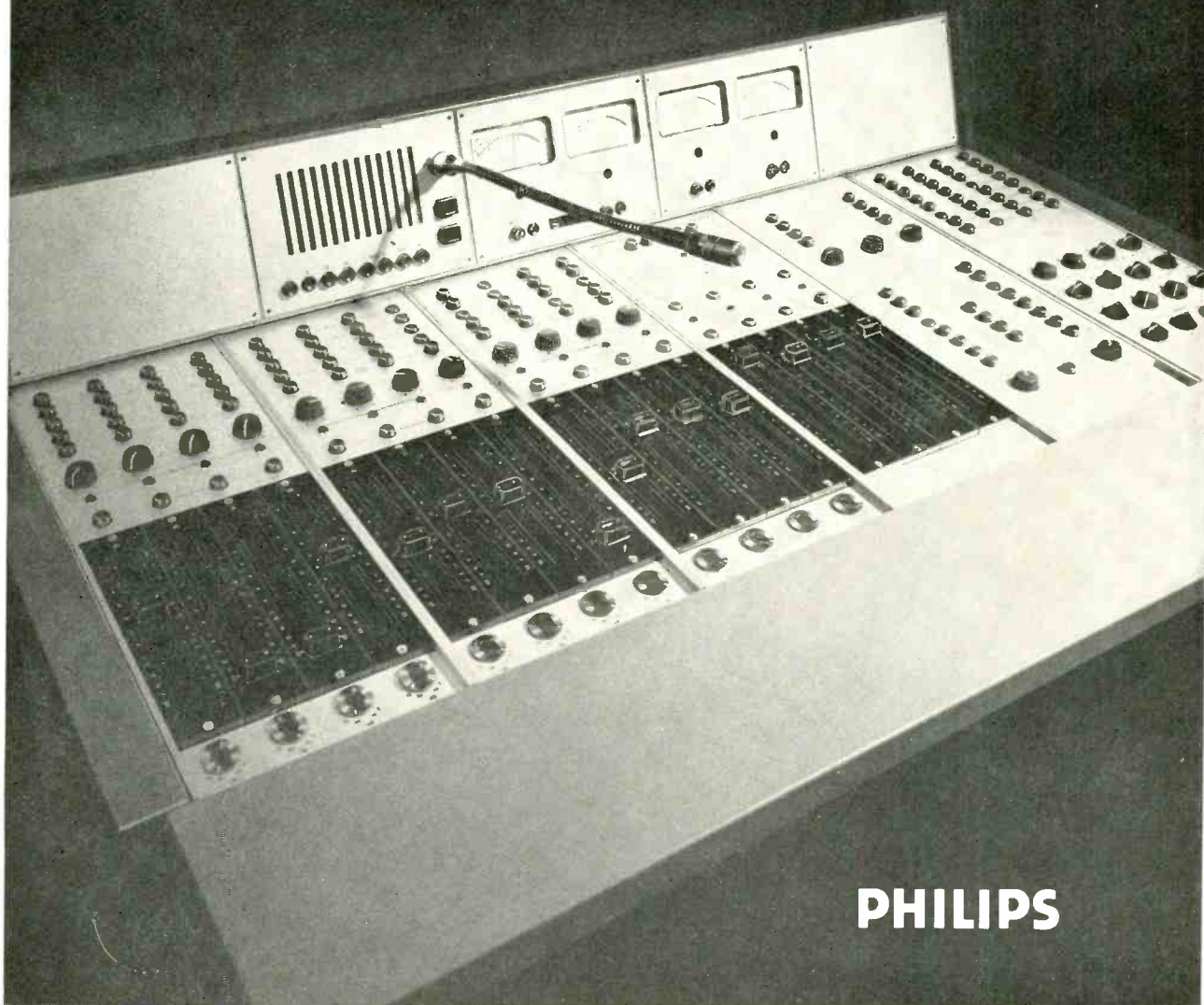

PHILIPS

REW AUDIO CONTRACTS

LONDON'S LEADING CONSULTANTS AND DISTRIBUTORS FOR P.A., STUDIO AND PROFESSIONAL AUDIO EQUIPMENT



TEAC 3340

The Teac A 3340 professional model is a very high quality, 4 track (separate) recorder. Operating at 7½ and 15 i.p.s. with full built-in sel-sync facility. Potential 8 input source (4 line and 4 mic) incorporating separate mixing controls on front panel. In stock.

NETT PROFESSIONAL PRICE ON APPLICATION

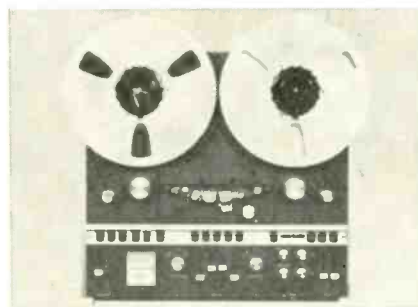

REVOX A 700

The Revox A 700 is a new precision drive 3 motor (electronically regulated) 3 speed (3¾, 7½ and 15 i.p.s.) superb quality pro recorder. Phase locked capstan motor speed; synchronous speed indicator; electronic controlled tape tension; semiconductor switching logic; memory circuit are just a few features. In stock.

NETT PROFESSIONAL PRICE ON APPLICATION

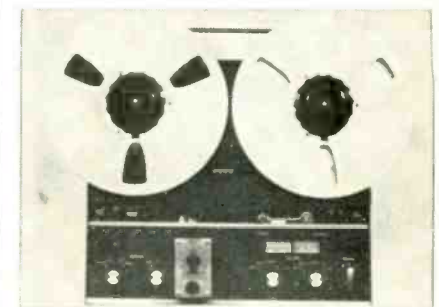

REVOX A77

The world famous A77 1102 Series III semi-professional recorder, available in 3¾ and 7½ i.p.s. or 7½ and 15 i.p.s. speeds + sel-sync and varipitch conversions. This machine proves a long standing favourite with the REW Audio Contracts range of mini-studios. In stock.

NETT PROFESSIONAL PRICE ON APPLICATION



SOUNDCRAFT MIXER

Newly arrived 16/2 PA or location recording mixing console. Complete in flight case incorporating 16 mic channels, stereo output channels, foldback output plus two echo return channels. Full monitoring facilities; pfl; balanced input; 4-band eq; f/b send; echo send; channel switch; pan pots and faders. Input and output XLR sockets plus 37 way socket for multicore connection.

NETT PROFESSIONAL PRICE
£992 + VAT

SPECIAL NOTE—NOW AVAILABLE

At a competitive price, a very high quality 12/4 recording console for use with the Teac A 3340 and Amcron 700/800 Series recorders. Specification to be released shortly.

NETT PROFESSIONAL PRICE £875 + VAT



NOW AVAILABLE

The long awaited Amcron tape deck and latest addition to the REW Audio Contracts Family of mini-studio high quality recorders. REW are able to offer this 800 and 700 series of decks with choice of CX or SX electronics.

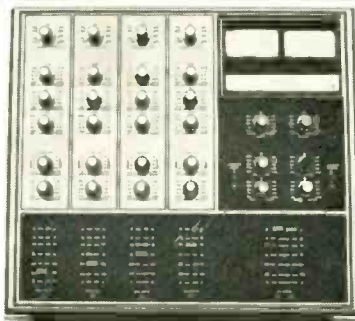

LAMB PML 420 MIXER

This high quality inexpensive 4/2 mixer incorporating 3 band e.q.; pan pots; faders; limiters and echo send controls make it a good starting point for the basic mini studio set-up.

NOW IN STOCK

NETT PROFESSIONAL PRICE ON APPLICATION

REW Audio Contracts are able to offer the following microphones at professional prices (subject to stock) to bona-fide pro users.

AKG	AKG	SHURE	CALREC	BEYER	RESLO
D190	D707	515SA	CM652	M160	S80
D160	D900	588SA	CM655	M500	CABARET
D109	D1200	545		M200	S91
D12	D2000	565		M101	
D90	D202E1	548		Available in	
D200	D224E	SM57		DIN or CANNON (XLR) connectors.	
D202	C451*	SM58			

*VERY SPECIAL PRICE WHILE STOCKS LAST

ALL PRICES ON APPLICATION Full range of mic stands and accessories by KMAL.

ALL PROFESSIONAL AUDIO EQUIPMENT AT

REW Audio Contracts, 146 Charing Cross Road, London WC2. Tel: 01-240 3883

VIDEO, INDUSTRIAL AND STUDIOS AT

REW Video Contracts, 10-12 High St., Colliers Wood, London SW19. Tel: 01-540 9684/5 Telex 896194

*NOTE REW Audio Contracts and REW Video Contracts are registered trade names and are part of The REW Group of Companies.

KJ ARE AGENTS FOR:

MICROPHONES

AKG D 190, D 707, D 202, D 200,
D 1200, D 12, D 224,
CALREC Capacitor

MONITOR SPEAKERS

AMCRON ES224
AR LST
BOSE 901
CELESTION Ditton 66
IMF Professional
JBL Studio
KEF Reference 104
ROGERS BBC LS3/6, BBC LS3/5
SPENDOR BC11/BC11

TAPE EQUIPMENT

TEAC A3300 Series/A450/A360
UHER 4000 series and CR210

Professional prices available against
official company orders on most
microphones, monitor speakers and
tape equipment.

RECORDING TAPE & CASSETTES

We stock a wide range of brands and
sizes including AGFA, BASF,
PHILIPS, MAXELL, MEMOREX,
SCOTCH and TDK.
Quantity rates on application.

ENQUIRY DESK!

Our sales office will be pleased to
answer any queries in respect of
technical problems, pricing and stock
availability.
Please ask for either Robin Marshall
or Chris Barker.

CATALOGUE

KJ stock a comprehensive range of
audio equipment which is detailed in
our catalogue — we will gladly send
you a copy.

**ROGERS
BBC**



LS3/5 MONITOR

Surely the best small studio speaker
yet - measures only 7¼" x 6½" x 11¼".
Frequency response 80-20,000Hz
±3dB. Absolutely ideal for a small
studio or mobile unit. Quite the
best sound we have heard
reproduced from such a small
cabinet. Each speaker is supplied
with an individual response curve
graph.

Revox

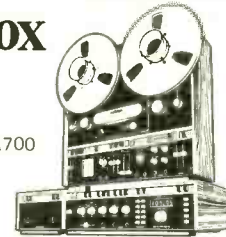

A700

A new series of equipment from one
of the world's most respected
manufacturers. Comprises stereo tape
deck, FM tuner-preamplifier, stereo
power amplifier and quadraphonic
power amplifier.
All the range of Revox tape units can
be supplied correctly set up for any
specified brand of tape by prior
arrangement.

PHILIPS

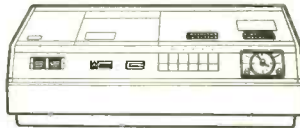

The new video cassette recorder with
a playing time of up to one hour.
Enables recording direct from a
normal TV aerial or from camera
(with modification) in black and
white or colour. Suitable for many
applications including advertising and
PR, training, coaching, educational
and collecting information.
Price: £409.00 + VAT

Kenonic Accuphase

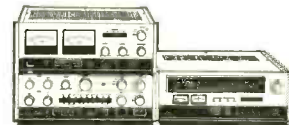

The most significant amplifier yet to
come out of Japan. Winner of the
'Grand Prix' award for the best
Amplifier of 1973 - one of a series of
awards made annually in Japan for all
categories of audio equipment by a
team of independent experts. This is
hand-built equipment of the highest
quality, also there is a matching tuner
available.



**ACCESS
&
BARCLAYCARD
ACCEPTED**

Showroom Hours:

Mon.—Sat. 9.30 am - 5.30 pm
Thurs. (late night) until 8.00 p.m.
No Half Day Closing

2 minutes walk from Watford Junction
Station - and just off the M1

AMCRON



IC 150

Harmonic distortion immeasurable
(computed at .00005%) — intermodu-
lation distortion just about measurable at
typically .003%. Utterly reliable,
guaranteed for 3 years and they actually
sound better too!

- IC 150 Pre-amp
- D 60 Power-amp (40w)
- D 150 Power-amp (100w)
- DC300a Power-amp (200w)
- ES 224 Speaker system

NAKAMICHI

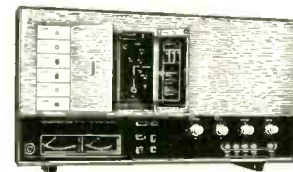

For the first time a cassette deck
with a response up to 20,000 Hz and
monitoring in Dolby 'B'. We have
measured both 700 and 1000 models
and have achieved a response of
30-20,000 Hz +1/-2dB — distortion
typically 1.7% mid band reference
200 nWb/m, and signal to noise ratio
-56dB unweighted. All measurements
on TDK CrO₂ tape.

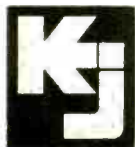

KJ LEISURESOUND LTD

101, St Albans Road, Watford, Herts. WD1 1RD

Telephone Watford 33011

MIXER

by

— TURNER —

Type 1071 ►
Channel amplifier
providing
comprehensive
equalisation
facilities.

THIS IS THE CHANNEL AMPLIFIER AS USED IN OUR STUDIO RANGE

Designed for the medium sized studio and sophisticated p.a. systems. The fully modular approach enables us to adjust the format to suit your own requirements.

We shall be pleased to quote for additional routing and other custom designed versions to cater for quadraphonic and multitrack applications.

TURNER ELECTRONIC INDUSTRIES LTD.

175 Uxbridge Road,
London W7 3TH
Tel: 01-567 8472

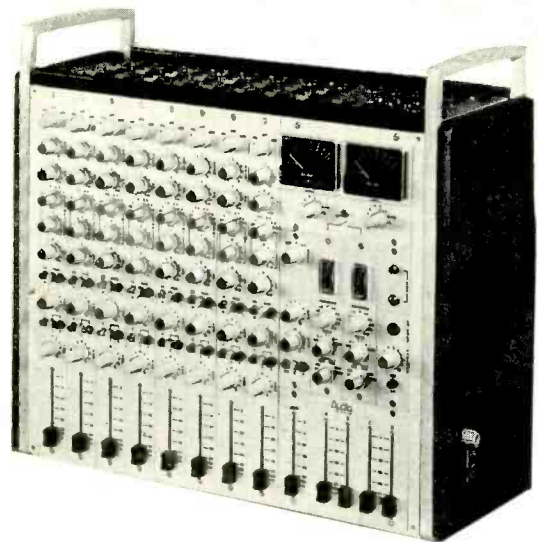
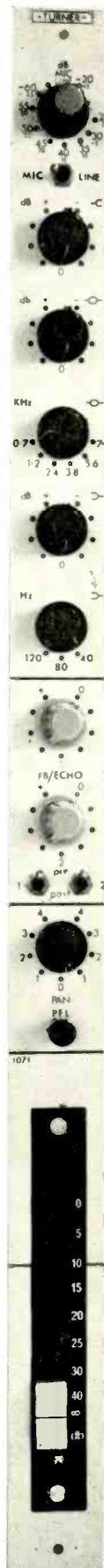

AD 007 PORTABLE MIXER

The Mini Mixer with the professional qualities and the professional performance.

- Battery or external power supply operable.
- 8 Inputs 4 Outputs all balanced into XLR connectors.
- 2 Compressors with stereo link.
- 2 Peak Programme Meters switchable to all channels and groups.
- Auxiliary send and returns.
- Modular construction is used to promote serviceability.
- Inputs extendable to 18 via the Ten Input Extension Unit.

Other facilities include insertion points in each channel and group, a line up oscillator and cue facility. The Extender Unit can also incorporate Talkback and Monitoring at the exclusion of input modules.

Customers so far supplied have been full of praise for the mixer. They include people in broadcasting studios and the live entertainment field.

Audio
Developments

Hall Lane
Walsall Wood
Staffs WS9 9AU

Tel. Brownhills 5351

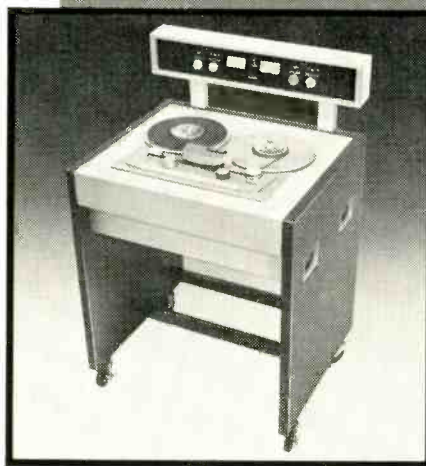

<p><i>PORTABLE:</i> in robust carrying case.</p>	<p><i>FUNCTIONAL:</i> in compact broadcast trolley.</p>
<p><i>ELEGANT:</i> in A80-style console.</p>	<p><i>ADAPTABLE:</i> in chassis form – for vertical or horizontal mounting.</p>

*The Versatile
STUDER B62*

– combining operational simplicity with proven reliability

*F.W.O. Bauch Limited
49 Theobald Street
Boreham Wood
Hertfordshire WD6 4RZ
Tel: 01-953 0091*

All versions available with or without VU-panel

Pye TVT win broadcasting contract

A CONTRACT for a complete television system has been placed with Cambridge-based Pye TVT by the Sultanate of Oman. Under the terms of the contract, a major colour studio centre is to be built at Salalah, capital of the Dhofar region. The studio centre will comprise two main studios and a smaller continuity studio. Eight LDK5 colour television cameras are to be supplied together with telecine, videotape, film and related control equipment. Also in the contract is a colour tv ob vehicle equipped with three LDK5 cameras and video tape equipment. An additional small studio will be installed at the palace of Sultan Qaboos Bin Saiid in Salalah. Four complete transmitting stations will operate on Band Three with a total of six 10kW and two 1 kW transmitters. Completion is expected to take just over a year for the main studio centre and two years for the complete project.

Popular connectors

IDENTIFICATION AND wiring details of commonly used audio, video and mains connectors are given in a 700 x 500 mm two-colour poster produced by University College, Cardiff. 17 connectors are detailed, encompassing XLR, jack, DIN, phono, F & E, BNC, Belling coax, Bulgin, Cannon EP4, 5A and 15A mains. The poster is available at 75p plus 10p post/packing from Centre for Educational Technology, University College, Cardiff CF1 1XL, Wales.

Continuous tapes

THE ELECTRO-acoustics division of Philips Ltd. market continuous cassettes and open reel tapes. The CC3 continuous cassette is 18µ thick, 3.8 mm wide and 9m long, plays for three minutes at 4.75 cm/s and costs £1.25. Unfortunately there are a few drawbacks: it cannot be wound, rewound or turned over, as it is based on an endless loop system.

The cassette is provided with a special lubricant and this makes it necessary to clean the magnetic heads, the capstan and the pressure roller every 20 hours.

The CE10 open reel continuous

tape is 60m long and 6.25 mm wide. It has four record/play speeds: 2.4 cm/s—42 minutes, 4.75 cm/s—21 minutes, 9.5 cm/s—10 minutes 30s, 19 cm/s—5 minutes 15s and costs £3.84.

Our mistake

OUR APOLOGIES to Cresta Electronics Ltd, 72 Loom Lane, Radlett, Hertfordshire, for printing incorrect material in our survey of tape/film synchronisers (June, STUDIO SOUND). In fact the RI, TT1 and CS/2 mark 3 have all been replaced. Their most recent addition to their products is the Carol Cinesound universal synchroniser at £70.50 which includes cables, six pin plug and socket, reed switch and magnet and instruction booklet.

James MacTaggart

THE DEATH occurred on Tuesday May 28 of television drama director James MacTaggart. Mr MacTaggart joined the BBC Scottish Service in 1956 and left the Corporation ten years later. His work included *Candide* and the outstanding *Alice Through the Looking Glass*, the latter shown last December and making extensive use of electronic visual effects.

Capital sell programmes

CAPITAL RADIO are to market programmes worldwide through Richard Price Radio Associates, who up until now have only handled television programmes.

Several commercial radio contractors and overseas stations have approached Capital for use of a number of their programmes.

John Whitney, managing director of Capital said 'London is still the most exciting entertainment centre in the world and we think it makes sense that radio stations worldwide will want to buy programmes that hitherto only Londoners could listen to'.

Contact by 'phone

THE TELEPHONE number of Johnson-Brody (agents for P & N equipment, microphone survey May STUDIO SOUND) is 01-422 1863 or 01-422 4825.

IBA appointments

MR PETER WOODHOUSE, head of copy clearance with the independent Television Companies' Association since 1969, will become head of advertising at the Independent Broadcast Authority when Mr

Archie Graham retires in October. Aged 53, Mr Woodhouse had 13 years on the staff of the Institute of Practitioners in Advertising prior to joining ITCA.

Mr Gerald Margolis has been appointed senior officer (radio) with particular responsibilities for finance and administration. He will assist Mr John Thompson, IBA director of radio, in the origination and development of plans for the commercial radio system now being created under the terms of the IBA Act 1973.

Cassette loader

A DESK-SIZE cassette loader designed to feed tape pancakes into C10 to C120 format cassettes is now available from Electronic Brokers Ltd. Manufactured in Milan by Duplison, the loader/winder incorporates automatic tape tension control, a splicer and vacuum pump. Price is £1,295.

Further data: Electronic Brokers Ltd, 49-53 Pancras Road, London NW1 2QB.

BBC Radio Carlisle increase vhf power

A TWO-STAGE increase in power radiated from BBC Radio Carlisle on 95.6M Hz was completed on May 31 when the permanent aerial at Sandale transmitting station came into operation. BBC Radio Carlisle also broadcast on 755k Hz and, in the Whitehaven and Workington areas, on 1,457k Hz medium wave.

Multichannel ppm innovated by NTP

AN ENTIRELY new form of multichannel audio level display has been developed by the Danish company NTP. Up to 28 channels may be registered simultaneously on a 625 line colour television unit, either a standard tv monitor or a domestic colour receiver. Sync and luminance signals are available on separate lines, facilities being available for coding different channel groups in identifying colours. In the overload range, the bar colours change to red. A high standard of accuracy is claimed for the system.

Further data: N. Tønnes Pedersen A/S, 44 Theklavej DK-2400, Copenhagen NV, Denmark.

Desk-size cassette loader from Electronic Brokers Ltd





Whichever way you look at it, it's great.

The NV3000E/AV colour video cassette recorder produced by Action Video and based on the National Panasonic U-matic standard is now available.

It is compatible with the Sony VO1810 and JVC CR6000 U-matic colour cassette recorders but offers a number of additional features not found on these models. The major difference is that the NV3000E/AV comes complete with a 9" monochrome receiver that gives full off air recording facility in colour. The 9" receiver plugs straight into the cassette recorder via a single lead which carries video and sound to the recorder. A colour detector light on the recorder lights up when a colour input signal is being received. If the set is tuned in the normal way this enables high quality colour recordings to be made straight off air.

The recorded tape may be played back into any conventional colour receiver* from the UHF output of the recorder. Video inputs and outputs are also standard to accept camera or CCTV monitor connections.

Other unique features are automatic colour lock and automatic loading. The recorder is easy to use even by an unskilled operator.

Price is £815, including the monitor, excluding VAT.

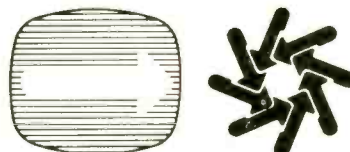

Action Video Part of the Action Group
45 Great Marlborough Street
London W1V 1DB
Telephone: 01-734 7465/7

*If you do not already have a colour set, the National TC85GA is recommended at £365 excluding VAT.

THE FOLLOWING list of Complete Specifications Accepted is quoted from the weekly *Official Journal (Patents)*. Copies of specifications may be purchased (25p) from the Patent Office, Orpington, Kent BR5 3RD.

May 1

1356814 Matsushita Electric Industrial Co Ltd.
Magnetic recorder heads.

1356815 Audio Optic Systems Inc.
Cartridge-loaded motion picture films and their associated cartridges and projectors.

1356843 Dynaco Inc.
Stereophonic sound systems.

1356848 Nippon Victor KK.
Noise reduction system and apparatus using a compression and expansion system.

1356955 Marconi Instruments Ltd.
Signal limiting input circuit arrangements.

1356970 Patelhold Patent - Verwertungs & Elektro-Holding AG.
Method of and apparatus for enciphering information by time-interchange of information elements.

1357047 Licentia Patent-Verwaltungs-GmbH.
Aerial arrays.

1357174/190/229 Sony Corporation.
Colour television receivers.

1357330 Defence, Secretary of State For.
Dynamic silencing systems.

1357349 Southern Communications Ltd.
Tape transport mechanisms.

1357378 Kureha Kagaku Kogyo KK.
Anti-friction member for inclusion in a tape or film cassette.

1357400 International Business Machines Corporation.
Magnetic recording and reproducing apparatus.

1357403 Microtel NV.
Electro-acoustic transducer.

1357427 Westinghouse Brake & Signal Co Ltd.
Inverters.

1357450 Philips Electronic & Associated Industries Ltd.
Transmission systems.

May 8

1357560 Badische Anilin-Soda Fabrik AG.
Tape recorder and magnetic tape cassette.

1357667 Motorola Inc.
Cartridge cassette tape player.

1357684 Singer Co.
Colour television convergence correction.

1357722 Motorola Inc.
Tape head indexing assembly for cartridge tape player including a rotary solenoid.

1357752 British Railways Board.
Communication system.

1357779 Western Electric Co Inc.
Mobile radio systems.

1357808 International Business Machines Corporation.
Image signal reproducing apparatus.

1357860 Sony Corporation.
Tuning indicator.

1357905/7 Minnesota Mining & MFG Co.
Time sharing subscriber communications system.

1357906 Minnesota Mining & MFG Co.
Transmitter terminal.

1357925 Eastman Kodak Co.
Sound transducer.

1357965 International Business Machines Corporation.
Method and apparatus for generating electrostatic images.

1358029 Standard Telephone & Cables Ltd.
Radio receivers.

1358032 Faye, A.
Magnetic tape cartridge dialer.

1358057 Bobb, L. M., and Pond, C. C.
Electrostatic loudspeakers.

1358071 International Computers Ltd.
Display control apparatus.

1358074 Tokyo Electric Power Co Inc and Osaki Electric Co Ltd.
Apparatus for generating pulse dips in a pulse dip carrier system.

1358084/7 International Business Machines Corporation.
Multigap magnetic transducers and methods of making them.

1358168 Philips Electronic & Associated Industries Ltd.
Piezo-electric element and method of manufacturing such an element.

May 15

1358280 Ted Bildplatten AG AEG-Telefunken-Teldec.
Reproduction device for reproducing a signal from a record carrier.

1358315 Nilsson, O. L. E.
Visual display device.

1358317 Licentia Patent-Verwaltungs-GmbH.
Multiple beam cathode ray tube arrangements.

1358355 Ohsawa, T., and Karita, M.
Automatic telegraphy monitoring device.

1358711 IIT Research Institute.
Magnetic transducer systems.

1358712 IIT Research Institute.
Magnetic tape cartridges.

1358751 Philips Electronic & Associated Industries Ltd.
Circuit arrangements for correcting television display errors.

1358766 Matsushita Electric Industrial Co Ltd.
Colour television signal recording and reproducing system.

1358782 Western Electric Co Inc.
Frequency division multiplex communication systems.

1358822 International Business Machines Corporation.
Tape cleaning devices.

1358833 EMI Ltd.
Automatic signal registration in colour television cameras.

1358860 Soc Italiana Telecomunicazioni Siemens SPA.
Variable equaliser for wide band cable transmission systems.

1358981 Birch, R. W. B.
Gramophone pickup guidance mechanisms.

May 22

1359052 Sony Corporation.
Devices and tapes for cleaning magnetic recording and reproducing apparatus.

1359192 RCA Corporation.
Tint correction circuits.

1359233 Blaupunkt-Werke GmbH.
Common antenna television system.

1359356 International Standard Electric Corporation.
Broadcast systems and receivers.

1359365 Philips Electronic & Associated Industries Ltd.
Colour television receiver.

1359509 Scheiber, P.
Decoder apparatus for use in a multidirectional sound system.

1359682 Matsushita Electric Industrial Co Ltd.
Phase modulating devices.

1359700 RCA Corporation.
Simultaneous digital transmission in both directions over one line.

1359710 Nihon Denshi KK.
Method and apparatus for recording signals.

1359825 EMI Ltd.
Duplication of magnetic recordings.

1359833 Nippon Kogaku KK.
Safety device for a normal-to-reverse rotation change-over switch in a movie camera.

1359835 GAF Corporation.
Tone arm automatic reset mechanism for an audio-visual device.

1359854 Ted Bildplatten AG AEG-Telefunken-Teldec.
Pressure pickup for the playback of deformations of a record carrier moved in relation to it.

1359858 Ted Bildplatten AG AEG-Telefunken-Teldec.
Disc-shaped storage medium with groove modulation and process for processing.

May 30

1359927 Soc Industrielle Honeywell Bull.
Apparatus for moving magnetic heads.

1359996 BPB Industries Ltd.
Acoustic or thermal insulation material.

1360411 Columbia Broadcasting System Inc.
Sound reproducing systems.

1360444 Sony Corporation.
Colour television camera.

1360445 General Corporation.
Colour synchronising system for a colour television receiver.

1360501 Matsushita Electric Industrial Co Ltd.
Video image recording apparatus.

1360502 Agfa-Gevaert AG.
Apparatus for use in the reproduction of coloured originals on a colour television receiver.

THE NEW TEAC A3340S

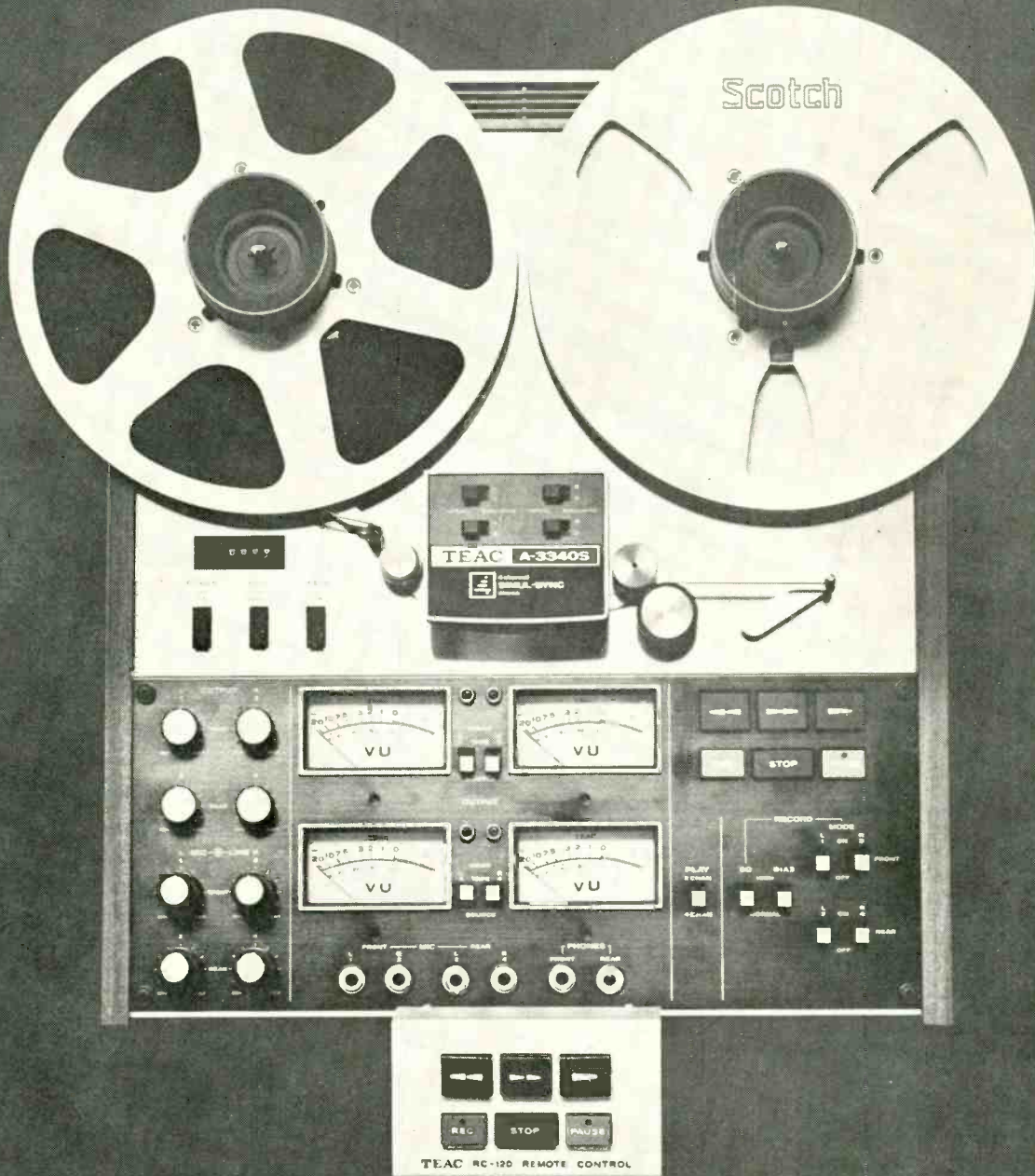

TESTED CHECKED AND SUPPLIED ONLY BY

**TAYLOR
HUTCHINSON
LTD**

105 HIGH STEET ETON BUCKS SL4 6AF PHONE WINDSOR 51403/53014

FIG. 1 Basic encoder circuit block diagram

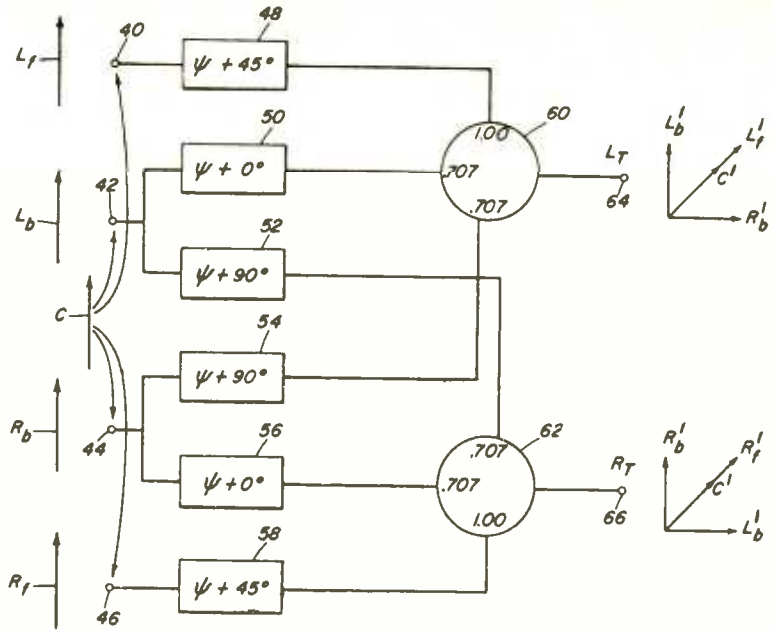

CBS quadraphonics

TWO CBS patents on quadraphonics have recently been published, British Patents 1,347,993 and 1,347,994 apparently covering the basic SQ system. Perhaps the most interesting of the two is BP 1,347,993, which was originally filed in the USA in June 1970. How this priority date and the content of the patent relate to other quadraphonic matrixing patents filed by other parties remains to be seen.

Conventional stereo record cutting techniques are described, as are the techniques for imposing a centre channel (c) on the left and right channels by applying 0.707 parts of the centre signal to each of the left and right channels in additive manner. Also described is the simple technique of imposing a fourth channel (D) by dividing it into equal parts and applying them in phase opposition to the left and right channels. All this, of course, is acknowledged as the old hat that it is, along with the rather more refined technique of taking the D signal and putting it through a phase shift network which splits it into two equal amplitude signals, each containing all the frequencies of the original, but displaced in phase with respect to the other. These simple techniques—encoding in its most basic form—can produce four-channel recordings but separation is poor. The illusion of separation can, however, be enhanced by a logic system which actuates automatic gain control amplifiers to push up the level of whichever channel contains the prominent signal. Just such a logic control is claimed by CBS in BP 1,347,994. A similar technique was suggested by Scheiber in his patents (BP 1,328,141 and 1,328,142).

What CBS are claiming in BP 1,347,993 is a more elaborate technique of encoding which may, if desired (and as in the more exotic SQ decoders), be psycho-acoustically enhanced by logic circuitry operating on automatic gain control amplifiers (presumably as per BP 1,347,994).

As part of the general descriptive matter included in the patent, there is an explanation of how the cutting and playback stylus moves in the groove under the influence of various types of signal and how mono-stereo compatibility is achieved.

In the basic encoder circuit shown in fig. 1, the four input terminals 40, 42, 44 and 46 receive discrete left front (lf), left back (lb), right back (rb) and right front (rf) signals. All these signals are phase-shifted by a reference shift which is a function of frequency and can be ignored in the present theoretical circumstances. The lf and rf signals are each shifted by 45° and the lb and rb are each split into two halves and one half of each split signal shifted by 90°. The lf (shifted by 45°), the unshifted half of lb, and the shifted half of lb are all fed to another summing circuit 62. The signals containing rear information are all attenuated by a factor of 0.707. The two channels LT and RT (one channel from each summing circuit) are now used for transmission, to cut a disc or make a tape. The signals LT and RT are stereo compatible and also compatible due to their horizontal mode components.

Decoding in its simplest form is by the

FIG. 2 Basic decoder circuit block diagram

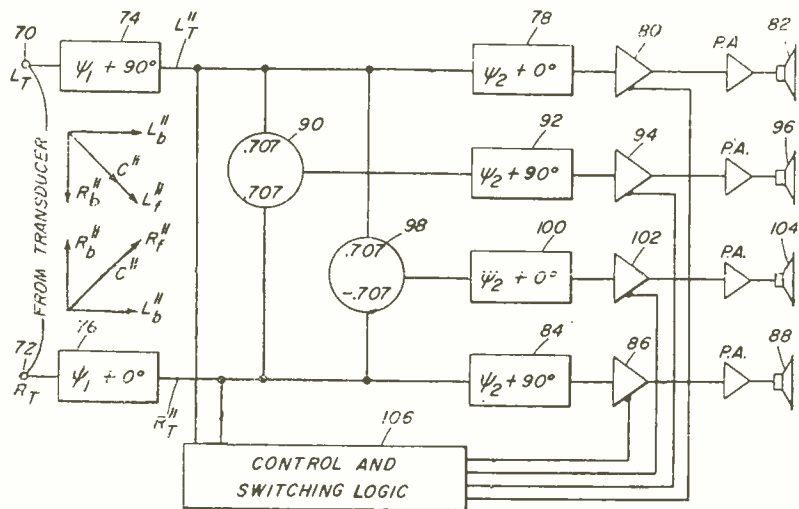

circuit shown in fig. 2. The same reference phase shift is applied to all signals and channels and thus can again be ignored for present purposes. The LT signal (corresponding to the output of the summing circuit 60) is phase shifted by 90° and the RT signal (corresponding to the output from the summing circuit 62) is unshifted. The signals are summed in one summing circuit 90 after each has been attenuated by the factor 0.707 and simultaneously in another summing circuit 98 after multiplication by factors of 0.707 and -0.707. The resultant sum signal is phase shifted by

90°, amplified and fed to one rear loudspeaker and the resultant difference signal from 98 is amplified and fed unshifted to the other rear speaker. Signal LT is fed direct to one power amplifier and loudspeaker, and signal RT is shifted through 90° and fed to another amplifier and loudspeaker. These are the left and right front loudspeakers. Control and switching logic at 106 recognises the channel with the dominant signal and applies control signals to gain control amplifiers which increase the gain of the dominant channel and reduce the other channels to enhance the illusion of directionality.

PATENT DETAILS reported in these columns are usually taken from published patents. Whereas the content of any published patent is free for anyone to read and report (although often, of course, not to put into practice), patent applications are kept secret. It is only where the owner of the patent deliberately releases details ahead of formal publication that they can be published. The National Research Development Corporation have released details of the Patent Application covering the surround-sound system developed by Professor Peter Fellgett of Reading University, IMF and Michael Gerzon. This is very welcome news because, although the system has attracted much interest and many words have been written on its advantages and potential, little if any hard fact has yet emerged on exactly how it works.

Bearing in mind the recent spate of IMF advertisements emphasising the importance of speakers which 'have the same phase relationships throughout the range', it will come as no surprise to readers that in matrix fashion the system codes and decodes by relying on the phase relationships of the signals involved. The inventors have made it clear that they do not regard Ambisonics as a multichannel system but more as a means of encoding the audio environment.

Whereas most coding systems to date seek to encode original discrete channels and decode them to produce as near discrete as possible replicas of the originals, the Ambisonics system is concerned with capturing a whole sound environment, encoding it and decoding it to reproduce the whole on playback. Even so, it appears that this is usually achieved by a tetrahedral array of microphones (rather like a double Blumlein crossed pair), the four outputs of which are encoded into two channels and thereafter decoded to feed four loudspeakers.

The patent specification explains how the NRDC system establishes a reference direction for the microphones placed round the sound

stage. This reference is shown as a line taken from the sound stage centre to some fixed point in the studio. The microphones are placed round the sound stage in positions specified in degrees with respect to the reference direction. For instance, four microphones spaced equally round the sound stage could make 0°, 90°, 180° and 270° with the reference direction.

The signal from each microphone is split into two components, an omni-directional component and an azimuth component. These two components are the same in terms of amplitude and frequency but the azimuth component is bodily phase shifted by a fixed angle with respect to the omnidirectional component. The angle through which the azimuth component is phase shifted is related to the direction from which the microphone was receiving the sound. Because phase shifts are conventionally

measured in degrees up to 360°, the phase shift angle can conveniently equal the angle between the direction of the sound received and the reference direction, i.e. the angle between the microphone in question and the reference direction.

In the diagram, the single microphone is at an angle from the reference direction for the sound stage. The signal produced by the microphone is split and fed unaltered to one output to provide an omnidirectional component and is phase shifted by the angle in a side chain to provide the azimuth component. Where four microphones are used, the angle will usually be 90° for one microphone, 180° for the next, and so on.

All the omnidirectional components are mixed into one channel and all the variously phase shifted azimuth components are mixed into another channel for recording of transmission. Sum and difference techniques can apparently be used to convert these omnidirectional and azimuth channels into a stereo and mono-compatible left and right stereo pair.

On reception or playback, the omnidirectional and azimuth channels are recovered from the left and right stereo pair and the azimuth component channel subjected to various phase shift and inversion techniques to produce a series of signals of progressively shifted phase. These variously phased signals are now combined with the omnidirectional signal in a series of adders. Each combination of the omnidirectional signal with a differently phased replica of itself produces a different result. These results are fed to the various loudspeakers located round the listening area in positions corresponding to the microphones round the original sound source. Thus there should be accurate recreation of the original sound environment captured by the microphones.

The system is reputed to resemble in many respects that proposed by Duane Cooper in the USA.

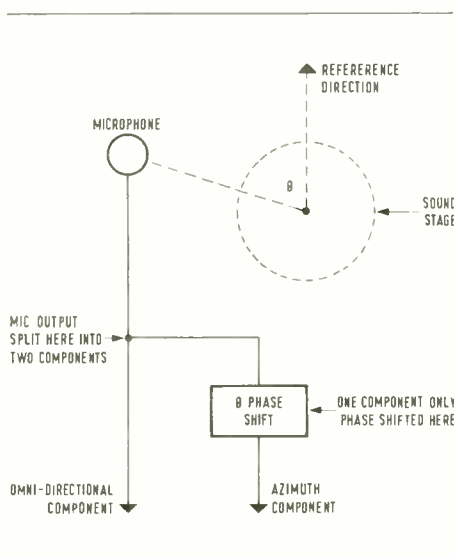

HIGH PERFORMANCE P.A. AND STUDIO MIXING CONSOLES.

Per Input Meter, Mic/Off, Gain, 3 band Eq., Echo Send, Reverb Send, 2 or 4 Foldback Sends, PAN, PFL, Fader.

Other Standard Facilities Talk back, internal Reverb Unit, Echo Return (with Eq.) Reverb Return (with Eq.) Headphone Monitoring of Foldback Channels, PFL of Echo, Reverb, Inputs, Tape output, Cannon Sockets per Channel plus Multipin Connector, Arm Rest.

10 into 4
15 into 4
23 into 4

£906
£1183
£1577

31 Station Road, London SE25 5AH
Telephone: 01-653 6018/8483.



Gritty-nitty. Complaints and rumours of complaints about noisy record surfaces . . . again. Can't they grind those old unsold records down a bit smaller, or try taking the labels off first? It would be nice to know what is going on before sales fall off in line with reducing product quality.

Up, up and outasight. The steady increase in the price of basic materials has been given another push by the addition of eight per cent on semi-fabricated aluminium. The recent announcement by Alcan will be reflected in the price of 'circles', the discs which take a plastic coating to make blanks for disc cutters. Alcan are the only suppliers in the world making circles with acceptable flatness tolerances. Oh well, just a few more pence.

Investment. Very good news that Shell and ICI are to build a multimillion petro-chemical complex in the North East to produce plastics in the styrene group. This is the base material for cassette and cartridge carcasses, spools and the like. On stream in three years says one report . . . if they can get the steel to erect the plant which needs the oil to make the stuff.

Silly question. If you have to pass an examination to get an internationally recognised certificate to operate as an amateur broadcaster what do you have to do to be a professional? (BBC Training Department please ignore.)

Black joke. Did you hear the one about the man in the bar at the Speakeasy who said to this other man, 'Have you tried that new studio yet?', and quick as a flash this other man says 'No, I'm waiting for the auction'. (We do not wish to know that. Kindly leave the page.)

Where's the point? The USA is not to go metric for at least ten years says the House of Representatives. A significant decision for us in the record industry. The US is our biggest market, followed by Japan, which follows the US example in all things to do with recording. Perhaps we had better stick to the NAB curve and go on cutting to the RIAA spec after all. (EBU to you—Ed.)

Pressing problem. Is any research going on into possible alternative materials for making gramophone records? We cannot expect to know what but a slight hint at it might be a comfort.

Troubled waters. BBC Records hope to release will three lps on the BEEB label in the autumn which contain tracks by such artists as Simon Garfunkel and The Sweet. The tracks have and been derived from *Top of the Pops*, *In Concert* and *Show of the Week*. Negotiations are going on to sort out contracts with the record companies and to decide who pays what and to whom and if it can be done at all. While

all licence holders will applaud the BBC's efforts to earn revenue, could it not be said that this sort of operation is taking work away from recording studios? Was there not an understanding once that the BBC would not use their special position to do this? Have the recording studios a right to complain anyway? Tricky one this but the fact is the BBC must earn extra money to maintain the service demanded by the public or the licence fee will have to go up. The BBC's efforts to earn money are increasingly successful and rightly so. However, it is one thing to derive tracks from sound and tv shows, quite another (but a perfectly fair and logical step) to mount a show with the intention of producing a commercial record. Recording studios could find Auntie offering some pretty stiff competition before very long. What might happen as a result of the coming revision of the BBC Charter gives food for thought. But then it is not only the BBC; some of the ITV companies produce commercial records and a few of the commercial radio boys have active plans to do the same. Will there soon be too many production facilities chasing too few recording jobs for which there will be too little plastic to press the records? Too gloomy a view? Almost certainly because the appetite of the record buying public is insatiable, provided they have the money and the gramophone record, on average, is still very good value. Even so the independent recording studios will do well to see they get their fair share of the production market.

Quote. Robert Stigwood may soon be seeking a quotation on the USA Stock Exchange. He says 60 per cent of RSO's business is in the USA and it seems likely to rise to 75 per cent in the near future. Deserved success and good news for all concerned.

Legge up. Elizabeth Schwarzkopf (Mrs Walter Legge) has been awarded the *Grosse Verdienstkreuz*, Germany's highest civilian honour, by President Dr Heinemann. Congratulations to a world-famous singer whose purity of tone is only matched by her physical beauty, and she is an absolute sweetie to record. Husband Walter, founder of the Philharmonia, stalwart of the Classical Repertoire Department when the 'His Master's Voice' plum label was still unobscured by the impersonal EMI logo, is one of that all too rare breed of record producers who know exactly what they want and precisely how to get it. There are those who say the recording business has never been quite the same since Walter left Manchester Square.

Tax. The effect on studios of the new tax regulations introduced by the last national budget are not altogether clear. Not direct tax, that is clear enough, but the alteration in arrangements to tax overseas residents in Britain and overseas earnings. The business gets a lot of bookings from overseas, directly

from visitors, indirectly from overseas producers and artists resident here. The film industry has already been hit by American producers, directors and artists packing up and going home. How are our own nationals to be affected? Will it no longer be convenient tax-wise to record overseas? If so, perhaps studios will be no worse off, on the swings and roundabouts principle. Isn't it grand that, under British law, we are all innocent until proven guilty except in the view of the Inland Revenue who take exactly the opposite opinion.

Matter of record. Dennis Basinger, dedicated sound man, who joined the BBC in 1947 and left to join ATV in 1955, eventually becoming controller of Elstree Studios, has been appointed to the Board of ATV Network Ltd. Dennis has had a lot of influence on the maintenance and improvement of sound quality in tv in spite of the frustrations of flybutton-sized speakers fitted to the average telly. Well done DB! It couldn't have happened to a nicer bloke.

Gas attack. To add to the troubles caused to the record industry by the shortage of pva/pvc comes the revelation that the manufacture of pvc presents a health hazard. The culprit is the feed stock vinyl chloride monomer, a gas which has been proved to cause liver cancer. How serious a problem this may be has yet to be established but the USA authorities, always commendably prompt in such matters, have already charged into action. If, as is reported, vcm can be absorbed in the diet (in 'harmless quantities') by eating pvc-wrapped food, it would be comforting to know what steps the record-pressing factories take to ensure protection for their operatives. Of course this sort of report should not be allowed to develop into an out-of-proportion scare story. Nobody is suggesting that anyone handling an lp is likely to drop down dead. Does it not seem though that industry as a whole, incorporating many inevitably dangerous processes, has for far too long treated the human element as expendable. Humans have a rapid and cheap self-replacement rate, which machines don't. Would it be fair to think that trade unions and management might spend a little time to greater benefit on in-depth welfare, and that doesn't mean sports clubs and day-trips, rather than eternally squabbling over money and worrying about balance sheets.

Stereo tv? On the very latest tvr machines the conventional mono sound track has been split into two parallel tracks. Is it possible the day will soon come when we will enjoy stereo sound with our telly? Will they be building sets like those lovely radiograms, a long box with a ducky little speaker at each end which is supposed to give a sound like stereo, and even sometimes does . . . twice as bad as mono. But we mustn't be rude about tv sound (again). It is certainly not the studio engineers' fault.

A SELECTION FROM OUR WIDE RANGE OF MICROPHONE STANDS

THE STUDIO SERIES

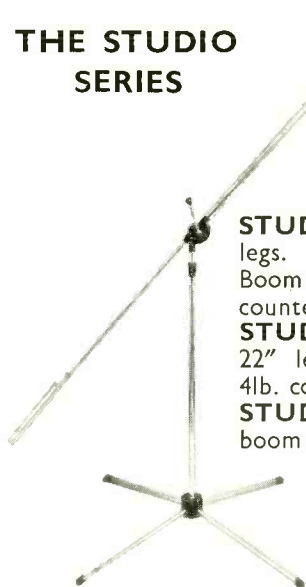

STUDIO 1. Stand with four 14" legs. Height extends to 6' 10". Boom arm 6' 6" long with 2lb. counterbalance.

STUDIO 2. As above but with 22" legs and boom arm, with 4lb. counterbalance.

STUDIO 3. As above but with boom arm 4' 6" long.

DB I

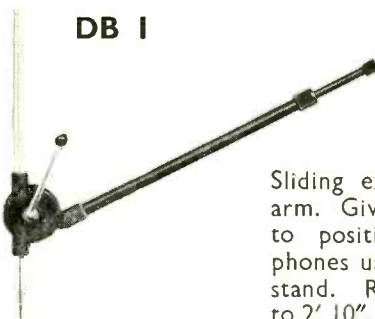

Sliding extension to boom arm. Gives a 360° coverage to position other microphones using the one boom stand. Reaches from 1' 8" to 2' 10".

EXT I



BOOM EXTENSION

Fits into tube end of boom to give a telescopic extension of an extra 3' 2".

KEITH MONKS (AUDIO) LTD

26-30 READING ROAD SOUTH · FLEET · HANTS

Telephone: Fleet (02514) 7316 and 3566

Alice . . . is BROADCASTING



AM 82/B SELF-OP MIXING DESK

SYSTEM DESIGNERS/MANUFACTURERS OF BROADCASTING
& STUDIO EQUIPMENT

Alice (STANCOIL LTD.) 38 Alexandra Road, Windsor, England.

Tel. Windsor
51056

The BBC Transcription Recording Unit have been recording high-prestige stereo for more than a decade to satisfy world demands, and is now issuing quadrasonic recordings to overseas radio organisations in discrete or matrixed form, according to the practical needs of the broadcasters. The recent Radio Three stereo production of Shakespeare's 'The Tempest' was produced by Ian Cotterell of BBC TS. How, at the same time it was made in quadrasonic, is told by the Production Engineer Adrian Revill.

The Tempest

'THE TEMPEST' is a play which seems well suited to radio: full of music, magic and strange phenomena the essence of which we believed could be conveyed in terms of sound and a production conceived for quadrasonic, could exploit the new medium and enhance the listener's appreciation of the play.

The music was to be composed by David Cain, who was at the time working in the BBC Radiophonic Workshop. He had specialised in writing music for radio drama and was extremely enthusiastic about the possibilities of quadrasonic. When the producer, composer and I met to start planning the recording, there began a close collaboration which lasted throughout all stages of the production. The first step was to record the music which was to be an almost continuous element in the play. Caliban comments that 'the isle is full of noises, sounds and sweet airs', and for much of the production there is very quiet musical background to the speech out of which emerge the definite cues and set pieces such as Ariel's songs and the Masque sequence of songs and dances.

The music was written for an unusual combination of electrically amplified instruments: electric piano, harpsichord, bass guitar, Hammond organ, with vibes, xylophone and a large collection of percussion instruments and was recorded in the Conway Hall London; a small concert hall with the sort of reverberation which seemed appropriate for the material. As it was written for quadrasonic, the natural approach seemed to place the instruments, or at least their loudspeakers, around a circle; so a chalk circle about 8m in diameter was drawn on the floor, the instruments positioned and in the centre a quadrasonic microphone cluster was set up.

The simplest microphone arrangement for recording quadrasonic is, of course, four almost coincident cardioids with their axes at right angles in a horizontal plane and we used such a cluster of Neumann KM 86s. Previously we had found that this arrangement can produce unbalanced and diffused quadrasonic, but here we were able to get the musicians to adjust their individual volumes to give a balanced sound at the circle centre, while the ambience and spread was just right for most of the music in its context. We also close microphoned all the instruments and fed their outputs, suitably grouped, to the remaining four tracks of our eight track recording machine to enable the perspective, level and position of instruments to be altered, where necessary, at a later remix. The backing of Ariel's songs was recorded on this session but the singing of Ariel was tracked on during the speech sessions. For their singing of parts in the Masque, the three singers in this session used close microphones fed to individual tracks.

The music backgrounds and much of the music in the set pieces was improvised by the musicians. David Cain had managed to assemble a group of players from jazz and classical backgrounds and the unusual elements in the music, in the recording and in the layout contributed to a remarkable atmosphere on the session with everyone enthusiastically piling into the tiny control room for a final playback.

A month or so after the music recording, we were due to record the play in Studio One, Kensington House and in the meantime thought was given to how we could achieve some of the effects required by the producer. Our mainten-

ance engineers had improved our original experimental ten channel quadrasonic mixing desk to take four quadrasonic pan pots and a quadrasonic source shift control and we were to make good use of this equipment at all subsequent stages for monitoring and remixing. Among the unusual effects called for was an attempt to convey the impression that the voices on the ship were spinning round as the ship sank. It seemed that the most direct way of doing this was to suspend the quadrasonic microphone cluster in such a way that it could be rotated. The purchase of several yards of knicker elastic from a local haberdashery ensured that the spinning effect could be achieved by tugging on one corner of the microphone array—and it also provided a good anti-rumble suspension. I thought that the most approach to record the speech would be to employ a quadrasonic microphone cluster—with perhaps other mono microphones if required.

Although it may be possible to get more definite positioning by using panned mono microphones, even radio actors need some freedom of movement for full expression. To require them to take up a static position and have the engineer supply movement by electronic panning would impose unacceptable limits on their performance. Also we knew that if the moves were to be achieved by electrical panning on a remix, a considerable amount of time would be needed and different perspectives are difficult to obtain. It is normal practice to spend some days rehearsing in studio when recording a major radio drama and we were able to use this time not only in rehearsing the cast and plotting their moves but also experimenting with different microphone arrangements and with varieties of echo and effects for certain scenes.

Record and play

It proved possible to record the play using four microphones in the cluster and four extra mono microphones; thus the track feeding arrangement was simple, eight microphones to eight tracks. We recorded speech only on these sessions but added the echo effects and some music to the quadrasonic monitoring in the control room to give the producer an idea of the production. During recording nothing was played into the studios but we had at rehearsals provided the actors with feeds of stereo and quadrasonic music for timing and atmosphere. Most of the action of the play was recorded on the quad cluster with the actors taking up their positions and moving according to the producer's concepts. The studio floor had been marked out with two concentric circles divided into quadrants to remind the actors of their positions but after a while they seemed able to act quite freely around the sound stage without getting too worried by exact positions.

Many of the best results were obtained by the most authentic performance; for instance when Caliban falls flat to hide under a gaberdine, the most effective way to get the sort of sound expected proved to be when the actor did just that and moaned into the studio carpet to produce a remarkable muffled sound. Similarly there is one point at which the king, Alonso, rushes off towards the sea. We opened the studio doors and he ran, shouting, right down the corridors to achieve a spectacularly realistic exit—fortunately it was Sunday and the building was almost

empty. However, there are certain problems the cluster technique does not solve. It proved necessary to use separate microphones for 'asides' and the close perspective on these was used, with suitable positioning in the quadraphonic picture, to suggest characters who on the stage are overheard only by the audience. Prospero also needed his own microphone for he has asides and talks very privately to Ariel, sometimes almost in the same breath as when he is addressing others—so we needed to use his microphone on remixing to point these differences to the listener. Ariel is also a problem in any radio production of 'The Tempest', he is a spirit who is never seen by anyone except Prospero yet affects a lot of the action. We tried to suggest his hovering presence by putting quadraphonic echo on his whispered conversations and moving his voice around quite a lot in his songs. For both the speech and the singing, a Pop vocal microphone AKG D1200E was found to be the best, fed to an individual track.

There are not a lot of spot effects in the production and these were usually achieved by the spot effects man standing behind the appropriate actor to draw his sword or rattle a chain or so in the usual radio drama way.

Recording the speech in the studio took no more time than would have been required for a stereo production and it did not prove particularly difficult technically. The actors soon got the idea of quad microphone techniques and entered enthusiastically into the spirit of recording in what was, to them, a new medium.

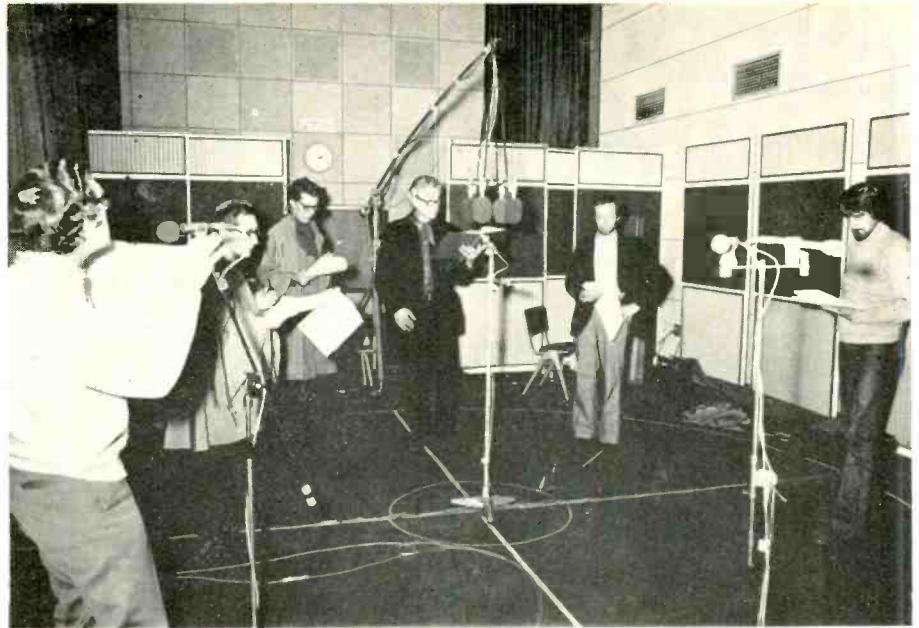

Ronnie Stevens (Ariel)

Timothy Bateson (Gonzalo)

John Justin (Alonso)

Paul Scofield (Prospero)

Charles Kay (Sebastian)

Michael Spice (Antonio)

Some of the cluster's disadvantages became obvious during the sessions; there is no dead area where unwanted noise, be it a discrete cough or a rumbling stomach, cannot be heard

and the studio acoustic is exaggerated in this arrangement. Quadraphonic drama requires a studio with a very dead acoustic, extremely quiet air conditioning and excellent sound insulation. When we had finished recording the play, the long tape assembly job was started. We decided to build up an eight-track master tape consisting of four tracks of quadraphonic speech and four of music and effects, which could then be reduced to discrete quadraphonic, stereo or any requested matrixed form, but which could be balanced differently as required to make the best of each medium.

The eight track speech tapes were edited and then, with such echo and perspective effects as needed (achieved by standard drama techniques using plate and tape echo) reduced to the top four tracks. The music was reduced to the other four tracks of the same tape to synchronise with the speech. At some points in the play where music cues speech, the order of operations was reversed and generally the operation was further complicated by the music requiring an intermediate mix because it overlapped with itself or with one of the set pieces—thus it was necessary to reduce to two lots of four tracks and then to remix these to the final four on the master tape. The music tracks are also mixed in with effects and these presented several problems. The BBC sound effects centre has a huge stock of effects recordings, but almost all of them are mono, some are stereo but none are quadraphonic. We were able to synthesise the quadraphonic from stereo effects by using long tape delays which worked well for continuous sounds, such as wind and rain.

For further effects such as thunder claps and the creaking of the ship's rigging, the mono sources had to be panned around, from side to side, to suggest the desired effect.

The storm scene proved the most difficult, we were trying to synthesise all the effects sources into a very dense texture to combine with several layers of voice effects to make the wreck seem as realistic as possible. It proved necessary to

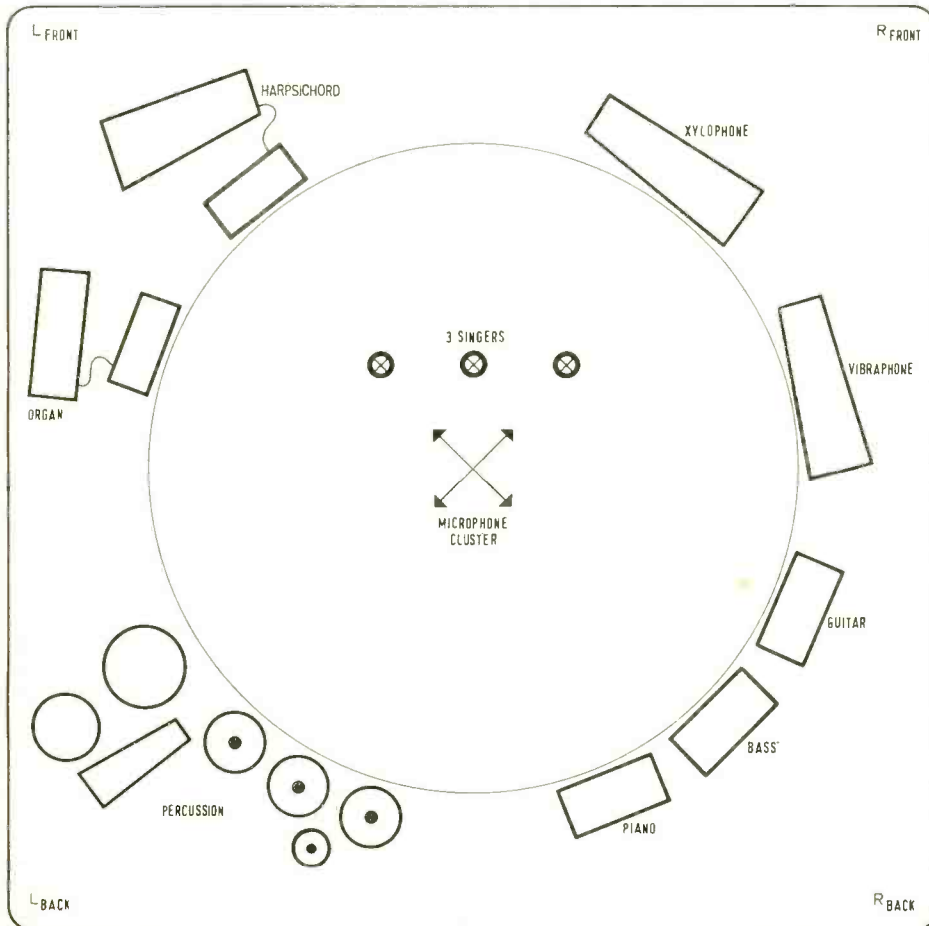

■ THE TEMPEST

compress the speech tracks so the words could still be heard above the confusion but the total effect seemed to be successful. For after the playback, one critic reported feeling drenched at the end of the scene.

Making up the eight-track master tape was a long and painstaking job which required accuracy of timing and a clear plan of operation at each stage. But in contrast it only employed two eight-track machines and some relatively simple mixing equipment. The equipment used was a combination of radiophonic workshop's stereo desk, used to derive echo feeds and track equalisation, several stereo tape machines and TRU's quadraphonic mixer and Dolbys. (All tapes were Dolby processed at each stage because we realised that at least three generations of dubbings would be required before the final product.) Like all such arrangements the lash-up was cumbersome but very flexible. Finally the master tape was reduced to discrete quadraphony (a mixing job which proved more exacting than anticipated) and then reduced separately to stereo for the Radio Three transmission copy. The quadraphony was technically compatible but some changes were artistically desirable (for instance in a scene where one group of characters are in front and another group at the back, in the collapsed stereo they all appeared in one spot and for the stereo transmission it seemed sensible to re-group them to the left and to the right.)

'The Tempest' was probably the first Shakespeare play to be recorded in quadraphonics and was certainly an exciting venture which, I think, proved worthwhile. The production was planned to involve the listeners in the drama, with action taking place all around him—for this is the unique advantage of the medium—and it makes a very enthralling, if demanding, listening experience.

Unsolved problems

There are of course many problems still to be solved and some simple practical details are difficult to get used to; for instance usually only the balance engineer can sit in the ideal listening position on a session which makes playing in tapes difficult for an operator who cannot exactly hear the effects of his fading or panning and again the producer has to wait for a playback of each section to hear the full effect of his production. This is not necessarily a disadvantage, since during the recording the producer is more likely to concentrate on interpretation and performance rather than techniques. We were not experimenting only with quadraphonics on this production—the application of multitrack techniques to radio drama is also a new field and one which could give major benefits to stereo drama.

'The Tempest' is perhaps unusually well suited to experiment; it has been described as an 'extraordinarily obliging piece of art' but it is hoped that it is only the first of many attempts to use modern recording techniques to benefit communications of the spoken word. To quote, in a different context, from the new Penguin edition's introduction: 'Shakespeare's play is virtually unique in that it is a complex and sophisticated work of art, the product of a simple mind, which, complete and inviolate in itself is a kind of matrix for further creation'.



Above: Ronnie Stevens (left) and David Cain (right) recording the vocal track for 'Where the Bee Sucks'.



Above (left to right): David Cain, generator electrician, Adrian Revill, Tom Tranter (technical assistant) and Gerry Hennecky (secretary).

Below (left to right): Ian Cotterell (producer), John Justin (Alonso), Paul Scofield (Prospero) and Jane Knowles (Miranda).



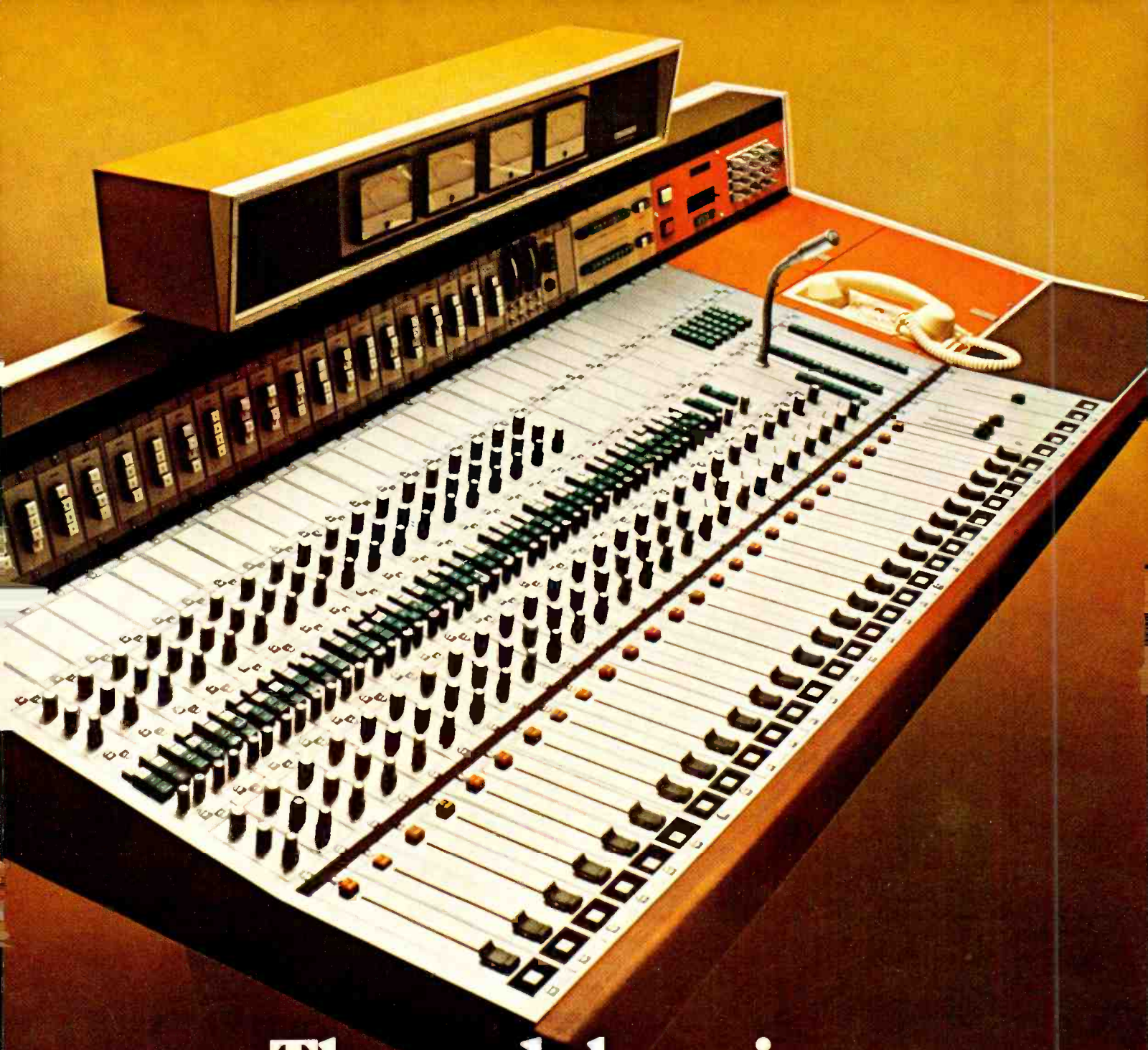

The modular mixer

Take a good look at this mixer. Under that eye-catching console is a system that reflects the technical expertise gained from years of experience in the studio sound business.

Here, at last, is a mixer tailor-made to your requirements, but costing no more than a standard production model.

It's the Schlumberger UPS 4000, giving you real state-of-the-art technology at your fingertips. Fully modular, with plug-in units made of die-cast aluminium alloy to ensure highest accuracies, it's the system that has everything – integrated circuits, field-effect transistors, printed circuit cabling.

And modularity means you get the facilities you need now . . . with the flexibility you could need later.

Just specify your system requirements, and leave the rest to us. We custom-build the mixer *you* want. At a price you can afford. With filters, reverberation, foldback and much, much more.

Find out about this new concept in studio mixers. Contact Schlumberger, now.

Schlumberger

Schlumberger Instruments and Systems, 296, Avenue Napoleon Bonaparte,
02500, Bruix, Malmaison, France, Tel. 077 02 23 46, Telex Labophy 286540

Test Material: Sennheiser Dummy Head Stereo Record 2. Recording made with Sennheiser Triaxial Stereo Microphone *MKE 2002* in conjunction with Stellavox Stellamaster *SM7* recorder; to be reproduced via open headphones such as Sennheiser *HD 44*, *HD 111*, *HD 424*.

'A MARVELLOUS party game!' is how my wife sums up this record. We have been testing people's reactions to this 45 rpm disc (available from Hayden Laboratories Ltd, Hayden House, 17 Chesham Road, Amersham, Bucks HP6 5AG, price 77p including p and p and VAT). The record is designed to promote interest in a particular technique of stereo recording, aimed primarily at headphone users, and consequent interest in Sennheiser headphones and the special *MKE 2002* microphone and dummy head system.

In recent months Sennheiser have aroused a little stir in various quarters by their revival of an old idea for stereo recording, using microphones separated by a dummy head, in this case to improve realism of reproduction for headphone users. Indeed they have gone a stage further by suggesting that the recordist will obtain the best results by using his own head to separate the microphones. One has a mental picture of that recordist, unbreathing and unflinching throughout a symphonic recording. To this end they have produced the *MKE 2002* electret microphone unit, which looks like a pair of small microphones mounted on the ends of a stethoscope headset. Sound quality is more reminiscent of a domestic moving coil microphone than a good electrostatic—but, to be fair, the microphone is aimed at the amateur market.

Enough of that. The record is apparently the result of a number of location recordings using the head of the dreamy lady on the sleeve (who could be using a Uher, though) or a suitable dummy substitute, like the one standing in front of her, who goes back a year or two. There are five bands on the first side, and two on the second; the latter two are music, the first five a variety of everyday situations. The record sleeve comes complete with diagrams of what the actual situation was like (in the horizontal plane) and the blurb says that you can hear all these sounds 'exactly as at the place of the recording'. To me this implies quite definitely that sounds coming from in front will be heard from in front, those from the side from the side, and those from behind from behind; it also implies that one may have the sense of a sound source passing overhead or below one, in other words true periphonic reproduction.

The idea behind the system, for those not already familiar, is that the left ear gets what it would have in real life, i.e. sounds from the left, plus sounds from the right, suitably delayed and modified according to frequency. So the brain can go through its normal processes of comparing the arrival times and



modifications of frequency in order to decide where the sound came from; the same process happens on the right-hand side of course. On the face of it, it seems an obvious way of overcoming at least one of the objections many people hold against headphones: that it is very difficult for the majority of people to get images from in front of them when listening via headphones; some indeed say they cannot localise the sounds at all, others hear them all coming from behind or above. Readers will surely be familiar with their own associations of headphone stereo. There have been various attempts in the past to introduce crosstalk and phase shifts to overcome these problems, but with limited success, at least commercially. If this system works, and is compatible with loudspeaker reproduction, it would be an attractive way of recording for both kinds of reproduction.

There are various other objections to headphones, such as the sound moving when you move your head, but these may be no worse than loudspeaker images moving with seating position; and it is possible to get over the feeling of claustrophobia that some people experience by using what Sennheiser term

open-air headphones (ones with the lightest of pressure on the ears and which do not seal the user from his surroundings and any room noise).

In order to test the effectiveness of the system (not necessarily of the principle, of course), a number of people were invited to listen to the record and to record where they heard whatever they heard. My own impressions are included in the table. None of the listeners had seen the diagrams before they heard the recording for the first time, though obviously with some of the sounds there would be preconceived expectations associated with the sound. In most cases listeners heard the record twice, and sometimes more. As time was a limiting factor it was not possible to go more deeply into the experiments than we did. Also, as no Sennheiser headphones were supplied for the evaluation, we made do with *AKG K50* headphones minus the rubber ear pads (these give very little sound insulation without the pads). To see whether the exclusion of room sounds affected localisation, several listeners tried the headphones with the rubber pads as well, and also tried *K60* which give rather better insulation as supplied. There was no apparent difference in ease, or otherwise, of locating sounds; one of the panel did however insist on removing the phones very quickly when the rubber pads or *K60* were used, as he felt claustrophobic with them on.

A comparison of Sennheiser's illustrations with the sketches produced from our panel's impressions is interesting, in that it shows how very differently people hear the same sounds. It should in fairness be stated that listener G is hard of hearing (but not deaf) in the right ear; it was felt interesting to include the results, however.

Band One is set at an airport arrival lounge. Two speakers approach from left and right behind the recordist and meet just behind his ears, then swap sides, talking into the other ear. There are general arrival-lounge noises, and a telephone rings. Almost everyone got the 'right' image of the two main characters. Three heard airport sounds 'all around them', four from behind, only two noticed the telephone. Replayed through loudspeakers, the two people appeared to approach the respective loudspeakers, then do a dramatic swop at the appropriate moment. The telephone rang nearly at the right speaker. There was no apparent extension of the sound stage beyond the speakers.

Band Two had an aircraft flying over the recordist diagonally from rear right to front left. Two heard it 'correctly', one heard it approach diagonally from behind, then fly away diagonally behind on the other side (a dramatic right-angle turn!); three heard the aircraft fly over them from right to left, one heard it fly overhead from behind and straight ahead. In loudspeaker stereo, the aircraft appeared to approach from beyond and slightly outside the right speaker (listening fairly

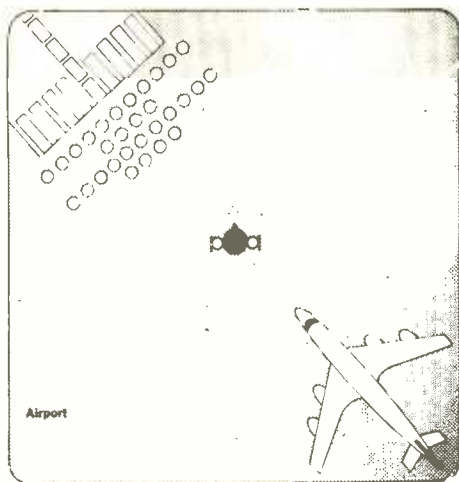

BAND 1

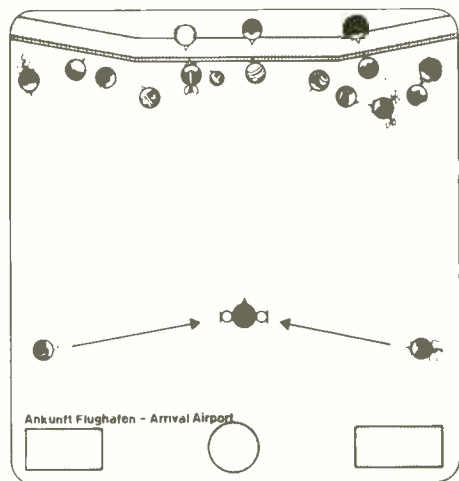

BAND 2

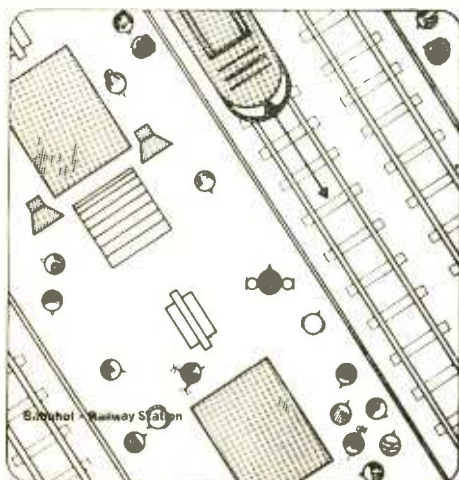

BAND 3

centrally) and flew off to the left in a similar way. There was no reported sensation of height.

In Band Three the train approaches diagonally from the left, with general station sounds and a station announcement. Two people heard the train pass in front of them left to right, but one of them subsequently changed his location of the sound and felt the train pass left to right behind him. Four people heard the train pass left to right behind them; G heard it approach from behind as though he were on a railway bridge and the train passed underneath. No one heard the train move 'correctly' in a diagonal path. Two people localised the loudspeaker announcement as coming from the left and slightly behind; G heard it from above and slightly left; the other three could not localise it. Via loudspeakers, the consensus was that the train approached diagonally from the left, with station noises and announcements vaguely in between the speakers.

Band Four is recorded in a telephone kiosk, and almost everyone immediately recognised the 'feeling' of being inside a small booth. Everyone heard the telephone earpiece at their left ear but there was more difficulty over the coins going into the box. Four heard the coins going in behind them, to the right; two could not localise the sound at all; G heard the coins in front. Two people heard the door distinctly behind them (it is not marked by Sennheiser), two could not locate it, one did not hear it, one heard it vaguely behind, one heard it vaguely to the left. On speakers, the earpiece appeared at the left, the door vaguely central and the coins at the right.

In Band Five, one hears a shower from behind left, a man calls from front-right, a girl in the shower answers, runs forward and dives into a swimming bath from front left and swims to the right across the bath. Three heard the girl swim across left to right, in front of them, three heard her swim left to right behind them, G heard her swim from in front diagonally to the right; five heard the shower behind left, one at the left and one behind; six people heard the man call from the right, or slightly forward of right, G heard him call from behind. In loudspeaker stereo, shower and girl were heard from behind the left speaker, the man from behind the right; in all cases the splashes as the girl landed in the water were heard in the appropriate position for the rest of the impressions.

Side two, which should have been easy, was much more difficult. Indeed it took so many replays to get any results that listeners D and E did not get a chance to record their impressions, and any attempt to make sense of the loudspeaker image was abandoned in the case of the first band.

In the first band of the side, a choir's conductor speaks first and moves around while talking; the choir then number-off in military fashion, clockwise from behind the recordist, and the choir then sing *Il est bel et bon*. Two listeners who had come most nearly to hearing all the right sounds so far could not localise the images, saying they came from 'all around'. C heard the conductor move in a semicircle behind, from right to left, and return to the start; numbering began from full right, went

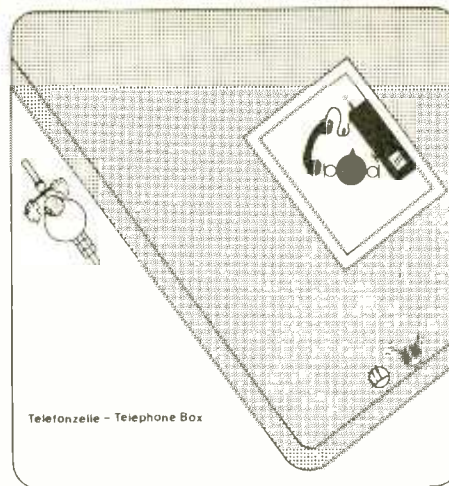

BAND 4

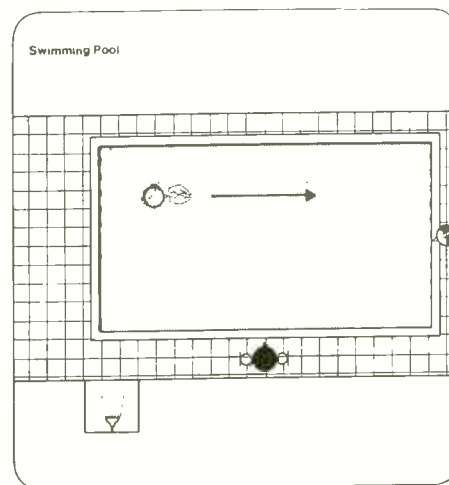

BAND 5

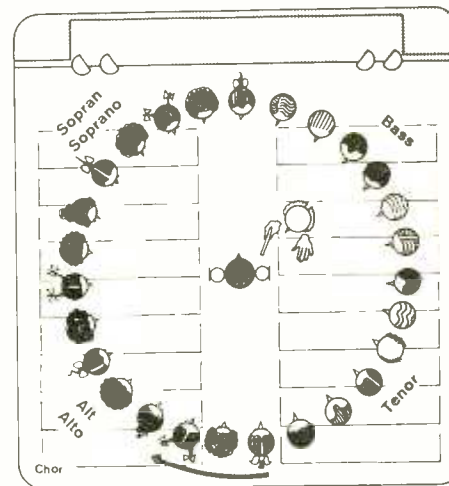

BAND 6

A	B	C	D	E	F	G	NORMAL LS STEREO

= LISTENER FACING ↑
 = LOUSPEAKER
 T = TELEPHONE
 --- GENERAL NOISES
 A = AIRCRAFT
 LS = STATION ANNOUNCEMENTS
 T = TELEPHONE EARPIECE
 C = COINS
 D = DOOR
 S = SHOWER
 X = SPLASH
 G = GIRL'S VOICE
 M = MAN'S VOICE
 C = CONDUCTOR'S VOICE
 N = CHOIR NUMBERING OFF
 SATB = POSITION OF VOICES
 B_j = BANJO
 W = WASHBOARD
 DB = DOUBLE DR STRING BASS
 G = GUITAR
 V = VOICE
 P = PIANO

PLAYBACK

round to full left, returned part of the way and ended by approaching C from behind-right, where the conductor also appeared. The choir were confined to the rear quadrant in the order SATB from the left. F heard conductor and numbering start from behind-right. The conductor went as far as full left; the numbering continued to front-left and back, moving in on its way back behind the listener to close-to, behind-right. The choir were in a rear quadrant when singing, though. G had great difficulty. The conductor moved anti-clockwise from the left; the choir were variously heard numbering from the left and from the right, always ending well to the rear. Their singing voices were heard SATB clockwise from in front. The loudspeaker image, as I said, was hopelessly inconclusive, nobody hearing it the same way twice.

The final band was a skiffle group, placed close in front of the recordist. Only one listener heard the group in front, one heard the group 'all around', three heard it behind, and the location of the instruments was fairly nebulous once the music really started. The plotted images look about right, though, apart from being behind instead of in front. The loudspeaker image was approximately correct, left to right in front, but some instruments were impossible to localise.

Conclusions

The sample was small and no hard and fast

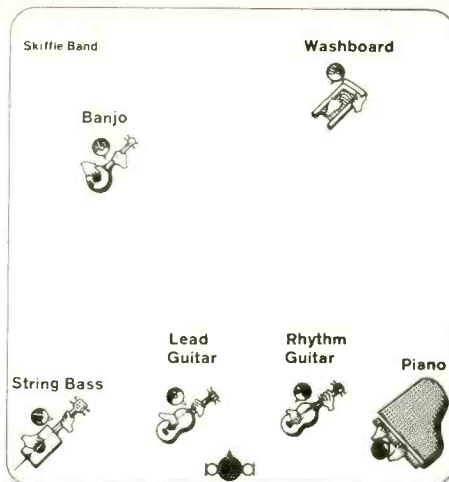

conclusions should be drawn from these tests. It does seem, however, that where one places sounds recorded in this way (or at least using this microphone system in this way) will vary considerably from one individual to another.

On the plus side, there appeared to be an improved sense of ambience, without the sound ever approaching that using a discrete four-channel recording and reproduction system—more like that obtained, using speakers, with the addition of rear speakers carrying a difference signal derived from the front channels; not exactly the same, but more like that than quadrphony. Of course the sound

moves with the listener's head. There also appeared to be some chance, with some listeners, of hearing sound from in front as well as behind.

On the debit side, compatibility with reproduction via loudspeakers does not appear particularly good—I would hardly expect it to be with slightly spaced microphones separated by an acoustic obstacle and with a polar response which must look a bit funny. The problems seem particularly bad with sound sources close to one or other microphone.

As a final test, two of us listened in between two loudspeakers placed approximately 3m apart; the results were hopeless. In the choir item, for example, if one moved one's head 25 mm during the numbering-off, the position of the sound could change completely from one side to another, and there was a strong front bias. The overall effect was very indeterminate and, after many attempts and a great deal of time on that exercise, it was abandoned as a possible way of satisfactory reproduction via loudspeakers. Indeed I am hardly surprised that it didn't work, but it was worth the try.

The idea is fascinating. I think the test pieces were well chosen and the results are interesting. I cannot say I find them altogether convincingly in favour of the system. If Sennheiser seriously want to sell the idea of using this method, then at least the public should be treated to less coloured sound than the *MKE 2002* appears to produce on this recording. But at 77p its entertainment value can hardly be bettered. John Fisher

CHRISTIAN BROADCASTERS

Radio Production Techniques Summer School, Tyndale House, Cambridge. September 2 to October 5 1974.

Don't miss this unique opportunity to increase your skills in the whole field of Sound Broadcasting. Especially those working overseas or in small studios who need to draw upon a wide range of skills and have a first hand understanding of their own and their colleagues problems.

DEVELOP RADIO SKILLS under professional guidance and with special reference to the needs of Christian personnel engaged in programme production. There will be three full-time lecturer/tutor/demonstrators. Visiting lecturers are drawn from professionals of distinction in their various fields. The cost per person is £220 inclusive of full board, all facilities and outings. A limited number of partial bursaries are available. List closes end of July.

Organising Committee: Rupert Neve. Metcalfe Collier. Chris Rees. Michael Rees. Geoff Watts.
Council of Reference: Rt. Rev. R. A. K. Runcie, M.C., M.A. Rev. Stephen Olford (U.S.A.). Rev. Michael Griffiths. Peter Cousins, Esq. Morgan Derham, Esq.

Basis of Curriculum

- 1 Theological principles involved in the use of mass media; asking the right questions.
- 2 Theory of communication; advantages and limitations of the media; broadcasting with a Christian ethos; religious broadcasting.
- 3 Administration: Budgeting; costing; staffing; casting; unions; copyright; marketing; relationships with governments and big business; publicity.
- 4 Material: Researching; Archives; Libraries; Radio journalism; interviewing; radiophonics; script writing—ideas, criteria, forms; Drama; documentary; feature.
- 5 Programming: the balanced programme; keeping it alive; the outside broadcast; types of programme—new formats.
- 6 Operational Production: Style; directing various types of programme; stereo production; the voice; sound effects; preparation; timing; integration; editing.
- 7 Equipment: theory and use of microphone, mixer tape machine, turntables, cartridge machine; monitoring and talk-back; stereo theory; special effects; acoustics.

Write NOW for details to: Summer School on Radio Production Techniques, 111 Cecil Road, Enfield EN26TR

**SOMETHING REVOLUTIONARY,
SOMETHING A LITTLE REVOLUTIONARY
...AND SOMETHING YOU CAN BETTER
PUT YOUR FINGER ON.**

ALL FROM



**JH-110 TRANSPORT AND ELECTRONICS
SPECIFICATIONS**

REEL SIZE: 3" to 11 $\frac{1}{4}$ "
TAPE TENSION: 4 oz., Supply and Take up Servo Controlled—Constant All Speeds and Reel Sizes
CAPSTAN DRIVE: Phase Locked D.C. Speed Variable 5 to 45 I.P.S. or 2.5 to 22 I.P.S. Dependent on Capstan Diameter
FIXED TAPE SPEEDS: 3 $\frac{3}{4}$, 7 $\frac{1}{2}$, 15, or 7 $\frac{1}{2}$, 15, 30 (dependent on capstan diameter)
FLUTTER AND WOW: .05% DIN at 15 I.P.S.
START TIME: .2 Seconds at 15 I.P.S. on 7 $\frac{1}{2}$, 15, 30 I.P.S. Capstan
REWIND TIME: 85 Seconds for 2,400 Feet
FREQUENCY RESPONSE AT 15 I.P.S.: Reproduce: 30 Hz-16KHz \pm 2 db; Cue: 30 Hz-16KHz \pm 3db; Record: 30 Hz-16KHz \pm 3 db
SIGNAL TO NOISE (30 to 18 KHz): 2 Track Reproduce: 62 db Below +4 dbm; Cue: 60 db Below +4 dbm; Record and Erase Less Than 4 db Noise Added to Bulk Erased Tape
DEPTH OF ERASE: Greater Than 75 db Below 0 VU
ELECTRONICS DISTORTION: Less Than .1% THD at 1 KHz, Less Than .2% IM 60 and 6000-4:1
INPUT: Level -15 to +24 dbm for 0 VU Impedance 10,000 Ohms Balanced
OUTPUT: Level +4 dbm for 0 VU, Source Impedance 50 Ohm Balanced Maximum Output at Clipping, +24 dbm
EQUALIZATION: 3 Speed NAB Internally Switchable to CCIR
BIAS AND ERASE FREQUENCIES: 120 KHz
BIAS ADJUSTMENT: Separate Bias Adjustment for Each of Three Speeds
RECORD HEAD-ROOM: Greater Than 20 db at 1 KHz at 15 I.P.S.
CUE: Switches Automatically to Input When Entering Record
POWER REQUIREMENTS: 100V-220V Selectable 50-60 Hz. Current Requirements for 120V Operation, 4 Amps.
HEIGHT: 35"
WIDTH: 25 $\frac{1}{4}$ "
DEPTH: 26"
SYSTEM WEIGHT: 190 Pounds

REVOLUTIONARY: That's the word for the JH-110 series quarter- and half-inch recorder, which we believe is the most sophisticated recorder of its type (available in mono, two- and four-track models). With a simple switch change, it can be operated on any-type electrical source in the world. Check out the specs for yourself, and we think you'll agree the JH-110 series *is* revolutionary.

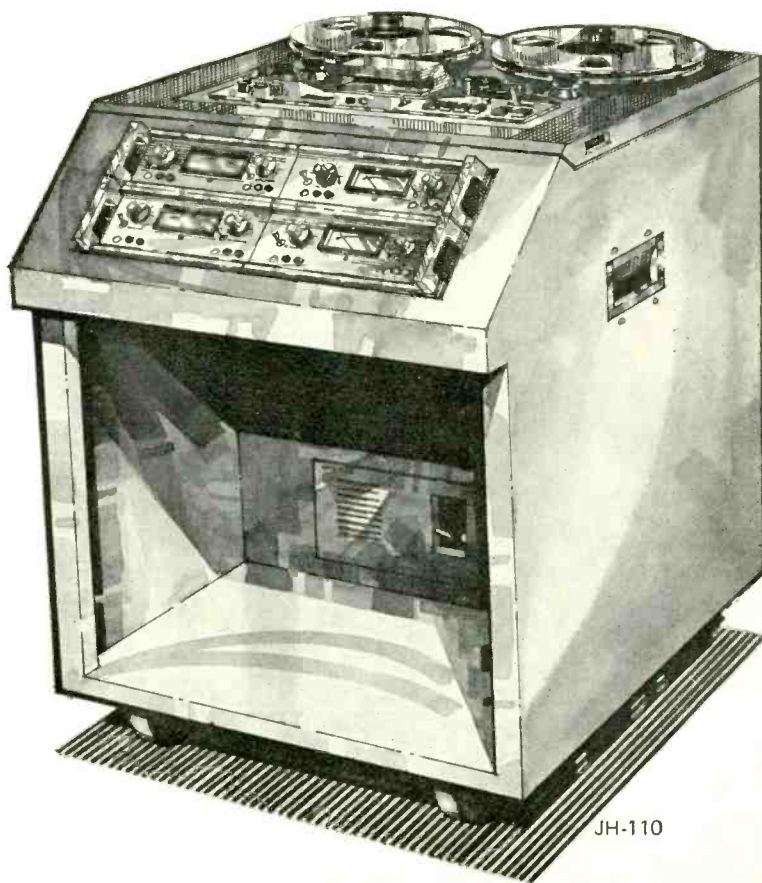

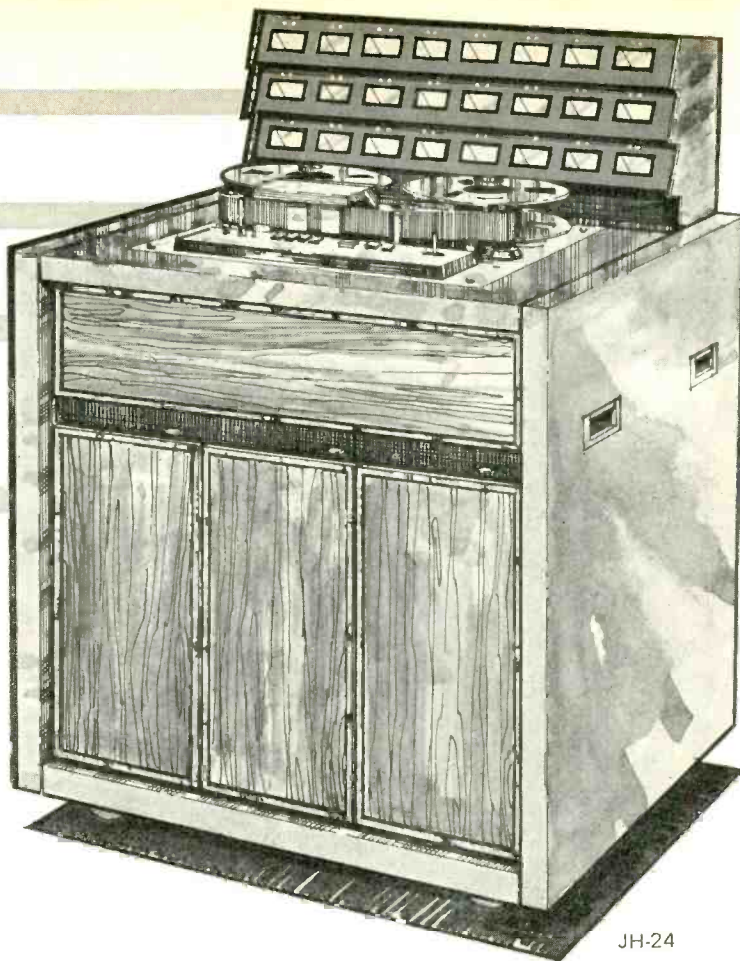

JH-24

A LITTLE REVOLUTIONARY:

Why "little"? Because we slimmed down the width of our JH-24 cabinet from 47" to 31½"—making it MCI's first 24-track recorder in a 16-track-size cabinet (and if you don't need the full 24-track capability now, you can buy an 8- or 16-track configuration and add the rest later, using the same cabinet). The JH-24 accommodates 14-inch reels, and, with newly added handles and oversize casters, boasts greater portability.

SOMETHING YOU CAN BETTER PUT YOUR FINGER ON:

After exhaustive field surveys, MCI learned that most fingertips are rounded, not square—so we responded to this anatomical revelation by replacing the square master status, record ready and cue buttons with round buttons, and adding a record LED on our remote package. So much for *that* pressing problem.

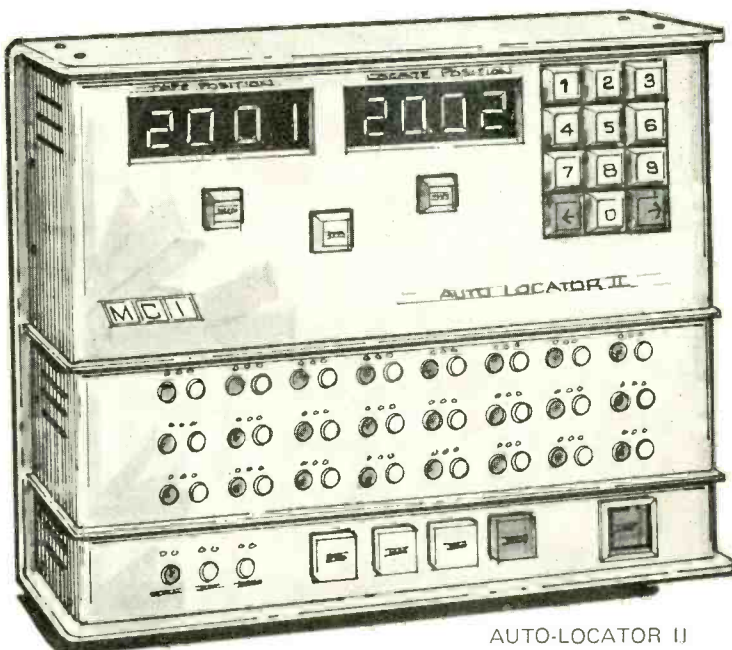

AUTO-LOCATOR II



Feldon Audio
126 Great Portland Street
London, W1
ENGLAND

N. V. Delta Equipment
Rue de Calevoet 112
1180 Brussels
BELGIUM

Roger Arnhoff Studios
St. Olavs Gate 26
Oslo 1
NORWAY

Roger Barth KG
2 Hamburg 76
Adolfstrasse 45
GERMANY

Remote control of tape machines permits greater control room flexibility. This practical design relates specifically to the Revox 77.

Constructing a Revox remote control

ANGUS ROBERTSON

FULL REMOTE control of the Revox 77 is a relatively easy matter to arrange. Basically, switches are connected in parallel with the control switches in the Revox where the connections are brought out on the 10 pole socket at the rear of the chassis.

The connections for the switches are shown in fig. 1. The forward wind, rewind and record buttons are press to make, release to break (in order that two buttons need to be pressed to go in to the record mode) while the stop button is a normally closed type. Also available from the remote control socket is a supply of +27V on terminal 7, the common connection between the wind buttons being earth.

Complications arise

So far the circuit has been quite straightforward. Complications arise only when it is desired to use lights to indicate the function that the Revox is operating in. After the button has been released, there is no indication on the remote box of the selected function. When the machine stops at the end of the tape, it is also useful if this is indicated.

In the logic that controls the operation of the motors and solenoids, there are only three relays to control the four functions, their operation being locked by diodes. A simplified diagram showing part of the logic is shown in fig. 2. Most of the electronics forming the photoelectric end of tape sensor are omitted as are a number of relay contacts concerned with the solenoids in the play/record return to earth circuit. However the basic operation of the relays can be followed. If the play button is pressed, relay RLA energises and is locked on by contact RLA 1. When the stop button is pressed, the locking circuit is broken and the relay falls off. When record and play are pressed together, both RLA and RLB are energised and locked. When the rewind button is pressed, RLB locks on and if either RLA or RLC were energised they would fall off since the power to both is shorted to earth. A similar situation occurs when the forward button is pressed, RLC being energised.

To operate lights on the remote control box we must be able to sense a voltage change on

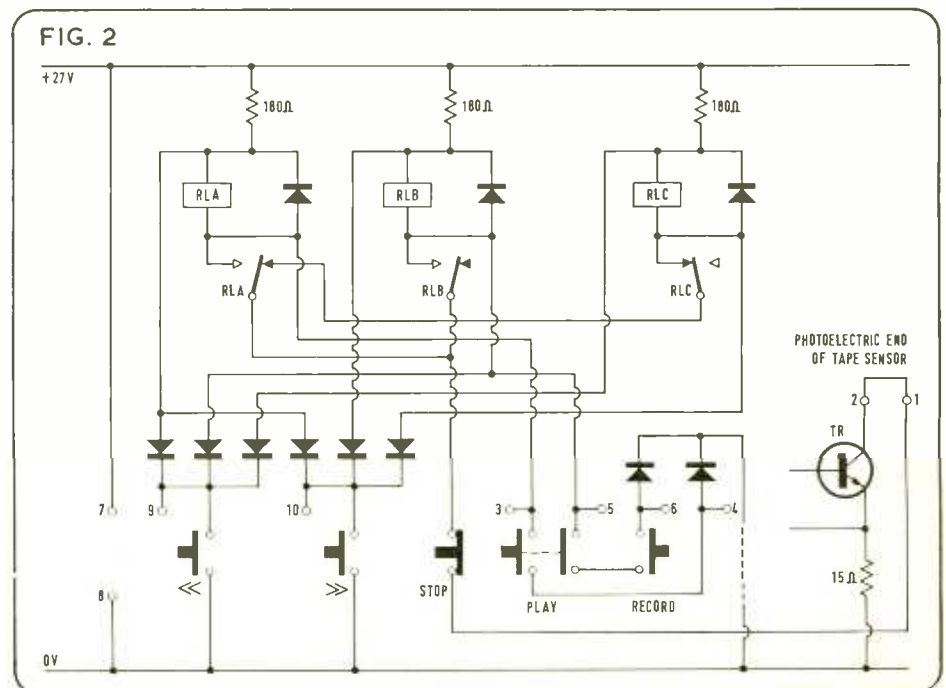
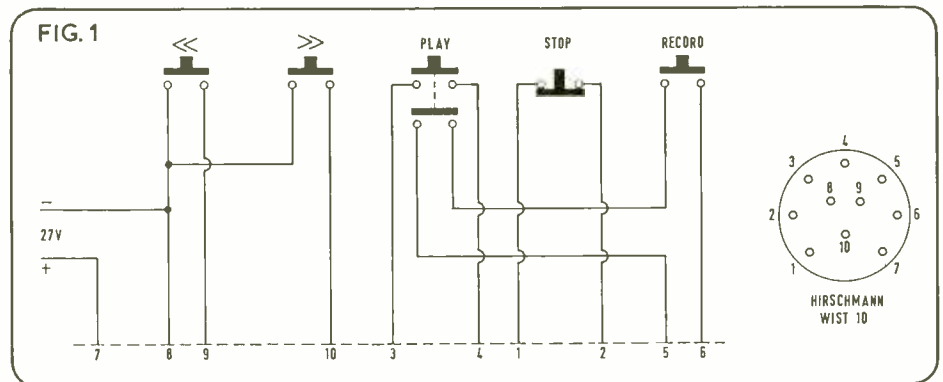

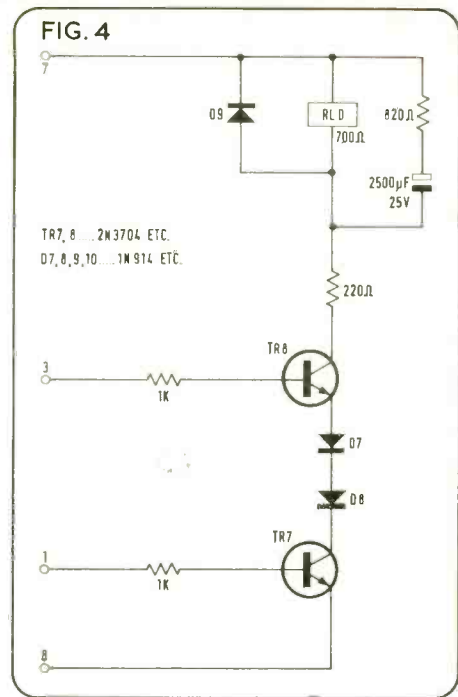
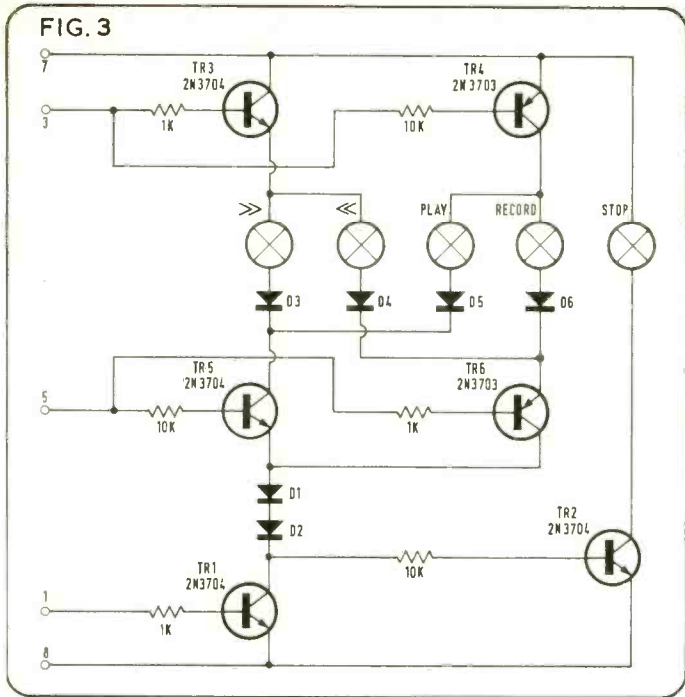

the terminals extended to the box. This is so in the case of play and record terminals 3 and 5 respectively. However, the wind buttons are not much help since the diodes form an efficient gate, ensuring that there are always positive volts on terminals 9 and 10 no matter what the state of the relays. We can now tell whether the machine is recording or playing but not if it is stopped or winding. It is possible to determine whether or not the machine is running from terminal 1. If the relays are all off there is only a very small voltage on terminal 1 due to the resistance of RLC but when a relay is energised current flows through the transistor and 15Ω resistor in the photoelectric circuit. The voltage drop is now higher and the difference can be easily sensed.

Table 1 shows the various voltages on the three terminals during the five modes. It can be seen that it is logically possible to recognise all five modes.

Final circuit

The final circuit is shown in fig. 2. Q1 determines whether the machine is running or not. If terminal 1 is low (500mV) the transistor is turned off and Q3, 4, 5, 6, are disabled. Q2 will however be turned on and indicate stop. Now if the volts on terminal 3 are high (27V) Q3 will turn on enabling either rewind or forward to illuminate depending on whether Q5 or Q6 are turned on. If terminal 5 is high Q5 will turn on and current will flow through Q3, D3, Q5, D2, D1, Q1 to earth, assuming that Q1 is turned on as it ought to be in the forward mode. Thus the rewind light will illuminate. The other modes are similar, Q4 and Q6 turning on when the voltage on terminals 3 or 5 respectively is low (3V). Diodes D3 to 6 provide isolation between the bulbs. D1 and D2 raise the Q3 to 6 turn-on voltage sufficiently for them to operate on the low signal voltage of 3V.

This voltage arises in the first place from the photoelectric circuit dripping volts.

Other problems

Another problem that arises with the Revox is its use in inexperienced hands. If the machine is fast winding (either way) and the stop button is pressed, the tape slows down to a halt, the time taken depending on the size spools in use and the velocity of the tape. But once stop has been pressed, as far as the logic is concerned

the machine is ready to function in another mode. If the play button is now pressed, the brakes will be released and the pinch wheel will move up with the result that, if the tape is still moving, it will tend to spew on the floor and wrap itself around guides. The tape is usually creased, if not broken or stretched, invariably the most important part of the recording. Naturally the experienced operator appreciates the problem and waits for the tape to come to a halt. This problem is more apparent when using the remote control box, presumably because of the lack of contact with the machine.

To overcome this, a delay has been built into the remote control box which disables both play and record for a short period after a fast wind which enables the reels to slow down.

Now assume the machine to be winding. The play button is pressed. The tape will slow down to a halt and, after a short delay, will automatically start to play. This simplifies operation because the stop button does not require to be operated. If stop had been pressed the machine would of course have come to a halt. However, the play button could be pressed while the tape was still moving and there would then be a delay before the machine automatically starts in play. The above will only occur when the play button on the remote box is pressed; the machine's play button will not operate straight into play—stop must be pressed first.

This facility has not been provided with record because I do not believe it necessary. Usually when going into record it is useful to know the precise second this will occur; this is not so when using the delay. Of course the circuit could easily be modified to accommodate this facility.

Referring to figs. 4 and 5, a fast wind is detected by Q7, D7, D8, Q8 which work in a similar way to Q1, D1, D2. They are repeated to avoid overloading T1 which does not operate

TABLE 1

	Terminals		
	1	3	5
Stop	0.5V	27V	27V
Record	1.7V	3V	3V
Play	1.7V	3V	27V
Rewind	1.7V	27V	3V
Fast Forward	1.7V	27V	27V

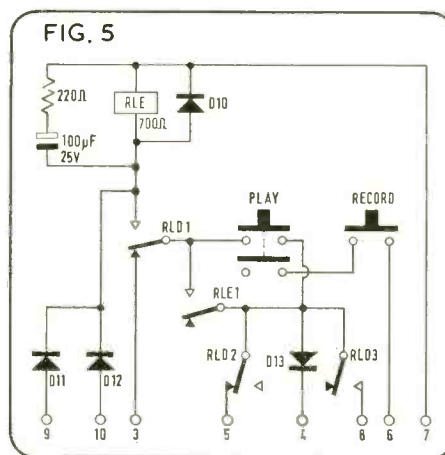

REVOX CONTROL

correctly when loaded. Q8 switches on when 27V appears on terminal 3.

Again assume the machine to be winding. The relay RLD (to avoid confusion with the relays in the Revox logic) then operates. The 2,500 μ F capacitor then charges up through the 820 Ω and 220 Ω resistors. Relay contacts RLD1 and RLD2 are normally closed types in series with the play and record switches respectively. These will disable play and record when RLD operates as the machine goes into wind. Now, if the play button is pressed, D11 and D12 will short all three relays in the Revox logic to earth via RLD1, RLE1 (which locks on as the play button is pressed) and RLD3. The machine thus stops. Q7 now turns off but RLD stays held on by the capacitor which now discharges. This causes a delay during which the machine is disabled. When the charge on the capacitor falls to zero, RLD falls off and reconnects terminal 3 to the play switch. The 100 μ F capacitor now holds RLE on for a fraction of a second. Thus RLD1 will break before RLE1 and the resulting pulse operates the machine into the play mode. D13 prevents RLD3 having any effect on the play button on the machine because it would be shorting out the logic circuitry that normally prevents play or record being operated while the machine is winding.

A suggested colour code for the multicore cable is shown in Table 2.

TABLE 2

Brown	1	Blue	6
Red	2	Violet	7
Orange	3	Grey	8
Yellow	4	White	9
Green	5	Black	10

The delay before the machine operates in play will depend to an extent on how long the capacitor was charging up for. Thus if the machine had only been winding for a few seconds, there would only be a short delay because the capacitor would not be charged up fully. If the machine has been winding for more than 10 seconds, the delay will be approximately 3s. The values chosen for this circuit provide suitable delays for the writer's Mk3 Revox A77 when using full metal NAB spools. These values might require altering for other machines and this is a matter of personal preference. While experimenting with the delay, it is recommended that an old strong tape be used.

If only small cine spools are used on the machine, a shorter delay will be more practical and a smaller value capacitor could be substituted. If both types of spool are regularly used, two capacitors could be provided together with a switch to select the one appropriate to the spools in use. This was not carried out on the prototype because of lack of space in the Eddystone box, which incidentally is packed tighter than sardines.

As pointed out earlier, the switches in the Revox will not perform the new functions of the remote box. However there is no reason why

FIG. 6

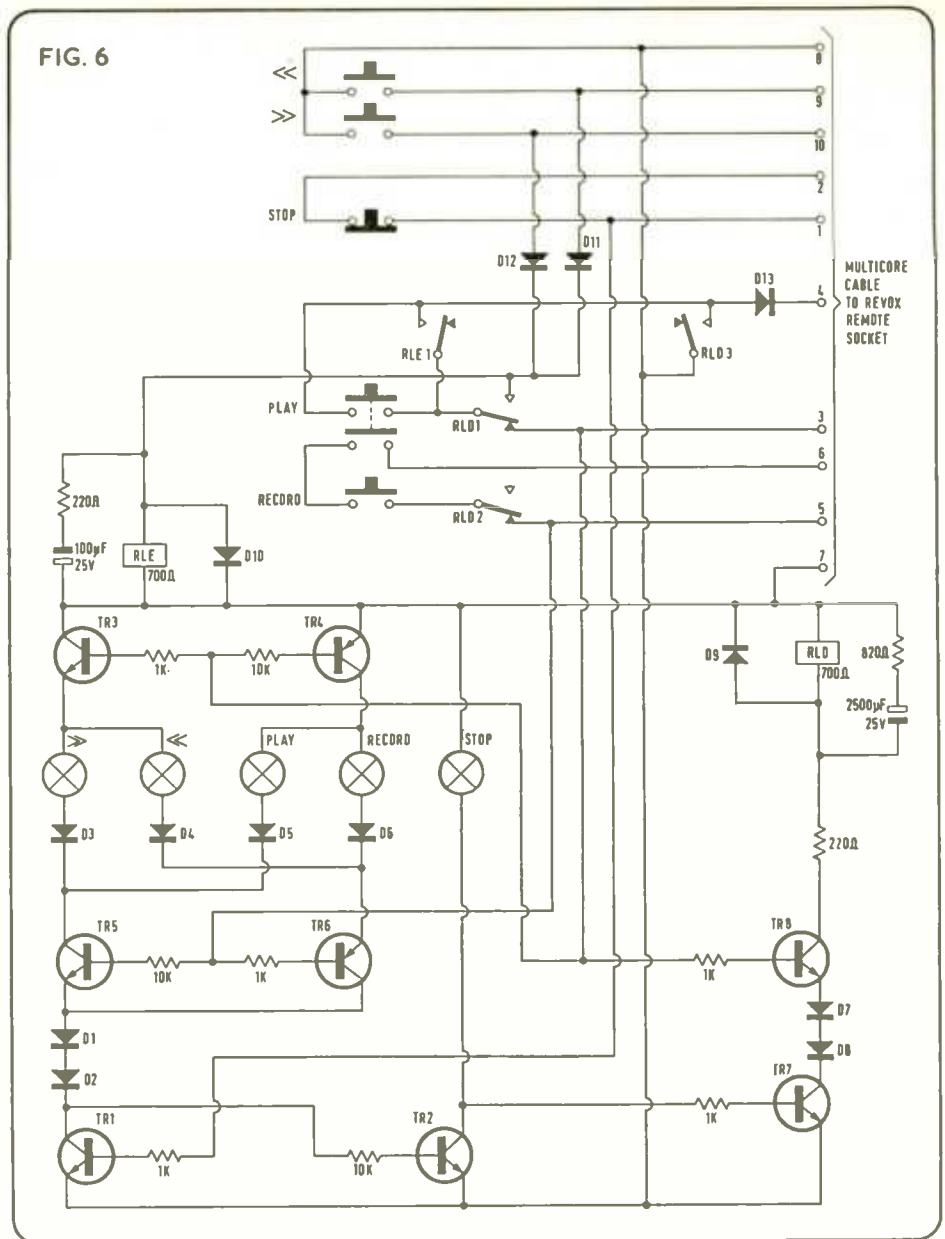

the circuits of figs. 4 and 5 should not be built into the Revox itself. Two tracks on the printed circuit board would have to be broken in order that the relay contacts could be installed in series with the switches. A better system than that described would be a detector to determine that the tape is moving and I hope to work on this soon.

It should be pointed out that the Revox brakes will last much longer if the wind is reversed to slow down the spools before stop is pressed. The delay is built in to take care of the worst case of treatment. Fig. 6 illustrates the total circuitry.

Complementary transistors

None of the components is critical. The transistors may be any complementary types (2N3703 and 2N3704). The diodes are small silicon (1N914 or 1N4148). The only problem

is likely to be the switches. It is preferable for them to be self illuminated with an internal light. RS Components Ltd have recently added a range of illuminated push buttons to their catalogue. TMC also produce a suitable range. If possible, use different colour lens caps for the various functions. The prototype used red for record, green for play, clear for stop and amber for the two winds. Finally, if all else fails, separate switches and lights could be employed. 24V bulbs were used in the prototype but there is a 220 Ω resistor in series with the stop light to reduce its brilliance with a clear lens.

The electronics can be built on a small piece of matrix board or veroboard, the layout not being critical. The whole set-up can be installed in a small Eddystone box, approximately 115 x 75 x 65 mm depending on the choice of switch. Alternatively it could be built into the mixer.

WHO'S WHO IN SOUND

RUPERT NEVE

Anyone who is anyone in sound knows, if professional audio control and distribution equipment is to do its job, only the best is good enough. They know what they want. The highest standards of quality and reliability and technical performance as near the theoretical limits as possible. Plus the fact that Neve equipment is custom built to individual requirements and tailored to fit neatly into limited studio space. Naturally it all goes to produce a very impressive list of Neve customers.

Here's a list of some of their 1973 customers:

Radio and TV: RTV Romania; Link Electronics; B.B.C.; Marconi; Granada Television; Radio Luxembourg; Tyne Tees Television; Damascus Radio; HTV Ltd.; Radio Telefis Eireann; Greater Manchester Radio; Gospel Radio Fellowship; HSV7, ATN7, ATVO, Australia; B.F.B.S. (British Forces Broadcasting Service); R.T.V. Singapore; Yorkshire Television; Capital Radio; Ampex; Rediffusion; London Weekend Television; I.B.A.; Radio Sofia; Nigerian Broadcasting; United Evangelistic Church; WGBH; WRMF, Encounter Ministries; KBYU; KHOF TV; WSM; WBZ; CBC.

Theatres: Royal Opera House; Congress Hall, Bucharest.

Communications: Pye Business Comms.; Fernseh GmbH.

Film: Shepperton Studios; Felix Acaso; Pinewood Studios; Consolidated Film Industries; Imperial War Museum; Zaar Films.

Recording: J. Albert; Metronome Records; Preview Sound; R.C.A.;

Radio Triunfo; C.T.S. De Lane Lea; Federal Records; CBS-Sony, Japan; Cockatoo Sound; R.G. Jones; Music for Pleasure; Pye Records; Weir Sound; Polydor; West of England Studios; Maritime Studios; EMI; Festival Records; Bavaria Atelier; Arne Bendiksen; Gallo; Belter Records; Carbo; Elliot Mazer; CBS Records; Decca;

Iyanda Records, Nigeria; Multi-Media; Creative House; Caribou Ranch; Eastman Kodak; Harcourt Brace; His Masters Wheels; PAC Inc.; Sound City; Track Recorders; Whitney Recording; Griffith Gibson; Les Productions Paul Baillargeon; Marc Productions; Mercey Brothers; Jeff Smith Interchange; Linkage Sound; Studio Marko; Studio 3; Intervideo; Mahogany Rush; Sound Toronto; Chatham Square; Neil Young; Belafonte Enterprises; Air Studios.

Universities and schools: Syracuse University; University of Surrey; Plymouth Polytechnic; Yale School of Music.



Neve internationally sound people

Rupert Neve, Cambridge House, Melbourn, Royston, Herts. Telephone: Royston (0763) 60776. Or Cambridge (0223) 53454. Telex 81381.
Cables Neve Cambridge. 2719 Rena Road, Malton, Ontario L4T 3K1, Canada. Telephone: 416 677 6611. Telex 0696 8753.
Berkshire Industrial Park, Bethel, Connecticut 06801, U.S.A. Telephone: (203) 7446230. Telex 969638. Hollywood Office: Telephone: (213) 465 4822.

Survey : dc/ac converters

GARDNERS TRANSFORMERS
Christchurch, Hampshire BH23 3PN.
Telephone: Christchurch (02015) 2284.

107A
Input: 11 to 15V dc.
Output: 220 or 240V ac nominal.
Wave: Square.
Frequency: 50 Hz \pm 1 Hz.
Power: 300 VA.
Efficiency at rated load: 80%.
Weight: 13 kg.
Size: 240 x 210 x 215 mm.
Price: £67.

107D
Input: 24V dc.
Output: 220 or 240V ac nominal.
Wave: Square.
Frequency: 50 \pm 1 Hz.
Power: 400 VA.
Efficiency at rated load: 80%.
Size: 240 x 210 x 215 mm.
Price: £85.

107B
Input: 22 to 30V dc.
Output: 220 or 240V ac nominal.
Wave: Square.
Frequency: 50 \pm 1 Hz.
Power: 300 VA.
Efficiency at rated load: 80%.
Weight: 13 kg.
Size: 240 x 210 x 215 mm.
Price: £67.

JERMYN
Sevenoaks, Kent.
Telephone: Sevenoaks (0732) 50144. Manchester (061) 832 8124.

150
Input: 12V dc.
Output: 240V ac.
Wave: Square.
Frequency: 50 Hz approx.
Power: 150W.
Price: £45.

300
Input: 24V dc.



Gardners Converter

Output: 240V ac.
Wave: Square.
Frequency: 50 Hz approx.
Power: 300W.
Price: £65.

LINDBERG
200 Islevdalvej, DK-2610 Roedovre, Denmark
Agents: Avel-Lindberg Ltd, South Ockendon, Essex RM15 5TD.
Telephone: Denmark: (01) 97 22 00. England: South Ockendon (700) 3444.
MP3-24; MP3-32; MP3-110; MP3-220.
Input: 20-30; 27-40; 100-125; 200-250V dc.
Output: 217.5 to 227.5V ac.
Wave: Sine.
Frequency: 50 \pm 1/2 Hz.
Power: 200 VA.
Efficiency at rated load: Better than 70%.

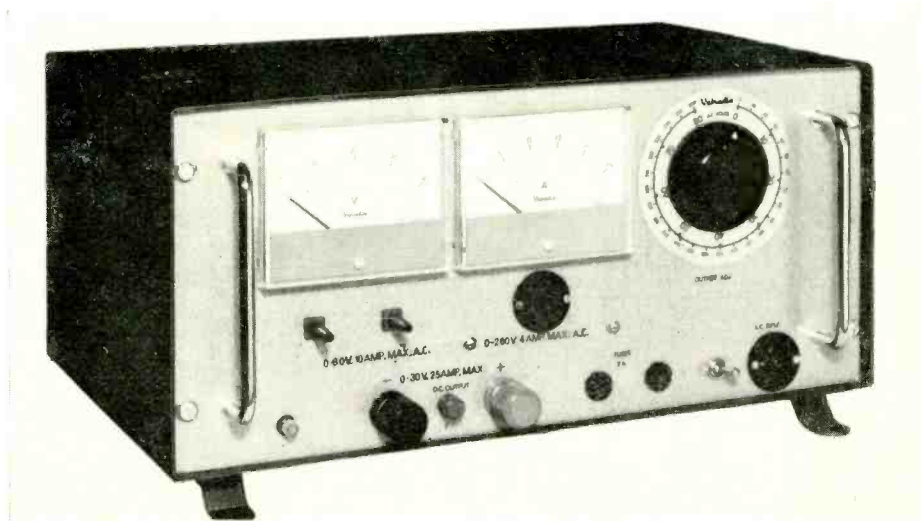

Valradio
Converter

Weight: 15.5 kg and 18 kg.
Size: 413 x 195 x 193 mm.
Price: £128 to £150.

MP4-24; MP4-110; MP4-220

Input: 24, 110 and 220V dc.
Output: 220V ac.
Wave: Sine.
Frequency: 50 \pm 1 Hz.
Power: 500 VA.
Efficiency at rated load: Better than 70%.
Weight: 40 kg.
Size: 444 x 431 x 217 mm.
Price: £290 to £300.

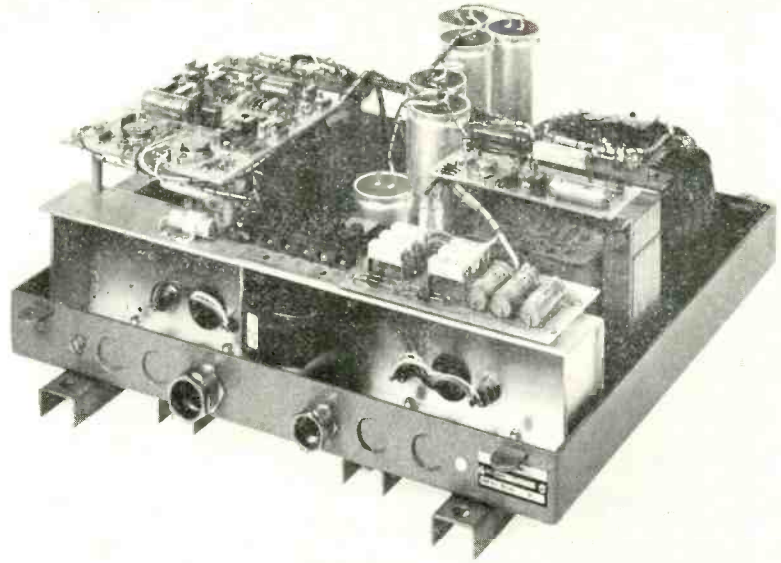

Avel-Lindberg MP4

VALRADIO

Browells Lane, Feltham, Middlesex.
Telephone: 01-890-4242/4837.
5; 6; 7; 8; 116; 117; 118.

Input: 12V dc.
Output: 115/230V ac.
Wave: Square.
Frequency: 50 \pm 3 Hz and 50 \pm 1 Hz.
Power: 50 to 500W.
Price: £22.60 to £122.35.

138; 139; 140; 141.

Input: 12V dc.
Output: 115/230V ac.
Wave: Sine.
Frequency: 50 \pm 1 Hz.
Power: 30 to 400W.
Price: £35.70 to £197.

142

Input: 12V dc.
Output: 115/230V ac.
Wave: Sine/square.
Frequency: 50 \pm 1 Hz.
Power: 200/250W.
Price: £142-35.

14; 15; 16; 17; 18; 124; 125; 126; 127.

Input: 24V dc.
Output: 115/230V ac.
Wave: Square.
Frequency: 50 \pm 3 Hz and 50 \pm 1 Hz.
Power: 50 to 750W.
Price: £23.75 to £186.45.

145; 146; 147; 148.

Input: 24V dc.
Output: 115/230V ac.
Wave: Sine.
Frequency: 50 \pm 1 Hz.
Power: 30 to 500W.
Price: £39 to £197

149; 150.

Input: 24V dc.
Output: 115/230V dc.
Wave: Sine/square.
Frequency: 50 \pm 1 Hz.
Power: 200/250 and 200/500W.
Price: £144.10 and £216.15.

300; 301; 302; 303; 304.

Input: 50V dc.
Output: 115/230V ac.
Wave: Square.
Frequency: 50 \pm 3 Hz.
Power: 100 to 750W.
Price: £40.65 to £139.85.

305; 306; 307; 308.

Input: 50V dc.
Output: 115/230V ac.
Wave: Sine.
Frequency: 50 \pm 1 Hz.
Power: 30 to 200W.
Price: £45.25 to £103.85.

250; 251; 252; 253; 261; 262.

Input: 110 and 220V dc.
Output: 115/230V ac.
Wave: Square.
Frequency: 50 \pm 3 Hz.
Power: 50 to 500W.
Price: £54.25 to £169.40.

256; 257; 258; 259; 260.

Input: 110, 220 and 110/220V dc.
Output: 115/230V ac.
Wave: Sine.
Frequency: 50 \pm 1 Hz.
Power: 30 to 200W.
Price: £58.10 to £111.30.

Jermyn 300 converter

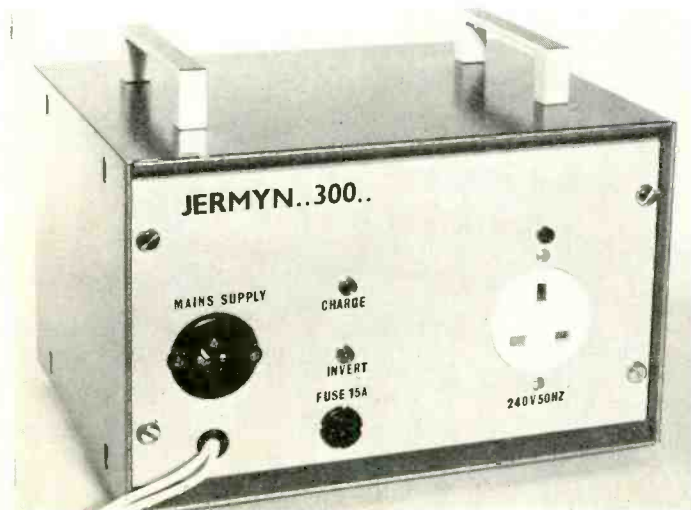

Avel-Lindberg MP3

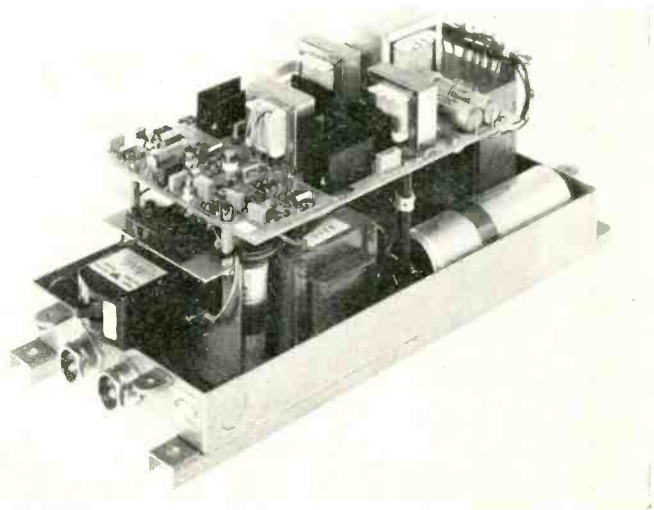

Electronics in music bibliography

R. M. YOUNGSON

- AKO Akustische U. Kino-Geräte GmbH. Electro-mechanical Apparatus for Producing Artificial Reverberation. Brit. Pat. No 1,289,055 (Aug 1972).
- ANDERTON, C. Build the Optimum Fuzz Adapter. *Pop. Electronics* (July 1972): 34. Electronic Music Synthesizers. *Pop. Electronics* (May 1973): 40.
- ANTHONY, M. The Shape of Sounds to Come. *STUDIO SOUND* 14 No 9: 49 (Sept 1972).
- ASBERY, J. H. Multiphonic Organ. *Wireless World* 79: 303 (1973).
- ATCHISON, R. A., LUTOLF, R. E., and MAGEE, E. F. Apparatus for the Digital Generation of Acoustic Waveforms. US Pat. 3,529,086 (1970).
- AYRES, W. R. Electrical Musical Instrument (Tone wheels and divider chains). US Pat. 3,489,842, (1970).
- BALDWIN, C. O. Electrical Stringed Instruments especially Electro-pianos. Brit. Pat. 1,300,246 (Nov 1972). Music Laboratory, U.S. Pat. 1,317,004 (1973).
- BARRETT, R. Diode Pump (Frequency to Voltage Converter) using 741 OP AMP. *Wireless World* 78: 274 (June 1972).
- BAUCH, J. Comments on Review of ARP 2500 Synthesiser. *STUDIO SOUND* 14 No 6: 16.
- BAXANDALL, P. J. Simple Frequency Doubler. *Wireless World* 79: 142 (1973).
- BENFIELD, D. Phasing Unit. *Practical Electronics* 9: 772 (Sept 1973).
- BEN-YAAKOV, S. Analog-to-frequency Converter is Accurate and Simple. *Electronic Design* 14 (July 1968).
- BERESKIN, A. B. Variable Time Delay Multivibrators for Electronic Organs. U.S. Pat. 3,476,865 (1969).
- BLY, D. W. J. Oscillator Using Operational Amplifier. *Wireless World* 75: 234 (May 1969).
- BODE, H. Solid State Audio Frequency Spectrum Shifter. Presented at the 17th Annual AES Convention (Oct 1965).
- BODE, H., and MOOG, R. A High-Accuracy Frequency Shifter for Professional Audio Applications. *Journal of the AES* 20: 453 (July/Aug 1972).
- BOMBI, F. High-performance Voltage to Frequency Converter. *Electronic Engineering* (Dec 1970): 65.
- BOOTHMAN, A. J. Electronic Piano. *Practical Electronics* 8: 733, 840, 924, 1038 and 9; 44 (Sept, Oct, Nov, Dec 1972, Jan 1973).
- BRACHO, S., and CIVIT, A. Op Amp makes easier A-D conversion (Voltage to frequency converter). *Electronic Engineering* (March 1972): 62.
- BRAND, J. R., and GALANTI, F. Electronic Musical Instrument Dual Purpose Gate and Keying Circuit. U.S. Pat. 3,543,281 (1970).
- BROWN, J. P. Practical Approach Simplified I.C. Oscillator Design. *Electronic Engineering* (Nov 1972): 76.
- BRUN, H. Technology and the Composer. UNESCO Conference on Music and Technology (Stockholm 1970).
- BRUNSTING, W. J. Enhanced Electronic Organ Performance by Means of Custom LSI Devices. *Journal of the AES* 21: 373 (June 1973).
- BUCHLA, D., and FRIEDMAN, R. A Computer-Aided Analog Electronic Music System. 42nd AES Convention (1972).
- BUNGER, D. A. Stepping Rhythmic Interpolator. U.S. Pat. 3,499,091 (March 1970). Accompaniment Chord Rhythm System. U.S. Pat. 3,499,092 (March 1970). Electronic Organ Having Upbeat Percussion Gate. U.S. Pat. 3,493,668 (1970).
- BUNKER-RAMO Corporation. Tuning Forks and Oscillators Embodying the Same. Brit. Pat. 1, 258, 034.
- BURHANS, R. W. Digital Tone Synthesis. *Journal of the AES* 19: 660 (Sept 1971). Single-Bus Keyboard Control for Digital Musical Instruments. *Journal of the AES* 19 No 10: 865 (1971). Pseudo-Noise Timbre Generators. *Journal of the AES* 20: 174 (April 1972). Harmonic Structure of PN Sequences. *Journal of the AES* 20: 210 (1972). Some TTL Circuits for Monophonic Devices. *Journal of the AES* 20: 829 (Dec 1972). Clavichord Amplification. *Journal of the AES* 21: 460 (1973).
- CAIRNS, J. B. F. Linear Ramp Generator. *Wireless World* 76: 604 (Dec 1971).
- CAMPBELL, D. J. Reiteration, Percussion and Speaking Tone Effects in Electronic Music Generation. U.S. Pat. 3, 467, 759 (1969). Conversion of Tonal Character of Aural Signals. U.S. Pat. 3,476,863 (Nov 1969).
- CIAMAGA, G. Training of the Composer in the New Technological Means. UNESCO Conference on Music and Technology (Stockholm 1970).
- CIVIT, A., and BRACHO, S. ICs Simplify voltage to frequency and voltage to time Conversions. *Electronic Engineering* (Dec 1971): 36.
- COLIN, D. P. Electrical Design and Musical Applications of an Unconditionally Stable Combination Voltage Controlled Filter/Resonator. *Journal of the AES* 19: 923 (Dec 1971).
- CORDRY, F. A. Electronic Musical Instrument Keying System including Attack and Decay Control. U.S. Pat. 3,509,263 (1970).
- COTTON, R. B., JR. Tempered Scale Generation from a Single Frequency Source. *Journal of the AES* 20: 376 (June 1972).
- CUNNINGHAM, T. W. Low-pitched Voices in Electronic Organs. U.S. Pat. 3,476,866 (Nov 1969).
- DAVIES, G. B. Stringed Musical Instrument. Brit. Pat. 1,285,542 (July 1972).
- DECORAT and PLAYART LTD. Electronic Organs. Brit. Pat. 1,276,183 (April 1972 issue of Official Journal).
- DE'SA, O., and MOLYNEUX, L. A Transistor Voltage to Frequency Converter. *Electronic Engineering* 34, 7 (1962).
- DEUTSCH, R. Pipe Organ Goes Digital. *Electron* Vol 44: 79 (May 1971). Digital Organ. U.S. Pat. 3,515,792 (1970).
- DIGITAL MUSICMAKING (Review-Allen Organ Co). *Electron* No 19 (Jan 1973): 15.
- DIVIDER. Seven-stage, for Electronic Organs. *Electron* Vol 1 No 4: 41. Application Note No 4 (May 1972).
- DIXIE, F. H. Polyphonic Electronic Keyboard Musical Instrument. Brit. Pat. 1,289,774 (Aug 1972).
- DOUGLAS, A. Digital Electronic Organ Systems. *Practical Electronics* 8: 559 (July 1972). Electronic Music Production. Pitman Publishing, London, pp 148 (1973).
- 'ELECTRONIC MUSICAL INSTRUMENTS.' Special Supplement to *Practical Electronics*. Vol 8

- No 11 (Nov 1972).
- EMI LTD. Modulated Oscillators. Brit. Pat. 1,270,528 (March 1972 issue of Official Journal). Frequency Divider Circuits. Brit. Pat. 1,298,939 (Oct 1972).
- EMINENT, N. V. Electronic Circuit Arrangement for Imitating a Percussion Musical Instrument. Brit. Pat. 1,327,214 (1973).
- EVANS, F. C. Frequency Divider with variable tuning. *Wireless World* 75: 324 (July 1969).
- EWINS, A. J. Wien-bridge Audio Oscillator. *Wireless World* 76: 104 (March 1971).
- FORD, H. Review of AKG BX 20 Reverberation Unit. STUDIO SOUND Vol 15 No 6: 52 (1973).
- FRANSSSEN, N. V., and van der PEET, C. J. Digital Tone Generation for a Transposing Keyboard Instrument. *Philips Tech. Rev.* Vol 31: 354 (1970).
- FRANSSSEN, N. V. Tempered Tone-scale Generation from a Single Oscillator. *Journal of the AES* 21: 457 (1973).
- FRANZ - VERTRIEBS GmbH. Reverberation Apparatus. Brit. Pat. 1,327,654 (1973).
- FREEMAN, A. B. Electronic Cord Selection Device for a Musical Instrument. Brit. Pat. 1,274,801 (April 1972 issue of Official Journal). Dynamic Keying Circuit for Musical Instrument. U.S. Pat. 3,526,702 (1970).
- FREQUENCY DIVISION, NON-INTEGER. *Electronic Engineering* Vol 44 (April 1972): 60.
- FRIEND, D. A Time-Shared Hybrid Sound Synthesiser. *Journal of the AES* 19: 928 (Dec 1971).
- FRIEND, D., and POWELL, R. The Application of Sequential Controllers in Live Performance. 43rd AES Convention Preprints (Sept 1972).
- FUNAKOSHI, T. Musical Tone-producing Device. Brit. Pat. 1,283,818 (*O.J.* June 1972).
- GARLAND, H., and MELEN, R. Build the Muscle Whistler. *Pop. Electronics* 35 No 5: 60 (Nov 1971).
- G.E.C. SEMICONDUCTORS. MOS Audio Tone Generator. GEC Semiconductor Bulletin M A 70S (1971).
- GEDDES, L. A., BOURLAND, J. D., and COULTER, T. W. The Strobophone. *Journal of the AES* 20: 115 (1972).
- GENERAL INSTRUMENT MICROELECTRONICS. IC AY-1-0212. 12 Note chromatic output from a single input frequency. Also six-stage binary dividers. Sales Office, 57 Mortimer Street, London W.1.
- GEORGE, T. J. Electronic Solo Instrument having High-note Guard Circuit. U.S. Pat. 3,538,804 (1970). Device for Producing Stringed Instrument or Muted Horn Resonant Tones, Employing a Microphone in or near a Speaker Enclosure. U.S. Pat. 3,506,773.
- GIBBINGS, D. L. H. Resistance-Capacitance Oscillator for Generating the Frequencies of the Equal-Tempered Musical Scale. *J. Acoust. Soc. Amer.* 47: 1563 (1970).
- GLEESON, P., and VIVEIRA, J. Complex Sounds from Subtractive Synthesis—some practical means. 42nd AES Convention 1972.
- GOLDSMITH, D. S. An Electronically Generated Complex Microtonal System of Horizontal and Vertical Tonality. *Journal of the AES* 19 No 10: 851 (1971).
- GSCHWANDTNER, E. Derivative Synthesis of Musical Instrument Tones by Means of Non-linear Transfer Function Device. U.S. Pat. 3,530,225 (1970).
- HAMMOND CORPORATION. Musical Instrument Rhythm Section having provision for introducing automatically selected chord components. Brit. Pat. 1,272,345 (March 1972 issue of *Official Journal*).
- HARRIS, M. R. Electronic Piano with Percussive Effects Employing Zener Operation. U.S. Pat. 3,544,699 (Dec 1970). Touch Percussion for Electronic Organ with Back-to-Back Diode Gate. U.S. Pat. 3,558,796 (1971).
- HARRIS, R. J. Simple Tunable Notch Filter. *Wireless World* 79: 253 (1973).
- HECK, L. Musical Timbre by means of the Klangumwandler. Proc. of 10th AES Convention (1958).
- HECK, L., and BÜRCK, F. Frequency shifting by means of the Klangumwandler. Germany Pat. 1,051,000.
- HEISERMAN, D. L. The Art and Technology of Electronic Music. *Pop. Electronics* (Feb 1972): 40.
- HILL, M. A. C. Device for use in Transposing Musical Keys or Notes. Brit. Pat. 1,322,910 (1973).
- HILLER, L. A., and ISAACSON, L. M. Experimental Music. New York McGraw-Hill Book Co.
- HIROSE, Y. Musical Instrument Driving Circuit for producing Percussion Sound. U.S. Pat. 3,557,296 (1971).
- HITCHCOCK, K. Organ Speaker Cabinets. Brit. Pat. 1,296,674 (Oct 1972).
- HOOD, J. L. L. Linear Voltage Controlled Oscillator. *Wireless World* 79: 567 (Nov 1973).
- HOOD, R. B. Simple, one per cent, Voltage-to-Frequency Converter. *Electronic Engineering* 44: 36 (Dec 1972).
- HOWDEN, J. W. Voltage-Controlled Triangle and Square wave generator. *Wireless World* 78: 540 (Nov 1972).
- HUEHNE, K. Digital Waveform Synthesis. *Electron* No 12. Application Note 12: 37 (Sept 1972).
- JARVIS, W. H., and GARTON, G. Musical Tuning Aids. Brit. Pat. 1,271,693 (March 1972 issue of *Official Journal*).
- JENNY, G. Monodic Electronic Musical Instrument Manually Playable without depression of Keys. U.S. Pat. 3,546,353 (Dec 1970).
- JOHNSON, S. G. Voltage-to-Frequency Converter Built with on UJT Oscillator. *Electronic Design* 25 (Dec 1967).
- JONES, E. M. Touch Sensitive Electronic Musical Instrument Responsive to Only Terminal Velocities of Keys. U.S. Pat. 3,507,970 (1970).
- JONES, E. M., MEYER, A., and WAYNE, W. C. A Multiwaveform Organ: From Computer to Optoelectronics. 43rd AES Convention Preprints (Sept 1972).
- JONES, R. J. P. A Wide Frequency Range Voltage Controlled Multivibrator. *Electronic Engineering* 39, 1 (1967).
- JUDD, F. C. Tremulant Systems (in two parts). *Practical Electronics* 7: 372 and 7: 477 (May/June 1971). Electronics in Music. *London Neville Spearman* pp. 169 (1972).
- JUNG, W. G. New TTL ICs—Voltage-Controlled Oscillator IC. *Pop. Electronics* (Oct 1973) 104.
- KAKEHASHI, I. Automatic Rhythm Performance Device. Brit. Pat. 1,297,319 (Oct 1972).
- KATSUHIKO HIRANO. Switching Circuit for Electronic Musical Instruments. U.S. Pat. 3,535,971 (Oct 1970).
- KEELE, D. B. The Design and Use of a Simple Pseudo-Random Pink Noise Generator. 42nd AES Convention (1972).
- KEY DEVELOPMENTS LTD. Automatic visual indicator and transposing device for organ, electronic organ and pianoforte. Brit. Pat. 1,281,170 *Official Journal* (June 1972).
- KIRK, D. K. Field Trial of ARP 2600/3604 Electronic Music Synthesiser. STUDIO SOUND 14 No 1: 33 (Jan 1972). Survey: Electronic Music Synthesisers. STUDIO SOUND 14 No 5: 33 (May 1972). Field Trial of ARP 2500 Electronic Music Synthesiser. STUDIO SOUND 14 No 5: 39 (May 1972). Field Trial of Triadex Muse Electronic Music Synthesiser. STUDIO SOUND 14 No 9: 83 (Sept 1972). Review of Mini-Moog Model D. STUDIO SOUND 14 No 11: 31 (Nov 1972). Field Trial: Synthi AKS. STUDIO SOUND 15 No 2: 38 (Feb 1973). Field Trial of ARP *Odyssey*. STUDIO SOUND 15 No 6: 40 (June 1973).
- KOANANTAKOOL, T. General Purpose Oscillator. *Wireless World* 76: 600 (Dec 1971).
- KOEHL, J. A. Tremulant Mechanism. U.S. Pat. 3,495,002 (1970).
- KOENIG, G. M. The Use of Computer Programmes in Creating Music. UNESCO Conference on Music and Technology (Stockholm 1970).
- KOHL, N. R. Musical Instrument Percussive Keyer with Variable Signal Decay. U.S. Pat. 3,465,088.
- KOHL, N. R. et. al. Organ Percussion System Providing Percussive Harmonic Synthesis. U.S. Pat. 3,480,718 (Nov 1969).
- LANCASTER, D. Introduction to Electronic Music. *Pop. Electronics* (Oct 1973): 35.
- LAUBE, H. Electric Musical Instrument Reverberation Nonlinear Control System. U.S. Pat. 3,463,868 (Aug 1969).
- LAWRENCE, L. G. How to Select an Electronic Organ. *Pop. Electronics* (June 1973): 45.
- LENTON-SMITH, K. Strictly Instrumental. *Practical Electronics* 9: 337 and 677.
- MACHANIAN, W. V. Keyboard Actuated Rhythm Accompaniment. U.S. Pat. 3,520,984 (1970). Electronic Organ with Diverse Filters and Anti-Plop Bias Arrangement. U.S. Pat. 3,526,701 (1970).
- MCKENZIE, A. Field Trial of AKG BX 20 Reverberation Unit. STUDIO SOUND 15 No 6: 50 (1973).
- MACKENZIE OF ORD. Electronic Keyboard Musical Instruments. Brit. Pat. 1,320,238 (1973).
- MCNERNEY, R. J. et. al. Electronic Diode Keying Circuit with Variable Sustain. U.S. Pat. 3,506,772 (April 1970).
- MARKOWITZ, J. Musical Instrument with Time Delay Characteristics. U.S. Pat. 3,453,371 (July 1969).
- MARTIN, D. W., and BERESKIN, A. B. Randomly Perturbed Locked-Wave Generator for Electronic Organs. U.S. Pat. 3,479,440 (Nov 1969).

MUSIC BIBLIOGRAPHY

- MARTIN, S. Creating Complex Timbre through the use of Amplitude Modulation in the Audio Band. 42nd AES Convention (1972).
- MASUO OMURA et al. Piano Keyboard Type Electronic Musical Instrument having a Bass Pedal and Single Continuous Keyboard. U.S. Pat. 3,461,217 (Aug 1969).
- MASUO OMURA and MASAHIKO TSUNOO. Electronic Musical Instrument for producing Novel Acoustic Effects from Multitone Signals. U.S. Pat. 3,505,461 (April 1970). Electronic Musical Instruments with Tone Generating, Mixing and Distributing Systems. U.S. Pat. 3,515,039 (June 1970).
- MATHEWS, M. V. Resonant Filter to Enhance Sound Quality. 43rd AES Convention Preprints (Sept 1972).
- MATSUSHITA ELECTRIC INDUSTRIAL CO. Improved Method of obtaining Vibrato and Tremolo Effects in Electronic Musical Instruments. Brit. Pat. 1,268,820. Signal processing arrangement for an Electronic Musical Instrument. (Inharmonic partials generated.) Brit. Pat. 1,286,128 (July 1972).
- MATSUURA, T. Attack and Decay Switching Circuit for Electronic Musical Instrument. U.S. Pat. 3,557,297 (1971).
- MAMORU KURIYAGAWA and MASAMI KOBAYASHI. Electronic Musical Instruments with Small Tone Generators Adjacent Key Switches. U.S. Pat. 3,536,819 (Oct 1970).
- MATTEL INC. Optical Disc Drive for Organ. Brit. Pat. 1,314,780 (1973). Keyboard Assembly for Organ. Brit. Pat. 1,314,779 (1973).
- MATTHEWS, M. Electronic Sound Studio of the 1970's. UNESCO Conference on Music and Technology (Stockholm 1970).
- MALHAM, D. G. Voltage-controlled filter and oscillator. *Wireless World* 78: 443 and *Wireless World* 78: 349 (1972).
- MAYNARD, F. B. Designing a Digital Organ Tone Generator. Motorola Application Note AN-424 (1968).
- MELIS, J., and NIJHOLT, B. Voltage-controlled Gain in the Audio Channel. *Journal of the AES* 20: 629 (Oct 1972).
- MEYER, A. Electronic Organ Frequency Dividing System Employing Division by Odd Numbers. U.S. Pat. 3,499,090. (March 1970).
- MIXER, 4 CHANNEL using RCA CA 3048. *Electronic Engineering* (Jan 1971): 53.
- MONTANARY, S. Sound Effect Generator. Brit. Pat. 1,264,230.
- MOOG INC. Control Mechanism. Brit. Pat. 1,273,310 (March 1972 issue of the *Official Journal*).
- MOORE, D. R. Electronic Musical Instrument (Monophonic, string tones). U.S. Pat. 3,484,529 (Dec 1969).
- MORGAN, R. Tremolo Generator for Guitars and Organs. *Practical Wireless* 49: 240 (1973).
- MULLARD LTD. Frequency Synthesizers. Brit. Pat. 1,264,903.
- MULLER, C. Electronic Percussion Instruments. *Electronics World* (Feb 1967): 36.
- MUNCH, W., JR., and UETRECHT, D. M. Chime Systems and the like for Electronic Organs. U.S. Pat. 3,499,093 (March 1970). Electronic Organ Reiteration System utilizing a Zero-crossing Preference Circuit. U.S. Pat. 3,476,864 (Nov 1969).
- MUNCH, W., JR. Bass Register Keying System Employing Preference Networks. U.S. Pat. 3,509,262 (1970).
- MUNCH, W., JR., and UETRECHT, D. M. Electronic Latch and Wipeout System for Musical Instruments. U.S. Pat. 3,512,935 (1970).
- MURAKI, S. Pedal Key Assembly of an Electronic Musical Instrument. U.S. Pat. 3,527,134 (1970).
- MYERS, J. P., and FEINBERG, A. High Quality Professional Recording Using New Digital Techniques. *Journal of the AES* 20: 622 (Oct 1972).
- NAUGHTON, N. Novel Tone Generator. *Practical Wireless* 48: 1088 (1973).
- NIPPON COLUMBIA. Sound Recorder Uses P.S.M. *Wireless World* 79: 548 (Nov 1973).
- NORTH AMERICAN ROCKWELL CORP. Electronic Musical Instruments. Brit. Pat. 3,312,161/2 (1973).
- OLSON, H. Build a Crystal-controlled Musical Instrument Tuner. *Pop. Electronics* Vol 2 No 6 (Dec 1972): 55.
- OP-AMP, 4-Channel, Programmable (HA 2100) (Applications include programmable oscillators etc). *Electron* No 1: 41 (April 1972).
- PACHE, F. Musical Instrument. Brit. Pat. 1,283,888 (June 1972 issue of *Official Journal*).
- PAIA. Music Synthesizer Brochure. Modules listed include VCA, VCO, VCF Function Generator, control oscillator/noise source power supply, envelope follower/trigger inverter buffer, sine converter/PWM. PAIA Electronics Inc., PO Box 14359, Oklahoma City 37411.
- PAGUET, A. Electronic Metronome. Brit. Pat. 1,280,117.
- PAUL, G. M. Square pulse from Unijunction Transister. *Wireless World* 76: 123 (March 1970).
- PERKINS, C. R. 4-8½ Tremolo Circuit from 'Applications of MOSFET Devices to Electronic Circuits'. Hughes, Newport Beach, California (1968): 10.
- PHILIPS TECH REV. Generation of Musical Intervals by a Digital Method. Vol 26 Nos 4-6 (1965).
- PHILIPS ELECTRONIC AND ASSOCIATED INDUSTRIES LTD. Electronic Musical Instrument. Brit. Pat. 1,264,143. Controllable Electric Oscillator. Brit. Pat. 1,270,564 (March 1972 issue of *Official Journal*). Electro-acoustic Transducer. Brit. Pat. 1,276,196 (April 1972 issue of *Official Journal*). Frequency Divider. Brit. Pat. 1,276,278 (April 1972 issue of *Official Journal*). Musical Scale Tone Generator. Brit. Pat. 1,326,912 (July 1973).
- PLESSEY CO LTD. Frequency Synthesizers. Brit. Pat. 1,263,928.
- PLUNKETT, B. J., and KUSHNER, L. L. Foot Controlled Continuously Variable Preference Circuit for Musical Instruments. U.S. Pat. 3,530,224 (1970).
- de PREE, L. Touch Sensitive Capacitor Timing Percussion Keying Circuit. U.S. Pat. 3,507,973 (1970).
- PULFER, J. K. The Computer as an Aid to the Composition and Production of Commercial Music. 42nd A.E.S. Convention 1972.
- RAKOVIC, B., and TESIC, S. Voltage to Frequency Conversion. *Electronic Engineering* (Dec 1967).
- RANZATO, M. Electronic Instruments for Simulating Stringed Instruments. Brit. Pat. 1,282,364 (June 1972 issue of *Official Journal*).
- REVERBERATION and AUDIO DELAY UNITS. Survey of 13 equipments. *STUDIO SOUND* 15 No 6: 44 (1973).
- RHYTHM BOX. MOS I.C. designed for use in a rhythm generator (Review). *Practical Electronics* 8: 574 (July 1972).
- RING, W. C. Keyer-synthesiser for an Electronic Musical Instrument employing an I.C. U.S. Pat. 3,534,144 (1970).
- ROBINSON, J. W. Pedal Circuit for Electronic Organ. U.S. Pat. 3,535,970 (Oct 1970).
- ROHEN, J. E. Add a Compression Amplifier to your Electronic Organ. *Pop. Electronics* Vol 2 No 6: 105 (Dec 1972).
- ROSENSTEIN, M. Computer-Generated Pure Tones and Noise and Its Application to Psychoacoustics. *Journal of the AES* 21: 121 (1973).
- RUPERT, R. E. Musical Instrument Employing Film Sound Track on Cathode Ray Tube Screen. U.S. Pat. 3,484,530 (1969). System for producing Musical Tones. Brit. Pat. 1,291,078 (Aug 1972).
- RUPPERT, K. D. Portable Electronic Chord Organ. U.S. Pat. 3,526,700 (1970).
- SAKAI, T. Tone Oscillator for an Electronic Musical Instrument. Brit. Pat. 1,289,028 (Aug 1972).
- SCHMIDT, G. A. Percussion Generating Circuit for Electric Organs. U.S. Pat. 3,484,531 (1969).
- SCHRECONGOST, R. B. Musical Instrument Frequency Divider which Divides by Two and Four. U.S. Pat. 3,469,109 (1969). Apparatus and Method for Producing Celeste Animation in Music by Producing Simultaneous Sharp and Flat Tone Signals from Tone Signals of True Frequency. U.S. Pat. 3,489,843. Electronic Musical Effects Apparatus. U.S. Pat. 3,502,782 (March 1970). Tone Signal Generator (Tone Wheel Generator). U.S. Pat. 3,509,395 (1970). Large-scale Integration in Organ Design. *Journal of the AES* 20: 275 (May 1972).
- SCHWARTZ, H. O. Electronic Organ Pedal Keying Circuit with Sustain and Cancellation of Sustain upon playing of Subsequent Pedal. U.S. Pat. 3,480,719 (Nov 1969).
- SCHWARTZ, H. O., MACHANIAN, W. V., and BARRY, R. D. Electronic Organ Keying Circuit. U.S. Pat. 3,544,698 (1970).
- SELDEN, O. C. Key Controlled Pulse Generator. Brit. Pat. 1,263,789.
- SHAW, A. N. Electronic Organs with Plural Stops, Channels and Loudspeakers. U.S. Pat. 3,553,333 (1971). Electronic Organs. Brit. Pat. 1,265,111.
- SHAW, G. D. Sound Synthesiser (Constructional details). *Practical Electronics* 9: 140, 232, 306, 420, 506, 596, 678, 775 (Feb to Sept 1973).
- SHIBATA, M. Music and Technology in Japan. UNESCO Conference on Music and Technology (Stockholm 1970).

CHECK OUR PERFORMANCE

Using active LCR filters in a special configuration, the unit is very stable and the faders can be moved to any position with confidence, and without interaction between the filters. The units are accurately calibrated and with all faders in the centre position, the output is very flat and peak free.

Input Impedance 10K ohms
 Input Level -20dbm to +20dbm
 internally adjustable
 Output Impedance 600 ohms
 Clipping Point +21dbm
 Noise Level -90dbm (unweighted)
 Distortion .01% controls in any position
 Controls Continuously variable from +12db
 to -12db from level position

As well as the five standard models the same basic unit can be built to suit your own specification.



TEKNIK

**M.O.S. Industrial Site
 Summerfield Kiddeminster
 Tel. 64027**

A Division of KlarkTeknik Limited

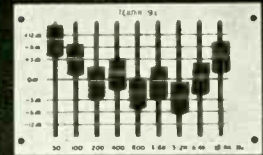
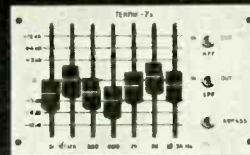
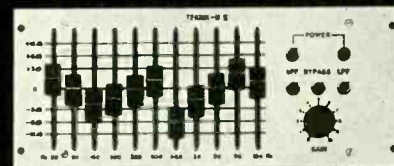
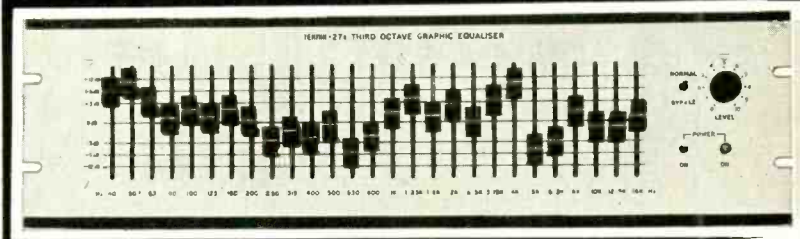
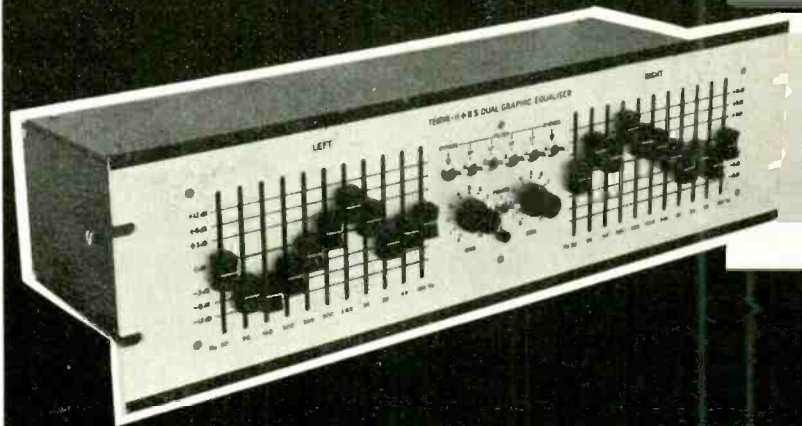

RANK KALEE WOW AND FLUTTER METER

By Hugh Ford

MANUFACTURERS' SPECIFICATION

General: Designed in accordance with BS 1999: 1953 and to match the performance of the Rank Kalee Wow and Flutter Meters types 1740 and 1741.

Measurement ranges

Input signal amplitude: 30 mV, 100 mV, 1000 mV, 3000 mV (mean sensing, calibrated rms).

Wow and flutter: 0.1%, 0.3%, 1.0%, 3.0%; meters scaled rms.

Drift: 1%, 3%, 10%.

Meter Displays

Meter movement: Moving coil, taut band suspension.

Scale length: 70 mm.

Meter 1: Input level or flutter.

Meter 2: Wow or total.

Meter 3: Drift.

Display frequency responses

Weighted: To Rank Kalee standard.

Flutter: Excluding frequencies below 20 Hz.

Wow: Excluding frequencies above 20 Hz.

300 Hz: unweighted, -3 dB at 0.5 Hz and 300 Hz.

1000 Hz: unweighted, -3 dB at 0.5 Hz and 1000 Hz.

Total: Weighted or unweighted as above.

Signal outputs

Test signal

Frequency: 3k Hz crystal controlled.

Amplitude: 1V rms sinusoidal.

Output impedance: 1k Ω .

Total unweighted drift, wow and flutter

(including DC components)

Sensitivity: $\pm 1\% \equiv \pm 1V$.

Output impedance: 1k Ω .

Total unweighted wow and flutter

(AC components only)

Sensitivity: $\pm 1\% \equiv \pm 1V$.

Output impedance: 1k Ω .

Indicated drift, wow and flutter

according to selected range, response etc

Sensitivity: Full scale deflection $\equiv 1V$.

Power output

Photocell excitation: 70V.

Power input: 45 to 60 Hz single phase mains 100 to 150V, 220 to 250V, switch selected. Consumption 10W.

Dimensions

Width: 340 mm.

Depth: 230 mm.

Height: 175 mm.

Can be rack mounted in standard 483 mm system, occupying a vertical space of four units. Rack mounting kit to special order.

Price: £355.

Distributor: Rank Film Equipment, PO Box 70, Great West Road, Brentford, Middx.

IT IS NOW some years since the Rank Organisation ceased production of the well-known type 1740 Wow and Flutter meter, which must have been one of the first Wow and Flutter standards in the world.

The new type 1742 instrument has been advertised in two versions, the version B being



intended to replace the function of the original type 1740 and the version A being designated to meet the current IEC and other quasi-peak standards which are now the norm in Europe. Unfortunately the A version is not yet in production and is therefore not available for review at the time of writing. But, as the two instruments are similar in construction, it is appropriate to review the B version. It is my opinion that it would have been more judicious to produce the quasi-peak version first, as this is the current European accepted standard which can be sold in the open market. However, Rank have produced the rms version B with priority because it is required for production line testing by a British manufacturer!

The new type 1742 has a certain similarity in styling to the old type 1740 but it is about half the size and adopts a modular form of construction. The majority of the components are mounted on some six high-quality printed boards which plug into a mother board. The layout of the boards and the standard of the wiring are first class and all components are identified for ease of servicing. The front panel is arranged with three meters with illuminated identification of their function which can be switched to indicate various parameters. The first indicates input voltage or flutter, the second wow or total wow and flutter, and the third drift. The selection of meter functions and ranges is by a multiplicity of coloured pushbuttons underneath the meters and, while the buttons are clearly identified, they do give a rather cluttered front panel.

In addition to the function pushbuttons there is a mains on/off pushbutton together with a neon pilot light which is unnecessary in view of the illuminated meter identification. A drift offset potentiometer and three 6.25 mm jack sockets which provide for the input, a standard frequency output and for a recorder output giving total unweighted drift+wow+flutter. I find the identification of the latter two jack sockets confusing because the standard

frequency output is identified by a sinewave symbol and the output to the recorder is identified 'output'.

The rear of the instrument provides five pairs of banana sockets on standard 19 mm spacing for monitoring any of the following: total unweighted drift + wow + flutter, total unweighted wow + flutter, indicated drift, indicated wow and finally indicated flutter. All these facilities are certainly of potential use when evaluating new products, and a further three banana sockets provide for powering a photo-electric cell as was the case with the type 1740 instrument. I do however find it rather surprising that this is still a requirement in this age of solid state devices, but maybe the cinema industry is still stuck in its ways of using photo cells? There is finally the mains input socket, which is not the IEC type but the miniature Belling Lee type, a 20 mm mains fuse and the mains voltage selector and, last of all, the calibrate/use switch, the sole function of which is to apply the internal standard frequency to the input for calibrating the drift meter. Unfortunately there is no front panel indication when the switch is in the calibrate position and certain control settings can give indications of wow, flutter and drift when in the calibrate position and/or without an input applied!

The input and oscillator

This is the only wow and flutter meter which to my knowledge incorporates an input voltage meter and, while such a facility is not necessary for wow and flutter measurement, it could be useful as a general purpose meter. However, as is shown in fig. 1, the frequency response of the meter varies according to the sensitivity setting which makes the meter quite useless as a general purpose measuring instrument. While the meter calibration is generally accurate at 3k Hz, even small variations in frequency introduce substantial errors, particularly on the maximum sensitivity range which

corresponds to 30 mV full scale deflection.

The inclusion of this metering facility has added some seven pushbutton switches and a meter movement to the instrument design, all of which could be replaced by a simple automatic gain control circuit and a pilot light, which would give a far larger input voltage range. In practice, with the exception of the 30 mV input range, the meter accepts an approximately 20 dB reduction in signal below full-scale deflection for satisfactory operation. However, while the 30 mV range operated down to its specified lower limit of input of 15 mV, spurious indications of wow and flutter occurred at all input levels on this input voltage range. Taking the best case for the instrument a .02 per cent spurious indication of total weighted wow and flutter was indicated at 30 mV input, increasing to .05 per cent at 15 mV input.

Even more embarrassing was the instrument's sensitivity to mains hum superimposed on the incoming 3k Hz signal, which gave the following spurious indications of total weighted wow and flutter (again being kind to the instrument by using the weighted measurement):

Percentage 50 Hz hum on 1V 3k Hz input	Spurious Indication %
10%	0.08%
20%	0.15%
30%	0.22%

The DIN standard 45507, while not relating to this version of the meter, calls for not more than 15 per cent error in indication when hum contributes 20 per cent of the input voltage—clearly this requirement would not be met.

Both the input and the standard frequency output had sensible impedances, the input impedance being 465k Ω and the output impedance about 150 Ω with an output voltage of 1.08V rms sinewave at 2,999.1 Hz from a crystal source.

The drift section

The drift section comprises a fast-acting centre zero meter with scales calibrated ± 10 and ± 3 which are read in conjunction with the setting of three pushbutton switches providing drift ranges of ± 10 per cent, ± 3 per cent and ± 1 per cent. The zero of the drift meter is adjusted by a single turn potentiometer on the front panel, which is a very sensitive adjustment when the ± 1 per cent range is in use. Absolute calibration is achieved by the use of the calibrate switch on the rear panel which applies the internal crystal oscillator to the input of the instrument.

Checks on the accuracy of the drift meter at four points on each range showed that the indication was creditably within 1 per cent of full-scale indication, and once the instrument was warmed-up calibration remained accurate. The range of the drift offset control was more than adequate, providing for offsets of -7.5 per cent to $+8.5$ per cent; the offset is not however calibrated.

It has been mentioned that the drift meter is a fast-acting meter, and in some circumstances where high peaks occur in wow and flutter or where the wow and flutter content is high it may be difficult to read accurately the drift because no alternative slow damping is provided.

FIG. 1
RANK 1742
VOLTMETER
FREQUENCY RESPONSE

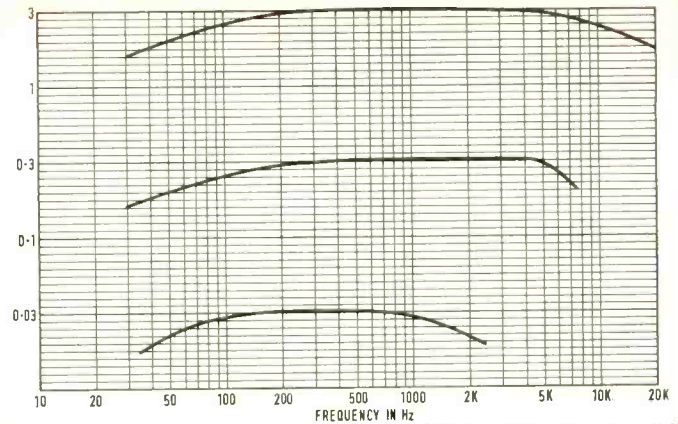

FIG. 2
RANK 1742B
WOW AND FLUTTER
CURVES (UNWEIGHTED)

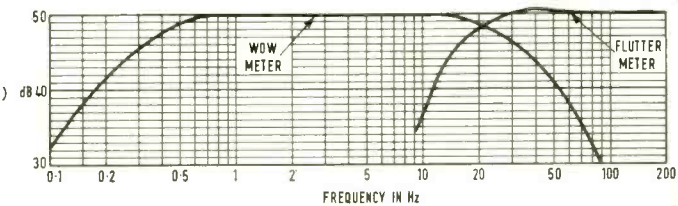
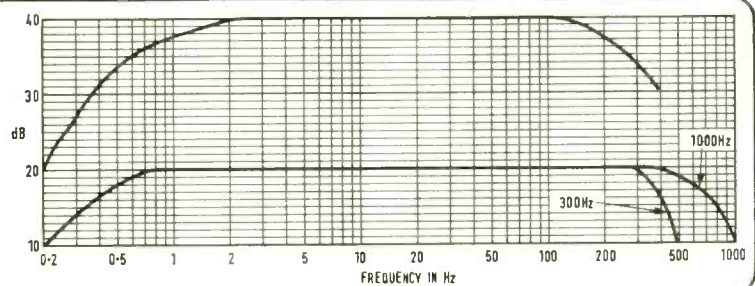

FIG. 3
RANK 1742B
WEIGHTING
CURVE AND
FILTERS



The wow and flutter section

Four wow and flutter ranges corresponding to 3 per cent, 1 per cent, 0.3 per cent and 0.1 per cent full-scale deflection of the meters is provided; also, three frequency characteristics weighted, 300 Hz or 1k Hz may be selected by pushbutton switches. While the two latter are straightforward lowpass characteristics, the former is the weighting used in the old type 1740 instrument and does not meet the current standard weighting curves.

Flutter is indicated by one meter, with either wow or total wow and flutter being indicated by a second meter which is switched between the two functions by two pushbutton switches. As can be seen from fig. 2, the wow and the flutter section frequency responses cross over at 20 Hz as recommended by the old British Standard 1988:1953 which gives recommendations for the rms measurement of wow and flutter. Fig. 3 shows the three filter curves, including the special weighting curve of this instrument, which is very different from the curve that is currently in use and will be included in the A version of this instrument.

Subject to certain conditions, which will be

outlined, the indicated wow and total wow and flutter were generally within 3 per cent of full-scale deflection, but the flutter meter consistently read about 10 per cent too low. However, of more concern was the problem of spurious readings when the 1k Hz bandwidth was selected; this amounted to an indication of 0.4 per cent total wow and flutter and 0.34 per cent flutter when no detectable modulation existed on the input to the meter.

The final matter investigated in the wow and flutter section was the rectifier characteristics—in this department all appears to be happy and sensibly rms indications are obtained.

The auxiliary outputs

The power supply for a photo electric cell was found to be close to its nominal 70V and the input sensitivity at the cathode socket was the same as that selected for the front panel input.

Of the remaining auxiliary outputs, only the front panel jack and the rear panel output, both giving total unweighted drift + wow + flutter, and also the 'indicated drift' outputs,

■ RANK KALEE

cared to function. The former gave an output of $\pm 1.24V$ peak corresponding to ± 1 per cent which is rather far from the specification of ± 1 per cent corresponding to $\pm 1V$. In the case of the indicated drift output there is clearly a specification error, as ± 1 per cent indicated drift gave an output of $\pm 0.504V$ dc when the output is specified at twice this voltage.

Summary

I have left it to the end of this review to mention that the sample so far reviewed had already been returned to the manufacturers as a result of its poor performance when it was initially tested. This action, it is understood, resulted in the mains transformers in all units so far manufactured being replaced; and I can but add that the manufacturers were most co-operative in this respect.

I do not propose to summarise all the points mentioned but, overall, I do not feel that this is a 'happy' instrument and I leave it to the reader to digest the results of the parameters that have been investigated.

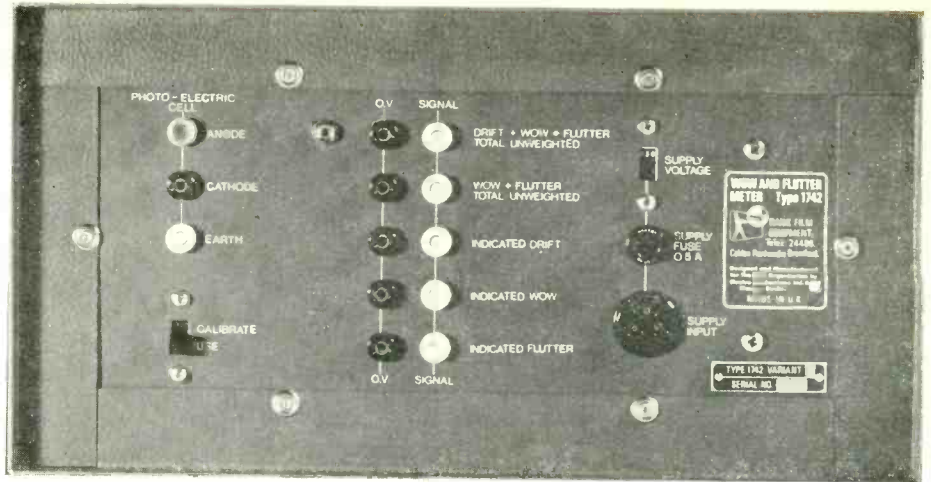

Meanwhile, I look forward to the opportunity of reviewing the A version of the instrument which is designed to meet the requirements of the quasi-peak measurement

to the latest British and other European Standards and which will be of somewhat greater interest in the Common Market countries.

AENGUS EQUALISER

By Hugh Ford

MANUFACTURERS' SPECIFICATION

Input impedance: High level, 9.5 k Ω low level, 5 k Ω .

Output impedance: 100 Ω balanced.

Normal operating level: +4 dBm, 0 VU.

Insertion loss: High level, none. Low level provides 6 dB of gain.

Frequency response unequalised: ± 0.2 dB, 20 Hz to 20k Hz, measured at +4 dBm.

Maximum output level transformer isolated: +21 dBm.

Equivalent input noise, unweighted 20 Hz to 20k Hz: Unequalised, -86 dBm. Equalised, -84 dBm. Noise appears white in nature.

Distortion, 20 Hz to 20k Hz: 0.1% THD at +4 dBm.

Power requirements: No signal, $\pm 15V$ at 45 mA. Maximum output, $\pm 15V$ at 75 mA.

Dimensions: Faceplate 38.1 mm x 133.4 mm. Depth behind panel 146 mm.

Connector: 15 pin single readout edge card connector (supplied).

Controls: Lever operated switches provide 12 steps of equalisation at eight centre frequencies. Boost or cut: +15, +12, +9, +6, +4, +2, 0, -2, -4, -6, -9, -12 dB. Centre frequencies: 50 Hz, 100 Hz, 220 Hz, 500 Hz, 1k Hz, 2.2k Hz, 5k Hz, 10k Hz. Push button with led indicator brings equalisation networks in or out of signal path.

Warranty: One year, parts and labour, when operated as specified.

Price: £137.

Manufacturers: Aengus Engineering Inc, 50 Oak Hill Road, Fayville, Mass 01745 USA.

UK Agents: Scenic Sounds Equipment, 28 Bryanston Street, London W1.

THE CONCISE and precise specification for the Aengus equaliser is a happy introduction to this beautifully engineered unit. The front panel is black anodised with white legends to identify the eight lever-type equalisation switches, each of which has its gain or loss setting showing in white through an aperture in the front panel. Each switch has 11 positions offering calibrated steps between 15 dB boost and 12 dB attenuation at the centre frequency, and perhaps somewhat surprisingly the switches are easy to manipulate in spite of their small size and large number of positions; in fact, they have a particularly nice 'feel' about their action.

In addition to the equalisation switches there is a pushbutton switch at the bottom of the front panel which enables the operator to switch out the equalisation components, an adjacent led indicator being extinguished when the equalisers are out of circuit.

The complete unit is mounted on a good quality plug-in printed board which supports eight miniature boards that connect the equalisation switches to their associated components in the eight active filter networks. The extensive use of integrated circuits gives the layout a clean and uncrowded appearance and only professional quality components are used.

Frequency response and noise

In the flat position of the equalisers, the overall frequency response is within ± 0.1 dB from 10 Hz to 40k Hz, from whence it rises to +3.5 dB at 120k Hz followed by a rapid fall-off. While this extended response may look good, I am not in favour of the practice of continuing a flat response above the audio

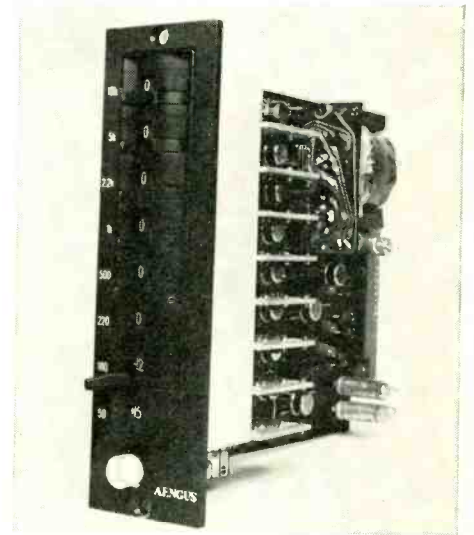

frequency band, because of the possible generation of intermodulation products in subsequent equipment.

The complete set of filter characteristics at maximum boost and cut for individual equalisers is shown in fig. 1, while fig. 2 shows the range of settings for an individual filter. Without doubt these curves confirm that the Aengus equaliser is a very versatile device, but perhaps the filter characteristics are a little wide at the skirts; the centre frequencies are, however, well chosen.

Measurement of the filter characteristics and overall response at the two available overall gain settings, and with the output either loaded with 600Ω or unloaded, had no effect on the performance.

The noise performance of the graphic equaliser was very good with any combination of settings, but it would appear that even better performance could be obtained if the noise in the output stage were reduced. The figures to the right detail noise referred to the input and show a far better performance than the manufacturers' specification would suggest.

Bearing in mind that the latter two columns are a worst condition that is extremely unlikely in practice, and that the unit will handle up to +21 dBm, there is certainly no cause for complaint with the noise performance! Furthermore, the noise spectrum is that of white noise without any unpleasant characteristics.

Band limited 2 Hz to 200k Hz
Band limited 22.5 Hz to 22.5k Hz
'A' weighted

	Rms noise referred to input		
	Flat	Max boost	Max cut
	-79.8 dBm	-74.0 dBm	-71.0 dBm
	-93.0 dBm	-80.5 dBm	-73.5 dBm
	-97.0 dBm (A)	-83.5 dBm (A)	-78.0 dBm (A)

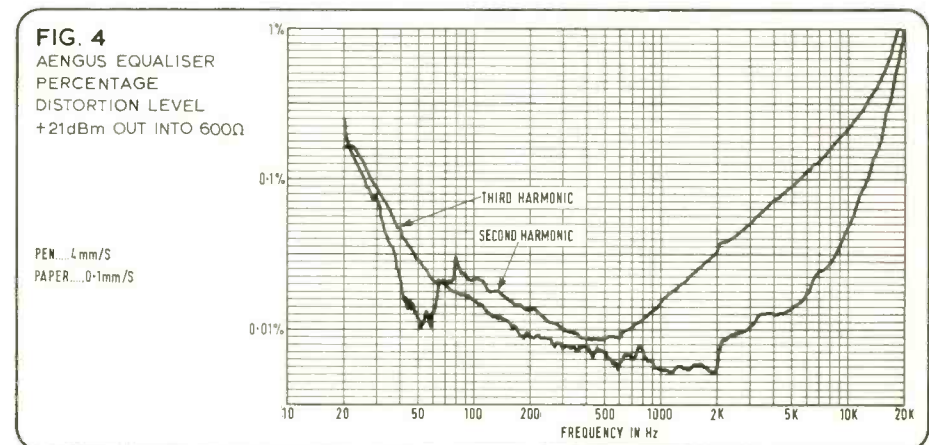
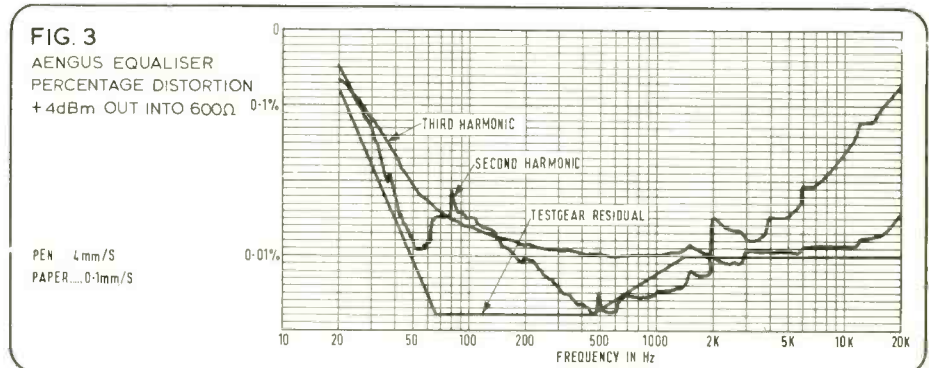
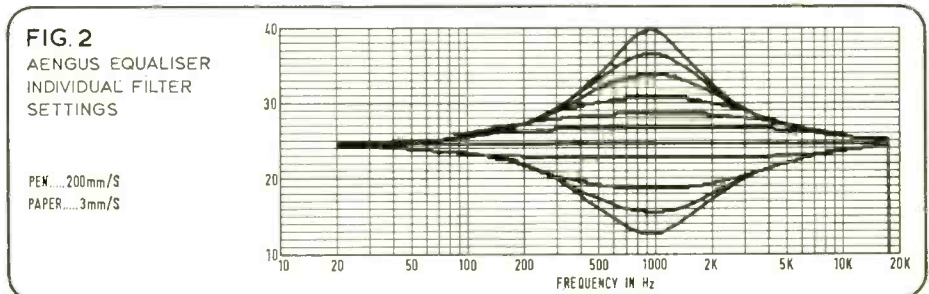
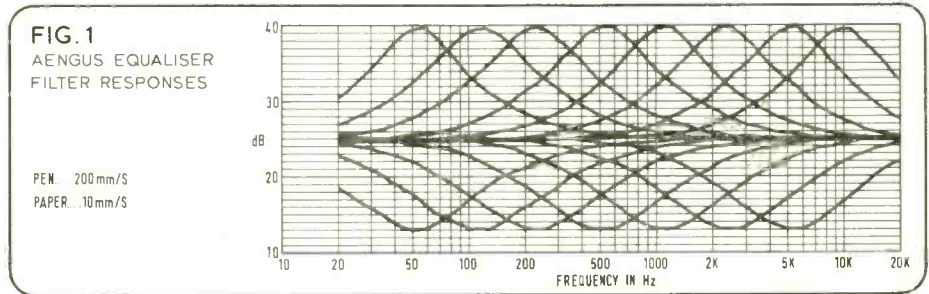

Distortion

The harmonic distortion was investigated over the audio frequency band with the output level set to both +4 dBm and the maximum rated +21 dBm and the unit loaded into 600Ω; the outstandingly good performance is shown in figs 3 and 4, the former of which shows that the distortion of the Aengus equaliser is very close to the test gear residual at +4 dBm output over most of the audio band, where it is an order of magnitude better than the manufacturers' specification. At the full rated output of +21 dBm, the distortion rises at high frequencies with a predominance of second harmonic. Even then, the performance is most respectable with the harmonics at less than 0.03 per cent over much of the audio band.

The measurement of intermodulation distortion by the SMPTE method using tones of 50 Hz and 7k Hz in a 4:1 ratio likewise gave absolutely first-class results which remained excellent with any settings of the equaliser controls. The following results were measured by means of an Amcron analyser which has a residual distortion reading of 0.002 per cent:

Equivalent peak rms into 600Ω	SMPTE IM distortion
+21 dBm	0.003%
+11 dBm	0.004%
+1 dBm	0.003%

At lower output levels, the apparent intermodulation distortion was the result of system noise and there was no evidence of significant intermodulation distortion.

Output clipping did not occur until the level reached +24 dBm into 600Ω with the specified power supply of ±15V and fell to +23.5 dBm when the power supplies were reduced to the minimum permitted level of ±12V.

Inputs and outputs

Two alternative inputs are available, the high level input having an input impedance of 948 kΩ at 1.592k Hz which is suitable for bridging 600Ω lines and the low level input offering a nominal 6 dB gain with an input impedance of 495 kΩ. Both inputs are unbalanced, while the output has a floating balanced low impedance drive with an internal impedance of 92Ω at 1.592k Hz. 56 ▶

■ AENGUS EQUALISER

The measured overall gain of the equaliser when driving into a high impedance was ± 0.7 dB, or -0.5 dB when driving into 600Ω , with the option of an extra 6 dB of gain when using the low level input.

Gain was independent of the dc power supply voltage within the specified limits, the current drain being 44 mA from each supply at 15V with no signal input; 50 mA when driving $+21$ dBm into 600Ω , or 85 mA under saturated clipping conditions into 600Ω .

Other aspects

Recovery from severe overloads into clipping did not present any problems to the equaliser, and recovery was virtually instantaneous without any appreciable waveform deformation. Likewise, the effect of the equaliser on rectangular pulses was clean unless the very maximum high frequency boosts were employed; the latter introduced a degree of ringing which was completely absent under other conditions.

Tone burst testing produced excellent results and prolonged operation at high output levels into 600Ω did not give any cause for suspicion in terms of overheating or increased distortion.

Summary

From a purely engineering point of view the Aengus Graphic Equaliser can only be described as first class—it is in fact considerably better than the manufacturers' specification implies, and that is no mean standard.

Furthermore, the standard of construction is excellent and the input and output facilities are sensible in level and impedance for operating at any of the common line standards.

My only possible criticism is that the skirts of the filter characteristics may be a little wide but this factor is a matter of personal preference.

WOELKE ME105

By Hugh Ford

MANUFACTURERS' SPECIFICATION

Power requirements: 110 to 125V or 220 to 240V $\pm 10\%$, 40 to 60 Hz.

Power consumptions: 10W.

Oscillator frequencies: 3k or 3.15k Hz (crystal controlled)

Oscillator voltage: 1V sine at BNC socket (600Ω), 10 mV at Phono socket ($10\text{ k}\Omega$).

Self-calibration: $\pm 5\%$ detuning (crystal controlled) for static. $\pm 0.1\%$ (50 Hz sine independent of mains frequency).

Test frequencies: 3k or 3.15k Hz (selectable), $\pm 10\%$ adjustable in five coarse steps of $\pm 1\%$, $\pm 0.6\%$ continuous fine adjustment.

Input: 3 mV to 20V ($10\text{ k}\Omega$ or $100\text{ k}\Omega$ source). Internal minimum level indicator and automatic switch connecting test oscillator directly to the input if the input signal falls below the minimum value.

Measuring ranges: *Drift:* 0.1%, 0.3%, 1%, 3% and 10% (all \pm).

Flutto: 0.03%, 0.1%, 0.3%, 1% and 3% (all \pm).

Weighting: To DIN/IEC/ANSI recommendations.

Flutter indication frequency response: 0.5 to 250 Hz -1 dB and 0.5 to 1k Hz -1 dB; optional weighting. Flutter below 1 Hz indicated by drift meter within 1 dB error.

Slow drift: Pushbutton facility giving improved readability of very slow speed frequency variations.

Measuring outputs: *Output One:* Absolute pitch, unweighted 0 to 250 Hz and 0 to 1k Hz. *Output Two:* Ac components according to selected bandwidth or weighting (see curve). *Output Three:* Value indicated by flutter meter (1V fsd). All outputs $10\text{ k}\Omega$ source impedance.

Dimensions: 368 x 150 x 277 mm (shd).

Weight: 4.1 kg.

Price: £500.

Manufacturers: Dipl.-Ing Bruno Woelke, 8000 Munchen 19, Notburgastr 5, West Germany.

Agents: Lennard Developments Ltd, 206 Chase Side, Enfield, Middx.

THE NAME Woelke is probably relatively unfamiliar to many readers although 'Miniflux' is no doubt better known in the field of wow and flutter meters. In fact the two were at one time the same but, as the result of some unfortunate commercial manoeuvring, Woelke



lost the 'Miniflux' name to their former UK agents.

Some years ago I had the pleasure of reviewing the Woelke *ME102B* wow and flutter meter and the *ME301* wave analyser in *STUDIO SOUND*, both of which units achieved a high standard of performance. While the wave analyser remains a current instrument in the range, the new *ME105* wow and flutter meter now offers considerably enhanced performance over the previous range. Unfortunately, as a result of the poor state of the pound sterling, the price is also somewhat enhanced but the unusually concise and realistic specification shows that the new instrument offers a large number of advantages of the previous range of wow and flutter meters.

Not only has the maximum sensitivity been increased to 0.03 per cent wow and flutter (full scale deflection) but there are facilities for measuring around the two standard test frequencies of 3.15k and 3k Hz, additional facilities for measuring speed drift with an increased sensitivity of ± 0.1 per cent full scale deflection and also three varieties of electrical output available.

Overall the performance of this new instrument is far in excess of the requirements for measuring the parameters of currently available tape recorders and turntables. But no doubt the time will shortly come when this exceptional standard of performance is a common laboratory requirement. Notwithstanding this comment, the new *ME105* offers additional

outputs which provide essential facilities for the design of high performance reproduction equipment and also an input sensitivity of only 3 mV so that turntables can be tested without the use of signal amplification.

The styling of the instrument is also of modern design with clearly calibrated (illuminated) meters and a very sensible front panel layout. It is, however, rather surprising that the instrument is not equipped with a tilting foot as the meters are rather difficult to read when the instrument is placed flat on a bench. Mechanical construction is robust, with the electronics being mounted on a high quality printed circuit board and the carrying handles protecting the front panel controls from damage in transit.

The input to the instrument can either be applied to a BNC socket on the front panel or to a five-pin DIN socket on the rear panel, both of which offer a switched input impedance of either $10\text{ k}\Omega$ with a nominal sensitivity of 3 mV to 20V or an input impedance of $100\text{ k}\Omega$ in conjunction with a nominal input sensitivity of 30 mV to 20V. When insufficient input is applied, the instrument's input is connected to its internal oscillator; once sufficient input is applied, a light is illuminated adjacent to the front panel input socket. The measured input impedances were close to their nominal impedances which have been very sensibly chosen and the measured input sensitivities were found to be better than specification at

58 ►

New from

AMITY SHROEDER

Top quality equipment for recording studios . . .

AMITY TAPE TRANSPORTS

For studios wishing to supply their own electronics.

SPECIFICATIONS

Max. spool diameter	10½"
Operating speeds	15/30 I.p.s.
Rewind time for 2400' tape	90 Sec
Wow & flutter (din weighted)	·05%
Speed stability	·1%
Dimensions (ins) Width	25½
Depth	19½
height above deck	4
height above deck*	13½

*Allowing room to tilt deck up through 90° for service.

Decks are normally supplied with undrilled head plates and two guides.

Delivery 6-8 weeks from receipt of order.

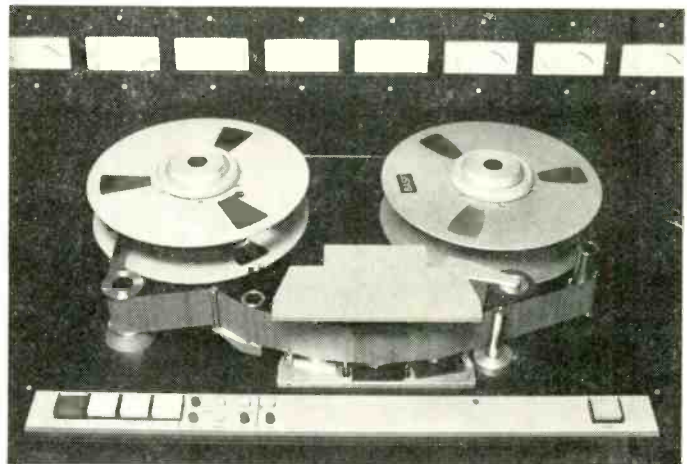

Tape transport for 1" tape £2490 + VAT
 Tape transport for 2" tape £2760 + VAT
 Prices include all control circuits and power supplies, but exclude heads.

. . . and broadcasting stations



AMITY BROADCAST CARTRIDGE MACHINES

Meets or exceeds all N.A.B. specifications. Normal operating speeds 7½ I.P.S. Cue speed 15 I.P.S. 1 kHz and 150 Hz tone generators and sensors provide automatic fast cue operation with manual override. Papst outside rotor capstan. Solenoid operated pull-up and start mechanisms for fast, one-handed operation. Hinge top lid for access to heads and audio circuits. Socket provided for remote control working. Rear mounted switch enables cue tone oscillators to be switched off for recording of continuous background music cartridges.

Stereo Record/Play	£525 + VAT
Stereo Play only	£475 + VAT
Mono Record/Play	£485 + VAT
Mono Play only	£445 + VAT

Please send me immediately full details of
 AMITY SHROEDER TAPE TRANSPORTS
 AMITY BROADCAST CARTRIDGE MACHINES

Name _____

Address _____

AMITY SHROEDER LTD.

3 NEW COMPTON STREET,
LONDON WC2 H8DD

01-836 7811 TELEX: 23197

LOCKWOOD

SOUND TO REMEMBER



LOCKWOOD MAJOR

UNIVERSAL LOUDSPEAKERS
For Wall or Ceiling Mounting.

LOCKWOOD

MINI-MONITOR
For High Quality in Confined areas.

NEW MODELS

LOCKWOOD GEMINI MAJOR
4 Drive Units 160 W.

LOCKWOOD GEMINI MINOR
4 Drive Units 80W

Lockwood Loudspeaker Protection Device Model LPD developed by M. Bradbury and S. Timms.

Protects any Loudspeaker against Overload Conditions.

LOCKWOOD

HARROW - MIDDX. - HA1 3AW
Tel. 422 3704 and 422 0768

WOELKE ME105

24 and 2.75 mV respectively. Wisely, the input sensitivity has considerable hysteresis so that the instrument does not continuously switch between external and internal references when the input level is marginal—the input signal can in fact fall 3 dB before the instrument reverts to its internal reference.

The internal oscillator and the wow and flutter measurement system can be switched by front panel pushbutton switches to operate at either of the common measuring frequencies of 3.15k or 3k Hz, the oscillator being crystal controlled with a measured accuracy and stability better than two parts in 10⁶. This performance is of course far better than is presently required.

In conjunction with the frequency selection switches, there are two further pushbutton switches which provide a +5 per cent frequency offset for calibration of the drift meter, and a ±0.1 per cent flutter reference for calibration of the flutter meter; the calibration controls are screwdriver-operated through holes in the base of the instrument (screwdriver being provided).

Output from the internal crystal oscillator is available at either a BNC socket on the front panel or at the DIN input/output socket on the rear panel. The BNC output offers a nominal 1V, measured as 1.14V rms unloaded from a source impedance of precisely 600Ω, while the DIN output gave 8 mV rms into a load of 10 kΩ from a source impedance of 12.5 kΩ (18 mV open circuit).

One of the particularly pleasing facilities on the ME105 is the ability to measure flutter and drift on independently calibrated meters, both sections also having comprehensive output facilities for the attachment of pen recorders or oscilloscopes.

Drift section

The drift meter is a centre zero instrument calibrated ±1 per cent and ±3 per cent which operates in conjunction with a drift range switch having five ranges from ±0.1 per cent to ±10 per cent in a 1:3 sequence. In addition there are two concentric drift offset controls, the outer control being an 11-position rotary switch providing a drift offset of between ±5 per cent in 1 per cent steps, and the inner

control being a potentiometer giving a 'fine' uncalibrated drift offset of ±0.6 per cent. Absolute drift can be measured by adjusting the 'fine' control for a zero reading with no input signal applied (when the internal oscillator is connected to the instrument's input); however, the 'fine' range of ±0.6 per cent is far too coarse when zeroing on the ±0.1 per cent range. The only solution to this problem would have been to provide two 'fine' drift offset controls, as the ±0.6 per cent offset capability is essential for interpolating between the calibrated 1 per cent offset steps. Furthermore, it is all too easy to upset the 'fine' drift offset when switching the calibrated concentric switch.

While these are objections that can be overcome with a little patience, there is room for improvement here. It may be tempting to use the calibrated drift offset in conjunction with the meter range switch to measure absolute drift to a great accuracy, but this is not surprisingly a fool's paradise because the accuracy of the calibrated drift offset naturally does not match the accuracy of the ±0.1 per cent drift meter range. In fact the accuracy of the calibrated drift offset is within 4 per cent of its nominal; +5 per cent offset was found to be +4.83 per cent offset, a 3.4 per cent error in calibration. The accuracy of the drift meter calibration was itself within 2 per cent of full-scale deflection which is a perfectly respectable standard.

A final aspect of the drift meter section is the facility to increase the meter time constant by means of a 'slow' pushbutton switch. This facility is very effective in ironing-out very long-term speed variations which would otherwise make the measurement of absolute drift a calculated guess.

Flutter section

The flutter meter is calibrated from 0 to ±10 per cent and 0 to ±3 per cent, which in conjunction with a five-position range switch provides full scale deflections from ±3 per cent flutter right down to ±0.03 per cent flutter, the measurements being to the DIN 45507 quasi-peak method of measurement. Calibration accuracy of the unweighted measurement was astoundingly accurate, as can be seen from the percentage figures on the next page.

Ballistic testing of the meter confirmed that it was to the requirements of the DIN 45507

FIG.1 MANUFACTURERS SPECIFICATION OF FILTERS

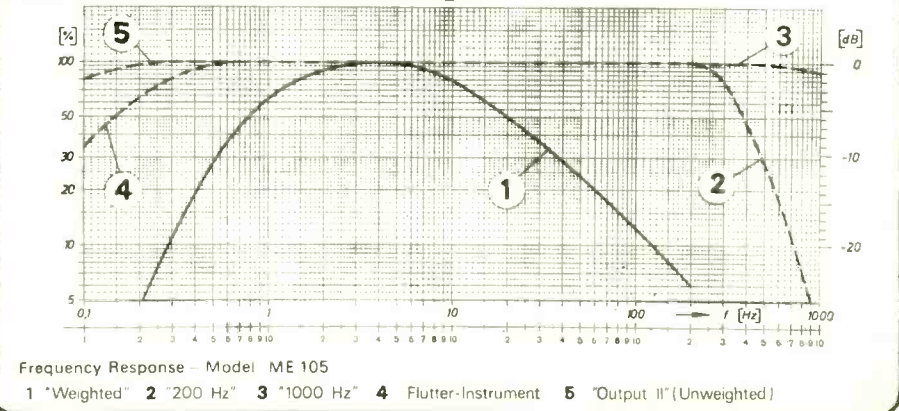

Indicated flutter (%)

3
1
0.3
0.1
0.03

Actual flutter (%)

2.97
0.987
0.296
0.0983
0.0296

standard and also confirmed that the indication was to the correct quasi-peak rectification.

In addition to unweighted measurement, there is of course the facility for weighted measurement to DIN 45507 and in addition switched selection of two low pass filters the characteristics of which are taken from the manufacturers' literature in fig. 1. Also, there is a switched facility for inserting a wave analyser which connects to a five-pin DIN socket on the rear panel.

Fig. 2 shows the performance of the internal weighting network and filters, as compared with the requirements of DIN 45507, and shows that the weighting network is well within the permitted tolerances. The specified turnover frequency of the two filters is, however, a little deceptive but this is of little consequence.

Finally, one comes to the three rear panel BNC outputs for connecting pen recorders, oscilloscopes or other analysing instrumentation. Output One is a dc coupled output always giving total unweighted drift and flutter at a constant nominal level where $\pm 1V$ corresponds to ± 1 per cent total speed error. The measured output for a 1 per cent error in drift was 0.998V. This output is an ideal output for making permanent recordings or drift with a dc recorder, or total wow and flutter with an ac recorder, the output impedance being a convenient $k\Omega$, and the output level being unaffected by the instrument's gain settings.

Output Two provides an output of the ac components only, with full-scale deflection of the flutter meter corresponding to a nominal $\pm 1V$ peak output. The output is after the weighting network and filter options and therefore gives filtered or weighted values where appropriate. The measured output was 0.97V corresponding to full-scale deflection; however this output can be used for measuring rms wow and flutter if a suitable true rms reading meter is attached. It can then be calibrated, in common with the other outputs, by means of the instrument's internal calibration facilities.

Output Three is a dc output proportional to the indication of the flutter meter, with a nominal sensitivity of $+1V$ corresponding to full-scale deflection of the flutter meter, the measured output being 1.01V.

To get some idea of how faithful the instrument's detection system was in reproducing flutter waveforms a 3.15k Hz tone, frequency modulated with a squarewave at 100 Hz, was applied to the instrument. The resulting waveform at output One was then investigated, shows the original modulating waveform together with the demodulated waveform and demonstrates really excellent performance.

Summary

It has been seen that the performance of the Woelke ME105 wow and flutter meter is practically beyond criticism and it is perhaps the most comprehensive audio wow and flutter meter available today. While such matters as drift and sensitivity to mains supply variations have not been mentioned, these things were investigated and found to be to a very high standard. This is a very accurate instrument

which entirely meets its published specification and the requirements of DIN 45507 with the exception of the input impedance which is specified by DIN as not less than 300 $k\Omega$ at 3.15k Hz. This is, however, of no practical significance in view of the instrument's high input sensitivity.

The only points which I think Herr Woelke might consider are the improvement of the drift offset 'fine' adjustment and the fitting of a suitable folding foot at the front of the instrument so that it can be tilted to improve visibility of the meters.

This is the Rolls Royce of audio wow and

flutter meters, which it probably should be with a price tag around £500.

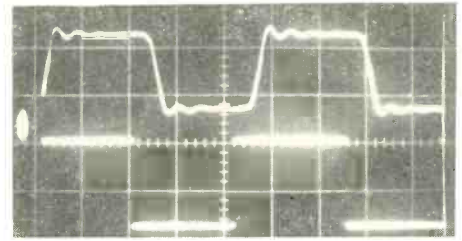
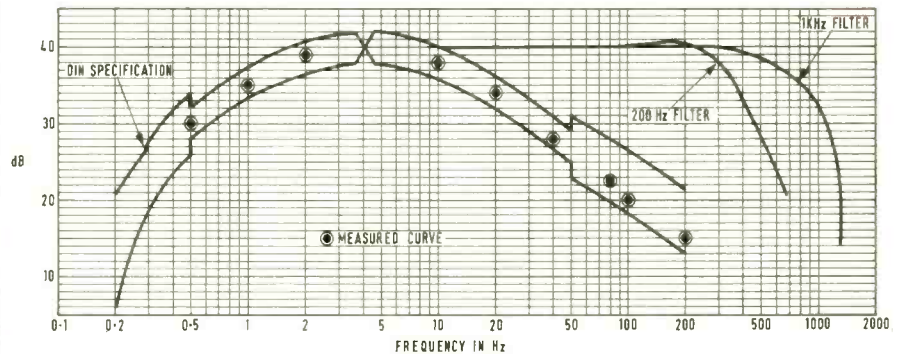
Fig. 3**FIG. 2** WOELKE ME105 MEASURED FREQUENCY RESPONSE

dbx

Noise Reduction Systems

AENGUS

Mixing Console Modules
and other products
for Professional Audio

Scenic Sounds Equipment
27-31 Bryanston Street, London W1H 7AB
Telephone: 01-935 0141

BRENELL IC2000

By Hugh Ford

MANUFACTURERS' SPECIFICATION

The Tape Transport

Tape drive: Three outer rotor motors. Hysteresis synchronous capstan drive for optimum speed stability. Large dynamically balanced flywheel for minimum wow and flutter.

Tape speeds: Four speeds 38, 19, 9.5, 4.75 cm/s.

Tape heads: Up to four. Separate erase, record, playback—stereo half track 2/2 or quarter track 2/4. An optional fourth head can be fitted, enabling a 1/2 track recorder to play back 1/2 track or full track tapes and a 1/4 track recorder to play back 1/4 track or full track tapes. Switching between playback heads is provided.

Reel capacity: Maximum diameter 27 cm, minimum diameter 8 cm. Special adaptors are provided for NAB, CINE and European hubs.

Operating position: Horizontal or vertical.

Tape Tension: Electrically controlled switchable for large and small spools.

Wow and flutter rms unweighted: 38 cm/s less than .05%, 19 cm/s less than .08%, 9.5 cm/s less than .13%, 4.75 cm/s less than .22%.

Winding time: 60s approx for 360m, 110s approx for 720m.

Tape types: Standard or long play. Matt or smooth back. No pressure pads are used.

Tape position indicator: Four digit counter with push button reset.

Pause and slow cue: Lockable control operates for record and replay modes.

Cue lever: For fast cueing during winding.

Access to heads: Pull-off, push-on type head covers for easy access to heads.

Reel overhang: With 27 cm diameter reels 6.5 cm top and sides approx.

Auto stop: Provides for end of tape or tape breakage.

ELECTRONICS COUPLED TO TAPE TRANSPORT

Inputs: Line one 150 mV to 25V into 1 MΩ. Line two 2 mV to 200 mV into 100 KΩ. PU 1 mV to 100 mV into 47 KΩ RIAA equalised for mag PU. Mic 100μV to 30 mV suitable low impedance microphone.

Outputs: Line 160 mV to 200 mV into 10 KΩ. Speakers 12W sinewave into 8Ω both channels driven. Equivalent to a total of 32W of music power. Headphones suitable low impedance headphones.

Amplifier frequency response: -2 dB 20 Hz to 25k Hz.

Overall frequency response: 38 cm/s 20 Hz to 22k Hz ±3 dB. 19 cm/s 30 Hz to 20k Hz ±3 dB. 9.5 cm/s 50 Hz to 16k Hz ±3 dB. 4.75 cm/s 70 Hz to 9k Hz ±3 dB.

Record-replay equalisation: To DIN std (NAB optional).

Distortion: .04% at 10W typical on amplifier.

Signal-to-noise ratio: to 0 dB DIN 38 cm/s 57dB. 19 cm/s 56 dB. 9.5 cm/s 50 dB.

Crosstalk: better than 60 dB.

Recording level meters: monitoring during recording by accurate individually calibrated VU meters with fast rise time.

A to B comparison switching: source to tape switching separate on each channel.

Bias: adjustable for both tracks from front.

Tone controls: Treble ±12 dB at 10k Hz. Bass ±12 dB at 50 Hz.

Volume controls: separate for each channel.

Internal speakers: two: 150 mm x 100 mm, handling 5W each

GENERAL

Mains supply: 110 to 260V ac 50 Hz (60 Hz optional).

Mains consumption: 100 VA max.

Dimensions: 43 x 43 x 19.5 cm approx.

Weight: 17 kg approx.

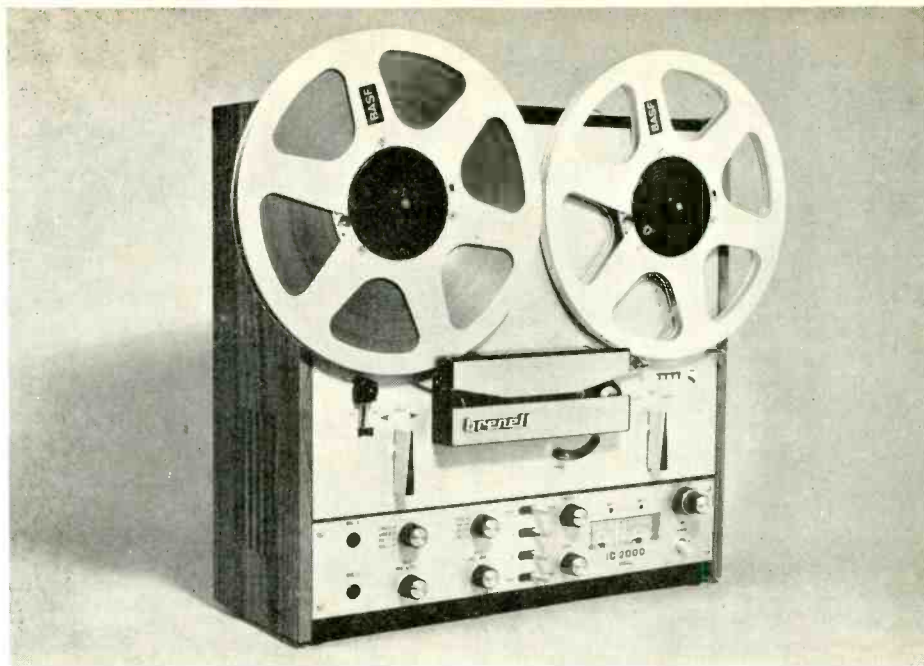

Cabinet: black metal, wooden side panels teak veneered, brushed aluminium panels satin finished.

Reels and tape: optional.

Price: £237.60.

Manufacturers: Brenell Engineering Co Ltd, 231/235 Liverpool Road, London N1.

THE BRENELL type IC 2000 recorder is the latest from Brenell Engineering, who are a long-established firm in the field of tape recording. Having regard to both the price and specification of the type IC2000, it is clearly aimed to fill a gap between the Ferrograph and Revox products, which both find a place in the smaller studios as well as in the many organisations which use tape for professional purposes.

As is to be seen from the specification, both two track and four track stereo versions of the machine are available with the option of switchable configurations of replay heads: the machine having space for up to four heads which would normally comprise an erase head, a record head and up to two replay heads. The review machine was a two track stereo machine, which is likely to be the most popular professional configuration.

In construction the machine is divided into the tape transport which includes the tape heads, and the amplifier system. These are supported by the cabinet which consists of two side plates of steel with bent (but not welded) flanges, to which are secured the wooden trim. The remaining outside surfaces are covered by ventilated metal panels which are finished in a black plastic. Two loudspeakers (one for each channel) are located within this cabinet and are secured to the side panels such that they face outwards at the sides of the recorder. As is to be expected from loudspeakers mounted within a recorder the quality of reproduction is only useful for 'rough listening' and I regard the provision of two loudspeakers as a doubtful

asset because their positioning is such that stereo reproduction is impossible.

As is normal, the tape transport is mounted above the amplifier section and all operational controls are on the front panels, together with the two microphone inputs. However, the headphone jack is mounted at the rear of the amplifier section, together with the low-level signal connections which are of the DIN type, jack outputs for external loudspeakers and the mains input connector which is of the miniature Bulgin type. The mains voltage selector is within the cabinet and is of the type which houses the mains fuse—a short, fat fuse about 12 mm long. Two further fuses of the 1 1/4 inch imperial variety are hidden underneath the mains transformer and protect the dc supplies, which themselves are mounted on small printed boards secured to the wire ends of the block type rectifiers in turn bolted to the cabinet side plates.

Connections between the tape transport and the amplifier chassis are by means of edge type connectors so it is relatively easy to separate the two sections which at first sight would aid servicing. However, the mains transformer and power supplies are within the tape transport section. For servicing the amplifier section it is therefore necessary to remove it from the cabinet and reconnect it outside the cabinet.

While the layout of the amplifier printed board is tidy and a good quality board is used, there is a forest of wiring to switches within the amplifier section and the tape transport section also has its share of loose wiring as well as several components which are precariously suspended on their leads (including large wire-wound resistors). Some components are secured in position by adhesive tape.

The tape transport

The main body of the tape transport is a 3 mm thick metal plate, on to which all the other mechanical components are mounted, the mounting holes being hidden from view at

the operating surface by a brushed aluminium trim plate. The spool drive is by means of two Papst type ROT 20.65-4 motors with integral cine type spool hubs. The motors are mounted so that the maximum spool capacity is 27 cm diameter where the spools overhang the sides and top of the cabinet by about 6 cm. Adaptors are provided for mounting either NAB or European type spools. There is not, however, enough clearance to use the full-size 29 cm European spool. However, because of the low winding tension at large reel diameters resulting from the rating of the type of motor used it would not be practicable to use single-sided spools of greater than about 18 cm diameter.

Capstan drive is accomplished by using a stepped pulley on the capstan motor with a movable idler wheel which bears on to the capstan flywheel and the stepped pulley, three tape speeds being selected by moving the idler between pulley steps. Sensibly, the idler wheel is kept out of contact with the other surfaces when the tape transport is not in action. Tape speeds of 38, 19 and 9.5 cm/s were standard on the review machine but the combination of 19, 9.5 and 4.75 cm/s can be obtained by changing the capstan for a smaller diameter capstan. The tape path starting at the pay-off reel proceeds as follows: a tension arm which mechanically controls the pay-off tension by the brakes, a fixed flanged guide (the heads which do not have pressure pads), a further fixed flanged guide, the capstan, a fixed post guide followed by the take-up spool. Unfortunately the capstan is of brass, as are the guides with some plating, so capstan and guide wear are likely to be a severe problem. Also, while no pressure pads are used, there are unfortunately no rotating guides in the tape path with the result that friction noise (scrape flutter) is extremely bad as is shown in fig. 1. This illustrates a 6k Hz fundamental recorded at 19 cm/s with its two major flutter sidebands about 100 Hz from the fundamental and about 20 dB down.

The heads are mounted on a separate plate on the main body and are provided with height and azimuth adjustment in a rather clever way. Between the heads and their mounting plate there is a layer of elastic material which is compressed when the three head mounting screws are tightened. As the mounting screws are located in a triangle, it is possible to adjust head height, azimuth and tilt by means of the three screws. In the fast wind mode the tape is normally held out of contact with the heads, thus reducing head wear of the metal record and replay heads. It is however possible to put the tape in contact for listening during fast winding.

A cue lever is provided for stopping the tape with the machine in the record or replay modes and, when in the cue state, the tape may be rocked for locating edit points; however, there is a metal hum screen close to the replay head so that it is virtually impossible to mark the tape for editing at the replay head. It was also found that operation of the cue lever had a most undesirable effect on the tape tension between the pay-off spool and the capstan; this is because the cue lever applies the brakes to the pay-off spool before the capstan is disengaged when entering the cue mode and vice versa when returning to the run mode—the tape is therefore stretched by the full capability of the capstan tension.

FIG. 1
BRENNELL IC2000
FRICTION NOISE
SIDE BANDS WITH
3KHz FUNDAMENTAL
NARROW BAND 3-15Hz
SPECTRUM ANALYSIS

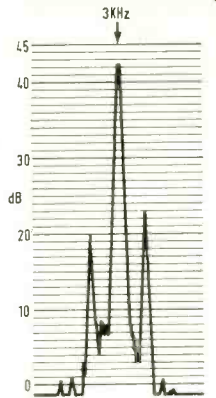

Accidental operation of the cue lever in the fast wind mode provided one of the most impressive tape breaking demonstrations that I have seen for a long time, and relatively rapid changes from the fast modes to replay were not interlocked so that generous loops could be thrown if the tape was not allowed to stop between operations. However, loop throwing was not bad when starting and stopping from record or replay but was present in spite of the tape tension switch which is intended to allow for the tension requirements of large or small spool.

Mode selection is by means of two knobs, one for selecting the fast forward or rewind modes and the other for selecting stop, replay or record (where there is an interlock button

62 ►

APRS

MEMBERS AND
AFFILIATES
SAVE MONEY
BY TEST
TAPE SCHEME

Details from:

APRS SECRETARY
E L MASEK
23 Chestnut Avenue,
Chorleywood,
Herts WD3 4HA

FIG. 2
BRENNELL IC2000
RECORD / PLAY
RESPONSE
CHANNELS ALTERNATELY
SWITCHED

PEN... 100mm/S
PAPER... 3mm/S

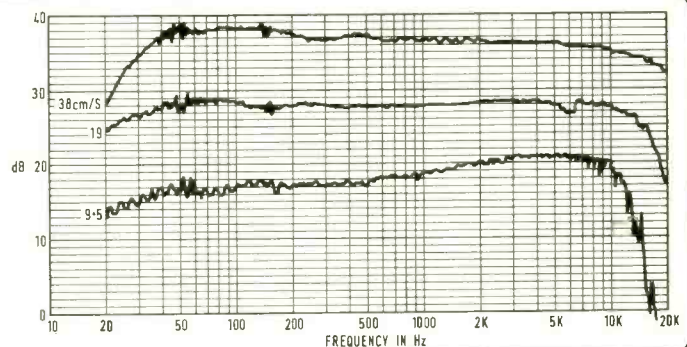
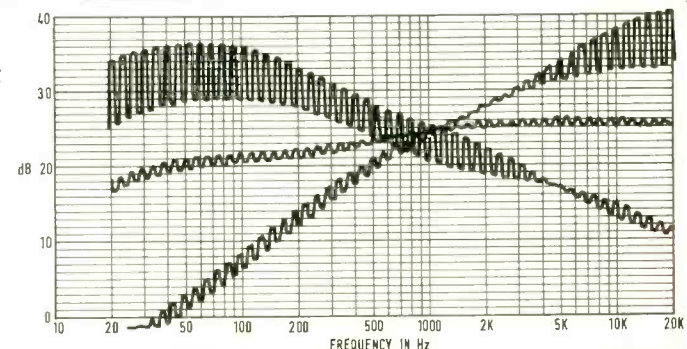

FIG. 3
BRENNELL IC2000
AMPLIFIER RESPONSE
CHANNELS ALTERNATELY
SWITCHED

PEN... 200mm/S
PAPER... 3mm/S



that must be pressed simultaneously). Operation of the latter control was rough and stiff and entering the record mode was a particularly heavy operation.

The above describes the major features of the tape transport itself but, as may be seen from the manufacturers' specification, there are other facilities such as a domestic-type tape length indicator and auto stop.

Wow and flutter and tape speed

The tape speed as measured by means of a standard frequency calibration tape was found to be 0.5 per cent slow at 38 cm/s at the beginning of a 29 cm diameter spool, 0.4 per cent slow at 19 cm/s, and correct at 9.5 cm/s. Speed drift between the beginning and end of a 27 cm diameter NAB spool was found to be 0.8 per cent, slowing down towards the end at the 38 cm/s and 19 cm/s speeds or a 1.12 per cent loss at the 9.5 cm/s tape speed. None of these performance figures can be described as being to a professional standard. Likewise the measured wow and flutter on the review sample was far outside the manufacturers' specification, the following figures being the average of measurements at the beginning, middle and end of reels of standard play tape:

Tape speed (nominal)	Cine spool		NAB spool
	DIN (W)	rms (UW)	DIN (W)
38 cm/s	0.09%	0.09%	0.07%
19 cm/s	0.14%	0.12%	0.12%
9.5 cm/s	0.44%	0.38%	0.40%

The close relation of the rms unweighted figures to the din weighted figures is rather unusual, but examination of the unweighted waveform demonstrated that this is accounted for by the high amplitude high frequency flutter components which are attenuated by the DIN weighting. This factor of course correlates with the poor friction noise previously noted.

The replay electronics

The performance of the replay section was evaluated from examination of the signal at the line output DIN socket which is wired before any level or tone controls, as of course it should be. The replay level at this socket was found to be 200 mV at both channel outputs for a tape flux of 320 nWb/m at 1k Hz at the tape speeds of 38 cm/s and 19 cm/s, or 160 mV for a flux of 250 nWb/m at 333 Hz at 9.5 cm/s.

At the tape speed of 38 cm/s, the replay frequency response as measured with the DIN standard 35 μs time constant tape was within +3 dB -0 dB relative to 1k Hz from 31.5 Hz to 18k Hz; at 19 cm/s with the DIN 19H tape with the 50 μs and 3,180 μs time constant the replay response was within the same limits above 63 Hz but the output rose to +5 dB at 31.5 Hz, a similar pattern being observed at the tape speed of 9.5 cm/s but with a mid frequency 'hump' around 4k Hz. While some of the bass boost is due to the fringing effect with half track heads, the bass equalisation is not above suspicion. However, the balance between tracks at all three speeds was first-class with a maximum deviation of only 1 dB being observed.

Measurement of the machine replay noise also produced a pleasant surprise so far as weighted measurements were concerned, but unweighted measurements were not so good as a result of rather poor hum performance. The machine is, however, generally in keeping with its specification.

Nominal tape speed	Machine only replay noise worst channel		
	Unweighted	'A'	50 Hz
	20 Hz to 20k Hz weighted hum		
38 cm/s reference 320 nWb/m	53.5 dB	69 dB(A)	54.5 dB
19 cm/s reference 320 nWb/m	53.5 dB	68 dB(A)	54.5 dB
9.5 cm/s reference 250 nWb/m	51.0 dB	63 dB(A)	52.5 dB

The record-replay performance

Each channel has two adjustments provided on the front panel for equalising the record section, a bias setting control and a high frequency equaliser. On the manufacturers' recommendation these were adjusted for 1 dB over bias at 1k Hz and the flattest response at the tape speed of 38 cm/s and the major parameters measured with standard play Scotch type 206 tape under these conditions.

The resulting record / replay frequency response is shown in fig. 2 from which the reader may draw his own conclusions. Three per cent third harmonic distortion at 1k Hz occurred at +2.5 dB above reference level of 320 nWb/m at the tape speeds of 38 cm/s and 19 cm/s, and 5 per cent third harmonic distortion at 333 Hz at the tape speed of 9.5 cm/s occurred at a level +2.5 dB above the reference level of 250 nWb/m, all figures indicating that the optimum tape performance is not taken advantage of. Similarly, the increase of tape noise above bulk erase noise when the tape was recorded with bias but no audio signal was rather high at 5 or 6 dB at the two higher tape speeds.

The operating instructions provided with the recorder state that the bias setting controls should not be set below their half-way positions, or within 10° of their maximum position—ignoring these instructions certainly had peculiar effects. However, in my opinion such limitations are not reasonable in spite of the instruction book warning and I have the impression that such limitations can be readily eliminated by the manufacturer. In spite of this, the range of the bias control is adequate for the common tape types including such tapes as *BASF LR56* which can also be driven to its full capacity by the record amplifier.

On this subject, the operation of the record level controls was observed to have some rather peculiar effects on the level metering—subsequent examination revealed that severe waveform clipping occurred when the level control was operated and from this I strongly suspect that the level control has dc across it and upsets the dc conditions of the record amplifier when it is operated.

The record level indicators

The level meters are permanently connected to the record section and appear to be located before any record pre-emphasis. Investigation into the meter ballistics showed that the meters had an integration time only slightly slower than a standard VU meter and that the rectifier

characteristic approximated to the standard average characteristic. The manufacturers' suggestion of 'VU meters with a fast rise time' does not appear to apply to the review sample.

Calibration of the meters was such that 0 VU corresponded to 1.5 dB below the DIN reference level at a tape speed of 38 cm/s which is only 4 dB below the three per cent distortion level—the calibration of the meters is therefore unsatisfactory in that an 8 to 10 dB margin should be allowed as stated in the NAB standard for reel to reel tape recorders.

The inputs and outputs

Four alternative inputs are provided, the required input being selected by a rotary switch such that it is only possible to use one input at a time and no mixing of inputs is possible. The performance of the inputs was reasonably satisfactory as is shown in the following table:

Input	Sensitivity for 0 VU at 1k Hz 38 cm/s	Overload	Impedance
Line one	147 mV	over 10V	496 kΩ
Line two	1.4 mV	320 mV	93 kΩ
Pickup	180 μV	180 mV	38 kΩ
Microphone	70 μV	70 mV	130 kΩ

On the output end there is a line output giving 200 mV out for the DIN reference level at a speed of 38 cm/s and from a low source impedance of 530Ω, and also a headphone output which is taken from the power amplifier and therefore subject to the tone control setting and the position on the A/B switch which is wired so that the 'A' position is before record and 'B' after.

The amplifiers

Abbreviated testing of the amplifiers showed that the rated power output of 12W sinewave into 8Ω with both channels driven was met with less than 1 per cent harmonic distortion, the distortion rapidly falling below this level as is shown by the following intermodulation distortion figures to the SMPTE method.

Power output	Channel One % IM	Channel Two % IM
Equivalent sinewave	% IM	% IM
12W	2.8%	3.4%
1.2W	0.6%	1.5%
120 mW	0.18%	0.59%

Fig. 3 shows the frequency response of the two amplifier channels with the tone controls in the mechanical centre positions and at the extreme positions, it being observed that severe imbalance occurs between channels in the treble or bass boost positions. A similar characteristic to the extent of 4 dB imbalance was observed in the RIAA pickup equalisation which was otherwise general to the correct curve.

When using the amplifier on its own, the input sensitivities are some 26 dB lower than those quoted for a 0 VU indication but the amplifier gain in the replay condition is more than adequate.

Summary

Even if the electronics department of this recorder had been perfect, I would be unable to give any recommendation to the entirety because of the poor standard of construction

This is SYSTEM 12

and so is this

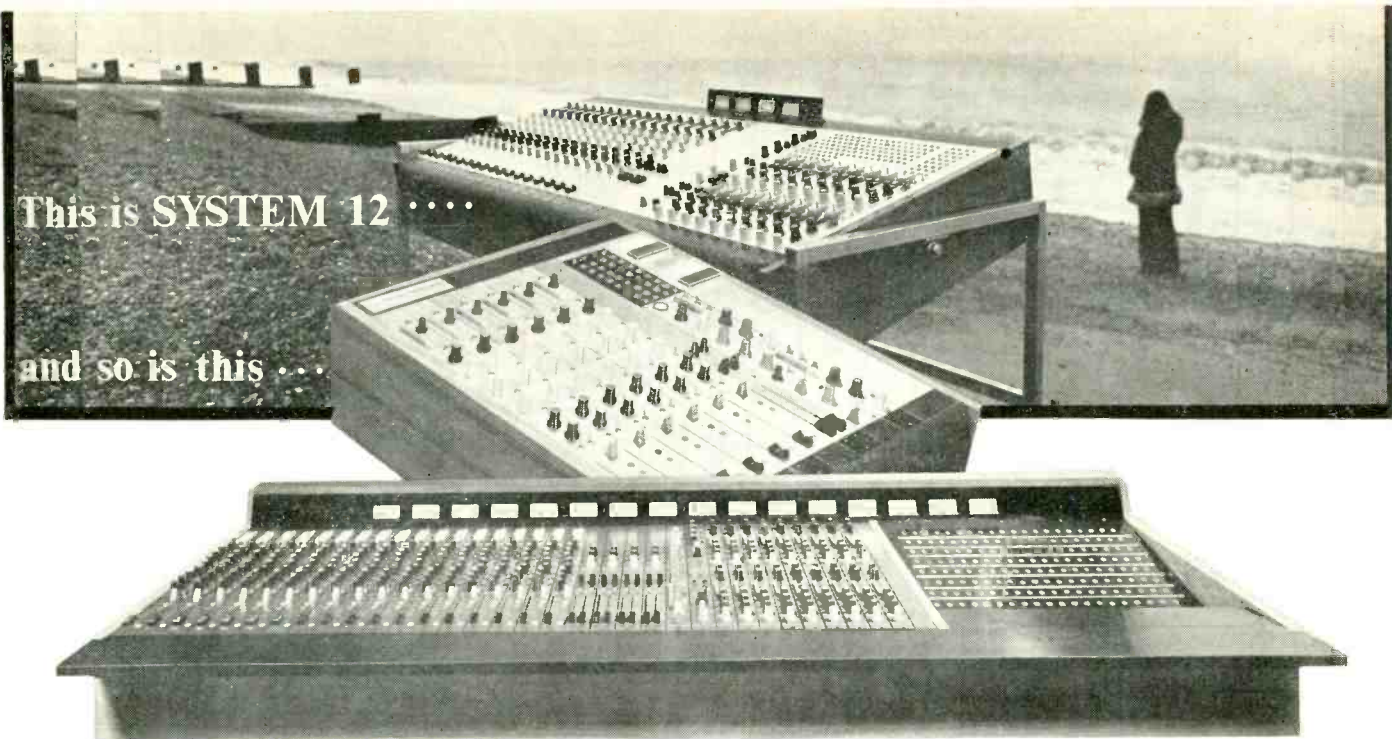

. . . . And now the Superlative SYSTEM 24

SOUND TECHNIQUES MIXERS come in all shapes and sizes. But they all have one thing in common—quality, flexibility, and unmatched value. SYSTEMS 12 and 24 require no installation and start earning their keep from the moment you plug them in.

Whatever your need—Big or small—there's a SOUND TECHNIQUES SYSTEM to fit it.

Sound Techniques Ltd.

HAMPSTEAD AVENUE ·
MILDENHALL · SUFFOLK ·
Tel.(0638)713631.

TELEX CASSETTE COPIER

Duplicating Speed: 30 ips (76 cm/s)

Rewind Speed: 60 ips (152 cm/s)

Frequency Response: 30-10 kHz.

Automatic Erase: Track selectable.

S/N Ratio: 45 dB below record level (3% T.H.D.)

Crosstalk Rejection: 50 dB minimum at 1 kHz.

Head Configuration: ½ track 2 channel.

Equalization: RIAA and DIN Standard.

Controls: Lighted amber rewind button.
Lighted blue copy button.
3 position track selector (for duplicating just track 1 or track 2 or both).
Red motion light for each transport to indicate stoppage of tape travel.

Weight: Less than 30 lb. (13.5 kg)

Dimensions: 15½" W x 17¾" D x 7½" H.
40 cm W x 45.5 cm D x 19 cm H.

Warranty: One year.

Price: £523.00

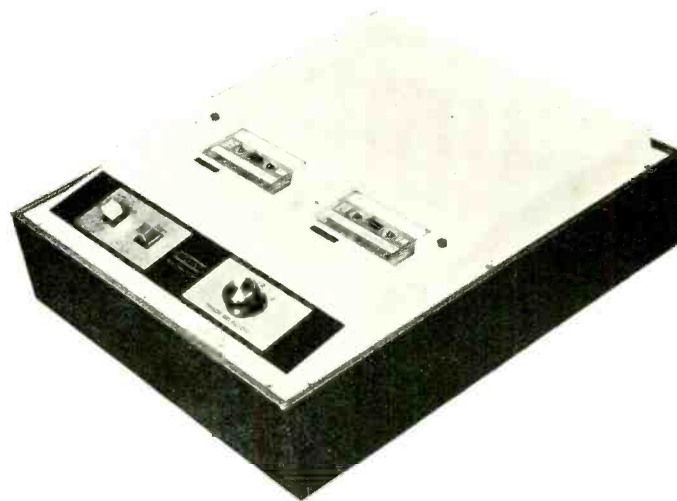

Avcom Systems Ltd

Newton Works, Stanlake Mews,
London W12 7HA Tel. 01 749 2201

■ BRENELL REVIEW

and performance of the tape transport; in particular the excessive friction noise (scrape flutter) and the violent treatment of the tape by the pause control condemn the mechanical department.

On top of these complaints, it has been seen that the record electronics in particular have a number of shortcomings and the amplifier section has very poor balance between channels when the tone controls are in the boost positions.

In spite of the length of time taken over this

review, I have not mentioned a number of functions of the machine and both good and bad points have been omitted. However, in conclusion, I consider this machine very poor value for money at a price of £237 when a modest additional expense will purchase a machine in a different class of performance.

RECORDINGS

BRENELL IC2000

By Hugh Ford

THE BRENELL IC2000 claims to provide studio quality performance 'at a breakthrough price'—some £237, subject to usual professional discount, at which it could be an interesting alternative to its semi-professional rivals (the two-speed Revox 77 and the 27 cm reel Ferrograph) if it fulfilled this claim. In the light of some criticisms and suggestions made with regard to the first sample submitted for review, Brenell have made a number of modifications to bring the design closer to current standards: this is now in production, and this trial will be concerned mainly with the second sample.

Background

Very briefly, Brenell started out as manufacturers of accessories for cameras, among other things. They went on to produce tape decks in kit form and subsequently became manufacturers of domestic and semiprofessional complete recorders; decks and amplifiers were still available separately. The Mk 5 series was probably the most widely known. The Mk 6 deck and that used on the *IC2000* owe much to its original design. Brenell have since gone on to produce the Type 19 professional tape transport and a variety of multitrack professional machines—even exporting tape transports to Switzerland—while maintaining a domestic and semi-professional range. It is to the latter that the *IC2000* belongs, being essentially a versatile domestic machine designed to appeal also to the professional user as a compact and transportable unit.

Brenell's customers will be familiar with two aspects of their design philosophy: that the machines are not designed with built-in obsolescence in mind and that special versions or adaptations are normal requirements to be met. They are happy to go on maintaining very old equipment and to modify their current machines to suit customer requirements.

Design

The *IC2000* features separate four-speed deck and amplifier units in a transportable case which also contains the power supply and two small elliptical loudspeakers for checking the signal. The machine provides ic power amplifiers, bias and record pre-emphasis are adjustable on the front panel. There is a provision for maintaining tape tension reasonably

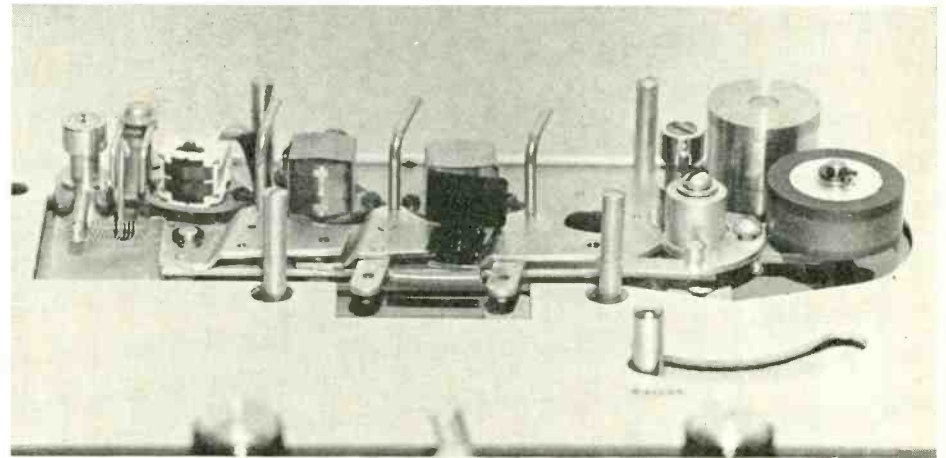

constant regardless of spool size and diameter. A pause facility is provided and a wide range of inputs and input levels can be accommodated (see review). A fourth head can be fitted to the machine, which in standard form is 2/2 track stereo/mono. The machine may be used horizontally or vertically.

Transport

The tape transport is a development of the familiar Mk 5 and Mk 6 mechanism, with certain major modifications: tensioning is switched for large and small spools, a mechanical servo brake assists constant tensioning, the heads are fitted in an arc, with a replay head screen but no pressure pads; capacity for 27 cm NAB spools and European hubs is standard, the mechanical pause of the Mk 6 has been incorporated, and there is a microswitch to cut power on the wind motors if the tape breaks or runs out.

Speed change is by three-position switch and capstan sleeve. As now supplied the machine is intended for use at the higher speeds only but a smaller capstan sleeve and pressure roller spring can be supplied to enable operation at 4.75 cm/s. A synchroniser Papst motor provides the drive via a stepped pulley and idler—simple and effective but mains frequency dependent. On the first sample the capstan appeared sensitive to loading. On the second sample, a slightly eccentric pinch wheel produced wow that was just audible on tone, piano or organ, particularly at 9.5 cm/s. There was also a certain amount of wow which appeared to be at capstan motor rotation frequency and therefore constant regardless of tape speed.

These faults were not evident on the first sample and curiously enough the capstan spindle on the modified machine had been very slightly extended, allegedly in order to improve the wobble performance. The capstan sleeves are of unplated brass and are located with a grub screw; they are not intended as a regularly changed item.

Two Papst motors are now used for spooling and tensioning (back tension is applied electrically both in play and wind), the record/play tension being assisted by the servo arm which senses tension and applies variable braking to the trailing spool carrier. The arm was slightly prone to scrape and chattered alarmingly towards the end of a NAB reel on fast wind without, however, causing any damage.

A four-digit turns counter is driven from the take-up spool. Plastic head covers pull off for cleaning and editing and to permit searching. No hf muting is provided so beware of damage to ears and speaker tweeters.

Control of the deck is entirely mechanical. A switch on the left provides wind/stop/wind control and a switch and interlock button on the right provide record/stop/play functions. As mentioned, speed selection is mechanical and a sliding control provides a locking pause facility: this is unfortunately spoiled by producing a click, which is recorded when using all but the least sensitive input, as the control is released; this really should be suppressed. In the pause condition the tape is held very firmly, rather too firmly for satisfactory editing.

As far as possible, steel bolts through guide

pillars, etc, have now been eliminated in favour of brass, in order to minimise the chances of running the tape over a permanent magnet! A fixed polished pin is now fitted to the right of the pinch roller and another near the edge of the deck reduces the risk of spillage from large spools. The absence of an adjustable tape guide was regretted as there is now no means of avoiding scrape with bent or non-standard spools.

Plastic cine/European/NAB reel adaptors are provided as standard, and reels are clamped in place by a turned plate with captive knurled nut. The record interlock button on the deck

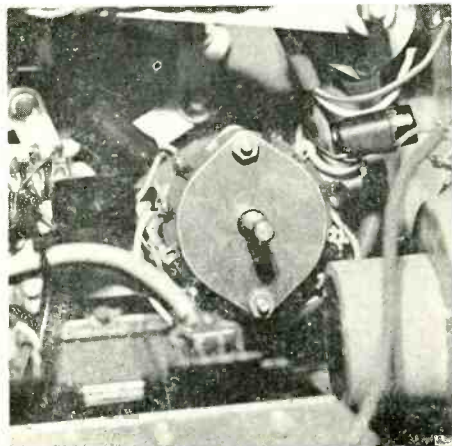

was extremely stiff and awkward to use. With the deck vertical, the pressure needed tended to topple the machine.

Heads

On the original sample, fine-gap Bogen heads were used for record as well as replay, which led to difficulties over proper biasing. A broad-gap record head is now fitted and the oscillator has been modified; most tapes will be properly biased at 38 cm/s. The replay head is a fine-gapped Bogen still, enabling a satisfactory replay response to be obtained at the lower speeds; the erase head is a Bogen 2/2 track ferrite type. A fourth head can be fitted if required to replay 2/4 or 4/4 format tapes.

Wobble

Wow on the second sample has already been mentioned. While on the earlier machine flutter had been intolerable at 9.5 cm/s, it was much improved by the addition of the tensioning arm. However, at all speeds it was possible to set up oscillations through tape snatch or splices passing the auto-stop pin. Despite the audibility of the wow on tone, the improved machine was just about usable at the three higher speeds on a great deal of material, though I would still not risk a live recording on it. The amount of flutter was found to depend both on spool size, the amounts of tape on the respective reels, and the amount of electrical back-tension applied. Minimum electrical back-tension at the start of a NAB reel and higher tension towards the end appeared to minimise the possibility of oscillations being set up, but obviously this is not something you

can do in practice during a recording.

Tension

With the improved tensioning arrangement, back-tension was felt to be adequate for 1p tapes on 27 cm spools in the play mode, and for standard play tapes on 18 cm spools, using the higher tension position of the selector switch. The small amount of back-tension on fast wind gave considerably better winding than on earlier Brenell decks, though with large reels the motors seem a little under-powered. The torque slide-switch and speed selector switch are very close together, making them inconvenient to operate; the deck lettering is almost bound to become scratched by fingernails.

Inputs and outputs

Two two-pole jacks on the front panel provide an input for medium or high impedance low level (microphone) sources; they are not duplicated at the rear, where all other inputs and outputs are grouped. Behind the amplifier section of the recorder (i.e. underneath it in normal use, or behind it when used vertically) a five-pin DIN socket provides inputs (at a nominal 47 k Ω) for magnetic gramophone cartridge, and a similar socket provides medium and high level line inputs as well as low-level high-impedance (10 k Ω) line outputs. Two two-pole jacks provide outputs to 8 Ω loudspeakers, and a three-contact jack provides a headphone outlet from the power amplifiers.

It seems odd to say the least that the microphone inputs should have been placed on the front panel but that the headphone outlet should be so inconveniently positioned. In practice the noise level of the power amplifier, even with the gain turned fully down, was far too high to enable the use of any but the least efficient low-impedance headphones. This fault was observed on both samples, despite minor modifications designed to overcome it in the second sample. It also seems odd to provide a switched input sensitivity ranging from magnetic cartridge level to volts, while providing only a nominal 200 mV line output, at an impedance which is too high for long leads to be used. I feel that at the very least, emitter follower outputs should have been provided. I understand however that Brenell may at a later date produce a version of this machine with low-impedance line-amplifier outputs in place of the power amplifiers.

Switching of the inputs is common to both channels and it is therefore not possible to record from differing sources on the two tracks.

Electronics

The amplifier section, which can be removed fairly easily for service, provides low-level input amplifiers, separate record and replay amplifiers, a/b monitoring and buffer amplifiers, meter drive, power amplifiers and record pre-emphasis and bias adjustments. The mains unit is mounted on the back of the deck, and the rear cover has to be removed to adjust the input voltage or change a fuse. Front-panel controls are input selector and equalisation selector (four speeds), separate record level controls, record pre-emphasis presets, separate play-record switches for the two channels with tape-source switches mounted between, treble and bass controls, bias adjustments, monitor

66 ▶

AB Pearl Mikrofon- laboratorium.

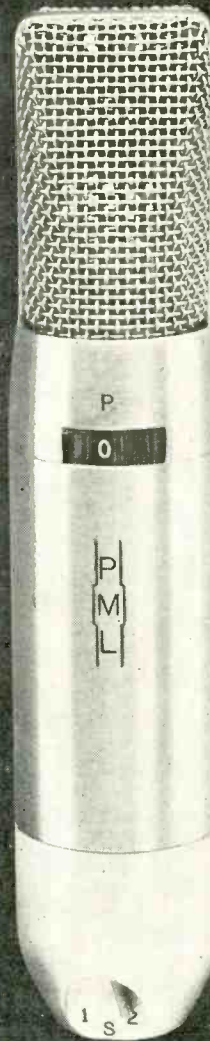

DC63.
48 volt, variable pattern.
Also available as
cardioid only DC96.

For further information on the complete range of Pearl microphones, contact:

Allotrope Limited

90 Wardour Street, London W1V 3LE.
Telephone: 01-437 1892. Telex: 21624.

U.K. Representatives for:

AB Pearl Mikrofonlaboratorium - Sweden, Microphones & accessories.

HES Electronics - Brussels, TSV series telephone balancing units, and studio equipment.

Inovonics Incorporated - Campbell California U.S.A., Audio electronics.

Roland Zeissler Werk Für Elektro Mechanik - Cologne, Racks and instrument housings.

■ BRENELL FIELD TRIAL

volume control, mains on-off and neon indicator, and of course the VU meters. Use of the speaker on headphone jacks mutes the internal speakers automatically.

I found the arrangement of the play-record switches and tape-source switches somewhat illogical. While on the former, play is to the left and record to the right, on the a/b switch direct is to the left and tape (i.e. play) is to the right; having them sandwiched together leads to all kinds of errors when used in haste.

The machine will not drop in and out of record silently. If the deck is first set to record and the amplifiers to play, and the amplifiers are then switched to record at the appropriate moment, a loud click goes on tape. A similar click is produced if the function switch is returned to play. Talking of clicks, rf and mains switching suppression were inadequate, and loud clicks were injected into the monitoring system. Input amplifiers were reasonably quiet, with a trace of hum obtruding on the magnetic cartridge input; the latter did not give particularly satisfactory results and I am very dubious about its conclusion. I feel it is a pity that selecting the appropriate speed on the deck does not automatically select the appropriate record and replay characteristics; I also found all the control knobs on the amplifiers too small.

Monitoring

Monitoring is via VU meters and inbuilt power amplifiers and speakers. The meters only read when the deck and amplifiers are switched to record (where the tape can be held on pause) though direct monitoring is possible via the power amps (or line output) both on play and when the tape is stationary. I understand that the version of the deck with low impedance line outputs instead of speaker outputs will also meter the replay signal. The meters are small and twitchy, and intended obviously for use in conjunction with other metering facilities. The 'source' signal is taken before the volume controls, this allows prefade listening, but makes a/b comparisons difficult because of differences in levels between direct and tape signals.

The problems of noise when using head-

phones has already been mentioned. The hiss problem was also apparent with speakers of reasonable sensitivity connected; the hiss through the internal speakers was so high as to suggest something amiss when switching on. There was also a certain amount of hum, but the second machine tested showed some improvement on the first; the hum level appeared lower at the line output if some care was taken with leads.

The ic monitor amplifiers would produce a reasonable sound level through external loudspeakers (the internal ones are small and to be disregarded when possible); I didn't think it wise to test their destructibility! The tone controls provided an adequate margin of bass and treble lift and cut, though on one machine the knobs required relocation so that the response was most flat at the central position; this brings into question the wisdom of fitting tone controls on monitoring outputs.

Bias and erase

On the second machine, with long-gap record head and modified oscillator, it proved possible to bias Scotch 202 and BASF LH long-play tapes properly at all three speeds. A screw-driver-torch with fine blade is ideal for adjustment of the bias; some care is needed in getting the blade into the slot first time, as the adjusters of the bias pots are made of soft plastic which wears badly with careless adjustment. Bias and erase noise were also improved on the second machine, but were not outstanding. On the first machine a low-frequency rumble was recorded on one channel, possibly the result of a leaky record-head capacitor.

Replay

The replay response of the machines was checked at 38 and 19 cm/s and was found to be correctly set within the confidence limits of the DIN test tapes used, except in the extreme bass. Detailed measurements were not carried out as the IC2000 is to be the subject of separate technical evaluation. Noise from the replay preamplifiers was adequately low.

Record

A sensibly flat response to 15k Hz was obtained at 38 cm/s, and reasonably flat response to domestic standards at 19 and 9.5 cm/s was obtained using Scotch 202 and BASF LH tapes. The record pre-emphasis adjustment appeared to operate at all speeds and needs to be reset (as does the bias) for the speed in use. Like the bias presets, the record pre-emphasis presets are a bit fiddly to adjust, but it is well worthwhile having them on the front panel.

Recorded quality

Although performance expectations today are somewhat higher than the IC2000 appears to achieve, the quality of recorded sound at 38 cm/s would probably be adequate for many purposes given careful adjustment of record pre-emphasis and bias, though without noise reduction the hiss level is not outstandingly good. At 9.5 and 19 cm/s the performance would again not be up to the best of domestic machines running at these speeds, but the machine will produce an acceptable sound. The performance at these two speeds has been considerably improved from the original design of the IC2000, and you must hope that improvements continue to be incorporated. The sound

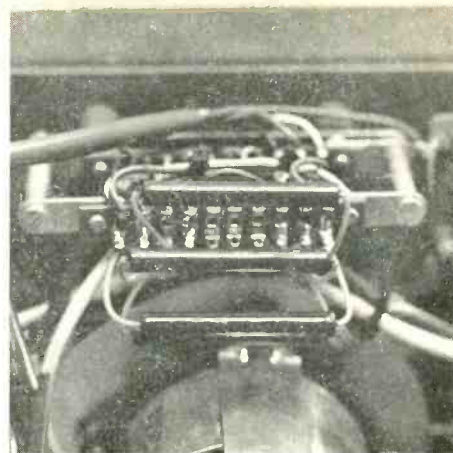

at 9.5 cm/s can still be gritty on some material with a large high-frequency content, and this may be due to a combination of clipping at high frequencies and flutter. The record amplifiers appeared to overload at a substantially lower level of modulation than on, say, a Revox 77.

I can understand why Brenell decided to incorporate some frills into what is, on the whole, a fairly basic machine, but I cannot help feeling that I would have been less disappointed with the results had they been omitted and the money spent on improving details such as wow and flutter, signal handling, noise and frequency response, not to mention clicks and plops. This is a pity, as it mars what could have been a very attractive machine.

Case and finish

The tape transport and amplifiers are clad in brushed aluminium, with aluminium and black plastic knobs. The case is partly teak veneered and partly black plastic-coated steel. A simple and fairly comfortable carrying handle is provided, but no protective lid. I understand that a later version may provide access to the voltage selector panel and mains fuse through a detachable flap in the bottom panel of the machine.

Safety and construction

I have mentioned points such as the headphone socket and function/monitor switches that would annoy me if I were using the machine. A glance under the deck plate reveals a standard of wiring that would not please me either. A point taken up with Brenell on the first sample was the excessive length of lead on the mains-bearing resistor mounted at the rear of the deck for torque control. On arrival, one resistor had moved so far on its leads that it shorted against the metal rear panel and blew the mains fuse. Had the machine not been earthed, it could have been dangerous as well. I was assured that this had been taken care of on the second sample, but alas on looking I found the leads only slightly shorter (admittedly insulated) and it might still be possible for movement of the resistors in transit, to make one short to metalwork or an adjacent component. Doubtless Brenell will look further into this.

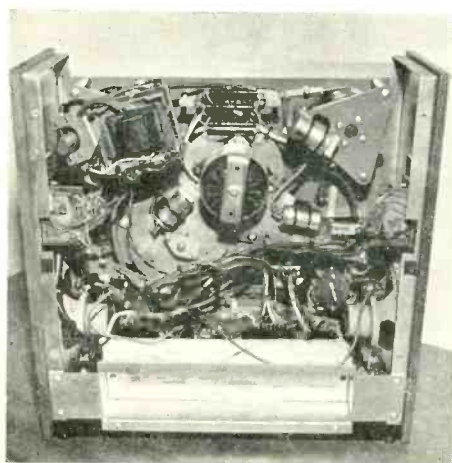

Conclusion

With its built-in power amplifiers and tone controls, and input for magnetic cartridge, the IC2000 is potentially the heart of a flexible, moderately-priced domestic audio system. For the industrial user it offers a three- (or four-) speed transportable machine which could if necessary be used for the replay or recordings of tapes made on or for replay on domestic equipment; the addition of a 2/4 track head would increase this versatility.

Brenell are open, in discussing the machine, in saying that it has been designed to keep the price to a minimum, and this should be borne in mind when weighing up certain shortcomings which have been brought out in this report. Nevertheless the price of the machine has risen in its first few months to a point where a potential purchaser must surely begin comparisons with longer-established competitors for

this sort of market. While I feel Brenell have made considerable and worthwhile improvements to the machine, and in some respects to the earlier valued designs, I would inevitably find myself making a number of modifications to an IC2000, if only adding low impedance outputs, suppressing clicks, and modifying the circuitry to enable the machine to drop in and out of record silently. The wow and flutter performance could still be improved with advantage. I understand that Brenell would consider modifying machines to suit customer requirements, but it would seem likely that this would increase the cost. The promised version with low impedance line amplifiers would seem a better starting point for the professional user—or indeed serious amateur—and I look forward to its appearance at an early date.

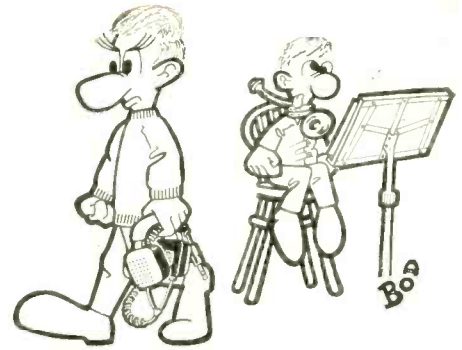

MUSIC BIBLIOGRAPHY

- SHIELDS, J. P. Simplest Theremin. From 'Novel Electronic Circuits'. H. W. SAMS 1968: 76.
- SHIPPEE, W. R. Simplified Tremolo. *Electronics World* (Oct 1966): 89.
- SHORT, G. W. Inverted Wien Bridge Oscillator. *Wireless World* 78: 78 (Feb 1972).
- SIGNETICS CORP. Voltage-controlled IC Oscillator of exceptional stability and linearity. Type No SE/NE 566 Function Generator (Signetics Corp, 811 E. Arques Avenue, Sunnyvale CA 94086). See *Pop. Electronics* (July 1971): 91.
- SIMONTON, J. S., JR. Surf Synthesiser. *Pop. Electronics* (Feb 1972): 45. Electronic Steam Whistle. *Pop. Electronics* (May 1972): 51. Electronic Wind Chimes. *Pop. Electronics* (April 1973): 51.
- SIMPSON, L. A Solid-State Theremin. *Electronics Australia* (June 1969): 98.
- SINGER CO. Frequency Divider Circuits. Brit. Pat. 1,265,560.
- SMALL, G. W. Synthesis of the Musical Scale Using Noninteger Frequency Division. *Journal of the AES* 21: 262 (1973).
- SMITH, D. T. Long-tailed pair LC Oscillator. *Wireless World* 76: 123 (March 1970). Multivibrators with Seven Decade Range in Period. *Wireless World* 78: 85 (Feb 1972).
- SMITH, D. The Music Maker Electronic Organ. *Practical Wireless* Vol 48 No 8: 716 (Dec 1972).
- SMITH, K. C., and SEDRA, A. Simple Wideband Linear Voltage to Frequency Converter. *Electronic Engineering* 40: 3 (1968).
- SMITH INDUSTRIES LTD. Frequency Dividing Circuits. Brit. Pat. 1,273,536.
- SMITH, L. SCORE—A Musician's Approach to Computer Music. *Journal of the AES* 20: 7 (Jan/Feb 1972).
- STAPELFELDT, R. Approximating the Frequencies of the Musical Scale with Digital Counter Circuits. *J. Acoust. Soc. Amer.* 46: 478 (1969).
- STEIN, J., and MARTIN, D. W. Electroacoustic Pipes for Organ. 43rd AES Convention Preprints (Sept 1972).
- SKAGSTAD, R. The Autotone (music generator). *Practical Electronics* 9: 490 (1973).
- SUMMER, S. E. Voltage Controlled Oscillator Uses an Integrated Circuit. *Electronic Design* 15 (July 1967).
- TESIC, S. Simple Voltage to Frequency Converter with Increased Frequency Range. *Electronic Letters* 4 No 2 (Jan 1968). Stable Voltage to Frequency Converter. *Wireless World* 78: 78 (Feb 1972).
- THOMAS, L. D. Wien Bridge Oscillator (using 741 OP AMP). *Wireless World* 78: 275 (June 1972).
- THOMAS ORGAN CO. Electrical Instruments. Automatic Bass. Brit. Pat. 1,296,593 (Oct 1972). Electrical Musical Instruments. Brit. Pat. 1,317,820 (1973).
- THOMAS, D. W., and ORR, T. Electronic Sound Synthesiser (Three Parts). *Wireless World* 79: 366, 485 (Aug/Oct 1973).
- TRIST, F. H. Audio Sweep Generator. *Wireless World* 76: 335 (July 1971).
- TSUKAMOTO, M., and NAKAJIMA, T. Signal-Selecting System for Keyboard Type Electronic Musical Instrument. U.S. Pat. 3,509,265 (1970).
- TYRELL, P. J. Waa-waa Pedal. *Everyday Electronics* 1: 214 (Feb 1972).
- UCHIYAMA, YASUJI. I.C. Switching Device for Electronic Musical Instruments. U.S. Pat. 3,535,429 (1970).
- UETRECHT, D. M. R.C. Distributed Filter for Electronic Organ. U.S. Pat. 3,538,805 (1970).
- de VISME, G. F. A. HOFFMAN. Audio Frequency Discriminator. *Practical Electronics* 9: 133 (Feb 1973).
- VOLPE, I. D. Multivibrator Frequency Divider Chain for Musical Instrument Employing a Master Oscillator which is Step Frequency Adjustable and a Twin-T Vibrato Oscillator. U.S. Pat. 3,490,327 (1970).
- VOLTAGE CONTROLLED ACTIVE FILTER (Fairchild Semiconductors). *Electronic Engineering* (Feb 1972): 45.
- WARD, C. C. Variable Astable Multivibrator using TTL ICs. *Wireless World* 76: 512 (Oct 1971).
- WARD, R. J. Sweep-frequency Audio Oscillator. *Wireless World* 76: 412 (Sept 1971).
- WAYNE, W. C. Choral Tone Effect Simulator by frequency shifting. U.S. Pat. 3,004,460. Baldwin Piano Co. Electrical Organ. U.S. Pat. 3,505,462 (April 1970). Frequency Changer Employing Opto-Electronics. U.S. Pat. 3,516,318 (1970).
- WEBB, R. E. Frequency Doubler. *Wireless World* 78: 540 (Nov 1972).
- WESTINGHOUSE ELECTRIC CORPORATION. Tuning Device for Integrated Circuits. Brit. Pat. 1,270,181 (March 1972).
- WHEELER, R. L., and TERLINDE, D. J. Stringed Guitar with Electronic Organ Tone Generator actuated by the Fingerboard Switches. U.S. Pat. 3,530,226 (1970).
- WIEST, J. A. Sustain Tone Device for Electrical Musical Instruments. U.S. Pat. 3,519,723 (July 1970).
- WILLIAMS, N., and LEO, A. Organ Tremulant Vibrato. *Electronics Australia* (March 1969): 61.
- WILLIAMS, P. Wien Oscillators. *Wireless World* 77: 541 (Nov 1971).
- WOODY, R. F., JR. Putting Electronic Organs in Tune with Natural Sounds. *Electronics* (June 1968): 100.
- WRIGHT, M. J. A Linear Voltage to Frequency Converter. *Electronic Engineering* (July 1973): 46.
- WURLITZER CO. Portable Music Laboratory. Brit. Pat. 1,276,489 (April 1972 issue of *Official Journal*). Electrical Simulation of the Sound of Rhythm Instrument. Brit. Pat. 1,318,061 (1973).
- WYVERN CHURCH ORGANS LTD. Frequency Dividing Circuits. Brit. Pat. 1,264,131.
- YOUNG, A. C. Photoresistor Delay Line Scanner for Vibrato. U.S. Pat. 3,452,145 (June 1969).
- YOUNGSON, R. M. Bibliography of Electronic Music. *STUDIO SOUND* 14 No 5: 45 (May 1972). Understanding Music Synthesisers. *STUDIO SOUND* 14 No 7: 55 (July 1972). Chromatic Intervals from a Single Frequency. *STUDIO SOUND* 15 No 10: 42 (Oct 1973). The Comma of Pythagoras. *STUDIO SOUND* 15 No 11: 66 (Nov 1973).
- YUICHI TERANISHI. Switching Device for Electronic Musical Instrument with Sustain Effect. U.S. Pat. 3,533,972 (Oct 1970).

Classified Advertisements

Advertisements for this section must be pre-paid. The rate is 8p per word, minimum 80p. Box Nos. 20p extra. Semi-display rates on application. Copy and remittance for advertisements in **SEPTEMBER 1974** issue must reach these offices by **15th JULY 1974** addressed to: The Advertisement Manager, **Studio Sound**, Link House, Dingwall Avenue, Croydon CR9 2TA.

NOTE: Advertisement copy must be clearly printed in block capitals or typewritten. Replies to Box Nos. should be addressed to the Advertisement Manager, Studio Sound, Link House, Dingwall Avenue, Croydon CR9 2TA, and the Box No. quoted on the outside of the envelope. The district after Box No. indicates its locality.

FOR SALE—TRADE

★ **A new dB tamer** from Cathedral . . . Compressor/Limiter module CLA 1, £15.50 post and VAT paid. Low distortion oscillator module OSC/2 £15.50 post and VAT paid. Quantity discounts available. S.A.E. details Cathedral Sound, Fourways, Morris Lane, Halsall, Lancs. L39 8SX.

★ **Mixer Kit.** Professional standard 5 channel mono and stereo kits. Full assembly instructions, fibre glass printed circuits, front panel case and all components. Slider controls—mains power — pre-fade listen — magnetic cartridge input—auto fade. Dimensions—24x6x3. Mono Kit-£33.00. Stereo Kit-£49.00 inc. VAT. Details, specification, picture SAE to Harwell Instruments Department BPC, Spice Yard, South End, Croydon CR0 1BF.

BUILDING or PURCHASING an AUDIO MIXER, pre-amp, autofade, V.U. or audio monitor, V.E. mixer, driver or power supply, etc. First consult
PARTRIDGE ELECTRONICS
(Ref. S.S.), 21-25 Hart Road, Benfleet, Essex. *Established 23 years*

★ **Nagra III and IV and SN models available.** Immediate delivery. Write or phone J. J. Francis (Wood Green) Ltd., Manwood House, Matching Green, Harlow, Essex. Tel. Matching 476.

★ **Less than 12 months old 4 track 1/2" Scully**, complete with all sync facilities. Also matching TRD mixing down twin track 8/4 mixer. H.P. facilities available. Only reason for selling: have gone 8 track. Phone: Radio Worcester Productions, 0905 21112.

★ **Audiofact No. 1!!** You can build 8 Cathedral Compliminters into your mixer for LESS than the cost of one medium price competitor. P.S. Ask about our new Graphic Equaliser. Cathedral Sound, Tel. Halsall 328.

Building Mixers?

zero88

AUDIO MODULES

offer high quality at competitive prices

Contact Richard Brown at Zero 88,

115 Hatfield Road, St. Albans, Herts

AL1 4JS Tel: 63727

RAC MIXERS

Custom-built mixers for groups, P.A., hospital broadcasting, recording, discos, etc. RAC plug-in audio modules for building your own mixers. Sony, Akai, TEAC, Tandberg, Marantz, Lux, Nikko, Dual, Quad and Armstrong dealers. Shure, Calrec, AKG mikes and stands, etc. APRS Manufacturing members.

RUGBY AUTOMATION CONSULTANTS
19 Freemantle Road, Bilton, Rugby,
Warwickshire CV22 7HZ
Tel. 0788-810877 (Rugby)
Call, write or phone us

SOWTER TRANSFORMERS

FOR SOUND RECORDING AND REPRODUCING EQUIPMENT
We are suppliers to many well-known companies, studios and broadcasting authorities and were established in 1941. Early deliveries. Competitive prices. Large or small quantities. Let us quote.
E. A. SOWTER LTD.
Transformer Manufacturers and Designers
7 Dedham Place, Fore Street, Ipswich IP4 1JP
Telephone 0473 52794

PEAK PROGRAM METERS TO BS4297

also 200KHz version for high speed copying:
Drive circuit, 35 x 80mm, for 1 ma L.H. zero meters to BBC ED 1477. Gold 8-way edge con supplied.

	4 off	10 off	50 off
Complete kit	£10.00	£9.50	£9.00
Built and aligned	£14.00	£13.30	£12.60

£11.90
ERNEST TURNER PPM meters. Below scalings stocked
Type 642, 71 x 56mm £10.90: 643, 102 x 79mm £12.90
TWIN MOVEMENT, scale 86 x 54mm £31.00.

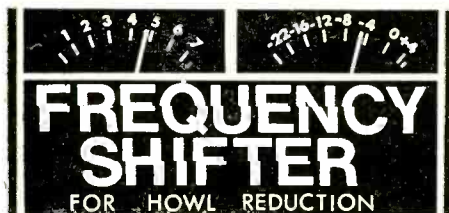

PUBLIC ADDRESS : SOUND REINFORCEMENT
In any public address system where the microphones and loudspeakers are in the same vicinity acoustic feedback (howl-round) occurs if the amplification exceeds a critical value. By shifting the audio spectrum fed to the speakers by a few Hertz the tendency to howling at room resonance frequencies is destroyed and an increase in gain of 6-8dB is possible before the onset of feedback.
SHIFTERS IN BOXES with overload LED, shift/bypass switch, BS4491 mains connector and housed in strong diecast boxes finished in attractive durable blue acrylic. Jack or XLR audio connectors.

Type	A	B	C
Input impedance	200Kohm	200Kohm	10Kohm Balanced
Output impedance	2Kohm	20or600ohm	20or600ohmBAL
PRICE	£58	£68	£84

SHIFTER CIRCUIT BOARDS FOR WW July 1973 article
Complete kit and board £21 including p.s.u. and
Board built and aligned £28 mains transformer
DESIGNER APPROVED

SURREY ELECTRONICS

The Forge, Lucks Green, Cranleigh, Surrey GU6 7B
(STD 04866) 5997
CASH WITH ORDER less 5% U.K. post free, add VAT

FOR SALE—PRIVATE

★ **Mic.** Cable braided 2x 14/.0076 grey in stock. Phone Ian, 01 586 0064. 9p Metre.

★ **Revox HS77 7 1/2/15** Recorder 6 months old, £225 o.n.o. Tel. Bury St Edmunds 2322.

★ **Naim-Audio Stereo Mixer:** 4 line and 6 mic inputs, pan bass and treble controls, oscillator 2 meters, £175.00. Also 2 Chilton tape decks type X 100S 15/7 1/2/3 3/4 7" reels recently serviced, £110.00, 7 1/2/3 1/4 7" reels, £85.00. All items 18 months old. Box No. 678.

★ **10/2** Portable mixer Allen Heath Modules, £350. Details 051 236 2086 or Southport 24994.

STUDIO FACILITIES

★ **Fanfare Records.** Tape-disc pressings, demo's, masters, any quantity. Studio/mobile. Neumann disc cutter. S.A.E. brochure. 1 Broomfield Close, Rydes Hill, Guildford. Tel. 0483 61684.

S.G.S. RECORDING STUDIO

DEMOS AND MASTER PRESSINGS
MULTITRACKING FACILITIES 01-778 0450
Complete studio service. Mobile studio service engineers. Music publishing. Independent production Group P.A. and amps serviced and sold. Disco equipment installed.
131A ANERLEY ROAD, LONDON S.E.20
Studio 01-778-0450 Messages 01-688 0728

RECORDS MADE TO ORDER

DEMO DISCS MASTERS FOR RECORD COMPANIES	VINYLLITE PRESSINGS
---	------------------------

Single discs, 1-20. Mono or Stereo, delivery 4 days from your tapes. Quantity runs 25 to 1,000 records **PRESSED IN VINYLLITE IN OUR OWN PLANT.** Delivery 3-4 weeks. Sleeves/Labels. Finest quality NEUMANN STEREO/Mono Lathes. We cut for many Studios UK/OVERSEAS. SAE list.

DEROY RECORDS
PO Box 3, Hawk Street, Carnforth, Lancs.
Tel. 2273

★ **7in.** pressings manufactured in our own pressing plant—speedy delivery. Yarmouth Recording Studios, Scratby, Great Yarmouth. Tel. Great Yarmouth 730136.

★ **County recording service** stereo and mono masters and lacquer discs from your tapes. Telephone Bracknell 4935. London Road, Binfield, Bracknell, Berks.

★ **J & B Recordings.** Tape to disc—latest high level disc cutting, all speeds. Master pressings, studio, mobile. 14 Willows Avenue, Morden, Surrey. MITcham 9952.

COMPACT CASSETTES

PROFESSIONAL HIGH-SPEED DUPLICATION
Dolby B—compression and equalisation available—competitive prices on small runs—full productions undertaken—music and language specialists.

Contact Chris Sands
AUDIO EDUCATION COMPANY
01-723 6635

ANGLIA PRESSING COMPANY

(Yarmouth Recording Studios)
Specialists in small orders of 7" and 12" vinyl pressings, manufactured in our own pressing plant.
SPEEDY DELIVERY—COMPETITIVE PRICES
Leaflet available.

112 Beach Rd., Scratby, Gt. Yarmouth
Tel. Gt. Yarmouth 730136. Member A.P.R.S.

APPOINTMENTS WANTED

★**Help!!!** Keen, educated, musical guy, 19, trying to start recording engineering career, seeks any studio employment (London). Tel. 96 20316.

SITUATIONS VACANT

★**Maintenance Engineers**, with good audio engineering background, required by London sound studio. Practical studio experience advantageous, salary negotiable. Write Box No. 677. (Own maintenance staff have been advised of this advertisement.)

SOUND ENGINEER

Experienced man with high standards required in the public address and sound recording field, capable of organising and operating temporary P.A. systems covering conferences etc.—knowledge of electronics, tape editing and recording desirable. Smart appearance essential—reliable driver—salary negotiable.

Full written details to:

Managing Director,
Griffiths Hansen (Recordings) Ltd.,
12 Balderton Street, London W1Y 1TF

We have a vacancy for a young Service Engineer. This is a junior position, but a basic electronic knowledge and mechanical training would be preferred. Varied and interesting work. Contact:

Ivor J. Congdon, Edric Films Ltd.,
34-36 Oak End Way, Gerrards
Cross, Bucks.

Tel. Gerrards Cross 84646 and 86521



ASSISTANT FILM RECORDIST (DUBBING)

The duties involve assisting the film dubbing mixer in the provision of sound and musical effects for television films, operating the sound transfer equipment, and when necessary assisting the mobile sound recordists on location.

The successful candidate will have had some professional experience in film sound transfer and recording, a good technical knowledge of magnetic tape recording and an understanding of the principles of cinematography.

Based in Cardiff.

Salary: £1,683 rising to £2,148 p.a. (may be higher if qualifications exceptional) + cost of living threshold payments currently £62.55 p.a. Please write or telephone now for application form (enclosing addressed foolscap envelope and quoting reference 74.G.822ss) to Appointments Department, BBC, London W1A 1AA. Tel. 01-580 4468 Ext. 4619.

BBC WALES
CYMRU

WANTED

★**Lee Electronics.** The Tape Recorder and Hi-Fi Specialists wish to purchase good quality Tape and Hi-Fi equipment for cash. 400 Edgware Road, W.2. Phone PAD 5521.

★**A.K.G. D.202, D.202E1, D.224,** microphones. Also top quality boom stands. C. Bentley, 4 Newton Road, Sudbury, Suffolk.

★**Operational Recording Studio** requires room for expansion—any premises in the London area considered. Box No. 679 Studio Sound.

★**Bias Electronics** Stereo Transportable Recorder, 7:5/15. Medway Organs, 101 Canterbury Street, Gillingham, Kent. Tel. Medway 55888.

★**All Nagra Equipment** urgently required for cash. J. J. Francis (W.G.) Ltd., Manwood House, Matching Green, Harlow, Essex CM17 0RS. Tel. Matching 476.

★**Tannoy 15" monitor** golds and 15" monitor reds. 15 ohm with cross-overs with or without enclosures. Fair price paid. Box No. 679.

MISCELLANEOUS

★**Tape and Cassette Recorder Repairs** by Specialists. The Tape Recorder Centre, 82 High Holborn, London, W.C.1.

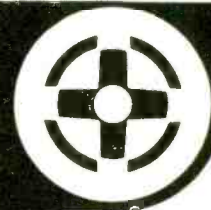

SALES EXECUTIVE

required to organise sales of new

TEKNIK

range of multi-track recorders and graphic equalisers. Applicants must have experience in selling high quality studio equipment to recording and broadcasting industries. Good salary and marvellous future with go-ahead company. Phone now for an early interview with **Philip Clarke**, Kidderminster 64027 or 63467

KLARK-TEKNIK LTD.

KEEP IN TOUCH WITH STUDIO SOUND 25p

Place a regular order with your Newsagent or take advantage of a POST FREE Annual Subscription

CLASSIFIED ADVERTISEMENTS ORDER FORM

Please use this coupon for your private sales and wants. Rates 8p per word. Box No's 20p extra.

To: *Studio Sound*, Classified Advertisements Dept., Link House, Dingwall Avenue, Croydon CR9 2TA. Please publish the advertisement indicated below for insertion/s under the heading

Name

Address

.....

Cheque/P.O. enclosed £

Is a Box No. required Yes/No. If no, please include remittance to cover name and address and/or Tel. No.

Please write in block capitals.

Link House Publications Ltd., Registered in England, No. 96948. Registered Office: 10/12 South Crescent, Store Street, London WC1E 7BG.

INDEX TO ADVERTISERS

Acoustico Enterprises Ltd. 13	Cologne International Trade Fair .. 7	Monks, Keith (Audio) Ltd. 31
Acoustical Manufacturing 15	Condor Electronics 14	Mustang Communications 16
Action Video 25	Duplitape 10	Naim Audio 8
Alice (Stancoil) Ltd. 31	Eagle International... .. 9	Neve, Rupert, & Co. Ltd... .. 39, 45
Allen & Heath 18	Electrosonic 4	Philips 17, 19
Allotrope Ltd. 65	Future Film Developments Ltd. .. 16	Revox 72
Amity 57	Grampian Reproducers Ltd. 12	R.E.W. Audio Visual Ltd. 20
A.P.R.S. 61	Industrial Tape Applications .. 5, 6, 16, 71	Scenic Sounds 59
Audio Design Recording 12	KJ Leisuresound Ltd. 21	Schlumberger 35
Audio Developments 22	Klark Teknik Inc. 51, 69	Sescom Inc. 8
Avcom 63	Lennard 18	Sound Techniques 63
Baileys 16	Lockwood 58	Stellavox 8
Bauch, F. W. O. Ltd. 23	Macinnes Labs Ltd. 14	Taylor Hutchinson Ltd. 27
Bias Electronics Ltd. 12	Magnegraph 18	Theatre Projects (Sound) Ltd. .. 10
Brenell Engineering Co. Ltd. 6	Magnetic Tapes Ltd. 7	Trident Audio Developments Ltd. .. 11
Cadac (London) Ltd. 2	M.C.I. 40, 41	Turner Electronic Industries Ltd. .. 22
		Zoot Horn 29

TEAC 4-CHANNEL INDUSTRIAL RECORDER

The complete mobile recording studio
4 totally independent channels.

Sel sync on all channels.
Mixing facilities 63dB signal to noise ratio.
Wide flat band width.

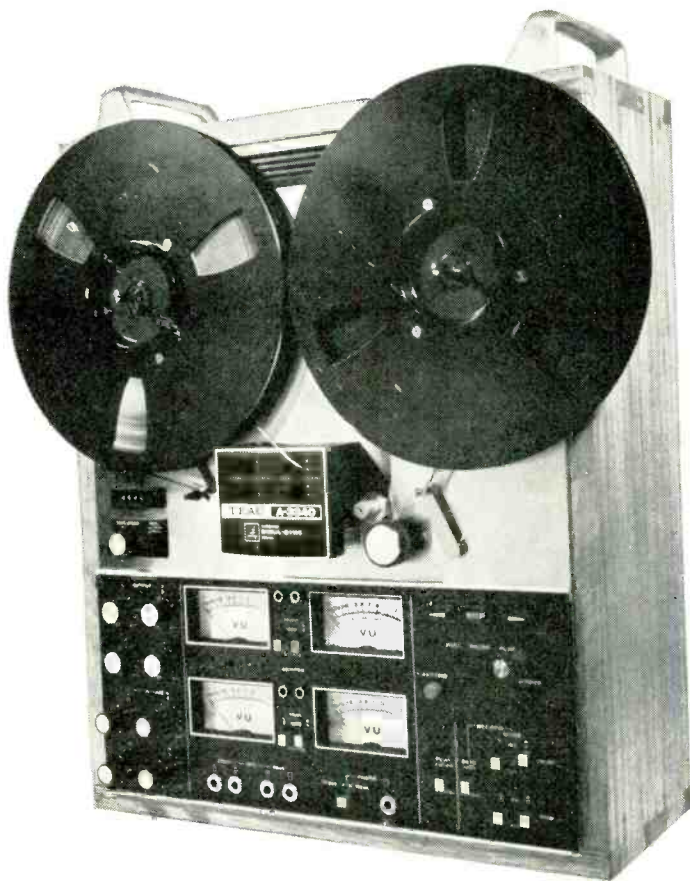

SOLE SUPPLIER

ITA 10-4 MODULAR MIXER

Ten inputs.
4 output groups.
4 limiters. Base, mid, treble EQ.
Balanced inputs.
Modular construction.
Headphone monitoring.

£590 + V.A.T.
IMMEDIATE DELIVERY



NOTE NEW ADDRESS~

ITA

Industrial Tape Applications
5 Pratt Street, London NW1 OAE. Tel: 01-485 6162 Telex: 21879

IF YOU DO ANYTHING WITH 1/4" TAPE, YOU CAN DO IT BETTER WITH REVOX

- Automated broadcast operations
- Scientific analysis
- On location mastering
- Tone or time changing
- Audio tape quality control
- Electronic music synthesis
- Noise analysis
- Film synchronization
- Radio telescope
- Language laboratory
- Machine tool control
- Phonetic analysis
- Radio telemetry
- Industrial research
- Information retrieval
- Electrocardiography
- Making calibration tapes
- Tape mastering with SELFSYNC
- Data storage from digital computers

And that's a simple statement of fact.

From the moment it was introduced, the Revox A77 was hailed as a recording instrument of unique quality and outstanding performance. The magazines were unanimous in their praise. Stereo Review summed it all up by saying, "We have never seen a recorder that could match the performance of the Revox A77 in all respects, and very few that even come close."

So much for critical opinion.

Of equal significance, is the fact that the Revox A77 rapidly found its way into many professional recording studios.

But what really fascinates us, is that the A77 has been singled out to

perform some unusual and highly prestigious jobs in government and industry. The kinds of jobs that require a high order of accuracy and extreme reliability.

Take NATO (the North Atlantic Treaty Organization) for example. When they wanted a machine to standardize on, a machine that would lend itself to use in a wide variety of circumstances. And most importantly, a machine that was simple to use, the logical choice was the Revox A77.

Or take the governmental agency that wanted an unfailingly reliable tape machine to register and record satellite bleeps. The choice? Revox.

Or the medical centers that use

specially adapted A77's for electrocardiographic recording.

We could go on and on (see accompanying list), but by now you probably get the point.

No other 1/4" tape machine combines the multi-functioned practicability, unfailing reliability, and outstanding performance of a Revox.

If you have a special recording problem that involves the use of 1/4" tape, write to us. We'll be happy to help you with it.

And if all you want is the best and most versatile recorder for home use, we'll be glad to tell you more about that too.



**REVOX
DELIVERS
WHAT ALL
THE REST
ONLY PROMISE.**

Revox at Lamb House, Church Street, Chiswick, London W4 2PB

Revox Corporation in USA: 155 Michael Drive, Syosset, NY 11791 and 3637 Cahuenga Boulevard West, Hollywood, California 90068

Revox Sales and Service in Canada.

For other countries: Revox International, Regensdorf 8105 ZH Althardstrasse 146, Switzerland